

1061701695-AO

ADVA® 1061701695 Compatible TAA 10GBase-CWDM XFP Transceiver (SMF, 1550nm, 40km, LC, DOM)

Features

- INF-8077i Compliance
- Duplex LC Connector
- Commercial Temperature 0 to 70 Celsius
- Single-mode Fiber
- Hot Pluggable
- Excellent ESD Protection
- Metal with Lower EMI
- RoHS Compliant and Lead Free



Applications

- 8x/10x Fibre Channel
- 10x Gigabit Ethernet over CWDM
- Access, Metro and Enterprise
- Mobile Fronthaul CPRI/OBSAI

Product Description

This ADVA® 1061701695 compatible XFP transceiver provides 10GBase-CWDM throughput up to 40km over single-mode fiber (SMF) using a wavelength of 1550nm via an LC connector. It is guaranteed to be 100% compatible with the equivalent ADVA® transceiver. This easy to install, hot swappable transceiver has been programmed, uniquely serialized and data-traffic and application tested to ensure that it will initialize and perform identically. Digital optical monitoring (DOM) support is also present to allow access to real-time operating parameters. This transceiver is Trade Agreements Act (TAA) compliant. We stand behind the quality of our products and proudly offer a limited lifetime warranty.

AddOn's transceivers are RoHS compliant and lead-free.

TAA refers to the Trade Agreements Act (19 U.S.C. & 2501-2581), which is intended to foster fair and open international trade. TAA requires that the U.S. Government may acquire only "U.S. – made or designated country end products."



Regulatory Compliance

- ESD to the Electrical PINs: compatible with MIL-STD-883E Method 3015.4
- ESD to the LC Receptacle: compatible with IEC 61000-4-3
- EMI/EMC compatible with FCC Part 15 Subpart B Rules, EN55022:2010
- Laser Eye Safety compatible with FDA 21CFR, EN60950-1& EN (IEC) 60825-1,2
- RoHS compliant with EU RoHS 2.0 directive 2015/863/EU

CWDM Available Wavelengths

Wavelengths	Min.	Typ.	Max.
47	1463.5	1471	1476.5
49	1483.5	1491	1496.5
51	1503.5	1511	1516.5
53	1523.5	1531	1536.5
55	1543.5	1551	1556.5
57	1563.5	1571	1576.5
59	1583.5	1591	1596.5
61	1603.5	1611	1616.5

Absolute Maximum Ratings

Parameter	Symbol	Min.	Typ.	Max.	Unit
Maximum Supply Voltage	Vcc3	-0.5		4.0	V
	Vcc5	-0.5		6.0	V
Storage Temperature	Ts	-40		85	°C
Operating Case Temperature	Tc	0		70	°C
Relative Humidity	RH	5		95	%
Data Rate		9.95		11.3	Gbps

Electrical Characteristics

Parameter	Symbol	Min.	Typ.	Max.	Unit	Notes
Power Supply Voltage	Vcc3	3.135	3.3	3.465	V	
	Vcc5	4.75	5.00	5.25	V	
Power Supply Current	Icc3			750	mA	
	Icc5			500	mA	
Power Dissipation	PD			3500	mW	
Transmitter						
Differential data input swing	V _{in,p-p}	120		1000	mVp-p	
Input differential impedance	Z _{in}		100		Ω	
Tx_Disable, P_Down/RST	V _{IH}	2.0		Vcc3+0.3	V	
	V _{IL}	-0.3		0.8	V	
Transmit Disable Assert Time				10	us	
Receiver						
Differential data output swing	V _{out, p-p}	340		850	mVp-p	1
Output differential impedance	Z _o		100		Ω	
Data Output Rise Time, Fall Time	t _r , t _f	24			ps	2
Rx_LOS, Mod_NR, Interrupt	V _{OH}	V _{CCHOST} -0.5		V _{CCHOST} +0.3	V	3
	V _{OL}	0		0.4	V	3

Notes:

1. Internally AC coupled, but requires an external 100Ω differential termination.
2. 20–80%.
3. Loss of Signal is an open collector output. Should be pulled up with a 4.7kΩ-10kΩ resistor on the host board.

Optical Characteristics

Parameter	Symbol	Min.	Typ.	Max.	Unit	Notes
Transmitter						
Launch Average Optical Power	P _O	-1		4	dBm	1
Center Wavelength Range	λ_c	1464.5		1617.5	nm	
Center Wavelength Tolerance	$\Delta\lambda_c$	-6.5		6.5	nm	
Extinction Ratio	EX	8.2			dB	2
Spectral Width (-20dB)	$\Delta\lambda$			0.3	nm	
Side Mode Suppression Ratio	SMSR	30			dB	
Dispersion Penalty @ 800ps/nm	DP			2	dB	2
Average Optical Power (Laser Off)	P _{OFF}			-30	dBm	1
Eye Diagram	ITU-T G.691 SDH STM S-64.2b compatible					2
Receiver						
Center Wavelength	λ_c	1460		1620	nm	
Receiver Sensitivity (P _{avg})	S			-16	dBm	3
Receiver Overload (P _{avg})	P _{OL}	-1.0			dBm	3
Optical Return Loss	ORL	27			dB	
LOS De-Assert	LOS _D			-20	dBm	
LOS Assert	LOS _A	-27			dBm	
LOS Hysteresis		0.5			dB	

Notes:

1. The optical power is launched into 9/125 μ m SMF.
2. Measured with a PRBS 2³¹-1 test pattern @ 9.953Gbps.
3. Average received power; BER less than 1E-12 and PRBS 231-1 test pattern.

Pin Descriptions

Pin	Logic	Symbol	Name/Descriptions	Notes
1		GND	Module Ground	1
2		VEE5	Optional -5.2V Power Supply - Not Required	
3	LVTTL-I	MOD_DESEL	Module De-select; When held low allows module to respond to 2-wire serial interface	
4	LVTTL-O	Interrupt	Interrupt; Indicates presence of an important condition which can be read via the 2-wire serial interface.	2
5	LVTTL-I	TX_DIS	Transmitter Disable; Turns off transmitter laser output	
6		VCC5	+5V Power Supply	
7		GND	Module Ground	1
8		VCC3	+3.3V Power Supply	
9		VCC3	+3.3V Power Supply	
10	LVTTL-I/O	SCL	2-Wire Serial Interface Clock.	2
11	LVTTL-I/O	SDA	2-Wire Serial Interface Data Line	2
12	LVTTL-O	MOD_Abs	Indicates Module is not present. Grounded in the Module.	2
13	LVTTL-O	MOD_NR	Module Not Ready; Indicating Module Operational Fault	2
14	LVTTL-O	RX_LOS	Receiver Loss of Signal Indicator	2
15		GND	Module Ground	1
16		GND	Module Ground	1
17	CML-O	RD-	Receiver Inverted Data Output	
18	CML-O	RD+	Receiver Non-Inverted Data Output	
19		GND	Module Ground	1
20		VCC2	+1.8V Power Supply (Not required).	
21	LVTTL-I	P_DOWN/RST	Power down; When high, requires the module to limit power consumption to 1.5W or below. 2-Wire serial interface must be functional in the low power mode. Reset; The falling edge initiates a complete reset of the module including the 2-wire serial interface, equivalent to a power cycle.	
22		VCC2	+1.8V Power Supply (Not required)	
23		GND	Module Ground	1
24	PECL-I	REFCLK+	Reference Clock Non-Inverted Input, AC coupled on the host board - Not Required	3
25	PECL-I	REFCLK-	Reference Clock Inverted Input, AC coupled on the host board – Not Required	3
26		GND	Module Ground	1
27		GND	Module Ground	1
28	CML-I	TD-	Transmitter Inverted Data Input	
29	CML-I	TD+	Transmitter Non-Inverted Data Input	
30		GND	Module Ground	1

Notes:

1. Module ground pins Gnd are isolated from the module case.
2. Shall be pulled up with 4.7KΩ to 10KΩ to a voltage between 3.15V and 3.45V on the host board.
3. Reference Clock is not required. If present, it will be ignored.

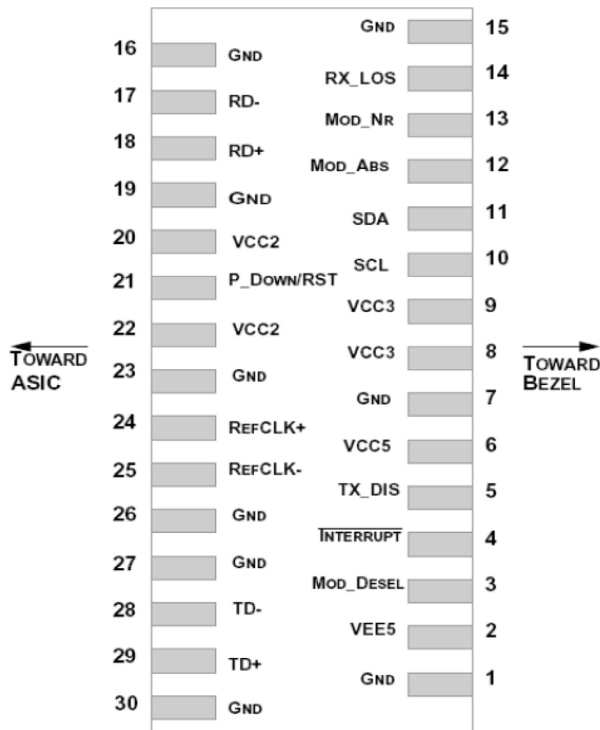

Pin-out of connector Block on Host board

Recommended Host Board Power Supply Filter Network

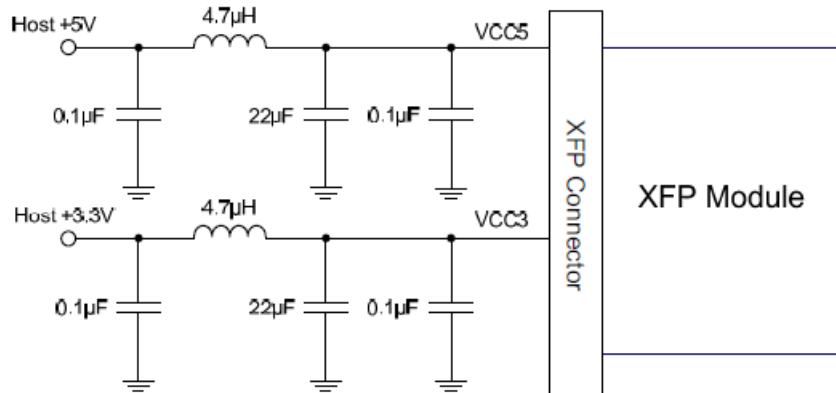

Recommended Application Interface Block Diagram



Mechanical Specifications



About AddOn Networks

In 1999, AddOn Networks entered the market with a single product. Our founders fulfilled a severe shortage for compatible, cost-effective optical transceivers that compete at the same performance levels as leading OEM manufacturers. Adhering to the idea of redefining service and product quality not previously had in the fiber optic networking industry, AddOn invested resources in solution design, production, fulfillment, and global support.

Combining one of the most extensive and stringent testing processes in the industry, an exceptional free tech support center, and a consistent roll-out of innovative technologies, AddOn has continually set industry standards of quality and reliability throughout its history.

Reliability is the cornerstone of any optical fiber network and is engrained in AddOn's DNA. It has played a key role in nurturing the long-term relationships developed over the years with customers. AddOn remains committed to exceeding industry standards with certifications from ranging from NEBS Level 3 to ISO 9001:2005 with every new development while maintaining the signature reliability of its products.

U.S. Headquarters

Email: sales@addonnetworks.com

Telephone: +1 877.292.1701

Fax: 949.266.9273

Europe Headquarters

Email: salesupportemea@addonnetworks.com

Telephone: +44 1285 842070