

The Palo Alto Networks logo, featuring a stylized orange and red icon to the left of the word "paloalto" in a lowercase, sans-serif font.

TECHDOCS

ION 9000 Hardware Reference

Contact Information

Corporate Headquarters:

Palo Alto Networks

3000 Tannery Way

Santa Clara, CA 95054

www.paloaltonetworks.com/company/contact-support

About the Documentation

- For the most recent version of this guide or for access to related documentation, visit the Technical Documentation portal docs.paloaltonetworks.com.
- To search for a specific topic, go to our search page docs.paloaltonetworks.com/search.html.
- Have feedback or questions for us? Leave a comment on any page in the portal, or write to us at documentation@paloaltonetworks.com.

Copyright

Palo Alto Networks, Inc.

www.paloaltonetworks.com

© 2020-2021 Palo Alto Networks, Inc. Palo Alto Networks is a registered trademark of Palo Alto Networks. A list of our trademarks can be found at www.paloaltonetworks.com/company/trademarks.html. All other marks mentioned herein may be trademarks of their respective companies.

Last Revised

September 3, 2021

Table of Contents

Before You Begin.....	5
Tamper Proof Statement.....	6
Third-Party Component Support.....	7
Product Safety Warnings.....	8
ION 9000 Overview.....	11
ION 9000.....	12
ION 9000 Ports.....	13
ION 9000 Front Panel with LEDs.....	14
ION 9000 Specifications.....	15
ION Device Compliance Statement.....	17
ION 9000 Installation Kit Components.....	19
Power on the ION 9000.....	20
Shut down the ION 9000.....	20
Reboot the ION 9000.....	20
Install the ION 9000.....	21
Rack Mount the ION 9000.....	22
Install the ION 9000 in Virtual In-Path Configuration.....	27
Configure Controller Port.....	27
Configure Peering Ports.....	28
Configure Internet Ports.....	29
Install ION 9000 in High Availability.....	30

Before You Begin

Read the following topics before you install or service a Palo Alto Networks® next-generation firewall or appliance. The following topics apply to all Palo Alto Networks firewalls and appliances except where noted.

- [Tamper Proof Statement](#)
- [Third-Party Component Support](#)
- [Product Safety Warnings](#)

Tamper Proof Statement

To ensure that products purchased from Palo Alto Networks were not tampered with during shipping, verify the following upon receipt of each product:

- The tracking number provided to you electronically when ordering the product matches the tracking number that is physically labeled on the box or crate.
- The integrity of the tamper-proof tape used to seal the box or crate is not compromised.
- The integrity of the warranty label on the firewall or appliance is not compromised.

Third-Party Component Support

Before you consider installing third-party hardware, read the [Palo Alto Networks Third-Party Component Support](#) statement.

Product Safety Warnings

To avoid personal injury or death for yourself and others and to avoid damage to your Palo Alto Networks hardware, be sure you understand and prepare for the following warnings before you install or service the hardware. You will also see warning messages throughout the hardware reference where potential hazards exist.



All Palo Alto Networks products with laser-based optical interfaces comply with 21 CFR 1040.10 and 1040.11.

The following safety warnings apply to all Palo Alto Networks firewalls and appliances, unless a specific hardware model is specified.

- When installing or servicing a Palo Alto Networks firewall or appliance hardware component that has exposed circuits, ensure that you wear an electrostatic discharge (ESD) strap. Before handling the component, make sure the metal contact on the wrist strap is touching your skin and that the other end of the strap is connected to earth ground.

French Translation: Lorsque vous installez ou que vous intervenez sur un composant matériel de pare-feu ou de dispositif Palo Alto Networks qui présente des circuits exposés, veillez à porter un bracelet antistatique. Avant de manipuler le composant, vérifiez que le contact métallique du bracelet antistatique est en contact avec votre peau et que l'autre extrémité du bracelet est raccordée à la terre.

- Use grounded and shielded Ethernet cables (when applicable) to ensure agency compliance with electromagnetic compliance (EMC) regulations.

French Translation: Des câbles Ethernet blindés reliés à la terre doivent être utilisés pour garantir la conformité de l'organisme aux émissions électromagnétiques (CEM).

- **(ION 7000 and ION 9000 only)** At least two people are recommended for unpacking, handling, and relocating the heavier firewalls.
- Do not connect a supply voltage that exceeds the input range of the firewall or appliance. For details on the electrical range, refer to electrical specifications in the hardware reference for your firewall or appliance.

French Translation: Veillez à ce que la tension d'alimentation ne dépasse pas la plage d'entrée du pare-feu ou du dispositif. Pour plus d'informations sur la mesure électrique, consulter la rubrique des caractéristiques électriques dans la documentation de votre matériel de pare-feu ou votre dispositif.

- WAN and LAN ethernet ports are suitable for interconnection to other local device ethernet ports. These ports are not designed for direct connection to Public Switched Telephone Network (PSTN) ports or interfaces. In addition, copper-based WAN ports, LAN ports, and copper-based modular transceivers are not rated to connect to Telecommunications Outside Plant (OSP) cabling.

- (Devices with serviceable batteries only) Do not replace a battery with an incorrect battery type; doing so can cause the replacement battery to explode. Dispose of used batteries according to local regulations.

French Translation: Ne remplacez pas la batterie par une batterie de type non adapté, cette dernière risquerait d'exploser. Mettez au rebut les batteries usagées conformément aux instructions.

- I/O ports are intended for intra-building connections only and not intended for OSP (Outside Plant) connections or any network connections subject to external voltage surge events.

<ul style="list-style-type: none">• 	<p>(All Palo Alto Networks appliances with two or more power supplies)</p> <p>Caution: Shock hazard</p> <p>Disconnect all power cords (AC or DC) from the power inputs to fully de-energize the hardware.</p> <p>French Translation: (Tous les appareils Palo Alto Networks avec au moins deux sources d'alimentation) Débranchez tous les cordons d'alimentation (c.a. ou c.c.) des entrées d'alimentation et mettez le matériel hors tension.</p>
---	--

ION 9000 Overview

Learn about Prisma SD-WAN Instant-On Network (ION) 9000 and plan your deployment.

- [ION 9000](#)
- [ION 9000 Ports](#)
- [ION 9000 Front Panel with LEDs](#)
- [ION 9000 Specifications](#)
- [ION Device Compliance Statement](#)
- [ION 9000 Installation Kit Components](#)
- [Power on the ION 9000](#)

ION 9000

Prisma SD-WAN ION 9000, designed for the data center, enables you to create a secure SD-WAN fabric across branches and data centers. It is designed to install seamlessly in the data center by peering with adjacent data center devices using traditional, standards-based routing protocols. Deploy the ION 9000 in an off-path model enabling elastic, non-disruptive scale-out and high availability (HA).

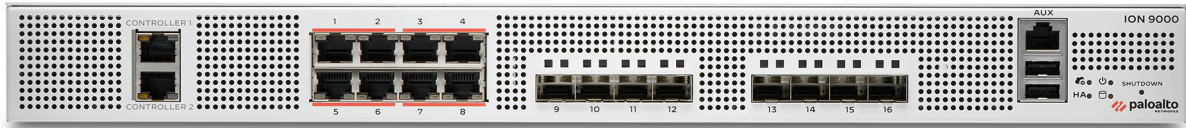

The ION 9000:

- Establishes connectivity to the data center network and exchanges routing information.
- Terminates virtual private networks (VPNs) for all Prisma SD-WAN deployed branch sites.
- Maintains path symmetry and ensures the best path for an application.
- Enables application Service Level Agreements (SLAs) and path selection in conjunction with branch ION devices.

ION 9000 Ports



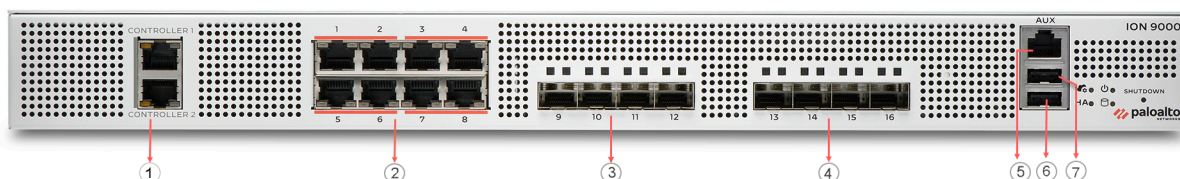









The ports on the ION 9000 are used as follows:



Item	Ports	Description
1	Controller Ports	This port is used by the ION device to communicate with the Prisma SD-WAN controller. By default, controller ports are DHCP enabled.
2	Fail-to-Wire Ports / Bypass Pairs	4 pairs - ports 1/2, 3/4, 5/6, 7/8.
3	SFP+ Ports	Ports 9 -12 support 10G SFP+ only.
4	SFP+ Ports	Ports 13 -16 support 1G SFP and 10G SFP+
5	AUX Port	This port is intended for offline access and configuration of an uninstalled system. The AUX port speed is 115200 bits/sec
6 and 7	USB Port	These ports are reserved for future use.

ION 9000 Front Panel with LEDs

The ION 9000 LEDs indicate the following:

Icons	Description
Displays power status 	Green light—Powered on.  Black light—Powered off. 
Displays Controller connectivity status 	Blue light—Connected.  No light—Not Connected.
Displays disk status 	Orange light (blinking)—Displays disk activity. 
HA LED 	Off—Not configured. Solid Green—Active with connected backup.  Green (blinking)—Active without backup.  Solid Red—Standby.  Red (blinking)—Failed. 

ION 9000 Specifications

The Prisma SD-WAN ION 9000 device specifications are described below:

Device Specifications	Description
Place in Network	Large and remote office data center.
I/O	
Controller ports	2 x 10/100/1000 RJ-45
WAN/LAN/Internet ports	<ul style="list-style-type: none"> 8 x 10 gigabit Ethernet SFP+ Ports 9 -12 support 10G SFP+ only, Ports 13 -16 support 1G SFP and 10G SFP+ 8x10 x 10/100/1000 RJ45 Port pairs 1/2, 3/4, 5/6, and 7/8 have programmable inline fail-to-wire capability for use in branch device mode
Throughput	
Encrypted IP throughput	Measured with 1400 byte packets - 15 Gbps (DC) 8 Gbps (Branch)
Power and Mechanical	
Type/Watts	1+1 Hot swappable redundant PSUs 450W AC
Power input	AC 100-240V @50-60Hz 6-3A
Fan cooling	4 x Hot Swappable cooling fans, direction of air-flow is from front to rear.
Certifications	
Certifications	IEC60950-1, cULus, FCC & CE Class A
Environmental	
Operating temperature	32°F to 104°F (0°C to 40°C)
Storage temperature	-40°F to 158°F (-40°C to 70°C)
Operating humidity	5% to 90% (non-condensing)
Storage humidity	5% to 95% (non-condensing)

Device Specifications	Description
Physical	
1RU standard 4-post rack space	Recommended
Weight	21.38lbs
Dimensions (D x W x H)	19.69" X 17.24" X 1.73"
Physical network connectivity	A single gigabit ethernet copper port with DHCP, and two or more gigabit or ten gigabit ports for other features.
BGP peers	Layer 2 connectivity to two separate network devices that are currently participating in any dynamic routing protocol (BGP, OSPF, EIGRP) with each other.
Internet connectivity	Used to reach the Prisma controller. This connectivity can be in the form of a private connection via a MPLS network through a corporate data center. It can also be a public internet connection provided via local a broadband connection.

ION Device Compliance Statement

The following compliance statements apply to this device:

- **VCCI**—This section provides the compliance statement for the Voluntary Control Council for Interference by Information Technology Equipment (VCCI), which governs radio frequency emissions in Japan.

The following information is in accordance to VCCI Class A requirements:

この装置は、クラスA情報技術装置です。この装置を家庭環境で使用する
と電波妨害を引き起こすことがあります。この場合には使用者が適切な対策
を講ずるよう要求されることがあります。 VCCI-A

Translation: This is a Class A product. In a domestic environment this product may cause radio interference, in which case the user may be required to take corrective actions.

- **UL**—Product Ambient Temperature: 0~40 degree C



Risk of explosion if battery is replaced by an incorrect type. Dispose of used battery according to local regulations.

- **CE (European Union (EU) Electromagnetic Compatibility Directive)**

This device is herewith confirmed to comply with the requirements set out in the Council Directive on the Approximation of the Laws of the Member States relating to Electromagnetic Compatibility Directive (2014/30/EU).

The above product conforms with Low Voltage Directive 2014/35/EU and complies with the requirements relating to electrical equipment designed for use within certain voltage limits.

- **Federal Communications Commission (FCC) statement for a Class A digital device or peripheral**—This equipment has been tested and found to comply with the limits for a Class A digital device, pursuant to Part 15 of the FCC Rules. These limits are designed to provide reasonable protection against harmful interference in a residential installation. This equipment generates, uses, and can radiate radio frequency energy and, if not installed and used in accordance with the instructions, may cause harmful interference to radio communications. However, there is no guarantee that interference will not occur in a particular installation. If this equipment does cause harmful interference to radio or television reception, which can be determined by turning the equipment off and on, the user is encouraged to try to correct the interference by one or more of the following measures.
 - Reorient or relocate the receiving antenna.
 - Increase the separation between the equipment and receiver.
 - Connect the equipment to an outlet on a circuit that is different from the one to which the receiver is connected.
 - Consult the dealer or an experienced radio/TV technician for help.

- **ICES (Canadian EMC Compliance Statement)**—This Class A digital apparatus complies with Canadian ICES-003.

French translation: Cet appareil numérique de la classe A est conforme à la norme NMB-003 du Canada.

- **Korean Communications Commission (KCC) Class A Statement**—This equipment is an electromagnetic compatible device for business purposes (Class A). The provider or user should be aware that the equipment is intended for use outside the home.

ION 9000 Installation Kit Components

The ION 9000 installation kit contains the following parts and tools to install the device:

- 2x 19-inch 1RU rack mount sliding rails built-in with quick-attach square hole adapters.
- 2x Mounting brackets with accompanying screws.
- 2x 19-inch slide lock ears with accompanying screws.
- 2x Red Cat.5E crossover/rollover ethernet cable.
- 1x Grey Cat.5E straight through ethernet cable.
- 2x Power cord—varies depending on the country or region.
- 1x Screwdriver.
- 1x USB to Cat5/RJ-45 serial cable.
- 2x Slide lock ears.
- Fitting pins.

Power on the ION 9000

Connect the power cables to the ION device and plug the device power cable into an AC power outlet. When you switch on the power, the device is powered on and the power indicator turns green.

After the device is powered on, [log in to the ION device through SSH](#) and assign a [static IP address using the console](#).

Shut down the ION 9000

Shut down the ION 9000 in the following ways:



Do not shut down the ION devices abruptly by pulling the power cord.

- **Shut down using the Device Toolkit commands**

Run the device toolkit command `debug shutdown` to shut down the device.



Ensure the device is physically accessible to turn it back on, before executing the command.

- **Shut down using the Power Switch**

Press the power switch 5 times (press and hold for 1 second, then, release) to shut down the device.

- **Shut down using a Python script**

Gracefully shut down a single ION device or multiple ION devices using a script.

First generate an API token and add it to `cloudgenix_settings.py` and then execute the command `./shutdown.py --serial <20-019291-9468>`. To shut down multiple devices, add the serial numbers of the ION devices as shown below:

```
./shutdown.py --serial 20-019291-9468
./shutdown.py --serial 20-019291-9469
./shutdown.py --serial 20-019291-9470
```

Reboot the ION 9000

Press the power switch 3 or 4 times to reboot the ION 9000.

Install the ION 9000

Deploy the Prisma SD-WAN ION 9000 in the following modes:

- [Rack Mount the ION 9000](#)
- [Install the ION 9000 in Virtual In-Path Configuration](#)
- [Install ION 9000 in High Availability](#)

Rack Mount the ION 9000

Rack mount the ION 9000 on a standard 19 inch rack with square holes:

STEP 1 | Attach the rack-mount brackets to the ION 9000

1. Unpack the installation kit and retrieve the rails.
2. Remove the chassis mounting brackets from the rails by extending the bracket out and sliding the bracket release button towards the front to fully withdraw it from the rails.

The ION 9000 uses the chassis mounting brackets to attach to the slide rails for mounting on the rack.

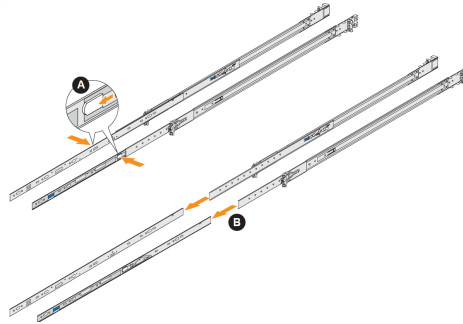

3. Attach the mounting brackets to both sides of the ION 9000.

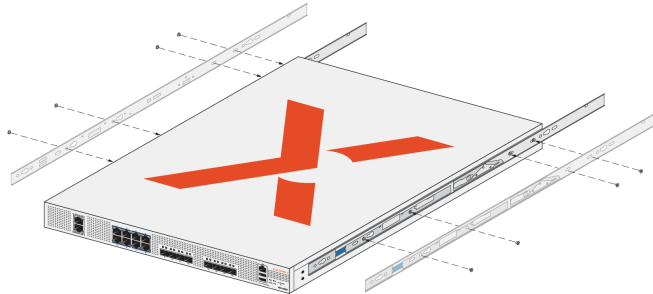

4. Retrieve the slide lock ears from the ION 9000 accessory kit.

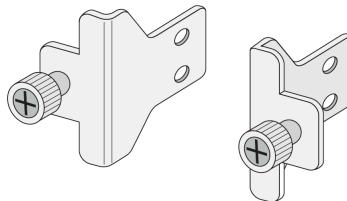

The slide lock ears attach to the front of the ION 9000 and lock the device in place in the rack.

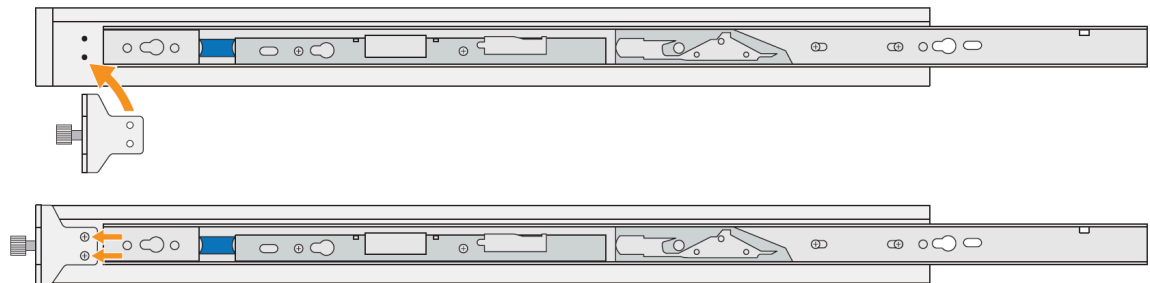

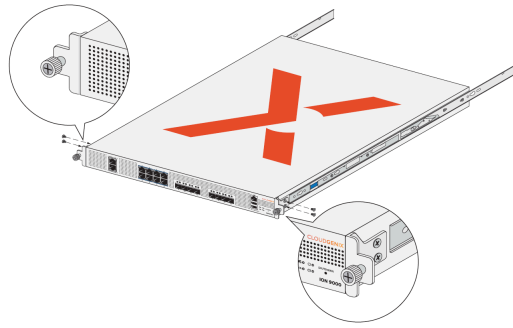

STEP 2 | Attach the slide rail to a standard 19-inch rack

1. Select a 1-RU slot to insert the slide rail to the rack.

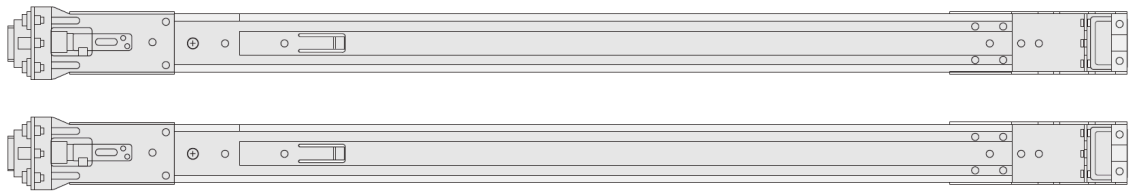

2. Align the rail end marked REAR to the rear side of the rack.

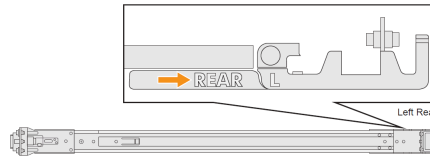

3. Insert the screws on the rails in the screw holes of the rack and ensure that the metal clasp secures the rails to the rack post.

 *If the screws are attached to the rails, do not detach the screws from the rails before inserting in the racks.*

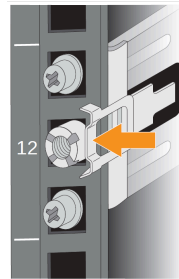

If the rack has threaded round holes:

1. Use fitting pins in the rack mounting kit and screw them through the rack holes.
2. Screw the fitting pins through the rails.
3. Attach the chassis-mounting brackets to either side of the ION 9000.
4. Slide the ION 9000 into the rack and confirm that the device is installed securely.

If the rack has unthreaded round holes:

1. Insert the rail behind the hole plate.
2. Secure the rail onto the mounting plates of the rack using screws from the installation kit.
3. Attach the chassis-mounting brackets to either side of the ION 9000.
4. Slide the ION 9000 into the rack and confirm that the device is installed securely.
4. On the front side of the racks, snap the rails in place by inserting the screws in the rack. Ensure that the spring retention clip is fully engaged, so that the rail is securely attached to the rack.

STEP 3 | Slide the ION 9000 into the rails

1. Align the mounting brackets on the ION 9000 with the slide rail slot and push the ION 9000 in.

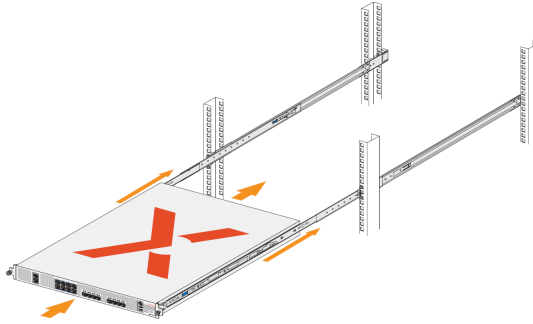

2. Slide the bracket release button on both the brackets and slide the ION 9000 into the rack until it clicks into place.

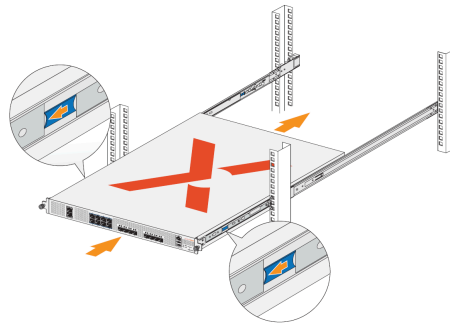

3. Secure the ION 9000 into the rails using the thumb screws on the slide lock ears.

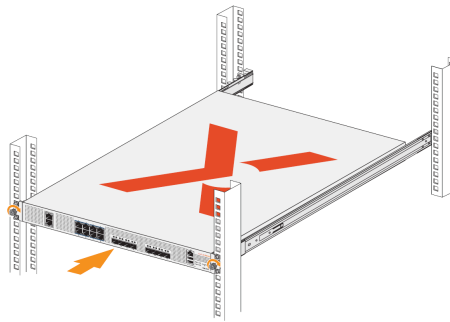

Install the ION 9000 in Virtual In-Path Configuration

The Prisma SD-WAN ION 9000 uses a virtual in-path configuration to allow the system to perform SD-WAN operations as it enters and exits the data center.

This mode of operation allows the ION 9000 cluster to:

- Solicit very specific traffic for specific endpoints using traditional network routing protocols.
- Require little or no changes in the existing data center network topology.
- Horizontally scale based on load and site number and geographic distribution.
- Seamlessly transition traffic to another ION 9000 or the legacy routing network, when there is a failure.

The following figure illustrates the virtual in-path deployment architecture of an ION 9000 data center.

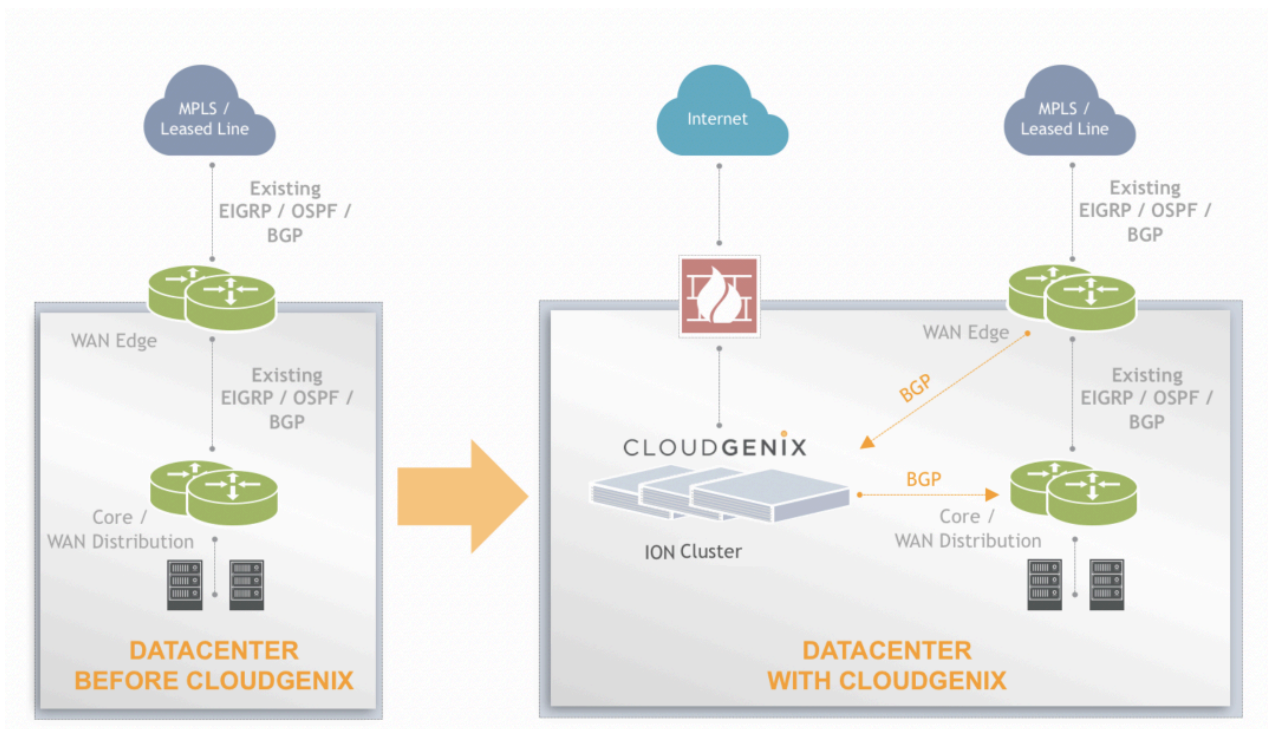

Configure the system with the following port types to set up the ION 9000 in a virtual in-path configuration:

- [Configure Controller Port](#)
- [Configure Peering Ports](#)
- [Configure Internet Ports](#)

Configure Controller Port

The Prisma SD-WAN ION 9000 uses the controller port to communicate with Prisma SD-WAN controller. By default, the controller port is configured for DHCP. However, if you want to set

a static IP or if there are no DHCP-enabled networks, access the console and set a [static IP](#) on Controller 1.

Connect the controller 1 port to a copper 1G ethernet port, similar to how client PC or Laptops are connected to a corporate network. Ensure that you allow outbound internet access on port 443 to enable communication between the controller port and the Prisma SD-WAN controller service.

After this, the port is connected and the ION 9000 powered on, the ION 9000 automatically connects and registers with the Prisma SD-WAN controller. After the registration, the ION 9000 is available for claiming and configuration in the Prisma SD-WAN console.

Configure Peering Ports

The Prisma SD-WAN ION 9000 uses the peering ports to communicate with WAN edge or core or WAN distribution routers via BGP. The routers may be connected using one physical port per router or multiple routers can share a single port by using a shared Layer 2 VLAN.

The below figure shows the peering port topologies of an ION 9000.

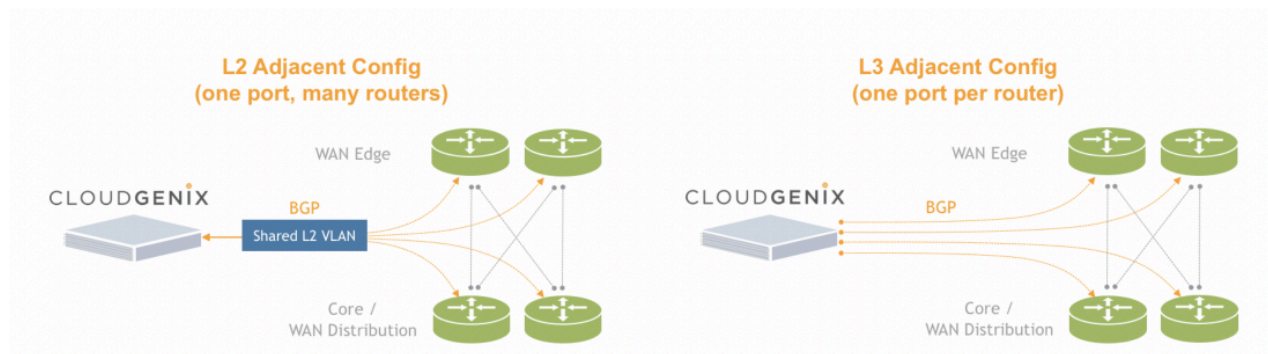

Depending on the number, type and choice of routers and Layer 2 or Layer 3 configurations, the number of peering ports required may vary. However, any non-controller port may be used for a peering port. These ports are set-up and identified at configuration time.

To pre-cable the peering ports before configuration:

1. Plan the type and the number of ION 9000 ports needed for peering configuration.
2. Physically plug in the ports from the ION 9000 devices to the appropriate routers or switches.
3. Record the ION port numbers and connecting router or switch port information for future reference.

Following are the various scenarios of HA deployments:

- [Branch HA with Internet, MPLS, and a Layer 3 LAN Switch](#)
- [Branch HA with Internet, MPLS, and a Layer 2 LAN Switch](#)
- [Branch HA with Dual Internet and a Layer 3 LAN Switch](#)
- [Branch HA with Dual Internet and a Layer 2 LAN Switch](#)
- [Branch HA for ION Devices without Bypass](#)

Configure Internet Ports

The Prisma SD-WAN ION 9000 uses the internet ports to receive inbound VPN connections from the internet. Typically, ION 9000 devices use one internet port per data center and this port must be able to receive traffic from the internet.

The internet port must specifically allow inbound UDP 4500 to the ION 9000 from remote ION devices. If a firewall or NAT is used outside the ION 9000 on this port, UDP 4500 needs to be port forwarded or passed-through from the firewall or NAT device.

To pre-cable the internet ports before configuration:

1. Plan the type and the number of ION 9000 ports needed for VPN configuration.
2. Physically plug in the ports from the ION 9000 devices to the appropriate devices.
3. Record the ION port numbers and connecting device port information for future reference.

Install ION 9000 in High Availability

The Prisma SD-WAN provides a horizontally-scalable, high availability (HA) solution between branch sites and data center clusters.

- STEP 1 |** Add a second ION 9000 to the data center that requires high availability (HA).
- STEP 2 |** Use the same ports to cable the second ION 9000.
- STEP 3 |** On the Prisma SD-WAN console, claim the ION device and assign it to the data center.

STEP 4 | Configure the ION device and confirm that it can talk to the core and WAN edge routers.

Ensure that the:

- The IP address for the controller port is unique for each ION device. Note that the controller port can be a part of the same subnet as the first ION device.
- The IP addresses for the core and WAN edge peering ports are unique for each ION device and their peering addresses are allocated a /29 or larger subnet block.
- The IP addresses for the internet ports are unique for each ION device.
- Finally, if NAT is configured, make sure that the NAT IP address or the NAT port is unique for each ION device.

 *There is no additional configuration required on the second ION device, except the IP addresses. Both the ION 9000 devices peer with the same core and WAN edge routers. The second ION device inherits the same BGP configuration as the first device.*

Sample physical and logical connectivity using two ION 9000 devices is illustrated below. Although the topology shows only a single core router and WAN edge router, you may use the same connectivity model in environments where there is more than one router.

The following image illustrates the physical connectivity for ION 9000 HA.

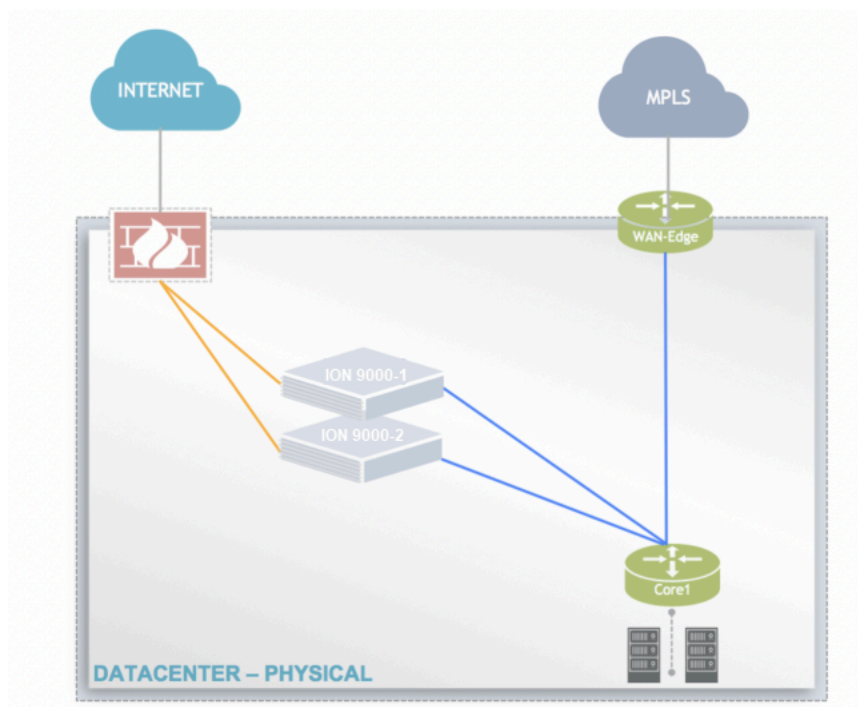

The following image illustrates the logical connectivity and IP addressing for the ION 9000 HA.

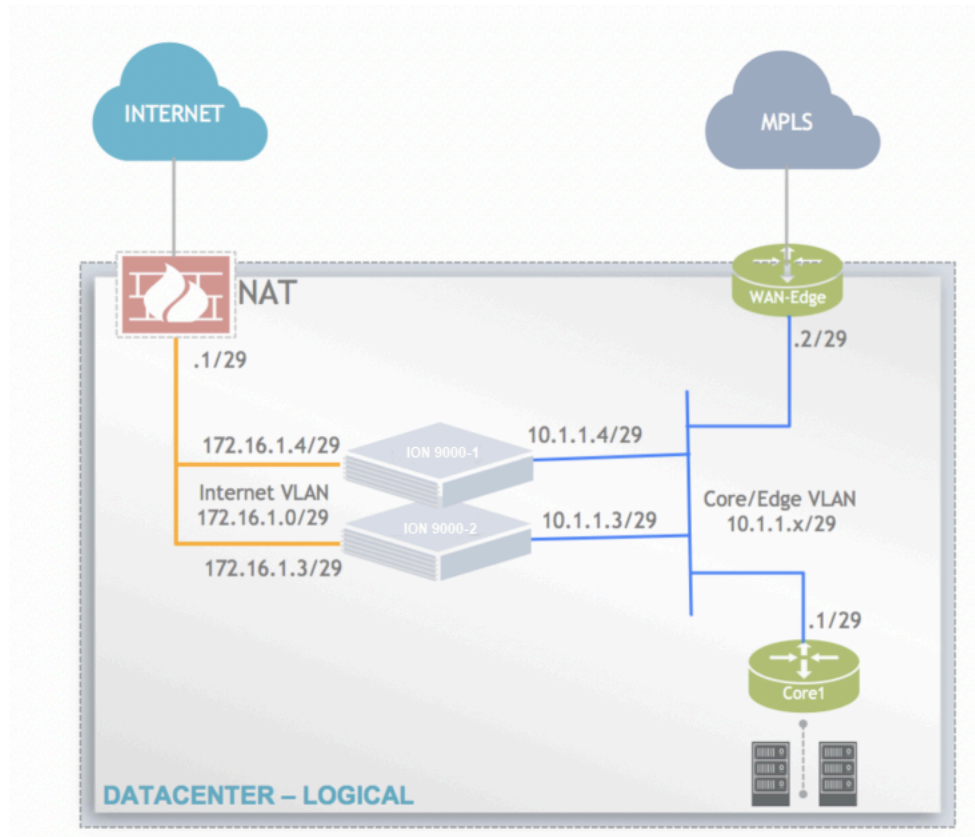

The following image illustrates the setting up BGP for ION 9000 HA.

