

## SFP-25GB-CW-27-10-J-AO

Juniper Networks® Compatible TAA 25GBase-CWDM SFP28 Transceiver (SMF, 1270nm, 10km, LC, DOM)

### Features

- SFF-8432 and SFF-8472 Compliance
- Duplex LC Connector
- Commercial Temperature 0 to 70 Celsius
- Single-mode Fiber
- Hot Pluggable
- Excellent ESD Protection
- Metal with Lower EMI
- RoHS Compliant and Lead Free



### Applications

- 25x Gigabit Ethernet over CWDM
- Access, Metro and Enterprise
- Mobile Fronthaul CPRI/OBSAI

### Product Description

This Juniper Networks® SFP28 transceiver provides 25GBase-CWDM throughput up to 10km over single-mode fiber (SMF) using a wavelength of 1270nm via an LC connector. It is guaranteed to be 100% compatible with the equivalent Juniper Networks® transceiver. This easy to install, hot swappable transceiver has been programmed, uniquely serialized and data-traffic and application tested to ensure that it will initialize and perform identically. Digital optical monitoring (DOM) support is also present to allow access to real-time operating parameters. We stand behind the quality of our products and proudly offer a limited lifetime warranty.

AddOn's transceivers are RoHS compliant and lead-free.

TAA refers to the Trade Agreements Act (19 U.S.C. & 2501-2581), which is intended to foster fair and open international trade. TAA requires that the U.S. Government may acquire only "U.S. – made or designated country end products."

## Regulatory Compliance

- ESD to the Electrical PINs: compatible with MIL-STD-883E Method 3015.4
- ESD to the LC Receptacle: compatible with IEC 61000-4-3
- EMI/EMC compatible with FCC Part 15 Subpart B Rules, EN55022:2010
- Laser Eye Safety compatible with FDA 21CFR, EN60950-1& EN (IEC) 60825-1,2
- RoHS compliant with EU RoHS 2.0 directive 2015/863/EU

## Absolute Maximum Ratings

Parameter	Symbol	Min.	Typ.	Max.	Unit	Notes
Maximum Supply Voltage	Vcc	-0.5		4.0	V	1
Storage Temperature	Tstg	-40		85	°C	2
Operating Case Temperature	Tc	0		70	°C	3
Data Rate	DR		24.3	26.5	Gb/s	4
Bit Error Rate	BER			5×10 <sup>-5</sup>		5

### Notes:

1. For Electrical power interface.
2. Ambient Temperature.
3. Case Temperature.
4. IEEE 802.3cc.
5. Measured with data rate at 25.78GBps, PRBS 2<sup>31</sup> – 1.

## Electrical Characteristics

Parameter	Symbol	Min.	Typ.	Max.	Unit	Notes
Power Supply Voltage	Vcc	3.14	3.3	3.46	V	
Module Supply Current	Icc		220	450	mA	1
<b>Transmitter</b>						
Input Differential Impedance	RIN		100		Ω	
Differential Data Input Swing	VIN, pp	250		900	mV	
Transmit Disable Voltage	Vd	2		Vcc	V	
Transmit Enable Voltage	Ven	Vee		Vee+0.8	V	
<b>Receiver</b>						
Differential Data Output Swing	Vout_pp	300		850	mV	
LOS Assert	Vlos_a	2		Vcc_host	V	
LOS De-Assert	Vlos_d	Vee		Vee+0.8	V	

### Notes:

1. For electrical power interface.

## Optical Characteristics

Parameter	Symbol	Min.	Typ.	Max.	Unit	Notes
<b>Transmitter</b>						
Output Optical Power	P <sub>tx</sub>	2	4.5	7	dBm	1
Optical Center Wavelength	$\lambda_c$	$\lambda_c - 6.5$	$\lambda_c$	$\lambda_c + 6.5$	nm	2
Transmitter and Dispersion Penalty	TDP			2.7	dB	
Extinction Ratio	ER	3.5			dB	
Spectral Width(-20dB)	$\Delta\lambda$			1	nm	
Side Mode Suppression Ratio	SMSR	30			dB	
Transmitter Reflectance				12	dB	
Launch Power of OFF Transmitter	P <sub>out_off</sub>			-30	dBm	1
<b>Receiver</b>						
Optical Center Wavelength	$\lambda_c$	1260		1390	nm	
Receive Overload	Pol	2			dBm	
Receiver Sensitivity (OMA)@ 25.78 Gbps	R <sub>x_sen</sub>			-13.3	dBm	3
Receiver Reflectance	TR <sub>rx</sub>			-26	dB	
LOS Assert	LOSA	-30			dBm	
LOS De-Assert	LOSD			-14	dBm	
LOS Hysteresis	LOSH	0.5			dB	

### Notes:

1. Average.
2.  $\lambda_c = 1271, 1291, 1311, 1331, 1351, 1371$ .
3. Average optical power, measured with data rate at 25.78Gbps, PRBS  $2^{31} - 1$ .

## Pin Descriptions

Pin	Symbol	Name/Descriptions	Notes
1	VeeT	Transmitter Ground. Common with receiver ground.	1
2	TX_Fault	Transmitter Fault.	2
3	TX_Disable	Transmitter Disable. Laser output disables on high or open.	3
4	SDA	Two wire serial interface Data Line.	4
5	SCL	Two wire serial interface Clock Line.	4
6	MOD_ABS	Module Absent. Grounded within the module.	4
7	RS0	No connection required.	
8	LOS	Loss of signal indication. Logic 0 indicated normal operation.	5
9	RS1	No connection required.	1
10	VeeR	Receiver Ground. Common with transmitter ground.	1
11	VeeR	Receiver Ground. Common with transmitter ground.	1
12	RD-	Receiver Inverted DATA out. AC coupled.	
13	RD+	Receiver Non-Inverted DATA out. AC coupled.	
14	VeeR	Receiver Ground. Common with transmitter ground.	1
15	VccR	Receiver power supply.	
16	VccT	Transmitter power supply.	
17	VeeT	Transmitter ground. Common with receiver ground.	1
18	TD+	Transmitter Non-Inverted Data in. AC coupled.	
19	TD-	Transmitter Inverted Data in. AC coupled.	
20	VeeT	Transmitter Ground. Common with receiver ground.	1

### Notes:

1. Circuit ground is isolated from chassis ground.
2. TX\_Fault is the open collector output and should be pulled up with 4.7k $\Omega$ -10k $\Omega$  on host board to a voltage between 2V and Vcc+0.3V.
3. Disables: T<sub>DIS</sub>>2V or open, Enabled T<sub>DIS</sub><0.8V.
4. Should be pulled up with 4.7k $\Omega$ -10k $\Omega$  on host board to a voltage between 2V and Vcc+0.3V.
5. LOS is open collector output and should be pulled up with 4.7k $\Omega$ -10k $\Omega$  on host board to a voltage between 2V and Vcc0.3V, the logic "0" indicated normal operation, and the logic "1" indicates that the receiver signal is lost.

## Block Diagram of Transceiver

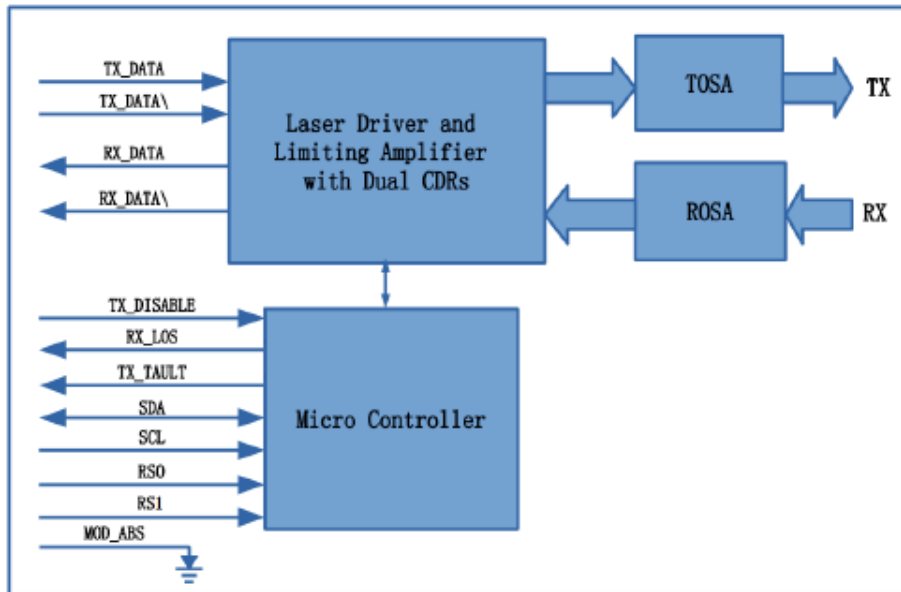

## Electrical Pad Layout

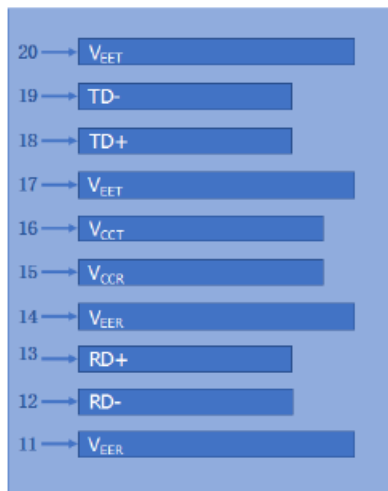

Top of Board

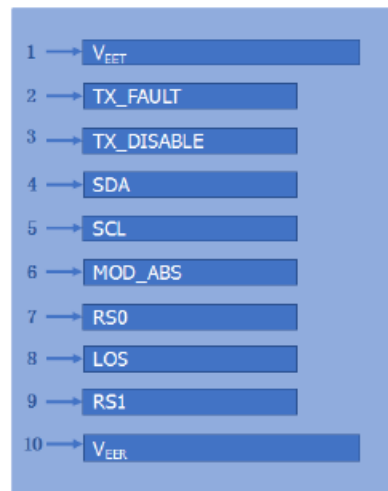
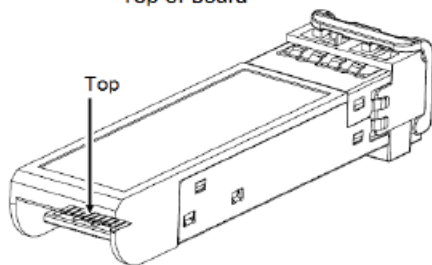

Bottom of Board

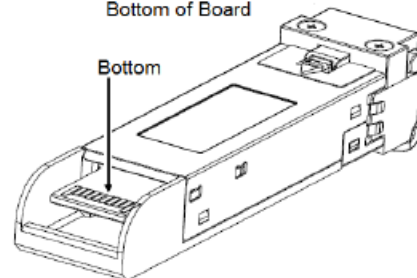

## Mechanical Specifications

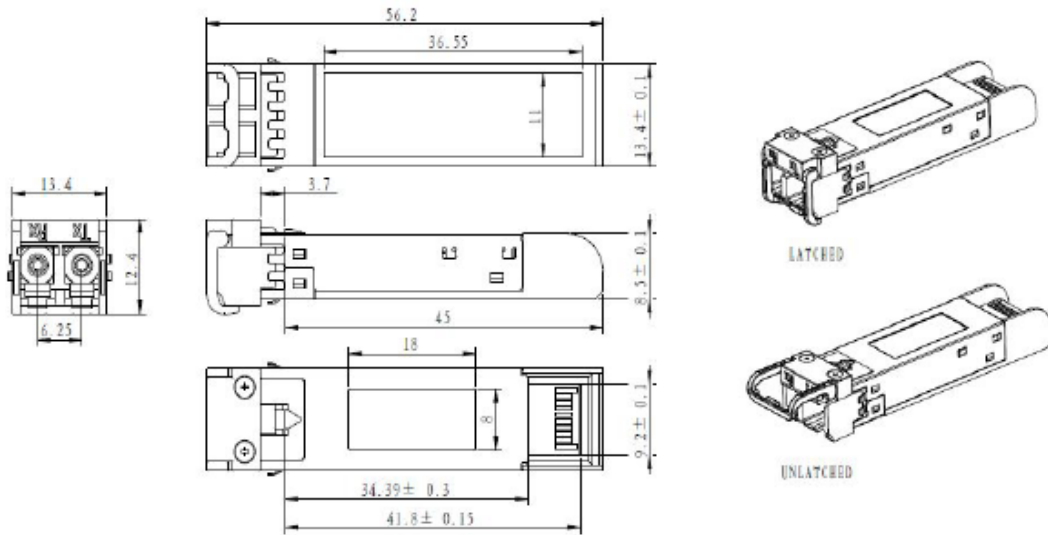

## Typical Eye Diagram

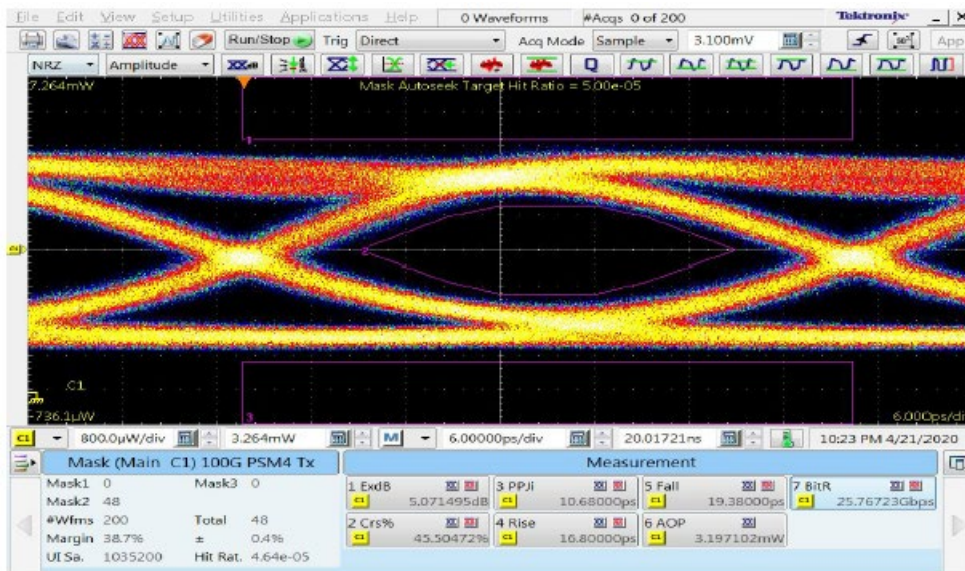

## **About AddOn Networks**

In 1999, AddOn Networks entered the market with a single product. Our founders fulfilled a severe shortage for compatible, cost-effective optical transceivers that compete at the same performance levels as leading OEM manufacturers. Adhering to the idea of redefining service and product quality not previously had in the fiber optic networking industry, AddOn invested resources in solution design, production, fulfillment, and global support.

Combining one of the most extensive and stringent testing processes in the industry, an exceptional free tech support center, and a consistent roll-out of innovative technologies, AddOn has continually set industry standards of quality and reliability throughout its history.

Reliability is the cornerstone of any optical fiber network and is engrained in AddOn's DNA. It has played a key role in nurturing the long-term relationships developed over the years with customers. AddOn remains committed to exceeding industry standards with certifications from ranging from NEBS Level 3 to ISO 9001:2005 with every new development while maintaining the signature reliability of its products.

## **U.S. Headquarters**

Email: [sales@addonnetworks.com](mailto:sales@addonnetworks.com)

Telephone: +1 877.292.1701

Fax: 949.266.9273

## **Europe Headquarters**

Email: [salesupportemea@addonnetworks.com](mailto:salesupportemea@addonnetworks.com)

Telephone: +44 1285 842070