

Acer Chromebook
R857T/R857TN/R857LT/R857LTN/R857T-TCO/
R857TN-TCO/R857LT-TCO/R857LTN-TCO
Rudriks_TKN

LIFECYCLE EXTENSION GUIDE

Self-Repair 1-1
Disassembly Procedures 1-2
Electronic Boards Diagrams 1-30
Troubleshooting 1-31
Exploded Diagrams 1-43
FRU List 1-46
Software Update 1-57
Factory Reset your Chromebook 1-58
Shimless RMA 1-59

Self-Repair

This chapter offers limited customer self-repair capabilities.

Prior performing self-repair, familiarize yourself with the Safety Guidelines and Recommended Equipment sections first as described in the chapter "[Disassembly Procedures](#)".

Due to the complexity of circuit boards, electronic components which are embedded to the motherboard or daughterboard(s) are strongly not advised to self-repair.

⇒ **NOTE:**

Before handling components, wear anti-static gloves to avoid damaging them due to static electricity.

⇒ **NOTE:**

For replacement parts, always use only Acer certified components in order to safeguard quality, optimum system performance, stability and reliability of the product.

⇒ **NOTE:**

Any damage to the product that occur during self-repair, or which has occurred as a result of a careless or unsuccessful self-repair attempt, is not covered by the standard product warranty.

Disassembly Procedures

Safety Guidelines

This chapter contains step by step procedures on how to remove and de-install components from the computer. Use these safety guidelines to ensure your personal safety. Each procedure included in this chapter assumes that you are preparing your computer for recycling and disposal. **By performing any of these procedures you acknowledge that any remaining warranty applicable to your computer will be voided if any damage is done to the unit or components during the repair. Before you start any of the procedures in this chapter, make sure to read the following safety guidelines and the respective instructions within the chapter.**

CAUTION!

- Turn off your computer and disconnect all power sources before opening the computer cover or panels.
- To avoid electrostatic discharge, ground yourself by using a wrist grounding strap or by periodically touching an unpainted metal surface at the same time as touching a connector on the back of the computer.
- Take off any metal objects on your arms or fingers such as bracelets, rings or watches and make sure your hands are completely dry. Even if your unit is unplugged, there may still be some remaining electric charge.
- If a component does not come out easily, do not forcefully remove it. Instead, check that you are removing it correctly and that no wires or other parts are in the way.
- When you disconnect a cable, pull on its connector or on its pull-tab, not on the cable itself. Some cables have connectors with locking tabs; if you are disconnecting this type of cable, press in on the locking tabs before you disconnect the cable.

Recommended Equipment

The following equipment are recommended to do the following maintenance procedures:

- Wrist grounding strap and conductive mat
- Flat screwdriver
- Philips screwdriver
- Polydrive screwdriver
- Plastic tweezers
- Flat plastic pry

WEEE Annex VII Component

These components are classified as requiring selective treatment:

- Battery pack
- Touchpad module
- LTE module
- Mainboard
- LTE board
- LCD panel

Pre-disassembly Instructions

Do the following prior to starting any maintenance procedures:

1. Place the system on a stable work surface.
2. Remove the power adapter from the USB Type-C port (A) as shown in [Figure 1-1](#) or from the USB-C port (B) as shown in [Figure 1-2](#).
3. Remove all cables from the system.

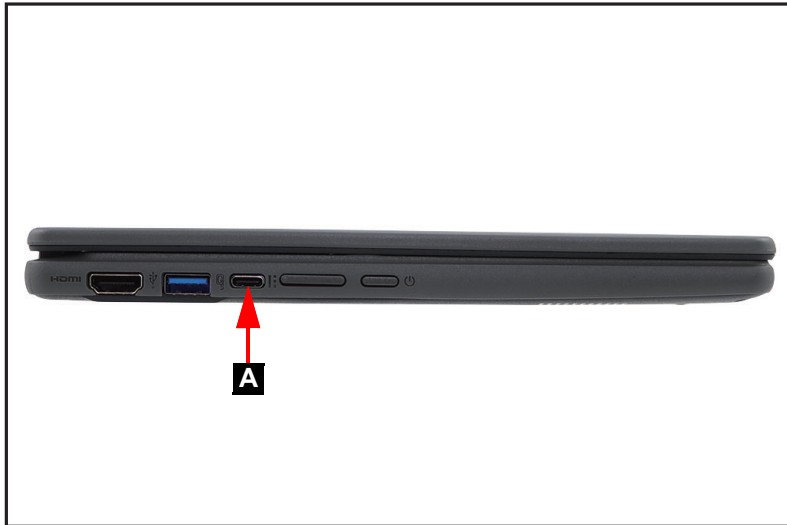

Figure 1-1. Adapter Outlet

4. Remove the stylus from the stylus slot (C) (Figure 1-2).
5. Insert the eject tool into the hole on the SIM card tray (D). Then push to eject the card tray and remove the SIM card (LTE SKU only) (Figure 1-2).

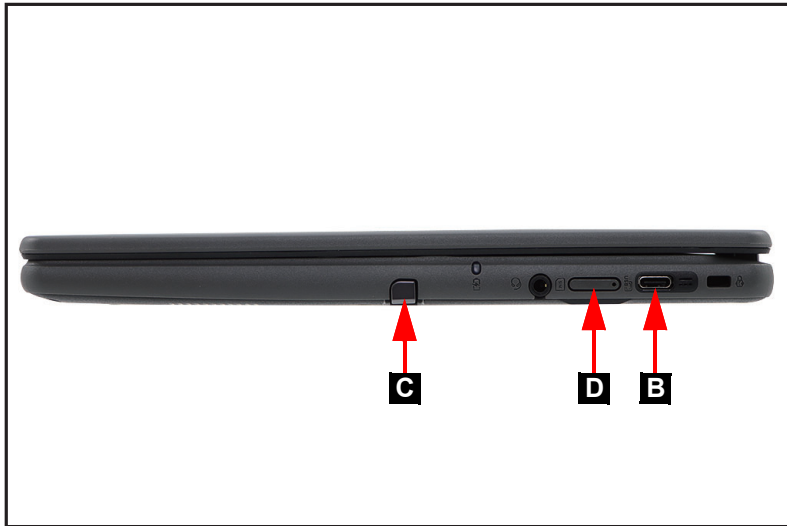

Figure 1-2. Adapter Outlet & Stylus and SIM Card Removal

⇒ **NOTE:**

Make sure the system is completely powered off.

3. Grasp and remove the base cover from the system (Figure 1-5).



Figure 1-5. Base Cover Removal

Battery Pack Removal

Prerequisite:

Base Cover Removal

1. Detach the tape (A) securing the battery cable connection (Figure 1-6).

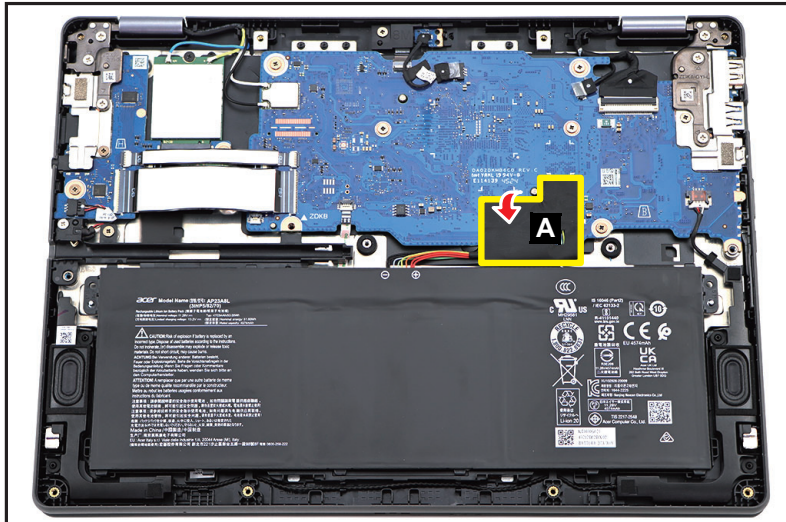

Figure 1-6. Battery Pack Removal

2. Disconnect the battery cable from the mainboard connector (B) (Figure 1-7).

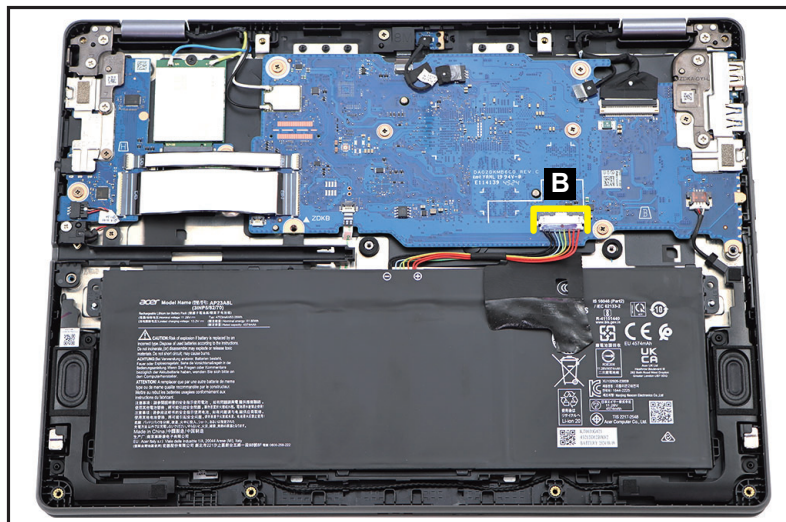

Figure 1-7. Battery Pack Removal

3. Lift to release the battery pack (C) from the guide pins (D) (Figure 1-8). Then remove the battery pack from the top assembly.

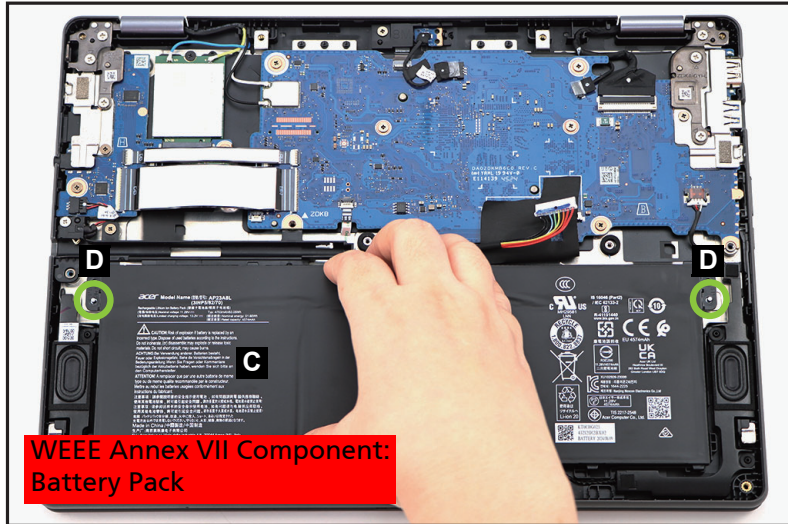





Figure 1-8. Battery Pack Removal

- + **IMPORTANT:** Follow local regulations for battery disposal.

Keyboard Removal

Prerequisite:

Disconnect the power source, and then enter the **Shipping Mode** by the following SOP if the **Refresh**  and **Power**  keys remain work.

1. Hold the **Refresh**  and **Power**  keys at the same time.
2. While holding these keys, remove the power cable from the device and then release the keys. The device should shut down and remain off.
3. Verify that the battery has been properly disconnected by the pressing the **Power** key. The device should not be powered on.

If the keyboard keys fail to function to enable the **Shipping Mode**, remove the battery pack to disconnect the power source.

Attention!

Before removing or installing the keyboard, **make sure to complete the Power Down Procedure** (Enter **Shipping Mode** SOP) to avoid damaging the Chromebook.

1. Carefully flip the top assembly and place it on the surface with the keyboard side facing up (Figure 1-9).
2. Using a flat-headed tool, carefully pry to disengage the bottom side latches of the keyboard (A) as shown in Figure 1-9.



Figure 1-9. Keyboard Removal

- Carefully lift the bottom part of the keyboard to release it from the top assembly (Figure 1-10). The upper latches will automatically disengage as you release the keyboard.



Figure 1-10. Keyboard Removal

- Detach the tape (B) securing the keyboard FPC (Figure 1-11).

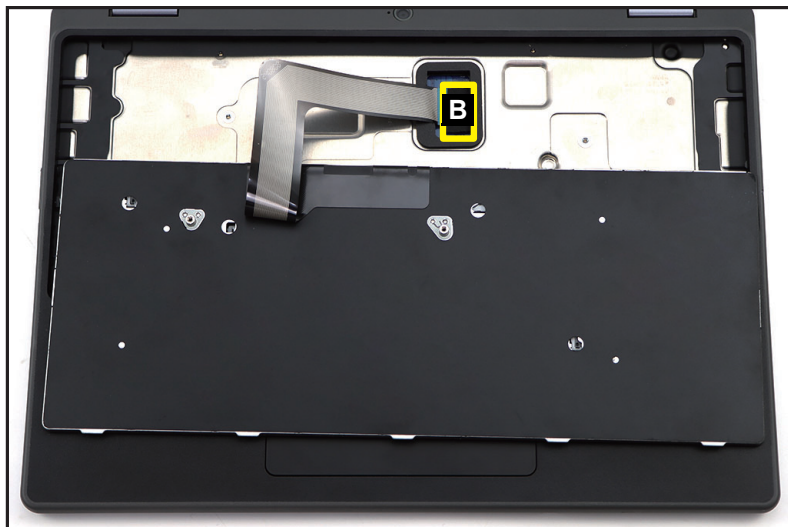

Figure 1-11. Keyboard Removal

5. Disconnect the keyboard FPC from the mainboard connector (C) (Figure 1-12). Then remove the keyboard.

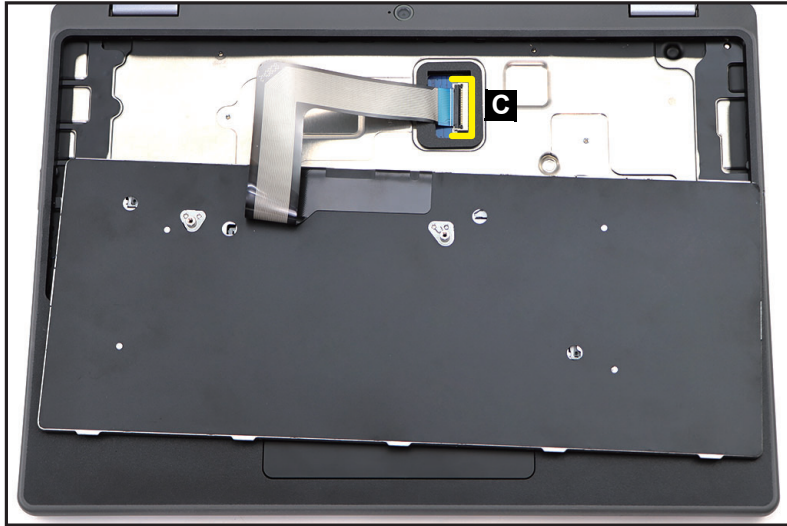

Figure 1-12. Keyboard Removal

⚠ CAUTION:

Keyboard FPC (Flexible Printed Circuit) can be damaged if removed while the mainboard connector is locked.

Touchpad Module Removal

Prerequisite:

Battery Pack Removal

1. Detach the mylar (A) securing the touchpad FFC connection ([Figure 1-13](#)).

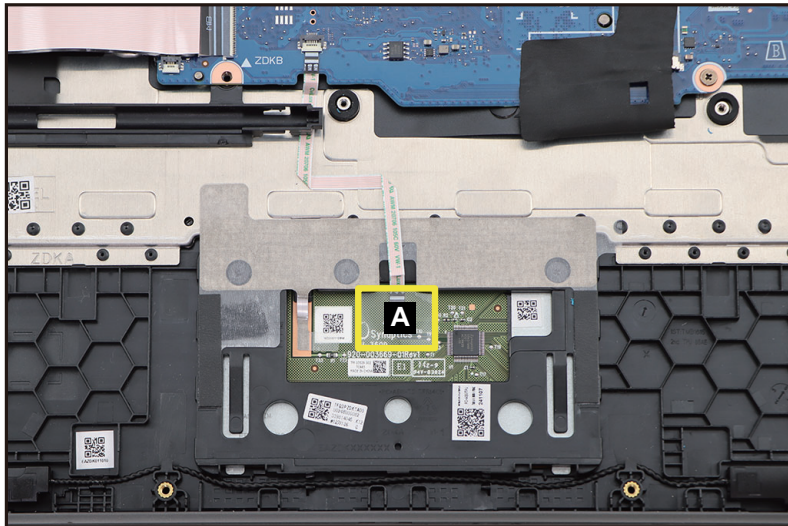

Figure 1-13. Touchpad Module Removal

2. Disconnect the touchpad FFC (B) from the touchpad module and mainboard connectors (Figure 1-14).
3. Pull the upper portion of the touchpad FFC to release the FFC from the stylus holder. Then carefully detach the touchpad FFC from its underneath adhesive (highlighted with the yellow lines) and remove the touchpad FFC (Figure 1-14).

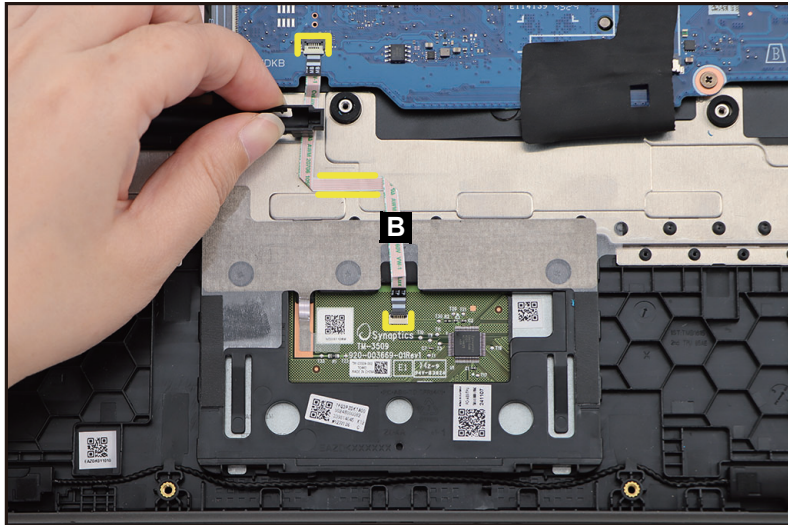

Figure 1-14. Touchpad Module Removal

⚠ CAUTION:

Touchpad FFC (Flexible Flat Circuit) can be damaged if removed while the mainboard and touchpad module connectors are locked.

4. Gently peel off the conductive tape with mylar (C) from the touchpad module and top assembly (Figure 1-15).

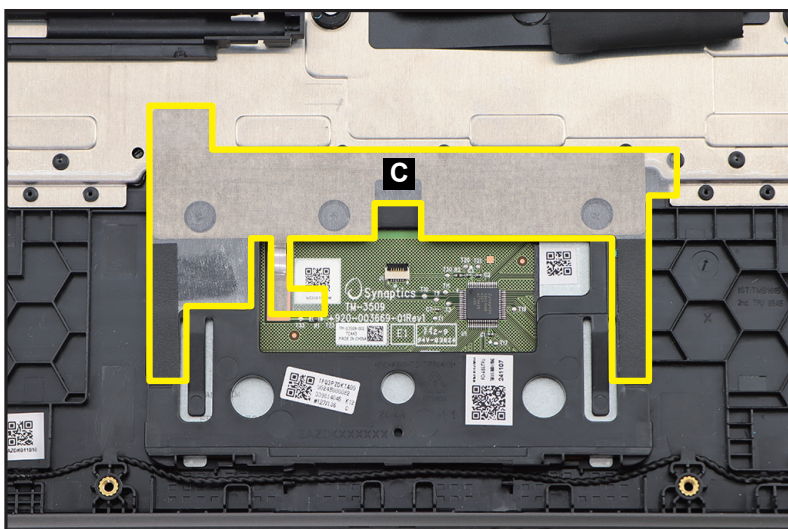

Figure 1-15. Touchpad Module Removal

5. Remove three (3) screws securing the touchpad module (Figure 1-16).

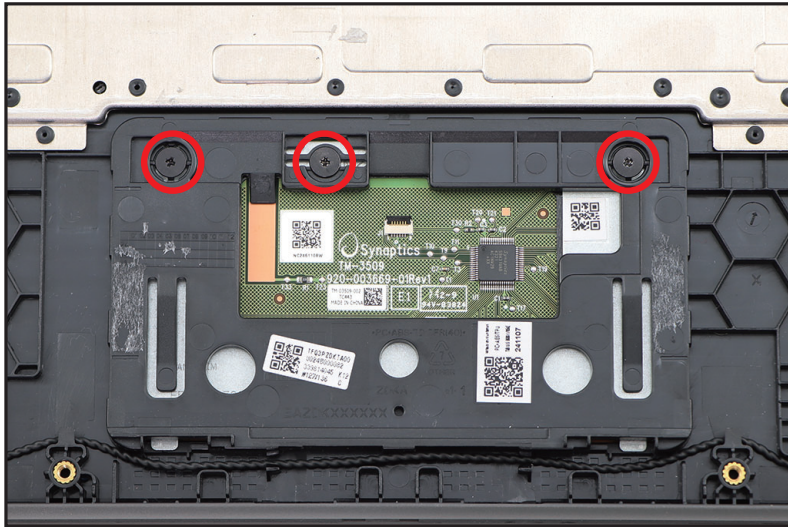

Figure 1-16. Touchpad Module Removal

6. Using the screwdriver, push the guide pins (D) firmly to release them from the top assembly (Figure 1-17).
7. Slide the touchpad module (E) slightly to disengage it from the bottom latches (F), and then remove the touchpad module from the top assembly (Figure 1-17).

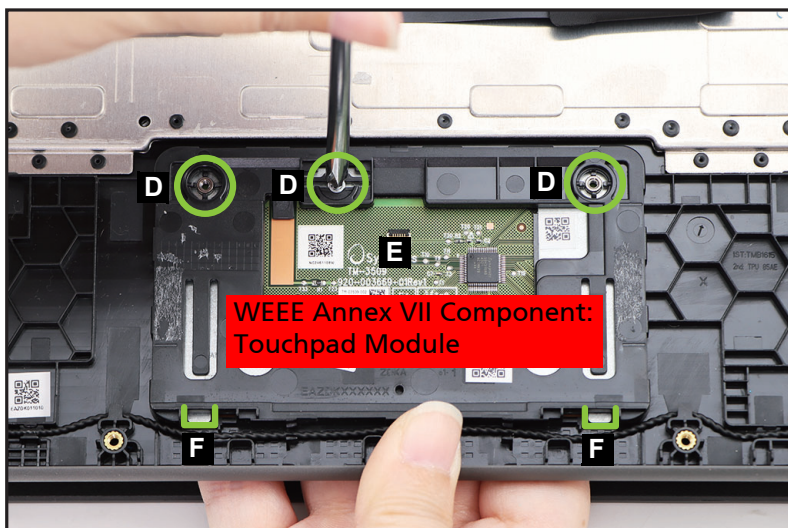

Figure 1-17. Touchpad Module Removal

LCD Module Removal

Prerequisite:

Battery Pack Removal

⇒ NOTE:

Please take note that the LCD cable includes the LCD panel cable, camera cable, touch control cable, and G-sensor cable.

1. Disconnect the WLAN antennas cables from the WLAN module connectors (A) (Figure 1-18).
2. Disconnect the LTE antennas cables from the LTE module connectors (B). Then unroute the antennas cables from the cable guides as shown in Figure 1-18.

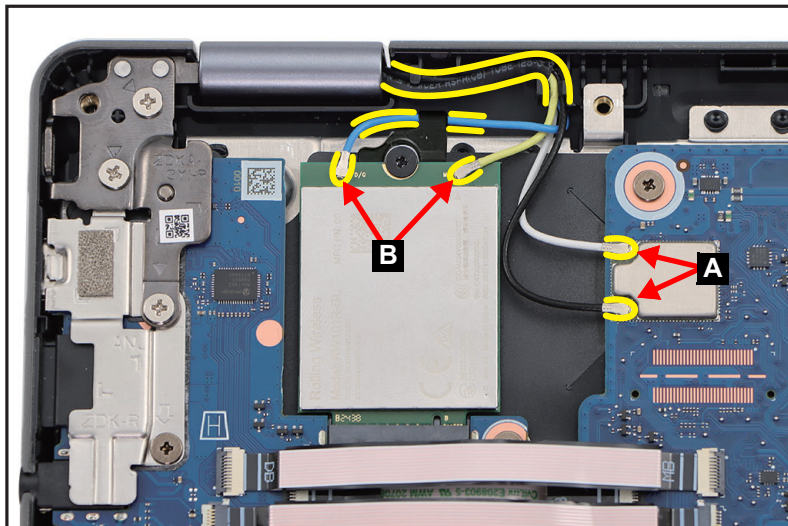

Figure 1-18. LCD Module Removal

3. Detach the mylar (C) securing the LCD cable connection. Then disconnect the cable from the mainboard connector (G-sensor) (D) (Figure 1-19).
4. Disconnect another LCD cable from the mainboard connector (E). Then unroute the cable from the cable guides as shown in Figure 1-19.

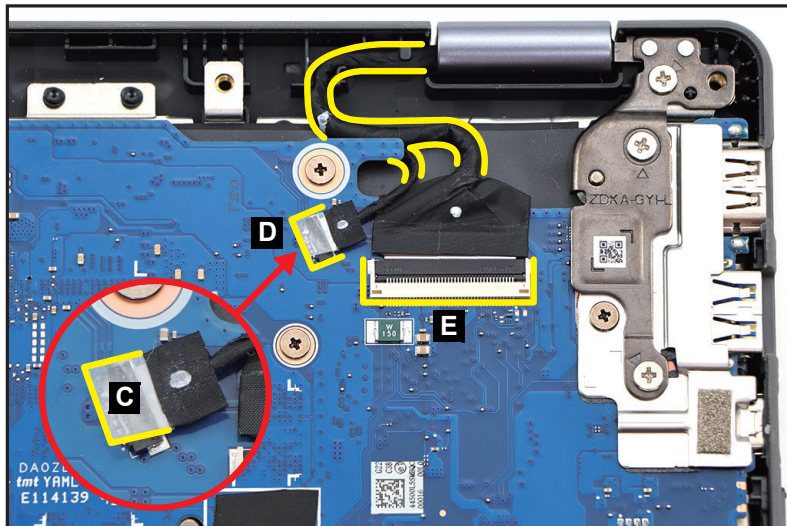

Figure 1-19. LCD Module Removal

5. Remove six (6) screws securing the LCD hinges (Figure 1-20).

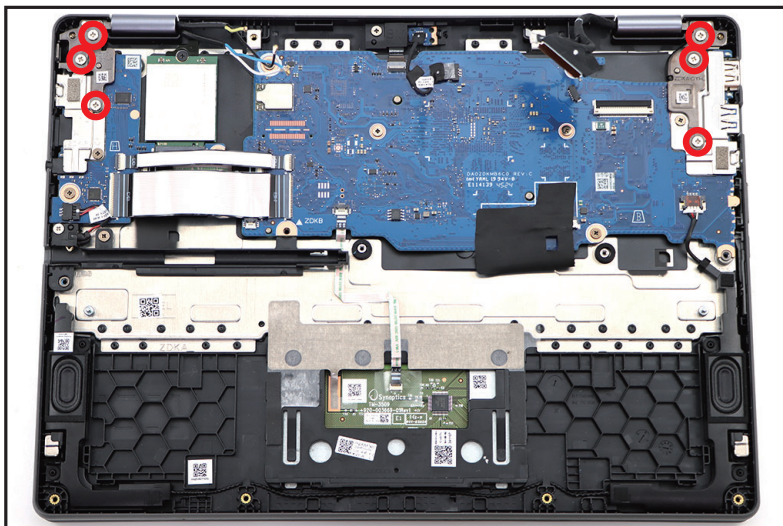

Figure 1-20. LCD Module Removal

6. By holding the LCD hinges, lift to open the top assembly (Figure 1-21).

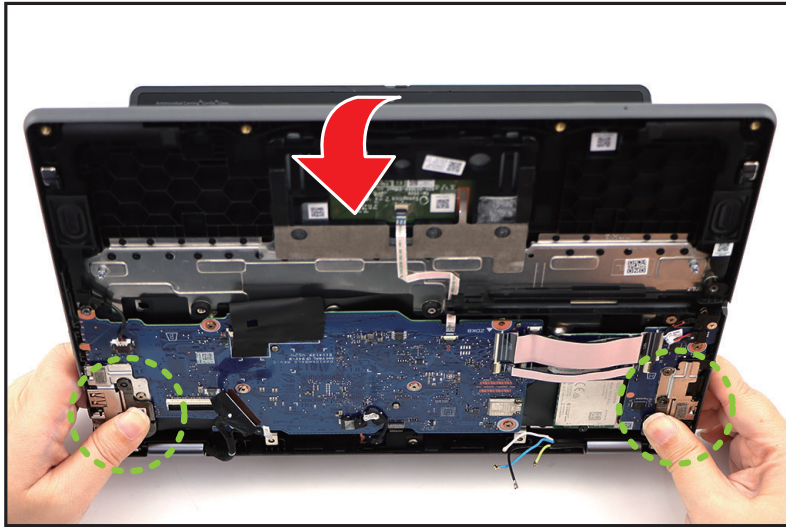

Figure 1-21. LCD Module Removal

7. Disengage the LCD hinges from the guide pins (highlighted with the green circles) on the top assembly. Then remove the top assembly away from the LCD module (Figure 1-22).

⚠ CAUTION:

Make sure all cables and antennas are moved away from the device to avoid damage during removal.

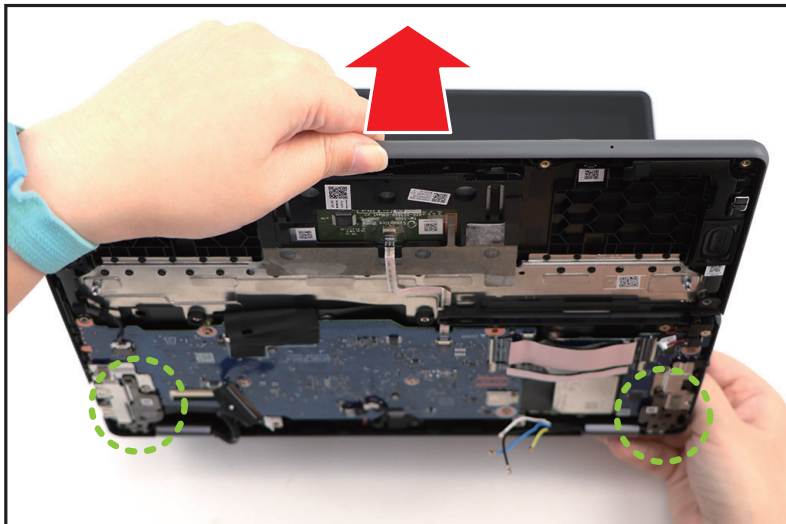

Figure 1-22. LCD Module Removal

LTE Module Removal (LTE SKU Only)

Prerequisite:

Battery Pack Removal

1. Disconnect the LTE antennas cables from the LTE module connectors (A). Then unroute the auxiliary antenna cable from the cable rubber guide as shown in [Figure 1-23](#).
2. Remove one (1) screw securing the LTE module in place ([Figure 1-23](#)).

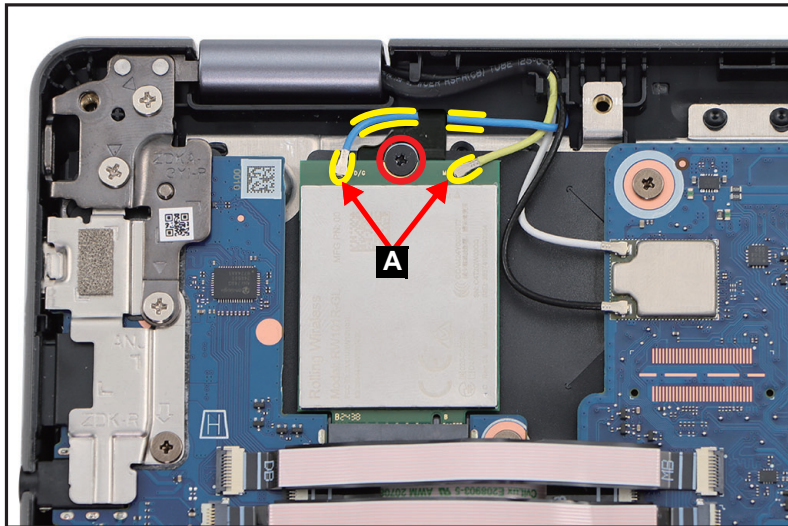

Figure 1-23. LTE Module Removal

3. Disconnect the LTE module (B) from the mainboard connector (C) (Figure 1-24). Then remove the LTE module.

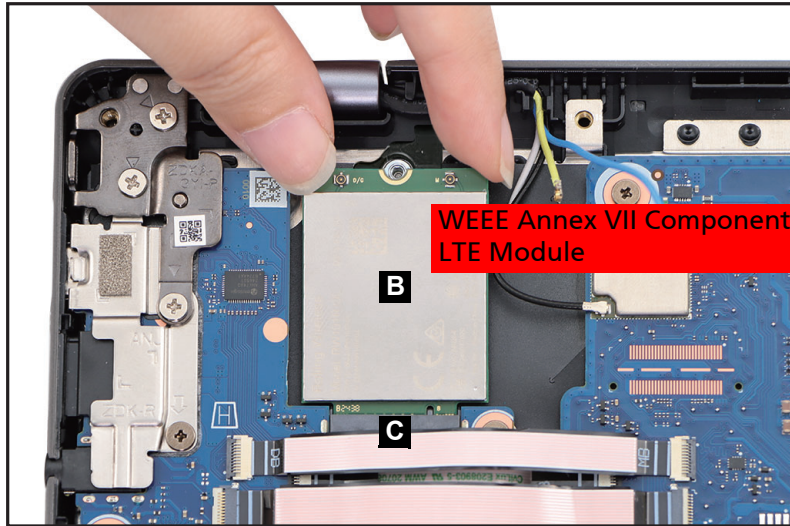

Figure 1-24. LTE Module Removal

Mainboard Removal

Prerequisite:

LCD Module Removal

1. Disconnect the LTE board FFC from the mainboard connector (A) (Figure 1-25).
2. Disconnect the 36-pin I/O board (L) FFC from the mainboard connector (B) (Figure 1-25).
3. Disconnect the touchpad FFC from the mainboard connector (C) (Figure 1-25).
4. Disconnect the speaker cable from the mainboard connector (D) (Figure 1-25).
5. Detach the tape (E) securing the LED board cable in place (Figure 1-25).
6. Detach the mylar (F) securing the LED board cable connection. Then disconnect the LED cable from the mainboard connector (G) (Figure 1-25).
7. Disconnect the 2nd camera cable from the mainboard connector (H) (Figure 1-25).

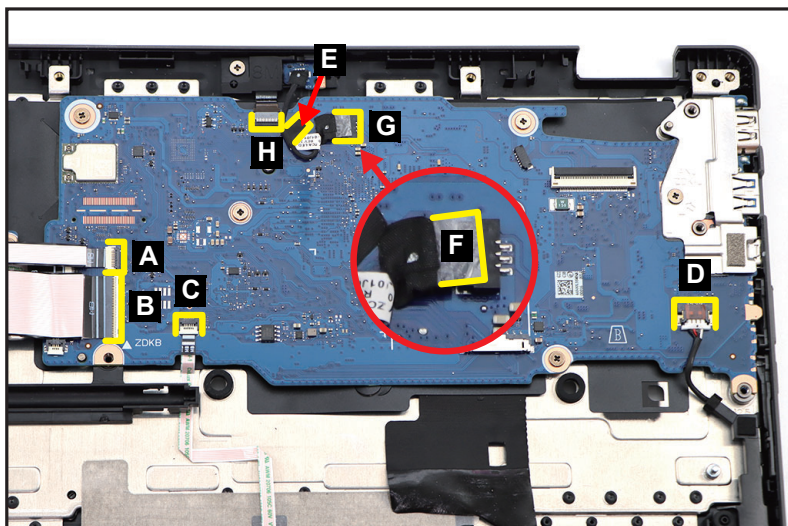

Figure 1-25. Mainboard Removal

⚠ CAUTION:

LTE board FFC (Flexible Flat Circuit), 36-pin I/O board (L), and touchpad FFC can be damaged if removed while the mainboard connectors are locked.

8. Remove six (6) screws securing the mainboard and I/O bracket (Figure 1-26).
9. Disconnect the 45-pin I/O board (H) FFC from the mainboard connector (I) (Figure 1-26).

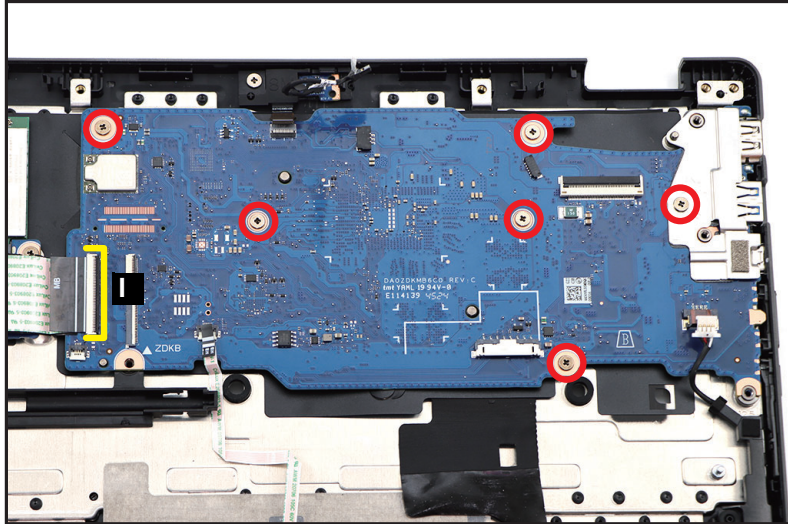

Figure 1-26. Mainboard Removal

⚠ CAUTION:

45-pin I/O board (H) FFC (Flexible Flat Circuit) can be damaged if removed while the mainboard connector is locked.

10. Release the I/O bracket (J) from the guide pins (K) on the top assembly (Figure 1-27). Then remove the I/O bracket.

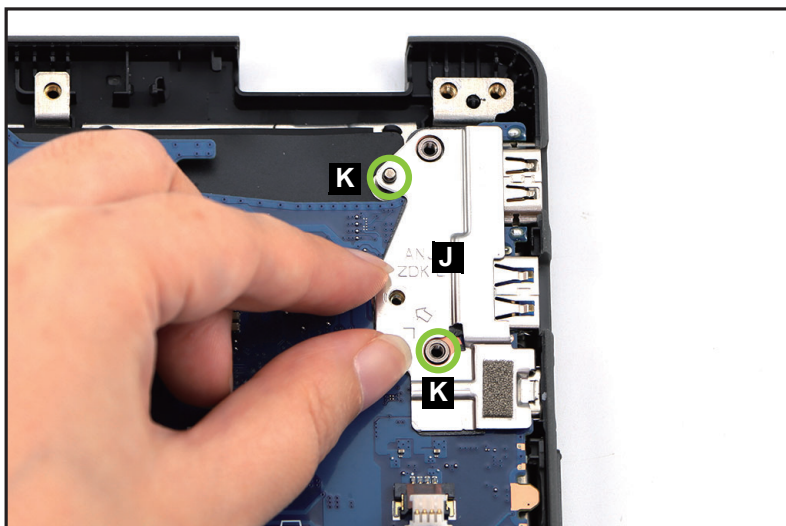

Figure 1-27. Mainboard Removal

11. Release the mainboard (L) from the I/O ports slots and guide pins (M) on the top assembly (Figure 1-28). Then remove the mainboard.

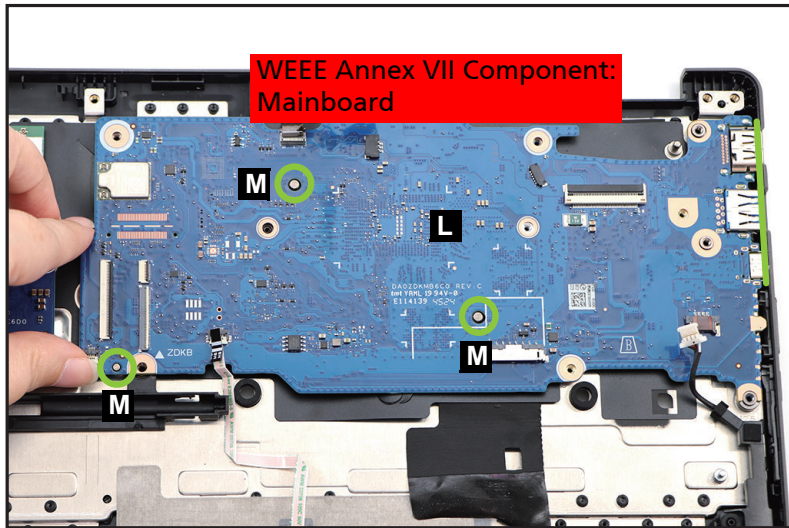

Figure 1-28. Mainboard Removal

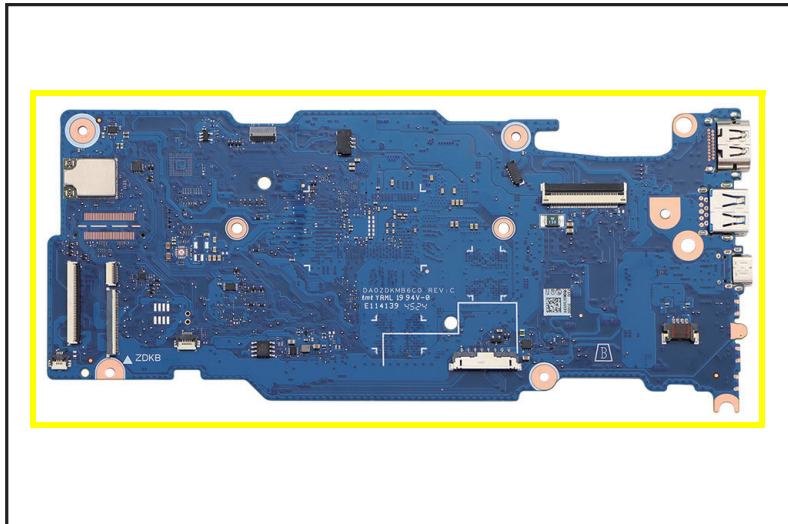

Figure 1-29. Mainboard

+ **IMPORTANT:**

Circuit boards >10 cm² have been highlighted with a yellow rectangle as shown in Figure 1-29. Remove the circuit board and follow local regulations for disposal.

4. Disconnect the 45-pin I/O board (H) FFC (D) from the LTE board and mainboard connectors (Figure 1-31). Then remove the FFC.

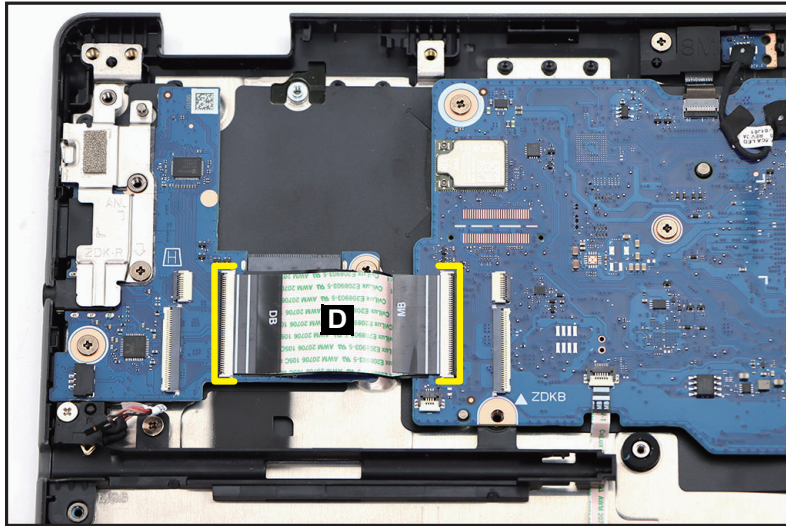

Figure 1-31. LTE Board Removal

⚠ CAUTION:

45-pin I/O board (H) FFC (Flexible Flat Circuit) can be damaged if removed while the LTE board and mainboard connectors are locked.

5. Remove three (3) screws securing the LTE board and I/O bracket (Figure 1-32).

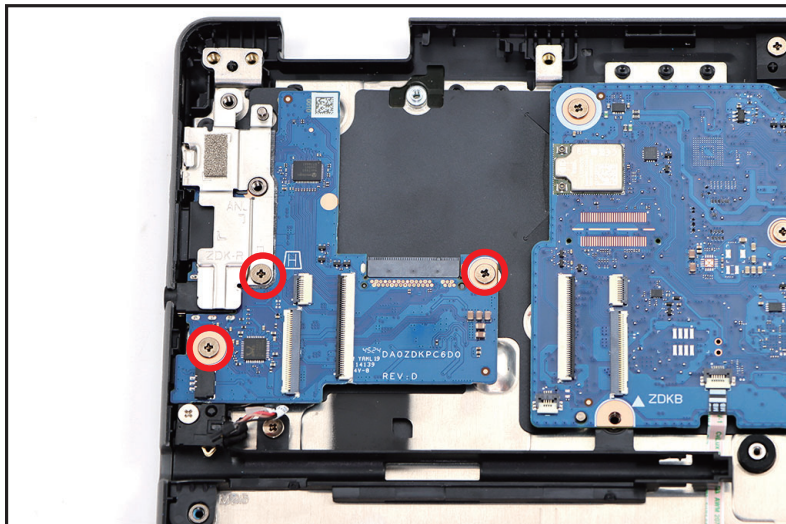

Figure 1-32. LTE Board Removal

6. Release the I/O bracket (E) from the guide pins (F) on the top assembly (Figure 1-33). Then remove the I/O bracket.

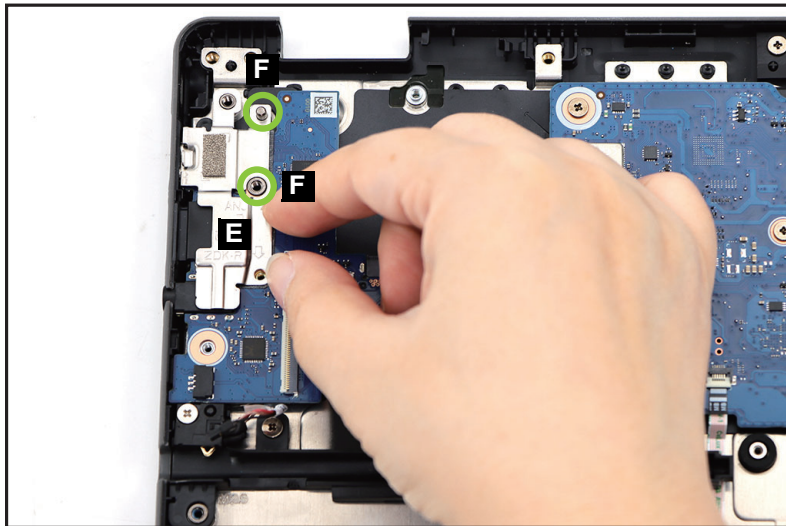

Figure 1-33. LTE Board Removal

7. Release the LTE board (G) from the I/O port slots and guide pin (H) on the top assembly (Figure 1-34). Then remove the LTE board.

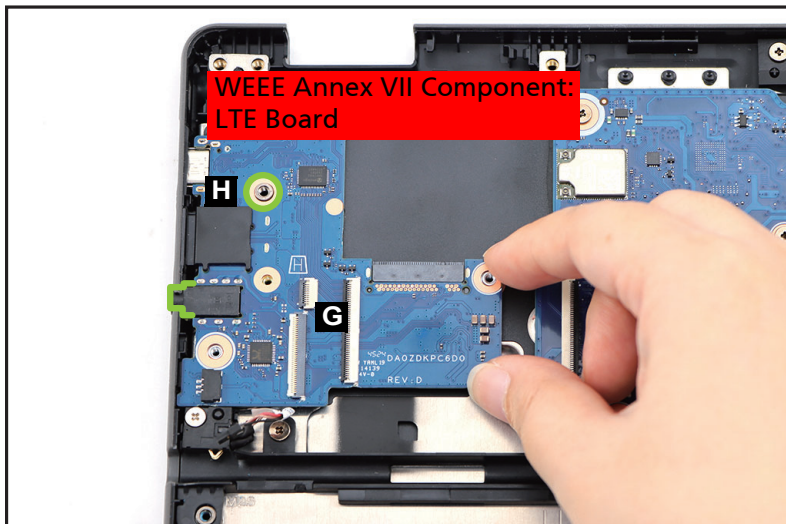

Figure 1-34. LTE Board Removal

LCD Panel Removal

Prerequisite:

[LCD Module Removal](#)

1. Bend both hinges 270° towards the LCD cover ([Figure 1-35](#)).



Figure 1-35. LCD Panel Removal

2. Pry around the bezel of the LCD panel to release the latches from the LCD cover ([Figure 1-36](#)).



Figure 1-36. LCD Panel Removal

3. Lift the LCD hinges to an upright position ([Figure 1-37](#)).



Figure 1-37. LCD Panel Removal

4. Release the LCD cable from the LCD hinge cap as shown in [Figure 1-38](#). Then remove the LCD panel.



Figure 1-38. LCD Panel Removal

Top Assembly Removal

Prerequisite:

Ensure that the **Keyboard, 2nd Camera Module and LED Board, Speaker Module, Touchpad Module, LTE Board, and Stylus Holder** have been disassembled prior removing the top assembly.

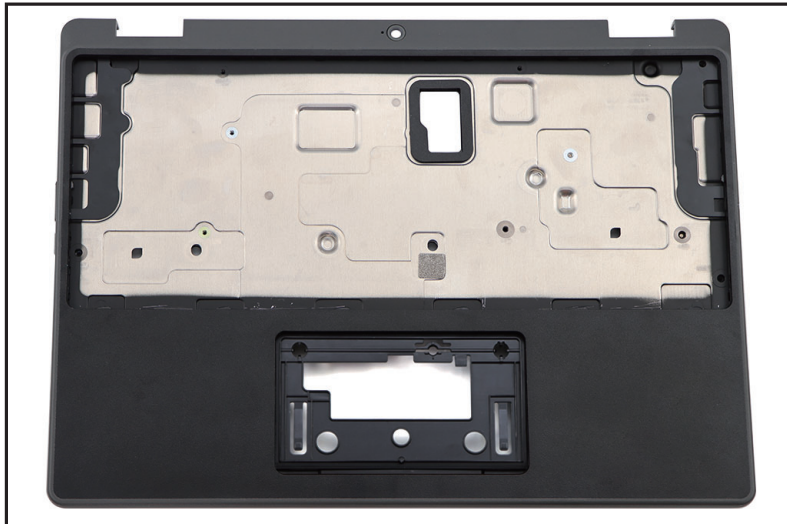
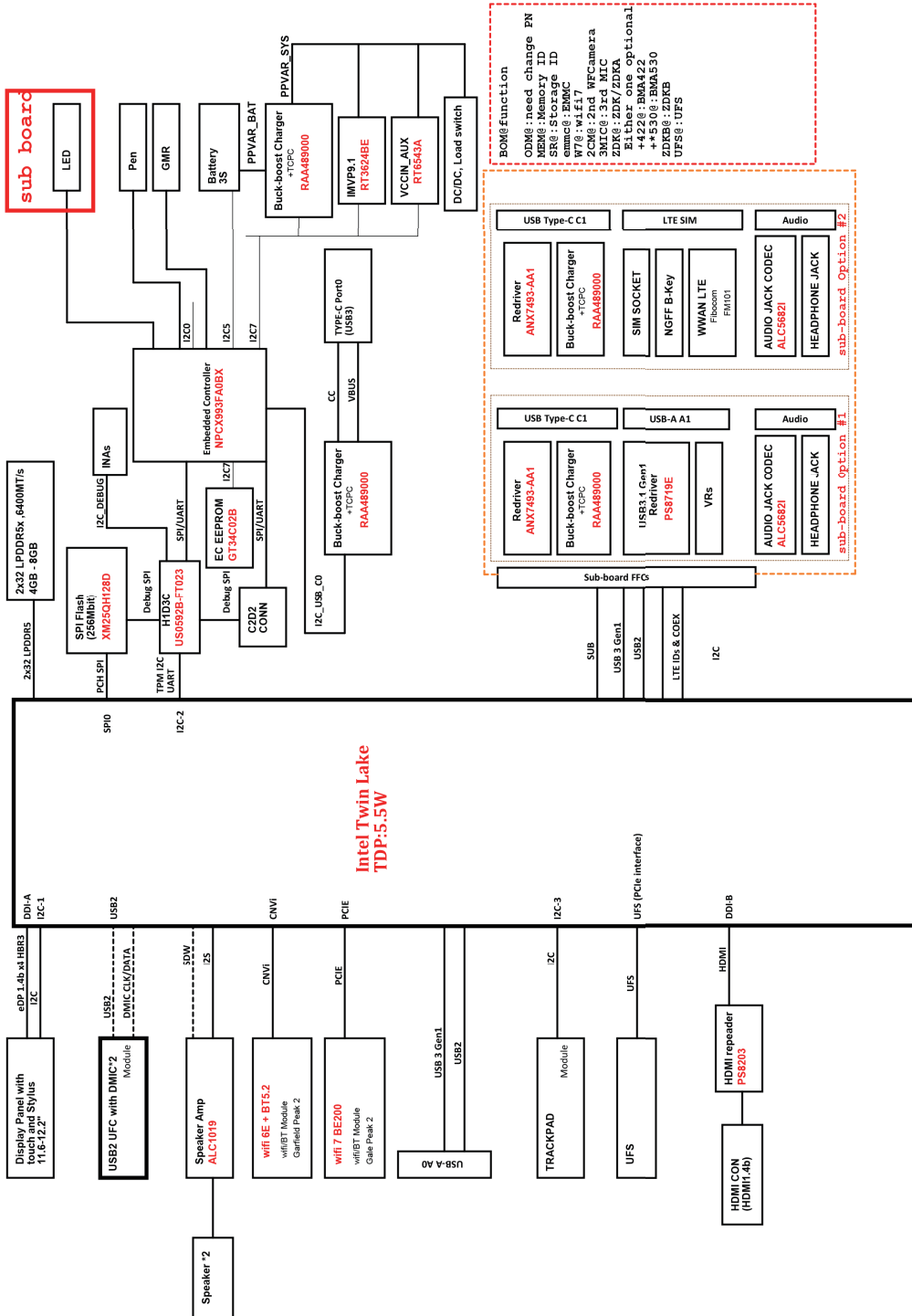

Figure 1-39. Top Assembly

Electronic Boards Diagrams



Troubleshooting

This chapter shows you how to deal with common system problems. Read it before calling a technician if a problem occurs. Solutions to more serious problems require opening up the computer. **By performing any of these procedures you acknowledge that any remaining warranty applicable to your computer will be voided if any damage is done to the unit or components during the repair.**

Introduction

This chapter contains information about troubleshooting common problems associated with the notebook.

General Information

The following procedures are a guide for troubleshooting computer problems. The step by step procedures are designed to be performed as described.

⇒ **NOTE:**

The diagnostic tests are intended for Acer products only. Non-Acer products, prototype cards, or modified options can give false errors and invalid system responses.

1. Obtain as much detailed information as possible about the problem.
2. If possible, verify the symptoms by re-creating the failure through diagnostic tests or repeating the operation that led to the problem.
3. Use [Table 1-1](#) with the verified symptom to determine the solution.

Table 1-1. Common Problems

Symptoms (Verified)
Power On Issues
No Display Issues
LCD Picture Failure
Internal Keyboard Failure
Touch Pad Failure
Internal Speaker Failure
Audio Codec Failure
Other Functions Failure
Intermittent Problems
Undetermined Problems

4. If the Issue is still not resolved, please contact Acer local service.

⇒ **NOTE:**

Do not replace non-defective FRU parts.

Power On Issues

If the system does not power on, perform the following:

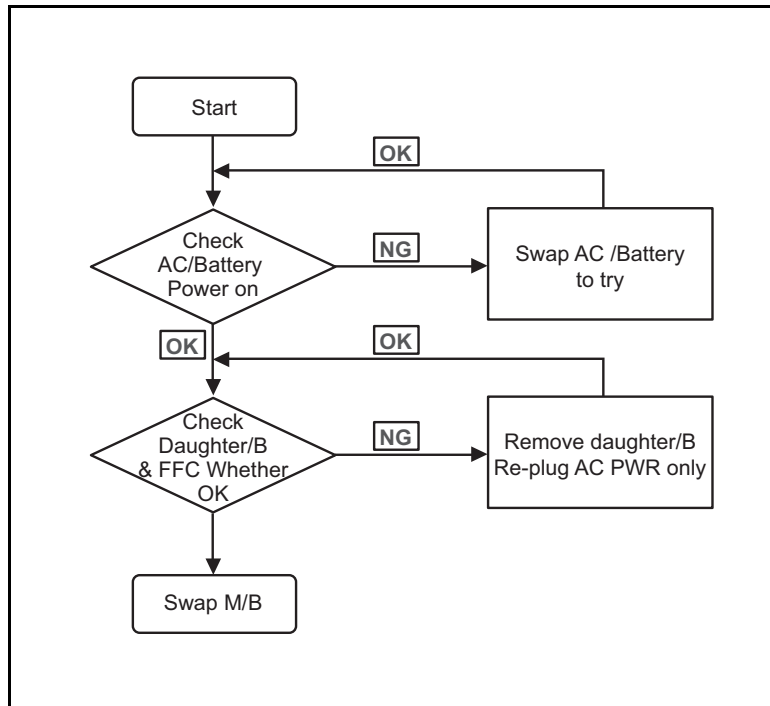

Figure 1-40. Power On Issue

Computer Shuts Down Intermittently

If the system powers off at intervals, perform the following.

1. Make sure the power cable is properly connected to the computer and the electrical outlet.
2. Remove all extension cables between the computer and the outlet.
3. Remove all surge protectors between the computer and the electrical outlet. Plug the computer directly into a known serviceable electrical outlet.
4. Remove all external and non-essential hardware connected to the computer that are not necessary to boot the computer to the failure point.
5. Remove any recently installed software.
6. If the issue is still not resolved, please contact Acer local service.

No Display Issues

If the Display does not work, perform the following:

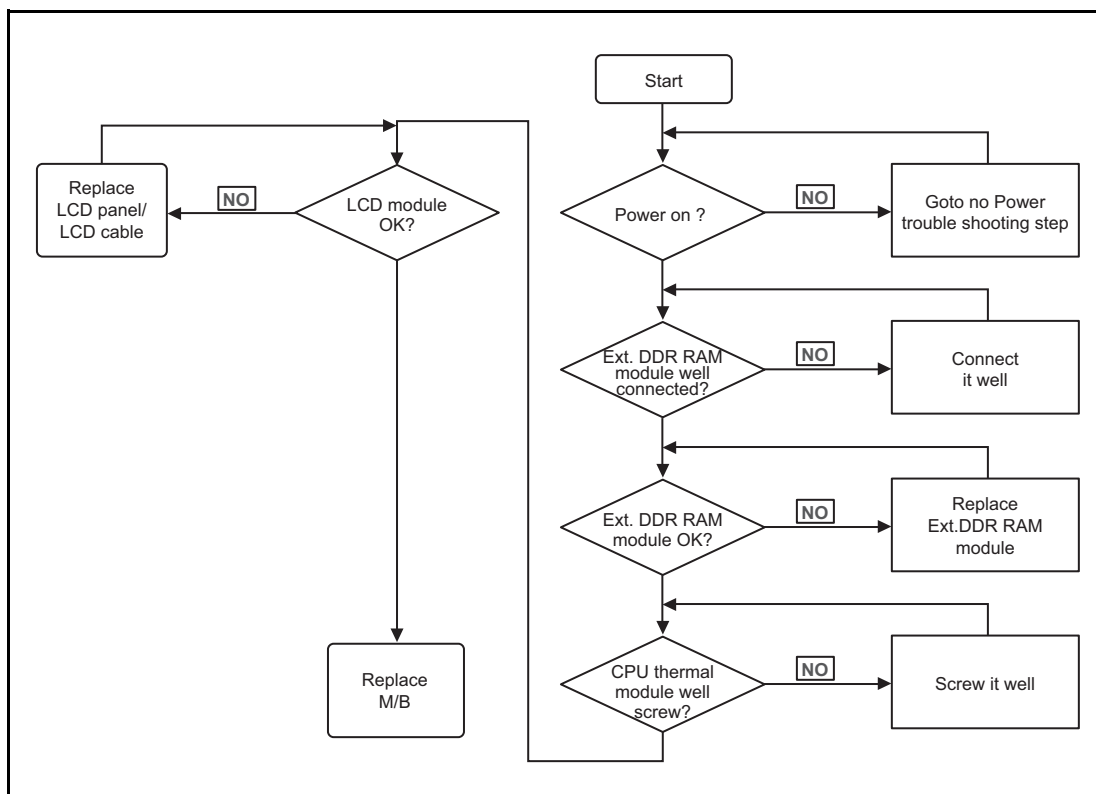

Figure 1-41. No Display Issue

No POST or Video

If the POST or video does not appear, perform the following:

1. Make sure that internal display is selected. Reference product pages for specific model procedures on how to switch between the internal display and the external display.
2. Make sure the computer has been turned on.
If no power, refer to [Power On Issues](#).
3. Turn off the Chromebook. Remove the power cable, and then plug it back in. Then perform the hard reset.
4. Connect an external monitor to the computer and switch between the internal display and the external display.

⇒ NOTE:

If you've connected an external monitor, the screen will only appear on the external monitor. If you've connected a projector, the screen will be displayed on both your Chromebook and via the projector.

5. If the POST or video appears on the external display only, refer to [LCD Picture Failure](#).

6. Disconnect power and all external devices including port replicators or docking stations. Remove any memory cards.
7. Start the computer. If the computer boots correctly, add the devices one by one until the failure point is discovered.
8. If the Issue is still not resolved, please contact Acer local service.

Abnormal Video

If the video appears abnormal, perform the following:

1. Boot the computer.
 - If permanent vertical/horizontal lines or dark spots appear in the same location, the LCD is faulty and should be replaced. Refer to [Disassembly Procedures](#).
 - If extensive pixel damage is present (different colored spots in the same locations on the screen), the LCD is faulty and should be replaced. Refer to [Disassembly Procedures](#).

⇒ NOTE:

Make sure that the computer is not running on battery alone as this may reduce display brightness.

2. Adjust the brightness to its highest level. Refer to the User Manual for instructions on adjusting the settings. If the display is too dim at the highest brightness setting, the LCD is faulty and should be replaced. Refer to [Disassembly Procedures](#).
3. Check the display resolution is correctly configured:
 - Minimize or close all Windows.
 - If display size is only abnormal in an application, check the view settings and control/mouse wheel zoom feature in the application.
 - If the Chromebook display resolution is not normal, click the status area where your account picture appears.
 - Click `Settings > Display Settings`.
 - Click on the `Resolution` drop-down menu to choose the desired resolution.
 - Check the display again. Readjust if necessary.
4. Roll back the video driver to the previous version if updated.
5. Remove and reinstall the video driver.
6. Run the Diagnostic test and follow the on-screen prompts.
7. If the Issue is still not resolved, please contact Acer local service.

LCD Picture Failure

If the LCD fails, perform the following:

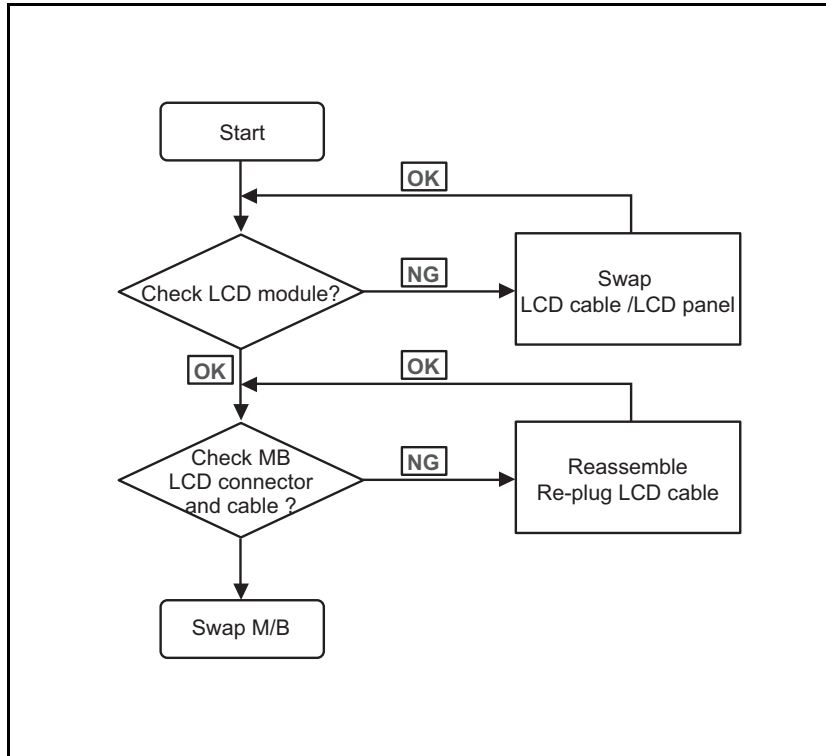

Figure 1-42. LCD Failure

Internal Keyboard Failure

If the internal keyboard fails, perform the following:

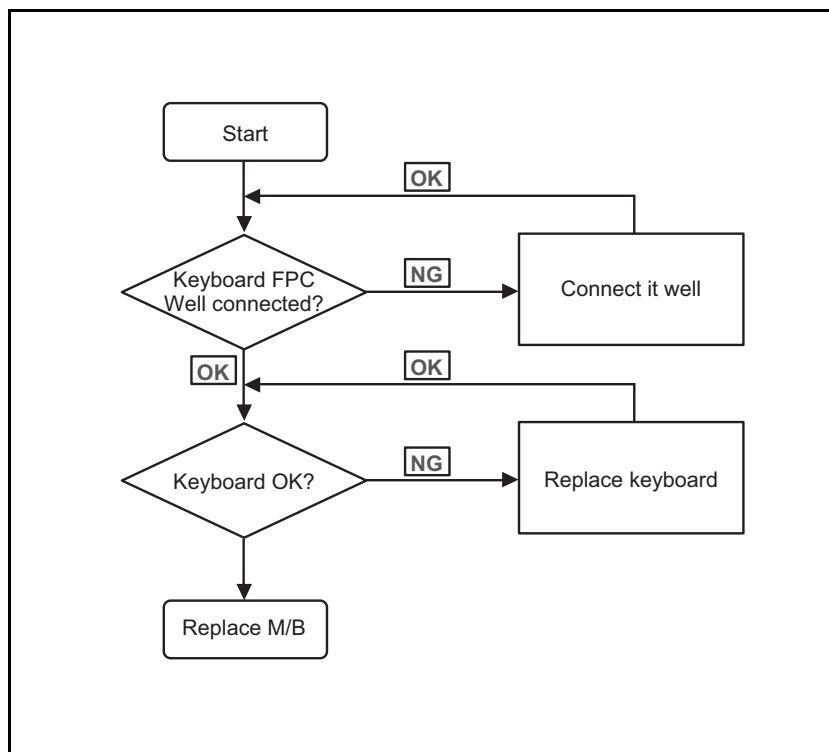

Figure 1-43. Internal Keyboard Failure

Touch Pad Failure

If the touch pad fails, perform the following:

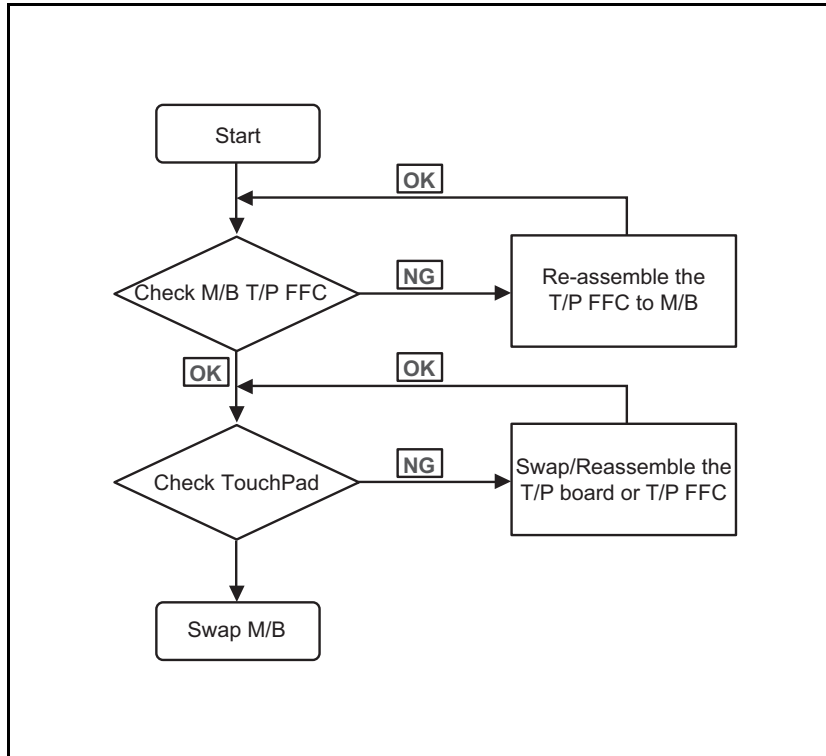

Figure 1-44. Touch Pad Failure

Internal Speaker Failure

If internal speakers fail, perform the following:

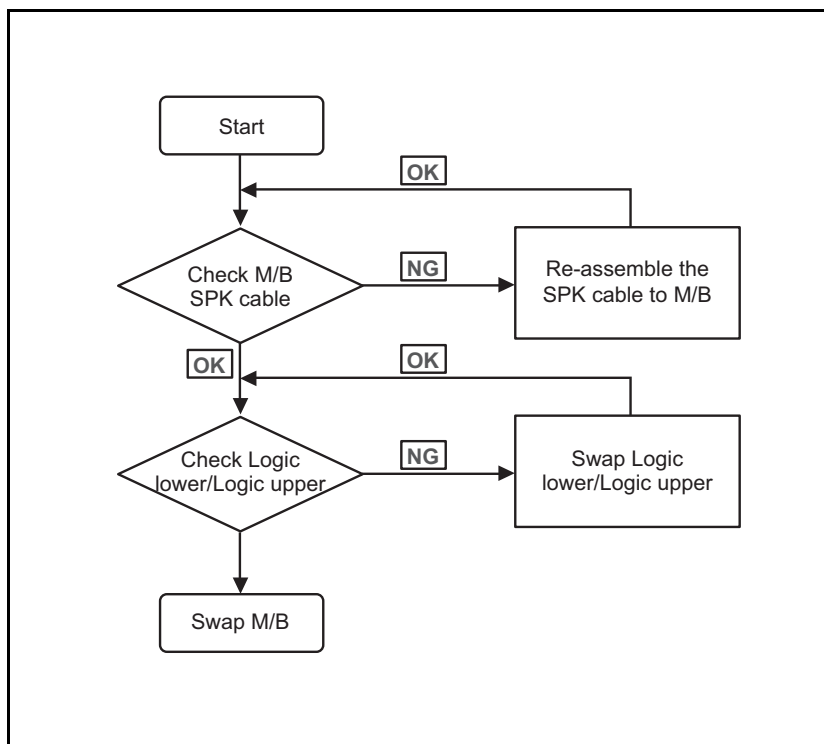

Figure 1-45. Internal Speaker Failure

Sound Problems

Perform the following, one at a time.

1. Boot the computer.
2. If updated recently, roll back the audio driver to the previous version. Remove and reinstall the audio driver.
3. Make sure that all volume controls are set mid range:
 - Click or , or click the status area of the taskbar.
 - Drag the slider to 50. Confirm that the volume is not muted.
 - Click Mixer to verify that other audio applications are set to 50 and not muted.
4. Remove any recently installed hardware or software.
5. Factory reset your Chromebook:

⇒ NOTE:

Make sure to back up all the files on Google Drive or an external hard drive.

- Sign out of the Chromebook and press and hold **Ctrl + Alt + Shift + R**.
- Click **Restart** to restart the Chromebook, and then follow the on-screen

instructions.

- Check if the problem is fixed once you set up the Chromebook.
6. Restore system and file settings from a known good date using *Chromebook Recovery Utility*.
 7. Reinstall the operating system.
 8. If the issue is still not resolved, please contact Acer local service.

Audio Codec Failure

If the audio codec fails, perform the following:

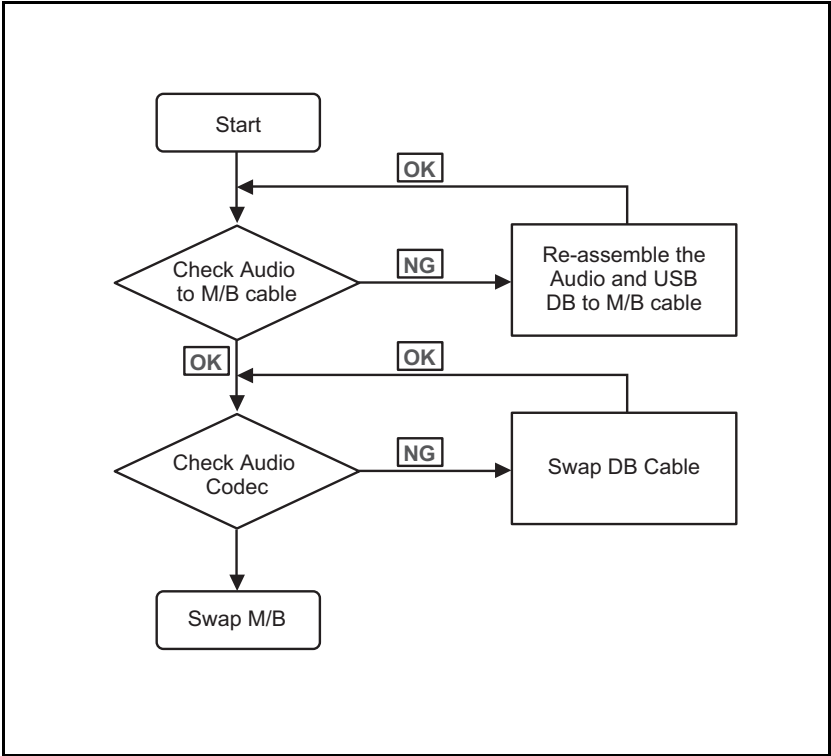

Figure 1-46. Audio Codec Failure

Other Functions Failure

1. Check if the drives are functioning correctly.
2. Check if the test fixtures are functioning correctly.
3. Change the mainboard to check if the current one is defective.

Intermittent Problems

Intermittent system hang problems can be caused by a variety of reasons that have nothing to do with a hardware defect, such as: cosmic radiation, electrostatic discharge, or software errors. FRU replacement should be considered only when a recurring problem exists.

When analyzing an intermittent problem, perform the following:

1. Run the advanced diagnostic test for the system board in loop mode at least 10 times.
2. If no error is detected, do not replace any FRU.
3. If an error is detected, replace the FRU. Rerun the test to verify that there are no more errors.

Undetermined Problems

The diagnostic problems do not identify which adapter or device failed, which installed devices are incorrect, whether a short circuit is suspected, or whether the system is inoperative.

Perform the following procedures to isolate the failing FRU (do not isolate non-defective FRU).

⇒ **NOTE:**

Verify that all attached devices are supported by the computer.

⇒ **NOTE:**

Verify that the power supply being used at the time of the failure is operating correctly. (Refer to [Power On Issues](#)).

1. Remove power from the computer.
2. Visually check components for damage. If any problems are found, replace the FRU.
3. Remove or disconnect all of the following devices:
 - Non-Acer devices
 - Printer, mouse, and other external devices
 - Battery pack
 - Hard disk drive
 - DIMM
 - BD/CD-ROM/Diskette drive Module
 - PC Cards
4. Apply power to the computer.
5. Determine if the problem has changed.
6. If the problem does not recur, connect the removed devices one at a time until failing FRU is found.
7. If the problem remains, replace the following FRUs:
 - System board
 - LCD assembly

Exploded Diagrams

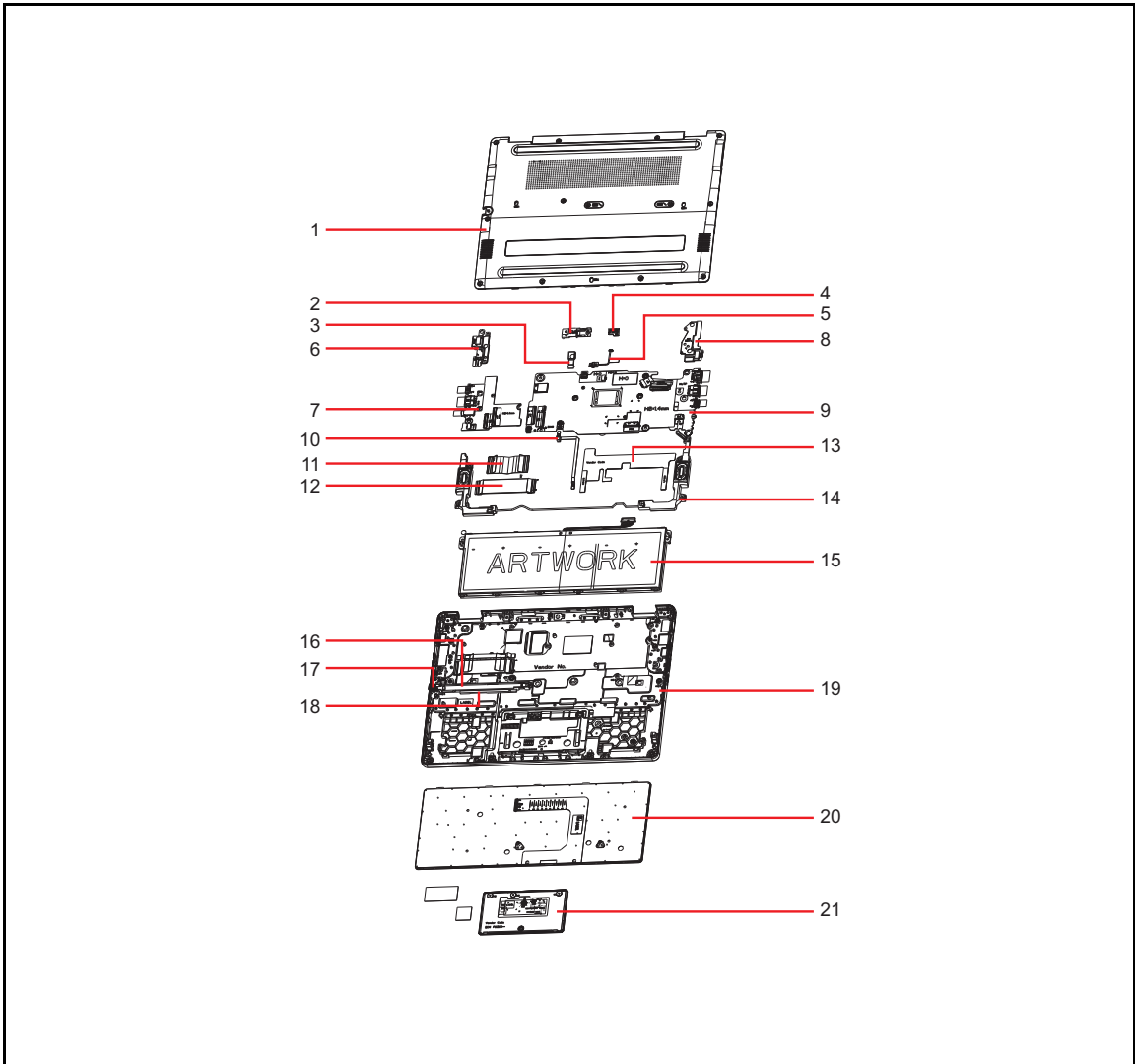

Figure 1-47. System Exploded Diagram

Table 1-2. System Exploded Diagram

No.	Description
1	LOWER CASE ASSY BLACK STYLUS SKU
2	CAMERA HOLDER ASSY
3	Camera Tech-Front 8M AF YHUX OV08856 1LS1035Q-H MIPI for Chrome (Intel solution)
4	BOARD LED
5	FFC CABLE - LED BOARD

Table 1-2. System Exploded Diagram (Continued)

No.	Description
6	BRACKET FOR IO - R
7	BOARD IO FOR LTE SKU
8	BRACKET FOR IO - L
9	Mainboard R857TN Intel N150 4GB eMMC64GB UMA Intel AX211 ,stylus touch
10	FFC CABLE TOUCHPAD
11	FFC CABLE FOR IO BOARD 45P
12	FFC CABLE FOR IO BOARD 36P
13	TOUCHPAD CONDUCTIVE TAPE W/ SPONGE & MYLEY
14	SPEAKER R + L
15	Battery CosMx Typ.53Wh 4661mAh 3S1P AP23ABL 248x84.4x5.5(mm) AP23A 11.37V 65W Li-Ion TI BQ40Z555 FW5.12
16	Acer Active Stylus Pen ESP-233-07B-6 AES 2.0/ USI 2.0 Backward Compatible
17	CABLE STYLUS CHARGER
18	STYLUS PEN HOLDER
19	UPPER CASE ASSY BLACK LTE STYLUS SKU
20	Keyboard SUNREX TD01T_C31B TD01T Internal 11 Standard 81KS Black Arabic Chrome OS, Strauss Vivaldi 2, TD01T, EDU/Lock
21	TOUCHPAD ASSY BLACK SYNAPTICS NC.24611.08W

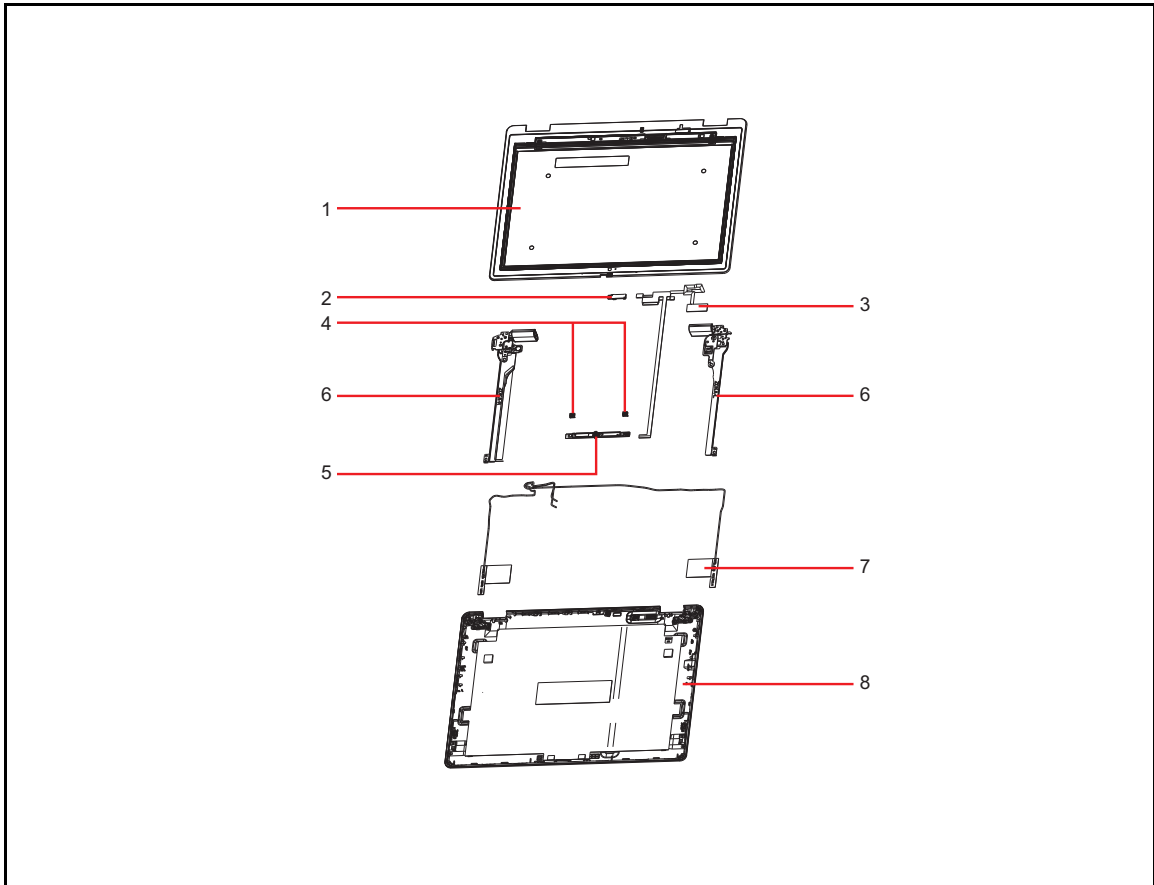

Figure 1-48. LCD Assembly Exploded Diagram

Table 1-3. LCD Assembly Exploded Diagram

No.	Description
1	LED Touch Panel HENGHAO 12.2" WUXGA IPS Glare HD-L122WM01-F5PA/ N122JCA-ENK V01 250nit NTSC 50% 60Hz 20ms 1200:1 (OFM/AM GG3 0.55t/Elan 3915N/HID-I2C)
2	BOARD G-SENSOR
3	LCD EDP CABLE FOR TOUCH LCD
4	RUBBER MIC
5	Camera CHICONY HD Camera C7FOH17 GC1029 RTS5855 DS-31072C (BG) FG6531S TNR Chrome V1.1 (ROI)
6	LCD HINGE - R
	LCD HINGE - L
7	ANTENNA MAIN FOR LTE SKU
	ANTENNA AUX FOR LTE SKU
8	LCD COVER ASSY BLACK

FRU List

This list is for reference only, please contact Acer local service to order the correct replacement part and availability.

Table 6-4. FRU List

Category	Pictures	Description
ADAPTER		Adapter Chicony Power A065RP99P 65W Type C Brick 5V/3A_9V/3A_12V/3A_15V/3A_20V_3.25 A Black TCO9.0, PCR 50%, with LOGO
		Adapter LITE-ON PA-1650-58AA 65W Type C Brick 5V/3A_9V/3A_12V/3A_15V/3A_20V_3.25 A Black TCO9.0, PCR 50%, with LOGO
		Adapter DELTA ADP-65KE DA 65W Type C Brick 5V/3A_9V/3A_12V/3A_15V/3A_20V_3.25 A Black TCO9.0, PCR 50%, with LOGO
BATTERY		Battery CosMx Typ.53Wh 4661mAh 3S1P AP23ABL 248x84.4x5.5(mm) AP23A 11.37V 65W Li-Ion TI BQ40Z555 FW5.12
		Battery LGES Typ.53Wh 4700mAh 3S1P AP23A8L 248x84.4x5.5(mm) AP23A 11.28V 70W Li-Ion
		Battery SIMPLO Typ.53Wh 4700mAh 3S1P AP23A7L 248x84.4x5.5(mm) AP23A 11.25V 70W Li-Ion FW5.09
		Battery SIMPLO Typ.53Wh 4700mAh 3S1P AP23A7L 248x84.4x5.5(mm) AP23A 11.25V 70W Li-Ion TI BQ40Z555 FW5.09
BOARD		LTE Fibocom LTE RW101R-GL Rolling Wireless
		LTE Quetcel LTE LCUK54-WWD NetPrisma
		BOARD IO FOR WIFI SKU

Table 6-4. FRU List (Continued)









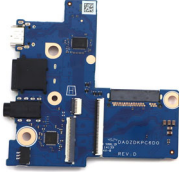

Category	Pictures	Description
BOARD		BOARD IO FOR LTE SKU
		BOARD LED
		BOARD G-SENSOR
CABLE		FFC CABLE FOR IO BOARD 36P
		FFC CABLE FOR IO BOARD 45P
		FFC CABLE FOR LTE SKU IO BOARD
		FFC CABLE - LED BOARD
		FFC CABLE TOUCHPAD
		CABLE STYLUS CHARGER
		LCD EDP CABLE FOR TOUCH LCD LCD EDP CABLE FOR TOUCH LCD LCD EDP CABLE FOR TOUCH LCD LCD EDP CABLE FOR TOUCH LCD LCD EDP CABLE FOR TOUCH LCD LCD EDP CABLE FOR TOUCH LCD

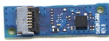
Table 6-4. FRU List (Continued)



Category	Pictures	Description
CABLE		ANTENNA MAIN FOR LTE SKU
		ANTENNA AUX FOR LTE SKU
		ANTENNA MAIN FOR WIFI SKU
		ANTENNA AUX FOR WIFI SKU
CAMERA		Camera Tech-Front 8M AF YHUX OV08856 1L51035Q-H MIPI for Chrome (Intel solution)
		Camera CHICONY HD Camera C7FOH17 GC1029 RTS5855 DS-31072C (BG) FG6531S TNR Chrome V1.1 (ROI)
		Camera Tech-Front HD Camera YHVW OV9734 SPCA2112N 1L3B059F1(BG) KMM4030102664DN9 TNR , Chrome V1.1 (ROI)
	Camera CHICONY FHD FF C7FMF26 OV02C10(CSP) SPCA2093N3 1L4C150A1 (BG) KMM4030102664DN9C (Chrome)V1.1(ROI)	

Table 6-4. FRU List (Continued)

Category	Pictures	Description
KEYBOARD		Keyboard SUNREX TD01T_C31B TD01T Internal 11 Standard 81KS Black Arabic Chrome OS, Strauss Vivaldi 2, TD01T, EDU/Lock
		Keyboard SUNREX TD01T_C31B TD01T Internal 11 Standard 81KS Black Traditional Chinese Chrome OS, Strauss Vivaldi 2, TD01T, EDU/Lock
		Keyboard SUNREX TD01T_C31B TD01T Internal 11 Standard 81KS Black Greek Chrome OS, Strauss Vivaldi 2, TD01T, EDU/Lock
		Keyboard SUNREX TD01T_C31B TD01T Internal 11 Standard 81KS Black Korean Chrome OS, Strauss Vivaldi 2, TD01T, EDU/Lock
		Keyboard SUNREX TD01T_C31B TD01T Internal 11 Standard 81KS Black Russian Chrome OS, Strauss Vivaldi 2, TD01T, EDU/Lock
		Keyboard SUNREX TD01T_C31B TD01T Internal 11 Standard 81KS Black Ukrainian Chrome OS, Strauss Vivaldi 2, TD01T, EDU/Lock
		Keyboard SUNREX TD01T_C31B TD01T Internal 11 Standard 81KS Black Persian Chrome OS, Strauss Vivaldi 2, TD01T, EDU/Lock
		Keyboard SUNREX TD01T_C31B TD01T Internal 11 Standard 81KS Black Thailand Chrome OS, Strauss Vivaldi 2, TD01T, EDU/Lock
		Keyboard SUNREX TD01T_C31B TD01T Internal 11 Standard 81KS Black US International Chrome OS, Strauss Vivaldi 2, TD01T, EDU/Lock
		Keyboard SUNREX TD01T_C31B TD01T Internal 11 Standard 81KS Black US Chrome OS, Strauss Vivaldi 2, TD01T, EDU/Lock
Keyboard SUNREX TD01T_C31B TD01T Internal 11 Standard 81KS Black US International w/ Hebrew Chrome OS, Strauss Vivaldi 2, TD01T, EDU/Lock		

Table 6-4. FRU List (Continued)

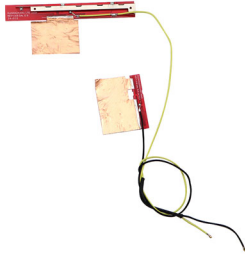
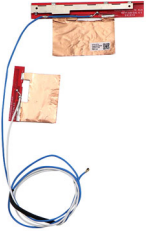
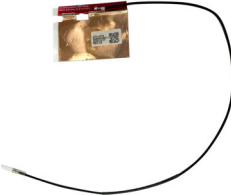
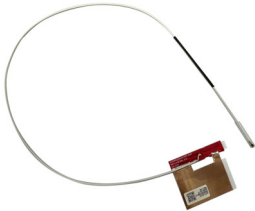
Category	Pictures	Description
KEYBOARD		Keyboard SUNREX TD01T_C31B TD01T Internal 11 Standard 81KS Black US International w/ Canadian French Chrome OS, Strauss Vivaldi 2, TD01T, EDU/Lock
		Keyboard SUNREX TD01T_C31B TD01T Internal 11 Standard 81KS Black US International w/ Bulgaria Chrome OS, Strauss Vivaldi 2, TD01T, EDU/Lock
		Keyboard SUNREX TD01T_C31B TD01T Internal 11 Standard 82KS Black ALA-Spanish Chrome OS, Strauss Vivaldi 2, TD01T, EDU/Lock
		Keyboard SUNREX TD01T_C31B TD01T Internal 11 Standard 82KS Black Belgium Chrome OS, Strauss Vivaldi 2, TD01T, EDU/Lock
		Keyboard SUNREX TD01T_C31B TD01T Internal 11 Standard 82KS Black Brazilian Portuguese Chrome OS, Strauss Vivaldi 2, TD01T, EDU/Lock
		Keyboard SUNREX TD01T_C31B TD01T Internal 11 Standard 82KS Black CZ/SK Chrome OS, Strauss Vivaldi 2, TD01T, EDU/Lock
		Keyboard SUNREX TD01T_C31B TD01T Internal 11 Standard 82KS Black Danish Chrome OS, Strauss Vivaldi 2, TD01T, EDU/Lock
		Keyboard SUNREX TD01T_C31B TD01T Internal 11 Standard 82KS Black FR/Arabic Chrome OS, Strauss Vivaldi 2, TD01T, EDU/Lock
		Keyboard SUNREX TD01T_C31B TD01T Internal 11 Standard 82KS Black French Chrome OS, Strauss Vivaldi 2, TD01T, EDU/Lock
		Keyboard SUNREX TD01T_C31B TD01T Internal 11 Standard 82KS Black German Chrome OS, Strauss Vivaldi 2, TD01T, EDU/Lock
Keyboard SUNREX TD01T_C31B TD01T Internal 11 Standard 82KS Black Hungarian Chrome OS, Strauss Vivaldi 2, TD01T, EDU/Lock		

Table 6-4. FRU List (Continued)

Category	Pictures	Description
KEYBOARD		Keyboard SUNREX TD01T_C31B TD01T Internal 11 Standard 82KS Black Italian Chrome OS, Strauss Vivaldi 2, TD01T, EDU/Lock
		Keyboard SUNREX TD01T_C31B TD01T Internal 11 Standard 82KS Black Nordic Chrome OS, Strauss Vivaldi 2, TD01T, EDU/Lock
		Keyboard SUNREX TD01T_C31B TD01T Internal 11 Standard 82KS Black Norwegian Chrome OS, Strauss Vivaldi 2, TD01T, EDU/Lock
		Keyboard SUNREX TD01T_C31B TD01T Internal 11 Standard 82KS Black Portuguese Chrome OS, Strauss Vivaldi 2, TD01T, EDU/Lock
		Keyboard SUNREX TD01T_C31B TD01T Internal 11 Standard 82KS Black SLO/CRO Chrome OS, Strauss Vivaldi 2, TD01T, EDU/Lock
		Keyboard SUNREX TD01T_C31B TD01T Internal 11 Standard 82KS Black Spanish Chrome OS, Strauss Vivaldi 2, TD01T, EDU/Lock
		Keyboard SUNREX TD01T_C31B TD01T Internal 11 Standard 82KS Black Sweden Chrome OS, Strauss Vivaldi 2, TD01T, EDU/Lock
		Keyboard SUNREX TD01T_C31B TD01T Internal 11 Standard 82KS Black Swiss/G Chrome OS, Strauss Vivaldi 2, TD01T, EDU/Lock
		Keyboard SUNREX TD01T_C31B TD01T Internal 11 Standard 82KS Black Turkish Chrome OS, Strauss Vivaldi 2, TD01T, EDU/Lock
		Keyboard SUNREX TD01T_C31B TD01T Internal 11 Standard 82KS Black UK Chrome OS, Strauss Vivaldi 2, TD01T, EDU/Lock
Keyboard SUNREX TD01T_C31B TD01T Internal 11 Standard 86KS Black Japanese Chrome OS, Strauss Vivaldi 2, TD01T, EDU/Lock		

Table 6-4. FRU List (Continued)

Category	Pictures	Description
LCD		LED Touch Panel HENGHAO 12.2" WUXGA IPS Glare HD-L122WM01-F5PA/ N122JCA-ENK V01 250nit NTSC 50% 60Hz 20ms 1200:1 (OFM/AM GG3 0.55t/Elan 3915N/HID-I2C)
		LED Touch Panel HENGHAO 12.2" WUXGA IPS Glare HD-L122WM01-F5PB/ MNC207QS2-1 V01 V01 250nit NTSC 50% 60Hz 20ms 1200:1 (OFM/AM GG3 0.55t/Elan 3915N/HID-I2C)
		LED Touch Panel HENGHAO 12.2" WUXGA IPS Glare HD-L122WM02-F5PA/ N122JCA-ENK 250nit NTSC 50% 60Hz 20ms 1200:1 (OFM/AM GG3 0.55t/Elan 7B18U/HID-I2C)
		LED Touch Panel HENGHAO 12.2" WUXGA IPS Glare HD-L122WM02-F5PB/ MNC207QS2-1 V01 250nit NTSC 50% 60Hz 20ms 1200:1 (OFM/AM GG3 0.55t/Elan 7B18U/HID-I2C)
		LED Touch Panel HENGHAO 12.2" WUXGA IPS Glare TBC/ N122JCA-ENK 250nit NTSC 50% 60Hz 20ms 1200:1 (OFM/AM GG3 0.55t/Elan 7B18U/HID-I2C)
		LED Touch Panel HENGHAO 12.2" WUXGA IPS Glare TBC/ MNC207QS2-1 V01 250nit NTSC 50% 60Hz 20ms 1200:1 (OFM/AM GG3 0.55t/Elan 7B18U/HID-I2C)
LCD COVER		LCD COVER ASSY BLACK
LCD MODULE		LCD MODULE N-STYLUS SKU W/ BEZEL,LCD HENGHAO 12.2" WUXGA IPS Glare HD-L122WM01-F5PA/ N122JCA-ENK KL.1220H.003
		LCD MODULE N-STYLUS SKU W/ BEZEL,LCD HENGHAO 12.2" WUXGA IPS Glare HD-L122WM01-F5PB/ MNC207QS2-1 KL.1220H.004

Table 6-4. FRU List (Continued)



Category	Pictures	Description
LCD MODULE		LCD MODULE STYLUS SKU W/ BEZEL,LCD HENGHAO 12.2" WUXGA IPS Glare HD-L122WM02-F5PA/ N122JCA-ENK KL.1220H.001
		LCD MODULE STYLUS SKU W/ BEZEL,LCD HENGHAO 12.2" WUXGA IPS Glare HD-L122WM02-F5PB/ MNC207QS2-1 KL.1220H.002
		LCD MODULE STYLUS SKU W/ BEZEL,LCD HENGHAO 12.2" WUXGA IPS Glare TBC/ N122JCA-ENK KL.1220H.009
		LCD MODULE STYLUS SKU W/ BEZEL,LCD HENGHAO 12.2" WUXGA IPS Glare TBC/ MNC207QS2-1 KL.1220H.010
LOWER CASE		LOWER CASE ASSY BLACK STYLUS SKU
		LOWER CASE ASSY BLACK N-STYLUS SKU
MAINBOARD		Mainboard R857TN Intel N150 4GB eMMC64GB UMA Intel AX211 ,stylus touch
		Mainboard R857TN Intel N150 8GB eMMC64GB UMA Intel AX211 ,stylus touch, LPDDR5x
		Mainboard R857TN Intel N150 8GB eMMC128GB UMA Intel AX211 ,stylus touch, LPDDR5x
		Mainboard R857TN Intel Twin Lake N150 8GB eMMC64GB UMA Intel BE200 8MP camera, LPDDR5x
		Mainboard R857TN Intel N250 8GB eMMC64GB UMA Intel AX211 ,stylus touch, LPDDR5x
		Mainboard R857TN Intel N250 8GB eMMC128GB UMA Intel AX211 ,stylus touch, LPDDR5x
		Mainboard R857TN N250 8GB eMMC64GB UMA Intel BE200 8MP camera, LPDDR5x

Table 6-4. FRU List (Continued)

Category	Pictures	Description
METAL		LCD HINGE - R
		LCD HINGE - L
		SIM TRAY ASSY
		PRIMETEK PRIMETEK Sim Card Ejector with Packing
		BRACKET FOR IO - R
	BRACKET FOR IO - L	
MISCELLANEOUS		RUBBER MIC
		THERMAL PAD FOR MAINBOARD
		ACETATE TAPE FOR KEYBOARD CONNECTOR
		ADHESIVE TAPE FOR SIM HOLDER
		TOUCHPAD CONDUCTIVE TAPE W/ SPONGE & MYLEY
		MYLAR FFC COONECTOR

Table 6-4. FRU List (Continued)



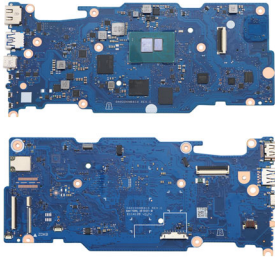











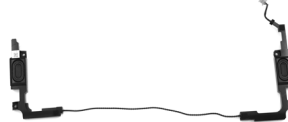

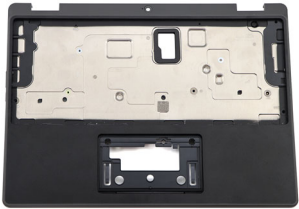
Category	Pictures	Description
MISCELLANEOUS		RUBBER FOR LTE ANTENNA
PLASTICS		SIM HOLDER
		CAMERA HOLDER ASSY
		STYLUS PEN HOLDER
POWER CORD		POWER CORD 1M 125V JAP BLACK
		POWER CORD 1M 125V ARG BLACK
		POWER CORD 1M 125V AUS BLACK
		POWER CORD 1M 125V BRAZIL BLACK
		POWER CORD 1M 125V CHINA BLACK
		POWER CORD 1M 125V DENMARK BLACK
		POWER CORD 1M 125V INDIA BLACK
		POWER CORD 1M 125V ISRAEL BLACK
		POWER CORD 1M 125V ITL BLACK
		POWER CORD 1M 125V S.AFRICA BLACK
		POWER CORD 1M 125V SWISS BLACK
		POWER CORD 1M 125V EUR+KOR BLACK
		POWER CORD 1M 125V US BLACK
POWER CORD 1M 125V UK BLACK		
POWER CORD 1M 125V TAIWAN BLACK		
SPEAKER/ MICROPHONE		SPEAKER R + L
STYLUS		Acer Active Stylus Pen ESP-233-07B-6 AES 2.0/ US1 2.0 Backward Compatible
TOUCHPAD		TOUCHPAD ASSY BLACK SYNAPTICS NC.24611.08W
		TOUCHPAD ASSY BLACK ELANTECH NC.24611.04K

Table 6-4. FRU List (Continued)

Category	Pictures	Description
UPPER CASE		UPPER CASE ASSY BLACK LTE STYLUS SKU
		UPPER CASE ASSY BLACK LTE N-STYLUS SKU
		UPPER CASE ASSY BLACK WIFI STYLUS SKU
		UPPER CASE ASSY BLACK WIFI N-STYLUS SKU
SCREW		SCREW W/WASHER KIT
		SCREW ASSY(M2.0*5.5)W/WASHER
		SCREW M2.0*4.0-IBNINYLOKD5.0T0.8)STL
		SCREW M2*2.5-IBZNNYLOKD5,T0.5STEEL
		SCREW M2.5*5.0-I(NINYLOKD5.0T0.8)STL
		SCREW M2.5*2.5-IBZNNYLOKD7.5T0.6 IRON
		SCREW M2.0*2.5-IBZNNYLOKD7.0 IRON
		SCREW M2.0-5.0-I(NI,NYLOK)STL

Software Update

1. Turn on your Chromebook.
2. Connect your Chromebook to Wi-Fi.
3. At the bottom right, select the time.
4. Select **Settings** .
5. At the bottom of the left panel, select **About Chrome OS**.
6. Under "Google Chrome OS", you'll find which version of the Chrome operating system your Chromebook uses.
7. Select **Check for updates**.
8. If your Chromebook finds a software update, it will start to download automatically.

Software Recovery

This product has embedded software recovery tools which can be used to either perform a partial or full software recovery, but also to create a Factory Default recovery media.

For more information about the software recovery options, how to perform a software recovery or creating a Factory Default recovery media, please refer to the chapter "Recovery" which is available in the User Manual of the product.

⇒ **NOTE:**

In the event of not being able to create a Factory Default recovery media, it is possible to obtain a copy of the recovery media through Google Help (<https://support.google.com/chromebook/answer/1080595?hl=en>)

This is not a free of charge service.

Factory Reset your Chromebook

1. Sign out of your Chromebook.
2. Press and hold **Ctrl + Alt + Shift + r**.
3. Select **Restart**.
4. In the box that appears, select **Powerwash > Continue**.
5. Follow the steps that appear and sign in with your Google Account.

⇒ **NOTE:**

The account you sign in with after you reset your Chromebook will be the owner account.

Shimless RMA

Getting Started

Shimless RMA provides a user-friendly repair flow that is built right into ChromeOS. These customized paths will result in quicker repairs.

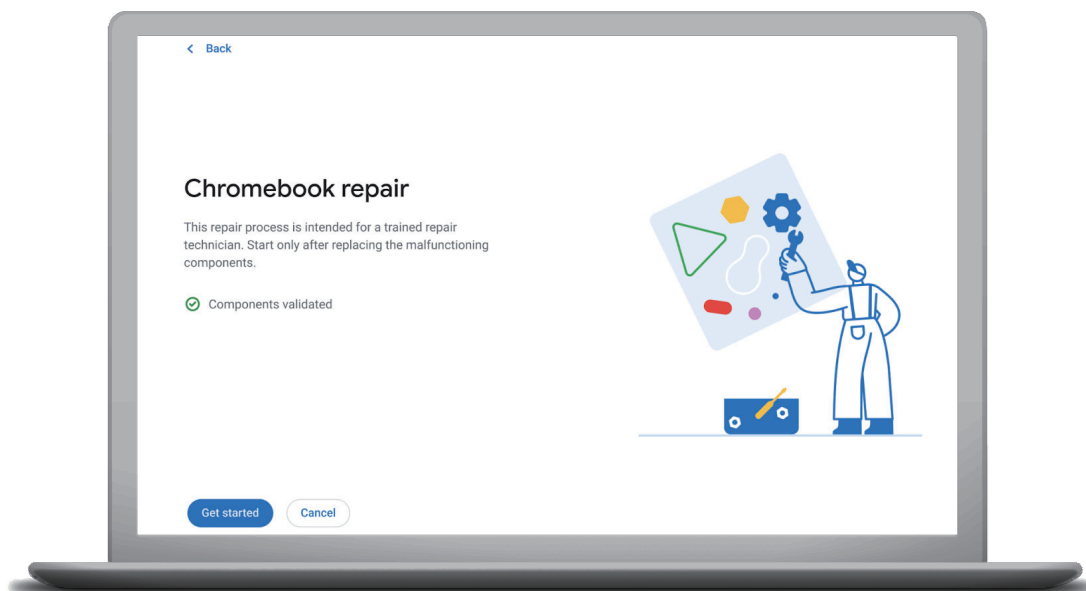

Before we get started, let's review the equipment you may need:

- Make sure you have any necessary tools to complete the repair or open the device.
- RSU setup to disable the hardware write protection. This includes a RSU-enabled security key, QR code scanner, and a secondary device on Wi-Fi.
- Make sure the Chromebook you are servicing is up to date (M107 or higher). If the device requires an update, it can be completed over Wi-Fi, Ethernet, or manually using a Recovery USB.
- ChromeOS Recovery USB or SD card.

Launching the Repair Flow

Before starting the Shimless workflow, make sure you have already replaced the malfunctioning components.

If you are not sure what components need to be replaced, you can use the Chromebook Diagnostic Tool or any internal OEM diagnostics.

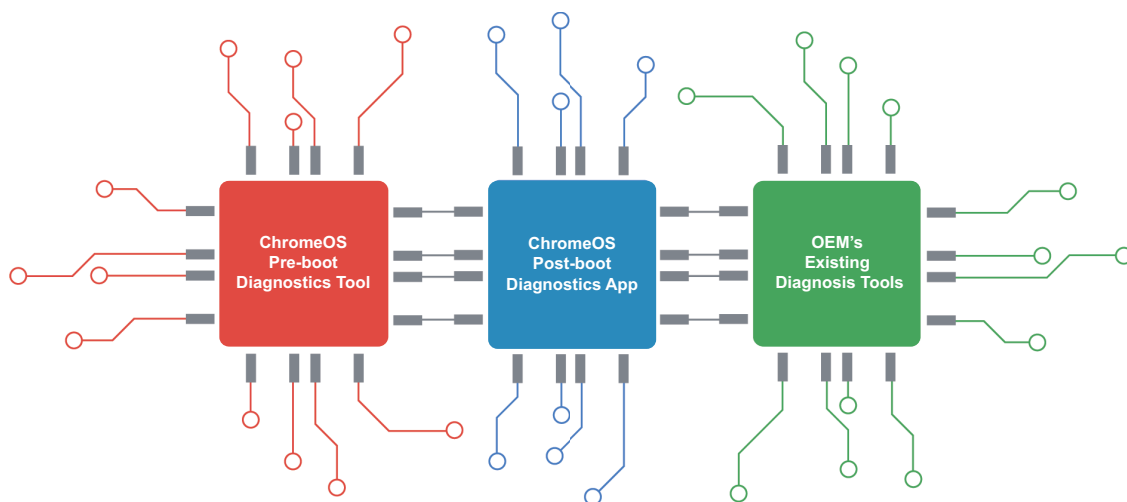

Step 1: Replace Malfunctioning Components

Any broken parts should be replaced **before** launching the repair flow.

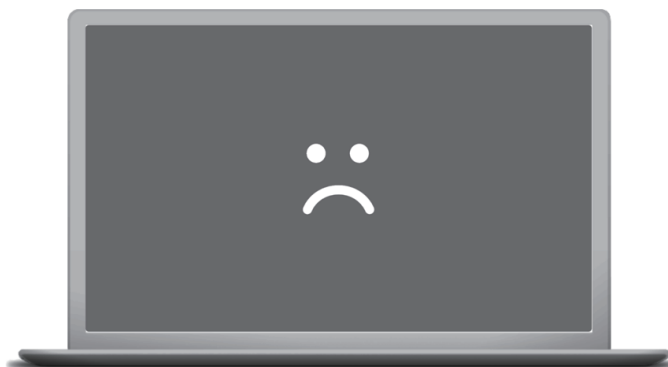

Step 2: Boot into ChromeOS

You don't need to login to initiate the Shimless RMA process.

If the message "ChromeOS is missing or damaged" appears on screen, you may need to use a Recovery USB to restore the OS first.

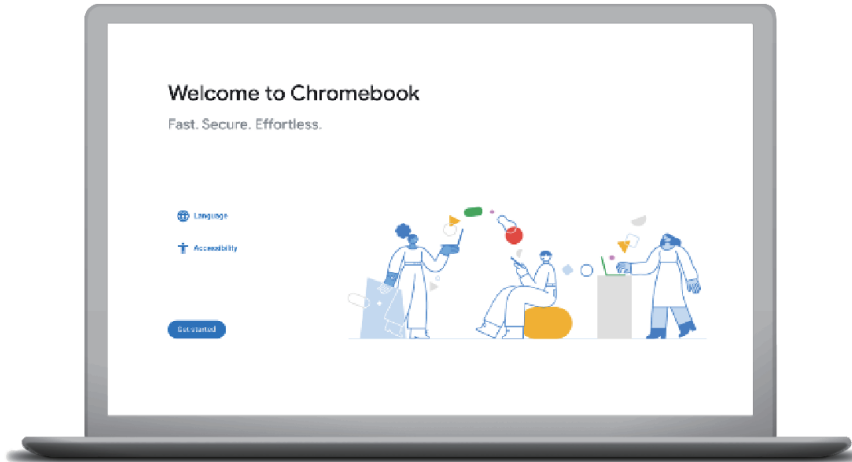

Step 3: Initiate the Shimless RMA Flow

To initiate the Repair Flow, we will need to use the new Shimless RMA Key combination. While **holding down the power button**, press the **Refresh button 3 times**. For best results, the Key Combination must be completed **within 3 seconds**.

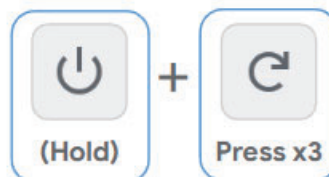

The device will then initiate the Shimless repair flow. The Chromebook will then validate the installed components. This may take up to 10 seconds.



Step 4: Components Validation

Once your components are validated, the screen will update with a message letting you know that the device is ready to start the repair flow.



Step 5: Replaced Component(s)

Select all the components that were replaced. Remember that you can scroll down to choose more than one component if it applies.

All the selections available correspond to the current Chromebook you are servicing.

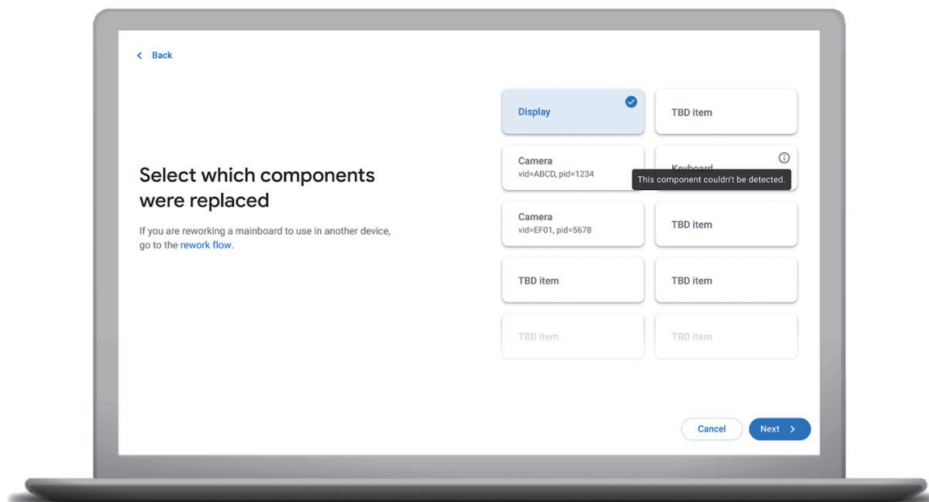

⇒ NOTE:

If the Main Logic Board (MLB) is being reworked, you will select the option to go directly to MLB rework flow.

Step 6: Who Will Be Using the Device?

After completing the repair, you will select whether the device is going to a new school, organization, enterprise or the existing one.

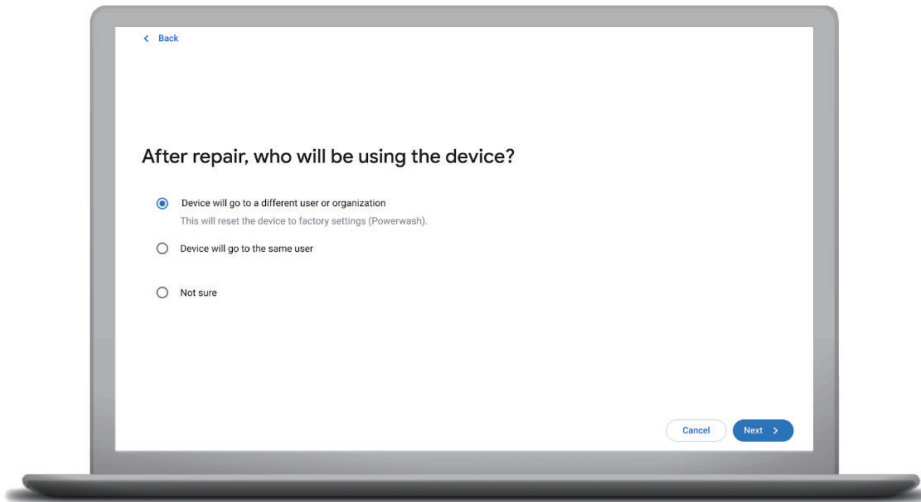

⇒ NOTE:

Same or Different User does not necessarily mean the same or another human being. A User can mean a company, school, or individual consumer.

The repair flow **may differ** depending on where the device is being sent and the components replaced during the repair. Make sure to **mark your choices accurately**.

Disable Write Protect (Different User)

Next, you will indicate how to disable Write Protect.

To utilize RSU (RMA Server Unlock), you will need to: scan a QR code using a hand-held scanner, a computer with the Chrome web browser installed, and an RSU-enabled security key in order to disable Write Protect.

- If the device is **unenrolled**, you can choose to disable Write Protect with RSU or the manual disablement option.
- If the device is **enrolled**, you will only be able to choose the RSU option.

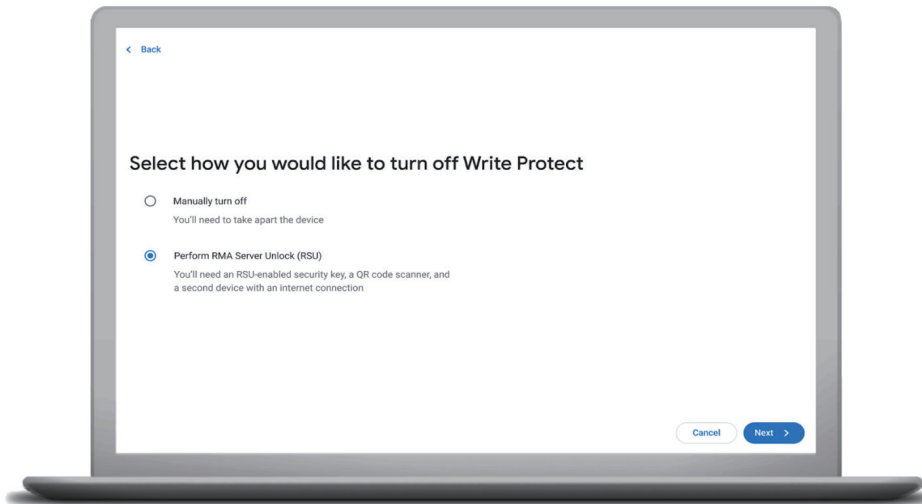

⇒ NOTE:

Not all repairs require turning off the Write Protect. In these cases, you will be prompted to the final step.

Once the Write Protect is disabled, you will not be able to **exit out of the repair flow** until you have completed the process.

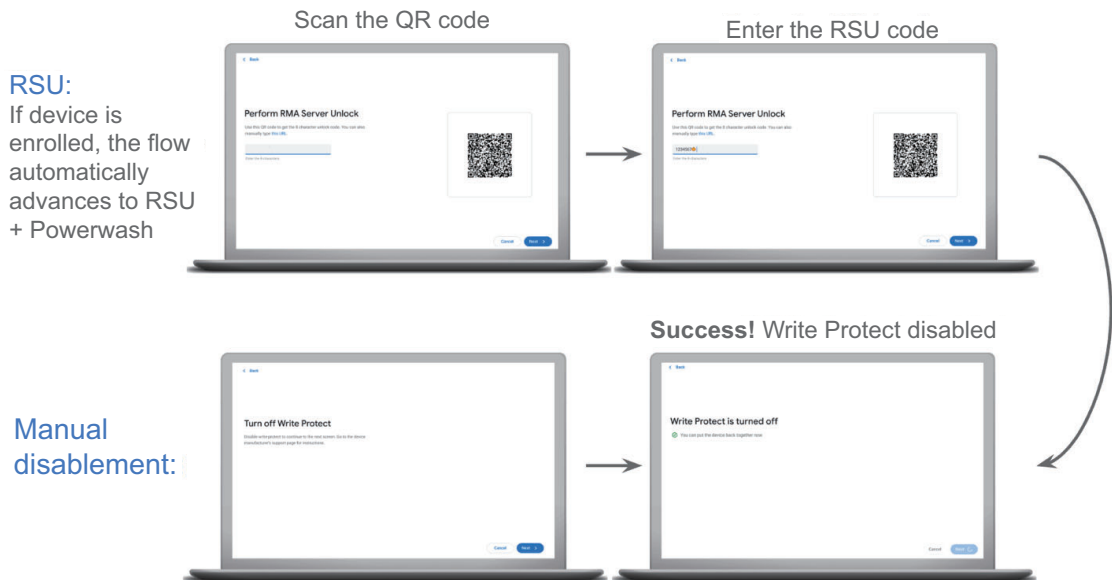

⇒ **NOTE:**

The manual disconnect method may vary depending on device. Refer to the device manufacturer's support page for the instructions.

Install Firmware Image

You will need to insert a USB thumbdrive or an SD Card that contains the Chromebook Recovery Utility image to recover the firmware.

If the device does not support the RO firmware verification, you **MUST** reimage the firmware using a Recovery USB thumbdrive.

Confirm Basic Information

During this step, you will be able to change any basic information about the device if necessary.

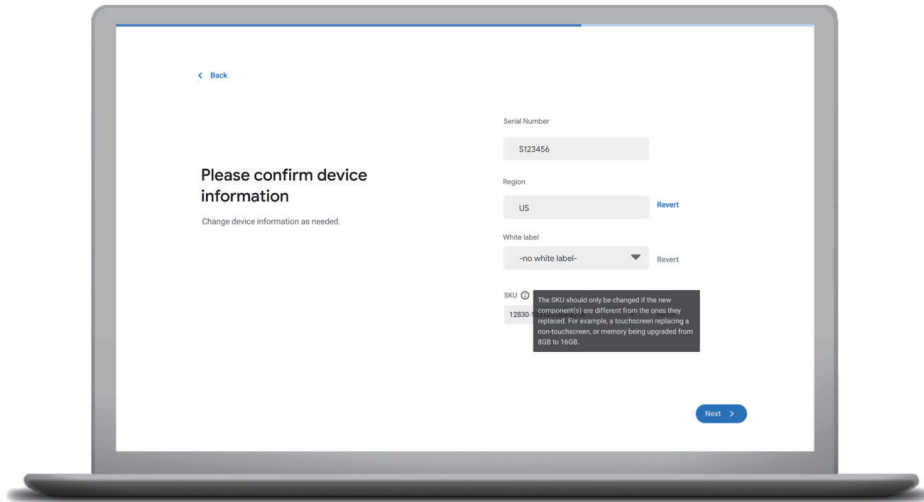

Provisioning the Device

At this stage, a variety of silent provisions will be happening in the background during the repair flow:

- Fingerprint sensor (if present) is reset.
- Registration code (if present) is cleared.
- Device stable secret is regenerated.
- FW_CONFIG is updated if the SKU changed.
- SSFC is updated if the replaced component(s) are second source.
- Replaced component(s) are silently calibrated if needed (eg. speakers).

Calibrate Components

Some components, such as the accelerometer, will require you to take certain steps to calibrate.

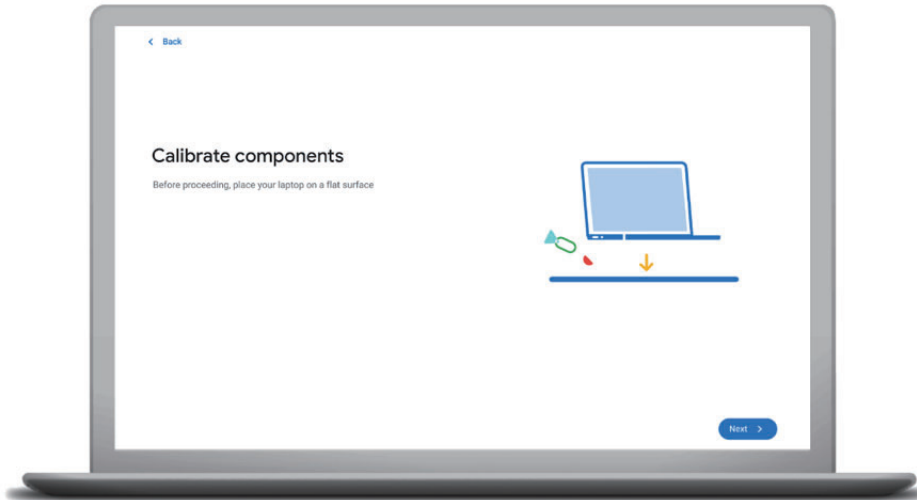

Finalizing the Repair

Once you see this screen, you're almost to the finish line of the RMA process.



Repair is Complete

Once the repair is complete, you can shut down the device or take additional actions, like running diagnostics, viewing RMA logs, etc.

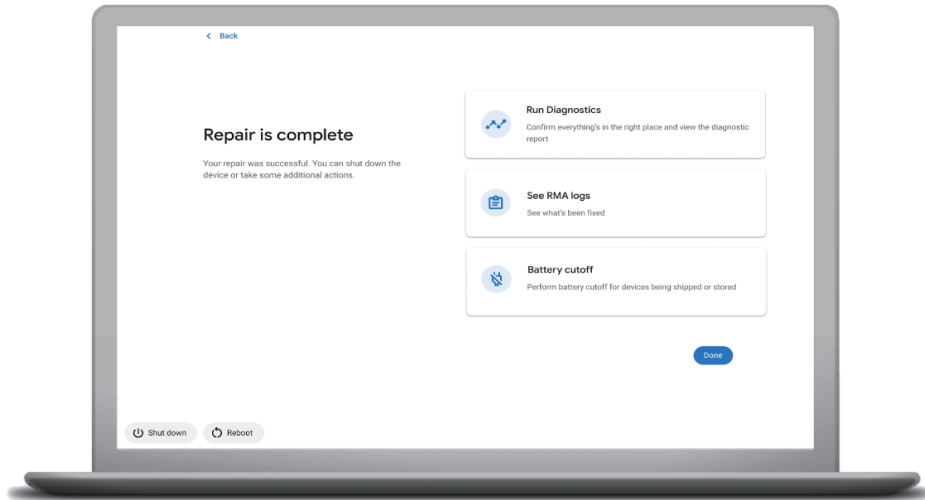

⇒ NOTE:

If you choose not to download the RMA logs at this screen, you may not be able to go back to get them later.

Disable Write Protect (Same User)

The first thing you will need to do is indicate how to disable Write Protect.

To utilize RSU (RMA Server Unlock), you will need to: scan a QR code using a hand-held scanner, a computer with the Chrome web browser installed, and an RSU-enabled security key in order to disable Write Protect.

- If the device is **unenrolled**, you can choose to disable Write Protect with RSU or the less secure manual disablement option.
- If the device is **enrolled**, you will have the option to disable the Write Protect using RSU or the less secure manual disablement option. Please **refer to your internal OEM guidelines on which path to take**.

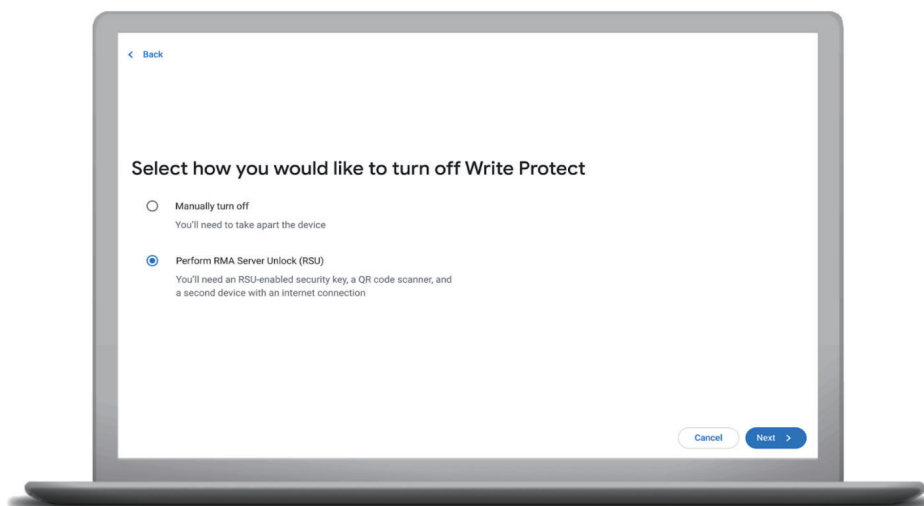

⇒ NOTE:

Not all repairs require turning off the Write Protect. In these cases, you will be prompted to the final step.

Once the Write Protect is disabled, you will not be able to **exit out of the repair flow** until you have completed the process.

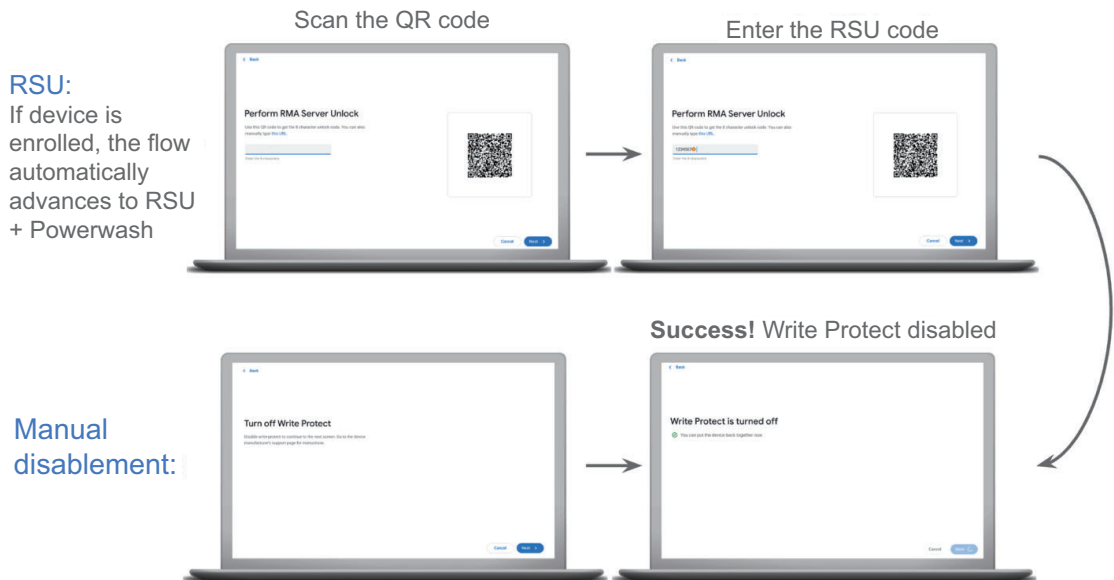

⇒ **NOTE:**

The manual disconnect method may vary depending on device. Refer to the device manufacturer's support page for the instructions.

⇒ **NOTE:**

If the QR Code appears on the screen, please contact your Chromebook Administrator at school or business for further assistance.

Install Firmware Image

You will need to insert a USB thumbdrive or an SD Card that contains the Chromebook Recovery Utility image to recover the firmware.

If the device does not support the RO firmware verification, you **MUST** reimage the firmware using a Recovery USB thumbdrive.

Confirm Basic Information

During this step, you will be able to change any basic information about the device if necessary.

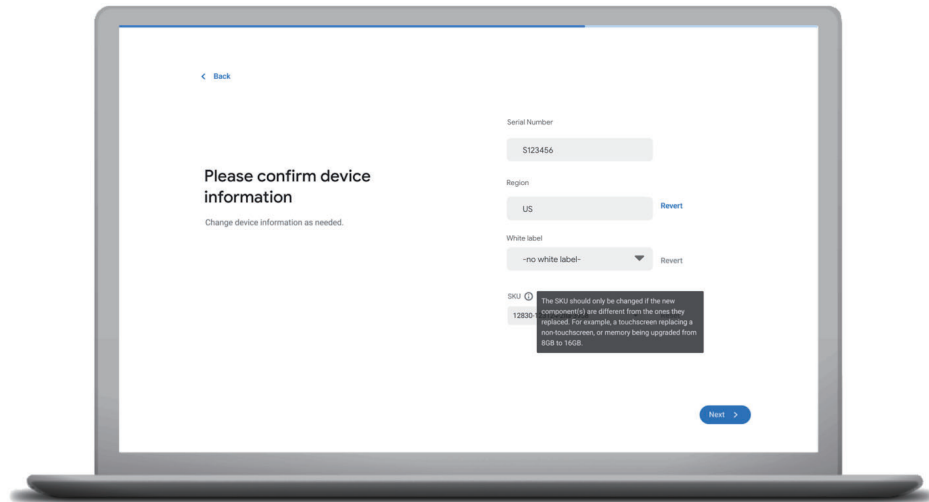

Provisioning the Device

Similar to the Different User process, the device is silently provisioned. However, the following steps will be skipped:

- Fingerprint is NOT reset.
- Registration code is NOT cleared.
- Device stable secret is NOT regenerated.

Calibrate Components

Some components, such as the accelerometer, will require you to take certain steps to calibrate.

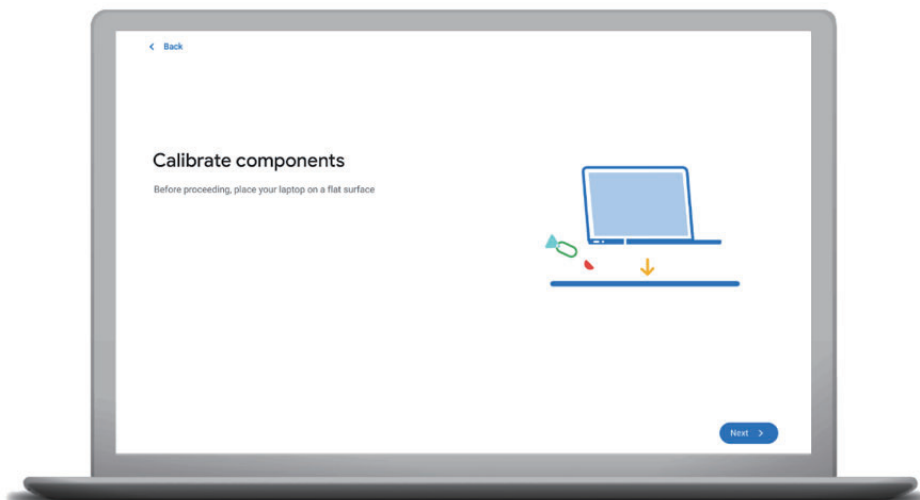

Finalizing the Repair

Once you see this screen, you're almost to the finish line of the RMA process.

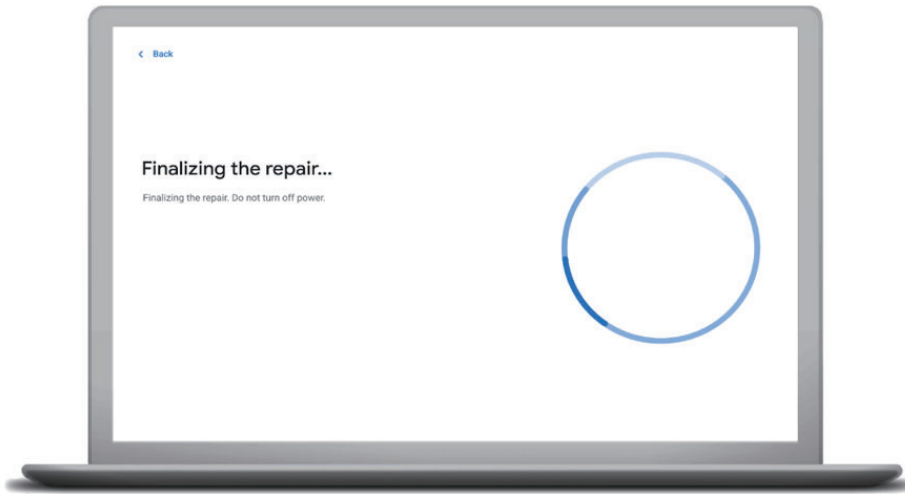

Repair is Complete

Once the repair is complete, you can shut down the device or take additional actions, like running diagnostics, viewing RMA logs, etc.

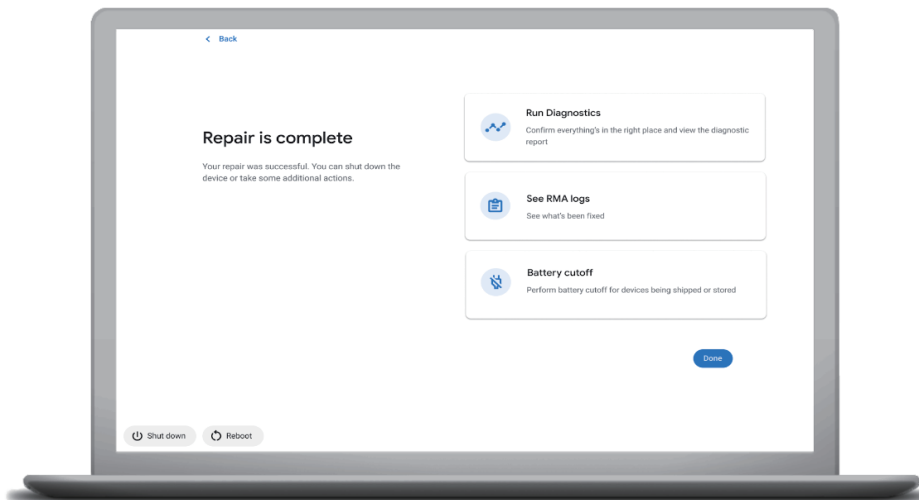

⇒ NOTE:

If you choose not to download the RMA logs at this screen, you may not be able to go back to get them later.