

LinkStation User Manual

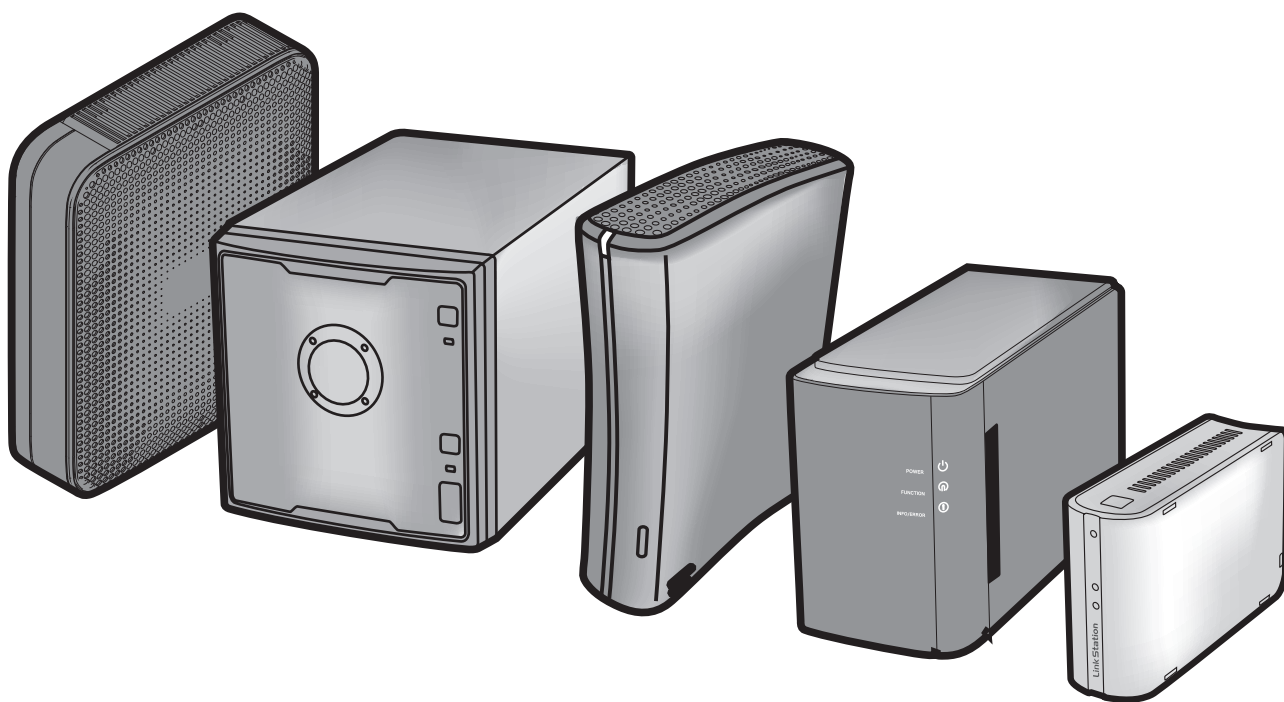

Buffalo Inc.
www.buffalotech.com

Contents

Chapter 1

Setup 5

| | |
|---|----|
| LinkNavigator Setup (LS-VL, LS-XHL, LS-CHL) | 5 |
| LinkNavigator Setup (LS-WVL, LS-WXL)..... | 7 |
| LinkNavigator Setup (LS-WSXL)..... | 9 |
| LinkNavigator Setup (LS-QVL)..... | 12 |
| LinkNavigator Setup (LS-XL) | 14 |
| Diagrams and Layout (LS-VL, LS-XHL, LS-CHL)..... | 16 |
| Diagrams and Layout (LS-WVL, LS-WXL) | 18 |
| Diagrams and Layout (LS-WSXL)..... | 20 |
| Diagrams and Layout (LS-QVL) | 22 |
| Diagrams and Layout (LS-XL) | 24 |

Chapter 2

Using your LinkStation..... 25

| | |
|---|----|
| Opening the Shared Folder..... | 25 |
| Opening the Shared Folder from Another PC..... | 26 |
| Adding Another LinkStations..... | 27 |
| Power Modes..... | 28 |
| Turning Off the Power in the LS-XL Series | 30 |
| Changing the IP Address..... | 31 |
| Settings..... | 32 |
| LinkStation Function List | 35 |
| Shared Folders | 36 |
| Access Restrictions | 40 |

| | |
|---------------------------------|-----|
| Disk Quotas..... | 50 |
| FTP Server..... | 55 |
| Direct Copy | 58 |
| Users/Groups..... | 60 |
| Adding Users..... | 60 |
| Adding Groups | 61 |
| Admin Password | 62 |
| Network..... | 63 |
| Jumbo Frame..... | 63 |
| Web Server | 65 |
| MySQL Server..... | 66 |
| System Settings..... | 67 |
| Name, Date, and Time | 67 |
| System Storage..... | 69 |
| Check Disk..... | 69 |
| Format a Drive..... | 71 |
| Adding Storage | 73 |
| Remove Disk..... | 77 |
| System Backup..... | 78 |
| Time Machine..... | 78 |
| System Backup..... | 82 |
| RAID Arrays | 90 |
| RAID Scanning | 101 |
| Maintenance..... | 102 |
| Email Notification | 102 |
| Power Management | 104 |
| UPS Settings | 104 |
| Sleep Timer..... | 105 |
| Restoring Factory Defaults..... | 107 |
| Format the LinkStation | 110 |
| Online Update..... | 111 |
| Extensions | 112 |
| WebAccess | 112 |

| | |
|--|-----|
| Network-USB Server | 113 |
| Print Server..... | 115 |
| BitTorrent Client | 122 |
| DLNA Server..... | 124 |
| Using iTunes Server..... | 133 |
| Squeezebox Server | 134 |
| Flickr Support..... | 135 |
| Eye-Fi Connected..... | 138 |
| Connecting to a Remote LinkStation | 140 |

Chapter 3

| | |
|-----------------------------|------------|
| NAS Navigator2 | 142 |
|-----------------------------|------------|

Chapter 4

| | |
|-----------------------|------------|
| Settings | 147 |
|-----------------------|------------|

| | |
|----------------------|-----|
| Home..... | 147 |
| Shared Folders | 148 |
| Users/Groups..... | 151 |
| Network..... | 154 |
| System | 161 |
| Extensions | 175 |

| | |
|----------------------|------------|
| Appendix..... | 181 |
|----------------------|------------|

| | |
|---------------------------------|-----|
| Specifications | 181 |
| Default Settings..... | 183 |
| Mapping Additional Shares | 184 |
| Windows | 184 |
| Mac OS..... | 185 |
| Software | 186 |

| | |
|--|-----|
| Info Folder | 188 |
| Status LED (LS-VL, LS-XHL, LS-CHL) | 189 |
| Status LED (LS-WVL, LS-WXL) | 192 |
| Status LED (LS-WSXL) | 197 |
| Status LED (LS-QVL) | 201 |
| Status LED (LS-XL)..... | 206 |
| Compliance Information | 207 |
| Troubleshooting..... | 208 |
| Data Backup..... | 210 |
| GPL Information | 210 |

Chapter 1

Setup

LinkNavigator Setup (LS-VL, LS-XHL, LS-CHL)

- 1 Connect the LinkStation with an Ethernet cable and the included AC adapter. Plug the power cord into a surge protector or power outlet. Connect the Ethernet cable to a router, hub, or switch on your network. The Ethernet cable will “click” and lock in place when inserted properly.

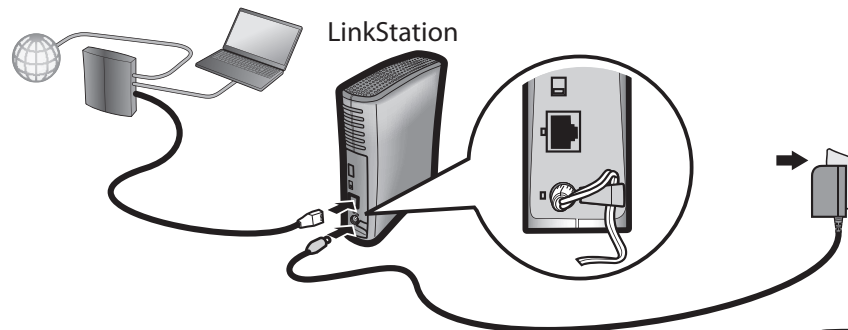

- 2 Move the power mode switch on the back of the LinkStation to the on position.

Note: Do not set the power mode switch to auto at this time. After the initial installation is complete, then the Auto Power Mode may be used.

- 3 Wait until the power LED stops blinking and glows a steady blue.

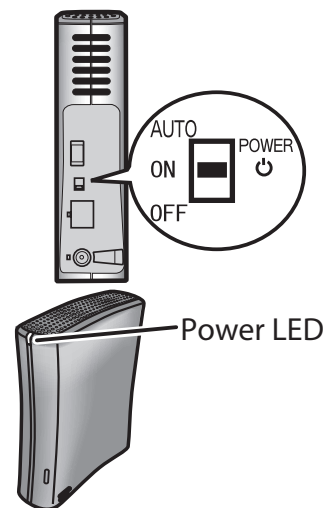

- 4 Insert the Utility CD in your computer's CD drive. LinkNavigator will launch. Click *Begin Installation*. The wizard will guide you through installation.



This example shows a LinkStation Pro (LS-VL). Your screen may be slightly different.

If LinkNavigator does not launch automatically, open the Utility CD and double-click  *LSNavi.exe*.

Notes:

- If you are using Windows 8, Windows 7 or Vista, the autoplay screen may appear. Click *Run LSNavi.exe*.
- If “Do you want to allow the following program to make changes to this computer?” is displayed in Windows 8, Windows 7 or Vista, click *Yes*.
- If “A program needs your permission to continue” is displayed in Windows Vista, click *Continue*.
- For Mac OS, double-click the LinkNavigator icon in the utility CD.
- If you have problems installing, temporarily disable your anti-virus software and software firewall. After setup is complete, re-enable the software.
- If your computer does not have a CD drive, you may download the LinkNavigator software from www.buffalotech.com.

5 Click *Finish*. NAS Navigator2 starts automatically.

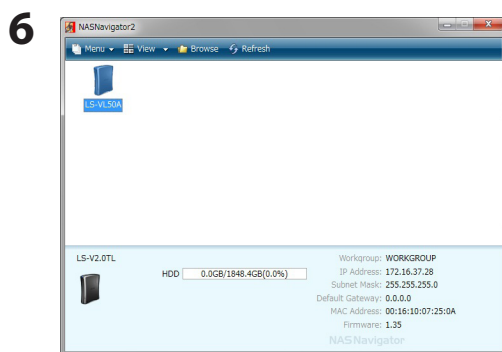

In NAS Navigator2, double-click your LinkStation’s icon.

7 The LinkStation’s shared folder opens. You can now use the LinkStation’s shared folder to save files just like any other folder.

Note: With Mac OS, the LinkStation is mounted as a drive icon on the desktop, or it is displayed in the sidebar of the Finder.

Setup is now complete.

LinkNavigator Setup (LS-WVL, LS-WXL)

- 1 Connect the LinkStation with an Ethernet cable and the included AC adapter. Plug the power cord into a surge protector or power outlet. Connect the Ethernet cable to a router, hub, or switch on your network. The Ethernet cable will “click” and lock in place when inserted properly.

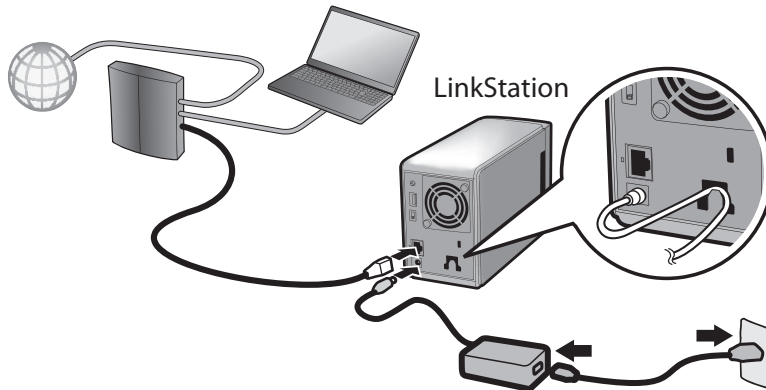

- 2 Move the power mode switch on the back of the LinkStation to the “on” position.
Note: Don’t set the power mode switch to the “auto” position until the initial installation is complete.

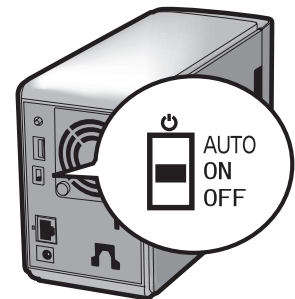

- 3 Wait until the power LED stops blinking and glows a steady blue.

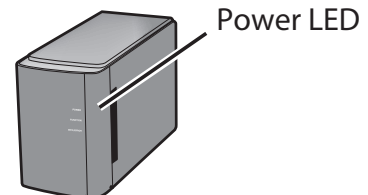

- 4 Insert the Utility CD in your computer’s CD drive. LinkNavigator will launch. Click *Begin Installation*. The wizard will guide you through installation.



This example shows a LinkStation Pro Duo (LS-WVL). Your screen may be slightly different.

If LinkNavigator does not launch automatically, open the Utility CD and double-click  *LSNavi.exe*.

Notes:

- If you are using Windows 8, Windows 7 or Vista, the autoplay screen may appear. Click *Run LSNavi.exe*.
- If “Do you want to allow the following program to make changes to this computer?” is displayed in Windows 8 or Windows 7, click *Yes*.
- If “A program needs your permission to continue” is displayed in Windows Vista, click *Continue*.
- For Mac OS, double-click the LinkNavigator icon in the utility CD.
- If you have problems installing, temporarily disable your anti-virus software and software firewall. After setup is complete, re-enable the software.
- If your computer does not have a CD drive, you may download the LinkNavigator software from www.buffalotech.com.

5 Click *Finish*. NAS Navigator2 starts automatically.

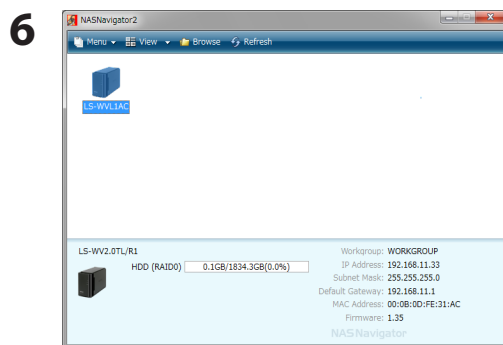

In NAS Navigator2, double-click your LinkStation’s icon.

7 The LinkStation’s shared folder opens. You can now use the LinkStation’s shared folder to save files just like any other folder.

Note: With Mac OS, the LinkStation is mounted as a drive icon on the desktop, or it is displayed in the sidebar of the Finder.

Setup is now complete.

LinkNavigator Setup (LS-WSXL)

- 1 Connect the LinkStation with the AC adaptor and an Ethernet cable. Plug the power cord into a surge protector or power outlet. Connect the Ethernet cable to a router, hub, or switch on your network. The Ethernet cable will “click” and lock in place when inserted properly.

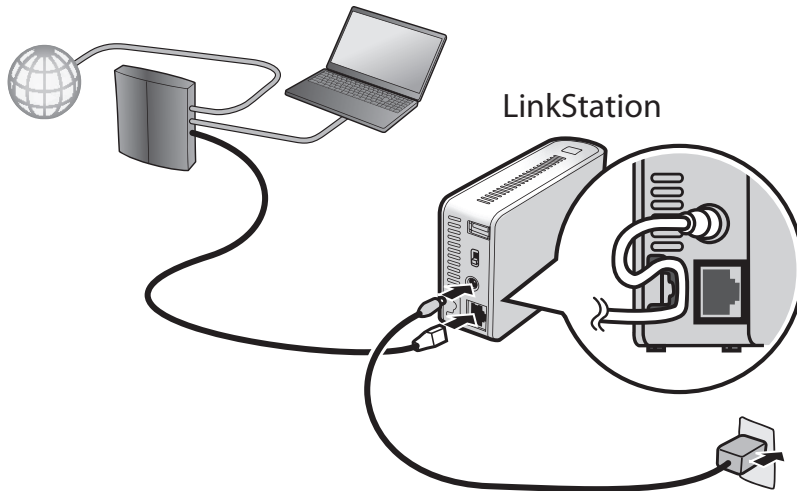

- 2 Move the power mode switch on the back of the LinkStation to the “on” position.
Note: Don't set the power mode switch to the “auto” position until the initial installation is complete.

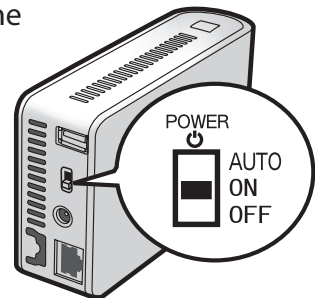

- 3 Wait until the power LED stops blinking and glows a steady blue.

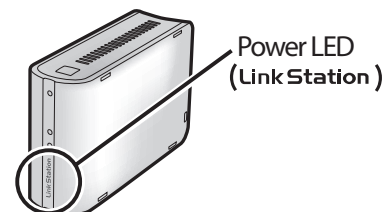

- 4** Insert the Utility CD in your computer's CD drive. LinkNavigator will launch. Click *Begin Installation*. The wizard will guide you through installation.



Notes:

- If LinkNavigator does not launch automatically, open the Utility CD and double-click *LSNavi.exe*.
- If you are using Windows 8, Windows 7 or Vista, the autoplay screen may appear. Click *Run LSNavi.exe*.
- If "Do you want to allow the following program to make changes to this computer?" is displayed in Windows 8 or Windows 7, click *Yes*.
- If "A program needs your permission to continue" is displayed in Windows Vista, click *Continue*.
- For Mac OS, double-click the LinkNavigator icon in the utility CD.
- If you have problems installing, temporarily disable your anti-virus software and software firewall. After setup is complete, re-enable the software.
- If your computer does not have a CD drive, you may download the LinkNavigator software from www.buffalotech.com.

- 5** Click *Finish*. NAS Navigator2 starts automatically.

6

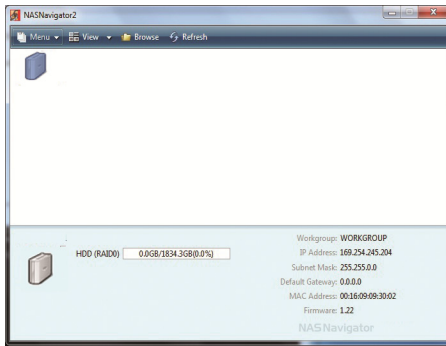

Double-click your LinkStation's icon in the NAS Navigator2 window.

7 The LinkStation's shared folder opens. You can now use the LinkStation's shared folder to save files just like any other folder.

Note: With Mac OS, the LinkStation is mounted as a drive on the desktop or displayed in the sidebar of the Finder.

Setup is now complete.

LinkNavigator Setup (LS-QVL)

- 1 Connect the LinkStation with an Ethernet cable and the included AC adapter. Plug the power cord into a surge protector or power outlet. Connect the Ethernet cable to a router, hub, or switch on your network. The Ethernet cable will “click” and lock in place when inserted properly.

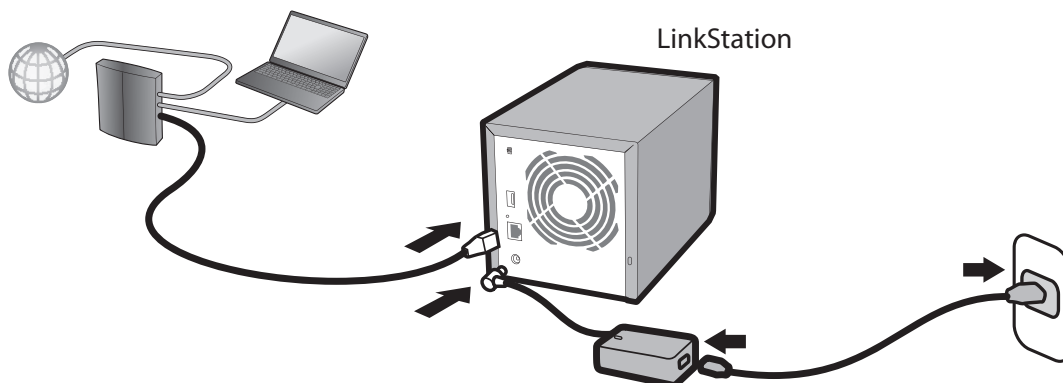

- 2 Hold down the power button on the front of the LinkStation for one second. The blue Power LED will blink as the LinkStation boots. When the LinkStation is ready, the LED will stop blinking and glow steadily.

Note: The power mode switch should be in the “on” position. Don’t set it to “auto” until the initial installation is complete.

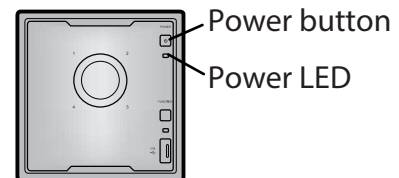

- 3 Insert the Utility CD in your computer’s CD drive. LinkNavigator will launch. Click *Begin Installation*. The wizard will guide you through installation.

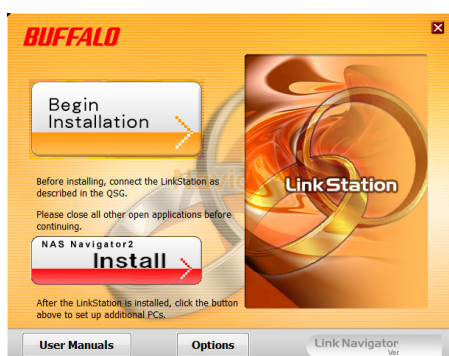

If LinkNavigator does not launch automatically, open the Utility CD and double-click  *LSNavi.exe*.

Notes:

- If you are using Windows 8, Windows 7 or Vista, the autoplay screen may appear. Click *Run LSNavi.exe*.
- If “Do you want to allow the following program to make changes to this computer?” is displayed in Windows 8 or Windows 7, click *Yes*.
- If “A program needs your permission to continue” is displayed in Windows Vista, click *Continue*.
- For Mac OS, double-click the LinkNavigator icon in the utility CD.
- If you have problems installing, temporarily disable your anti-virus software and software firewall. After setup is complete, re-enable the software.
- If your computer does not have a CD drive, you may download the LinkNavigator software from www.buffalotech.com.

4 Click *Finish*. NAS Navigator2 starts automatically.

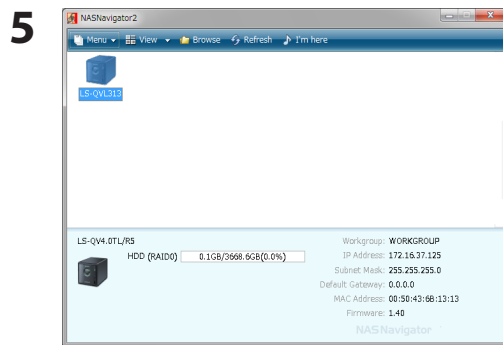

In NAS Navigator2, double-click your LinkStation’s icon.

6 The LinkStation’s shared folder opens. You can now use the LinkStation’s shared folder to save files just like any other folder.

Note: With Mac OS, the LinkStation is mounted as a drive icon on the desktop, or it is displayed in the sidebar of the Finder.

Setup is now complete.

LinkNavigator Setup (LS-XL)

- 1 Connect the LinkStation with the Ethernet cable and the AC adapter. It will power on automatically. Wait until the blue Power LED stops flashing and glows steadily.

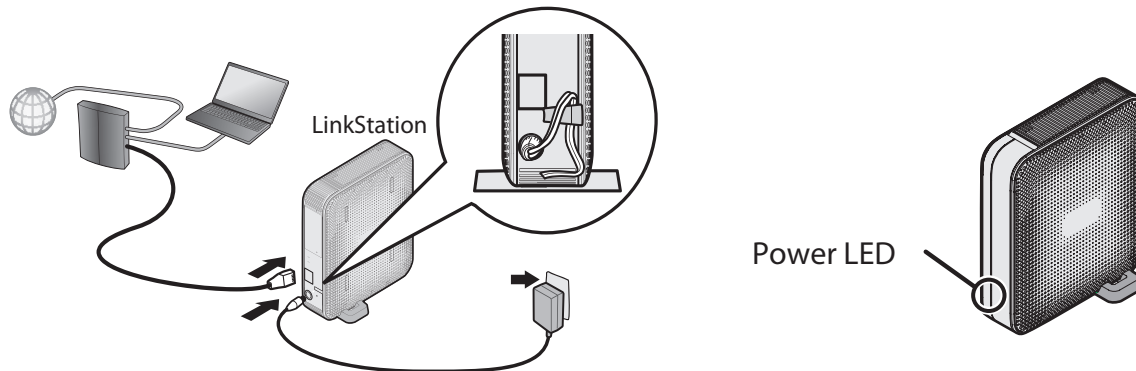

- 2 Insert the LinkNavigator CD into your computer. LinkNavigator will launch. Click *Begin Installation*. The wizard will guide you through installation.



If LinkNavigator does not launch automatically, open the Utility CD and double-click  *LSNavi.exe*.

Notes:

- If you are using Windows 8, Windows 7 or Vista, the autoplay screen may appear. Click *Run LSNavi.exe*.
- If "Do you want to allow the following program to make changes to this computer?" is displayed in Windows 8 or Windows 7, click *Yes*.
- If "A program needs your permission to continue" is displayed in Windows Vista, click *Continue*.
- For Mac OS, double-click the LinkNavigator icon in the utility CD.
- If you have problems installing, temporarily disable your anti-virus software and software firewall. After setup is complete, re-enable the software.
- If your computer does not have a CD drive, you may download the LinkNavigator software from www.buffalotech.com.

3 Click *Finish*. NAS Navigator2 starts automatically.

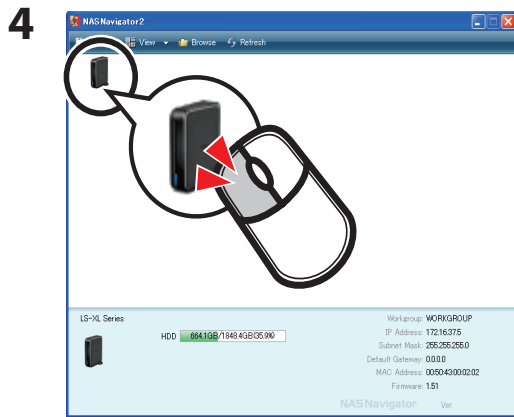

In NAS Navigator2, double-click your LinkStation's icon. This opens the shared folder of the LinkStation.

You can now use the LinkStation's shared folder to save files just like any other folder.

Note: For Mac OS, the LinkStation is mounted as a drive icon on the desktop, or it is displayed in the sidebar of the Finder.

Setup is now complete.

Diagrams and Layout (LS-VL, LS-XHL, LS-CHL)

Front

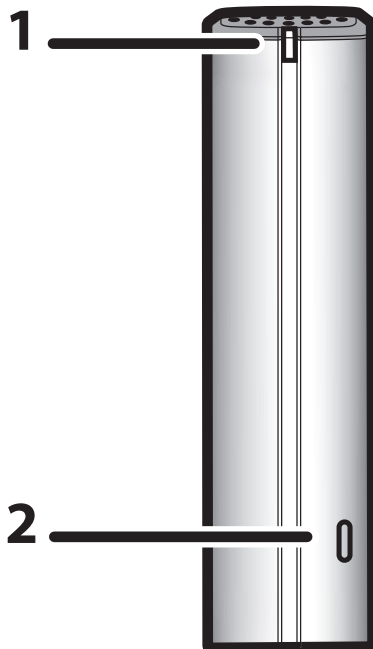

1 Power LED

Blue LED: Power on.

LED off: Power off.

Blinks blue: During startup or shutdown.

Amber light is flashing: The amber light flashes if there is a message. Flashing pattern varies depending on the message. For more information, refer to "Status LED" on page 192.

Red light is flashing: Red light flashes when an error occurs. Flashing pattern varies depending on the message. For more information, refer to "Status LED" on page 190.

2 Function Button

The Function button initiates direct copy, dismounts USB devices, and is used to initialize the LinkStation

Back

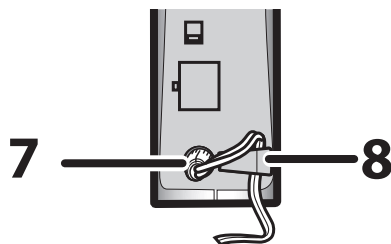
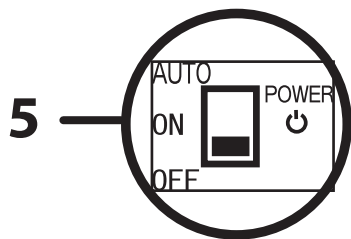
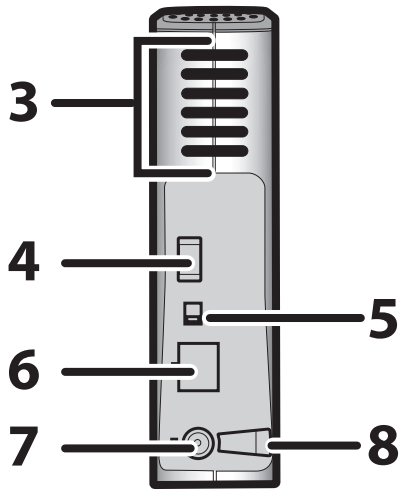

3 Fan

Do not block the fan when installing the unit.

4 USB 2.0 Connector

You may attach a USB device such as a digital camera, printer, memory card reader, or hard drive. USB hubs, mice, keyboards, and all-in-one printers are not supported. USB card readers that support multiple memory cards may not function properly.

5 Power Mode Switch

Auto: Automatically powers the LinkStation on and off with your computer.

On: Turns the LinkStation on.

Off: Turns the LinkStation off.

6 LAN Port Connect an Ethernet cable here. The LED by the LAN port turns green when the unit is connected to the network and flashes when there is network activity.

7 Power Connector Connect the AC adapter here. When it's connected properly, the LED to the right will glow green.

8 Hook Use as a strain relief for the AC adapter cable.

Diagrams and Layout (LS-WVL, LS-WXL)

Front

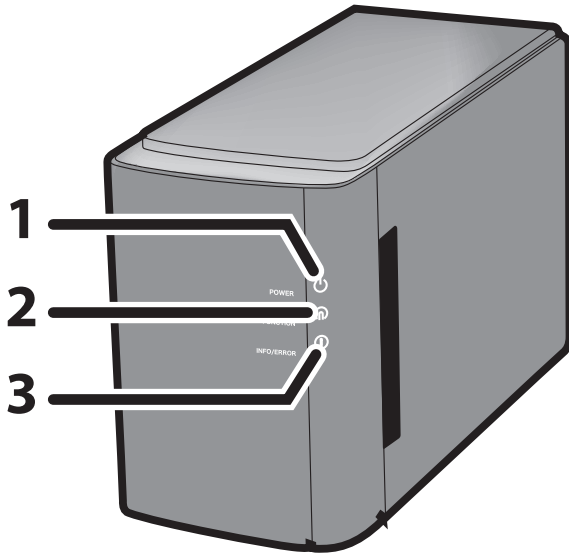

Back

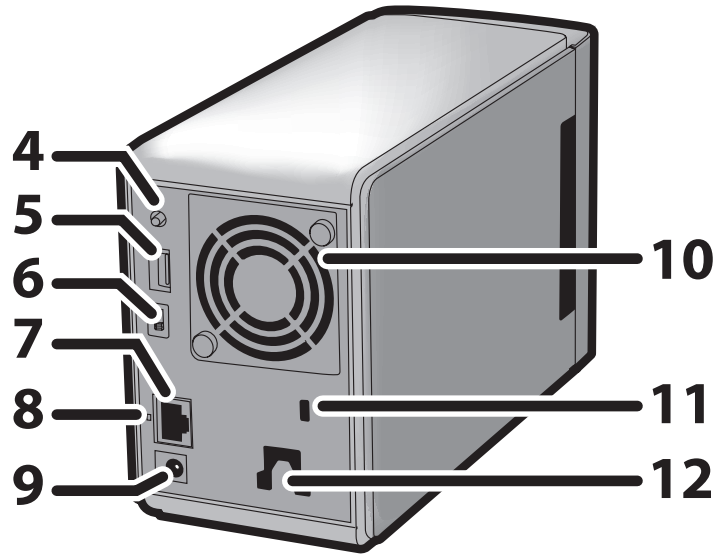

Note: – Do not lift the LinkStation by its front cover. It might come off.

1 Power LED

Blue LED: Power on.

LED off: Power off.

Blinks blue: During startup or shutdown.

2 Function LED

The function LED glows blue when direct copy is finished, during initialization, and during USB dismounting (about 60 seconds). During direct copy it blinks blue.

3 Info/Error LED

The info/error LED blinks orange when there's a message and red when there's an error.

4 Function Button

The function button initiates direct copy, dismounts USB devices, and is used to initialize the LinkStation.

5 USB 2.0 connector

You may attach a USB device such as a digital camera, printer, memory card reader, or hard drive. USB hubs, mice, keyboards, and all-in-one printers are not supported. USB card readers that support multiple memory cards may not function properly.

6 Power Mode Switch

Auto: The LinkStation turns on and off automatically with your PC (s).

On: The LinkStation boots and is operational.

Off: The LinkStation shuts down.

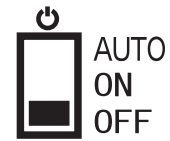

7 LAN Port

Connect to your LAN with an Ethernet cable.

8 Link/Act LED

Glows green for connection.

Blinks green for access.

9 Power connector

The AC adaptor connects here.

10 Fan

Do not block the fan when installing the unit.

11 Security lock for anti-theft

Many security cables are compatible with this lock.

12 Hook

Secure the power cable so that it does not come off by mistake. Slide the cable down to secure.

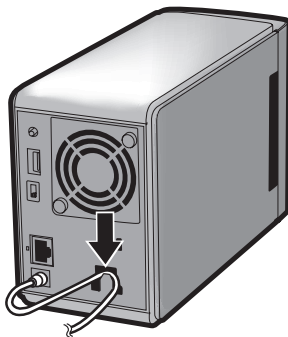

Diagrams and Layout (LS-WSXL)

Front

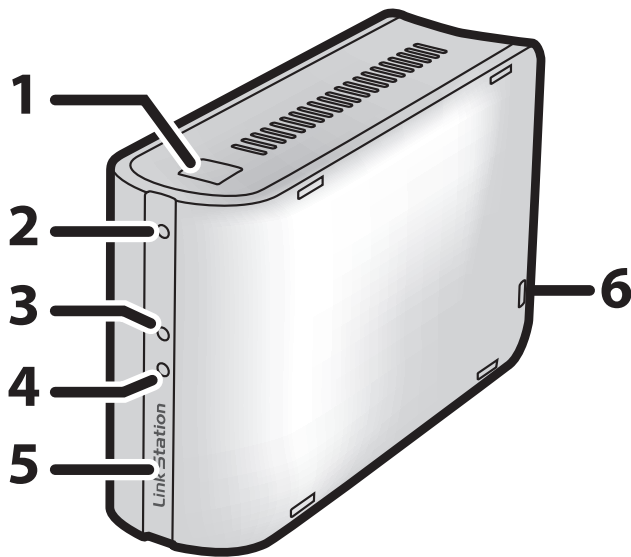

Back

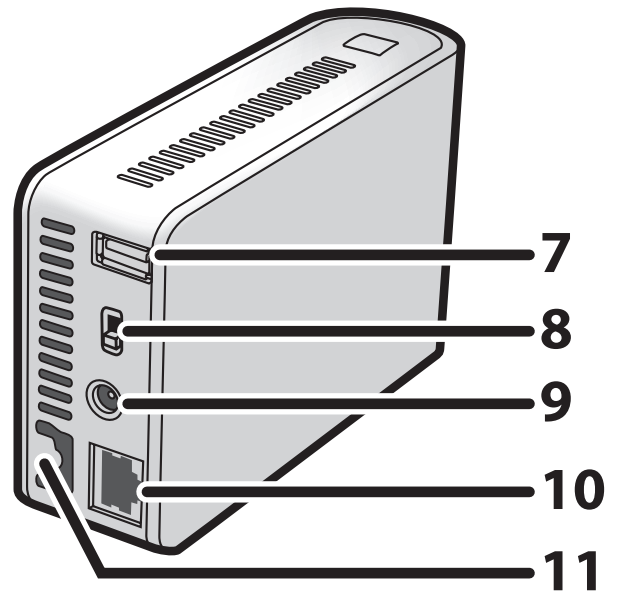

1 Function Button

The function button initiates direct copy, dismounts USB devices, and is used to initialize the LinkStation.

2 Function LED

The function LED glows blue when direct copy is finished, during initialization, and during USB dismounting (about 60 seconds). During direct copy the function LED blinks blue.

3 Link/Act LED

Glows green for connection.
Blinks green for access.

4 Info/Error LED

The info/error LED blinks orange when there's a message and red when there's an error.

5 Power LED (LinkStation)

Blue LED: Power on.

LED off: Power off.

Blinks blue: During startup or shutdown.

6 Security lock for anti-theft

Many security cables are compatible with this lock.

7 USB 2.0 connector

You may attach a USB device such as a digital camera, printer, memory card reader, or hard drive. USB hubs, mice, keyboards, and all-in-one printers are not supported. USB card readers that support multiple memory cards may not function properly.

8 Power Mode Switch

Auto: The LinkStation turns on and off automatically with your PC(s).

On: The LinkStation boots and is operational.

Off: The LinkStation shuts down and turns off.

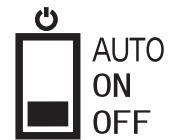

9 Power connector

The AC adaptor connects here.

10 LAN Port

Connect to your LAN with an Ethernet cable.

11 Hook

Secure the power cable so that it does not come off by mistake. Slide the cable down to secure.

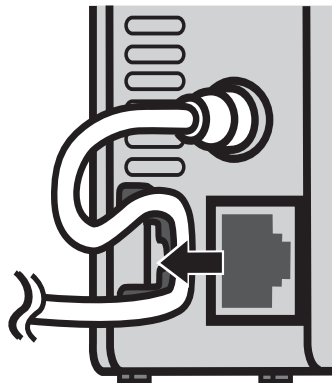

Diagrams and Layout (LS-QVL)

Front

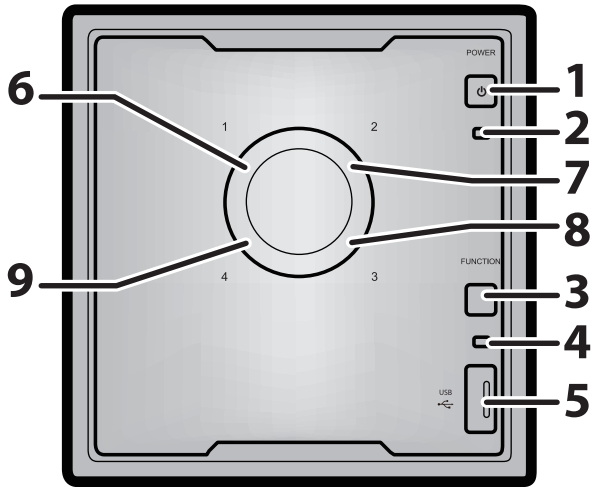

Back

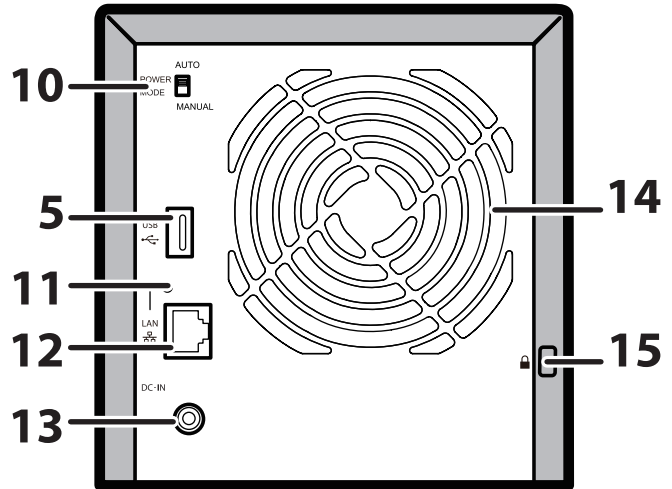

1 Power Button

Power on: Press the power button to turn on.

Power off: Press and hold the power button for 3 seconds.

2 Power LED

Blue LED: Power on.

LED off: Power off.

Blinks blue: During startup or shutdown.

Amber light is flashing: The amber light flashes if there is a message. Flashing pattern varies depending on the message. For more information, refer to "Status LED" on page 204.

Red light is flashing: Red light flashes when an error occurs. Flashing pattern varies depending on the message. For more information, refer to "Status LED" on page 202.

3 Function Button

Use this button to perform the following operations:

- DirectCopy
- Removal of USB devices
- Restoring factory defaults

4 Function LED

The function LED glows blue when operating the function button.

5 USB 2.0 Connector

You may attach a USB device such as a digital camera, printer, memory card reader, or hard drive. USB hubs, mice, keyboards, and all-in-one printers are not supported. USB card readers that support multiple memory cards may not function properly.

6 ~ 9 Status LEDs 1 to 4

These display the status of the hard drive corresponding to the drive number.

Glowing green: Normal operation (flashes during access)

Glowing red: An error occurred in the hard drive. Replace the hard drive for the drive number that is lit red.

10 Power Mode Switch

Switches between auto and manual power modes (page 29).

11 LINK/ACT LED

Glowing green: Linked

Flashing green: Accessing

12 LAN Port

Connect to a router, hub, or switch on your Ethernet network.

13 Power Connector

Use the included AC cable to connect.

14 Fan

Do not block the fan.

15 Anti-Theft Security Slot

You can also secure it using an off-the-shelf wire lock.

Diagrams and Layout (LS-XL)

Front

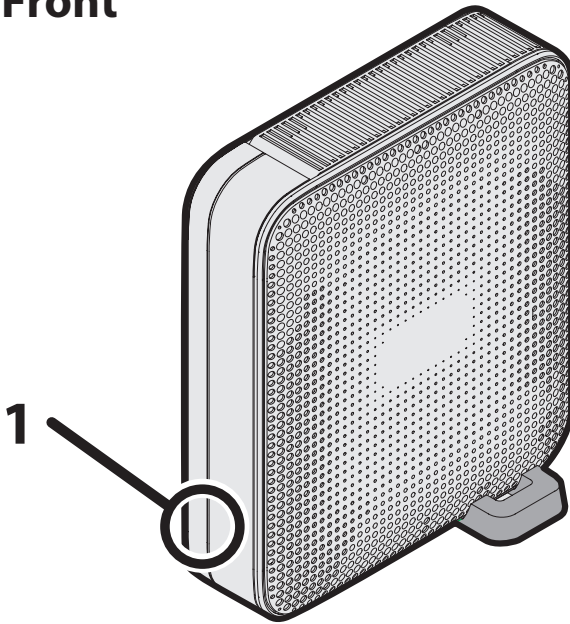

Back

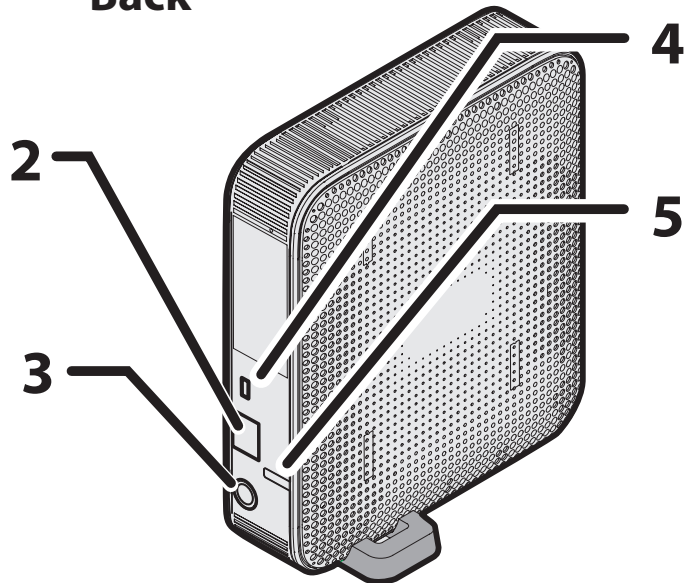

1 Power LED

The blue Power LED glows when you connect the AC adapter. The blue LED blinks while booting, shutting down, or updating firmware.

Note: Do not disconnect the AC adapter while the blue LED is on or blinking. You may shut down the LinkStation from Settings or from NAS Navigator2. If the AC adapter is unplugged without first shutting down the LinkStation properly, the unit may be damaged. Refer to page 30 to shut down your LinkStation properly.

2 LAN Port

Connect to a router, hub, or switch on your Ethernet network. When LAN port 2 is connected to a network, it is illuminated in green.

3 Power Connector

Use the included AC cable to connect.

4 Anti-Theft Security Slot

Use this slot to secure your LinkStation with a Kensington-type cable lock (not included).

5 Hook

Use as a strain relief for the AC adapter cable.

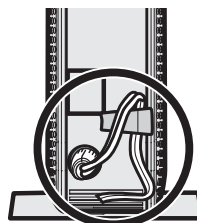



Chapter 2

Using your LinkStation

Opening the Shared Folder

1 Launch NAS Navigator2.

- Windows: Double-click the  icon on the desktop.
- Mac OS: Click the  icon in the Dock.

2

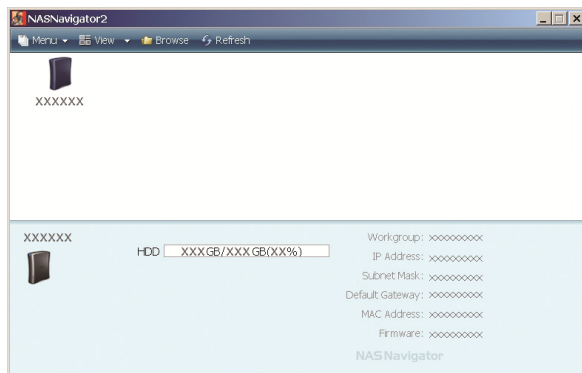

Double-click the LinkStation's icon.

3 The LinkStation's shared folder opens.

Note: In Mac OS, the share is mounted as a drive icon on the desktop, or displayed in the sidebar of the Finder.

You can now use the LinkStation's shared folder to save files just like any other folders.

Opening the Shared Folder from Another PC

After the LinkStation is installed on one computer, you don't have to go through the full installation to add a second computer. Just install NAS Navigator2 on each additional computer to access the LinkStation.

1 Insert the Utility CD in your computer's CD drive. LinkNavigator will launch.

Notes:

- If LinkNavigator does not open, open the Utility CD and double-click  *LSNavi.exe*.
- If you are using Windows 8, Windows 7 or Vista, the autoplay screen may appear. Click *Run LSNavi.exe*.
- If "Do you want to allow the following program to make changes to this computer?" is displayed in Windows 8 or Windows 7, click *Yes*.
- If "A program needs your permission to continue" is displayed in Windows Vista, click *Continue*.
- For Mac OS, double-click the LinkNavigator icon in the utility CD.

2





Click *Options - Additional Software Installation*.

For Mac OS, click *Begin Installation*.

3 Follow the instruction on the screen to install NAS Navigator2.

4 After NAS Navigator2 is installed, click  at the top right top of the installer window to close it.

5 Launch NAS Navigator2:

- Windows: Double-click the  icon on the desktop.
- Mac OS: Click the  icon in the Dock.

6

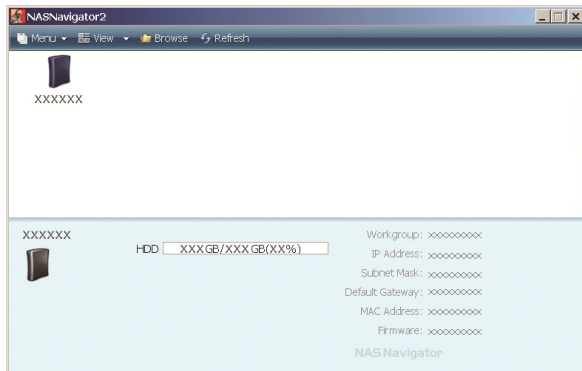

Double-click the LinkStation icon.

7 The LinkStation's shared folder opens.

Note: On Mac OS, LinkStation is mounted as a drive icon on the desktop, or displayed in the sidebar on the Finder.

Setup is complete. You can now use the LinkStation's shared folder to save files just like any other folders.

Adding Another LinkStations

To add one or more additional LinkStations to your network, rerun the installation program for each one.

Power Modes

The LinkStation can automatically turn on and off with your computers. To use this feature, install NAS Navigator2 on each computer and then set the power mode switch to the auto position.

LS-VL, XHL, CHL

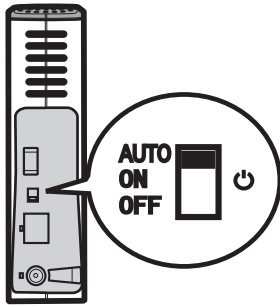

LS-WVL, WXL

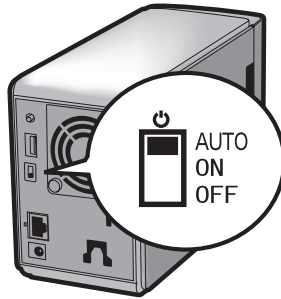

LS-WSXL

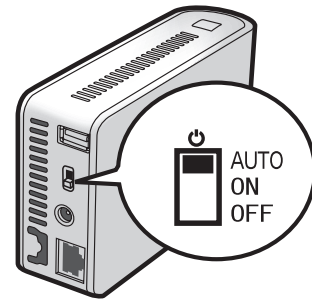

Auto: When the switch is in the auto position, the LinkStation automatically turns off when all computers on the network with NAS Navigator2 turn off. If any computer on the network is powered on, the LinkStation automatically powers on as well.

On: The LinkStation stays on, even when all computers are off.

Off: Turns the LinkStation off.

Notes:

- Never disconnect power from the LinkStation while the switch is in the on position.
- The Auto Power Mode may not work in some network environments. If this occurs, move the switch to the on position to use the LinkStation.
- After all computers are powered down, it may take several minutes for the LinkStation to shut down.
- During initial setup, leave the power mode switch in the on position. Do not move it to the auto position until the unit is set up and NAS Navigator2 is installed on all computers that will access the LinkStation.
- If a power outage disconnects power from the LinkStation while it's in Auto Power Mode, will not power on automatically when power is restored. Move the power mode switch to the on position to power on the LinkStation. Once the unit has booted, you can move the power mode switch back to the auto position.
- Immediately after the power mode switch is switched to the auto position, it will not shut down for at least 5 minutes even if all PCs on the network are turned off.
- The LinkStation models with multiple hard drives do not shut down during RAID initialization or rebuild.

LS-QVL

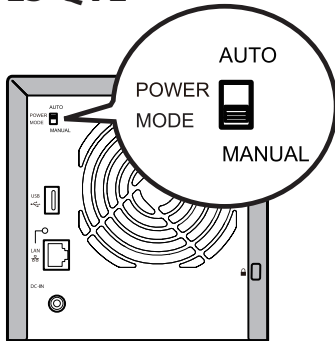

Manual (default):

In this position, the power button on the front of the LinkStation turns it on and off. It is not affected by the power state of connected computers.

Auto:

In this position, if all connected computers are turned off, the LinkStation will turn off too. If a connected computer is powered on, the LinkStation will power on too.

Notes:

- After you turn off your computer, it may take several minutes for the LinkStation to shut down.
- When the power mode switch is changed from Auto to Manual or vice-versa, it takes about five minutes for the change to take effect.
- Power on the LinkStation before moving the switch to the Auto position.
- Install NAS Navigator2 on all computers that will be accessing the LinkStation before switching to Auto Power Mode.
- Some networks may not support the Auto Power Mode. If you have problems with it, just use Manual Power Mode.



Turning Off the Power in the LS-XL Series

The LS-XL series LinkStation does not have a power button. It automatically turns on when the AC adapter is connected. To turn off the power, use the procedure below to perform a shutdown. The LinkStation may be damaged if the AC adapter is removed without first shutting down the unit properly.

Note: To turn the LinkStation on after a shutdown, unplug the AC adapter and then plug it back in again.

Using NAS Navigator2

1 Launch NAS Navigator2.

- Windows: Double-click the  icon on the desktop.
- Mac OS: Click the  icon in the Dock.

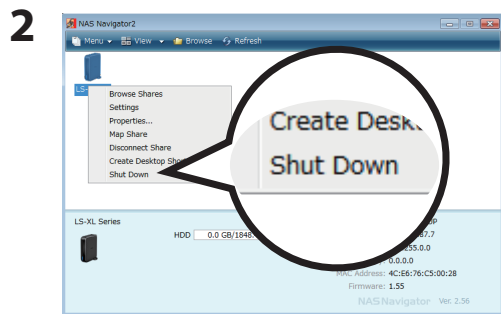

Windows : Right-click the LinkStation icon and select *Shut Down*.

Mac OS : Click the LinkStation icon while holding down the control key and select *Shut Down*.
The LinkStation administrator password must be entered to perform a shutdown. The default password is "password".

This completes shutdown of your LinkStation.

Using the LinkStation's settings

1 Open the LinkStation's settings (page 32).

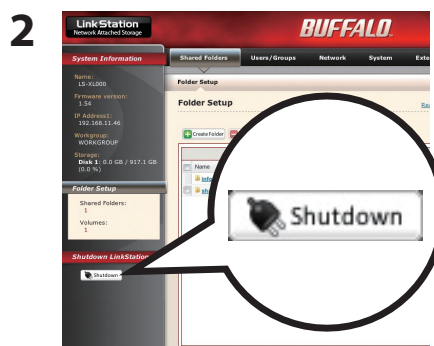



Click *Shut Down* on the left side of Settings.

This completes shutdown of your LinkStation.

Changing the IP Address

Normally, the LinkStation's IP address is set automatically from a DHCP server on your network. If you prefer, you can set it manually. To change the LinkStation's IP address settings, your computer should be coCnnected to the same router (subnet) as the LinkStation and should be running NAS Navigator2 (included on your LinkNavigator CD).

1 Launch NAS Navigator2.

- Windows: Double-click the  icon on the desktop.
- Mac OS: Click the  icon in the Dock.

2 For a PC, right-click your LinkStation's icon and choose *Properties - IP Address*. For a Mac, hold the Control key, click your LinkStation's icon, then click *Configure - IP Address*.

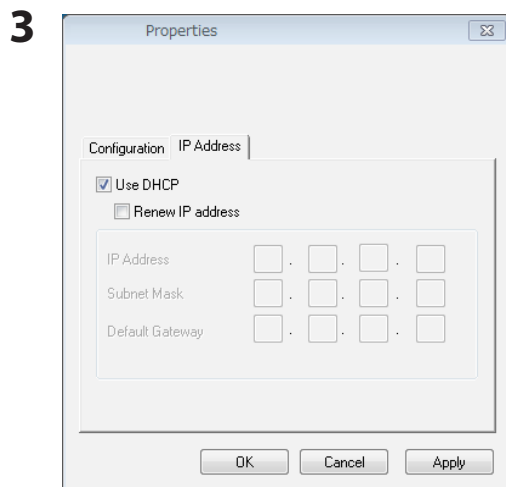



Uncheck *Use DHCP*. Enter the desired *IP Address* and *Subnet Mask*. Click *OK*, or *Apply* if you're using a Mac.

You've configured a static IP address for the LinkStation. To return to using DHCP, reopen the Network Properties screen and recheck *Use DHCP*.

Settings

To open the LinkStation's settings, follow the steps below.

1 Launch NAS Navigator2.

- Windows: Double-click the  icon on the desktop.
- Mac OS: Click the  icon in the Dock.

2

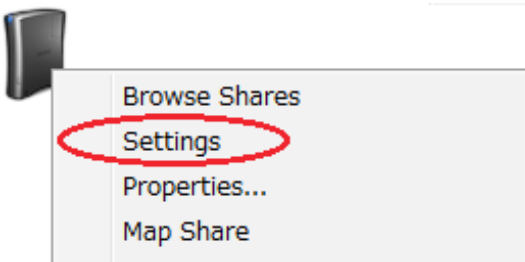

Windows : Right-click the LinkStation icon and select *Settings*.

Mac OS: Click the LinkStation icon while holding down the control key and select *Settings*.

If 2 or more LinkStations and TeraStations are connected on the network, multiple icons will be displayed. Right-click the unit that you want to display.

When a LinkStation's icon is selected, information about its settings appears in the bottom right of the window.

3

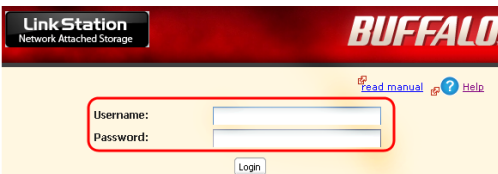

Enter your username and password and click *Login*. The default username and password are:

Username: "admin"

Password: "password"

After you log in, refer to page 63 to change the password for security purposes.

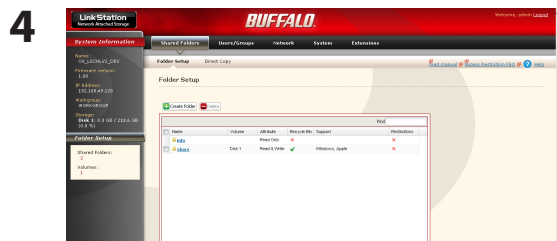

Settings opens. The LinkStation's name, IP address, workgroup and hard disk information are displayed on the left side of the window.

Note: Settings is compatible with Internet Explorer 6.0 Service Pack 2 or later, Firefox 1.5 or later, and Safari 3 or later.

Settings contains the following sections.

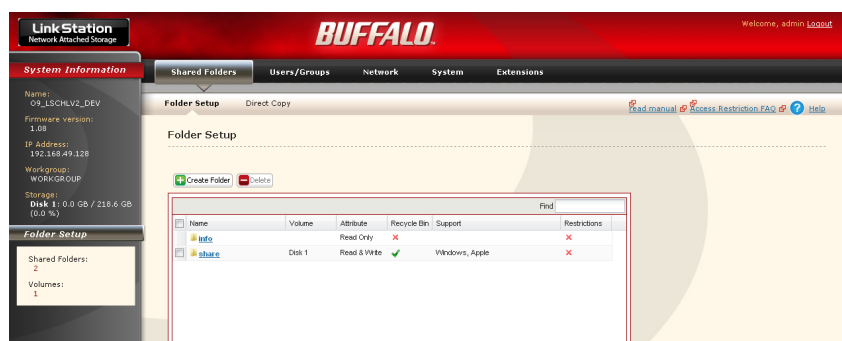

- *Shared Folders*
Add/delete shared folders, set access restrictions, and configure direct copy.
- *Users/Groups*
Register and delete users and groups.
- *Network*
Register and delete networks and workgroups.
- *System*
Configure name, time, disk check format, backup, mail notification settings, timers, UPS synchronization settings, initialization, and format drives.
- *Extensions*
Configure WebAccess, Media Server, Print Server, BitTorrent, Time Machine and Web Service Support.

To open Settings from a different computer, open a browser and type the LinkStation's IP address into the URL field.

With a Mac, you can open Settings from Bonjour as described below.

1 Launch Safari.

2 Select *View - View Bookmark Bar* from Safari's menu.



Select *Bonjour* from the left-side menu, then click your LinkStation in the bookmark list.

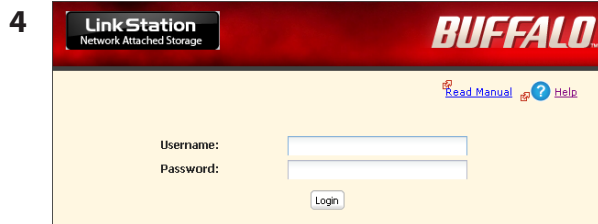

1 Enter your username and password.

2 Click *Login*.

Note:

To log in as a guest, enter "guest" as the username and leave the password blank.

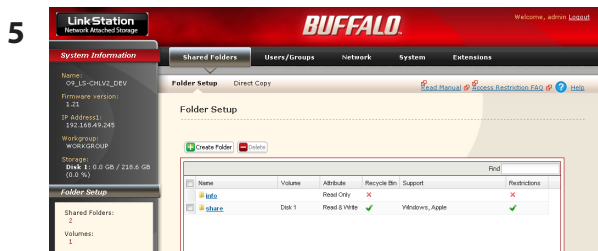

The Settings page opens.

The LinkStation's name, IP address and drive information are displayed on the left.

LinkStation Function List

Different LinkStation models include different features. The table below shows the features included in each model.

○ : Available, — : Not Available

| | LS-WVL, LS-QVL | LS-WXL | LS-WSXL | LS-VL | LS-XL | LS-XHL | LS-CHL |
|--------------------|-------------------|--------|---------|-------|-------|--------|--------|
| Direct Copy | ○ | ○ | ○ | ○ | — | ○ | ○ |
| Print Server | ○ | ○ | ○ | ○ | — | ○ | ○ |
| Network-USB Server | ○ | — | — | ○ | — | — | — |
| UPS Settings | ○ | ○ | ○ | ○ | — | ○ | ○ |
| Web Server | ○ | ○ | ○ | ○ | — | ○ | — |
| MySQL Server | ○ | ○ | ○ | ○ | — | ○ | — |
| DLNA Server | ○ | ○ | ○ | ○ | ○ | ○ | ○ |
| iTunes Server | ○ | ○ | ○ | ○ | ○ | ○ | ○ |
| DTCP-IP | ○ | ○ | ○ | ○ | — | ○ | — |
| Squeezebox Server | ○ | ○ | ○ | ○ | — | ○ | — |
| WebAccess | ○ | ○ | ○ | ○ | ○ | ○ | ○ |
| BitTorrent | ○ | ○ | ○ | ○ | ○ | ○ | ○ |
| Time Machine | ○ | ○ | ○ | ○ | ○ | ○ | ○ |
| Flickr Support | ○ | ○ | ○ | ○ | ○ | ○ | ○ |
| Eye-Fi connected | ○ | ○ | ○ | ○ | ○ | ○ | ○ |
| WebAccess Connect | ○ | ○ | ○ | ○ | ○ | ○ | ○ |
| Power Modes | ○ | ○ | ○ | ○ | — | ○ | ○ |
| Online Update | ○ | ○ | ○ | ○ | ○ | ○ | ○ |
| RAID Arrays | ○ | ○ | ○ | — | — | — | — |
| RAID Scanning | ○ | ○ | ○ | — | — | — | — |

Firmware version 1.62

Shared Folders

By default, the LinkStation includes one shared folder “share”. You may add additional folders as follows.

1

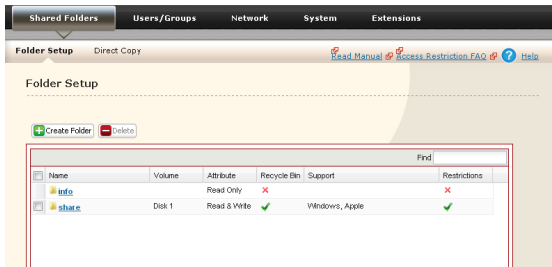

1 In Settings, click *Shared Folders - Folder Setup*.

2 Click *Create Folder*.

2

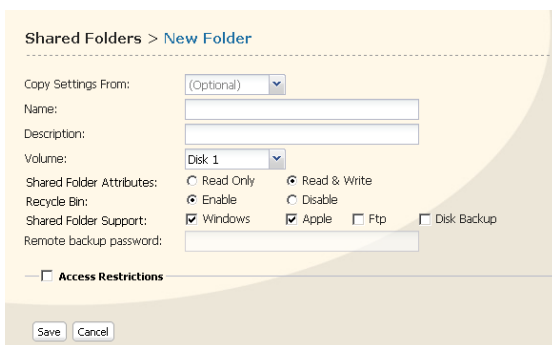

1 Enter desired characteristics for the new share.

Note: If you would like to copy the settings of an existing folder, select a source folder from the *Copy Settings From* dropdown.

2 Click *Save*.

You have created a new share.

• Preventing accidental deletion of data

To protect your data from accidental deletion, you may enable a Recycle Bin for each shared folder. Only SMB and CIFS connections can use a Recycle Bin. If the Recycle Bin is enabled, data that is deleted from the shared folder is temporarily moved to the Recycle Bin folder. To restore the deleted data, open the Recycle Bin folder and move the files back to the share.

Note: After the Recycle Bin is enabled, the Recycle Bin folder is created when a file or folder is deleted from the shared folder. The Recycle Bin folder is not created immediately after it is enabled.

• To set a shared folder to Read-Only

In the Shared Folders settings window, select Read-Only for the *Shared Folder Attributes* and click *Apply*.

Notes:

- The default setting is *Read & Write*.
- Data in a shared folder that is set to Read-Only can be written only by users and groups with write access.
- Read-only shared folders and NTFS/HFS+ formatted USB hard drives will have “(Read Only)” added to the shared folder description.

Notes:

- File and folder names should contain 255 single-byte characters or less (UTF-8). DBCS characters (such as Japanese) count as two characters (2 bytes) each. File and folder names should contain 255 bytes of data or less. You may not be able to copy a folder or file whose name contains more than 255 bytes of information.
- You cannot set hidden or read-only attributes to subfolders or files on the LinkStation.
- If non-Roman alphabetical folder names or workgroup names do not display properly, rename the folder or workgroup with Roman alphabetical characters.
- Do not use any of the following words as a Username or Group Name:
root, bin, daemon, sys, adm, tty, disk, lp, sync, shutdown, halt, operator, nobody, mail, news, uucp, ftp, kmem, utmp, shadow, users, nogroup, all, none, hdusers, admin, guest, man, www, sshd, administrator, ftpuser, apache, mysql
- Do not use any of the following words as the name of a shared folder. These words are reserved for internal use by the LinkStation:
info, spool, usbdisk1, usbdisk2, usbdisk3, usbdisk4, lost+found, global, printers, homes, lp, auth, test, ram, disk1, disk2, disk3, disk4, disk5, disk6, disk7, disk8, array1, array2, array3, array4, msdfs_root, mt-daapd
- The following characters are handled differently by Mac OS and Windows. Avoid using these characters when sharing data between Mac OS and Windows:
— ~ || - © £ ¬
- Windows does not support some characters that Mac OS and the LinkStation allow. If you create a filename on a Mac with any of the following characters, it will not display correctly on a Windows computer. With OS X 10.2 or later, you may have to connect to the LinkStation via AFP in order to display or copy any of the following characters.
? [] / ¥ = + < > ; : " , | *
- Never turn off the LinkStation or unplug its Ethernet cable while data is being written. Doing so may result in an incomplete file that cannot be opened or deleted. If this happens, restart the LinkStation, delete the file, then retry copying the file.
- File copying to the LinkStation is protected by a journaling file system, but if the copying process is canceled while in progress or is ended before completion (such as by a disconnected Ethernet cable or power outage), incomplete files may be copied, and it may not be possible to delete the files. If this happens, restart the LinkStation, delete the files, and then perform the copying process again.
- Even if the LinkStation's hard drive is formatted, "Amount Used" and "Percent Used" in Settings will not be 0. This is because some drive space is being used for the system area.

- Set the username and password used for the LinkStation to the same username and password used to log into the Windows network. If they are different, it may not be possible to access shared folders that were set with access restrictions in the LinkStation.
- When files are copied to the LinkStation, or to a USB drive connected to the LinkStation, file information such as date created, date modified, and other date information may be updated or changed.
- The value for the hard drive capacity when checked from a browser may differ from the value shown when checked from the Properties window of the hard drive in Windows.
- If logging into Windows 8, Windows 7, Windows Vista, Windows XP, or Windows 2000 using a guest account, the access restrictions may not work properly because a guest account already exists in the LinkStation default settings.
- The attributes (read, write, execute) for files and directories cannot be changed using FTP client software.
- If jumbo frames (4102, 7422, or 9694 bytes) are used to connect a switching hub to the LinkStation, do not use a switching hub incompatible with jumbo frames. Data transfer may fail if using an incompatible switching hub.
- When using jumbo frames, if backing up the LinkStation/TeraStation data to another LinkStation/TeraStation, set the Ethernet frame size for the two LinkStations/TeraStations to the closest possible values. If the Ethernet frame sizes are significantly different, the backup operation may fail. If this happens, select the default frame size (1518 bytes).
- If the LinkStation is formatted, reconfigure any regularly scheduled backup jobs, or errors will occur when they try to run.
- If shared folders are accessed from a Macintosh, information files for the Macintosh may be generated automatically. Do not delete these files. If they are deleted using Windows, this may prevent further access from a Mac. If access is no longer possible from a Mac, in the LinkStation's settings, go to the *System > Storage > Check Disk* screen, select [Delete any hidden, non-essential MacOS dedicated files], and click *Check*.
- LinkStation belongs to the default zone in AppleShare server. The zone cannot be specified.
- In certain cases, it may not be possible to delete new or copied folders using an FTP client when using an AFP connection (because the folder name of the automatically-generated ".AppleDouble" folder begins with a dot). In this case, delete these folders over an SMB connection.
- In OS X 10.5 to 10.5.6, if a search is conducted using Spotlight, the search cannot be performed over an AFP connection. In this case, either use an SMB connection, or use OS X 10.5.7 or later.
- If the AirMac utility is installed in Windows, the AirMac utility setting screen may be displayed when the LinkStation is connected to the network, but the LinkStation cannot be set using the AirMac utility.

- If creating files or folders over an FTP connection, try not to exceed 250 bytes in UTF-8 conversion including the directory path name. If 250 bytes is exceeded, reading and deleting operations may not be possible using Explorer.
- In some cases, the internal clock of the LinkStation may become out of sync after usage over an extended period of time. If this happens, correct the time. Also, the NTP function can be used to automatically correct the time.
- If LinkNavigator is used to automatically set up a LinkStation, initialize the LinkStation before using LinkNavigator to automatically set up the LinkStation again.

Access Restrictions

There are several ways to restrict access to users of a LinkStation.

Access restrictions for Users and/or Groups on the LinkStation

The next page describes how to configure access restrictions for local users and/or groups.

Access Restrictions on NT Domain

Follow the procedure on page 43 to configure.

Access Restrictions on Active Directory

Follow the procedure on page 45 to configure.

Notes:

- This chapter describes the procedure to use Active Directory with Windows 2000 Server, Server 2003, and Server 2008.
- Depending on the security settings, the LinkStation may not be able to join a domain, or may be able to join but not be authenticated by a domain. In such a case, restrict access by delegating authority.

Access restrictions by using the Delegate Authority server feature

Follow the procedure on page 47 to configure.

Notes:

- Permissions are assigned to shared folders. Child folders in a shared folder inherit their permissions from the parent folder. If a file or folder is moved into a new shared folder with different permissions from the folder it was originally in, it will now have the access restrictions from the new shared folder.
- When accessing the LinkStation from Windows via SMB, changing permissions from the folder's security tab in the properties screen of a folder is not supported. Access restrictions for shared folders on the LinkStation can only be configured from within Settings.

Restricting access for Users and Groups on the LinkStation

You can set access restrictions for shared folders by username or group names for users that are registered on the LinkStation.

- 1 Create new user accounts and passwords in Windows, or record existing Windows usernames and passwords. Each account on the LinkStation will have the same username and password as the user's Windows account.
- 2 Register users and groups on the LinkStation.
 - 1 Add users as described on page 60.
 - 2 Add groups as described on page 62.
- 3 Configure access restrictions for groups and/or users.



In Settings, navigate to *Shared Folders - Folder Setup*.

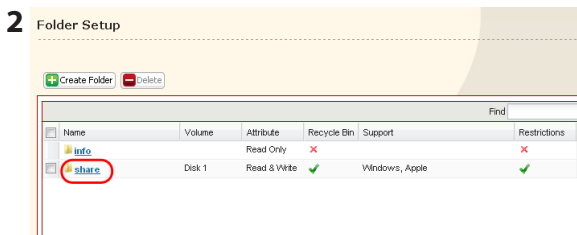

Click a shared folder you want to set access restrictions for.

3

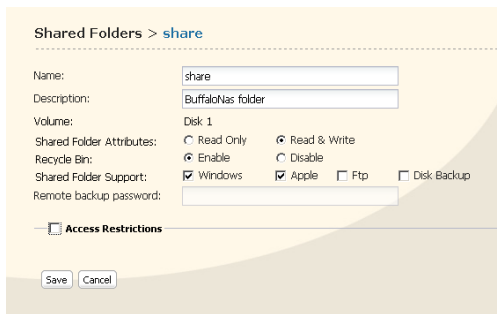

Check *Access Restrictions* to enable.

4

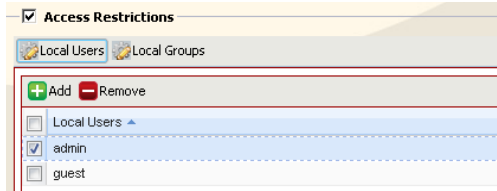

Click *Add*.

Note: The procedure described here shows how to set access restrictions for users. To set access restrictions for a group of users, click *Local Groups - Add*.

5

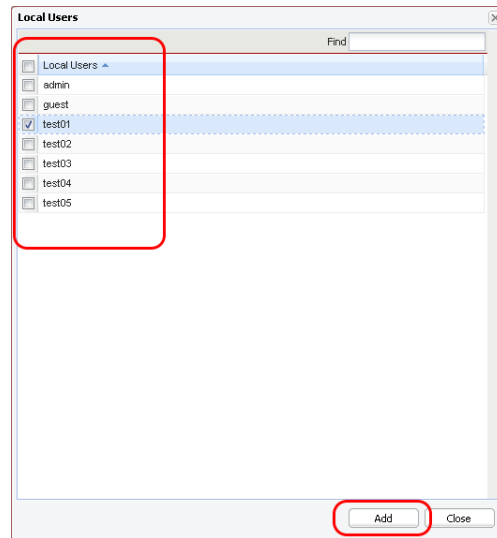

1 Check the users (or groups) that you want to permit to access the share.

2 Click *Add*.

6

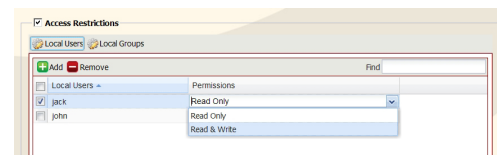

Select the level of access for the user or group you added.

7 Click *Save*.

You have assigned access restrictions.

- If you log on from a Microsoft Network Domain, you can set "Access Restrictions" with the users and/or groups which are registered on the domain.
- If both *Read only* and *Read & Write* permissions are given to a user, that user will have read-only access.

Access Restrictions on NT Domain

The LinkStation can download users, groups, and passwords from an NT Domain server. This procedure is recommended for system administrators only.

Note: The LS-CHL LinkStation doesn't support NT Domain in the US and the EU.

1 Create an account on the Domain Controller for the LinkStation.

Note: If there is an option to "Accept accounts for computers with Windows 2000 or earlier", then select it.

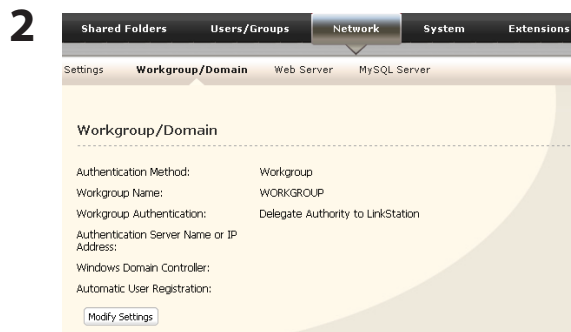

Click *Network - Workgroup/Domain - Modify Settings* in Settings.



- 1** Select *NT Domain*.
- 2** Enter *NT Domain Name*.
- 3** Enter *NT Domain Controller Name*.
- 4** Enter *Administrator Name*.
- 5** Enter *Administrator Password*.
- 6** Enter *WINS Server IP Address*. (Optional)
- 7** Click *Save*.

4 Follow the instructions in the previous section to add access restrictions to the domain.

Notes:

- You can enter up to 23 bytes (UTF-8) for *NT Domain Name*. Alphanumeric characters, multi-byte characters, -(hyphen), _(underscore), and .(dot) may be used. Do not use a symbol as the first character.
- You can enter up to 63 bytes(UTF-8) for *NT Domain Controller Name*. Do not use multi-byte characters. Alphanumeric characters, -(hyphen), and _(underscore) may be used. Do not use a symbol as the first character.

Notes:

- If you change the LinkStation's name, you will no longer be able to use domain users and groups or access restrictions. Rejoin the domain.
- If a domain username contains more than 20 bytes, the LinkStation truncates it to 20 bytes.
- The LinkStation only downloads the first 1000 users or the first 1000 groups from a domain controller.
- If you operate LinkStation as a member server of NT Domain or Active Directory domain, you cannot connect as a guest user via AFP.
- When you change the user or group settings on the domain controller, these changes may not take effect immediately on LinkStation. If you need to reflect changes on the domain controller immediately, reboot LinkStation.
- If your LinkStation is a member server in NT Domain or Active Directory domain and you change the *Authentication Method* to *Workgroup* in *Network - Workgroup/Domain - Modify Settings* on *Settings*, the computer account on the domain controller will not be deleted automatically.
- If it has joined a domain network, you cannot connect to the LinkStation via FTP.

Access Restrictions on Active Directory

The LinkStation can download users, groups, and passwords from an Active Directory domain server. This procedure is recommended for system administrators only.

Note: The LS-CHL LinkStation doesn't support Active Directory in the US and the EU.

1 Create an account on the Domain Controller for the LinkStation.

Note: If there is an option to "Accept accounts for computers with Windows 2000 or earlier", then select it.



Click *Network - Workgroup/Domain - Modify Settings* in Settings.

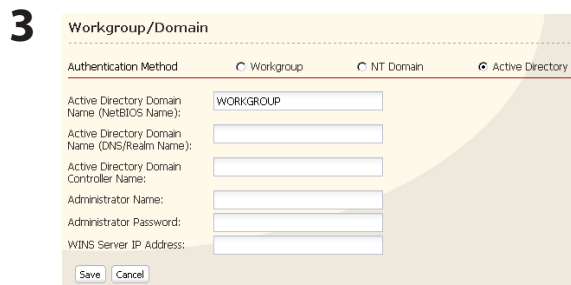

- 1** Select *Active Directory*.
- 2** Enter *Active Directory Domain Name (NetBIOS Name)*.
- 3** Enter *Active Directory Domain Name (DNS/Realm Name)*.
- 4** Enter *Active Directory Domain Controller Name*.
- 5** Enter *Administrator Name*.
- 6** Enter *Administrator Password*.
- 7** Enter *WINS Server IP Address. (Optional.)*
- 8** Click *Save*.

4 Follow the instructions on page 41 to 42 to add Access Restrictions to Domain Users/Domain Groups.

You have completed the settings for this feature.

Notes:

- When you have the LinkStation joined to an Active Directory domain, you must specify the DNS Server which can resolve names for Active Directory domain.
- After building an Active Directory domain, the administrator's password which is needed to join the Active Directory domain must be changed at least once, or joining the Active Directory domain will fail.
- Active Directory domain's DNS name and NetBIOS name must be identical.
- If the time recorded by the LinkStation's clock and the Domain controller's clock differ by more than 5 minutes, joining or authenticating the domain user or group may fail.

Access restrictions by using the Delegate Authority server feature

You may administer all user accounts and passwords centrally from a delegate server as described below. This procedure is intended for network administrators only.

Notes:

- You can set access restrictions on shared folders. You cannot set different restrictions on folders in a shared folder. Child folders in a shared folder inherit their permissions from the parent folder.
- When accessing the LinkStation from Windows via SMB, changing permissions from the folder's security tab in the properties screen of a folder is not supported. Access restrictions for shared folders on the LinkStation can only be configured from within Settings.

There are restrictions when administrating through a delegate authority server:

- To access the LinkStation, you must be logged into Windows with the account registered to the authentication server.
- If you use the Delegate Authority option, you cannot connect as a guest user via AFP.
- If you use the Delegate Authority option, you cannot connect anonymously via FTP.
- If the LinkStation is connected to OS X 10.7 (Lion) via SMB, shared folders that were set with access restrictions cannot be opened. In this case, use AFP to connect. To connect via AFP, enable AFP in *Network - Network Services* and select *Apple* in *Shared Folders - Shared Folder Support*.

Notes:

- Windows 8, Windows 7, Windows Vista, Windows Server 2003 and Windows Server 2008 users need to change the security settings to use the Delegate Authority to External SMB server feature to restrict access.
- Open the File Sharing Security Level Change Tool, then select *Change security level* to change the security level (when changing back again, select *Recover default security level*).
- You may download the latest version of the File Sharing Security Level Change Tool from www.buffalotech.com.

1

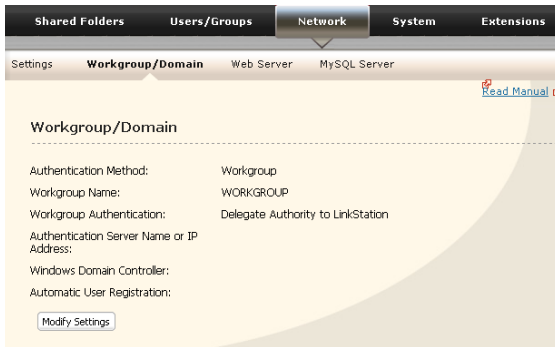

1 In Settings, navigate to *Network - Workgroup/ Domain*.

2 Click *Modify Settings*.

2

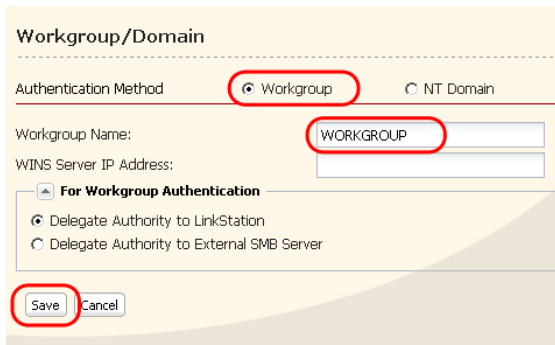

1 Click *Workgroup* (even if you are in a domain environment).

2 Enter the *Workgroup Name*. To use a Windows Domain Controller as an external SMB authentication server, enter its name for the *Workgroup Name*.

3 Select *Delegate Authority to External SMB Server*.

3

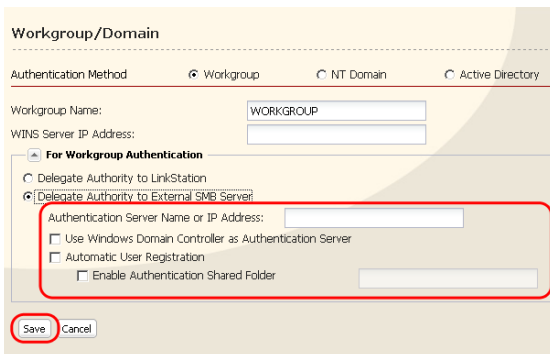

1 Enter the *Authentication Server Name or IP Address* .

Note: When connecting with AFP or FTP, an IP address is recommended.

2 Check *Use Windows Domain Controller as Authentication Server, Automatic User Registration and Enable Authentication Shared Folder*.

3 Enter the shared folder name for authentication.

4 Click *Save*.

4 The shared folder for authentication should be created on the LinkStation.

A user that has been registered to the specified authentication server will be automatically registered as a user on the LinkStation when they open the shared folder for authentication (you can also register users directly).

Configuration of the Authentication Server is complete.

Notes:

- A user who is automatically registered will belong to the "hdusers" group. They are added to other groups from within Group settings.
- You can restrict access to shared folders by username or group.
- The names of registered users are listed in *Users/Groups - External Users*. To delete an automatically registered user, select that user and click *Delete*.
- When connecting through AFP or FTP, always use an IP address. Using a server name may cause problems with authentication.
- To specify a server from another subnet, enter its IP address.
- AFP and FTP connections do not support delegating authority to an external SMB server.

Disk Quotas

Notes:

- When using quotas, disable the recycle bin or empty the trash folder. The limited space includes the space used for trash.
- Quotas apply per drive or per array. If a quota is set to 1 GB, each drive or array can use maximum of 1 GB.
- Quotas can't be set for external USB hard drives connected to the LinkStation, only internal drives.
- The LS-CHL LinkStation doesn't support disk quotas in the US and the EU.

Disk space quotas for users

To limit the space of shared folders that each user can use, follow the procedure below.

1

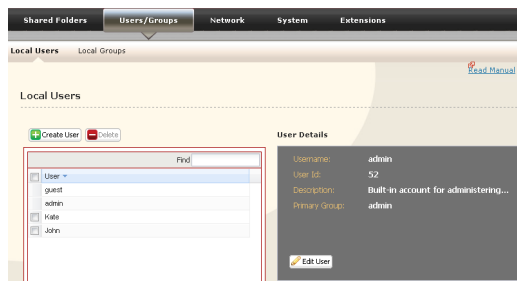

- 1 In Settings, navigate to *Users/Groups - Local Users*.
- 2 Click *Create User*.

2

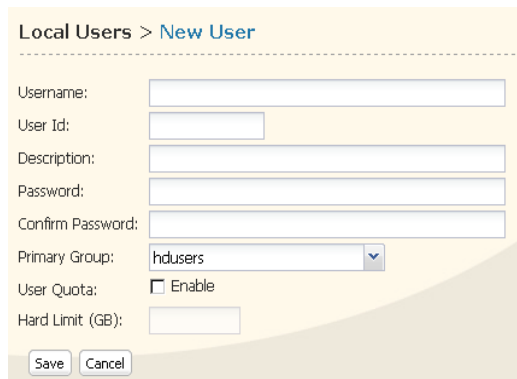

- 1 Enter *Username, User Id, Password, and Description*.
- Note: User IDs may be between 1000 and 1999. Do not duplicate user IDs.
- 2 Check *Enable for User Quota*.
 - 3 Enter the maximum space this user is allowed for the *Hard Limit (GB)*.
 - 4 Click *Save*.

Notes:

- Username and password must be the same one that the user logs into Windows with. If these values are different, shared folders with access restrictions cannot be accessed.
- Deleting or adding users repeatedly may cause quotas to not work properly.
- Usernames should not contain the character "@". Because of this, you can't register a Windows Live ID as your username. For Windows 8, use a local username instead of your Windows Live ID.

3 Select *Shared Folders - Folder Setup* and click *Create Folder*.

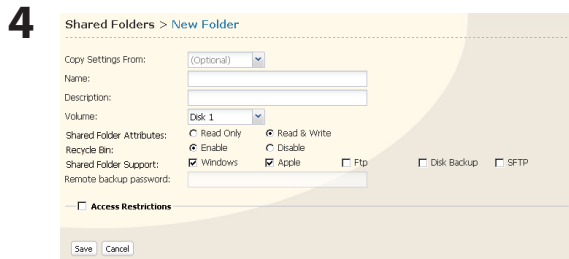

- 1 Configure the desired settings.
- 2 Click *Access Restrictions*.

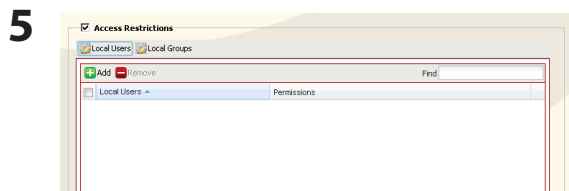

Click *Add*.

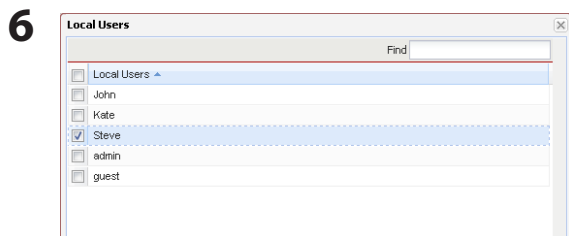

- 1 Check the user you created in step 2.
- 2 Click *Add*.

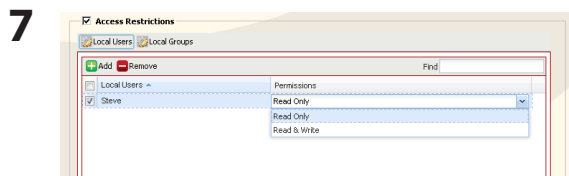

Select level of access privileges for the user you added from *Read Only* or *Read & Write*.

8 Click *Save*.

You've configured a disk quota for users.

Disk space quotas for groups

To limit the space of shared folders that each group can use, follow the procedure below.

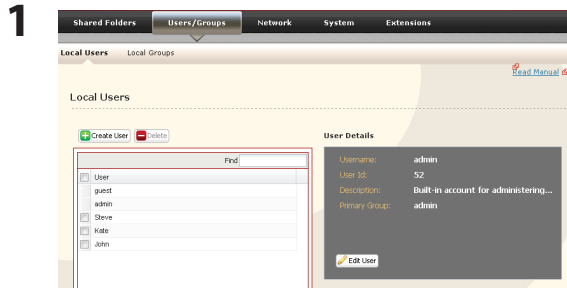

- 1 In Settings, select *Users/Groups - Local Users*.
- 2 Click *Create User*.

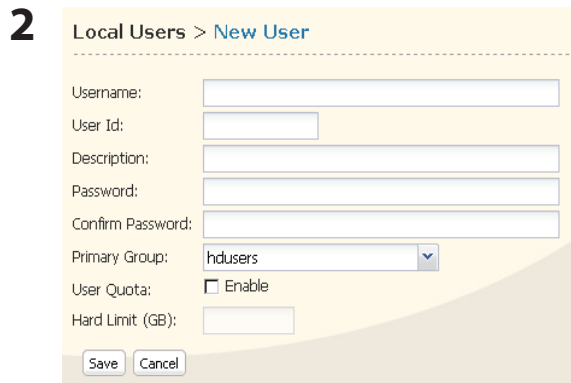

- 1 Enter *Username, User Id, Password* and *Description*.
Note:
User IDs may be between 1000 and 1999. Do not duplicate user IDs.
- 2 Click *Save*.

Repeat steps 1 and 2 for each user in the group.

Notes:

- Usernames and passwords should be the same ones that the users log in to Windows with.
- If two different quotas apply, such a user quota and a group quota, the smaller quota is applied.

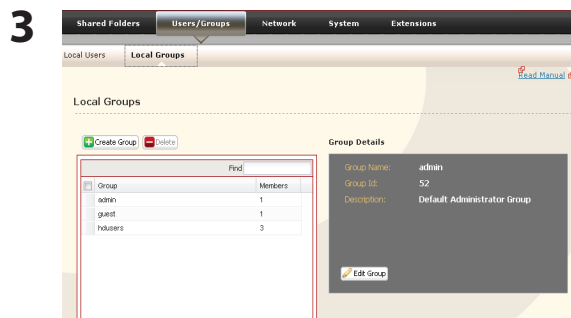

- 1 Select *Users/Groups - Local Groups*.
- 2 Click *Create Group*.

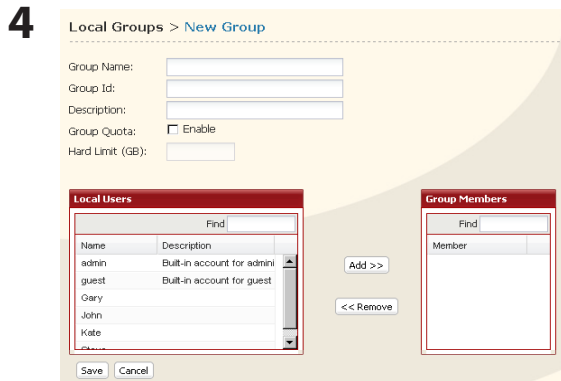

1 Enter *Group Name*, *Group Id* and *Description*.

Note:

The group ID may be any number from 1000 and 1999. Do not duplicate Group IDs.

2 Click *Enable* for *Group Quota*.

3 Enter the total space that the group can use in the *Hard Limit (GB)* field.

4 Select users from step 2 in *Local Users*, and click *Add* for each.

5 Click *Save*.

Note: Deleting and adding groups repeatedly may cause quotas to not work properly.

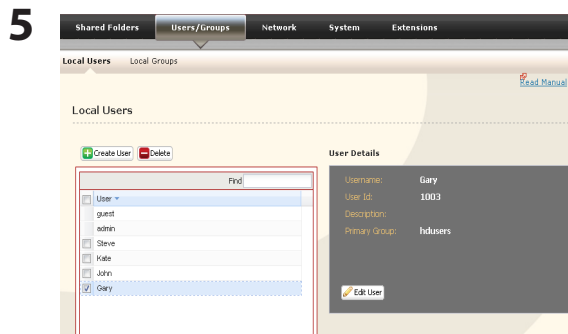

1 Click *Users/Groups - Local Users*.

2 Select a user from step 2, and click *Edit User*.

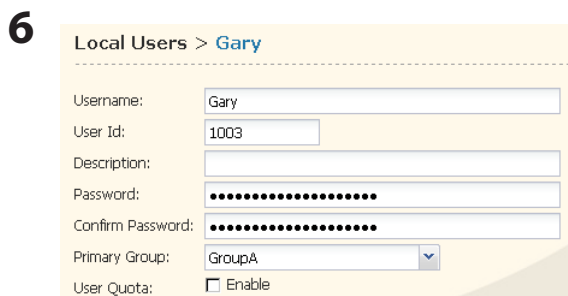

Select the group created in step 4 for *Primary Group* and click *Save*.

7 Click *Shared Folders - Folder Setup*.

8 Click *Create Folder*.

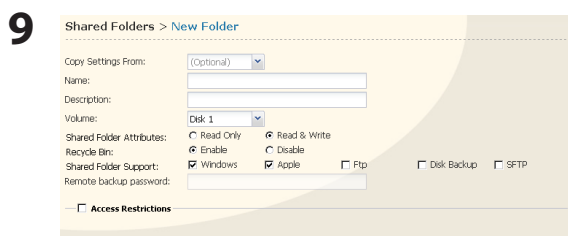

1 Configure the desired settings.

2 Click *Access Restrictions*.

10

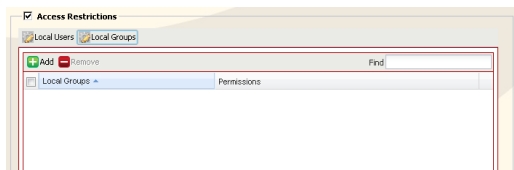

- 1 Click *Local Groups*.
- 2 Click *Add*.

11

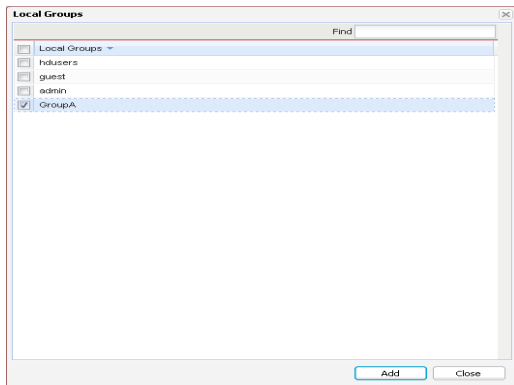

- 1 Check the group you created step 4.
- 2 Click *Add*.

12



Select level of access privileges for group you added from *Read Only* or *Read & Write*.

13 Click *Save*.

You have configured a group quota.

FTP Server

By default, the LinkStation's shares are only accessible by users connected to the same network or router as the LinkStation. The optional FTP server allows users to access the LinkStation from outside of the local network. You may enable it as follows.

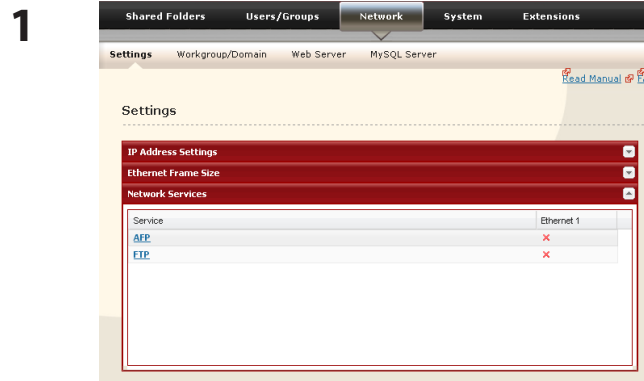

In Settings, navigate to *Network - Settings - Network Services* and click *FTP*.

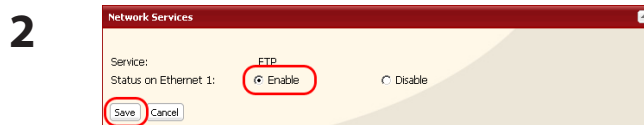

- 1** Select *Enable*.
- 2** Click *Save*.

3 Click *Shared Folders - Folder Setup*.

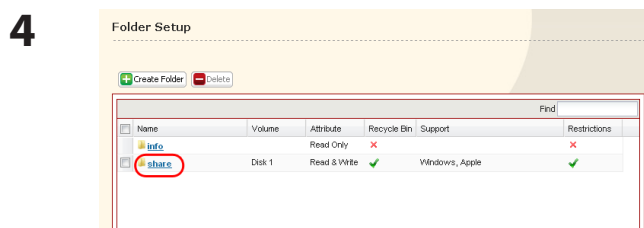

Click the folder to enable remote FTP access on.

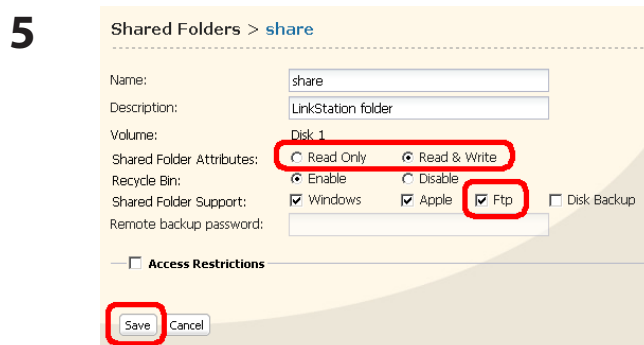

- 1** Select whether the shared folder is *Read Only* or *Read & Write*.
- 2** Check *Ftp*.
- 3** Click *Save*.

The folder is now configured for FTP access. Do not forget to give read (or write) permissions for the FTP share to any users that will be accessing the share remotely. Folder permissions can only be changed from Settings. Changing them remotely with FTP client software is not supported.

To access to the LinkStation with an FTP client

Configure your FTP client software with the following settings:

- Host Name IP address of the LinkStation.
- Username Username registered on the LinkStation
- Password Password registered to the LinkStation
- Port 21

Example `ftp://192.168.11.150/`

- You cannot write by FTP if the shared folder is set to read-only on the LinkStation.
- Access restrictions are applied based on the settings in the LinkStation. The restrictions are not displayed for users without permissions for the share.
- To access your FTP share from outside of your network, you may need to configure your router and firewall. Consult your router documentation for more information.
- Shared folders appear as follows when connected by FTP:
 - disk1 share
 - usbdisk1
 - info
- The internal hard drive of the LinkStation is displayed as disk1, and a USB hard drive (optional) will be displayed as usbdisk1.
- "usbdisk1" is not displayed when the USB hard drive is not connected, or if access is restricted.

Accessing the LinkStation with an Anonymous user:

To allow anonymous access to your FTP share, disable access restrictions on the FTP share. Configure your FTP client as follows:

- Host Name IP address of the LinkStation
- Username anonymous
- Password any set of characters
- Port 21

Example `ftp://192.168.11.150/`

- To make your FTP share available from outside your network, you will need to configure your router and firewall. Consult your router's documentation for information on how to allow FTP traffic.
- If the LinkStation joins a domain, anonymous users cannot access it.
- Folders created or copied via an AFP connection may not be deleted from the AFP connection. This is because an automatically generated ".AppleDouble" folder begins with a dot. To delete these files, use an SMB connection.
- Do not exceed 250 characters for a file/folder name including directory path when you are creating it by using an FTP connection. Otherwise, you cannot view or delete it in Explorer or other applications.

Direct Copy

DirectCopy automatically copies movie, music, and images directly to the LinkStation from a USB device.

Note: Not all LinkStations support Direct Copy. Check the LinkStation Function List on page 35 to see if your LinkStation supports Direct Copy.

Direct Copy supports LinkStations that have a USB port.

You can connect many types of USB devices to the LinkStation, including USB hard drives, USB flash drives, single-card card readers, digital cameras, and USB printers. USB hubs, mice, keyboards, and card readers that support 2 or more cards are *not* supported.

- 1 Connect to a USB device (USB flash/digital camera/hard disk/card reader) to the LinkStation.

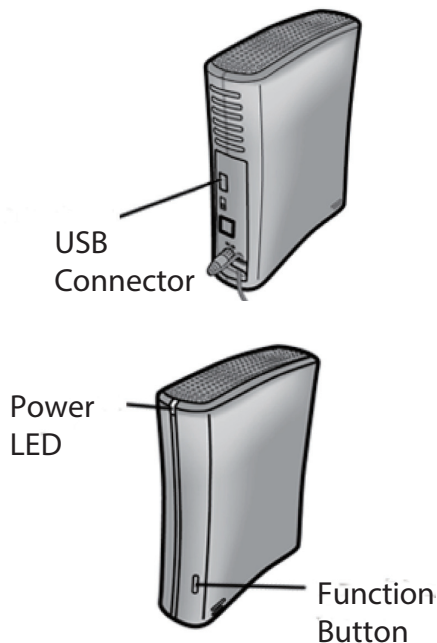

After the USB device is recognized, the function button or the function LED is lit in blue for 60 seconds. After the function button is lit in blue, you can access the USB device.

Note: If using a USB device that is not in the USB mass storage class, the following limitations apply.

- In LinkStations with firmware version 1.40 or earlier, the function button or function LED will not flash.
- The drive will not appear in the computer screen (drive is not mounted).

- 2** While the function button is blue, press it to automatically copy data from the USB device to a shared folder on the LinkStation. The function button will flash blue during the copy. Push the function button again to abort the copy.

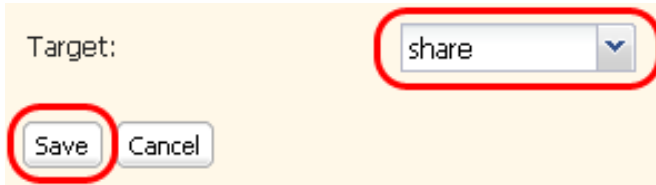

Files are copied to the folder:

<shared folder>/pictures/yyyymmdd
yyyy: year copied
mm: month copied
dd: date copied

You may change the destination shared folder for DirectCopy in *Shared Folders - Direct Copy - Modify Settings* in Settings. Subsequent DirectCopy folders are created at:

<DirectCopy folder>/pictures/yyyymmdd/n
yyyy: year copied
mm: month copied
dd: date copied
n: 1st time n=0, 2nd time n=1, 3rd time=2 and so on.

For USB Mass Storage class USB devices, files with following extensions will be copied.

avi, divx, asf, mpg, mpe, m1v, vob, mts, m2ts, m2t, mpeg, mpeg2, vdr, spts, tp, ts, 3gp, mov, m4v, wmv, dvr-ms, xvid, mp4, jpg, jpeg, gif, png, tif, tiff, yuv, bmp, mp3, mpa, wma, aac, apl, ac3, lpcm, pcm, wav, m3u, m4a, m4b, aif, aiff, flac, ogg, mp2, mp1

For digital cameras that do not follow the USB Mass Storage Class standard, all files on the device will be copied.

- 3** When the access LED of the USB device goes off, the copy is finished. Dismount the USB device before unplugging it.

To dismount the USB device if the LinkStation is on, hold in the function button for 3 seconds. The blue LED will go out, and the USB device is dismounted. You may now unplug it safely.

If you turn off the LinkStation, the USB device is already dismounted, and you can remove it safely.

Users/Groups

Adding Users

Add users as shown below.

1

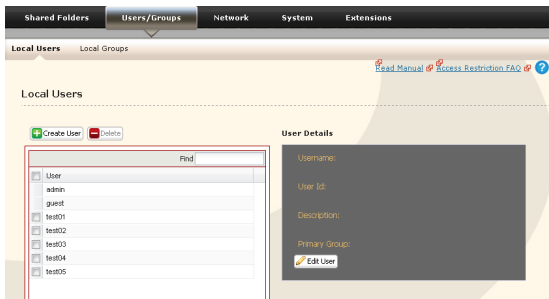

1 In Settings, navigate to *Users/Groups - Local Users*.

2 Click *Create User*.

2

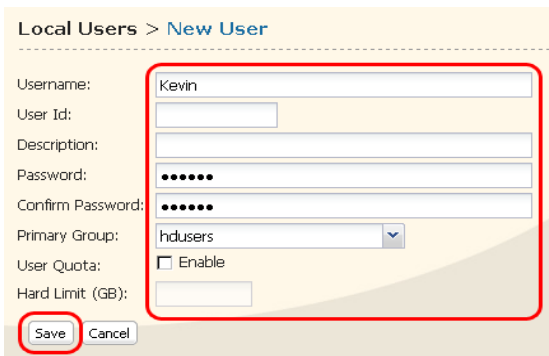

1 Configure the desired settings for the new user.

2 Click *Save*.

You have added a user.

Use the same username and password that the user logs into Windows with. If the username and passwords are different, the user may not be able to access restricted shares.

Notes:

- When using access restrictions, you can register up to 300 users on the LinkStation.
- Do not use any of the following words as a username or a group name:
root, bin, daemon, sys, adm, tty, disk, lp, sync, shutdown, halt, operator, nobody, mail, news, uucp, ftp, kmem, utmp, shadow, users, nogroup, all, none, hdusers, admin, guest, man, www, sshd, administrator, ftpuser, apache, mysql
- If you are using Mac OS 9 or earlier, do not use more than 9 alphanumeric characters for the user password, or the user will not be able to access shared folders on the LinkStation.
- Usernames should not contain the character "@". Because of this, you can't register a Windows Live ID as your username. For Windows 8, use a local username instead of your Windows Live ID.

Adding Groups

Add groups as shown below:

1

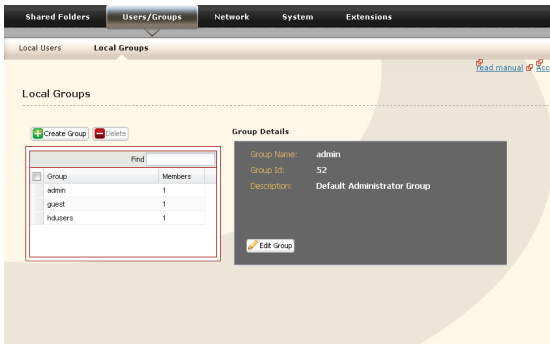

1 In Settings, navigate to *Users/Groups - Local Groups*.

2 Click *Create Group*.

2

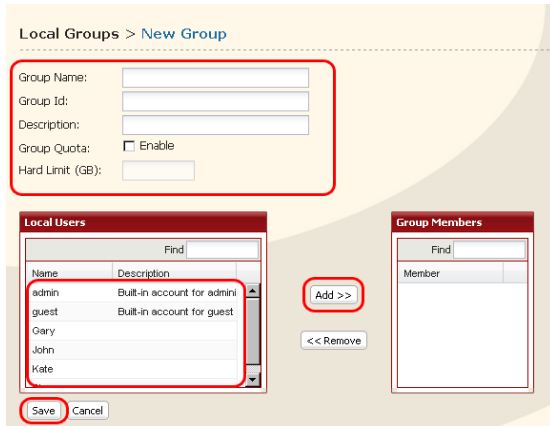

1 Enter *Group Name* and *Description*.

2 Select users to include in the group.

3 Click *Add*, then *Save*.

You have added a group.

Do not use any of the following words as a group name:

root, bin, daemon, sys, adm, tty, disk, lp, sync, shutdown, halt, operator,
nobody, mail, news, uucp, ftp, kmem, utmp, shadow, users, nogroup, all,
none, hdusers, admin, guest, man, www, sshd, administrator, ftpuser, apache, mysql

Admin Password

You may change the admin password as follows.

1 In Settings, navigate to *Users/Groups - Local Users*.

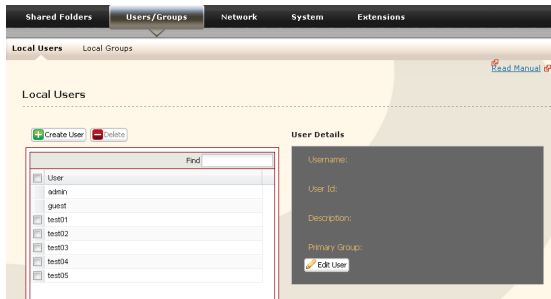

2 Select *admin* and click *Edit User*.

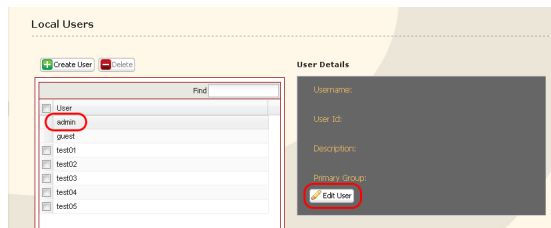

3 **1** Enter a *Username* and *Password*.

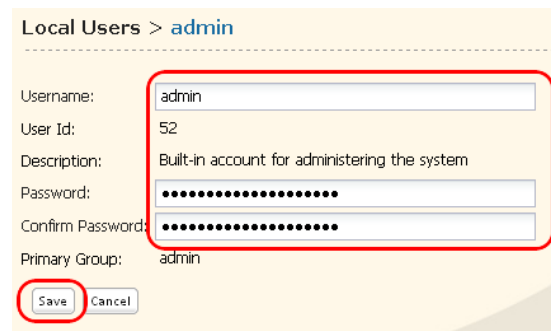

2 Click *Save*.

You have now changed the admin password.

Note: You cannot set access restrictions or use WebAccess with the admin account. Use the admin account only to log in to Settings.

Network

Jumbo Frame

If your other network devices support it, you may be able to increase network performance with Jumbo Frame.

1

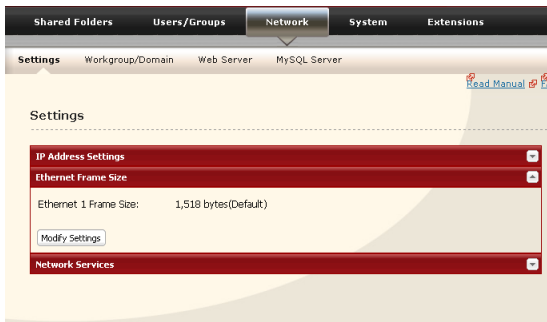

1 In Settings, navigate to *Network - Settings - Ethernet Frame Size*.

2 Click *Modify Settings*.

2

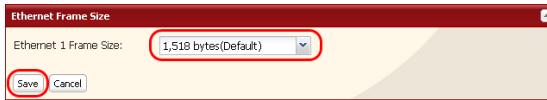







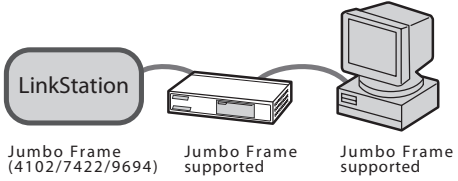

1 Select *Ethernet Frame Size*.

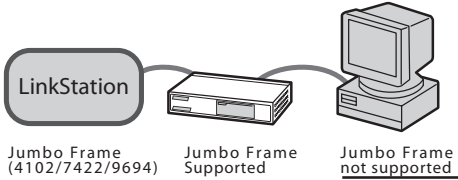
2 Click *Save*.

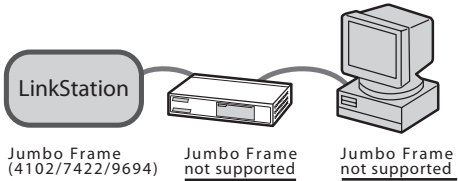
Notes:

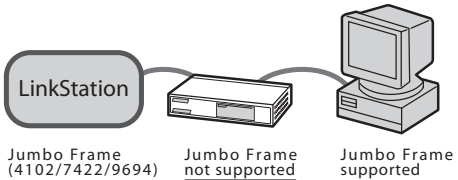
- To use the LinkStation with Jumbo Frame, your router/switch/hub must support Jumbo Frame.
- To use Jumbo Frame (4102/7422/9694 bytes), your computer's NICs and all switches, hubs, and routers on the transmission route need to support Jumbo Frame. If any device on the route does not support Jumbo Frame, use standard transmission (1518 bytes) instead.
- If you are using Jumbo Frame and back up data from a LinkStation/TeraStation to another LinkStation/TeraStation, set the Ethernet frame sizes of the LinkStations/TeraStations to the same settings (or the closest available). If the Ethernet frame sizes are significantly different, the backup job may fail. If you have problems with backup jobs, select the default frame size (1518 bytes).

| Connection | | | Transmission | |
|---|--|--|--------------|--|
|  <p>LinkStation Jumbo Frame (4102/7422/9694)</p> <p>Jumbo Frame supported</p> <p>Jumbo Frame supported</p> |  | <p>Transmit Jumbo Frame (4102/7422/9694)</p> | | |
|  <p>LinkStation Jumbo Frame (4102/7422/9694)</p> <p>Jumbo Frame Supported</p> <p>Jumbo Frame <u>not supported</u></p> |  | <p>Transmit normally (1518)</p> | | |
|  <p>LinkStation Jumbo Frame (4102/7422/9694)</p> <p>Jumbo Frame <u>not supported</u></p> <p>Jumbo Frame <u>not supported</u></p> |  | <p>Transmit normally (1518)</p> | | |
|  <p>LinkStation Jumbo Frame (4102/7422/9694)</p> <p>Jumbo Frame <u>not supported</u></p> <p>Jumbo Frame supported</p> |  | <p>No transmission</p> | | |

Web Server

The LinkStation can be used as a Web server.
HTML, CGI scripts, images, and JavaScript are supported.

Notes:

- Not all LinkStations include Web server functionality. Check the LinkStation Function List on page 35 to see if your LinkStation supports Web server.
- The LinkStation's Web server is for advanced users only. Do not enable it unless you know what you're doing.

- 1 Navigate to *Network – Web Server – Web Server Settings* in Settings and click *Modify Settings*.
- 2 Select *Enable* for *Web Server*, choose an external port setting (81 is the default) for *Port No.* and a Web server public folder for *Target Folder*, and click *Save*.

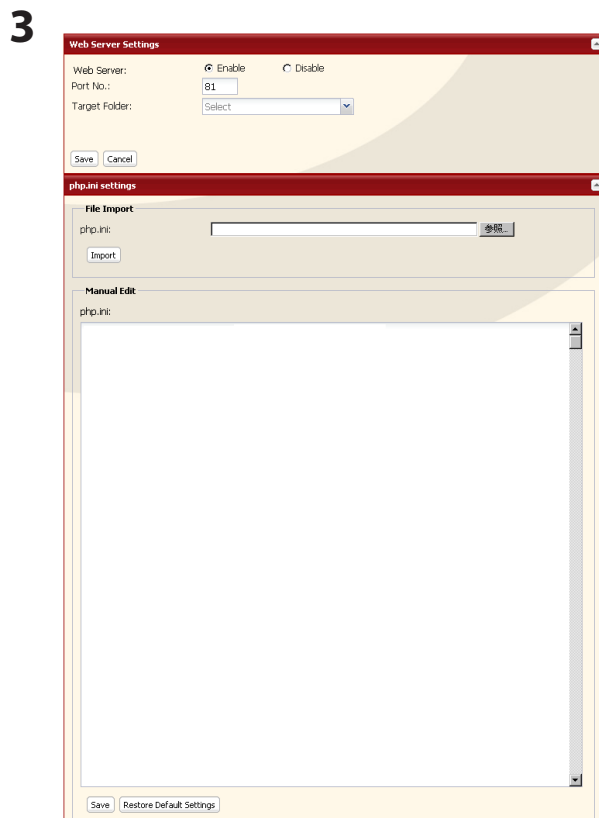

Edit the php.ini file to change the PHP language interpreter settings. Instructions are in the file.

The Web server is now configured.

MySQL Server

The LinkStation can be used as a MySQL server.

A MySQL database may be installed and linked with the web server.

Notes:

- Not all LinkStations include MySQL server functionality. Check the LinkStation Function List on page 35 to see if your LinkStation supports MySQL server.
- The LinkStation's MySQL server is for advanced users only.

1 Navigate to *Network – MySQL Server* in Settings and click *Modify Settings*.

2 Select *Enable* for *MySQL Server*, choose a *Port No.* and *Data Folder*, and click *Save*.

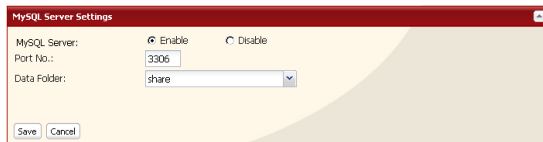

The MySQL server is now configured.

System Settings

Name, Date, and Time

Configure the LinkStation's host name, date, or time as follows:

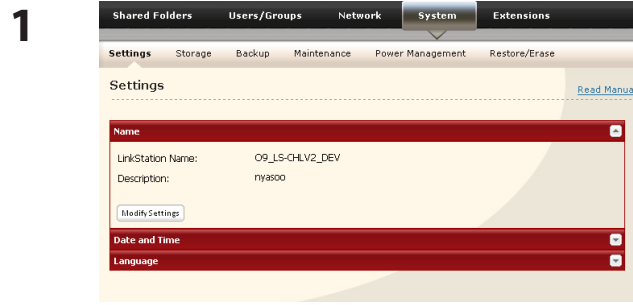

1 In Settings, navigate to *System - Settings - Name*.

2 Click *Modify Settings*.

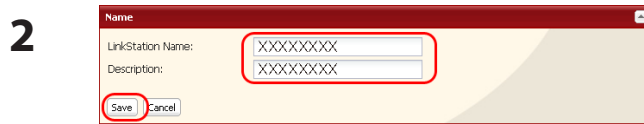

Enter the *LinkStation Name* and *Description*, then click *Save*.

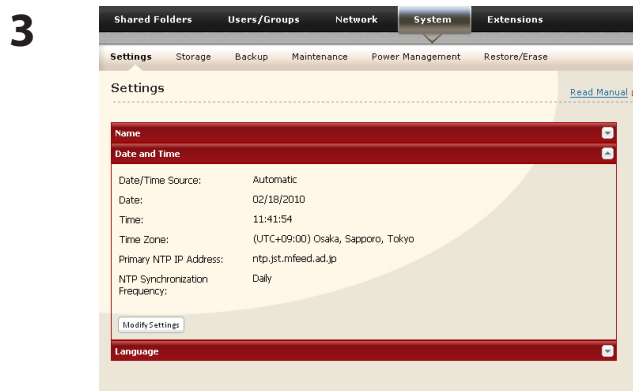

1 In Settings, navigate to *System - Settings - Date and Time*.

2 Click *Modify Settings*.

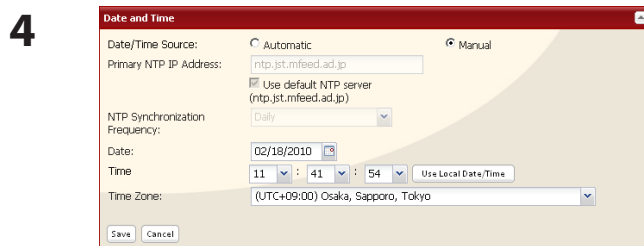

1 Enter the *Date* and *Time*.

2 Click *Save*.

Click *Use Local Date/Time* to use your computer's time settings for the LinkStation.

By default, the LinkStation adjust its clock automatically by using an NTP server.

| |
|---|
| NTP |
| NTP may not be usable in some networks. |
| The default NTP Server (ntp.jst.mfeed.ad.jp) belongs to Internet Multi Feed Inc. For more information, visit www.jst.mfeed.ad.jp . |
| Use NTP at your own risk. Buffalo is not responsible for any loss or damage caused by using of this service, stopping the service, or missing service. |

You've completed hostname and time settings for the LinkStation.

Note: The LinkStation's internal clock may run at a slightly different speed from other clocks on you network, and over a long period of time your network devices may show different times. If clocks on your network vary by more than 5 minutes it may cause unexpected behavior. For best results, keep all clocks on the network set to the same time by adjusting them regularly, or use an NTP server to correct them all automatically.

System Storage

Check Disk

A disk check tests the data on a drive in the LinkStation or connected via USB. Errors are fixed automatically. A disk check may run for more than ten hours. Shared folders cannot be accessed during the disk check. Do not turn off power to the LinkStation during the disk check.

If the power mode switch is set to auto, then the LinkStation will turn off when the disk check is finished.

Run a disk check as follows:

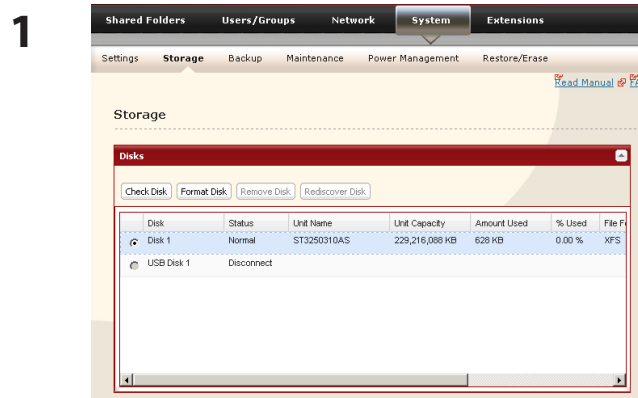

In Settings, navigate to *System - Storage*.

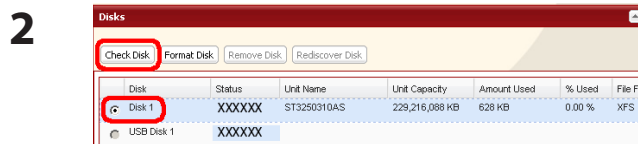

1 Select the hard drive to test.

2 Click *Check Disk*.

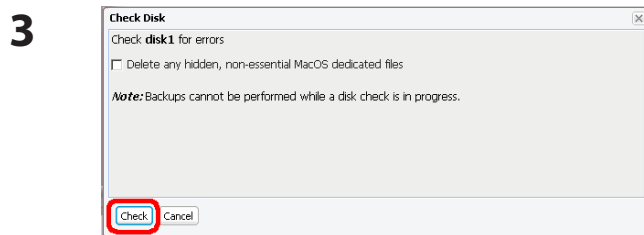

Click *Check*.

The Status LED on the front of the LinkStation will flash during the disk check.

Notes:

- If a power outage disconnects the LinkStation in the middle of a disk check, then you may not be able to access shares on the LinkStation from Mac OS. This is because the database created by Mac OS is damaged. To resolve, navigate to *System - Storage - Check Disk* and check [Delete any hidden, non-essential Mac OS dedicated files]. Rerun the disk check when done.
- If you access a shared folder from a Mac, information files for Mac may be automatically generated. Do not delete these files from a Windows computer. Otherwise, you may no longer be able to access folders from the Mac. If you cannot access them, check [Delete any hidden, non-essential Mac OS dedicated files] in *System - Storage - Check Disk*.

Format a Drive

- A format deletes all data from a hard drive. Be careful! Back up any important data on a drive before formatting it. It will take several minutes to format a hard drive.
- Shared folders cannot be accessed during formatting.
- Do not turn off the power switch or disconnect power while formatting a hard drive.
- If the power mode switch is set to auto, then the LinkStation will turn off when the format is finished.
- To erase all data on a disk, choose *Disk Management - Erase Disk*.

1 In Settings, navigate to *System - Storage*.

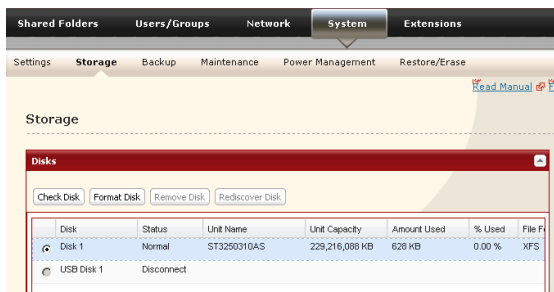

2 1 Select the drive to format.

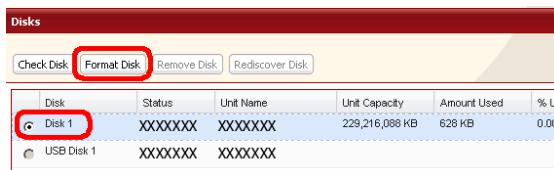

2 Click *Format Disk*.

3 1 Select format type.

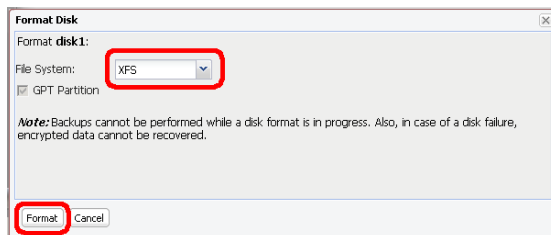

2 Click *Format*.

4 The "Confirm Operation" screen will be displayed. Enter the displayed number into the "Confirmation Number" field within 60 seconds, then click *Apply*.

5 Follow the instructions displayed on the screen.

Notes:

- The time needed to format a hard drive varies based on the hard drive's size and format types (a few seconds to several minutes).
- The Info LED on the front of the LinkStation will flash during formatting. The LinkStation's shared folders cannot be accessed until the disk format is complete.
- If the hard drive is connected to the USB connector, partitions will be recreated.

Adding Storage

Your LinkStation includes USB ports. You can connect a Buffalo external hard drive to it. It will appear as an additional shared folder on the LinkStation.

USB hard drives cannot be added to LinkStations that do not have a USB port.

Connect the hard drive as shown below. If the hard drive is already formatted, it will be detected automatically. If the hard disk is not formatted, format it from Settings (next page).

To disconnect the external drive from the LinkStation, refer to page 78.

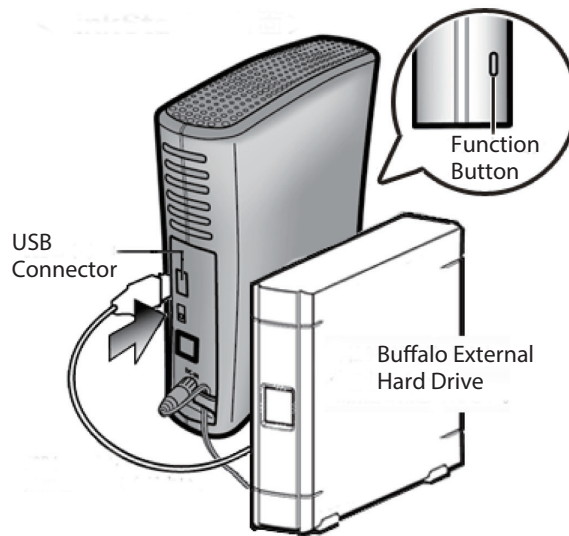

Notes:

- Only one hard drive should be connected to the LinkStation (except the LS-QVL).
- Bus-powered hard drives are not supported. Use a hard drive with an AC adapter or other power supply.
- For best results, use a Buffalo external USB drive. DUB and DUI series drives are not supported.
- Backup data from Mac OS may include characters that cannot be written to FAT16 or FAT32 drives such as “.DS_Store”. For best results, reformat the drive before using as a backup target.

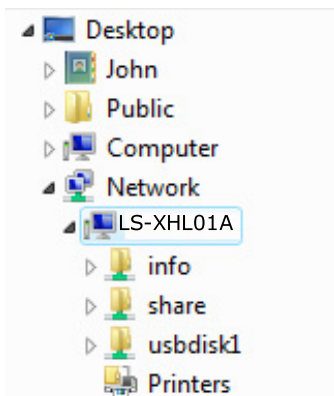

- If the drive is connected properly, “usbdisk1” will be added to the shares under the LinkStation in Network.
- If two hard drives are connected to the LS-QVL series, they appear as “usbdisk1” and “usbdisk2”.

To format a USB hard drive

For best results with the LinkStation, reformat the external USB drive from Settings. Formatting will delete all data on the drive. Back up any important data before formatting.

1

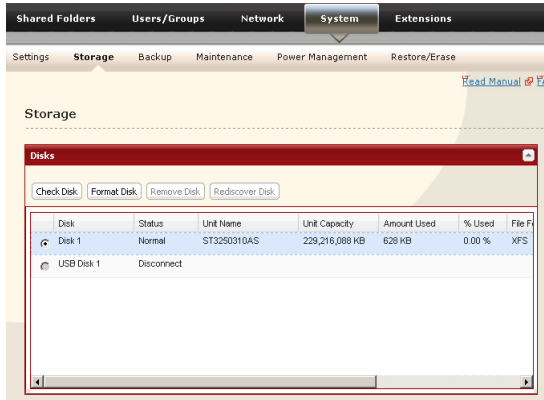

In Settings, navigate to *System - Storage*.

2

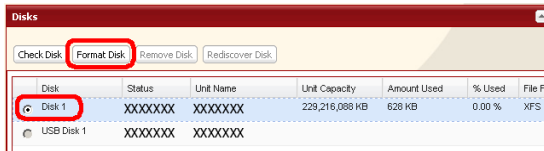

1 Select the USB hard drive.

2 Click *Format Disk*.

3



1 Select a format type (see next page).

2 Click *Format*.

4

The "Confirm Operation" screen will be displayed.

Enter the number shown in the "Confirmation Number" field within 60 seconds, and click *Apply*.

5

Follow the instructions on the screen.

When the format is complete, create a shared folder on the drive.

Notes:

| Format type | Advantages | Disadvantages |
|---|---|---|
| <p>FAT 32 Drives formatted with FAT 32 can be disconnected from the LinkStation and connected to a Windows or Mac directly. They work well with many devices, but do not support large filesizes.</p> | <ul style="list-style-type: none"> • Read/Write support with LinkStation, PCs, and Macs. • You can connect the hard drive to a Windows PC or a Mac at any time and use it normally. | <ul style="list-style-type: none"> • Cannot copy or back up files larger than 4 GB. • Cannot use some characters from Mac OS such as [:]. • It takes extra time to access from Settings or NAS Navigator2. |
| <p>EXT3 This is recommended if you may have to reconnect to and use other LinkStations/ TeraStations.</p> | <ul style="list-style-type: none"> • Supports both Reading and Writing. • Supports Journaling File System. • Also available when connecting to other LinkStation. | <ul style="list-style-type: none"> • May take a while to format (a few minutes to several minutes). • Less space is available than XFS after format. • The more files in a folder, the slower the access. <p>You cannot read data by directly connecting a PC.</p> |
| <p>XFS This format is recommended when you only use the drive with a LinkStation or TeraStation.</p> | <ul style="list-style-type: none"> • Supports both Reading and Writing. • Supports Journaling File System. • More space is available with XFS after format. • Access speed will not degrade even though more files in 1 folder. | <p>Not supported by legacy LinkStations such as HD-LAN, HD-HLAN, HD-HGLAN Series. You cannot read data by directly connecting to a PC.</p> |
| <p>NTFS NTFS works well with Windows PCs. Read-Only from the LinkStation.</p> | <p>Can be used with Windows XP, Windows 2000, Vista, Windows Server2003, and Windows Server2008.</p> | <ul style="list-style-type: none"> • Read-only from the LinkStation or a Mac. • Not suitable for backup from the LinkStation. |
| <p>HFS+ HFS+ works well with Macs. Read-Only from the LinkStation.</p> | <p>Can be used to connect to OS X 10.3.9 or later.</p> | <ul style="list-style-type: none"> • Read-only from the LinkStation. • Not suitable for use with Windows PCs. |

To set access restrictions on an additional hard drive

You can set access restrictions for shares on an external USB hard drive. In Settings, navigate to *Shared Folders - Folder Setup*.

Note:

Even if a shared folder is not visible, you can still format the drive, run a disk check, or back up to the external USB hard drive.

About the USB connector on the LinkStation

- You can connect many types of USB devices to the LinkStation, including USB hard drives, USB flash drives, single-card card readers, digital cameras, and USB printers. USB hubs, mice, keyboards, and card readers that support 2 or more cards are NOT supported.
- One hard drive or other device may be connected to the LinkStation at a time. USB hubs are not supported. Only Buffalo hard drives are supported.
- Hard drives with their power mode switch set to auto may not be recognized by the LinkStation. Set the power mode switch to MANUAL for use with the LinkStation.
- Bus-powered hard drives are not supported. Always use the AC adapter for a hard disk.
- Only the primary partition of USB hard drives can be recognized. Secondary or other partitions will not be recognized.
- If the external USB drive is formatted as FAT32 or FAT 16, you may not be able to copy or back up files or folders from Mac OS to it. These files may include characters that are not supported by FAT 32 or FAT 16.
- When you back up to a FAT 32 USB hard drive with Overwrite Backup (Differential) enabled, the system may overwrite data even though there are no difference in data. If the second of the date when the file created is an odd number, an overwrite backup is performed every time regardless of differences in the data.

Remove Disk

To remove the hard drive:

If the LinkStation is powered on, dismount the USB hard drive before unplugging it. Hold in the function button for 3 seconds. The blue LED will go out, and the drive is dismounted. You may now unplug it safely.

Notes:

- If the LinkStation is off, then the USB device is already dismounted, and you can remove it safely.
- If a USB drive is unplugged without being dismounted first, it may not be recognized properly when it is reconnected. If this happens, restart the LinkStation and then reconnect the drive.

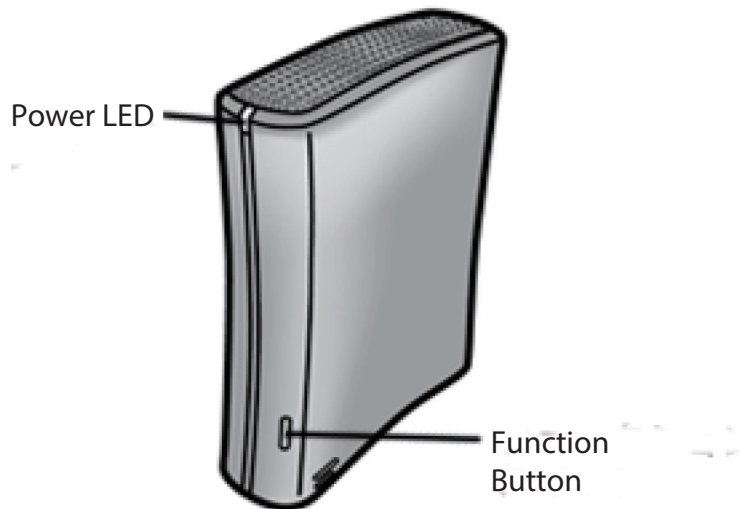

System Backup

Time Machine

Time Machine is a backup program included with OS X 10.5 and later version. It can back up to your LinkStation if you configure the LinkStation as follows:

Notes:

- Not all LinkStations support Time Machine. Check the LinkStation Function List on page 35 to see if your LinkStation supports Time Machine.
- LinkStations using version 1.43 or earlier firmware created an image file during Time Machine setup. Newer versions of the firmware don't require this. For best results, update your LinkStation to the latest firmware. Updated firmware can be downloaded from www.buffalotech.com.
- If your LinkStation with version 1.43 or earlier firmware is already configured to work with Time Machine, the firmware can still be updated to the latest version.

1

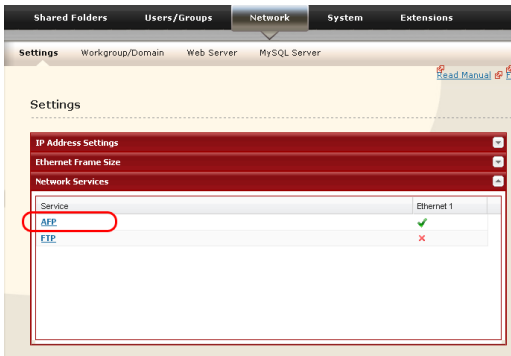

1 In Settings, navigate to *Network - Settings - Network Services*.

2 Click *AFP*.

2

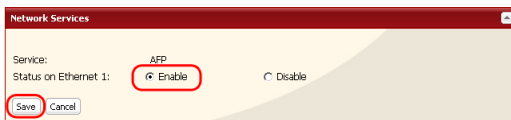

Select *Enable* and click *Save*.

3

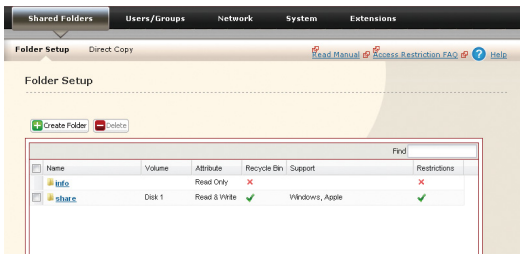

1 Click *Shared Folders*.

2 Select a shared folder to use as the backup destination for Time Machine, or create a new share and then select it.

4

Shared Folders > share

Name: share

Description: BuffaloNas folder

Volume: Disk 1

Shared Folder Attributes: Read Only Read & Write

Recycle Bin: Enable Disable

Shared Folder Support: Windows Apple Ftp Disk Backup

Remote backup password:

Access Restrictions

Save Cancel

- 1 Select *Apple*.
- 2 Click *Save*.

5

Time Machine

Time Machine: Enabled

Target Folder: share

Modify Settings

- 1 Click *Extensions - Time Machine*.
- 2 Click *Modify Settings*.

6

Time Machine

Time Machine: Enable Disable

Target Folder: share

Save Cancel

- 1 Select *Enable*.
- 2 Select the shared folder that you chose in steps 3~4.
- 3 Click *Save*.

7

Select *System Preferences* from the Apple menu of OS X 10.5.

8



Click *Time Machine*.

9



Click *Choose Backup Disk*.

10

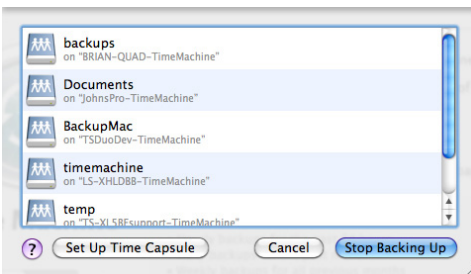

Select the folder on the LinkStation and click *Use for Backup*.

11

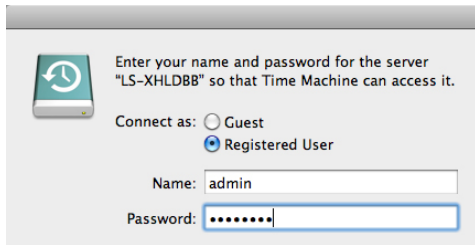

Enter *Name* and *Password* to access the shared folder on the LinkStation, and click *Connect*.

If you do not use access restrictions for the shared folder of the LinkStation you set as a backup destination, enter "admin" in the username box and your password for "admin" in the password. If you use access restrictions, enter a username and password that has read and write access rights to the share.

12



Make sure that the switch for Time Machine is "on". The number of seconds displayed in "Next Backup" will count down and a backup job will start when it hits zero. The backup job will run in the background, so you can use and shut down the Mac as usual. To recover data or set items you want to exclude from backup, refer to Mac OS Help.

You've configured your LinkStation to work with Time Machine.

System Backup

1 Back up data on the LinkStation

You can back up shared folders on the LinkStation from Settings.

• Other LinkStation

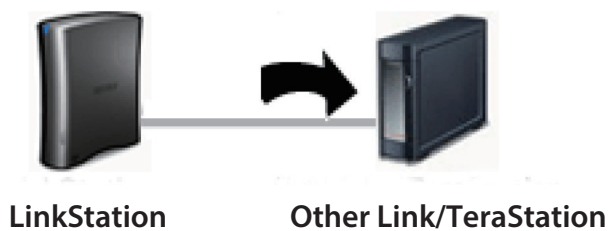

The following sections will discuss how to:

- *Set up the backup destination folder on LinkStation*
- *Find the backup destination folder from LinkStation*
- *Set up a backup job on LinkStation*

• USB hard drive connected to the LinkStation

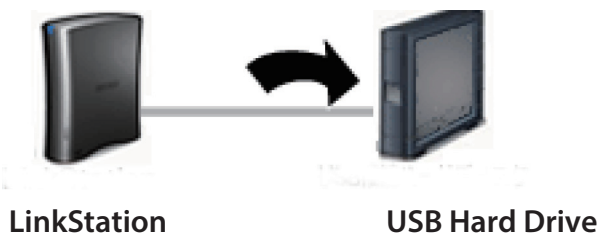

The following sections will discuss how to:

- *Set up a backup job on LinkStation*

2 Setting up the backup destination folder on LinkStation # 1

You may configure a destination folder on a LinkStation for backup jobs from a TeraStation or another LinkStation.

1

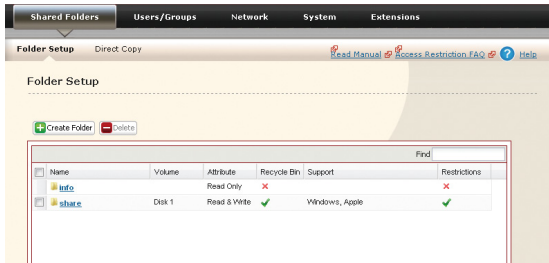

In Settings, click *Shared Folders*.

2

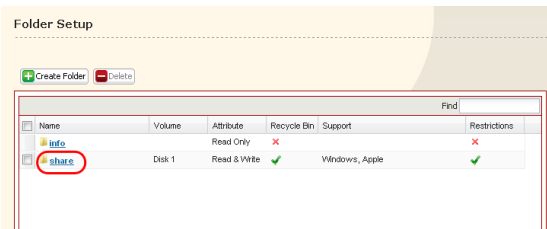

Click the shared folder you want to set as a backup destination.

3

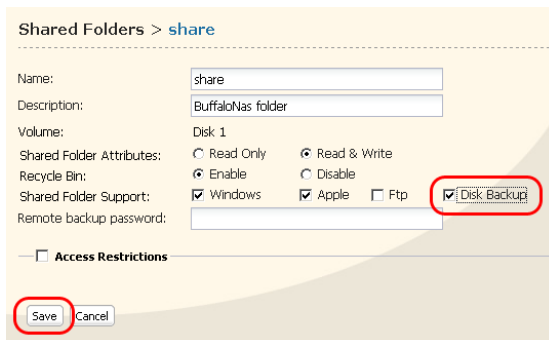

1 Check *Disk Backup*.

Note:

If you enter a backup password, users of other LinkStations (and TeraStations) will have to enter the password before using this LinkStation as a backup destination.

2 Click *Save*.

3 Finding the backup destination folder from LinkStation # 2

If the password is set for the backup destination folder, you must enter the password to configure the folder as the destination for a backup job.

1

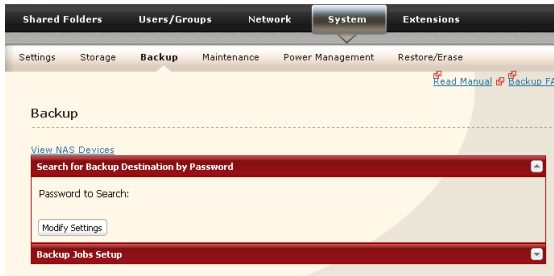

In Settings, navigate to *System - Backup*.

2

Click *Modify Settings* in *Search for Backup Destination by Password*.

3



Enter the *Password to Search* for the folder that is the backup destination.

The search will find backup-enabled folders on the network that have the same password that you are searching for, or that have no password set.

4 Configuring LinkStation # 2 to use LinkStation # 1 as a backup destination

1



In Settings, navigate to *System - Backup*.

2



Click *View NAS Devices*.

3

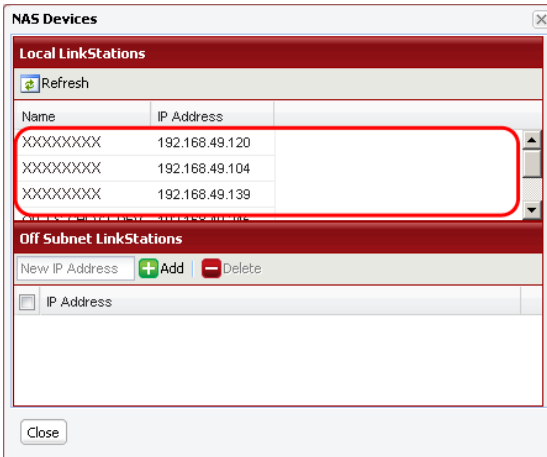

1 Check the *IP address* of the LinkStation you want to specify as a backup destination from *Local LinkStations*.

2 Enter IP address of the LinkStation you want to specify as a backup to "Off Subnet LinkStations" and click *Add*.

Notes:

- If LinkStation # 2 (backing up) and LinkStation # 1 (with the destination folder) are on different networks, you must create a VPN connection between the two networks before the LinkStations will be able to see or back up to each other.
- If you are using Jumbo Frame and back up data from one LinkStation or TeraStation to another LinkStation or TeraStation, set the Ethernet frame sizes of the LinkStations/TeraStations to the same settings (or the closest available). If the Ethernet frame sizes are significantly different, the backup job may fail. If you have problems with backup jobs, select the default frame size (1518 bytes).

5 Set up a backup job on LinkStation # 2

1

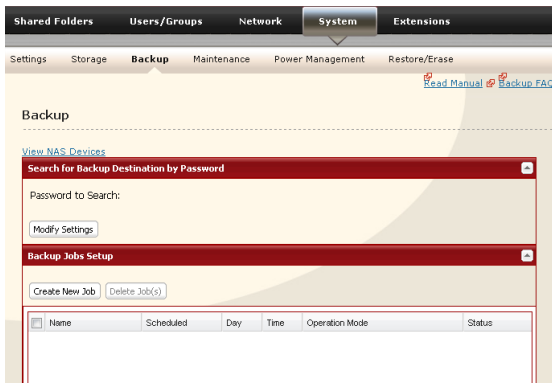

In Settings, navigate to *System - Backup - Backup Jobs Setup*.

2



Click *Create New Job*.

3

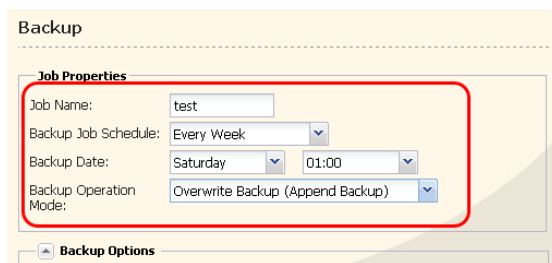

Select backup options.

Backup operation modes

Three backup operation modes are available.

Normal Backup

All files in the source folder are backed up to the destination folder.

Overwrite Backup (Append Backup)

The first time the backup runs, it backs up all files in the source folder just like a normal backup. If later, file A is added to the backup source and file B is deleted, the next backup will add file A, but file B will not be deleted from the backup destination. This will use more space on the backup destination because of the files that are not deleted.

Overwrite Backup (Differential Backup)

The first time the backup runs, it backs up all files in the source folder just like a normal backup. If later, file A is added to the backup source and file B is removed, the next backup will add file A and delete file B. This uses the same space on the backup destination as a normal backup.

The following types of folders may be used as either backup sources or backup destinations:

- Shared folders on your LinkStation, including attached USB drives, but not including the info folder
- Shared folders on a different TeraStation or LinkStation on the local network, but not USB drives attached to it
- Shared folders of a TeraStation or LinkStation on a different network that has been selected manually by IP address, but not USB drives attached to it

Notes:

- Before using a folder for backup, navigate to *Shared Folders* in Settings and check *Disk Backup for Shared Folder Support*.
- Subfolders of shared folders are not supported for backup.
- To make a TeraStation or LinkStation that is on a different network available for use as a backup target, navigate to *System - Backup - View NAS Devices* in the source LinkStation's settings and add it by IP address.

4

Backup

Job Properties

Job Name: test

Backup Job Schedule: Every Week

Backup Date: Saturday 01:00

Backup Operation Mode: Overwrite Backup (Append Backup)

Backup Options

Backup Folders

+ Add - Remove

| Backup Sources | Backup Targets |
|----------------|----------------|
|----------------|----------------|

Click *Add* in the *Backup Folders*.

5

Source & Destination Folders

Backup Sources Backup Targets

Add Close

Select the *Backup Source* and *Backup Targets* folders, then click *Add*.

6

Backup Folders

+ Add - Remove

| Backup Sources | Backup Targets |
|----------------|----------------|
| share | LS-CHLAB1@test |

Apply Cancel

Click *Apply*.

Backup Jobs Setup

Create New Job Delete Job(s)

| Name | Scheduled | Day | Time | Operation Mode | Status |
|------|------------|--------|-------|----------------|--------|
| test | Every Week | Sunday | 00:00 | Normal Backup | Idle |

The task added is displayed to the backup list.

You've now configured a backup job.

Notes:

- You can register up to the second level of subfolders. However, folders with more than 80 bytes (UTF-8) in their names cannot be selected.
- The backup destination device must be configured as a backup destination in advance in order to select it.
- For best results, USB hard drives connected to the LinkStation for backup should be formatted with XFS or EXT3. If a hard disk connected to LinkStation is formatted in FAT32 or FAT16, the following restrictions apply:
 - You cannot back up more than 2 GB of data per file in FAT16 and more than 4 GB of data per file in FAT32.
 - Files created by Mac OS cannot be backed up, since they contains character not allowed by FAT32 or FAT16.
- If you format the hard drive after configuring backup settings, you must reset them.

RAID Arrays

Several RAID modes are available for LinkStation models with multiple hard drives. LinkStations with only one hard drive do not support RAID modes.

Notes:

- Not all LinkStations support RAID arrays. Check the LinkStation Function List on page 35 to see if your LinkStation supports RAID arrays.
- All data is lost when the RAID mode is changed. Back up any important data before changing RAID modes.
- In this document, "Recovery" means putting the LinkStation back to the state it was in before the malfunction happened. It does not mean reading data from broken hard drives.
- When the RAID mode is changed, all data on the drives is lost. Before changing RAID modes, back up any important data from the array.

• RAID 1 mode

Uses 2 hard drives in a mirrored array. One drive's worth of space is usable. Identical data is written to both drives. If one drive is damaged, data can be recovered by replacing the damaged drive.

Note: Hard drives in the LS-WSXL LinkStation are not user-replaceable. If you experience a drive failure with this model, contact Buffalo tech support for assistance.

• RAID 0 mode (default for LS-WVL, LS-WXL, and LS-WSXL)

Multiple hard drives are combined into a single array. The total capacity of all drives is usable. If any drive is damaged, all data on the array is lost.

Note: Use all 4 hard drives to configure RAID 0 with LS-QVL.

• JBOD

Each drive is accessible as a separate, individual drive. The total capacity of each drive is usable. If any drive is damaged, all data on that drive is lost.

- **RAID 5 mode (4 hard drives) (default for LS-QVL)**

RAID 5 mode (4 hard drives) is available for LinkStation models with 4 hard drives. Uses 4 hard drives as one array. It generates parity during writes, so access speeds are slower than other RAID modes. Usable space is the sum of 3 hard drives' space. If one hard drive in the array is damaged, you can recover data by replacing the hard drive. You cannot recover data if 2 or more drives are damaged.

- **RAID 5 mode (3 hard drives)**

RAID 5 mode (3 hard drives) is available for LinkStation models with more than 3 hard drives. Uses 3 hard drives as one array. It generates parity during writes, so access speeds are slower than other RAID modes. Usable space is the sum of 2 hard drives' space. If one hard drive in the array is damaged, you can recover data by replacing the hard drive. You cannot recover data if 2 or more drives are damaged.

- **RAID 10 mode**

RAID 10 mode is available for LinkStation models with 4 hard drives. RAID 10 combines 4 hard drives into a single array. Usable space is the sum of the capacity of 2 hard drives. Data is written quickly and access speed is faster than other RAID modes except for RAID 0. Since the same data is written to 2 hard drives at the same time, if a drive in a pair (1 - 2 or 3 - 4) is damaged, data can be recovered by replacing the damaged hard drive. If both drives in a pair (1 - 2 or 3 - 4) are damaged, you cannot recover data.

• Using in RAID 1 mode

1 Change system to normal mode (page 96).

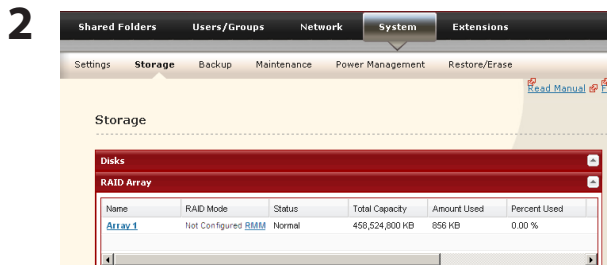

Click System - Storage - RAID Array in Settings.

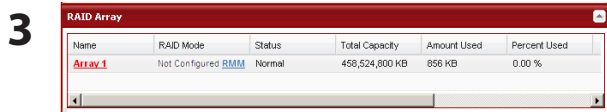

Click the array you want to set.

Note: For details on RMM and EDP, see page 99.

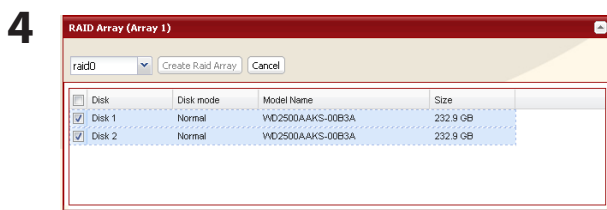

Select hard drives to use in RAID 1.

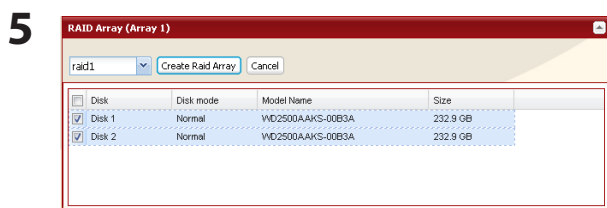

1 Select raid 1.

2 Click Create Raid Array.

6 The "Confirm Operation" screen will appear. Enter the number shown in the "Confirmation Number" field within 60 seconds, and click Apply.

While the array is being built, the file transfer speed will be slower than usual. It will take about 6 hours for a 1 TB RAID array. The Info/Error LED or the Power LED will blink amber while the array is being built. Do not turn off the LinkStation until the RAID array is built.

7 Follow the instructions displayed on the screen.

When the build finishes, the LED will stop blinking. You have set up a RAID 1 array. Turn to page 36 to create a shared folder.

Note: If power is turned off during a RAID rebuild, the RAID rebuild will continue when power is restored.

Confirm Operation screen

When you perform any of the following tasks, a “Confirm Operation” screen is displayed . To continue, enter the displayed number within 60 seconds and click *Apply*.

- Change RAID array (Create/Delete)
- Delete Folder
- Restore Factory Defaults
- Format LinkStation
- Format Array or Disk
- Remove Disk
- Rebuild RAID array

• **Changing to RAID 0 mode**

1 Change system to normal mode (page 96).

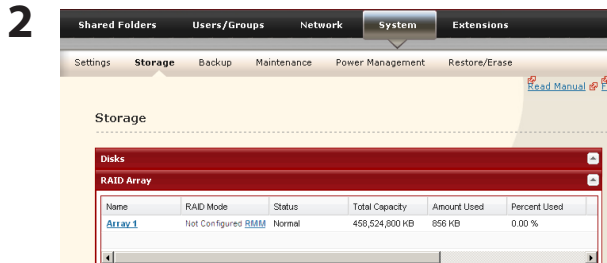

Click *System - Storage - RAID Array* in Settings.

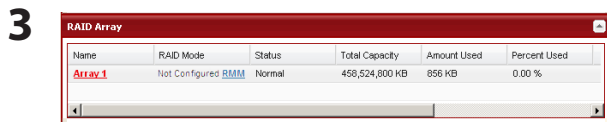

Click the array you want to set.

Note: For details on RMM and EDP, see page 99.

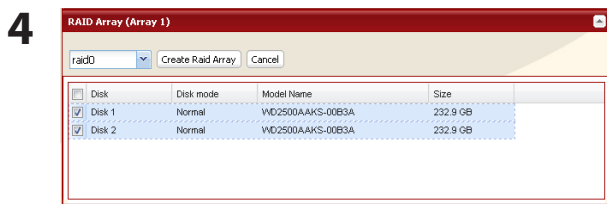

Select all available hard drives.

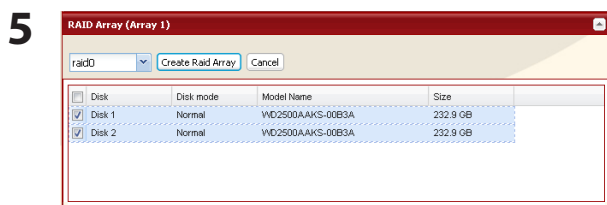

1 Select *raid 0*.

2 Click *Create Raid Array*.

6 The “Confirm Operation” screen will appear. Enter the number shown in the “Confirmation Number” field within 60 seconds, and click *Apply*.

7 Follow the instructions displayed on the screen.

You have set up a RAID 0 array. Turn to page 36 to create a shared folder.

• Changing to JBOD

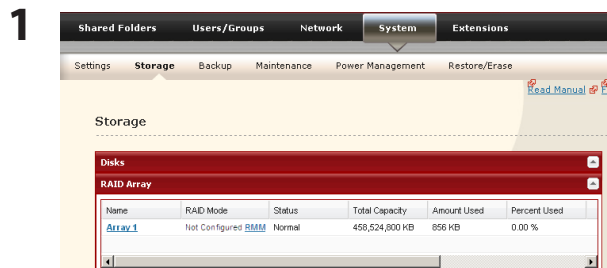

Click *System - Storage - RAID Array* in Settings.



Click the array you want to set.

Note: For details on RMM and EDP, see page 99.

3 Click *Delete RAID Array*.

4 When [Are you sure you want to change RAID mode?] is displayed, click *Apply*.

5 The "Confirm Operation" screen will appear. Enter the number shown in the "Confirmation Number" field within 60 seconds, and click *Apply*.

6 Follow the instructions displayed on the screen.

You have configured Normal mode. Turn to page 36 to create a shared folder.

• Changing to RAID 5 mode (4 hard drives)

1 Change system to normal mode (page 96).

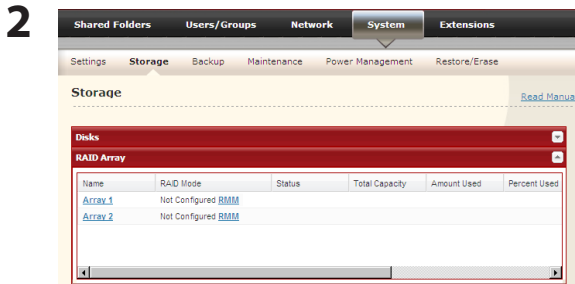

Click *System - Storage - RAID Array* in Settings.

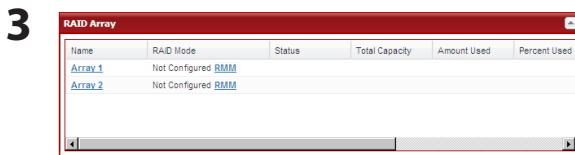

Click the array you want to configure.

Note: For details on RMM and EDP, see page 99.

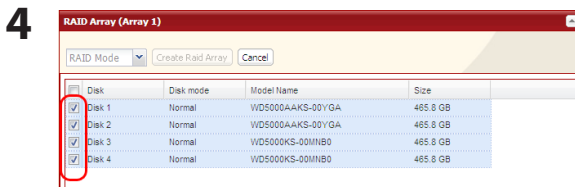

Select hard disks (all 4 of them) to use in RAID 5.

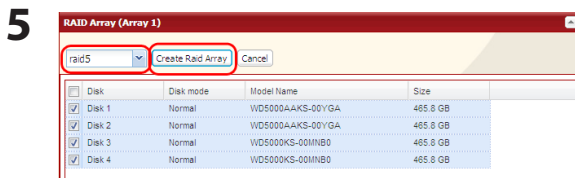

1 Select *raid5*.

2 Click *Create Raid Array*.

6 The “Confirm Operation” screen will appear. Enter the number shown in the “Confirmation Number” field within 60 seconds, and click *Apply*.

While the array is being built, the file transfer speed will be slower than usual. It will take about 6 hours for a 1 TB RAID array. The Power LED will blink amber while the array is being built. Do not turn off the LinkStation until the RAID array is built.

7 Follow the instructions displayed on the screen.

When the build finishes, the LED will stop blinking. You have now set up a RAID 5 array. Turn to page 36 to create a shared folder.

• **Changing to RAID 5 mode (3 hard drives)**

1 Change system to normal mode (page 96).

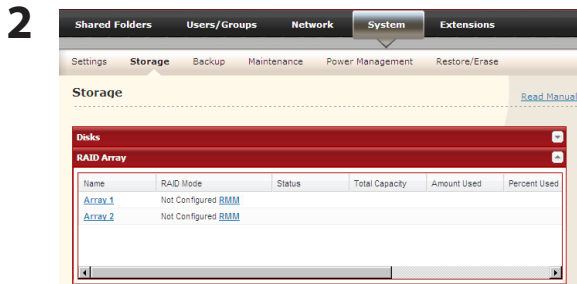

Click *System - Storage - RAID Array* in Settings.

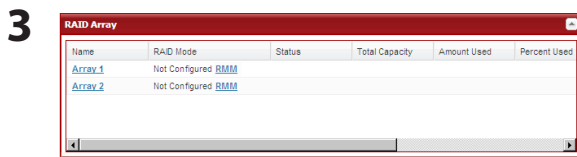

Click the array you want to configure.

Note: For details on RMM and EDP, see page 99.

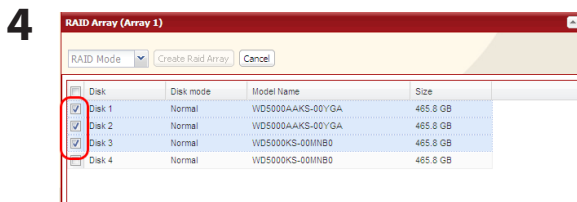

Select hard disks (3 of them) to use in RAID 5.

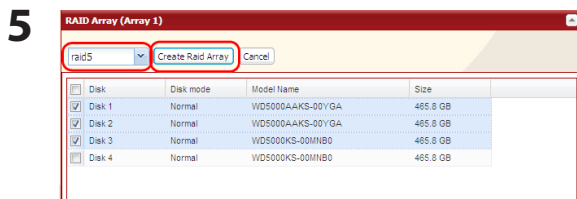

1 Select *raid5*.

2 Click *Create Raid Array*.

6 The “Confirm Operation” screen will appear. Enter the number shown in the “Confirmation Number” field within 60 seconds, and click *Apply*.

While the array is being built, the file transfer speed will be slower than usual. It will take about 6 hours for a 1 TB RAID array. The Power LED will blink amber while the array is being built. Do not turn off the LinkStation until the RAID array is built.

7 Follow the instructions displayed on the screen.

When the build finishes, the LED will stop blinking. You have now set up a RAID 5 array. Turn to page 36 to create a shared folder.

• **Changing to RAID 10 mode**

1 Change system to normal mode (page 96).

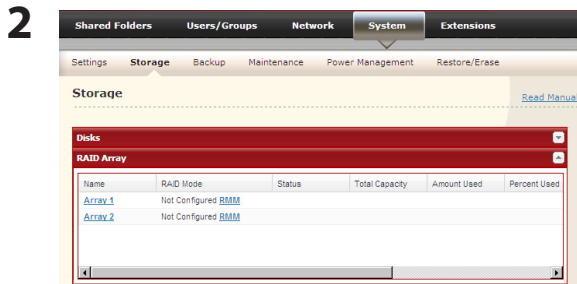

Click *System - Storage - RAID Array* in Settings.

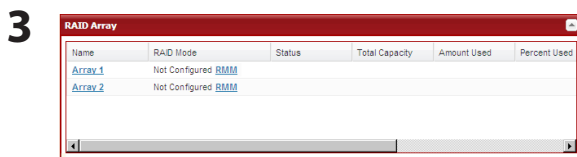

Click the array you want to configure.
Note: For details on RMM and EDP, see page 99.

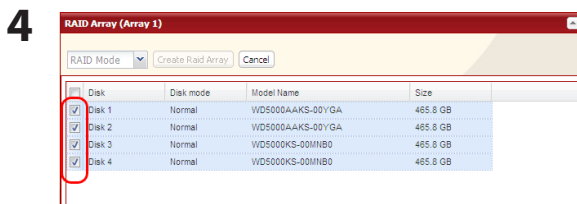

Select hard disks (all 4 of them) to use in RAID 10.

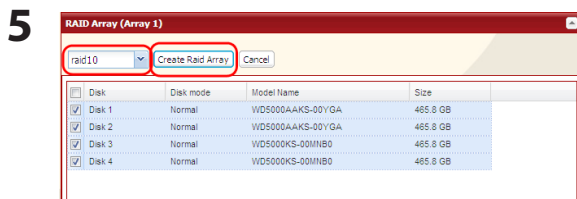

1 Select *raid10*.
2 Click *Create Raid Array*.

6 The “Confirm Operation” screen will appear. Enter the number shown in the “Confirmation Number” field within 60 seconds, and click *Apply*.

While the array is being built, the file transfer speed will be slower than usual. It will take about 6 hours for a 1 TB RAID array. The Power LED will blink amber while the array is being built. Do not turn off the LinkStation until the RAID array is built.

7 Follow the instructions displayed on the screen.

When the build finishes, the LED will stop blinking. You have now set up a RAID 10 array. Turn to page 36 to create a shared folder.

RMM (RAID Mode Manage) and EDP (Easy Data Protection)

Note: LinkStation firmware version 1.25 and later only

With RMM or EDP, you can create or expand a RAID 1 or RAID 5 array without erasing the data on the drives. The following example shows RMM. EDP, as used on LS-WVL, LS-WXL, LS-WSXL and LS-WSXSL LinkStations, is similar.

Note: Each drive in a RAID array should have the same capacity.

Changing from JBOD to RAID 1:

Hard drives that aren't in a RAID array will show "Normal (RMM available)".

Adding a drive to an existing RAID array or adding a drive and changing the RAID mode:

Drives not currently in the array will show either "Normal (RMM available)" or "Normal Mode".

Caution:

If your hard drives show "Normal Mode" instead of "Normal (RMM available)", then you cannot use RMM. If you create a RAID 1 array, all data on both drives will be lost. Back up any important data before changing your RAID array.

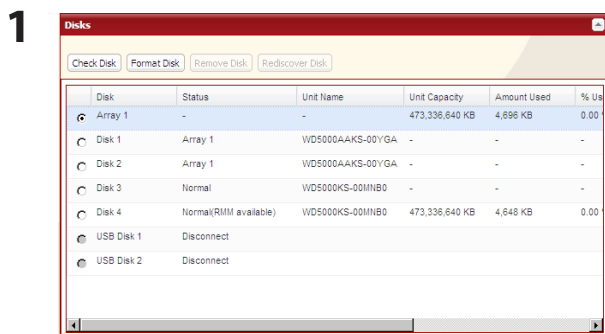

If there are multiple internal hard drives not already included in a RAID array, or if drives were formatted from Settings, *Status* under *System - Storage* appears as "Normal (RMM available)".

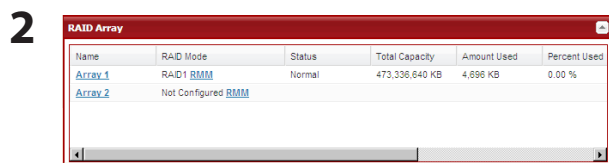

In Settings, navigate to *System-Storage-RAID Array*. Select *RMM* for *RAID Mode*.

3 Note: Any data on the new drive is deleted. Be sure to back up any valuable data beforehand.

Changing from normal mode to RAID 1:

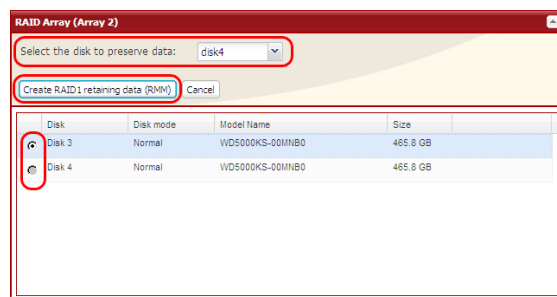

- 1** Select the drive whose data will not be erased from the pull-down menu.
- 2** Select the drive to be added to the RAID array.
- 3** Click *Create RAID 1 retaining data (RMM)*.

Adding a drive to an existing RAID array or adding a drive and changing the RAID mode:

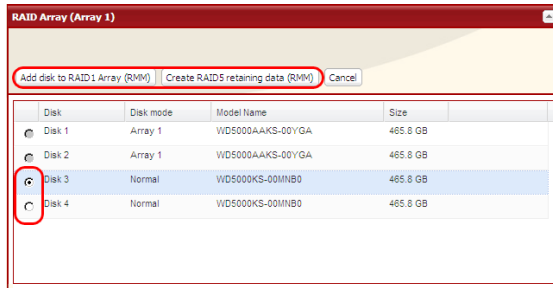

- 1 Select the drive to be added to the RAID array.
- 2 After adding the drive, click your desired RAID mode for the RAID array.

- 4 The “Confirm Operation” screen will open. Within 60 seconds, enter the displayed number in the “Confirmation Number” field. Click *Apply*.

While the array is being built, the file transfer speed will be slower than usual. It will take about 6 hours for a 1 TB RAID array. The Info/Error LED or the Power LED will blink amber while the array is being built. Do not turn off the LinkStation until the RAID array is built.

- 5 Follow the instructions displayed on the screen.

When the build finishes, the LED will stop blinking. This completes the procedure for changing the RAID mode with RMM or EDP.

RAID Scanning

LinkStations that are in RAID 1, RAID 5 and RAID 10 modes support RAID scanning. A RAID scan tests the RAID array for read performance. If defective sectors are found, they are repaired automatically. If your multiple-drive LinkStation is in RAID 1 mode, you should run RAID scans regularly. Configure regular RAID scans as follows:

Note: Not all LinkStations support RAID scanning. Check the LinkStation Function List on page 35 to see if your LinkStation supports RAID scanning.

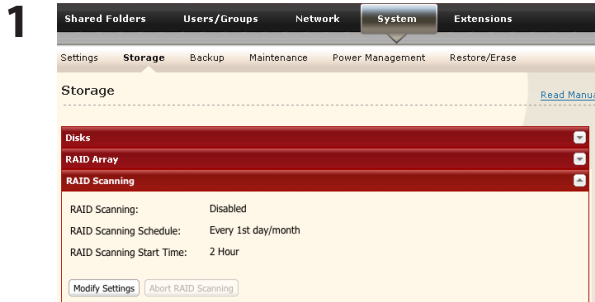

Navigate to *System - Storage - RAID Scanning* in Settings. Under *RAID Scanning*, click *Modify Settings*.



Choose *Enable*, enter your desired schedule, and click *Save*.

Notes:

- Check *Shut Down* to automatically shut down the LinkStation whenever a RAID error occurs. Check *Begin Immediate RAID Scan* to initiate an immediate RAID scan.
- To stop a RAID scan, click *Abort RAID Scanning*.
- Single-drive LinkStations do not support RAID arrays or RAID scanning.

RAID Scanning is now configured.

Maintenance

Email Notification

Your LinkStation can send you daily email reports. It can also send you an email when settings are changed or an error occurs.

The following things will be sent via email:

- The condition of the hard drive
- Notification of completed backup jobs
- Notification of fan errors
- Notification of hard drive errors

1

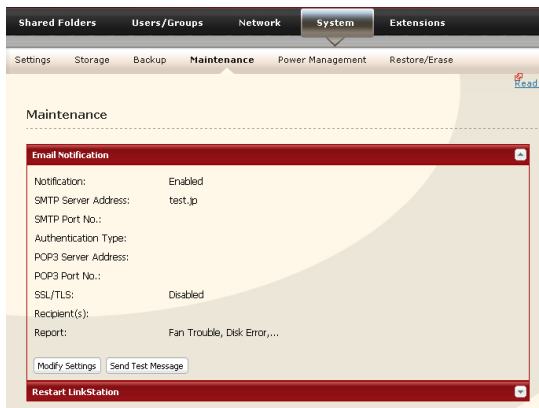

In Settings, navigate to *System - Maintenance*.

2

Click *Modify Settings* in "Email Notification".

3

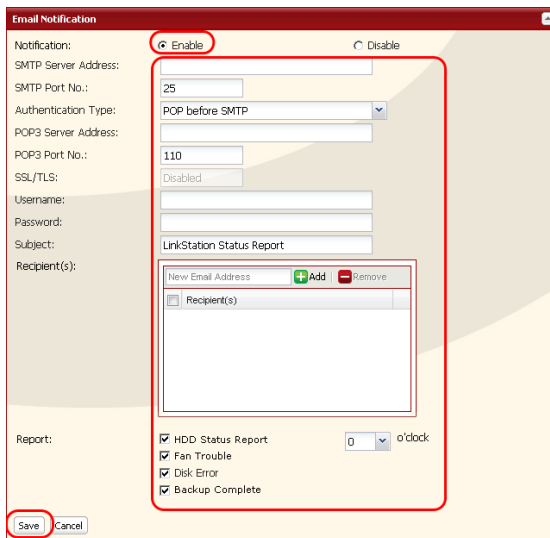

1 Click *Enable* in Notification.

2 Type the *SMTP Server Address* and *SMTP port No.*

Note: If using *POP before SMTP*, enter *POP3 Server address* and *POP3 port No.*

3 Select *Authentication Type* from *Disabled/POP before SMTP/LOGIN(SMTP-AUTH)/CRAM-MD5 (SMTP-AUTH)/CRAM-MD5*.

4 Enter an *username*.

- 5 Enter a password that will be used to verify.
- 6 To use a secured connection, select *SSL/TLS*.
- 7 Enter the *Subject* for notification email.
- 8 Enter a receiver's email address. Email can be sent to up to 5 addresses.
- 9 Select conditions for emails to be sent.
 - *HDD Status Report* Sends status of hard drive periodically.
 - *Fan Failure* Sends a message when a fan error occurs.
 - *Disk Error* Sends a message when a hard drive fails.
 - *Backup Complete* Sends a message when the backup is complete.
- 10 If you have selected *HDD Status Report* for sending condition, select time to send.
- 11 Click *Save*.

4

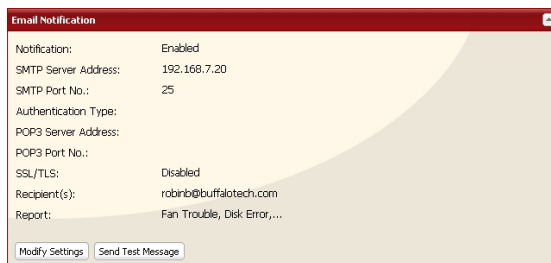

Click *Send Test Message* to send a test message.

Power Management

UPS Settings

A UPS (uninterruptible power supply) can automatically shut down your LinkStation in case of a power outage. To use the LinkStation with a UPS, configure the following settings.

Note: Not all LinkStations support UPSs. Check the LinkStation Function List on page 35 to see if your LinkStation supports UPSs.

- 1 Plug the Power cable of UPS to a wall socket.
- 2 Connect the AC adapter of the LinkStation to the UPS.
- 3 Connect the UPS and the LinkStation with a USB cable.
- 4 Turn on the UPS, then the LinkStation.

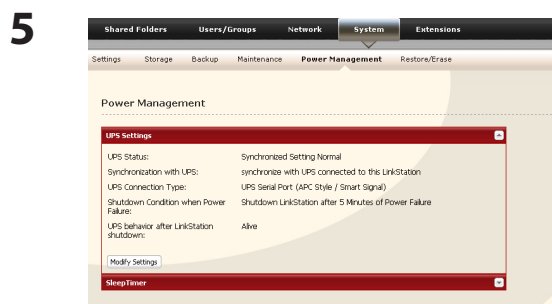

In Settings, navigate to *System - Power Management - UPS Settings* and click *Modify Settings*.

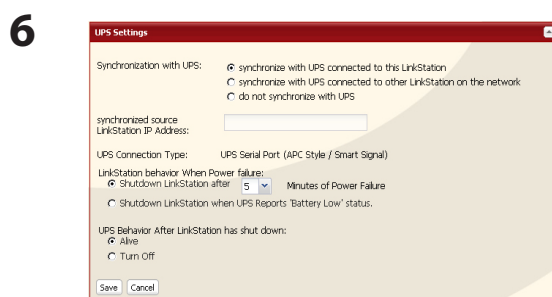

1 If your LinkStation is connected directly to the UPS, select *synchronize with UPS connected to this LinkStation*. To have the UPS shut down multiple LinkStations on the same network, select *synchronize with UPS connected to other LinkStation on the network* and enter the IP address of the LinkStation that is connected directly to the UPS in the field below.

2 Click *Save*.

The LinkStation is now configured to work with the UPS.

Note: If the LinkStation shuts down automatically due to a power outage, make sure that the power issue is resolved before turning it back on. If the LinkStation is turned back on while it's still running on the UPS battery, the UPS will not shut it down again, even if the battery runs low.

Sleep Timer

To save energy, you can specify times to put the LinkStation into standby mode, where the hard disk and LED lights are turned off. The sleep timer only works when the LinkStation's power mode switch is on. This feature cannot be used when it is set to auto.

Note: If you are using LS-QVL LinkStation models, set the power mode switch to MANUAL.

1

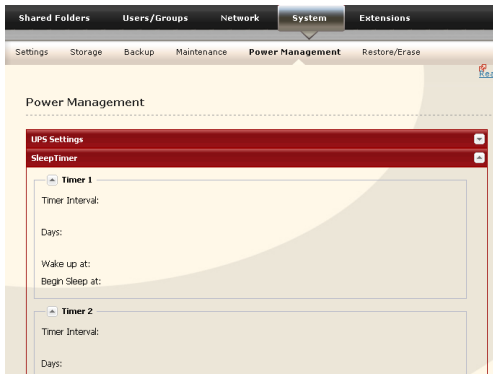

1 In Settings, navigate to *System - Power Management - Sleep Timer*

2 Click *Modify Settings*.

2

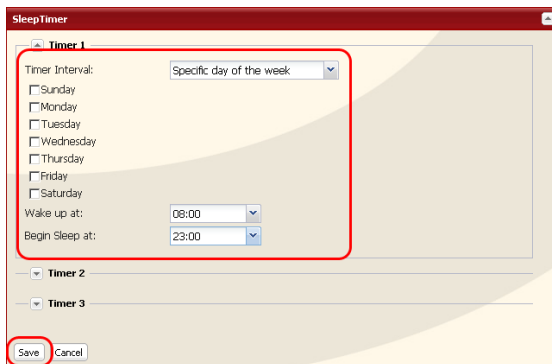

1 Specify "Timer Interval", "Wake up at" and "Begin Sleep at".

2 Click *Save* at the bottom of the screen.

- You can set up to 3 timers.
- You can set ending time from 0:00 to 27:45.
- You can set beginning time from 0:00 to 23:45.
(If the ending time is 24:00 or later, the beginning time can be set from 4:00 to 23:45.)
If 24:00 is equivalent to 0:00 of the next day, and 27:00 is equivalent to 3:00 of the next day.
- You can not set the ending time before or the same time as a beginning time.
- During processing disk check, disk format, and backup jobs or when a backup job is scheduled before and after 5 minutes of the current time, the LinkStation will not be proceeded to Standby mode even though the end time has reached.
- If time of the timers are duplicated, the longest interval time is used to operate.

Examples of multiple timers:

(e.g.1) It is at 10:00 Wednesday with the LinkStation powered on:

Timer 1 Everyday 12:00 - 24:00

Timer 2 not used

Timer 3 not used

-> Nothing happens at 12:00 and goes into sleep mode at 24:00

(e.g.2) It is at 10:00 Wednesday with the LinkStation powered on:

Timer 1 Everyday 9:00 - 18:00

Timer 2 Day specified Wednesday 10:00 - 20:00

Timer 3 not used

-> Except on Wednesdays, the LS powers on at 9:00 and goes into sleep mode at 18:00.
On Wednesdays, it goes into sleep mode at 20:00.

(e.g.3) It is at 10:00 Wednesday with the LinkStation powered on:

Timer 1 Everyday 9:00 - 18:00

Timer 2 Day specified Wednesday 10:00 - 25:00

Timer 3 not used

-> Except on Wednesdays, the LS powers on at 9:00 and goes into sleep mode at 18:00.
-> On Wednesdays, it goes into sleep mode at 1:00 of the next day.

(e.g.4) It is at 10:00 Wednesday with the LinkStation powered on:

Timer 1 Everyday 9:00 - 18:00

Timer 2 Day specified Wednesday 07:30 - 22:00

Timer 3 not used

-> Except on Wednesdays, the LS goes into sleep mode at 18:00.
-> LS turns on Wednesday at 7:30, and goes into sleep mode at 22:00.

Notes:

- In standby mode, pressing the LinkStation's function button or moving the power mode switch to auto will turn the LinkStation on.
- If Sleep Timer has shut down your LinkStation, to turn it on before the wakeup time, power down the LinkStation and then turn it on again. For the LS-XL series, power it down, then disconnect and reconnect the AC adapter.

Sleep timer settings are now complete.

Restoring Factory Defaults

To initialize the LinkStation to its factory defaults, follow the procedure below.

For LS-VL, LS-XHL, LS-CHL, LS-WVL, LS-WXL, LS-WSXL LinkStation models

- 1 Move the power switch to the off position to shut down the LinkStation.
- 2 Move the power switch to the on position while holding down the function button. The function button will flash blue for 1 minute.

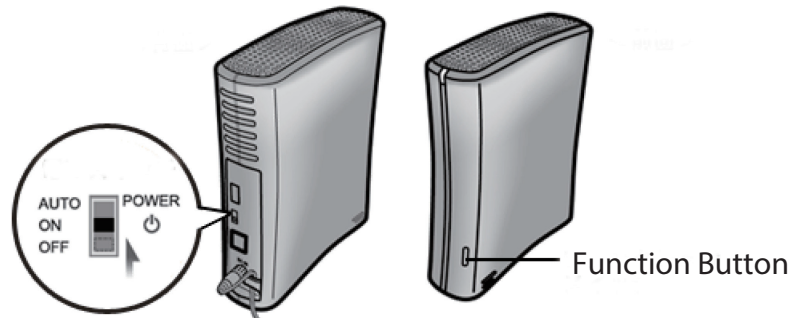

- 3 While the function button is flashing blue, press it again. The status LED will flash blue. It will start flashing amber when initialization begins (2 - 3 minutes).

For LS-QVL LinkStation model

- 1 Hold down the Power button for three seconds to shut down the LinkStation.
- 2 Turn on the Power button while holding down the Function button. The Function LED flashes blue (for about one minute).

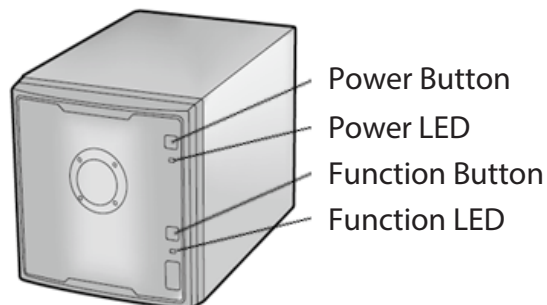

- 3 While the Function LED is flashing blue, press the Function button one more time. This starts the initialization process. During initialization, the Power LED flashes amber.

For LS-XL LinkStation model

To initialize the LinkStation to its factory defaults, follow the procedure on the next page.

Notes:

- This method of initializing the LinkStation restores its IP address settings, Ethernet frame size settings, and administrator (admin) password to their factory defaults. If you chose not to initialize the administrator's password from Settings, only the IP address and Ethernet frame size settings are initialized. You can initialize other items from Settings.
- If you do not want to initialize the admin password when you initialize the LinkStation, select *Keep current admin password* in the *System - Restore/Erase - Restore Factory Defaults* screen, and click *Save*.
- If you choose to not initialize the admin password from the function button, you can no longer configure the LinkStation if you forget the password! Write your password down and put it in a safe place.

Initialization from Settings

You can initialize the following settings from Settings: LinkStation name, Description, NTP settings, Workgroup settings, Shared service settings, access restrictions of the shared folder, User settings, Groups, mail notification settings, UPS synchronization settings, Backup Settings, Admin Username and password, Print server settings, WebAccess, Language settings, SleepTimer, Media server settings, BitTorrent settings, Time Machine configuration, Web Server, MySQL Server, Network Services, Network-USB Server, Eye-Fi connected, and Flickr Support.

1

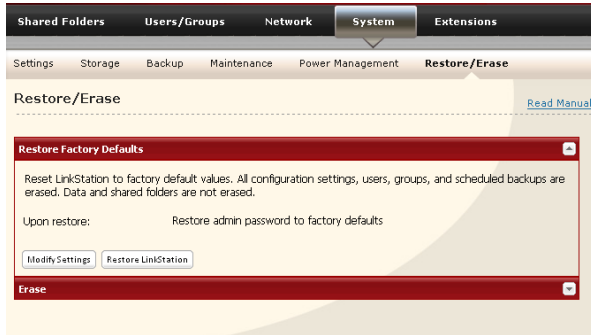

In Settings, navigate to *System - Restore/Erase*.

2

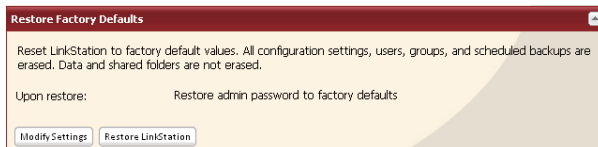

Click *Restore LinkStation*.

3 The "Confirm Operation" screen will appear. Enter the number shown in the "Confirmation Number" field within 60 seconds, and click *Apply*.

4 Follow the instructions displayed on the screen.

Your LinkStation has been initialized.

Format the LinkStation

1

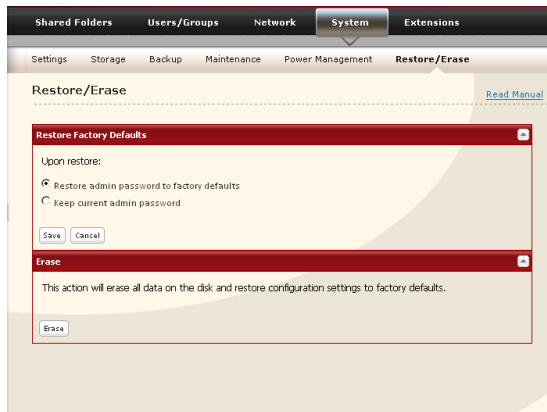

In Settings, navigate to *System - Restore/Erase*.

2

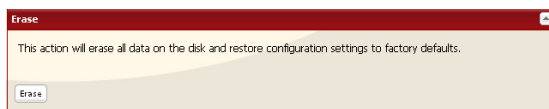

Click *Erase*.

3

The “Confirm Operation” screen will be displayed.

Enter the number from the “Confirmation Number” field within 60 seconds, and click *Apply*.

4

Follow the instructions displayed on the screen.

Warning:

Formatting the LinkStation will erase all data on the drive! Back up any important data before formatting.

After a format, your LinkStation will reboot. Settings will be returned to their factory defaults. LinkStations with multiple hard drives will be set to “normal” mode, where individual drives are addressed separately. Drives will be blank, with no shares on them. You will need to create at least one shared folder before you can use the LinkStation.

Online Update

LinkStation firmware versions 1.41 and later support online updating.

Note: Not all LinkStations support online update. Check the LinkStation Function List on page 35 to see if your LinkStation supports online update.

If a new firmware is available, the message “A new version of the firmware has been released. The current firmware can be updated to the latest version.” is displayed when the LinkStation boots.

To update the firmware, open the LinkStation’s settings and navigate to *System – Maintenance – Firmware Installation*. Click *Check for Update* to check the change log, then *Install Update* to update to the latest firmware.

Extensions

WebAccess

What is WebAccess?

WebAccess lets you access files on your LinkStation through the Internet. Access restrictions can be set for folders that are shared, and automatic router settings by UPnP and redirect functionality from the buffalonas.com server (similar to Dynamic DNS) make configuration easy.

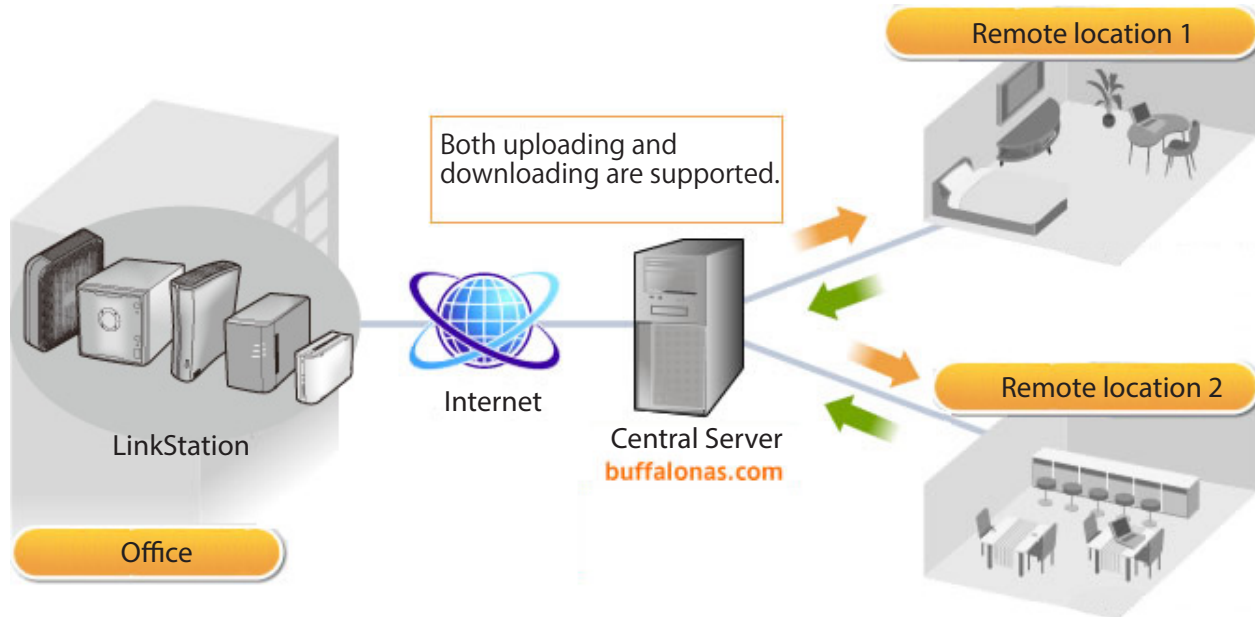

Notes:

- Care should be taken with configuration of WebAccess. Certain settings can make the files in the shared folder available to anyone on the Internet without any access restrictions.
- Use compatibility mode to use WebAccess with Windows 8.

**For the initial WebAccess configuration procedure, visit
<http://buffalonas.com/manual/setup/en/>**

For more information, see WebAccess online Help. Which client device will you use with WebAccess?

- Android:
<http://buffalonas.com/manual/a/en/index.html>
- iPhone, iPod touch, iPad:
<http://buffalonas.com/manual/i/en/index.html>
- Computer:
<http://buffalonas.com/manual/en/index.html>

Network-USB Server

A Network-USB server lets you connect to USB devices attached to a LinkStation from multiple computers. Only one computer can be connected to each USB device at one time.

Before connecting a USB device to your LinkStation, first connect it directly to your computer so that the driver is installed.

Notes:

- Not all LinkStations support Network-USB Server. Check the LinkStation Function List on page 35 to see if your LinkStation supports Network-USB Server.
- For a list of compatible USB devices that can be connected with the Network-USB server, see www.buffalotech.com.
- While the Network-USB server is enabled, the following devices and functions will not be able to use the USB port:
 - USB hard drives
 - Print server
 - USB UPS connection
 - DirectCopy
- Maximum number of connectable USB devices: 15 (not including one USB hub). The number of connectable devices may vary depending on the customer's operating environment.
- If a device is recognized as multiple USB devices, the maximum number of connectable devices is reduced.
- Only one USB hub can be connected.



In Settings, navigate to *Extensions - Network-USB Server - Modify Settings*.



1 Select *Enable*.

2 Click *Save*.

Next, follow the procedure on the next page to install Network-USB Navigator.

Network-USB Navigator Installation

Windows Users

- 1 Insert the LinkNavigator CD.
- 2 The Setup Wizard should launch automatically.
If not, open the CD and double-click *LSNavi.exe*. LinkNavigator will launch.
- 3 Click *Options - Additional Software Installation - Network-USB Navigator - Install*.

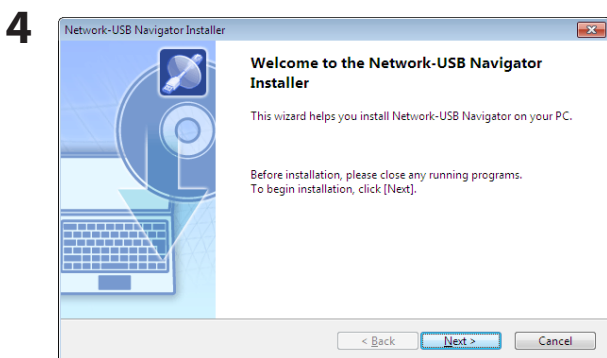

Click *Next*. The wizard will guide you through installation.

Network-USB Navigator installation is complete. Refer to "Network-USB User Manual" for more information.

Macintosh Users

- 1 Insert the LinkNavigator CD.
- 2 Double-click the LinkNavigator icon in the utility CD. LinkNavigator will launch.
- 3 Click *Install Network-USB Navigator*.

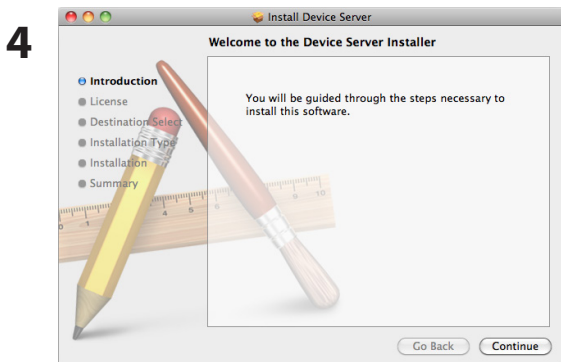

Click *Continue*. The wizard will guide you through installation.

Network-USB Navigator installation is complete. Refer to "Network-USB User Manual" for more information.

Print Server

LinkStation is equipped with a USB connector on the back. LS-QVL LinkStation is equipped with a USB connector each on the front and back. You can connect a USB printer to the LinkStation as shown below.

Note: Not all LinkStations include printer support. Check the LinkStation Function List on page 35 to see if your LinkStation includes printer support.

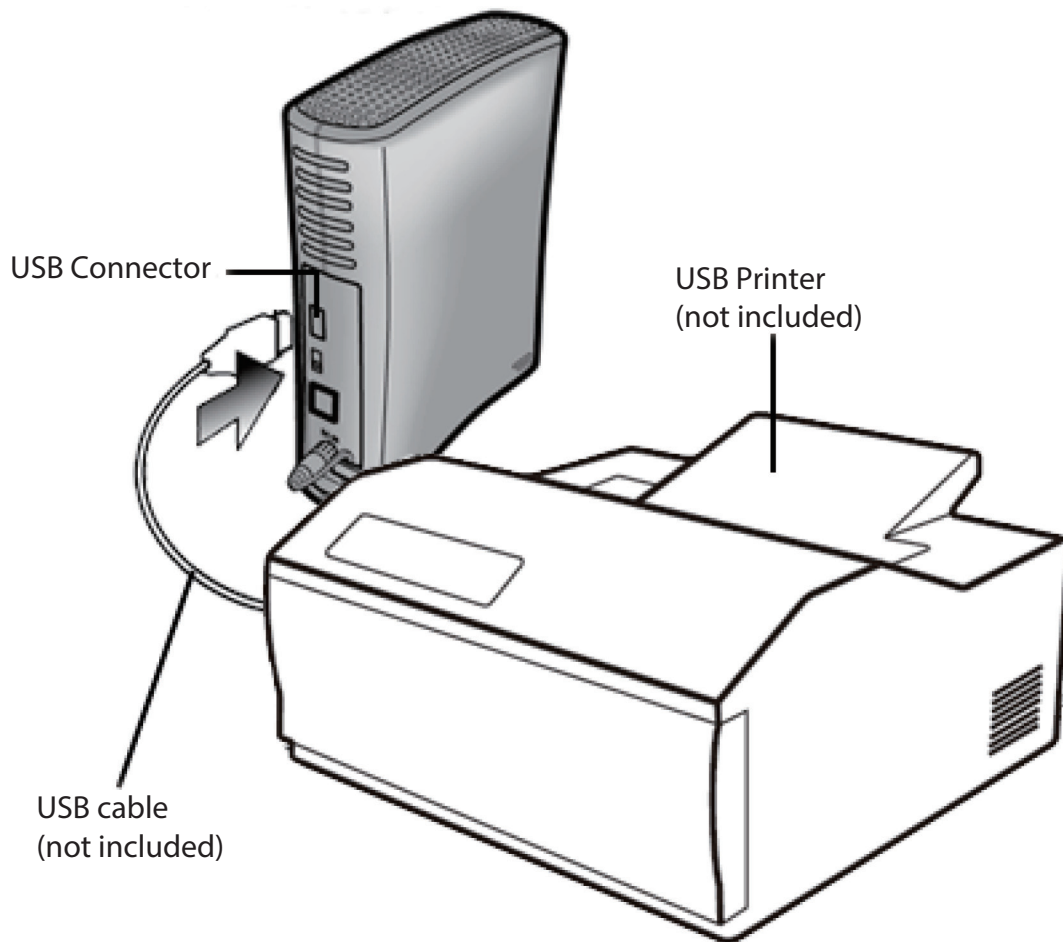

Notes:

- Only one printer can be connected to the LinkStation.
- The LinkStation does not support 2-way communication. For example, it cannot tell you the amount of ink left.
- Multi-function printers are not supported.
- Printers which only support 2-way communication or WPS (Windows Printing System) are not supported.
- Mac OS cannot print to a printer connected to the LinkStation.

Setting up a printer on Windows 8, Windows 7 or Windows Vista

1

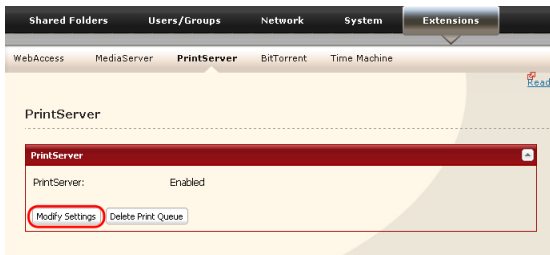

In Settings, navigate to *Extensions - PrintServer* and click *Modify Settings*.

2



Select *Enable* and click *Save*.

3

Refer to your printer's manual installation instructions. You may need to install the printer driver from a software disk.

4

Click *Start - Network*.
For Windows 8, click *Network* in File Explorer.

5

Double-click the LinkStation's server name.

6

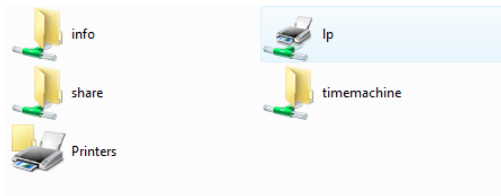

Double-click the LinkStation's printer icon ("lp").

7

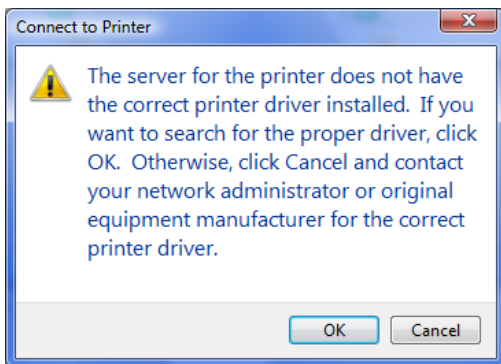

Click *OK*.

8

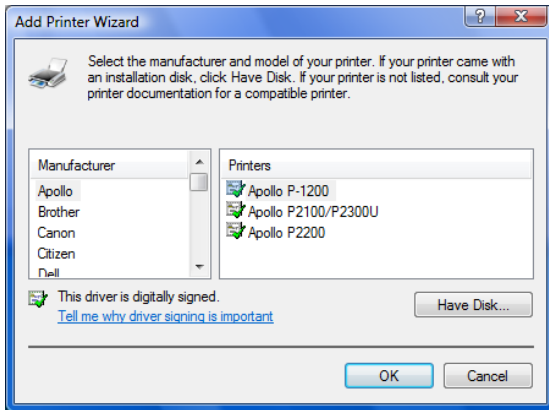

- 1 Select your printer. Choose the manufacturer on the left and the model on the right. If your printer is not listed, click *Have Disk* and follow the printer manufacturer's directions for installation.
- 2 Click *OK*.

You have added a printer.

Setting up a printer on Windows XP

1

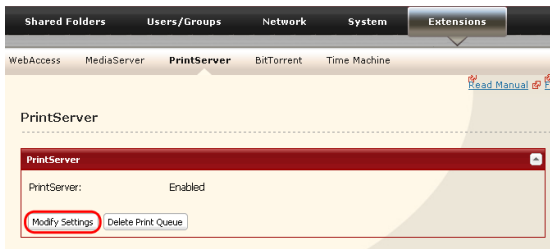

In Settings, navigate to *Extensions - PrintServer* and click *Modify Settings*.

2



1 Choose *Enable* and click *Save*.

3

Refer to your printer's manual installation instructions. You may need to install the printer driver from a software disk.

4

Click *Start - Control Panel*.

5

Click *Network and Internet Connections* icon.

6

Double-click *View workgroup computers*, then on the name of your LinkStation server name.

7



Double-click the LinkStation's printer icon ("lp").

8

If "The printer driver to your computer will be automatically installed. Would you like to continue?" is displayed, click *Yes*.

9

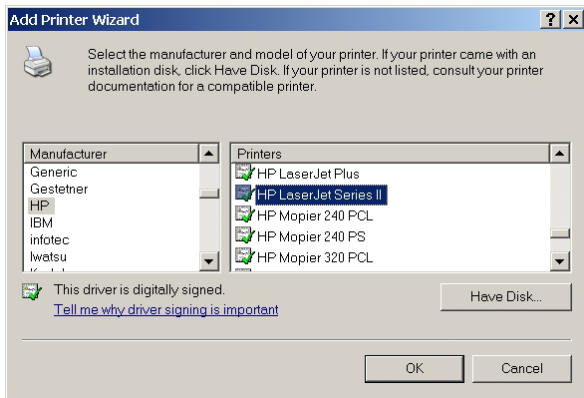

- 1 Select your printer. Choose the manufacturer on the left and the model on the right. If your printer is not listed, click *Have Disk* and follow the printer manufacturer's directions for installation.
- 2 Click *OK*.

You have added a printer.

Setting up a printer on Windows 2000

1

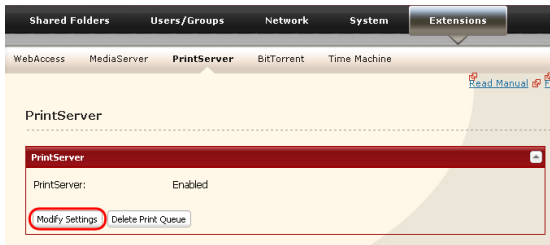

In Settings, navigate to *Extensions - PrintServer* and click *Modify Settings*.

2

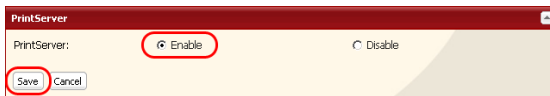

1 Click *Enable*.

2 Click *Save*.

3

Refer to your printer's manual to install the printer driver.

4

Double-click [My Network Places (*)] -*Entire Network* - (the LinkStation Server Name).

* On Windows NT 4.0 this is *Network*.

5



Double-click the LinkStation's printer icon ("lp").

6

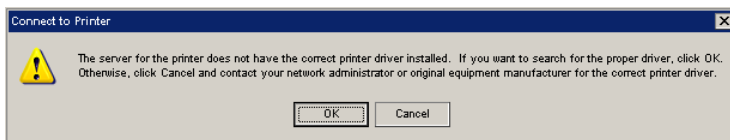

Click *OK*.

7

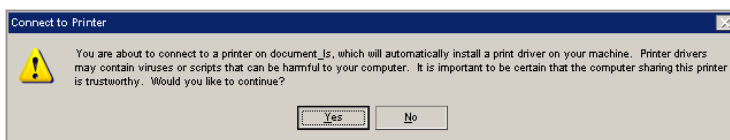

Click *Yes*.

8

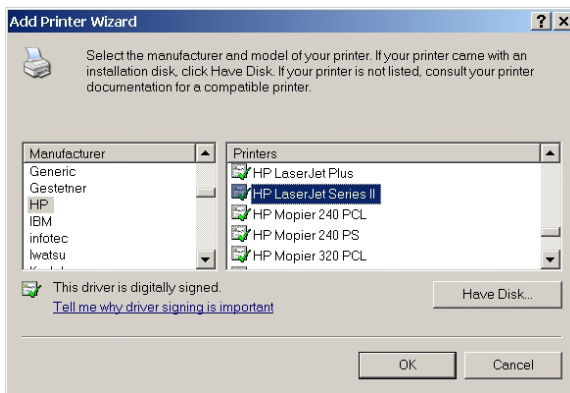

- 1 Select your printer. Choose the manufacturer on the left and the model on the right. If your printer is not listed, click *Have Disk* and follow the printer manufacturer's directions for installation.
- 2 Click *OK*.

You have added a printer.

BitTorrent Client

BitTorrent is a protocol for sharing files. You can download files quickly since files are distributed on the network and network traffic is not concentrated, even with a large file. It does not keep anonymity, and it is easily known who publishes what files.

Warning:

Do not download copyrighted files without permission from the owner.

See <http://www.bittorrent.com/> for more information about BitTorrent.

Notes:

- Not all LinkStations include the BitTorrent Client. Check the LinkStation Function List on page 35 to see if your LinkStation includes the BitTorrent Client.
- Use compatibility mode to use WebAccess with Windows 8.

Flow chart of downloading with BitTorrent:

1 Use a search engine to find the torrent for a file that you want. Download the torrent.

Notes:

- Torrents are information files with a ".torrent" extension.
- Torrents can be downloaded from BitTorrent Inc.'s website or many other websites. Follow the terms of use and copyright rules for each website.

2 Send torrent information to a server called "tracker" and receive information about a terminal which has a file.

3 Start downloading based on the information received from the "tracker" server.

4 Download pieces of data from multiple terminals and make one file.

Use the following steps to download shared files to the LinkStation with BitTorrent.

Enabling BitTorrent and selecting folders

1

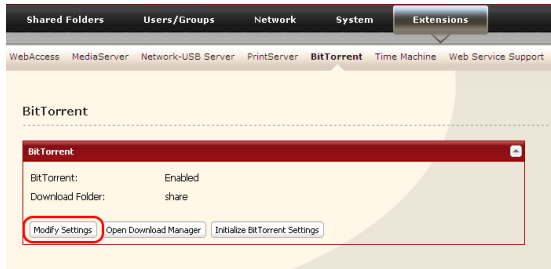

- 1 In Settings, navigate to *Extensions - BitTorrent*.
- 2 Click *Modify Settings*.

2

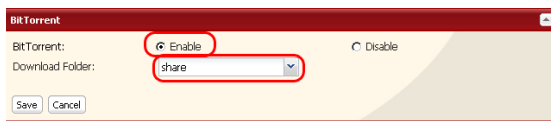

- 1 Click *Enable*.
- 2 Select a folder for downloads on the LinkStation from *Download Folder*.
- 3 Click *Save*.

3



Click *Open Download Manager*.

Note:

If you click *Initialize BitTorrent Settings*, you can initialize BitTorrent settings.

Enter the username and password for Download Manager.

The default username and password are:

Username: admin

Password: (blank; no password)

The Download Manager will open.

The download manager is similar to “µTorrent”. For more information on how to use it, do an Internet search for “µTorrent”.

DLNA Server

The LinkStation is equipped with a DLNA server. Videos, pictures and music saved on the LinkStation can be displayed or played on TV, audio devices, game devices and other DLNA compatible network devices.

DLNA (Digital Living Network Alliance) defines Home Network Device Interoperability Guidelines, which are product design guidelines in the industry's standard technology in order to achieve the interconnecting environment for digital devices (computers, home appliance, mobile devices and so on).

To use DLNA server on the LinkStation, begin by enabling it.

1



In Settings, navigate to *Extensions - MediaServer - DLNA Server* and click *Modify Settings*.

2

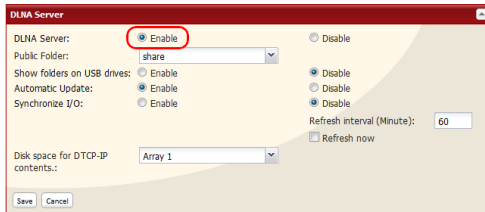

Enable *DLNA Server*.

3

Click *Save* at the bottom of Settings.

DLNA server is now enabled on the LinkStation.

Connecting to the LinkStation and playing the files

This example shows how to use DLNA compatible media players to play files on the LinkStation. Screenshots are from a Buffalo LinkTheater LT-H90 media player.

- 1 Connect DLNA compatible devices to the network and turn them on.
Note: Refer to the devices' manuals for how to connect them.
- 2 Select the DLNA server of the LinkStation from the screen to select DLNA compatible devices

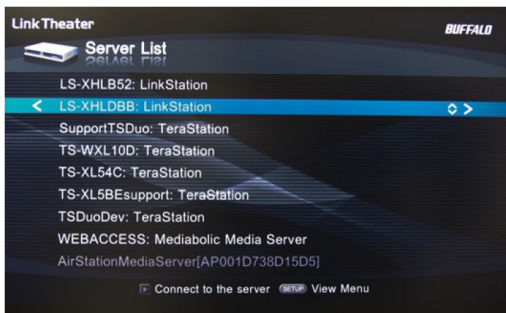

Select your LinkStation from the list of available devices. By default, its name will be its model number followed by the last 3 digits of its MAC address. For example, a LS-XHL LinkStation Pro whose MAC address ends in DBB will have the name LS-XHLDBB.

- 3 Select the contents you want to play.



Select from *Videos*, *Music*, or *Photos*.

- 4 Select the file that you want to play, then play it.

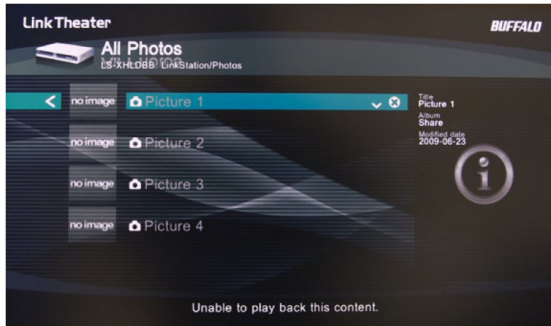

DLNA Server Settings

By default, the LinkStation is set to allow all videos, pictures, and music in the shared folder “share” to be played. You may configure it to only play videos, pictures, and music from a specific folder.

1

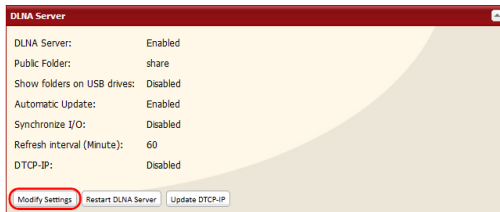

In Settings, navigate to *Extensions - MediaServer - DLNA Server* and click *Modify Settings*.

2

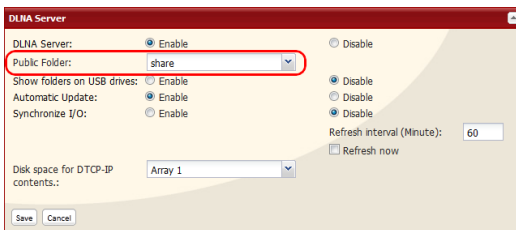

Shared folders and subfolders can be pulled down from *Public Folder*. Select a folder to share.

3 Click *Save* at the bottom of the page.

4 Now, only files saved in the folder you selected in step 2 can be selected or played from DLNA compatible devices.

To view DLNA compatible devices connected to the LinkStation:

1

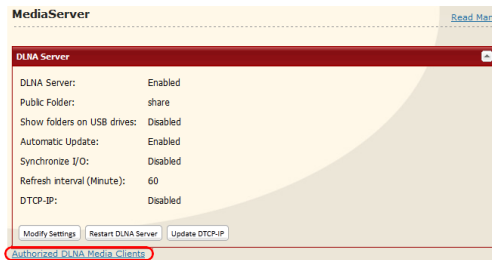

1 In Settings, navigate to *Extensions - MediaServer*.

2 Click *Authorized DLNA Media Clients*.

2

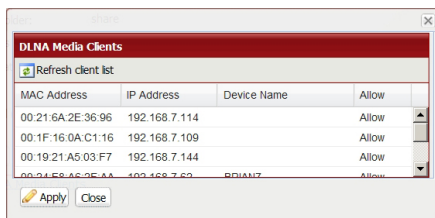

A list of DLNA compatible devices on the network will appear, showing *MAC Address, IP Address* and *Device Name*.

If a DLNA device does not broadcast its name or IP address, it will be displayed as “cannot be acquired”.

After connecting a new DLNA device to the network, or changing its settings, click *Refresh client list*.

DLNA Media List

The LinkStation will maintain a database of videos, pictures, and music saved in its media folder and distribute a list of available media to DLNA media players on the network. This list is distributed after each reboot and once every 60 minutes by default. Configure the database as described below.

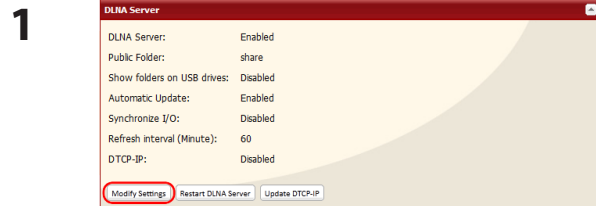

In Settings, navigate to *Extensions - MediaServer - DLNA Server* and click *Modify Settings*.

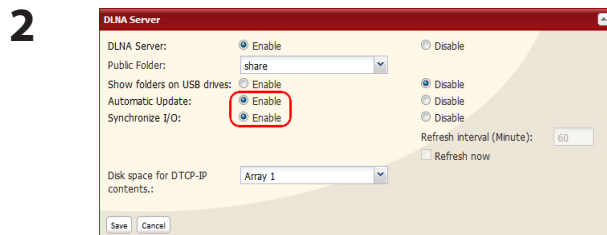

To refresh the media list whenever files are added to the media folder, enable *Automatic Update* and *Synchronize I/O*.

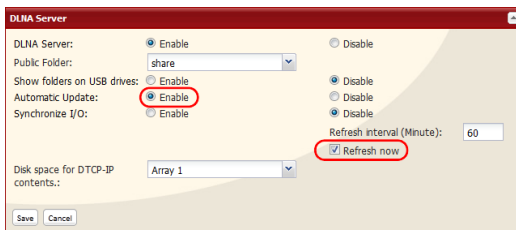

To refresh the media list now, enable *Automatic Update*, disable *Synchronize I/O*, and select *Refresh now*.

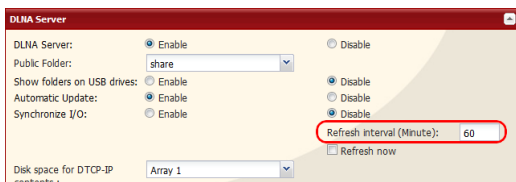

Optionally, you may choose a different refresh interval. To distribute the media list at a different interval, enter the desired interval in minutes in the "Refresh interval" field.

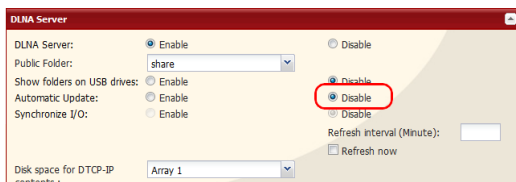

To completely disable distribution of the media list, click *Disable* for "Automatic Update".

3 Click *Save* to save your settings.

If other DLNA media devices do not recognize the LinkStation:

If the Media Server on the LinkStation is disabled, other DLNA devices won't be able to see it. You may enable the Media Server on the LinkStation as follows.

1



In Settings, navigate to *Extensions - MediaServer - DLNA Server* and click *Modify Settings*.

2

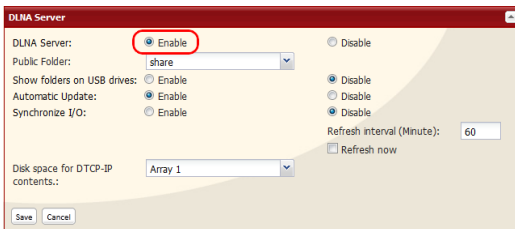

Click *Enable*.

3

Click *Save*.

To disable playback from a specific DLNA media player

By default, the LinkStation will allow playback from any compatible media player on the same network. To prohibit playback for a specific DLNA media player, follow the directions below.

1



1 In Settings, navigate to *Extensions - MediaServer*.

2 Click *Authorized DLNA Media Clients*.

2

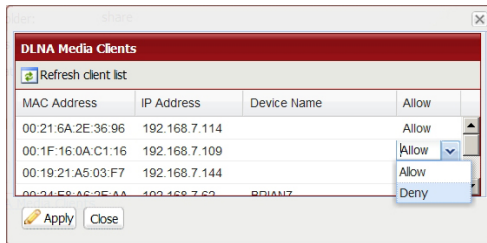

Select *Deny* for DLNA media player(s) that you want to block from accessing media on the LinkStation. Media players that are allowed to access media on the LinkStation should be set to *Allow*.

3

Click *Save*.

Troubleshooting:

Problem: The DLNA media player can't see media files on the LinkStation

If your DLNA media players can't access the media files on the LinkStation, then the list of available media files should be updated. Try the following:

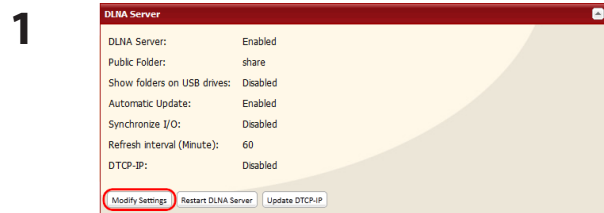

In Settings, navigate to *Extensions - MediaServer - DLNA Server* and click *Modify Settings*.

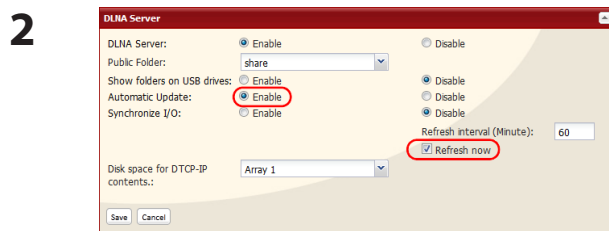

Select *Enable* for *Media Server* and *Automatic Update*. Check *Refresh now*.

3 Click *Save*.

If you cannot play certain files:

The LinkStation's DLNA media server supports the following types of files.

| Types | File Extensions |
|----------------------|--|
| Video files | .avi, .divx, .asf, .mpg, .mpe, .m1v, .vcb, .mts, .m2ts, .m2t, .mpeg, .mpeg2, .vdr, .spts, .tp, .ts, .3gp, .mov, .m4v, .wmv, .dvr-ms, .xvid, .mp4, .m4v |
| Picture files | .jpg, .jpeg, .gif, .png, .tif, .tiff, .yuv, .bmp |
| Music files | .mp3, .mpa, .wma, .aac, .apl, .ac3, .lpcm, .pcm, .wav, .m3u, .m4a, .mp4, .3gp, .m4b, .aif, .aiff, .flac, .ogg, .mp2, .mp1, .mp4 |

Your media player may not support all of these filetypes. Files that your media player does not support may not be visible from the media player. Check your media player's documentation for a list of the types of files that it can play.

Using iTunes Server

Computers on the network running iTunes can access MP3, M4A, and M4P music files from the LinkStation's media server. Enable the LinkStation's media server as described below.

1



In Settings, navigate to *Extensions - MediaServer - iTunes Server* and click *Modify Settings*.

2

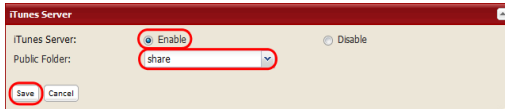

- 1 Select *Enable*.
- 2 Select the public folder.
- 3 Click *Save*.

Note:

If you add, change, or delete music files on the LinkStation during playback of a music file, playback is stopped for rebuilding the database. Connect to the iTunes server again to play the music file.

This completes the settings for the iTunes server.

Connect the iTunes server-compatible device to the network to enjoy your music files.

Squeezebox Server

The Squeezebox is a network music player by Logitech that can play back music stored on your network using your wired or wireless LAN. Enable the Squeezebox Server to play music on the LinkStation with the Squeezebox. No computer is needed. Follow the procedure below to configure.

Note: Not all LinkStations include the Squeezebox server. Check the LinkStation Function List on page 35 to see if your LinkStation supports Squeezebox.



In Settings, navigate to *Extensions - MediaServer - Squeezebox Server - Modify Settings*.

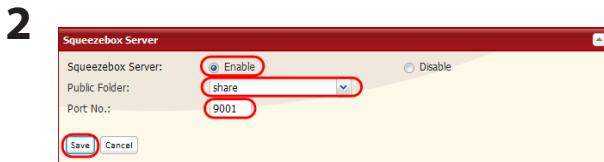

- 1 Select *Enable*.
- 2 Select the public folder.
- 3 Enter the *Port No.*. The initial setting is 9001. Normally, this does not need to be changed.
- 4 Click *Save*.

- 3** Click *Open Squeezebox Server Settings*. This displays the setting screen for the Squeezebox Server.

For more information on how to use the Squeezebox Server, do an Internet search for "Squeezebox Server".

Note:

The following file types are supported.

| | |
|-------------|--------------------------------|
| Music Files | mp3, flac, ogg, he-aac v2, wma |
|-------------|--------------------------------|

This completes the procedure for enabling playback of music data saved in the LinkStation.

Flickr Support

Note: Not all LinkStations include Flickr support. Check the LinkStation Function List on page 35 to see if your LinkStation supports Flickr.

Flickr (www.flickr.com) is a photo sharing website operated by Yahoo! Inc. After linking your LinkStation's shared folder to Flickr, you can use the features below.

- Your Flickr image data is synchronized with your LinkStation shared folder. Images saved to the LinkStation's shared folder can be viewed in Flickr, and images uploaded to Flickr can be viewed in the LinkStation's shared folder.
- View images from your Flickr account as a slideshow on your DLNA-compatible device.
- Your friends can access your photos through Flickr share.
- OS X 10.5 and earlier versions do not support the uploading of files to the LinkStation. Browsing is supported however.

1 In the LinkStation settings, navigate to *Extensions – Web Service Support*.

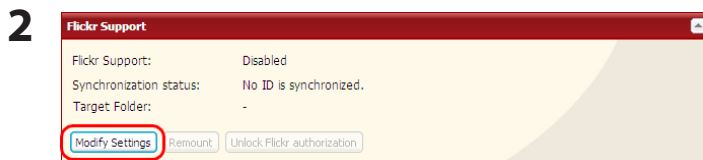

Click *Modify Settings*.

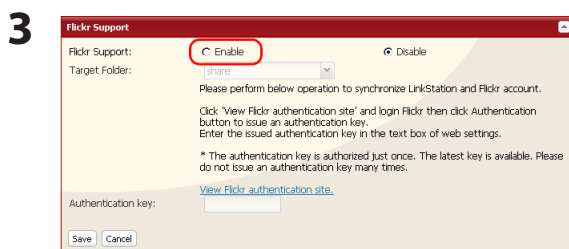

Select *Enable*.

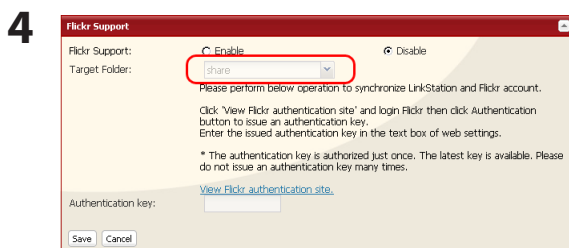

In the "Target Folder" field, select the folder to link.

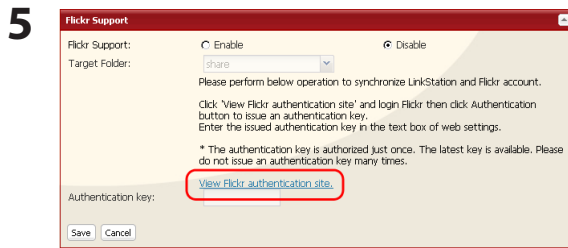

Click *View Flickr authentication site.* Flickr's web site will open. Enter your Yahoo ID and password. If you do not have a Yahoo account, create one.

6 Click [OK, I'LL AUTHORIZE IT] to display your authentication key (a 9-digit number). Make a note of the displayed authentication key.

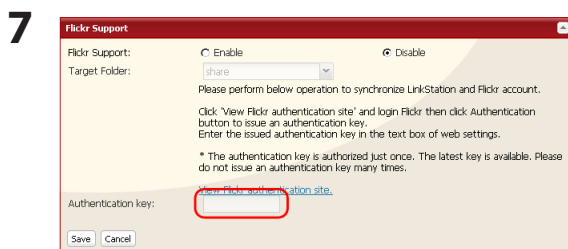

Enter the Flickr authentication key from the previous step, then click *Save.*

The folder on your LinkStation is now linked to your Flickr account, and your pictures will sync in both places. Drag-and-drop pictures to the folder to automatically upload them to Flickr.

Special Folders

The special folders "sets" and "stream" will be created in the linked shared folder. Subfolders cannot be created in these folders. These folders are linked to your Flickr account. Images copied to the "stream" or "sets" folders will be uploaded to Flickr. Images uploaded on Flickr will be copied to the "stream" folder.

Note: If an error occurs during uploading, a "fail to upload" folder is automatically created, and the images are copied there.

These file types are supported:

jpg, jpeg, gif, png, and tiff

Notes:

- Displaying images will take longer than opening files saved on your computer's hard drive.
- The size of image files may be displayed as 0 bytes until transfer is complete.
- After copying an image file, it may take some time for the file to be uploaded to Flickr.
- There are some limitations on uploaded photographs. For more information, refer to the Flickr website.
- Only one LinkStation can be linked to a Flickr account at a time.
- To link another LinkStation, first click *Unlock Flickr authorization* to disconnect the first LinkStation.
- If a file cannot be uploaded, either click *Remount* under *Extensions - Web Service Support - Flickr Support* in Settings of the LinkStation, or restart the LinkStation.
- When an image file is deleted from Flickr, a 0 KB file may remain in the shared folder of the LinkStation. If this happens, click *Remount* in *Extensions - Web Service Support* in the LinkStation's settings.
- If a folder linked with Flickr is specified as a backup source, all image downloads from Flickr must be completed before the backup is made. If a backup cannot be made, wait for all downloads to finish and then try again.
- If the "sets" folder does not appear during linking to Flickr, either click *Extensions - Web Service Support - Flickr Support - Remount* in Settings or restart the LinkStation.
- If multiple files cannot be uploaded to Flickr at the same time, upload the files one at a time.

Eye-Fi Connected

Eye-Fi connected can transfer images from a digital camera with an Eye-Fi card (available from Eye-Fi) to your LinkStation over the Internet.

Note: Not all LinkStations include Eye-Fi upload functionality. Check the LinkStation Function List on page 35 to see if your LinkStation supports Eye-Fi connectivity.

The following things are required to use Eye-Fi connected:

- Wireless LAN access point
- SD card or SDHC-compatible digital camera
- Computer with USB port and Internet connection
- Eye-Fi card

1 If using the Eye-Fi card for the first time, connect the Eye-Fi card to the computer beforehand to make the initial settings.

Note: For the mounting procedure, driver installation procedure, and removal procedure, refer to the manual supplied with the Eye-Fi card.

2 Remove the Eye-Fi card from the computer and insert it into your digital camera.

3 In Settings, navigate to *Extensions-Web Service Support-Eye-Fi connected*.

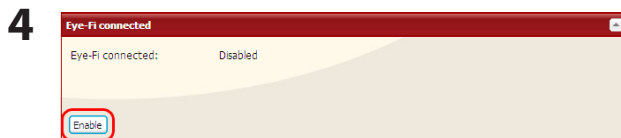

Click *Enable*.



- 1** Enter the *email* and *password* that was set in step 1.
- 2** Click *Log in*.

6 The name of the card or device that was set in *Eye-Fi connected - Cards/Devices Settings* in step 1 is displayed. Click the name of the card or device whose data will be transferred to the LinkStation.

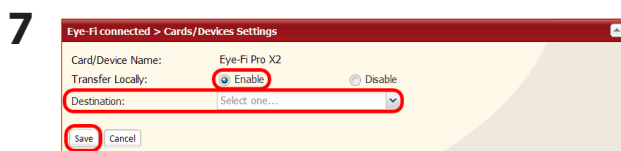

- 1** Select *Enable*.
- 2** Select *Destination*.
- 3** Click *Save*.

Images that are saved on the card will be copied to the LinkStation automatically.

Notes:

- Video files are not copied to the LinkStation.
- Only JPEG images are copied.
- In step 7, if the LinkStation is not set as the Destination, images will not be transferred to the LinkStation.
- After a picture is taken, it may take some time for it to be transferred to the LinkStation.
- A USB drive connected to the LinkStation cannot be specified as the target folder.
- If a subfolder to the main shared folder is specified as the Destination, the subfolder name must be in single-byte alphanumeric characters. Subfolders with names in multi-byte characters cannot be used.
- When the LinkStation firmware is updated, the Destination is initialized. Reset the Destination before using Eye-Fi.
- Photos will be transferred to the Destination share even if it is set to Read-only.

Connecting to a Remote LinkStation

WebAccess Connect enables you to open a shared folder on a remote LinkStation or TeraStation from Explorer, My Computer, or other file manager.

To use WebAccess Connect, the following conditions must be satisfied.

- You have LinkStations or TeraStations in two different locations, such as at home and at a remote location.
- WebAccess is enabled for both devices.

1 In the LinkStation's settings, click *Extensions – Web Service Support*.

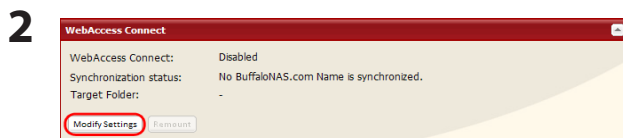

Click *Modify Settings* under *WebAccess Connect*.

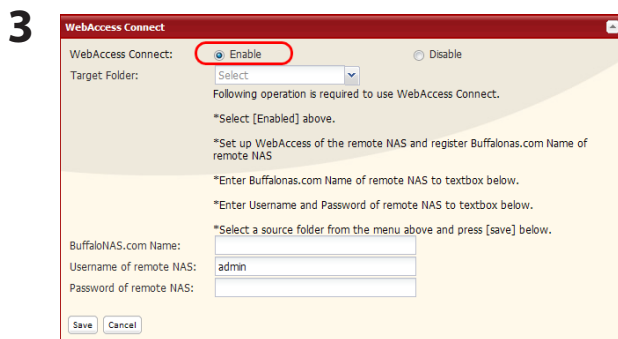

Enable *WebAccess Connect*.

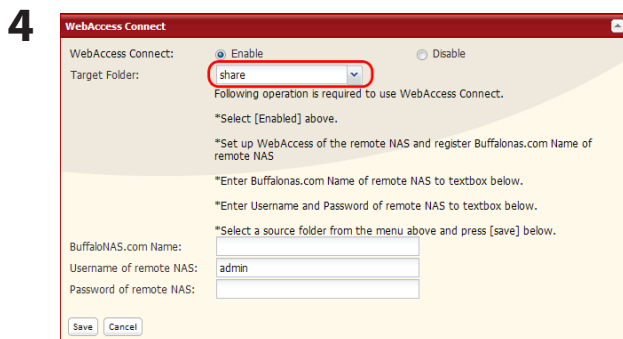

From *Target Folder*, select the shared folder that will be connected.

Note: The selected folder is used internally by WebAccess Connect. Files are not added to this folder and the amount of used space does not increase.

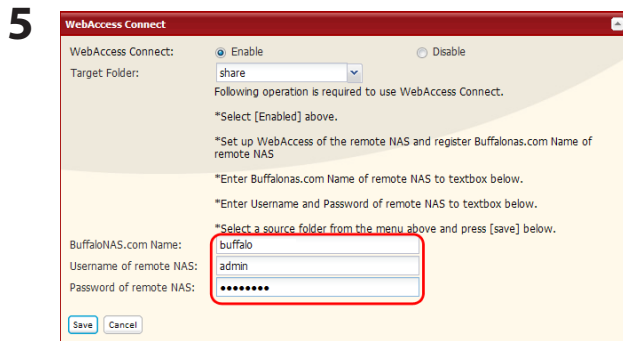

- 1 In “BuffaloNAS.com Name”, enter the BuffaloNAS.com name that is set for the remote LinkStation’s WebAccess.
- 2 Enter the remote LinkStation’s WebAccess username and password.
- 3 Click *Save*.

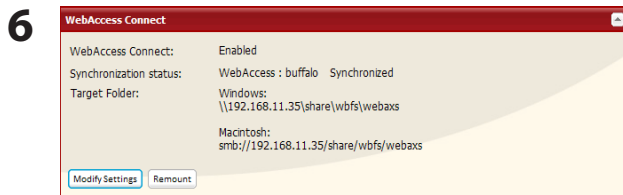

You can directly access the shared folder in the remote LinkStation by entering the path displayed in *Target Folder* into the address box in Explorer, My Computer, or other file manager.

Notes:

- If using after the network has been temporarily disconnected, click *Remount*.
- To disable WebAccess Connect, click *Modify Settings - Disable - Save*.

This completes the WebAccess Connect settings.

Chapter 3

NAS Navigator2

NAS Navigator2 is a utility program that makes it simple to display Settings, change its IP address or check its hard drive.

Windows

If you set up the LinkStation with the LinkNavigator CD, NAS Navigator2 is installed and configured to run automatically in the system tray at startup.



Starting NAS Navigator2:

Double-click the  icon on the desktop.

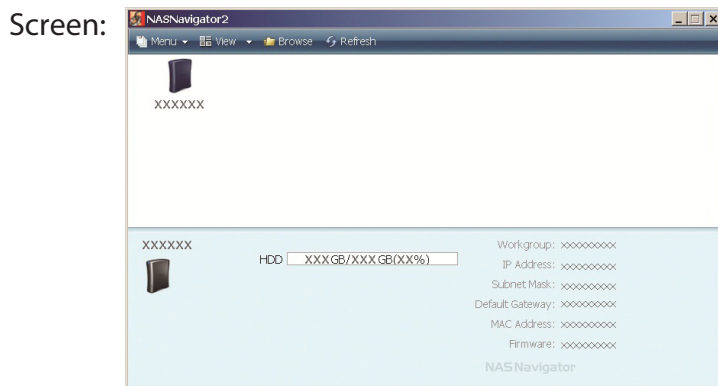

Clicking a LinkStation's icon will display its total capacity, capacity being used, *IP Address*, *Workgroup*, *Subnet Mask*, *Default Gateway*, *MAC Address*, and *Firmware* version.

| Name | Descriptions | |
|---------|--|--|
| Menu | Map Share* | Assigns the LinkStation's shared folder as a network drive. |
| | Disconnect Share* | Removes the network drive mapping. |
| | Map All Remote Shares to Drive Letters | Assigns all the LinkStation's shared folders as network drives. |
| | Create desktop shortcut* | Creates a shortcut to the LinkStation's shared folder (share). |
| | Launch NAS Navigator2 on startup | Launches NAS Navigator2 in the task tray when Windows boots. |
| | Display Errors | If an error occurs, an error message will pop up from the NAS Navigator2 icon in the task tray. |
| | Properties* | Opens the selected LinkStation's Properties window. |
| | Close | Closes NAS Navigator2. |
| View | View | Icons: Displays icon for ease. Details: Displays Name, Product Name, Workgroup, IP Address, Subnet Mask, and Default Gateway. |
| | Sort by | Selects the sort order from following to display when multiple LinkStations are found: Host name, Product Name, Workgroup, IP Address, Subnet Mask, Default Gateway |
| Browse* | Opens the LinkStation's shared folder. | |
| Refresh | Searches for NAS devices on the network again. | |

*Click once on the LinkStation or TeraStation's icon to display these options.

The menu below is displayed when you right-click a device's icon.

| Name | Descriptions |
|------------------|---|
| Browse Shares | Opens the LinkStation's shared folder. |
| Settings | Displays Settings of the selected LinkStation. |
| Properties | Opens the Properties screen of the selected LinkStation. |
| Map Share | Maps the selected LinkStation's shared folder to a network drive. |
| Disconnect Share | Disconnects the mapped network drive. |
| Create Shortcut | Creates a shortcut icon to the selected LinkStation's shared folder (share) on the Desktop. |
| Shut Down | This is displayed when using a LS-XL series LinkStation. The LS-XL series does not have a power switch on the case. Use this command to turn off the power. |

When NAS Navigator2 is minimized to the task tray, you have the following options from its icon.

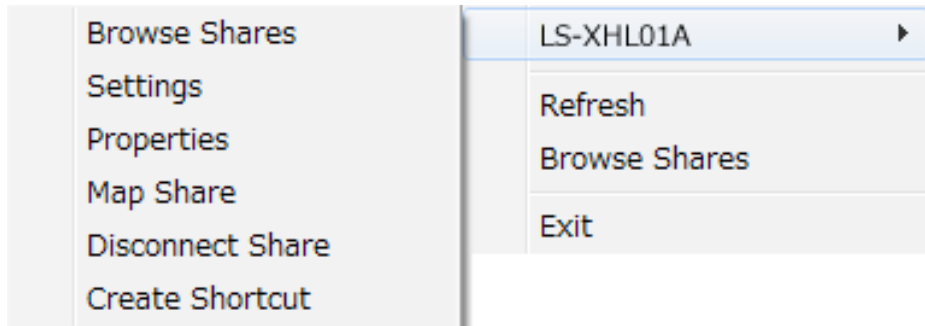

| Menu Item | | Descriptions |
|---------------------|------------------|--|
| LinkStation Name | Browse Shares | Opens the LinkStation's Share folder. |
| | Settings | Opens Settings in a web browser. |
| | Properties | Opens the LinkStation's properties page. |
| | Map Share | Assigns the LinkStation's default share as a network drive. |
| | Disconnect Share | Unmaps the network drive. |
| | Create Shortcut | Creates a shortcut to a LinkStation's shared folder (share). |
| Refresh | | Refreshes list of NAS devices. |
| Browse Shares | | Displays NAS Navigator2 window. |
| Exit | | Exits NAS Navigator2. |

You can perform the following tasks from a LinkStation's properties window.

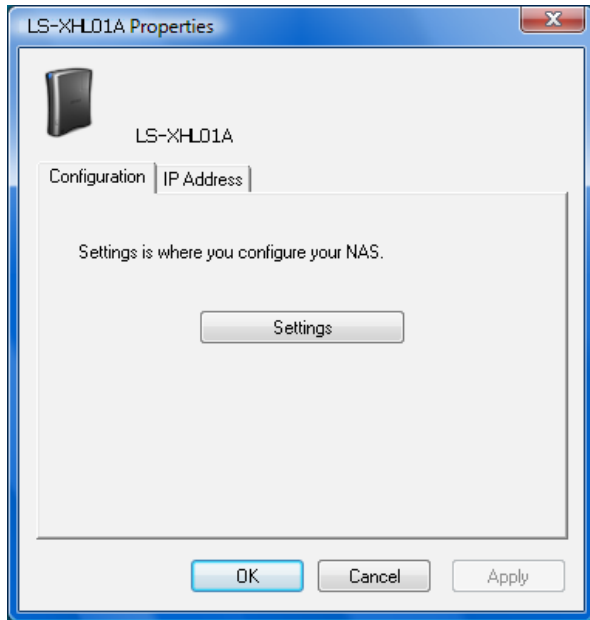

| Menu Item | Descriptions |
|---------------|---|
| Configuration | Click <i>Settings</i> to open the configuration interface. |
| IP Address | Check <i>Use DHCP</i> to assign an IP address from DHCP server automatically. If there is no DHCP server in the network, you cannot use this function. Check <i>Renew IP address</i> to obtain an IP address from the DHCP server. Alternately, you can manually enter an IP address, subnet mask, and default gateway. |

Mac OS

If you installed the LinkStation with the LinkNavigator CD, NAS Navigator2 was installed automatically. To launch it, click the  icon in the Dock.

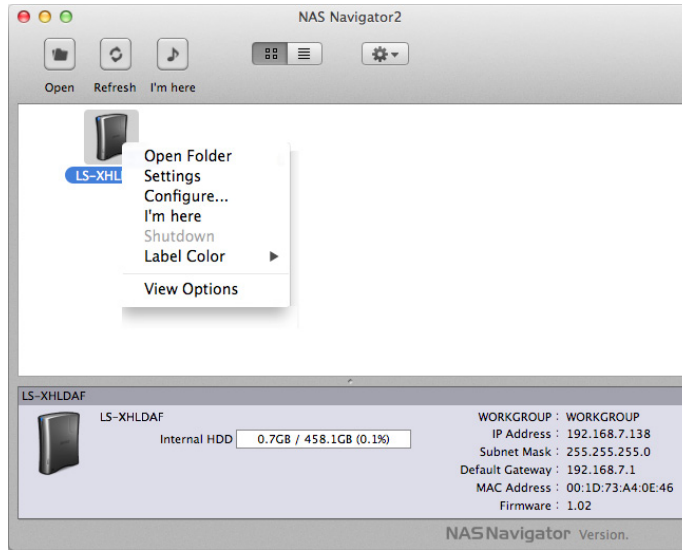

Click a LinkStation’s icon to display its total capacity, used capacity, workgroup, IP address, subnet mask, default gateway, MAC address, and firmware version. Double-click to open a share on the LinkStation.

| Name | | Descriptions |
|---|--------------|---|
| Open | | Opens the default shared folder for a selected LinkStation. |
| Refresh | | Refreshes list of NAS devices. |
| To display these options, hold down the control key and select your LinkStation’s icon. | Open Folder | Opens the LinkStation shared folder. |
| | Settings | Opens Settings for the selected LinkStation. |
| | Configure | Opens a window that lets you configure the NAS’s IP address or open Settings. |
| | Label Color | Selects the color of the name displayed below the icon. |
| | View Options | Let you choose icon size, position, and view mode. |
| Shutdown | | This is displayed when using a LS-XL series LinkStation. The LS-XL series does not have a power switch on the case. Use this command to turn off the power. |

Chapter 4

Settings

Home

The following options can be configured from the Home screen.

| Name | Descriptions |
|------------------|--|
| Name | Displays the name of the LinkStation. |
| Firmware Version | Displays the firmware version of the LinkStation. |
| IP Address | Displays the IP address of the LinkStation. |
| Workgroup | Displays the LinkStation's workgroup. |
| Storage | Displays the total capacity of the LinkStation's hard drive, as well as the amount used. |
| Shared Folders | Displays shared folders and disks on the LinkStation. If the <i>Users/Groups</i> tab is selected, Users and Groups are displayed. If the <i>Network</i> tab is selected, it shows if DHCP is Enabled or Disabled and displays the Ethernet Frame Size. |
| Logout | Log out of Settings. |
| Shutdown | This is displayed when using the LS-XL series. The LS-XL series does not have a power switch on the case. Use this command to turn off the power. |

Shared Folders

The following options can be set from the *Shared Folders* screen.

| Name | | Descriptions |
|---|--------------------|---|
| Folder Setup | Folder Setup | <p>Click <i>Create Folder</i> to open the Adding a New Shared Folder screen. Click a shared folder name to open the shared folder's settings screen. Select the shared folder and click <i>Delete</i> to delete the shared folder. Enter a letter in the "Refresh" field to display folders that begin with that letter. Click a folder name from the list to select the folder. The following tasks open the "Confirm Operation" screen.</p> <ul style="list-style-type: none"> • Delete Folder • Restore Factory Defaults • Format <p>Enter the number from the "Confirmation Number" field within 60 seconds, and click <i>Apply</i>.</p> |
| Folder Setup - New Folder Click <i>Create Folder</i> to view this option. | Copy Settings From | Select the shared folder you want to copy settings from. |
| | Name | <p>Enter a name for the share folder.</p> <ul style="list-style-type: none"> • You can enter up to 27 bytes (UTF-8). Alphanumeric characters, multi-byte characters, hyphens, and underscores may be used. • Do not use a symbol as the first character of the name. |
| | Description | <p>Enter a description for the shared folder.</p> <ul style="list-style-type: none"> • You can enter up to 75 bytes (UTF-8). Alphanumeric characters, multi-byte characters, hyphens, underscores, and spaces may be used. • Do not use a symbol as the first character of the description. |

| Name | | Description | | | | | | | | | | | | |
|---|--|---|-----------------------|-------------|---------------|---|-------------|---|-----|--|-------------|---|------|---------------------------------|
| Folder Setup - New Folder Click <i>Create Folder</i> to view this option. | Volume | Select the volume for the shared folder. | | | | | | | | | | | | |
| | Shared Folder Attributes | The shared folder may be read-only or writable. | | | | | | | | | | | | |
| | Recycle Bin | If enabled, deleted files are moved to a trashbox folder rather than actually deleted. You can enable recycle bin functionality for each shared folder on the LinkStation as well as usbdisk1. <ul style="list-style-type: none"> To use Recycle Bin with usbdisk1, format it with EXT3, XFS, or FAT32. NTFS and HFS+ are not supported because files cannot be deleted with these formats. Recycle Bin is not supported while connecting via AFP or FTP. | | | | | | | | | | | | |
| | Shared Folder Support | Select which operating systems and features the share will support. <table border="1" data-bbox="609 787 1453 1333"> <thead> <tr> <th>Shared Folder Support</th> <th>Description</th> </tr> </thead> <tbody> <tr> <td>Windows (SMB)</td> <td>Check to enable SMB support for connection to Windows and Mac OS.</td> </tr> <tr> <td>Apple (AFP)</td> <td>Check to enable AFP support for connection to Mac OS. Also, navigate to <i>Network-Network Settings-Network Services</i> and make sure that AFP is enabled there as well.</td> </tr> <tr> <td>FTP</td> <td>Check to enable remote FTP access to the share. Also, navigate to <i>Network-Network Settings-Network Services</i> and enable FTP there as well.</td> </tr> <tr> <td>Disk Backup</td> <td>Check to allow other LinkStations to use this share as a backup target.</td> </tr> <tr> <td>SFTP</td> <td>Select when connecting by SFTP.</td> </tr> </tbody> </table> | Shared Folder Support | Description | Windows (SMB) | Check to enable SMB support for connection to Windows and Mac OS. | Apple (AFP) | Check to enable AFP support for connection to Mac OS. Also, navigate to <i>Network-Network Settings-Network Services</i> and make sure that AFP is enabled there as well. | FTP | Check to enable remote FTP access to the share. Also, navigate to <i>Network-Network Settings-Network Services</i> and enable FTP there as well. | Disk Backup | Check to allow other LinkStations to use this share as a backup target. | SFTP | Select when connecting by SFTP. |
| | Shared Folder Support | Description | | | | | | | | | | | | |
| | Windows (SMB) | Check to enable SMB support for connection to Windows and Mac OS. | | | | | | | | | | | | |
| | Apple (AFP) | Check to enable AFP support for connection to Mac OS. Also, navigate to <i>Network-Network Settings-Network Services</i> and make sure that AFP is enabled there as well. | | | | | | | | | | | | |
| FTP | Check to enable remote FTP access to the share. Also, navigate to <i>Network-Network Settings-Network Services</i> and enable FTP there as well. | | | | | | | | | | | | | |
| Disk Backup | Check to allow other LinkStations to use this share as a backup target. | | | | | | | | | | | | | |
| SFTP | Select when connecting by SFTP. | | | | | | | | | | | | | |
| Remote Backup Password | If another LinkStation will be backing up to this share, consider configuring a password for remote backup. This will make it easy to configure the other LinkStation to back up to the correct share and prevent other users from mistakenly backing up to it. Passwords may contain up to 8 bytes (UTF-8). Alphanumeric character, hyphen, and underscore may be used. | | | | | | | | | | | | | |

| Name | | Description |
|--|----------------------------|---|
| <p>Access Restrictions</p> <p>Click <i>Access Restrictions</i> from the <i>Create Shared Folders</i> screen to view this option.</p> | <p>Access Restrictions</p> | <p>If using access restrictions, click <i>Add</i> to add users or groups that will be allowed to access the share.</p> <p>You may delete users and groups from the access list with the <i>Disconnect</i> button.</p> <p>With AFP and FTP connections, access restrictions can be set per user.</p> |
| <p>Direct Copy</p> <p>Click <i>Modify Settings</i> to change settings.</p> | <p>Target</p> | <p>Choose the destination folder for Direct Copy.</p> |

Users/Groups

The following options can be set from the *Users/Groups* screen.

| Name | | Descriptions |
|--|-------------|--|
| Local Users | Local Users | <p>Displays <i>Username</i>, <i>User Id</i>, <i>Description</i>, and <i>Primary Group</i>.</p> <ul style="list-style-type: none"> To create a new user, click <i>Create User</i>. To edit the user, select the username and click <i>Edit User</i>. To delete the user, select the user and click <i>Delete</i>. If <i>Delegate Authority to External SMB Server</i> is selected from <i>Network - Workgroup/Domain</i> for the "For Workgroup Authentication", a user who are registered at the LinkStation can be converted to an authorized user of the external SMB server by clicking <i>The selected user(s) will be converted to external users</i>. Enter a letter in the "Refresh" field to list users that begin with that letter. The users "admin" and "guest" are built-in to the LinkStation. They cannot be deleted. If the LinkStation is a domain member, <i>Domain Users</i> will also be available. |
| Local Users - New User To display, click <i>Create a user</i> . | Username | <p>Usernames may contain up to 20 bytes (UTF-8).</p> <ul style="list-style-type: none"> Alphanumeric characters, hyphens (-), underscores (_), periods (.), !, #, &, @, \$, *, ^, % may be used. Do not use multi-byte characters. Do not use a symbol as the first character of the Username. |
| | User Id | <p>If a user ID is left blank, a user ID will be automatically assigned. When using the quota feature, use numbers between 1000 and 1999 to set a group ID manually. Make sure that a user ID does not duplicate to other users.</p> |
| | Description | <p>Descriptions may contain up to 75 bytes (UTF-8).</p> <ul style="list-style-type: none"> Alphanumeric characters, multi-byte characters, hyphens, underscores, and spaces may be used. Do not use a symbol and space as the first character. New users automatically belong to the "hdusers" group. You can change the group the user belongs to in Group Settings. |

| Name | | Descriptions |
|---|------------------|---|
| Local Users - New User To display, click <i>Create a user.</i> | Password | Enter the user's password. This should be the same password that the user uses to log in to his computer. <ul style="list-style-type: none"> • Passwords may contain up to 20 bytes (UTF-8). • Do not use multi-byte characters. Alphanumeric character and the following characters may be use. - _ @ ! # \$ % & ' () * + , . / ; < > = ? ^ { } ~ • Do not use a symbol except _ (underscore) as the first character. • You can enter up to 8 bytes (UTF-8) if you are using Mac OS. Otherwise, you will not able to access shared folders on your LinkStation. |
| | Confirm Password | Enter the password again for confirmation. |
| | Primary Group | When the user belongs to the multiple groups, select which group is the main for that user. If the space usage is limited by the quota feature for the group, the limitation of the usage of the group selected is applied. |
| | User Quota | To use a quota to restrict the space which is available for a user, click <i>Enable</i> . |
| | Hard Limit(GB) | Set space to be available to use (in GB). <ul style="list-style-type: none"> • Quotas only restrict the available hard drive space. This feature does not provide quotas per user; it should be managed by individual users. To verify the owner, open the new window and click <i>Owner</i> tab by selecting <i>Security</i> tab on Properties screen for each file or folder and click <i>Advanced Settings</i>. (The steps to check the owner may vary according to your OS. The example above is for Windows XP). |
| Domain Users | Domain Users | The list of Domain Users is displayed when it joins <i>NT Domain</i> or <i>Active Directory</i> . |
| Domain Groups | Domain Groups | The list of Domain Groups is displayed when it joins <i>NT Domain</i> or <i>Active Directory</i> . |
| External Users | External Users | Navigate to <i>Network - Workgroup/Domain - For Workgroup Authentication</i> and select <i>Delegate Authority to External SMB Server</i> and <i>Automatic User Registration</i> . Users will be registered automatically and listed. To delete automatically registered users, select each user and click <i>Delete External Users</i> . |

| Name | | Descriptions |
|--|----------------|--|
| Local Groups | Local Groups | <p>Displays <i>Group Name</i>, <i>Group Id</i>, and <i>Description</i>.</p> <ul style="list-style-type: none"> To create a new group, click <i>Create Group</i>. To edit a group, select it and click <i>Edit Group</i>. To delete a group, select it and click <i>Delete</i>. <p>Note: Enter a letter in the <i>Refresh</i> field and groups beginning with that letter are displayed. Click a group name in the list to select the group.</p> |
| Local Groups - New Group To display, click <i>Create Group</i> on the Group Screen. | Group Name | <p>Group names may contain up to 20 bytes (UTF-8).</p> <ul style="list-style-type: none"> Alphanumeric characters, hyphens, underscores, and periods may be used. Do not use multi-byte characters. Do not use a symbol as the first character of a group name. |
| | Group Id | <p>If Group ID is left blank, a group ID will be automatically assigned. When using the quota feature, use numbers between 1000 and 1999 to set a group ID manually. Make sure that the group ID does not duplicate to other groups.</p> |
| | Description | <p>Group descriptions may contain up to 75 bytes (UTF-8).</p> <ul style="list-style-type: none"> Alphanumeric characters, multi-byte characters, hyphens, underscores, and spaces may be used. Do not use a space as the first character in a description. |
| | Group Quota | <p>To use a quota to restrict the space which is available for a group, click <i>Enable</i>.</p> |
| | Hard Limit(GB) | <p>Set space to be available for use (in GB).</p> <ul style="list-style-type: none"> Quotas only restrict available hard drive space. It does not show the space that each group is currently using: this should be managed by the individual group. |
| Local Users/ Group Members | Local Users | <p>To add a user to the group, select the user and click <i>Add</i>.</p> <p>Note: Domain Users from the Domain Controller cannot be added to groups here.</p> |
| | Group Members | <p>Displays users who are registered to a group. To unregister a user, select the user and click <i>Disconnect</i>.</p> |

Network

The following options can be set from the *Network* screen.

| Name | | Descriptions |
|---|-------------------------|--|
| IP Address Settings Click <i>Modify Settings</i> to change settings. | DHCP | If enabled, the LinkStation will attempt to get its IP address from a DHCP server on the network. |
| | Primary IP Address | Set IP address. |
| | Subnet Mask | Set Subnet Mask. |
| | Default Gateway Address | Specify by IP address if Default Gateway Address exists. |
| | Primary DNS Server | Specify an IP address of the DNS server which has priority. |
| | Secondary DNS Server | Specify an IP address of an alternative DNS server. |
| Ethernet Frame Size Click <i>Modify Settings</i> to change settings. | Ethernet Frame Size | <p>Ethernet frame size is the maximum size of data that can be sent at a time. If all devices on your network support Jumbo Frame, you may be able to improve transmission efficiency by choosing a larger frame size than the default.</p> <ul style="list-style-type: none"> • <i>1518 bytes (Default)</i>: It is set to 1518 bytes at default. • <i>4102 bytes (Jumbo Frame)</i>: Transfer at 4102 bytes. • <i>7422 bytes (Jumbo Frame)</i>: Transfer at 7422 bytes. • <i>9694 bytes (Jumbo Frame)</i>: Transfer at 9694 bytes. |
| Network Services | Network Services | <p>Enable or disable AFP and FTP.</p> <p><i>AFP</i> must be enabled here for Mac OS computers to connect via AFP. Also, enable AFP in the shared folder settings to use AFP.</p> <p><i>FTP</i> must be enabled here for remote users to access the LinkStation via FTP. Also, enable FTP in the shared folder settings to use FTP.</p> |

| Name | | Descriptions |
|--|---|---|
| Workgroup/Domain Click <i>Modify Settings</i> to change settings. | Authentication Method | Select the method to join the network (<i>Workgroup</i> , <i>NT Domain</i> , or <i>Active Directory</i>). <i>Workgroup</i> is the default. Networking knowledge is required to configure other methods. Consult your network administrator for details. |
| | Workgroup Name | Enter the <i>Workgroup Name</i> to have the LinkStation join a Microsoft network group. <ul style="list-style-type: none"> • Workgroup names may contain up to 23 bytes (UTF-8). • Alphanumeric characters, multi-byte characters, hyphens, underscores, and periods may be used. • Do not use a symbol as the first character of the workgroup name. |
| | WINS Server IP Address | Enter the IP address of a WINS Server to use WINS Server. |
| | NT Domain Name | Enter <i>NT Domain Name</i> to use <i>NT Domain</i> as the method to join the network. <ul style="list-style-type: none"> • You can enter up to 23 bytes (UTF-8). • Alphanumeric characters, multi-byte characters, hyphens (-), underscores (_), and periods (.) may be used. • Do not use a symbol as the first character. |
| | NT Domain Controller Name | Enter <i>NT Domain Controller Name</i> to use <i>NT Domain</i> as a method to join the network. Register the computer account which has the same name as the LinkStation to the Domain Controller. <ul style="list-style-type: none"> • You can enter up to 63 bytes (UTF-8). Do not use multi-byte characters. • Alphanumeric characters, hyphens (-), underscores (_) may be used. • Do not use a symbol as the first character. |
| | Active Directory Domain Name (NetBIOS Name) | Enter <i>Active Directory Domain Name (NetBIOS Name)</i> to use <i>Active Directory</i> as a method to join the network. <ul style="list-style-type: none"> • You can enter up to 23 bytes (UTF-8). • Alphanumeric characters, multi-byte characters, hyphens (-), underscores (_), and periods (.) may be used. • Do not use a symbol as the first character. |

| Name | | Descriptions |
|---|---|--|
| Workgroup/Domain Click <i>Modify Settings</i> to change settings. | Active Directory Domain Name (DNS/Realm Name) | Enter <i>Active Directory Domain Name (DNS/Realm Name)</i> when selecting <i>Active Directory</i> as a method to join the network. <ul style="list-style-type: none"> You can enter up to 255 bytes (UTF-8). Do not use multi-byte characters. Alphanumeric characters, hyphens (-), underscores (_), and periods (.) may be used. |
| | Active Directory Domain Controller Name | Enter <i>Active Directory Domain Controller Name</i> to use <i>Active Directory</i> . <ul style="list-style-type: none"> You can enter up to 63 bytes (UTF-8). Do not use multi-byte characters. Alphanumeric characters, hyphens (-), underscores (_) may be used. Do not use a symbol as the first character. |
| | Administrator Name | Enter the Administrator account username for <i>Administrator Name</i> . <ul style="list-style-type: none"> This must be entered if <i>NT Domain</i> or <i>Active Directory</i> is selected for <i>Authentication Method</i>. You can enter up to 256 bytes (UTF-8). Do not use multi-byte characters. Alphanumeric characters, hyphens (-), underscores (_), and periods (.) may be used. Do not use a symbol as the first character. |
| | Administrator Password | Enter <i>Administrator Password</i> . <ul style="list-style-type: none"> This must be entered if <i>NT Domain</i> or <i>Active Directory</i> is selected for <i>Authentication Method</i>. You can enter up to 256 bytes (UTF-8). Do not use multi-byte characters. Alphanumeric characters, hyphens (-), underscores (_) may be used. Do not use a symbol as the first character. |

| Name | | Descriptions |
|---|--|---|
| <p>Workgroup/Domain</p> <p>Click <i>Modify Settings</i> to change settings.</p> | For Workgroup Authentication | <p>Select the user authentication method here.</p> <p><i>Delegate Authority to LinkStation:</i> (usually recommended) Only registered users may access the LinkStation. Usernames and passwords should be exactly the same as those used for Windows login.</p> <p><i>Delegate Authority to External SMB Server:</i> Users are authenticated by an external Authentication server. Microsoft network knowledge required for setup. Consult your System Administrator for details.</p> <p><i>Use Windows Domain Controller as Authentication Server:</i> Select this option when you want to authenticate against Domain Controller, but the LinkStation does not join the domain.</p> <p>Note: The Windows Domain Controller has been assigned to be an external authentication SMB Server. The workgroup name on the LinkStation must be identical to the Windows Domain Name.</p> <p><i>Automatic User Registration:</i> Select to automatically register users allowed by the Authentication Server to the LinkStation's authenticated user list .</p> <p><i>Enable Authentication Shared Folder:</i> Use the folder as an authentication test folder which can be accessed by users registered to Authentication Server.</p> |
| | Authentication Server Name or IP Address | <p>When <i>Delegate Authority to External SMB Server</i> is selected for "For Workgroup Authentication", specify the external server which is used for the user authentication by the server name or IP address of the server</p> <ul style="list-style-type: none"> • When connecting using AFP or FTP/FTPS, always use an IP address. Authentication may fail if a server name is used. • Enter the IP address rather than the server name anytime that the server is not on the same subnet. |

| Name | | Descriptions |
|---|-------------------------------------|---|
| Workgroup/Domain Click <i>Modify Settings</i> to change settings. | Enable Authentication Shared Folder | <p>When <i>Delegate Authority to External SMB Server</i>, <i>Automatic User Registration</i>, and <i>Enable Authentication Shared Folder</i> are selected for "For Workgroup Authentication", specify the shared folder name for the authentication test. It can be registered as the users of the LinkStation automatically who open the shared folder for the authentication test.</p> <ul style="list-style-type: none"> You cannot create more than 2 shared folders for the Authentication test . A user who is automatically registered will belong to the "hdusers" group. You cannot use shared folder names which already exist as a shared folder name for the authentication test. You can enter up to 27 bytes (UTF-8). Alphanumeric characters, multi-byte characters, hyphens (-), underscores (_) may be used. Do not use a number or symbol as the first character. AFP and FTP/FTPS connection do not allow delegating authority to external SMB server to obtain user information. |
| Web Server Settings Click <i>Modify Settings</i> to change settings. | Web Server | Enable to use the Web Server. |
| | Port No. | Enter a port number here, or leave blank to use the default port (port 81). |

| Name | | Descriptions |
|--|------------------|---|
| <p>Web Server Settings</p> <p>Click <i>Modify Settings</i> to change settings.</p> | Target Folder | <p>Select a target folder for the Web Server to access.</p> <ul style="list-style-type: none"> - (Target folder)/htdocs/ <ul style="list-style-type: none"> • This folder holds the content. • Use this folder as the installation location for HTML files and PHP scripts. • Example: If the target folder is set as a shared folder with the name “web”, HTML files, PHP files, and other content are installed under \\(LinkStation name)\web\htdocs over the SMB. - (Target folder)/cgi-bin/ <ul style="list-style-type: none"> • This folder holds Perl scripts. • Use this folder as the installation location for Perl scripts. Only Perl scripts with .pl or .cgi extensions should be placed in this folder. To run a CGI script, copy it to the “cgi-bin” folder. • CGI files in the Perl language with .cgi or .pl extensions are supported in the cgi-bin folder. PHP files with .php extensions are supported in the htdocs folder. - (Target folder)/log/ <ul style="list-style-type: none"> • Logs from the Web Server are sorted in this folder. If phpinfo (PHP interpreter setting information) is displayed, then the Web Server is working properly. <p>To access the Web Server, navigate to <code>http://LinkStation IP address: port number</code>. Example: <code>http://192.168.11.150:81</code></p> |
| Web Server | php.ini settings | <p>To change PHP language interpreter settings, edit the php.ini file. Don't do this unless you know what you're doing! To restore php.ini to its original state, click <i>Restore Default Settings</i>.</p> <p><i>File Import</i> allows you to import a php.ini file from your computer.</p> <p><i>Manual Edit</i> allows you to manually edit the php.ini file displayed in the text box.</p> |

| Name | | Descriptions |
|---|-----------------|--|
| MySQL Server Settings Click <i>Modify Settings</i> to change settings. | MySQL Server | Enable to use MySQL server. |
| | Port No. | Enter the number of a port for MySQL server. |
| | Data Folder | This selects the shared folder where the MySQL database is saved. |
| | Open phpMyAdmin | This opens phpMyAdmin where MySQL database management can be performed. The Web Server must be enabled to use phpMyAdmin. By default, the phpMyAdmin username and password are: Username: admin Password: password <ul style="list-style-type: none"> • The phpMyAdmin username and password can be changed in phpMyAdmin. • Although they have the same default values, the usernames and passwords for phpMyAdmin and LinkStation administration are completely independent. • Buffalo does not provide technical support for phpMyAdmin. |

System

The following options can be set from the *System* tab.

| Name | | Descriptions |
|---|-------------------------------|---|
| Settings | | |
| Name Click <i>Modify Settings</i> to change settings. | LinkStation Name | Enter a name to identify the LinkStation on the network. Names may contain up to 15 bytes (UTF-8). Alphanumeric characters, hyphens, and underscores may be used. Do not use multi-byte characters. Do not use a symbol as the first character of the name. |
| | Description | Descriptions may contain up to 75 bytes (UTF-8). Alphanumeric characters, multi-byte characters, hyphens, underscores and spaces may be used. Descriptions are only displayed in Windows. They will not be displayed on a Macintosh. |
| Date and Time Click <i>Modify Settings</i> to change settings. | Date/Time Source | Select <i>Automatic</i> to use an NTP to correct system time automatically. Select <i>Manual</i> to set time manually. |
| | Primary NTP IP Address | Enter the DNS name or the IP address of an NTP server. You may use <code>ntp.jst.mfeed.ad.jp</code> or <code>192.168.11.123</code> , for example. To specify <code>ntp.jst.mfeed.ad.jp</code> as the NTP server, select <i>Use default NTP server (ntp.jst.mfeed.ad.jp)</i> . |
| | NTP Synchronization Frequency | You may have NPT correct your system time <i>Daily, Weekly, or Every 3 hours</i> . When accessing an NTP server through a proxy server, access to an NTP server outside the proxy server may fail in certain network environments. |
| | Time Zone | Specify Time Zone. |
| | Date | Displays year, month and date. Enter numbers to change these values. |
| | Time | Displays time. Enter numbers to change the value manually. Click <i>Use Local Date/Time</i> to obtain time and time zone from the internal clock of your computer. Note: If system clocks on your network get more than 5 minutes off from each other, it may cause problems with your network. For best results, use an NTP server to automatically set the system time for all of your network devices, including the LinkStation. |
| Language Click <i>Modify Settings</i> to change settings. | Display Language | Select the language to be displayed. |
| | Windows Client Language | Select the language to be used in the Windows client. |

| Name | Descriptions | |
|----------------|--------------|--|
| Storage | | |
| Disks | Check Disk | <p>You may run a disk check on hard drives in or attached to the LinkStation via USB. Depending on the size of the disk, a disk check may take many hours to complete.</p> <p>Notes:</p> <ul style="list-style-type: none">• You cannot run a disk check at the same time as a backup job.• During the disk check, the file sharing service stops.• If the unit is disconnected abnormally from Mac OS, the database created by Mac OS may be destroyed and you can no longer connect to the unit. If this happens, select <i>Delete any hidden</i> and run a disk check. All of the files listed below will be deleted, including sub directories.<ul style="list-style-type: none">- AppleDB- AppleDesktop- AppleDouble- TheVolumeSettingsFolder- Network Trash Folder• Make sure the LinkStation is not selected as a backup destination of other LinkStation before you run the disk check. If the LinkStation is selected as the backup destination, do not run the disk check. |

| Name | | Descriptions | | |
|-------------------------------|--|---|-------------|--------------|
| Disks | Format Disk | <p>You may format disks in or connected to the LinkStation. All data on the disk will be deleted if the drive is formatted. Back up any important data before formatting a disk.</p> <p>You cannot format a drive if you've scheduled a backup job. Also, do not format the drive if it's configured as the backup target of another LinkStation.</p> <p>The following tasks open a <i>Confirm Operation</i> screen.</p> <ul style="list-style-type: none"> • Delete Folder • LinkStation's Restore Factory Defaults • Erase Disk of the LinkStation <p>Enter the number shown in the <i>Confirmation Number</i> field within 60 seconds, and click <i>Apply</i>.</p> <p>The LinkStation can format or recognize the following format types:</p> | | |
| | | <table border="1"> <thead> <tr> <th>Format type</th> <th>Descriptions</th> </tr> </thead> <tbody> <tr> <td>EXT3 (USB hard drive only)</td> <td> <p>EXT3 is recommended for external drives attached to the LinkStation.</p> <ul style="list-style-type: none"> • You can perform both Read and Write. • Supports Journaling File System. • May take a while to format (a few minutes to a hour). • Less space is available than XFS after formatted. • More files in 1 folder, slower the access space. <p>Note: An EXT3 Reader is included in this package for reading EXT3 disks from a Windows PC.</p> </td> </tr> </tbody> </table> | Format type | Descriptions |
| Format type | Descriptions | | | |
| EXT3 (USB hard drive only) | <p>EXT3 is recommended for external drives attached to the LinkStation.</p> <ul style="list-style-type: none"> • You can perform both Read and Write. • Supports Journaling File System. • May take a while to format (a few minutes to a hour). • Less space is available than XFS after formatted. • More files in 1 folder, slower the access space. <p>Note: An EXT3 Reader is included in this package for reading EXT3 disks from a Windows PC.</p> | | | |

| Name | | Descriptions | |
|---|-----------------|---|--|
| Disks | Format Disk | Format type | Descriptions |
| | | XFS (USB Hard Drive/ LinkStation Internal Hard Drive) | This format is recommended for the internal drive in the TeraStation or LinkStation. <ul style="list-style-type: none"> • Supports both Reading/Writing. • Supports Journaling File System. • More space is available than XFS after formatted. • Access speed will not degrade even with many files in a single folder. XFS is not supported by legacy LinkStations such as HD-LAN, HD-HLAN, or HD-HGLAN series. You cannot read data on an XFS drive by directly connecting to your PC. |
| | | FAT32 (USB hard drive only) | FAT32 is recommended if you're going to connect the drive to Windows and Mac computers as well as the LinkStation. It works with most computers and devices. <ul style="list-style-type: none"> • Supports both Reading/Writing. • Cannot copy or backup data with more than 4 GB per file. • Cannot use some characters which are used in Mac OS such as [:]. |
| | | NTFS (USB hard drive only) | Cannot format from Settings. This is Read Only for the LinkStation. It can be used read/write with Windows 8, Windows 7, Windows Vista, Windows XP, Windows 2000, or Windows Server 2003, Windows Server 2008. <ul style="list-style-type: none"> • Read Only (not writable for backup either). |
| | | HFS+ (USB hard drive only) | Cannot format from Settings. Read-Only. Can be used to connect to OS X 10.3.9 or later. <ul style="list-style-type: none"> • Read Only (not writable for backup either). |
| <p>GPT partitions (64-bit) are recommended for connected USB hard drives of 2.2 TB or larger. Other types of partitions will not address the full size of larger drives. GPT partitions are supported by Windows 7, Windows Vista, Windows Server 2003 SP1 or later, Windows Server 2008, OS X 10.4 or later, and Buffalo TeraStations and LinkStations (e.g.TS-XL, TS-XEL, TS-WXL, LS-XHL, and LS-CHL series).</p> <p>Note that other operating systems (including Windows XP) may not detect GPT partitions correctly. To read hard drives larger than 2.2 TB from Windows XP, either use a proprietary GPT solution, or use multiple partitions smaller than 2.2 TB.</p> | | | |
| | Remove Disk | Select the USB hard drive and click <i>Remove Disk</i> to safely remove the USB hard drive. | |
| | Rediscover Disk | Not used for this product | |

| Name | Descriptions | | | | | | |
|--|---|--------|----------|--------------------|--|----------------------|--|
| <p>RAID Array *1</p> <p>*1: LinkStation models with multiple hard drives only</p> | <p>Configure RAID arrays from this menu. Several RAID modes are available for LinkStation models with multiple hard drives. If RAID is disabled, the drives in the LinkStation will be available as separate drives.</p> <p>Notes:</p> <ul style="list-style-type: none"> • RAID 1 and 0 modes are available for LinkStations with 2 or more hard drives. (Use all 4 hard drives to configure RAID 0 with LS-QVL.) • RAID 5 and 10 modes are available for LinkStations with 3 or more hard drives. <p><i>Disk Structure:</i> To configure a RAID array, check the target drives, select a RAID mode, and click <i>Create Raid Array</i>. To delete the RAID array, select <i>Delete RAID Array</i>. Warning: All data is lost when the RAID array is modified. Back up any important data before changing RAID settings.</p> <p><i>RAID Array Error Detection Response:</i> If shutdown is enabled, the LinkStation will automatically shut down when a RAID 1 error is detected. RAID 0 arrays and drives in normal mode are not affected by this setting. The default setting is <i>Shut Down</i>.</p> <p><i>RAID Array check speed:</i> Select the RAID scanning speed from the following: <i>High:</i> ~ 10 hours per TB <i>Normal Mode:</i> ~ 20 hours per TB <i>Low:</i> ~ 100 hours per TB</p> | | | | | | |
| <p>RAID Scanning *1</p> <p>*1: LinkStation models with multiple hard drives only</p> | <p>A RAID scan tests your RAID array for errors. If errors are found, they are fixed automatically if possible. If you are using a RAID array, regular RAID scans are recommended.</p> <p>Recoverable errors found during standard file operations will be automatically repaired regardless of whether RAID Scanning is enabled or not.</p> <table border="1" data-bbox="529 1417 1446 1600"> <thead> <tr> <th data-bbox="529 1417 824 1455">Status</th> <th data-bbox="824 1417 1446 1455">Examples</th> </tr> </thead> <tbody> <tr> <td data-bbox="529 1455 824 1528">Recoverable errors</td> <td data-bbox="824 1455 1446 1528">Read errors in data or system area of a RAID 1 array</td> </tr> <tr> <td data-bbox="529 1528 824 1600">Unrecoverable errors</td> <td data-bbox="824 1528 1446 1600">Write errors, RAID management area errors, partition errors, drive detection failure</td> </tr> </tbody> </table> | Status | Examples | Recoverable errors | Read errors in data or system area of a RAID 1 array | Unrecoverable errors | Write errors, RAID management area errors, partition errors, drive detection failure |
| Status | Examples | | | | | | |
| Recoverable errors | Read errors in data or system area of a RAID 1 array | | | | | | |
| Unrecoverable errors | Write errors, RAID management area errors, partition errors, drive detection failure | | | | | | |

| Name | | Descriptions |
|---|-------------------------|---|
| Storage | | |
| RAID Scanning *1 | | <p>If many recoverable errors (bad cluster) are found in one of the hard drives which builds RAID, that drive will be removed and the system will automatically move to degrade mode. Since the data is not protected in the degrade mode, it is strongly recommended to replace the erroneous hard drive immediately. When running RAID Scanning in the first time, it is strongly recommended to backup data on the LinkStation in advance.</p> <p><i>RAID Scanning:</i> Set whether using RAID Scanning or not.</p> <p><i>RAID Scanning Schedule:</i> Select the schedule to perform RAID Scanning.</p> <ul style="list-style-type: none"> • <i>Every Week</i>, select from <i>Sunday</i> to <i>Saturday</i> • <i>1st</i>, from <i>Sunday</i> to <i>Saturday</i> • <i>2nd</i>, from <i>Sunday</i> to <i>Saturday</i> • <i>3rd</i>, from <i>Sunday</i> to <i>Saturday</i> • <i>4th</i>, from <i>Sunday</i> to <i>Saturday</i> • <i>[1st, 3rd]</i>, from <i>Sunday</i> to <i>Saturday</i> • <i>[2nd, 4th]</i>, from <i>Sunday</i> to <i>Saturday</i> • <i>Every 1st day / month</i> <p>Select <i>Begin Immediate RAID Scan</i> and click <i>Save</i> to immediately run the maintenance.</p> <p><i>RAID Scanning Start Time:</i> Select time to start RAID from 0 to 23 o'clock. Click <i>Abort RAID Scanning</i> to stop the operation.</p> |
| *1: LinkStation models with multiple hard drives only | | |
| Backup | | |
| View NAS Devices | Local LinkStations | Displays LinkStations and TeraStations on the network with shares enabled for backup. Click <i>Refresh</i> to update the list. |
| | Off Subnet LinkStations | You can add an off-subnet LinkStation or TeraStation to the list. Enter the IP address of the LinkStation/TeraStation and click <i>Add</i> . Note: Only devices with active backup shares can be registered. |

| Name | | Descriptions | | | | | | | | | | | | | | | | | | | | | |
|---|--------------------|---|------------|--|--|------|--------|--------|------------|------------------------|-----|-----|------|---|------|---------------|------|---|---------------|------|------|--|---------------|
| Search for Backup Destination by Password | Password to Search | Enter a password to search for LinkStations and TeraStations with that password for backup. | | | | | | | | | | | | | | | | | | | | | |
| | | <p>Example of Configuration Configuration on the LinkStation (Backup Destination)</p> <table border="1"> <tr> <td>Name</td> <td>share1</td> <td>share2</td> <td>share_free</td> </tr> <tr> <td>Remote backup password</td> <td>111</td> <td>222</td> <td>None</td> </tr> </table> <p>Example of Configuration Configuration on the LinkStation (Backup Source)</p> <table border="1"> <tr> <td>The shared folder as a backup destination displayed when "222" is set on "Search for Backup Destination by Password" on the LinkStation as a backup source.</td> <td>View</td> <td>Not displayed</td> <td>View</td> </tr> <tr> <td>The shared folder as a backup destination displayed when "111" is set on "Search for Backup Destination by Password" on the LinkStation as a backup source.</td> <td>Not displayed</td> <td>View</td> <td>View</td> </tr> <tr> <td>A shared folder as a backup destination displayed when the password is not set</td> <td>Not displayed</td> <td>Not displayed</td> <td>View</td> </tr> </table> | | | | Name | share1 | share2 | share_free | Remote backup password | 111 | 222 | None | The shared folder as a backup destination displayed when "222" is set on "Search for Backup Destination by Password" on the LinkStation as a backup source. | View | Not displayed | View | The shared folder as a backup destination displayed when "111" is set on "Search for Backup Destination by Password" on the LinkStation as a backup source. | Not displayed | View | View | A shared folder as a backup destination displayed when the password is not set | Not displayed |
| Name | share1 | share2 | share_free | | | | | | | | | | | | | | | | | | | | |
| Remote backup password | 111 | 222 | None | | | | | | | | | | | | | | | | | | | | |
| The shared folder as a backup destination displayed when "222" is set on "Search for Backup Destination by Password" on the LinkStation as a backup source. | View | Not displayed | View | | | | | | | | | | | | | | | | | | | | |
| The shared folder as a backup destination displayed when "111" is set on "Search for Backup Destination by Password" on the LinkStation as a backup source. | Not displayed | View | View | | | | | | | | | | | | | | | | | | | | |
| A shared folder as a backup destination displayed when the password is not set | Not displayed | Not displayed | View | | | | | | | | | | | | | | | | | | | | |
| Click <i>Modify Settings</i> to change settings. | | | | | | | | | | | | | | | | | | | | | | | |

| Name | | Descriptions |
|--|---------------------------|---|
| <p>Search for Backup Destination by Password</p> <p>Click <i>Modify Settings</i> to change settings.</p> | <p>Password to Search</p> | <p>Steps for Setup</p> <p>1 In Settings of the backup destination, set <i>Remote backup password</i> for each shared folder.</p> <p>2 When setting up the backup for the LinkStation which is the backup source, set the same password of <i>Search for Backup Destination by Password</i> as for <i>Remote backup password</i> which is set for the shared folder you want to display as the backup destination.</p> <p>3 Set up the backup at the LinkStation which is the backup source. Select the shared folders of the backup destination from the following.*</p> <ul style="list-style-type: none"> • Shared folders in the LinkStation which is the backup source. • The USB hard drive connected to the LinkStation which is the backup source. • A shared folder for which <i>Remote backup password</i> is not set in the Link/ TeraStation which is the backup destination. • A shared folder whose <i>Remote backup password</i> in the LinkStation/ TeraStation which is the backup source matches with "Search for Backup Destination by Password". <p>* <i>Backup</i> must be enabled as a published destination when setting up the shared folder.</p> |
| <p>Backup Jobs Setup</p> | <p>Backup Jobs Setup</p> | <p>Click <i>Create New Job</i> to set up to 8 backup timers. Backup data saved on the LinkStation to the USB external hard drive or another Link/TeraStation at the specified time.</p> <p>Notes:</p> <ul style="list-style-type: none"> • If you choose the USB hard drive in order to utilize this backup feature, the USB drive must be formatted in FAT32, XFS or EXT3 The format type for a USB hard drive can be displayed on Settings, <i>System - Storage</i>. • If a USB drive is formatted in FAT32, the maximum file size that can be backed up is 4 GB. • Never unplug the Ethernet cable connected to the LinkStation or USB hard drive during backup. • Do not restore, run Check Disk, Backup Job setup and Folder Setup, User/ Group, Add, Edit, or Delete User during backup. Otherwise, the backup may fail. • If an error occurs during a regularly scheduled backup (Every day/Every Week), the backup job will not be performed after that. You will need to configure the backup job again. However, this does not apply when <i>Ignore Errors and Proceed with Backup</i> option is selected. |

| Name | | Descriptions |
|--|-----------------------|---|
| Backup Jobs Setup Click <i>Create New Job</i> to display this option in the <i>Backup</i> screen. | Job Name | Enter the name you want for a backup task. |
| | Backup Job Schedule | Select the schedule to run from <i>Not Scheduled, Immediate, Every Day, Every Week1st, 2nd, 3rd, 4th, [1st, 3rd], [2nd, 4th]</i> or <i>Every 1st day/month</i> . |
| | Backup Date | Select the day or time to run the backup job. |
| | Backup Operation Mode | Select the Backup Operation Mode from the following choice. <ul style="list-style-type: none"> • <i>Normal Backup</i> • <i>Overwrite Backup (Append Backup)</i> • <i>Overwrite Backup (Differential Backup)</i> <p>Caution:</p> <ul style="list-style-type: none"> • If you select <i>Overwrite Backup (Differential Backup)</i>, any files which do not exist in the source will be deleted without further warning or notice. • All operation modes other than normal backup will overwrite all data at the backup destination. • Do not perform any file operations (such as rename or delete a file) in the Backup Sources during the Backup. If you do so, the backup job may halt with errors. In such a case, rerun the backup job. <p>The following table shows behavior during each operation mode. Behaviors will vary if <i>Create Target Folder for Backup</i> is selected or not in Backup Option.</p> <p>Note: This example uses “/target” as the backup target.</p> <ul style="list-style-type: none"> • If data is backed up to the USB hard drive, the “target” below, will be displayed as “usbdisk*”. and * will be 1 - 2 (number). • If data is backed up to the LinkStation, the “target” below, the shared folder name of the backup source will be displayed. • The Backup Log File is displayed under the following names in Backup Sources. backuplog (backup task number)_(backup starting time).txt Example: If the date the backup is started on March 27, 2004, 19:55, “backuplog1_200403271955.txt” is created. |

| Name | | Descriptions | | | | |
|--|-------------------------|--|----------------|-------------------------|------------|-----|
| Backup Jobs Setup Click <i>Create New Job</i> to display this option in the <i>Backup</i> screen. | Backup Operation Mode | Normal (Copy all files without overwriting previously backed up data every time) | | | | |
| | | Target Folder for Backup | Backup Sources | Backup Targets / Result | Re-remarks | |
| | | Create (Forced) | /share | /target/(Date)*/share | | |
| | | | /share/folder | /target/(Date)*/folder | | |
| | | Overwrite Backup (Append Backup) (Only copy and overwrite the files with changes based on the file size and time stamp*2) | | | | |
| | | Target Folder for Backup | Backup Sources | Backup Targets / Result | Re-remarks | |
| | | Create | /share | /target/_backups/share | | |
| | | | /share/folder | /target/_backups/folder | | |
| | | Do not create | /share | /target | | |
| | | | /share/folder | /target | | |
| | | Overwrite Backup (Differential Backup) (Only copy and overwrite the files with changes based on the file size and time stamp**) <ul style="list-style-type: none"> Files/Folders exit only on the Backup Destination will be deleted. | | | | |
| | | Target Folder for Backup | Backup Sources | Backup Targets / Result | Re-remarks | |
| | | Create | /share | /target/_backups/share | | |
| | | | /share/folder | /target/_backups/folder | | *** |
| | | Do not create | /share | /target | | |
| /share/folder | /target/_backups/folder | | *** | | | |
| *The format of the folder is <i>yyyymmddhhmm</i> by using the backup starting time. For example, if the starting time is March 27, 2004, 19:55, the folder name is displayed as "200403271955". **"Time Stamp" here is not the time information that can be verified Windows Macintosh, but the time information managed by LinkStation. ***If there is the difference in the shared folders that is above the backup folder, files will not be deleted. | | | | | | |

| Name | | Descriptions |
|---|----------------|---|
| <p>Backup Jobs Setup</p> <p>Click <i>Create New Job</i> to display this option in the <i>Backup</i> screen.</p> | Backup Options | <p><i>Create Target Folder for Backup:</i> The options you have selected on the Backup Operation Mode will make a big differences on behavior. Refer to the table described in the Operation Mode.</p> <p><i>Create Backup Log File:</i> Create the backup log file.</p> <p><i>Use Encrypted Transfer Method:</i> Select whether having data to be transferred encrypted or not when backup data.</p> <ul style="list-style-type: none"> • The throughput is degraded if the encryption is enabled. • Do not select this option when the backup destination is a USB hard drive. <p><i>Use Compressed Transfer Method:</i> Select whether having data to be transferred compressed or not when backup data.</p> <ul style="list-style-type: none"> • If running a backup job via the network, the compressed transfer may improve the transfer speed when the network bandwidth is narrow (this does not mean that data is archived into 1 file and backed up). • Do not select this option when the backup destination is a USB hard drive. <p><i>Ignore backup failure and continue backup job on schedule:</i> The next backup will be performed even though the last backup is halt in error.</p> <p><i>Exclude trash boxes from backup target:</i> Exclude the data in the trash boxes to backup.</p> <p><i>Complete Backup:</i> Overwrite the files which have not changed.</p> |
| <p>Backup Folders</p> <p>Click a task number to display this option in the <i>Backup</i> Screen.</p> | Backup Folders | <p>Select the backup source and the shared folder on the backup destination folders, and click <i>Add</i>.</p> <p>You can select following folder as a shared folder on the backup destination.</p> <ul style="list-style-type: none"> • Shared folders on the Link/TeraStation displayed in <i>View NAS Devices</i> • usbdisk1 and usbdisk2 connected to the backup source of the LinkStation <p>Do not specify the backup source folder which include Japanese katakana in the folder name. The backup job will halt if any of these characters are included.</p> |

| Name | | Descriptions |
|--|---------------------|--|
| Maintenance | | |
| <p>Email Notification Click <i>Modify Settings</i> to change settings.</p> <p>Click <i>Send Test Message</i> to send a test email to the email address which has been set.</p> | Notification | Select whether using email notification feature or not. Following message is sent by using Email Notification. Note: Mail Server displays the list of <i>POP before SMTP</i> (the method to give the permission to use SMTP server by authenticating at specified POP server before sending email). If this is set, this feature cannot be used. |
| | SMTP Server Address | Enter <i>SMTP Server Address</i> (Mail Server Address). |
| | SMTP Port No. | Enter <i>SMTP Port No.</i> |
| | Authentication Type | Select <i>Authentication Type</i> from <i>POP before SMTP</i> , <i>LOGIN(SMTP-AUTH)</i> , and <i>CRAM-MD5(SMTP-AUTH/CRAM-MD5)</i> . |
| | POP3 Server Address | Enter the <i>POP3 Server Address</i> (Email server address). |
| | POP3 Port No. | Enter <i>POP Port No.</i> |
| | SSL/TLS | When <i>LOGIN(SMTP-AUTH)</i> and <i>CRAM-MD5(SMTP-AUTH/CRAM-MD5)</i> are selected for <i>Authentication Type</i> , specify either using <i>SSL</i> or <i>TLS</i> . |
| | Username | Enter a username that will be used for authentication. |
| | Password | Enter the password used to access with above user name. |
| | Subject | Specify the subject of the email to be sent. Use only one-byte characters, not two-byte characters. |
| | Recipient(s) | Enter the email address of the receiver, and click <i>Add</i> . You can register up to 5 email addresses as receivers. |
| | Report | Select the contents to send in the email notification. <i>HDD Status Report:</i> Send the status other hard drive of the LinkStation on the specified time on <i>HDD Status Sending Time</i> . <i>Fan Failure:</i> Sent if a problem on the fan of the LinkStation. <i>Disk Error:</i> Sent when an error occurs on the drive. <i>Backup Complete:</i> Sent if the backup of the LinkStation is completed. |

| Name | | Descriptions |
|---|-------------------------|--|
| Restart LinkStation | Restart the LinkStation | Click <i>Restart</i> to reboot the LinkStation. |
| Shutdown* * LS-QVL LinkStation models only | Shutdown | Click <i>Shut Down</i> to turn off the LinkStation. <ul style="list-style-type: none"> To turn the LinkStation back on, press the power button on the front of the LinkStation. To prevent the corruption of data, check that there are no data operations in progress before turning off the LinkStation. |
| Firmware Installation | Updating Firmware | Clicking <i>Check For Update</i> will check for the latest firmware version. If the installed firmware version is not the latest, click <i>Install Update</i> to update the firmware. |

| Power Management | | |
|--|--|---|
| UPS Settings Click <i>Modify Settings</i> to change settings. | Synchronization with UPS | <i>synchronize with UPS connected to this LinkStation:</i> Select to synchronize the LinkStation with a UPS that is directly connected. <i>synchronize with UPS connected to other LinkStation on the network:</i> Select to synchronize the LinkStation with a UPS that is connected to a different LinkStation on the same network. <i>do not synchronize with UPS:</i> Select if synchronizing to a UPS is not desired. |
| | synchronized source LinkStation IP Address | If <i>synchronize with UPS connected to other LinkStation on the network</i> is selected, enter the IP address of the LinkStation that is directly connected to the UPS. |
| | UPS Connection Type | Select a connection method with UPS. Note: <i>USB Port (APC Style)</i> or <i>USB Port (OMRON Style)</i> can be only set when UPS manufactured by APC for USB connection is connected. |
| | LinkStation behavior When Power failure | Allows you to set the time until shutdown when the power failure continues. Or, it can shut down when it detects "Battery Low" from UPS. Note: "Low Battery" shutdown is only supported with UPSs that are connected to the LinkStation via USB. |
| | UPS Behavior After LinkStation has shut down | Specify whether or not to shut down the UPS after shutting down the LinkStation. |

| | | |
|--|----------------|--|
| SleepTimer Click <i>Modify Settings</i> to change settings. | Timer Interval | Select Sleep Timer interval from <i>Disable</i> , <i>Everyday</i> , or <i>Specific day of the week</i> . If selecting <i>Specific day of the week</i> , specify the day by clicking the check box of the day. Timer can be set from 1 - 3. |
| | Wake up at | Specify a wake-up time for the LinkStation to recover from sleep mode and resume its normal state. Times from 0:00 to 23:45 are allowed. |
| | Begin Sleep at | Specify a time for the LinkStation to move from its normal functionality to a standby state ("sleep mode"). Times from 0:00 to 27:45 are allowed. Note: The wake-up time must be later than the beginning time. |

| Name | | Descriptions |
|--------------------------|---------------------|---|
| Restore/Eraser | | |
| Restore Factory Defaults | Upon restore | Click <i>Modify Settings</i> and select whether or not Initialization will reset the admin password. Note: If <i>Keep current admin password</i> has been selected, you cannot reconfigure the LinkStation without the password. Write down the password and keep it in a safe place!. |
| | Restore LinkStation | The following settings are initialized by <i>Restore LinkStation</i> . LinkStation Name, Description, NTP Settings, Workgroup Settings, Shared Service Settings, Access Restrictions for Shared Folders, User Settings, User Group Settings, Email Notification, UPS Settings, Backup Jobs Setup, Admin username and password, Print server settings, WebAccess, Language settings, SleepTimer, HDD Spindown, Media server settings, BitTorrent settings, Time Machine configuration, Web Server, and MySQL Server. Note: The following tasks require a <i>Confirm Operation</i> screen. <ul style="list-style-type: none"> • Delete Folder • Restore LinkStation • Format LinkStation • Erase Disk Enter the number shown in the <i>Confirmation Number</i> field within 60 seconds, and click <i>Apply</i> . |
| Erase | Erase | Clicking <i>Erase</i> will erase data completely on the hard drive of the LinkStation. Notes: <ul style="list-style-type: none"> • All data will be erased. There is no "undo" for this! • While erasing, the settings for the LinkStation cannot be changed. |

Extensions

The following options can be set from the *Extensions* tab.

| Name | | Descriptions |
|---|--------------------|--|
| WebAccess | | |
| WebAccess | WebAccess Settings | <p>Enable the WebAccess service first, then click a shared folder name to display the <i>Edit</i> screen.</p> <p>Folder information of the LinkStation to be published by WebAccess Settings will be displayed on <i>Name</i> and <i>Description</i></p> <p>In <i>WebAccess Settings</i>, the following Access Restrictions can be selected.</p> <ul style="list-style-type: none"> • <i>Disable:</i> Does not publish shared folders. • <i>Allow Anonymous:</i> Anyone can access (view) shared folders. • <i>Allow All Groups / Users:</i> Allow to access (or view) only groups or users registered to the LinkStation. • <i>Use Inherited Folder Permissions:</i> Use same permissions as set on the Shared Folder Screen. If access restrictions are not set in the Shared Folder Screen, this option is not displayed. |
| WebAccess Service Click <i>Easy WebAccess Settings</i> to change settings. | WebAccess Service | <p><i>WebAccess Service:</i> Configure if using WebAccess or not.</p> <p><i>BuffaloNAS.com Name:</i> Enter a name for your account with WebAccess.</p> <ul style="list-style-type: none"> • Write this name down in a safe place. You will need it to use WebAccess. • If your LinkStation is left disconnected from the Internet for 60 days or more, your BuffaloNAS name and account may be deleted from the BuffaloNAS.com server. |

| Name | Descriptions | |
|---|--------------------------|--|
| WebAccess | | |
| <p>WebAccess Service</p> <p>Click [Advanced WebAccess Settings] to change settings.</p> | <p>WebAccess Service</p> | <p><i>WebAccess Service:</i> Configure if using WebAccess or not.</p> <p><i>HTTPS/SSL Encryption:</i> Configure if encrypting your data transfers with SSL.</p> <p><i>Use BuffaloNAS.com:</i> Configure if using "BuffaloNAS.com" server.</p> <p><i>BuffaloNAS.com Name:</i> Enter a name for your account with WebAccess.</p> <ul style="list-style-type: none"> • Write this name down in a safe place. You will need it to use WebAccess. • If your LinkStation is left disconnected from the Internet for 60 days or more, your BuffaloNAS name and account may be deleted from the BuffaloNAS.com server. <p><i>BuffaloNAS.com Key:</i> Choose a password (optional) to enter a name for your account with WebAccess.</p> <p><i>DNS Hostname:</i> Use of BuffaloNAS.com is recommended for most users, but you may specify a different DNS service by entering its hostname.</p> <p><i>Auto-Configure Firewall (UPnP):</i> If your router supports UPnP, selecting <i>Enable</i> for <i>Auto-Configure Firewall (UPnP)</i> is recommended. UPnP must be enabled in the router for this to work.</p> <p><i>External Port:</i> To configure the firewall manually without using UPnP, enter a port number. In the router's settings, forward this external port number to an internal port on your LinkStation on your local network.</p> <p><i>NAS Internal Port:</i> Enter internal port number for your LinkStation on your network.</p> <p><i>Exclusive session:</i> If <i>Exclusive session</i> is enabled, a user account cannot be used to log multiple computers in to WebAccess simultaneously. Only the last login will be active.</p> <p><i>Session expiration time (minute):</i> Enter a time in minutes (1 - 120) before inactive users are logged out of WebAccess, or select <i>Unlimited</i>.</p> <ul style="list-style-type: none"> • If <i>Exclusive session</i> is enabled, <i>Unlimited</i> may not be selected. |

| Name | | Descriptions |
|---------------------|-------------|---|
| Media Server | | |
| Media Server | DLNA Server | <p><i>Restart DLNA Server:</i> Click to restart the DLNA server.</p> <p><i>Authorized DLNA Media Clients:</i> This displays the MAC Address, IP Address, and Device Name of connected DLNA clients. Click <i>Allow</i> to let a selected client to access DLNA media, then click <i>Apply</i>. Click <i>Refresh client list</i> to refresh the list of available clients connected to the network.</p> <p><i>DLNA Server:</i> To turn on the DLNA server, click <i>Modify Settings</i> and select <i>Enable</i>.</p> <p><i>Public Folder:</i> Click <i>Modify Settings</i> and select a DLNA server folder. If <i>Show folders on USB drives</i> is enabled, media on connected USB drives will also be available to DLNA clients.</p> <p><i>Automatic Update:</i> If <i>Automatic Update</i> is enabled, the DLNA database is automatically refreshed. To immediately refresh the database, select <i>Refresh now</i> and then click <i>Save</i>. To both initialize and refresh the database, select <i>Initialize database before refresh</i> and then click <i>Save</i>.</p> <p>Note: The <i>Initialize database before refresh</i> option is not available for LS-XHL LinkStations with firmware version 1.20 or later.</p> <p><i>Refresh interval (Minute):</i> After clicking <i>Modify Settings</i>, the automatic refresh interval can be specified in minutes here.</p> |

| | | |
|--------------|-------------------|--|
| | DLNA Server | <p>The LS-WXL LinkStation supports DTCP-IP. Copyright-protected content can be used in players that support DTCP-IP. Incompatible players don't display any DTCP-IP-related media.</p> <p><i>Update DTCP-IP:</i> This downloads the latest version of the DTCP-IP encryption key. When the download is complete, the media server will restart automatically.</p> <p><i>DTCP-IP:</i> This displays whether DTCP-IP is enabled or disabled as well as the current DTCP-IP version number. DTCP-IP is enabled by default for LinkStation firmware 1.20 and later.</p> <p><i>Disk space for DTCP-IP contents.:</i> For LinkStation with multiple hard drives, you may choose which disk or array is used to store DTCP-IP media files.</p> <p><i>How to enable DTCP-IP.:</i> When DTCP-IP is disabled, click <i>How to enable DTCP-IP function</i> and follow the directions.</p> |
| Media Server | iTunes Server | <p><i>Restart iTunes Server:</i> Click to restart the iTunes server.</p> <p><i>iTunes Server:</i> To turn on the iTunes server, click <i>Modify Settings</i> and select <i>Enable</i>.</p> <p><i>Public Folder:</i> Click <i>Modify Settings</i> and select a iTunes server folder.</p> |
| | Squeezebox Server | <p><i>Restart Squeezebox Server:</i> Click to restart the Squeezebox Server.</p> <p><i>Open Squeezebox Server Settings:</i> Click to open Squeezebox server settings screen.</p> <p><i>Delete Squeezebox cache:</i> Click to delete Squeezebox cache saved on your LinkStation.</p> <p><i>Squeezebox Server:</i> To turn on the Squeezebox server, click <i>Modify Settings</i> and select <i>Enable</i>.</p> <p><i>Public Folder:</i> Click <i>Modify Settings</i> and select a Squeezebox server folder.</p> <p><i>Port No.:</i> The default port (9001) is recommended.</p> |

| Name | Descriptions |
|--|--|
| PrintServer | |
| PrintServer Click <i>Modify Settings</i> to change settings. | Select whether or not to use the PrintServer (Windows only). Click <i>Delete Print Queue</i> to delete printer jobs. Note: Some printers may not work with the PrintServer. |
| Network-USB Server | |
| Network-USB Server Click <i>Modify Settings</i> to change settings. | Select whether or not to use the Network-USB Server. |
| BitTorrent | |
| BitTorrent Click <i>Modify Settings</i> to change settings. | <i>Enable or Disable:</i> Select <i>Enable</i> to use Bit Torrent. <i>Download Folder:</i> If using BitTorrent, select a download destination folder and click <i>Save</i> . To display the download screen, click <i>Open Download Manager</i> . |
| Time Machine | |
| Time Machine Click <i>Modify Settings</i> to change settings. | Select <i>Enable</i> when using to specify the LinkStation as a backup destination for Time Machine on OS X 10.5 or later. Select a shared folder as a backup destination in <i>Target Folder</i> . |

| Web Service Support | |
|----------------------------|---|
| Flickr Support | <i>Flickr Support:</i> Select <i>Enable</i> to synchronize with Flickr. <i>Synchronization status:</i> This displays whether the LinkStation is currently synchronized with Flickr. <i>Target Folder:</i> Select the shared folder that is synchronized with Flickr. <i>Authentication key:</i> Enter the Flickr authentication key. <i>Remount:</i> Click to remount the shared folder. <i>Unlock Flickr authorization:</i> Click to revoke the Flickr authorization. |

| | |
|--------------------------|---|
| <p>Eye-Fi connected</p> | <p><i>Enable:</i> This enables Eye-Fi connected.</p> <p><i>Email:</i> Enter the email address that was registered to the Eye-Fi card during setup.</p> <p><i>Password:</i> Enter the password that was registered to the Eye-Fi card during setup.</p> <p><i>Login:</i> The name of the card or device is displayed.</p> <p><i>Disable:</i> This disables Eye-Fi connected.</p> |
| <p>WebAccess Connect</p> | <p><i>WebAccess Connect:</i> Select <i>Enable</i> to enable opening of a shared folder of a remote LinkStation/ TeraStation using Explorer, My Computer, or other file manager. To disable WebAccess Connect , select <i>Disable</i>.</p> <p><i>Target Folder:</i> Select the shared folder that will be connected. The selected folder is used internally by WebAccess Connect. Files are not added to the selected folder, and the amount of used space does not automatically increase.</p> <p><i>BuffaloNAS.com Name:</i> Enter the BuffaloNAS.com name that is set for WebAccess on the remote LinkStation.</p> <p><i>Username of remote NAS:</i> Enter the username that is set for WebAccess on the remote LinkStation.</p> <p><i>Password of remote NAS:</i> Enter the password that is set for WebAccess on the remote LinkStation.</p> <p><i>Remount:</i> If using after the network has been temporarily disconnected, click <i>Remount</i>.</p> |

Appendix

Specifications

Check www.buffalotech.com for information about the latest products and specifications.

| | | |
|----------------------|---|---|
| Interface (LAN Port) | <p>Interface</p> <p>Transfer Speed</p> <p>Number of Ports</p> <p>Connector Type</p> <p>Protocol</p> <p>Access Method</p> <p>File Sharing</p> <p>Management</p> <p>Jumbo Frame</p> | <p>Complied with IEEE 802.3ab (1000BASE-T)</p> <p>Complied with IEEE 802.3u (100BASE-TX)</p> <p>Complied with IEEE 802.3 (10BASE-T)</p> <p>1000 Mbps Full duplex (auto-negotiation)</p> <p>100 Mbps Full duplex/Half duplex (auto-negotiation)</p> <p>10 Mbps Full duplex/Half duplex (auto-negotiation)</p> <p>1 port (supports Auto-MDIX)</p> <p>RJ-45 8-pin</p> <p>TCP/IP</p> <p>CSMA/CD</p> <p>CIFS/SMB, AFP, HTTP/HTTPS, FTP, SFTP*, FTPS*</p> <p>*LS-QVL, LS-WVL, LS-WXL, LS-VL series LinkStations only</p> <p>HTTP/HTTPS</p> <p>1518/4102/7422/9694 bytes (Including 14 bytes of the header and 4 bytes of FCS)</p> |
| Interface (USB Port) | <p>Interface</p> <p>Data Transfer Speed</p> <p>Port</p> <p>Compatible USB Devices</p> <p>Note: Only UPS products connected via USB are supported.</p> | <p>USB Standard Revision 2.0</p> <p>Max 480 Mbps (Theoretical value)</p> <p>USB connector (Series A) × 1*</p> <p>*LS-QVL : USB connector (Series A) × 2</p> <p>USB hard disk manufactured by Buffalo, USB UPS, and USB printer.</p> |

| | |
|-----------------------------|--|
| Internal Hard Drive | <p>Drive configuration: By default, a RAID 0 array using all drives.</p> <p>Notes:</p> <ul style="list-style-type: none"> • Several RAID modes are available for LinkStation models with multiple hard drives. LinkStations with only one hard drive do not support RAID modes. If a hard drive in the LinkStation malfunctions, replace it with a Buffalo OP-HD series drive of the same capacity, available from www.buffalotech.com. • Use all 4 hard drives to configure RAID 0 with LS-QVL. |
| Power Supply | AC 100 - 240 V, 50/60 Hz |
| Power Consumption | <p>LS-VL, XHL, CHL: Max ~24 W, Average 17 W</p> <p>LS-XL: Max ~24 W, Average 17 W</p> <p>LS-WVL, WXL: Max ~48 W, Average 26 W</p> <p>LS-WSXL: Max ~15 W, Average 9 W</p> <p>LS-QVL: Max ~80 W, Average 45 W</p> |
| Dimensions (W×H×D) / Weight | <p>LS-VL, XHL, CHL: 45 × 175 × 156 mm; 1.8 × 6.9 × 6.2 in. / ~1.1 kg (2.5 lbs.)</p> <p>LS-XL: 45 × 175 × 150 mm; 1.8 × 6.9 × 6 in. / ~1.1 kg (2.5 lbs.)</p> <p>LS-WVL, WXL: 86 × 127 × 204 mm; 3.4 × 5 × 8.1 in. / ~ 2.3 kg (5.1 lbs.)</p> <p>LS-WSXL: 40 × 82 × 135 mm; 1.6 × 3.3 × 5.4 in. / ~0.5 kg (1.1 lbs.)</p> <p>LS-QVL: 150 × 150 × 230 mm; 5.9 × 5.9 × 9 in. / ~5.5 kg (12.2 lbs.)</p> |
| Operating Environment | <p>Temperature: 5 - 35° C; 41 - 95° F</p> <p>Humidity: 20 - 80% (no condensation)</p> |
| Compatibility | <p>Windows and Mac computers with Ethernet interface.</p> <p>The LinkStation requires an Ethernet connection with your computer for operation. It cannot be connected via USB.</p> |
| Supported OS | <p>Windows 8*, Windows 7*, Vista*, Windows XP*, Windows 2000, Windows Server 2008, Windows Server 2008 R2, Windows Server 2003, Windows Server 2003 R2</p> <p>OS X 10.7, 10.6, 10.5, 10.4, 10.3.9</p> <p>* Supports both 32-bit and 64-bit versions.</p> |

Default Settings

The following settings are factory defaults for the LinkStation.

| | |
|---------------------------------|---|
| Administrator's Name | admin |
| Password | password |
| Shared folders | By default, the folder "share" may be accessed from both Windows and Macintosh computers. The recycle bin is <i>Enabled</i> on 'share' by default. |
| DHCP Client | Normally, the LinkStation will get its IP address automatically from a DHCP server on the network. If no DHCP server is available, then an IP address will be assigned as follows: IP Address: 169.254.xxx.xxx where xxx are random numbers between 1 and 254. Subnet Mask: 255.255.0.0 |
| Registered Group | The LinkStation has 3 default groups: hdusers, admin and guest. You cannot edit or delete these groups. |
| Microsoft Network Group Setting | WORKGROUP Note: If you installed the LinkStation from the LinkNavigator installation CD, then the LinkStation's workgroup is set to the same workgroup as the computer you used for setup. |
| Ethernet Frame Size | 1518 bytes |
| AFP | Disabled |
| FTP | Disabled |
| NTP | Automatic |
| PrintServer | Enabled |
| WebAccess | Disabled |
| Media Server (DLNA/iTunes) | Enabled |
| BitTorrent | Disabled |
| Network-USB Server | Disabled |
| Flickr Support | Disabled |
| Eye-Fi connected | Disabled |

Mapping Additional Shares

When you installed the LinkStation, a share was mapped as a network drive on the computer that was used for installation. You can map additional shares, or map shares to different computers.

Windows

With Windows 8, Windows 7, Windows Vista, Windows XP, Windows 2000, Windows Server 2003, or Windows Server 2008, use NAS Navigator2 to map a driveletter to a shared folder on the LinkStation.

1 Double-click the  icon on the desktop. NAS Navigator2 will launch.

2

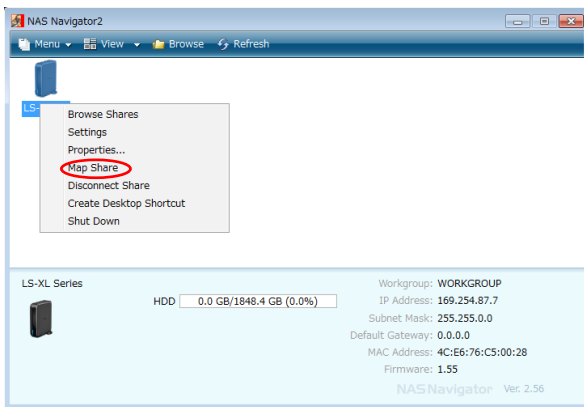

Right-click the LinkStation's icon and choose *Map Share*.

3





An icon for the mapped share will appear in *Computer* or *My Computer*. You can use this network drive just like other hard drives.

You've now mapped a driveletter to the network share. If the LinkStation is disconnected or off when your computer is booted, the message "The network path could not be found. The connection was not established" will be displayed.

Mac OS

With OS X 10.3 or later, use NAS Navigator2 to mount a share from the LinkStation as a drive on the Mac.

- 1  Click the  icon in the Dock. NAS Navigator2 will launch.
- NasNavigator2**

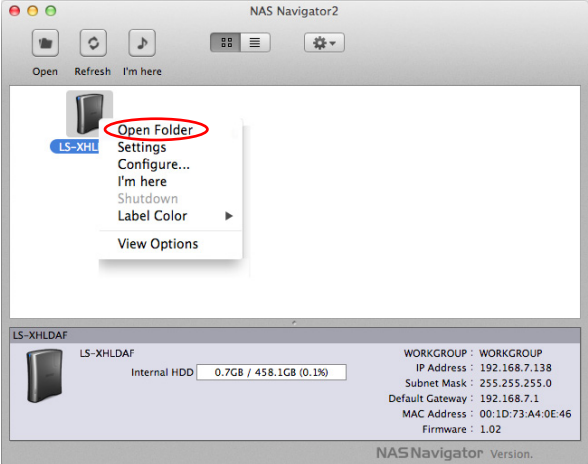
- 2  Hold the control key, click your LinkStation's icon, then choose *Open Folder*.

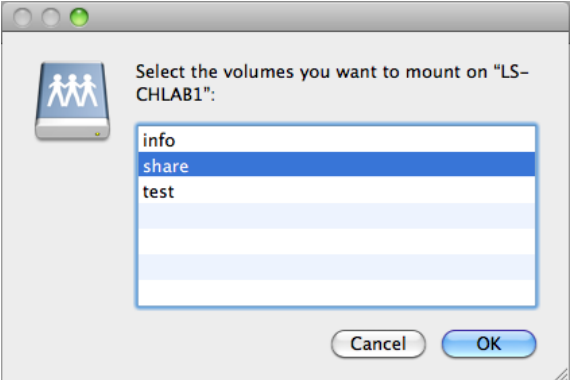
- 3  Select the folder that you want to mount and click *OK*.

- 4  A drive icon will appear on the desktop. The shared folder is now mounted as a network drive. To dismount the share, drag and drop the share icon to the Trash.

Software

You can install following software applications and the manual by using utilities CD which comes with the LinkStation.

Select and install software from the selection screen which is displayed during Setup (Or click *Option* and follow the instruction on the screen to install software).

NAS Navigator2

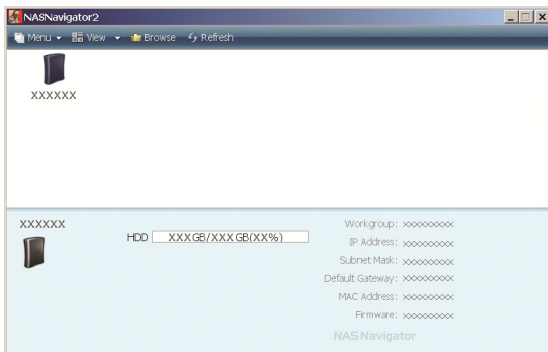

You need NAS Navigator2 in order to display Settings of the LinkStation or search for the LinkStation from the network.

It is always installed when you setup by clicking *Begin Installation* on LinkNavigator.

Note: When using Power Management with PC feature, you need to install NAS Navigator2 on all computers connected within the same network as LinkStation.

File Sharing Security Level Change Tool

To use the LinkStation with Windows 8, Windows 7, Windows Vista, Windows Server 2003, or Windows Server 2008, you must change some security settings in Windows. The File Security Tool will make these changes for you automatically.

During initial setup, the message "Change security level. Will you continue?" will be displayed. Click *Yes*, follow the instructions on the screen, and restart your PC.

You can download the File Sharing Security Level Change Tool from www.buffalotech.com.

- 1 Open the File Sharing Security Level Change Tool.

The File Sharing Security Level Change Tool will launch. If "A program needs your permission to continue" is displayed, click *Continue*.

2

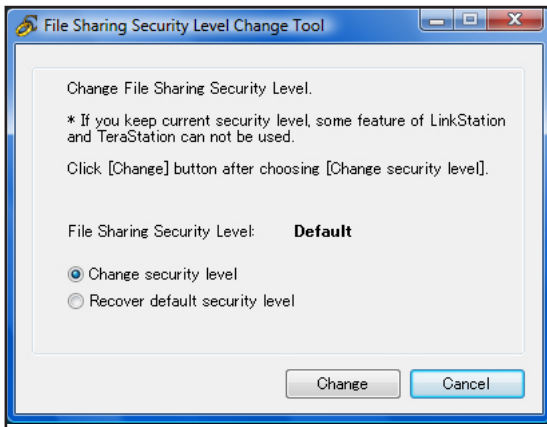

1 When the *Change File Sharing Security Level* window opens, select *Change security level*.

2 Click *Change*.

3 The message, "Change security level. Will you continue?" is displayed. Click Yes.

4 The message, "Will you restart your computer?" is displayed. Click Yes.

Your PC should reboot.

You have changed the security level.

You can reset the security settings to their Windows defaults with the following procedure.

1 Open the File Sharing Security Level Change Tool. If "A program needs your permission to continue" is displayed, click *Continue*.

2 When the *Change File Sharing Security Level* window opens, select *Recover default security level*.

3 Click *Change*.

The setting is now changed back.

Info Folder

Installation programs for software such as NAS Navigator2 are included on the LinkStation's hard drive in a folder called "info"

For example, in the *info - English - NASNavi2* folder, double-click *Inst.exe* to install NAS Navigator2.

Status LED (LS-VL, LS-XHL, LS-CHL)

During normal operation, the power LED will glow blue.



Flashing Red

The Power LED flashes red if the LinkStation experiences an error. The way it flashes indicates the type of error.

Note:

If there is an error, open NAS Navigator2. It may have an error message displayed.



| Place of error code | Status |
|-------------------------|--|
| 10s place of error code | The LED illuminates for 1.0 second every 0.3 seconds. The number of flashes is the tens place of the error code. |
| 1s place of error code | The LED illuminates for 0.5 seconds every 0.3 seconds. The number of flashes is the ones place of the error code. |

| Error code | Descriptions |
|-------------------|---|
| E04 | The firmware is corrupted. Contact Buffalo technical support for assistance. |
| E10 | The LinkStation is running on the UPS battery due to a power outage. The system will now be shut down safely. Check that power is being supplied to the UPS, and if there are no problems, turn on the LinkStation. |
| E11 | An error occurred in the fan speed. Check that no foreign objects or dust are clogging the fan. If any foreign objects or dust are found, use a pair of tweezers, air duster, or other tool to remove them. If the error is displayed again, contact Buffalo technical support for assistance. |
| E12 | System temperature has exceeded the maximum safe value. Do not place objects in the area around the LinkStation. Also, move the LinkStation to a cooler location. |
| E15 | The bad sectors in the hard drive have reached a dangerous level. Contact Buffalo technical support for assistance. |
| E16 | Unable to find the hard drive. The drive may be disconnected or may have failed. Contact Buffalo technical support for assistance. |
| E22 | Mounting of hard drive failed. Format the hard drive. After formatting and rebooting, if the error still appears, contact Buffalo technical support for assistance. |
| E30 | The hard drive may be damaged. Contact Buffalo technical support for assistance. |

Power LED flashing amber

The Power LED flashes amber with information codes. The way it flashes indicates the message.

Note:

If the Power LED is flashing amber, you can open NAS Navigator2. It will tell you the status of the LinkStation.



| Place | Status |
|-----------|--|
| 10s place | The LED illuminates for 1.0 second every 0.3 seconds. The number of flashes is the tens place of the information code. |
| 1s place | The LED illuminates for 0.5 seconds every 0.3 seconds. The number of flashes is the ones place of the information code. |

| Information codes | Descriptions |
|-------------------|--|
| I10 | System temperature may have exceeded the maximum safe value. Move the LinkStation to a cooler location. Do not place objects in the area around the LinkStation. |
| I11 | The bad sectors in the hard drive may have reached a dangerous level. |
| I20 | Formatting the hard drive. |
| I21 | Checking the hard drive. |
| I22 | Erasing hard drive data. |
| I25 | Updating the LinkStation firmware. Do not turn off the power during the updating process. |
| I26 | Initializing all settings in Settings. |
| I27 | Checking a USB hard drive. |
| I28 | Formatting a USB hard drive. |

Power LED glowing amber

When new firmware is available, the power LED will glow amber. Update the firmware as described on page 112.

Status LED (LS-WVL, LS-WXL)

There are 5 LEDs on the LinkStation: "Power", "Function", "Info/Error", "Link/Act", and "AC adaptor".

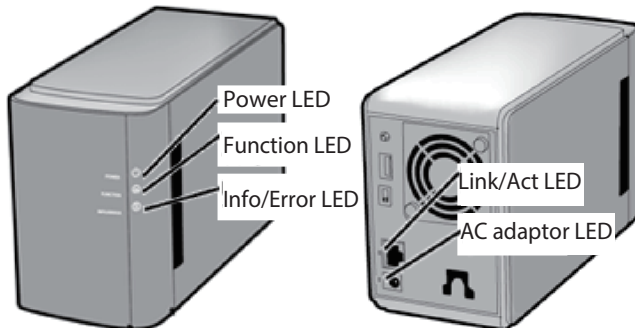

Power LED

| Status | Descriptions |
|---------------|--|
| Glowing Blue | The LinkStation is powered on. |
| Blinking Blue | The LinkStation is starting up or shutting down. |
| LED off | The LinkStation is off. |

Function LED

| Status | Descriptions |
|---------------|--|
| Glowing Blue | DirectCopy is ready (lights for 1 minute). USB device is dismounted (lights for 5 seconds). Initialization is in progress. |
| Blinking Blue | DirectCopy is in use. Note: The function LED (blue) and the info/error LED (orange) blink together if an error occurs during DirectCopy. Do the following if this happens: 1. Shut down the LinkStation . 2. Detach the USB device from the LinkStation. 3. Reattach the USB device to the LinkStation. 4. Power on the LinkStation. |

Info/Error LED

The Info/Error LED blinks orange when it has a message. The message is coded by the pattern of blinking.

Note:

The messages are also available (uncoded) in NAS Navigator2.

| Place | Status |
|-----------|--|
| 10s place | The LED illuminates for 1.0 second every 0.3 seconds. The number of flashes is the tens place of the information code. |
| 1s place | The LED illuminates for 0.5 seconds every 0.3 seconds. The number of flashes is the ones place of the information code. |

| Information code | Descriptions |
|------------------|--|
| I10 | System temperature may have exceeded the maximum safe value. Move the LinkStation to a cooler location. Do not place objects in the area around the LinkStation. |
| I11 | The bad sectors in the hard drive may have reached a dangerous level. Replace the hard drive. |
| I12 | Operating in degraded mode. |
| I13 | Formatting the RAID array. |
| I14 | Checking the RAID array. |
| I15 | Examining the error status of the RAID array. Transfer speeds are slower during the examination process. |
| I16 | Creating the RAID array. |
| I17 | Resyncing the RAID array. Transfer speeds are slower during the resyncing process. |
| I18 | Rebuilding the RAID array. Transfer speeds are slower during the rebuilding process. |
| I19 | Writing 0s to the RAID array, erasing all data. |
| I20 | Formatting the hard drive. |
| I21 | Checking the hard drive. |
| I22 | Erasing the data for the hard drive. |
| I25 | Updating the LinkStation firmware. Do not turn off the power during the updating process. |

| | |
|-----|--|
| I26 | Initializing all settings in Settings. |
| I27 | Checking a USB hard drive. |
| I28 | Formatting a USB hard drive. |
| I32 | The RAID should be rebuilt or a drive should be formatted. Normally this is displayed after a hard drive has been replaced. Rebuild the RAID array or format the hard drive in Settings. |
| I46 | Data migration or conversion (RAID migration) is in progress. Do not turn off the LinkStation power. |
| I47 | Data migration or conversion (RAID migration) is in progress. Do not turn off the LinkStation power. |

The Info/Error LED blinks red to indicate an error.

The error may be identified by the pattern of blinking.

Note:

The error may also be viewed from NAS Navigator2.

| Place | Status |
|-----------|--|
| 10s place | The LED illuminates for 1.0 second every 0.3 seconds. The number of flashes is the tens place of the error code. |
| 1s place | The LED illuminates for 0.5 seconds every 0.3 seconds. The number of flashes is the ones place of the error code. |

| Error code | Descriptions |
|------------|---|
| E04 | The firmware is corrupted. Contact Buffalo technical support for assistance. |
| E10 | The LinkStation is running on the UPS battery due to a power outage. The system will now be shut down safely. Check that power is being supplied to the UPS, and if there are no problems, turn on the LinkStation. |
| E11 | An error occurred in the fan speed. Check that no foreign objects or dust are clogging the fan. If any foreign objects or dust are found, use a pair of tweezers, air duster, or other tool to remove them. If the error is displayed again, contact Buffalo technical support for assistance. |
| E12 | System temperature has exceeded the maximum safe value. Do not place objects in the area around the LinkStation. Also, move the LinkStation to a cooler location. |
| E13 | An error occurred in the RAID array. It will run in degraded mode until the error is corrected. Replace the failed drive indicated by the red LED as soon as possible. After replacement, rebuild the RAID array after starting the LinkStation. |
| E14 | The RAID array cannot be mounted. Run the RAID array disk check in the LinkStation's settings. |
| E15 | The bad sectors in the hard drive have reached a dangerous level. Replace the hard drive indicated by the red LED. |
| E16 | Unable to find the hard drive. The drive may be disconnected or may have failed. After shutting down, reinstall the hard drive. |
| E22 | Mounting of hard drive failed. Format the hard drive. After formatting and rebooting, if the error still appears, replace the drive. If this error is displayed again, contact Buffalo technical support for assistance. |
| E23 | An error occurred, so the hard drive was removed from the RAID array. Replace the hard drive indicated by the red LED. |
| E30 | The hard drive may be damaged. Replace the hard drive indicated by the red LED. |

Info/Error LED glowing amber

When new firmware is available, the Info/Error LED will glow amber. Update the firmware as described on page 112.

Link/Act LED

| Status | Descriptions |
|----------------|--------------|
| Glowing green | Linking. |
| Blinking green | Accessing. |

AC adaptor LED

| Status | Descriptions |
|--------|-------------------------|
| Green | Power is connected. |
| Off | Power is not connected. |

Status LED (LS-WSXL)

There are 4 LEDs on the LinkStation: "Function", "Info/Error", "Link/Act", and "Power".

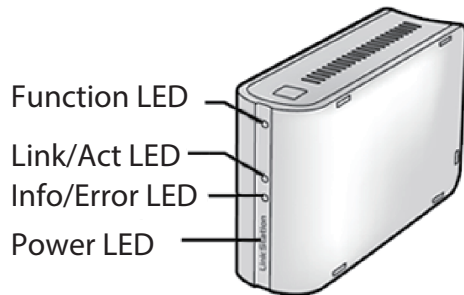

Function LED

| Status | Descriptions |
|---------------|--|
| Glowing Blue | DirectCopy is ready (lights for 1 minute). USB device is dismounted (lights for 5 seconds). Lights during initialization. |
| Blinking Blue | DirectCopy is in use. Note: The function LED (blue) and the info/error LED (orange) blink together if an error occurs during DirectCopy. Do the following if this happens: <ol style="list-style-type: none"> 1. Shut down the LinkStation. 2. Detach the USB device from the LinkStation. 3. Reattach the USB device to the LinkStation. 4. Power on the LinkStation. |

Link/Act LED

| Status | Descriptions |
|----------------|--------------|
| Glowing green | Linking. |
| Blinking green | Accessing. |

Info/Error LED

The Info/Error LED blinks orange when it has a message. The message is coded by the pattern of blinking.

Note: The messages are also available (uncoded) in NAS Navigator2.

| Place | Status |
|-----------|--|
| 10s place | The LED illuminates for 1.0 second every 0.3 seconds. The number of flashes is the tens place of the information code. |
| 1s place | The LED illuminates for 0.5 seconds every 0.3 seconds. The number of flashes is the ones place of the information code. |

| Information code | Descriptions |
|------------------|---|
| I10 | System temperature has exceeded the maximum safe value. Move the LinkStation to a cooler location. Do not place objects in the area around the LinkStation. |
| I11 | The bad sectors in the hard drive may have reached a dangerous level. |
| I12 | Operating in degraded mode. |
| I13 | Formatting the RAID array. |
| I14 | Checking the RAID array. |
| I15 | Examining the error status of the RAID array. Transfer speeds are slower during the examination process. |
| I16 | Creating the RAID array. |
| I17 | Resyncing the RAID array. Transfer speeds are slower during the resyncing process. |
| I18 | Rebuilding the RAID array. Transfer speeds are slower during the rebuilding process. |
| I19 | Writing 0s to the RAID array, erasing all data. |
| I20 | Formatting the hard drive. |
| I21 | Checking the hard drive. |
| I22 | Erasing the data for the hard drive. |
| I25 | Updating the LinkStation firmware. Do not turn off the power during the updating process. |
| I26 | Initializing all settings in Settings. |
| I27 | Checking a USB hard drive. |

| | |
|-----|--|
| I28 | Formatting a USB hard drive. |
| I46 | Data migration or conversion (RAID migration) is in progress. Do not turn off the LinkStation power. |
| I47 | Data migration or conversion (RAID migration) is in progress. Do not turn off the LinkStation power. |

Info/Error LED glowing amber

When new firmware is available, the Info/Error LED will glow amber. Update the firmware as described on page 112.

The Info/Error LED blinks red to indicate an error. The error may be identified by the pattern of blinking.

Note: The error may also be viewed from NAS Navigator2.

| Place | Status |
|-----------|--|
| 10s place | The LED illuminates for 1.0 second every 0.3 seconds. The number of flashes is the tens place of the error code. |
| 1s place | The LED illuminates for 0.5 seconds every 0.3 seconds. The number of flashes is the ones place of the error code. |

| Error code | Descriptions |
|------------|--|
| E04 | The firmware is corrupted. Contact Buffalo technical support for assistance. |
| E10 | The LinkStation is running on the UPS battery due to a power outage. The system will now be shut down safely. Check that power is being supplied to the UPS, and if there are no problems, turn on the LinkStation. |
| E11 | An error occurred in the fan speed. Check that no foreign objects or dust are clogging the fan. If any foreign objects or dust are found, use a pair of tweezers, air duster, or other tool to remove them. If the error is displayed again, contact Buffalo technical support for assistance. |
| E12 | System temperature has exceeded the maximum safe value. Do not place objects in the area around the LinkStation. Also, move the LinkStation to a cooler location. |
| E13 | An error occurred in the RAID array. It will run in degraded mode until the error is corrected. Contact Buffalo technical support for assistance. |

| | |
|-----|---|
| E14 | The RAID array cannot be mounted. Run the RAID array disk check in the LinkStation's settings. |
| E15 | The bad sectors in the hard drive have reached a dangerous level. Contact Buffalo technical support for assistance. |
| E16 | Unable to find the hard drive. Hard drive may be disconnected or may have failed. Contact Buffalo technical support for assistance. |
| E22 | Mounting of hard drive failed. Format the hard drive. After formatting, if the error still appears after rebooting, contact Buffalo technical support for assistance. |
| E23 | An error occurred, so the hard drive was removed from the RAID array. Contact Buffalo technical support for assistance. |
| E30 | The hard drive may be damaged. Contact Buffalo technical support for assistance. |

Power LED

| Status | Descriptions |
|---------------|--|
| Glowing Blue | The LinkStation is powered on. |
| Blinking blue | The LinkStation is starting up or shutting down. |
| Off | The LinkStation is off. |

Status LED (LS-QVL)

During normal operation, the power LED will glow blue.

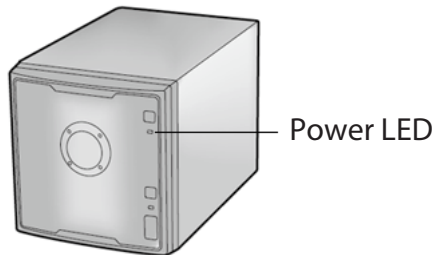

Flashing Red

The Power LED flashes red if the LinkStation experiences an error. The way it flashes indicates the type of error.

Note: If there is an error, open NAS Navigator2. It may have an error message displayed.

| Place of error code | Status |
|-------------------------|--|
| 10s place of error code | The LED illuminates for 1.0 second every 0.3 seconds. The number of flashes is the tens place of the error code. |
| 1s place of error code | The LED illuminates for 0.5 seconds every 0.3 seconds. The number of flashes is the ones place of the error code. |

| Error code | Descriptions |
|------------|--|
| E04 | The firmware is corrupted. Contact Buffalo technical support for assistance. |
| E10 | The LinkStation is running on the UPS battery due to a power outage. The system will now be shut down safely. Check that power is being supplied to the UPS, and if there are no problems, turn on the LinkStation. |
| E11 | An error occurred in the fan speed. Check that no foreign objects or dust are clogging the fan. If any foreign objects or dust are found, use a pair of tweezers, air duster, or other tool to remove them. If the error is displayed again, contact Buffalo technical support for assistance. |
| E12 | System temperature has exceeded the maximum safe value. Do not place objects in the area around the LinkStation. Also, move the LinkStation to a cooler location. |
| E13 | An error occurred in the RAID array. Operation will continue, but in degraded mode for RAID 1, 5 or 10. Replace the failed drive as soon as possible. After replacement, rebuild the RAID array after starting the LinkStation. |

| | |
|-----|--|
| E14 | The RAID array cannot be mounted. Run the RAID array disk check in the LinkStation's settings. |
| E15 | The bad sectors in the hard drive have reached a dangerous level. Replace the hard drive indicated by the red Status LED. |
| E16 | Unable to find the hard drive. Hard drive may be disconnected or may have failed. After shutting down, reinstall the hard drive. |
| E22 | Mounting of the hard drive failed. Format the hard drive. After formatting, if the error still appears after rebooting, replace the hard drive. If the error is displayed again, contact Buffalo technical support for assistance. |
| E23 | An error occurred, so the hard drive was removed from the RAID array. Replace the hard drive indicated by the red Status LED. |
| E30 | The hard drive may be damaged. Replace the hard drive indicated by the red Status LED. |

Power LED flashing amber

The Power LED flashes amber with information codes. The way it flashes indicates the message.

Note: If the Power LED is flashing amber, you can open NAS Navigator2. It will tell you the status of the LinkStation.

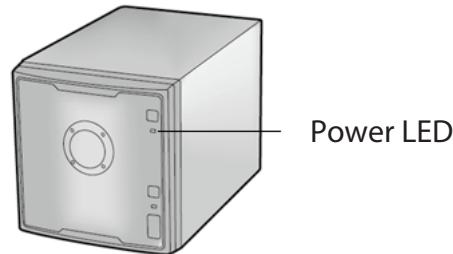

| Place | Status |
|-----------|--|
| 10s place | The LED illuminates for 1.0 second every 0.3 seconds. The number of flashes is the tens place of the information code. |
| 1s place | The LED illuminates for 0.5 seconds every 0.3 seconds. The number of flashes is the ones place of the information code. |

| Information code | Descriptions |
|------------------|---|
| I10 | System temperature has exceeded the maximum safe value. Move the LinkStation to a cooler location. Do not place objects in the area around the LinkStation. |
| I11 | The bad sectors in the hard drive may have reached a dangerous level. Replace the hard drive. |
| I12 | Operating in degraded mode. |
| I13 | Formatting the RAID array. |
| I14 | Checking the RAID array. |
| I15 | Examining the error status of the RAID array. Transfer speeds are slower during the examination process. |
| I16 | Creating the RAID array. |
| I17 | Resyncing the RAID array. Transfer speeds are slower during the resyncing process. |
| I18 | Rebuilding the RAID array. Transfer speeds are slower during the rebuilding process. |
| I19 | Writing 0s to the RAID array, erasing all data. |
| I20 | Formatting the hard drive. |

| | |
|-----|--|
| I21 | Checking the hard drive. |
| I22 | Erasing the data for the hard drive. |
| I25 | Updating the LinkStation firmware. Do not turn off the power during the updating process. |
| I26 | Initializing all settings in Settings. |
| I27 | Checking a USB hard drive. |
| I28 | Formatting a USB hard drive. |
| I32 | The RAID should be rebuilt or a drive should be formatted. Normally this is displayed after a hard drive has been replaced. Rebuild the RAID array or format the hard drive in Settings. |
| I46 | Data migration or conversion (RAID migration) is in progress. Do not turn off the LinkStation power. |
| I47 | Data migration or conversion (RAID migration) is in progress. Do not turn off the LinkStation power. |

Power LED glowing amber

When new firmware is available, the power LED will glow amber. Update the firmware as described on page 112.

Status LED 1~4

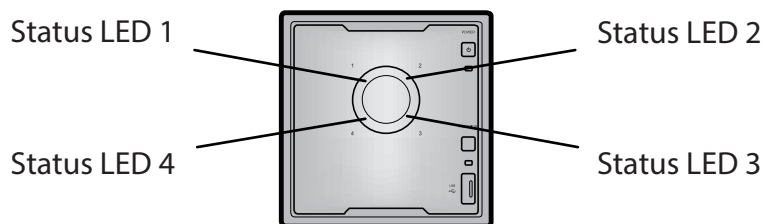

| Status | Descriptions |
|---------------|--|
| Glowing green | Normal state. This flashes during access. |
| Glowing red | An error occurred in the hard drive. Replace the hard drive indicated by the drive number that is lit red. |

Link/Act LED

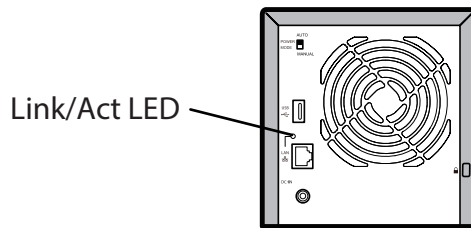

| Status | Descriptions |
|----------------|--------------|
| Glowing green | Linking. |
| Blinking green | Accessing. |

Function LED

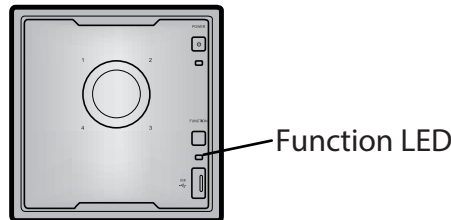

| Status | Descriptions |
|---------------|--|
| Glowing Blue | <p>When installing a USB device When the USB device is recognized, the Function LED is lit blue (for about 60 seconds). After the Function LED is lit blue, the USB device can be accessed.</p> <p>When removing a USB device To remove a USB device connected to the LinkStation, hold down the Function button for at least three seconds. The Function LED will turn blue, then turn off. Once it has turned off, it is safe to unplug the USB device.</p> <p>When starting DirectCopy After the USB device is connected, pressing the LinkStation Function button while the Function LED is glowing blue (about 60 seconds) copies the data from the USB device to the DirectCopy folder.</p> |
| Blinking Blue | <p>During execution of DirectCopy The LED flashes blue during the DirectCopy operation. Pressing the Function button again during the DirectCopy operation cancels it.</p> <p>Initialization of Settings To return the LinkStation's settings to their factory defaults, hold down the function button and press the power button, then release both. The function LED will blink blue for one minute. Press the function button again while the LED is blinking to initialize all settings.</p> |

Status LED (LS-XL)

When the AC adapter is connected, the power LED will glow blue.
The LED turns off when the power is turned off.
The LED will blink blue during startup and during the firmware update process.

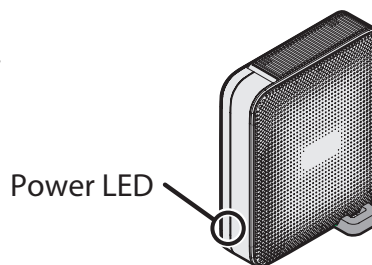

Notes:

- Do not disconnect the AC adapter while the LED is flashing or glowing. This could cause a device failure. The AC adapter can be disconnected when the LED is off.
- When updating the firmware, the power LED will blink as shown below.
A pattern of two 1-second (long) flashes followed by five 0.5-second (short) flashes is repeated.
- NAS Navigator2 displays the LinkStation error and information below.

| Error code | Descriptions |
|------------|---|
| E15 | The bad sectors in the hard drive have reached a dangerous level. Contact Buffalo technical support for assistance. |
| E22 | Mounting of hard drive failed. Format the hard drive. After formatting, if the error still appears after rebooting, contact Buffalo technical support for assistance. |
| E30 | The hard drive may be damaged. Contact Buffalo technical support for assistance. |

| Information code | Descriptions |
|------------------|---|
| I11 | The bad sectors in the hard drive may have reached a dangerous level. Replace the hard drive. |
| I20 | Formatting the hard drive. |
| I21 | Checking the hard drive. |
| I22 | Erasing the data for the hard drive. |
| I25 | Updating the LinkStation firmware. Do not turn off the power during the updating process. |
| I26 | Initializing all settings in Settings. |
| I52 | A new firmware version has been released. Update the firmware. |

Compliance Information

FCC Information

This equipment has been tested and found to comply with the limits for a Class B digital device, pursuant to Part 15 of the FCC Rules. These limits are designed to provide reasonable protection against harmful interference in a residential installation. This equipment generates, uses and can radiate radio frequency energy and, if not installed and used in accordance with the instructions, may cause harmful interference to radio communications. However, there is no guarantee that interference will not occur in a particular installation. If this equipment does cause harmful interference to radio or television reception, which can be determined by turning the equipment off and on, the user is encouraged to try to correct the interference by one or more of the following measures:

- Reorient or relocate the receiving antenna.
- Increase the separation between the equipment and receiver.
- Connect the equipment into an outlet on a circuit different from that to which the receiver is connected.
- Consult the dealer or an experienced radio/TV technician for help.

CE Mark Warning

This is a Class B product. In a domestic environment, this product may cause radio interference, in which case the user may be required to take adequate measures.

Environmental Information

- The equipment that you have purchased required the extraction and use of natural resources for its production.
- The equipment may contain hazardous substances that could impact health and the environment.
- In order to avoid the dissemination of those substances in our environment and to diminish the load on natural resources, we encourage you to use the appropriate take-back systems.
- The take-back systems will reuse or recycle most of the materials of your end of life equipment appropriately.
- The crossed-out wheeled bin symbol invites you to use those systems.
- If you need more information on the collection, reuse and recycling systems, please contact your local or regional waste administration.



| 기종별 | 사 용 자 안 내 문 |
|--------------------------|--|
| B 급 기기 (가정용 정보통신기기) | 이 기기는 가정용 (B 급) 전자파적합기기로서 주로 가정에서 사용하는 것을 목적으로 하며, 모든 지역에서 사용할 수 있습니다. |

Troubleshooting

Cannot Setup

The following section lists typical occurrences and causes when you cannot setup the LinkStation by using LinkNavigator or cannot use LinkStation even after finishing setup,

Occurrence: The message "Cannot find LinkStation", "No available LinkStation was found", or "Setup cannot be completed" is displayed.

Cause 1. An Ethernet cable is not connected.

Reconnect the AC Adapter and the Ethernet cable, and turn on the LinkStation again.

Cause 2. The firewall is enabled, or software running in the background is installed.

Disable the firewall or uninstall software which enables the firewall, and try to search for the LinkStation again.

Cause 3. Both wireless and Ethernet adapter are enabled.

Disable any adapters other than the Ethernet Adapter to connect to the LinkStation.

Cause 4. The defective Ethernet cable or the connection is not stable.

Change a port on the hub to connect or replace the Ethernet cable.

Cause 5. Your Ethernet board, card, or adapter is malfunctioning.

Replace a Ethernet board, card, or adapter.

Cause 6. The Ethernet board you are using or the transfer mode of the hub is not set.

Change the Ethernet board, or change the transfer mode to *10M half-duplex* or *100M half-duplex*.

Some Ethernet boards and hubs may not be connected to the network properly if the transfer mode is set to *Auto Negotiation*.

Cause 7. There is a network bridge.

If any network bridge which is not used, delete them.

Cause 8. You are searching from a different network.

You cannot search for the LinkStation over network segments. Connect the LinkStation to the same segment as the computer you use for search.

Cause 9. TCP/IP does not work properly.

Install the LAN adapter's driver again.

Cause 10. You are running Setup second time or more (it has been already run before).

After initializing the LinkStation, follow steps described in "LinkNavigator Setup" on page 5 to run Setup.

Note: When using Power Management with PC feature, you need to install NAS Navigator2 on all computers connected within the same network as the LinkStation

If a shared folder does not open on NAS Navigator2

The LinkStation may not be physically connected or may not be recognized properly. Reconnect the Ethernet cable and restart your computer and the LinkStation.

A shared folder does not open suddenly

If you use a shared folder on the LinkStation as a network drive, you may not be able to access to the LinkStation when the IP address or the workgroup has changed.

In such a case, follow the instructions in "Opening the Shared Folder" on page 25 and open the shared folder on the LinkStation by using NAS Navigator2.

Notes:

- On Mac OS, LinkStation is mounted as a drive icon on the desktop, or displayed in the sidebar on Finder.
- If the problem still persists after you tried the procedures described above on Mac OS, select *System-Storage-Disks-Check Disk*-[Delete any hidden, non-essential MacOS dedicated files] on Settings, and run Disk Check.

If a shared folder does not open even though NAS Navigator 2 recognizes the LinkStation

If power outage occurred or the AC adapter is unplugged while the LinkStation is on, the LinkStation's firmware may be corrupted and shared folders may not open (You can search for folders on NAS Navigator2 but they do not open).

Note: In such a case, the LinkStation name displayed on NAS Navigator2 or Settings on the LinkStation is displayed as LS-XHL-EM abc(abc stands for last 3 digits of the MAC address of the LinkStation) or LS-CHL-EM abc, LS-WXL-EM abc, LS-WSXL-EM abc,. In such a case, download the latest firmware from BUFFALO's website (www.buffalotech.com) and update it.

Data Backup

While using the LinkStation, you may lose your important data due to sudden accidents, hard disk failure, or accidental misoperation. It is important to back up your data to recover data or minimize losses in such a case.

Use Mass Storage class hard disk manufactured by Buffalo (such as TeraStation/LinkStation and a USB external hard disk) as Backup Targets.

GPL Information

The source code for Buffalo products that use GPL code is available at <http://opensource.buffalo.jp/>