

Veritas NetBackup™ 5330 Appliance Hardware Installation Guide

Last updated: 2018-09-21

Legal Notice

Copyright © 2018 Veritas Technologies LLC. All rights reserved.

Veritas, the Veritas logo, and NetBackup are trademarks or registered trademarks of Veritas Technologies LLC or its affiliates in the U.S. and other countries. Other names may be trademarks of their respective owners.

This product may contain third party software for which Veritas is required to provide attribution to the third party ("Third Party Programs"). Some of the Third Party Programs are available under open source or free software licenses. The License Agreement accompanying the Software does not alter any rights or obligations you may have under those open source or free software licenses. Refer to the third party legal notices document accompanying this Veritas product or available at:

<https://www.veritas.com/about/legal/license-agreements>

The product described in this document is distributed under licenses restricting its use, copying, distribution, and decompilation/reverse engineering. No part of this document may be reproduced in any form by any means without prior written authorization of Veritas Technologies LLC and its licensors, if any.

THE DOCUMENTATION IS PROVIDED "AS IS" AND ALL EXPRESS OR IMPLIED CONDITIONS, REPRESENTATIONS AND WARRANTIES, INCLUDING ANY IMPLIED WARRANTY OF MERCHANTABILITY, FITNESS FOR A PARTICULAR PURPOSE OR NON-INFRINGEMENT, ARE DISCLAIMED, EXCEPT TO THE EXTENT THAT SUCH DISCLAIMERS ARE HELD TO BE LEGALLY INVALID. VERITAS TECHNOLOGIES LLC SHALL NOT BE LIABLE FOR INCIDENTAL OR CONSEQUENTIAL DAMAGES IN CONNECTION WITH THE FURNISHING, PERFORMANCE, OR USE OF THIS DOCUMENTATION. THE INFORMATION CONTAINED IN THIS DOCUMENTATION IS SUBJECT TO CHANGE WITHOUT NOTICE.

The Licensed Software and Documentation are deemed to be commercial computer software as defined in FAR 12.212 and subject to restricted rights as defined in FAR Section 52.227-19 "Commercial Computer Software - Restricted Rights" and DFARS 227.7202, et seq. "Commercial Computer Software and Commercial Computer Software Documentation," as applicable, and any successor regulations, whether delivered by Veritas as on premises or hosted services. Any use, modification, reproduction release, performance, display or disclosure of the Licensed Software and Documentation by the U.S. Government shall be solely in accordance with the terms of this Agreement.

Veritas Technologies LLC
500 E Middlefield Road
Mountain View, CA 94043

<http://www.veritas.com>

Technical Support

Technical Support maintains support centers globally. All support services will be delivered in accordance with your support agreement and the then-current enterprise technical support policies. For information about our support offerings and how to contact Technical Support, visit our website:

<https://www.veritas.com/support>

You can manage your Veritas account information at the following URL:

<https://my.veritas.com>

If you have questions regarding an existing support agreement, please email the support agreement administration team for your region as follows:

Worldwide (except Japan)

CustomerCare@veritas.com

Japan

CustomerCare_Japan@veritas.com

Documentation

The latest documentation is available on the Veritas website:

<https://sort.veritas.com/documents>

Documentation feedback

Your feedback is important to us. Suggest improvements or report errors or omissions to the documentation. Include the document title, document version, chapter title, and section title of the text on which you are reporting. Send feedback to:

APPL.docs@veritas.com

You can also see documentation information or ask a question on the Veritas community site:

<http://www.veritas.com/community/>

Veritas Services and Operations Readiness Tools (SORT)

Veritas Services and Operations Readiness Tools (SORT) is a website that provides information and tools to automate and simplify certain time-consuming administrative tasks. Depending on the product, SORT helps you prepare for installations and upgrades, identify risks in your datacenters, and improve operational efficiency. To see what services and tools SORT provides for your product, see the data sheet:

https://sort.veritas.com/data/support/SORT_Data_Sheet.pdf

Contents

Chapter 1	Hardware overview	6
	NetBackup 5330 compute node overview	6
	NetBackup 5330 compute node PCIe card configurations	8
	NetBackup 5330 compute node Ethernet port configurations	9
	NetBackup 5330 storage shelves and disk drives	10
	NetBackup 5330 cables and connectors	12
	Serial number locations	13
	Required reading	15
	Understanding hardware scenarios	15
	Understanding the NetBackup 5330 hardware installation sequence	16
	About IPMI configuration	20
	Other NetBackup 5330 product documentation	22
Chapter 2	Pre-installation requirements	24
	Package contents for NetBackup 5330 hardware	24
	Customer-provided items for a NetBackup 5330 hardware installation	25
	Unpacking a primary shelf or an expansion shelf	26
	Unpacking a compute node	29
	Determining rack locations	30
	Determining SAS2 cable length	32
	Prerequisites for IPMI configuration on a 52xx and 5330	33
Chapter 3	Hardware installation procedures	35
	Hardware installation scenarios	36
	Installing a primary shelf or an expansion shelf	36
	Installing disk drives into a primary shelf or an expansion shelf	44
	Installing the compute node	47
	Installing the SFPs into the Fibre Channel (FC) ports	50
	Connecting a NetBackup 5330 compute node to a primary shelf	52
	Connecting one expansion shelf to a primary shelf	54
	Performing a soft shutdown before adding a new expansion shelf	57

	Connecting new expansion shelves to existing expansion shelves and an existing primary shelf	58
	Connecting the power cords to the hardware	71
	Turning on the hardware and verifying operation	72
	Configuring the IPMI port from the NetBackup Appliance Shell Menu	80
	Accessing and using the Veritas Remote Management interface	82
Chapter 4	Hardware installation procedures for a NetBackup 5330 high availability configuration	85
	Hardware installation scenarios for a NetBackup 5330 high availability configuration	85
	Installation procedures for a new deployment of a high availability configuration	86
	Installation procedures for converting existing systems to a high availability configuration	87
	Connecting the partner node to the Primary Storage Shelf	87
	Connecting two nodes for HA communication	89
	Verifying the hardware installation of a high availability configuration	90
Appendix A	Adding the disk space of a new Expansion Storage Shelf	92
	Prerequisites for adding the disk space of new expansion shelves	92
	Adding the disk space of an Expansion Storage Shelf from the NetBackup Appliance Web Console	96
	Adding the disk space of an Expansion Storage Shelf from the NetBackup Appliance Shell Menu	98
Index		100

Hardware overview

This chapter includes the following topics:

- [NetBackup 5330 compute node overview](#)
- [NetBackup 5330 compute node PCIe card configurations](#)
- [NetBackup 5330 compute node Ethernet port configurations](#)
- [NetBackup 5330 storage shelves and disk drives](#)
- [NetBackup 5330 cables and connectors](#)
- [Serial number locations](#)
- [Required reading](#)
- [Understanding hardware scenarios](#)
- [Understanding the NetBackup 5330 hardware installation sequence](#)
- [About IPMI configuration](#)
- [Other NetBackup 5330 product documentation](#)

NetBackup 5330 compute node overview

The front panel of the compute node contains 12 disk drive slots. The slots are numbered from zero (lower left slot) to 11 (upper right slot).

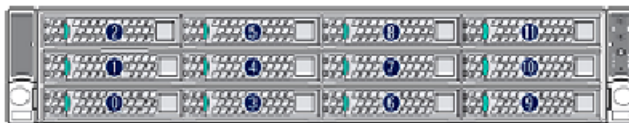

The NetBackup 5330 compute node contains eight disk drives. Slots 0 through 5 contain mirrored volumes for the operating system and system logs, and two hot-spares. Slots 6 and 7 are currently unconfigured and reserved for future use. Slots 8 through 11 contain blank carriers to maintain airflow.

The rear panel of the compute node contains embedded ports and PCIe card slots.

The embedded ports include the following (with numbers associating the ports to the items in the bulleted list):

- Four 1Gb Ethernet ports (Item 1)
- One Video Graphics Array (VGA) port (Item 2)
- One serial port (for Veritas Technical Support use only) (Item 3)
- Three USB ports (Item 4)
- One Intelligent Platform Management Interface (IPMI) port for remote management (Item 5)
- Two 10Gb Ethernet ports (Item 6)

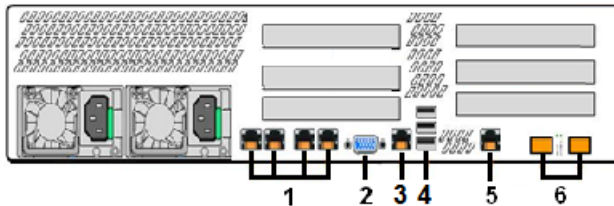

Two power supply modules are installed in the lower left corner of the rear panel. One of the power supplies must be operational at all times. Turn off the device if both power supplies do not work properly.

Input power for the compute node can be 120VAC or 220VAC.

You can deploy a NetBackup 5330 high availability (HA) configuration through either of the following methods:

- New deployment for an HA configuration
- Converting existing systems to an HA configuration

See [“Hardware installation scenarios for a NetBackup 5330 high availability configuration”](#) on page 85.

For the detailed information about HA configuration, refer to *NetBackup Appliance High Availability Reference Guide*.

NetBackup 5330 compute node Ethernet port configurations

All NetBackup 5330 Appliances include the following ports, which are embedded along the base of the rear panel:

- 1-GbE ports: eth0, eth1, eth2, and eth3
- 10-GbE ports: eth4 and eth5

By default, NIC1 (eth0) is factory set to IP address 192.168.229.233. This private network address is reserved to provide a direct connection from a laptop to perform the initial configuration. NIC1 (eth0) is typically not connected to your network environment.

Once the initial configuration has been completed, you can connect NIC1 (eth0) to an administrative network that does not provide any backup data transfer.

The rear panel of the NetBackup 5330 compute node contains six PCIe slots, which are populated according to five different supported configurations. The PCIe slot configuration determines the total number of Ethernet ports that are available.

The following picture shows the location of all Ethernet ports on the rear panel of the compute node, including the PCIe card-based ports.

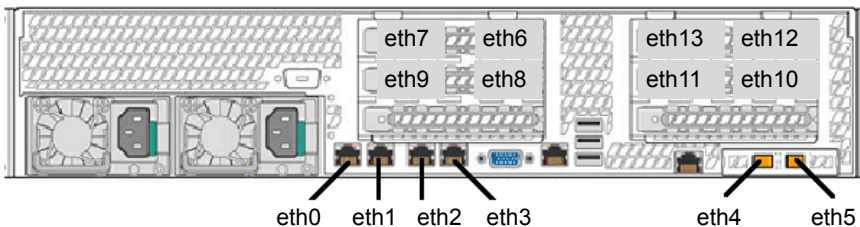

For a NetBackup 5330 high availability (HA) configuration, Veritas requires that you reserve the NIC3/eth2 and NIC4/eth3 ports to connect the two nodes. Do not connect these ports to a network.

The 10-Gb Ethernet network interface cards that are installed in the PCIe slots contain additional ports. The number of ports depends on the PCIe slot configuration of your compute node.

[Table 1-2](#) shows the available Ethernet ports for each PCIe slot configuration.

Table 1-2 NetBackup 5330 compute node PCIe Ethernet port configurations

Option	Slot and Ethernet port numbers
A (four 10-Gb Ethernet cards)	<ul style="list-style-type: none"> ■ Slot 2: eth8 (right), eth9 (left) ■ Slot 3: eth6 (right), eth7 (left) ■ Slot 5: eth10 (right), eth11 (left) ■ Slot 6: eth12 (right), eth13 (left)
B (three 10-Gb Ethernet cards)	<ul style="list-style-type: none"> ■ Slot 2: eth8 (right), eth9 (left) ■ Slot 3: eth6 (right), eth7 (left) ■ Slot 5: eth10 (right), eth11 (left)
C (two 10-Gb Ethernet cards)	<ul style="list-style-type: none"> ■ Slot 2: eth8 (right), eth9 (left) ■ Slot 3: eth6 (right), eth7 (left)
D (one 10-Gb Ethernet card)	<ul style="list-style-type: none"> ■ Slot 3: eth6 (right), eth7 (left)
E (zero 10-Gb Ethernet cards)	N/A

For information about 5340 PCIe based I/O configurations, refer to the *NetBackup 5340 Appliance Product Description Guide*.

NetBackup 5330 storage shelves and disk drives

The NetBackup 5330 compute node supports two types of external disk drive storage as follows:

- Primary Storage Shelf - required
- Expansion Storage Shelf - optional

Note: A 220VAC power supply is required for the Primary Storage Shelf and the Expansion Storage Shelf.

Each NetBackup 5330 compute node requires one Primary Storage Shelf. You can install up to five expansion shelves to provide additional storage capacity. Refer to the *NetBackup 5330 Appliance Product Description* for supported storage capacities at the following website.

[NetBackup Appliance documentation](#)

Due to weight considerations, the storage shelves should be installed at or as close to the bottom of the rack as is possible. When the storage shelves and the compute node have been installed, the Fibre Channel (FC), SAS, and power cables are connected between the units. The FC cables connect the compute node to the

Primary Storage Shelf. The SAS2 cables connect a Primary Storage Shelf to an Expansion Storage Shelf. When all connections are completed, turn on the storage shelves and the compute node to initialize and synchronize the units.

Note: If more than one Expansion Storage Shelf is used, turn on the shelves furthest from the primary shelf first. Then turn on the expansion shelf that is connected to the primary shelf. Next, turn on the primary shelf. Finally, turn on the compute node.

To help reduce the weight of the units during installation, the disk drives are not factory-installed into the storage shelves. The disks are shipped in separate packages, with ten disks in each package. Six packages are required to fully populate each storage shelf. Each individual disk is wrapped in an anti-static bag. Disks must be installed into the storage shelves by opening the storage shelf drawers and inserting each disk into a slot. Best practices recommend that you start at the bottom drawer and move up. Insert the disks into the storage shelves one drawer at a time.

The drawers for each shelf are numbered from 1 to 5.



The disk slots in each drawer are numbered from 1 to 12 starting on the left front corner.

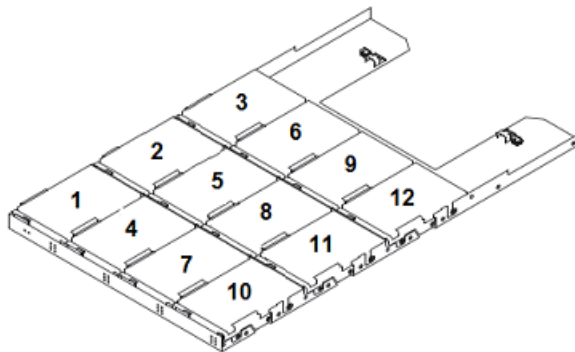

Three LEDs on the front of each drawer provide information about each column of three slots.



See “Installing disk drives into a primary shelf or an expansion shelf ” on page 44.

NetBackup 5330 cables and connectors

The following types of cables and connectors are provided:

- Power cords that connect each device to AC power distribution units (PDUs) in the rack.

Note: A 220VAC power supply is required for the Primary Storage Shelf and the Expansion Storage Shelf. The NetBackup 5330 compute node can accommodate a 120VAC or 220VAC input power supply.

The following list provides the voltages of the power connectors for the compute node and storage shelves. The green pin denotes the ground.

The compute node uses the following outlet (C-13) and inlet (C-14) connectors.



These connectors are rated for the following:

- Voltage: 125 - 250 VAC
- Current: 15A

The storage shelves use the following outlet (C-19) and inlet (C-14) connectors.

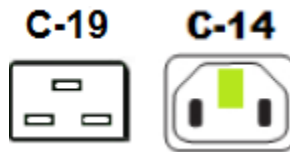

These connectors are rated for the following:

- Voltage and current: 200 - 240 VAC, 15A
- The storage shelves only operate at 200 - 240 VAC.
- Ethernet cables that connect the two nodes in a high availability (HA) configuration.
- Fibre Channel (FC) cables that connect the compute node to the Primary Storage Shelf.
- SA2S cables that connect the Primary Storage Shelf to the Expansion Storage Shelf and that connect Expansion Shelves to each other.
- Small Form-factor Pluggable (SFP) modules for FC and 10GbE ports. SFPs are factory-installed in the cards in the PCIe risers. Two SFPs are provided for use with the 10GbE ports on the rear panel of the compute node.

You may need to obtain the following types of cables depending on the I/O configuration of your compute node:

- Ethernet cables between the 1Gb Ethernet and the 10Gb Ethernet ports on the compute node rear panel and your network.
- Ethernet cable between the Intelligent Program Management Interface (IPMI) port on the compute node rear panel and your network for remote access.
- Additional FC cables between the 8Gb FC HBA ports on the compute node rear panel and your network for connection to tape or other devices.

Serial number locations

A vertical bar on the rear panel of the compute node contains the serial number.



The serial number of the storage shelves is located in two places.

- The front of the shelf contains the serial number, on the lower right-hand corner.



- The top of the storage shelf includes the serial number label, near the rear of the unit. The number is outlined in red.



Required reading

Read the following sections before proceeding. Information in these sections helps you determine the hardware you have already installed and any additional hardware that you need to install.

- See [“Understanding hardware scenarios”](#) on page 15.
- See [“Performing a soft shutdown before adding a new expansion shelf”](#) on page 57.
- See [“NetBackup 5330 cables and connectors”](#) on page 12.

Understanding hardware scenarios

Support of the 6TB disk drives in the storage shelves started with the NetBackup 5330 Appliance Release 2.7.1. Previous releases supported only the 3TB storage disk drives. You cannot mix 3TB and 6TB drives in a single storage shelf. However, you can use storage shelves with the 3TB drives or the 6TB drives in an appliance system.

The support of the high availability (HA) solution begins with the NetBackup 5330 Appliance Release 3.1. The solution requires two NetBackup 5330 nodes, a Primary Shelf, and an optional maximum of five Expansion Shelves.

The following list describes the instructions that this guide provides.

- Installing and connecting a compute node and a primary shelf.
- Installing and connecting a partner node to an existing primary shelf and an existing compute node to create an HA environment.
- Installing and connecting an expansion shelf to a primary shelf and a compute node.
- Installing additional expansion shelves and connecting them to an existing expansion shelf, primary shelf, and compute node.

Caution: When you add expansion shelves to an operational appliance, best practices recommend that you turn off the compute node, the primary shelf, and expansion shelves.

Note: Before you add expansion shelves to systems that currently use versions 2.6.1.2 and earlier, you must upgrade to NetBackup Appliance Release 2.7.1, or later. Refer to the *NetBackup Appliance Upgrade Guide for Release 2.7.x - RedHat Enterprise Linux (RHEL) Operating System*, which is located at the following website. [NetBackup Appliance documentation](#)

Before you add the partner node to complete the NetBackup 5330 HA configuration, upgrade your system to NetBackup Appliance software version 3.1, or later. Refer to the *NetBackup 52xx and 5330 Appliance Upgrade Guide*, which is located at the following website. [NetBackup Appliance documentation](#)

Understanding the NetBackup 5330 hardware installation sequence

For easier installation and cabling between units, the installation of the compute node and the storage shelves must be performed in a specific sequence.

The recommended installation sequence is as follows:

- Install the storage shelves
 - Expansion Storage Shelves - install in the lowest available 4RU rack spaces.
 - Primary Storage Shelf - install in the next available 4RU rack space on top of the Expansion Storage Shelves.
The storage shelves are the heaviest units. They are physically similar and both use the same rail type for mounting. For easier installation, do not install the disk drives until after the units are installed into the rack.
 - The estimated time to install one storage shelf is about 2.5 hours.
- Install the node
 - Install a single compute node in the next available 2RU rack space on top of the Primary Storage Shelf.
 - The estimated time to install one compute node is about 1.25 hours.
 - For a high availability (HA) configuration, install a partner node in the next available 2RU rack space on top of the Primary Storage Shelf.

The following sections describe the installation steps and include links to the specific procedures.

See [Table 1-3](#) on page 17.

See [Table 1-4](#) on page 18.

This section describes the installation steps for a NetBackup 5330 HA configuration and includes links to specific procedures. You can also refer to the following chapter:

See [“Hardware installation scenarios for a NetBackup 5330 high availability configuration”](#) on page 85.

Table 1-3 Storage shelf and compute node hardware installation sequence

Step	Description
1	Unpack the storage shelves. See “Unpacking a primary shelf or an expansion shelf” on page 26.
2	Unpack the compute node. See “Unpacking a compute node” on page 29.
3	Determine the rack locations for the storage shelves and the compute node. See “Determining rack locations ” on page 30.
4	Mount the storage shelf rails in the rack and install the storage shelves. Install all expansion shelves below the primary shelf. The following topic can be used for both the expansion shelf and the primary shelf. See “Installing a primary shelf or an expansion shelf” on page 36.
5	Install the disk drives into each storage shelf. Be sure to install only 3TB or 6TB disks into one shelf. You cannot put both types of disks into a single shelf. See “Installing disk drives into a primary shelf or an expansion shelf ” on page 44.
6	Mount the compute node rails in the rack and install the compute node. See “Installing the compute node” on page 47.
7	Connect the four Fibre Channel cables between the Primary Storage Shelf and the compute node. See “Connecting a NetBackup 5330 compute node to a primary shelf” on page 52.
8	If you want to connect one expansion shelf to a primary shelf: Connect four SAS2 cables between the expansion shelf and the primary shelf. See “Connecting one expansion shelf to a primary shelf” on page 54.

Table 1-3 Storage shelf and compute node hardware installation sequence
(continued)

Step	Description
9	<p>If you want to connect one or more expansion shelves to existing expansion shelves: Connect two new SAS2 cables between the two expansion shelves. Then, disconnect one end of two SAS2 cables from the existing expansion shelf and connect them to a new expansion shelf.</p> <p>See “Connecting new expansion shelves to existing expansion shelves and an existing primary shelf” on page 58.</p>
10	<p>Connect the Power Distribution Unit (PDU) cords between the compute node and the power distribution outlets in the rack.</p> <p>See “Connecting the power cords to the hardware” on page 71.</p>
11	<p>Connect the Power Distribution Unit (PDU) cords between each storage shelf and the power distribution outlets in the rack. The storage shelves require 220 VAC.</p> <p>See “Connecting the power cords to the hardware” on page 71.</p>
12	<p>Turn on power to the storage shelves and the compute node. Be sure to use the correct sequence.</p> <p>See “Turning on the hardware and verifying operation” on page 72.</p>
13	<p>Configure the IPMI port and the NIC1 (eth0) interface.</p> <p>See “Configuring the IPMI port from the NetBackup Appliance Shell Menu” on page 80.</p>

Table 1-4 Storage shelf and compute node hardware installation sequence for a NetBackup 5330 high availability configuration

Step	Description
1	<p>Unpack the storage shelves.</p> <p>See “Unpacking a primary shelf or an expansion shelf” on page 26.</p>
2	<p>Unpack the compute nodes.</p> <p>See “Unpacking a compute node” on page 29.</p>
3	<p>Determine the rack locations for the storage shelves and the compute nodes.</p> <p>See “Determining rack locations” on page 30.</p>

Table 1-4 Storage shelf and compute node hardware installation sequence for a NetBackup 5330 high availability configuration (*continued*)

Step	Description
4	<p>Mount the storage shelf rails in the rack and install the storage shelves.</p> <p>Install all expansion shelves below the primary shelf.</p> <p>The following topic can be used for both the expansion shelf and the primary shelf. See "Installing a primary shelf or an expansion shelf" on page 36.</p>
5	<p>Install the disk drives into each storage shelf. Be sure to install only 3TB or 6TB disks into one shelf. You cannot put both types of disks into a single shelf.</p> <p>See "Installing disk drives into a primary shelf or an expansion shelf" on page 44.</p>
6	<p>Mount the compute node rails in the rack and install the nodes as follows:</p> <ul style="list-style-type: none"> ■ For a new deployment of the HA solution, install one of the nodes on top of the Primary Storage Shelf. Install the other node on top of the first node. ■ For converting existing systems to an HA configuration, install the partner node on top of the existing node. <p>See "Installing the compute node" on page 47.</p>
7	<p>Connect the four fibre channel cables between the Primary Storage Shelf and the compute node.</p> <p>See "Connecting a NetBackup 5330 compute node to a primary shelf" on page 52.</p>
8	<p>Connect the four Fibre Channel cables between the Primary Storage Shelf and the partner node.</p> <p>See "Connecting the partner node to the Primary Storage Shelf" on page 87.</p>
9	<p>Connect the two Ethernet cables between the two nodes.</p> <p>See "Connecting two nodes for HA communication" on page 89.</p>
10	<p>Verify the hardware installation of the high availability configuration.</p> <p>See "Verifying the hardware installation of a high availability configuration" on page 90.</p>
11	<p>If you want to connect one expansion shelf to a primary shelf: Connect four SAS cables between the expansion shelf and the primary shelf.</p> <p>See "Connecting one expansion shelf to a primary shelf" on page 54.</p>

Table 1-4 Storage shelf and compute node hardware installation sequence for a NetBackup 5330 high availability configuration (*continued*)

Step	Description
12	<p>If you want to connect one or more expansion shelves to existing expansion shelves: Connect two new SAS cables between the two expansion shelves. Then, disconnect one end of two SAS cables from the existing expansion shelf and connect them to a new expansion shelf.</p> <p>See “Connecting new expansion shelves to existing expansion shelves and an existing primary shelf” on page 58.</p>
13	<p>Connect the Power Distribution Unit (PDU) cords between the nodes and the power distribution outlets in the rack.</p> <p>See “Connecting the power cords to the hardware” on page 71.</p>
14	<p>Connect the Power Distribution Unit (PDU) cords between each storage shelf and the power distribution outlets in the rack. The storage shelves require 220 VAC.</p> <p>See “Connecting the power cords to the hardware” on page 71.</p>
15	<p>Turn on power to the storage shelves and the nodes. Be sure to use the correct sequence.</p> <p>See “Turning on the hardware and verifying operation” on page 72.</p>
16	<p>Configure the IPMI port and the NIC1 (eth0) interface on the two nodes.</p> <p>See “Configuring the IPMI port from the NetBackup Appliance Shell Menu” on page 80.</p>

About IPMI configuration

The Intelligent Platform Management Interface (or IPMI) provides management and monitoring capabilities independently of the host system's CPU, firmware, and operating system. You can configure the IPMI sub-system for your appliances. You can use the remote management port, located on the rear panel of the appliance, to connect to the IPMI sub-system.

The following figure shows the remote management port (or the IPMI port) on the rear panel of a NetBackup 5330 appliance:



The IPMI is beneficial after an unexpected power outage shuts down the connected system. In case the appliance is not accessible after the power is restored, you can use a laptop or desktop computer to access the appliance remotely by using a network connection to the hardware rather than to an operating system or login shell. This enables you to control and monitor the appliance even if it is powered down, unresponsive, or without any operating system.

The following diagram illustrates how IPMI works:

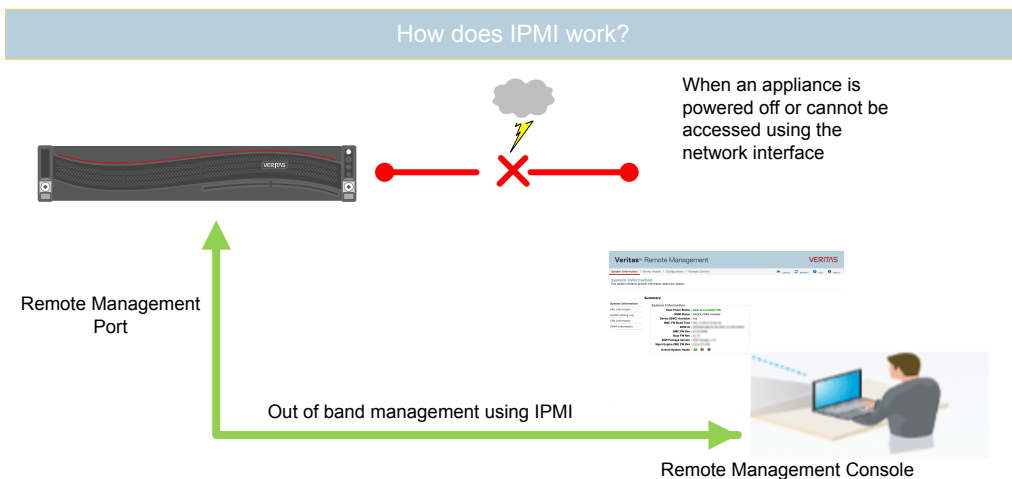

The following are some of the main uses of IPMI:

- Manage an appliance that is powered off or unresponsive. Using the IPMI, you can power on, power off, or restart the appliance from a remote location.
- Provide out-of-band management and help manage situations where local physical access to the appliance is not possible or preferred like branch offices and remote data centers.

- Access the NetBackup Appliance Shell Menu remotely using IPMI if regular network interface is not possible.

Note: Only the NetBackup Appliance Shell Menu can be accessed by using the IPMI interface. The NetBackup Appliance Web Console cannot be accessed by using the IPMI interface.

- Reimage the appliance from the IPMI interface by using ISO redirection.
- Monitor hardware health of the appliance from a remote location.
- Avoid messy cabling and hardware like keyboard, monitor, and mouse (KVM) solutions to access the appliance.

See [“Configuring the IPMI port from the NetBackup Appliance Shell Menu”](#) on page 80.

See [“Accessing and using the Veritas Remote Management interface”](#) on page 82.

Other NetBackup 5330 product documentation

Documents for the NetBackup 5330 compute node and storage shelves are listed in the following table.

Table 1-5 NetBackup 5330 Appliance documentation

Document	Description
<i>NetBackup 5330 Appliance Product Description Guide</i>	Describes all aspects of the NetBackup 5330 compute node and the attached storage shelves.
<i>NetBackup 5330 Initial Configuration Guide</i>	Provides guidelines and checklists for the initial configuration of the compute node. Describes the initial configuration through the NetBackup Appliance Web Console.

The following documents are also available.

- *NetBackup Appliance Safety and Maintenance Guide*
- *NetBackup Appliance Administrator's Guide*
- *NetBackup Appliance Command Reference Guide*
- *NetBackup Appliance Release Notes*
- *NetBackup Appliance High Availability Reference Guide*

You can find hardware and software documentation for the NetBackup 5330 appliance at the following URL.

[NetBackup Appliance documentation](#)

Pre-installation requirements

This chapter includes the following topics:

- [Package contents for NetBackup 5330 hardware](#)
- [Customer-provided items for a NetBackup 5330 hardware installation](#)
- [Unpacking a primary shelf or an expansion shelf](#)
- [Unpacking a compute node](#)
- [Determining rack locations](#)
- [Determining SAS2 cable length](#)
- [Prerequisites for IPMI configuration on a 52xx and 5330](#)

Package contents for NetBackup 5330 hardware

Each node and the storage shelves are shipped in separate containers. Each container includes other boxes and contents. The disk drives for the storage shelves are shipped in additional boxes.

[Table 2-1](#) describes the contents of the shipping containers for a NetBackup 5330 appliance system.

Table 2-1 NetBackup 5330 compute node container contents

Container	Contents
Compute node	<ul style="list-style-type: none"> ■ Cable connections poster ■ Deployment guide ■ Safety manual ■ Left and right rack rails ■ Rack mounting template ■ Compute node ■ Bezel ■ Four Fibre Channel cables ■ Four SFPs ■ Two Ethernet cables for the high availability configuration ■ Two power cords ■ Cable straps ■ Envelope containing the following: <ul style="list-style-type: none"> ■ USB stick(s) with factory reset files. ■ Warranty and license information
Primary Storage Shelf	<ul style="list-style-type: none"> ■ Left and right rack rails with mounting hardware ■ Rack rail mounting template ■ Bezel ■ Primary Storage Shelf ■ Two SAS2 cables ■ Two power cords
Expansion Storage Shelf	<ul style="list-style-type: none"> ■ Left and right rack rails with mounting hardware ■ Rack rail mounting template ■ Bezel ■ Expansion Storage Shelf ■ Two SAS2 cables ■ Two power cords

Customer-provided items for a NetBackup 5330 hardware installation

The following describes the necessary personnel and equipment that are needed at the installation site:

- At least three people or a mechanical lift to move the storage shelves.
- A keyboard and a monitor to connect to the compute node.

- Ethernet and Fibre Channel (FC) cables to connect the compute node to your corporate network.
- A 19-inch rack with dual Power Distribution Units (PDUs).
 - 220VAC power supply for the Primary Storage Shelf and the Expansion Storage Shelf
 - 120VAC or 220VAC power supply for the nodes

Unpacking a primary shelf or an expansion shelf

Each storage shelf is shipped in a separate container. Veritas recommends that you have a table nearby where you can safely place the contents of the container.

Due to weight considerations the storage shelves ship without any disk drives installed.

Warning: Each empty storage shelf weighs 80kg (176 lbs). To help prevent personal injury, three persons or a mechanical lift are required to unpack and to move a storage shelf.

To unpack a storage shelf

- 1 DO NOT slice open the top of the cardboard container.



- 2 Remove the white, plastic inserts from the sides of the container.



- 3 Lift up the top of the container.



- 4 Lower and flatten the sides of the container so that you can access the storage shelf.

- 5 Remove the front and the rear rack templates from the shipping container. You will use these templates to locate holes in the rack where screws and pins are placed.

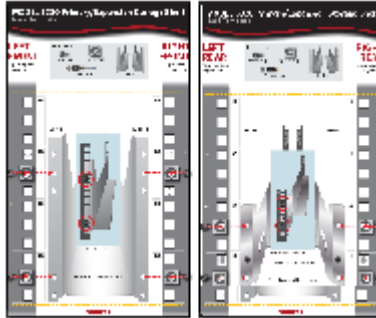

Note: The templates may be enclosed in the Open Me First box.

- 6 Remove any foam, air bags, or other cushioning materials.
- 7 Remove the extension bracket and screws.

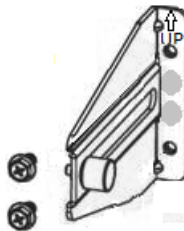

- 8 Remove the bezel and set it aside.
- 9 Remove the mounting rails and set them aside.
- 10 Remove the four metal handles and set them aside.
- 11 Remove any fasteners, power cords, and cables and set them aside.
- 12 Remove the storage shelf from the shipping container.

Unpacking a compute node

Each node is shipped in a separate container from the storage shelves. Both types of devices are shrink-wrapped together. Veritas recommends that you have a table nearby where you can safely place the contents of the containers.

Warning: The nodes weigh 30kg (66 lbs) each. Be sure that you have adequate personnel or a mechanical lift to move the node.

To unpack the node

- 1 Open the cardboard container.



- 2 Remove the Open Me First box and the poster at the top of the container.

- 3 Remove the rail template from the Open Me First box.

The template shows where the left-hand rail and the right-hand rail fit into the front and the rear of the rack.

Fold the template at the yellow horizontal lines. There are two lines; one in the middle and one at the bottom of the template. Then you can align the rack holes in the template to the rack holes in your equipment rack.

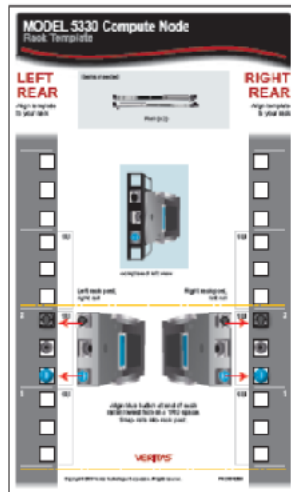

- 4 Remove the bezel.
- 5 Remove the mounting rails.
- 6 Remove the accessory box that contains the fasteners, the power cords, and other contents.
- 7 Remove the node from the shipping container.

Determining rack locations

The height of the node and the storage shelves require a different rack unit (RU) space. The node needs 2RU rack space and each storage shelf needs 4RU.

To help you identify RU spacing, many rack manufacturers typically use a system of lines and sequential numbers starting at the bottom of the rack. The front and the rear of the rack are marked the same to ensure that the rails are installed straight and level.

One RU has three holes. The holes for one RU are typically marked with a line below the bottom hole and another line above the top hole. A number at the center hole identifies where the RU appears in the rack.

Figure 2-1 shows the markings as described.

Figure 2-1 Rack RU space markings



Use the node and the storage shelf Rack Templates to determine the mounting locations.

Best practices for hardware installation are as follows:

- When you install the rails, be sure to use complete RUs. Do not use holes from different RUs.
- The storage shelves are much heavier than the node and should be installed as close to the bottom of the rack as possible.
- The node should always be installed on top of the storage shelves.
- Do not leave any spaces between the compute node and a storage shelf, or between two storage shelves.
- When you add expansion shelves to an operational appliance system, turn off the node(s), the primary shelf, and existing expansion shelves.

To determine rack locations for the hardware

- 1 Determine the total number of rack units (RUs) that you need as follows:

- A compute node (2RU) and a Primary Storage Shelf (4RU) require a total of six RUs.
 - A compute node (2RU), a Primary Storage Shelf (4RU), and one Expansion Storage Shelf (4RU) require a total of ten RUs.
 - A compute node (2RU), a Primary Storage Shelf (4RU), and five Expansion Storage Shelves (4RU each) require a total of 26 RUs.
 - An HA configuration with a compute node (2RU), a partner node (2U), a Primary Shelf (4RU), and one Expansion Shelf (4RU) requires 12 RUs.
 - An HA configuration with a compute node (2RU), a partner node (2U), a Primary Shelf (4RU), and five Expansion Shelves (4RU each) requires 28 RUs.
- 2 Use the Rack Templates that are provided with the hardware to determine RU locations.

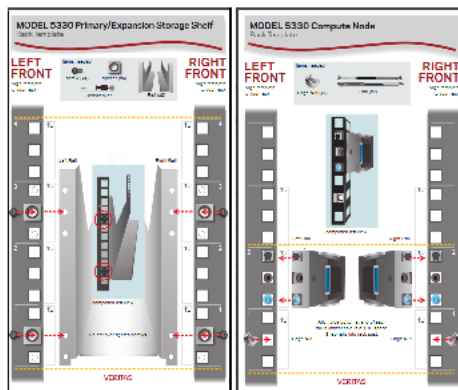

- 3 Record the rack positions to help you locate them easily when mounting the hardware.
- See [“Installing a primary shelf or an expansion shelf”](#) on page 36.
- See [“Installing the compute node”](#) on page 47.

Determining SAS2 cable length

Before you add any expansion shelves, be sure to verify that the location of the shelf accommodates the length of the SAS2 cables. Each SAS2 cable is 1 meter (3.28 feet) long. A 2 meter (6.56 feet) SAS2 cable is available separately. Contact Veritas Technical Support, if needed.

To determine adequate cable length

- 1 Locate a 4U space as close to the primary shelf as possible.
- 2 Verify that the SAS2 cables that ship with the expansion shelf easily connect to the primary shelf.

Best practices recommend that you physically hold the SAS2 cables between the primary shelf and the intended expansion shelf location. Visually confirm that the cables are long enough.

Prerequisites for IPMI configuration on a 52xx and 5330

Verify the following configuration prerequisites:

- Ensure that you have a dedicated network infrastructure. The remote management port is 1 Gbps for NetBackup 5330 appliances.
- The remote management port auto-negotiates its link speed to 1 Gbps.

Note: If the IPMI port is connected to a managed switch port, it is recommended that you configure the switch port to auto-negotiation.

- If a firewall exists between the appliance and the remote devices that manage an appliance (like a laptop computer), open the following ports:

22	SSH
80	HTTP
162	SNMP
443	HTTPS
623	KVM
5120	RMM ISO/CD
5123	RMM floppy
5124	CD
5127	SSL
5900	KVM CLI

7578 RMM CLI

7582 SSL

Note: If you have a private internal network, remember to configure the settings accordingly in your network address translation (NAT).

- The remote management port must be configured as a DHCP or static address. See [“About IPMI configuration”](#) on page 20.

Hardware installation procedures

This chapter includes the following topics:

- [Hardware installation scenarios](#)
- [Installing a primary shelf or an expansion shelf](#)
- [Installing disk drives into a primary shelf or an expansion shelf](#)
- [Installing the compute node](#)
- [Installing the SFPs into the Fibre Channel \(FC\) ports](#)
- [Connecting a NetBackup 5330 compute node to a primary shelf](#)
- [Connecting one expansion shelf to a primary shelf](#)
- [Performing a soft shutdown before adding a new expansion shelf](#)
- [Connecting new expansion shelves to existing expansion shelves and an existing primary shelf](#)
- [Connecting the power cords to the hardware](#)
- [Turning on the hardware and verifying operation](#)
- [Configuring the IPMI port from the NetBackup Appliance Shell Menu](#)
- [Accessing and using the Veritas Remote Management interface](#)

Hardware installation scenarios

This chapter provides information about the installation of NetBackup 5330 Appliance system. Each system requires one compute node and one Primary Storage Shelf. Up to five Expansion Storage Shelves are supported.

A NetBackup 5330 High Availability (HA) configuration requires one compute node, one partner node, and one Primary Storage Shelf. Up to five Expansion Storage Shelves are supported.

Two HA scenarios are as follows:

- New deployment for a high availability configuration
- Converting existing systems to a high availability configuration

Refer to the following section for details about installing both HA scenarios.

See [“Hardware installation scenarios for a NetBackup 5330 high availability configuration”](#) on page 85.

Installing a primary shelf or an expansion shelf

This installation procedure can be used for either storage shelf. For the systems that include expansion shelves, install those shelves first followed by the primary shelf.

There must be a minimum depth of 76 cm (30 in.) between the front of the rack and the rear of the rack.

Veritas recommends that two people install the rails; one person at the back of the rack and one at the front. Veritas also recommends that three people lift and place the storage shelf into the mounted rails.

Warning: To avoid potential equipment damage and personal injury, do not install disk drives into the storage shelves before mounting them into the rack. The added weight of the disk drives hinders the ability to safely install the storage shelves.



≥ 32 kg (70.5 lb)

To install the storage shelf into the rack

- 1 Locate the left and the right rails.
- 2 Using a Phillips screwdriver, remove the four screws from the front of the rail and the two screws from the rear. Set the screws aside.
- 3 Identify the front, taller end of each rail.

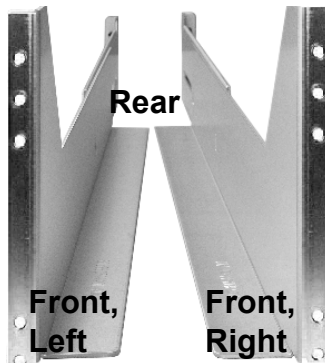

- 4 Identify the ledges that are perpendicular to the main part of each rail. The storage shelf sits on these ledges in the rack.

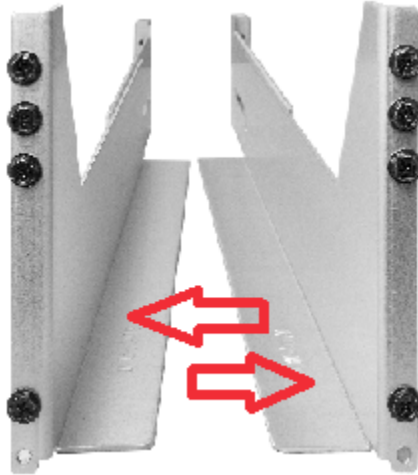

- 5 Locate the spacers and place them near the rail screws.



Note: Two types of spacers may ship with the storage shelves. Some spacers are round, while other spacers are square. Both types of spacers are galvanized steel. Both types of spacers have the same usage and functionality.

- 6 To align the rail with the front and the rear RUs, do the following:
 - Locate the RUs on the front and the rear of the rack that you plan to use.



Note: The rear of the rack uses the two lower RUs for installation. The front of the rack uses all three RUs.

- Use a flathead screwdriver to loosen the inside screws of the rail.

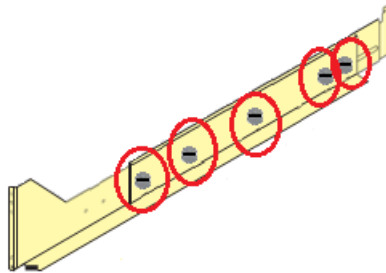

- Extend the rail so that it fits inside the front and the rear rack posts.

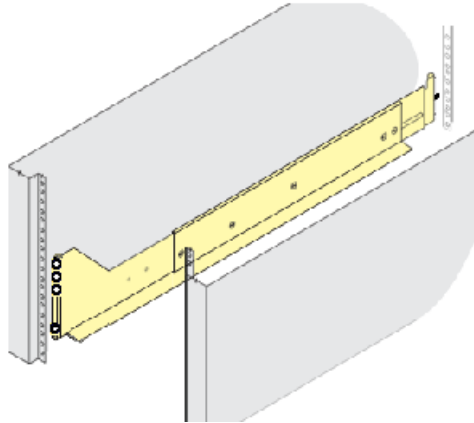

- Insert the guide pin on the rear of the rail into the top hole of the lowest rear RU that you plan to use.



- 7 You can use the flathead screws on the inside of the rail to extend or shorten it to fit into the rack.

- 8 You can also use an expansion bracket if you need to reinforce the rear of the rack.

Use the UP arrow to determine whether the bracket should be attached to the rear of the left or the right rail.

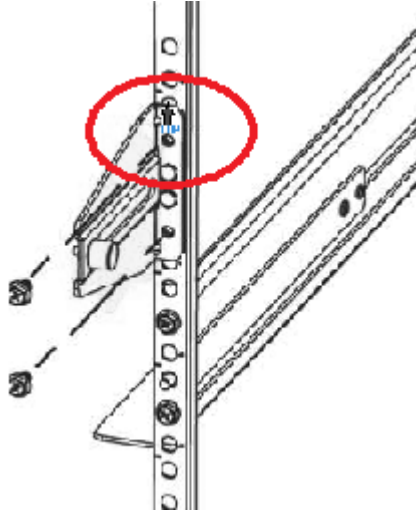

- 9 To secure the rail to the rack, do the following:
- Place one spacer, each, on two screws. The following illustrations show square and round spacers. Either type of spacer may ship with the storage shelf.

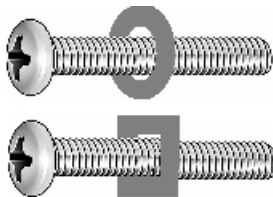

- If you have round spacers insert the raised portion of the spacer into the rack hole from the rack front. The spacer centers the screw for rail installation. The raised side of the round spacer is shown at the top of the following picture.



- Position the rail behind the rack holes.
- On the front of the rack, install one spacer and one screw in the lowest hole in the rack. Then install another spacer and a screw in the middle of the third RU in the rack.



The two remaining screws are used later to attach the shelf to the rack.

- On the rear of the rack, install a spacer and a screw in the middle rack holes of the two lowest RUs.
- 10** Be sure to tighten the flathead screws on the inside of the rail. The rail should fit snugly, without any room for movement.

- 11 Repeat the previous steps to install the right-hand rail.



Front, right Rear, right

- 12 To prepare for storage shelf installation, attach the metal handles to the sides of the storage shelf as follows:

- Push the top tabs on the handles into the slots on the shelf (1).
- Angle the handles and insert the bottom tabs (2).
- Push the entire handle towards the side of the shelf (3).
- Pull the handles up to secure them into place (4).

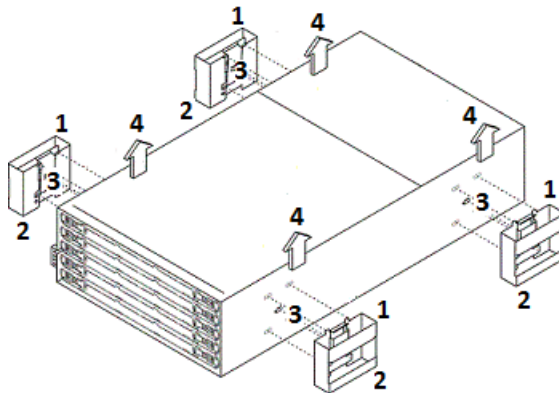

- 13 With one person on each side and one person in front, carefully lift the storage shelf.
 - 14 Place the rear of the shelf into the rear of the extended rails.
 - 15 Slide the shelf partially into the rack and remove the two rear metal handles.
 - 16 Lift the front of the storage shelf up slightly, then slide it completely into the rack until it engages securely.
 - 17 Remove the two front metal handles.
 - 18 Repeat the previous steps to install the Primary Storage Shelf.
- See [“Determining rack locations”](#) on page 30.

Installing disk drives into a primary shelf or an expansion shelf

The disk drive installation procedure is the same for both types of storage shelves. Power should not be applied to the storage shelves when you initially install all of the drives, such as when installing a new shelf.

Each storage shelf has 5 disk drawers, and each drawer holds 12 disks. All 60 disk drives must be installed.

To help reduce the installation time, Veritas recommends that two people perform the disk installation. One person should unwrap the disk drive and lift the handle, then hand it to the other person to install it into the drawer. Both people should wear ESD protection.

Note: If disks are not installed correctly when power is turned on later, errors are shown in the hardware monitoring systems. The first place to look for information is the NetBackup Appliance Web Console. Go to the **Monitor > Hardware** page.

To install the disk drives into a storage shelf

- 1 Move all disk drive boxes to the storage shelf location and open each box. Do not remove any disks or their protective sleeves at this time.
- 2 Attach an ESD protective (anti-static) wrist strap to one wrist and connect the other end to the rack.

- 3 Starting with the bottom drawer (5), use your thumbs to pull out the two orange latches towards the sides of the rack. Then, grasp the latches and pull out the drawer until you can see all of the disk slots. Do not pull the drawer out further.



The front of each drawer identifies the disk drive slot numbering inside the drawer. The numbering is the same in all drawers, as follows:

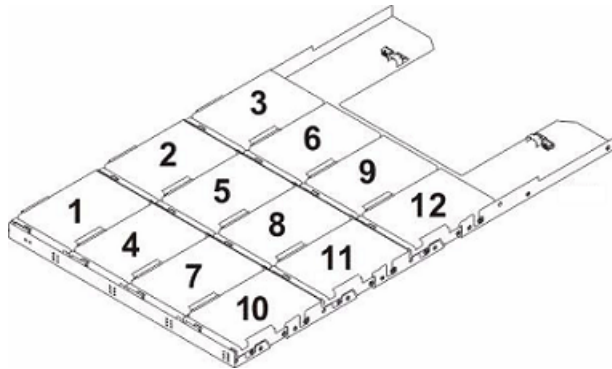

- 4 Take a disk drive from a box and remove its protective sleeve.
- 5 Pull up the disk latch and use it as a handle to install the disk into disk space number 1 as follows:
 - Insert the disk straight down into the slot.
 - Align the two raised buttons on each side of the disk with matching gaps in the slot.

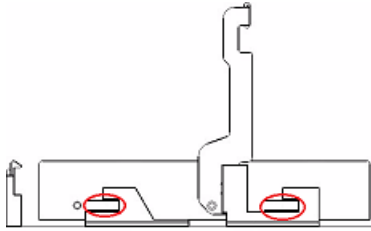

- Make sure that the bottom of the disk is seated completely.



- Push down slightly and start to pull the disk latch towards you. This action moves the disk backwards. The connector on the right, rear, of the disk fits into the pins in the rear of the slot.

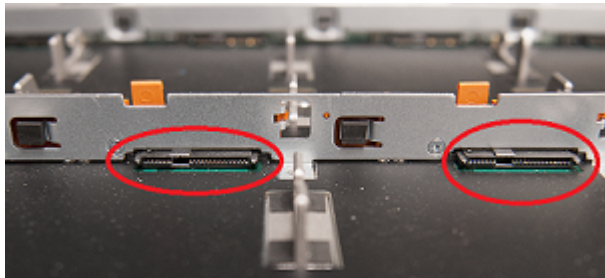

- Continue pulling the latch all the way down until it snaps in place under the orange tab in the front.

Repeat this step for the remaining disk slots in the drawer.

- 6** After all 12 disks are installed, push the drawer back into the shelf and push the orange latches inward to secure the drawer.
- 7** Repeat steps 4 - 6 for the remaining drawers in the following order:
Drawer 4, 3, 2, and then 1.

Installing the compute node

The NetBackup 5330 requires two RU rack spaces. Veritas recommends that you install the compute node in the space on top of the primary shelf.

The rails require one RU rack space and must be installed in the upper RU of the two required for the compute node.

To install the compute node

- 1 Use the rack rail templates that are provided with the compute node.

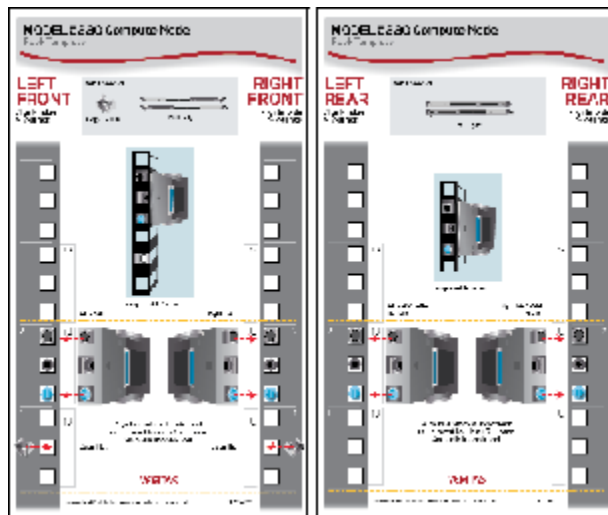

- Determine which 2 RUs to use.
 - Determine which rack holes to use for pins and screws.
- 2 Locate the RUs on the front and the rear of the rack that you plan to use.
 - 3 At the front of the rack, install a cage nut in the center hole of the lower RU on each side.

This hole is used later to secure the compute node to the rack.

- 4 Locate the left rail, marked with an L on the side near the front.

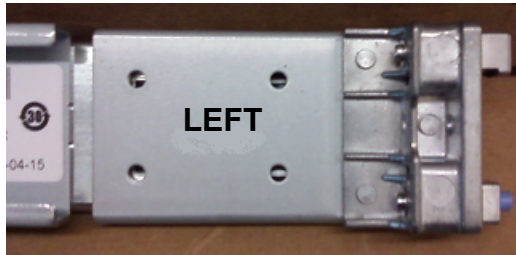

The marked side of the rail must face the side of the rack cabinet when mounted, not the side of the compute node.

- 5 Identify the protrusions at the end of the rails.



The square protrusion at the top should be placed in the top hole of the RU. The round blue protrusion at the bottom should be placed in the bottom hole of the RU.

- 6 At the rear upper RU of the rack, insert the rear of the rail into the top and the bottom holes of the RU.
- 7 Extend the rail toward the front of the rack and insert it into the top and the bottom holes of the RU.

- 8 Repeat steps 6 and 7 to install the right rail.



- 9 Make sure that both rails are parallel and secure.
- 10 Fully extend both rails forward until the release buttons click.
- 11 Carefully lift the compute node and tilt the rear down towards the back of the rails.
- 12 Locate the slots at the back of each rail.



- 13 Insert the two rear standoff pegs that extend from the side of the compute node into the last rail slots.

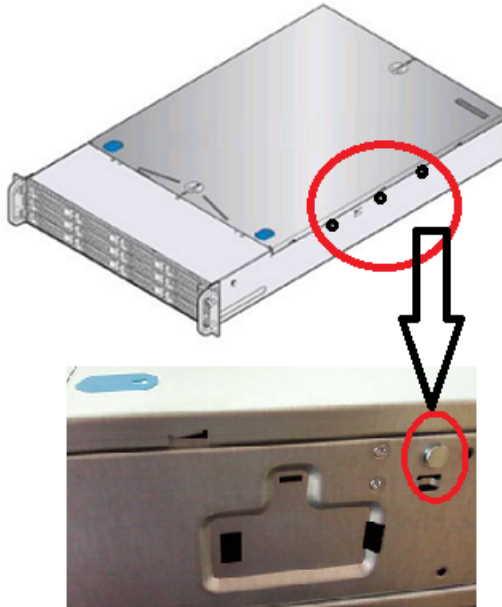

- 14 Lower the front of the compute node into the rail slots at the front of the rail extenders. A peg in the middle and a peg at the front of the compute node fit into the rail slots.
- 15 Lift up on the rail release buttons and slide the compute node completely into the rack.
- 16 Secure the compute node to the rack on each side by tightening the thumbscrew on the front.

Installing the SFPs into the Fibre Channel (FC) ports

Four small form-factor pluggable (SFP) transceivers are provided. You must insert them into the four Fibre Channel (FC) ports in slots 1 and 4 in the compute node rear panel.



To install the SFPs

- 1 Locate the SFPs.



- 2 Identify the FC ports in slots 1 and 4.

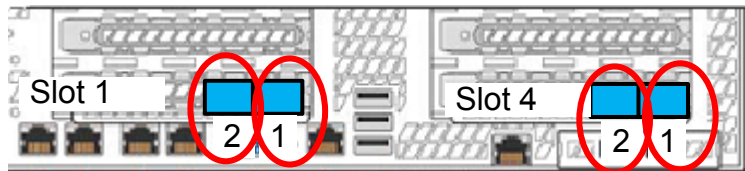

- 3 Remove the black rubber cap on each SFP that you want to install.

- 4 Slide the SFP completely into the port until it clicks into place.

Be sure that the metal handle on the end of the SFP is on the top. You do not need to lift up the handle.

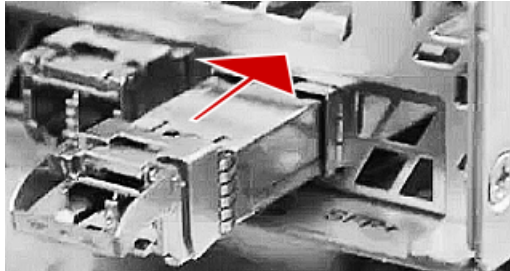

- 5 Verify that the SFP is seated properly.

The SFPs should be parallel to each other. They should not be twisted or incompletely inserted.

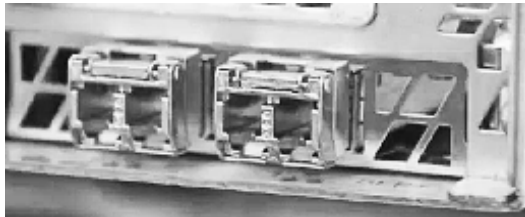

Connecting a NetBackup 5330 compute node to a primary shelf

The compute node ships with 4, 1 meter, Fibre Channel (FC) cables. FC cables connect the compute node to the primary shelf canisters. To ensure communication redundancy, connect the units exactly as described in this topic.

Note: If you have a 6TB primary shelf, you must upgrade to NetBackup Appliance Release 2.7.1, or later. Refer to the *NetBackup Appliance Upgrade Guide for Release 2.7.x - RedHat Enterprise Linux (RHEL) Operating System*, which is located at the following site. [NetBackup Appliance documentation](#)

The following diagrams and tables show the locations of the FC ports on both components.

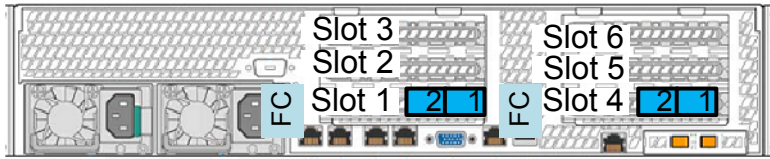

Table 3-1 Compute node FC ports

Compute node FC ports
Slot 1; ports 1 and 2
Slot 4; ports 1 and 2

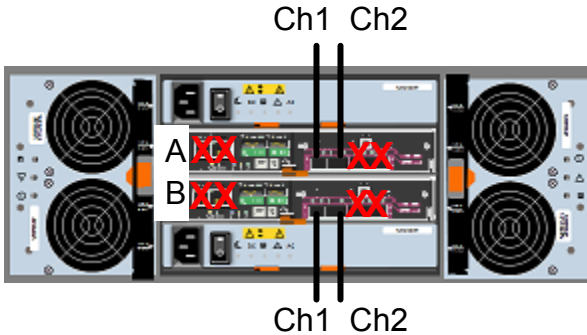

Table 3-2 Primary shelf FC ports

Primary Storage Shelf FC ports
Canister A; FC Ch1 and FC Ch2
Canister B; FC Ch1 and FC Ch2

To connect the compute node to the primary shelf

- 1 Connect the slot 1 FC ports on the compute node to the appropriate primary shelf canister FC ports as follows:
 - Connect compute node slot 1, port 2 to primary shelf canister B, FC Ch1.
 - Connect compute node slot 1, port 1 to primary shelf canister A, FC Ch1.
- 2 Connect the slot 4 FC ports on the compute node to the appropriate primary shelf canister FC ports as follows:
 - Connect compute node slot 4, port 2 to primary shelf canister B, FC Ch2.

- Connect compute node slot 4, port 1 to primary shelf canister A, FC Ch2.
- 3 Verify that the connections match the ports in the following diagram.

Compute node

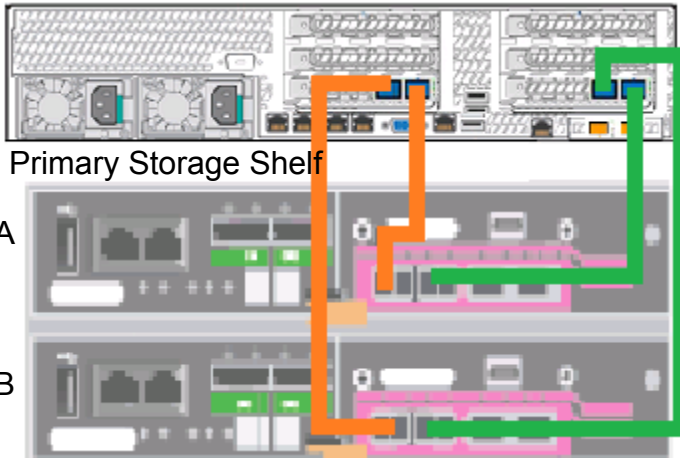

See [“Connecting one expansion shelf to a primary shelf”](#) on page 54.

Connecting one expansion shelf to a primary shelf

This topic describes the process of adding one new expansion shelf to an existing primary shelf and compute node.

You can also use these instructions to install and connect an expansion shelf at the same time you install a primary shelf and a compute node.

Note: If you have a 6TB expansion shelf with a 6TB or 3TB primary shelf, you must upgrade to NetBackup Appliance Release 2.7.1, or later. Refer to the *NetBackup Appliance Upgrade Guide for Release 2.7.x - RedHat Enterprise Linux (RHEL) Operating System*, which is located at the following site. [NetBackup Appliance documentation](#)

When you install a compute node and storage shelves at the same time, leave the power turned off until all of the cabling is complete. Use the provided sequence to turn on the devices.

Caution: Be sure to install the SAS cables correctly before you turn on the expansion shelf. If you need to disconnect and reconnect cables on an operational expansion shelf, there is a risk that the primary shelf cannot recognize the new configuration.

Prerequisites for adding an expansion shelf

- Be sure that you have 4U of rack space for each new shelf. One shelf must be close to the primary shelf.
- Refer to the following section to verify that cable lengths are adequate for your rack installation.
 See [“Determining SAS2 cable length”](#) on page 32.
- Be sure that you have 220VAC power input for the storage shelf.
- Verify that the compute node and the primary shelf are connected correctly.

Compute node



Primary Storage Shelf

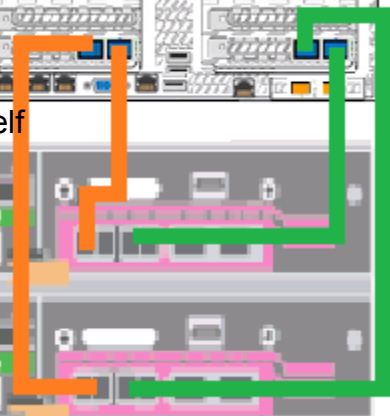

To connect one new expansion shelf to a primary shelf

- 1 Connect the two SAS ports on canister A of the primary shelf to the left SAS ports on canisters A and B of the expansion shelf.

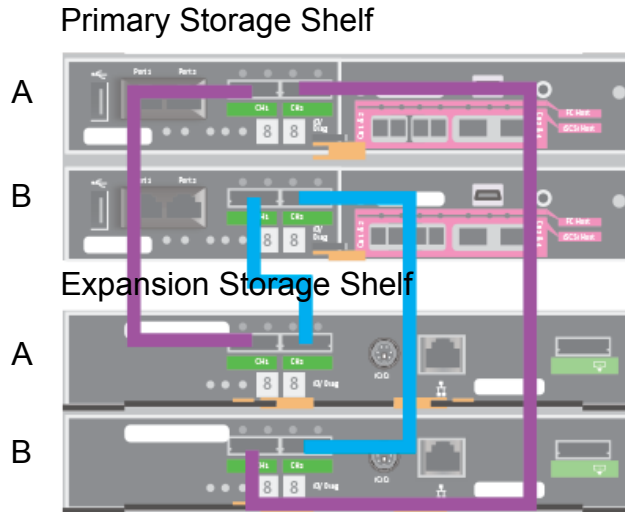

- 2 Connect the two SAS ports on canister B of the primary shelf to the two SAS ports on the expansion shelf. Do not use the single SAS port on the right-hand side of each expansion shelf canister.
- 3 Connect two power cords to the expansion shelf.

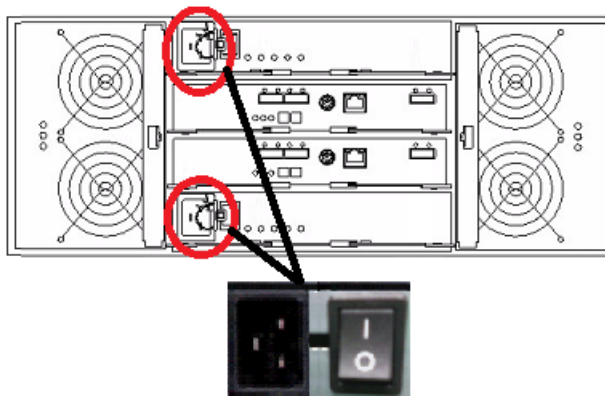

- 4 Turn on both power switches.
- 5 Wait for the 00 display on the expansion shelf.

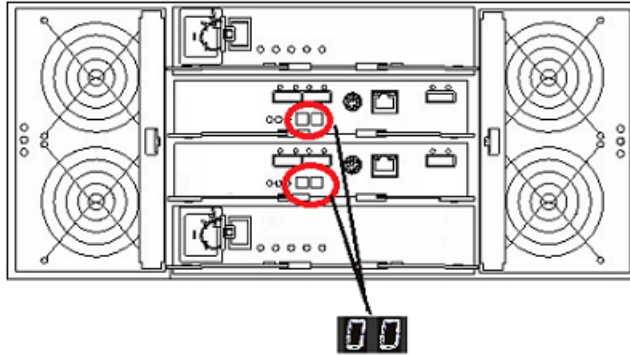

Refer to the following sections as needed.

- Turn on the devices and verify operations.
See [“Turning on the hardware and verifying operation”](#) on page 72.
- Add the new disk space from the expansion shelves.
See [“Adding the disk space of an Expansion Storage Shelf from the NetBackup Appliance Web Console”](#) on page 96.
See [“Adding the disk space of an Expansion Storage Shelf from the NetBackup Appliance Shell Menu”](#) on page 98.

Performing a soft shutdown before adding a new expansion shelf

Best practices recommend that the compute node is turned off before you install and connect a second expansion shelf. A soft shutdown preserves data and functionality of the compute node. The addition of a new expansion shelf to an operating compute node can cause the primary shelf to shutdown unless the soft shutdown procedure is performed. After the compute node is turned off, the primary shelf is also turned off.

Warning: You should never perform a hard shutdown by using the power button to turn off the appliance. Using the power button to turn off the appliance can cause data corruption to occur.

A soft shutdown informs the appliance operating system to stop and close all active processes. A soft shutdown also stops all communications to the attached storage shelf. After the operating system stops all of the processes, the compute node turns itself off. All attached storage shelves should be turned off with the power switches on the rear panel of each shelf.

Note: When you add one expansion shelf to the primary shelf, you do not have to turn off the power.

To perform a soft shutdown

- 1 Ensure that all backup or all restore operations have been completed.
- 2 Log in to the NetBackup Appliance Shell Menu and issue the command, `Support > Shutdown.`

Connecting new expansion shelves to existing expansion shelves and an existing primary shelf

The NetBackup 5330 compute node requires one Primary Storage Shelf. NetBackup Appliance software version 3.1 supports the use of up to five Expansion Storage Shelves. Refer to the *NetBackup 5330 Appliance Product Description Guide* for details about the available storage options.

Note: Before you add a second expansion shelf to your system, you must upgrade to NetBackup Appliance Release 2.7.1, or later. Refer to the *NetBackup Appliance Upgrade Guide for Release 2.7.x - RedHat Enterprise Linux (RHEL) Operating System*, which is located at the following site: [NetBackup Appliance documentation](#)

Caution: When you add new expansion shelves to an operational system, best practices recommend that you turn off the attached compute node and all storage shelves.

However, it is possible to add an expansion shelf to a functioning system while the power remains on. If you need to keep the power turned on, contact Veritas Technical Support for assistance. Ask your representative to reference Article 000097607.

Turn off the compute node, the primary shelf, and any existing expansion shelves in that order. Refer to the following link for background information as needed.

See [“Performing a soft shutdown before adding a new expansion shelf”](#) on page 57.

Connecting new expansion shelves to existing expansion shelves and an existing primary shelf**To turn off an operating system**

- 1 First, turn off the compute node from the NetBackup Appliance Shell Menu.
- 2 Enter `support` and then `shutdown`.
- 3 Next, turn off the primary shelf.
- 4 Turn off both AC power switches on the rear panel of the primary shelf.

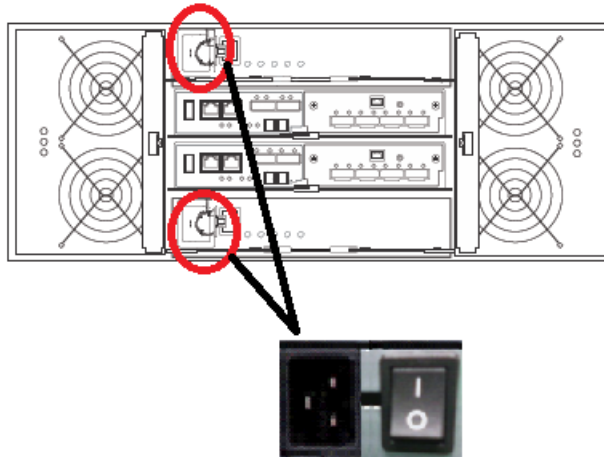

- 5 Turn off both AC power switches on the rear panel of the existing expansion shelves.

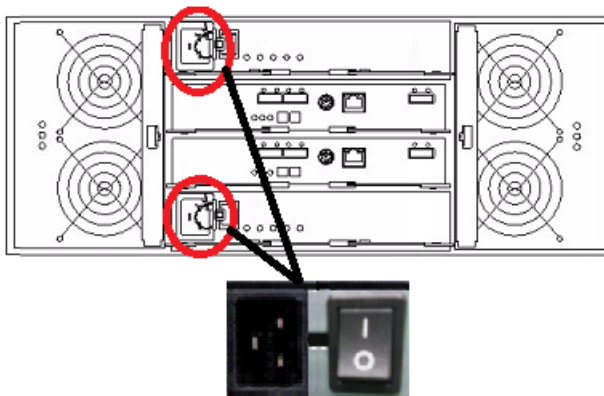

Connecting new expansion shelves to existing expansion shelves and an existing primary shelf

To connect new expansion shelves to existing expansion shelves

Note: These instructions apply to one existing expansion shelf and one new expansion shelf. Other scenarios are possible but the cable procedures are the same.

- 1 Verify that the compute node, the primary shelf, and the existing expansion shelves are turned off.
- 2 Verify that your existing primary shelf and expansion shelves are cabled correctly, as shown.

Four SAS cables connect the primary shelf to the expansion shelf.

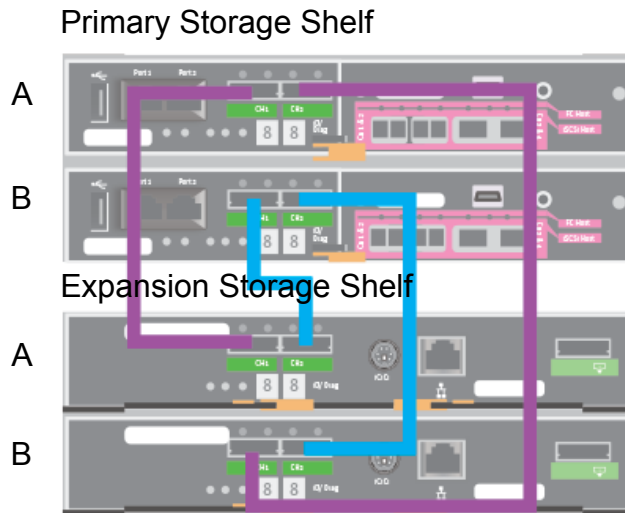

Note: The following illustrations show only the specific cable and action(s) required. Cables that are already connected are shown in black. The cable for each step is shown in color. A yellow circle represents a new connection. A red circle indicates a cable that needs to be removed from a specified port.

Connecting new expansion shelves to existing expansion shelves and an existing primary shelf

- 3 Connect one new SAS cable as shown in yellow.

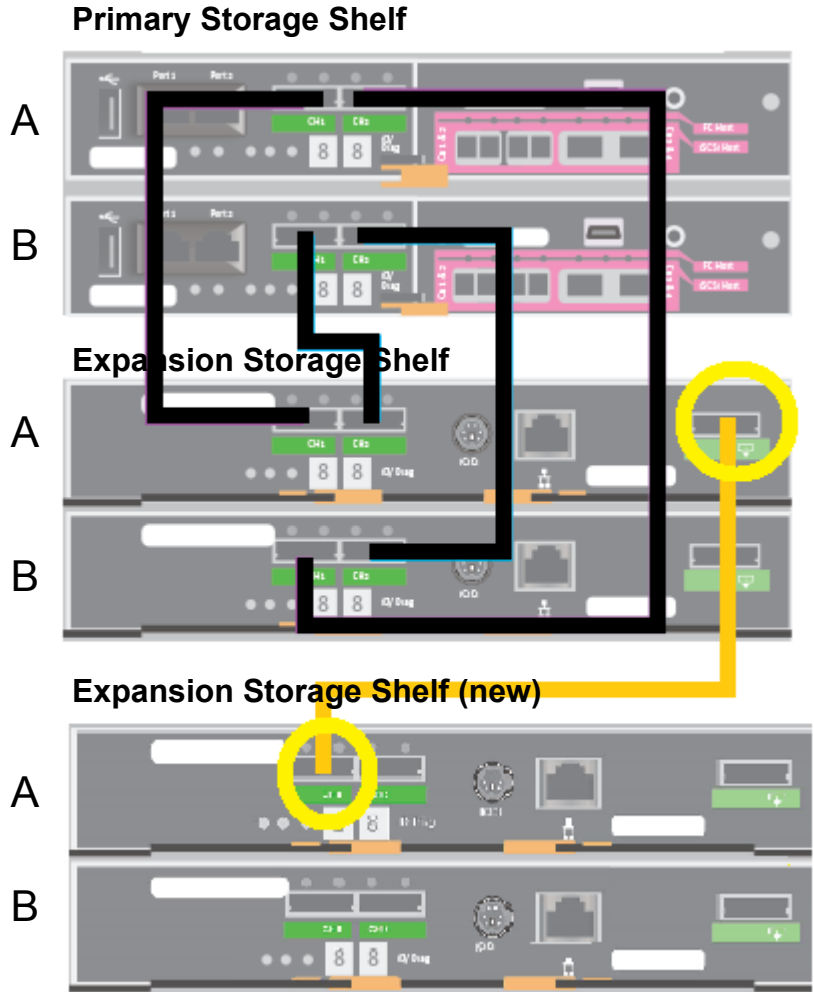

Connecting new expansion shelves to existing expansion shelves and an existing primary shelf

- 4 Connect the other new SAS cable to canister B of the new expansion shelf. Use the SAS port on the right-hand side of canister B as shown in yellow.

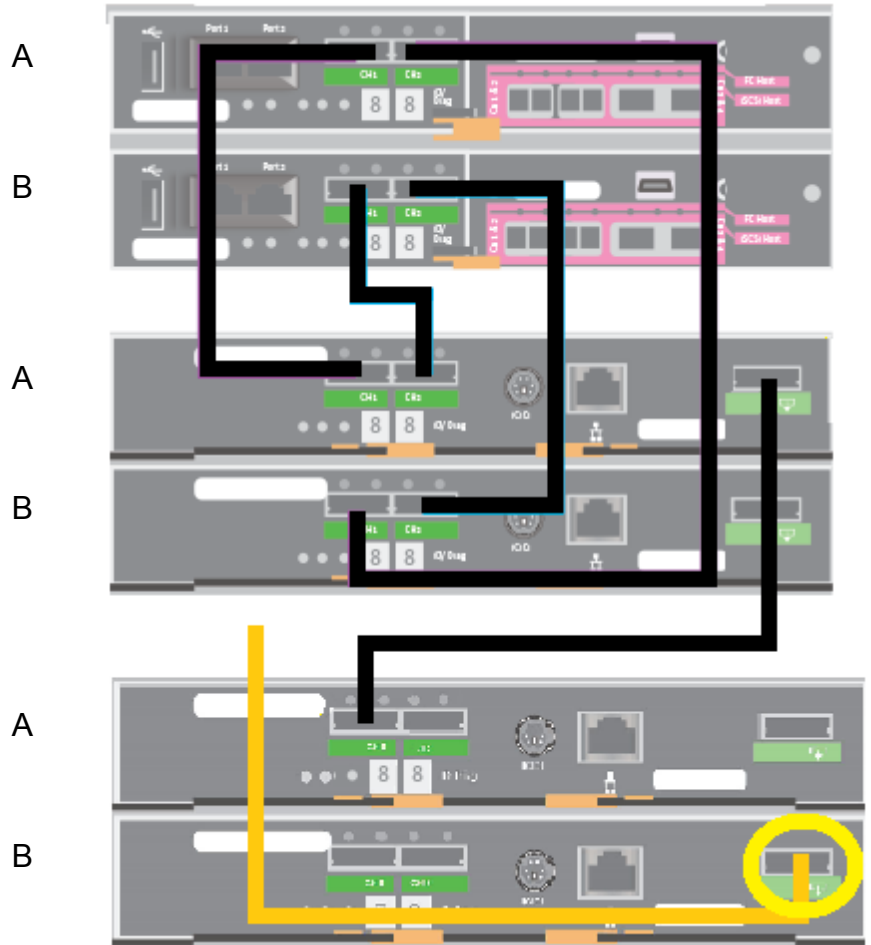

The other end of this new SAS cable is connected later.

Connecting new expansion shelves to existing expansion shelves and an existing primary shelf

- 5 Disconnect the cable from the left-most SAS port in canister B in the existing expansion shelf, as shown.

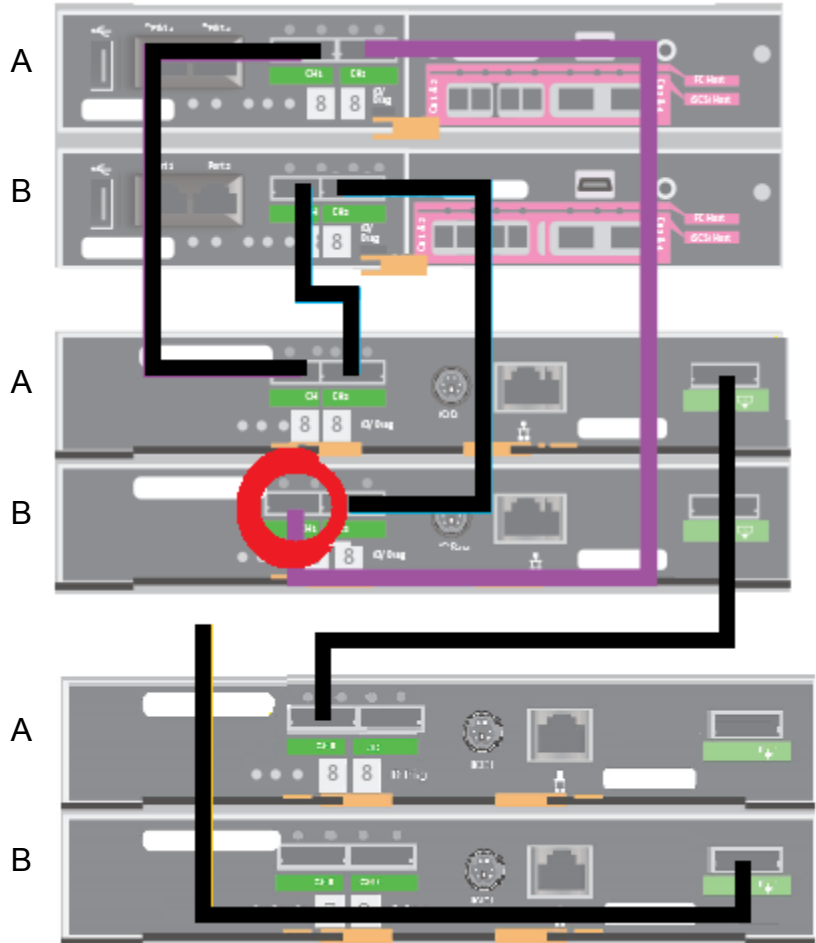

Connecting new expansion shelves to existing expansion shelves and an existing primary shelf

- 6 Connect the cable that was not completely connected to the left-most SAS port to canister B in the existing expansion shelf as shown.

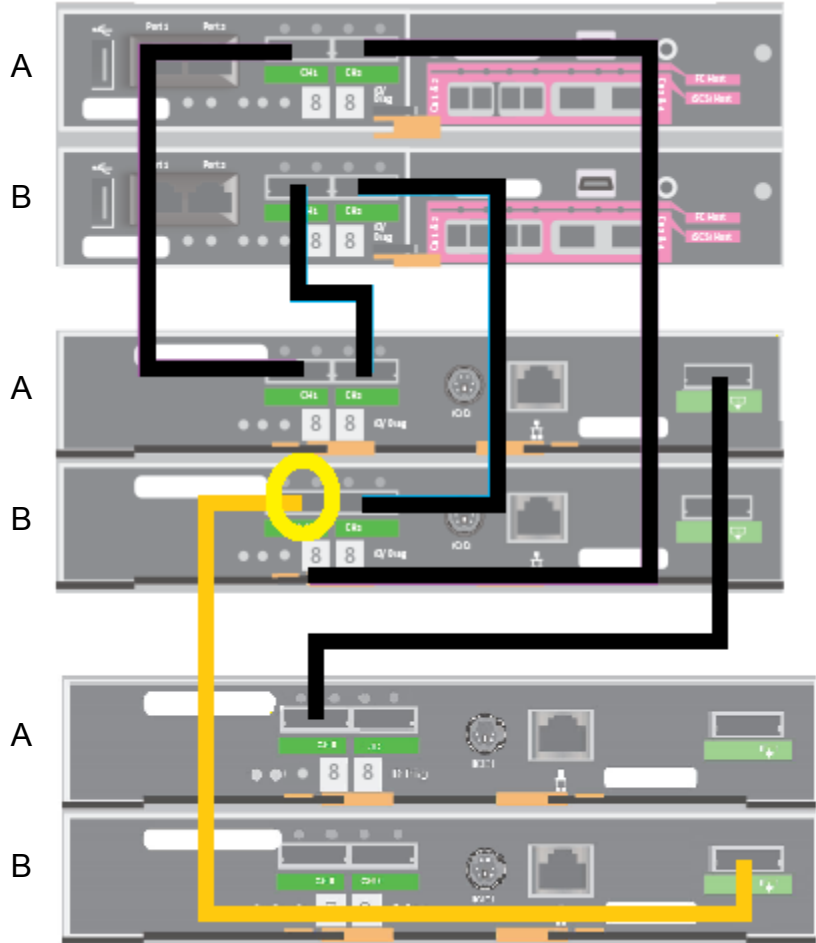

Connecting new expansion shelves to existing expansion shelves and an existing primary shelf

- 7 Connect the cable that was disconnected from canister B of the existing expansion shelf to the left port in canister B of the second expansion shelf.

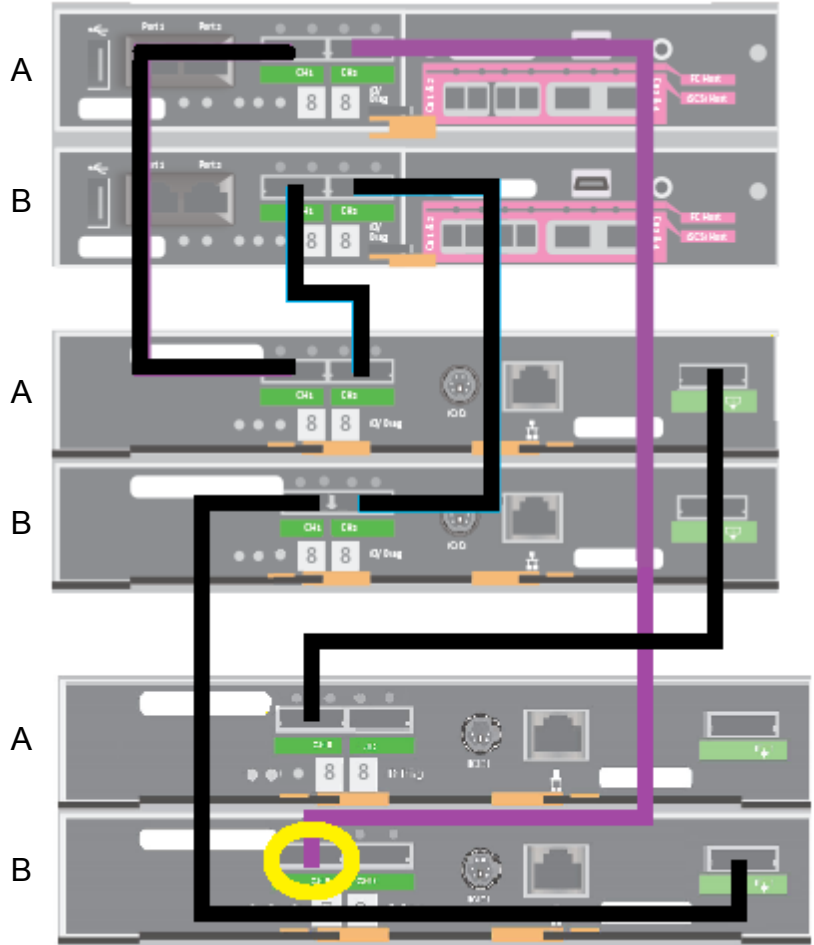

Connecting new expansion shelves to existing expansion shelves and an existing primary shelf

- 8 Disconnect the cable from the existing expansion shelf, canister B, port 1.

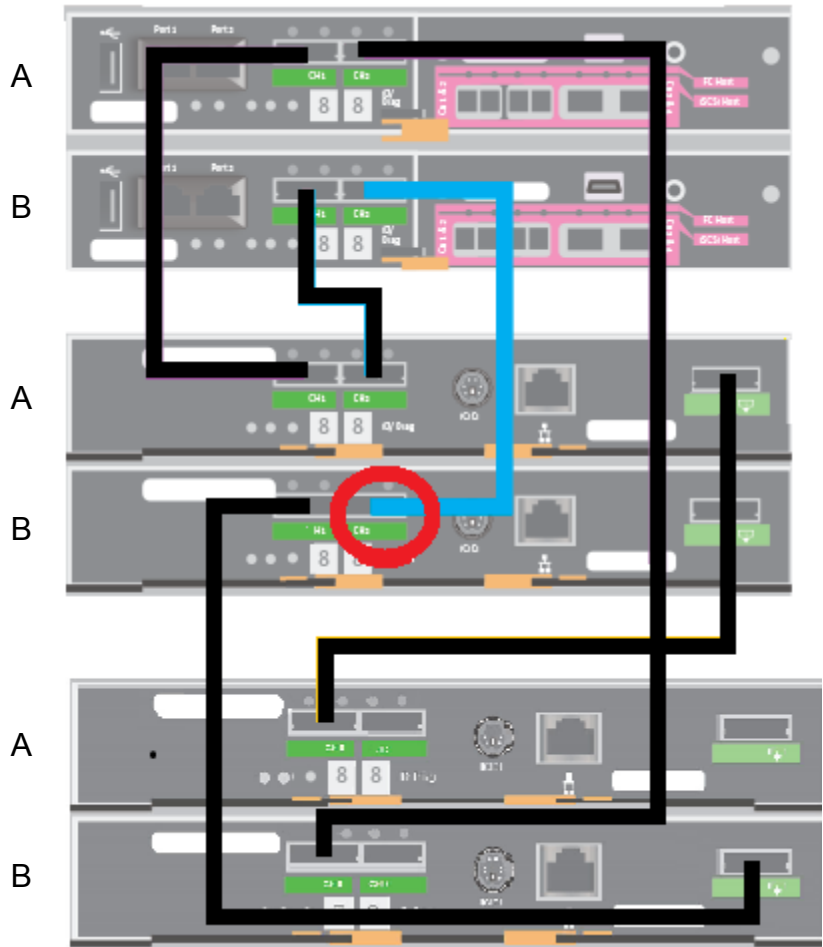

Connecting new expansion shelves to existing expansion shelves and an existing primary shelf

- 9 Connect the cable to the second expansion shelf, canister B, port 1, as shown.

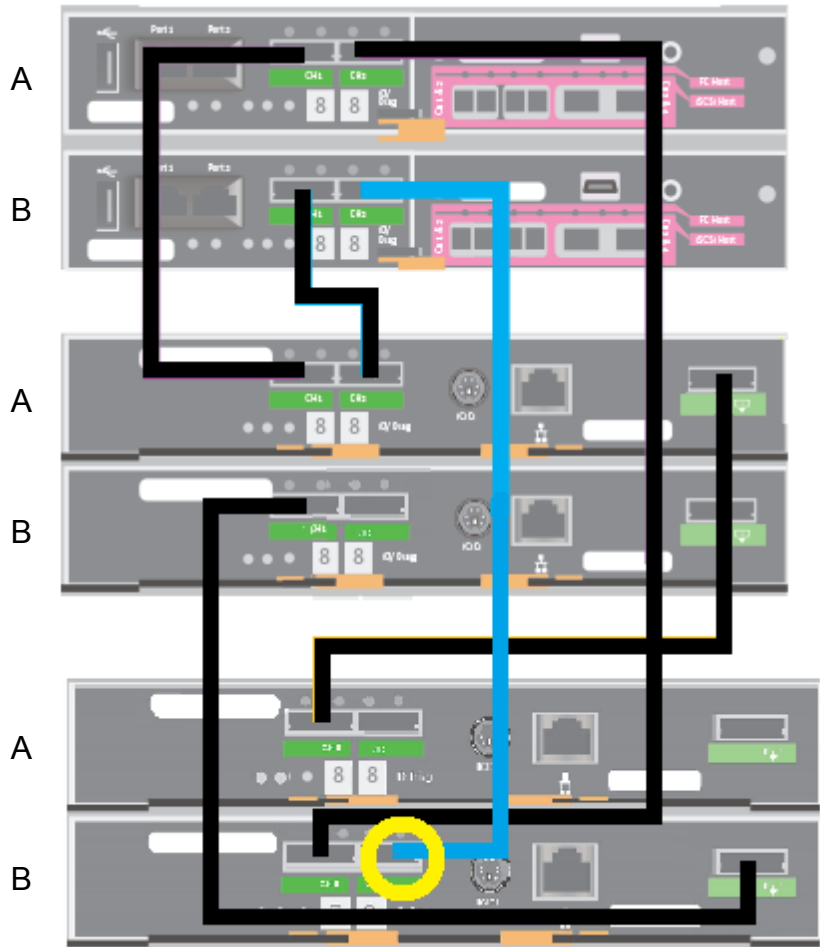

Connecting new expansion shelves to existing expansion shelves and an existing primary shelf

- 10** Verify that all cables are connected correctly, as shown in the following two illustrations.

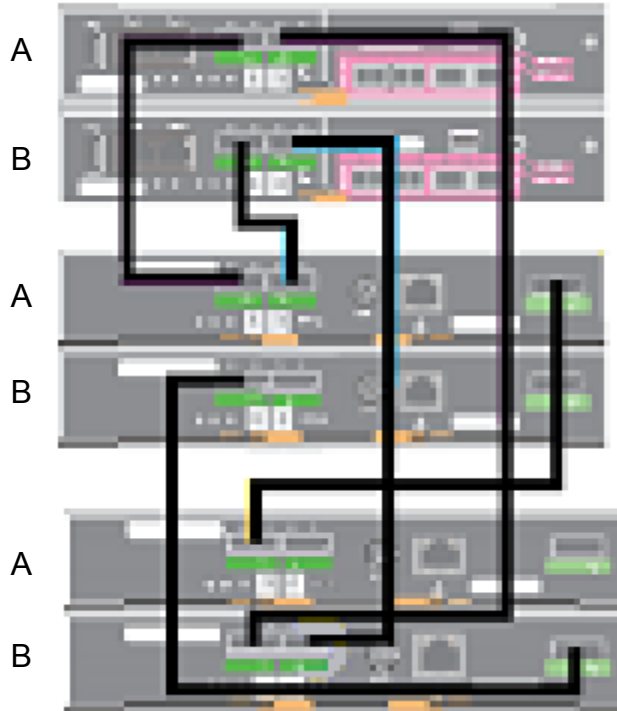

Connecting new expansion shelves to existing expansion shelves and an existing primary shelf

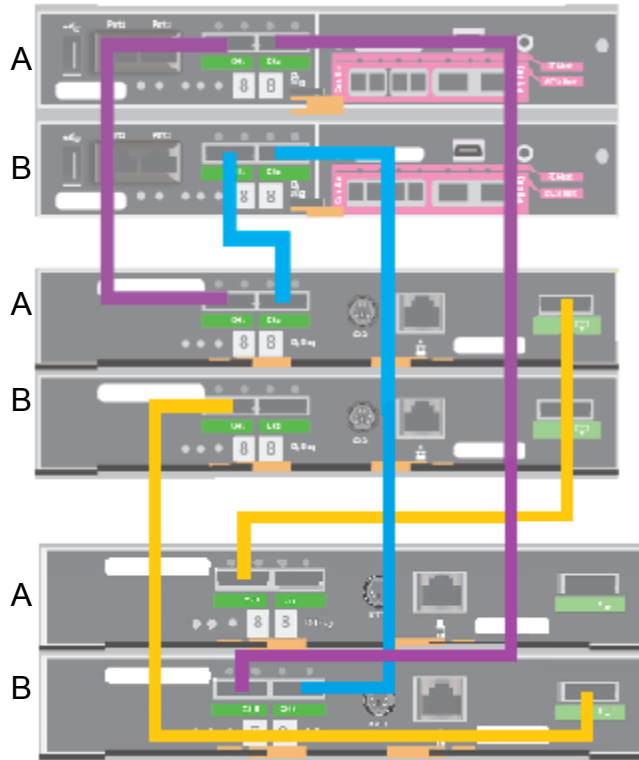

Connecting new expansion shelves to existing expansion shelves and an existing primary shelf

The following illustration shows the maximum number of five Expansion Shelves, with one Primary Shelf, and one compute node.

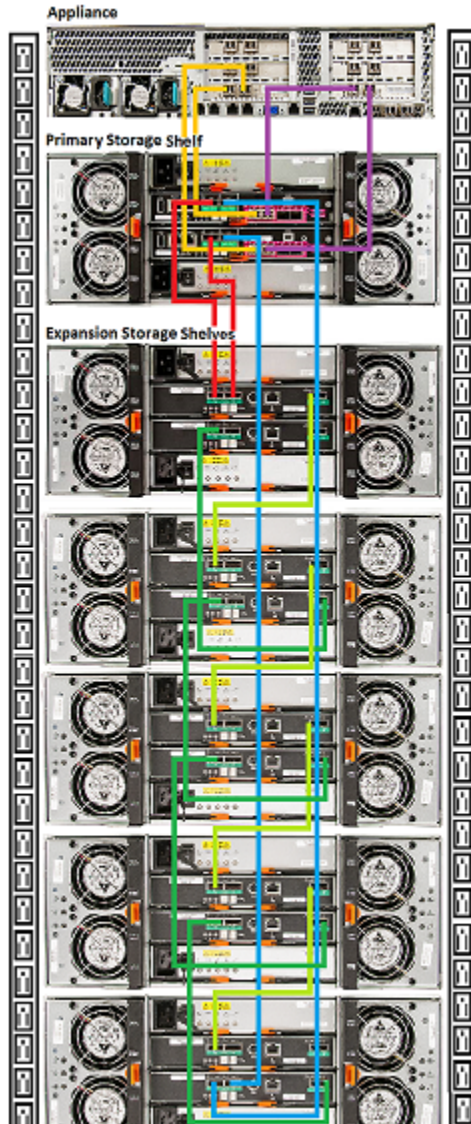

-
- 11 Warning:** Turn on the devices in the correct sequence; new expansion shelves, existing expansion shelves, primary shelf, compute node.
-

Refer to the following section to turn on all devices in the proper order.

See [“Turning on the hardware and verifying operation”](#) on page 72.

- 12** When all devices are operational, add the storage disk space to the appliance system.

Connecting the power cords to the hardware

Typically, the rear of a rack is configured with a Power Distribution Unit (PDU) on each side. The PDU on each side is from a different source to provide power redundancy.

Caution: Do not turn on the power to any components while connecting the power cords. The components must be turned on in a specific sequence to ensure correct communication.

Refer to the following section for a description of the power cable connectors.

See [“NetBackup 5330 cables and connectors”](#) on page 12.

To connect the power cables

- 1 Verify that the AC power supply input for the compute node is within one of these ranges:
 - 100 - 127 VAC at 50/60 Hz, 8.2 A
 - 200 - 240 VAC at 50/60 Hz, 4.4 A
- 2 Verify that the AC power supply input for the storage shelves is within the range of 200 - 240 VAC at 50/60 Hz, 9.13 - 10.95 A.
- 3 For each component, obtain two power cords that are appropriate for your region and equipment.
- 4 On the compute node, connect a power cord to each power supply socket. Connect the other end of each cord to a different PDU.

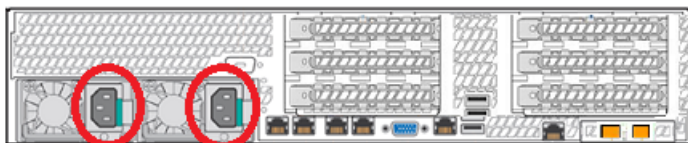

- 5 On the primary shelf, connect a power cord to each power supply socket. Connect the other end of each cord to a different PDU.

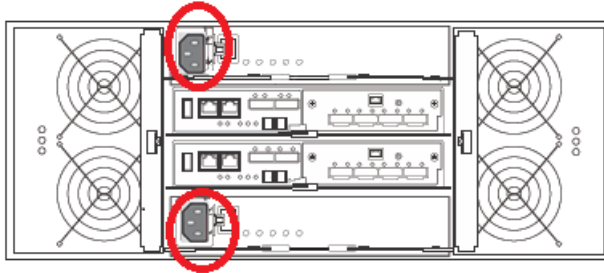

- 6 On the expansion shelf, connect a power cord to each power supply socket. Connect the other end of each cord to a different PDU.

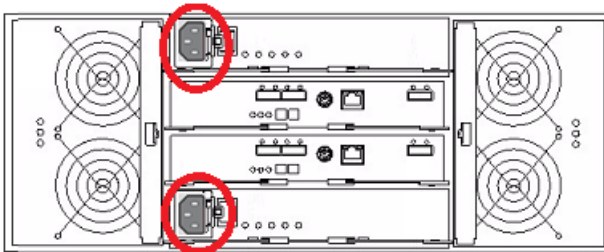

See [“Turning on the hardware and verifying operation”](#) on page 72.

Turning on the hardware and verifying operation

You must turn on the hardware components in a specific sequence to ensure correct communication between them.

The correct sequence is as follows:

1. Expansion Storage Shelf (if installed)
 - If more than one expansion shelf is installed, turn on the shelf furthest from the primary shelf first.
 - Turn on the expansion shelf that is connected to the shelf that you turned on. Continue in this manner until you turn on the last expansion shelf.
2. Primary Storage Shelf

Turn on the Primary Storage Shelf after the expansion shelves are operational.

3. NetBackup 5330 compute node

For a high availability (HA) configuration, turn on the compute node that is closest to the primary shelf, and then turn on the other node.

To turn on the components and verify operation

- 1 Verify that the following cables are connected properly and securely:
 - Data and network cables on the compute node
 - Fibre Channel (FC) cables between the compute node and the primary shelf
 - SAS cables between the primary shelf and the expansion shelf
 - Power cords from each component to the appropriate Power Distribution Unit (PDU) in the rack
- 2 On the rear of the expansion shelf, turn on both power switches.

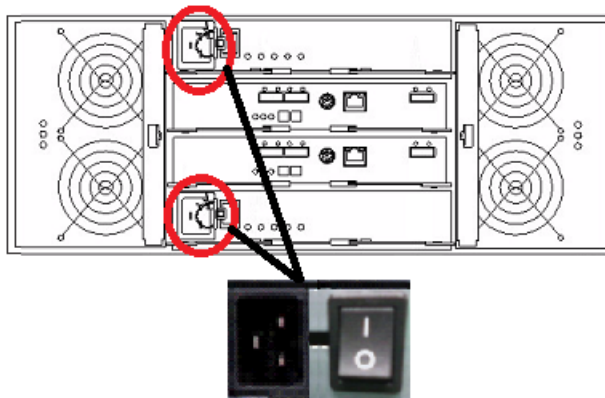

- 3 Verify that the left-most LEDs on both power canisters are green.

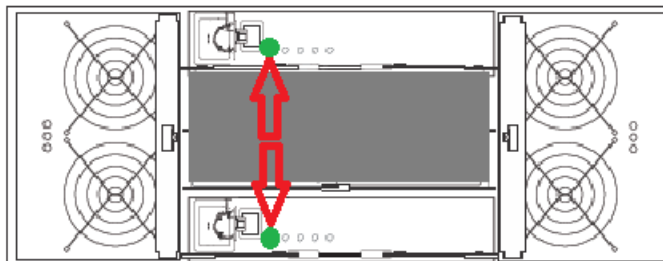

- 4 Verify that the Power LED on the front, left, of the shelf is green.

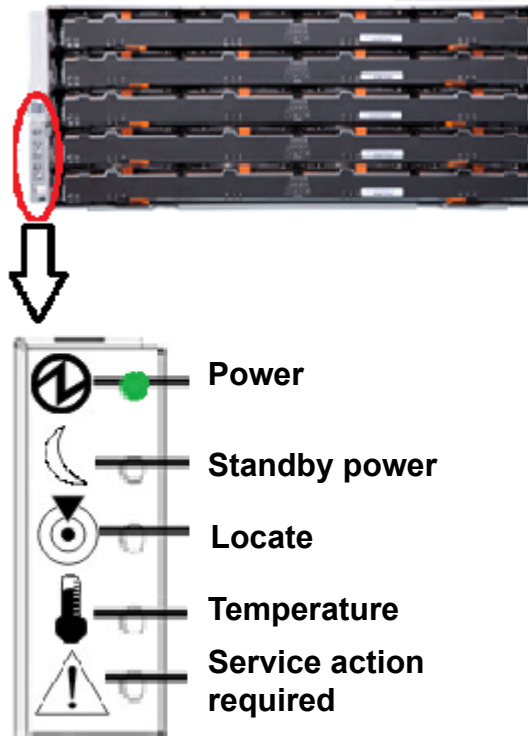

- 5 After approximately 5 minutes to 10 minutes, verify that the shelf has fully initialized as follows:
 - The 12 disk LEDs on the front of each drawer are green.



- The blue Service Action Allowed LED is not lit.

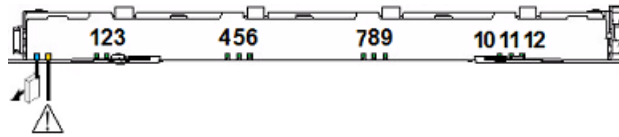

- The amber Service Action Required LED is not lit.

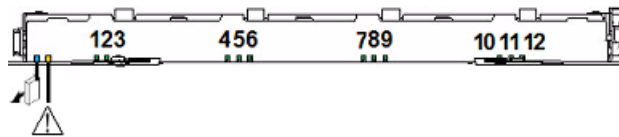

- The two seven-segment numbers on the rear of the shelf show the shelf ID.

For the new Expansion Storage Shelf, this number should be 01.

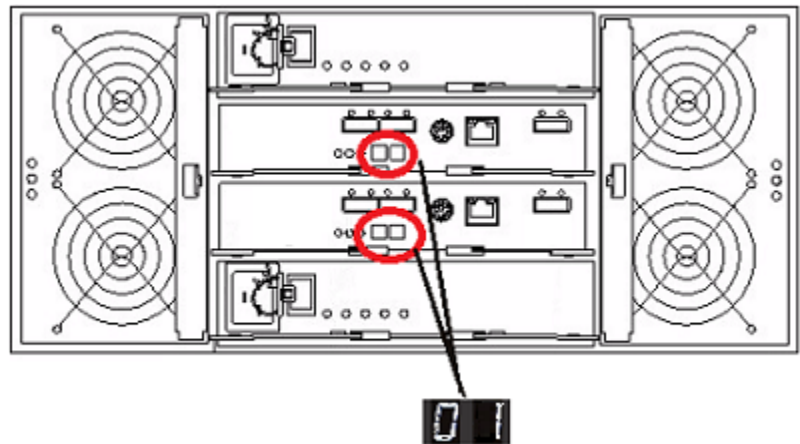

For the original Expansion Storage Shelf, this number should be 00.

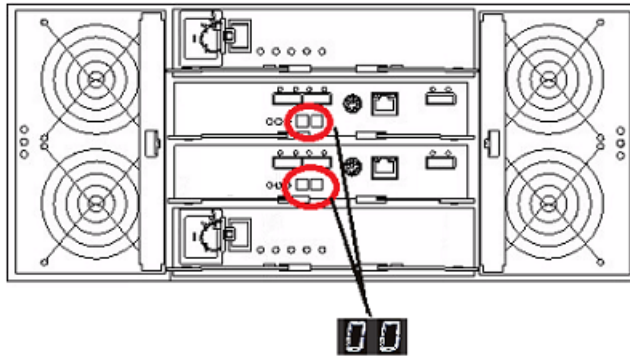

- 6 On the rear of the primary shelf, turn on both power switches.

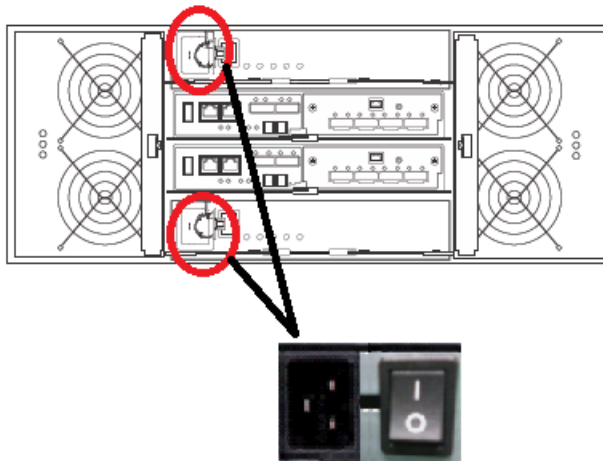

- 7 Verify that the left-most LEDs on both power canisters are green.

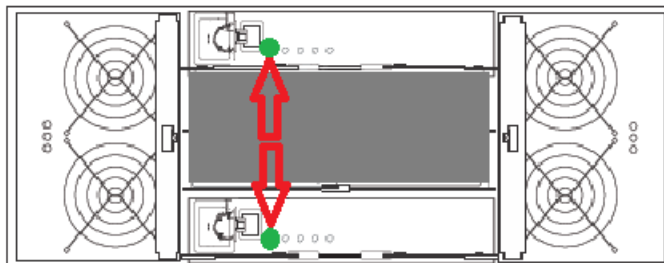

- 8 Verify that the Power LED on the front, left, of the shelf is green.

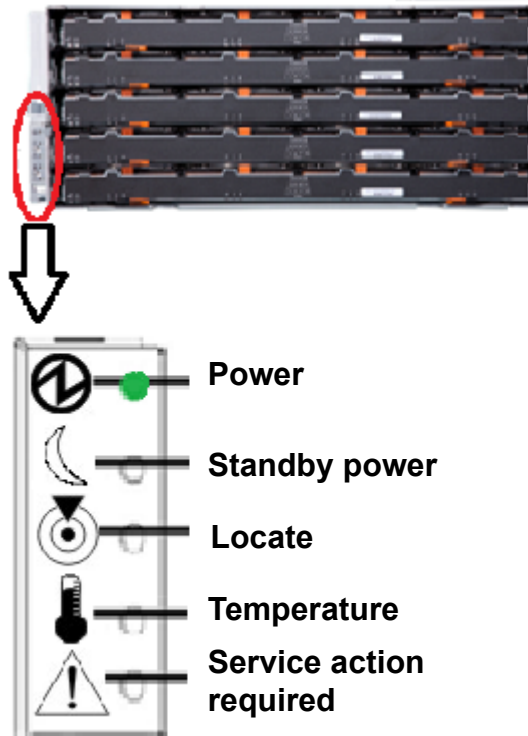

- 9 After approximately 5 minutes to 10 minutes, verify that the shelf has fully initialized as follows:
- The 12 disk LEDs on the front of each drawer are green.



- The blue Service Action Allowed LED is not lit.

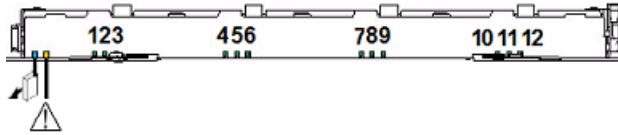

- The amber Service Action Required LED is not lit.

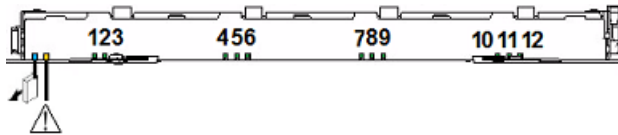

- 10** The two seven-segment numbers on the rear of the shelf show the shelf ID. For the Primary Storage Shelf, this number should be 99.

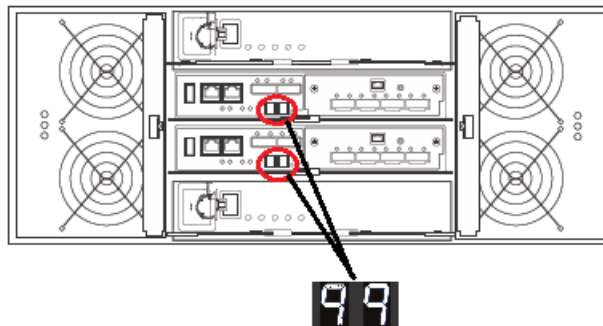

- 11 On the front right panel of the compute node, press the power button to turn on the compute node.

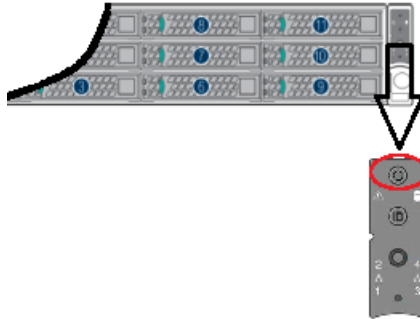

- 12 After a few minutes, verify that the compute node has fully initialized as follows:
 - On the right front panel of the compute node, locate the triangular Status LED near the top of the LED panel. The LED should be green during normal operations.

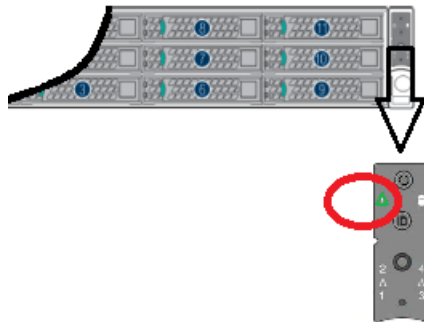

- Verify that the disk drive LEDs have initialized properly as follows:



The Status LED (1) should not be lit. The following indications are also possible:

- A solid, amber, LED indicates a disk fault.

- A blinking, amber LED indicates that a RAID rebuild is in progress. The Activity LED (2) indicates the following:
 - The LED is not lit when the disk has spun down, although power is still on.
 - The LED is solid green when there is no disk activity, although power is still on.
 - The LED blinks green when the disk spins up.
 - The LED blinks green occasionally when commands are processed.
- 13** Launch the NetBackup Appliance Web Console and verify that all devices appear on the **Monitor > Hardware** page. If the devices do not appear, inspect the cable connections and make sure that the power is on.
- 14** Proceed to the initial configuration of the appliance. Refer to instructions at the following site: [NetBackup Appliance documentation](#)

Configuring the IPMI port from the NetBackup Appliance Shell Menu

This section explains how to configure IPMI from the NetBackup Appliance Shell Menu.

If you have more than one node in your system you must configure each node's IPMI port individually.

Before starting the IPMI configuration, obtain the following information for the appliance for which you want to configure the IPMI:

IP address	IP address for the remote management port so that the default static IP address of the remote management port can be changed.
Subnet mask	Enable connectivity between your network computer and the remote management port.
Gateway IP address	Enable connectivity between your network computer and the remote management port.

The defaults for the remote management port are:

- IP Address: 192.168.0.10
- Subnet Mask: 255.255.255.0

Also review the following section on the IPMI prerequisites.

See “Prerequisites for IPMI configuration on a 52xx and 5330 ” on page 33.

To configure the IPMI port by using a keyboard and monitor

- 1 Connect the following components to the appropriate ports on the rear panel of the appliance:
 - A standard video cable between the VGA (Video Graphics Array) port and a computer monitor.
 - A USB keyboard to a USB port on the appliance.

- 2 Verify that the appliance is turned on.

Once the startup process is complete, a login prompt appears.

- 3 Enter the username and password for the appliance. By default, the user name is `admin` and the password is `P@ssw0rd` where 0 is the number zero.

- 4 At the **Main_Menu** prompt, type **Support** to navigate to the **Support** menu.

- 5 From the **Main_Menu > Support** view, enter the following command to configure the remote management port:

```
IPMI Network Configure <IPAddress> <Netmask> <GatewayIPAddress>
```

where *IP address* is the new IP address of the remote management port. The Subnet mask and Gateway enable connectivity between your network computer and the remote management port.

The remote management port must be configured as a DHCP or static address.

At any point in time, you can run the following command to see the IPMI network details:

```
IPMI Network Show
```

- 6 Enter the following command if you want to add a new user to access the IPMI sub-system. Note that this is an optional step.

```
IPMI User Add <User_Name>
```

At the **New Password** prompt, enter a password for the user.

The default user name is **sysadmin**. The default password is **P@ssw0rd**, where **0** is the number zero.

At any point in time, you can run the following command to view the users who can access the IPMI:

```
IPMI User List
```

- 7 Type **Return** to return to the **Main_Menu** prompt.

- 8 Use a Cat5 or a Cat6 cable to connect the remote management port to the network.
- 9 Make sure you can reach the Veritas Remote Management Console over the network by using the new address in a web browser.
- 10 The appliance is ready for initial configuration. See the *NetBackup Appliance Initial Configuration Guide* for the appropriate platform for information about initial configuration requirements and procedures.

Note: Once the initial configuration has been completed, you can connect NIC1 (eth0) to an administrative network that does not provide any backup data transfer.

See [“About IPMI configuration”](#) on page 20.

See [“Configuring the IPMI port from the NetBackup Appliance Shell Menu”](#) on page 80.

See [“Accessing and using the Veritas Remote Management interface”](#) on page 82.

Accessing and using the Veritas Remote Management interface

The IPMI web interface is known as Veritas Remote Management interface. You can use Veritas Remote Management interface to log on to the NetBackup Appliance Shell Menu.

Note: Alert configuration is not supported using the Veritas Remote Management interface. Alert configuration is supported from either the **Settings > Notification > Alert Configuration** menu in the NetBackup Appliance Web Console or the **Settings > Alerts** command view in the NetBackup Appliance Shell Menu. For details, see the Settings > Notifications > Alert Configuration section in the *NetBackup Appliance Administrator's Guide* or the Main > Settings > Alerts view commands section in the *NetBackup Appliance Commands Reference Guide*.

Before you use the Remote Management interface, the following prerequisites must be met:

- The Remote Management interface must first be configured using the NetBackup Appliance Shell Menu.
- At least one power cable must be connected to a functioning power source.

- At least one user must be enabled to use the LAN channel(s).

To access and use the IPMI web interface from a remote computer

- 1 Log on to a remote computer in the network and open a supported Windows browser.
- 2 Enter the remote management port IP address that is assigned to the remote management port. The following page appears:

Logged out. Please log in again to access the device.

Username

Password

- 3 Enter your login information. The default user name is **sysadmin**. The default password is **P@ssw0rd**, where **0** is the number zero.

Click **Login**.

- 4 The **Remote Control** section lets you remotely monitor and control the server. Click **Launch Console** under the **Console Redirection** tab to launch the appliance NetBackup Appliance Shell Menu.

The following figure shows the interface for a 5230 or 5330 appliance.

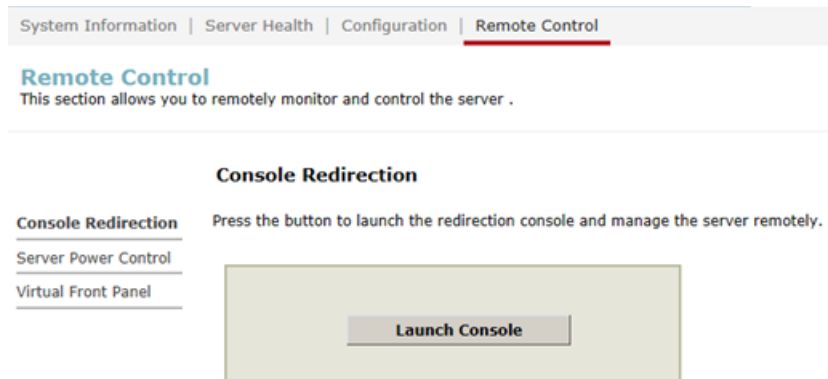

- 5 A JViewer application opens that enables you to remotely monitor and control the appliance. This application requires Java Runtime Environment (JRE) version 6.0 or later. Install Java (as needed).

Caution: Starting with Java 7 update 45, you may receive a security warning when you launch the KVM remote console from the appliance IPMI port. The warning states that you do not have proper permissions and prevents appliance access from the IPMI port. For information about how to resolve this issue, refer to the following document:

https://www.veritas.com/support/en_US/article.100011121.html

- 6 You can now access and log on to the NetBackup Appliance Shell Menu. Enter the user name and password for the appliance.

By default, the user name `admin` has the password, `P@ssw0rd` where 0 is the number zero.

See “[About IPMI configuration](#)” on page 20.

See “[Configuring the IPMI port from the NetBackup Appliance Shell Menu](#)” on page 80.

Hardware installation procedures for a NetBackup 5330 high availability configuration

This chapter includes the following topics:

- [Hardware installation scenarios for a NetBackup 5330 high availability configuration](#)
- [Connecting the partner node to the Primary Storage Shelf](#)
- [Connecting two nodes for HA communication](#)
- [Verifying the hardware installation of a high availability configuration](#)

Hardware installation scenarios for a NetBackup 5330 high availability configuration

The hardware installation procedures for a high availability (HA) configuration are slightly different from a non-HA installation. The differences are as follows:

- Two NetBackup 5330 compute nodes with the same I/O hardware configurations are used.
- Both nodes connect to each other using the NIC3/eth2 and NIC4/eth3 Ethernet ports.
- Both nodes connect directly to the NetBackup 5330 Primary Storage Shelf.

Currently, you can deploy a NetBackup 5330 HA configuration through either of the following methods:

- New deployment for an HA configuration
- Converting existing systems to an HA configuration

The hardware installation scenarios are different for the two deployment methods. For detailed installation instructions for each deployment:

- See [“Installation procedures for a new deployment of a high availability configuration”](#) on page 86.
- See [“Installation procedures for converting existing systems to a high availability configuration”](#) on page 87.

Installation procedures for a new deployment of a high availability configuration

The installation procedures for a new deployment of a NetBackup 5330 high availability (HA) configuration are as follows:

1. Install the components from the bottom of the rack in the following order: the Expansion Storage Shelves, the Primary Storage Shelf, and then the two nodes.

For the installation instructions:

- See [“Installing a primary shelf or an expansion shelf”](#) on page 36.
 - See [“Installing the compute node”](#) on page 47.
2. Connect the Expansion Storage shelves to the Primary Storage Shelf.
See [“Connecting one expansion shelf to a primary shelf”](#) on page 54.
 3. Connect one of the nodes to the Primary Storage Shelf.
See [“Connecting a NetBackup 5330 compute node to a primary shelf”](#) on page 52.
 4. Connect the other node to the Primary Storage Shelf.
See [“Connecting the partner node to the Primary Storage Shelf”](#) on page 87.
 5. Connect the two nodes for HA communication.
See [“Connecting two nodes for HA communication”](#) on page 89.
 6. Verify the hardware installation of an HA configuration.
See [“Verifying the hardware installation of a high availability configuration”](#) on page 90.
 7. Connect the power cords to the hardware.

- See [“Connecting the power cords to the hardware”](#) on page 71.
8. Turn on the power to each component in the same order as the installation.
See [“Turning on the hardware and verifying operation”](#) on page 72.

Installation procedures for converting existing systems to a high availability configuration

The installation procedures for converting existing systems to a NetBackup 5330 high availability (HA) configuration are as follows:

1. Install the new NetBackup 5330 node (the partner node) in the rack with the existing NetBackup 5330 appliance.
See [“Determining rack locations ”](#) on page 30.
See [“Installing the compute node”](#) on page 47.
2. Connect the new node to the Primary Storage Shelf.
See [“Connecting the partner node to the Primary Storage Shelf”](#) on page 87.
3. Connect the new node to the existing node for HA communication.
See [“Connecting two nodes for HA communication”](#) on page 89.
4. Verify the hardware installation of an HA configuration.
See [“Verifying the hardware installation of a high availability configuration”](#) on page 90.
5. Connect the power cords to the hardware.
See [“Connecting the power cords to the hardware”](#) on page 71.
6. Turn on the power to the new node.
See [“Turning on the hardware and verifying operation”](#) on page 72.

Connecting the partner node to the Primary Storage Shelf

The following figure shows the locations of the FC ports in the partner node.

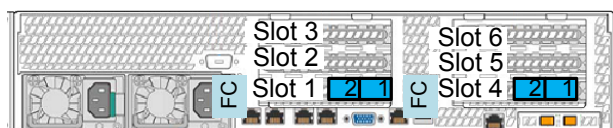

The following figure shows the locations of the FC ports Ch3 and Ch4 in the canisters A and B of the Primary Storage Shelf.

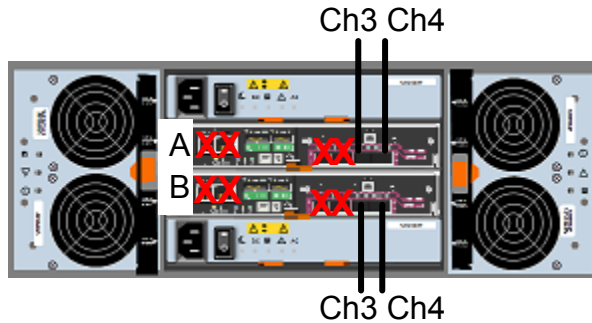

To connect the partner node to the Primary Storage Shelf

- 1 Connect the slot 1 FC ports on the partner node to the following Primary Storage Shelf canister FC ports:
 - Connect partner node slot 1, port 2 to Primary Storage Shelf canister B, FC Ch3.
 - Connect partner node slot 1, port 1 to Primary Storage Shelf canister A, FC Ch3.
- 2 Connect the slot 4 FC ports on the partner node to the following Primary Storage Shelf canister FC ports:
 - Connect partner node slot4, port 2 to Primary Storage Shelf canister B, FC Ch4.

- Connect partner node slot 4, port 1 to Primary Storage Shelf canister A, FC Ch4.
- 3 Verify that the connections match the ports in the following diagram.

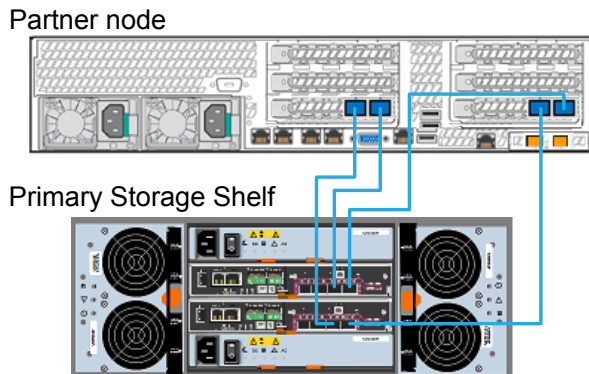

Connecting two nodes for HA communication

When both nodes are connected to the primary shelf, connect the nodes to establish the high availability (HA) communication between them.

Note: Veritas requires that you reserve the NIC3/eth2 and NIC4/eth3 ports to connect the two nodes. Do not connect these ports to a network.

To connect the two nodes

- 1 Locate the NIC3/eth2 and NIC4/eth3 ports on each node.

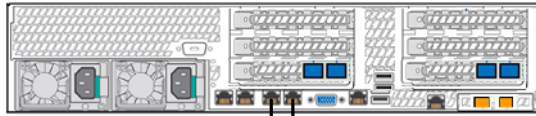

NIC3/eth2 NIC4/eth3

- 2 Connect the NIC3/eth2 and NIC4/eth3 ports on both nodes with two Ethernet cables.
- 3 Verify that the connections match the ports in the following diagram.

Existing compute node

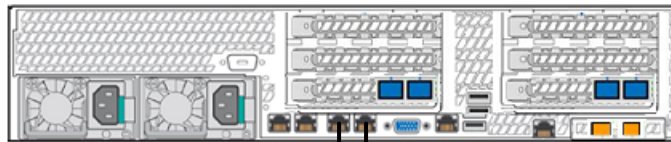

Partner node

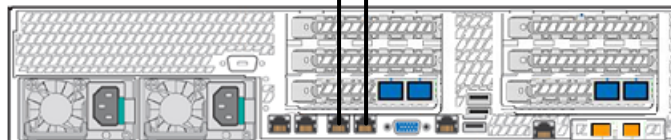

Verifying the hardware installation of a high availability configuration

Verify that the connections match the ports in the following diagram for the hardware installation of a high availability (HA) configuration:

Compute node

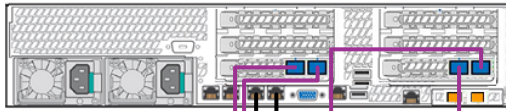

Partner node



Primary Storage Shelf

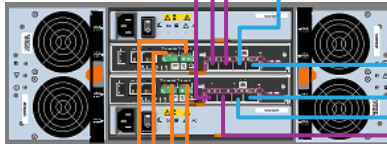

Expansion Storage Shelf



Color keys

Orange: SAS cables connecting the storage shelves

Purple: FC cables connecting the node and Primary Storage Shelf

Blue: FC cables connecting the partner node and Primary Storage Shelf

Black: Ethernet cables connecting the two nodes

When all the cables are connected properly, connect the power cords to the hardware, turn on the hardware, and verify the connections. If the connections are correct, configure the IPMI port and the NIC1 (eth0) interface.

See [“Connecting the power cords to the hardware”](#) on page 71.

See [“Turning on the hardware and verifying operation”](#) on page 72.

See [“Configuring the IPMI port from the NetBackup Appliance Shell Menu”](#) on page 80.

Adding the disk space of a new Expansion Storage Shelf

This appendix includes the following topics:

- [Prerequisites for adding the disk space of new expansion shelves](#)
- [Adding the disk space of an Expansion Storage Shelf from the NetBackup Appliance Web Console](#)
- [Adding the disk space of an Expansion Storage Shelf from the NetBackup Appliance Shell Menu](#)

Prerequisites for adding the disk space of new expansion shelves

Verifying functionality

Before you add the disk space of a new expansion shelf you must make sure that the entire appliance system operates correctly.

To verify appliance functionality

- 1 Verify that the compute node power supply LEDs are green.

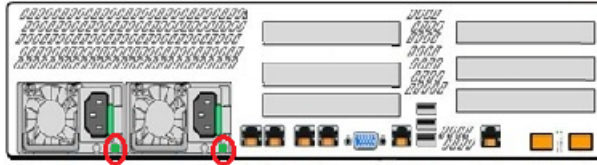

- 2 Verify that the compute node disk drive LEDs are green.



- 3 Verify that the compute node LEDs on the front panel are green.

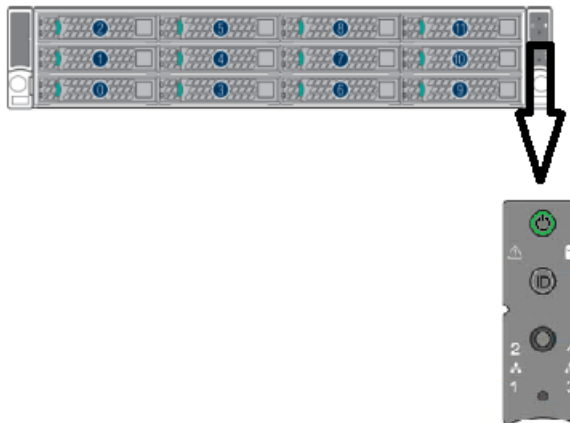

- 4 Verify that the primary shelf and the expansion shelf front panel LEDs are green.

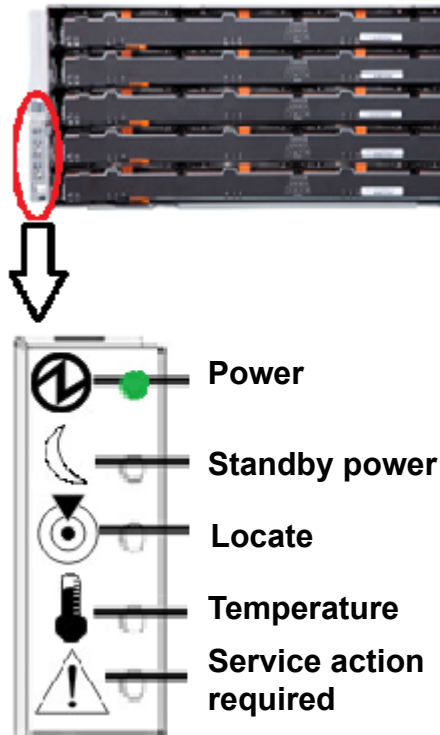

- 5 Verify that the primary shelf and the expansion shelf drawer LEDs are green.



- 6 Verify that the primary shelf and the expansion shelf power canister LEDs are green.

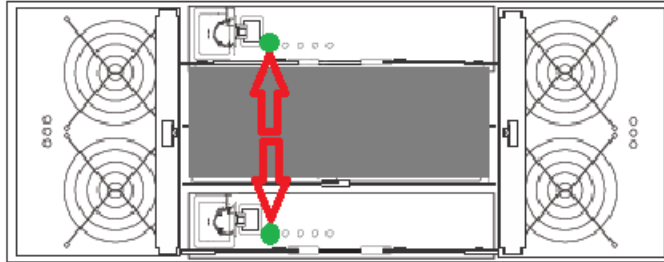

- 7 Verify that the primary shelf and the expansion shelf fan canister LEDs are green.
- 8 Verify that the primary shelf displays 99.

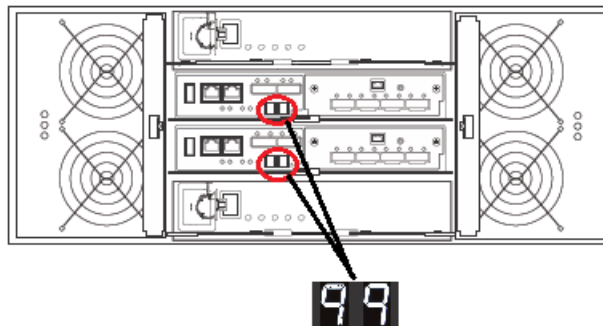

- 9 Verify that the first expansion shelf displays 00.

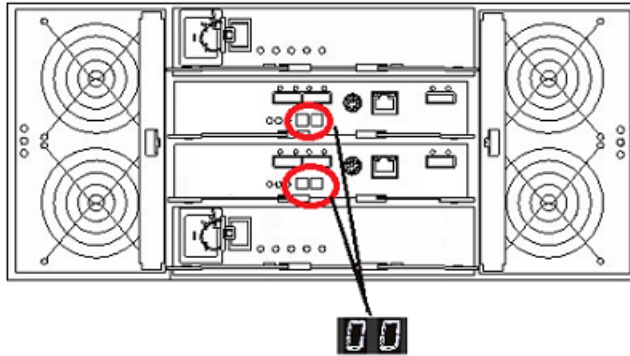

- 10 Verify that the second expansion shelf displays 01.

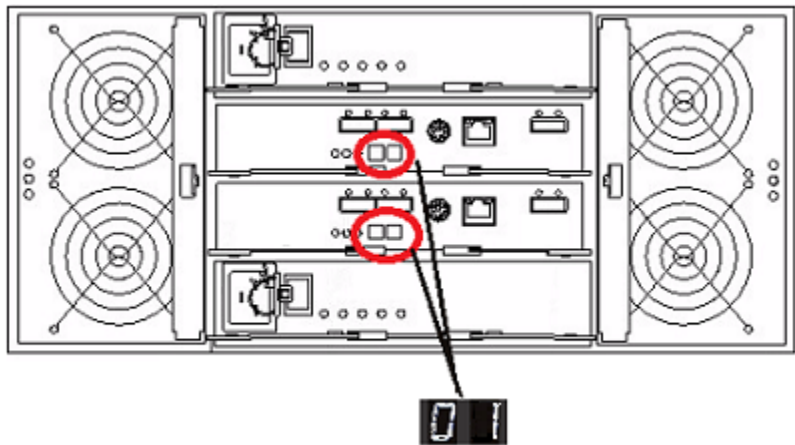

Adding the disk space of an Expansion Storage Shelf from the NetBackup Appliance Web Console

The following procedure describes how to add new storage shelf disk space to an operational NetBackup 53xx appliance by using the NetBackup Appliance Web Console.

To add the disk space of an expansion shelf from the NetBackup Appliance Web Console

- 1 Launch the NetBackup Appliance Web Console and verify that the new storage device appears on the **Monitor > Hardware** page. If the new storage device does not appear, check the cable connections and make sure that the power is on.
- 2 Click **Manage > Storage**.
- 3 Select the **Disks** tab.
- 4 Click **Scan**.
- 5 In the **Do you want to scan for new disks?** dialog box, click **Yes** to start the scan.
- 6 When the scan is complete, click **OK** to refresh the **Disks** tab.

In the **Disk** column, new ID's should appear for the new Expansion Shelf. Six new Data disks and one new Meta disk is displayed. The data disks have the following attributes:

- **Type = Data.**
- **Status = New Available**

The Meta disk has the following attributes:

- **Type = Meta**
- **Status = New Available**

- 7 Click **Add** for each newly available disk to activate the storage.
- 8 In the **Confirmation** dialog box, click **Yes** to continue.

When the process completes, the following message should appear:

Adding disk <disk ID>. Succeeded.

- 9 Click **OK** to refresh the system.

Repeat steps 7 through 9 to add each new disk.

After the disks have been added, the **Disks** tab should show the following attributes for the new disks:

- **Status = In Use**
- **Unallocated = *n* TB**

Where *n* is the usable volume or disk space available in the new disk.

Adding the disk space of an Expansion Storage Shelf from the NetBackup Appliance Shell Menu

The following procedure describes how to add new storage shelf disk space to a 53xx appliance by using the NetBackup Appliance Shell Menu.

To add the disk space of an expansion shelf from the NetBackup Appliance Shell Menu

- 1 Use PuTTY to start an SSH session to access the NetBackup Appliance Shell Menu.

Note: You can also connect a laptop, keyboard and monitor, or KVM to the appliance to access the NetBackup Appliance Shell Menu.

- 2 Log in to the NetBackup Appliance Shell Menu. The **Main_Menu** prompt appears.
- 3 Navigate to the **Monitor** menu as follows:
Enter `Monitor` and press `Enter`.
- 4 Type `Hardware ShowHealth` and press `Enter`.
Information about the system appears. Browse to the **Primary Storage Shelf to Expansion Storage Shelf Connection information**. The **Status** column should say **Connected**.
- 5 At the prompt, type **return** to return to the **Main** menu.
- 6 Perform a scan as follows:
 - At the **Main_Menu** prompt, type `Manage` and press `Enter`.
 - Type `Storage` and press `Enter`.
 - Type `Scan` and press `Enter`.The scan takes a couple of minutes to complete.
- 7 View the available storage space as follows:
 - Navigate to the **Storage** menu.
 - At the prompt, type `Show Disk` and press `Enter`.
Note that you can add the disks with status **New Available**.
- 8 From the **Storage** menu, enter `Add` and press `Enter`. It displays the disks that are in a **New Available** state and can be added. Copy a disk ID that is displayed.

9 At the prompt, enter **add <disk ID>** and press `Enter`. <disk ID> is the disk ID that you copied.

Repeat step **8** and **9** to add each disk ID that is displayed.

10 View the available storage space as follows:

- Navigate to the **Storage** menu.
- At the prompt, enter `Show Disk` and press `Enter`.
The status of the newly added disks is displayed as **In Use** and space in the **Unallocated** column is the disk space available for the new disk.

Index

A

- appliance
 - remote management port IP address 80

B

- best practices
 - hardware installation 31
 - turning off the power 58

C

- compute node
 - connecting to primary shelf 52
 - installation 47
 - PCIe add-in cards 8
 - unpacking 29
 - weight 29
- configure
 - IPMI 80
- connectors
 - C-13 to C-14 12
 - C-14 to C-19 12
- customer-provided items 25

D

- disk drives
 - compute node 6
 - storage shelves 10

E

- Ethernet ports
 - NetBackup 5330 configurations 9

H

- hardware
 - correct turn on sequence 72
 - installation sequence 16
 - rack locations 30
 - verifying operation 72

- hardware installation scenarios
 - high availability configuration 85
 - one compute node 15

I

- installation
 - compute node 47
 - customer-provided items 25
 - expansion shelf 36
 - primary shelf 36
 - sequence 16
 - storage shelf disks 44
 - storage shelf into rails 43
 - storage shelf rails 38
 - times 16
- IP address
 - remote management port 80
- IPMI configuration 80
 - about 20
 - prerequisites 33

P

- PCIe add-in cards
 - compute node configurations 8
- power cords
 - connecting to storage shelves 71
- power supply
 - compute node input voltage 7
 - storage shelves 10, 12
- primary shelf
 - connecting to an expansion shelf 55
 - connecting to compute node 52

R

- rack locations 30

S

- SAS2 cable 32
- shipping container contents 24

- storage shelves
 - disk drives
 - installing 44
 - layout 44
 - slot numbers 44
 - six-shelf cable example 70
 - two-shelf cable example 68
 - unpacking 26
 - weight 26

U

- unpacking
 - compute node 29
 - storage shelves 26

W

- weight
 - compute node 29
 - storage shelves 26