



MB5400 series Online Manual

Printer Functions
 Overview
 Printing
 Scanning
 Faxing
 Troubleshooting

Contents

Using This Online Manual.	23
Trademarks and Licenses.	24
Search Tips.	33
Using the Machine.	35
Printing Documents from Your Computer (Windows).	36
Printing Documents from Your Computer (Mac OS).	39
Copying.	43
Faxing.	46
Printer Functions.	49
Printing from an AirPrint-enabled Printer.	50
Printing from an AirPrint-enabled Printer with Mac.	51
Printing from an AirPrint-enabled Printer with iOS Device.	53
Connect Wirelessly in "Direct Connection".	57
Download a Variety of Content Materials.	58
Print Items with Easy-PhotoPrint+ (Web Application).	59
Managing Printer Conveniently Using Quick Utility Toolbox.	60
Available Connection Methods.	61
Scan Originals Larger than the Platen.	63
Scan Multiple Originals at One Time.	64
Using PIXMA/MAXIFY Cloud Link.	65
Notice for Web Service Printing.	66
Using PIXMA/MAXIFY Cloud Link from Your Printer.	67
Before Using PIXMA/MAXIFY Cloud Link.	68
Registering Printer Information to PIXMA/MAXIFY Cloud Link.	70
Application Management.	73
Using PIXMA/MAXIFY Cloud Link.	78
Cloud Windows.	81
Cloud Troubleshooting.	84
Using PIXMA/MAXIFY Cloud Link from Your Smartphone, Tablet, or Computer.	85
Before Using Canon Inkjet Cloud Printing Center.	86

Requirements for Canon Inkjet Cloud Printing Center operation.	87
Registering User Information to Canon Inkjet Cloud Printing Center.	89
Registering User Information to Canon Inkjet Cloud Printing Center (Color LCD Monitor). . .	90
Registering User Information to Canon Inkjet Cloud Printing Center (Monochrome LCD Monitor).	98
Registering User Information to Canon Inkjet Cloud Printing Center (No LCD Monitor/Using PRO-1000 series or PRO-500 series).	107
Using Canon Inkjet Cloud Printing Center.	114
Canon Inkjet Cloud Printing Center window.	118
Adding a Printer.	157
Adding a PIXMA/MAXIFY Cloud Link User.	160
Troubleshooting Canon Inkjet Cloud Printing Center.	166
Print Easily from a Smartphone or Tablet with Canon PRINT Inkjet/SELPHY.	169
Printing with Windows RT.	170
Online Storage Integration Function.	171
Handling Paper, Originals, Ink Tanks, etc.	172
Loading Paper.	173
Paper Sources.	174
Loading Plain Paper / Photo Paper.	177
Loading Envelopes.	182
Loading Originals.	187
Where to Load Originals.	188
Loading Originals on the Platen Glass.	189
Loading Documents in the ADF (Auto Document Feeder).	190
Loading Based on Use.	191
Supported Originals.	193
Inserting a USB Flash Drive.	195
Inserting a USB Flash Drive.	196
Removing a USB Flash Drive.	197
Replacing Ink Tanks.	198
Replacing Ink Tanks.	199
Checking Ink Status on the Touch Screen.	204
Maintenance.	205

If Printing Is Faint or Uneven.	206
Maintenance Procedure.	207
Printing the Nozzle Check Pattern.	209
Examining the Nozzle Check Pattern.	211
Cleaning the Print Head.	213
Deep Print Head Cleaning.	215
Aligning the Print Head.	217
Aligning the Print Head Manually.	219
Performing Maintenance Functions from Your Computer (Windows).	223
Cleaning the Print Heads.	224
Aligning the Print Head Position.	226
Aligning the Print Head Position Manually.	227
Printing a Nozzle Check Pattern.	230
Cleaning.	231
Cleaning Exterior Surfaces.	232
Cleaning the Platen Glass and Document Cover.	233
Cleaning the ADF (Auto Document Feeder).	234
Cleaning Paper Feed Rollers.	236
Cleaning Inside the Machine (Bottom Plate Cleaning).	238
Cleaning Cassette Pads.	241
Overview.	242
Safety.	244
Safety Precautions.	245
Regulatory Information.	246
WEEE (EU&EEA).	251
Main Components and Their Use.	263
Main Components.	264
Front View.	265
Rear View.	268
Inside View.	269
Operation Panel.	270
Power Supply.	272
Confirming that the Power Is On.	273
Turning the Machine On and Off.	274

Checking the Power Plug/Power Cord.	276
Unplugging the Machine.	277
Using the Operation Panel.	278
Entering Numbers, Letters, and Symbols.	282
Changing Settings.	284
Changing Printer Settings from Your Computer (Windows).	285
Changing the Print Options.	286
Registering a Frequently Used Printing Profile.	288
Managing the Printer Power.	290
Reducing the Printer Noise.	291
Changing the Printer Operation Mode.	293
Changing Settings from Operation Panel.	295
Changing Settings from Operation Panel.	296
Setting Items on Operation Panel.	298
FAX settings.	299
Print settings.	303
LAN settings.	304
Device user settings.	309
Timezone List.	312
Language selection.	314
Firmware update.	315
Cassette settings.	317
Administrator password setting.	318
Setting Administrator Password on Operation Panel.	319
Operation restrictions.	321
Restricting Machine Operation.	322
Reset setting.	325
Web service setup.	327
System information.	328
ECO settings.	329
Quiet setting.	334
Registering Favorite Settings (Custom profiles).	336
Checking the Total Number of Uses of Machine.	338
Changing Printer's Setting Using Web Browser.	339
Changing Settings Using Web Browser.	340

Registering Printer's Root Certificate to Web Browser.	343
Changeable Setting Items Using Web Browser.	347
Setting Password.	349
Setting Mail Server.	351
Specifying Mail Setting for Sending Scanned Data.	353
Receiving Printer Status by E-mail.	354
Network Connection.	356
Network Connection Tips.	357
Default Network Settings.	358
Another Printer Found with Same Name.	360
Connecting to Another Computer via LAN/Changing from USB to LAN Connection.	361
Printing Network Settings.	362
Changing LAN Connection Method/Changing Wireless LAN Connection Method.	368
Network Settings (IJ Network Device Setup Utility) (Windows).	370
IJ Network Device Setup Utility.	371
Starting Up IJ Network Device Setup Utility.	372
IJ Network Device Setup Utility Screen.	373
Performing Network Settings.	378
Performing/Changing Wired LAN Settings.	379
Performing/Changing Wireless LAN Settings.	382
Assigning Printer Information.	386
Initializing Network Settings.	387
Changing Administrator Password.	388
Setting Criteria for Printer Search/Searching Specific Printer.	389
If WEP Details Screen Appears.	391
If WPA/WPA2 Details Screen Appears.	392
Checking Network Status.	393
Checking Wireless Network Status.	394
Displaying Computer Network Information.	395
Displaying Printer Network Information.	396
Checking Connection Status between Printer and Wireless Router.	397
Checking Network Setting Difference.	398
IJ Network Device Setup Utility Menus.	399
Printer Menu.	400
View Menu.	402

Option Menu.	404
Help Menu.	405
Other Network Information.	406
Technical Terms.	407
Restrictions.	414
Firewall.	415
Ensuring Optimal Printing Results.	416
Ink Tips.	417
Printing Tips.	418
Check Paper Settings Before Printing.	419
Set Cassette Paper Information After Loading Paper.	420
Canceling Print Jobs.	421
Keeping Print Quality High.	422
Transporting Your Machine.	423
Legal Restrictions on Scanning/Copying.	424
Specifications.	425
Information about Paper.	430
Supported Media Types.	431
Paper Load Limit.	433
Unsupported Media Types.	435
Handling Paper.	436
Print Area.	437
Print Area.	438
Standard Sizes.	439
Envelopes.	441
Administrator Settings.	442
Sharing the Printer on a Network.	443
Setting Up a Shared Printer.	444
Restrictions on Printer Sharing.	446
Administrator Password.	448
Password and Cookie.	450
How to locate your printer's serial number.	452

Registering Root Certificate to Web Browser.	453
Printing.	454
Printing from Computer.	455
Printing from Application Software (Windows Printer Driver).	456
Printing with Easy Setup.	457
Paper Settings on the Printer Driver and the Printer (Media Type).	461
Paper Settings on the Printer Driver and the Printer (Paper Size).	462
Various Printing Methods.	463
Setting a Page Size and Orientation.	464
Setting the Number of Copies and Printing Order.	465
Setting the Stapling Margin.	467
Fit-to-Page Printing.	469
Scaled Printing.	471
Page Layout Printing.	474
Tiling/Poster Printing.	476
Booklet Printing.	479
Duplex Printing.	481
Stamp/Background Printing.	485
Setting Up Envelope Printing.	494
Printing on Postcards.	496
Switching the Paper Source to Match the Purpose.	498
Displaying the Print Results before Printing.	500
Setting Paper Dimensions (Custom Size).	501
Editing the Print Document or Reprinting from the Print History.	503
Changing the Print Quality and Correcting Image Data.	507
Printing a Color Document in Monochrome.	508
Specifying Color Correction.	510
Adjusting Color Balance.	518
Adjusting Color Balance Using Sample Patterns (Printer Driver).	520
Adjusting Brightness.	524
Adjusting Intensity.	526
Adjusting Contrast.	528
Adjusting Intensity/Contrast Using Sample Patterns (Printer Driver).	530
Overview of the Printer Driver.	534
Canon IJ Printer Driver.	535

Canon IJ Status Monitor.	537
Canon IJ Preview.	539
Deleting the Undesired Print Job.	540
Instructions for Use (Printer Driver).	541
Printer Driver Description.	543
Quick Setup tab Description.	544
Main tab Description.	550
Page Setup tab Description.	555
Maintenance tab Description.	568
Canon IJ Preview Description.	574
Canon IJ XPS Preview Description.	577
Canon IJ Status Monitor Description.	586
Updating the MP Drivers.	589
Obtaining the Latest MP Drivers.	590
Deleting the Unnecessary MP Drivers.	591
Before Installing the MP Drivers.	592
Installing the MP Drivers.	593
Printing Using a Web Service.	594
Using PIXMA/MAXIFY Cloud Link.	65
Printing with Google Cloud Print.	596
Getting Google Account.	598
Registering Printer with Google Cloud Print.	599
Printing from Computer or Smartphone with Google Cloud Print.	602
Deleting Printer from Google Cloud Print.	606
Printing from an AirPrint-enabled Printer with Mac.	51
Printing from a Device Equipped with Windows 10 Mobile.	610
Printing from Smartphone/Tablet.	611
Printing Directly from Smartphone/Tablet.	612
Android Print.	613
Printing from an AirPrint-enabled Printer with iOS Device.	53
Using Machine with Direct Connection.	619
Printing Using a Web Service.	624
Using PIXMA/MAXIFY Cloud Link.	65
Printing with Google Cloud Print.	596
Printing Using Operation Panel.	628

Printing Photo Data.	629
Printing Photographs Saved on USB Flash Drive.	630
Setting Items for Photo Printing Using Operation Panel.	635
Using Useful Display Functions.	637
Printing Documents (PDF File) Saved on USB Flash Drive.	639
Paper Settings.	643
Copying.	647
Making Copies.	648
Displaying Preview Screen.	651
Setting Items for Copying.	653
Reducing/Enlarging Copies.	656
Two-Sided Copying.	658
Special Copy Menu.	662
Copying Two Pages onto Single Page.	663
Copying Four Pages onto Single Page.	666
Copying Thick Originals Such as Books.	669
Copying ID Card to Fit onto Single Page.	670
Collated Copying.	672
Copying from Smartphone/Tablet.	674
Scanning.	676
Scanning from Computer (Windows).	677
Using IJ Scan Utility.	678
What Is IJ Scan Utility (Scanner Software)?.	679
Starting IJ Scan Utility.	681
Scanning Documents.	682
Scanning Photos.	683
Scanning with Favorite Settings.	684
Scanning Originals Larger than the Platen (Image Stitch).	685
Adjusting Cropping Frames in the Image Stitch Window.	690
Extracting Text from Scanned Images (OCR).	691
Sending Scanned Images via E-mail.	693
Scanning Multiple Originals at One Time.	694
Scanning Multiple Documents at One Time from the ADF (Auto Document Feeder).	698

Scanning Both Sides of Each Document at One Time.	703
Saving after Checking Scan Results.	707
IJ Scan Utility Screens.	710
IJ Scan Utility Main Screen.	711
Settings Dialog Box.	713
Save Settings Dialog Box.	770
Password Security Settings Dialog Box.	774
Image Stitch Window.	776
Scanning Using Application Software (ScanGear).	781
What Is ScanGear (Scanner Driver)?	782
Scanning with Advanced Settings Using ScanGear (Scanner Driver).	784
Starting ScanGear (Scanner Driver).	785
Scanning in Basic Mode.	786
Scanning in Advanced Mode.	789
Scanning Multiple Documents from the ADF (Auto Document Feeder) in Advanced Mode.	791
Scanning Multiple Documents at One Time with ScanGear (Scanner Driver).	793
Correcting Images and Adjusting Colors with ScanGear (Scanner Driver).	797
Correcting Images (Unsharp Mask, Reduce Dust and Scratches, Fading Correction, etc.).	798
Adjusting Colors Using a Color Pattern.	802
Adjusting Saturation and Color Balance.	804
Adjusting Brightness and Contrast.	806
Adjusting Histogram.	809
Adjusting Tone Curve.	813
Setting Threshold.	816
ScanGear (Scanner Driver) Screens.	817
Basic Mode Tab.	818
Advanced Mode Tab.	826
Input Settings.	832
Output Settings.	835
Image Settings.	838
Color Adjustment Buttons.	843
Preferences Dialog Box.	846
Scanner Tab.	847
Preview Tab.	850
Scan Tab.	852
Color Settings Tab.	853

Positioning Originals (Scanning from Computer)	855
Adjusting Cropping Frames (ScanGear)	858
General Notes (Scanner Driver)	862
Other Scanning Methods	864
Scanning with WIA Driver	865
IJ Network Scanner Selector EX2 Menu and Setting Screen	869
Uninstalling IJ Network Scanner Selector EX2	872
Scanning Tips	873
Resolution	874
Data Formats	876
Color Matching	877
Positioning Originals (Scanning from Computer)	878
Network Scan Settings	881
Scanning from Computer (Mac OS)	885
Scanning from Operation Panel	886
Forwarding Scanned Data to Computer Using Operation Panel	887
Sending Scanned Data as E-Mail from Computer	891
Sending Scanned Data as E-Mail from Machine	895
Sending Scanned Data as E-Mail from Machine	896
Registering Recipients' E-Mail Address	901
Registering Recipients in Group E-Mail	904
Changing Registered Information	908
Deleting Registered Information	910
Importing/Exporting E-Mail Address Book	911
Saving Scanned Data on USB Flash Drive	913
Forwarding Scanned Data to Shared Folder on Computer	917
Deleting Scanned Data on USB Flash Drive	920
Setting Items for Scanning Using Operation Panel	922
Setting Up Operation Panel with IJ Scan Utility (Windows)	924
Scanning Using Smartphone/Tablet	927
Using PIXMA/MAXIFY Cloud Link	65
Faxing	929
Preparing for Faxing	930
Connecting Telephone Line	931

Setting Telephone Line Type.	934
Setting Receive Mode.	937
Setting Sender Information.	942
Sending Faxes Using Operation Panel of Printer.	949
Sending Faxes by Entering Fax/Telephone Number.	950
Resending Faxes (Redialing Busy Number).	954
Setting Items for Sending Faxes.	956
Sending Faxes Using Useful Functions.	957
Sending Fax after Speaking on Telephone.	958
Sending Fax to Registered Recipient.	960
Sending Same Document to Several Recipients (Sequential Broadcasting).	963
Preventing Mistransmission of Faxes.	967
Using On Hook Dial Function.	969
Registering Recipients.	971
Registering Recipients Using Operation Panel of Printer.	972
Registering Fax/Telephone Number of Recipients.	973
Registering Recipients in Group Dial.	977
Changing Registered Information.	981
Deleting Registered Information.	983
Printing List of Registered Destinations.	984
Registering Recipients Using Speed Dial Utility2 (Windows).	985
Starting Up Speed Dial Utility2.	986
Speed Dial Utility2 Dialog box.	987
Saving Registered Telephone Directory on Printer to Your Computer.	989
Registering a Fax/telephone Number Using Speed Dial Utility2.	990
Changing a Fax/telephone Number Using Speed Dial Utility2.	992
Deleting a Fax/telephone Number Using Speed Dial Utility2.	994
Changing Sender Information Using Speed Dial Utility2.	995
Registering/Changing Rejected Number Using Speed Dial Utility2.	996
Registering Telephone Directory Has been Saved on Your Computer to Printer.	997
Receiving Faxes.	998
Receiving Faxes.	999
Changing Paper Settings.	1004
Memory Reception.	1006
Receiving Faxes Using Useful Functions.	1008

Saving Received Faxes Automatically on USB Flash Drive.	1009
Forwarding Received Faxes Automatically to Shared Folder on Computer.	1011
Remote Reception.	1013
Rejecting Fax Reception.	1014
Using Caller ID Service to Reject Calls.	1017
Other Useful Fax Functions.	1019
Using Information Services.	1020
Transmission/Reception of Faxes Using ECM.	1022
Document Stored in Printer's Memory.	1023
Printing Document in Printer's Memory.	1024
Deleting Document in Printer's Memory.	1026
Saving Document in Printer's Memory to USB Flash Drive.	1028
Forwarding Document in Printer's Memory to Shared Folder on Computer.	1031
Summary of Reports and Lists.	1034
Sending Faxes from Computer (Windows).	1039
Sending a FAX (Fax Driver).	1040
Creating an Address Book (Fax Driver).	1043
Edit or Remove a Recipient from an Address Book (Fax Driver).	1047
Search for a Recipient in an Address Book (Fax Driver).	1050
Cannot Send Faxes from Computer.	1052
How to Open the Setting Screen of the Fax Driver.	1054
General Notes (Fax Driver).	1056
Sending Faxes from Computer (Mac OS).	1057
Sending a Fax.	1058
General Notes.	1061
Troubleshooting.	1062
Network Communication Problems.	1064
Cannot Find Machine on Network.	1065
Cannot Find Machine on Check Printer Settings Screen.	1066
Check 1: Cannot Find Machine on Check Printer Settings Screen During Wireless LAN Setup.	1067
Check 2: Cannot Find Machine on Check Printer Settings Screen During Wireless LAN Setup.	1068
Check 3: Cannot Find Machine on Check Printer Settings Screen During Wireless LAN Setup.	1069

Check 4: Cannot Find Machine on Check Printer Settings Screen During Wireless LAN Setup.	1071
Check 5: Cannot Find Machine on Check Printer Settings Screen During Wireless LAN Setup.	1072
Check 6: Cannot Find Machine on Check Printer Settings Screen During Wireless LAN Setup.	1073
Check 1: Cannot Find Machine on Check Printer Settings Screen During Wired LAN Setup.	1074
Check 2: Cannot Find Machine on Check Printer Settings Screen During Wired LAN Setup.	1075
Check 3: Cannot Find Machine on Check Printer Settings Screen During Wired LAN Setup.	1076
Check 4: Cannot Find Machine on Check Printer Settings Screen During Wired LAN Setup.	1077
Check 5: Cannot Find Machine on Check Printer Settings Screen During Wired LAN Setup.	1078
Check 6: Cannot Find Machine on Check Printer Settings Screen During Wired LAN Setup.	1079
Cannot Find Machine after Searching it on Printer Detection Screen During Setup.	1080
Searching Machine by IP Address or Host Name During Setup (Windows).	1082
Cannot Proceed beyond Printer Connection Screen/Connect Cable Screen.	1085
Cannot Find Machine while Using Wireless LAN.	1087
Cannot Find Machine while Using Wired LAN.	1089
Network Connection Problems.	1090
Machine Suddenly Cannot Be Used.	1091
Network Key Unknown.	1096
Administrator Password Set for Machine Unknown.	1098
Machine Cannot Be Used After Replacing Wireless Router or Changing Its Settings.	1099
Printing Is Slow.	1101
Cannot Access to Internet on Wireless LAN from Communication Device.	1102
Ink Level Not Shown on Printer Status Monitor (Windows).	1103
Other Network Problems.	1104
Message Appears on Computer During Setup.	1105
Packets Are Sent Constantly (Windows).	1107
Checking Network Information.	1108
Restoring to Factory Defaults.	1111
Problems while Printing/Scanning from Smartphone/Tablet.	1112
Cannot Print/Scan from Smartphone/Tablet.	1113

Printing Problems.	1116
Printing Does Not Start.	1117
Paper Jams.	1120
Print Results Are Unsatisfactory.	1122
Cannot Complete Printing.	1124
Part of Page Is Not Printed (Windows).	1125
Paper Is Blank/Printing Is Blurry/Colors Are Wrong/White Streaks Appear.	1126
Lines Are Misaligned.	1129
Lines Incomplete or Missing (Windows).	1130
Images Incomplete or Missing (Windows).	1131
Ink Blots / Paper Curl.	1132
Paper Is Smudged / Printed Surface Is Scratched.	1133
Back of Paper Is Smudged.	1137
Uneven or Streaked Colors.	1138
No Ink Comes Out.	1140
Paper Does Not Feed Properly/"No Paper" Error.	1141
Automatic Duplex Printing Problems.	1143
Copying/Printing Stops.	1145
Cannot Print Using AirPrint.	1146
Scanning Problems (Windows).	1147
Scanning Problems.	1148
Scanner Does Not Work.	1149
ScanGear (Scanner Driver) Does Not Start.	1150
Error Message Appears and the ScanGear (Scanner Driver) Screen Does Not Appear.	1151
Cannot Scan Multiple Originals at One Time.	1152
Slow Scanning Speed.	1153
"There is not enough memory." Message Is Displayed.	1154
Computer Stops Operating during Scanning.	1155
Scanner Does Not Work after Upgrading Windows.	1156
Scanned Image Does Not Open.	1157
Scan Results Are Unsatisfactory.	1158
Moire Appears in Scan Results.	1159
Scan Quality (Image Displayed on the Monitor) Is Poor.	1160
Scanned Image Is Surrounded by Extra White Areas.	1162
Cannot Scan at the Correct Size.	1163

Position or Size of the Image Cannot be Detected Correctly When Scanning from the Operation Panel.	1164
Original Is Placed Correctly, but the Scanned Image Is Slanted.	1165
Scanned Image Is Enlarged (Reduced) on the Computer Monitor.	1166
Software Problems.	1167
The E-mail Client You Want to Use Does Not Appear in the Screen for Selecting an E-mail Client.	1168
IJ Scan Utility Error Messages.	1169
ScanGear (Scanner Driver) Error Messages.	1171
Faxing Problems.	1174
Problems Sending Faxes.	1175
Cannot Send a Fax.	1176
Cannot Perform Sequential Broadcasting by Redialing, or Cannot Dial by Entering Numbers.	1178
Errors Often Occur When You Send a Fax.	1179
Problems Receiving Faxes.	1180
Cannot Receive a Fax, Cannot Print a Fax.	1181
Printer Does Not Switch Automatically between Voice and Fax Calls.	1184
Quality of Received Fax is Poor.	1185
Cannot Receive a Color Fax.	1186
Errors Often Occur When You Receive a Fax.	1187
Cannot Send a Fax Clearly.	1188
Telephone Problems.	1189
Cannot Dial.	1190
Telephone Disconnects During a Call.	1191
Mechanical Problems.	1192
Power Does Not Come On.	1193
USB Connection Problems.	1194
Cannot Communicate with Machine via USB.	1195
Display on Touch Screen Is Off.	1196
Touch Screen Shows Wrong Language.	1197
Print Head Holder Does Not Move to Replacement Position.	1198
Printer Status Monitor Not Displayed (Windows).	1199
Installation and Download Problems.	1200
Cannot Install MP Drivers.	1201
Easy-WebPrint EX Does Not Start or Easy-WebPrint EX Menu Does Not Appear (Windows).	1203

Updating MP Drivers in Network Environment (Windows)	1204
Errors and Messages	1205
An Error Occurs	1206
A Message for Faxing Is Displayed on Fax Standby Screen	1208
Message Appears	1211
If You Cannot Solve a Problem	1220
List of Support Code for Error	1221
List of Support Code for Error (Paper Jams)	1223
1300	1224
1303	1228
1313	1231
1314	1234
2801	1237
Other Cases	1240
1007	1241
1008	1242
1200	1243
1309	1244
1310	1245
1319	1246
1575	1247
1600	1248
1660	1249
1688	1250
1700	1251
1701	1252
1754	1253
1755	1254
1872	1255
1873	1256
1874	1257
1890	1258
2001	1259

2002.....	1260
2111.....	1261
2112.....	1264
2113.....	1267
2121.....	1270
2122.....	1271
2500.....	1272
2700.....	1273
2802.....	1274
2803.....	1275
2805.....	1278
3401.....	1279
3402.....	1280
3403.....	1281
3404.....	1282
3405.....	1283
3406.....	1284
3407.....	1285
3408.....	1286
3410.....	1287
3411.....	1288
3412.....	1289
3413.....	1290
3414.....	1291
3415.....	1292
3416.....	1293
3417.....	1294
3418.....	1295
3419.....	1296
3420.....	1297
3421.....	1298
3422.....	1299
3423.....	1300

3424.....	1301
3425.....	1302
3426.....	1303
3427.....	1304
3428.....	1305
3429.....	1306
3430.....	1307
3431.....	1308
3432.....	1309
3433.....	1310
4100.....	1311
4103.....	1312
4104.....	1313
5011.....	1314
5012.....	1315
5040.....	1316
5050.....	1317
5051.....	1318
5100.....	1319
5102.....	1320
5103.....	1321
5104.....	1322
5105.....	1323
5200.....	1324
5203.....	1325
5204.....	1326
5205.....	1327
5206.....	1328
5207.....	1329
5208.....	1330
5209.....	1331
5400.....	1332
5500.....	1333

5501.....	1334
5B00.....	1335
5B01.....	1336
5C01.....	1337
6000.....	1338
6500.....	1339
6502.....	1340
6700.....	1341
6701.....	1342
6800.....	1343
6801.....	1344
6900.....	1345
6901.....	1346
6902.....	1347
6910.....	1348
6911.....	1349
6920.....	1350
6921.....	1351
6930.....	1352
6931.....	1353
6932.....	1354
6933.....	1355
6936.....	1356
6937.....	1357
6938.....	1358
6939.....	1359
693A.....	1360
6940.....	1361
6941.....	1362
6942.....	1363
6943.....	1364
6944.....	1365
6945.....	1366

6946.....	1367
7100.....	1368
7200.....	1369
7201.....	1370
7202.....	1371
7203.....	1372
7204.....	1373
7205.....	1374
9000.....	1375
9500.....	1376
B202.....	1377
B203.....	1378
B204.....	1379
B205.....	1380
B502.....	1381
B503.....	1382
B504.....	1383
C000.....	1384

Using This Online Manual

- [Symbols Used in This Document](#)
- [Touch-enabled Device Users \(Windows\)](#)

Symbols Used in This Document

Warning

Instructions that, if ignored, could result in death or serious personal injury caused by incorrect operation of the equipment. These must be observed for safe operation.

Caution

Instructions that, if ignored, could result in personal injury or material damage caused by incorrect operation of the equipment. These must be observed for safe operation.

Important

Instructions including important information. To avoid damage and injury or improper use of the product, be sure to read these indications.

Note

Instructions including notes for operation and additional explanations.

Basics

Instructions explaining basic operations of your product.

Note

-
- Icons may vary depending on your product.
-

Touch-enabled Device Users (Windows)

For touch actions, you need to replace "right-click" in this document with the action set on the operating system. For example, if the action is set to "press and hold" on your operating system, replace "right-click" with "press and hold."

Trademarks and Licenses

- Microsoft is a registered trademark of Microsoft Corporation.
- Windows is a trademark or registered trademark of Microsoft Corporation in the U.S. and/or other countries.
- Windows Vista is a trademark or registered trademark of Microsoft Corporation in the U.S. and/or other countries.
- Internet Explorer is a trademark or registered trademark of Microsoft Corporation in the U.S. and/or other countries.
- Mac, Mac OS, AirPort, Safari, Bonjour, iPad, iPhone and iPod touch are trademarks of Apple Inc., registered in the U.S. and other countries. App Store, AirPrint and the AirPrint logo are trademarks of Apple Inc.
- IOS is a trademark or registered trademark of Cisco in the U.S. and other countries and is used under license.
- Google Cloud Print, Google Chrome, Chrome OS, Chromebook, Android, Google Play, Google Drive, Google Apps and Picasa are either registered trademarks or trademarks of Google Inc.
- Adobe, Flash, Photoshop, Photoshop Elements, Lightroom, Adobe RGB and Adobe RGB (1998) are either registered trademarks or trademarks of Adobe Systems Incorporated in the United States and/or other countries.
- Bluetooth is a trademark of Bluetooth SIG, Inc., U.S.A. and licensed to Canon Inc.
- Autodesk and AutoCAD are registered trademarks or trademarks of Autodesk, Inc., and/or its subsidiaries and/or affiliates in the USA and/or other countries.

»» Note

- The formal name of Windows Vista is Microsoft Windows Vista operating system.

Copyright (c) 2003-2004, Apple Computer, Inc. All rights reserved.

Redistribution and use in source and binary forms, with or without modification, are permitted provided that the following conditions are met:

1. Redistributions of source code must retain the above copyright notice, this list of conditions and the following disclaimer.
2. Redistributions in binary form must reproduce the above copyright notice, this list of conditions and the following disclaimer in the documentation and/or other materials provided with the distribution.
3. Neither the name of Apple Computer, Inc. ("Apple") nor the names of its contributors may be used to endorse or promote products derived from this software without specific prior written permission.

THIS SOFTWARE IS PROVIDED BY APPLE AND ITS CONTRIBUTORS "AS IS" AND ANY EXPRESS OR IMPLIED WARRANTIES, INCLUDING, BUT NOT LIMITED TO, THE IMPLIED WARRANTIES OF MERCHANTABILITY AND FITNESS FOR A PARTICULAR PURPOSE ARE DISCLAIMED. IN NO EVENT SHALL APPLE OR ITS CONTRIBUTORS BE LIABLE FOR ANY DIRECT, INDIRECT, INCIDENTAL, SPECIAL, EXEMPLARY, OR CONSEQUENTIAL DAMAGES (INCLUDING, BUT NOT LIMITED TO, PROCUREMENT OF SUBSTITUTE GOODS OR SERVICES; LOSS OF USE, DATA, OR PROFITS; OR BUSINESS INTERRUPTION) HOWEVER CAUSED AND ON ANY THEORY OF LIABILITY, WHETHER IN CONTRACT, STRICT LIABILITY, OR TORT INCLUDING NEGLIGENCE OR OTHERWISE) ARISING IN ANY WAY OUT OF THE USE OF THIS SOFTWARE, EVEN IF ADVISED OF THE POSSIBILITY OF SUCH DAMAGE.

Apache License

Version 2.0, January 2004

<http://www.apache.org/licenses/>

TERMS AND CONDITIONS FOR USE, REPRODUCTION, AND DISTRIBUTION

1. Definitions.

"License" shall mean the terms and conditions for use, reproduction, and distribution as defined by Sections 1 through 9 of this document.

"Licensor" shall mean the copyright owner or entity authorized by the copyright owner that is granting the License.

"Legal Entity" shall mean the union of the acting entity and all other entities that control, are controlled by, or are under common control with that entity. For the purposes of this definition, "control" means (i) the power, direct or indirect, to cause the direction or management of such entity, whether by contract or otherwise, or (ii) ownership of fifty percent (50%) or more of the outstanding shares, or (iii) beneficial ownership of such entity.

"You" (or "Your") shall mean an individual or Legal Entity exercising permissions granted by this License.

"Source" form shall mean the preferred form for making modifications, including but not limited to software source code, documentation source, and configuration files.

"Object" form shall mean any form resulting from mechanical transformation or translation of a Source form, including but not limited to compiled object code, generated documentation, and conversions to other media types.

"Work" shall mean the work of authorship, whether in Source or Object form, made available under the License, as indicated by a copyright notice that is included in or attached to the work (an example is provided in the Appendix below).

"Derivative Works" shall mean any work, whether in Source or Object form, that is based on (or derived from) the Work and for which the editorial revisions, annotations, elaborations, or other modifications represent, as a whole, an original work of authorship. For the purposes of this License, Derivative Works shall not include works that remain separable from, or merely link (or bind by name) to the interfaces of, the Work and Derivative Works thereof.

"Contribution" shall mean any work of authorship, including the original version of the Work and any modifications or additions to that Work or Derivative Works thereof, that is intentionally submitted to Licensor for inclusion in the Work by the copyright owner or by an individual or Legal Entity authorized to submit on behalf of the copyright owner. For the purposes of this definition, "submitted" means any form of electronic, verbal, or written communication sent to the Licensor or its representatives, including but not limited to communication on electronic mailing lists, source code control systems, and issue tracking systems that are managed by, or on behalf of, the Licensor for the purpose of discussing and improving the Work, but excluding communication that is conspicuously marked or otherwise designated in writing by the copyright owner as "Not a Contribution."

"Contributor" shall mean Licensor and any individual or Legal Entity on behalf of whom a Contribution has been received by Licensor and subsequently incorporated within the Work.

2. Grant of Copyright License. Subject to the terms and conditions of this License, each Contributor hereby grants to You a perpetual, worldwide, non-exclusive, no-charge, royalty-free, irrevocable

copyright license to reproduce, prepare Derivative Works of, publicly display, publicly perform, sublicense, and distribute the Work and such Derivative Works in Source or Object form.

3. Grant of Patent License. Subject to the terms and conditions of this License, each Contributor hereby grants to You a perpetual, worldwide, non-exclusive, no-charge, royalty-free, irrevocable (except as stated in this section) patent license to make, have made, use, offer to sell, sell, import, and otherwise transfer the Work, where such license applies only to those patent claims licensable by such Contributor that are necessarily infringed by their Contribution(s) alone or by combination of their Contribution(s) with the Work to which such Contribution(s) was submitted. If You institute patent litigation against any entity (including a cross-claim or counterclaim in a lawsuit) alleging that the Work or a Contribution incorporated within the Work constitutes direct or contributory patent infringement, then any patent licenses granted to You under this License for that Work shall terminate as of the date such litigation is filed.
4. Redistribution. You may reproduce and distribute copies of the Work or Derivative Works thereof in any medium, with or without modifications, and in Source or Object form, provided that You meet the following conditions:
 1. You must give any other recipients of the Work or Derivative Works a copy of this License; and
 2. You must cause any modified files to carry prominent notices stating that You changed the files; and
 3. You must retain, in the Source form of any Derivative Works that You distribute, all copyright, patent, trademark, and attribution notices from the Source form of the Work, excluding those notices that do not pertain to any part of the Derivative Works; and
 4. If the Work includes a "NOTICE" text file as part of its distribution, then any Derivative Works that You distribute must include a readable copy of the attribution notices contained within such NOTICE file, excluding those notices that do not pertain to any part of the Derivative Works, in at least one of the following places: within a NOTICE text file distributed as part of the Derivative Works; within the Source form or documentation, if provided along with the Derivative Works; or, within a display generated by the Derivative Works, if and wherever such third-party notices normally appear. The contents of the NOTICE file are for informational purposes only and do not modify the License. You may add Your own attribution notices within Derivative Works that You distribute, alongside or as an addendum to the NOTICE text from the Work, provided that such additional attribution notices cannot be construed as modifying the License.

You may add Your own copyright statement to Your modifications and may provide additional or different license terms and conditions for use, reproduction, or distribution of Your modifications, or for any such Derivative Works as a whole, provided Your use, reproduction, and distribution of the Work otherwise complies with the conditions stated in this License.

5. Submission of Contributions. Unless You explicitly state otherwise, any Contribution intentionally submitted for inclusion in the Work by You to the Licensor shall be under the terms and conditions of this License, without any additional terms or conditions. Notwithstanding the above, nothing herein shall supersede or modify the terms of any separate license agreement you may have executed with Licensor regarding such Contributions.
6. Trademarks. This License does not grant permission to use the trade names, trademarks, service marks, or product names of the Licensor, except as required for reasonable and customary use in describing the origin of the Work and reproducing the content of the NOTICE file.
7. Disclaimer of Warranty. Unless required by applicable law or agreed to in writing, Licensor provides the Work (and each Contributor provides its Contributions) on an "AS IS" BASIS, WITHOUT WARRANTIES OR CONDITIONS OF ANY KIND, either express or implied, including, without

limitation, any warranties or conditions of TITLE, NON-INFRINGEMENT, MERCHANTABILITY, or FITNESS FOR A PARTICULAR PURPOSE. You are solely responsible for determining the appropriateness of using or redistributing the Work and assume any risks associated with Your exercise of permissions under this License.

8. Limitation of Liability. In no event and under no legal theory, whether in tort (including negligence), contract, or otherwise, unless required by applicable law (such as deliberate and grossly negligent acts) or agreed to in writing, shall any Contributor be liable to You for damages, including any direct, indirect, special, incidental, or consequential damages of any character arising as a result of this License or out of the use or inability to use the Work (including but not limited to damages for loss of goodwill, work stoppage, computer failure or malfunction, or any and all other commercial damages or losses), even if such Contributor has been advised of the possibility of such damages.
9. Accepting Warranty or Additional Liability. While redistributing the Work or Derivative Works thereof, You may choose to offer, and charge a fee for, acceptance of support, warranty, indemnity, or other liability obligations and/or rights consistent with this License. However, in accepting such obligations, You may act only on Your own behalf and on Your sole responsibility, not on behalf of any other Contributor, and only if You agree to indemnify, defend, and hold each Contributor harmless for any liability incurred by, or claims asserted against, such Contributor by reason of your accepting any such warranty or additional liability.

END OF TERMS AND CONDITIONS

---- Part 1: CMU/UCD copyright notice: (BSD like) ----

Copyright 1989, 1991, 1992 by Carnegie Mellon University

Derivative Work - 1996, 1998-2000

Copyright 1996, 1998-2000 The Regents of the University of California

All Rights Reserved

Permission to use, copy, modify and distribute this software and its documentation for any purpose and without fee is hereby granted, provided that the above copyright notice appears in all copies and that both that copyright notice and this permission notice appear in supporting documentation, and that the name of CMU and The Regents of the University of California not be used in advertising or publicity pertaining to distribution of the software without specific written permission.

CMU AND THE REGENTS OF THE UNIVERSITY OF CALIFORNIA DISCLAIM ALL WARRANTIES WITH REGARD TO THIS SOFTWARE, INCLUDING ALL IMPLIED WARRANTIES OF MERCHANTABILITY AND FITNESS. IN NO EVENT SHALL CMU OR THE REGENTS OF THE UNIVERSITY OF CALIFORNIA BE LIABLE FOR ANY SPECIAL, INDIRECT OR CONSEQUENTIAL DAMAGES OR ANY DAMAGES WHATSOEVER RESULTING FROM THE LOSS OF USE, DATA OR PROFITS, WHETHER IN AN ACTION OF CONTRACT, NEGLIGENCE OR OTHER TORTIOUS ACTION, ARISING OUT OF OR IN CONNECTION WITH THE USE OR PERFORMANCE OF THIS SOFTWARE.

---- Part 2: Networks Associates Technology, Inc copyright notice (BSD) ----

Copyright (c) 2001-2003, Networks Associates Technology, Inc

All rights reserved.

Redistribution and use in source and binary forms, with or without modification, are permitted provided that the following conditions are met:

- * Redistributions of source code must retain the above copyright notice, this list of conditions and the following disclaimer.
- * Redistributions in binary form must reproduce the above copyright notice, this list of conditions and the following disclaimer in the documentation and/or other materials provided with the distribution.
- * Neither the name of the Networks Associates Technology, Inc nor the names of its contributors may be used to endorse or promote products derived from this software without specific prior written permission.

THIS SOFTWARE IS PROVIDED BY THE COPYRIGHT HOLDERS AND CONTRIBUTORS ``AS IS" AND ANY EXPRESS OR IMPLIED WARRANTIES, INCLUDING, BUT NOT LIMITED TO, THE IMPLIED WARRANTIES OF MERCHANTABILITY AND FITNESS FOR A PARTICULAR PURPOSE ARE DISCLAIMED. IN NO EVENT SHALL THE COPYRIGHT HOLDERS OR CONTRIBUTORS BE LIABLE FOR ANY DIRECT, INDIRECT, INCIDENTAL, SPECIAL, EXEMPLARY, OR CONSEQUENTIAL DAMAGES (INCLUDING, BUT NOT LIMITED TO, PROCUREMENT OF SUBSTITUTE GOODS OR SERVICES; LOSS OF USE, DATA, OR PROFITS; OR BUSINESS INTERRUPTION) HOWEVER CAUSED AND ON ANY THEORY OF LIABILITY, WHETHER IN CONTRACT, STRICT LIABILITY, OR TORT (INCLUDING NEGLIGENCE OR OTHERWISE) ARISING IN ANY WAY OUT OF THE USE OF THIS SOFTWARE, EVEN IF ADVISED OF THE POSSIBILITY OF SUCH DAMAGE.

---- Part 3: Cambridge Broadband Ltd. copyright notice (BSD) -----

Portions of this code are copyright (c) 2001-2003, Cambridge Broadband Ltd.

All rights reserved.

Redistribution and use in source and binary forms, with or without modification, are permitted provided that the following conditions are met:

- * Redistributions of source code must retain the above copyright notice, this list of conditions and the following disclaimer.
- * Redistributions in binary form must reproduce the above copyright notice, this list of conditions and the following disclaimer in the documentation and/or other materials provided with the distribution.
- * The name of Cambridge Broadband Ltd. may not be used to endorse or promote products derived from this software without specific prior written permission.

THIS SOFTWARE IS PROVIDED BY THE COPYRIGHT HOLDER ``AS IS" AND ANY EXPRESS OR IMPLIED WARRANTIES, INCLUDING, BUT NOT LIMITED TO, THE IMPLIED WARRANTIES OF MERCHANTABILITY AND FITNESS FOR A PARTICULAR PURPOSE ARE DISCLAIMED. IN NO EVENT SHALL THE COPYRIGHT HOLDER BE LIABLE FOR ANY DIRECT, INDIRECT, INCIDENTAL, SPECIAL, EXEMPLARY, OR CONSEQUENTIAL DAMAGES (INCLUDING, BUT NOT LIMITED TO, PROCUREMENT OF SUBSTITUTE GOODS OR SERVICES; LOSS OF USE, DATA, OR PROFITS; OR BUSINESS INTERRUPTION) HOWEVER CAUSED AND ON ANY THEORY OF LIABILITY, WHETHER IN CONTRACT, STRICT LIABILITY, OR TORT (INCLUDING NEGLIGENCE OR OTHERWISE) ARISING IN ANY WAY OUT OF THE USE OF THIS SOFTWARE, EVEN IF ADVISED OF THE POSSIBILITY OF SUCH DAMAGE.

---- Part 4: Sun Microsystems, Inc. copyright notice (BSD) -----

Copyright c 2003 Sun Microsystems, Inc., 4150 Network Circle, Santa Clara, California 95054, U.S.A. All rights reserved.

Use is subject to license terms below.

This distribution may include materials developed by third parties.

Sun, Sun Microsystems, the Sun logo and Solaris are trademarks or registered trademarks of Sun Microsystems, Inc. in the U.S. and other countries.

Redistribution and use in source and binary forms, with or without modification, are permitted provided that the following conditions are met:

- * Redistributions of source code must retain the above copyright notice, this list of conditions and the following disclaimer.
- * Redistributions in binary form must reproduce the above copyright notice, this list of conditions and the following disclaimer in the documentation and/or other materials provided with the distribution.
- * Neither the name of the Sun Microsystems, Inc. nor the names of its contributors may be used to endorse or promote products derived from this software without specific prior written permission.

THIS SOFTWARE IS PROVIDED BY THE COPYRIGHT HOLDERS AND CONTRIBUTORS ``AS IS" AND ANY EXPRESS OR IMPLIED WARRANTIES, INCLUDING, BUT NOT LIMITED TO, THE IMPLIED WARRANTIES OF MERCHANTABILITY AND FITNESS FOR A PARTICULAR PURPOSE ARE DISCLAIMED. IN NO EVENT SHALL THE COPYRIGHT HOLDERS OR CONTRIBUTORS BE LIABLE FOR ANY DIRECT, INDIRECT, INCIDENTAL, SPECIAL, EXEMPLARY, OR CONSEQUENTIAL DAMAGES (INCLUDING, BUT NOT LIMITED TO, PROCUREMENT OF SUBSTITUTE GOODS OR SERVICES; LOSS OF USE, DATA, OR PROFITS; OR BUSINESS INTERRUPTION) HOWEVER CAUSED AND ON ANY THEORY OF LIABILITY, WHETHER IN CONTRACT, STRICT LIABILITY, OR TORT (INCLUDING NEGLIGENCE OR OTHERWISE) ARISING IN ANY WAY OUT OF THE USE OF THIS SOFTWARE, EVEN IF ADVISED OF THE POSSIBILITY OF SUCH DAMAGE.

---- Part 5: Sparta, Inc copyright notice (BSD) -----

Copyright (c) 2003-2009, Sparta, Inc

All rights reserved.

Redistribution and use in source and binary forms, with or without modification, are permitted provided that the following conditions are met:

- * Redistributions of source code must retain the above copyright notice, this list of conditions and the following disclaimer.
- * Redistributions in binary form must reproduce the above copyright notice, this list of conditions and the following disclaimer in the documentation and/or other materials provided with the distribution.
- * Neither the name of Sparta, Inc nor the names of its contributors may be used to endorse or promote products derived from this software without specific prior written permission.

THIS SOFTWARE IS PROVIDED BY THE COPYRIGHT HOLDERS AND CONTRIBUTORS ``AS IS" AND ANY EXPRESS OR IMPLIED WARRANTIES, INCLUDING, BUT NOT LIMITED TO, THE IMPLIED WARRANTIES OF MERCHANTABILITY AND FITNESS FOR A PARTICULAR PURPOSE ARE DISCLAIMED. IN NO EVENT SHALL THE COPYRIGHT HOLDERS OR CONTRIBUTORS BE LIABLE FOR ANY DIRECT, INDIRECT, INCIDENTAL, SPECIAL, EXEMPLARY, OR CONSEQUENTIAL DAMAGES (INCLUDING, BUT NOT LIMITED TO, PROCUREMENT OF SUBSTITUTE GOODS OR SERVICES; LOSS OF USE, DATA, OR PROFITS; OR BUSINESS INTERRUPTION) HOWEVER CAUSED AND ON ANY THEORY OF LIABILITY, WHETHER IN CONTRACT, STRICT LIABILITY, OR TORT (INCLUDING NEGLIGENCE OR OTHERWISE) ARISING IN ANY WAY OUT OF THE USE OF THIS SOFTWARE, EVEN IF ADVISED OF THE POSSIBILITY OF SUCH DAMAGE.

---- Part 6: Cisco/BUPTNIC copyright notice (BSD) ----

Copyright (c) 2004, Cisco, Inc and Information Network Center of Beijing University of Posts and Telecommunications.

All rights reserved.

Redistribution and use in source and binary forms, with or without modification, are permitted provided that the following conditions are met:

- * Redistributions of source code must retain the above copyright notice, this list of conditions and the following disclaimer.
- * Redistributions in binary form must reproduce the above copyright notice, this list of conditions and the following disclaimer in the documentation and/or other materials provided with the distribution.
- * Neither the name of Cisco, Inc, Beijing University of Posts and Telecommunications, nor the names of their contributors may be used to endorse or promote products derived from this software without specific prior written permission.

THIS SOFTWARE IS PROVIDED BY THE COPYRIGHT HOLDERS AND CONTRIBUTORS ``AS IS" AND ANY EXPRESS OR IMPLIED WARRANTIES, INCLUDING, BUT NOT LIMITED TO, THE IMPLIED WARRANTIES OF MERCHANTABILITY AND FITNESS FOR A PARTICULAR PURPOSE ARE DISCLAIMED. IN NO EVENT SHALL THE COPYRIGHT HOLDERS OR CONTRIBUTORS BE LIABLE FOR ANY DIRECT, INDIRECT, INCIDENTAL, SPECIAL, EXEMPLARY, OR CONSEQUENTIAL DAMAGES (INCLUDING, BUT NOT LIMITED TO, PROCUREMENT OF SUBSTITUTE GOODS OR SERVICES; LOSS OF USE, DATA, OR PROFITS; OR BUSINESS INTERRUPTION) HOWEVER CAUSED AND ON ANY THEORY OF LIABILITY, WHETHER IN CONTRACT, STRICT LIABILITY, OR TORT (INCLUDING NEGLIGENCE OR OTHERWISE) ARISING IN ANY WAY OUT OF THE USE OF THIS SOFTWARE, EVEN IF ADVISED OF THE POSSIBILITY OF SUCH DAMAGE.

---- Part 7: Fabasoft R&D Software GmbH & Co KG copyright notice (BSD) ----

Copyright (c) Fabasoft R&D Software GmbH & Co KG, 2003 oss@fabasoft.com

Author: Bernhard Penz

Redistribution and use in source and binary forms, with or without modification, are permitted provided that the following conditions are met:

- * Redistributions of source code must retain the above copyright notice, this list of conditions and the following disclaimer.
- * Redistributions in binary form must reproduce the above copyright notice, this list of conditions and the following disclaimer in the documentation and/or other materials provided with the distribution.
- * The name of Fabasoft R&D Software GmbH & Co KG or any of its subsidiaries, brand or product names may not be used to endorse or promote products derived from this software without specific prior written permission.

THIS SOFTWARE IS PROVIDED BY THE COPYRIGHT HOLDER ``AS IS" AND ANY EXPRESS OR IMPLIED WARRANTIES, INCLUDING, BUT NOT LIMITED TO, THE IMPLIED WARRANTIES OF MERCHANTABILITY AND FITNESS FOR A PARTICULAR PURPOSE ARE DISCLAIMED. IN NO EVENT SHALL THE COPYRIGHT HOLDER BE LIABLE FOR ANY DIRECT, INDIRECT, INCIDENTAL, SPECIAL, EXEMPLARY, OR CONSEQUENTIAL DAMAGES (INCLUDING, BUT NOT LIMITED TO, PROCUREMENT OF SUBSTITUTE GOODS OR SERVICES; LOSS OF USE, DATA, OR PROFITS; OR BUSINESS INTERRUPTION) HOWEVER CAUSED AND ON ANY THEORY OF LIABILITY, WHETHER

IN CONTRACT, STRICT LIABILITY, OR TORT (INCLUDING NEGLIGENCE OR OTHERWISE) ARISING IN ANY WAY OUT OF THE USE OF THIS SOFTWARE, EVEN IF ADVISED OF THE POSSIBILITY OF SUCH DAMAGE.

LEADTOOLS

Copyright (C) 1991-2009 LEAD Technologies, Inc.

CMap Resources

Copyright 1990-2009 Adobe Systems Incorporated.
All rights reserved.

Copyright 1990-2010 Adobe Systems Incorporated.
All rights reserved.

Redistribution and use in source and binary forms, with or without modification, are permitted provided that the following conditions are met:

Redistributions of source code must retain the above copyright notice, this list of conditions and the following disclaimer.

Redistributions in binary form must reproduce the above copyright notice, this list of conditions and the following disclaimer in the documentation and/or other materials provided with the distribution.

Neither the name of Adobe Systems Incorporated nor the names of its contributors may be used to endorse or promote products derived from this software without specific prior written permission.

THIS SOFTWARE IS PROVIDED BY THE COPYRIGHT HOLDERS AND CONTRIBUTORS "AS IS" AND ANY EXPRESS OR IMPLIED WARRANTIES, INCLUDING, BUT NOT LIMITED TO, THE IMPLIED WARRANTIES OF MERCHANTABILITY AND FITNESS FOR A PARTICULAR PURPOSE ARE DISCLAIMED. IN NO EVENT SHALL THE COPYRIGHT HOLDER OR CONTRIBUTORS BE LIABLE FOR ANY DIRECT, INDIRECT, INCIDENTAL, SPECIAL, EXEMPLARY, OR CONSEQUENTIAL DAMAGES (INCLUDING, BUT NOT LIMITED TO, PROCUREMENT OF SUBSTITUTE GOODS OR SERVICES; LOSS OF USE, DATA, OR PROFITS; OR BUSINESS INTERRUPTION) HOWEVER CAUSED AND ON ANY THEORY OF LIABILITY, WHETHER IN CONTRACT, STRICT LIABILITY, OR TORT (INCLUDING NEGLIGENCE OR OTHERWISE) ARISING IN ANY WAY OUT OF THE USE OF THIS SOFTWARE, EVEN IF ADVISED OF THE POSSIBILITY OF SUCH DAMAGE.

MIT License

Copyright (c) 1998, 1999, 2000 Thai Open Source Software Center Ltd

Permission is hereby granted, free of charge, to any person obtaining a copy of this software and associated documentation files (the "Software"), to deal in the Software without restriction, including without limitation the rights to use, copy, modify, merge, publish, distribute, sublicense, and/or sell copies of the Software, and to permit persons to whom the Software is furnished to do so, subject to the following conditions:

The above copyright notice and this permission notice shall be included in all copies or substantial portions of the Software.

THE SOFTWARE IS PROVIDED "AS IS", WITHOUT WARRANTY OF ANY KIND, EXPRESS OR IMPLIED, INCLUDING BUT NOT LIMITED TO THE WARRANTIES OF MERCHANTABILITY, FITNESS FOR A PARTICULAR PURPOSE AND NONINFRINGEMENT. IN NO EVENT SHALL THE AUTHORS OR COPYRIGHT HOLDERS BE LIABLE FOR ANY CLAIM, DAMAGES OR OTHER LIABILITY, WHETHER IN AN ACTION OF CONTRACT, TORT OR OTHERWISE, ARISING FROM, OUT OF OR IN CONNECTION WITH THE SOFTWARE OR THE USE OR OTHER DEALINGS IN THE SOFTWARE.

The following applies only to products supporting Wi-Fi.

(c) 2009-2013 by Jeff Mott. All rights reserved.

Redistribution and use in source and binary forms, with or without modification, are permitted provided that the following conditions are met:

- * Redistributions of source code must retain the above copyright notice, this list of conditions, and the following disclaimer.
- * Redistributions in binary form must reproduce the above copyright notice, this list of conditions, and the following disclaimer in the documentation or other materials provided with the distribution.
- * Neither the name CryptoJS nor the names of its contributors may be used to endorse or promote products derived from this software without specific prior written permission.

THIS SOFTWARE IS PROVIDED BY THE COPYRIGHT HOLDERS AND CONTRIBUTORS "AS IS," AND ANY EXPRESS OR IMPLIED WARRANTIES, INCLUDING, BUT NOT LIMITED TO, THE IMPLIED WARRANTIES OF MERCHANTABILITY AND FITNESS FOR A PARTICULAR PURPOSE, ARE DISCLAIMED. IN NO EVENT SHALL THE COPYRIGHT HOLDER OR CONTRIBUTORS BE LIABLE FOR ANY DIRECT, INDIRECT, INCIDENTAL, SPECIAL, EXEMPLARY, OR CONSEQUENTIAL DAMAGES (INCLUDING, BUT NOT LIMITED TO, PROCUREMENT OF SUBSTITUTE GOODS OR SERVICES; LOSS OF USE, DATA, OR PROFITS; OR BUSINESS INTERRUPTION) HOWEVER CAUSED AND ON ANY THEORY OF LIABILITY, WHETHER IN CONTRACT, STRICT LIABILITY, OR TORT (INCLUDING NEGLIGENCE OR OTHERWISE) ARISING IN ANY WAY OUT OF THE USE OF THIS SOFTWARE, EVEN IF ADVISED OF THE POSSIBILITY OF SUCH DAMAGE.

Enter keywords in the search window and click  (Search).

You can search for target pages in this guide.

Entry example: "(your product's model name) load paper"

Search Tips

You can search for target pages by entering keywords in the search window.

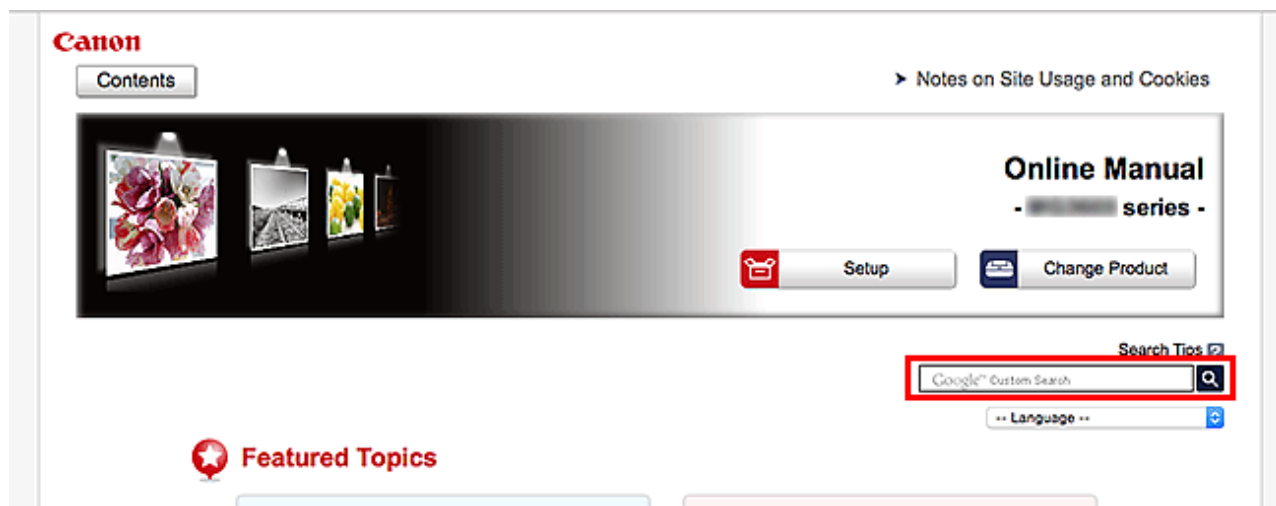

►►► Important

- This function may not be available in some countries/regions.

►►► Note

- The displayed screen may vary.
- When searching from this page without entering your product's model name or your application's name, all products supported by this guide will be considered for the search.
If you want to narrow down the search results, add your product's model name or your application's name to the keywords.

• Searching for Functions

Enter your product's model name and a keyword for the function you want to learn about

Example: When you want to learn how to load paper

Enter "(your product's model name) load paper" in the search window and perform a search

• Troubleshooting Errors

Enter your product's model name and a support code

Example: When the following error screen appears

Enter "(your product's model name) 1003" in the search window and perform a search

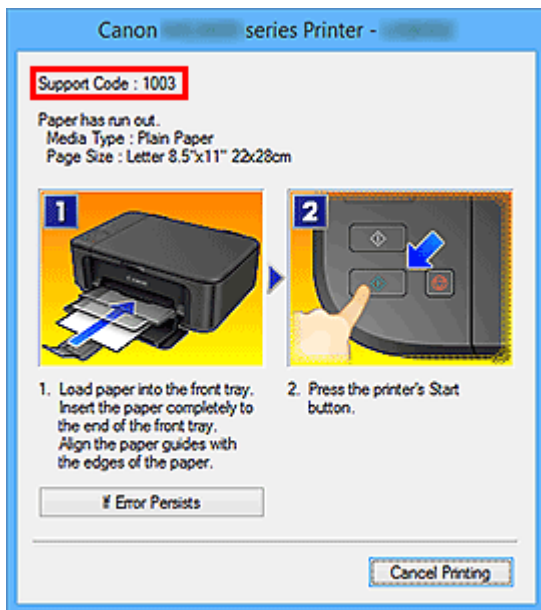

►►► Note

- The displayed screen varies depending on your product.

• **Searching for Application Functions**

Enter your application's name and a keyword for the function you want to learn about

Example: When you want to learn how to print collages with My Image Garden

Enter "My Image Garden collage" in the search window and perform a search

• **Searching for Reference Pages**

Enter your model name and a reference page title*

* You can find reference pages more easily by entering the function name as well.

Example: When you want to browse the page referred to by the following sentence on a scanning procedure page

Refer to "Color Settings Tab" for your model from Home of the Online Manual for details.

Enter "(your product's model name) scan Color Settings Tab" in the search window and perform a search

Using the Machine

- ▶ **Printing Documents from Your Computer (Windows)**
- ▶ **Printing Documents from Your Computer (Mac OS)**
- ▶ **Copying**
- ▶ **Faxing**

Printing Documents from Your Computer (Windows)

Print documents from applications on a computer or other device as follows.

1. Pull out a cassette.



2. Load paper printing-side DOWN.
3. Align the paper guides with the paper length and width.

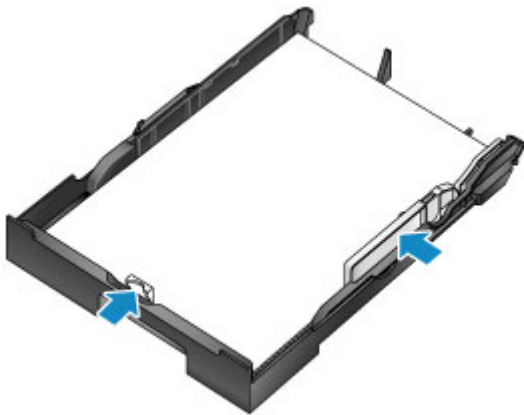

4. Insert the cassette.

After you insert the cassette, a screen for registering paper information for the cassette is displayed on the touch screen.

5. Select the size and type of paper in the cassette in **Page size** and **Type**, and then tap **Register**.

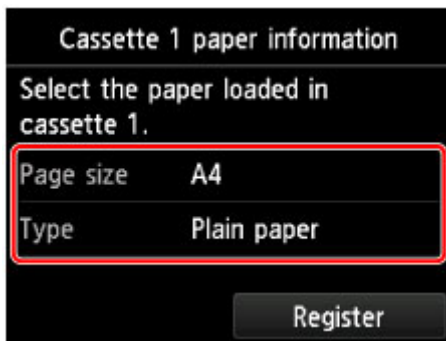

Follow the instructions of any messages displayed to register the paper information.

6. Pull out the output tray extension (A) and open the paper output support (B).



7. In the application, select Print.

You can often access the **Print** dialog box by selecting **Print** in the **File** menu.

8. Select the model name and click **Preferences** (or **Properties**).

Printer driver settings are displayed.

▶▶▶ Note

- Command and menu names vary by application, and printing may involve more steps. For detailed instructions, refer to the application user manual.

9. Select a typical printing profile.

In **Commonly Used Settings** on the **Quick Setup** tab, select a profile that suits the purpose of printing.

Once you select a printing profile, preset values are automatically applied to **Additional Features**, **Media Type**, and **Printer Paper Size** settings.

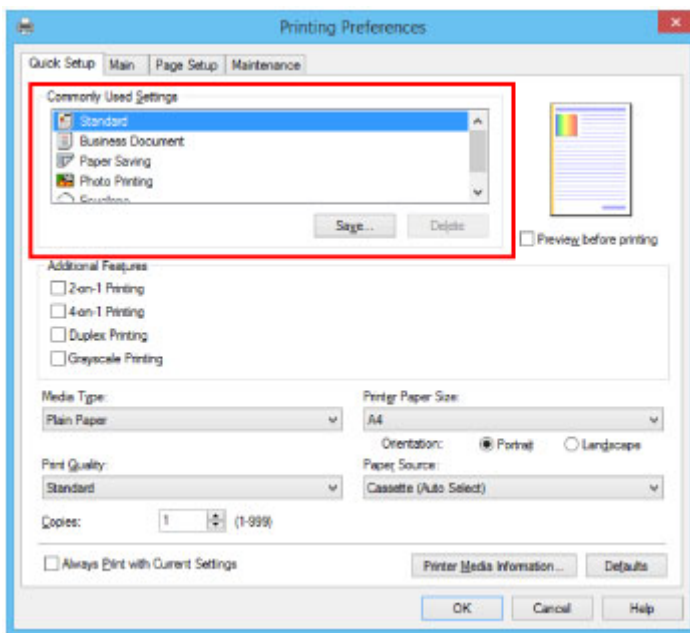

10. Select the paper source.

In **Paper Source**, select the cassette where the paper is loaded.

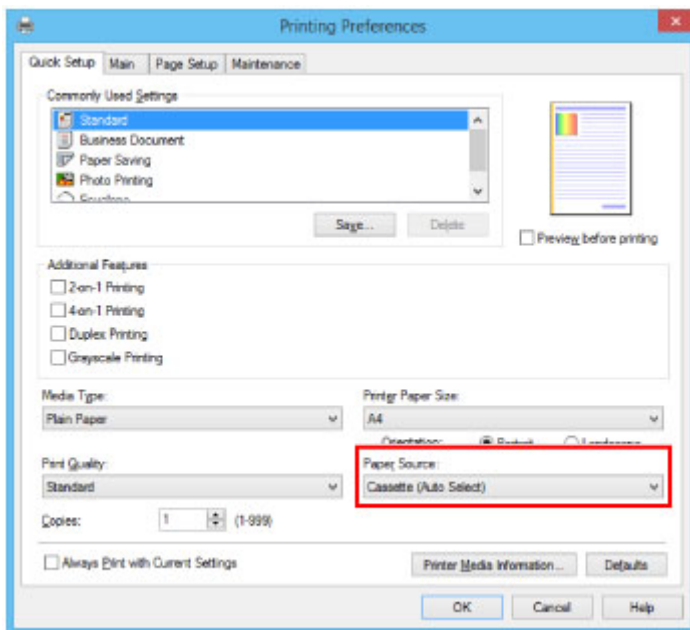

11. Once the print settings are complete, click **OK** to print.

▶▶▶ Note

- A variety of print settings can be configured with the printer driver.

■ [Printing from Application Software \(Windows Printer Driver\)](#)

Printing Documents from Your Computer (Mac OS)

Print documents from applications on a computer or other device as follows.

1. Pull out a cassette.



2. Load paper printing-side DOWN.
3. Align the paper guides with the paper length and width.

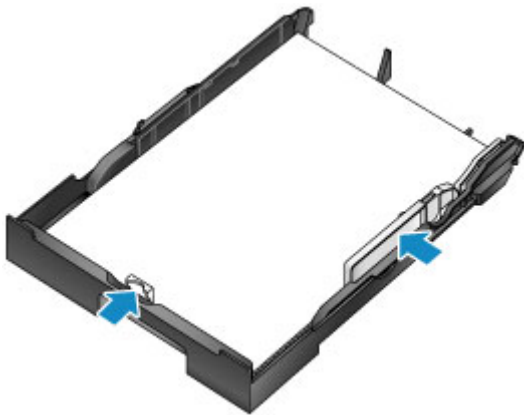

4. Insert the cassette.

After you insert the cassette, a screen for registering paper information for the cassette is displayed on the touch screen.

5. Select the size and type of paper in the cassette in **Page size** and **Type**, and then tap **Register**.

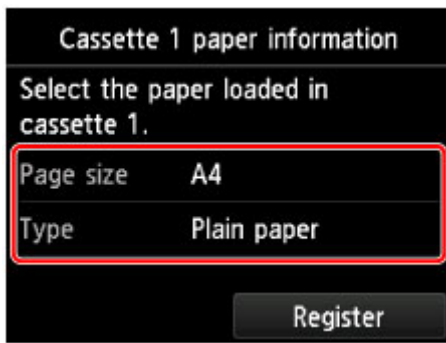

Follow the instructions of any messages displayed to register the paper information.

6. Pull out the output tray extension (A) and open the paper output support (B).



7. In the application, select Print.

You can often access the Print dialog by selecting **Print...** in the **File** menu.

▶▶▶ Note

- For detailed instructions on operation, refer to the application user manual.

8. Select the model name and click **Printer** list.

Click **Show Details** to switch the Setup window to the detailed display.



9. Select the paper size.

In **Paper Size**, select the paper size you use.

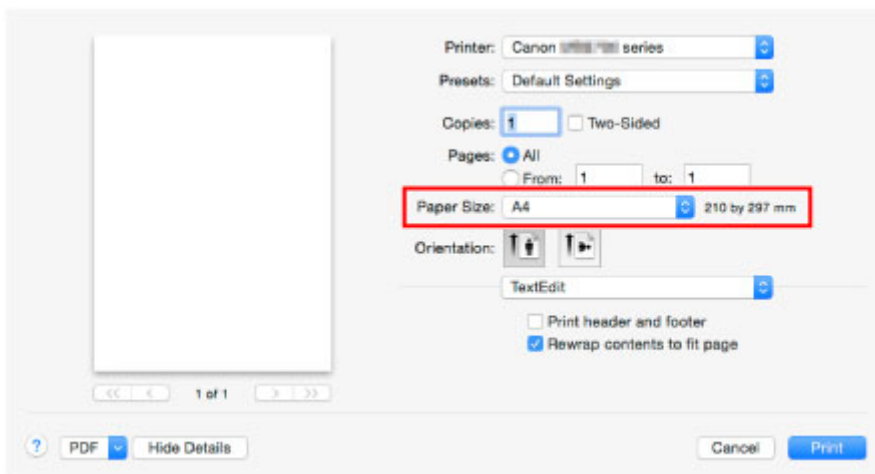

10. Select **Quality & Media** from the pop-up menu.

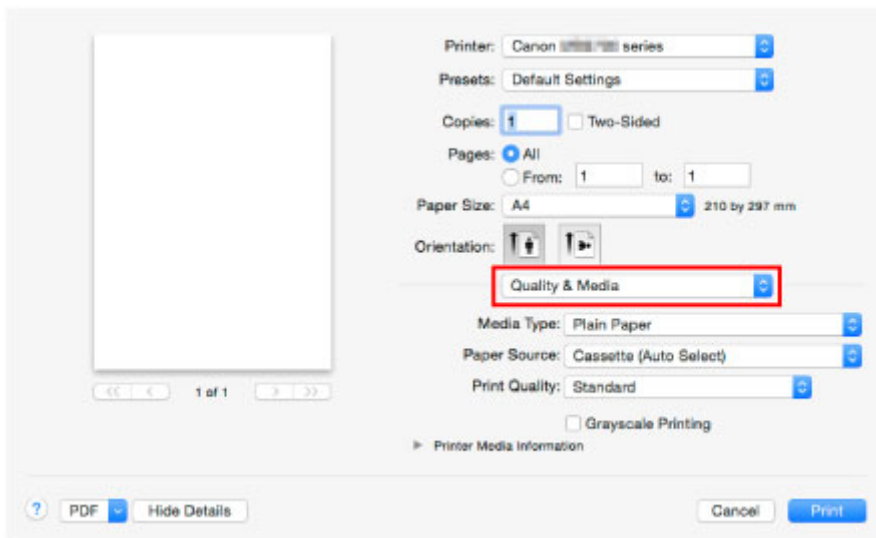

11. Select the media type.

In **Media Type**, select the same media type loaded in the machine.

12. Select the paper source.

In **Paper Source**, select the cassette where the paper is loaded.

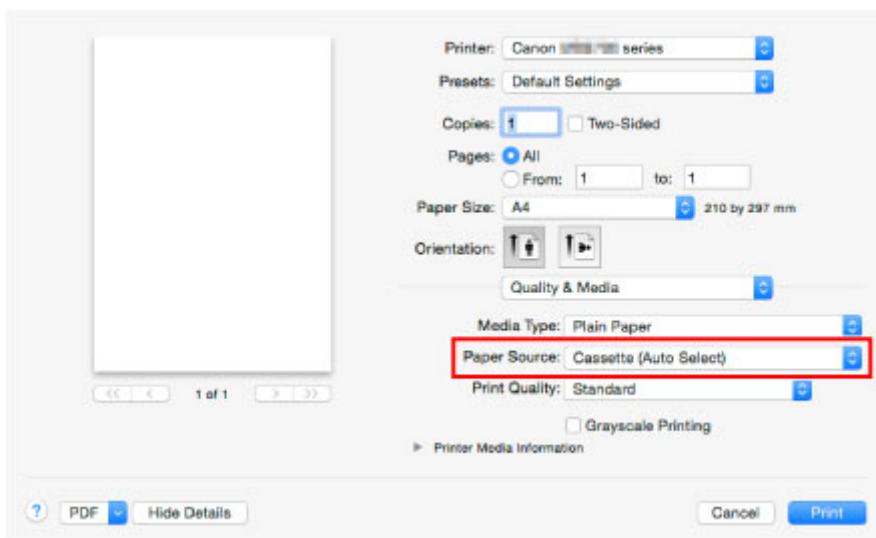

13. Once the print settings are complete, click **Print** to print.

▶▶▶ Note

- A variety of print settings can be configured with the printer driver.
 - Printing from Application Software (Mac OS Printer Driver)

Copying

Load originals and copy them on plain paper as follows.

1. Pull out a cassette.



2. Load paper printing-side DOWN.
3. Align the paper guides with the paper length and width.

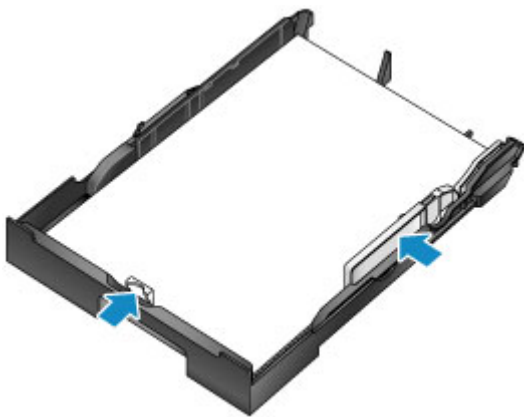

4. Insert the cassette.

After you insert the cassette, a screen for registering paper information for the cassette is displayed on the touch screen.

5. Select the size and type of paper in the cassette in **Page size** and **Type**, and then tap **Register**.

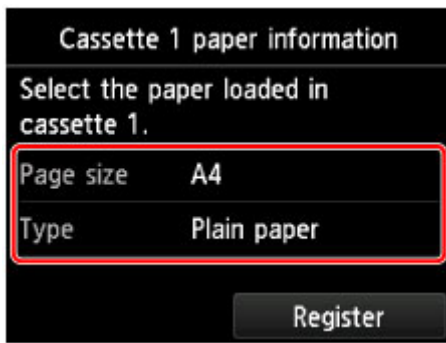

Follow the instructions of any messages displayed to register the paper information.

6. Pull out the output tray extension (A) and open the paper output support (B).



7. Press the **HOME** button (C).

8. Tap  **Copy** (D).

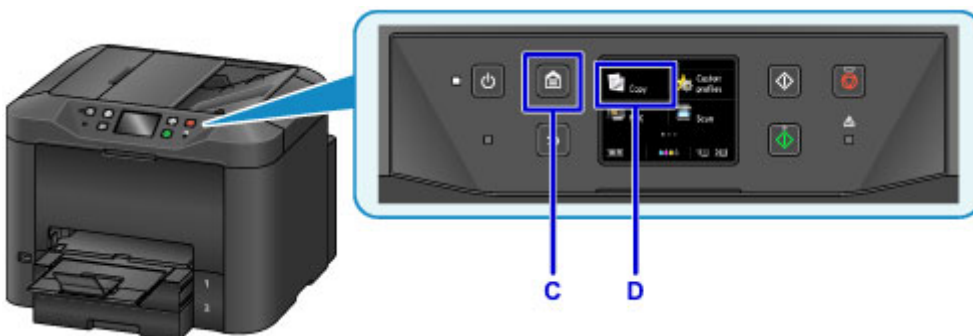

9. Open the document cover (E).

10. Load the original face-DOWN, aligned with the alignment mark (F).

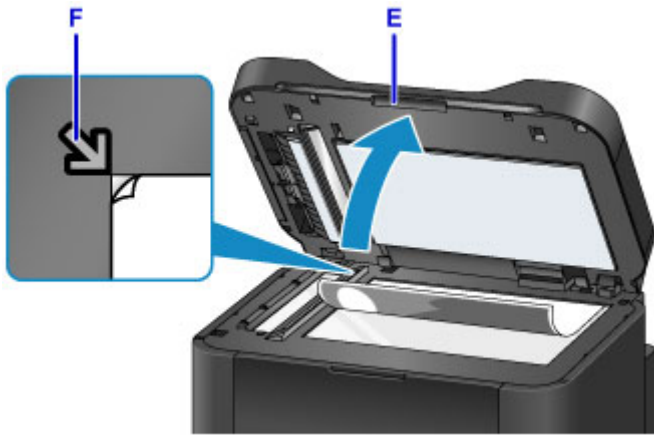

▶▶▶ **Note**

- For continuous copying of multiple originals, use the ADF (Auto Document Feeder).



11. Close the document cover.

12. Check the paper settings, and then press the **Black** or **Color** button (G).



▶▶▶ **Important**

- Do not open the document cover until copying is finished.

▶▶▶ **Note**

- The machine offers many other convenient copying features.

■ [Copying](#)

Faxing

Fax multiple documents in black and white as follows.

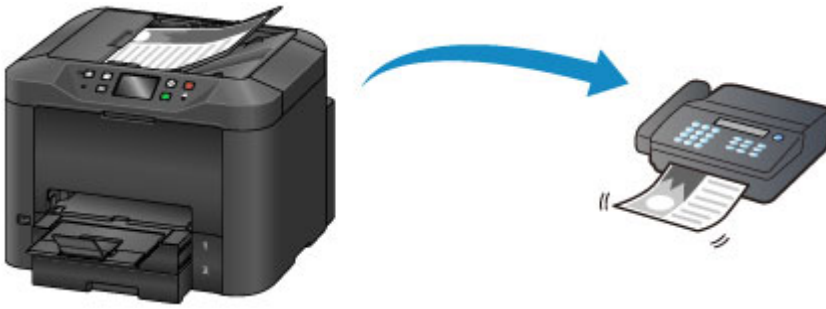

1. Open the document tray (A).



2. Insert the documents face-UP.
3. Adjust the document guides as needed.



4. Press the **HOME** button (B).

5. Tap  **FAX** (C).

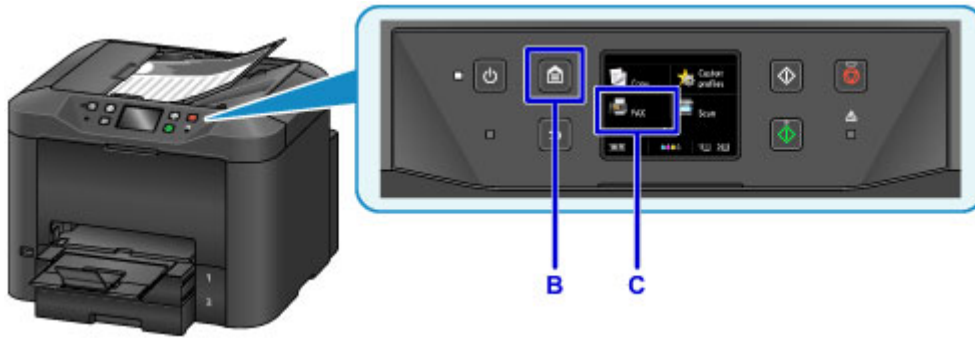

6. Tap **Enter the number** (D).



7. Tap in the fax number (E), and then tap **OK** (F).

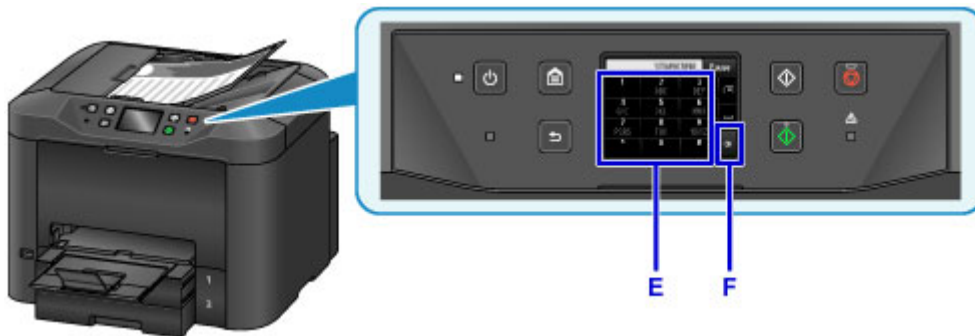

8. Press the **Black** button (G).



▶▶▶ **Note**

- Many other convenient faxing features are available.

Printer Functions

- ▶ **Connect Wirelessly in "Direct Connection"**
- ▶ **Download a Variety of Content Materials**
- ▶ **Print Items with Easy-PhotoPrint+ (Web Application)**
- ▶ **Managing Printer Conveniently Using Quick Utility Toolbox**
- ▶ **Available Connection Methods**
- ▶ **Scan Originals Larger than the Platen**
- ▶ **Scan Multiple Originals at One Time**
- ▶ **Using PIXMA/MAXIFY Cloud Link**
- ▶ **Print Easily from a Smartphone or Tablet with Canon PRINT Inkjet/SELPHY**
- ▶ **Printing with Windows RT**
- ▶ **Online Storage Integration Function**

Printing from an AirPrint-enabled Printer

- **Printing from an AirPrint-enabled Printer with Mac**
- **Printing from an AirPrint-enabled Printer with iOS Device**

Printing from an AirPrint-enabled Printer with Mac

Using AirPrint to print from your iPhone, iPad, iPod touch, or Mac.

AirPrint enables you to print photos, email, Web pages and documents from iPhone, iPad, iPod touch, and Mac without the need to install drivers, or download apps or software.

▶▶▶ Note

- If you want to print using AirPrint from iOS device, see below.

■ [Printing from an AirPrint-enabled Printer with iOS Device](#)



Checking Your Environment

First, check your environment.

- **AirPrint Operation Environment**
 - iPhone, iPad, and iPod touch running the latest version of iOS
 - Mac running the latest version of Mac OS

- **Requirement**

The iOS device or Mac and the printer must be connected to the same network over a LAN or connected directly without wireless router.

Adding Printer as AirPrint Printer to Your Mac

1. Open **System Preferences**, and select **Printers & Scanners (Print & Scan)** on your Mac.
2. Select **+** to display the printer list.
3. Select the printer's name listed as **Bonjour Multifunction**.
4. Select **Secure AirPrint** or **AirPrint** from **Use**.
5. Select **Add**.

Printing with AirPrint from Mac

1. [Make sure printer is turned on.](#)

▶▶▶ Note

- If the printer's Auto Power On function is enabled, the printer is turned on automatically when it receives the print data.

2. [Load paper.](#)

3. Perform printing on your application software.

Print dialog appears.

4. Select your model name added as AirPrint printer from the **Printer** list in the Print Dialog.

5. Set the paper size, media type, and other settings as needed.

6. Select **Print**.

When you execute printing, the printer prints according to the specified settings.

▶▶▶ Note

- For wireless LAN connection:
 - After you turn on the printer, it may take few minutes before the printer can communicate through a wireless LAN connection. Make sure the printer is connected to the wireless LAN and try printing.
 - If Bonjour on the printer is disabled, AirPrint cannot be used. Check the LAN settings on the printer, and enable Bonjour.
- For other AirPrint troubleshooting, see below.

■ [Cannot Print Using AirPrint](#)

Checking Print Status

- Display the Printing Status Screen

Deleting Print Job

To delete a print job with AirPrint, use one of the following two methods:

- From printer: Use **Stop** button to cancel the print job.
- From iOS device: Deleting the Undesired Print Job

Printing from an AirPrint-enabled Printer with iOS Device

Using AirPrint to print from your iPhone, iPad, iPod touch, or Mac.

AirPrint enables you to print photos, email, Web pages and documents from iPhone, iPad, iPod touch, and Mac without the need to install drivers, or download apps or software.

►►► Note

- If you want to print using AirPrint from Mac, see below.

■ [Printing from an AirPrint-enabled Printer with Mac](#)



Checking Your Environment

First, check your environment.

- **AirPrint Operation Environment**
 - iPhone, iPad, and iPod touch running the latest version of iOS
 - Mac running the latest version of Mac OS

- **Requirement**

The iOS device or Mac and the printer must be connected to the same network over a LAN or connected directly without wireless router.

Printing with AirPrint from iOS Device

1. [Make sure printer is turned on.](#)

►►► Note

- If the printer's Auto Power On function is enabled, the printer is turned on automatically when it receives the print data.

2. [Load paper.](#)
3. Tap operation icon to display menu options from applications of your iOS device.

The figure below is an example of when printing from the iPad web browser. The screen differs depending on the devices or applications.



4. Tap **Print** from menu options.



5. Select your model name from **Printer** on **Printer Options**.

➤➤➤ **Important**

- Because some applications do not support AirPrint, **Printer Options** may not be displayed. If an application does not let you use printer options, you cannot print from that application.

▶▶▶ Note

- **Printer Options** differ depending on the application that you are using.

6. When printing file type that has multiple pages, such as PDF file, tap **Range** and tap **All Pages** or select range of pages to be printed.
7. For **1 Copy**, tap **+** or **-** to set number of required copies.
8. For **Duplex Printing**, tap **On** to enable duplex printing or tap **Off** to disable function.
9. Tap **Print**.

When you execute printing, the printer prints according to the specified settings.

▶▶▶ Note

- For wireless LAN connection:
 - After you turn on the printer, it may take few minutes before the printer can communicate through a wireless LAN connection. Make sure the printer is connected to the wireless LAN and try printing.
 - If Bonjour on the printer is disabled, AirPrint cannot be used. Check the LAN settings on the printer, and enable Bonjour.
- For other AirPrint troubleshooting, see below.

■ [Cannot Print Using AirPrint](#)

Paper Size

With AirPrint, the paper size is selected automatically according to the application being used on the iOS device and the region in which AirPrint is used.

When you use the photo application, the default paper size is L size in Japan, and 4"x6" or KG in other countries and regions.

When you use the document application, the default paper size is letter size in the U.S. region, and A4 in Japan and Europe.

▶▶▶ Important

- Depending on the device or operation system, the default paper size is different from above size.
We recommend you perform test printing.
- Your application may support different paper sizes.

Printing of Envelopes

For printing on the envelope from iOS device with AirPrint, refer to the following.

Print result image	Orientation of print data	Orientation of loading envelope
--------------------	---------------------------	---------------------------------

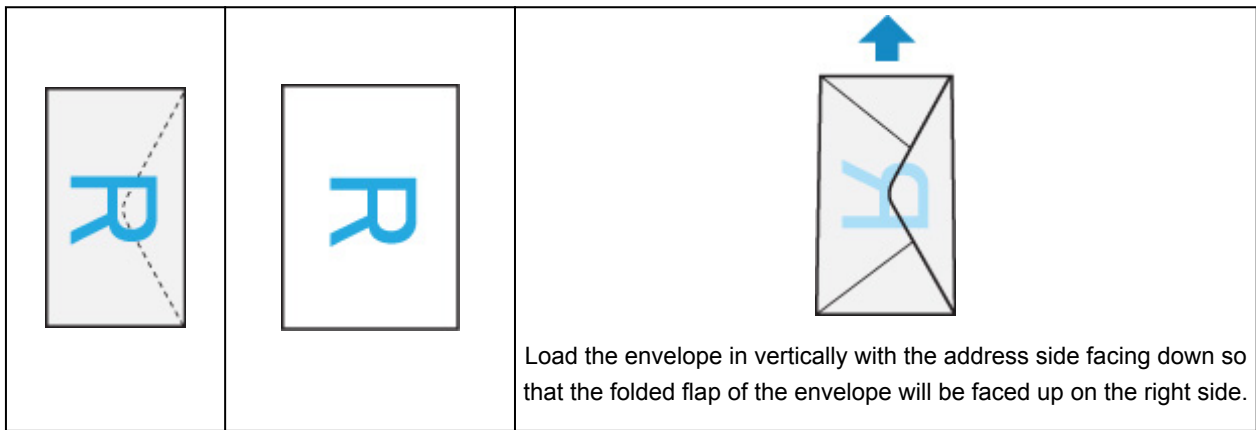

Checking Print Status

During printing, a **Print Center** icon is displayed in the list of recently used applications and you can use it to check the print progress.

Press the Home button on the iOS device twice to set the **Multitasking** mode. Then swipe to the right to display the **Print Center** icon and a **Print Summary**.

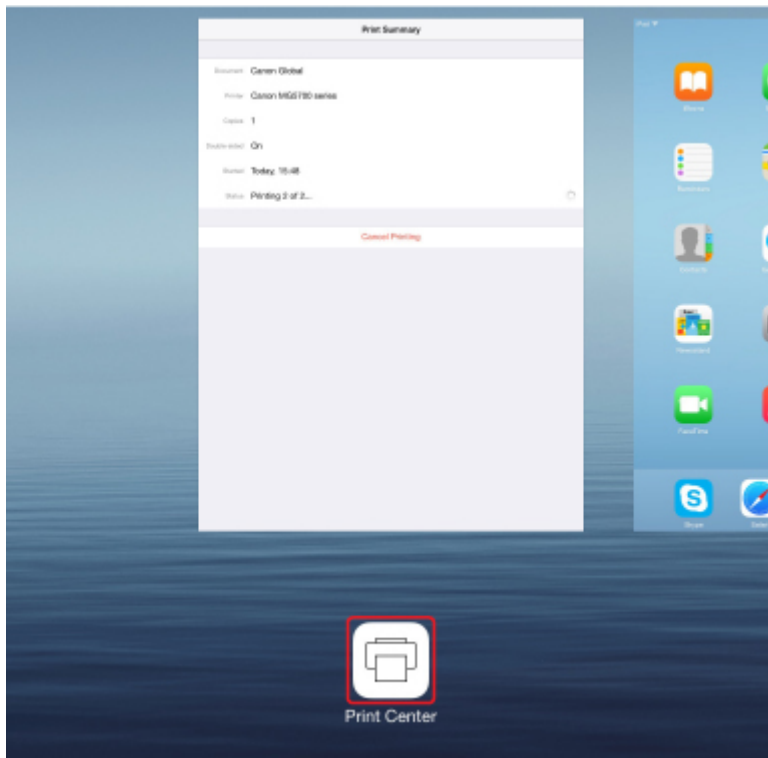

Deleting Print Job

To delete a print job with AirPrint, use one of the following two methods:

- From printer: Use **Stop** button to cancel the print job.
- From iOS device: Press the Home button on the iOS device twice to set the **Multitasking** mode and swipe to the right. Tap the **Print Center** icon to display a **Print Summary**. Tap the print job to be canceled and tap **Cancel Printing**.

Connect Wirelessly in "Direct Connection"

The printer supports "direct connection" in which you can connect to the printer wirelessly from a computer or smartphone without a wireless router.

Switch to "direct connection" to print or scan wirelessly.

■ [Using Machine with Direct Connection](#)



Download a Variety of Content Materials

CREATIVE PARK

A "printing materials site" where you can download all the printing materials for free.

Various types of content such as seasonal cards and paper crafts that can be made by assembling paper parts are provided.

CREATIVE PARK PREMIUM

A service where customers using models that support PREMIUM Contents can download exclusive printing materials.

PREMIUM Contents can be downloaded easily via Easy-PhotoPrint+. Downloaded PREMIUM Contents can be printed directly with Easy-PhotoPrint+.

To download PREMIUM Contents, make sure that genuine Canon ink tanks/ink cartridges are installed for all colors on a supported printer.



►► Note

- The designs of PREMIUM Contents provided in this page are subject to change without prior notice.

Print Items with Easy-PhotoPrint+ (Web Application)

You can easily create and print personalized items such as calendars and collages, anytime and anywhere, by simply accessing Easy-PhotoPrint+ on the web from a computer or tablet.

By using Easy-PhotoPrint+, you can create items in the latest environment without going through the trouble of installation.

Moreover, you can use various photos for your item through integration with social networks such as Facebook, or with online storage, web albums, etc.

Refer to "Easy-PhotoPrint+ Guide" for details.



Managing Printer Conveniently Using Quick Utility Toolbox

Quick Utility Toolbox is a shortcut menu that lets you access the functions you want to use with one click. After installing utilities compatible with Quick Utility Toolbox, they will be added to this menu. The Quick Utility Toolbox provides a convenient way to quickly launch added utilities for making printer settings and doing other management tasks.

Refer to the following for details.

- Quick Utility Toolbox Guide (Windows)
- Quick Utility Toolbox Guide (Mac OS)



Available Connection Methods

The following connection methods are available on the printer.

Wireless Connection

- With a wireless router



- Without a wireless router



Wired Connection



USB Connection



Wireless Connection

There are two methods for connecting the printer to your device (e.g. smartphone or tablet). One method is to connect using a wireless router, and the other method is to connect without using a wireless router.

The two connection methods cannot be used at the same time.

If you have a wireless router, we recommend you use the method described in Connection Using a Wireless Router.

When connecting another device while a device is already connected to the printer, connect it using the same connection method as the connected device.

If you connect using a different connection method, the connection to the device in use will be disabled.

• Connection Using a Wireless Router



- Connect the printer and a device using a wireless router.
- Connection methods vary depending on the wireless router type.
- You can change network settings such as the SSID and security protocol on the printer.
- When the connection between a device and a wireless router is completed and  (Wi-Fi icon) is displayed in the device's screen, you can connect the device to the printer using the wireless router.

• Connection without Using a Wireless Router



- Connect the printer and a device without using a wireless router. Connect a device and the printer directly using the printer's direct connection.
- While you are using the printer with direct connection, Internet connection from the printer becomes unavailable. In that case, web services for the printer cannot be used.
- If you connect a device connected to the Internet via a wireless router to the printer that is in the direct connection, the connection between the device and wireless router will be disabled. In that case, the connection of the device may switch to a mobile data connection automatically depending on your device. Transmission fees for connecting to the Internet using a mobile data connection apply.
- In the direct connection, you can connect up to five devices at the same time. If you try to connect a sixth device while five devices are already connected, an error will appear. If an error appears, disconnect a device you do not use and configure settings again.
- Network settings such as the SSID and security protocol are specified automatically.

Wired Connection

Connect the printer and a hub or router with an Ethernet cable. Prepare an Ethernet cable.

USB Connection

Connect the printer and a computer with a USB cable. Prepare a USB cable.

Restrictions

(Appears in a new window)

Scan Originals Larger than the Platen

By using the stitch function of IJ Scan Utility, you can scan the left and right halves of an item larger than the platen and combine them back into one image. Items up to approximately twice as large as the platen are supported.

Refer to the following for details.

- [Scanning Originals Larger than the Platen \(Image Stitch\) \(Windows\)](#)
- [Scanning Originals Larger than the Platen \(Image Stitch\) \(Mac OS\)](#)



Scan Multiple Originals at One Time

By using IJ Scan Utility, you can scan two or more photos (small items) placed on the platen at one time and save each image individually.

Refer to the following for details.

- [Scanning Multiple Originals at One Time](#) (Windows)
- Scanning Multiple Originals at One Time (Mac OS)

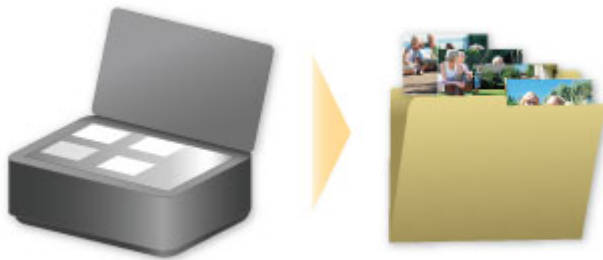

Using PIXMA/MAXIFY Cloud Link

By using PIXMA/MAXIFY Cloud Link, you can connect your printer to a cloud service, such as CANON IMAGE GATEWAY, Evernote, or Twitter, and use the following functions without using a computer:

- Print images from a photo-sharing service
- Print documents from a data management service
- Save scanned images to a data management service.
- Use Twitter to report the printer status, such as no paper or low ink levels.

In addition, you can use various functions by adding and registering apps that are linked with various cloud services.

■ [Using PIXMA/MAXIFY Cloud Link from Your Printer](#)

■ [Using PIXMA/MAXIFY Cloud Link from Your Smartphone, Tablet, or Computer](#)



▶▶▶ Important

- In certain countries, PIXMA/MAXIFY Cloud Link may not be available or the available apps may be different.
- Some apps require that you have an account before you use those apps. For such apps, please set up an account beforehand.
- To find out which models support PIXMA/MAXIFY Cloud Link check the Canon homepage.
- The screen display may change without prior notice.

Notice for Web Service Printing

When Using Web Service

- Canon does not guarantee the continuity and reliability of the web services provided, the availability of site access, or permission to download the materials.
- Canon may at any time update, change, or delete the information provided through the web service, or may suspend or discontinue the service without prior notice. Canon shall not be held responsible for any damages resulting from such actions.
- In no event shall Canon be liable for any damages whatsoever resulting from the use of the web services.
- User registration is necessary before you can use the external link site.
When you use the external link site, observe the conditions of use of the site and use the service within your own responsibility.
- All or part of the web service may not be available depending on the country or region you live in.
- Depending on your network environment, some functions on web service are not available. Even if they are available, it may take a while to print or display the contents, or communication may be interrupted while operation is in progress.
- When you use web service, your machine's name, information of your region or country, your selected language, and what kind of service you use (e.g. photo sharing site) are sent to and saved in our server. Canon is unable to identify specific customers using this information.
- Before you transfer ownership or dispose of a printer that supports a color LCD monitor, select **Device settings** -> **Reset setting** -> **Reset all** and delete your login name and password.
- For details, contact a Canon-authorized sales representative in the country or region you live in.

To Those Living in Mainland China

- PIXMA/MAXIFY Cloud Link, Easy-PhotoPrint+, and some functions of Canon PRINT Inkjet/SELPHY, which are included with this machine, are provided by Canon Inc.
However, as the server is installed outside of mainland China, some of these services may not be available yet.

Copyrights and Rights of Publicity

When printing using a service provided by Canon

1. The copyright of each material (photos, illustrations, logos, or documents: hereinafter referred to as "the materials") provided on the printing service belongs to their respective owners. Issues pertaining to Rights of Publicity may arise regarding the use of any of people or characters displayed on the printing service.

Except as otherwise permitted (please see "2" below), copying, modifying or distributing all or a portion of any of the materials contained on the web template printing service without prior consent of the respective rights (Rights of Publicity and Copyright) holder is strictly prohibited.
2. All of the materials provided on the web template printing service can be freely used for personal and non-commercial purposes.

Using PIXMA/MAXIFY Cloud Link from Your Printer

- ▶ [Before Using PIXMA/MAXIFY Cloud Link](#)
- ▶ [Registering Printer Information to PIXMA/MAXIFY Cloud Link](#)
- ▶ [Using PIXMA/MAXIFY Cloud Link](#)
- ▶ [Cloud Troubleshooting](#)

Before Using PIXMA/MAXIFY Cloud Link

First, check the following content:

- **Precautions**

If you plan to use the web service to print documents, be sure to check these [precautions](#) beforehand.

- **Printer Specifications**

- The printer must support a color LCD monitor.
To check whether your model supports this function, see "Models that Support PIXMA/MAXIFY Cloud Link from Your Printer".
- Your printer may not support the scan function.
- The printer must support the Canon Inkjet Cloud Printing Center.
To check whether your model supports this function, see "Models that Support Canon Inkjet Cloud Printing Center".

- **Network environment**

The printer must be connected to a LAN and to the Internet.

If your printer is not connected to a LAN, see here and set one up.

For information on the LAN and Internet settings, see the manual of your network devices or contact the manufacturer.

Important

- The user will bear the cost of Internet access.

■ [Registering Printer Information to PIXMA/MAXIFY Cloud Link](#)

Copyright c 1991-2015 Unicode, Inc. All rights reserved. Distributed under the Terms of Use in <http://www.unicode.org/copyright.html>.

This software is based in part on the work of the Independent JPEG Group.

THE BASIC LIBRARY FUNCTIONS

Written by: Philip Hazel

Email local part: ph10

Email domain: cam.ac.uk

University of Cambridge Computing Service, Cambridge, England.

Copyright (c) 1997-2008 University of Cambridge All rights reserved.

THE "BSD" LICENCE

Redistribution and use in source and binary forms, with or without modification, are permitted provided that the following conditions are met:

* Redistributions of source code must retain the above copyright notice, this list of conditions and the following disclaimer.

* Redistributions in binary form must reproduce the above copyright notice, this list of conditions and the

following disclaimer in the documentation and/or other materials provided with the distribution.

* Neither the name of the University of Cambridge nor the name of Google Inc. nor the names of their contributors may be used to endorse or promote products derived from this software without specific prior written permission.

THIS SOFTWARE IS PROVIDED BY THE COPYRIGHT HOLDERS AND CONTRIBUTORS "AS IS" AND ANY EXPRESS OR IMPLIED WARRANTIES, INCLUDING, BUT NOT LIMITED TO, THE IMPLIED WARRANTIES OF MERCHANTABILITY AND FITNESS FOR A PARTICULAR PURPOSE ARE DISCLAIMED. IN NO EVENT SHALL THE COPYRIGHT OWNER OR CONTRIBUTORS BE LIABLE FOR ANY DIRECT, INDIRECT, INCIDENTAL, SPECIAL, EXEMPLARY, OR CONSEQUENTIAL DAMAGES (INCLUDING, BUT NOT LIMITED TO, PROCUREMENT OF SUBSTITUTE GOODS OR SERVICES; LOSS OF USE, DATA, OR PROFITS; OR BUSINESS INTERRUPTION) HOWEVER CAUSED AND ON ANY THEORY OF LIABILITY, WHETHER IN CONTRACT, STRICT LIABILITY, OR TORT (INCLUDING NEGLIGENCE OR OTHERWISE) ARISING IN ANY WAY OUT OF THE USE OF THIS SOFTWARE, EVEN IF ADVISED OF THE POSSIBILITY OF SUCH DAMAGE.

Registering Printer Information to PIXMA/MAXIFY Cloud Link

Follow the steps described below to register the printer information to the cloud service server.

1. Check that the printer is connected to the Internet

2. From the printer home screen, select  **Cloud**

▶▶▶ Note

- [If multiple users will be using the printer](#) after the initial registration, select the login user name from the **Switch user** screen, enter the **Security code**, and proceed with the registration. If the **Security code** is incorrect, use your smartphone, tablet, or computer, and change the setting from the [My account](#) of the Canon Inkjet Cloud Printing Center.

3. When the registration preparation completed screen appears, select **OK**

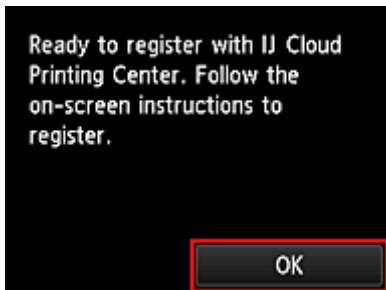

4. On the confirmation screen, select **Next**

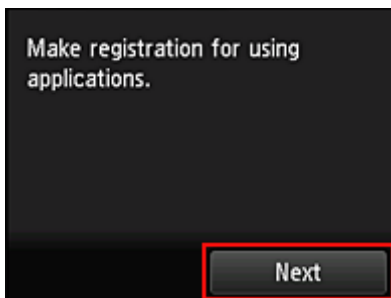

5. In the **License agreement** and **Privacy statement** windows, read the statements, and then select **Agree** if you agree

<License agreement>



<Privacy statement>

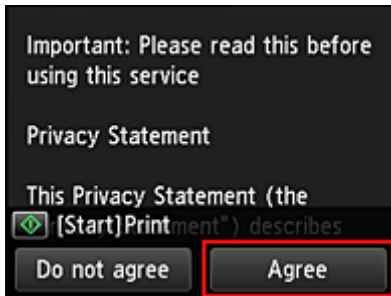

»» Note

- If you select **Do not agree**, a confirmation screen asking whether you want to cancel **Register My account** appears. If you select **Yes**, then **Register My account** is canceled, and you return to the Home screen. Even if you select **Do not agree**, you can still use this service by selecting **Agree** from the registration screen later.
- You can print the displayed information by pressing the **Start** button.

6. On the **Current time check** screen, select the time closest to the current time, and then select **Next**

You can set the time in 10-minute units.

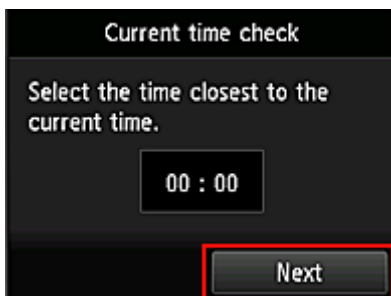

7. In the time zones list, select the region closest to you

For some regions, a screen for applying the daylight saving time setting may appear.

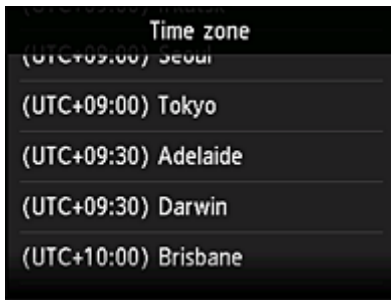

The registration of printer information is completed, and a list of apps is displayed.

See [here](#) for the description of the apps list screen.

After you complete the registration, you can [print photos and documents](#) that have been uploaded to apps on the linked cloud service and [add/delete/sort apps](#).

■ [Using PIXMA/MAXIFY Cloud Link](#)

Application Management

This section explains how to [add](#), [delete](#), and [sort](#) apps.

▶▶ Important

- **Select how to manage** allows you to change which users can use this service.
For details, see "[Canon Inkjet Cloud Printing Center window](#)".

Add apps

You can add your favorite apps to the printer.
Follow the steps described below to add apps.

1. From the printer home screen, select  **Cloud**
2. On the cloud's Main screen, select **Add/delete**

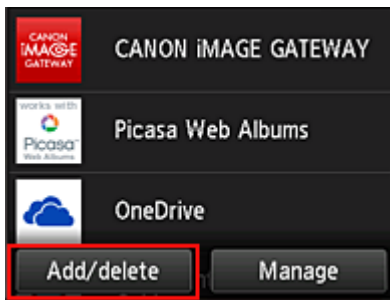

3. Select **Register apps**

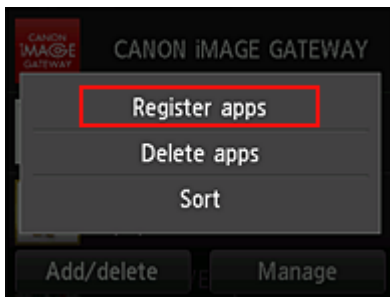

4. From the list, select the category of the app

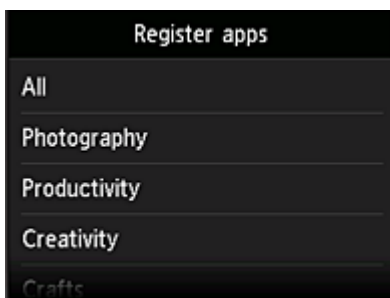

5. From the displayed apps list, select the app that you want to register

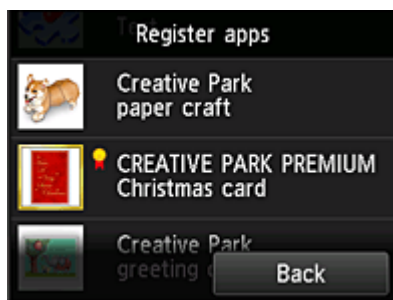

▶▶▶ Note

- Description of displayed icons



: Can be used with genuine Canon ink.

If you are using a G3000 series model, you cannot use this service because the model is not supported.

6. Select **Register**

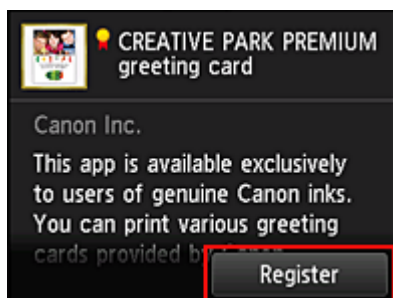

The registration is completed and the app is added to the apps list.

To register another app, repeat the procedure from step 5.

To end the app registration, select **Back** and return to the cloud's Main screen.

▶▶▶ Important

- Some apps may require a linked app account before you can use the app. If this is the case, set up an account beforehand.

Delete apps

You can delete unnecessary apps from the apps list.

Follow the steps described below to delete apps.



1. From the printer home screen, select **Cloud**

2. On the cloud's Main screen, select **Add/delete**

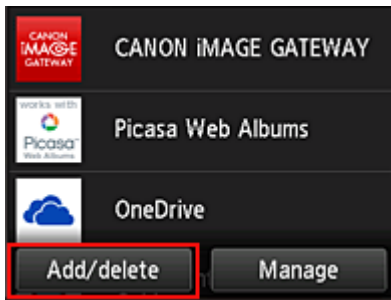

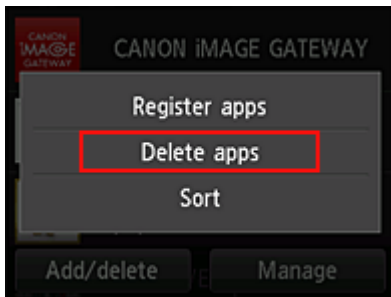

3. Select **Delete apps**

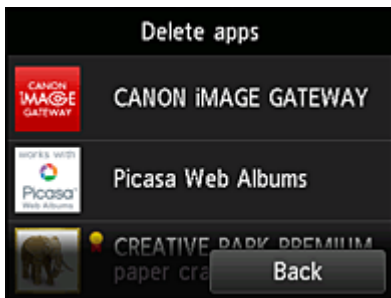

4. From the apps list, select the app that you want to delete



➤➤➤ **Note**

- Description of displayed icons
 -  : Cannot be used because it is not yet released or does not support your region, model, or language.
 -  : Can be used with genuine Canon ink.
- If you are using a G3000 series model, you cannot use this service because the model is not supported.

5. Select **Delete**

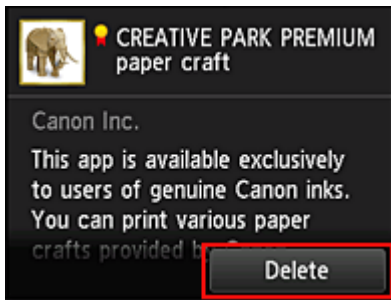

When the deletion is finished, the app will be deleted from the apps list on the main screen.

To delete another app, repeat the procedure from step 4.

To end the app deletion, select **Back** and return to the cloud's Main screen.

»» Note

- **Config** allows you to re-register deleted apps.

Sort apps

You can sort apps displayed on the apps list.

Follow the steps described below to sort apps.

1. From the printer home screen, select  **Cloud**
2. On the cloud's Main screen, select **Add/delete**

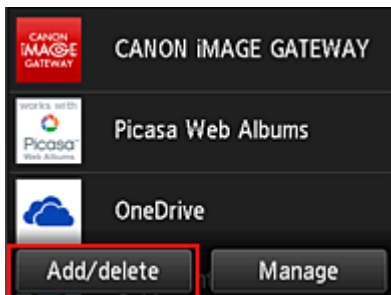

3. Select **Sort**

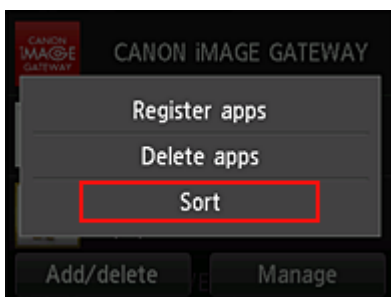

4. On the apps list, select the app that you want to sort

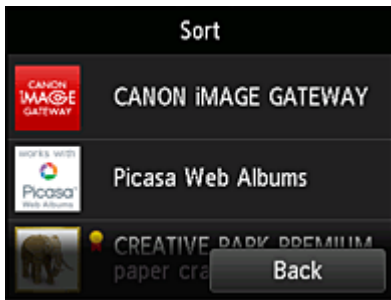

▶▶▶ Note

- Description of displayed icons



: Cannot be used because it is not yet released or does not support your region, model, or language.



: Can be used with genuine Canon ink.

If you are using a G3000 series model, you cannot use this service because the model is not supported.

5. Use ▲ / ▼ buttons to move the app

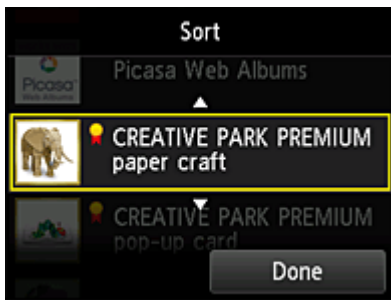

6. Select **Done**

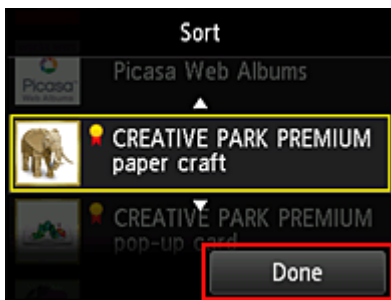

Sorting is complete.

To continue the sorting, repeat the procedure from step 4.

To end the sorting, select **Back** and return to the cloud's Main screen.

Using PIXMA/MAXIFY Cloud Link

This section introduces the photo printing procedure by using CANON IMAGE GATEWAY as an example.

▶▶▶ Important

- The available functions differ depending on the app.
- The printing procedure differs depending on the app.
- You need to get the account and register photo and other data beforehand.
- The following file formats can be printed: jpg, jpeg, pdf, docx, doc, xlsx, xls, pptx, ppt, and rtf.
The file formats that can be printed differ depending on the app.
- Before you print, check that printer is on and is connected to the network. Then start.

▶▶▶ Note

- You can use CANON IMAGE GATEWAY to print jpg and jpeg file formats.

1. On the [Main screen](#), select the app to be used
2. Enter the information according to the instructions on the authentication screen, and then select **Log in**

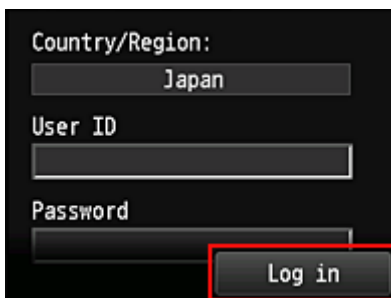

▶▶▶ Important

- Some apps may not be fully displayed in the display area. If this is the case, scroll up, down, right, and left to change the display area.

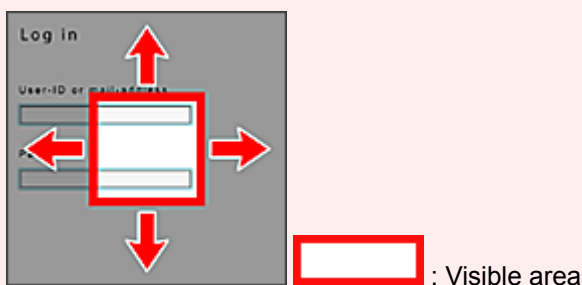

- The Login screen may vary between apps.
- After logging in, you may be asked from an external service to agree to use their app. Agree if you are using the app.

3. In the displayed album list, select the album of your choice



4. In the displayed image list, select the image that you want to print, and then select **Next**

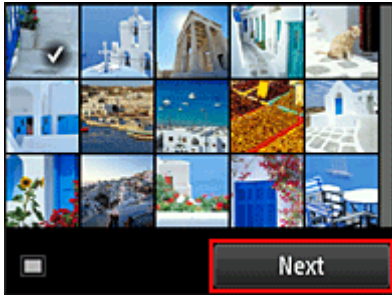

5. Make the necessary print settings, and then select **Color**

A message that indicates the completion of issuing print job appears, and printing starts.

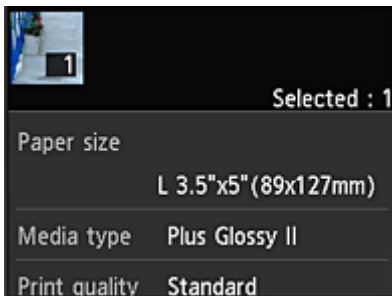

To continue printing, select **Continue**, and perform the operation from Step 3.

To end the printing, select **Apps**. The screen returns to the apps list screen.

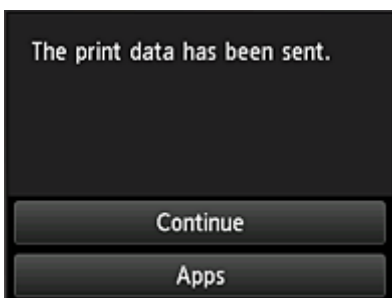

▶▶ Important

- If a print job is not printed within 24 hours after the print job is issued, the print job will expire and cannot be printed.
- With premium apps that limit the number of print jobs, print jobs that cannot be printed due to expiration and other reasons are also included in the print count.

▶▶▶ Note

- To leave a usage history of this service, from the Home window on the operation panel, select 

 **Setup -> Web service setup -> Web service connection setup -> IJ Cloud Printing Center setup -> History setting for this service -> Save.**

■ [Cloud Troubleshooting](#)

Cloud Windows

This section describes the Main screen of **Cloud** and the services available on the Main screen.

▶▶▶ Important

- **Select how to manage** allows you to change which users can use this service.
For details, see "[Canon Inkjet Cloud Printing Center window](#)".



When you select **Cloud** from the printer home screen, the cloud's Main screen appears.

You can use the areas shown below to perform various functions, including adding, starting, and managing apps.

You can also print photos and documents by starting the appropriate app.



- (1) [Applications](#)
- (2) [Add/delete button](#)
- (3) [Manage button](#)

▶▶▶ Important

- Depending on the apps you plan to use, you may need to have an account beforehand. If this is the case, get an account for each of those apps.
- After selecting the app, some apps may not be fully displayed in the display area. If this is the case, scroll up, down, right, and left to change the display area.

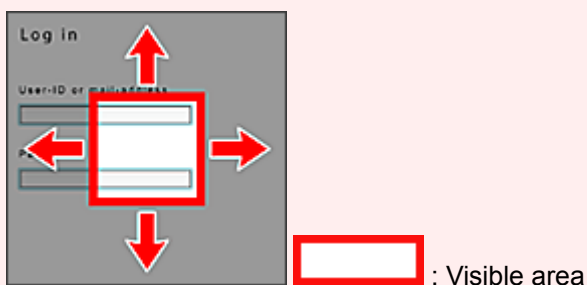

- If an app is not yet released or does not support your model, language, or region, you will not be able to start that app.

(1) Applications

Immediately after the cloud's Main screen appears, a list of the registered apps appears.

To start an app, select the app that you want to use on the list.

▶▶▶ Note

- Description of displayed icons



: Cannot be used because it is not yet released or does not support your region, model, or language.



: Can be used with genuine Canon ink.

If you are using a G3000 series model, you cannot use this service because the model is not supported.

(2) Add/delete button

Use this button to add, delete, and sort apps.

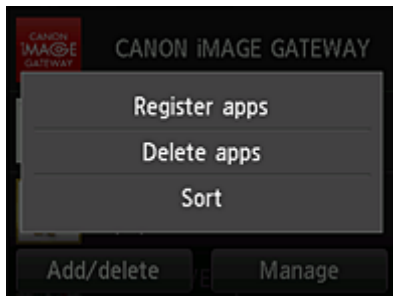

Register apps

Select this to add your favorite apps.

- [See here for details on how to add apps](#)

Delete apps

Select this to delete registered apps.

- [See here for details on how to delete apps](#)

Sort

Select this to sort the apps list.

- [See here for details on how to sort the apps list](#)

(3) Manage button

Use this button to manage jobs, log out of an app, show the license agreement and privacy statement, and set the time zone.

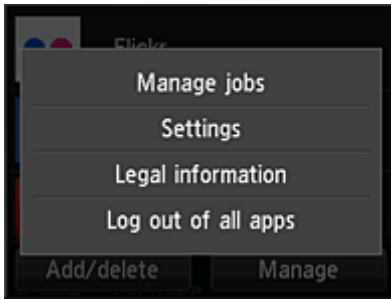

Manage jobs

From the **Status list** window, you can check the status of a job.

Settings

Select this to set the **Time zone**.

Select your region on the list. For some regions, you can set whether or not to apply the daylight saving time setting.

»»» Important

- If you cannot find your region on the list, select the one closest to your region.

Legal information

This shows the **License agreement** and **Privacy statement**.

Press the **Start** button to print the displayed information.

Log out of all apps

You can log out at the same time from all apps that you are logged into.

»»» Note

- Some apps may keep you logged in even after the app ends. Therefore if you want to log in again with a different account, select **Log out of all apps** to log out first.
- Once you log out, you need to log in again. You may lose the settings with some apps.

Cloud Troubleshooting

If you cannot print

Check the following if you cannot print.

- Check that the printer is connected to the Internet.
- Check that the printer is connected to a LAN and the LAN environment is connected to the Internet.
- Check that no error message is displayed on the printer's LCD monitor.



- If printing does not start even after you wait awhile, go to the printer's home screen, and select **Setup -> Web service inquiry**.

If the problem is not resolved, use the printer driver from your computer to perform the print job and check whether the data can be printed normally on the printer.

If you still cannot print, see the troubleshooting page for your model on the Home of the Online Manual.

▶▶ Note

- With a wireless LAN connection, after the printer is turned on, it may take several minutes before communication is possible. Check that your printer is connected to the wireless network, and wait a while before you start printing.
- If the printer is not turned on or is not connected to the Internet, and consequently a print job is not processed within 24 hours after it was submitted, the print job is automatically canceled. If this happens, check the printer power and the Internet connection, and then re-submit the print job.

Using PIXMA/MAXIFY Cloud Link from Your Smartphone, Tablet, or Computer

- ▶ **Before Using Canon Inkjet Cloud Printing Center**
- ▶ **Registering User Information to Canon Inkjet Cloud Printing Center**
- ▶ **Using Canon Inkjet Cloud Printing Center**
- ▶ **Adding a Printer**
- ▶ **Adding a PIXMA/MAXIFY Cloud Link User**
- ▶ **Troubleshooting Canon Inkjet Cloud Printing Center**

Before Using Canon Inkjet Cloud Printing Center

Canon Inkjet Cloud Printing Center is a service that links with the cloud function of the printer and allows you to perform operations such as registering and managing apps from your smartphone or tablet device, and checking the print status, print error, and ink status of the printer. You can also print app photos and documents from your smartphone or tablet.

First, check the following content:

- **Precautions**

If you plan to use the web service to print documents, be sure to check these [precautions](#) beforehand.

- **Printer specification**

Check that Canon Inkjet Cloud Printing Center supports the printer.

Some models do not support this function. To check whether your model supports this function, see "Models that Support Canon Inkjet Cloud Printing Center".

- **Network environment**

The printer must be connected to a LAN and to the Internet.

▶▶▶ Important

- The user will bear the cost of Internet access.

- **Operating requirements**

For computers, smartphones, and tablet devices, see "[Requirements for Canon Inkjet Cloud Printing Center operation](#)".

▶▶▶ Important

- This service may not be available in certain countries or regions. Also even if the service is available, there are apps that cannot be used in certain regions.

■ [Registering User Information to Canon Inkjet Cloud Printing Center](#)

Requirements for Canon Inkjet Cloud Printing Center operation

Computer

CPU	x86 or x64 1.6 GHz or higher
RAM	2 GB or higher
Monitor display	Resolution 1024 x 768 pixels or higher Number of display colors 24 bits (true-color) or higher

OS	Browser
Windows Vista SP2	Internet Explorer 9 Mozilla Firefox Google Chrome
Windows 7	Internet Explorer 9, 10, 11 Mozilla Firefox Google Chrome
Windows 8	Internet Explorer 10, 11 Mozilla Firefox Google Chrome
Windows 8.1	Internet Explorer 11 Mozilla Firefox Google Chrome
Windows 10	Internet Explorer 11 Microsoft Edge Mozilla Firefox Google Chrome
Mac OS X v10.6-OS X Yosemite v10.10	Safari 5.1, 6, 7, 8

Smartphone or tablet

OS	Browser	Resolution
iOS 7 or later	OS standard browser	320 x 480 or higher
Android 4 or later		480 x 800 or higher

The operation requirements may change without prior notice. If this happens, you may no longer be able to use this service from your computer, smartphone, or tablet.

»»» Important

- On the browser you are using, enable JavaScript and cookies.
- If you use the zoom function or change the font size on your browser, the web pages may not display correctly.
- If you use the translation function of Google Chrome, the web pages may not display correctly.
- The service does not support the use of its provided services through a proxy server outside of your country.

- In an in-house network environment, the 5222 port must be released. For confirmation instructions, contact the network administrator.
-

Registering User Information to Canon Inkjet Cloud Printing Center

To use the Canon Inkjet Cloud Printing Center, you need to follow the steps described below and register **My account** information.

- [If your model has color LCD monitor](#)
- [If your model has monochrome LCD monitor](#)
- [If your model has no LCD monitor/If you are using PRO-1000 series or PRO-500 series](#)

Registering User Information to Canon Inkjet Cloud Printing Center (Color LCD Monitor)

To use the Canon Inkjet Cloud Printing Center, you need to follow the steps described below and register **My account** information.

Registering from Printer

1. Check that the printer is connected to the Internet

2. From the printer home screen, select  **Cloud**

If printer information has not been registered to the cloud service server, the [Registration Preparation Completion Screen](#) appears.

3. From cloud main screen, select **Use from Smartphone** or **Mobile Integration Guide**

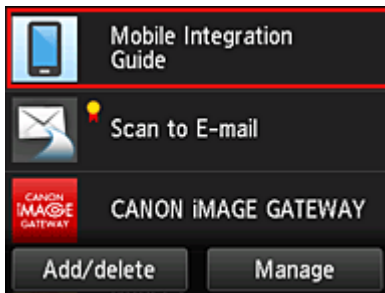

4. Follow instructions appearing in screen, and select **Next**
5. In user registration screen, select **Show QR Code**

You can also access the URL manually from you smartphone, tablet, or computer.

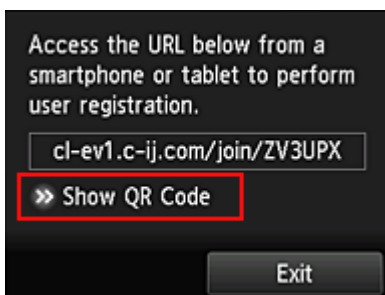

6. Read displayed QR code by using your smartphone or tablet



To return to the cloud main screen, select **Exit**.

➤➤➤ Note

- You must have a special app to read QR codes from your smartphone or tablet. If you do not have an app that reads QR codes on your smartphone or tablet, install one from App Store or Google Play.

7. In **Preparation for registration** screen, select **Send blank e-mail**

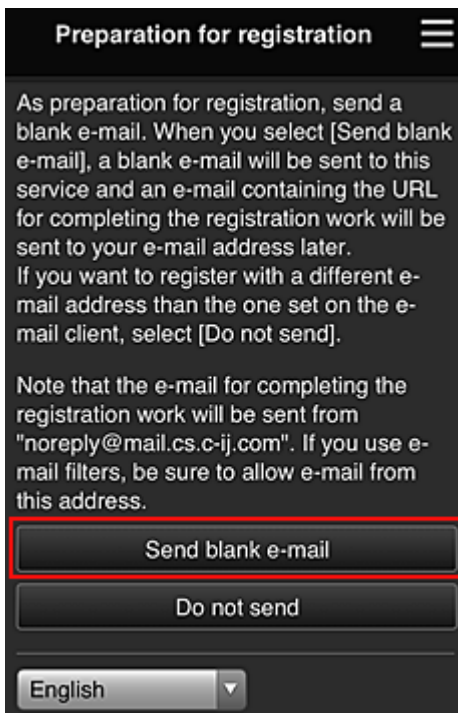

➤➤➤ Note

- When you select **Send blank e-mail**, the "destination entry completed" mailer starts up automatically.
After the blank e-mail is created, send that e-mail without making any changes.

If you want to register a different e-mail address, select **Do not send** to display the **E-mail address** entry screen.

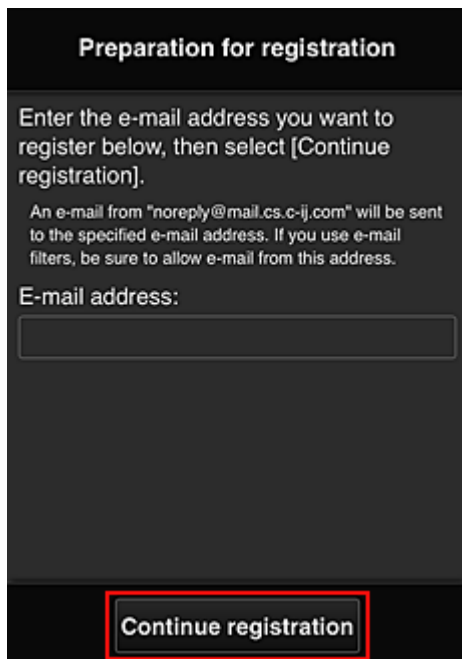

In the displayed screen, enter the **E-mail address** that you want to register, and then select **Continue registration**.

➤➤ Note

- If you enter an e-mail address that has already been registered, you will receive an "already registered" e-mail. Follow the instructions in the e-mail, and register a different e-mail address.

➤➤ Important

- There are character restrictions for the e-mail address, as shown below.
 - Up to 255 characters consisting of single-byte alphanumeric characters and symbols (!\$*/^_{}~.-@). (Uppercase and lowercase letters are differentiated.)
 - Multibyte characters cannot be used.
You will get an error if the e-mail address you enter contains a character that cannot be used.
- If you registered a different e-mail address by mistake, you can cancel the registration by going to the printer's Home screen and selecting **Setup** -> **Web service setup** -> **Web service connection setup** -> **IJ Cloud Printing Center setup** -> **Delete from this service**.
- You may not be able to receive the notification if you are using a spam filter. If you have a setting to receive only the e-mails from certain domains, be sure to change the setting to allow receiving e-mails from "noreply@mail.cs.c-ij.com".
There will be no error display even if you could not receive the e-mail because of the spam filter setting or if you entered an incorrect e-mail address.

8. Check that you received blank e-mail, and then select **Yes**

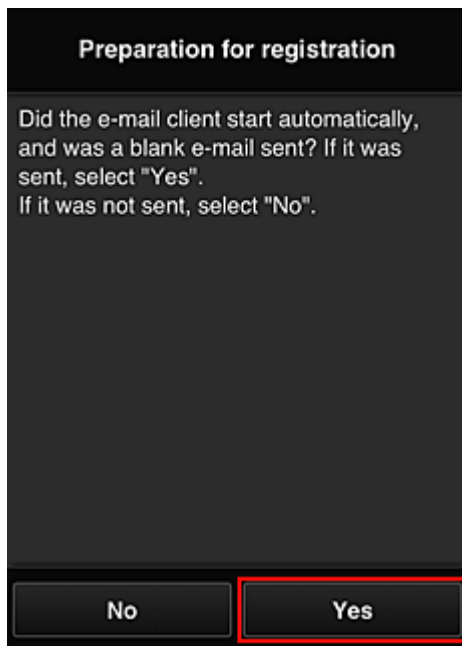

9. Follow instructions in screen display, and select **OK**

The registration page URL will be sent to the registered e-mail address.

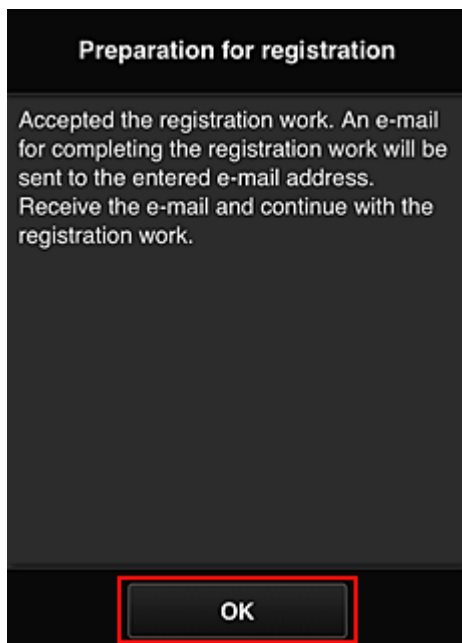

Access the URL in the e-mail, Register the Information, and Complete the User Registration

1. Check that e-mail containing URL has been sent to registered e-mail address, and access URL
2. In the **License agreement** and **Privacy statement** windows of Canon Inkjet Cloud Printing Center, read the statements, and select **Agree** if you agree

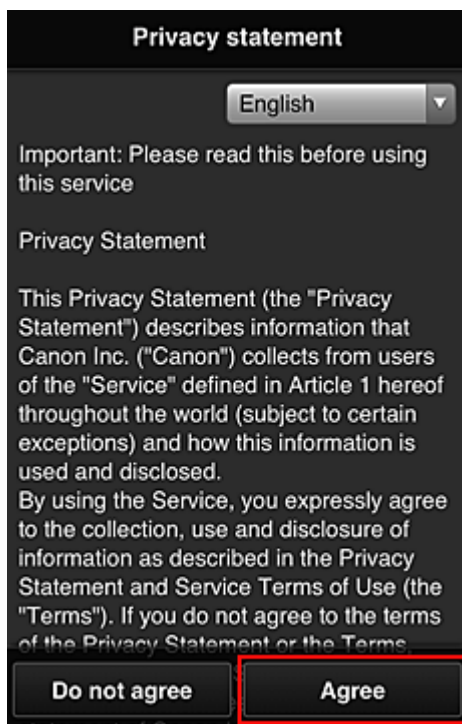
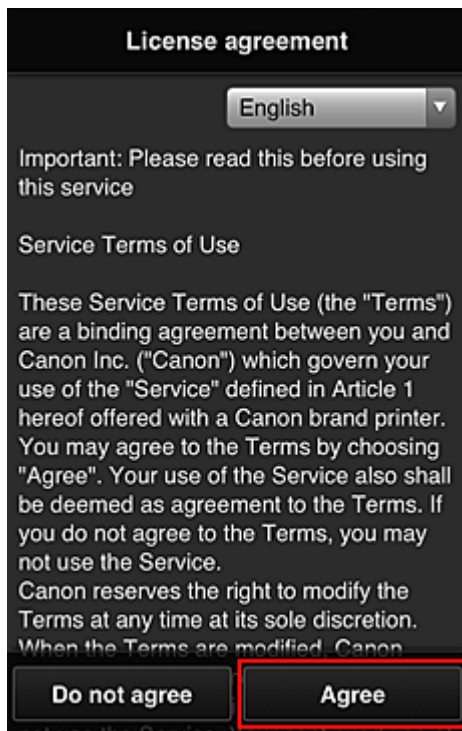

3. Register password for logging in to Canon Inkjet Cloud Printing Center

In the My account registration screen, enter the password you want to register into **Password** and **Password (Confirmation)**, and then select **Next**.

Register My account

Set a password for logging into this service.

Password:

Password (Confirmation):

8 to 32 characters

Cancel Next

»» Important

- There are character restrictions for the **Password**, as shown below.
- The password must be between 8 and 32 characters long, using single-byte alphanumeric characters and symbols (!"#\$\$%&'()*+,-./:;<=>@[¥]^_`{|}~). (Alphabets are case-sensitive)

4. Enter **Nickname**

Enter any user name you want to use.

Register My account

Nickname:

1 to 20 characters

Time zone:

(UTC) Coordinated Universal Time ▼

Back Done

»» Important

- The user name entry field has the following character restrictions:

- The user name must be between 1 and 20 characters long, using single-byte alphanumeric characters and symbols (!"#\$%&'()*+,-./:;<=>@[¥]^_`{|}~). (Alphabets are case-sensitive)

5. Specify the **Time zone** setting, and select **Done**

Select your region on the list. If you cannot find your region on the list, select the one closest to your region.

Apply daylight saving time

This appears only when there is a daylight saving time in the **Time zone** that you selected. Select whether or not to apply the daylight saving time.

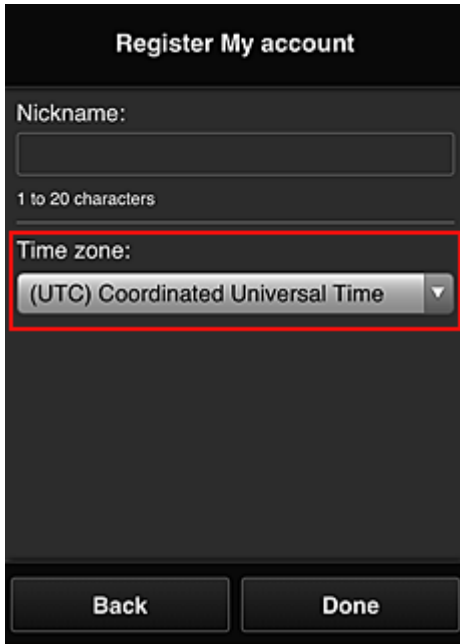

The screenshot shows a registration form titled "Register My account". It includes a "Nickname:" field with a character count of "1 to 20 characters". Below this is a "Time zone:" dropdown menu, which is highlighted with a red border and currently displays "(UTC) Coordinated Universal Time". At the bottom of the form are two buttons: "Back" and "Done".

The registration is complete. A registration completion message is displayed. When you select the **OK** button in the message, the login screen is displayed.

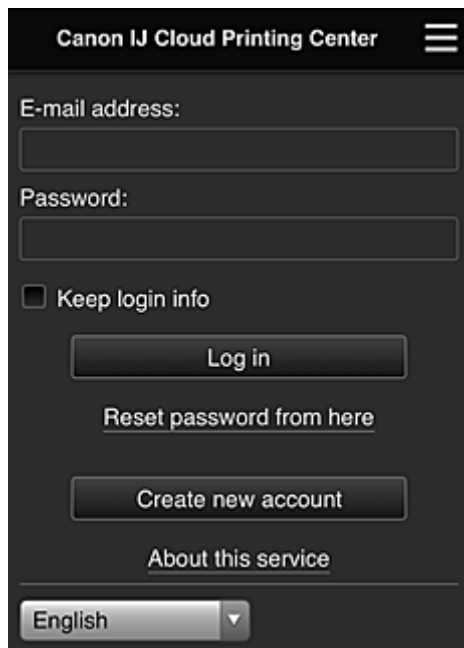

The screenshot shows the login screen for "Canon IJ Cloud Printing Center". It features an "E-mail address:" field, a "Password:" field, and a "Keep login info" checkbox. Below these are buttons for "Log in", "Reset password from here", "Create new account", and "About this service". At the bottom, there is a language dropdown menu currently set to "English".

Enter the registered **E-mail address** and **Password**, and [Log in](#) to the Canon Inkjet Cloud Printing Center.

■ [Using Canon Inkjet Cloud Printing Center](#)

Registering User Information to Canon Inkjet Cloud Printing Center (Monochrome LCD Monitor)

To use the Canon Inkjet Cloud Printing Center, you need to follow the steps described below and register **My account** information.

Print registration information from the printer

1. On the printer operation panel, select the  **Setup** button, and then select **Web service setup** -> **Connection setup** -> **IJCloudPrintingCtr** -> **Register w/ service**

2. In the registration confirmation window, Select **Yes**

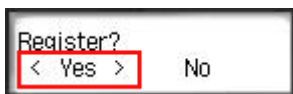

3. In the print settings, select the display language

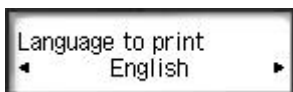

4. Follow the instructions displayed in the window, and print the URL of the authentication site and the [Printer registration ID](#)

Set A4 size or Letter size or Legal size plain paper and select **OK**.

The authentication URL and **Printer registration ID** are printed.

►► Important

- The operation to complete the registration should be done within 60 minutes.

Access the URL on the printed page, and then enter the e-mail address and other necessary information

►► Important

- Do not use the Back button of the web browser while an operation is processing. The screen may not transition properly.

►► Note

- If you enter an e-mail address that has already been registered, you will receive an "already registered" e-mail. Follow the instructions in the e-mail, and register a different e-mail address.

1. Use the web browser on your PC, smartphone, tablet, or other devices to access the authentication URL



2. When the printer registration screen is displayed, select **Create new account**

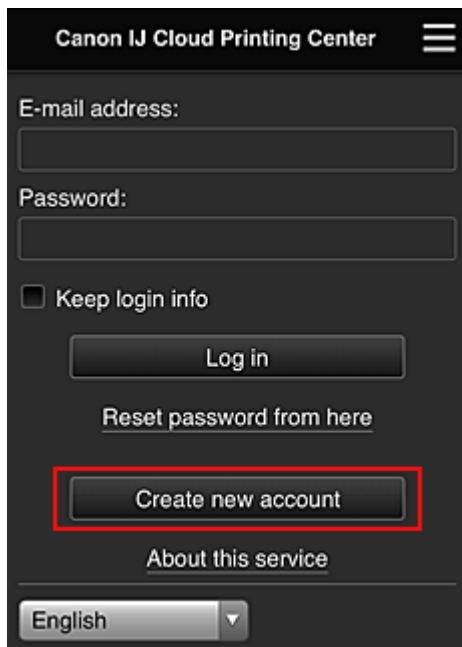

3. Enter the **E-mail address** and **Printer registration ID** of the printer's owner, and then select **OK**

The registration page URL is sent to the e-mail address entered.

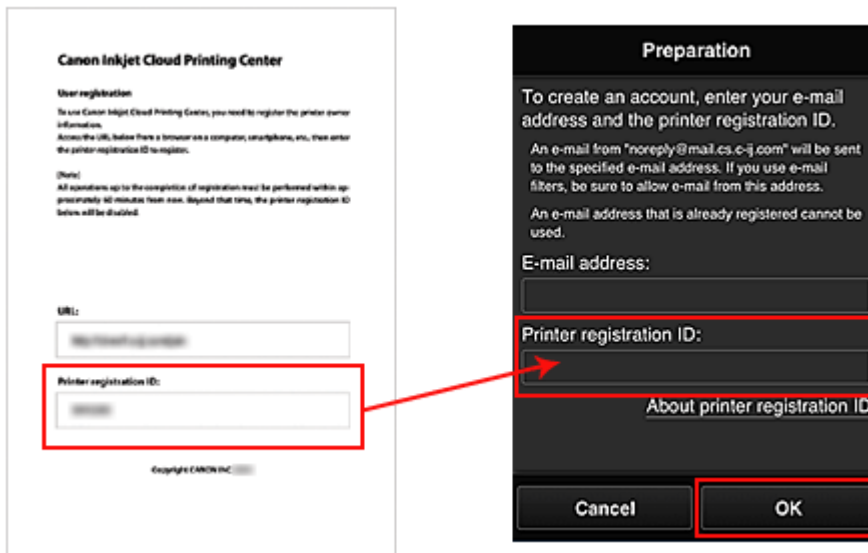

➤➤➤ Important

- There are character restrictions for the e-mail address, as shown below.
 - Up to 255 characters consisting of single-byte alphanumeric characters and symbols (!\$*/^_{}|~.-@). (Uppercase and lowercase letters are differentiated.)
 - Multibyte characters cannot be used.
You will get an error if the e-mail address you enter contains a character that cannot be used.
- If you registered a different e-mail address by mistake, you can cancel the registration by selecting the **Setup** button on the printer operation panel, and then selecting **Web service setup -> Connection setup -> IJCloudPrintingCtr -> Delete from service**.
- You may not be able to receive the notification if you are using a spam filter. If you have a setting to receive only the e-mails from certain domains, be sure to change the setting to allow receiving e-mails from "noreply@mail.cs.c-ij.com".
There will be no error display even if you could not receive the e-mail because of the spam filter setting or if you entered an incorrect e-mail address.

Access the URL in the e-mail, Register the Information, and Complete the User Registration

1. Check that e-mail containing URL has been sent to entered e-mail address, and access URL
2. In the **License agreement** and **Privacy statement** windows of Canon Inkjet Cloud Printing Center, read the statements, and select **Agree** if you agree

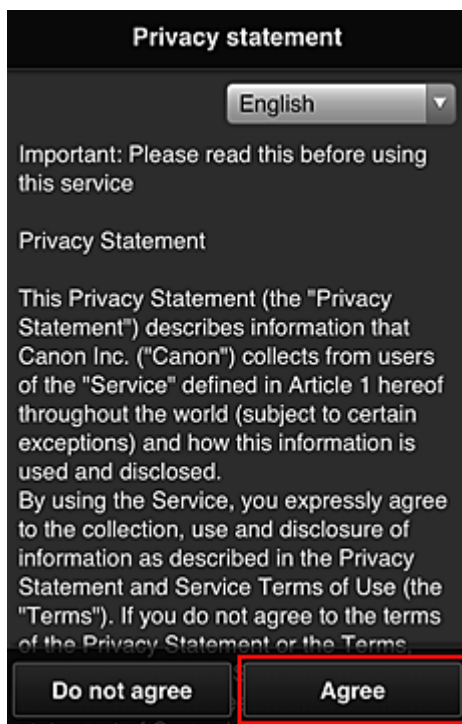
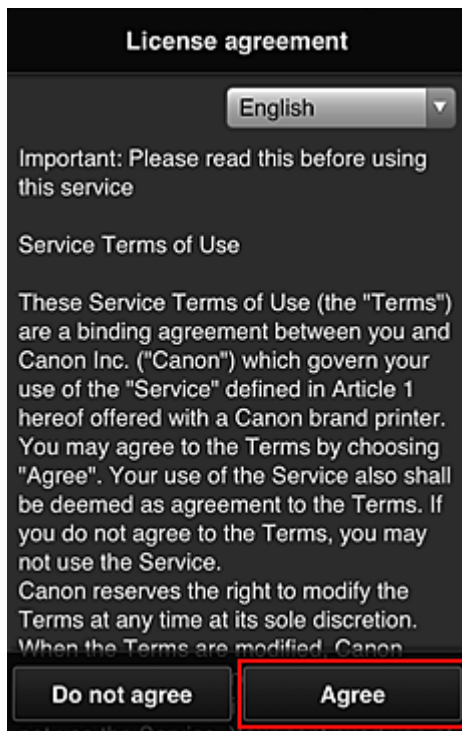

3. Register password for logging in to Canon Inkjet Cloud Printing Center

In the My account registration screen, enter the password you want to register into **Password** and **Password (Confirmation)**, and then select **Next**.

Register My account

Set a password for logging into this service.

Password:

Password (Confirmation):

8 to 32 characters

Cancel Next

»» Important

- There are character restrictions for the **Password**, as shown below.
- The password must be between 8 and 32 characters long, using single-byte alphanumeric characters and symbols (!"#%&'()*+,-./:;<=>@[¥]^_`{|}~). (Alphabets are case-sensitive)

4. Enter **Nickname**

Enter any user name you want to use.

Register My account

Nickname:

1 to 20 characters

Time zone:

(UTC) Coordinated Universal Time ▼

Back Done

»» Important

- The user name entry field has the following character restrictions:

- The user name must be between 1 and 20 characters long, using single-byte alphanumeric characters and symbols (!"#\$%&'()*+,-./:;<=>@[¥]^_`{|}~). (Alphabets are case-sensitive)

5. Specify the **Time zone** setting, and select **Done**

Select your region on the list. If you cannot find your region on the list, select the one closest to your region.

Apply daylight saving time

This appears only when there is a daylight saving time in the **Time zone** that you selected. Select whether or not to apply the daylight saving time.

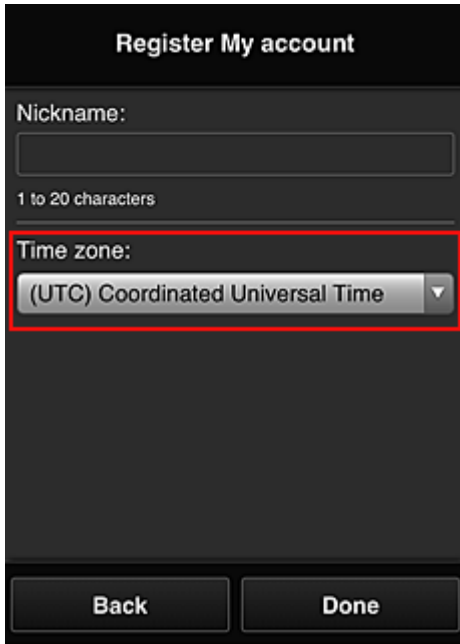

The screenshot shows a registration form titled "Register My account". It includes a "Nickname:" field with a character count of "1 to 20 characters". Below this is a "Time zone:" dropdown menu, which is highlighted with a red border and currently displays "(UTC) Coordinated Universal Time". At the bottom of the form are two buttons: "Back" and "Done".

The registration is complete. A registration completion message is displayed. When you select the **OK** button in the message, the login screen is displayed.

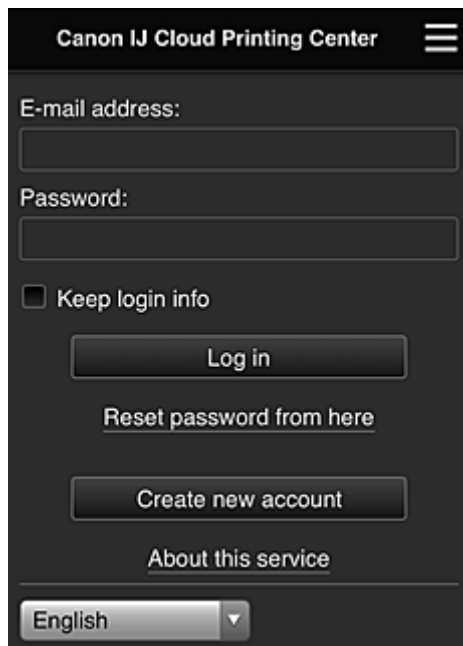

The screenshot shows the login screen for "Canon IJ Cloud Printing Center". It features an "E-mail address:" field, a "Password:" field, and a "Keep login info" checkbox. Below these are buttons for "Log in", "Reset password from here", "Create new account", and "About this service". At the bottom, there is a language dropdown menu currently set to "English".

Enter the registered **E-mail address** and **Password**, and [Log in](#) to the Canon Inkjet Cloud Printing Center.

■ [Using Canon Inkjet Cloud Printing Center](#)

Printing Your Printer Registration ID

»» Important

- Some models do not support this function.

To add a printer by using Canon Inkjet Cloud Printing Center, you will need a **Printer registration ID**.



From the operation panel of this printer, print the URL of the authentication site and your **Printer registration ID**. The procedure is as follows:

1. Check that the printer is connected to the Internet

»» Important

- To use this function, you must connect this printer to the Internet.

If your model has color LCD monitor

2. From the home window, select  **Setup** ( Various settings) ->  **Web service setup** -> **Web service connection setup** -> **IJ Cloud Printing Center setup** -> **Register with this service**

3. In the registration confirmation window, Select **Yes**

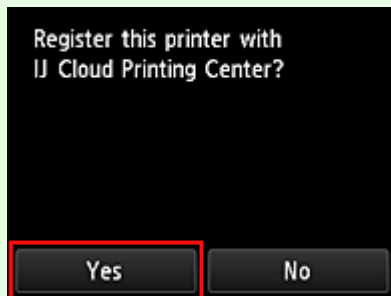

4. In the print settings, select the display language



If your model has monochrome LCD monitor

2. On the printer operation panel, select the  **Setup** button, and then select **Web service setup -> Connection setup -> IJCloudPrintingCtr -> Register w/ service**

3. In the registration confirmation window, Select **Yes**

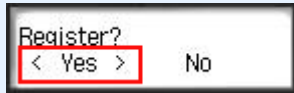

4. In the print settings, select the display language

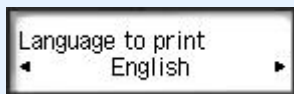

5. Follow the instructions displayed in the window, and print the URL of the authentication site and your **Printer registration ID**

When you set A4 size or Letter size or Legal size plain paper and select **OK**, the authentication site URL and your **Printer registration ID** are printed.

Important

- The operation to complete the registration should be done within 60 minutes.

Registering User Information to Canon Inkjet Cloud Printing Center (No LCD Monitor/Using PRO-1000 series or PRO-500 series)

To use the Canon Inkjet Cloud Printing Center, you need to follow the steps described below and register **My account** information.

Registering from Your Smartphone, Tablet, or Computer

1. Check that the printer is connected to the Internet

▶▶▶ Important

- To use this function, you must connect this printer to the Internet.

2. Displaying Printer Information

For details, go to the Online Manual home page, and see "Checking Printer Information" for your model.

3. Select **IJ Cloud Printing Center setup -> Register with this service**

4. Follow the instructions displayed in the window, and run the authentication

5. When the **Preparation for registration** screen appears, select **Send blank e-mail**

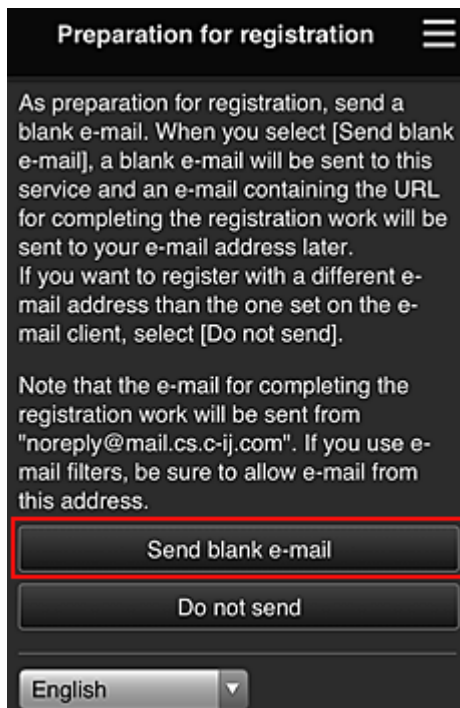

▶▶▶ Note

- When you select **Send blank e-mail**, the "destination entry completed" mailer starts up automatically.
After the blank e-mail is created, send that e-mail without making any changes.

If you want to register a different e-mail address, select **Do not send** to display the **E-mail address** entry screen.

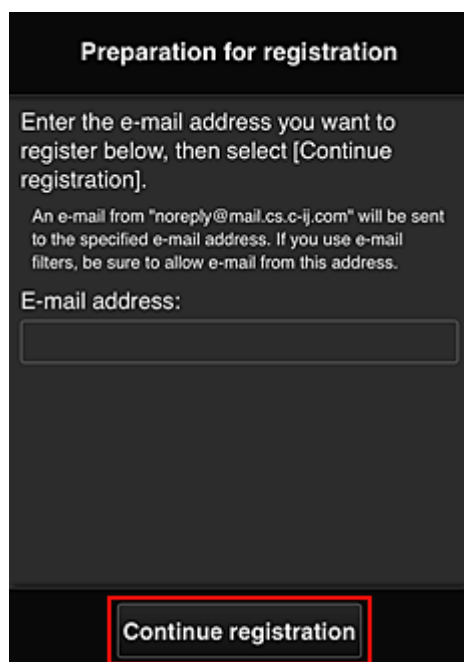

Preparation for registration

Enter the e-mail address you want to register below, then select [Continue registration].

An e-mail from "noreply@mail.cs.c-ij.com" will be sent to the specified e-mail address. If you use e-mail filters, be sure to allow e-mail from this address.

E-mail address:

Continue registration

In the displayed screen, enter the **E-mail address** that you want to register, and then select **Continue registration**.

▶▶▶ Note

- If you enter an e-mail address that has already been registered, you will receive an "already registered" e-mail. Follow the instructions in the e-mail, and register a different e-mail address.

▶▶▶ Important

- There are character restrictions for the e-mail address, as shown below.
 - Up to 255 characters consisting of single-byte alphanumeric characters and symbols (!\$*/^_{}|~.-@). (Uppercase and lowercase letters are differentiated.)
 - Multibyte characters cannot be used.
You will get an error if the e-mail address you enter contains a character that cannot be used.
- If you registered a different e-mail address by mistake, you can cancel the registration by Displaying Printer Information and selecting **IJ Cloud Printing Center setup -> Delete from this service**.
To display printer information, go to the Online Manual home page, and see "Checking Printer Information" for your model.
- You may not be able to receive the notification if you are using a spam filter. If you have a setting to receive only the e-mails from certain domains, be sure to change the setting to allow receiving e-mails from "noreply@mail.cs.c-ij.com".
There will be no error display even if you could not receive the e-mail because of the spam filter setting or if you entered an incorrect e-mail address.

6. Check that you received blank e-mail, and then select **Yes**

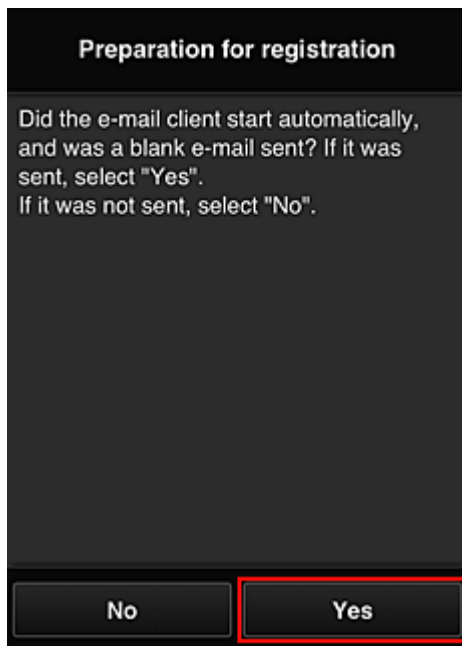

7. Follow instructions in screen display, and select **OK**

The registration page URL will be sent to the registered e-mail address.

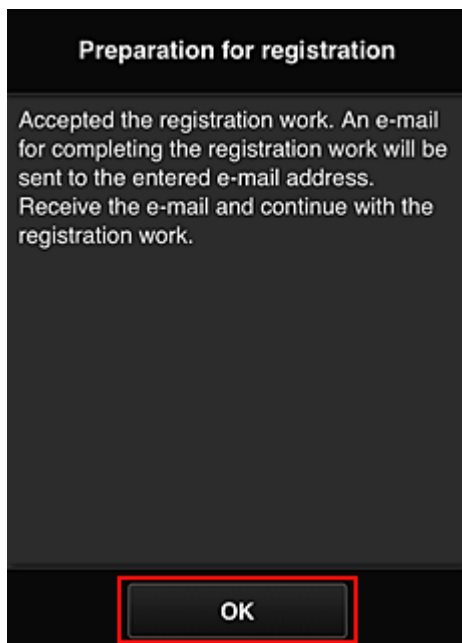

Access the URL in the e-mail, Register the Information, and Complete the User Registration

1. Check that e-mail containing URL has been sent to registered e-mail address, and access URL
2. In the **License agreement** and **Privacy statement** windows of Canon Inkjet Cloud Printing Center, read the statements, and select **Agree** if you agree

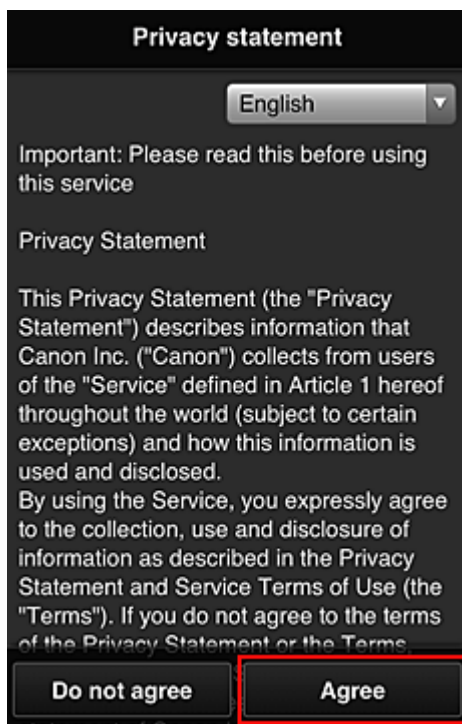
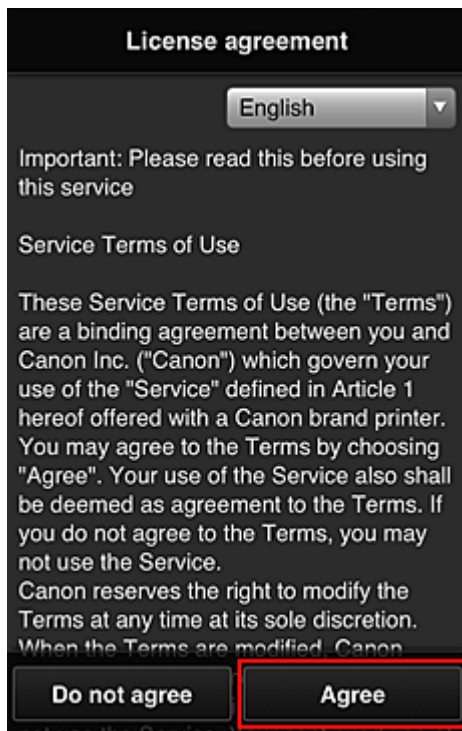

3. Register password for logging in to Canon Inkjet Cloud Printing Center

In the My account registration screen, enter the password you want to register into **Password** and **Password (Confirmation)**, and then select **Next**.

Register My account

Set a password for logging into this service.

Password:

Password (Confirmation):

8 to 32 characters

Cancel Next

»» Important

- There are character restrictions for the **Password**, as shown below.
- The password must be between 8 and 32 characters long, using single-byte alphanumeric characters and symbols (!"#%&'()*+,-./:;<=>@[¥]^_`{|}~). (Alphabets are case-sensitive)

4. Enter **Nickname**

Enter any user name you want to use.

Register My account

Nickname:

1 to 20 characters

Time zone:

(UTC) Coordinated Universal Time ▾

Back Done

»» Important

- The user name entry field has the following character restrictions:

- The user name must be between 1 and 20 characters long, using single-byte alphanumeric characters and symbols (!"#\$%&'()*+,-./:;<=>@[¥]^_`{|}~). (Alphabets are case-sensitive)

5. Specify the **Time zone** setting, and select **Done**

Select your region on the list. If you cannot find your region on the list, select the one closest to your region.

Apply daylight saving time

This appears only when there is a daylight saving time in the **Time zone** that you selected. Select whether or not to apply the daylight saving time.

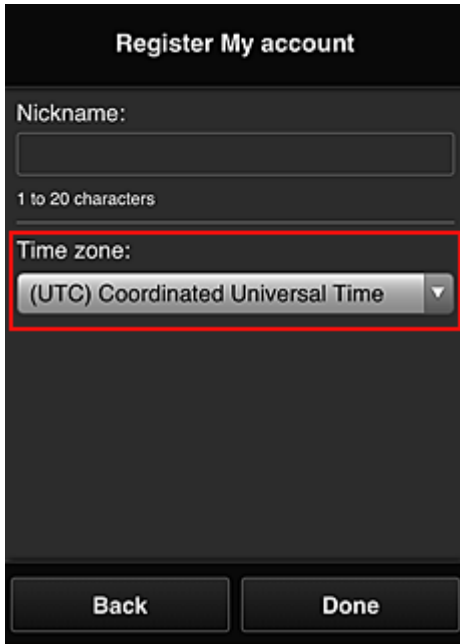

The screenshot shows a registration form titled "Register My account". It includes a "Nickname:" field with a "1 to 20 characters" constraint. Below this is a "Time zone:" dropdown menu, which is highlighted with a red border and currently displays "(UTC) Coordinated Universal Time". At the bottom of the form are two buttons: "Back" and "Done".

The registration is complete. A registration completion message is displayed. When you select the **OK** button in the message, the login screen is displayed.

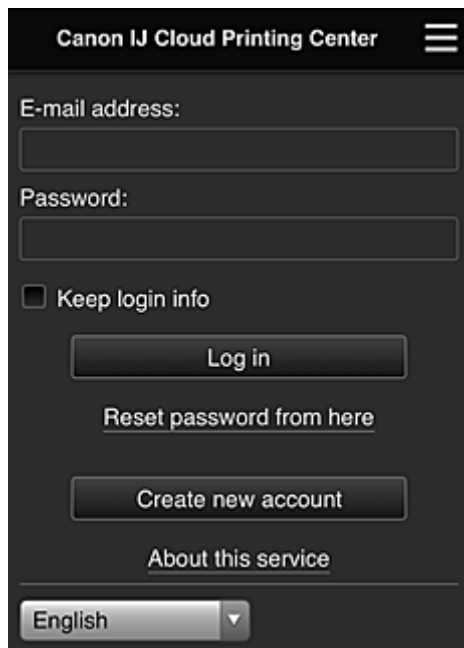

The screenshot shows the login screen for "Canon IJ Cloud Printing Center". It contains an "E-mail address:" field, a "Password:" field, and a "Keep login info" checkbox. Below these are buttons for "Log in", "Reset password from here", "Create new account", and "About this service". At the bottom, there is a language dropdown menu currently set to "English".

Enter the registered **E-mail address** and **Password**, and [Log in](#) to the Canon Inkjet Cloud Printing Center.

■ [Using Canon Inkjet Cloud Printing Center](#)

Using Canon Inkjet Cloud Printing Center

When the user registration is completed, you can log in to the Canon Inkjet Cloud Printing Center and use the service.

1. From your PC, smartphone, or tablet, access the service login URL (<http://cs.c-ij.com/>)
2. On the Login screen, enter the **E-mail address** and **Password**, and then select **Log in**

»» Important

- The e-mail address and password are case-sensitive. Make sure the case is correct.

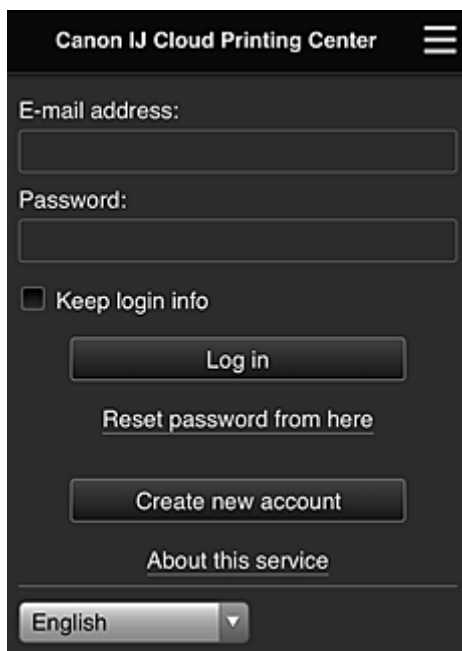

E-mail address

Enter the e-mail address that you entered in the user registration.

Password

Enter the password that you entered in the user registration.

Keep login info

When you select the check box, the login screen is skipped for 14 days since the last day that the service screen was accessed.

»» Important

- If you fail to log in five straight times, you will not be able to login again for about the next 60 minutes.
- You remain logged in for 60 minutes after the last access.
- The service may not function properly if you log in by using the same e-mail address from multiple devices at the same time.

After logging in, you can use useful services such as adding/managing apps that work in conjunction with this product's cloud functionality and checking the ink status.

For screen descriptions and operation instructions, see "[Canon Inkjet Cloud Printing Center window](#)".

Printing procedure

This section introduces the photo printing procedure by using CANON iIMAGE GATEWAY as an example.

▶▶ Important

- The available functions differ depending on the app.
- The printing procedure differs depending on the app.
- You need to get the account and register photo and other data beforehand.
- The following file formats can be printed: jpg, jpeg, pdf, docx, doc, xlsx, xls, pptx, ppt, and rtf.
The file formats that can be printed differ depending on the app.
- Before you print, check that printer is on and is connected to the network. Then start.
- This is available if you are using a smartphone or tablet.

▶▶ Note

- You can use CANON iIMAGE GATEWAY to print jpg and jpeg file formats.

1. On the Main screen, select the app to be used
2. Enter the information according to the instructions on the authentication screen, and then select **Log in**

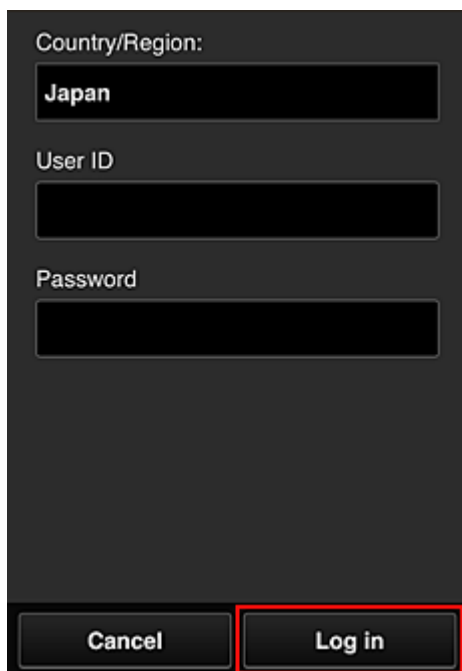

Country/Region:
Japan

User ID

Password

Cancel Log in

3. In the displayed album list, select the album of your choice

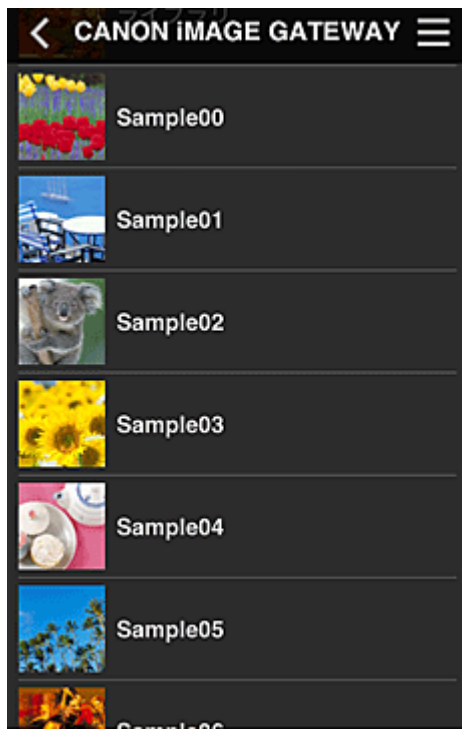

4. In the displayed image list, select the image that you want to print, and then select **Next**



5. Make the necessary print settings, and then select **Print**

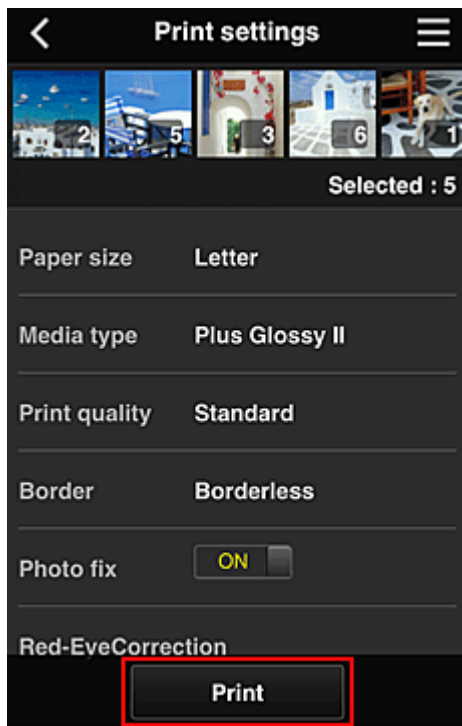

6. A print job completion message appears, and printing starts

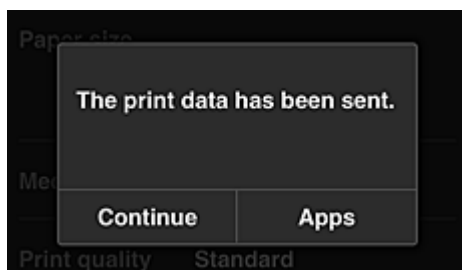

To continue printing, select **Continue**, and perform the operation from Step 3.

To end the printing, select **Apps**. The screen returns to the apps list screen.

»» Important

- If a print job is not printed within 24 hours after the print job is issued, the print job will expire and cannot be printed.
- With premium apps that limit the number of print jobs, print jobs that expire and cannot be printed are also included in the print count.

■ [Adding a Printer](#)

Canon Inkjet Cloud Printing Center window

This section describes the Canon Inkjet Cloud Printing Center screens that are displayed on your smartphone, tablet device, or computer.

■ [Description of the Login screen](#)

■ [Description of the Main screen](#)

Description of the Login screen

This section provides the description of the Login screen of Canon Inkjet Cloud Printing Center.

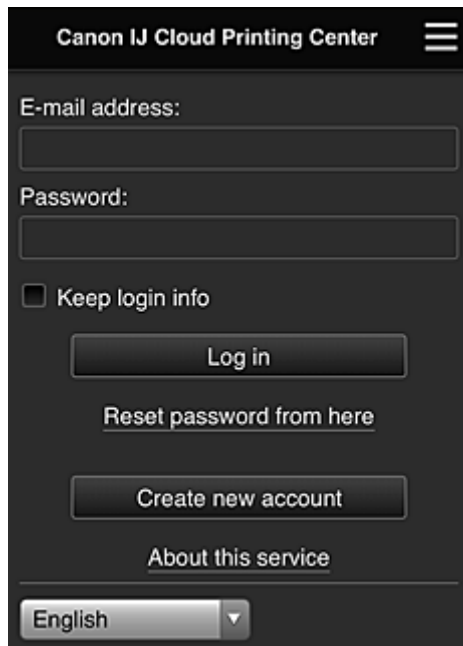

»» Important

- You have 5 tries to enter your password. If you fail, you will not be able to log in for about the next 60 minutes.
- You remain logged in for 60 minutes after the last access.

Language

Select the language you will be using.

E-mail address

Enter the e-mail address that you entered in the user registration.

»» Important

- The e-mail address is case-sensitive. Make sure the case is correct.

Password

Enter the password that you entered in the user registration.

Keep login info

When you select the check box, the login screen is skipped for 14 days since the last day that the service screen was accessed.

Reset password from here

Select this if you forgot the password.

Reset your password by following the instructions on the screen.

Create new account

A new registration will be added to the Canon Inkjet Cloud Printing Center.

For a new registration, you need the [Printer registration ID](#).

About this service

This displays the descriptions of this service.

System requirements

This displays the system requirements for the Canon Inkjet Cloud Printing Center.

Software license info

The licensing information of Canon Inkjet Cloud Printing Center is displayed.

Description of the Main screen

When you log in to the Canon Inkjet Cloud Printing Center, the Main screen appears.

If you are using a smartphone or a tablet, you can also print photos and documents.

»» Important

- With this service, the available functions differ depending on whether the user is the [Administrator](#) or [Standard user](#) of the printer, and also on the management method that was set.

You can use areas shown below to start, add, and manage apps.

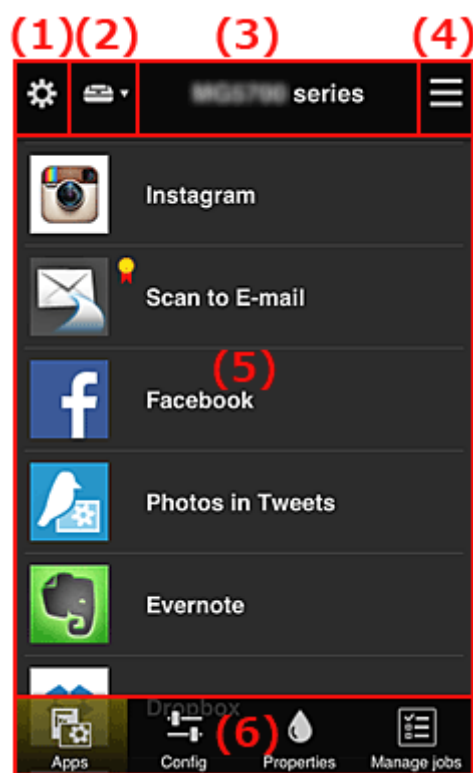

(1) [Left context menu \(Administrator only\)](#)

(2) [Select printer](#)

(3) [Printer name area](#)

- (4) [Right context menu](#)
- (5) [Display area](#)
- (6) [Menu area](#)

(1) Left context menu (Administrator only)

When you select , the left context menu appears.

When you select **Mng. printer**, **Manage users**, **Group management**, or **Advanced management**, the corresponding screen appears.

▶▶▶ Note

- **Group management** appears only when you use [Select how to manage](#) and set **Manage by group (for office users)**.

Mng. printer screen

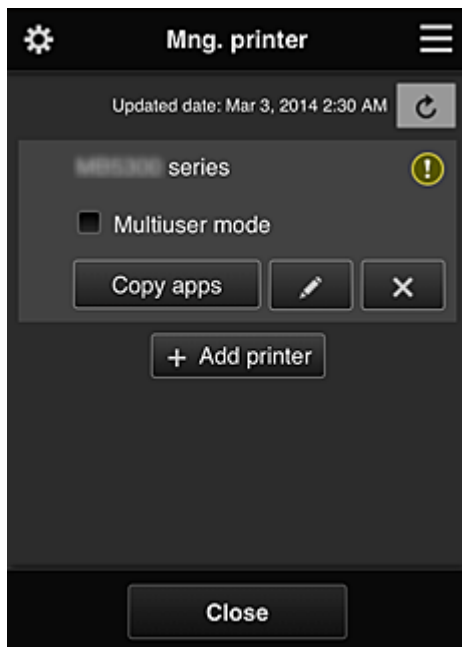

From the **Mng. printer** screen, you can [check](#) or [update](#) printer information registered to the Canon Inkjet Cloud Printing Center, [copy apps](#), [change printer names](#), [delete printers](#), and [add printers](#).

• Check the printer information

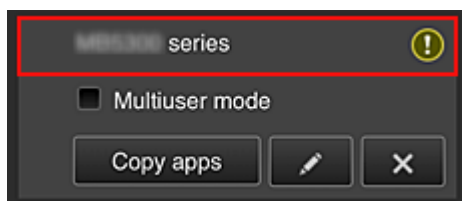

The registered printer name is displayed.

 indicates that an error occurred on the printer.

- **Display update date/time of the printer information**

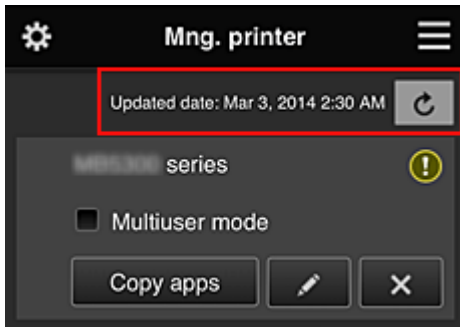

This displays the date and time the printer information was last updated.

 refreshes the information.

- **Multiuser mode (MAXIFY series only)**

If multiple users will be using the printer, add a check mark to [Multiuser mode](#).

The check mark is linked to the **Require security code** screen.

- **Copy apps**

Select this to copy apps added in the selected printer to another printer.

When you select , the screen shown below appears.

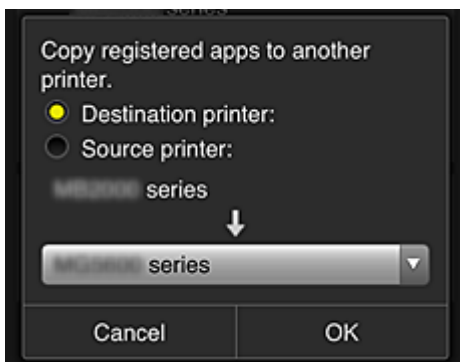

Set the **Destination printer** and the **Source printer**. Then select **OK**.

▶▶▶ Note

- If **Select how to manage** has been set, you can use this function only when you select **Manage app availability by printer**.
For details, see "[Tips on Using Canon Inkjet Cloud Printing Center \(at Work\)](#)".

- **Change the printer name**

When you select , a screen to change the printer name appears.

Follow the instructions on the screen to change the name.

▶▶▶ Important

- The printer name entry has the following character limitation:
 - Up to 128 characters (Uppercase and lowercase letters are differentiated.)

- **Delete printers**

When you select , the printer is deleted from the Canon Inkjet Cloud Printing Center.
When transferring the ownership of the printer, select **Clear the information saved on the printer**.

- **Add printers**

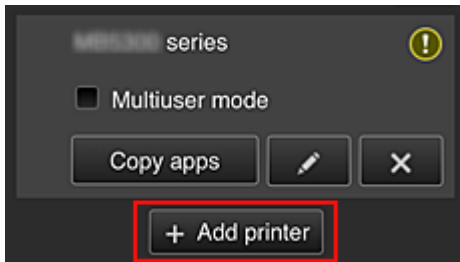

Select this to add printers to be used in the Canon Inkjet Cloud Printing Center.
You need a [Printer registration ID](#) to add a printer.

➤➤➤ **Note**

- Although the number of printers that can be registered for one domain is not limited, only up to 16 printers are guaranteed to operate.

Manage users screen

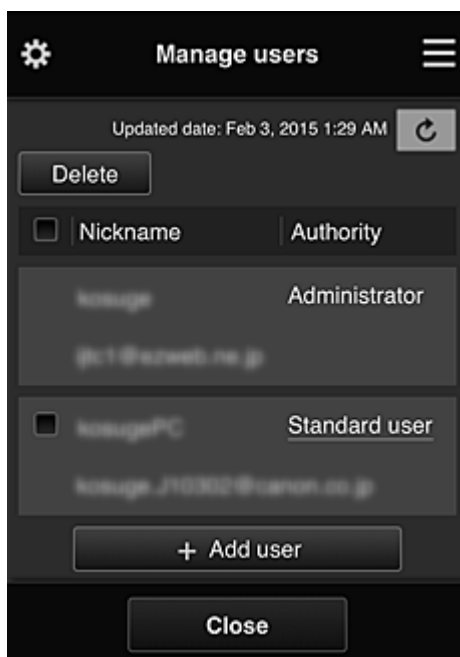

From the **Manage users** screen, you can check user information registered to the Canon Inkjet Cloud Printing Center, [delete users](#), [add users](#), and [change the Administrator and Standard user settings](#).

- **User deletion**

Select the check box of the user to be deleted, and select **Delete**.
However, you cannot delete yourself. To delete yourself, cancel your membership from the [My account](#) screen.

- **Adding a user**

Select **Add user**. The user registration screen appears.

- **Changing Administrator and Standard user settings**

To change the privileges of the **Administrator** or a **Standard user**, select **Authority** for the user whom you want to change the settings for.

Group management screen

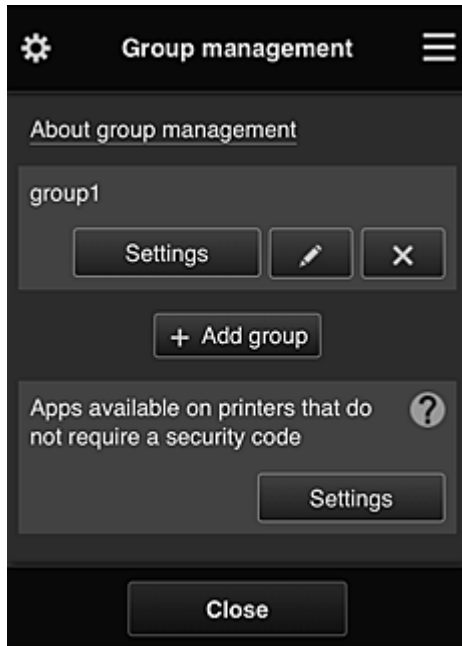

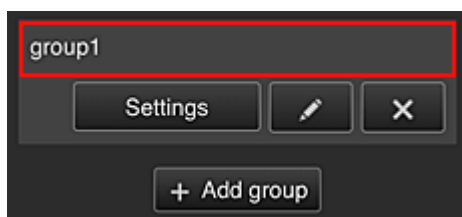

From the **Group management** screen, you can use functions for [checking group information](#) registered to Canon Inkjet Cloud Printing Center, [changing groups](#), [deleting groups](#), [adding groups](#), and setting up users, printers, and apps belonging to each group.

- **Checking group information**



The registered group names appear.

If there are items that have not been set,  appears.

Select  to display the following screen, which allows you to set up information for each group.

The displayed information changes depending on the selected tab.

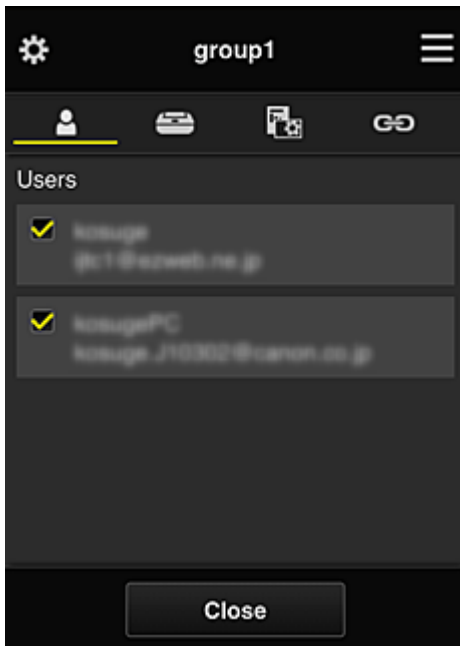

 **Users**

Displays all users and mail addresses registered in the domain.

 **Printers**

Displays all printers registered in the domain.

 **Apps**

With the default settings, the screen displays all apps. To display only registered apps, select the **Registered** category.

To switch between app registration/deletion, select ON / OFF.

 **Web services**

Displays the external link service.

You can restrict the use of other web services that use Canon Inkjet Cloud Printing Center accounts such as Easy-PhotoPrint+.

To switch between service linking/release, select ON / OFF.

 appears for items that do not have anything selected.

In the default settings, all check marks are cleared for **Printers** and **Users**. Only the system apps under **Apps** are set to **ON**.

• **Changing a Group name**

To display the **Group name** change screen, select .

You can change the name to one of your liking by following the instructions in the displayed screen.

Important

- When you enter a **Group name**, the following restrictions apply:
 - When using single-byte alphanumeric characters, enter at least 1 but not more than 20 characters. When using double-byte characters, enter at least 1 but not more than 10 characters.

- Duplicate group names cannot be registered in the same domain.

• Deleting a Group

To delete a group from Canon Inkjet Cloud Printing Center, select .

If you delete all groups, you must create a new one. To set a different management method, set the target method from the **Select how to manage** screen.

• Add group

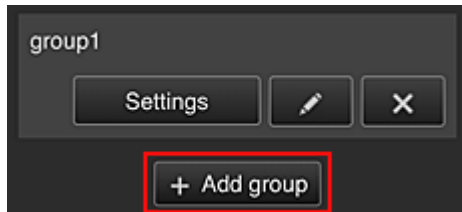

Add a group to be used in Canon Inkjet Cloud Printing Center.

▶▶▶ Note

- You can register up to 20 groups.

• Apps available on printers that do not require a security code

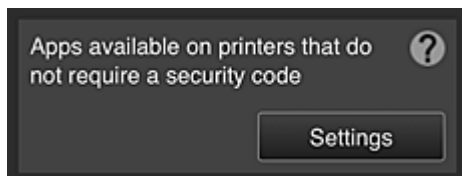

For printers without the **Multuser mode** setting or **Security code** settings, set the apps to be

displayed when a user selects  **Cloud** from the printer's home screen.

If the domain does not have a printer that meets this condition, this setup screen does not appear.

To go to the setup screen, select .

▶▶▶ Note

- If only the following printer is registered in the domain, it is not displayed.
 - Printer without LCD monitor
 - Printer with monochrome LCD monitor
 - Multuser mode printer

Advanced management screen



The **Advanced management** screen allows you to set the management method for printer users and apps that can be used.

To go to the setup screen, select .

- **Require security code**

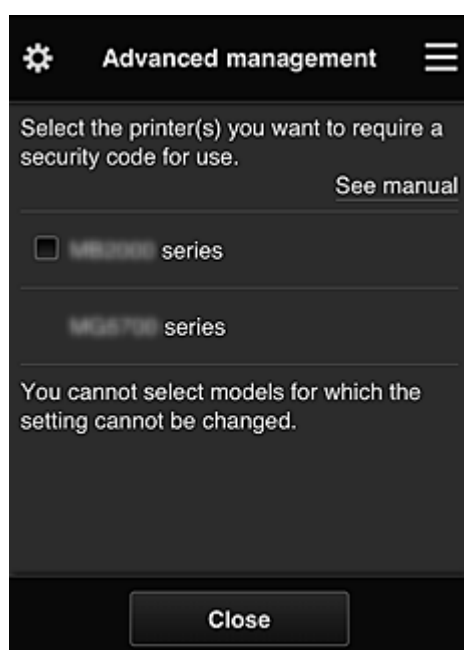

Each user can set a [Security code](#), start the app, and perform printing and other operations. This setting is linked with **Multuser mode** on the **Mng. printer** screen.

▶▶▶ Note

- The list does not display models without an LCD or models with a monochrome LCD.
- The check box does not appear for models that do not support **Multuser mode**.

- **Select how to manage**

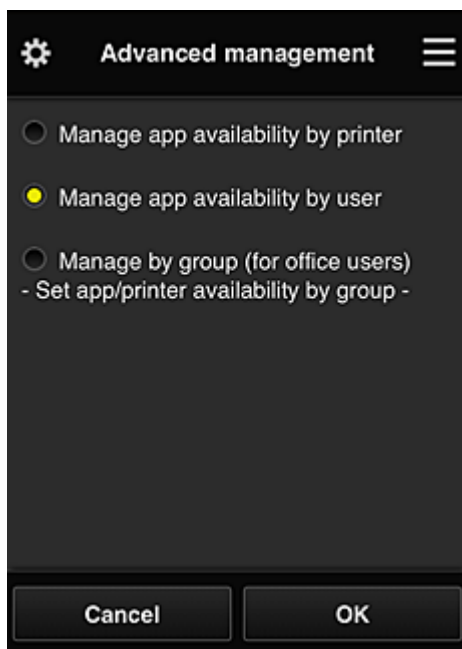

You can change the management method for usable apps and printers.

Manage app availability by printer

If you are using multiple printers, you can manage the useable apps for each printer.

Manage app availability by user

When one printer is used, you can manage the usable apps by user.

For usage examples, see "[Tips on Using Canon Inkjet Cloud Printing Center \(at Home/If you are using PRO-1000 series or PRO-500 series\)](#)".

Manage by group (for office users)

You can manage the usable apps and printers by group.

For usage examples, see "[Tips on Using Canon Inkjet Cloud Printing Center \(at Work\)](#)".

»»» Note

- If you manage the usable apps by printer, the default settings will allow all users to add, delete, and rearrange apps.
Also, if you are using a MAXIFY series printer and you select **Multuser mode** in the [Mng. printer screen](#), only the administrator will be able to add, delete, and rearrange apps.
- If you manage the usable apps by user, all users will be able to add, delete, and rearrange apps, regardless of the **Multuser mode** setting.
- If you manage the usable apps and printers by group, all users will only be able to rearrange apps.

(2) Select printer

Select , and then from the **Select printer** screen, select a printer.

If you are using a computer, you can select a printer directly from the pull-down menu.

»»» Note

- Printers with settings that restrict their use do not appear.

(3) Printer name area

The registered name of the printer selected is displayed.

The **Administrator** can [change the printer name](#) from the **Mng. printer** screen of the left context menu.

(4) Right context menu

When you select , the context menu appears.

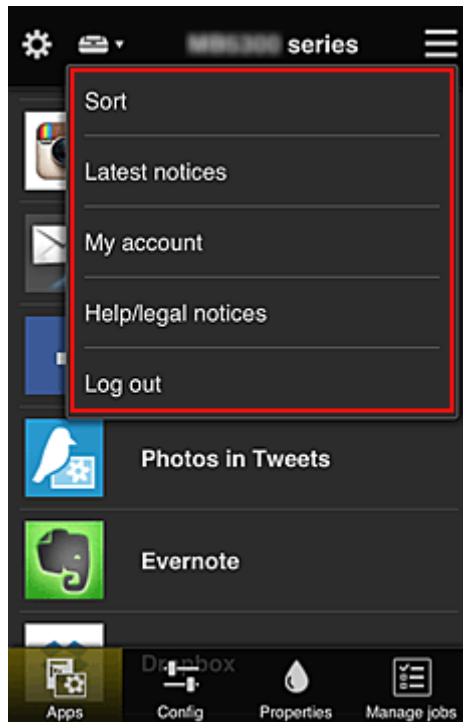

The information displayed depends on the menu currently selected in the menu area.

The  symbol indicates that there is a new unread notice.





• **Sort** **Sort**

This displays the screen to sort registered apps.

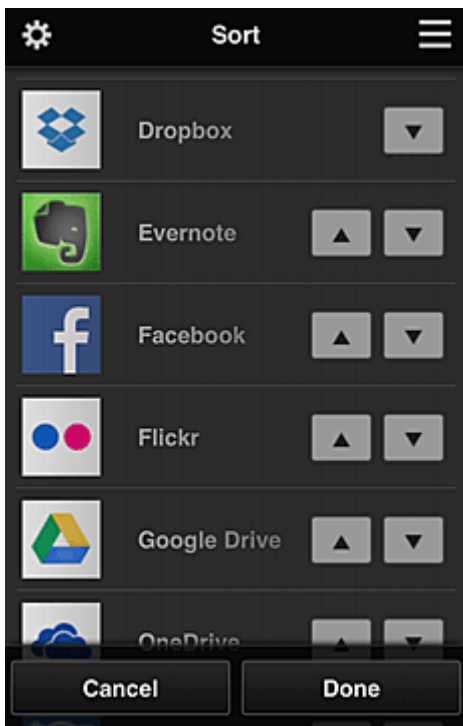
You can use the   buttons to change the display order of apps. When you finish sorting, select **Done**.



➤➤ Note

- Description of displayed icons
 -  : Cannot be used because it is not yet released or does not support your region, model, or language.
 -  : Can be used with genuine Canon ink.

If you are using a G3000 series model, you cannot use this service because the model is not supported.

• Latest notices **Latest notices**

This displays the latest notices. The  symbol indicates that there is a new unread notice.

• My account **My account**

Displays user information.

From the **My account** screen, you can change your account settings.

From the **My account** screen, you can display the **Permitted services** screen and clear any linked service setting.

• Help/legal notices **Help/legal notices**

The description of the Canon Inkjet Cloud Printing Center screen and various reminders are displayed.

• Log out **Log out**

This opens the Log out screen of the Canon Inkjet Cloud Printing Center.

(5) Display area

The display changes based on the menu you select.

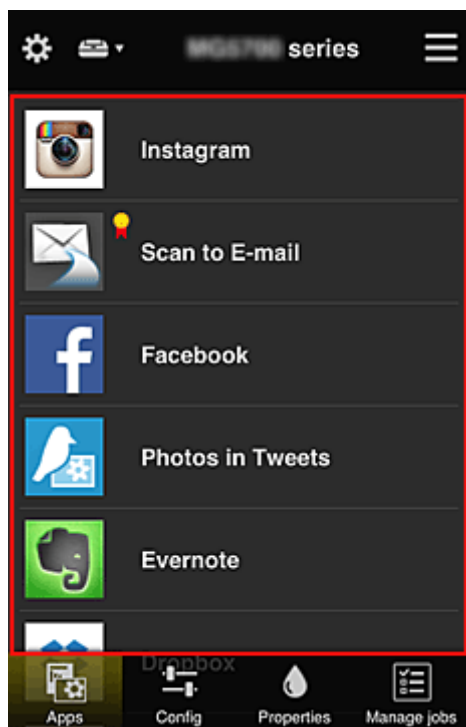

(6) Menu area

The following 4 menu buttons are displayed:

-  **Apps**

This displays the list of registered apps in the [Display area](#).

-  **Config**

This displays the Register apps screen in the [Display area](#).

The display can be toggled between **Registered** and **Search apps**.

The **Registered** screen lists registered apps.

You can check the information of these apps or deregister them.

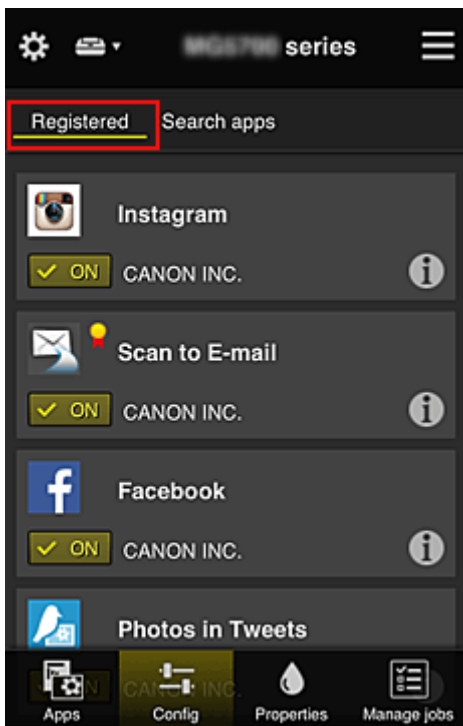

»» Note

- If **Group management** has been set, **Config** is not displayed.
- If **Manage app availability by user** has been set, even **Standard user** can register and delete apps.

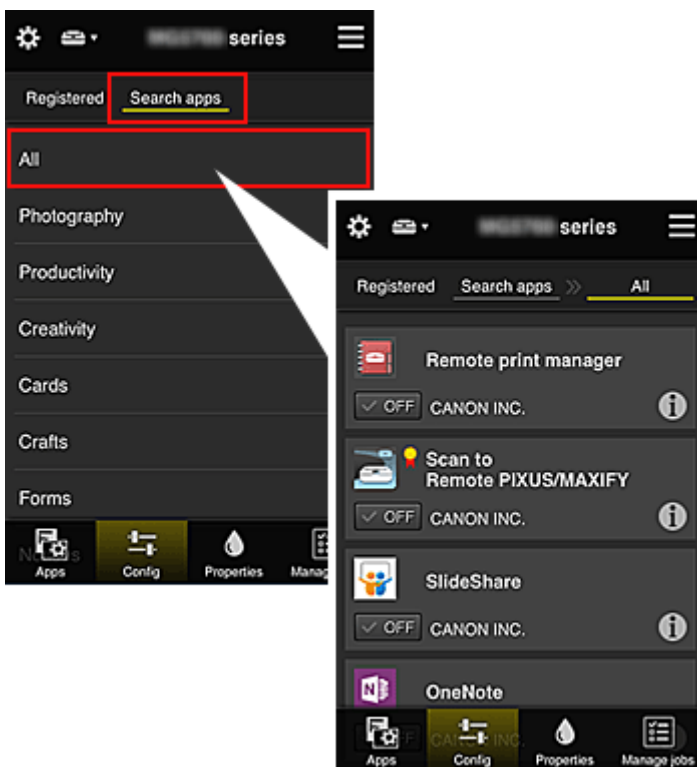

On the **Search apps** screen, the apps that you can register by using the Canon Inkjet Cloud Printing Center are displayed by category.



- When you select , the details of the app are displayed.
- When you select  / , you can choose to register or unregister the app.

➤➤➤ Note

- Description of displayed icons
 -  : Cannot be used because it is not yet released or does not support your region, model,

or language.



: Can be used with genuine Canon ink.

If you are using a G3000 series model, you cannot use this service because the model is not supported.



- **Properties**

This screen displays the status of the printer that is currently selected.

You can check how much ink is remaining or details about an error that occurred. You can also access the ink purchasing site and the Online Manual.

▶▶▶ Important

- The Properties displayed may differ from the actual status at the display time, depending on the printer status.



- **Manage jobs**

This screen displays the print or scan status and history.

You can check the print or scan status by looking at **Status list**, and the print or scan history by looking at **History**.

You can also cancel print or scan jobs and delete history information.

To cancel or delete a job, select that job and then select **Cancel** or **Delete**.

Tips on Using Canon Inkjet Cloud Printing Center (at Home/If you are using PRO-1000 series or PRO-500 series)

The **Advanced management** function allows you to take advantage of the many useful functions that the service offers for home use.

This section introduces those functions by using a family of 3 (father, mother, and child) as an example.

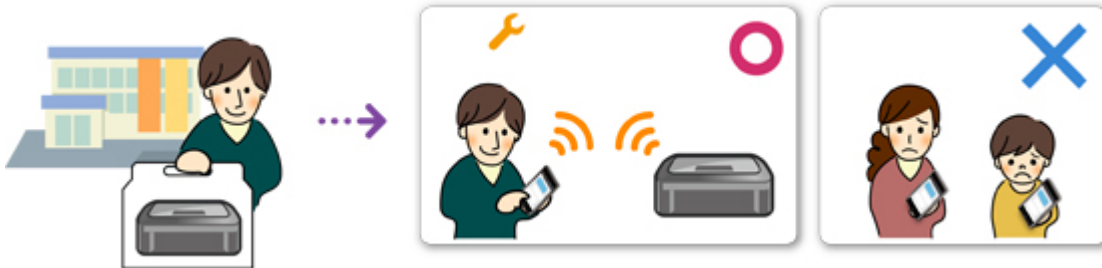

If the father registers the printer to Canon Inkjet Cloud Printing Center, only the father is managed by the service, and the mother and the child cannot use the service unless the father tells them the login **E-mail address** and **Password**.

If Mother and Child Want to Use the Service from Their Smartphones

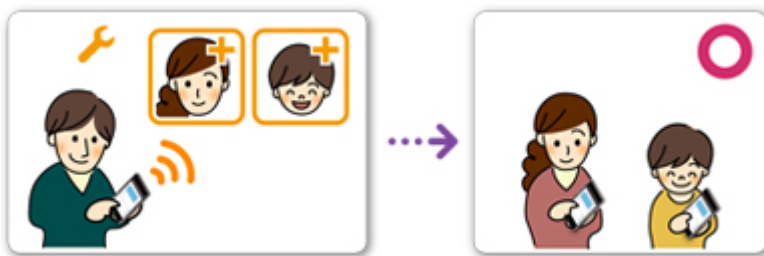

1. The father [registers to Canon Inkjet Cloud Printing Center](#) and becomes the **Administrator**
2. After logging in, the father selects [Manage users](#) from 

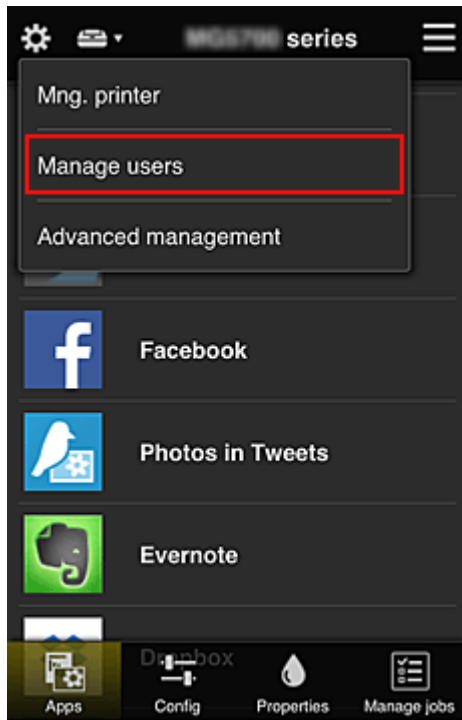

3. The father selects **Add user**, and by following the screen instructions, registers the mother and child as users.

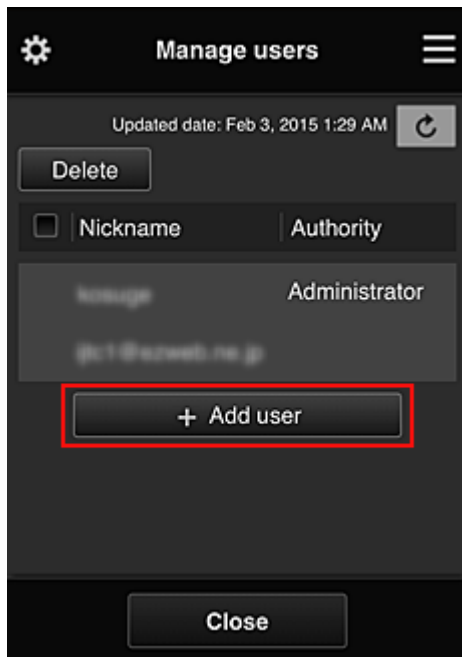

After this registration is complete, the mother and child can individually use the service.

If Father, Mother, and Child Want to Manage Apps Individually



With the default settings, only the **Administrator** (father) can register apps to be used or delete apps. After the **Administrator** (father) specifies settings according to the procedure below, the father, the mother, and the child will be able to manage apps individually.

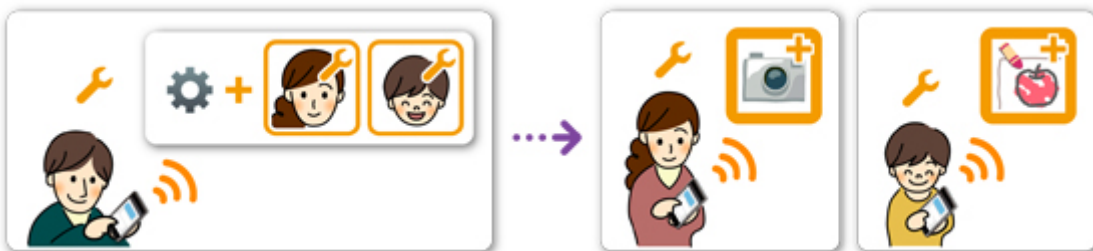

1. As the **Administrator**, the father [logs in to Canon Inkjet Cloud Printing Center](#) and selects **Advanced management** from 

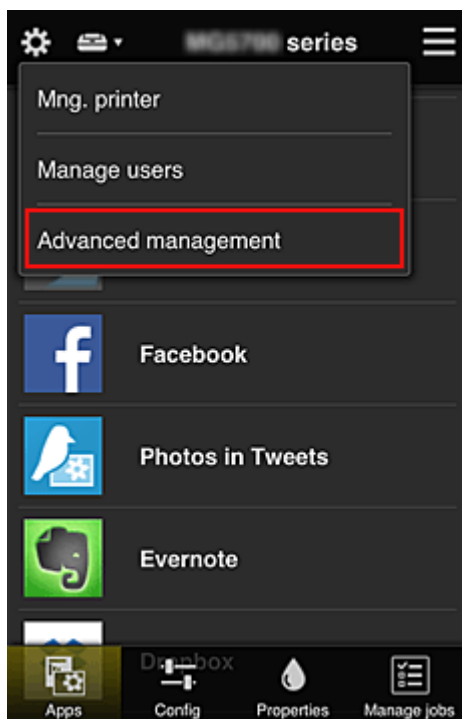

2. For **Select how to manage**, the father selects **Set**



3. The father sets **Manage app availability by user** and selects **OK**

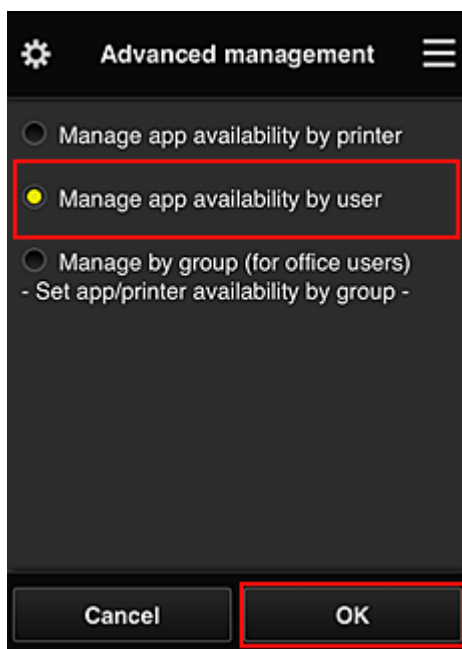

4. The screen for checking the management method change appears

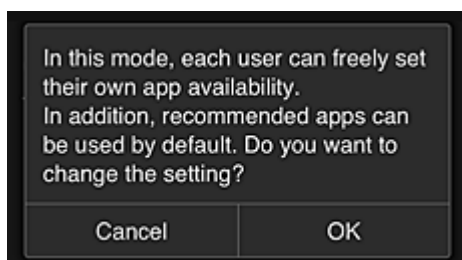

To complete the setup and return to the **Advanced management** window, select **OK**.

All registered users can register and delete apps freely.

Tips on Using Canon Inkjet Cloud Printing Center (at Work)

The **Group management** function allows you take advantage of the many useful functions that the service offers for office use.

This section introduces an example in which two printers are used, the **Administrator** is the senior clerk, and the other members are the company president, the section manager, and the new hire.

»» Note

- If the second printer has not been registered, select "[Adding a Printer](#)" and register the printer by following the procedure.

Creating a Group for All Office Members to Use

Set the basic group.

In this example, only the Evernote app will be used on 2 printers.

1. The senior clerk [registers to Canon Inkjet Cloud Printing Center](#) and becomes the **Administrator**
2. The senior clerk selects [Manage users](#) from 

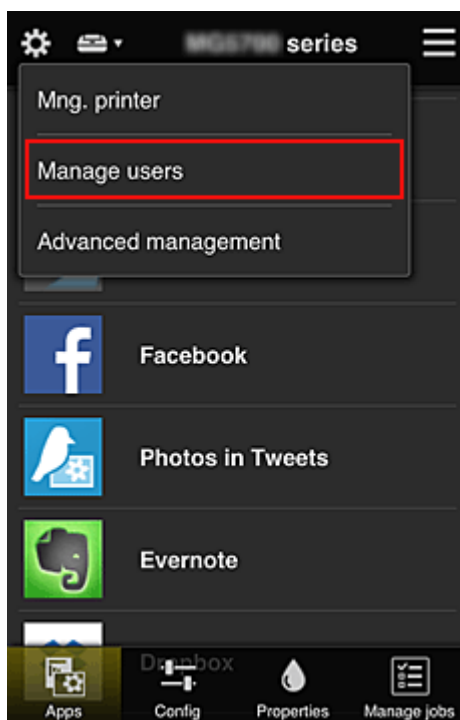

3. On the displayed screen, the senior clerk selects **Add user** and registers the company president, the section manager, and the new hire as users

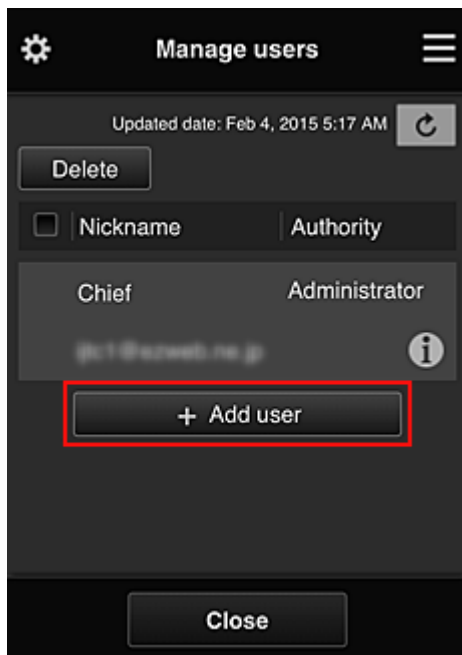

4. The senior clerk selects **Advanced management** from 

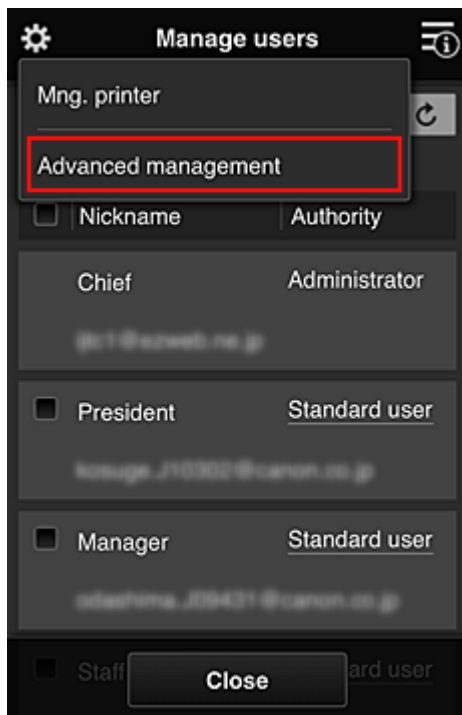

5. For **Select how to manage**, the senior clerk selects **Set**



6. The senior clerk sets **Manage by group (for office users)** and selects **OK**

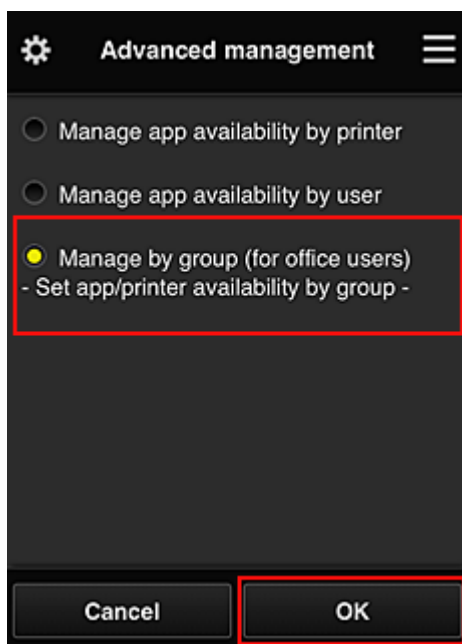

➤➤➤ **Note**

- If **Group management** has already been set up, refer to step 10 and the subsequent steps.

7. On the screen for checking management method changes, the senior clerk checks the displayed information and selects **OK**.

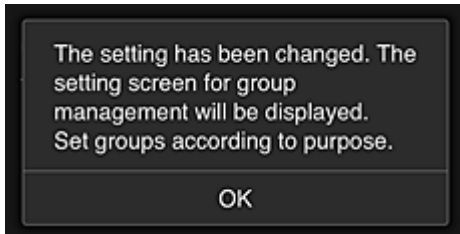
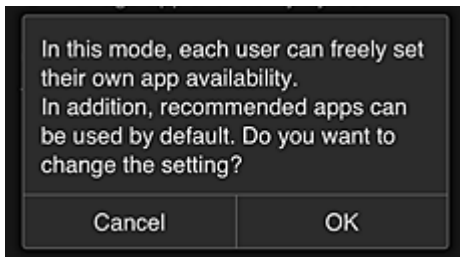

This appears only if the selected mode is **Group management**.

To complete the setup and display the **Group management** screen, select **OK**.

»» Note

- With the default settings, the group is named "group1".
- With the default settings, all registered users belong to the same group.

8. In the **Group management** screen, the senior clerk selects the  of the group to be renamed

9. The senior clerk enters the **Group name** and selects **OK**

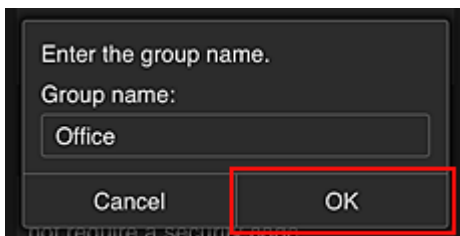

The chief clerk enters "Office" here because the clerk is setting up a group that everyone in the office will use.

»» Important

- The following restrictions apply to entering the **Group name**.
 - The group name can have up to 20 single-byte alphanumeric characters or up to 10 double-byte characters.
 - The same group name cannot be registered more than once in the same domain.
 - Up to 20 groups can be registered.
- The person who created the group becomes the **Administrator**.

10. Select **Settings**, and in group setup screen, check that all users on the **Users** tab are selected

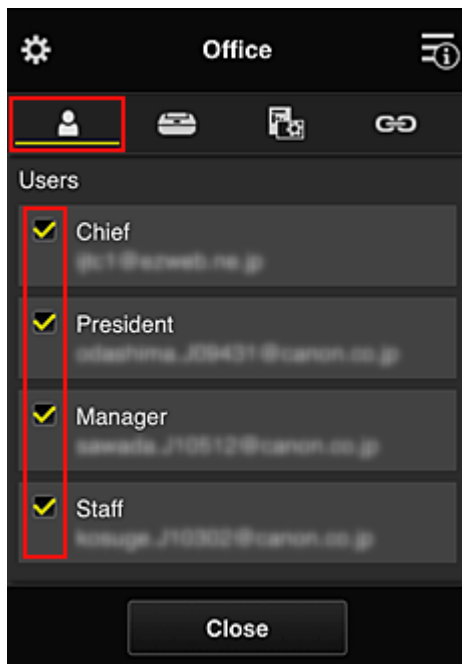

11. On **Printers** tab, check that all printers are selected

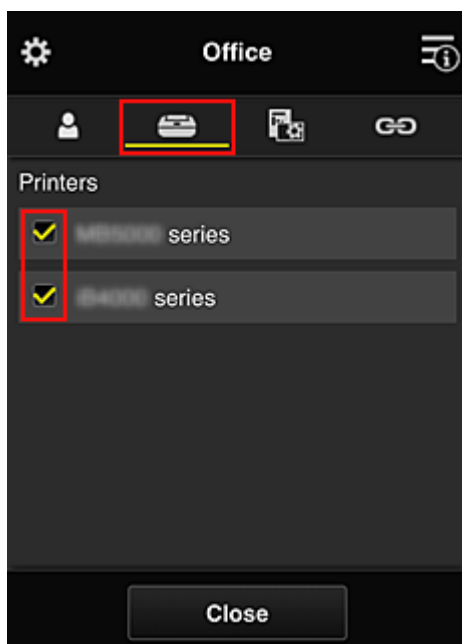

12. On **Apps** tab, set only Evernote app to ON

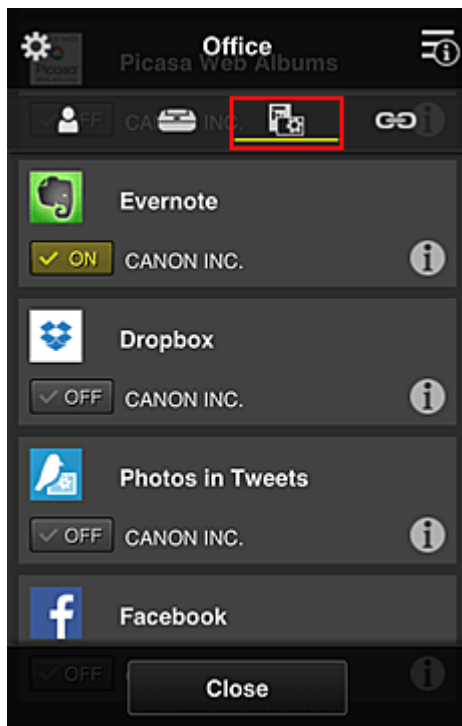

To switch between app registration/deletion, select ON / OFF.
 To return to the **Group management** screen, select **Close**.

This completes the setup of the group to be used by the entire office.

»» Note

- The group setup screen displays all users and printers that are registered in the domain.
- If you want to set up new apps as an individual, you can add a group.
 To create a new group, use **Add group**, and then in the setup screen for the added group, add users and printers.

- [Limiting Apps That Each User Can Use](#)
- [Limiting Apps That All Members Can Use on Printer](#)
- [Limiting Apps That Individual Users Can Use on Printer](#)
- [Limiting Printers That Individual Users Can Use](#)

»» Important

- The available apps may differ depending on the country or the region.

Limiting Apps That Each User Can Use

Set the following:

- Entire office: Use only Evernote app
- President: Use Evernote app and Facebook app

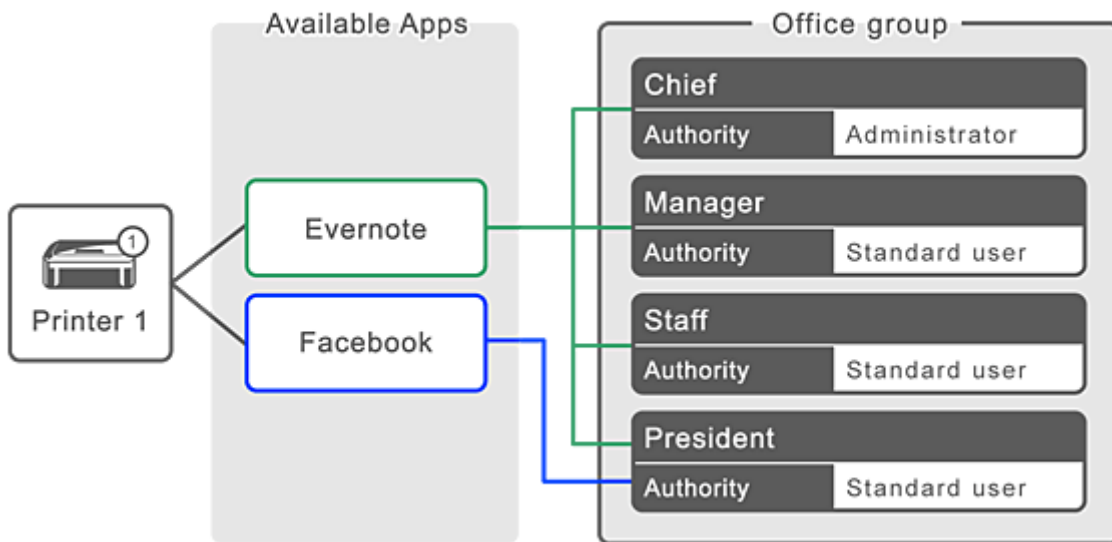

1. From , select **Group management**

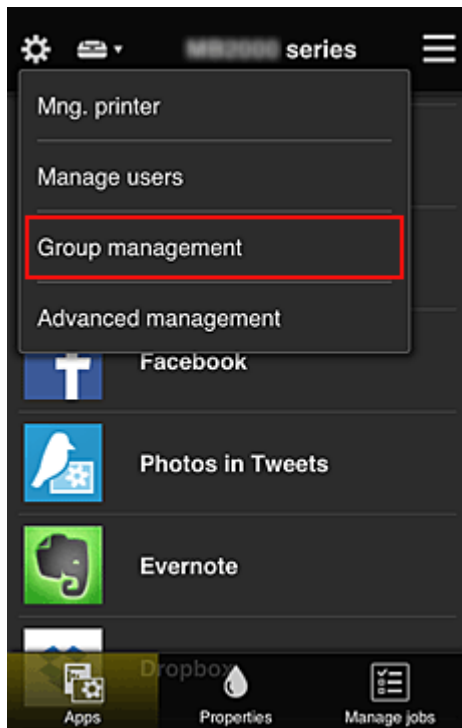

➤➤➤ Note

- This appears only if **Manage by group (for office users)** is set in **Advanced management**.

2. In displayed screen, select **Add group**

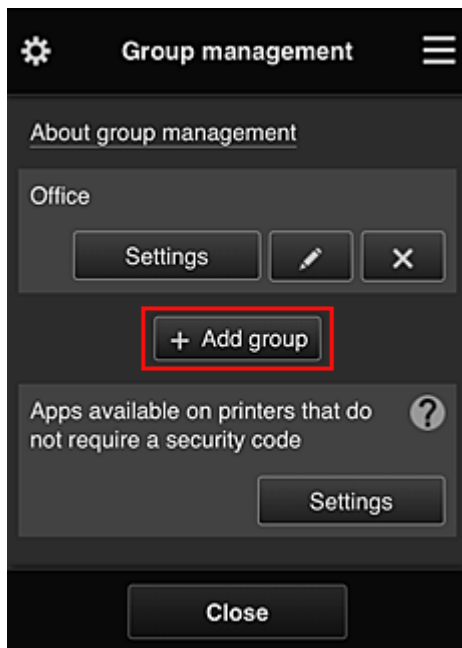

3. The senior clerk enters the **Group name** and selects **OK**

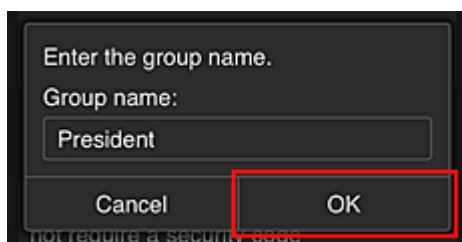

In this field, enter "President" as the president-only group because you will be setting apps that only the president can use.

»»» Important

- The following restrictions apply to entering the **Group name**.
 - The group name can have up to 20 single-byte alphanumeric characters or up to 10 double-byte characters.
 - The same group name cannot be registered more than once in the same domain.
 - Up to 20 groups can be registered.
- The person who created the group becomes the **Administrator**.

4. Follow messages displayed on screen, and select **OK**

The group setup screen appears.

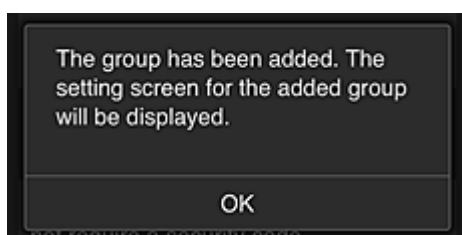

5. On **Users** tab, select only president

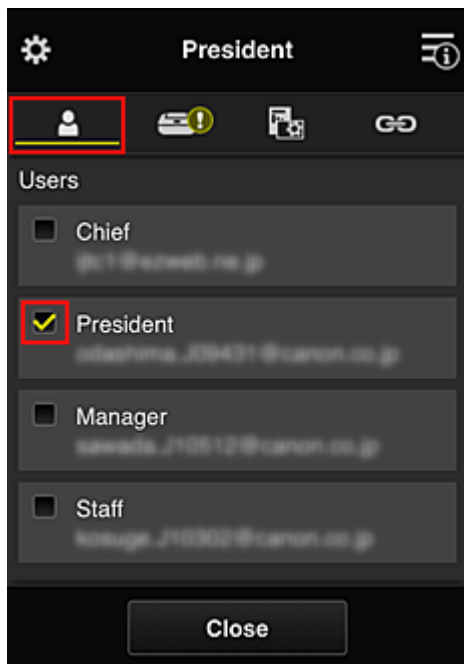

6. On the **Printers** tab, select printer to be used.

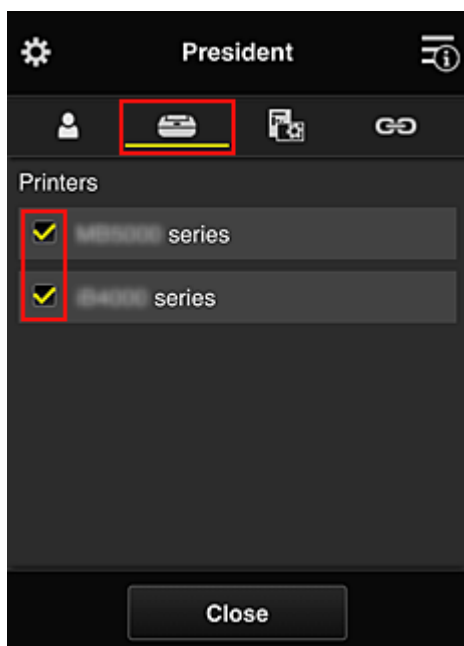

7. On the **Apps** tab, set the Evernote and Facebook apps to 

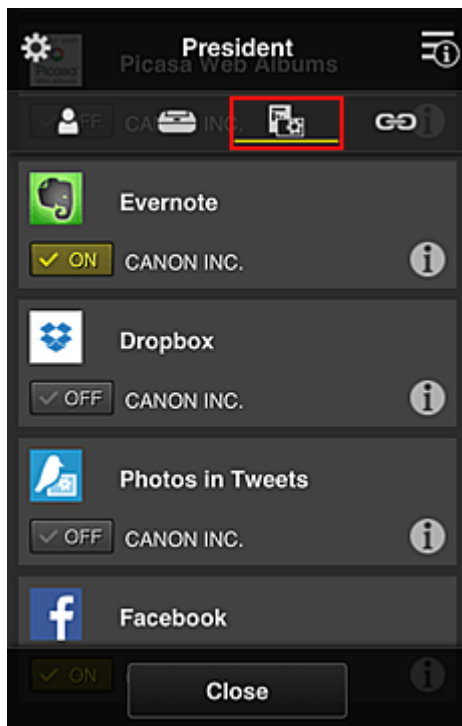

To switch between app registration/deletion, select ON / OFF.

To return to the **Group management** screen, select **Close**.

The above procedure allows you to set apps that only the president can use.

➤➤ Note

- The group setup screen displays all users and printers that are registered in the domain.

Limiting Apps That All Members Can Use on Printer

To set the apps to be used on the printer, use the following procedure provided by this service. As an example, this section describes the procedure for allowing all users to use the Evernote app from the printer.

1. From , select **Group management**

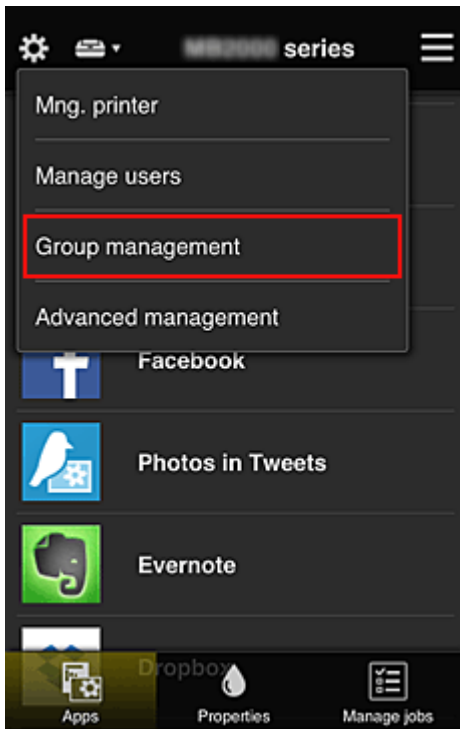

➤➤➤ **Note**

- This appears only if **Manage by group (for office users)** is set in **Advanced management**.

2. For **Apps** available on printers that do not require a security code, select **Settings**

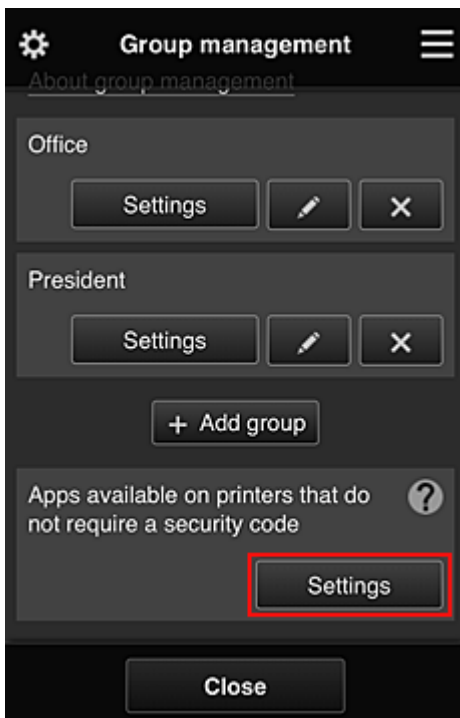

3. On **Apps** tab, set only Evernote app to 

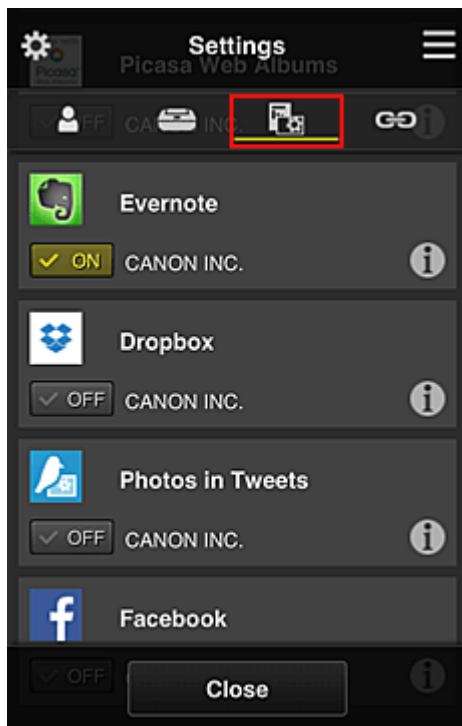

To switch between app registration/deletion, select ON / OFF.

To return to the **Group management** screen, select **Close**.

The above procedure sets up Evernote as the only app that all users can use on the printer.

Limiting Apps That Individual Users Can Use on Printer

For each user, you can set the apps that the user can use on the printer.

As an example, this section describes the procedure for allowing only the president to also use the Facebook app from the printer.

1. From , select **Advanced management**

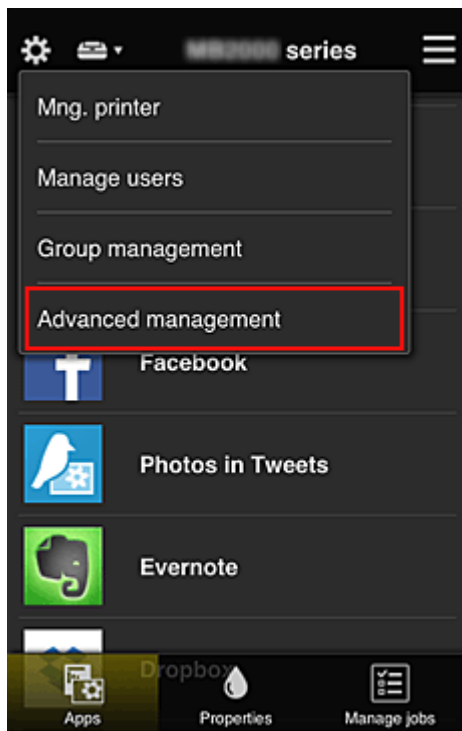

2. For **Require security code**, select **Set**.



3. Select printer for setting up **Security code**.

[Security codes](#) identify individual users when multiple users are using a printer.

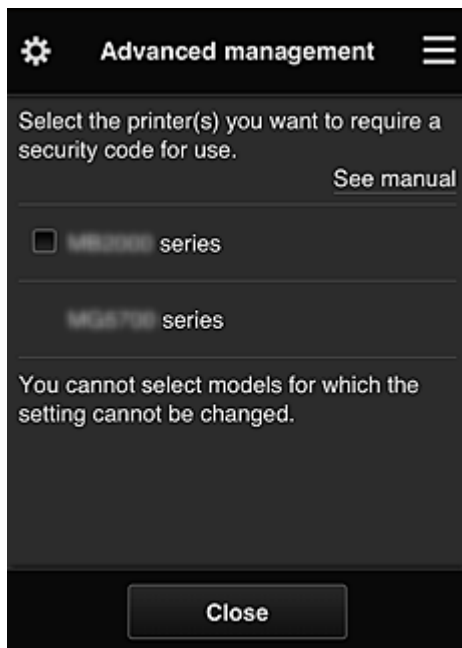

➤➤➤ Note

- On models where the settings cannot be changed, this function cannot be selected. Some models do not support this function. To check whether your model supports this function, see "Models that Support Security Codes".

4. Set up **Security code**

If there are users who have not set up a **Security code**, a screen appears for checking whether to send an e-mail prompting those users to set up a **Security code**.



To send a notification e-mail only to users without a **Security code**, select **OK**.

To display the **Security code** setup screen when each user logs in and not send the notification e-mail, select **Cancel**.



»» Important

- The following character restriction applies to **Security code** entries:
 - Up to 8 alphanumeric characters

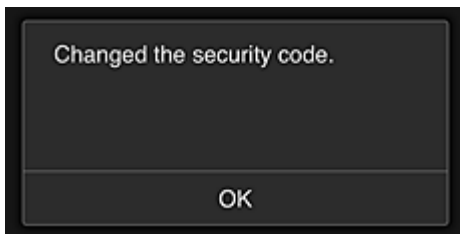

The **Security code** change process ends, and the change completion message appears. In the message screen, select **OK** to return to the main screen.

5. Select  **Cloud** from the printer's home screen

6. In **Switch user** screen, select user



7. Enter **Security code** that you set and **Log in**

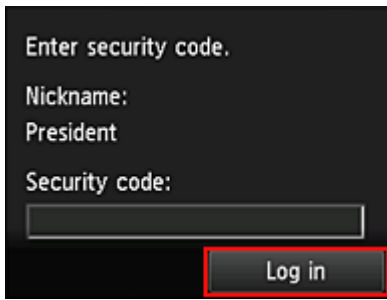

➤➤➤ **Note**

- If you have not set a **Security code**, set a **Security code** from [My account](#), and then **Log in**.

8. Select Facebook app

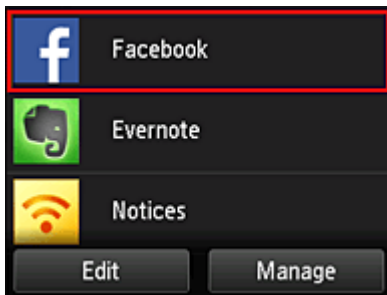

Only the president will be able to use the Facebook app from the printer.

Limiting Printers That Individual Users Can Use

As an example, this section describes the procedure for setting up one printer for the president and another printer for all users.

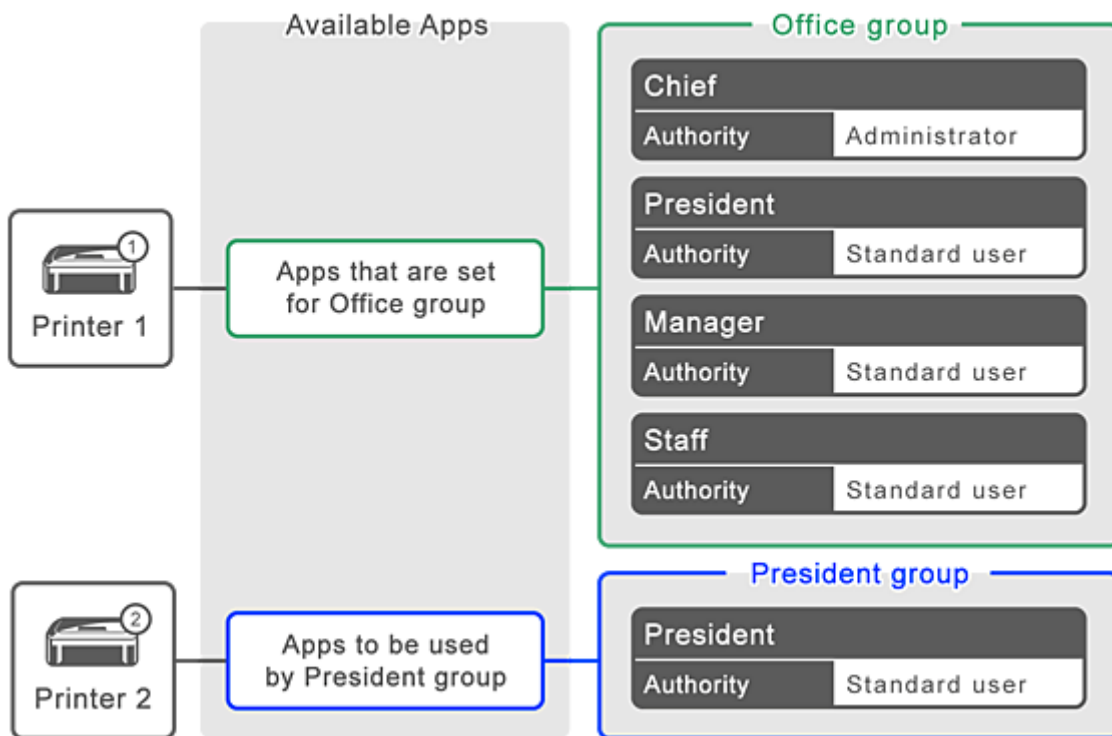

1. From , select **Group management**

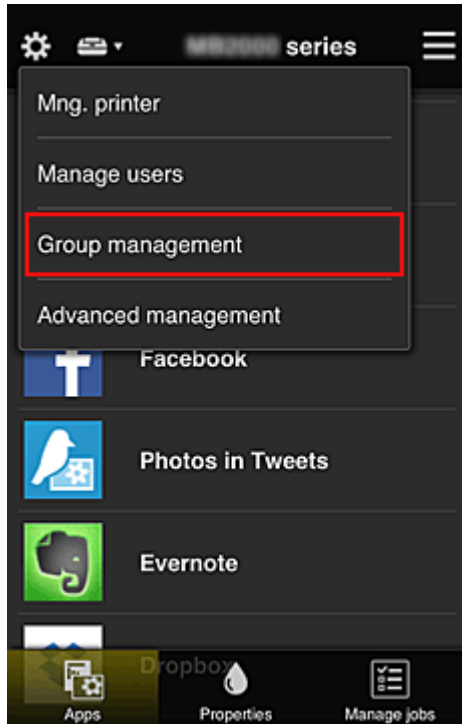

➤➤➤ **Note**

- This appears only if **Manage by group (for office users)** is set in **Advanced management**.

2. Select **Settings** for the group containing all users

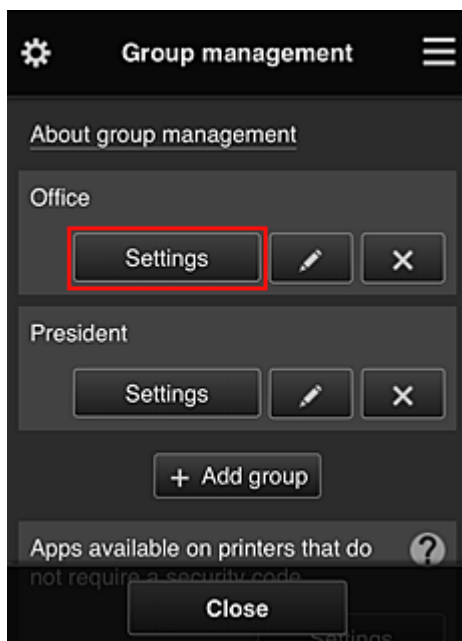

3. On the **Printers** tab, clear printer that was set up for president

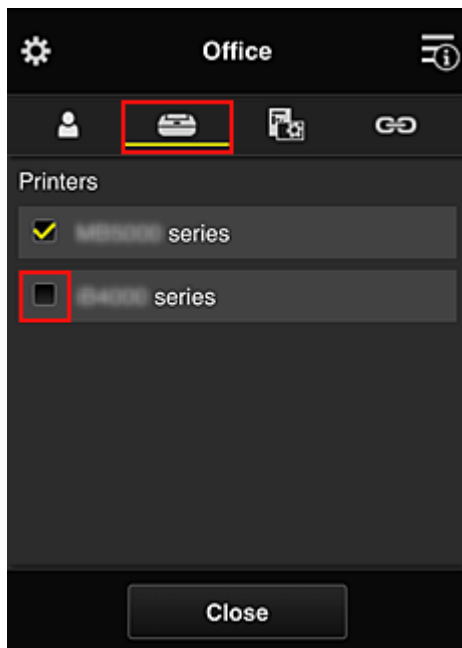

To return to the **Group management** screen, select **Close**.

»» Important

- If a user is being managed in multiple groups and an app is deleted or the target printer is changed for one of those groups, the user can still use that app or printer if the one of the other groups allows it.

Only the printer that was set can be used by all users.

What is a Security code?

A **Security code** identifies the user when multiple other users are sharing the same printer.

Important

- If you are using the MAXIFY series, you can set a **Security code**. We recommend that you set a **Security code** to prevent other users from using your account.
- This code is valid only when you use MAXIFY Cloud Link from the printer operation panel. You cannot use this code when you access the Canon Inkjet Cloud Printing Center from your smartphone, tablet, or computer.

Adding a Printer

With one account, you can use the Canon Inkjet Cloud Printing Center services on multiple printers.

The procedure for adding a printer is as follows:

- [If your model has color LCD monitor](#)
- [If your model has monochrome LCD monitor](#)
- [If your model has no LCD monitor/If you are using PRO-1000 series or PRO-500 series](#)

If your model has color LCD monitor

1. Check that an e-mail containing the URL has been sent to [the registered e-mail address](#), and access the URL
2. Enter the information according to the instructions on the authentication screen, and then select **Log in**

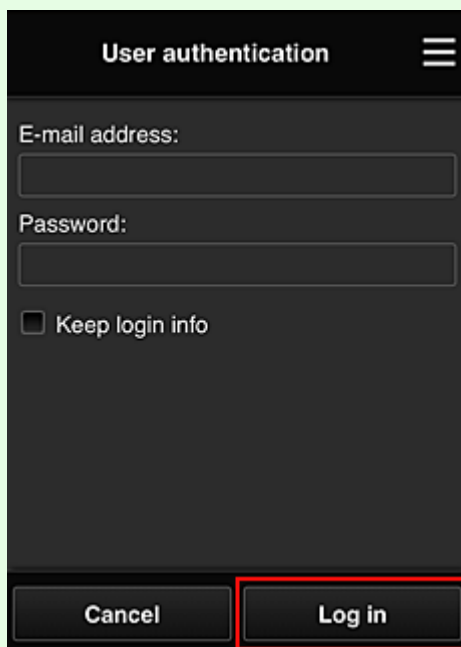

3. When printer addition complete message appears, select **OK**

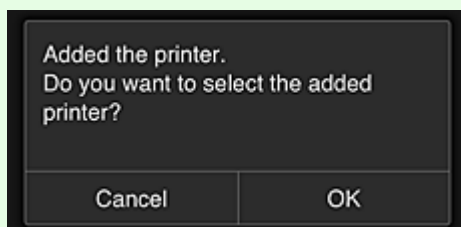

The printer addition process ends, and the main screen of Canon Inkjet Cloud Printing Center appears.

▶▶▶ Note

- If you select **Cancel**, the printer selection status does not change and the main screen of Canon Inkjet Cloud Printing Center appears.

If your model has monochrome LCD monitor If your model has no LCD monitor/If you are using PRO-1000 series or PRO-500 series

1. Check that an e-mail containing the URL has been sent to the registered e-mail address, and access the URL

■ [If your model has monochrome LCD monitor](#)

■ [If your model has no LCD monitor/If you are using PRO-1000 series or PRO-500 series](#)

2. Enter the information according to the instructions on the authentication screen, and then select **Log in**

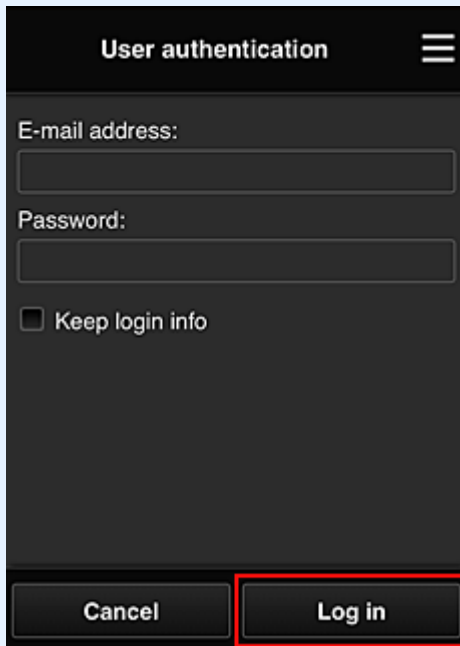

3. When printer addition complete message appears, select **OK**

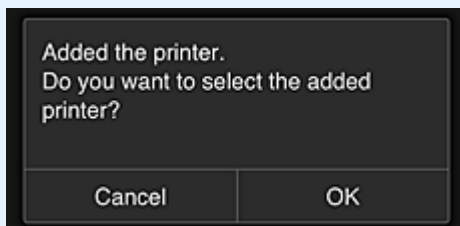

The printer addition process ends, and the main screen of Canon Inkjet Cloud Printing Center appears.

▶▶▶ **Note**

- If you select **Cancel**, the printer selection status does not change and the main screen of Canon Inkjet Cloud Printing Center appears.

■ [Adding a PIXMA/MAXIFY Cloud Link User](#)

Adding a PIXMA/MAXIFY Cloud Link User

Several people can use one printer.

This section describes the user addition procedure and the user privileges.

Adding a user

1. On the service screen, select **Manage users** from .

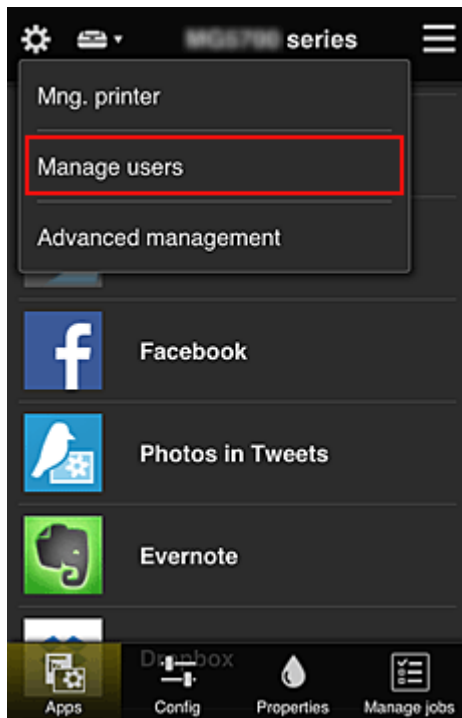

2. Select **Add user**

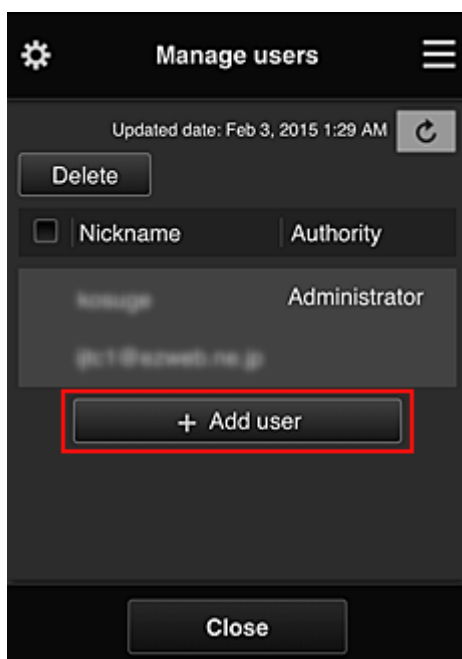

▶▶▶ **Note**

- When you select **Add user**, the service first checks whether the maximum number of users has been reached. If new users can be added, the user registration screen appears.
- The maximum number of users that can be added for 1 printer is 20.

3. Enter the e-mail address of the user to be added, and then select **OK**

The URL for completing the registration is then sent to the entered e-mail address.

▶▶▶ **Note**

- If you enter an e-mail address that is already registered, you will receive notification that the address is registered. To specify another e-mail address, follow the displayed instructions.

4. Access the URL reported in the e-mail

The procedure that follows describes what to do if you receive a notification e-mail.

5. Read the terms displayed in the **License agreement** and **Privacy statement** screens. If you agree to the terms, select **Agree**.

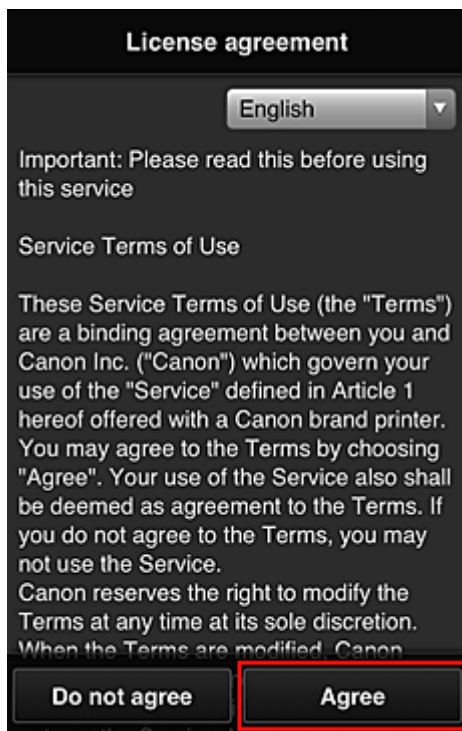

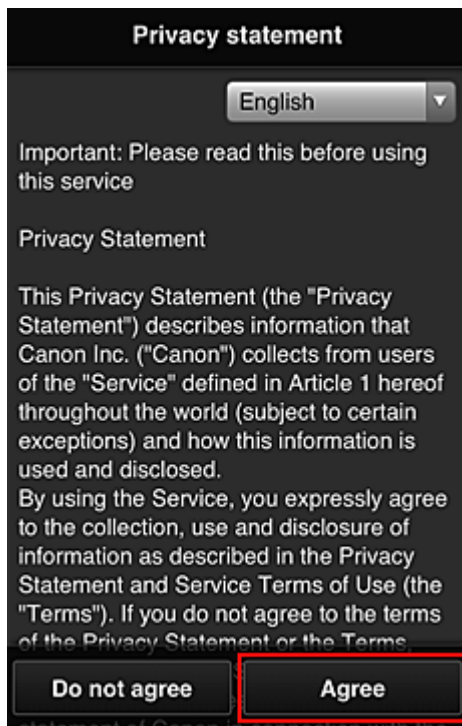

6. Register a password for logging in to the Canon Inkjet Cloud Printing Center.

On the My Account Registration screen, enter you desired password into **Password** and **Password (Confirmation)** and select **Next**.

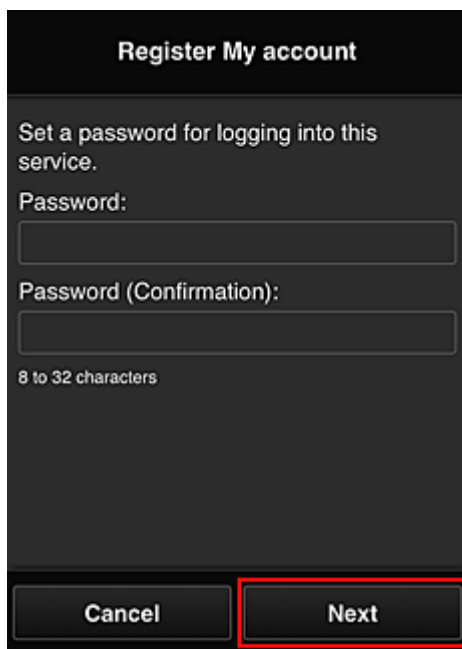

➤➤➤ **Important**

- There are character restrictions for the **Password**, as shown below.
 - The password must be between 8 and 32 characters long, using single-byte alphanumeric characters and symbols (!"#\$%&'()*+,-./:;<=>?@[¥]^_`{|}~). (Alphabets are case-sensitive)

7. Enter **Nickname**

Enter any user name that you want to use.

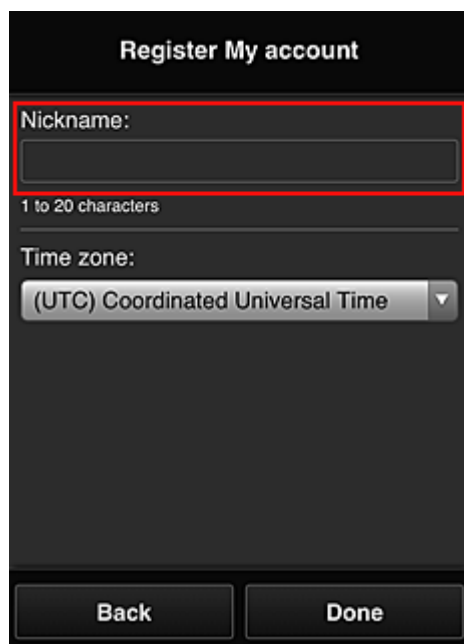

Register My account

Nickname:

1 to 20 characters

Time zone:

(UTC) Coordinated Universal Time

Back Done

»» Important

- The user name entry field has the following character restrictions:
 - The user name must be between 1 and 20 characters long, using single-byte alphanumeric characters and symbols (!"#\$%&'()*+,-./:;<=>@[¥]^_`{|}~). (Alphabets are case-sensitive)

8. Specify the **Time zone** setting, and select **Done**

Select your region on the list. If you cannot find your region on the list, select the one closest to your region.

Apply daylight saving time

This appears only when there is a daylight saving time in the **Time zone** that you selected. Select whether or not to apply the daylight saving time.

The main registration is complete, and a registration completion e-mail is sent.

➤➤➤ Note

- When you use MAXIFY Cloud Link, a cookie for the selected user is added to the printer, and the login status of each user is recovered. For each printer, you can register cookies for up to 8 users.

Printer user privileges

If several users are using the cloud service for 1 printer, each user is categorized as the **Administrator** or a **Standard user**.

➤➤➤ Note

- The user who is registered first becomes the **Administrator**. The administrator can change the privileges of users from the [Manage users screen](#).

An **Administrator** can change printer information, add and delete apps, manage users, and perform various other operations.

A **Standard user** can check printer information and start apps.

For information about the functions that each user can use, refer to the "[Canon Inkjet Cloud Printing Center window](#)".

If you are using MAXIFY Cloud Link from the printer, select **Multiusers mode** in the [Mng. printer screen](#) to set the printer to **Multiusers mode**. Each user can then start an app and print documents.

➤➤➤ Note

- If you have not set your own **Security code**, select **Multiusers mode** to display the **Security code** setup screen.
If you select **Cancel**, you will not be able to set **Multiusers mode**.
- If you are the **Administrator**, a confirmation screen appears asking whether you want to send an e-mail prompting standard users without a **Security code** to set up their **Security code**.
 - To send a notification e-mail is sent only to users without a **Security code** and to set **Multiusers mode**, select **OK**.

- To set **Multuser mode** without sending a notification e-mail, select **Cancel**.

■ [Troubleshooting Canon Inkjet Cloud Printing Center](#)

Troubleshooting Canon Inkjet Cloud Printing Center

- [If an app cannot be installed](#)
- [If the registered app is not in the Apps list](#)
- [If the information is not updated when you press the update button](#)
- [If you do not receive the registration e-mail](#)
- [If you cannot print](#)
- [Printing starts on its own even if you do not do anything](#)
- [If you are unable to log in correctly even after entering the correct password in iOS or Mac](#)

If an app cannot be installed

Check the country or region where the printer was purchased.

If the printer is taken outside the country or region where it was purchased, apps cannot be installed.

If You Are Using iP110 series

Check the country or region where the printer was purchased.

If you take the printer outside the country or region where you purchased it, you may not be able to install certain apps.

You can continue to use apps that are already installed, as long as the apps support the country or region you are moving to.

If the registered app is not in the Apps list

Check the display language of Canon Inkjet Cloud Printing Center.

If the display language is switched to a language that does not support an app, the app will not be displayed in the apps list but will continue to be registered.

If you switch back to the target language of the app, it will be displayed in the apps list and you will be able to start, register, or unregister the app.

If the information is not updated when you press the update button



Because the Properties screen requires network connection with this product, the information may not be reflected immediately. Please wait awhile, and then try updating the information again.

If the information is still not updated, then check that the product is connected to the Internet.

If you do not receive the registration e-mail

You may have entered a different e-mail address during the user registration of Canon Inkjet Cloud Printing Center.

If your model has color LCD monitor

On the printer's Home screen, select  **Setup** ( Various settings) ->  **Web service setup** -> **Web service connection setup** -> **IJ Cloud Printing Center setup** -> **Delete from this service** to delete the service registration.

If your model has monochrome LCD monitor



On the printer operation panel, select the **Setup** button, and then select **Web service setup** -> **Connection setup** -> **IJCloudPrintingCtr** -> **Delete from service** to delete the service registration.

If your model has no LCD monitor

Displaying Printer Information -> **IJ Cloud Printing Center setup** -> **Delete from this service** to delete the service registration.

To display printer information, go to the Online Manual home page, and see "Checking Printer Information" for your model.

After resetting the printer, repeat the user registration of Canon Inkjet Cloud Printing Center from the beginning.

If you cannot print

Check the following if you cannot print.

If your model has color LCD monitor

- Check that the printer is connected to the Internet.
- Check that the printer is connected to a LAN and the LAN environment is connected to the Internet.
- Check that no error message is displayed on the printer's LCD monitor.
- If printing does not start even after you wait awhile, go to the printer's home screen, and select



Setup (



Various settings) -> **Web service inquiry**.

If your model has monochrome LCD monitor

- Check that the printer is connected to the Internet.
- Check that the printer is connected to a LAN and the LAN environment is connected to the Internet.
- Check that no error message is displayed on the printer's LCD monitor.

- If printing does not start even after you wait awhile, go to the printer operation panel, select  **Setup**, and run **Web service inquiry**. If printing does not start, run the inquiry several times.

If your model has no LCD monitor

- Check that the printer is connected to the Internet.
- Check that the printer is connected to a LAN and the LAN environment is connected to the Internet.
- If printing does not start even after you wait awhile, first turn off the printer, and then turn it back on again.

If the problem is not resolved, use the printer driver from your computer to perform the print job and check whether the data can be printed normally on the printer.

If you still cannot print, see the troubleshooting page for your model on the Home of the Online Manual.



▶▶▶ Note

- With a wireless LAN connection, after the printer is turned on, it may take several minutes before communication is possible. Check that your printer is connected to the wireless network, and wait a while before you start printing.
- If the printer is not turned on or is not connected to the Internet, and consequently a print job is not processed within 24 hours after it was submitted, the print job is automatically canceled. If this happens, check the printer power and the Internet connection, and then re-submit the print job.

Printing starts on its own even if you do not do anything

A third party may be able to illegally use the Canon Inkjet Cloud Printing Center services.

If your model has color LCD monitor

On the printer's Home screen, select  **Setup** ( Various settings) ->  **Web service setup** -> **Web service connection setup** -> **IJ Cloud Printing Center setup** -> **Delete from this service** to delete the service registration.

If your model has monochrome LCD monitor

On the printer operation panel, select the  **Setup** button, and then select **Web service setup** -> **Connection setup** -> **IJCloudPrintingCtr** -> **Delete from service** to delete the service registration.

If your model has no LCD monitor

Displaying Printer Information -> **IJ Cloud Printing Center setup** -> **Delete from this service** to delete the service registration.

To display printer information, go to the Online Manual home page, and see "Checking Printer Information" for your model.

After resetting the printer, repeat the user registration of Canon Inkjet Cloud Printing Center from the beginning.

If you are unable to log in correctly even after entering the correct password in iOS or Mac

If you are using iOS or Mac and the password contains the ¥ or ₩ symbol, enter a backslash instead. For instructions on entering a backslash, see the OS help.

Print Easily from a Smartphone or Tablet with Canon PRINT Inkjet/SELPHY

Use the "Canon PRINT Inkjet/SELPHY" application to easily print photos saved on a smartphone or tablet (iOS or Android) wirelessly.

You can also receive scanned data (PDF or JPEG) directly on a smartphone or tablet without using a computer.



Canon PRINT Inkjet/SELPHY can be downloaded from App Store and Google Play.

Follow the steps below to print photos easily.

1. Download Canon PRINT Inkjet/SELPHY.

For iOS

For Android

2. Connect printer to Wi-Fi by following instructions on application screen.
3. Select photo in **Photo Print** of application, and then tap **Print**.

Printing with Windows RT

When you use Windows RT 8.1 or a later version, printing is easy because you simply connect this printer to the network.

For information about connecting to the network, see the setup URL (<http://www.canon.com/ijsetup>) for using this product from your computer, smartphone, or tablet device.

When the connection is complete, the Canon Inkjet Print Utility software, which allows you to specify detailed print settings, is downloaded automatically.

By using Canon Inkjet Print Utility, you can check the **Printer status** and specify detailed print settings. (The available functions will differ depending on your usage environment and connection method.)

Online Storage Integration Function

The printer can integrate with online storage services such as Evernote.



Integration with Online Notetaking Service "Evernote"

If an Evernote client application is installed on your computer, you can import scanned images into the application and upload them to the Evernote server.

The uploaded images can be browsed from other computers, smartphones, etc.

To use Evernote, you need to create an account. See the "CREATE ACCOUNT" page of Evernote for account creation.

Settings

For Windows:

In the Settings Dialog Box of IJ Scan Utility, select the item you want to set, then select Evernote for **Send to an application** in **Application Settings**.

Refer to "Settings Dialog Box" for your model from Home of the Online Manual for details.

For Mac OS:

In the Settings Dialog of IJ Scan Utility, select the item you want to set, then select Evernote for **Send to an application** in **Application Settings**.

Refer to "Settings Dialog" for your model from Home of the Online Manual for details.

Important

- The Evernote service features are subject to change or termination without prior notice.

Handling Paper, Originals, Ink Tanks, etc.

▶ Loading Paper

- Paper Sources
- Loading Plain Paper / Photo Paper
- Loading Envelopes

▶ Loading Originals

- Where to Load Originals
- Loading Originals on the Platen Glass
- Loading Documents in the ADF (Auto Document Feeder)
- Loading Based on Use
- Supported Originals

▶ Inserting a USB Flash Drive

- Inserting a USB Flash Drive
- Removing a USB Flash Drive

▶ Replacing Ink Tanks

- Replacing Ink Tanks
- Checking Ink Status on the Touch Screen

Loading Paper

- ▶ **Paper Sources**
- ▶ **Loading Plain Paper / Photo Paper**
- ▶ **Loading Envelopes**

Paper Sources

Types and Sizes of Paper You Can Use

Paper can be loaded in cassette 1 (A) and in cassette 2 (B).

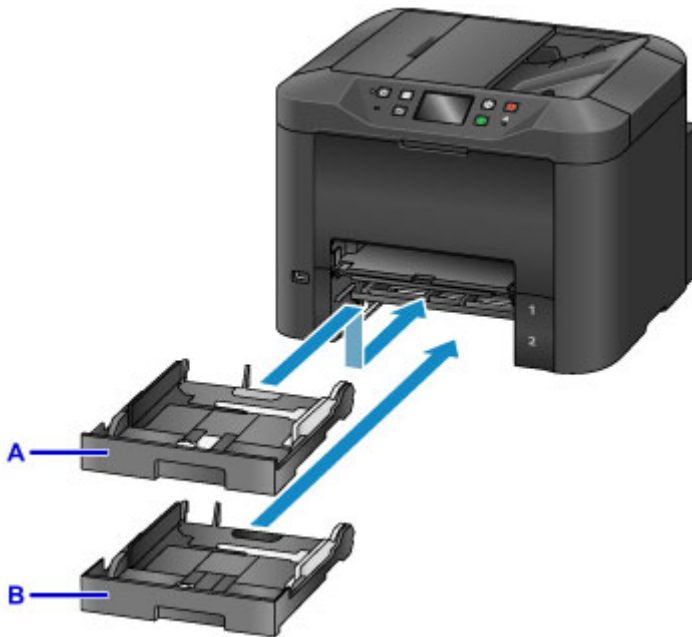

On top, cassette 1 (A) holds all sizes of paper that are compatible with the machine, such as plain paper, photo paper, and envelopes.

Below it, cassette 2 (B) holds A4, Letter, Legal, Oficio, B-Oficio, M-Oficio, Foolscap, and Legal (India)-sized plain paper.

■ [Supported Media Types](#)

To avoid running out of paper, you can load the same size of plain paper (A4, Letter, Legal, Oficio, B-Oficio, M-Oficio, Foolscap, or Legal (India)) in both cassettes and set the machine to automatically switch to the other cassette when the first one is empty.

■ [Cassette settings](#)

▶▶▶ Note

- When printing, select the correct sizes and types of paper. Incorrect page size and media type settings may cause feeding from the wrong paper source, or print quality may be affected.

For instructions on loading paper in a cassette, see these sections.

■ [Loading Plain Paper / Photo Paper](#)

■ [Loading Envelopes](#)

Adjusting the cassette to the Size of Paper Used

The cassette can be adjusted to three lengths. To extend the cassette, hold down the lock (C) as you pull the front toward you.

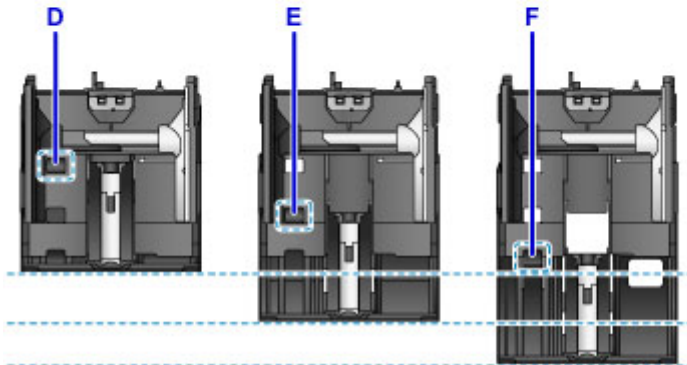
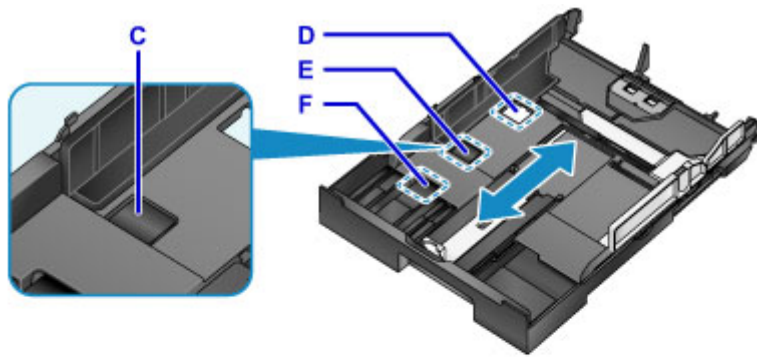

D: Lock position for stowing the cassette

Set to position D when the machine will not be used for some time, or before shipping it. In this position, the cassette is flush against the surface of the machine. Note that paper cannot be loaded in this position.

E: Lock position for A4 or Letter-sized paper or smaller

Set to position E for paper of A4 or Letter size or smaller. The cassette is not flush against the machine, but you can cover it by pulling out the paper output tray. Set the cassette to this position for normal use.

F: Lock position for paper larger than A4 or Letter size

Set to position F for paper larger than A4 size, such as Legal-sized paper. In this position, the cassette is not fully covered when you pull out the paper output tray. (By design, the cassette protrudes from the machine a little.)

Load Paper Printing-Side Down

Some paper such as photo paper has distinct top and bottom surfaces. Load this paper with the whiter or glossy side facing down.

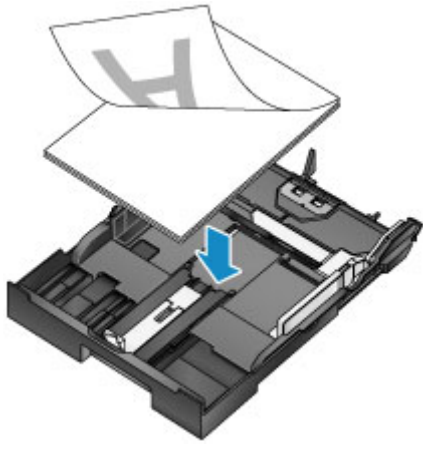

Loading Plain Paper / Photo Paper

Load paper in cassette 1 or cassette 2.

* This example demonstrates loading in cassette 1, but paper is loaded the same way in cassette 2.

▶▶▶ Important

- Paper may jam if you test printing by cutting plain paper into smaller sizes, such as 4" x 6" (10 x 15 cm) or 5" x 7" (13 x 18 cm).

▶▶▶ Note

- In cassette 1, you can load all sizes of paper that are compatible with the machine, such as plain paper, photo paper, and envelopes.
- In cassette 2, load A4, Letter, Legal, Oficio, B-Oficio, M-Oficio, Foolscap, or Legal (India)-sized plain paper.
- For details on sizes and weights of paper you can use, see [Supported Media Types](#).
- For instructions on loading envelopes, see [Loading Envelopes](#).

1. Prepare the paper.

Align the edges of the paper. If the paper is curled, flatten it.

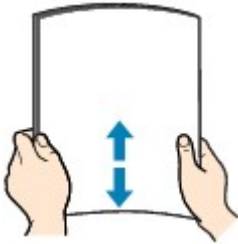

▶▶▶ Note

- Align the edges of paper neatly before loading it. Loading an uneven stack of paper may cause paper jams.
- If paper is curled, gently bend the curled corners in the opposite direction to flatten the paper.
For details on how to flatten curled paper, see "Correct curl before loading paper." in [Paper Is Smudged / Printed Surface Is Scratched](#).
- Slight curling of Photo Paper Plus Semi-gloss SG-201 should not be straightened. Instead, load one sheet at a time as-is. Bending this kind of paper to flatten it may crack the surface and reduce print quality.

2. Pull out a cassette.



3. Slide the front (A) and right (B) paper guides out to make room for the paper.
4. Load the stack of paper printing-side DOWN, centered on the cassette.

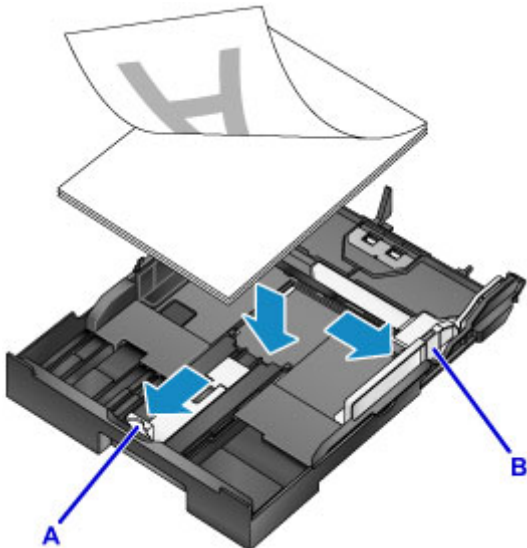

»»» Important

- Always load paper in portrait orientation (C). Loading paper in landscape orientation (D) may cause paper jams.

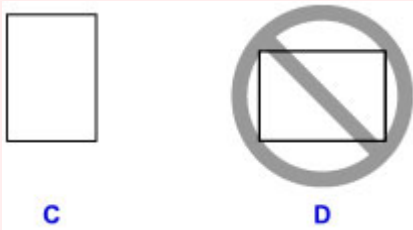

»»» Note

- Some paper such as photo paper has distinct top and bottom surfaces. Load this paper with the whiter or glossy side facing down.

- Align the stack of paper with the edge of the cassette as shown.

Feeding problems may occur if the paper is touching the protrusion (E).

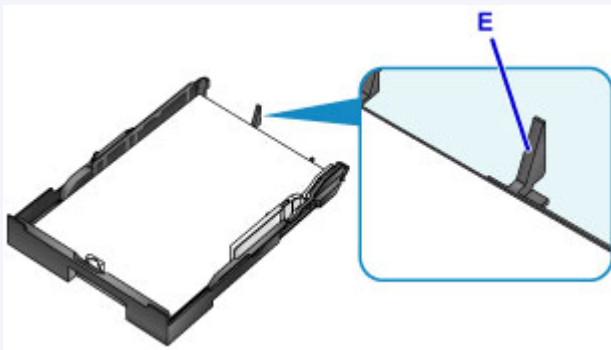

- To load paper 5" x 7" (13 x 18 cm) or smaller, lift the tab (F) on the paper guide. (Only cassette 1 can be used for paper of this size.)

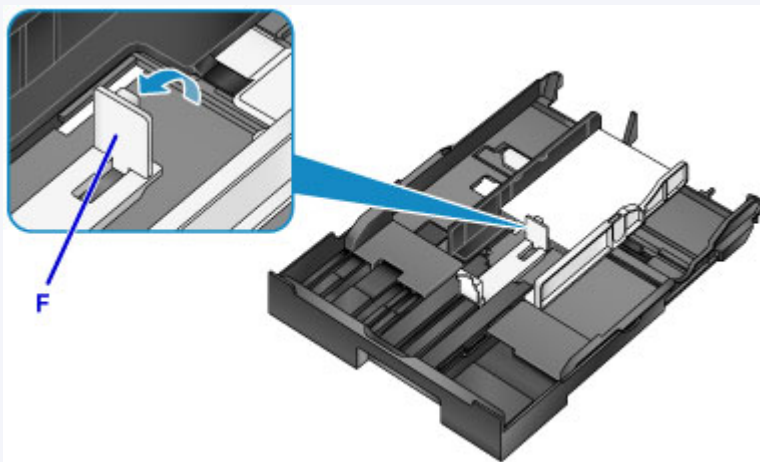

- To load paper larger than A4 size, press the lock (G) and pull the cassette all the way out.

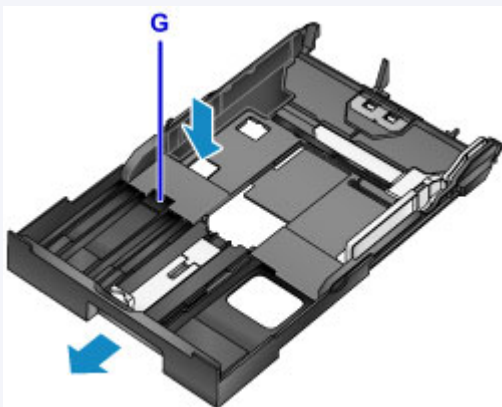

5. Align the front paper guide (A) with the stack.

The paper guide (A) clicks into place when aligned with a page size marked on the cassette.

6. Slide the right paper guide (B) to align the right and left guides with both edges of the stack.

Do not set the paper guides too firmly against the paper, which may cause feeding problems.

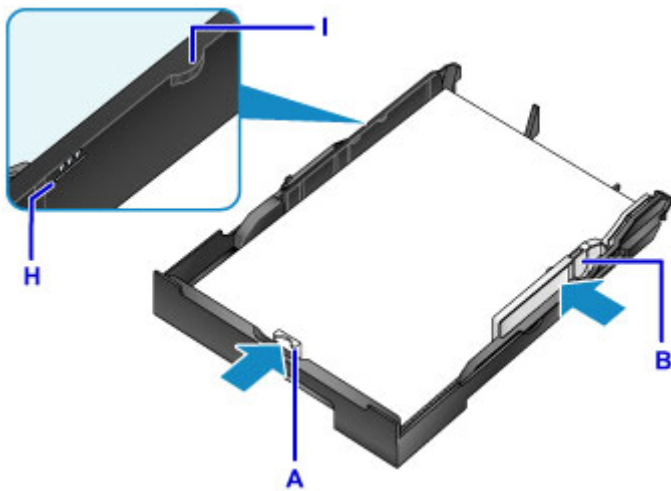

►► Note

- Do not load sheets of paper past the load limit mark (H).
- Keep the stack height below the paper guide tabs (I).

7. Insert the cassette.

Push the cassette into the machine until it stops.

After you insert the cassette, a screen for registering paper information for the cassette is displayed on the touch screen.



►► Note

- Paper A4 or Letter-sized or smaller: The cassette stops at the same position as the extended paper output tray, which then covers the cassette.
- Paper larger than A4 or Letter size: The cassette protrudes past the paper output tray. Do not force the cassette into the machine any further, which may damage the machine or cassette.



8. Select the size and type of paper in the cassette in **Page size** and **Type**, and then tap **Register**.

Follow the instructions of any messages displayed to register the paper information.

■ [Paper Settings](#)

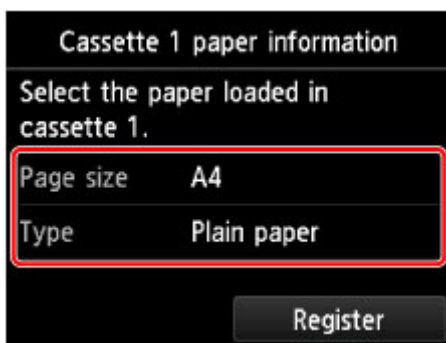

9. Pull out the output tray extension (J) and open the paper output support (K).



▶▶▶ **Note**

- Before printing, select the size and type of paper loaded, either on the print settings screen of the operation panel or in the printer driver.

Loading Envelopes

Load envelopes in cassette 1.

Once you have set up the printer driver correctly, addresses are automatically rotated and printed to suit the envelope orientation.

▶▶▶ Important

- Do not use the following envelopes. These kinds of envelopes may become stuck or cause the machine to malfunction.
 - Envelopes with embossed or coated surfaces
 - Envelopes with a double flap
 - Envelopes with adhesive flaps that are already moistened

▶▶▶ Note

- For details on sizes and weights of paper you can use, see [Supported Media Types](#).

1. Prepare the envelopes.

- To flatten the envelopes, press down on the corners and edges.

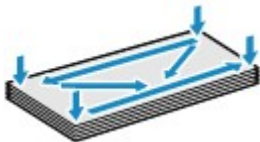

- If the envelopes are curled, hold opposite corners and gently bend them the opposite way.



- Flatten any flaps that are bent.
- Using a pen, press the leading edge in the direction of insertion to flatten the envelope.

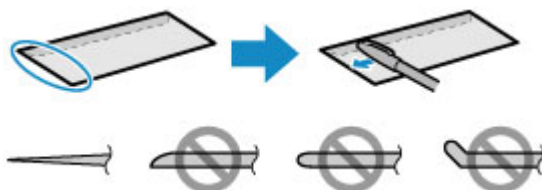

Side view of the envelope's leading edge.

▶▶▶ Important

- Envelopes that are not flat or that are loaded unevenly may become stuck. Make sure that any curled or bowed surfaces are no higher than 0.1 inch (3 mm).

2. Pull out cassette 1.



3. Slide the front (A) and right (B) paper guides out to make room for the paper.

4. Load the envelopes face-DOWN, centered in cassette 1.

The flap will face up, as shown below.



Up to 10 envelopes can be loaded at once.

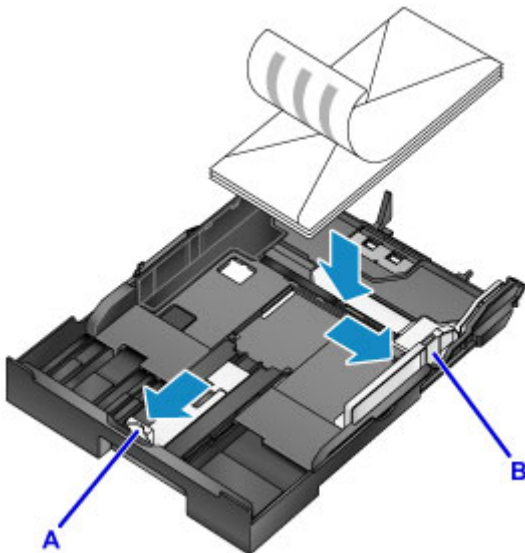

►► Note

- Align the stack of envelopes with the edge of cassette 1 as shown.
Feeding problems may occur if the envelopes are touching the protrusion (C).

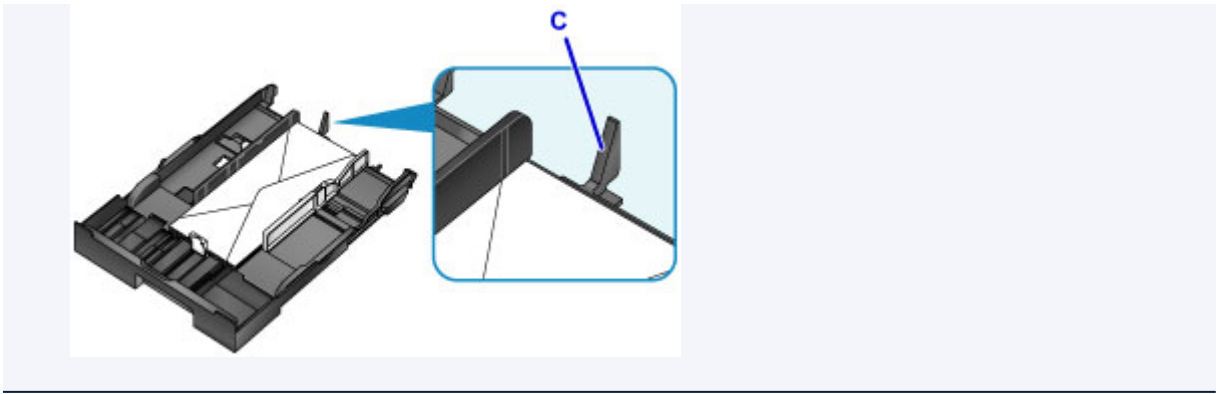

5. Align the front paper guide (A) with the edge of the envelopes.
6. Slide the right paper guide (B) to align the right and left guides with both edges of the envelopes.

Do not set the paper guides too firmly against the envelopes, which may cause feeding problems.

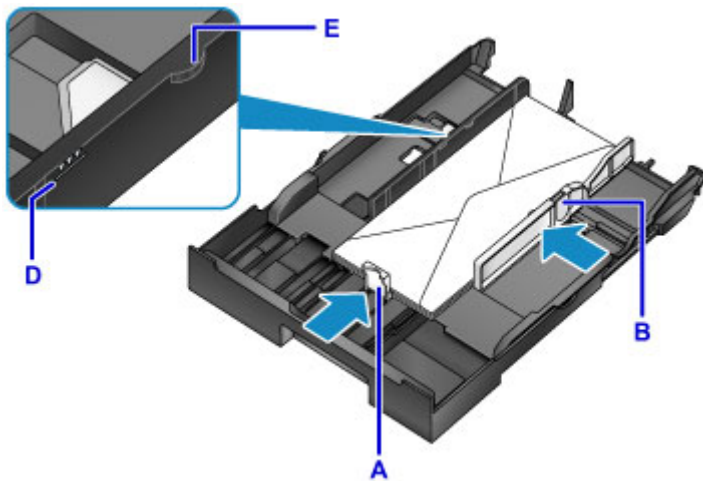

▶▶▶ Note

- Do not load envelopes past the load limit mark (D).
- Keep the stack height below the paper guide tabs (E).

7. Insert cassette 1.

Push cassette 1 into the machine until it stops.

After you insert the cassette, a screen for registering paper information for the cassette is displayed on the touch screen.



8. Select the size and type of envelopes in the cassette in **Page size** and **Type**, and then tap **Register**.

■ [Paper Settings](#)

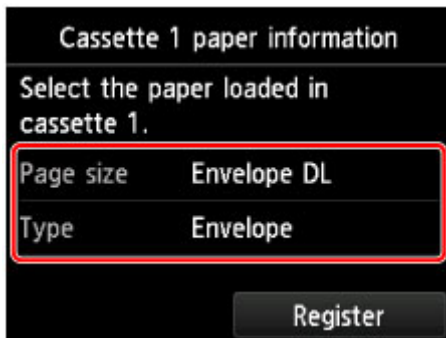

9. Pull out the output tray extension (F), and then open the paper output support (G).



»» Note

- Before printing, select the size and type of loaded envelopes on the print settings screen of the printer driver.

Loading Originals

- ▶ **Where to Load Originals**
- ▶ **Loading Originals on the Platen Glass**
- ▶ **Loading Documents in the ADF (Auto Document Feeder)**
- ▶ **Loading Based on Use**
- ▶ **Supported Originals**

Where to Load Originals

Load originals on the platen glass or in the ADF (Auto Document Feeder).

To decide where to load originals, consider the size and type of originals and the purpose of use.

■ [Supported Originals](#)

Loading Originals, Photos, or Books on the platen glass



Loading Multiple Documents of the Same Size and Thickness in the ADF

Individual documents can also be loaded in the ADF.



▶▶ Note

- The ADF can also be used for duplex copying, faxing, and scanning.
- For best results, load originals on the platen glass.

Loading Originals on the Platen Glass

1. Open the document cover.

▶▶▶ Important

- When opening or closing the document cover, be careful not to touch buttons or the touch screen on the operation panel. This may cause unexpected operation.

2. Load the original face-DOWN on the platen glass.

- [Supported Originals](#)
- [Loading Based on Use](#)



▶▶▶ Important

- Note these precautions when loading originals on the platen glass.
 - Do not place any objects weighing 4.4 lb (2.0 kg) or more on the platen glass.
 - Do not apply pressure of 4.4 lb (2.0 kg) or more against the platen glass, as by pressing down on originals.

This may prevent correct scanning or damage the platen glass.

3. Close the document cover gently.



▶▶▶ Important

- After loading an original on the platen glass, close the document cover before copying, faxing, or scanning.

Loading Documents in the ADF (Auto Document Feeder)

▶▶▶ Note

- For best results, load documents on the platen glass.

1. Remove any originals left on the platen glass.
2. Open the document tray.



3. Insert the document in the document tray until the machine beeps.

Load documents face-UP in the document tray.

■ [Supported Originals](#)

▶▶▶ Note

- No tone is played if you have silenced beeping in **Device user settings > Sound control**.

■ [Device user settings](#)

4. Adjust the document guides (A) to match the width of the document.

Do not set the document guides too firmly against the document, which may cause feeding problems.

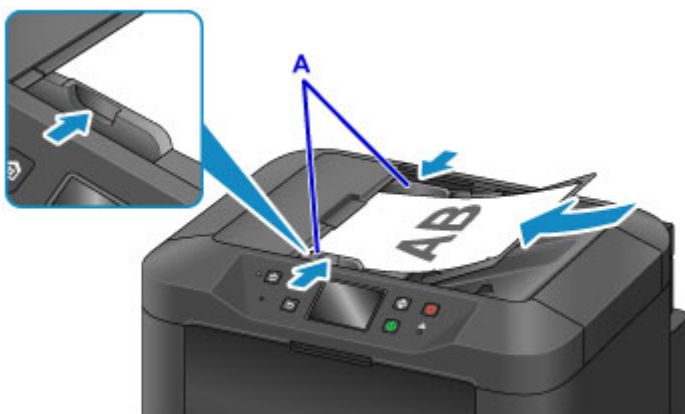

Loading Based on Use

Load originals correctly for how they will be used. Originals loaded incorrectly may cause scanning problems.

Align Originals with the alignment mark

- When loading originals to copy or fax
- When selecting **Doc.type** > **Document** or **Photo** in **Scan** and specifying a standard size (such as A4/Letter) in **Scan size**
- When using a computer to:
 - Scan documents, magazines, or newspapers
 - Specify a standard size (such as A4/Letter) to scan originals

Place the original face-DOWN on the platen glass and align it with the alignment mark (). The diagonally striped area is outside the scanning area.

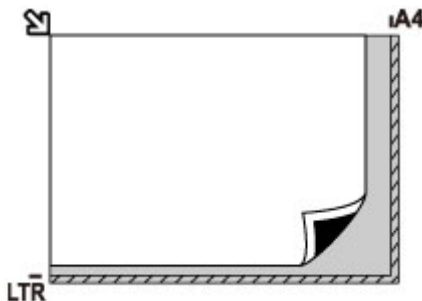

Important

- The striped area (A, 0.04 inch (1 mm) from the edges of the platen glass) is outside the scanning area.

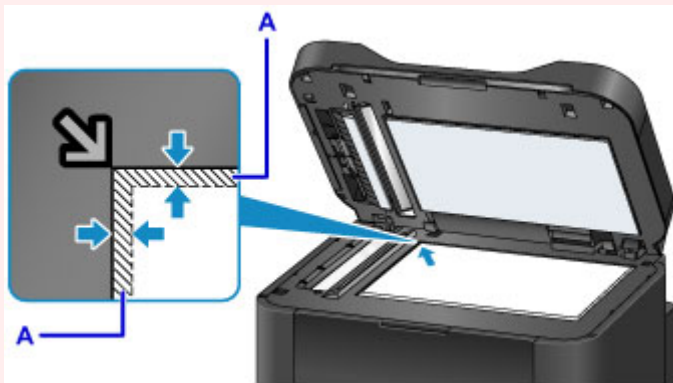

Center One Original on the platen glass

- When selecting **Doc.type** > **Photo** in **Scan** and specifying **Scan size** > **Auto scan** to scan one original

Load the original face-DOWN at least 0.4 inch (1 cm) from the edges of the platen glass. The diagonally striped area is outside the scanning area.

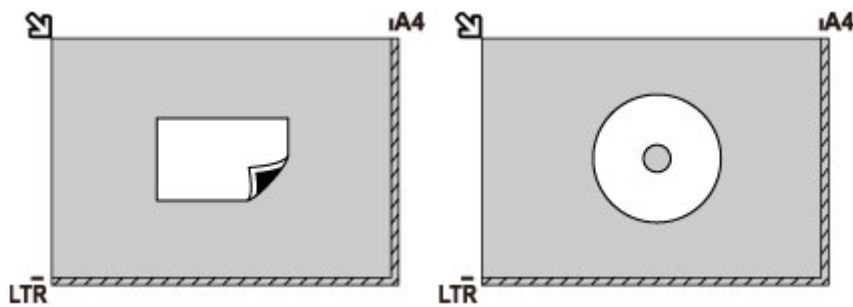

Load Multiple Originals on the platen glass

- When selecting **Doc.type** > **Photo** in **Scan** and specifying **Scan size** > **Auto multi scan** to scan multiple originals
- When scanning multiple photos, postcards, or business cards from a computer

Load the originals face-DOWN. Leave at least 0.4 inch (1 cm) open between originals and from the edges of the platen glass. The diagonally striped area is outside the scanning area.

You can load up to 12 originals at once.

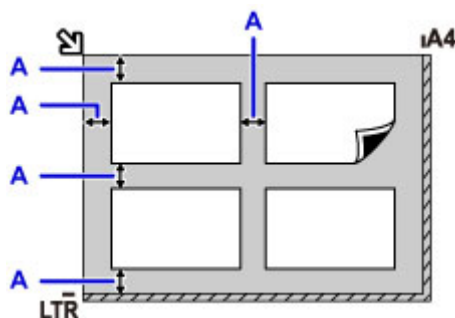

A: At least 0.4 inch (1 cm)

►► Note

- Skew Correction automatically straightens images scanned from originals loaded askew (up to approximately 10°). However, scans of photos with a long edge of 7.1 inches (180 mm) or more that are loaded askew cannot be corrected.
- Non-rectangular or irregularly shaped photos (such as cut-out photos) may not be scanned correctly.

Supported Originals

On the platen glass

Item	Details
Kind of original	- Document, magazine, or newspaper - Photo, postcard, business card, or optical disc (Blu-ray disc, DVD, or CD) - Documents unsuitable for the ADF
Size (width x height)	Max. 8.5 x 11.7 inches (216 x 297 mm)
Quantity	One or more sheets*
Thickness	Max. 0.4 inch (10 mm)

* With some functions, multiple originals can be loaded on the platen glass.

■ [Loading Based on Use](#)

In the ADF (Auto Document Feeder)

Item	Details
Kind of original	Plain-paper documents with multiple pages of the same size, thickness, and weight
Size (width x height)	- Max. 8.5 x 14.0 inches (216 x 356 mm) - Min. 5.8 x 5.8 inches (148 x 148 mm) Duplex copying/scanning or 2-on-1/4-on-1 copying: A4/Letter only
Quantity	- A4/Letter: Max. 50 sheets (20 lb (75 g /m ²) paper), up to 0.20 inch (5 mm) high - Legal: Max. 10 sheets (20 lb (75 g /m ²) paper), up to 0.04 inch (1 mm) high - Other sizes: 1 sheet
Thickness	0.003 to 0.005 inch (0.07 to 0.13 mm)
Weight	16.0 to 25.3 lb (60 to 95 g /m ²)

►► Note

- Make sure any liquids on documents, such as glue, ink, or correction fluid are dry before loading.
Do not load glued documents in the ADF, even if the glue is dry, because this may cause paper jams.
- Remove all staples, paper clips, or other fasteners before feeding documents.
- Load Legal-sized documents in the ADF.
- Do not load these kinds of documents in the ADF, which may cause paper jams.
 - Wrinkled or creased documents
 - Curled documents
 - Torn documents
 - Documents with holes

- Glued documents
 - Documents with sticky notes
 - Documents on carbon paper
 - Documents on coated paper
 - Documents on onion skin or other thin paper
 - Photos or excessively thick documents
-

Inserting a USB Flash Drive

- ▶ [Inserting a USB Flash Drive](#)
- ▶ [Removing a USB Flash Drive](#)

Inserting a USB Flash Drive

Supported Image Files

- Can print images taken with cameras conforming to Design Rule for Camera File System specifications, as well as TIFF images. Both types of images must conform to Exif 2.2/2.21/2.3. Other types of images or movies such as RAW images cannot be printed.
- Can print images scanned and saved by the machine itself with **Doc.type** set to **Photo** and **Format** set to **JPEG** (file extension ".jpg").

▶▶ Note

- This device incorporates exFAT technology licensed from Microsoft.
- If the USB flash drive does not fit in the machine's USB flash drive port, you may need an extension cable for it. This accessory is available at electronics stores.
- Not all USB flash drives may be detected by the machine, and correct operation is not guaranteed.
- Secure USB flash drives may not be compatible.

1. Insert the USB flash drive into the USB flash drive port.

Make sure the USB flash drive is right-side up and insert it straight into the port.

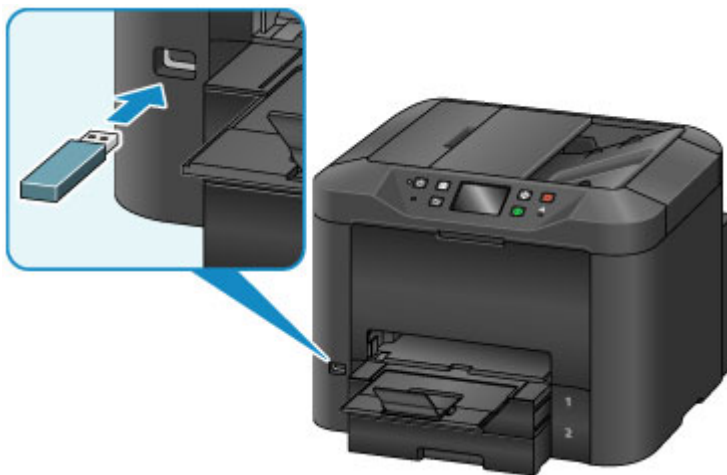

Removing a USB Flash Drive

1. Before removing a USB flash drive, make sure the machine is not reading or writing data.

During these operations, a message appears on the touch screen.

Important

- Do not remove a USB flash drive or turn off the machine while the machine is reading or writing data.

Note

- If your USB flash drive has an access indicator, check it to make sure reading or writing is finished. Refer to the USB flash drive instruction manual, as needed.

2. Remove the USB flash drive.

Hold the USB flash drive and pull it straight out of the machine.

Replacing Ink Tanks

- ▶ [Replacing Ink Tanks](#)
- ▶ [Checking Ink Status on the Touch Screen](#)

Replacing Ink Tanks

In the case of warnings or errors caused by low ink levels, messages appear on the touch screen to notify you. Respond to the message as needed.

■ [Message Appears](#)

▶▶▶ Note

- If printing is faint or affected by white streaks even when there is enough ink, see [Maintenance Procedure](#).
- For precautionary notes on handling ink tanks, see [Notes on ink tanks](#).

Steps to Replace ink tanks

When needed, replace ink tanks as follows.

1. After confirming that the machine is on, open the front cover.

The ink tanks you can replace are identified on the touch screen, and the print head holder (A) moves into position for replacement of those ink tanks.

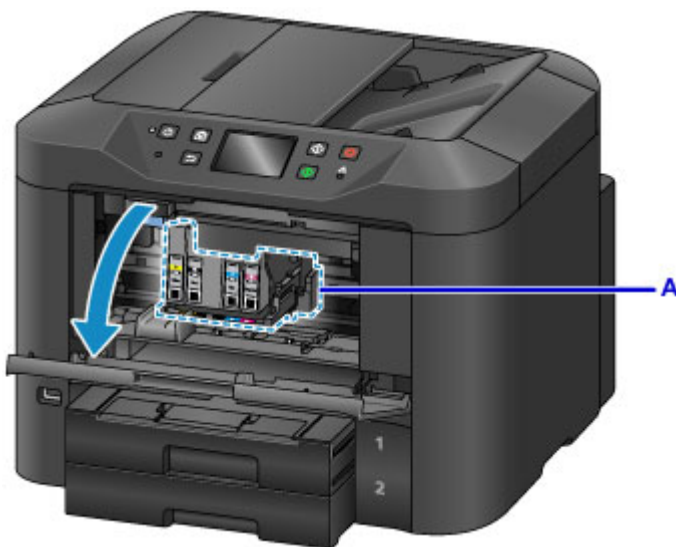

⚠ Caution

- Do not stop the moving print head holder or force it to a different position. Do not touch the print head holder until it stops moving.

▶▶▶ Important

- Do not remove an ink tank until a new one is prepared to be installed.
 - Once you remove an ink tank, the machine will not operate until a new one is installed.
 - Once you remove an ink tank, the machine will not operate even if the removed ink tank is just reinstalled.
- The ink tanks in other positions cannot be replaced. Forcing them out may damage the machine or cause malfunction.
- Do not touch metallic parts or other areas inside the machine.

- If you leave the front cover open for more than 60 minutes, the print head holder will move to the right. In this case, close the front cover and open it again.

▶▶▶ Note

- If a warning about ink tank replacement appears, check the message and tap **OK**.

2. Once the ink tank for replacement is identified on the touch screen, push up the ink tank eject lever (B).

The ink tank is ejected.

To replace another ink tank, tap **Next** to display the screen for the next ink tank to replace.

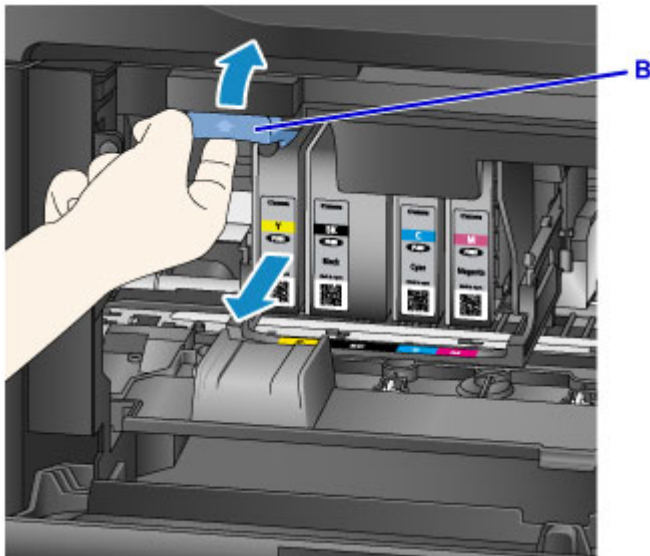

▶▶▶ Important

- Place the removed ink tank into a plastic bag immediately after removing from the machine. Otherwise, ink residue may stain your clothes or the surrounding area.
- Do not touch parts other than ink tanks.
- Follow local regulations when discarding used ink tanks.
- Handle ink tanks carefully. Do not drop them or press hard on them.

3. Remove the ink tank from the package.

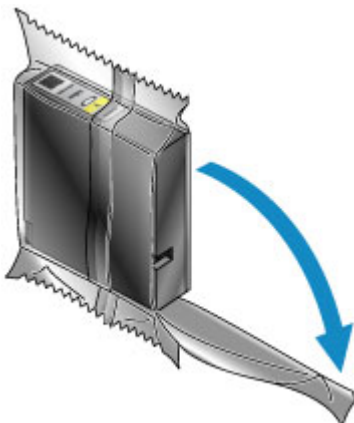

»» Important

- Do not touch the contact (C) or interface (D) of the ink tank.

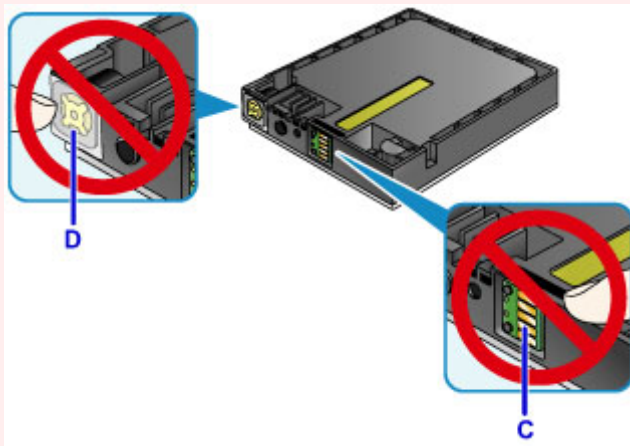

4. Insert the new ink tank, aligning it with the installation guide (E) on the machine.

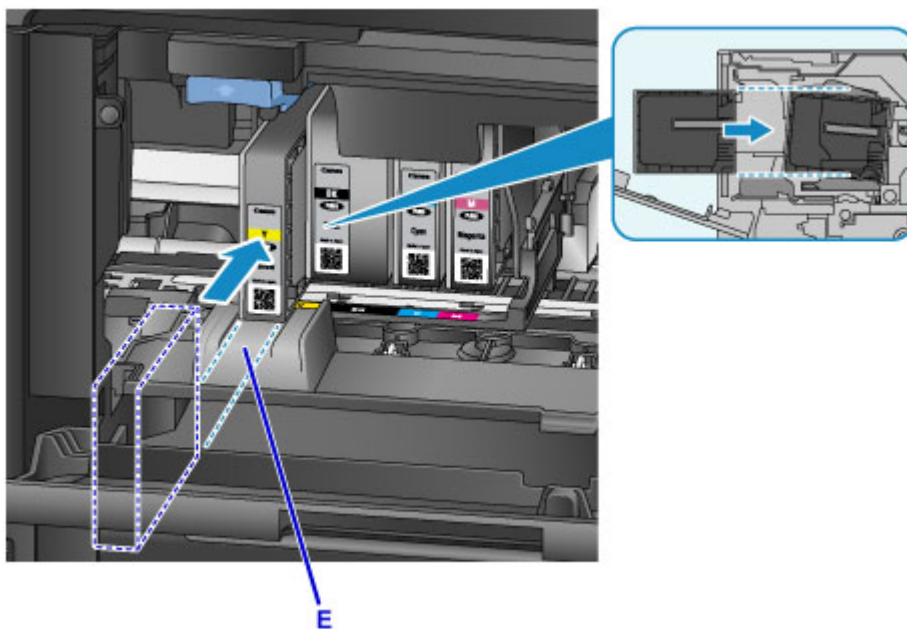

»» Important

- The ink tank will not fit in the wrong position. Check the label under the installation position, and install the ink tank in the correct position.

5. Push the ink tank in firmly until it clicks into place.

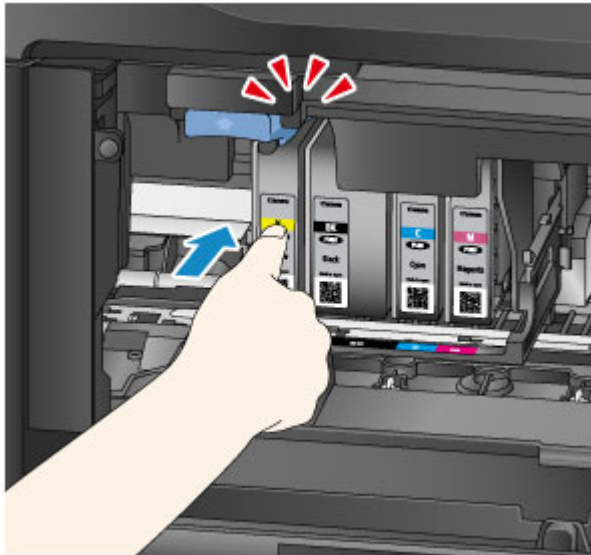

6. Tap **Exit** on the touch screen.

If **Next** is displayed, another ink tank can be replaced.

To replace the next ink tank, tap **Next** and repeat this procedure from step 2.

To exit ink tank replacement, tap **Next** until **Exit** is displayed.

The print head holder moves to the standby position. The ink tanks cannot be removed from this position.

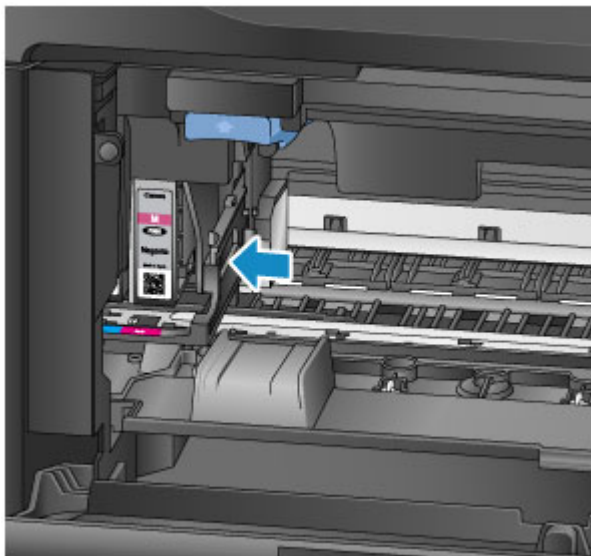

►► Important

- Printing is not possible without a complete set of ink tanks installed. Install all ink tanks.
- Installed ink tanks cannot be removed until a replacement message appears.

7. Close the front cover.



After ink tank replacement, the machine starts mixing the ink automatically. Wait until this noise stops. (Mixing takes 1–2 minutes.)

▶▶▶ Note

- Respond to any error messages as needed.
 - [Message Appears](#)
- If the print head is out of alignment, as when parallel lines are not printed parallel, [align the print head](#).
- The machine may make a noise during these operations, but this does not indicate a problem.

Notes on ink tanks

▶▶▶ Important

- Install replacement ink tanks promptly. Do not leave the machine without ink tanks installed.
- Replace empty ink tanks with new ones. Installing used ink tanks may clog the nozzles. Used ink tanks may also prevent correct notification of the ink tank replacement timing.
- Do not remove installed ink tanks and leave them outside the machine. In this state, ink tanks will dry out, which may prevent correct operation when they are reinstalled. To maintain optimal print quality, use up ink tanks within six months after you install them.

▶▶▶ Note



- Color ink may be consumed even when printing black-and-white originals, or when black-and-white printing is specified.

All colors of ink are also consumed during standard and deep print head cleaning to maintain performance. When ink tanks run out of ink, promptly replace them with new ones.

■ [Ink Tips](#)

Checking Ink Status on the Touch Screen

►► Note

- If one or more ink colors runs out,  changes to  in the HOME screen. When  appears, check which ink (or inks) has run out using the following procedure.

1. Make sure the machine is on, and display the HOME screen.

If the HOME screen is not displayed, press the **HOME** button to display it.

2. Tap  on the HOME screen.

■ [Using the Operation Panel](#)

A symbol appears in area A in case of any messages about the remaining ink level.

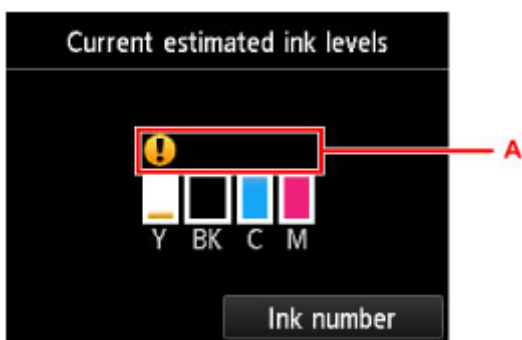

Example: 

Ink tank is running low. Prepare a new ink tank.

►► Note

- Ink levels on this screen are estimates.
- You can also display the **Current estimated ink levels** screen by tapping **Setup** on the HOME screen and selecting **Estimated ink levels** in the setup menu.
- To check the ink tank model number, display the **Ink number** screen by tapping **Ink number**. Tapping **Print no.** on this screen enables you to print the ink tank model number. Tapping **Order ink now** displays the QR code for accessing the ink order site. Cost of connecting to Internet is to be born by the customer.
- Ink status can also be checked from the touch screen during printing.
- You can also check ink status from a computer.
 - [Checking the Ink Status from Your Computer](#) (Windows)
 - [Checking the Ink Status from Your Computer](#) (Mac OS)

Maintenance

- ▶ **If Printing Is Faint or Uneven**
- ▶ **Performing Maintenance Functions from Your Computer (Windows)**
- ▶ **Performing Maintenance Functions from Your Computer (Mac OS)**
- ▶ **Cleaning**

If Printing Is Faint or Uneven

- **Maintenance Procedure**
- **Printing the Nozzle Check Pattern**
- **Examining the Nozzle Check Pattern**
- **Cleaning the Print Head**
- **Deep Print Head Cleaning**
- **Aligning the Print Head**
- **Aligning the Print Head Manually**

Maintenance Procedure

Follow these steps to restore print quality if printing becomes faint or uneven, colors are incorrect, or printing results are not as expected (as when parallel lines are not printed parallel).

►►► Note

- Increasing the print quality in the printer driver may give better results.
 - [Changing the Print Quality and Correcting Image Data](#) (Windows)
 - [Changing the Print Quality and Correcting Image Data](#) (Mac OS)

To Correct Faint or Uneven Printing:

|| Step1 Print the nozzle check pattern.

From your machine

- [Printing the Nozzle Check Pattern](#)

From your computer

- [Printing a Nozzle Check Pattern](#) (Windows)
- [Printing a Nozzle Check Pattern](#) (Mac OS)

|| Step2 [Examine the nozzle check pattern.](#)

Some missing lines or horizontal white streaks in the pattern:



|| Step3 Clean the print head.

From your machine

- [Cleaning the Print Head](#)

From your computer

- [Cleaning the Print Heads](#) (Windows)
- [Cleaning the Print Heads](#) (Mac OS)

After cleaning the print head, print and examine the nozzle check pattern again: ➡ [Step1](#)

Problem not resolved after you perform from step 1 to step 3 twice:



|| Step4 Perform deep print head cleaning.

From your machine

- [Deep Print Head Cleaning](#)

From your computer

- [Cleaning the Print Heads](#) (Windows)
- [Cleaning the Print Heads](#) (Mac OS)

►► Note

- If printing problems remain even after step 4, turn the machine off, wait at least 24 hours, and perform deep print head cleaning again. Leave the machine plugged in after you turn it off.

If the problem is still not resolved, the print head may be damaged. Contact the service center.

To Correct Misalignment:

|| Step | Align the print head.

From your machine

- [Aligning the Print Head](#)

From your computer

- [Aligning the Print Head Position](#) (Windows)
- [Aligning the Print Head Position](#) (Mac OS)

Printing the Nozzle Check Pattern

Print the nozzle check pattern to determine whether ink is being ejected correctly from the print head nozzles.

▶▶▶ Note

- If ink runs out as the nozzle check pattern is printed, an error message appears on the touch screen.

■ [Message Appears](#)

What you will need: one sheet of A4 or Letter-sized plain paper

1. Make sure the machine is on.

2. Flick the HOME screen, and then tap  **Setup**.

■ [Using the Operation Panel](#)

The setup menu screen is displayed.

3. Tap  **Maintenance**.

The **Maintenance** screen is displayed.

4. Tap **Print nozzle check pattern**.

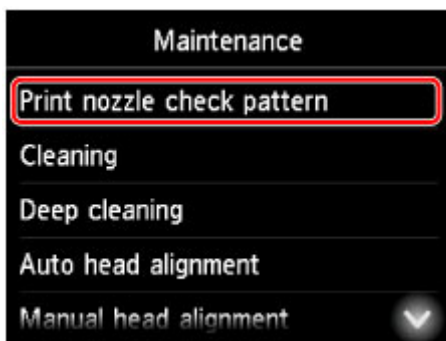

A confirmation screen is displayed.

5. Load a sheet of A4 or Letter-sized plain paper in cassette 1.

▶▶▶ Important

- The screen for registering page size and media type is not displayed during any of the operations available in the **Maintenance** screen. Therefore, printing will be executed even if paper other than A4 or Letter-sized plain paper is loaded.
- Nozzle check patterns cannot be printed from cassette 2. Load paper in cassette 1.

6. Pull out the output tray extension and open the paper output support.

7. Tap **Yes**.

After the nozzle check pattern is printed, two pattern confirmation screens are displayed.

8. [Examine the nozzle check pattern](#).

Examining the Nozzle Check Pattern

Examine the nozzle check pattern and clean the print head if necessary.

1. Check for any missing lines in pattern C or horizontal white streaks in pattern D.

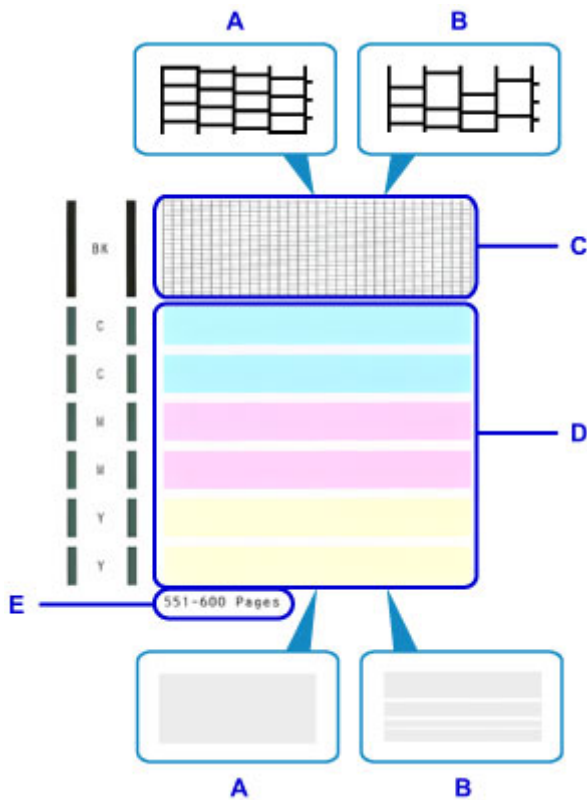

- A: No missing lines or horizontal white streaks
- B: Some missing lines and horizontal white streaks
- E: Number of pages printed to date

2. On the checking screen, select patterns that most resemble the printed nozzle check pattern.

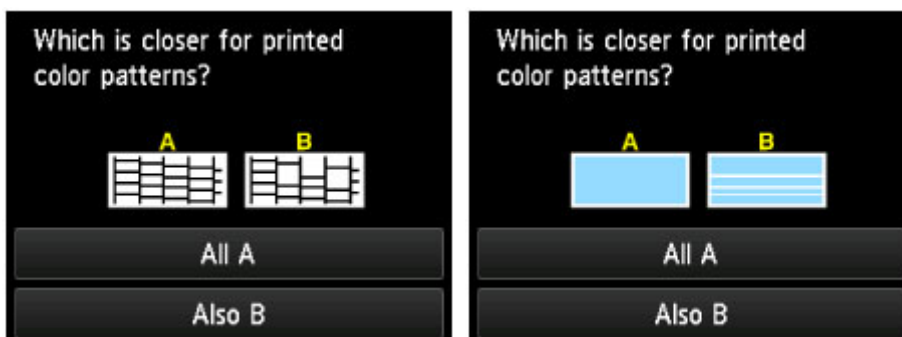

In the case of A (no missing lines or horizontal white streaks) in both patterns (C and D):

No cleaning is required. Tap **All A**, check the message, and then tap **OK**.

The **Maintenance** screen is now displayed again.

In the case of B (some missing lines or horizontal white streaks) in either pattern (C or D) or both patterns:

Cleaning is required. Tap **Also B**, and then tap **Yes** on the cleaning confirmation screen.

The machine now starts cleaning the print head.

■ [Cleaning the Print Head](#)

▶▶ Note

- On the nozzle check printout, the record of total pages printed is indicated in increments of 50 pages.

Cleaning the Print Head

Clean the print head if the nozzle check pattern has missing lines or horizontal white streaks. Cleaning unclogs nozzles and restores the print head to a better condition. However, because print head cleaning consumes ink, this operation is advisable only when necessary.

▶▶▶ Note

- Cleaning can also be performed from a computer. When using a computer, you can also select the ink group for cleaning.
 - [Cleaning the Print Heads](#) (Windows)
 - [Cleaning the Print Heads](#) (Mac OS)
- Cleaning from the operation panel cleans all print head colors.

What you will need: one sheet of A4 or Letter-sized plain paper

1. Make sure the machine is on.

2. Flick the HOME screen, and then tap  **Setup**.

■ [Using the Operation Panel](#)

The setup menu screen is displayed.

3. Tap  **Maintenance**.

The **Maintenance** screen is displayed.

4. Tap **Cleaning**.

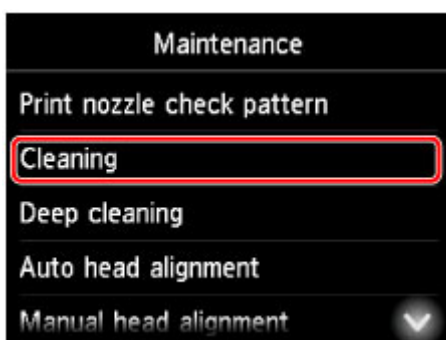

A confirmation screen is displayed.

5. Tap **Yes**.

The machine now starts cleaning the print head.

Do not perform any other operations until print head cleaning is finished. Cleaning will take about 2 minutes.

Afterward, a confirmation screen is displayed for printing a nozzle check pattern.

6. Load a sheet of A4 or Letter-sized plain paper in cassette 1.

▶▶▶ Important

- The screen for registering page size and media type is not displayed during any of the operations available in the **Maintenance** screen. Therefore, printing will be executed even if paper other than A4 or Letter-sized plain paper is loaded.
- Nozzle check patterns cannot be printed from cassette 2. Load paper in cassette 1.

7. Pull out the output tray extension and open the paper output support.

8. Tap **Yes**.

The nozzle check pattern is now printed.

9. [Examine the nozzle check pattern](#).

▶▶▶ Note

- If printing problems remain even after you clean the print head twice, [perform deep print head cleaning](#).

Deep Print Head Cleaning

If standard print head cleaning does not improve print quality, try deep print head cleaning. However, because deep print head cleaning consumes more ink, this operation is advisable only when necessary.

»» Note

- Deep print head cleaning can also be performed from a computer. When using a computer, you can also select the ink group for deep cleaning.
 - [Cleaning the Print Heads](#) (Windows)
 - [Cleaning the Print Heads](#) (Mac OS)
- Deep print head cleaning from the operation panel cleans all print head colors.

What you will need: one sheet of A4 or Letter-sized plain paper

1. Make sure the machine is on.

2. Flick the HOME screen, and then tap  **Setup**.

- [Using the Operation Panel](#)

The setup menu screen is displayed.

3. Tap  **Maintenance**.

The **Maintenance** screen is displayed.

4. Tap **Deep cleaning**.

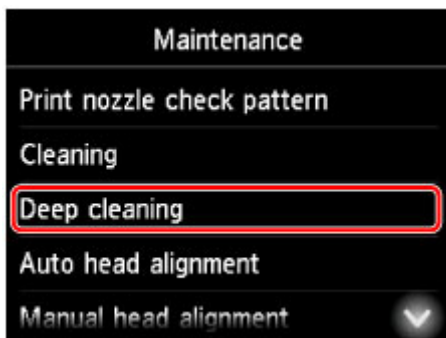

A confirmation screen is displayed.

5. Tap **Yes**.

Deep print head cleaning now begins.

Do not perform any other operations until deep print head cleaning is finished. Cleaning will take 2–3 minutes.

Afterward, a confirmation screen is displayed for printing a nozzle check pattern.

6. Load a sheet of A4 or Letter-sized plain paper in cassette 1.

»» Important

- The screen for registering page size and media type is not displayed during any of the operations available in the **Maintenance** screen. Therefore, printing will be executed even if paper other than A4 or Letter-sized plain paper is loaded.
- Nozzle check patterns cannot be printed from cassette 2. Load paper in cassette 1.

7. Pull out the output tray extension and open the paper output support.

8. Tap **Yes**.

The nozzle check pattern is now printed.

9. Tap **OK** when a message is displayed indicating that deep print head cleaning is finished.

10. [Examine the nozzle check pattern](#).

If printing problems remain, turn the machine off, wait at least 24 hours, and perform deep print head cleaning again. Leave the machine plugged in after you turn it off.

If the problem is still not resolved, the print head may be damaged. Contact the service center.

Aligning the Print Head

If printed images seem distorted, as when parallel lines are not printed parallel, align the print head.

▶▶▶ Note

- If ink runs out as the print head alignment sheet is printed, an error message appears on the touch screen.

■ [Message Appears](#)

What you will need: one sheet of A4 or Letter-sized plain paper (recycled paper is acceptable)*

* Use white paper that is clean on both sides.

1. Make sure the machine is on.

2. Flick the HOME screen, and then tap  **Setup**.

■ [Using the Operation Panel](#)

The setup menu screen is displayed.

3. Tap  **Maintenance**.

The **Maintenance** screen is displayed.

4. Tap **Auto head alignment**.

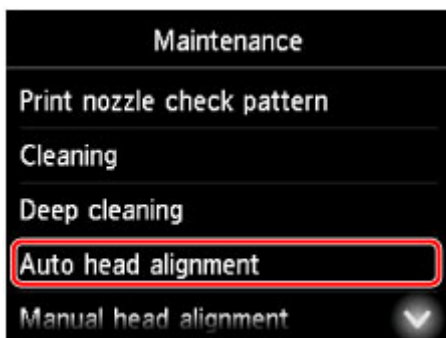

A confirmation screen is displayed.

5. Load a sheet of A4 or Letter-sized plain paper in cassette 1.

▶▶▶ Important

- The screen for registering page size and media type is not displayed during any of the operations available in the **Maintenance** screen. Therefore, printing will be executed even if paper other than A4 or Letter-sized plain paper is loaded.
- Print head alignment cannot be performed from cassette 2. Load paper in cassette 1.

6. Pull out the output tray extension and open the paper output support.

7. Tap **Yes**.

The print head alignment sheet is printed, and the print head is aligned automatically.

This process takes 3–4 minutes.

▶▶▶ Note

- If automatic print head alignment fails, an error message appears on the touch screen.

■ [Message Appears](#)

8. Tap **OK** when a message is displayed indicating that print head alignment is finished.

▶▶▶ Note

- If printing is still unsatisfactory after automatic print head alignment, [align the print head manually](#).

You can also align the print head manually from a computer.

■ [Aligning the Print Head Position Manually](#) (Windows)

■ [Aligning the Print Head Position Manually](#) (Mac OS)

Aligning the Print Head Manually

Try aligning the print head manually after automatic alignment if printing results are not as expected, as when parallel lines are not printed parallel.

»» Note

- For details on automatic print head alignment, see [Aligning the Print Head](#).

What you will need: two sheets of A4 or Letter-sized plain paper

1. Make sure the machine is on.

2. Flick the HOME screen, and then tap  **Setup**.

■ [Using the Operation Panel](#)

The setup menu screen is displayed.

3. Tap  **Maintenance**.

The **Maintenance** screen is displayed.

4. Tap **Manual head alignment**.

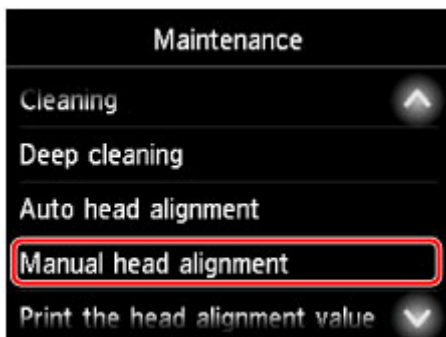

A confirmation screen is displayed.

»» Note

- To print and check the current head position alignment values, select **Print the head alignment value**.

5. Load two sheets of A4 or Letter-sized plain paper in cassette 1.

»» Important

- The screen for registering page size and media type is not displayed during any of the operations available in the **Maintenance** screen. Therefore, printing will be executed even if paper other than A4 or Letter-sized plain paper is loaded.
- Manual print head alignment cannot be performed from cassette 2. Load paper in cassette 1.

6. Pull out the output tray extension and open the paper output support.

7. Tap **Yes**.

The print head alignment pattern is printed.

8. Confirm that the pattern was printed correctly, and if so, tap **Yes** after "**Did the patterns print correctly?**" is displayed.

9. Check the message and tap **Next**.

The input screen for head position alignment values is displayed.

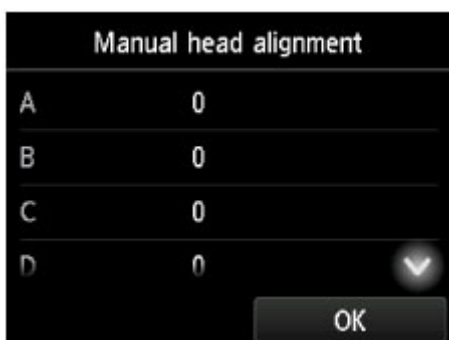

10. Examine the first patterns and tap **A**. In column A, find the pattern in which vertical streaks are least noticeable, and then tap the number of that pattern.

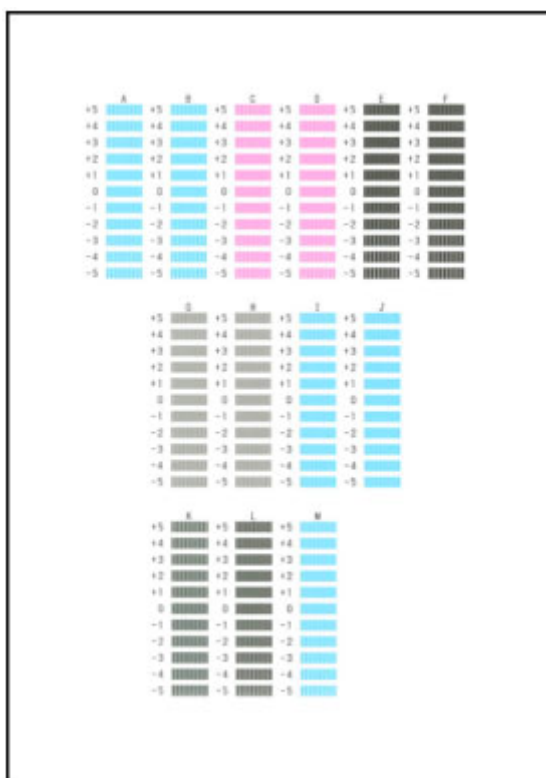

►►► **Note**

- If all patterns look different, choose the pattern in which vertical streaks are least noticeable.

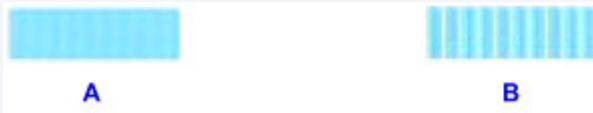

A: Subtle vertical streaks

B: Noticeable vertical streaks

11. Repeat these steps until you have finished entering pattern numbers for columns B to M, and then tap **OK**.

12. Check the message, and then tap **OK**.

The second set of patterns is printed.

13. Examine the second patterns and tap **N**. In column N, find the pattern in which horizontal streaks are least noticeable, and then tap the number of that pattern.

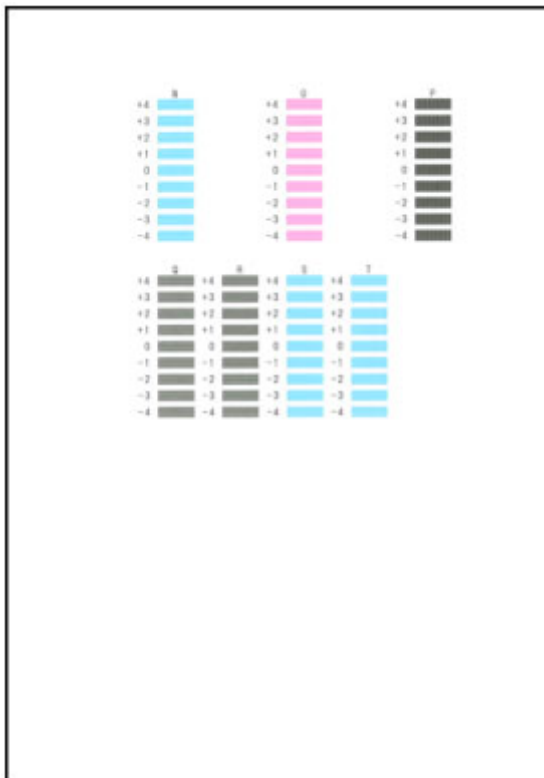

►►► **Note**

- If all patterns look different, choose the pattern in which horizontal streaks are least noticeable.

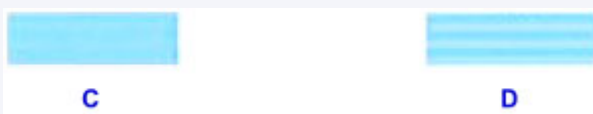

C: Subtle horizontal streaks

14. Repeat these steps until you have finished entering pattern numbers for columns O to T, and then tap **OK**.

For column P, choose the pattern in which vertical streaks are least noticeable.

15. Tap **OK** when a message is displayed indicating that print head alignment is finished.

Performing Maintenance Functions from Your Computer (Windows)

- ▶ **Cleaning the Print Heads**
- ▶ **Aligning the Print Head Position**
- ▶ **Printing a Nozzle Check Pattern**

Cleaning the Print Heads

The print head cleaning function allows you to clear up clogged print head nozzle. Perform print head cleaning if printing is faint or a specific color fails to print, even though there is enough ink.

The procedure for cleaning the print head is as follows:



Cleaning

1. Open the [printer driver setup window](#)

2. Click **Cleaning** on the **Maintenance** tab

When the **Print Head Cleaning** dialog box opens, select the ink group for which cleaning is to be performed.

Click **Initial Check Items** to display the items you need to check before performing cleaning.

3. Execute cleaning

Make sure that the printer is on and then click **Execute**.

Print head cleaning starts.

4. Complete cleaning

The **Nozzle Check** dialog box opens after the confirmation message.

5. Check the results

To check whether the print quality has improved, click **Print Check Pattern**. To cancel the check process, click **Cancel**.

If cleaning the head once does not resolve the print head problem, clean it once more.

▶▶▶ Important

- **Cleaning** consumes a small amount of ink.
Cleaning the print head frequently will rapidly deplete your printer's ink supply. Consequently, perform cleaning only when necessary.



Deep Cleaning

Deep Cleaning is more thorough than cleaning. Perform deep cleaning when two **Cleaning** attempts do not resolve the print head problem.

1. Open the [printer driver setup window](#)

2. Click **Deep Cleaning** on the **Maintenance** tab

When the **Deep Cleaning** dialog box opens, select the ink group for which deep cleaning is to be performed.

Click **Initial Check Items** to display the items you need to check before performing deep cleaning.

3. Execute deep cleaning

Make sure that the printer is on and then click **Execute**.

Click **OK** when the confirmation message appears.

Print head deep cleaning starts.

4. Complete deep cleaning

The **Nozzle Check** dialog box opens after the confirmation message.

5. Check the results

To check whether the print quality has improved, click **Print Check Pattern**. To cancel the check process, click **Cancel**.

Important

- **Deep Cleaning** consumes a larger amount of ink than **Cleaning**.
Cleaning the print head frequently will rapidly deplete your printer's ink supply. Consequently, perform cleaning only when necessary.

Note

- If there is no sign of improvement after **Deep Cleaning**, turn off the printer, wait 24 hours, and then perform **Deep Cleaning** again. If there is still no sign of improvement, the ink may have run out or the print head may be worn. For details on the remedial action to be taken, see "No Ink Comes Out."

Related Topic

- [Printing a Nozzle Check Pattern](#)

Aligning the Print Head Position

Print head alignment corrects the installation positions of the print head and improves deviated colors and lines.

This printer supports two head alignment methods: automatic head alignment and manual head alignment. Normally, the printer is set for automatic head alignment.

If the printing results of automatic print head alignment are not satisfactory, [perform manual head alignment](#).

The procedure for performing automatic print head alignment is as follows:

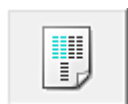

Print Head Alignment

1. Open the [printer driver setup window](#)
2. Click **Print Head Alignment** on the **Maintenance** tab

The **Start Print Head Alignment** dialog box opens.

3. Load paper in the printer

Load one sheet of A4 size or Letter size plain paper into the cassette 1.

▶▶▶ Important

- The cassette 2 is not available for the print head alignment procedure. Be sure to load paper in the cassette 1.

▶▶▶ Note

- The number of sheets to be used differs when you select the manual head alignment.

4. Execute head alignment

Make sure that the printer is on and click **Align Print Head**.

Follow the instruction in the message.

▶▶▶ Important

- Do not open the front cover while printing is in progress.

▶▶▶ Note

- Wait until printing ends before performing other operations. Printing takes about 3 to 4 minutes to complete.

▶▶▶ Note

- To print and check the current setting, open the **Start Print Head Alignment** dialog box, and click **Print Alignment Value**.

Aligning the Print Head Position Manually

Print head alignment corrects the installation positions of the print head and improves deviated colors and lines.

This printer supports two head alignment methods: [automatic head alignment](#) and manual head alignment. Normally, the printer is set for automatic head alignment.

If the printing results of automatic print head alignment are not satisfactory, perform manual head alignment.

The procedure for performing manual print head alignment is as follows:



Print Head Alignment

1. Open the [printer driver setup window](#)
2. Click **Custom Settings** on the **Maintenance** tab

The **Custom Settings** dialog box opens.

▶▶▶ Note

- If the printer is off or if communication between the printer and the computer is disabled, an error message may appear because the computer cannot collect the printer status. If this happens, click **OK** to display the most recent settings specified on your computer.

3. Switch head alignment to manual
4. Apply the settings
5. Click **Print Head Alignment** on the **Maintenance** tab

Check the **Align heads manually** check box.

Click **OK** and when the confirmation message appears, click **OK**.

The **Start Print Head Alignment** dialog box opens.

6. Load paper in the printer
- Load two sheets of A4 size or Letter size plain paper into the cassette 1.

▶▶▶ Important

- The cassette 2 is not available for the print head alignment procedure. Be sure to load paper in the cassette 1.

7. Execute head alignment

Make sure that the printer is on and click **Align Print Head**.

Follow the instruction in the message.

Important

- Do not open the front cover while printing is in progress.

8. Check the printed pattern

Enter the numbers of the patterns with the least noticeable streaks in the associated boxes.

Even if the patterns with the least noticeable streaks are clicked in the preview window, their numbers are automatically entered in the associated boxes.

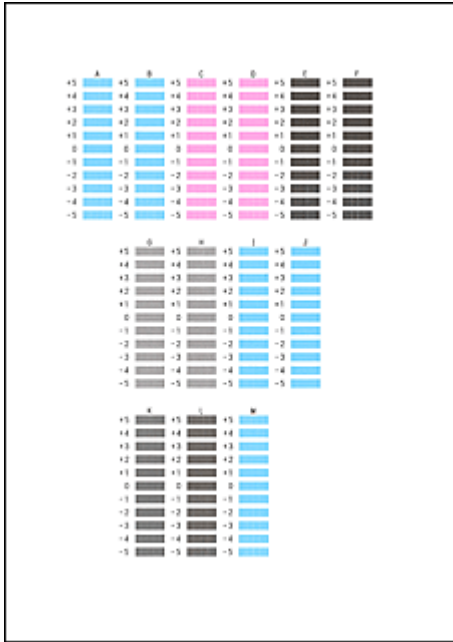

When you have entered all the necessary values, click **OK**.

Note

- If it is difficult to pick the best pattern, pick the setting that produces the least noticeable vertical streaks.



(A)



(B)

(A) Least noticeable vertical streaks

(B) Most noticeable vertical streaks

9. Confirm the displayed message and click **OK**

The second pattern is printed.

Important

- Do not open the front cover while printing is in progress.

10. Check the printed pattern

Enter the numbers of the patterns with the least noticeable stripes or streaks in the associated boxes. Even if the patterns with the least noticeable stripes or streaks are clicked in the preview window, their numbers are automatically entered in the associated boxes.

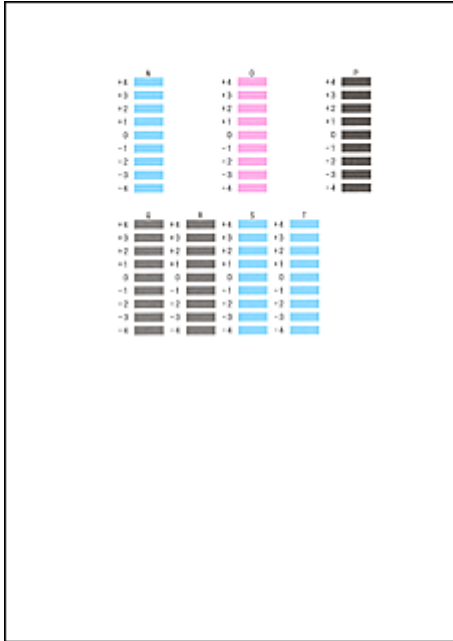

When you have entered all the necessary values, click **OK**.

▶▶▶ Note

- If it is difficult to pick the best pattern, pick the setting that produces the least noticeable horizontal stripes.



(A)



(B)

(A) Least noticeable horizontal stripes

(B) Most noticeable horizontal stripes

- If it is difficult to pick the best pattern, pick the setting that produces the least noticeable vertical streaks.



(A)



(B)

(A) Least noticeable vertical streaks

(B) Most noticeable vertical streaks

▶▶▶ Note

- To print and check the current setting, open the **Start Print Head Alignment** dialog box, and click **Print Alignment Value**.

Printing a Nozzle Check Pattern

The nozzle check function allows you to check whether the print head is working properly by printing a nozzle check pattern. Print the pattern if printing becomes faint, or if a specific color fails to print.

The procedure for printing a nozzle check pattern is as follows:



Nozzle Check

1. Open the [printer driver setup window](#)
2. Click **Nozzle Check** on the **Maintenance** tab

The **Nozzle Check** dialog box opens.

Click **Initial Check Items** to display the items that you need to check before printing the nozzle check pattern.

3. Load paper in the printer

Load one sheet of A4 size or Letter size plain paper into the cassette 1.

▶▶ Important

- The cassette 2 is not available for the nozzle check pattern printing. Be sure to load paper in the cassette 1.

4. Print a nozzle check pattern

Make sure that the printer is on and click **Print Check Pattern**.

Printing of the nozzle check pattern begins.

Click **OK** when the confirmation message appears.

The **Pattern Check** dialog box opens.

5. Check the print result

Check the print result. If the print result is normal, click **Exit**.

If the print result is smudged or if there are any unprinted sections, click **Cleaning** to clean the print head.

Related Topic

- [Cleaning the Print Heads](#)

Cleaning

- ▶ **Cleaning Exterior Surfaces**
- ▶ **Cleaning the Platen Glass and Document Cover**
- ▶ **Cleaning the ADF (Auto Document Feeder)**
- ▶ **Cleaning Paper Feed Rollers**
- ▶ **Cleaning Inside the Machine (Bottom Plate Cleaning)**
- ▶ **Cleaning Cassette Pads**

Cleaning Exterior Surfaces

Using a soft, dry cloth such as an eyeglass cloth, gently wipe the surfaces clean. Smooth out any wrinkles in the cloth before you begin.

»» Important

- Before cleaning the machine, turn it off and unplug it.
 - The power cannot be turned off while the machine is sending or receiving a fax, or when unsent faxes are stored in the machine's memory. Make sure the machine has finished sending or receiving faxes before turning it off.
 - Remember that faxes cannot be sent or received while the machine is off.
 - Unplugging the machine will erase all documents in the machine's memory. Send faxes, print documents, or save jobs to a USB flash drive as needed before unplugging the machine.
- To avoid scratching surfaces, do not clean with tissue paper, paper towels, or rough-textured cloth. Additionally, paper dust or fibers may remain in the machine and clog the print head or affect printing quality.
- Never clean the machine with detergent or volatile chemicals such as thinner, benzine, or acetone, which may cause malfunction or damage surfaces.
- When cleaning the touch screen, use a soft cloth such as an eyeglass cloth to wipe the surface. Do not press down too firmly. Never wipe the touch screen with cleaners containing organic solvents.

Cleaning the Platen Glass and Document Cover

►► Important

- Before cleaning the machine, turn it off and unplug it.
 - The power cannot be turned off while the machine is sending or receiving a fax, or when unsent faxes are stored in the machine's memory. Make sure the machine has finished sending or receiving faxes before turning it off.
 - Remember that faxes cannot be sent or received while the machine is off.
 - Unplugging the machine will erase all documents in the machine's memory. Send faxes, print documents, or save jobs to a USB flash drive as needed before unplugging the machine.
- To avoid scratching surfaces, do not clean with tissue paper, paper towels, or rough-textured cloth. Additionally, paper dust or fibers may remain in the machine and clog the print head or affect printing quality.
- Never clean the machine with detergent or volatile chemicals such as thinner, benzene, or acetone, which may cause malfunction or damage surfaces.

Use a soft, dry cloth that is clean and lint-free.

Wipe away any smudges or dust on the glass surfaces of the platen glass and bottom of the document cover (A, B, and C), and on the white parts that come into contact with these surfaces (D, E, and F).

Wipe the glass surfaces carefully, leaving no residue.

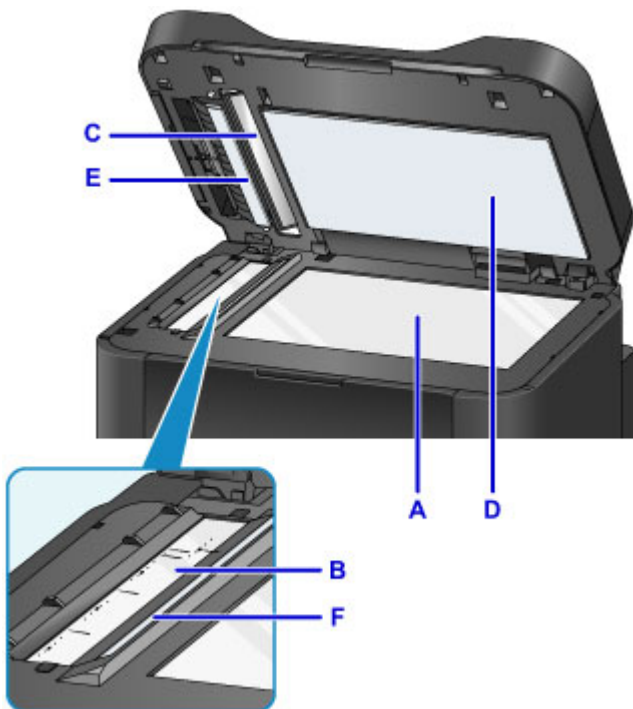

►► Important

- Be especially gentle when wiping the bottom of the document cover (D, in white).
- Any glue, ink, correction fluid, or other substances on the ADF glass (B and C) may cause black streaks in scanned images. Gently wipe away any of these substances on the glass.

Cleaning the ADF (Auto Document Feeder)

Use a soft, dry cloth that is clean and lint-free to clean the ADF (Auto Document Feeder).

▶▶▶ Important

- Before cleaning the machine, turn it off and unplug it.
 - The power cannot be turned off while the machine is sending or receiving a fax, or when unsent faxes are stored in the machine's memory. Make sure the machine has finished sending or receiving faxes before turning it off.
 - Remember that faxes cannot be sent or received while the machine is off.
 - Unplugging the machine will erase all documents in the machine's memory. Send faxes, print documents, or save jobs to a USB flash drive as needed before unplugging the machine.
- To avoid scratching surfaces, do not clean with tissue paper, paper towels, or rough-textured cloth. Additionally, paper dust or fibers may remain in the machine and clog the print head or affect printing quality.
- Never clean the machine with detergent or volatile chemicals such as thinner, benzene, or acetone, which may cause malfunction or damage surfaces.

1. Open the document tray.



2. Open the document feeder cover.



3. Use the cloth to wipe off any paper dust inside the document feeder cover (A).

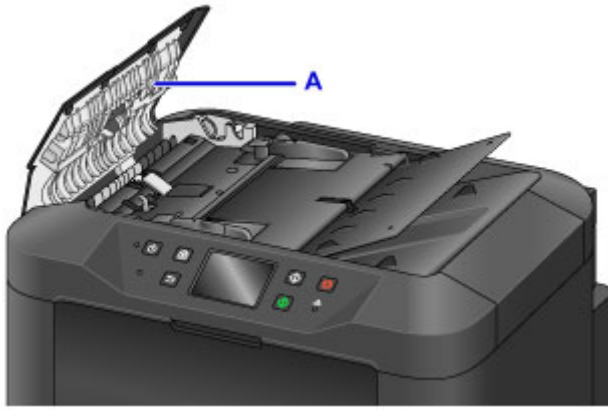

4. When finished, push the document feeder cover closed until it clicks into place.
5. Close the document tray.

Cleaning Paper Feed Rollers

Dusty or dirty paper feed rollers may prevent correct feeding.

In this case, clean the paper feed rollers. However, because cleaning causes roller wear, perform cleaning only when necessary.

What you will need: three sheets of A4 or Letter-sized plain paper

1. Make sure the machine is on.

2. Flick the HOME screen, and then tap  **Setup**.

 [Using the Operation Panel](#)

The setup menu screen is displayed.

3. Tap  **Maintenance**.

The **Maintenance** screen is displayed.

4. Tap **Roller cleaning**.

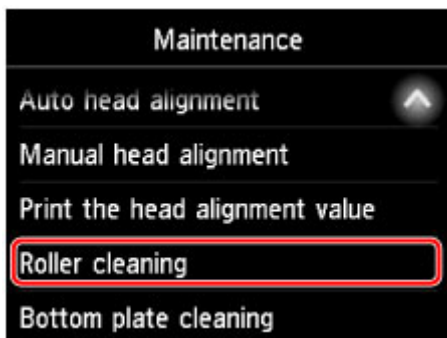

A confirmation screen is displayed.

5. Tap **Yes**.
6. Tap the paper source to clean (**Cassette 1** or **Cassette 2**).
7. Follow the instructions to remove any paper from the paper source selected in step 6.
8. Tap **OK**.

The paper feed rollers rotate as they are cleaned without paper.

9. After confirming that the paper feed rollers have stopped rotating, follow the instructions to load three sheets of A4 or Letter-sized plain paper in the paper source selected in step 6.

Important

- The screen for registering page size and media type is not displayed during any of the operations available in the **Maintenance** screen. Therefore, printing will be executed even if paper other than A4 or Letter-sized plain paper is loaded.

10. Pull out the output tray extension and open the paper output support.

11. Tap **OK**.

Cleaning begins again. Once the paper is ejected, cleaning is finished.

12. Tap **OK** when a message is displayed indicating that cleaning is finished.

If the problem remains after you clean the paper feed rollers, contact the service center.

Cleaning Inside the Machine (Bottom Plate Cleaning)

Remove stains inside the machine as follows. Clean this way regularly, because any dust or excess ink in the machine may get on your printouts.

What you will need: one sheet of A4 or Letter-sized plain paper*

* Use a new sheet of paper.

1. Make sure the machine is on.

2. Flick the HOME screen, and then tap  **Setup**.

 [Using the Operation Panel](#)

The setup menu screen is displayed.

3. Tap  **Maintenance**.

The **Maintenance** screen is displayed.

4. Tap **Bottom plate cleaning**.

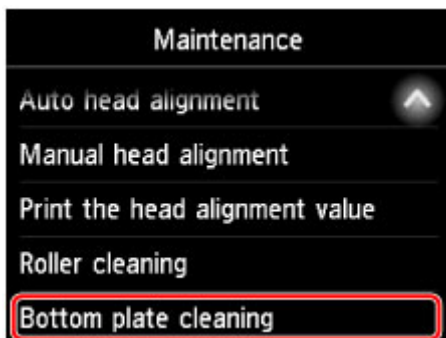

A confirmation screen is displayed.

5. Tap **Yes**.

6. Follow the instructions to remove any paper from cassette 1, and then tap **OK**.

7. Fold a single sheet of A4 or Letter-sized plain paper in half widthwise, and then unfold it.

8. Fold one side in half again, aligning the edge of the sheet with the center crease. Unfold the paper and tap **OK**.

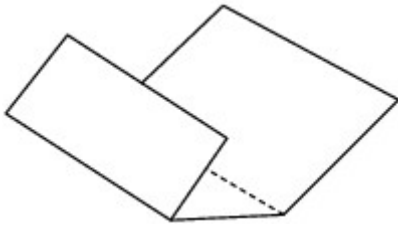

9. Load only this sheet in cassette 1, with the ridges of the creases facing up and the edge of the uncreased half facing away from you.

Important

- The screen for registering page size and media type is not displayed during any of the operations available in the **Maintenance** screen. Therefore, printing will be executed even if paper other than A4 or Letter-sized plain paper is loaded.
- Bottom Plate Cleaning cannot be performed from cassette 2. Load paper in cassette 1.



10. Pull out the output tray extension and open the paper output support.

11. Tap **OK**.

The paper now cleans inside the machine as it passes through.

Check the ridges of the ejected paper. If they are smudged with ink, perform Bottom Plate Cleaning again.

12. Tap **OK** when a message is displayed indicating that cleaning is finished.

Note

- When repeating Bottom Plate Cleaning, use a new sheet of paper.

If the problem remains after repeated cleaning, protrusions inside the machine may be stained. Carefully wipe off any ink on the protrusions using a cotton swab or the like.

»» Important

- Before cleaning the machine, turn it off and unplug it.
 - The power cannot be turned off while the machine is sending or receiving a fax, or when unsent faxes are stored in the machine's memory. Make sure the machine has finished sending or receiving faxes before turning it off.
 - Remember that faxes cannot be sent or received while the machine is off.
 - Unplugging the machine will erase all documents in the machine's memory. Send faxes, print documents, or save jobs to a USB flash drive as needed before unplugging the machine.



Cleaning Cassette Pads

If the pad in a cassette becomes dirty or covered with paper dust, multiple sheets of paper may be ejected at once. Clean cassette pads as follows.

What you will need: cotton swab

1. Pull out cassette 1 or cassette 2 and remove the paper.
2. Use a moistened cotton swab to wipe away any dirt or debris on the pad (A).

▶▶▶ Important

- After cleaning, allow the pad to dry completely.

Example of cleaning cassette 1:

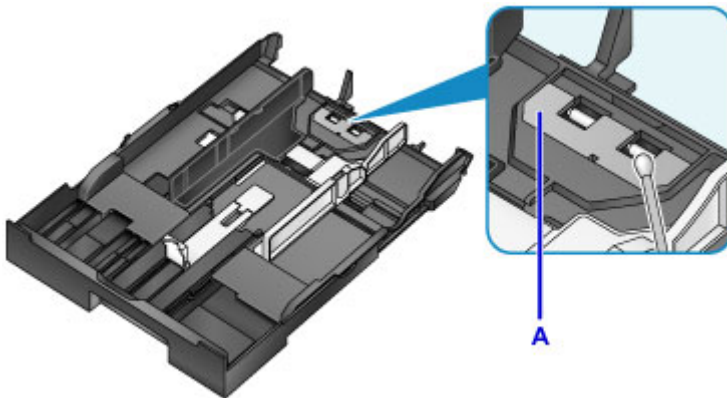

3. Reload the paper and insert the cassette.

▶▶▶ Note

- If a message appears after you insert the cassette, tap **Register**.

If the problem is not resolved, contact the service center.

Overview

▶ **Safety**

- Safety Precautions
- Regulatory Information
- WEEE (EU & EEA)

▶ **Main Components and Their Use**

- Main Components
- Power Supply
- Using the Operation Panel
- Entering Numbers, Letters, and Symbols

▶ **Changing Settings**

- Changing Printer Settings from Your Computer (Windows)
- Changing Printer Settings from Your Computer (Mac OS)
- Changing Settings from Operation Panel
- Changing Printer's Setting Using Web Browser

▶ **Network Connection**

- Network Connection Tips

▶ **Network Settings (IJ Network Device Setup Utility) (Windows)**

- IJ Network Device Setup Utility
- Starting Up IJ Network Device Setup Utility
- IJ Network Device Setup Utility Screen
- Performing Network Settings
- Checking Network Status
- IJ Network Device Setup Utility Menus
- Other Network Information

▶ **Network Communication (Mac OS)**

- Checking and Changing Network Settings

- Network Communication Tips

▶ **Ensuring Optimal Printing Results**

- Ink Tips
- Printing Tips
- Check Paper Settings Before Printing
- Set Cassette Paper Information After Loading Paper
- Canceling Print Jobs
- Keeping Print Quality High
- Transporting Your Machine

▶ **Legal Restrictions on Scanning/Copying**

▶ **Specifications**

Safety

- ▶ **Safety Precautions**
- ▶ **Regulatory Information**
- ▶ **WEEE (EU&EEA)**

Safety Precautions

Choosing a location

- Do not install the printer in a location that is unstable or subject to excessive vibration.
- Do not install the printer in locations that are very humid or dusty, in direct sunlight, outdoors, or close to a heating source.

To avoid the risk of fire or electric shocks, use the printer under the operating environment specified in the [Specifications](#).

- Do not place the printer on a thick rug or carpet.
- Place the printer with its back in a location that is more than 2 inches (5 cm) away from the wall.

Power Supply

- Ensure that the area around the power outlet is kept clear at all times so you can easily unplug the power cord if necessary.
- Never remove the plug by pulling on the cord.
Pulling the cord may damage the power cord, leading to possible fire or electrical shock.
- Do not use an extension lead/cord.

Working Around the Printer

- Never put your hands or fingers in the printer while it is printing.
- When moving the printer, carry the printer at both ends. In case the printer weighs more than 14 kg, it is recommended to have two people lifting the printer. Accidental dropping of the printer causes injury. For the printer's weight, refer to the [Specifications](#).
- Do not place any object on the printer. Especially do not place metal objects (paper clips, staples, etc.) or containers of flammable solvents (alcohol, thinners, etc.) on top of the printer.
- Do not transport or use the printer on a slant, vertically or upside-down, as the ink may leak and damage the printer.
- When loading a thick book on the Platen Glass, do not press hard on the Document Cover. The Platen Glass may break and cause injury.

Print Heads/Ink Tanks/FINE Cartridges

- Keep ink tanks out of the reach of children. In case ink is accidentally licked or swallowed, rinse out mouth or give one or two glasses of water to drink. If irritation or discomfort occurs, obtain medical advice immediately.
- In case ink gets in contact with eyes, rinse with water immediately. In case ink gets in contact with skin, wash with soap and water immediately. If irritation to eyes or skin persists, obtain medical advice immediately.
- Never touch the electrical contacts on a print head or FINE cartridges after printing.
The metal parts may be very hot and could cause burns.
- Do not throw ink tanks and FINE cartridges into fire.
- Do not attempt to disassemble or modify the print head, ink tanks, and FINE cartridges.

Regulatory Information

Lithium Battery

- Dispose of used batteries according to the local regulations.
- Risk of explosion if battery is replaced by an incorrect type.

IMPORTANT SAFETY INSTRUCTIONS

SAVE THESE INSTRUCTIONS

When using your telephone equipment, basic safety precautions should always be followed to reduce the risk of fire, electric shock and injury to persons, including the following:

1. Do not use this product near water, for example, near a bath tub, wash bowl, kitchen sink or laundry tub, in a wet basement or near a swimming pool.
2. Avoid using this product during an electrical storm. There may be a remote risk of electric shock from lightning.
3. Do not use this product to report a gas leak in the vicinity of the leak.

"CAUTION - To reduce the risk of fire, use only No. 26 AWG or larger telecommunication line cord."

IMPORTANTES MESURES DE SÉCURITÉ

CONSERVER CES INSTRUCTIONS

Certaines mesures de sécurité doivent être prises pendant l'utilisation de matériel téléphonique afin de réduire les risques d'incendie, de choc électrique et de blessures.

En voici quelquesunes :

1. Ne pas utiliser l'appareil près de l'eau, p.ex., près d'une baignoire, d'un lavabo, d'un évier de cuisine, d'un bac à laver, dans un sous-sol humide ou près d'une piscine.
2. Éviter d'utiliser l'appareil pendant un orage électrique. Ceci peut présenter un risque de choc électrique causé par la foudre.
3. Ne pas utiliser l'appareil pour signaler une fuite de gaz s'il est situé près de la fuite.

"ATTENTION - Pour réduire les risques d'incendie, utiliser uniquement des conducteurs de télécommunications 26 AWG au de section supérieure."

Users in the U.S.A.

FCC Notice (U.S.A. Only)

For 120V, 60Hz model

Model Number: K10437 (Contains FCC Approved WLAN Module K30365)

This device complies with Part 15 of the FCC Rules. Operation is subject to the following two conditions:

(1) This device may not cause harmful interference, and (2) this device must accept any interference received, including interference that may cause undesired operation.

Note: This equipment has been tested and found to comply with the limits for a Class B digital device, pursuant to Part 15 of the FCC Rules. These limits are designed to provide reasonable protection against harmful interference in a residential installation. This equipment generates, uses and can radiate radio frequency energy and, if not installed and used in accordance with the instructions, may cause harmful

interference to radio communications.

However, there is no guarantee that interference will not occur in a particular installation. If this equipment does cause harmful interference to radio or television reception, which can be determined by turning the equipment off and on, the user is encouraged to try to correct the interference by one or more of the following measures:

- Reorient or relocate the receiving antenna.
- Increase the separation between the equipment and receiver.
- Connect the equipment into an outlet on a circuit different from that to which the receiver is connected.
- Consult the dealer or an experienced radio/TV technician for help.

Use of a shielded cable is required to comply with Class B limits in Subpart B of Part 15 of the FCC Rules.

Do not make any changes or modifications to the equipment unless otherwise specified in the manual. If such changes or modifications should be made, you could be required to stop operation of the equipment.

FCC ID:AZDK30365

Changes or modifications not expressly approved by the party responsible for compliance could void the user's authority to operate equipment.

This transmitter must not be co-located or operating in conjunction with any other antenna or transmitter.

The equipment complies with FCC radiation exposure limits for at uncontrolled equipment. This equipment should be installed and operated with minimum distance at least 20cm between the radiator and persons body (excluding extremities: hands, wrists, feet and ankles) and must not be colocated or operated with any other antenna or transmitter.

Canon U.S.A., Inc.
One Canon Park
Melville, New York 11747
1-800-652-2666

Pre-Installation Requirements

Order Information

When ordering service from the telephone company for this equipment, the following may be required.

Universal Service Order Code (USOC): RJ11C

The Facility Interface Code (FIC): 02LS2

Service Order Code (SOC): 9.0F

Connection of the Equipment

This equipment complies with Part 68 of the FCC rules and the requirements adopted by the ACTA.

A label on this equipment contains, among other information, a product identifier in the format US:AAAEQ##TXXXX. If requested, this number must be provided to the telephone company.

The REN is used to determine the number of devices that may be connected to a telephone line.

Excessive RENs on a telephone line may result in the devices not ringing in response to an incoming call. In most but not all areas, the sum of RENs should not exceed five (5.0). To be certain of the number of

devices that may be connected to a line, as determined by the total RENs, contact the local telephone company. The REN for this product is part of the product identifier that has the format US:AAAEQ##TXXXX. The digits represented by ## are the REN without a decimal point (e.g., 03 is a REN of 0.3).

A plug and jack used to connect this equipment to the premises wiring and telephone network must comply with the applicable FCC Part 68 rules and requirements adopted by the ACTA. A compliant telephone cord and modular plug is provided with this product. It is designed to be connected to a compatible modular jack that is also compliant. See installation instructions for details.

Connection to party lines is subjected to state tariffs. Contact the state public utility commission, public service commission or corporation commission for information.

If your home has specially wired alarm equipment connected to the telephone line, ensure the installation of this equipment does not disable your alarm equipment. If you have questions about what will disable alarm equipment, consult your telephone company or a qualified installer.

In Case of Equipment Malfunction

Should any malfunction occur which cannot be corrected by the procedures described in the Online Manual, disconnect the equipment from the telephone line cable, turn off the power and disconnect the power cord. The telephone line cable should not be reconnected or the main power switch turned ON until the problem is completely resolved. Users should contact their local authorized Canon Facsimile Service Dealer for the servicing of equipment.

Information regarding Authorized Service Facility locations can be obtained by calling the Canon Customer Center.

Rights of the Telephone Company

If this equipment causes harm to the telephone network, the telephone company may temporarily disconnect service. The telephone company also retains the right to make changes in facilities and services that may affect the operation of this equipment. When such changes are necessary, the telephone company is required to give adequate prior notice to the user. However, if advance notice is not possible, the telephone company will notify the customer as soon as possible. Also, the customer will be advised of his/her right to file a complaint with the FCC if he/she believes it is necessary.

Warning

The Telephone Consumer Protection Act of 1991 makes it unlawful for any person to use a computer or other electronic device to send any message via a telephone FAX machine unless such message clearly contains in a margin at the top or bottom of each transmitted page, or on the first page of the transmission, the date and time it is sent and an identification of the business or other entity, or other individual sending the message and the telephone number of the sending machine or such business, other entity, or individual.

In order to program this information into your FAX machine, you should complete the procedure to register your name, unit's telephone number, time, and date. Refer to the Online Manual.

Users in Canada

This device complies with Industry Canada license-exempt RSS standard(s). Operation is subject to the following two conditions:

(1) this device may not cause interference, and (2) this device must accept any interference, including interference that may cause undesired operation of the device.

This equipment complies with IC radiation exposure limits set forth for an uncontrolled environment and meets RSS-102 of the IC radio frequency (RF) Exposure rules. This equipment should be installed and operated keeping the radiator at least 20cm or more away from person's body (excluding extremities: hands, wrists, feet and ankles).

Pre-Installation Requirements

Notice

This product meets the applicable Innovation, Science and Economic Development Canada technical specifications.

The Ringer Equivalence Number is an indication of the maximum number of devices allowed to be connected to a telephone interface. The termination on an interface may consist of any combination of devices subject only to the requirement that the sum of the RENs of all the devices does not exceed five.

Pour les usagers résidant au Canada

Le présent appareil est conforme aux CNR d'Industrie Canada applicables aux appareils radio exempts de licence. L'exploitation est autorisée aux deux conditions suivantes :

(1) l'appareil ne doit pas produire de brouillage, et (2) l'utilisateur de l'appareil doit accepter tout brouillage radioélectrique subi, même si le brouillage est susceptible d'en compromettre le fonctionnement.

Cet équipement est conforme aux limites d'exposition aux rayonnements énoncées pour un environnement non contrôlé et respecte les règles d'exposition aux fréquences radioélectriques (RF) CNR-102 de l'IC. Cet équipement doit être installé et utilisé en gardant une distance de 20 cm ou plus entre le dispositif rayonnant et le corps (à l'exception des extrémités : mains, poignets, pieds et chevilles).

Conditions de pré-installation

Avis

Le présent produit est conforme aux spécifications techniques applicables d'Innovation, Sciences et Développement économique Canada.

L'indice d'équivalence de la sonnerie (IES) sert à indiquer le nombre maximal de terminaux qui peuvent être raccordés à une interface téléphonique. La terminaison d'une interface peut consister en une combinaison quelconque de dispositifs, à la seule condition que la somme d'indices d'équivalence de la sonnerie de tous les dispositifs n'excède pas 5.

Users in New Zealand

The grant of a Telepermit for any item of terminal equipment indicates only that Spark has accepted that the item complies with minimum conditions for connection to its network. It indicates no endorsement of

the product by Spark, nor does it provide any sort of warranty. Above all, it provides no assurance that any item will work correctly in all respects with another item of Telepermitted equipment of a different make or model, nor does it imply that any product is compatible with all of Spark's network services.

This equipment is not capable, under all operating conditions, of correct operation at the higher speeds for which it is designed. Spark will accept no responsibility should difficulties arise in such circumstances.

This condition typically applies to 56 kbit/s modems and V34 facsimile machines.

Please note when you connect an extension phone to this device, if you use an extension phone which has features such as "last number redial", redial memory numbers may be lost.

The automatic calling functions of this equipment must not be used to a nuisance to other Spark customers.

Telepermitted equipment only may be connected to the telephone port. The telephone port is not specifically designed for 3-wire connected equipment. 3-wire connected equipment might not respond to incoming ringing when attached to this port.

Environmental Information

Reducing your environmental impact

Power Consumption and Operational Modes

The amount of electricity a device consumes depends on the way the device is used. This product is designed and set in a way to allow you to reduce the power consumption. After the last print it switches to Ready Mode. In this mode it can print again immediately if required. If the product is not used for a time, the device switches to its Sleep Mode. The devices consume less power (Watt) in these modes.

Energy Star®

The Energy Star® programme is a voluntary scheme to promote the development and purchase of energy efficient models, which help to minimise environmental impact.

Products which meet the stringent requirements of the Energy Star® programme for both environmental benefits and the amount of energy consumption will carry the Energy Star® logo accordingly.

Paper types

This product can be used to print on both recycled and virgin paper (certified to an environmental stewardship scheme), which complies with EN12281 or a similar quality standard. In addition it can support printing on media down to a weight of 64g/m², lighter paper means less resources used and a lower environmental footprint for your printing needs.



WEEE (EU&EEA)

Only for European Union and EEA (Norway, Iceland and Liechtenstein)



These symbols indicate that this product is not to be disposed of with your household waste, according to the WEEE Directive (2012/19/EU), the Battery Directive (2006/66/EC) and/or national legislation implementing those Directives. If a chemical symbol is printed beneath the symbol shown above, in accordance with the Battery Directive, this indicates that a heavy metal (Hg = Mercury, Cd = Cadmium, Pb = Lead) is present in this battery or accumulator at a concentration above an applicable threshold specified in the Battery Directive. This product should be handed over to a designated collection point, e.g., on an authorized one-for-one basis when you buy a new similar product or to an authorized collection site for recycling waste electrical and electronic equipment (EEE) and batteries and accumulators. Improper handling of this type of waste could have a possible impact on the environment and human health due to potentially hazardous substances that are generally associated with EEE. Your cooperation in the correct disposal of this product will contribute to the effective usage of natural resources. For more information about the recycling of this product, please contact your local city office, waste authority, approved scheme or your household waste disposal service or visit www.canon-europe.com/weee, or www.canon-europe.com/battery.

Nur für Europäische Union und EWR (Norwegen, Island und Liechtenstein)



Diese Symbole weisen darauf hin, dass dieses Produkt gemäß WEEE-Richtlinie (2012/19/EU; Richtlinie über Elektro- und Elektronik-Altgeräte), Batterien-Richtlinie (2006/66/EG) und nationalen Gesetzen zur Umsetzung dieser Richtlinien nicht über den Hausmüll entsorgt werden darf. Falls sich unter dem oben abgebildeten Symbol ein chemisches Symbol befindet, bedeutet dies gemäß der Batterien-Richtlinie, dass in dieser Batterie oder diesem Akkumulator ein Schwermetall (Hg = Quecksilber, Cd = Cadmium, Pb = Blei) in einer Konzentration vorhanden ist, die über einem in der Batterien-Richtlinie angegebenen Grenzwert liegt. Dieses Produkt muss bei einer dafür vorgesehenen Sammelstelle abgegeben werden. Dies kann z. B. durch Rückgabe beim Kauf eines neuen ähnlichen Produkts oder durch Abgabe bei einer autorisierten Sammelstelle für die Wiederaufbereitung von Elektro- und Elektronik-Altgeräten sowie Batterien und Akkumulatoren geschehen. Der unsachgemäße Umgang mit Altgeräten kann aufgrund potenziell gefährlicher Stoffe, die generell mit Elektro- und Elektronik-Altgeräten in Verbindung stehen, negative Auswirkungen auf die Umwelt und die menschliche Gesundheit haben. Durch Ihre Mitarbeit bei der umweltgerechten Entsorgung dieses Produkts tragen Sie zu einer effektiven Nutzung natürlicher Ressourcen bei. Um weitere Informationen über die Wiederverwertung dieses Produkts zu erhalten, wenden Sie sich an Ihre Stadtverwaltung, den öffentlich-rechtlichen Entsorgungsträger, eine autorisierte Stelle für die Entsorgung von Elektro- und Elektronik-Altgeräten oder Ihr örtliches Entsorgungsunternehmen oder besuchen Sie www.canon-europe.com/weee, oder www.canon-europe.com/battery.

Union Européenne, Norvège, Islande et Liechtenstein uniquement.



Ces symboles indiquent que ce produit ne doit pas être mis au rebut avec les ordures ménagères, comme le spécifient la Directive européenne DEEE (2012/19/UE), la Directive européenne relative à l'élimination des piles et des accumulateurs usagés (2006/66/CE) et les lois en vigueur dans votre pays appliquant ces directives. Si un symbole de toxicité chimique est imprimé sous le symbole illustré ci-dessus conformément à la Directive relative aux piles et aux accumulateurs, il indique la présence d'un métal lourd (Hg = mercure, Cd = cadmium, Pb = plomb) dans la pile ou l'accumulateur à une concentration supérieure au seuil applicable spécifié par la Directive. Ce produit doit être confié au distributeur à chaque fois que vous achetez un produit neuf similaire, ou à un point de collecte mis en place par les collectivités locales pour le recyclage des Déchets des Équipements Électriques et Électroniques (DEEE). Le traitement inapproprié de ce type de déchet risque d'avoir des répercussions sur l'environnement et la santé humaine, du fait de la présence de substances potentiellement dangereuses généralement associées aux équipements électriques et électroniques. Votre entière coopération dans le cadre de la mise au rebut correcte de ce produit favorisera une meilleure utilisation des ressources naturelles. Pour plus d'informations sur le recyclage de ce produit, contactez vos services municipaux, votre éco-organisme ou les autorités locales compétentes, ou consultez le site www.canon-europe.com/weee, ou www.canon-europe.com/battery.

Uitsluitend bestemd voor de Europese Unie en EER (Noorwegen, IJsland en Liechtenstein)



Met deze symbolen wordt aangegeven dat dit product in overeenstemming met de AEEA-richtlijn (2012/19/EU), de richtlijn 2006/66/EG betreffende batterijen en accu's en/of de plaatselijk geldende wetgeving waarin deze richtlijnen zijn geïmplementeerd, niet bij het normale huisvuil mag worden weggegooid. Indien onder het hierboven getoonde symbool een chemisch symbool gedrukt staat, geeft dit in overeenstemming met de richtlijn betreffende batterijen en accu's aan dat deze batterij of accu een zwaar metaal bevat (Hg = kwik, Cd = cadmium, Pb = lood) waarvan de concentratie de toepasselijke drempelwaarde in overeenstemming met de genoemde richtlijn overschrijdt. Dit product dient te worden ingeleverd bij een hiervoor aangewezen inzamelpunt, bijv. door dit in te leveren bij een hiertoe erkend verkooppunt bij aankoop van een gelijksoortig product, of bij een officiële inzameldienst voor de recycling van elektrische en elektronische apparatuur (EEA) en batterijen en accu's. Door de potentieel gevaarlijke stoffen die gewoonlijk gepaard gaan met EEA, kan onjuiste verwerking van dit type afval mogelijk nadelige gevolgen hebben voor het milieu en de menselijke gezondheid. Uw medewerking bij het op juiste wijze weggoien van dit product draagt bij tot effectief gebruik van natuurlijke hulpbronnen. Voor verdere informatie over recycling van dit product kunt u contact opnemen met uw plaatselijke gemeente, afvaldienst, officiële dienst voor klein chemisch afval of afvalstortplaats, of kunt u terecht op www.canon-europe.com/weee, of www.canon-europe.com/battery.

Sólo para la Unión Europea y el Área Económica Europea (Noruega, Islandia y Liechtenstein)



Estos iconos indican que este producto no debe desecharse con los residuos domésticos de acuerdo con la Directiva sobre RAEE (2012/19/UE) y la Directiva sobre Pilas y Acumuladores (2006/66/CE) y/o la legislación nacional. Si aparece un símbolo químico bajo este icono, de acuerdo con la Directiva sobre Pilas y Acumuladores, significa que la pila o el acumulador contiene metales pesados (Hg = Mercurio, Cd = Cadmio, Pb = Plomo) en una concentración superior al límite especificado en dicha directiva. Este producto deberá entregarse en un punto de recogida designado, por ejemplo, entregándolo en el lugar de venta al adquirir un producto nuevo similar o en un centro autorizado para la recogida de residuos de aparatos eléctricos y electrónicos (RAEE), baterías y acumuladores. La gestión incorrecta de este tipo de residuos puede afectar al medio ambiente y a la salud humana debido a las sustancias potencialmente nocivas que suelen contener estos aparatos. Su cooperación en la correcta eliminación de este producto contribuirá al correcto aprovechamiento de los recursos naturales. Los usuarios tienen derecho a devolver pilas, acumuladores o baterías usados sin coste alguno. El precio de venta de pilas, acumuladores y baterías incluye el coste de la gestión medioambiental de su desecho, y no es necesario mostrar la cuantía de dicho coste en la información y la factura suministradas a los usuarios finales. Si desea más información sobre el reciclado de este producto, póngase en contacto con su municipio, el servicio o el organismo encargado de la gestión de residuos domésticos o visite www.canon-europe.com/weee, o www.canon-europe.com/battery.

Només per a la Unió Europea i a l'Espai Econòmic Europeu (Noruega, Islàndia i Liechtenstein)



Aquests símbols indiquen que aquest producte no s'ha de llençar amb les escombraries de la llar, d'acord amb la RAEE (2012/19/UE), la Directiva relativa a piles i acumuladors (2006/66/CE) i la legislació nacional que implementi aquestes directives. Si al costat d'aquest símbol hi apareix imprès un símbol químic, segons especifica la Directiva relativa a piles i acumuladors, significa que la bateria o l'acumulador conté un metall pesant (Hg = mercuri, Cd = cadmi, Pb = plom) en una concentració superior al límit aplicable especificat en la Directiva. Aquest producte s'hauria de lliurar en un dels punts de recollida designats, com per exemple, intercanviant un per un en comprar un producte similar o lliurant-lo en un lloc de recollida autoritzat per al reciclatge de residus d'aparells elèctrics i electrònics (RAEE) i piles i acumuladors. La manipulació inadequada d'aquest tipus de residus podria tenir un impacte negatiu en l'entorn i en la salut humana, a causa de les substàncies potencialment perilloses que normalment estan associades a l'RAEE. La vostra cooperació a l'hora de rebutjar correctament aquest producte contribuirà a la utilització efectiva dels recursos naturals. Els usuaris tenen dret a retornar les bateries o els acumuladors usats sense cap càrrec. El preu de venda de les bateries i els acumuladors inclou el cost de la gestió ambiental dels residus i no es necessari mostrar l'import d'aquest cost en aquest fullet o en la factura que es lliuri a l'usuari final. Per a més informació sobre el reciclatge d'aquest producte, contacteu amb l'oficina municipal, les autoritats encarregades dels residus, el pla de residus homologat o el servei

de recollida d'escombraries domèstiques de la vostra localitat o visiteu www.canon-europe.com/weee, o www.canon-europe.com/battery.

Solo per Unione Europea e SEE (Norvegia, Islanda e Liechtenstein)



Questi simboli indicano che il prodotto non può essere smaltito con i rifiuti domestici, ai sensi della Direttiva RAEE (2012/19/UE), della Direttiva sulle Batterie (2006/66/CE) e/o delle leggi nazionali che attuano tali Direttive. Se sotto il simbolo indicato sopra è riportato un simbolo chimico, in osservanza della Direttiva sulle batterie, tale simbolo indica la presenza di un metallo pesante (Hg = Mercurio, Cd = Cadmio, Pb = Piombo) nella batteria o nell'accumulatore con un livello di concentrazione superiore a una soglia applicabile specificata nella Direttiva sulle batterie. Il prodotto deve essere conferito a un punto di raccolta designato, ad esempio il rivenditore in caso di acquisto di un nuovo prodotto simile oppure un centro di raccolta autorizzato per il riciclaggio di rifiuti di apparecchiature elettriche ed elettroniche (RAEE) nonché di batterie e accumulatori. Un trattamento improprio di questo tipo di rifiuti può avere conseguenze negative sull'ambiente e sulla salute umana a causa delle sostanze potenzialmente nocive solitamente contenute in tali rifiuti. La collaborazione dell'utente per il corretto smaltimento di questo prodotto contribuirà a un utilizzo efficace delle risorse naturali ed eviterà di incorrere in sanzioni amministrative ai sensi dell'art. 255 e successivi del Decreto Legislativo n. 152/06. Per ulteriori informazioni sul riciclaggio di questo prodotto, contattare le autorità locali, l'ente responsabile della raccolta dei rifiuti, un rivenditore autorizzato o il servizio di raccolta dei rifiuti domestici, oppure visitare il sito www.canon-europe.com/weee, o www.canon-europe.com/battery.

Apenas para a União Europeia e AEE (Noruega, Islândia e Liechtenstein)



Estes símbolos indicam que este produto não deve ser eliminado juntamente com o seu lixo doméstico, segundo a Diretiva REEE de 2012/19/UE, a Diretiva de Baterias (2006/66/CE) e/ou a sua legislação nacional que transponha estas Diretivas. Se houver um símbolo químico impresso como mostrado abaixo, de acordo com a Diretiva de Baterias, isto indica que um metal pesado (Hg = Mercúrio, Cd = Cádmio, Pb = Chumbo) está presente nesta pilha ou acumulador, numa concentração acima de um limite aplicável especificado na Diretiva. Este produto deve ser entregue num ponto de recolha designado, por exemplo num local autorizado de troca quando compra um equipamento novo idêntico, ou num local de recolha autorizado para reciclar equipamento elétrico e eletrónico (EEE) em fim de vida, bem como pilhas e baterias. O tratamento inadequado deste tipo de resíduos pode ter um impacto negativo no ambiente e na saúde humana, devido a substâncias potencialmente perigosas que estão associadas com equipamentos do tipo EEE. A sua cooperação no tratamento correto deste produto irá contribuir para a utilização mais eficaz dos recursos naturais. Para obter mais informações acerca de como reciclar este produto, por favor contacte as suas autoridades locais responsáveis pela matéria, serviço de recolha aprovado para pilhas e baterias ou serviço de recolha de resíduos sólidos domésticos da sua municipalidade, ou visite www.canon-europe.com/weee, ou www.canon-europe.com/battery.

Γæλδερ κун i Ευρωπαϊςκε Union og ΕØS (Norge, Island og Liechtenstein)



Disse symboler betyder, at produktet ikke må bortskaffes sammen med dagrenovation i henhold til WEEE-direktivet (2012/19/EU), batteridirektivet (2006/66/EF) og/eller den lokale lovgivning, som disse direktiver er gennemført i. Hvis der i overensstemmelse med batteridirektivet er trykt et kemisk symbol under det symbol, der er vist ovenfor, betyder det, at batteriet eller akkumulatoren indeholder tungmetaller (Hg = kviksølv, Cd = cadmium, Pb = bly) i en koncentration, som ligger over de grænseværdier, der er beskrevet i batteridirektivet. Produktet skal afleveres på et godkendt indsamlingssted, f.eks. i overensstemmelse med en godkendt én-til-én-procedure, når du indkøber et nyt tilsvarende produkt, eller på et godkendt indsamlingssted for elektronikaffald samt for batterier og akkumulatører. Forkert håndtering af denne type affald kan medføre negative konsekvenser for miljøet og menneskers helbred på grund af de potentielt sundhedsskadelige stoffer, der generelt kan forefindes i elektrisk og elektronisk udstyr. Når du foretager korrekt bortskaffelse af produktet, bidrager du til effektiv brug af naturressourcerne. Kontakt din kommune, den lokale affaldsmyndighed, det lokale affaldsanlæg, eller besøg www.canon-europe.com/weee, eller www.canon-europe.com/battery for at få flere oplysninger om genbrug af dette produkt.

Μόνο για την Ευρωπαϊκή Ένωση και τον ΕΟΧ (Νορβηγία, Ισλανδία και Λιχτενστάιν)



Αυτά τα σύμβολα υποδεικνύουν ότι αυτό το προϊόν δεν πρέπει να απορρίπτεται μαζί με τα οικιακά απορρίμματα, σύμφωνα με την Οδηγία για τα Απόβλητα Ηλεκτρικού και Ηλεκτρονικού Εξοπλισμού (ΑΗΗΕ) (2012/19/ΕΕ), την Οδηγία για τις Ηλεκτρικές Στήλες (2006/66/ΕΚ) ή/και την εθνική νομοθεσία που εφαρμόζει τις Οδηγίες εκείνες. Εάν κάποιο χημικό σύμβολο είναι τυπωμένο κάτω από το σύμβολο που φαίνεται παραπάνω, σύμφωνα με την Οδηγία για τις Ηλεκτρικές Στήλες, υποδηλώνει ότι κάποιο βαρύ μέταλλο (Hg = Υδράργυρος, Cd = Κάδμιο, Pb = Μόλυβδος) υπάρχει στην μπαταρία ή τον συσσωρευτή σε συγκέντρωση μεγαλύτερη από το ισχύον επίπεδο που καθορίζεται στην Οδηγία για τις Ηλεκτρικές Στήλες. Αυτό το προϊόν πρέπει να παραδίδεται σε καθορισμένο σημείο συλλογής, π.χ. σε μια εξουσιοδοτημένη βάση ανταλλαγής όταν αγοράζετε ένα νέο παρόμοιο προϊόν ή σε μια εξουσιοδοτημένη θέση συλλογής για την ανακύκλωση των αποβλήτων ηλεκτρικού και ηλεκτρονικού εξοπλισμού (ΗΗΕ) και των ηλεκτρικών στηλών και συσσωρευτών. Ο ακατάλληλος χειρισμός αυτού του τύπου αποβλήτων μπορεί να έχει αρνητικό αντίκτυπο στο περιβάλλον και την υγεία του ανθρώπου, λόγω δυνητικά επικίνδυνων ουσιών που γενικά συνδέονται με τον ΗΗΕ. Η συνεργασία σας για τη σωστή απόρριψη αυτού του προϊόντος θα συμβάλει στην αποτελεσματική χρήση των φυσικών πόρων. Για περισσότερες πληροφορίες σχετικά με ανακύκλωση αυτού του προϊόντος, επικοινωνήστε με το τοπικό γραφείο της πόλης σας, την υπηρεσία απορριμμάτων, το εγκεκριμένο σχήμα ή την υπηρεσία απόρριψης οικιακών αποβλήτων ή επισκεφθείτε τη διεύθυνση www.canon-europe.com/weee ή www.canon-europe.com/battery.

Gjelder kun den europeiske union og EØS (Norge, Island og Liechtenstein)



Disse symbolene indikerer at dette produktet ikke skal kastes sammen med husholdningsavfall, i henhold til WEEE-direktivet (2012/19/EU), batteridirektivet (2006/66/EF) og/eller nasjonal lov som har implementert disse direktivene. Hvis et kjemisk symbol vises under symbolet vist ovenfor, i samsvar med batteridirektivet, indikerer dette at et tungmetall (Hg = kvikksølv, Cd = kadmium, Pb = bly) finnes i batteriet eller akkumulatoren i en konsentrasjon over en gjeldende øvre grense som er spesifisert i batteridirektivet. Produktet må leveres til et dertil egnet innsamlingspunkt, det vil si på en autorisert en-til-en-basis når en kjøper et nytt lignende produkt, eller til et autorisert innsamlingssted for resirkulering av avfall fra elektrisk og elektronisk utstyr (EE-utstyr) og batterier og akkumulatorene. Feil håndtering av denne typen avfall kan være miljø- og helseskadelig på grunn av potensielt skadelige stoffer som ofte brukes i EE-utstyr. Din innsats for korrekt avhending av produktet vil bidra til effektiv bruk av naturressurser. Du kan få mer informasjon om resirkulering av dette produktet ved å kontakte lokale myndigheter, avfallsadministrasjonen, et godkjent program eller husholdningens renovasjonsselskap, eller gå til www.canon-europe.com/weee, eller www.canon-europe.com/battery.

Vain Euroopan unionin sekä ETA:n (Norja, Islanti ja Liechtenstein) alueelle.



Nämä tunnukset osoittavat, että sähkö- ja elektroniikkalaiteromua koskeva direktiivi (SER-direktiivi, 2012/19/EU), paristoista ja akuista annettu direktiivi (2006/66/EY) sekä kansallinen lainsäädäntö kieltävät tuotteen hävittämisen talousjätteen mukana. Jos yllä olevan symbolin alapuolelle on paristodirektiivin mukaisesti painettu kemiallisen aineen tunnus, kyseinen paristo tai akku sisältää raskasmetalleja (Hg = elohopea, Cd = kadmium, Pb = lyijy) enemmän kuin paristodirektiivin salliman määrän. Tuote on vietävä asianmukaiseen keräyspisteeseen, esimerkiksi kodinkoneliikkeeseen uutta vastaavaa tuotetta ostettaessa tai viralliseen sähkö- ja elektroniikkalaiteromun tai paristojen ja akkujen keräyspisteeseen. Sähkö- ja elektroniikkalaiteromun virheellinen käsittely voi vahingoittaa ympäristöä ja ihmisten terveyttä, koska laitteet saattavat sisältää ympäristölle ja terveydelle haitallisia aineita. Tuotteen asianmukainen hävittäminen säästää myös luonnonvaroja. Jos haluat lisätietoja tämän tuotteen kierrätyksestä, ota yhteys kunnan jätehuoltoviranomaisiin tai käyttämäsi jätehuolto-yhtiöön tai käy osoitteessa www.canon-europe.com/weee, tai www.canon-europe.com/battery.

Endast för Europeiska unionen och EES (Norge, Island och Liechtenstein)



De här symbolerna visar att produkten inte får sorteras och slängas som hushållsavfall enligt WEEE-direktivet (2012/19/EU), batteridirektivet (2006/66/EG) och/eller nationell lagstiftning som implementerar dessa direktiv. Om en kemisk symbol förekommer under ovanstående symbol innebär detta enligt Batteridirektivet att en tungmetall (Hg = Kvikksilver, Cd = Kadmium, Pb = Bly) förekommer i batteriet eller

ackumulatormed med en koncentration som överstiger tillämplig gräns som anges i Batteridirektivet. Produkten ska lämnas in på en avsedd insamlingsplats, t.ex. på en återvinningsstation auktoriserad att hantera elektrisk och elektronisk utrustning (EE-utrustning) samt batterier och ackumulatörer eller hos handlare som är auktoriserade att byta in varor då nya, motsvarande köps (en mot en). Olämplig hantering av avfall av den här typen kan ha negativ inverkan på miljön och människors hälsa på grund av de potentiellt farliga ämnen som kan återfinnas i elektrisk och elektronisk utrustning. Din medverkan till en korrekt avfallshantering av produkten bidrar till effektiv användning av naturresurserna. Om du vill ha mer information om var du kan lämna in den här produkten, kontakta ditt lokala kommunkontor, berörd myndighet eller företag för avfallshantering eller se www.canon-europe.com/weee, eller www.canon-europe.com/battery.

Pouze Evropská unie a EHP (Norsko, Island a Lichtenštejsko)



Tento symbol znamená, že podle směrnice OEEZ (2012/19/EU), směrnice o bateriích (2006/66/ES) a/ nebo podle vnitrostátních právních prováděcích předpisů k těmto směrnicím nemá být tento výrobek likvidován s odpadem z domácností. Je-li v souladu s požadavky směrnice o bateriích vytištěna pod výše uvedeným symbolem chemická značka, udává, že tato baterie nebo akumulátor obsahuje těžké kovy (Hg = rtuť, Cd = kadmium, Pb = olovo) v koncentraci vyšší, než je příslušná hodnota předepsaná směrnicí. Tento výrobek má být vrácen do určeného sběrného místa, např. v rámci autorizovaného systému odběru jednoho výrobku za jeden nově prodaný podobný výrobek, nebo do autorizovaného sběrného místa pro recyklaci odpadních elektrických a elektronických zařízení (OEEZ), baterií a akumulátorů. Nevhodné nakládání s tímto druhem odpadu by mohlo mít negativní dopad na životní prostředí a lidské zdraví, protože elektrická a elektronická zařízení zpravidla obsahují potenciálně nebezpečné látky. Vaše spolupráce na správné likvidaci tohoto výrobku napomůže efektivnímu využívání přírodních zdrojů. Chcete-li získat podrobné informace týkající se recyklace tohoto výrobku, obraťte se prosím na místní úřad, orgán pro nakládání s odpady, schválený systém nakládání s odpady či společnost zajišťující likvidaci domovního odpadu, nebo navštivte webové stránky www.canon-europe.com/weee nebo www.canon-europe.com/battery.

Csak az Európai Unió és az EGT (Norvégia, Izland és Liechtenstein) országaiban



Ezek a szimbólumok azt jelzik, hogy a termék hulladékkezelése a háztartási hulladéktól különválasztva, az elektromos és elektronikus berendezések hulladékairól (WEEE) szóló (2012/19/EU) irányelvnek és az elemekről és akkumulátorokról, valamint a hulladék elemekről és akkumulátorokról szóló (2006/66/EK) irányelvnek megfelelően és/vagy ezen irányelveknek megfelelő helyi előírások szerint történik. Amennyiben a fent feltüntetett szimbólum alatt egy vegyjel is szerepel, az elemekről és akkumulátorokról szóló irányelvben foglaltak értelmében ez azt jelzi, hogy az elem vagy az akkumulátor az irányelvben meghatározott határértéknél nagyobb mennyiségben tartalmaz nehézfémeket (Hg = higany, Cd = kadmium, Pb = ólom). E terméket az arra kijelölt gyűjtőhelyre kell juttatni – pl. hasonló termék vásárlásakor a régi

becserélésére vonatkozó hivatalos program keretében, vagy az elektromos és elektronikus berendezések (EEE) hulladékainak gyűjtésére, valamint a hulladék elemek és hulladék akkumulátorok gyűjtésére kijelölt hivatalos gyűjtőhelyre. Az ilyen jellegű hulladékok nem előírászerű kezelése az elektromos és elektronikus berendezésekhez (EEE) általánosan kapcsolható potenciálisan veszélyes anyagok révén hatással lehet a környezetre és az egészségre. E termék megfelelő leselejtezésével Ön is hozzájárul a természeti források hatékony használatához. A termék újrahasznosítását illetően informálódjon a helyi polgármesteri hivatalnál, a helyi közterület-fenntartó vállalatnál, a hivatalos hulladéklerakó telephelyen vagy a háztartási hulladék begyűjtését végző szolgáltatónál, illetve látogasson el a www.canon-europe.com/weee, vagy www.canon-europe.com/battery internetes oldalra.

Tylko dla krajów Unii Europejskiej oraz EOG (Norwegia, Islandia i Liechtenstein)



Te symbole oznaczają, że produktu nie należy wyrzucać razem z odpadami gospodarstwa domowego, zgodnie z dyrektywą WEEE w sprawie zużytego sprzętu elektrycznego i elektronicznego (2012/19/UE) lub dyrektywą w sprawie baterii (2006/66/WE) bądź przepisami krajowymi wdrażającymi te dyrektywy. Jeśli pod powyższym symbolem znajduje się symbol chemiczny, zgodnie z dyrektywą w sprawie baterii oznacza to, że bateria lub akumulator zawiera metal ciężki (Hg = rtęć, Cd = kadm, Pb = ołów) w stężeniu przekraczającym odpowiedni poziom określony w dyrektywie w sprawie baterii. Użytkownicy baterii i akumulatorów mają obowiązek korzystać z dostępnego programu zwrotu, recyklingu i utylizacji baterii oraz akumulatorów. Niewłaściwe postępowanie z tego typu odpadami może mieć wpływ na środowisko i zdrowie ludzi ze względu na substancje potencjalnie niebezpieczne, związane ze użytym sprzętem elektrycznym i elektronicznym. Państwa współpraca w zakresie właściwej utylizacji tego produktu przyczyni się do efektywnego wykorzystania zasobów naturalnych. W celu uzyskania informacji o sposobie recyklingu tego produktu prosimy o kontakt z właściwym urzędem miejskim lub zakładem gospodarki komunalnej bądź zapraszamy na stronę www.canon-europe.com/weee, lub www.canon-europe.com/battery.

Platí len pre štáty Európskej únie a EHP (Nórsko, Island a Lichtenštajnsko)



Tieto symboly označujú, že podľa Smernice o odpade z elektrických a elektronických zariadení (OEEZ) 2012/19/EÚ, Smernice o batériách (2006/66/ES) a podľa platnej legislatívy Slovenskej republiky sa tento produkt nesmie likvidovať spolu s komunálnym odpadom. Ak je chemická značka vytlačená pod vyššie uvedeným symbolom, znamená to, že táto batéria alebo akumulator obsahuje ťažký kov (Hg = ortuť, Cd = kadmium, Pb = olovo) v koncentrácii vyššej, ako je príslušná povolená hodnota stanovená v Smernici o batériách. Produkt je potrebné odovzdať do určenej zberne, napr. prostredníctvom výmeny za kúpu nového podobného produktu, alebo na autorizované zberné miesto, ktoré spracúva odpad z elektrických a elektronických zariadení (EEZ), batérií a akumulatorov. Nesprávna manipulácia s takýmto typom odpadu môže mať negatívny vplyv na životné prostredie a ľudské zdravie, pretože elektrické a elektronické zariadenia obsahujú potenciálne nebezpečné látky. Spoluprácou na správnej likvidácii tohto

produktu prispejete k účinnému využívaniu prírodných zdrojov. Ďalšie informácie o recyklácii tohto produktu získate od miestneho úradu, úradu životného prostredia, zo schváleného plánu OEEZ alebo od spoločnosti, ktorá zaisťuje likvidáciu komunálneho odpadu. Viac informácií nájdete aj na webovej stránke: www.canon-europe.com/weee, alebo www.canon-europe.com/battery.

Üksnes Euroopa Liit ja EMP (Norra, Island ja Liechtenstein)



Antud sümbolid viitavad sellele, et vastavalt elektri- ja elektroonikaseadmete jäätmeid käsitlevale direktiivile (2012/19/EL), patareisid ja akusid ning patarei- ja akujäätmeid käsitlevale direktiivile (2006/66/EÜ) ja/või nimetatud direktiive rakendavatele riiklikele õigusaktidele ei või seda toodet koos olmejäätmetega ära visata. Kui keemiline sümbol on trükitud eespool toodud sümboli alla, siis tähendab see, et antud patareis või akus leiduva raskemetalli (Hg = elavhõbe, Cd = kaadmium, Pb = plii) kontsentratsioonitase on kõrgem kui patareisid ja akusid ning patarei- ja akujäätmeid käsitlevas direktiivis sätestatud piirmäär. Antud tootest tekkinud jäätmed tuleb anda vastavasse kogumispunkti, nt müügipunkti, mis on volitatud üks ühe vastu vahetama, kui ostate uue sarnase toote, või vastavasse elektri- ja elektroonikaseadmete jäätmete ning patareide ja akude ümbertöötlemiseks mõeldud kogumispunkti. Antud liiki jäätmete vale käitlemine võib kahjustada keskkonda ja inimeste tervist elektri- ja elektroonikajäätmetes tavaliselt leiduvate potentsiaalselt ohtlike ainete tõttu. Antud tootest tekkinud jäätmete nõuetekohase kõrvaldamisega aitate kasutada loodusvarasid efektiivselt. Täiendava teabe saamiseks elektri- ja elektroonikaseadmetest tekkinud jäätmete ning patarei- ja akujäätmete tagastamise ja ümbertöötlemise kohta võtke ühendust kohaliku omavalitsusega, asjakohase valitsusasutusega, asjakohase tootjavastutusorganisatsiooniga või olmejäätmete käitlejaga. Lisateavet leitate ka Interneti-leheküljelt www.canon-europe.com/weee või www.canon-europe.com/battery.

Tikai Eiropas Savienībai un EEZ (Norvēģijai, Islandei un Lihtenšteinai)



Šie simboli norāda, ka atbilstoši ES Direktīvai (2012/19/ES) par elektrisko un elektronisko iekārtu atkritumiem (EEIA), Direktīvai (2006/66/EK) par baterijām un akumulatoriem, un akumulatoru atkritumiem, ar ko atceļ Direktīvu 91/157/EEK, un vietējiem tiesību aktiem šo izstrādājumu nedrīkst izmest kopā ar sadzīves atkritumiem. Ja zem iepriekš norādītā simbola ir uzdrukāts ķīmiskais simbols, saskaņā ar direktīvu par baterijām un akumulatoriem tas nozīmē, ka šīs baterijas vai akumulatori satur smagos metālus (Hg = dzīvsudrabs, Cd = kadmijs, Pb = svins) un to koncentrācijas līmenis pārsniedz direktīvā par baterijām un akumulatoriem minēto piemērojamo sliekšni. Šis izstrādājums ir jānodod piemērotā savākšanas vietā, piemēram, apstiprinātā veikalā, kur iegādājaties līdzīgu jaunu produktu un atstājat veco, vai apstiprinātā vietā izlietotu elektrisko un elektronisko iekārtu un bateriju un akumulatoru pārstrādei. Nepareiza šāda veida atkritumu apsaimniekošana var apdraudēt vidi un cilvēka veselību tādu iespējami bīstamu vielu dēļ, kas parasti ir elektriskajās un elektroniskajās iekārtās. Jūsu atbalsts pareizā šāda veida atkritumu apsaimniekošanā sekmēs efektīvu dabas resursu izmantošanu. Lai saņemtu pilnīgāku informāciju par šāda veida izstrādājumu nodošanu otrreizējai pārstrādei, sazinieties ar vietējo pašvaldību, atkritumu savākšanas atbildīgo dienestu, pilnvaroto organizāciju vai iestādi, kas veic sadzīves

atkritumu apsaimniekošanu, vai apmeklējiet tīmekļa vietni www.canon-europe.com/weee, vai www.canon-europe.com/battery.

Tik Europos Sąjungai ir EEE (Norvegijai, Islandijai ir Lichtenšteinui)



Šie simboliai reiškia, kad šio gaminio negalima išmesti į buitines atliekas, kaip reikalaujama WEEE Direktyvoje (2012/19/ES) ir Baterijų direktyvoje (2006/66/EB) ir (ar) jūsų šalies nacionaliniuose įstatymuose, kuriais šios Direktyvos yra įgyvendinamos. Jeigu cheminio ženklo simbolis yra nurodytas žemiau šio ženklo, tai reiškia, kad vadovaujantis Baterijų direktyvą, baterijų ar akumuliatorių sudėtyje yra sunkiųjų metalų (Hg = gyvsidabris, Cd = kadmio, Pb = švino), kurių koncentracija viršija Baterijų direktyvoje nurodytas leistinas ribas. Šį gaminį reikia pristatyti į specialųjį surinkimo punktą, pavyzdžiui, mainais, kai jūs perkate naują panašų gaminį, arba į specialiąją surinkimo vietą, kurioje perdirbamos elektrinės ir elektroninės įrangos atliekos bei naudotos baterijos ir akumuliatoriai. Dėl netinkamo šio tipo atliekų tvarkymo gali nukentėti aplinka ir iškilti grėsmė žmogaus sveikatai dėl galimai kenksmingų medžiagų, iš esmės susijusių su elektrine ir elektronine įranga. Bendradarbiaudami ir teisingai utilizuodami šiuos gaminius, jūs padėsite efektyviai naudoti gamtinius išteklius. Daugiau informacijos apie gaminio perdirbimą jums gali suteikti vietinis biuras, atliekų tvarkymo bendrovė, sertifikuoti organai ar buitinių atliekų surinkimo įmonės. Taip pat siūloma apsilankyti interneto svetainėje www.canon-europe.com/weee, arba www.canon-europe.com/battery.

Samo za Evropsko unijo in EGP (Norveška, Islandija in Lihtenštajn)



Ti simboli pomenijo, da tega izdelka skladno z Direktivo OEEO (2012/19/EU), Direktivo 2006/66/ES in/ali nacionalno zakonodajo, ki uvaja ti direktivi, ne smete odlagati z nesortiranimi gospodinjskimi odpadki. Če je pod zgoraj prikazanim simbolom natisnjen kemijski simbol, to v skladu z Direktivo pomeni, da je v tej bateriji ali akumulatorju prisotna težka kovina (Hg = živo srebro, Cd = kadmij, Pb = svinec), in sicer v koncentraciji, ki je nad relevantno mejno vrednostjo, določeno v Direktivi. Ta izdelek je potrebno odnesti na izbrano zbirno mesto, t. j. pooblaščenemu trgovino, kjer ob nakupu novega (podobnega) izdelka vrnete starega, ali na pooblaščenemu zbirno mesto za ponovno uporabo odpadne električne in elektronske opreme (EEO) ter baterij in akumulatorjev. Neustrezno ravnanje s to vrsto odpadkov lahko negativno vpliva na okolje in človeško zdravje zaradi potencialno nevarnih snovi, ki so pogosto povezane z EEO. Vaše sodelovanje pri pravilnem odlaganju tega izdelka predstavlja pomemben prispevek k smotrni izrabi naravnih virov. Za več informacij o ponovni uporabi tega izdelka se obrnite na lokalni mestni urad, pristojno službo za odpadke, predstavnika pooblaščenega programa za obdelavo odpadkov ali na lokalno komunalo. Lahko pa tudi obiščete našo spletno stran www.canon-europe.com/weee, ali www.canon-europe.com/battery.

Само за Европейския съюз и ЕИП (Норвегия, Исландия и Лихтенщайн)



Тези символи показват, че този продукт не трябва да се изхвърля заедно с битовите отпадъци съгласно Директивата за ИУЕЕО (2012/19/ЕС), Директивата за батерии (2006/66/ЕО) и/или Вашето национално законодателство, прилагащо тези Директиви. Ако под показания горе символ е отпечатан символ за химически елемент, съгласно разпоредбите на Директивата за батерии, този втори символ означава наличието на тежък метал (Hg = живак, Cd = кадмий, Pb = олово) в батерията или акумулатора в концентрация над указаната граница за съответния елемент в Директивата. Този продукт трябва да бъде предаден в предназначен за целта пункт за събиране, например на база размяна, когато купувате нов подобен продукт, или в одобрен събирателен пункт за рециклиране на излязло от употреба електрическо и електронно оборудване (ИУЕЕО), батерии и акумулатори. Неправилното третиране на този тип отпадъци може да доведе до евентуални отрицателни последици за околната среда и човешкото здраве поради потенциално опасните вещества, които обикновено са свързани с ЕЕО. В същото време Вашето съдействие за правилното изхвърляне на този продукт ще допринесе за ефективното използване на природните ресурси. За повече информация относно това къде можете да предадете за рециклиране на този продукт, моля свържете се с Вашите местни власти, с органа, отговорен за отпадъците, с одобрената система за ИУЕЕО или с Вашата местна служба за битови отпадъци, или посетете www.canon-europe.com/weee, или www.canon-europe.com/battery.

Doar pentru Uniunea Europeană și EEA (Norvegia, Islanda și Liechtenstein)



Ацесте символурн индикă фактурн чă ацест продус ну требуе арункат ъмпреунă ку деџеурн менажере, ън конформитате ку Директивă ДЕЕЕ (2012/19/УЕ), Директивă реферитоаре ла батерии (2006/66/СЕ) џи/сау легиле днс. наџионале це импленеаеазă ацесте Директиве. Дакă ун символ химиче есте импримат суб символул де май сус, ън конформитате ку Директивă реферитоаре ла батерии, ацест символ индикă презенџа ън батерие сау акумулатор а унуи метал греу (Hg = Меркур, Cd = Кадмиу, Pb = Плумб) ънтр-о концентраџие май маре декăт прагул адмис спецификат ън Директивă реферитоаре ла батерии. Ацест продус требуе ънмăнат пунктului де колектаре адекват, ех: принтр-ун schimb авторизат уну ла уну атунци чăнд купăраџи ун продус нуу силмар сау ла ун лок де колектаре авторизат пентру рециклареа резидуурнл де ечипамент електрич џи електронич (ЕЕЕ) џи батерии џи акумулатори. Администрареа неадекватă а ацестуи тип де деџеури, ар пуеа аеа ун импакт асупра медиулуи џи асупра сăнăтăџии umane даторитă субстанџелор ку потенџил де рнск care сунт ън генерал асоциате ку ЕЕЕ. Кооперареа днс. ън дирекџия рециклăрии коректе а ацестуи продус ва контрибуи ла о утилizare ефициентă а ресурселор натурале. Пентру май multe информăџии despre рециклареа ацестуи продус, вă ругăм сă контактаџи бирул днс. локал, авторитăџиле responsible ку деџеурнл, schema апробатă сау serviciул днс. responsible ку деџеурнл менажере сау визитаџи-не ла www.canon-europe.com/weee, сау www.canon-europe.com/battery.

Samo za Europsku uniju i EEA (Norveška, Island i Lihtenštajn)



Oznaka pokazuje da se ovaj proizvod ne smije odlagati s komunalnim i ostalim vrstama otpada, u skladu s direktivom WEEE (2012/19/EC), Direktivom o baterijama (2006/66/EC) i Pravilnikom o gospodarenju otpadnim baterijama i akumulatorima te Pravilnikom o gospodarenju otpadnim električnim i elektroničkim uređajima i opremom. Ako je ispod prethodno prikazane oznake otisnut kemijski simbol, u skladu s Direktivom o baterijama, to znači da se u ovoj bateriji ili akumulatoru nalazi teški metal (Hg = živa, Cd = kadmij, Pb = olovo) i da je njegova koncentracija iznad razine propisane u Direktivi o baterijama. Ovaj bi proizvod trebalo predati ovlaštenom skupljaču EE otpada ili prodavatelju koji je dužan preuzeti otpadni proizvod po sistemu jedan za jedan, ukoliko isti odgovara vrsti te je obavljao primarne funkcije kao i isporučena EE oprema. Otpadne baterije i akumulatori predaju se ovlaštenom skupljaču otpadnih baterija ili akumulatora ili prodavatelju bez naknade i obveze kupnje za krajnjeg korisnika. Neodgovarajuće rukovanje ovom vrstom otpada može utjecati na okoliš i ljudsko zdravlje zbog potencijalno opasnih supstanci koje se najčešće nalaze na takvim mjestima. Vaša suradnja u pravilnom zbrinjavanju ovog proizvoda pridonijet će djelotvornom iskorištavanju prirodnih resursa. Dodatne informacije o recikliranju ovog proizvoda zatražite od svog lokalnog gradskog ureda, službe za zbrinjavanje otpada, odobrenog programa ili komunalne službe za uklanjanje otpada ili pak na stranicama www.canon-europe.com/weee ili www.canon-europe.com/battery.

Korisnici u Srbiji



Ovaj simbol označava da ovaj proizvod ne sme da se odlaže sa ostalim kućnim otpadom, u skladu sa WEEE Direktivom (2012/19/EU), Direktivom o baterijama (2006/66/EC) i nacionalnim zakonima. Ukoliko je ispod gore navedenog simbola odštampan hemijski simbol, u skladu sa Direktivom o baterijama, ovaj simbol označava da su u ovoj bateriji ili akumulatoru prisutni teški metali (Hg – živa, Cd – kadmijum, Pb - olovo) u koncentracijama koje premašuju prihvatljivi prag naveden u Direktivi o baterijama. Ovaj proizvod treba predati određenom centru za prikupljanje, npr. po principu „jedan-za-jedan“ kada kupujete sličan novi proizvod, ili ovlašćenom centru za prikupljanje za reciklažu istrošene električne i elektronske opreme (EEE), baterija i akumulatora. Nepravilno rukovanje ovom vrstom otpada može imati negativne posledice po životnu sredinu i ljudsko zdravlje usled potencijalno opasnih materijala koji se uglavnom vezuju za EEE. Vaša saradnja na ispravnom odlaganju ovog proizvoda će doprineti efikasnom korišćenju prirodnih resursa. Više informacija o tome kako možete da reciklirate ovaj proizvod potražite od lokalnih gradskih vlasti, komunalne službe, odobrenog plana reciklaže ili servisa za odlaganje kućnog otpada, ili posetite stranicu www.canon-europe.com/weee, ili www.canon-europe.com/battery.

Main Components and Their Use

- ▶ **Main Components**
- ▶ **Power Supply**
- ▶ **Using the Operation Panel**
- ▶ **Entering Numbers, Letters, and Symbols**

Main Components

- ▶ **Front View**
- ▶ **Rear View**
- ▶ **Inside View**
- ▶ **Operation Panel**

Front View

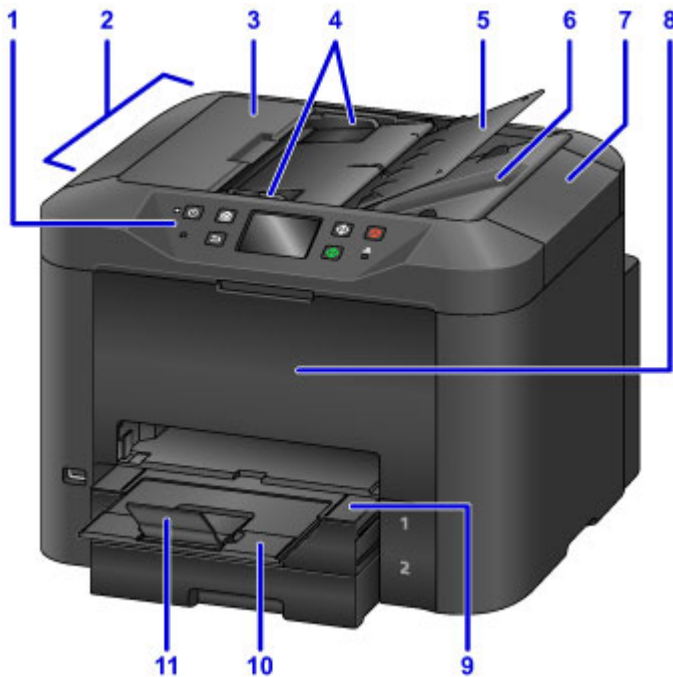

(1) operation panel

Used to adjust settings or operate the machine.

■ [Operation Panel](#)

(2) ADF (Auto Document Feeder)

Load documents here. Documents loaded in the document tray are scanned automatically, one page at a time.

■ [Loading Documents in the ADF \(Auto Document Feeder\)](#)

(3) document feeder cover

Open to clear jammed documents.

(4) document guides

Adjust to match the width of documents in the ADF.

(5) document tray

Open to load documents in the ADF. You can load multiple pages of the same size and thickness. Load documents face-up.

(6) document output slot

Ejects documents scanned in the ADF.

(7) document cover

Open to load originals on the platen glass.

(8) front cover

Open to replace ink tanks or clear internal paper jams.

(9) paper output tray

Pull out to support printed documents. The tray covers the cassette when extended. Normally, leave the tray out.

(10) output tray extension

Pull out to support ejected paper.

(11) paper output support

Open to support ejected paper.



(12) USB flash drive port

[Insert USB flash drives](#) here.

⚠ Warning

- Do not connect any equipment other than USB flash drives to the machine's USB flash drive port. This may cause fire, electric shock, or damage to the machine.

»» Important

- Do not touch any exposed metal parts.
- Do not connect USB cables longer than 10 feet (3 meters), which may affect operation of other peripherals.

(13) cassette 1

Holds all sizes of paper that are compatible with the machine, such as plain paper, photo paper, and envelopes.

■ [Paper Sources](#)

(14) cassette 2

Holds A4, Letter, Legal, Oficio, B-Oficio, M-Oficio, Foolscap, and Legal (India)-sized plain paper.

■ [Paper Sources](#)

(15) platen glass

Load originals here.

Rear View

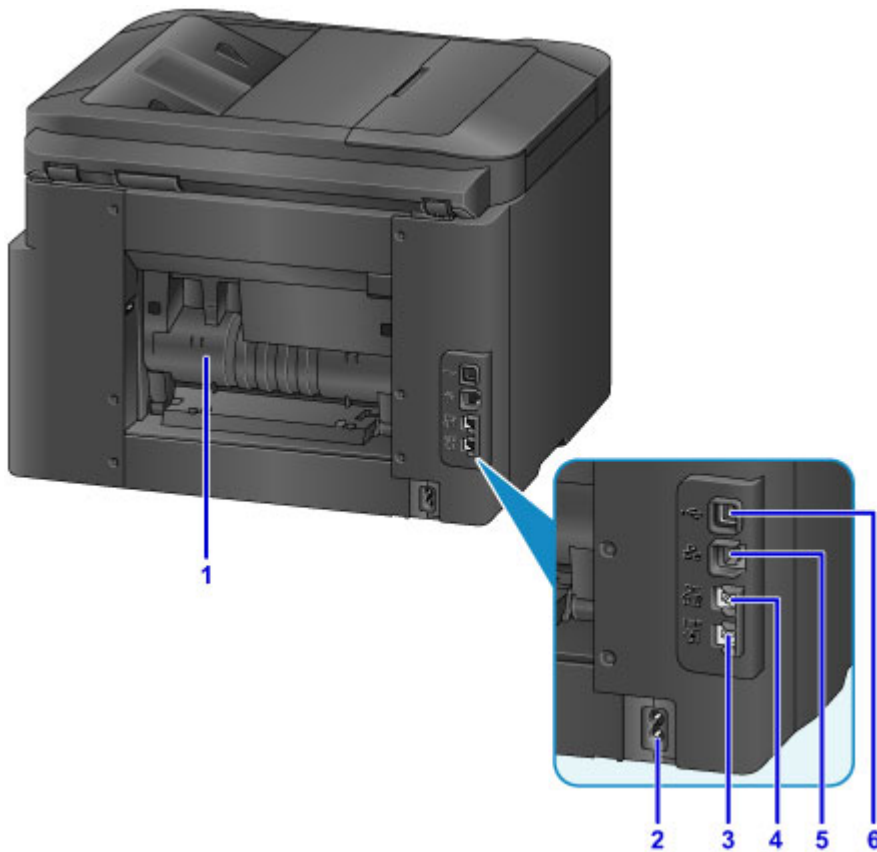

(1) rear cover

Open to clear paper jams.

(2) power cord connector

Connect the supplied power cord.

(3) telephone line jack

Connect the phone cord.

(4) external device jack

Connect a telephone or answering machine.

(5) wired LAN connector

Connect an Ethernet cable to use the machine in a local network.

(6) USB port

Connect the USB cable for a direct connection with a computer.

»» Important

- Do not touch any exposed metal parts.
- Do not connect or disconnect the USB or Ethernet cable while printing or scanning from a computer.

Inside View



(1) ink tank eject lever

Push up to remove ink tanks.

(2) print head holder

The print head is pre-installed.

▶▶▶ Note

- For instructions on replacing ink tanks, see [Replacing Ink Tanks](#).

Operation Panel

* Here, all operation panel indicators are shown lit for the purpose of illustration.

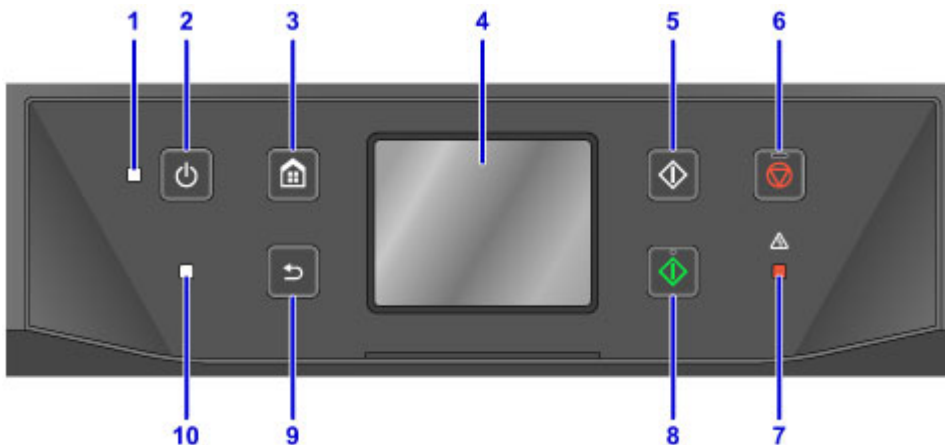

(1) POWER lamp

Remains lit after flashing when the machine is turned on.

(2) ON button

Turns the machine on or off.

■ [Turning the Machine On and Off](#)

(3) HOME button

Used to display the HOME screen.

■ [Using the Operation Panel](#)

(4) touch screen

Displays messages, menu items, and operating status. Touch the screen lightly with your finger to select a menu item or button.

■ [Basic Touch Screen Operations](#)

(5) Black button

Starts black-and-white copying, scanning, or faxing.

(6) Stop button

Cancels printing, copying, scanning, or faxing in progress.

(7) Alarm lamp

Lights up or flashes in case of errors.

(8) Color button

Starts color copying, scanning, or faxing.

(9) Back button

Returns to the previous screen.

(10) FAX Memory lamp

When lit, indicates that there are received or unsent documents in the machine's memory.

▶▶▶ Note

- The machine beeps or plays alarm tones in response to touching button on the operation panel. You can adjust the volume in **Device user settings > Sound control**.

Power Supply

- **Confirming that the Power Is On**
- **Turning the Machine On and Off**
- **Checking the Power Plug/Power Cord**
- **Unplugging the Machine**

Confirming that the Power Is On

The **POWER** lamp is lit when the machine is on.

Even if the touch screen is off, as long as the **POWER** lamp is lit, the machine is on.



»» Note

- After you turn the machine on, it requires a warm-up period of about 20 seconds before any operations. Wait until the HOME screen is displayed.
- The touch screen display turns off automatically after about 5 minutes of inactivity. To activate the touch screen again, touch it. The display is also activated again when a fax is received or an original is printed from a computer.

Turning the Machine On and Off

Turning the machine on

1. Press the **ON** button to turn the machine on.

The **POWER** lamp flashes and then remains lit.

- [Confirming that the Power Is On](#)



▶▶▶ Note

- After you turn the machine on, it requires a warm-up period of about 20 seconds before any operations. Wait until the HOME screen is displayed.
- If the **Alarm** lamp lights up or flashes and an error message appears on the touch screen, see [Message Appears](#).
- You can schedule automatic power-on at specified times on specified days of the week.

- [ECO settings](#)

- You can set the machine to turn on automatically when printing is started from a machine connected by USB or network or when scanning or fax reception is started. This feature is disabled by default.

- [ECO settings](#)

Turning the machine off

1. Press the **ON** button to turn the machine off.

Once the **POWER** lamp stops flashing, the machine goes off.



▶▶▶ Important

- Before [unplugging the machine](#) after turning it off, confirm that the **POWER** lamp is off.

»» Note

- Remember that faxes cannot be sent or received while the machine is off.
- The power cannot be turned off while the machine is sending or receiving a fax, or when unsent faxes are stored in the machine's memory.
- You can schedule automatic power-off at specified times on specified days of the week.

- [ECO settings](#)

- You can set the machine to turn off automatically after a specified period when no operations are performed or print jobs are received from a computer. (The machine cannot be turned off when a telephone is connected.) This feature is enabled by default.

- [ECO settings](#)

Checking the Power Plug/Power Cord

Check the power plug/power cord once a month to ensure that it is not affected by these problems.

- Excessively hot
- Corroded
- Bent
- Worn
- Cracked or split

Caution

- If the power plug/power cord case is affected by these or other problems, [unplug the machine](#) and request service. Continuing to use the machine with any of these problems may cause a fire or electric shock.

Unplugging the Machine

Always follow these steps when unplugging the machine.

▶▶▶ Important

- Unplug the machine only after pressing the **ON** button and confirming that the **POWER** lamp is off. Unplugging the machine while the **POWER** lamp is still on may cause the print head to dry out or become clogged, which may affect print quality.
- Unplugging the machine will erase all documents in the machine's memory. Send faxes, print documents, or save jobs to a USB flash drive as needed before unplugging the machine.

1. Press the **ON** button to turn the machine off.



2. Confirm that the **POWER** lamp is off.



3. Unplug the machine.

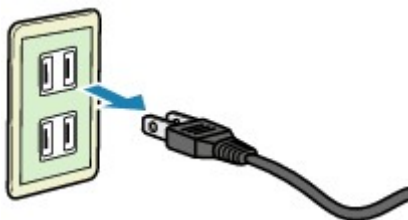

Power cord specifications vary by region.

Using the Operation Panel

The operation panel features a touch screen (A) and buttons (B).

Touch icons on the touch screen's HOME screen to select menus for copying, scanning, and other functions.

The HOME screen consists of three sections.

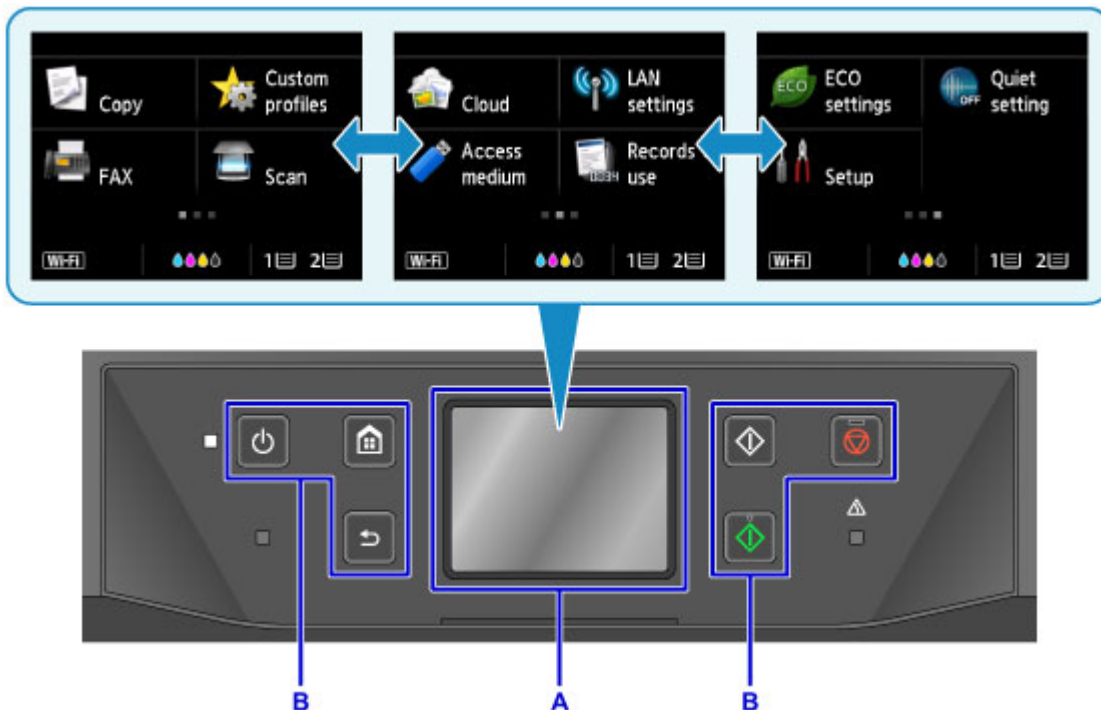

A: touch screen

B: Buttons on the operation panel

Basic touch screen operations

Tap the touch screen lightly or use other gestures to access various functions and settings.

►►► Important

- Note the following touch screen precautions to avoid malfunction or damage to the machine.
 - Do not press hard against the touch screen.
 - Do not press the touch screen with objects other than your finger—especially sharp objects, such as pens, pencils, or nails.
 - Do not touch the touch screen if your hands are wet or dirty.
 - Do not place any objects on the touch screen.
- Do not apply a screen protector to the touch screen. Removing it may damage the touch screen.

Tap

Touch lightly and briefly with your fingertip.

Tap to select an item or photo on the screen, for example.

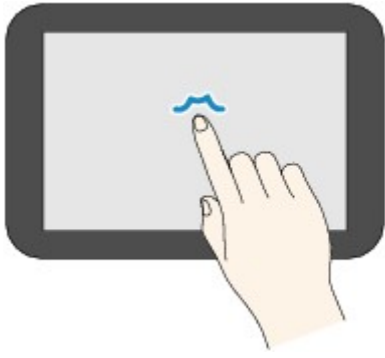

Touch

Touch with your fingertip, pressing lightly.

Keep touching the "next" (or "back") icon to move forward or back through menus or photos continuously, for example.

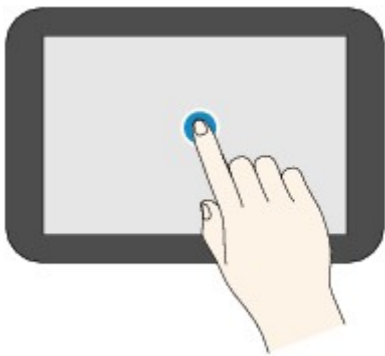

Flick

Flick up, down, left, or right on the screen with your finger.

Flick to switch menus or move forward or back through photos, for example.

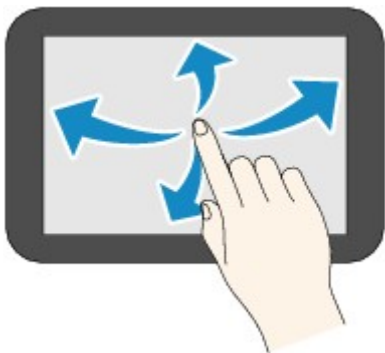

Drag

While lightly touching the screen, move your finger up, down, left, or right.

Drag to view listed items or move sliders, for example.

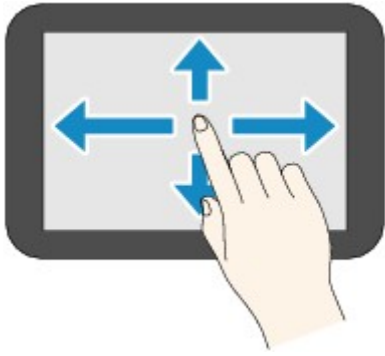



Example of using the touch screen

These touch screen operations are available on the copy standby screen.



Tap A to display the print settings menu.

Drag up or down, and then tap an item to select it.

You can scroll up and down through the menu by touching  or  (D).

After the list is displayed, tap a setting to select it.

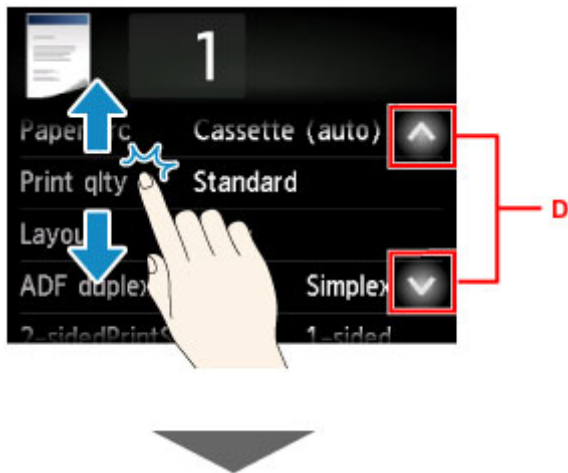

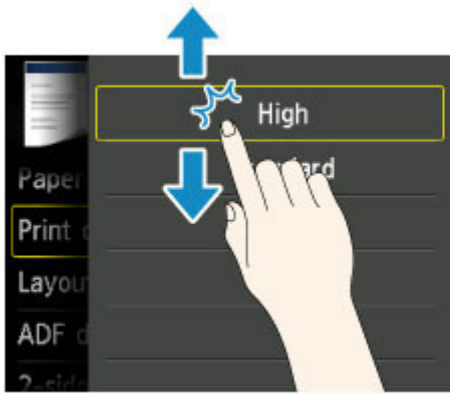

Tap B to display the screen for selecting the number of copies.



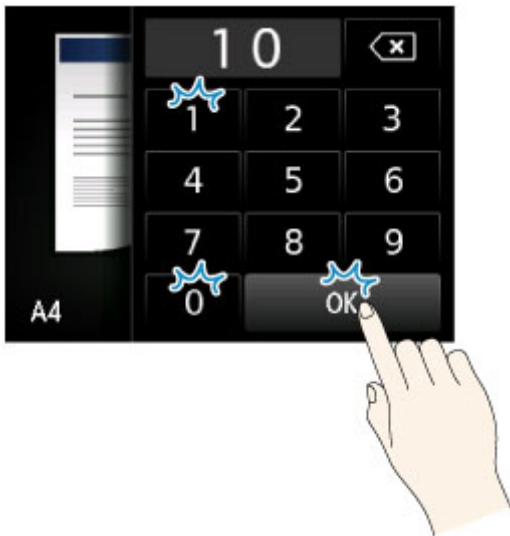

Tap a number to specify the number of copies, and then tap **OK**.

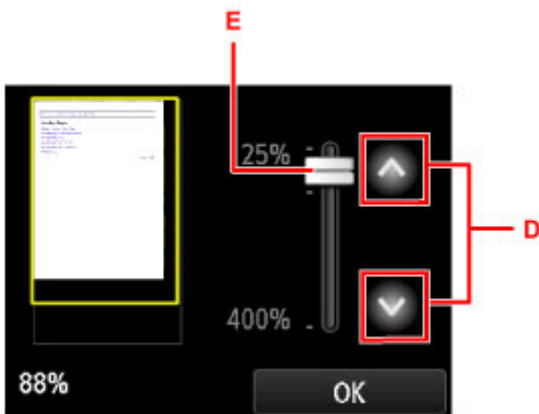

Tap C to display the preview screen.

As you view the preview at left, drag the slider (E) up or down to reduce or enlarge the image.



You can also tap  or  (D) to reduce or enlarge images. Keep touching  or  to adjust magnification continuously.

After you have the desired magnification, tap **OK**.

Entering Numbers, Letters, and Symbols

When entering user or recipient names or other information, you can enter or edit characters by selecting them on the screen.

Switching the Input Mode

The machine has one input mode for letters and another for numbers and symbols. To switch modes, tap  (A) in the lower left.

To switch between lower and uppercase in the alphabetic mode and between different types of characters in the number/symbol mode, tap  (B).

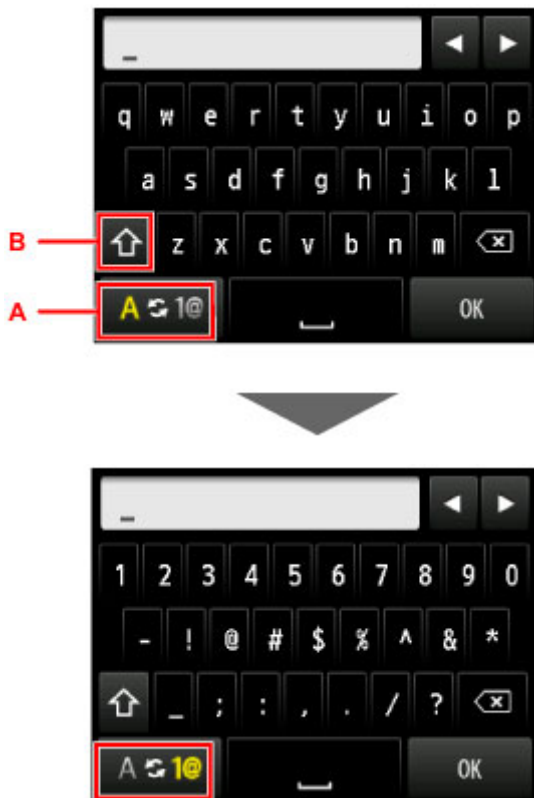

»» Note

- The screen only shows numbers and symbols that are available for the type of information you are entering, such as numbers for telephone or fax number input.

Entering or Editing Numbers, Letters, and Symbols



Enter information as follows.

- To move the insertion point (cursor position) in the input field (C)

Tap or (D).

- To delete an entered character

Move the cursor to the character to delete, and then tap (E).

Touch to keep deleting characters.

- To insert a space

Tap (F).

After you are finished entering information, tap **OK** (G).

Entering Letters With Accents or Diacritics

Tap the same key repeatedly until the desired character is displayed in the input field (C).

Key	Lowercase	Uppercase
a / A	a á â ã ä å æ	A Ä Å Æ
c / C	c ç	C Ç
e / E	e ë é ê	E È É Ê
i / I	í î ï	I Í Î
n / N	n ñ	N Ñ
o / O	o ø ö ò ô õ	O Ø Ó Ô Õ
p / P	p þ	P Þ
u / U	u ü ú û û	U Ü Ú Û Ü
y / Y	y ý	Y Ý

Changing Settings

- ▶ **Changing Printer Settings from Your Computer (Windows)**
- ▶ **Changing Printer Settings from Your Computer (Mac OS)**
- ▶ **Changing Settings from Operation Panel**
- ▶ **Changing Printer's Setting Using Web Browser**

Changing Printer Settings from Your Computer (Windows)

- **Changing the Print Options**
- **Registering a Frequently Used Printing Profile**
- **Managing the Printer Power**
- **Reducing the Printer Noise**
- **Changing the Printer Operation Mode**

Changing the Print Options

You can change the detailed printer driver settings for print data that is sent from an application software. Check this check box if part of the image data is cut off, the paper source during printing differs from the driver settings, or printing fails.

The procedure for changing the print options is as follows:

1. Open the [printer driver setup window](#)
2. Click **Print Options...** on the **Page Setup** tab

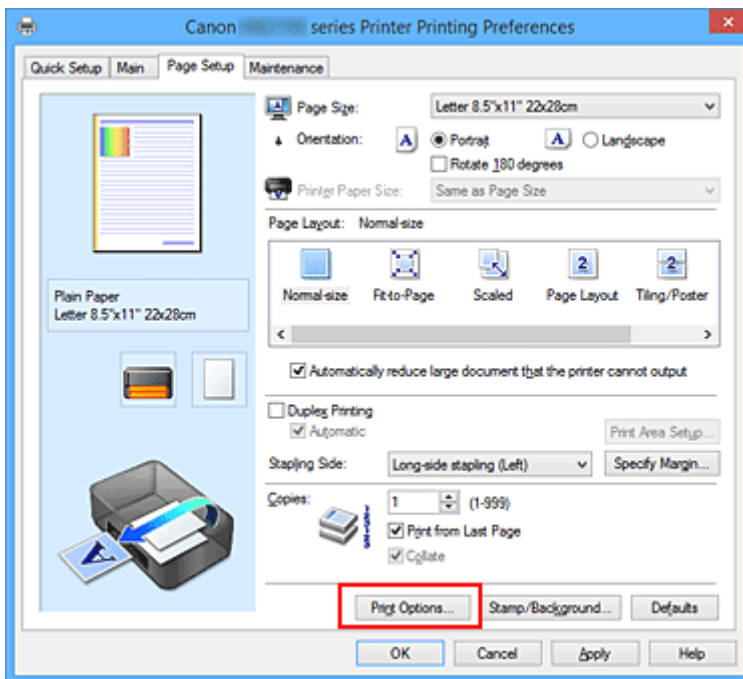

The **Print Options** dialog box opens.

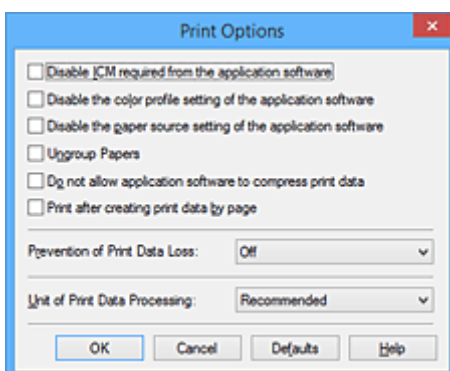

►►► Note

- When you use the XPS printer driver, the functions available to you are different.

3. Change the individual settings

If necessary, change the setting of each item, and then click **OK**.

The **Page Setup** tab is displayed again.

Registering a Frequently Used Printing Profile

You can register the frequently used printing profile to **Commonly Used Settings** on the **Quick Setup** tab. Unnecessary printing profiles can be deleted at any time.

The procedure for registering a printing profile is as follows:

Registering a Printing Profile

1. Open the [printer driver setup window](#)

2. Set the necessary items

From **Commonly Used Settings** on the **Quick Setup** tab, select the printing profile to be used and if necessary, change the settings after **Additional Features**.

You can also register necessary items on the **Main** and **Page Setup** tabs.

3. Click **Save...**

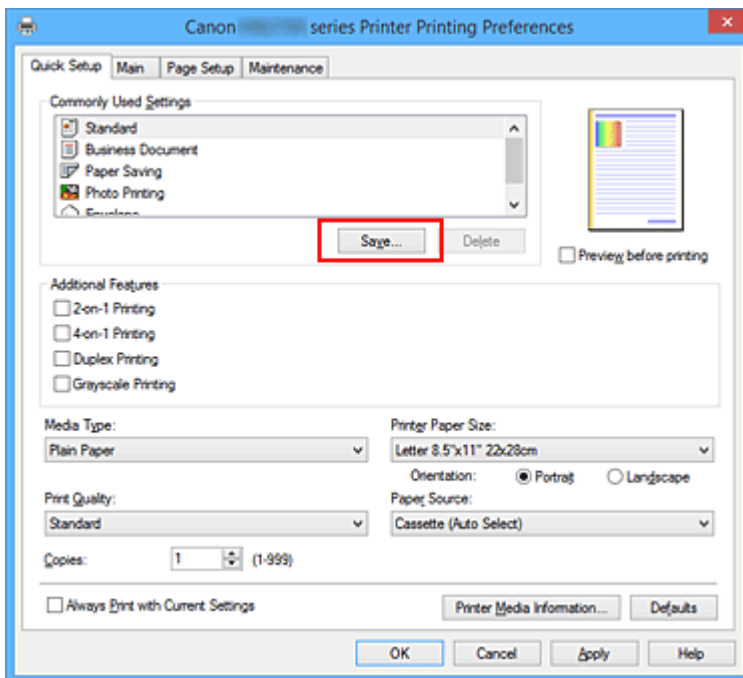

The **Save Commonly Used Settings** dialog box opens.



4. Save the settings

Enter a name in the **Name** field. If necessary, click **Options...**, set the items, and then click **OK**.

In the **Save Commonly Used Settings** dialog box, click **OK** to save the print settings and return to the **Quick Setup** tab.

The name and icon are displayed in **Commonly Used Settings**.

▶▶▶ Important

- To save the page size, orientation, and number of copies that was set in each sheet, click **Options...**, and check each item.

▶▶▶ Note

- When you re-install the printer driver or upgrade the printer driver version, the print settings that are already registered will be deleted from **Commonly Used Settings**.
Registered print settings cannot be saved and preserved. If a profile is deleted, register the print settings again.

Deleting Unnecessary Printing Profile

1. Select the printing profile to be deleted

Select the printing profile you want to delete from the **Commonly Used Settings** list on the **Quick Setup** tab.

2. Delete the printing profile

Click **Delete**. When the confirmation message appears, click **OK**.

The selected printing profile is deleted from the **Commonly Used Settings** list.

▶▶▶ Note

- Printing profiles that are registered in the initial settings cannot be deleted.

Managing the Printer Power

This function allows you to manage the printer power from the printer driver.

The procedure for managing the printer power is as follows:



Power Off

The **Power Off** function turns off the printer. When you use this function, you will not be able to turn the printer on from the printer driver.

1. Open the [printer driver setup window](#)
2. Execute power off

Click **Power Off** on the **Maintenance** tab. When the confirmation message appears, click **OK**.

The printer power switches off, and the **Maintenance** tab is displayed again.

»» Important

- You cannot receive faxes when the printer is switched off.

Reducing the Printer Noise

The silent function allows you to reduce the operating noise of this printer. Select when you wish to reduce the operating noise of the printer at night, etc.

Using this function may lower the print speed.

The procedure for using the quiet mode is as follows:



Quiet Settings

1. Open the [printer driver setup window](#)
2. Click **Quiet Settings** on the **Maintenance** tab

The **Quiet Settings** dialog box opens.

▶▶▶ Note

- If the printer is off or if communication between the printer and the computer is disabled, an error message may appear because the computer cannot collect the printer status.

3. Set the quiet mode

If necessary, specify one of the following items:

Do not use quiet mode

Select this option when you wish to use the printer with volume of normal operating noise.

Always use quiet mode

Select this option when you wish to reduce the operating noise of the printer.

Use quiet mode during specified hours

Select this option when you wish to reduce the operating noise of the printer during a specified period of time.

Set the **Start time** and the **End time** of the quiet mode you wish to be activated. If both are set to the same time, the quiet mode will not function.

▶▶▶ Important

- You can set the quiet mode from the operation panel of the printer, the printer driver, or ScanGear (scanner driver).
No matter how you use to set the quiet mode, the mode is applied when you perform operations from the operation panel of the printer or printing and scanning from the computer.

4. Apply the settings

Make sure that the printer is on and click **OK**.

Click **OK** when the confirmation message appears.

The settings are enabled hereafter.

»» Note

- The effects of the quiet mode may be less depending on the paper source and the print quality settings.

Changing the Printer Operation Mode

If necessary, switch between various modes of printer operation.

The procedure for configuring **Custom Settings** is as follows:



Custom Settings

1. Open the [printer driver setup window](#)
2. Make sure that the printer is on, and then click **Custom Settings** on the **Maintenance** tab

The **Custom Settings** dialog box opens.

▶▶▶ Note

- If the printer is off or if communication between the printer and the computer is disabled, an error message may appear because the computer cannot collect the printer status. If this happens, click **OK** to display the most recent settings specified on your computer.

3. If necessary, complete the following settings:

Prevent paper abrasion

The printer can increase the gap between the print head and the paper during high-density printing to prevent paper abrasion.

Check this check box to prevent paper abrasion.

Align heads manually

Usually, the **Print Head Alignment** function on the **Maintenance** tab is set to automatic head alignment, but you can change it to manual head alignment.

If the printing results of automatic print head alignment are not satisfactory, [perform manual head alignment](#).

Check this check box to perform the manual head alignment. Uncheck this check box to perform the automatic head alignment.

Rotate 90 degrees left when orientation is [Landscape]

On the **Page Setup** tab, you can change the rotation direction of the **Landscape** in the **Orientation**.

To rotate the print data 90 degrees to the left during printing, select this item. To rotate the print data 90 degrees to the right during printing, clear this item.

▶▶▶ Important

- Do not change this setting while the print job is displayed in the print wait list. Otherwise, characters may be omitted or the layout may become corrupt.

Don't detect mismatch of paper settings when printing from computer

When you print documents from your computer and the paper settings on the printer driver and the cassette paper information registered on the printer do not match, this setting disables the

message display and allows you to continue printing.

To disable detection of paper setting mismatches, select this check box.

Ink Drying Wait Time

You can set the length of the printer rest time until printing of the next page begins. Moving the slider to the right increases the pause time, and moving the slider to the left decreases the time.

If the paper gets stained because the next page is ejected before the ink on the printed page dries, increase the ink drying wait time.

Reducing the ink drying wait time speeds up printing.

4. Apply the settings

Click **OK** and when the confirmation message appears, click **OK**.

The printer operates with the modified settings hereafter.

Changing Settings from Operation Panel

- ▶ **Changing Settings from Operation Panel**
- ▶ **Setting Items on Operation Panel**
- ▶ **FAX settings**
- ▶ **Print settings**
- ▶ **LAN settings**
- ▶ **Device user settings**
- ▶ **Language selection**
- ▶ **Firmware update**
- ▶ **Cassette settings**
- ▶ **Administrator password setting**
- ▶ **Operation restrictions**
- ▶ **Reset setting**
- ▶ **Web service setup**
- ▶ **System information**
- ▶ **ECO settings**
- ▶ **Quiet setting**
- ▶ **Registering Favorite Settings (Custom profiles)**
- ▶ **Checking the Total Number of Uses of Machine**

Changing Settings from Operation Panel

This section describes the procedure to change the settings in the **Device settings** screen, taking the steps to specify **Prevent paper abrasion** as an example.

1. [Make sure printer is turned on.](#)

2. Flick HOME screen and tap  **Setup**.

■ ■ [Using the Operation Panel](#)

3. Tap  **Device settings**.

The **Device settings** screen appears.

4. Tap setting item to adjust.

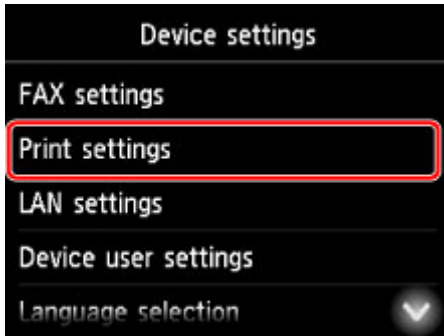

The setting screen for the selected item is displayed.

5. Tap setting item.

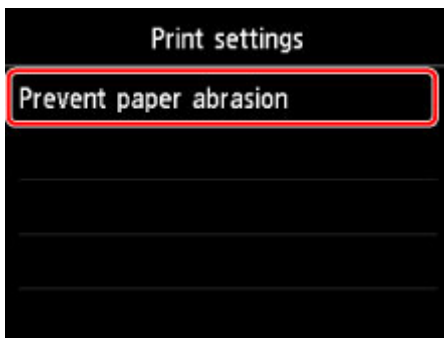

6. Tap setting to specify.

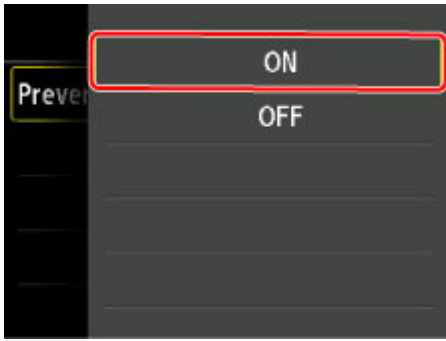

For more on setting items on the operation panel:

- [Setting Items on Operation Panel](#)

Setting Items on Operation Panel

►►► Note

- The administrator password is required to change some setting items if it is enabled for changing settings using the operation panel.

For more on setting items which the administrator password is required:

- [Setting Administrator Password on Operation Panel](#)

Items for Security

- [Administrator password setting](#)
- [Operation restrictions](#)

Items for Printer

- [FAX settings](#)
- [Device user settings](#)
- [Web service setup](#)
- [Language selection](#)
- [ECO settings](#)
- [Quiet setting](#)
- [Registering Favorite Settings \(Custom profiles\)](#)

Items for Paper/Printing

- [Print settings](#)
- [Cassette settings](#)
- [Paper Settings](#)

Items for Maintenance/Management

- [System information](#)
- [Firmware update](#)
- [LAN settings](#)
- [Reset setting](#)
- [Checking the Total Number of Uses of Machine](#)

FAX settings

▶▶▶ Important

- This setting item is for the administrator.

This section describes the setting items in **FAX settings**.

- [FAX user settings](#)
- [Advanced FAX settings](#)
- [Auto print settings](#)
- [Auto save setting](#)
- [Security control](#)
- [Easy setup](#)

▶▶▶ Note

- Before changing the settings, you can confirm the current settings by printing USER'S DATA LIST.

- [Summary of Reports and Lists](#)

FAX user settings

- **User information settings**

Registers your name and fax/telephone number printed on sent faxes.

- [Registering User Information](#)

- **Telephone line type (Country or region of purchase other than China)**

Selects the telephone line type setting for the printer.

- [Setting Telephone Line Type](#)

▶▶▶ Note

- This setting may not be available depending on the country or region of purchase.

- **Telephone line auto selection (China only)**

If you select **ON**, the telephone line type is selected automatically.

If you select **OFF**, you can select the telephone line type manually.

- [Setting Telephone Line Type](#)

Advanced FAX settings

- **Auto redial**

Enables/disables automatic redialing.

If you select **ON**, you can specify the maximum number of redial attempts and the length of time the printer waits between redial attempts.

- **Dial tone detect**

Avoids mistransmission when reception and transmission occur at the same time.

If you select **ON**, the printer transmits the fax after confirming the dial tone.

►► Note

- This setting may not be available depending on the country or region of purchase.

- **Pause time settings**

Sets the length of pause time for each when you enter "P" (pause).

- **TTI position**

Selects the position of the sender information (outside or inside the image area).

- **Remote RX**

Enables/disables remote reception.

If you select **ON**, you can specify the remote reception ID.

- [Remote Reception](#)

- **Color transmission**

When faxing color documents using the ADF, selects whether to convert them into black & white data if the recipient's fax device does not support color faxing.

If you select **Disconnect**, the printer does not send color documents when the recipient's fax device does not support color faxing.

- **RX image reduction**

Enables/disables automatic reduction of incoming faxes so that they fit in the selected paper.

If you select **ON**, you can select the image reduction direction.

- **Adv. communication settings**

- **ECM TX**

Selects whether to send faxes in Error Correction Mode (ECM).

- [Transmission/Reception of Faxes Using ECM](#)

- **ECM RX**

Selects whether to receive faxes in Error Correction Mode (ECM).

- [Transmission/Reception of Faxes Using ECM](#)

- **TX start speed**

Selects the fax transmission speed.

The fax transmission start speed will be faster as the value is bigger.

When the telephone line condition or connection is poor, selecting a lower transmission start speed may solve transmission problems.

- **RX start speed**

Selects the fax reception speed.

The fax reception start speed will be faster as the value is bigger.

When the telephone line condition or connection is poor, selecting a lower reception start speed may solve reception problems.

Auto print settings

- **Received documents**

Selects whether to print the received fax automatically when receiving a fax.

If you select **Do not print**, the received fax is stored in the printer's memory.

For details on the received fax stored in the printer's memory:

- [Document Stored in Printer's Memory](#)

- **Activity report**

Selects whether to print ACTIVITY REPORT automatically.

If you select **Print**, the printer prints ACTIVITY REPORT for the 20 histories of sent and received faxes automatically.

For details on the procedure to print ACTIVITY REPORT manually:

- [Summary of Reports and Lists](#)

- **TX report**

Selects whether to print TX REPORT/ERROR TX REPORT automatically after sending a fax.

If you print the report, select **Print error only** or **Print for each TX**.

If you select **Print error only** or **Print for each TX**, you can specify the print setting that the first page of the fax is printed along with the report.

- **RX report**

Selects whether to print RX REPORT automatically after receiving a fax.

If you print RX REPORT, select **Print error only** or **Print for each RX**.

- **Print when out of ink**

Sets whether to continue printing the received fax without storing it in the printer's memory when the ink has run out.

However, part or all of the fax may not be printed since the ink has run out.

Auto save setting

Selects whether to save the received fax on the USB flash drive automatically or to forward to the shared folder on the computer automatically after receiving a fax.

- [Saving Received Faxes Automatically on USB Flash Drive](#)

- [Forwarding Received Faxes Automatically to Shared Folder on Computer](#)

Security control

- **FAX number re-entry**

If you select **ON**, you can set the printer to send faxes after entering the number twice. By using this setting, you can avoid the mistransmission of faxes.

■ [Preventing Mistransmission of Faxes](#)

- **Check RX FAX information**

If you select **ON**, the printer checks whether the recipient's fax device information matches the dialed number. If it matches the number, the printer starts to send faxes.

■ [Preventing Mistransmission of Faxes](#)

- **Hook key setting**

If you select **Enable**, you can use the on hook dial function.

- **FAX reception reject**

If you select **ON**, the printer rejects the reception of faxes with no sender information or faxes from specific senders.

■ [Rejecting Fax Reception](#)

- **Caller rejection**

If you subscribe to the Caller ID service, the printer detects the sender's Caller ID. If the sender's ID matches the condition specified in this setting, the printer rejects the phone call or fax reception from the sender.

If you select **Yes** on the subscribing confirmation screen, you can specify the settings of rejection.

■ [Using Caller ID Service to Reject Calls](#)

▶▶▶ Note

- This setting may not be supported depending on the country or region of purchase. Contact your telephone company to confirm whether it provides this service.

Easy setup

The printer must be set up depending on your telephone line and use of the faxing function. Follow the procedure according to the instructions on the touch screen.

▶▶▶ Note

- You can specify the setup setting individually or the advanced setting.

For details on how to specify the setting:

■ [Preparing for Faxing](#)

Print settings

Select this setting item from **Device settings** on **Setup**.

- **Prevent paper abrasion**

Use this setting only if the print surface becomes smudged.

»» Important

- Be sure to set this back to **OFF** after printing since it may result in lower printing speed or lower print quality.

LAN settings

Select this setting item from **Device settings** on **Setup**.

▶▶▶ Important

- The administrator password is required to change settings if it is enabled for changing settings using the operation panel.

- **Change LAN**

Enables either wireless LAN, wired LAN, or direct connection. You can also disable all.

- **Wireless LAN setup**

Selects the setup method for wireless LAN connection.

▶▶▶ Note

- You can also enter this setting menu by selecting **LAN settings** on the HOME screen. In this case, enable wireless LAN.

- **Cableless setup**

Select if you specify the settings of the access point information to the printer directly from a device (e.g. smartphone, or tablet) without operating the wireless router. Follow the on-screen instructions of the connecting device for the setup procedure.

- **Standard setup**

Select when you perform settings for wireless LAN manually using the operation panel of the printer.

- **WPS (Push button method)**

Select when you perform settings for wireless LAN using a wireless router supporting a Wi-Fi Protected Setup (WPS) push button method. Follow the on-screen instructions during setup.

- **Other setup**

- **Advanced setup**

Select when you perform settings for wireless LAN manually. You can specify multiple WEP keys.

- **WPS (PIN code method)**

Select when you perform settings for wireless LAN using a wireless router supporting a Wi-Fi Protected Setup (WPS) PIN code method. Follow the on-screen instructions during setup.

- **Confirm LAN settings**

The list of wireless/wired LAN settings or the direct connection of this printer is displayed on the touch screen. Tap **Print details** and then **Yes** to print the list.

For more information on the printer's network setting is printed out:

- [Printing Network Settings](#)

▶▶▶ Important

- The network settings printout contains important information about your network. Handle it with care.

- **WLAN setting list**

The list of wireless LAN settings of this printer is displayed on the touch screen.

The following setting items are displayed. (Some setting items are not displayed depending on the printer settings.)

Items	Setting
SSID	XXXXXXXXXXXXXXXXXXXX XXXXXXXXXXXXXXXXXXXX (up to 32 characters)
Wireless LAN security	Inactive/WEP(64bit)/WEP(128bit)/WPA-PSK(TKIP)/WPA-PSK(AES)/ WPA2-PSK(TKIP)/WPA2-PSK(AES)
Signal strength (%)	XXX
IPv4 address	XXX. XXX. XXX. XXX (12 characters)
IPv4 subnet mask	XXX. XXX. XXX. XXX (12 characters)
IPv4 default gateway	XXX. XXX. XXX. XXX (12 characters)
IPv6 address	XXXX: XXXX: XXXX: XXXX: XXXX: XXXX: XXXX: XXXX (32 characters)
MAC address	XX:XX:XX:XX:XX:XX (12 characters)
Printer name	XXXXXXXXXXXXXXXXXXXX (up to 15 characters)
Bonjour service name	XXXXXXXXXXXXXXXXXXXX XXXXXXXXXXXXXXXXXXXX XXXXXXXXXXXXXXXXXXXX XXXXXXXXXXXXXXXXXXXX (up to 52 characters)
Root cert. thumbprint (SHA-1)	XXXXXXXXXX XXXXXXXXXX XXXXXXXXXX XXXXXXXXXX XXXXXXXXXX
Root cert. thumbprint (SHA-256)	XXXXXXXXXX XXXXXXXXXX XXXXXXXXXX XXXXXXXXXX XXXXXXXXXX XXXXXXXXXX XXXXXXXXXX XXXXXXXXXX

("XX" represents alphanumeric characters.)

- **LAN setting list**

The list of wired LAN settings of this printer is displayed on the touch screen.

The following setting items are displayed. (Some setting items are not displayed depending on the printer settings.)

Items	Setting
IPv4 address	XXX. XXX. XXX. XXX (12 characters)
IPv4 subnet mask	XXX. XXX. XXX. XXX (12 characters)
IPv4 default gateway	XXX. XXX. XXX. XXX (12 characters)

IPv6 address	XXXX: XXXX: XXXX: XXXX: XXXX: XXXX: XXXX: XXXX (32 characters)
MAC address	XX:XX:XX:XX:XX:XX (12 characters)
Printer name	XXXXXXXXXXXXXXXXXX (up to 15 characters)
Bonjour service name	XXXXXXXXXXXXXXXXXX XXXXXXXXXXXXXXXXXX XXXXXXXXXXXXXXXXXX XXXXXXXXXXXXXXXXXX (up to 52 characters)
Root cert. thumbprint (SHA-1)	XXXXXXXXXX XXXXXXXXXX XXXXXXXXXX XXXXXXXXXX XXXXXXXXXX
Root cert. thumbprint (SHA-256)	XXXXXXXXXX XXXXXXXXXX XXXXXXXXXX XXXXXXXXXX XXXXXXXXXX XXXXXXXXXX XXXXXXXXXX XXXXXXXXXX

("XX" represents alphanumeric characters.)

- **Direct connection setting list**

The list of direct connection settings of this printer is displayed on the touch screen.

The following setting items are displayed. (Some setting items are not displayed depending on the printer settings.)

Items	Setting
SSID	DIRECT-XXXX-XXXXXXseries
Password	XXXXXXXXXXXX (10 characters)
Wireless LAN security	WPA2-PSK(AES)
IPv4 address	XXX. XXX. XXX. XXX (12 characters)
IPv4 subnet mask	XXX. XXX. XXX. XXX (12 characters)
IPv4 default gateway	XXX. XXX. XXX. XXX (12 characters)
IPv6 address	XXXX: XXXX: XXXX: XXXX: XXXX: XXXX: XXXX: XXXX (32 characters)
MAC address	XX:XX:XX:XX:XX:XX (12 characters)
Printer name	XXXXXXXXXXXXXXXXXX (up to 15 characters)
Bonjour service name	XXXXXXXXXXXXXXXXXX XXXXXXXXXXXXXXXXXX XXXXXXXXXXXXXXXXXX XXXXXXXXXXXXXXXXXX (up to 52 characters)
Direct connection device name	XXXXXX-XXXXXXseries
Root cert. thumbprint (SHA-1)	XXXXXXXXXX XXXXXXXXXX XXXXXXXXXX XXXXXXXXXX XXXXXXXXXX

Root cert. thumbprint (SHA-256)	XXXXXXXX XXXXXXXX XXXXXXXX XXXXXXXX XXXXXXXX XXXXXXXX XXXXXXXX XXXXXXXX
--	--

("XX" represents alphanumeric characters.)

- **Other settings**

»» Important

• You cannot select the items below when **Disable LAN** is selected for **Change LAN**.

- **Direct connection settings**

Setting items are available when you connect a device to the printer.

»» Important

• You can select these setting items only when **Activate direct connect.** is selected for **Change LAN**.

- **Update SSID/password**

Selecting **Yes** updates the identifier (SSID) and password for direct connection.

- **Change device name**

Changes the printer's name displayed on a Wi-Fi Direct compatible device.

- **Connection request confirmation**

Selecting **Yes** displays the confirmation screen when a Wi-Fi Direct compatible device is connecting the printer.

- [Using Machine with Direct Connection](#)

- **Set printer name**

Specifies the printer name. You can use up to 15 characters for the name.

»» Note

- You cannot use the same printer name as that already used for other LAN connected devices.
- You cannot use a hyphen for the initial or last character of the printer name.

- **TCP/IP settings**

Performs IPv4 or IPv6 setting.

- **WSD setting**

Setting items when you use WSD (one of the network protocols supported in Windows 10, Windows 8.1, Windows 8, Windows 7, and Windows Vista).

- **Enable/disable WSD**

Selects whether WSD is enabled or disabled.

»» Note

- When this setting is enabled, the printer icon is displayed on the Network Explorer in Windows 10, Windows 8.1, Windows 8, Windows 7, and Windows Vista.

- **Optimize inbound WSD**

Selecting **Enable** allows you to receive the WSD printing data faster.

- **WSD scan from this device**

Selecting **Enable** allows you to transfer the scanned data to the computer using WSD.

- **Timeout setting**

Specifies the timeout length.

- **Bonjour settings**

Setting items for LAN using Bonjour for Mac OS.

- **Enable/disable Bonjour**

Selecting **Enable** allows you to use Bonjour to perform the network settings.

- **Service name**

Specifies the Bonjour service name. You can use up to 48 characters for the name.

▶▶▶ **Note**

- You cannot use the same service name as that already used for other LAN connected devices.

- **LPR protocol setting**

Enables/disables the LPR setting.

- **RAW protocol**

Enables/disables RAW printing.

- **LLMNR**

Enables/disables LLMNR (Link-Local Multicast Name Resolution). Selecting **Active** allows the printer to detect printer's IP address from the printer name without a DNS server.

- **Wired LAN DRX setting**

Selecting **Enable** allows you to activate discontinuous reception when the printer is connected to a device compatible with wired LAN.

Device user settings

Select this setting item from **Device settings** on **Setup**.

▶▶▶ Important

- The administrator password is required to change settings if it is enabled for changing settings using the operation panel.

- **Date/time setting**

Sets the current date and time.

For more on the procedure:

- [Setting Sender Information](#)

- **Date display format**

Sets the format of dates displayed on the touch screen and printed on sent faxes and photos.

▶▶▶ Note

- When **ON** is selected for **Print date** on the print settings screen in printing from a USB flash drive, the shooting date is printed in the date display format you selected.

- [Setting Items for Photo Printing Using Operation Panel](#)

- **Daylight saving time setting**

Enables/disables the summer time setting. If you select **ON**, you can select additional sub-settings. This setting may not be available depending on the country or region of purchase.

- **Start date/time**

Sets the date and time that summer time starts.

Month: Specify the month.

Week: Specify the week.

DOW: Specify the day of the week.

The screen to set the shift time to start summer time will be displayed after specifying the items above and tapping **OK**.

After specifying the shift time and tapping **OK**, you can specify the end date/time.

- **End date/time**

Sets the date and time that summer time ends.

Month: Specify the month.

Week: Specify the week.

DOW: Specify the day of the week.

The screen to set the shift time to end summer time will be displayed after specifying the items above and tapping **OK**.

Specify the shift time and tap **OK**.

- **Time zone**

Specifies the time zone according to a country or region you live in.

Specifying the time zone allows you to display the correct time and date an e-mail was sent on your mail software.

For more on the time zone for each country or region:

■ [Timezone List](#)

- **Sound control**

Selects the volume.

- **Keypad volume**

Selects the beep volume when tapping the touch screen or the buttons on the operation panel.

- **Alarm volume**

Selects the alarm volume.

- **Line monitor volume**

Selects the line monitor volume.

- **Offhook alarm**

Selects the alarm volume when the phone receiver is not put on the hook properly.

- **Country or region**

Selects the country or region where you are using the printer.

»» **Note**

- This setting may not be available depending on the country or region of purchase.

- **Device info sending setting**

Selects whether you will send the printer usage information to Canon. The information sent to Canon will be utilized to develop better products. Select **Agree** to send the printer usage information to Canon.

- **Power control**

Allows you to turn on/off the printer automatically to save electricity. In addition, you can specify the time and day to turn it on/off.

- **Enable auto power control**

Specifies the length of time to turn off the printer automatically when no operation is made or no printing data is sent to the printer. In addition, you can allow the printer to turn on automatically when a scanning command from a computer or printing data is sent to the printer.

- **Enable scheduling**

Specifies the time to turn on/off the printer automatically for each day.

- **Do not control power**

Disables the function to turn on/off the printer automatically.

»» Note

- You can also enter this setting menu by selecting **ECO settings** and **Power control** on the HOME screen.

■ [ECO settings](#)

Timezone List

Time zone	Country or region
(UTC-12:00)	Baker Island, Howland Island
(UTC-11:00)	American Samoa, Niue
(UTC-10:00)	Hawaii, Western area of Aleutian Islands
(UTC-9:00)	Alaska
(UTC-8:00)	US/Canada/Mexico (Pacific Time)
(UTC-7:00)	US/Canada/Mexico (Mountain Time)
(UTC-6:00)	US/Canada/Mexico (Central Time)
(UTC-5:00)	US/Canada/Mexico (Eastern Time), Cuba, Peru
(UTC-4:30)	Venezuela
(UTC-4:00)	Canada (Atlantic Time), Most areas of Lesser Antilles, Brazil (Amazon Time), Chile
(UTC-3:30)	Canada (Newfoundland)
(UTC-3:00)	Brazil (Brasilia time), Argentina, Greenland
(UTC-2:00)	Brazil (Fernando de Noronha)
(UTC-1:00)	Azores, Cape Verde
(UTC+00:00)	United Kingdom, Ireland, Portugal, Iceland, Morocco (Western Africa), Ghana
(UTC+1:00)	Central European Time (France, Germany), West Africa Time (Nigeria, Congo)
(UTC+2:00)	Eastern European Time (Finland, Greece), Central Africa Time, South Africa
(UTC+3:00)	Russia (Kaliningrad), Ukraine, Belarus, Saudi Arabia, East Africa Time
(UTC+3:30)	Iran
(UTC+4:00)	Russia (Moscow), Azerbaijan, Georgia, United Arab Emirates, Mauritius
(UTC+4:30)	Afghanistan
(UTC+5:00)	Pakistan
(UTC+5:30)	India
(UTC+5:45)	Nepal
(UTC+6:00)	Russia (Yekaterinburg), Kazakhstan, Bangladesh
(UTC+6:30)	Myanmar, Cocos Islands
(UTC+7:00)	Russia (Omsk), Mongolia, Thailand, Vietnam, Jakarta
(UTC+8:00)	Russia (Krasnoyarsk), China, Mongolia, Malaysia, Australia (Western Australia)
(UTC+8:45)	Australia (Eucla)
(UTC+9:00)	Russia (Irkutsk), South Korea, Japan, Palau
(UTC+9:30)	Australia (Northern Territory, South Australia)
(UTC+10:00)	Russia (Yakutsk), Guam, Australian Eastern Standard Time
(UTC+10:30)	Australia (Lord Howe Island)

(UTC+11:00)	Russia (Vladivostok), Solomon Islands, New Caledonia
(UTC+12:00)	Russia (Magadan), New Zealand, Fiji, Kiribati (Gilbert Islands)
(UTC+12:45)	New Zealand (Chatham Island)
(UTC+13:00)	Tonga, Kiribati (Phoenix Islands), Samoa (From 2011/12/31), Tokelau (From 2011/12/31)
(UTC+14:00)	Kiribati (Line Islands)

Language selection

Select this setting item from **Device settings** on **Setup**.

Important

- The administrator password is required to change settings if it is enabled for changing settings using the operation panel.

Changes the language for the messages and menus on the touch screen.

Firmware update

Select this setting item from **Device settings** on **Setup**.

▶▶▶ Important

- The administrator password is required to change settings if it is enabled for changing settings using the operation panel.

You can update the firmware of the printer, check the firmware version, or perform settings of a notification screen, a DNS server and a proxy server.

▶▶▶ Note

- Only **Check current version** is available when **Disable LAN** or **Activate direct connect**. is selected for **Change LAN** in **LAN settings**.

• Install update

Performs the firmware update of the printer. If you select **Yes**, the firmware update starts. Follow the on-screen instructions to perform update.

▶▶▶ Important

- When you use this function, make sure the printer is connected to the Internet.
- If the firmware update is carried out, all faxes stored in the printer's memory are deleted.
- You cannot start the firmware update under the following conditions:
 - While the printer is sending or receiving a fax
 - While the printer is storing the unprinted fax in printer's memory (memory reception)
 - When the unsent faxes are stored in the printer's memory

▶▶▶ Note

- If the firmware update is not complete, check the following and take an appropriate action.
 - When using wired LAN, make sure the printer is connected to the computer with a LAN cable properly.
 - Check the network settings such as a router.
 - If **Cannot connect to the server**. is displayed on the touch screen, tap **OK** and try again after a while.

• Check current version

You can check the current firmware version.

• Update notification setting

When **Yes** is selected and the firmware update is available, the screen to inform you of the firmware update is displayed on the touch screen.

• DNS server setup

Performs settings for a DNS server. Select **Auto setup** or **Manual setup**. If you select **Manual setup**, follow the display on the touch screen to perform settings.

- **Proxy server setup**

Performs settings for a proxy server. Follow the display on the touch screen to perform settings.

Cassette settings

Select this setting item from **Device settings** on **Setup**.

By registering the paper size and the media type loaded in the cassette, you can prevent the printer from misprinting by displaying the message before printing starts when the paper size or the media type of the loaded paper differs from the print settings. In addition, you can allow the printer to switch the paper source automatically when a cassette runs out of paper.

For details:

■ [Paper Settings](#)

• **Register cassette paper info**

Registers the paper size and the media type you load in the cassette.

▶▶▶ **Note**

- When you register the paper size and the media type, the screen to select whether you apply the settings to those for copying is displayed. Select **Yes** to apply the registered settings to copying.
- For more on the combination of paper settings you can specify by the printer driver or on the touch screen:
 - For Windows:
 - [Paper Settings on the Printer Driver and the Printer \(Media Type\)](#)
 - [Paper Settings on the Printer Driver and the Printer \(Paper Size\)](#)
 - For Mac OS:
 - Paper Settings on the Printer Driver and the Printer (Media Type)
 - Paper Settings on the Printer Driver and the Printer (Paper Size)

• **Detect paper setting mismatch**

If you select **Yes**, the printer detects whether the paper size and the media type are identical with those registered in **Register cassette paper info**. If printing starts with the settings that do not match, an error message is displayed on the touch screen.

• **Detect cassette reinsertion**

If you select **Yes**, the printer detects the cassette is reinserted. When the **Register cassette paper info** screen is displayed, register the paper size and the media type.

• **Auto feed switch**

If you select **Yes**, the printer switches the paper source automatically when a cassette runs out of paper. Load A4, Letter, or Legal sized plain paper in both of the cassettes to activate this function.

Administrator password setting

Select this setting item from **Device settings** on **Setup**.

Important

- The administrator password is required to change settings if it is enabled for changing settings using the operation panel.

You can specify or disable the administrator password.

If you specify the administrator password, select the range and specify the administrator password.

Remote UI or other tools

Entering the administrator password is required to change the setting items using Remote UI or some software.

LCD, Remote UI, or other tools

Entering the administrator password is required to change the setting items using the operation panel of the printer, Remote UI, or some software.

For details:

- [Setting Administrator Password on Operation Panel](#)

Setting Administrator Password on Operation Panel

You can specify or disable the administrator password.

Specifying the administrator password requires you to enter the password to use the items or change the settings below.

- **Web service setup**
- **FAX settings**
- **LAN settings**
- **Device user settings**
- **Language selection**
- **Firmware update**
- **ECO settings**
- **Quiet setting**
- **Administrator password setting**
- **Operation restrictions**
- **Reset setting** (except for **Reset all**)
- **Import e-mail address book**
- **Export e-mail address book**

Follow the procedure below to specify the administrator password.

1. [Make sure printer is turned on.](#)

2. Flick HOME screen and tap  **Setup.**

■ [Using the Operation Panel](#)

3. Tap  **Device settings.**

The **Device settings** screen appears.

4. Tap **Administrator password setting.**

5. When confirmation screen to specify administrator password is displayed, tap **Yes.**

If an administrator password is not specified, the register confirmation message appears. Tapping **Yes** displays the message again. Tap **OK.**

▶▶▶ Important

- The administrator password is set at the time of purchase. The printer's serial number is used as the password.

For the administrator password, refer to [Administrator Password.](#)

6. Tap **Change administrator password.**

If you do not specify an administrator password, tap **Remove administrator password**. Tapping **Yes** displays the message again. Tap **OK**.

7. Tap range where administrator password is valid.

Remote UI or other tools

Entering the administrator password is required to change the setting items using Remote UI or some software.

LCD, Remote UI, or other tools

Entering the administrator password is required to change the setting items using the operation panel of the printer, Remote UI, or some software.

8. Enter administrator password.

 **Important**

- The following character restrictions apply to the password:
 - Set the password by using 4 to 32 characters.
 - The allowed characters are single-byte alphanumeric characters.
 - For security reasons, we recommend you use 6 and more alphanumeric characters.

9. Tap **Apply**.

10. Enter administrator password you specified again.

11. Tap **Apply**.

The administrator password is enabled.

When You Want to Change or Disable the Administrator Password:

When the administrator password is enabled, tapping **Setup**, **Device settings**, and **Administrator password setting** in this order and entering the administrator password displays **Change administrator password** and **Remove administrator password** on the touch screen. Select either item and follow the on-screen instructions to perform settings.

Operation restrictions

Select this setting item from **Device settings** on **Setup**.

▶▶ Important

- The administrator password is required to change settings if it is enabled for changing settings using the operation panel.

You can restrict printing, copying, or faxing operations or to use a USB flash drive or a shared folder on the computer.

▶▶ Note

- When no operation restrictions are enabled, the confirmation screen to enable operation restrictions is displayed. Tapping **Yes** enables you to restrict operations. If you have already restricted any operations, the menu items are displayed. Tapping **Change operation restrictions** enables you to change the settings of operation restrictions.

For details:

- [Restricting Machine Operation](#)

Restricting Machine Operation

You can restrict printing, copying, or faxing operations or to use a USB flash drive or a shared folder on the computer. Restrictions can be disabled temporarily.

■ [Disabling Operation Restriction Temporarily](#)

To enable this function, apply the administrator password for changing settings on the operation panel.

■ [Setting Administrator Password on Operation Panel](#)

1. [Make sure printer is turned on.](#)

2. Flick HOME screen and tap  **Setup**.

■ [Using the Operation Panel](#)

3. Tap  **Device settings**.

4. Tap **Operation restrictions**.

5. Enter administrator password.

6. When confirmation screen of operation restriction is displayed, tap **Yes**.

If you have already performed operation restriction setting, the menu items are displayed. Tap **Change operation restrictions**.

7. Tap operation you want to restrict and tap function you want to restrict.

Copy

Restricts copying operations. If you select **Restrict all copying**, you can restrict all copying operations. If you select **Restrict color copying**, you can restrict color copying operations only.

Print from storage medium

Restricts to print from a USB flash drive.

Scan to USB flash drive

Restricts to save the scanned data on a USB flash drive.

Scan to destination folder

Restricts to forward the scanned data to a shared folder on the computer.

Scan (E-mail direct from device)

Restricts to send an e-mail with scanned data attached from the printer.

E-mail address book

Restricts operations related to the printer's e-mail address book.

FAX transmission

Restricts to send a fax from the printer. (Sending a fax from the computer is not restricted.)

FAX reception

Restricts to receive a fax.

»» Important

- If the printer receives a fax while **Restrict** is selected, **Not available. An operation restriction is set.** is displayed on the touch screen and the fax standby screen is displayed. In this case, you cannot receive the faxes. Ask the administrator of the printer you are using to change the setting and have the sender resend the faxes.

Directory

Restricts operations related to the printer's directory.

8. Tap **Exit**.

The operation restrictions you selected are enabled.

»» Note

- If you disable all restrictions, tap **Cancel operation restrictions** in step 6. When the confirmation screen is displayed, tap **Yes**.

To disable each operation restriction, tap the item in step 7 and tap **Do not restrict**.

Disabling Operation Restriction Temporarily

Specify the override password to disable operation restriction temporarily following the procedure below.

1. [Make sure printer is turned on.](#)

2. Flick HOME screen and tap  **Setup**.

■ [Using the Operation Panel](#)

3. Tap  **Device settings**.

4. Tap **Operation restrictions**.

5. Enter administrator password.

6. Tap **Override password setting** on displayed screen.

7. Tap **Yes** on displayed screen.

8. Tap **OK** on displayed screen.

9. Specify password.

10. Tap **Apply**.

11. Enter password you specified again.

12. Tap **Apply**.

The override password is enabled.

»» Note

- Receiving a fax is restricted even though operation restriction is disabled by the override password.
- If the touch screen turns off while disabling operation restriction temporarily, enter the override password again to resume the printer.

Reset setting

Select this setting item from **Device settings** on **Setup**.

Returns all settings you made to the printer back to the default. However, some data may not be changed, depending on the current usage state of your printer.

▶▶▶ Important

- The administrator password is required to change settings if it is enabled for changing settings using the operation panel.
- Depending on the setting item, it is necessary to perform connection or setup again after you have returned the setting back to the default.

- **Web service setup only**

Deletes IJ Cloud Printing Center and Google Cloud Print registrations.

- **LAN settings only**

Sets the LAN settings other than the administrator password back to the default.

After resetting, perform setup again as necessary.

- **Telephone number only**

Deletes all registered telephone/fax numbers.

- **Settings only**

Returns the settings such as the paper size, media type, or other setting items back to the default. The LAN settings and the telephone/fax number are not returned back to the default.

- **Device info sending setting only**

Applies the setting not to send the device information to Canon.

- **E-mail address book entries only**

Deletes all registered e-mail addresses.

- **FAX settings only**

Returns all fax settings back to the default. Disconnect the telephone line from the printer before you return this setting item back to the default.

After resetting, perform setup again as necessary.

- **Reset all**

Sets all settings you made to the printer back to the default. The administrator password specified for the printer is set to the default setting.

After resetting, perform setup again as necessary.

▶▶▶ Note

- You cannot set the following setting items back to the default:
 - The language displayed on the touch screen
 - The current position of the print head

- The country or region selected for **Country or region**
- Total use of copying, scanning, and faxing recorded in **Records of use**
- CSR (Certificate Signing Request) for encryption method (SSL/TLS) setting

You can delete the registered user's name or telephone number following the procedure below.

1. Display **User information settings** screen.

■ [Setting Sender Information](#)

2. Tap user's name or telephone number and delete all characters or numbers.
 3. Tap **OK** when you finished deleting all characters or numbers.
- **Agree** is selected for **Device info sending setting** on **Device user settings** after you have reset the setting to send device information. However, the printer does not send device information. Tap **Do not agree** to disable the function to send device information.

Web service setup

Select this setting item from **Web service setup** on **Setup**.

▶▶ Important

- The administrator password is required to change settings if it is enabled for changing settings using the operation panel.

- **Web service connection setup**

The following setting items are available.

- **Google Cloud Print setup**

Registers/Deletes the printer to/from Google Cloud Print.

- **IJ Cloud Printing Center setup**

Registers/Deletes the printer to/from Canon Inkjet Cloud Printing Center.

- **Check Web service setup**

Make sure whether the printer is registered to Google Cloud Print or Canon Inkjet Cloud Printing Center.

- **DNS server setup**

Performs settings for a DNS server. Select **Auto setup** or **Manual setup**. If you select **Manual setup**, follow the display on the touch screen to perform settings.

- **Proxy server setup**

Performs settings for a proxy server. Follow the display on the touch screen to perform settings.

System information

Select this setting item from **System information** on **Setup**.

- **Current version**

Displays the current firmware version.

- **Printer name**

Displays the printer name currently specified.

- **Serial number**

Displays the printer serial number.

- **MAC address of wireless LAN**

Displays the MAC address for wireless LAN.

- **MAC address of wired LAN**

Displays the MAC address for wired LAN.

ECO settings

Select this setting item from HOME screen.

This setting allows you to use following functions.

- Using automatic duplex printing to save paper
 - [Using Duplex Printing](#)
- Turning on the printer automatically when printing or scanning from a device, or turning it off automatically during the specified elapsed time to save electricity
 - [Turning On/Off Printer Automatically](#)
- Turning on/off the printer automatically at the specified time and day
 - [Specifying Time and Day to Turn on/off Printer Automatically](#)

▶▶▶ Note

- You cannot enable the functions below at the same time.
 - Turning on/off the printer automatically
 - Specifying the time and day to turn on/off the printer automatically

▶▶▶ Important

- The administrator password is required to change settings if it is enabled for changing settings using the operation panel.

Using Duplex Printing

Follow the procedure below to use duplex printing.

1. [Make sure printer is turned on.](#)

2. Flick HOME screen and tap  **ECO settings**.

- [Using the Operation Panel](#)

3. Tap **Two-sided printing setting**.

4. Specify settings as necessary.



- A. Tap to select two-sided copying as a default.
- B. Tap to select duplex printing PDF files saved on a USB flash drive as a default.
- C. Tap to select two-sided printing of sent/received faxes, reports, or lists as a default.
- D. Tap to specify the print settings.

▶▶▶ Note

- When duplex printing is selected, the  icon is displayed on each menu of the HOME screen or on the setting items for duplex printing on each print setting screen.

Turning On/Off Printer Automatically

Follow the procedure below to enable turning on/off the printer automatically.

1. [Make sure printer is turned on.](#)

2. Flick HOME screen and tap  **ECO settings**.

■ [Using the Operation Panel](#)

3. Tap **Power control**.
4. Tap **Enable auto power control**.
5. Check message and tap **Next**.
6. Specify settings as necessary.

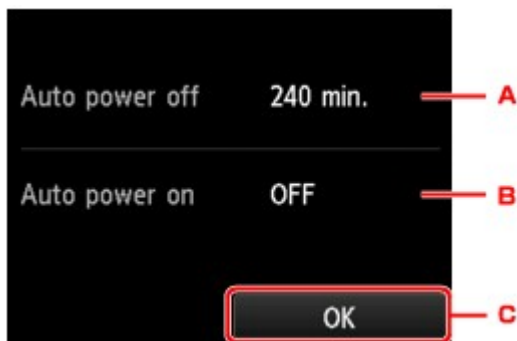

- A. Tap to specify the length of time to turn the printer off automatically when no operation is made or no printing data is sent to the printer.
- B. Tap to select the setting.
Selecting **ON** enables the printer to turn on automatically when a scanning command from a computer or printing data is sent to the printer.
- C. Tap to confirm the settings.

Specifying Time and Day to Turn on/off Printer Automatically

Follow the procedure below to use power saving function.

1. [Make sure printer is turned on.](#)

2. Flick HOME screen and tap  **ECO settings**.

■ [Using the Operation Panel](#)

3. Tap **Power control**.
4. Tap **Enable scheduling**.
5. Check message and tap **Next**.
6. Specify settings as necessary.

- When you specify the time and day to turn the printer on:

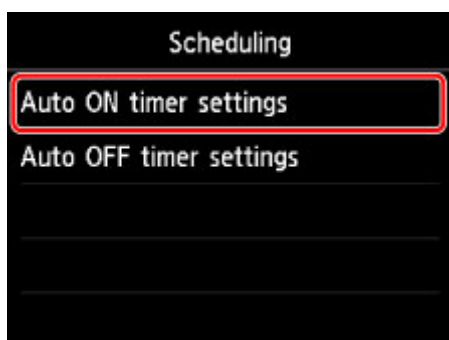

1. Tap **Auto ON timer settings**.
2. Tap **ON** on the displayed screen.

The screen below is displayed.

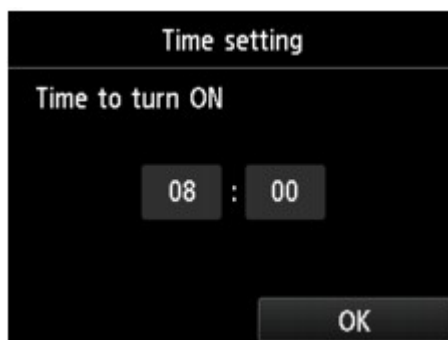

3. Tap time.

The screen below is displayed.



4. Tap numbers to specify time to turn on printer.

You can specify the hour from 0 to 24 and specify the minute in increments of 10 minutes.

5. Tap **OK** to confirm time to turn on printer.

After confirming the time to turn the printer on, the screen to specify the day is displayed.

Tap the day, tap **Enable** or **Disable**, and then tap **OK**. The setting is valid on the day(s) you select **Enable** for.

- When you specify the time and day to turn the printer off:

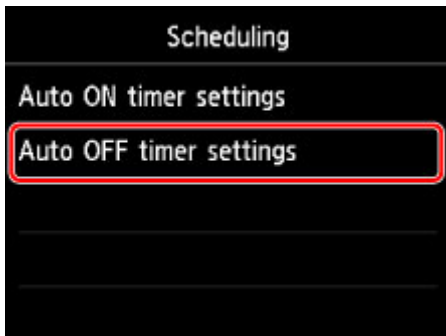

1. Tap **Auto OFF timer settings**.
2. Tap **ON** on displayed screen.
3. Check message and tap **OK**.

The screen below is displayed.

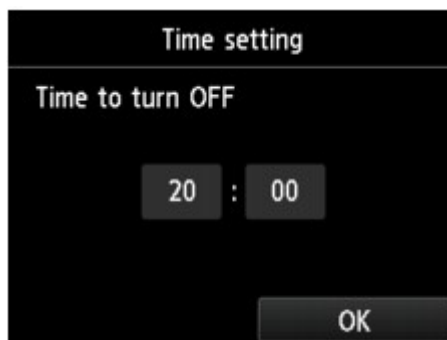

4. Tap time.

The screen below is displayed.



5. Tap numbers to specify time to turn off printer.

You can specify the hour from 0 to 24 and specify the minute in increments of 10 minutes.

6. Tap **OK** to confirm time to turn off printer.

After confirming the time to turn the printer off, the screen to specify the day is displayed.

Tap the day, tap **Enable** or **Disable**, and then tap **OK**. The setting is valid on the day(s) you select **Enable** for.

Quiet setting

Select this setting item from HOME screen.

Enables this function on the printer if you want to reduce the operating noise, such as when printing at night. In addition, you can specify the time range to reduce the operating noise.

▶▶▶ Important

- The administrator password is required to change settings if it is enabled for changing settings using the operation panel.
- Set the current date and time in advance.

■ [Setting Sender Information](#)

Follow the procedure below to perform setting.

1. [Make sure printer is turned on.](#)

2. Flick HOME screen and tap  **Quiet setting**.

■ [Using the Operation Panel](#)

3. Tap **Use quiet mode** or **Use during specified hours**.

- When **Use quiet mode** is selected:

The confirmation screen is displayed and the  icon appears as the **Quiet setting** menu icon.

- When **Use during specified hours** is selected:

The **Quiet mode hours** screen is displayed.

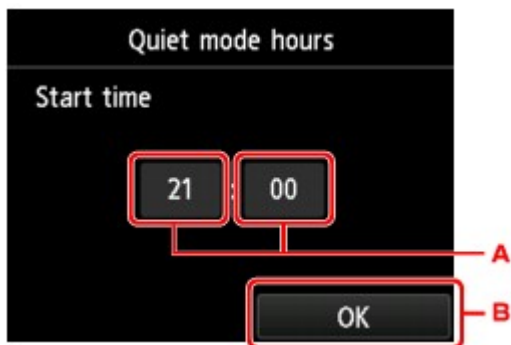

- A. Tap to display the screen below.



1. Tap numbers to specify starting time.

You can specify the hour from 0 to 24.

2. Tap to confirm starting time.

After specifying the starting time, specify the ending time following the same procedure.

- B. Tap to confirm the time to start and to end.

You can reduce the operating noise during the specified time.

The confirmation screen is displayed and the  icon appears as the **Quiet setting** menu icon.

»» Important

- Operating speed is reduced compared to when **Do not use quiet mode** is selected.
- This function may not be so effective depending on the printer's setting. Furthermore, certain noise, such as when the printer is preparing for printing, is not reduced.

»» Note

- You can set the quiet mode from the operation panel of the printer or the printer driver. No matter how you set the quiet mode, the mode is applied when you perform operations from the operation panel of the printer or printing and scanning from the computer.
- For Windows, you can set the quiet mode from ScanGear (scanner driver).

Registering Favorite Settings (Custom profiles)

You can register the favorite copying, scanning, or faxing settings and call them up from the HOME screen.

You can register up to 20 settings.

- [Registering the Setting](#)
- [Calling Up the Registered Setting](#)
- [Editing/Deleting the Registered setting](#)

Registering the Setting

Tap **Save profile** on each standby screen or on the screen displayed after the settings are specified.

Copy standby screen

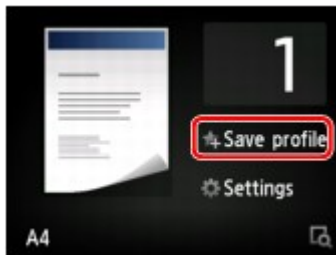

Scan standby screen



Fax transmission standby screen

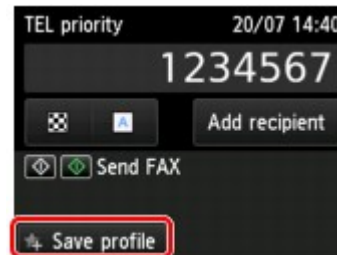

When the confirmation screen of **Save profile** is displayed, tap **Yes**.

When the screen to enter the name of the setting is displayed, enter the name and tap **Register**.

➤➤➤ Note

- If you tap **Register** without entering the name, the name currently shown is applied as the name of the setting.

Calling Up the Registered Setting

Follow the procedure below to call up the registered setting.

1. [Make sure printer is turned on.](#)

2. Flick HOME screen and tap  **Custom profiles**.

- [Using the Operation Panel](#)

3. Tap setting you want to call up.

➤➤➤ Note

- You can change the displayed items by tapping **Switch view**.

Editing/Deleting the Registered setting

Follow the procedure below to edit or delete the registered setting.

1. [Make sure printer is turned on.](#)

2. Flick HOME screen and tap  **Custom profiles.**

■ [Using the Operation Panel](#)

3. Tap **Edit/delete.**

You can change the order or name of the registered settings and delete the settings.

- To change the order of the registered settings

1. Tap **Rearrange.**

2. Tap setting you want to move.

3. Tap  or  to move selected setting.

4. Tap **Apply.**

5. Tap **Exit.**

- To change the name of the registered settings

1. Tap **Rename.**

2. Tap setting you want to rename.

3. Enter new name and tap **OK.**

■ [Entering Numbers, Letters, and Symbols](#)

4. Tap **Exit.**

- To delete the registered settings

1. Tap **Delete.**

2. Tap setting you want to delete.

3. Tap **Yes** on displayed screen.

4. Tap **Exit.**

Checking the Total Number of Uses of Machine

You can check the total number of uses of the printer (e.g. the total number of printing, copying, sending/receiving faxes, or scanning).

1. [Make sure printer is turned on.](#)

2. Flick HOME screen and tap  **Records of use.**

■ ■ [Using the Operation Panel](#)

The **Records of use** screen is displayed.

3. Tap item to check.

Total sheets used on the device

Displays the total number of printing.

No. of sheets used for copying

Displays the total number of copying.

No. of sheets used for FAX

Displays the total number of received or printed faxes.

Sheets used for other functions

Displays the total number of printing other than copying or faxing.

Number of FAX sheets sent

Displays the total number of sent faxes.

Number of sheets scanned

Displays the total number of scanning.

▶▶▶ **Note**

- The record of the total number of uses is not reverted even if the printer is reverted back to the default by **Reset setting** in **Device settings**.

Changing Printer's Setting Using Web Browser

- ▶ **Changing Settings Using Web Browser**
- ▶ **Changeable Setting Items Using Web Browser**
- ▶ **Setting Password**
- ▶ **Setting Mail Server**
- ▶ **Specifying Mail Setting for Sending Scanned Data**
- ▶ **Receiving Printer Status by E-mail**

Changing Settings Using Web Browser

You can check the printer status and change the printer settings using the web browser on your smartphone, tablet, or computer.

To check the printer status and to change the printer settings, display "Remote UI" on the web browser.

▶▶▶ Note

- Remote UI is a software that enables you to perform operations, which are usually performed on the printer's operation panel, using a Web browser over a network.

LAN connection with the printer is required to use Remote UI.

- You can use Remote UI on the following OS and the web browser.

- iOS device

OS: iOS 7.0 or later

Web browser: iOS standard Web browser (Mobile Safari)

- Android device

OS: Android 4.0 or later

Web browser: Android standard Web browser (Browser or Chrome)

- Mac OS device

OS: Mac OS X v.10.6 or later

Web browser: Safari 5.1 or later

- Windows device

OS: Windows Vista SP2 or later

Web browser: Internet Explorer 9 or later, Google Chrome 41.0.2272.118m or later, Mozilla Firefox 37.0.1 or later

1. [Make sure printer is turned on.](#)

2. Check printer's IP address.

Check the printer's IP address by following the steps below.

1. Flick HOME screen and tap  **Setup.**

■ [Using the Operation Panel](#)

The menu screen is displayed.

2. Tap  **Device settings.**

3. Tap **LAN settings.**

4. Tap **Confirm LAN settings.**

5. Check **IPv4 address.**

3. Open web browser on your smartphone, tablet, or computer and enter IP address.

Enter as following in the URL field of the web browser.

http://XXX.XX.X.XXX

Enter the IP address in "XXX.XX.X.XXX".

When you access, "Remote UI" will be displayed on the web browser on your smartphone, tablet, or computer.

4. If you display Remote UI for the first time on your smartphone, tablet, or computer, select **For secure communication**.

Download the root certificate, and then register it.

 [Registering Printer's Root Certificate to Web Browser](#)

Note

- Once you register the root certificate to the web browser on your smartphone, tablet, or computer, this step is not necessary after the next time.
If **Reset all** was performed from the printer's operation panel, download the root certificate again, and then register it.
- If the root certificate is not registered, a message to warn you that the secure connection is not guaranteed may appear.

5. Select **Log on**.

The password authentication screen appears.

Note

- When the standard user mode is enabled, choose either administrator mode or standard user mode to log on.
- After choosing a mode and selecting **Log on**, the password authentication screen of each mode appears.

6. Enter password.

When the password authentication is complete, the menus that can be utilized are displayed on the web browser.

Important

- The password is set at the time of purchase. The password is the printer serial number. The printer serial number is printed on the sticker attached on the printer. It consists of 9 alphanumeric characters (four alphabets followed by five numbers).

For details on setting password, see [Setting Password](#).

7. Check printer status and change printer settings.

For changeable setting items, see below.

■ [Changeable Setting Items Using Web Browser](#)

8. When you finish checking printer status and changing printer settings, select **Log off**.
9. Close web browser.

Registering Printer's Root Certificate to Web Browser

If the printer's root certificate has not been registered to the web browser, a message to warn you that the secure connection is not guaranteed may appear.

When you display Remote UI for the first time on your smartphone, tablet, or computer, download the root certificate, and then register it to the web browser. The secure connection will be confirmed and a message will not appear.

How to register the root certificate varies depending on the web browser.

- [For Internet Explorer](#)
- [For Safari](#)
- [For Chrome on Android](#)
- [For Mobile Safari on iOS](#)

For other web browser, refer to each help.

▶▶▶ Important

- Make sure that you have accessed to the printer IP address correctly by checking the URL field of the web browser before registering the root certificate.

For Internet Explorer

1. Select **Download** on Remote UI.

Downloading the root certificate is started.

2. If confirmation screen appears, select **Open**.

Certificate screen is displayed.

▶▶▶ Note

- To save the certificate file to your device and register it, select **Save**. Select **Internet options** from **Tool** menu of Internet Explorer, register the root certificate from **Certificates** on **Content** sheet.

3. Select **Install Certificate**.

Certificate Import Wizard screen is displayed.

4. Select **Next**.

5. Select **Place all certificates in the following store**.

6. Select **Browse**.

Select Certificate Store screen is displayed.

7. Select **Trusted Root Certification Authorities** and **OK**.

8. Select **Next** on **Certificate Import Wizard** screen.
9. If **Completing the Certificate Import Wizard** appears, select **Finish**.
Security Warning screen is displayed.
10. Make sure that thumbprint on **Security Warning** screen matches printer's thumbprint.
For printer's thumbprint, press the **HOME** button, select **Setup -> Device settings -> LAN settings -> Confirm LAN settings**, check **Root cert. thumbprint (SHA-1)** or **Root cert. thumbprint (SHA-256)**.
11. If thumbprint on **Security Warning** screen matches printer's thumbprint, select **Yes**.
12. Select **Yes** on **Certificate Import Wizard** screen.
The root certificate registration is completed.

For Safari

1. Select **Download** on Remote UI.
Downloading the root certificate is started.
2. Open the download file.
Add Certificates screen is displayed.
3. Select **Add**.
4. Make sure that thumbprint of certificate detail information matches printer's thumbprint.
For printer's thumbprint, press the **HOME** button, select **Setup -> Device settings -> LAN settings -> Confirm LAN settings**, check **Root cert. thumbprint (SHA-1)** or **Root cert. thumbprint (SHA-256)**.
5. If thumbprint of certificate detail information matches printer's thumbprint, select **Always Trust**.
The root certificate registration is completed.

▶▶▶ Note

- If a password is set on your device, entering a password may be required.

For Chrome on Android

1. Select **Download** on Remote UI.
Downloading the root certificate is started and then **Downloading Certificate** screen is displayed.

2. Specify certificate name, and then select **OK**.

The root certificate registration is completed.

▶▶▶ Note

- If PIN or password is not set as security type, the attention screen may appear. Select **OK**, and then set the security type to PIN or password.
- If the message to warn you that the secure connection is not guaranteed appears when you select **Log on** on Remote UI after registering the root certificate, restart the web browser. The message will not appear on the web browser.

After Root Certificate Registration

We recommend that you make sure that the correct root certificate has been registered.

Depending on the Android device, a warning may appear because the root certificate that contains the authentication information was registered.

To make sure that the correct root certificate has been registered, make sure that thumbprint of certificate information matches printer's thumbprint. Follow the steps below.

▶▶▶ Note

- Some Android devices cannot check the thumbprint of a registered root certificate.

1. From **Settings** menu on your device, select **Security, Trust credentials**, and **USER**.

The list of downloaded certificates is displayed.

2. Select downloaded certificate.

The certificate information is displayed.

3. Make sure that thumbprint of certificate information matches printer's thumbprint.

For printer's thumbprint, press the **HOME** button, select **Setup -> Device settings -> LAN settings -> Confirm LAN settings**, check **Root cert. thumbprint (SHA-1)** or **Root cert. thumbprint (SHA-256)**.

4. If thumbprint of certificate information matches printer's thumbprint, select **OK**.

Confirmation of the root certificate is completed.

For Mobile Safari on iOS

1. Select **Download** on Remote UI.

Downloading the root certificate is started and then **Install Profile** screen is displayed.

2. Select **Install**.

Warning screen is displayed.

▶▶▶ Note

- If a password is set on your device, entering a password may be required.

3. Select **Install**.

4. Select **Install** on displayed dialog.

The root certificate registration is completed.

Changeable Setting Items Using Web Browser

►► Note

- The items described here and the items displayed in the web browser may differ in display order.
- The item which can be used is different in administrator mode or in standard user mode.

Items for Security

Security (Item for administrator)

This function allows you to specify the password, the standard user mode settings, the operation restrictions, and SSL/TLS settings of certificate for encrypted communication.

For details on setting password, see [Setting Password](#).

Items for Maintenance/Management

Utilities

This function allows you to set and execute the printer utility functions such as cleaning.

System info and LAN settings

This function allows you to check the system information and to change the LAN settings.

Using **IP filtering** in **Other settings** in **LAN settings**, you can permit or refuse the connection of a specific IP address for IPv4 address or IPv6 address.

Using **SNMP settings** in **Other settings** in **LAN settings**, you can specify the SNMP and MIB setting to management the printer via a network.

►► Important

- If you has refused the IP address of administrator's device using **IP filtering** by mistake, reset LAN settings of the printer.

For resetting LAN settings, see [Reset setting](#).

►► Note

- Some of the menu is available only when you logged on in administrator mode.

Firmware update (Item for administrator)

This function allows you to update the firmware and check version information.

Language selection (Item for administrator)

This function allows you to change the language on the display.

Items for Printer

Device settings

This function allows you to change the printer settings such as the quiet setting, the energy saving settings, and the print settings.

Additionally, this function allows you to change the mail settings and to receive the printer status information such as the remaining ink level and the error.

■ [Setting Mail Server](#)

■ [Specifying Mail Setting for Sending Scanned Data](#)

■ [Receiving Printer Status by E-mail](#)

▶▶▶ Note

- Some of the menu is available only when you logged on in administrator mode.

AirPrint settings

This function allows you to specify the AirPrint settings, such as position information.

Web service connection setup (Item for administrator)

This function allows you to register to Google Cloud Print or IJ Cloud Printing Center, or delete a registration.

Other Items

Printer status

This function displays printer information such as the remaining ink amount, the status, and detailed error information.

You can also connect to the ink purchase site or support page, and use Web Services.

Records of use

This function displays the total number of uses of the printer (e.g. the total number of printing, copying, sending/receiving faxes, or scanning).

Manual (Online)

This function displays the Online Manual.

Setting Password

Each of passwords for administrator and standard user can be set.

When logging on with password for administrator, all settings can be changed.

When logging on with password for standard user, some of the settings can be changed.

When logging on with password for administrator, you can restrict the function for standard user.

■ [Setting Administrator Password](#)

■ [Setting Standard User Password](#)

▶▶▶ Note

- Password can be set only when you are logged in administrator mode.

Setting Administrator Password

Change the administrator password by following the steps below.

▶▶▶ Important

- The password is set at the time of purchase. The password is the printer serial number. The printer serial number is printed on the sticker attached on the printer. It consists of 9 alphanumeric characters (four alphabets followed by five numbers).

1. [Display printer status on web browser.](#)

2. Select **Security**.

The menus are displayed.

3. Select **Administrator password setting**.

4. Select **Change administrator password**.

If the administrator password is not set, registration confirming message is displayed. Select **Yes**.
When message is displayed again, select **OK**.

5. Select a range where the administrator password is valid, and then select **OK**.

Remote UI or other tools

Entering the administrator password is required to change the setting items using the Remote UI or some software.

Operation panel/Remote UI/other tools

Entering the administrator password is required to change the setting items using the operation panel of the printer, the Remote UI, or some software.

6. Enter a password, and then select **OK**.

»» Important

- The following character restrictions apply to the password:
 - Set the password by using 4 to 32 characters.
 - The allowed characters are single-byte alphanumeric characters.
 - For security reasons, we recommend you use 6 and more alphanumeric characters.

7. When the completion message is displayed, select **OK**.

Setting Standard User Password

For restricting the function for standard user, enable the standard user mode and set a standard user password by following the steps below.

1. [Display printer status on web browser.](#)
2. Select **Security**.
The menus are displayed.
3. Select **Standard user mode settings**.
4. When the confirming message is displayed, select **Yes**.
5. Enter a password, and then select **OK**.

»» Important

- The following character restrictions apply to the password:
 - Set the password by using 4 to 32 characters.
 - The allowed characters are single-byte alphanumeric characters.
 - For security reasons, we recommend you use 6 and more alphanumeric characters.

6. When the completion message is displayed, select **OK**.

Setting Mail Server

To use mail function, specify the mail server settings.

▶▶▶ Note

- If you did not specify the time zone setting using the printer's operation panel, a message to inform you that the correct time may not be reflected on the sent e-mail appears. We recommended that you set the time zone setting using the printer's operation panel.

For the time zone setting, see [Device user settings](#).

- These functions can be set only when you are logged in administrator mode.

1. [Display printer status on web browser](#).

2. Select **Device settings**.

The menus are displayed.

3. Select **Set mail server / test connect**.

4. Select **Set mail server**.

The setting items for mail server are displayed.

5. Specify mail server settings.

Specify the following items.

Sender address

Enter the e-mail address of the sender (this printer).

Outgoing mail server (SMTP)

Enter the address of your SMTP server.

Port number (SMTP)

Enter the port number of your SMTP server.

Secure connection (SSL)

Select if you use the secure connection (SSL).

Don't verify certificates

Select if you do not verify the certificate.

Authentication method

Select one of the following authentication methods.

SMTP authentication

Select if you send e-mail with SMTP authentication.

Next, you can specify the following settings.

- **Outgoing account**

Enter the account name for sending to perform the authentication.

- **Outgoing password**

Enter the password for sending to perform the authentication.

POP before SMTP

Select if you send e-mail with POP before SMTP authentication.

Next, you can specify the following settings.

- **Incoming mail server (POP3)**

Enter the address of your POP server.

- **Port number (POP3)**

Enter the port number of your POP server.

- **Incoming account**

Enter the account name for receiving to perform the authentication.

- **Incoming password**

Enter the password for receiving to perform the authentication.

- **Use APOP authentication**

Select if you send the password by the encryption transmission.

- **Clear mailbox**

Select if you delete the e-mails that remain in the POP3 server.

»» Important

- When this setting is enabled, e-mail in the Inbox on the server will have all been removed. If you specify the e-mail address of your everyday, be sure to disable this setting as unread e-mail is not deleted. We recommended that you prepare this printer dedicated e-mail account not to accidentally delete the unread e-mail.

No authentication

Select if the authentication is not necessary.

6. After specifying mail server settings, select **OK**.

The setting operation is completed.

»» Note

- To make sure that the mail server settings have been specified correctly, select **Test connection to mail server**.

Specifying Mail Setting for Sending Scanned Data

You can specify the mail settings to send the scanned data from printer via e-mail.

This section describes the mail settings such as the title of e-mail, initial body text, and file size.

▶▶▶ Note

- These functions can be set only when you are logged in administrator mode.
- To send the scanned data from printer via e-mail and to register the e-mail address of the destination, see below.

■ [Sending Scanned Data as E-Mail from Machine](#)

- Specify the mail server settings in advance.

■ [Setting Mail Server](#)

1. [Display printer status on web browser.](#)

2. Select **Device settings**.

The menus are displayed.

3. Select **Scan(Email direct from device)**.

4. Select **E-mail transmission settings**.

The setting items for mail setting are displayed.

5. Specify mail settings.

Specify the following items.

Subject

Enter the title of the e-mail up to 20 alphanumeric characters.

▶▶▶ Note

- The title that you specify here is the initial title when sending scan data. You can change the title when sending scan data using the printer's operation panel.

Body text

Enter the body text of the e-mail up to 80 alphanumeric characters.

Maximum attachment size

Select a maximum file size of the scan data that can be sent.

6. After specifying mail settings, select **OK**.

The setting operation is completed.

Receiving Printer Status by E-mail

You receive the printer status information such as the remaining ink level and the error from the printer.

▶▶▶ Note

- Specify the mail server settings in advance.

■ [Setting Mail Server](#)

- If you did not specify the the date and time setting using the printer's operation panel, the date and time may not be reflected on the sent e-mail. We recommended that you set the date and time setting using the printer's operation panel.

For the date and time setting, see [Device user settings](#).

- These functions can be set only when you are logged in administrator mode.

Specify the information settings by following the steps below.

1. [Display printer status on web browser](#).

2. Select **Device settings**.

The menus are displayed.

3. Select **Status notification e-mail**.

4. Select **Notification recipients**.

The screen to register the destination is displayed.

5. Specify destination settings.

Up to 5 destinations can be registered by following the steps below.

1. Select number of destination.
2. Select **Register**.
3. Enter e-mail address, and then select printer status to send information.
4. Select **OK**.

The registration for destination is completed.

6. Select **Device settings** -> **Status notification e-mail** -> **Retry settings**.

7. Specify resending settings.

The number of resending can be specified by following the steps below.

1. Specify number of resending.
2. Specify interval of resending.
3. Select **OK**.

The resending setting is completed.

Network Connection

- ▶ [Network Connection Tips](#)

Network Connection Tips

- ▶ **Default Network Settings**
- ▶ **Another Printer Found with Same Name**
- ▶ **Connecting to Another Computer via LAN/Changing from USB to LAN Connection**
- ▶ **Printing Network Settings**
- ▶ **Changing LAN Connection Method/Changing Wireless LAN Connection Method**

Default Network Settings

LAN Connection Defaults

Item	Default
Change LAN	Disable LAN
SSID	BJNPSETUP
Communication mode	Infrastructure
Wireless LAN security	Disable
IP address (IPv4)	Auto setup
IP address (IPv6)	Auto setup
Set printer name*	XXXXXXXXXXXX
Enable/disable IPv6	Enable
Enable/disable WSD	Enable
Timeout setting	1 minute
Enable/disable Bonjour	Enable
Service name	Canon MB5400 series
LPR protocol setting	Enable
Wired LAN DRX setting	Enable
RAW protocol	Enable
LLMNR	Active

("XX" represents alphanumeric characters.)

* Default value depends on printer. To check value, use operation panel.

■ [LAN settings](#)

Direct Connection Defaults

Item	Default
SSID (Identifier for direct connection)	DIRECT-abXX-MB5400series *1
Password	YYYYYYYYYYY *2
Wireless LAN security	WPA2-PSK (AES)
Direct connection device name	ZZZZZZ-MB5400series *3
Connection request confirmation	Displayed

*1 "ab" is specified at random and "XX" represents last two digits of printer's MAC address. (The value is specified when the printer is turned on for the first time.)

*2 The password is specified automatically when the printer is turned on for the first time.

*3 "ZZZZZZ" represents last six digits of printer's MAC address.

Another Printer Found with Same Name

When the printer is found during setup, other printers with the same name may appear on the results screen.

Select a printer with checking the printer settings against those on detection result screen.

- For Windows:

Check the printer's MAC address or serial to select the correct printer from the results.

- For Mac OS:

The printer names appear with the MAC address added at the end or as the printer name specified by Bonjour.

Check identifiers such as the MAC address, the printer name specified by Bonjour, and the printer's serial number to select the printer from among those that appear.

▶▶▶ Note

- Serial number may not appear on result screen.

Check the printer's MAC address and the serial number by one of the following methods.

- Display on the touch screen.

MAC address

- [LAN settings](#)

Serial number

- [System information](#)

- Print the network settings.

- [Printing Network Settings](#)

Connecting to Another Computer via LAN/Changing from USB to LAN Connection

■ [For Windows:](#)

■ [For Mac OS:](#)

For Windows:

To add a computer to connect to the printer on a LAN or to change from USB to LAN connection, perform setup using the Setup CD-ROM or follow the instructions on the Canon website.

For Mac OS:

To connect an additional computer to the printer via LAN, or to change from USB to LAN connection, follow the instructions on the Canon website.

Printing Network Settings

Use the operation panel to print the printer's current network settings.

▶▶▶ Important

- The network settings printout contains important information about your network. Handle it with care.

1. [Make sure printer is turned on.](#)
2. [Load three sheets of A4 or Letter-sized plain paper.](#)

3. Flick HOME screen and tap  **Setup.**

■ [Using the Operation Panel](#)

The menu screen appears.

4. Tap  **Device settings.**

5. Tap **LAN settings.**

If you specify the administrator password, enter the password.

6. Tap **Confirm LAN settings.**

7. Check message and tap **OK.**

8. Tap **Print details.**

9. Tap **Yes.**

The printer starts printing network settings information.

The printed network settings information is as follows:

Item	Description	Setting
Product Information	Product information	–
Product Name	Product name	XXXXXXXXXX
ROM Version	ROM version	XXXXXXXXXX
Serial Number	Serial number	XXXXXXXXXX
Wireless LAN	Wireless LAN	Enable/Disable
MAC Address	MAC address	XX:XX:XX:XX:XX:XX

Infrastructure	Infrastructure	Enable/Disable
Connection	Connection status	Active/Inactive
SSID	SSID	Wireless LAN SSID
Channel *1	Channel	XX (1 to 11)
Encryption	Encryption method	None/WEP/TKIP/AES
WEP Key Length	WEP key length (bits)	Inactive/128/64
Authentication	Authentication method	None/auto/open/shared/WPA-PSK/WPA2-PSK
Signal Strength	Signal strength	0 to 100 [%]
TCP/IPv4	TCP/IPv4	Enable
IP Address	IP address	XXX.XXX.XXX.XXX
Subnet Mask	Subnet mask	XXX.XXX.XXX.XXX
Default Gateway	Default gateway	XXX.XXX.XXX.XXX
TCP/IPv6	TCP/IPv6	Enable/Disable
Link Local Address	Link local address	XXXX:XXXX:XXXX:XXXX XXXX:XXXX:XXXX:XXXX
Link Local Prefix Length	Link local prefix length	XXX
Manual Setting	Manual setting	Enable/Disable
IP Address *2	IP address	XXXX:XXXX:XXXX:XXXX XXXX:XXXX:XXXX:XXXX
Subnet Prefix Length	Subnet prefix length	XXX
Stateless Address1 *2	Stateless address 1	XXXX:XXXX:XXXX:XXXX XXXX:XXXX:XXXX:XXXX
Stateless Prefix Length1 *2	Stateless prefix length 1	XXX
Stateless Address2 *2	Stateless address 2	XXXX:XXXX:XXXX:XXXX XXXX:XXXX:XXXX:XXXX
Stateless Prefix Length2 *2	Stateless prefix length 2	XXX
Stateless Address3 *2	Stateless address 3	XXXX:XXXX:XXXX:XXXX XXXX:XXXX:XXXX:XXXX
Stateless Prefix Length3 *2	Stateless prefix length 3	XXX
Stateless Address4 *2	Stateless address 4	XXXX:XXXX:XXXX:XXXX XXXX:XXXX:XXXX:XXXX

Stateless Prefix Length4 *2	Stateless prefix length 4	XXX
Default Gateway1 *2	Default gateway 1	XXXX:XXXX:XXXX:XXXX XXXX:XXXX:XXXX:XXXX
Default Gateway2 *2	Default gateway 2	XXXX:XXXX:XXXX:XXXX XXXX:XXXX:XXXX:XXXX
Default Gateway3 *2	Default gateway 3	XXXX:XXXX:XXXX:XXXX XXXX:XXXX:XXXX:XXXX
Default Gateway4 *2	Default gateway 4	XXXX:XXXX:XXXX:XXXX XXXX:XXXX:XXXX:XXXX
IPsec *3	IPsec setting	Active
Security Protocol *3	Security method	ESP/ESP & AH/AH
Direct Connection	Direct connection	Enable/Disable
Connection	Connection status	Active/Inactive
SSID	SSID	Direct Connection SSID
Password	Password	Direct Connection password (10 alphanumeric characters)
Channel	Channel	3
Encryption	Encryption method	AES
Authentication	Authentication method	WPA2-PSK
TCP/IPv4	TCP/IPv4	Enable
IP Address	IP address	XXX.XXX.XXX.XXX
Subnet Mask	Subnet mask	XXX.XXX.XXX.XXX
Default Gateway	Default gateway	XXX.XXX.XXX.XXX
TCP/IPv6	TCP/IPv6	Enable/Disable
Link Local Address	Link local address	XXXX:XXXX:XXXX:XXXX XXXX:XXXX:XXXX:XXXX
Subnet Prefix Length *2	Subnet prefix length	XXX
IPsec *3	IPsec setting	Active
Security Protocol *3	Security method	–
Wired LAN	Wired LAN	Enable/Disable
MAC Address	MAC address	XX:XX:XX:XX:XX:XX

Connection	Wired LAN status	Active/Inactive
TCP/IPv4	TCP/IPv4	Enable
IP Address	IP address	XXX.XXX.XXX.XXX
Subnet Mask	Subnet mask	XXX.XXX.XXX.XXX
Default Gateway	Default gateway	XXX.XXX.XXX.XXX
TCP/IPv6	TCP/IPv6	Enable/Disable
Link Local Address	Link local address	XXXX:XXXX:XXXX:XXXX XXXX:XXXX:XXXX:XXXX
Link Local Prefix Length	Link local prefix length	XXX
Manual Setting	Manual setting	Enable/Disable
IP Address *2	IP address	XXXX:XXXX:XXXX:XXXX XXXX:XXXX:XXXX:XXXX
Subnet Prefix Length	Subnet prefix length	XXX
Stateless Address1 *2	Stateless address 1	XXXX:XXXX:XXXX:XXXX XXXX:XXXX:XXXX:XXXX
Stateless Prefix Length1 *2	Stateless prefix length 1	XXX
Stateless Address2 *2	Stateless address 2	XXXX:XXXX:XXXX:XXXX XXXX:XXXX:XXXX:XXXX
Stateless Prefix Length2 *2	Stateless prefix length 2	XXX
Stateless Address3 *2	Stateless address 3	XXXX:XXXX:XXXX:XXXX XXXX:XXXX:XXXX:XXXX
Stateless Prefix Length3 *2	Stateless prefix length 3	XXX
Stateless Address4 *2	Stateless address 4	XXXX:XXXX:XXXX:XXXX XXXX:XXXX:XXXX:XXXX
Stateless Prefix Length4 *2	Stateless prefix length 4	XXX
Default Gateway1 *2	Default gateway 1	XXXX:XXXX:XXXX:XXXX XXXX:XXXX:XXXX:XXXX
Default Gateway2 *2	Default gateway 2	XXXX:XXXX:XXXX:XXXX XXXX:XXXX:XXXX:XXXX
Default Gateway3 *2	Default gateway 3	XXXX:XXXX:XXXX:XXXX XXXX:XXXX:XXXX:XXXX
Default Gateway4 *2	Default gateway 4	XXXX:XXXX:XXXX:XXXX XXXX:XXXX:XXXX:XXXX

IPsec *3	IPsec setting	Active
Security Protocol *3	Security method	ESP/ESP & AH/AH
Wired LAN DRX	Discontinuous reception (wired LAN)	Enable/Disable
Other Settings	Other settings	–
Printer Name	Printer name	Printer name (Up to 15 alphanumeric characters)
Direct Conn. DevName	Device name for direct connection (Up to 32 characters)	Device name for direct connection
WSD Printing	WSD printing setting	Enable/Disable
WSD Timeout	Timeout	1/5/10/15/20 [min]
LPD Printing	LPD printing setting	Enable/Disable
RAW Printing	RAW printing setting	Enable/Disable
Bonjour	Bonjour setting	Enable/Disable
Bonjour Service Name	Bonjour service name	Bonjour service name (Up to 52 alphanumeric characters)
LLMNR	LLMNR setting	Enable/Disable
SNMP	SNMP setting	Enable/Disable
DNS Server	Obtain DNS server address automatically	Auto/Manual
Primary Server	Primary server address	XXX.XXX.XXX.XXX
Secondary Server	Secondary server address	XXX.XXX.XXX.XXX
Proxy Server	Proxy server setting	Enable/Disable
Proxy Address	Proxy address	XXXXXXXXXXXXXXXXXXXXXXX
Proxy Port	Proxy port specification	1 to 65535
Cert. Fingerprt(SHA-1)	Certificate fingerprint(SHA-1)	XXXXXXXXXX XXXXXXXXXXX XXXXXXXXXXX XXXXXXXXXX XXXXXXXXXXX
Cert. Fingerprt(SHA-256)	Certificate fingerprint(SHA-256)	XXXXXXXXXX XXXXXXXXXXX XXXXXXXXXXX XXXXXXXXXX XXXXXXXXXX XXXXXXXXXXX XXXXXXXXXXX XXXXXXXXXX

("XX" represents alphanumeric characters.)

*1 Channel may range from 1 to 11 depending on country or region of purchase.

*2 Network status is only printed when IPv6 is enabled.

*3 Network status is only printed when IPv6 and IPsec settings are enabled.

Changing LAN Connection Method/Changing Wireless LAN Connection Method

■ [Changing LAN Connection Method](#)

■ [Changing Wireless LAN Connection Method](#)

Changing LAN Connection Method

Follow either procedure below to change LAN connection method (wired or wireless).

• For Windows:

- Use the Setup CD-ROM or follow the instructions on the Canon website to redo setup.
- Tap the icon on the lower left on HOME screen, select **Change LAN**, and then select **Activate wireless LAN** or **Activate wired LAN**.

After that, perform settings on the **Protocol Settings** screen on IJ Network Device Setup Utility.

For details, refer to [Performing/Changing Wireless LAN Settings](#) or [Performing/Changing Wired LAN Settings](#).

• For Mac OS:

- Follow the instructions on the Canon website to redo setup.
- Tap the icon on the lower left on HOME screen, select **Change LAN**, and then select **Activate wireless LAN** or **Activate wired LAN**.

After that, perform settings on the **Wireless LAN** or **Wired LAN** sheet on IJ Network Tool.

For details, refer to Changing Settings in Wireless LAN Sheet or Changing Settings in Wired LAN Sheet.

Changing Wireless LAN Connection Method

Follow either procedure below to change wireless LAN connection method (infrastructure or direct connection).

• For Windows:

- Use the Setup CD-ROM or follow the instructions on the Canon website to redo setup.
- Perform settings on the **Protocol Settings** screen on IJ Network Device Setup Utility.

▶▶▶ Important

- Before you perform settings using IJ Network Device Setup Utility, turn on cableless setup mode on the printer following the procedure below.

1. [Make sure printer is turned on.](#)

2. Flick HOME screen and tap  **LAN settings**.

■ [Using the Operation Panel](#)

If you specify the administrator password, enter the password.

3. Tap **Wireless LAN setup**.

4. Tap **Cableless setup**.

5. Check message and tap **OK**.

Follow instructions on your smartphone or tablet.

6. If message saying setup is completed appears, tap **OK**.

- **For Mac OS:**

Follow the instructions on the Canon website to redo setup.

Network Settings (IJ Network Device Setup Utility) (Windows)

- ▶ **IJ Network Device Setup Utility**
- ▶ **Starting Up IJ Network Device Setup Utility**
- ▶ **IJ Network Device Setup Utility Screen**
- ▶ **Performing Network Settings**
- ▶ **Checking Network Status**
- ▶ **IJ Network Device Setup Utility Menus**
- ▶ **Other Network Information**

IJ Network Device Setup Utility

IJ Network Device Setup Utility allows a network/printer administrator to manage printers on network. When you perform printer setup, the utility is installed at the same time.

Use IJ Network Device Setup Utility for:

- Searching printers on network and performing initial network setup for detected printers
- Performing initial network setup by connecting the printer and computer using a USB cable (Not available for some models)
- Changing printer network settings
- Checking status between computer on which IJ Network Device Setup Utility is installed and printer if anything is wrong with connection

»» Important

- Depending on the printer you are using, an administrator password is already specified for the printer at the time of purchase. When you change the network settings, authentication by the administrator password is required.

For details:

- [Administrator Password](#)

For improving security, we recommend to change the administrator password.

- [Changing Administrator Password](#)

- To use the printer over LAN, make sure you have the equipment necessary for the connection type, such as a wireless router or a LAN cable.
- When you perform setup or install IJ Network Device Setup Utility, disable block function of firewall.
- Do not change network settings using IJ Network Device Setup Utility while printing is in progress.

Starting Up IJ Network Device Setup Utility

Start up IJ Network Device Setup Utility as shown below.

- In Windows 10, click the **Start** button, select **All apps**, **Canon Utilities**, and then **IJ Network Device Setup Utility**. If **IJ Network Device Setup Utility** is not displayed, search for "IJ Network Device Setup Utility" on **Search the web and Windows**.
- In Windows 8.1 or Windows 8, select **IJ Network Device Setup Utility** on the **Start** screen to start IJ Network Device Setup Utility. If **IJ Network Device Setup Utility** is not displayed on the **Start** screen, select the **Search** charm and search for "IJ Network Device Setup Utility".
- In Windows 7 or Windows Vista, click **Start** and select **All Programs**, **Canon Utilities**, **IJ Network Device Setup Utility**, and then **IJ Network Device Setup Utility**.

When you start up IJ Network Device Setup Utility, it searches for printers on network and detected printers are listed.

IJ Network Device Setup Utility Screen

- [Items on IJ Network Device Setup Utility Screen](#)
- [Menus on IJ Network Device Setup Utility Screen](#)
- [Items on IJ Network Device Setup Utility Screen Toolbar](#)

Items on IJ Network Device Setup Utility Screen

The screen below appears when you start up IJ Network Device Setup Utility. Detected printers are listed on the screen and the items below are shown.

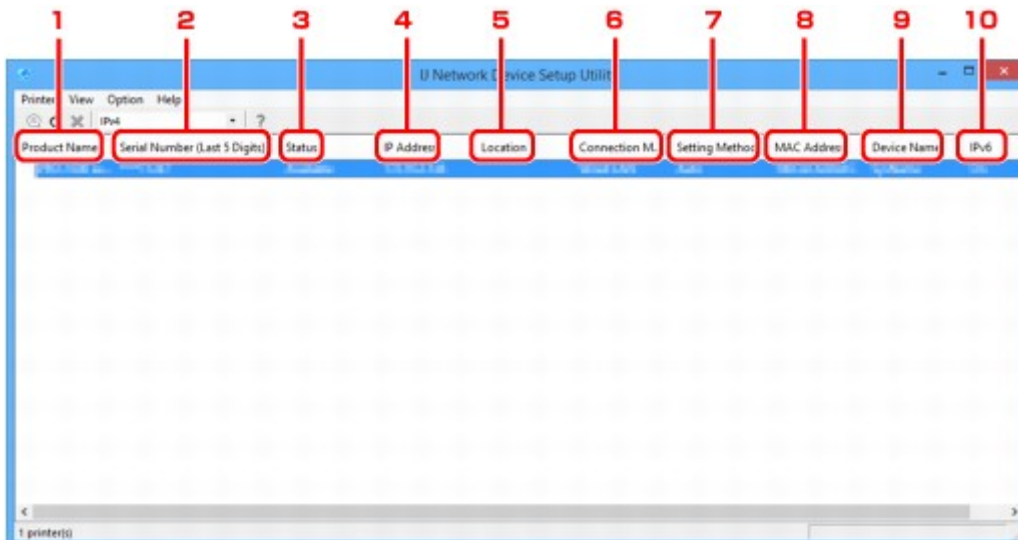

1. Product Name

Displays the product name of detected printer. The icon below appears on the left if the printer cannot be used.

: Appears when the printer has not been connected or configured.

: Appears when the IP address is duplicated to another printer.

: Appears when you cannot communicate with the printer.

Note

- If a printer you want to use is not detected, try to set the criteria for printer search.

- [Setting Criteria for Printer Search/Searching Specific Printer](#)

2. Serial Number (Last 5 Digits)

Displays the last five digits of printer's serial number.

3. Status

Displays the printer status as shown below.

Available

Indicates the printer is available.

Setup Completed

Appears after performing network setup and clicking **Set** to close the window.

Not Connected

Indicates the printer is required to perform wireless LAN setup.

■ [Performing/Changing Wireless LAN Settings](#)

Not Set

Indicates the printer cannot be used on network. Specify an IP address or enable IPv6.

IP Address Overlap

Indicates the IP address is duplicated to another printer.

Unknown

Indicates the printer used in the past cannot be used currently.

▶▶▶ Note

- If **USB** is selected from the pulldown menu on the toolbar, nothing is displayed.

4. IP Address

Displays the printer IP address.

▶▶▶ Note

- If **USB** is selected from the pulldown menu on the toolbar, "-" is displayed for the interface (wireless/wired LAN) disabled on the printer setting.

5. Location

Displays the printer location if it is registered.

▶▶▶ Note

- If **USB** is selected from the pulldown menu on the toolbar, nothing is displayed.

■ [Assigning Printer Information](#)

6. Connection Method

Displays printer connection method (wired or wireless LAN).

▶▶▶ Note

- If **USB** is selected from the pulldown menu on the toolbar, either of the LAN connection method (wired or wireless) available for the printer is displayed.
- If the printer supports both of the LAN connection methods, the printer is recognized as two printers and they are displayed separately.
- If the printer does not support wired LAN, wired LAN is not displayed.
- If you are using IJ Network Device Setup Utility on the computer which does not support wireless LAN, wireless LAN is not displayed.
- If you are using the printer with direct connection, neither wired LAN nor wireless LAN is displayed.

7. Setting Method

Displays printer setting method.

- **Auto**

Appears if the printer is used by IP address specified automatically.

- **Manual**

Appears if the printer is used by IP address specified manually.

▶▶▶ Note

- If **USB** is selected from the pulldown menu on the toolbar, "-" is displayed for the interface (wireless/wired LAN) disabled on the printer setting.

8. MAC Address

Displays the MAC address of the detected printer.

▶▶▶ Note

- If **USB** is selected from the pulldown menu on the toolbar, "-" is displayed for the interface (wireless/wired LAN) disabled on the printer setting.

9. Device Name

Displays the printer device name if it is registered.

▶▶▶ Note

- If **USB** is selected from the pulldown menu on the toolbar, nothing is displayed.

■ [Assigning Printer Information](#)

10. IPv6

On appears when an IPv6 address is assigned for the printer.

▶▶▶ Note

- If **USB** is selected from the pulldown menu on the toolbar, "-" is displayed.

Menus on IJ Network Device Setup Utility Screen

This section describes menus on IJ Network Device Setup Utility screen.

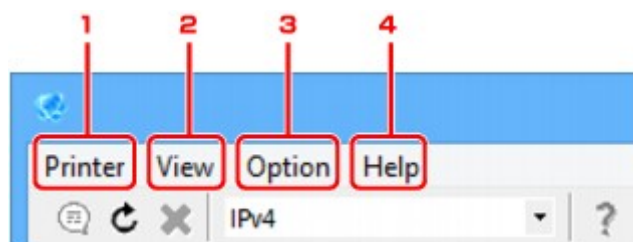

1. **Printer** menu

■ [Printer Menu](#)

2. **View** menu

■ [View Menu](#)

3. **Option** menu

■ [Option Menu](#)

4. **Help** menu

■ [Help Menu](#)

Items on IJ Network Device Setup Utility Screen Toolbar

This section describes items on IJ Network Device Setup Utility Screen toolbar.

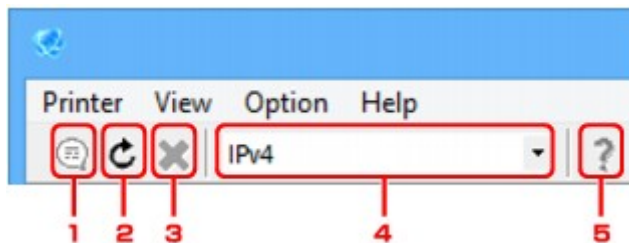

1. Perform wired or wireless LAN setup.

➤➤➤ **Note**

- This item has the same function as [Protocol Settings...](#) in the **Printer** menu.

2. Redetects printers.

➤➤➤ **Note**

- This item has the same function as [Update](#) in the **View** menu.

3. Stops detecting printers.

➤➤➤ **Note**

- This item has the same function as [Cancel](#) in the **View** menu.

4. Switches the printer list. (IPv4, IPv6, or USB printers)

➤➤➤ **Note**

- This item has the same function as [Switch IPv4/IPv6/USB](#) in the **View** menu.
- You can also display the USB connected printer list. (Not available for some models.) In this case, select **USB**.

5. Displays this guide.

▶▶ Note

- This item has the same function as [Online Manual](#) in the **Help** menu.

Performing Network Settings

- ▶ **Performing/Changing Wired LAN Settings**
- ▶ **Performing/Changing Wireless LAN Settings**
- ▶ **Assigning Printer Information**
- ▶ **Initializing Network Settings**
- ▶ **Changing Administrator Password**
- ▶ **Setting Criteria for Printer Search/Searching Specific Printer**
- ▶ **If WEP Details Screen Appears**
- ▶ **If WPA/WPA2 Details Screen Appears**

Performing/Changing Wired LAN Settings

Follow the procedure below to perform/change wired LAN settings.

▶▶▶ Note

- For some models, you can perform network setup for a USB connected printer using IJ Network Device Setup Utility. Select **USB** on **Switch IPv4/IPv6/USB** under the **View** menu to display printers for which you can perform setup.

1. [Start up IJ Network Device Setup Utility.](#)

Detected printers are listed.

2. Select printer to perform/change settings from printer list.

Select the printer with **Wired LAN** displayed on **Connection Method** and the setting other than **Unknown** or **Setup Completed** displayed on **Status** to perform settings.

To perform setup for a USB connected printer, select **USB** from the pulldown menu on the toolbar and select the printer with **Wired LAN** displayed on **Connection Method**.

3. Select **Protocol Settings...** on **Printer** menu.

The **Confirm Printer Password** screen appears.

For more on the password, refer to [Administrator Password](#).

▶▶▶ Note

- Clicking the  icon allows you to perform/change settings.

4. Enter password and click **OK**.

The **Protocol Settings** screen appears.

5. Perform/change settings.

You can switch the screen between IPv4 and IPv6. Click the tab to switch the protocol.

- IPv4 settings

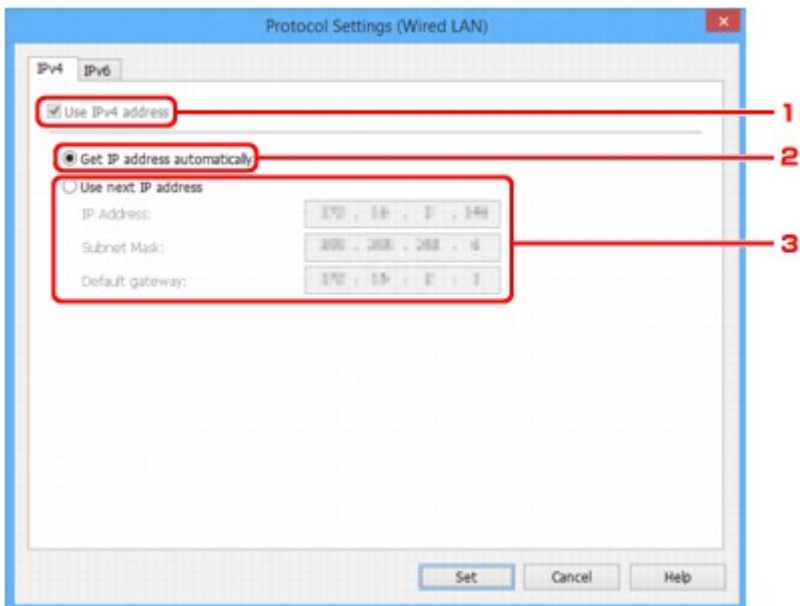

1. Use IPv4 address

Always selected. (displayed in a gray out state)

2. Get IP address automatically

Select this option to use an IP address automatically assigned by a DHCP server. DHCP server functionality must be enabled on your router.

3. Use next IP address

Select this option if no DHCP server functionality is available in your setup where you use the printer, or you want to use a fixed IP address.

Enter the IP address, subnet mask, and default gateway.

• IPv6 settings

▶▶▶ Note

- If **USB** is selected from the pulldown menu on the toolbar, you cannot perform IPv6 settings.

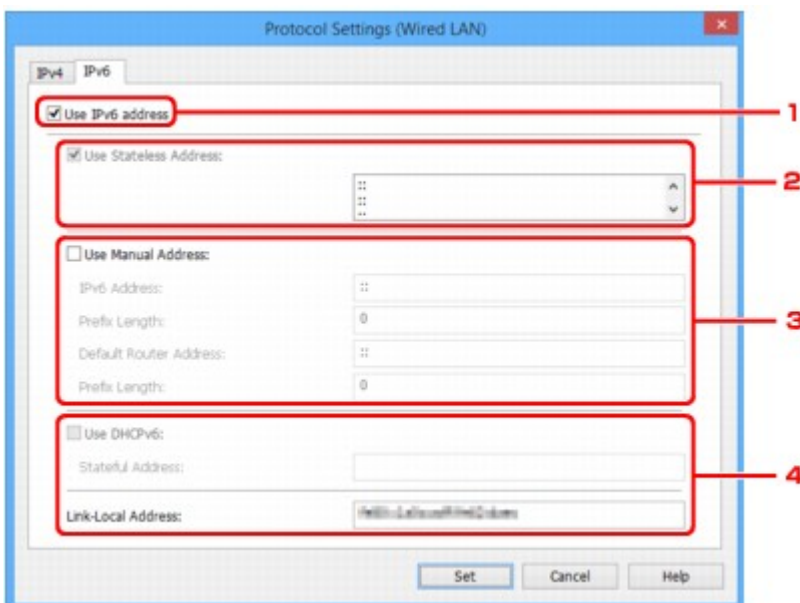

1. **Use IPv6 address**

Select when you use the printer with IPv6 environment.

2. **Use Stateless Address:**

Select when you use an IP address assigned automatically. Use a router compatible with IPv6.

▶▶▶ Note

- This setting item is not available depending on the printer you are using.

3. **Use Manual Address:**

Select this option if no DHCP server functionality is available in your setup where you use the printer, or you want to use a fixed IP address.

Enter the IP address and IP address prefix length.

▶▶▶ Note

- This setting item is not available depending on the printer you are using.

4. **Use DHCPv6:**

Select when you obtain an IP address using DHCPv6.

▶▶▶ Note

- This setting item is not available depending on the printer you are using.

6. Click **Set**.

Performing/Changing Wireless LAN Settings

Follow the procedure below to perform/change wireless LAN settings.

▶▶▶ Important

- Enable cableless setup before performing printer setup. (Not required if you change the IP address.) For details, search for "NR049" on your printer's online manual and see the page shown.

▶▶▶ Note

- For some models, you can perform network setup for a USB connected printer using IJ Network Device Setup Utility. Select **USB** on **Switch IPv4/IPv6/USB** under the **View** menu to display printers.

1. [Start up IJ Network Device Setup Utility.](#)

Detected printers are listed.

2. Select printer to perform/change settings from printer list.

Select the printer with **Wireless LAN** displayed on **Connection Method** and the setting other than **Unknown** or **Setup Completed** displayed on **Status** to perform settings.

To perform setup for a USB connected printer, select **USB** from the pulldown menu on the toolbar and select the printer with **Wireless LAN** displayed on **Connection Method**.

3. Select **Protocol Settings...** on **Printer** menu.

The **Confirm Printer Password** screen appears.

For more on the password, refer to [Administrator Password](#).

▶▶▶ Note

- Clicking the  icon allows you to perform/change settings.

4. Enter password and click **OK**.

The **Protocol Settings** screen appears.

5. Perform/change settings.

You can switch the screen between IPv4 and IPv6. Click the tab to switch the protocol.

- IPv4/IPv6 settings

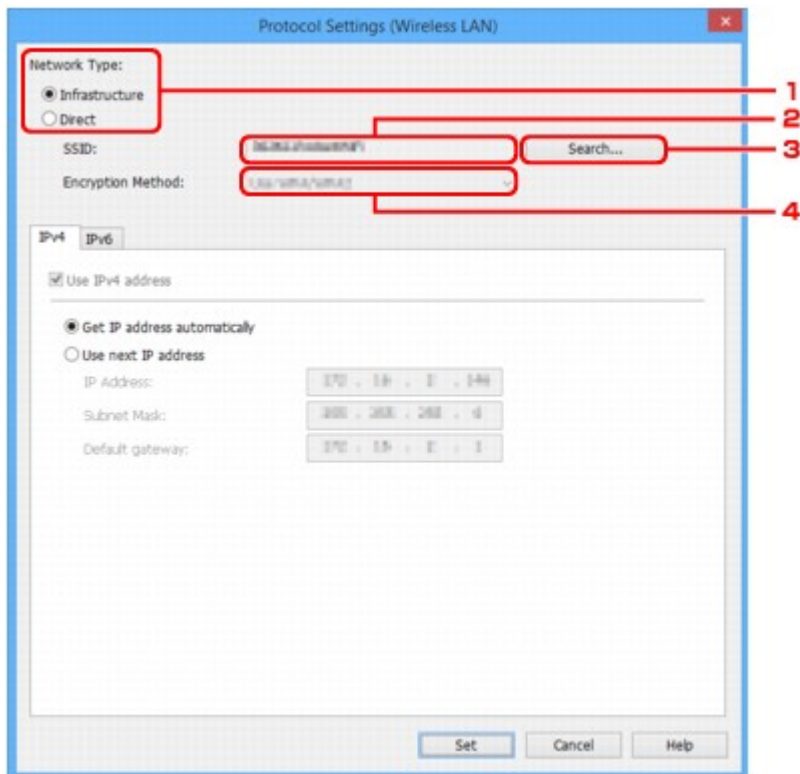

1. Network Type:

Select the wireless LAN mode.

Infrastructure

Connects the printer to the wireless LAN with a wireless router.

Direct

Connects the printer to wireless communication devices without a wireless router.

▶▶▶ Note

- If **Direct** is selected, the **Search...** button is displayed in a gray out status.
In addition, you cannot connect to Internet from your computer depending on your operating environment.

2. SSID:

The network identifier (SSID) of the wireless LAN currently used is displayed.

The identifier for direct connection (SSID) appears while in direct connection.

3. Search...

The **Detected Wireless Routers** screen is displayed to select a wireless router to connect to. For a wireless router already connected to the computer, **Available** is displayed on **Communication Status**.

If you select a wireless router with **Not Connected** on **Communication Status** from the list, clicking **Set** displays the WPA/WPA2 or WEP setting screen for a wireless router.

■ [If WEP Details Screen Appears](#)

■ [If WPA/WPA2 Details Screen Appears](#)

4. Encryption Method:

Displays the encryption method used over the wireless LAN.

- IPv4 settings

▶▶▶ Note

- The setting items below are available only when **Infrastructure** is selected for **Network Type**:

If **Direct** is selected, the setting items below are displayed in a gray out status.

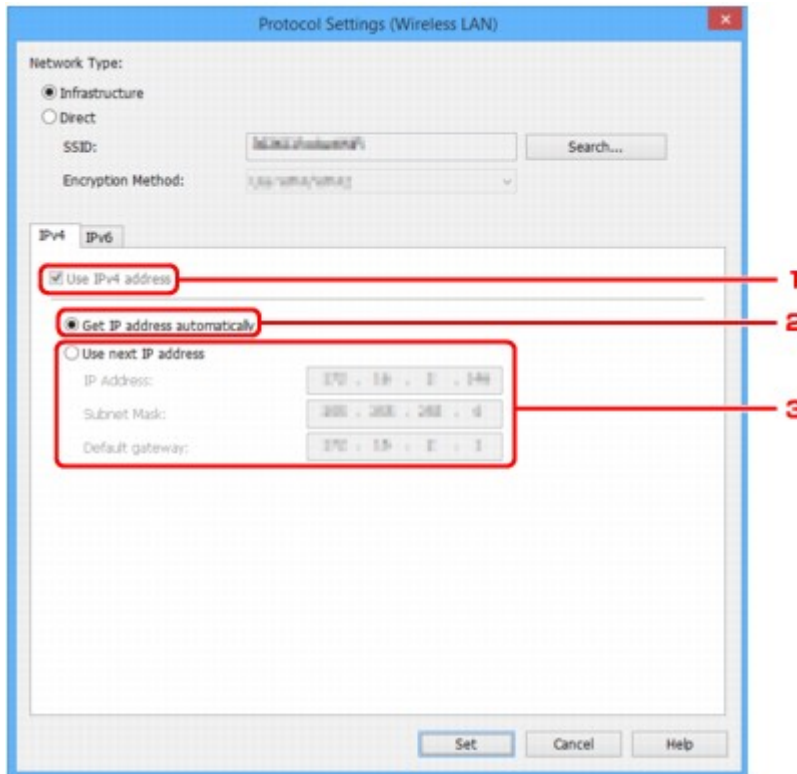

1. Use IPv4 address

Always selected. (displayed in a gray out state)

2. Get IP address automatically

Select this option to use an IP address automatically assigned by a DHCP server. DHCP server functionality must be enabled on your router.

3. Use next IP address

Select this option if no DHCP server functionality is available in your setup where you use the printer, or you want to use a fixed IP address.

Enter the IP address, subnet mask, and default gateway.

- IPv6 settings

▶▶▶ Note

- If **USB** is selected from the pulldown menu on the toolbar, you cannot perform IPv6 settings.
- The setting items below are available only when **Infrastructure** is selected for **Network Type**:

If **Direct** is selected, the setting items below are displayed in a gray out status.

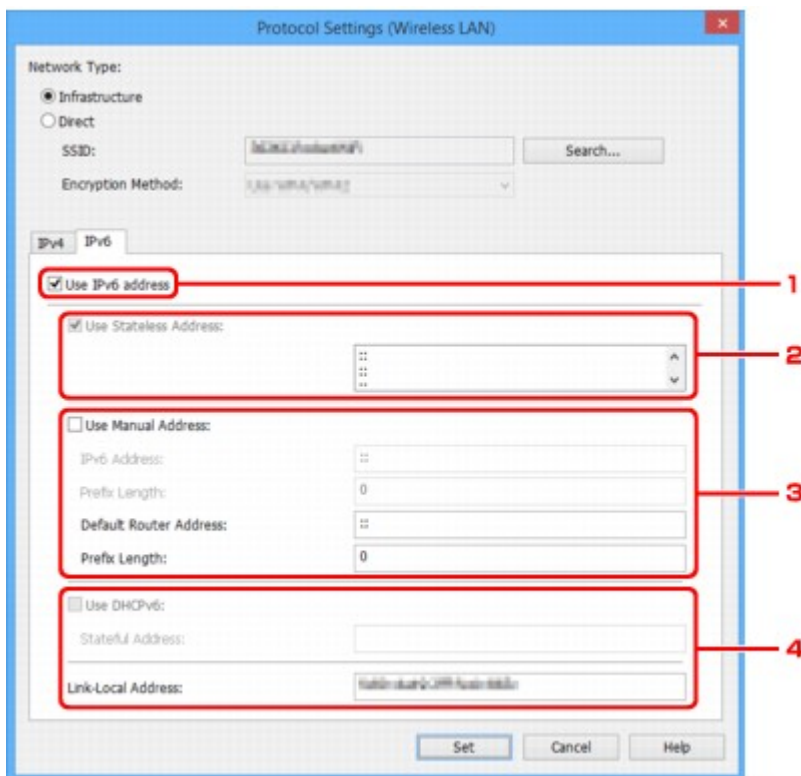

1. Use IPv6 address

Select when you use the printer with IPv6 environment.

2. Use Stateless Address:

Select when you use an IP address assigned automatically. Use a router compatible with IPv6.

»» Note

- This setting item is not available depending on the printer you are using.

3. Use Manual Address:

Select this option if no DHCP server functionality is available in your setup where you use the printer, or you want to use a fixed IP address.

Enter the IP address and IP address prefix length.

»» Note

- This setting item is not available depending on the printer you are using.

4. Use DHCPv6:

Select when you obtain an IP address using DHCPv6.

»» Note

- This setting item is not available depending on the printer you are using.

6. Click **Set**.

Assigning Printer Information

Follow the procedure below to assign/change printer location name or device name.

The names appear on **Device Name:** and **Location:** on the **IJ Network Device Setup Utility** screen.

»» Note

- If **USB** is selected from the pulldown menu on the toolbar, this setting item is not available.

1. [Start up IJ Network Device Setup Utility.](#)

Detected printers are listed.

2. Select printer to assign location name and device name.

Select the printer with **Available** displayed on **Status**.

3. Select **Detailed Printer Settings...** on **Printer** menu.

The **Confirm Printer Password** screen appears.

For more on the password, refer to [Administrator Password](#).

4. Enter password and click **OK**.

The **Detailed Printer Settings** screen appears.

5. Perform/change settings.

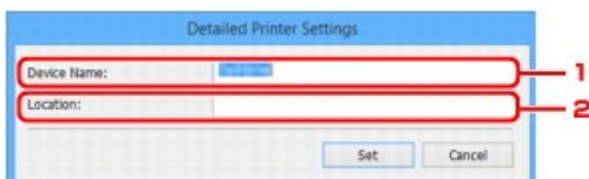

The setting items below are available.

1. **Device Name:**

Assigns the device name.

2. **Location:**

Assigns the location name.

6. Click **Set**.

Initializing Network Settings

Follow the procedure below to initializing printer network settings.

1. [Start up IJ Network Device Setup Utility.](#)

Detected printers are listed.

2. Select printer to initialize settings.

Select the printer with **Available** displayed on **Status**.

3. Select **Reset LAN settings** on **Printer** menu.

The **Confirm Printer Password** screen appears.

For more on the password, refer to [Administrator Password](#).

4. Enter password and click **OK**.

5. Click **Yes** on the displayed screen.

6. Click **OK** on the displayed screen.

The printer network settings are initialized.

Changing Administrator Password

Follow the procedure below to change the administrator password.

1. [Start up IJ Network Device Setup Utility.](#)

Detected printers are listed.

2. Select printer to change password.

Select the printer with **Available** displayed on **Status**.

3. Select **Change Password...** on **Printer** menu.

The **Change Printer Password** screen appears.

For more on the password, refer to [Administrator Password](#).



The image shows a screenshot of a Windows-style dialog box titled "Change Printer Password". The dialog box has a blue title bar with a close button (X) on the right. Inside the dialog, there are three text input fields stacked vertically, labeled "Old Password:", "New Password:", and "Confirm:". At the bottom right of the dialog, there are two buttons: "OK" and "Cancel".

4. Enter current password and new password.

5. Enter new password in **Confirm:** again.

6. Click **OK**.

The administrator password is updated.

Setting Criteria for Printer Search/Searching Specific Printer

You can set the criteria for printer search when you start up IJ Network Device Setup Utility or update the printer search, or you can search the specific printer.

Changing these settings may detect the printer you want to use if it is not detected

▶▶▶ Note

- If the printer you want to use is not detected, it may be detected by entering IP address, subnet mask, or default gateway on the operation panel and search again.

■ [Setting Criteria for Printer Search](#)

■ [Searching Specific Printer](#)

Setting Criteria for Printer Search

1. [Start up IJ Network Device Setup Utility.](#)
2. Select **Search Settings...** on **Option** menu.
The **Search Settings** screen appears.
3. Enter criteria for printer search.

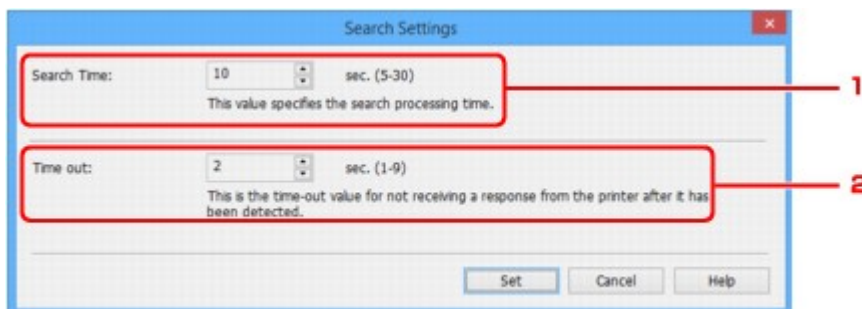

1. **Search Time:**
Specifies the time to search printers.
2. **Time out:**
Specifies the timeout length for not receiving a response from printer.

▶▶▶ Note

- Printers you want to find are more likely to be detected as the values are larger, however, it may take a while to search them.

4. Click **Set**.

Searching Specific Printer

1. [Start up IJ Network Device Setup Utility.](#)

2. Select **Specified Searching...** on **Option** menu.

The **Specified Searching** screen appears.

3. Select item to specify and enter value.

Specified Searching

Select the search method, and then click [Search].
The results will be displayed in the list.

IPv4 Address

IPv6 Address

Host Name

Search Cancel Help

1. **IPv4 Address**

Specifies the IPv4 address of the printer you want to search.

2. **IPv6 Address**

Specifies the IPv6 address of the printer you want to search.

3. **Host Name**

Specifies the host name of the printer you want to search.

4. Click **Search**.

IJ Network Device Setup Utility starts searching by the specified criteria and detected printers are listed.

If WEP Details Screen Appears

Enter the password (passphrase) according to wireless router's encryption method if you change a wireless router to connect to the printer.

1. Enter items below when **WEP Details** screen appears.

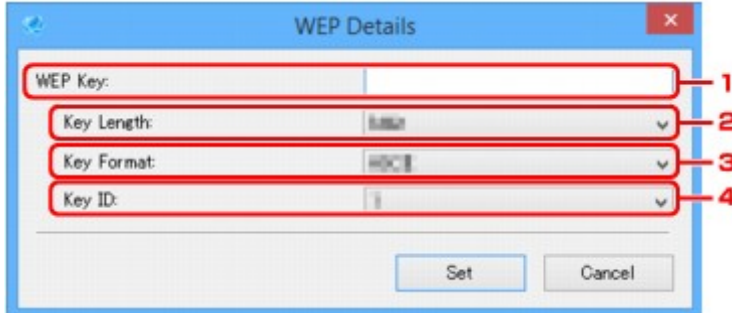

1. **WEP Key:**

Enter the same key as the one set to the wireless router.

The number of characters and character type that can be entered differ depending on the combination of the key length and key format.

		Key Length:	
		64bit	128bit
Key Format:	ASCII	5 characters	13 characters
	Hexadecimal (Hex)	10 digits	26 digits

2. **Key Length:**

Select either **64bit** or **128bit**.

3. **Key Format:**

Select either **ASCII** or **Hex**.

4. **Key ID:**

Select the Key ID (index) set to the wireless router.

2. Click **Set**.

▶▶▶ Important

- If the printer cannot communicate with the computer after the encryption type of the printer was switched, make sure encryption types for the computer and the wireless router match that set to the printer.

If WPA/WPA2 Details Screen Appears

Enter the password (passphrase) according to wireless router's encryption method if you change a wireless router to connect to the printer.

1. Enter passphrase when **WPA/WPA2 Details** screen appears.

Enter the passphrase set to the wireless router. The passphrase should be a string of 8 to 63 alphanumeric characters or a 64-digit hexadecimal value.

If you do not know the wireless router passphrase, refer to the instruction manual provided with the wireless router or contact its manufacturer.

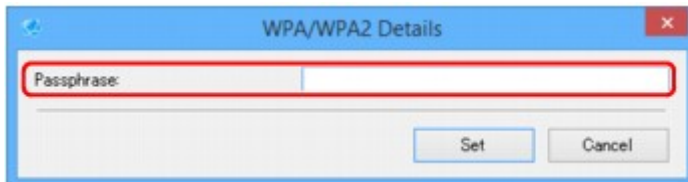

2. Click **Set**.

▶▶▶ Important

- If the printer cannot communicate with the computer after the encryption type of the printer was switched, make sure encryption types for the computer and the wireless router match that set to the printer.

Checking Network Status

- **Checking Wireless Network Status**
- **Displaying Computer Network Information**
- **Displaying Printer Network Information**
- **Checking Connection Status between Printer and Wireless Router**
- **Checking Network Setting Difference**

Checking Wireless Network Status

Follow the procedure below to check the wireless network status (signal strength) between the printer and computer.

If anything is wrong with the wireless LAN connection, check the network status from this menu.

1. [Start up IJ Network Device Setup Utility.](#)

The detected printers are listed.

2. Select printer to check wireless network status from printer list.

Select the printer with **Available** displayed on **Status**.

3. Select **Check Wireless Communication Status** on **Printer** menu.

The **Confirm Printer Password** screen appears.

For more on the password, refer to [Administrator Password](#).

4. Enter password and click **OK**.

- If the printer is connected to the computer with a wireless router:

The screen below appears.

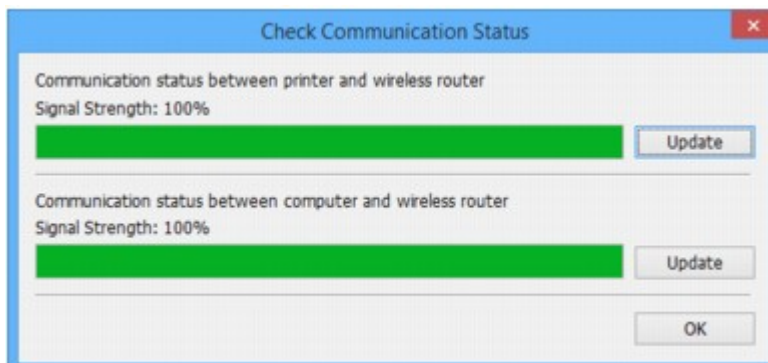

- If the printer is connected to the computer using direct connection:

The screen below appears.

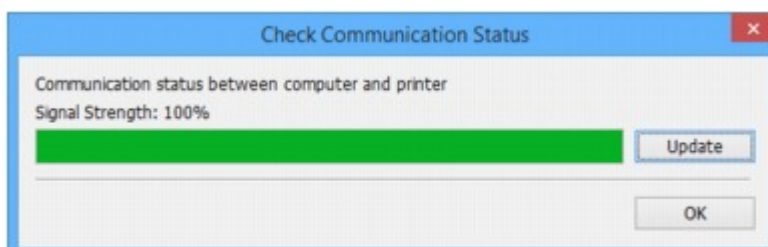

Clicking **Update** measures the signal strength again.

5. Click **OK** to close screen.

Displaying Computer Network Information

Follow the procedure below to display the network information of the computer which the printer selected in the **IJ Network Device Setup Utility** screen connects to and on which IJ Network Device Setup Utility is installed.

1. [Start up IJ Network Device Setup Utility.](#)
2. Select **Computer Network Information** on **View** menu.

The screen below appears.

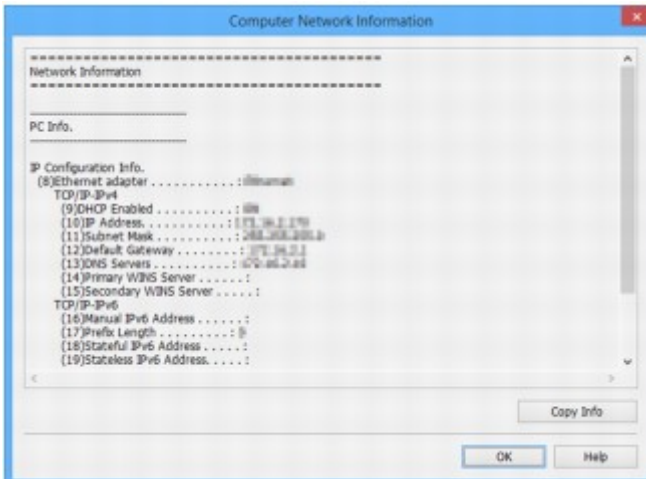

Clicking **Copy Info** copies all network information on the clipboard.

3. Click **OK** to close screen.

Displaying Printer Network Information

Follow the procedure below to display the printer network information.

1. [Start up IJ Network Device Setup Utility.](#)

The detected printers are listed.

2. Select printer to display network information from printer list.

Select the printer with **Available** displayed on **Status**.

3. Select **Printer Network Information** on **View** menu.

The **Confirm Printer Password** screen appears.

For more on the password, refer to [Administrator Password](#).

4. Enter password and click **OK**.

The screen below appears.

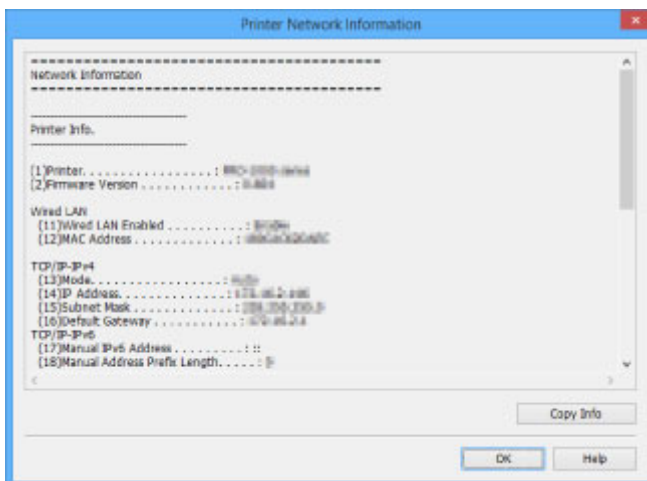

Clicking **Copy Info** copies all network information on the clipboard.

5. Click **OK** to close screen.

Checking Connection Status between Printer and Wireless Router

Follow the procedure below to check the wireless router information detected by the printer.

Detects wireless routers around the printer and the detected ones are listed. Use this menu to make sure whether the printer is located properly.

1. [Start up IJ Network Device Setup Utility.](#)

The detected printers are listed.

2. Select printer to check connection status between printer and wireless router from printer list.

Select the printer with **Available** displayed on **Status** and **Wireless LAN** displayed on **Connection Method**.

3. Select **Status of Printer and Wireless Router Connection** on **View** menu.

The **Confirm Printer Password** screen appears.

For more on the password, refer to [Administrator Password](#).

4. Enter password and click **OK**.

The screen below appears.

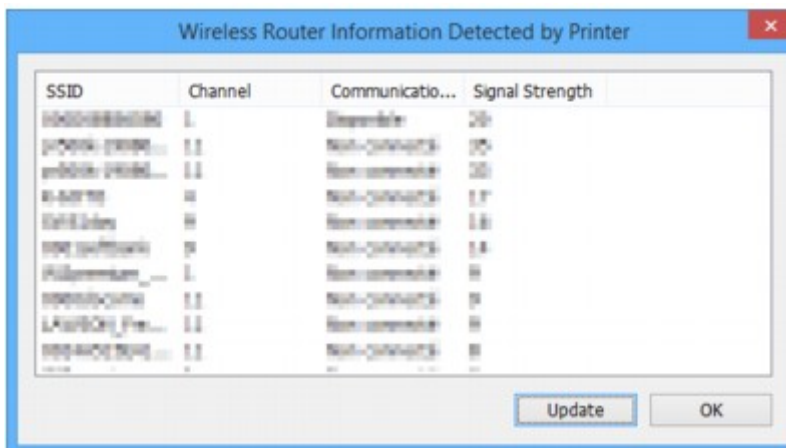

Clicking **Update** searches wireless routers again.

5. Click **OK** to close screen.

Checking Network Setting Difference

If you cannot use a printer you used on the network before, compare the current network status with that when you could use the printer and check the difference.

1. [Start up IJ Network Device Setup Utility.](#)

The detected printers are listed.

2. Select printer with **Unknown** or **Not Set** displayed on **Status** from printer list.
3. Select **Check Connection Status** on **View** menu.

The screen below appears.

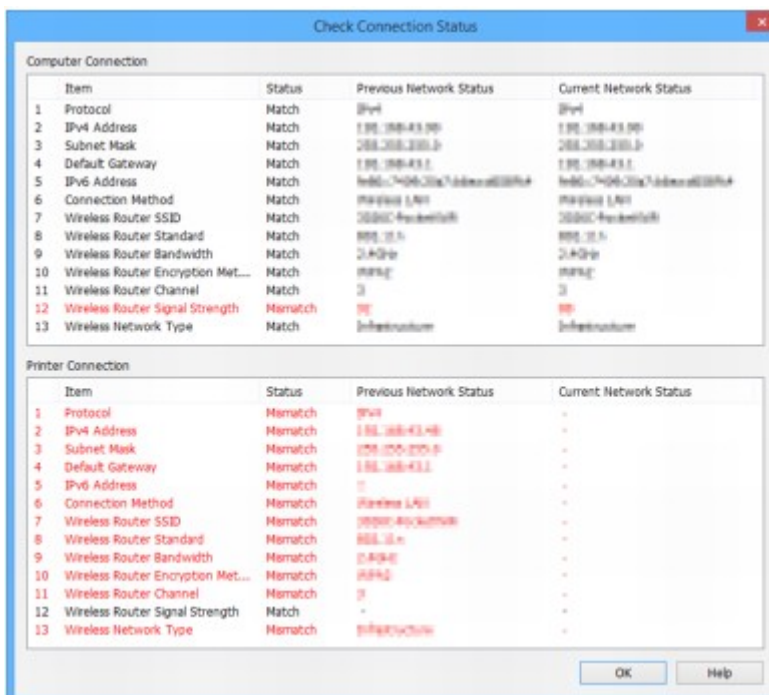

If the network status when you used the printer is different from the current status, **Mismatch** appears on **Status** and the items are displayed in red. Check the red items.

4. Click **OK** to close screen.

IJ Network Device Setup Utility Menus

- ▶ **Printer Menu**
- ▶ **View Menu**
- ▶ **Option Menu**
- ▶ **Help Menu**

Printer Menu

This section describes the items displayed on the **Printer** menu.

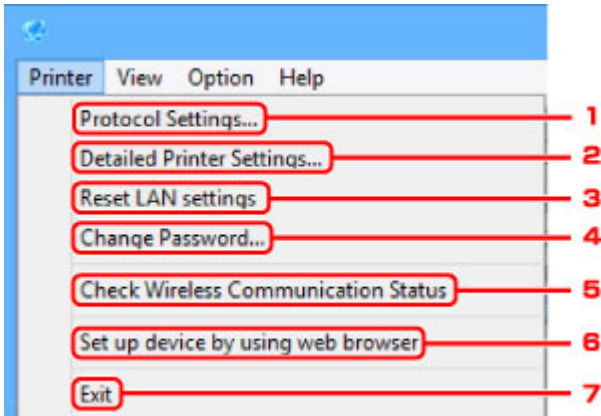

1. Protocol Settings...

Performs wired or wireless LAN settings.

- [Performing/Changing Wired LAN Settings](#)
- [Performing/Changing Wireless LAN Settings](#)

2. Detailed Printer Settings...

Assigns the printer device name and location name.

- [Assigning Printer Information](#)

3. Reset LAN settings

Initializes the printer LAN settings.

- [Initializing Network Settings](#)

4. Change Password...

Changes the password specified for the printer.

- [Changing Administrator Password](#)

5. Check Wireless Communication Status

Check wireless LAN communication status.

- [Checking Wireless Network Status](#)

6. Set up device by using web browser

Check the printer information or perform settings in detail on the web page.

▶▶▶ Note

- You can use this function on the following the OS and the web browser.
OS: Windows Vista SP2 or later

Web browser: Internet Explorer 9 or later, Google Chrome 41.0.2272.118m or later, Mozilla Firefox 37.0.1 or later

7. **Exit**

Finishes IJ Network Device Setup Utility.

View Menu

This section describes the items displayed on the **View** menu.

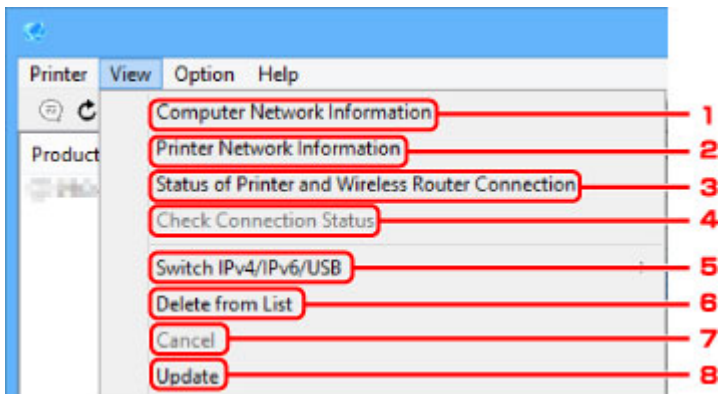

1. Computer Network Information

Check the computer network information.

■ [Displaying Computer Network Information](#)

2. Printer Network Information

Check the printer network information.

■ [Displaying Printer Network Information](#)

3. Status of Printer and Wireless Router Connection

Searches wireless routers and check the wireless router information (wireless channel, communication status, and signal strength) detected by the printer.

■ [Checking Connection Status between Printer and Wireless Router](#)

4. Check Connection Status

If you cannot use a printer you used on the network before, compare the current network status with that when you can use the printer and check the difference.

■ [Checking Network Setting Difference](#)

5. Switch IPv4/IPv6/USB

Switches the printer list between IPv4 printers and IPv6 printers. For some models, you can list USB connected printers.

6. Delete from List

Deletes the selected printer from the printer list.

7. Cancel

Cancels printer search.

»» Note

- You can also cancel printer search by clicking the  icon.

8. Update

Searches printers again.

»» Note

- You can also search printers again by clicking the  icon.

Option Menu

This section describes the items displayed on the **Option** menu.

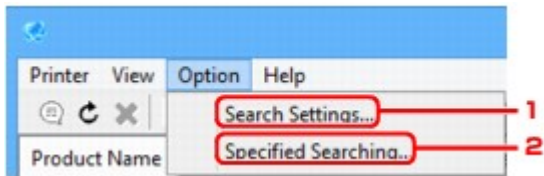

1. Search Settings...

Specifies criteria for printer search.

- [Setting Criteria for Printer Search](#)

2. Specified Searching...

Searches the printer by an IP address or host name.

- [Searching Specific Printer](#)

Help Menu

This section describes the items displayed on the **Help** menu.

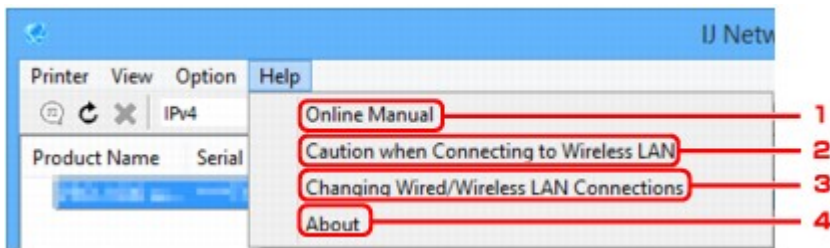

1. **Online Manual**

Displays this guide.

2. **Caution when Connecting to Wireless LAN**

Displays the caution message for wireless LAN connection.

3. **Changing Wired/Wireless LAN Connections**

Displays the message on changing LAN connection method (wired or wireless) for the selected printer.

4. **About**

Displays IJ Network Device Setup Utility version information.

Other Network Information

- ▶ [Technical Terms](#)
- ▶ [Restrictions](#)
- ▶ [Firewall](#)

Technical Terms

In this section, technical terms used in the manual are explained.

- [A](#)
- [B](#)
- [C](#)
- [D](#)
- [E](#)
- [H](#)
- [I](#)
- [K](#)
- [L](#)
- [M](#)
- [O](#)
- [P](#)
- [R](#)
- [S](#)
- [T](#)
- [U](#)
- [W](#)

A

- **Access point mode**

The printer is used as an access point to connect external wireless communication devices (e.g. computers, smartphones, or tablets) in an environment where no access point (wireless router) is available. You can connect up to 5 devices to the printer using the access point mode (direct connection).

- **Ad-hoc**

Client computer and printer setting where wireless communication occurs on a peer-to-peer basis, i.e., all clients in with the same SSID/network name communicate directly with each other. No wireless router is required. This printer does not support ad-hoc communication.

- **Admin Password**

Administrator password in IJ Network Device Setup Utility to restrict access to network users. It must be entered to access the printer and change printer settings.

- **AES**

An encryption method. It is optional for WPA. Strong cryptographic algorithm adopted within U.S. government organizations for information processing.

- **Authentication Method**

The method that a wireless router uses to authenticate a printer through a wireless LAN. The methods are agreeable each other.

For WPA/WPA2, authentication method is PSK.

B

- **Bonjour**

A service built into Mac OS X operating system to detect the connectable devices on a network automatically.

C

- **Cableless setup**

Specifies a wireless router settings using a device (e.g. smartphone) directly without using a wireless router.

- **Channel**

Frequency channel for wireless communication. In the infrastructure mode, the channel is automatically adjusted to match that set to the wireless router. This printer supports channels 1 to 13. (Channels 12 and 13 are not supported depending on the country or region of purchase.) Note that the number of channels that can be used for your wireless LAN varies depending on the region or country.

D

- **Default Gateway**

A relay device to connect to another network such as a router or a computer.

- **Default router address**

A default IP address set for a router.

- **DHCP server functionality**

The router assigns an IP address automatically whenever the printer or the personal computer on a network starts up.

- **DHCPv6**

A protocol to assign necessary information automatically when a computer connects to network. DHCPv6 can be used when IPv6 is enabled.

- **Direct connection (Access point mode)**

The printer is used as an access point to connect external wireless communication devices (e.g. computers, smartphones, or tablets) in an environment where no wireless router is available. You can connect up to 5 devices to the printer using the direct connection (access point mode).

- **DNS server**

A server that converts device names into IP addresses. When specifying IP addresses manually, specify the addresses of both a primary and a secondary server.

F

- **Firewall**

It is a system that prevents an unlawful computer access in the network. To prevent, you can use the firewall function of a broadband router, the security software installed in the computer, or operation system for computer.

H

- **Host name**

A name for a computer or printer on network so that it can be recognized easily. Single-byte alphanumeric characters are used generally.

I

- **IEEE802.11b**

International standard for wireless LAN using the 2.4 GHz frequency range with a throughput of up to 11 Mbps.

- **IEEE802.11g**

International standard for wireless LAN using the 2.4 GHz frequency range with a throughput of up to 54 Mbps. Compatible with 802.11b.

- **IEEE802.11n**

International standard for wireless LAN using the 2.4 GHz and 5 GHz frequency ranges. Even when using two or more antennas simultaneously or obtaining a bigger transfer rate than before by using multiple communication channels at the same time, the transmission speed may be influenced by the connected apparatus.

At the maximum transfer rate of 600 Mbps, it is possible to communicate with multiple computer terminals within a dozen or so metre radius.

Compatible with 802.11b and 802.11g.

- **Infrastructure**

One of the wireless communication methods. Wireless communication devices (e.g. computer or printer) are connected to the network via a wireless router.

- **IP Address**

A unique number with four parts separated by dots. Every network device that is connected to the Internet has an IP address. Example: 192.168.0.1

An IP address is usually assigned by a wireless router or a DHCP server of the router automatically.

- **IPv4/IPv6**

They are internetwork-layer protocol used on the internet. IPv4 uses 32-bit addresses and IPv6 uses 128-bit addresses.

K

- **Key Format**

Select either **ASCII** or **Hex** as the WEP key format. The character that can be used for the WEP key differs depending on the selected key formats.

- ASCII

Specify with a 5 or 13-character string that can include alphanumeric and underscore "_" characters. It is case-sensitive.

- Hex

Specify a 10-digit or 26-digit string that can contain hexadecimal (0 to 9, A to F, and a to f).

- **Key Length**

Length of the WEP key. Select either 64 bits or 128 bits. Longer key length allows you to set a more complex WEP key.

L

- **Link local address**

An IP address generated automatically from a specific prefix (information of current network: fe80::) and an interface identifier generated from printer's MAC address.

- **Link Quality**

The status of the connection between the wireless router and the printer excluding noise (interference) is indicated with a value from 0 to 100%.

- **LPR**

A platform-independent printing protocol used in TCP/IP networks. It does not support bidirectional communication.

M

- **MAC Address**

Also known as the physical address. A unique and permanent hardware identifier that is assigned to network devices by its manufacturer. MAC addresses are 48 bits long and are written as a hexadecimal number separated by colons, i.e., 11:22:33:44:55:66.

O

- **Operation Status**

Indicates the status on whether the printer can be used.

P

- **Prefix length**

The number of bits on the network part of an IP address. The number of bits is 8 bit to 24 bit for IPv4, and 64 bit for IPv6.

- **Proxy server**

A server that links a LAN-connected computer to the Internet. When using a proxy server, specify the address and the port number of the proxy server.

- **PSK**

An encryption method employed by WPA/WPA2.

R

- **Router**

A relay device to connect to another network.

S

- **Signal Strength**

The strength of the signal received by the printer from the wireless router is indicated with a value from 0 to 100%.

- **SSID**

Unique label for wireless LAN. It is often represented such as a network name or a wireless router name.

SSID distinguishes one wireless LAN from another to prevent interference.

The printer and all clients on a wireless LAN must use the same SSID in order to communicate with each other. The SSID can be up to 32 characters long, and is made up of alphanumeric characters. The SSID may also be referred to by its network name.

- **Stealth**

In the stealth mode, a wireless router hides itself by not broadcasting its SSID. The client must specify the SSID set to the wireless router to detect it.

- **Stateful address**

An IPv6 address acquired from a DHCP server using DHCPv6.

- **Stateless address**

A tentative IPv6 address generated automatically using a prefix included in RA (Router Advertisement) and a MAC address. An IPv6 address is generated in an environment where a DHCP server is not available.

- **Subnet Mask**

IP address has two components, the network address and the host address. Subnet Mask used to calculate the Subnet Mask address from the IP address. A Subnet Mask is usually assigned by a wireless router or a DHCP server of the router automatically.

Example:

IP Address: 192.168.127.123

Subnet Mask: 255.255.255.0

Subnet Mask Address: 192.168.127.0

T

- **TCP/IP**

Suite of communications protocols used to connect hosts on the Internet or the LAN. This protocol allows different terminals to communicate with each other.

- **TKIP**

An encryption protocol employed by WPA/WPA2.

U

- **USB**

Serial interface designed to enable you to "hot-swap" devices, i.e., by plugging and unplugging them without turning off the power.

W

- **WCN (Windows Connect Now)**

Users running Windows Vista or later can obtain the setting information directly via wireless network (WCN-NET).

- **WEP/WEP Key**

An encryption method employed by IEEE 802.11. Shared security key used to encrypt and decrypt data sent over wireless networks. This printer supports key length of 64 bits or 128 bits, key format of ASCII code or Hexadecimal, and key number of 1 to 4.

- **Wi-Fi**

International association that certifies interoperability of wireless LAN products based on the IEEE 802.11 specification.

This printer is a Wi-Fi authorized product.

- **Wireless LAN**

A network that, instead of being connected by physical wires, is connected by a wireless technology, such as Wi-Fi.

- **Wireless Router**

A wireless transceiver or base station that receives information from wireless clients/the printer and rebroadcasts it. Required in an infrastructure network.

- **WPA**

Security framework announced by the Wi-Fi Alliance in October 2002. The security has been strengthened more than WEP.

- Authentication

WPA defines the following authentication methods: PSK that can be used without an authentication server, plus WPA-802.1x that do require an authentication server.

This printer supports WPA-PSK.

- Passphrase

This encrypted key is used to perform WPA-PSK authentication.

The passphrase should be a string of 8 to 63 alphanumeric characters or a 64-digit hexadecimal value.

- **WPA2**

Security framework released by the Wi-Fi Alliance in September 2004 as a later version of WPA. Provides a stronger encryption mechanism through Advanced Encryption Standard (AES).

- Authentication

WPA2 defines the following authentication methods: PSK that can be used without an authentication server, plus WPA2-802.1x that do require an authentication server.

This printer supports WPA2-PSK.

- Passphrase

This encrypted key is used to perform WPA2-PSK authentication.

The passphrase should be a string of 8 to 63 alphanumeric characters or a 64-digit hexadecimal value.

- **WPS (Wi-Fi Protected Setup)**

WPS is a standard for easy and secure establishment of a wireless network.

There are 2 primary methods used in the Wi-Fi Protected Setup:

PIN entry: a mandatory method of setup for all WPS certified devices

Push button configuration (PBC): an actual push button on the hardware or through a simulated push button in the software.

Restrictions

If you use a printer over the wireless LAN, the printer may recognize nearby wireless systems, you should set a network key (WEP or WPA/WPA2) to the access point to encrypt wireless transmission. Wireless communication with a product that does not comply with the Wi-Fi standard cannot be guaranteed.

Connecting with too many computers may affect the printer performance, such as printing speed.

If you use a printer with direct connection, you cannot perform the following settings:

- Specifying an IP address manually
- Enabling/disabling IPv6

Firewall

A firewall is a function of the security software installed in the computer or operation system for computer, and is a system that is designed to prevent unauthorized access to a network.

Precautions When Firewall Function is Enabled

- A firewall function may limit communications between a printer and a computer. This may disable printer setup and communications.
- During the printer setup, you may be prompted to enable or disable communications, depending on the firewall function of the security software or operation system. If so, choose to enable communications.
- When using IJ Network Device Setup Utility, you may be prompted to enable or disable communications, depending on the firewall function of the security software. If so, choose to enable communications.
- If you cannot set up the printer, temporarily disable the firewall function of the security software or operation system.

Important

- If you disabled the firewall function, disconnect your network from the Internet.

- Some applications (like the network configuration software) override firewall settings. Check the application's settings beforehand.
- If the printer you use is set to **Get IP address automatically**, the IP address changes every time the printer connects to the network. This may disable printer setup and communications, depending on the firewall settings. In this case, either change the firewall settings or assign a fixed IP address to the printer. An IP address can be set using IJ Network Device Setup Utility.

■ [Performing/Changing Wired LAN Settings](#)

■ [Performing/Changing Wireless LAN Settings](#)

When assigning a fixed IP address to the printer, you will need to specify an IP address with which the computer can communicate.

Note

- For the operation system firewall settings or the security software firewall settings, refer to the instruction manual of the computer or software, or contact its manufacturer.

Ensuring Optimal Printing Results

- ▶ **Ink Tips**
- ▶ **Printing Tips**
- ▶ **Check Paper Settings Before Printing**
- ▶ **Set Cassette Paper Information After Loading Paper**
- ▶ **Canceling Print Jobs**
- ▶ **Keeping Print Quality High**
- ▶ **Transporting Your Machine**

Ink Tips

Is ink consumed for purposes other than printing?

Ink is sometimes consumed for purposes other than printing.

When you use the Canon printer for the first time after you install the bundled ink tanks, the printer consumes a small amount of ink in the amount to enable printing by filling the nozzles of the Print Head with ink.

The printing costs described in the brochures or websites are based on the consumption data from not the first ink tank /ink cartridge but the succeeding ink tank /ink cartridge.

Ink is sometimes used to maintain the optimal printing quality.

To keep printer's performance, Canon printer performs cleaning automatically according to its condition. When the printer performs cleaning, a small amount of ink is consumed. In this case, all colors of ink may be consumed.

[Cleaning function]

The cleaning function helps the printer to suck air bubbles or ink itself from the nozzle and thus prevents print quality degradation or nozzle clogging.

Is color ink consumed for black-and-white printing?

Black-and-white printing may consume ink in colors other than black, depending on the type of paper and printer driver settings used. Color ink is therefore consumed in some cases even for black-and-white print jobs.

▶▶ Note

- The machine uses pigment ink. With pigment ink, some ink on printed surfaces may come off when rubbed or scratched.

Printing Tips

Check status before printing

- Is the print head in good condition?

Clogged print head nozzles make printing fainter, which affects print quality and wastes paper. To check the print head, print the nozzle check pattern.

■ [Maintenance Procedure](#)

- Is ink smeared inside the machine?

After many print jobs, areas where paper passes through the machine may become smeared with ink. To clean the inside the machine, perform [Bottom Plate Cleaning](#).

Confirm that paper is loaded correctly

- Is the paper loaded in the correct orientation?

To load paper in a cassette, load paper printing-side DOWN.

■ [Loading Paper](#)

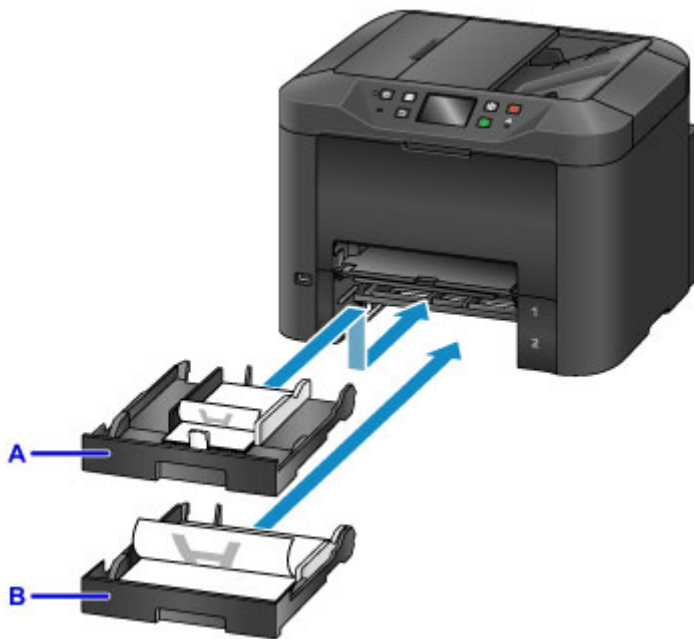

A: cassette 1

B: cassette 2

- Is the paper curled?

The curled paper causes paper jam. Flatten the curled paper, and then reload it.

■ "Correct curl before loading paper." in [Paper Is Smudged / Printed Surface Is Scratched](#)

Check Paper Settings Before Printing

Before printing, complete paper settings on the operation panel or from a computer.

Paper comes in many varieties. Some is specially coated for high-quality photo printing, while other paper is designed for documents.

Each type of paper has specific preset settings that determine details such as ink application and usage and the distance from nozzles, which ensures optimal print quality for the paper. In contrast, incorrect paper settings may impair color performance, or printed surfaces may rub against the machine.

If printing seems blurry or colors uneven, try printing again at a higher print quality setting.

Set Cassette Paper Information After Loading Paper

When you insert a cassette after loading paper, a screen for setting the type and size of paper is displayed. Set the paper information for the cassette, indicating the type and size of paper loaded.

To prevent incorrect printing, the machine can compare paper information entered for the cassette to print job paper settings to ensure they match. Before printing, specify paper settings consistent with the cassette paper information. If these settings do not match, automatic paper checking (if enabled) will prevent incorrect printing and display an error message. In this case, check and correct the paper settings.

To check cassette paper information, display the paper information screen on the operation panel.

Canceling Print Jobs

Do not press the ON button to cancel print jobs

Pressing the **ON** button to turn off the machine during printing may prevent the machine from printing again if print jobs are not cleared internally.

Press the **Stop** button to cancel printing.

Keeping Print Quality High

The key to maintaining optimal print quality is preventing the print head from drying out or becoming clogged. To ensure print quality, follow these tips.

»» Note

- On some paper, ink may run if you mark over it with a highlighter or water-based marker, or if water or sweat comes into contact with printed areas.

Never unplug the machine until it is off

Pressing the **ON** button to turn off the machine will automatically cap the print head (which is equipped with nozzles) to prevent it from drying out. However, capping is not performed if you unplug the machine while the **POWER** lamp is lit or flashing. This may cause drying or clogging.

Before [unplugging the machine](#), make sure the **POWER** lamp is not lit.

»» Important

- Unplugging the machine will erase all documents in the machine's memory. Send faxes, print documents, or save jobs to a USB flash drive as needed before unplugging the machine.

Print regularly

Just as felt-tip pens dry up and become unusable (even when capped) if not used over extended periods, the print head may dry out or become clogged if the machine is not used for some time. Use the machine at least once a month, if possible.

Allow regular ink mixing

The machine automatically mixes ink periodically to maintain optimal print quality. Regular printing helps keep the ink in good condition.

If the machine is not used for some time, it will automatically mix the ink before printing.

Transporting Your Machine

Take these precautions when relocating the machine for changing your living place or repairing it.

►► Important

- Place the machine upright in a sturdy box and pack it with sufficient cushioning to protect it in transit.
- With the print head and ink tank set still installed, press the **ON** button to turn off the machine. This enables automatic capping of the print head, which prevents it from drying out.
- After packing, do not tilt the box, tip it over, or turn it upside down. This may damage the machine and cause ink leakage in transit.
- When shipping the machine via a courier service, label the box "THIS SIDE UP". Also label the box "FRAGILE" or "HANDLE WITH CARE".



1. Turn the machine off.
2. After confirming that the **POWER** lamp is off, [unplug the machine](#).

►► Important

- Do not unplug the machine while the **POWER** lamp is lit or flashing. This may damage the machine or cause it to malfunction, which may prevent you from printing.

3. Take out the cassettes and remove the paper. Shorten the cassettes in preparation for stowing them inside.

■ [Paper Sources](#)

4. Close the paper output support, and then push in the output tray extension and paper output tray.
5. Reinsert the cassettes.
6. Disconnect all cables and the power cord from the machine.
7. Tape down all covers on the machine to prevent them from opening, and to prevent the cassettes from coming out in transit. Place the machine in a plastic bag.
8. In the box, surround the machine with cushioning material to protect it.

Legal Restrictions on Scanning/Copying

Scanning, printing, copying, or modifying copies of the following may be punishable under law.

This list is non-exhaustive. When in doubt, check with a local legal representative.

- Paper money
- Money orders
- Certificates of deposit
- Postage stamps (canceled or uncanceled)
- Identification badges or insignia
- Selective service or draft papers
- Checks or drafts issued by governmental agencies
- Motor vehicle licenses and certificates of title
- Traveler's checks
- Food stamps
- Passports
- Immigration papers
- Internal revenue stamps (canceled or uncanceled)
- Bonds or other certificates of indebtedness
- Stock certificates
- Copyrighted works or works of art, without the owner's consent

Specifications

General Specifications

Printing resolution (dpi)	600 (horizontal) x 1200 (vertical)
Interface	<p>USB Port: Hi-Speed USB *1</p> <p>USB Flash Drive Port: USB flash drive</p> <p>LAN Port: Wired LAN: 100BASE-TX / 10BASE-T Wireless LAN: IEEE802.11n / IEEE802.11g / IEEE802.11b *2</p> <p>*1 A computer that complies with Hi-Speed USB standard is required. Since the Hi-Speed USB interface is fully upwardly compatible with USB 1.1, it can be used at USB 1.1.</p> <p>*2 Setup possible through Standard setup, WPS (Wi-Fi Protected Setup), WCN (Windows Connect Now) or Cableless setup.</p> <p>USB and LAN can be used at the same time.</p> <p>Wireless LAN and wired LAN cannot be used at the same time.</p>
Print width	8 inches/203.2 mm
Operating environment	<p>Temperature: 41 to 95 °F (5 to 35 °C) Humidity: 10 to 90 % RH (no condensation)</p> <p>* The performance of the printer may be reduced under certain temperature and humidity conditions.</p> <p>Recommended conditions: Temperature: 59 to 86 °F (15 to 30 °C) Humidity: 10 to 80 % RH (no condensation)</p> <p>* For the temperature and humidity conditions of papers such as photo paper, refer to the paper's packaging or the supplied instructions.</p>
Storage environment	<p>Temperature: 32 to 104 °F (0 to 40 °C) Humidity: 5 to 95 % RH (no condensation)</p>
Power supply	AC 100-240 V, 50/60 Hz
Power consumption	<p>Printing (Copy): Approx. 27 W Standby (minimum): Approx. 0.9 W *1*2 OFF: Approx. 0.3 W *1</p> <p>*1 USB connection to PC *2 The wait time for standby cannot be changed.</p>
External dimensions	<p>Approx. 18.3 (W) x 15.5 (D) x 13.9 (H) inches Approx. 463 (W) x 394 (D) x 351 (H) mm</p>

	* With the Paper Output Tray and Cassettes retracted.
Weight	Approx. 28.4 lb (Approx. 12.9 kg) * With the Print Head and ink tanks installed.
Print Head/Ink	Total 4352 nozzles (BK 1280 nozzles, C/M/Y 512 x 6 nozzles)
ADF capacity	A4 or Letter size: max. 50 sheets (20 lb/75 g /m ² paper), up to 0.20 inch/5 mm in height Legal size: max. 10 sheets (20 lb/75 g /m ² paper), up to 0.04 inch/1 mm in height Other sizes: 1 sheet

Copy Specifications

Multiple copy	max. 99 pages
Intensity adjustment	9 positions, Auto intensity (AE copy)
Reduction / Enlargement	25 % - 400 % (1 % unit)

Scan Specifications

Scanner driver	Windows: TWAIN 1.9 Specification, WIA Mac OS: ICA
Maximum scanning size	Platen Glass: A4/Letter, 8.5" x 11.7"/216 x 297 mm ADF: A4/Letter/Legal, 8.5" x 14.0"/216 x 356 mm
Scanning resolution	Optical resolution (horizontal x vertical) max: 1200 x 1200 dpi *1 Interpolated resolution max: 19200 x 19200 dpi *2 *1 Optical Resolution represents the maximum sampling rate based on ISO 14473. *2 Increasing the scanning resolution will limit the maximum possible scanning area.
Gradation (Input / Output)	Gray: 16 bit/8 bit Color: 48 bit/24 bit (RGB each 16 bit/8 bit)

Fax Specifications

Applicable line	Public Switched Telephone Network (PSTN)
Communication mode	Super G3, G3
Data compressing system	Black: MH, MR, MMR Color: JPEG
Modem speed	max. 33.6 kbps

	(Automatic fallback)
Transmission speed	<p>Black: Approx. 3 seconds/page at 33.6 kbps (Based on ITU-T No.1 chart for US specifications and Canon FAX Standard chart No.1 for others, both in standard mode.)</p> <p>Color: Approx. 1 minute/page at 33.6 kbps (Based on Canon COLOR FAX TEST SHEET.)</p>
Gradation	<p>Black: 256 levels</p> <p>Color: 24 bit Full Color (RGB each 8 bit)</p>
Density adjustment	3 levels
Memory	<p>Transmission/reception: approx. 250 pages (Based on ITU-T No.1 chart for US specifications and Canon FAX Standard chart No.1 for others, both in standard mode.)</p>
Fax resolution	<p>Black Standard: 203 pels/inch x 98 lines/inch (8 pels/mm x 3.85 lines/mm)</p> <p>Black Fine, Photo: 203 pels/inch x 196 lines/inch (8 pels/mm x 7.70 lines/mm)</p> <p>Black Extra fine: 300 x 300 dpi</p> <p>Color: 200 x 200 dpi</p>
Dialing	<p>Automatic dialing</p> <ul style="list-style-type: none"> - Recipient (max. 100 destinations) - Group dial (max. 99 destinations) <p>Regular dialing</p> <p>Automatic redialing</p> <p>Manual redialing (max. 10 destinations)</p>
Others	<p>Activity report (after every 20 transactions)</p> <p>Sequential broadcasting (max. 101 destinations)</p> <p>Rejected numbers (max. 10 destinations)</p>

Network Specifications

Communication protocol	SNMP (supports Canon-MIB), TCP/IP
Wired LAN	<p>Supported Standards: IEEE802.3u (100BASE-TX) / IEEE802.3 (10BASE-T)</p> <p>Transfer speed: 10 M/100 Mbps (auto switching)</p>
Wireless LAN	<p>Supported Standards: IEEE802.11n / IEEE802.11g / IEEE802.11b</p> <p>Frequency bandwidth: 2.4 GHz</p> <p>Channel: 1-11 or 1-13</p> <p>* Frequency bandwidth and available channels differ depending on country or region.</p> <p>Communication distance: Indoors 164 feet/50 m</p> <p>* Effective range varies depending on the installation environment and location.</p>

	<p>Security:</p> <p>WEP (64/128 bits)</p> <p>WPA-PSK (TKIP/AES)</p> <p>WPA2-PSK (TKIP/AES)</p> <p>Setup:</p> <p>Standard setup</p> <p>WPS (Push button configuration/PIN code method)</p> <p>WCN (WCN-NET)</p> <p>Cableless setup</p> <p>Other Features: Administration password</p>
--	---

Minimum System Requirements

Conform to the operating system's requirements when higher than those given here.

Windows

Operating System	<p>Windows 10, Windows 8.1*, Windows 8</p> <p>Windows 7, Windows 7 SP1</p> <p>Windows Vista SP2</p> <p>* Windows 8.1 includes Windows 8.1 Update.</p> <p>For the printer driver, fax driver, Quick Utility Toolbox, and IJ Network Device Setup Utility:</p> <p>Windows Server 2008, Windows Server 2008 R2, Windows Server 2012, and Windows Server 2012 R2</p>
Hard Disk Space	<p>3.1 GB</p> <p>Note: For bundled software installation.</p> <p>The necessary amount of hard disk space may be changed without notice.</p>
Display	XGA 1024 x 768

Mac OS

Operating System	OS X v10.8.5 - OS X v10.11
Hard Disk Space	<p>1.5 GB</p> <p>Note: For bundled software installation.</p> <p>The necessary amount of hard disk space may be changed without notice.</p>
Display	XGA 1024 x 768

Other Supported OS

Some functions may not be available with each OS. Refer to the Canon web site for details on operation with iOS, Android, and Windows RT.

Mobile Printing Capability

Apple AirPrint
Google Cloud Print
MAXIFY Cloud Link

- An internet connection is required to use Easy-WebPrint EX and all the Online Manual.
- Windows: Operation can only be guaranteed on a computer with Windows 10, Windows 8.1, Windows 8, Windows 7 or Windows Vista pre-installed.
- Windows: A CD-ROM Drive or internet connection is required during software installation.
- Windows: Internet Explorer 8, 9, 10 or 11 is required to install Easy-WebPrint EX.
- Windows: Some functions may not be available with Windows Media Center.
- Windows: .NET Framework 4 or 4.5 must be installed to use the Windows software.
- Windows: The TWAIN driver (ScanGear) is based on the TWAIN 1.9 Specification and requires the Data Source Manager bundled with the operating system.
- Mac OS: For Mac OS, an internet connection is required during software installation.
- In an in-house network environment, the 5222 port must be open. Contact the network administrator for details.

Information in this guide is subject to change without notice.

Information about Paper

▶ Supported Media Types

- Paper Load Limit

▶ Unsupported Media Types

▶ Handling Paper

▶ Print Area

- Print Area
- Standard Sizes
- Envelopes

Supported Media Types

For best results, choose paper designed for how you are printing. A variety of paper for documents as well as photos or illustrations is available from Canon. Use genuine Canon paper to print important photos, when possible.

Media Types

Genuine Canon paper

▶▶▶ Note

- For warnings on use of the non-printable side, see each product's usage information.
- For details on page sizes and media types, access the Canon website.
- Genuine Canon paper is not available in some countries or regions. Note that in the United States, Canon paper is not sold by model number. Instead, purchase paper by name.

Paper for printing documents:

- Canon Red Label Superior <WOP111>
- Canon Océ Office Colour Paper <SAT213>
- High Resolution Paper <HR-101N>

Paper for printing photos:

- Glossy Photo Paper "Everyday Use" <GP-501/GP-601>
- Photo Paper Glossy <GP-601>
- Photo Paper Plus Glossy II <PP-201>
- Photo Paper Pro Luster <LU-101>
- Photo Paper Plus Semi-gloss <SG-201>
- Matte Photo Paper <MP-101>

Paper other than genuine Canon paper

- Plain Paper (including recycled paper)
- Envelopes
- Label Paper

■ [Paper Load Limit](#)

■ [Paper Settings on the Printer Driver and the Printer \(Media Type\)](#) (Windows)

■ [Paper Settings on the Printer Driver and the Printer \(Media Type\)](#) (Mac OS)

Page Sizes

You can use the following page sizes.

▶▶▶ Note

- Page sizes and media types the machine supports differ depending on the OS you are using.

Standard sizes:

- Letter

- Legal
- Executive (7.25 x 10.5 inches (184.2 x 266.7 mm))
- A4
- B5
- A5
- A6
- Oficio (8.5 x 12.5 inches (215.9 x 317.5 mm))
- B-Oficio (8.5 x 14 inches (216.0 x 355.0 mm))
- M-Oficio (8.50 x 13.43 inches (216.0 x 341.0 mm))
- Foolscap (8.5 x 13 inches (215.9 x 330.2 mm))
- Legal(India) (8.46 x 13.58 inches (215 x 345 mm))
- L(89x127mm)
- KG/4"x6"(10x15)
- 2L/5"x7"(13x18)
- Hagaki
- Hagaki 2
- 8"x10"(20x25cm)
- Envelope Com 10
- Envelope DL
- Nagagata 3
- Nagagata 4
- Yougata 4
- Yougata 6
- Envelope C5
- Envelope Monarch (3.88 x 7.5 inches (98.4 x 190.5 mm))

Special sizes

Special page sizes must be within the following limits:

- cassette 1
 - Minimum size: 3.50 x 5.00 inches (89.0 x 127.0 mm)
 - Maximum size: 8.50 x 14.00 inches (216.0 x 355.6 mm)
- cassette 2
 - Minimum size: 8.27 x 11.00 inches (210.0 x 279.4 mm)
 - Maximum size: 8.50 x 14.00 inches (216.0 x 355.6 mm)

Paper Weight

You can use paper in the following weight range.

- 17 to 28 lb (64 to 105 g /m²) (plain paper other than genuine Canon paper)

Paper Load Limit

Genuine Canon Paper

Paper for printing documents:

Media Name <Model No.>	Cassette 1	Cassette 2	Paper Output Tray
Canon Red Label Superior <WOP111>	Approx. 250 sheets	Approx. 250 sheets	Approx. 75 sheets
Canon Océ Office Colour Paper <SAT213>	Approx. 200 sheets	Approx. 200 sheets	Approx. 75 sheets
High Resolution Paper <HR-101N>	65 sheets	N/A*1	65 sheets

Paper for printing photos:

▶▶▶ Note

- Feeding the following paper from cassette 2 may damage the machine. Always load in cassette 1.
- For best results in continuous printing, remove printed sheets from the paper output tray to avoid smearing or discoloration.

Media Name <Model No.>	Cassette 1
Glossy Photo Paper "Everyday Use" <GP-501/GP-601>*2	A4, Letter: 10 sheets 4" x 6" (10 x 15 cm): 20 sheets
Photo Paper Glossy <GP-601>*2	A4, Letter: 10 sheets 4" x 6" (10 x 15 cm): 20 sheets
Photo Paper Plus Glossy II <PP-201>*2	A4, Letter, 5" x 7" (13 x 18 cm), 8" x 10" (20 x 25 cm): 10 sheets 4" x 6" (10 x 15 cm): 20 sheets
Photo Paper Pro Luster <LU-101>*2	A4, Letter: 10 sheets
Photo Paper Plus Semi-gloss <SG-201>*2	A4, Letter, 5" x 7" (13 x 18 cm), 8" x 10" (20 x 25 cm): 10 sheets 4" x 6" (10 x 15 cm): 20 sheets
Matte Photo Paper <MP-101>	A4, Letter: 10 sheets 4" x 6" (10 x 15 cm): 20 sheets

Paper other than Genuine Canon Paper

Common Name	Cassette 1	Cassette 2	Paper Output Tray
Plain Paper (including recycled paper)*3	Approx. 250 sheets	Approx. 250 sheets	Approx. 75 sheets
Envelopes	10 envelopes	N/A*1	*4
Label Paper	10 sheets	N/A*1	*4

*1 Feeding paper and envelopes from cassette 2 may damage the machine. Always load in cassette 1.

- *2 Feeding from a loaded stack of paper may leave marks on the printed side or prevent efficient feeding. In this case, load one sheet at a time.
- *3 Normal feeding at maximum capacity may not be possible with some types of paper, or under very high or low temperature or humidity. In this case, load half the amount of paper or less.
- *4 For best results in continuous printing, remove printed paper or envelopes from the paper output tray to avoid smearing or discoloration.

Unsupported Media Types

Do not use the following paper. Not only will print quality be poor, the paper may jam or cause the machine to malfunction.

- Paper that is folded, curled, or wrinkled
- Paper that is damp
- Plain paper or notepad paper cut to a smaller size
- Picture postcards
- Postcards with photos or stickers attached
- Envelopes with a double flap
- Envelopes with embossed or coated surfaces
- Envelopes with adhesive flaps that are already moistened
- Any paper with holes
- Non-rectangular paper
- Stapled or glued paper
- Paper with an adhesive surface
- Paper coated with glitter or other decorative particles

Handling Paper

- Be careful not to rub or scratch the surfaces of any types of paper when handling.
- Hold the paper as closely as possible to its edges and try not to touch the printing surface. The print quality may be degraded if the printing surface is smudged with sweat or oil that comes from your hands.
- Do not touch the printed surface until the ink is dried. Even when the ink is dried, be careful not to touch the printed surface as much as possible when handling. Due to the nature of the pigment ink, the ink on the printed surface may be removed when being rubbed or scratched.
- Take out only the necessary number of paper from the package, just before printing.
- To avoid curling, when you do not print, put unused paper back into the package and keep it on a level surface. And also, store it avoiding heat, humidity, and direct sunlight.

Print Area

- ▶ **Print Area**
- ▶ **Standard Sizes**
- ▶ **Envelopes**

Print Area

To maintain print quality, the machine leaves a margin around the edges of paper. The printable area is inside this margin.

 (recommended print area): Print within this area, when possible.

 (printable area): You can also print in this area. However, feeding precision or print quality may be affected.

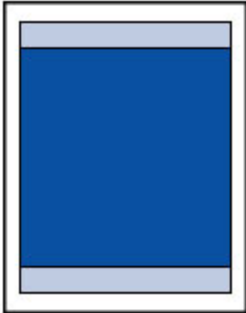



Note

- Automatic duplex printing and duplex copying reduces the printable area by 0.08 inch (2 mm) in the top margin.

Standard Sizes

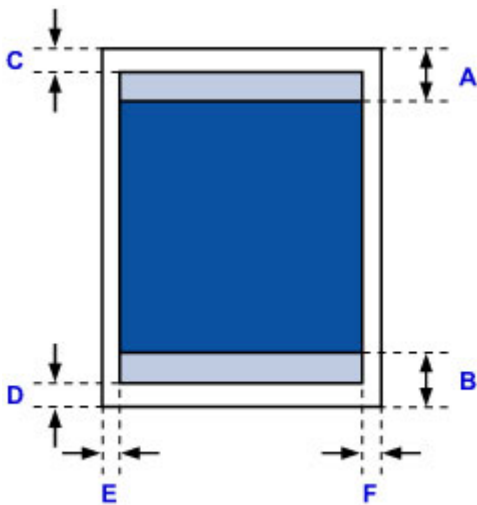
Size	Print Area (width x height)
Letter	8.00 x 10.69 inches (203.2 x 271.4 mm)
Legal	8.00 x 13.69 inches (203.2 x 347.6 mm)
Executive	6.98 x 10.19 inches (177.4 x 258.7 mm)
A6	3.87 x 5.51 inches (98.2 x 140.0 mm)
A5	5.56 x 7.95 inches (141.2 x 202.0 mm)
A4	8.00 x 11.38 inches (203.2 x 289.0 mm)
B5	6.90 x 9.80 inches (175.2 x 249.0 mm)
Oficio	8.00 x 12.09 inches (203.2 x 307.0 mm)
B-Oficio	8.00 x 13.66 inches (203.2 x 347.0 mm)
M-Oficio	8.00 x 13.11 inches (203.2 x 333.0 mm)
Foolscap	8.00 x 12.69 inches (203.2 x 322.2 mm)
Legal (India)	8.00 x 13.27 inches (203.2 x 337.0 mm)
4" x 6" (10 x 15 cm)	3.73 x 5.69 inches (94.8 x 144.4 mm)
5" x 7" (13 x 18 cm)	4.73 x 6.69 inches (120.2 x 169.8 mm)
8" x 10" (20 x 25 cm)	7.73 x 9.69 inches (196.4 x 246.0 mm)



 Recommended print area

A: 1.80 inches (45.8 mm)

B: 1.45 inches (36.8 mm)

 Printable area

Executive, A6, A5, A4, B5, 4" x 6" (10 x 15 cm), 5" x 7" (13 x 18 cm), 8" x 10" (20 x 25 cm)

C: 0.12 inch (3.0 mm)

D: 0.20 inch (5.0 mm)

E: 0.13 inch (3.4 mm)

F: 0.13 inch (3.4 mm)

Letter, Legal, Foolscap

C: 0.12 inch (3.0 mm)

D: 0.20 inch (5.0 mm)

E: 0.25 inch (6.4 mm)

F: 0.25 inch (6.3 mm)

Legal (India)

C: 0.12 inch (3.0 mm)

D: 0.20 inch (5.0 mm)

E: 0.23 inch (5.9 mm)

F: 0.23 inch (5.9 mm)

Oficio

C: 0.12 inch (3.0 mm)

D: 0.30 inch (7.5 mm)

E: 0.25 inch (6.4 mm)

F: 0.25 inch (6.3 mm)

B-Oficio, M-Oficio

C: 0.12 inch (3.0 mm)

D: 0.20 inch (5.0 mm)

E: 0.25 inch (6.4 mm)

F: 0.25 inch (6.4 mm)

Envelopes

Size	Recommended Print Area (width x height)
Envelope Com 10	3.68 x 8.50 inches (93.5 x 215.9 mm)
Envelope DL	3.88 x 7.67 inches (98.8 x 194.6 mm)
Envelope C5	5.94 x 8.02 inches (150.8 x 203.6 mm)
Envelope Monarch	3.43 x 6.50 inches (87.2 x 165.1 mm)

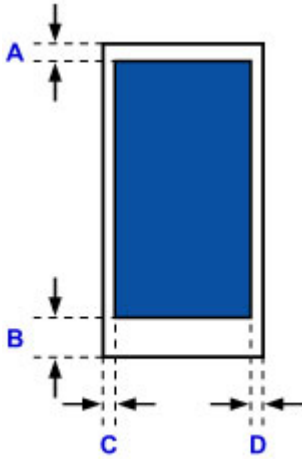

 Recommended print area

A: 0.5 inch (12.7 mm)

B: 0.5 inch (12.7 mm)

C: 0.22 inch (5.6 mm)

D: 0.22 inch (5.6 mm)

Administrator Settings

- ▶ [Sharing the Printer on a Network](#)

Sharing the Printer on a Network

When computers are used in a network environment, documents can be printed from multiple computers that share a single printer.

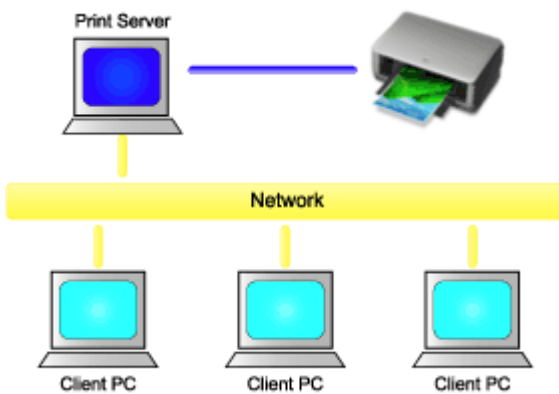

- [Setting Up a Shared Printer](#)

This section describes how to set up the print server and the client.

▶▶▶ Note

- The Windows versions of the computers connected to the network do not necessarily have to be the same.
- To set up the fax driver, use the same procedure.

Related Topic

- [Restrictions on Printer Sharing](#)

Setting Up a Shared Printer

On the print server, set up sharing of the printer driver. Then from the client, set up the connection to the print server.

1. [Install the printer driver](#) on the print server system
2. Select as described below:
 - If you are using Windows 10, Windows 8.1, Windows 8, Windows 7, Windows Server 2012 R2, Windows Server 2012, or Windows Server 2008 R2, select the **Control Panel -> Hardware and Sound (Hardware) -> Devices and Printers**
The **Devices and Printers** window is displayed.
 - If you are using Windows Vista or Windows Server 2008, select the **Control Panel -> Hardware and Sound -> Printers**
The **Printers** window is displayed.
3. Click the icon for the model name of printer to be shared
 - If you are using Windows 10, Windows 8.1, Windows 8, Windows 7, Windows Server 2012 R2, Windows Server 2012, or Windows Server 2008 R2, press the Alt key, and from the displayed **File** menu, select **Printer properties -> Sharing** tab.
 - If you are using Windows Vista, press the Alt key, and from the displayed **File** menu, select **Run as administrator -> Sharing...**
 - If you are using Windows Server 2008 select **Sharing...** from the **File** menu.

Important

- A confirmation/warning dialog box may appear when starting, installing or uninstalling software. This dialog box appears when administrative rights are required to perform a task. When you are logged on to an administrator account, click **Yes** (or **Continue, Allow**) to continue. Some applications require an administrator account to continue. In such cases, switch to an administrator account, and restart the operation from the beginning.

4. Set sharing

On the **Sharing** tab, check (or select) **Share this printer**, set the shared name as necessary, and then click **OK**.
5. If the print server and the client have different architectures (32 bit or 64 bit), install an additional driver
 1. Display the **Devices and Printers, Printers, or Printers and Faxes** window.
 2. Select as described below:
 - If you are using Windows 10, Windows 8.1, Windows 8, Windows 7, Windows Server 2012 R2, Windows Server 2012, or Windows Server 2008 R2, select the printer icon, click **Print server properties**, and select the **Drivers** tab
 - If you are using Windows Vista, press the Alt key, and from the displayed **File** menu, select **Run as administrator -> Server Properties...**, and select the **Drivers** tab

- If you are using Windows Server 2008 from the **File** menu, open **Server Properties**, and select the **Drivers** tab
3. Click **Add...**
 4. When the **Add Printer Driver Wizard** window is displayed, click **Next**.
 5. If the print server has a 32-bit architecture, select **x64**. If the print server has a 64-bit architecture, select **x86**. Then click **Next**.
 6. Click **Have Disk...**
 7. In the **Install From Disk** window, open the "Driver" folder of the downloaded printer driver, specify the ".inf" file, and click **OK**.
 8. Select the printer to be used, and click **Next**.

▶▶▶ Note

- If an error message is displayed, select the other printer.

9. Click **Finish**

The setup on the print server system is complete. Next, set up the client systems.

6. On the client, open Explorer, and double-click the icon of the printer to be shared
7. Follow the window instructions, and install the printer driver

The setup on the client system is complete.

Even when you perform the setup on a different client, follow the same steps 6 and 7.

Restrictions on Printer Sharing

If you are using the XPS printer driver, replace "Canon IJ Preview" with "Canon IJ XPS Preview" when reading this information.

These are restrictions that apply when you are using a printer in a network environment. Check the restrictions for the environment you are using.

Restriction on setting up printer sharing

- If "ntprint.inf" is requested when you install the driver from **Add Printer**, specify the file as follows:
 1. Start Explorer on the print server and on the client with the different architecture, paste the following path in the address bar, and press Enter on the keyboard:
%windir%\system32\driverstore\
 2. Right-click the **FileRepository** folder, and click **Properties**.
 3. On the **Sharing** tab, click **Share**.
 4. In the message window displayed on the print server, specify "ntprint.inf_xxxxxxx" in the folder that was shared in step 3, and click **OK**.
If there are multiples copies, select the file with the latest update date and time.

Restrictions on sharing and using a printer

- A print completion message may be displayed. To disable the message display, follow the procedure below.
 - If you are using Windows 10, Windows 8.1, Windows 8, Windows Server 2012 R2, or Windows Server 2012:
In the **Devices and Printers** window of the client system, select the printer from **Printers**, and click **Print server properties** on the command bar.
Uncheck **Show informational notifications for network printers** on the **Advanced** tab, and then restart the computer.
 - If you are using Windows 7 or Windows Server 2008 R2:
In the **Devices and Printers** window of the client system, select the printer from **Printers and Faxes**, and click **Print server properties** on the command bar.
Uncheck **Show informational notifications for network printers** on the **Advanced** tab, and then restart the computer.
 - If you are using Windows Vista:
In the **Printers** window of the client system, press the Alt key, and from the displayed **File** menu, click **Run as administrator -> Server Properties...**
Uncheck **Show informational notifications for network printers** on the **Advanced** tab, and then restart the computer.
 - If you are using Windows Server 2008:
In the **Printers** window of the client system, click **Server Properties...** from the **File** menu.
Uncheck **Show informational notifications for network printers** on the **Advanced** tab, and then restart the computer.
- The bi-directional communication function is disabled and the correct printer status may not be recognized.
If a client user opens the printer driver properties and then clicks **OK** with the **Enable bidirectional**

support check box cleared on the **Ports** tab, the bidirectional communication function of the print server may also be disabled.

In this case, check **Enable bidirectional support** check box on both the print server system and the client system.

- When you print from a client system, you cannot use Canon IJ Preview.
- When the functions on the **Maintenance** tab cannot be set properly from a client system, they may be grayed out. In this case, change the settings from the print server.
When you change the settings of the print server, you should delete the icon of the shared printer from the client system, and then specify the shared settings again in the client system.
- If the same driver installed on the print server is also installed on the client, the network printer icon may be created automatically.
- If an error occurs when you print a document on a shared printer from a client, the error message of the Canon IJ status monitor is displayed on both the client and the print server. If a document is printed out normally, the Canon IJ status monitor is displayed only on the client.

Administrator Password

Depending on the printer you are using, an administrator password is specified at the time of purchase. The password is either "canon" or the printer serial number if it is specified.

Model whose administrator password is specified as "canon":

MG7500 series, MG6700 series, MG6600 series, MG5600 series

MG2900 series, MX490 series, MB5300 series, MB5000 series

MB2300 series, MB2000 series, E480 series, E460 series

iP110 series, iB4000 series, PRO-100S series, PRO-10S series

- At the time of purchase, the user name "ADMIN" is also specified for the models above.
- The following character restrictions apply to the password that you change:
 - Set the password by using 0 to 32 characters.
 - The allowed characters are single-byte alphanumeric characters.
- For security reasons, we recommend you use 6 and more alphanumeric characters.

Model whose serial number is used as the administrator password:

- For the models other than the above, the printer serial number is used as the administrator password.

■ [Where Serial Number Is Located](#)

- The following character restrictions apply to the password that you change:
 - Set the password by using 4 to 32 characters.
 - The allowed characters are single-byte alphanumeric characters.
- For security reasons, we recommend you use 6 and more alphanumeric characters.

▶▶ Important

- You can change the password using one of the tools below. (Some tools may not be available depending on the printer you are using.)
 - operation panel of the printer
 - IJ Network Tool
 - printer information screen displayed on some Canon application software
 - IJ Network Device Setup Utility*
- * Only for Windows
- If the password has been changed while you are sharing the printer and you do not know the password, ask the administrator of the printer you are using.
- Set the password back to the default setting by initializing the printer settings.

For more on initializing the printer, search for "UG067" or "UG505" on your printer's Online Manual and see the instructions shown.

Password and Cookie

[Password](#)

[Cookie](#)

Password

Enter the password when the authentication screen is displayed.

[Administrator Password](#)

You need to enter the user name as well as the password depending on the printer you are using. For more on the user name, see the link above.

Important

- A message to warn you that the identification information is not verified may be displayed depending on the printer you are using.
- We recommend you change the password.

Cookie

Cookie allows a website master to save user information or user's access log on each computer through a web browser temporarily.

The printer may send one or more cookies to your communication device to verify **Remote UI** users and to enable the printer to offer useful information for each user.

Important

- Most browsers automatically accept cookies, but you can modify your browser setting so as not to accept cookies.

If you modify your browser so as not to accept cookies, you cannot log on to **Remote UI** and none of its functions are available.

Note

- Use an OS or web browser below to use **Remote UI**.
 - iOS devices:
 - OS: iOS 7.0 or later
 - Browser: Default browser of iOS device (Mobile Safari)
 - Android devices:
 - OS: Android 4.0 or later
 - Browser: Default browser of Android device (browser or Chrome)
 - Mac OS devices:
 - OS: Mac OS X v.10.6 or later
 - Browser: Safari 5.1 or later
 - Windows devices:

OS: Windows Vista SP2 or later

Browser: Internet Explorer 9 or later / Google Chrome 41.0.2272.118m or later / Mozilla Firefox 37.0.1 or later

How to locate your printer's serial number

The serial number is printed on a white sticker attached to each printer. The serial number will consists of 9 alphanumeric characters (4 letters followed by 5 numbers).

Example:

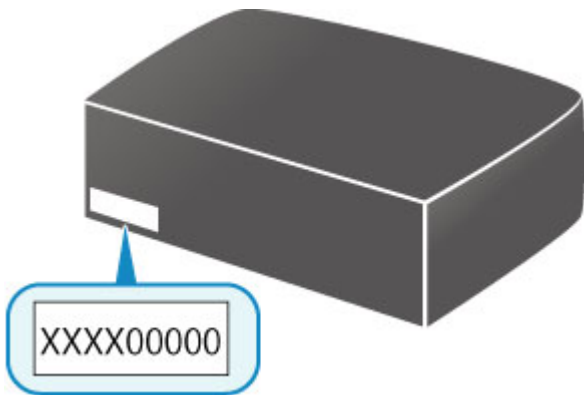

▶▶ Note

- Depending on the printer you are using, you can check the serial number by printing out the network setting information of the printer. For more on printing, search for "NR044" on your printer's Online Manual and see the instructions shown.

Registering Root Certificate to Web Browser

When you display **Remote UI** for the first time on your smartphone, tablet, or computer, download the root certificate, and then register it to the web browser. The secure connection will be confirmed and a message will not appear.

For details, search for "AF111" on your printer's Online Manual and see the instructions shown.

Printing

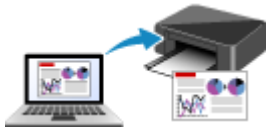

Printing from Computer



Printing from Smartphone/Tablet



Printing Using Operation Panel



Paper Settings

Printing from Computer

- **Printing from Application Software (Windows Printer Driver)**
- **Printing from Application Software (Mac OS Printer Driver)**
- **Printing Using Canon Application Software**
- **Printing Using a Web Service**
- **Printing from an AirPrint-enabled Printer with Mac**

Printing from Application Software (Windows Printer Driver)

- **Printing with Easy Setup** 📌 **Basic**
- **Various Printing Methods**
- **Changing the Print Quality and Correcting Image Data**
- **Overview of the Printer Driver**
- **Printer Driver Description**
- **Updating the MP Drivers**

Printing with Easy Setup

This section describes the simple procedure for setting the [Quick Setup tab](#) so that you can carry out appropriate printing on this printer.

Printing with Easy Setup

1. [Check that the printer is turned on](#)
2. [Load paper](#) on the printer
3. Open the [printer driver setup window](#)
4. Select a frequently used profile

In **Commonly Used Settings** on the **Quick Setup** tab, select a printing profile suited for the purpose. When you select a printing profile, the **Additional Features**, **Media Type**, and **Printer Paper Size** settings are automatically switched to the values that were preset.

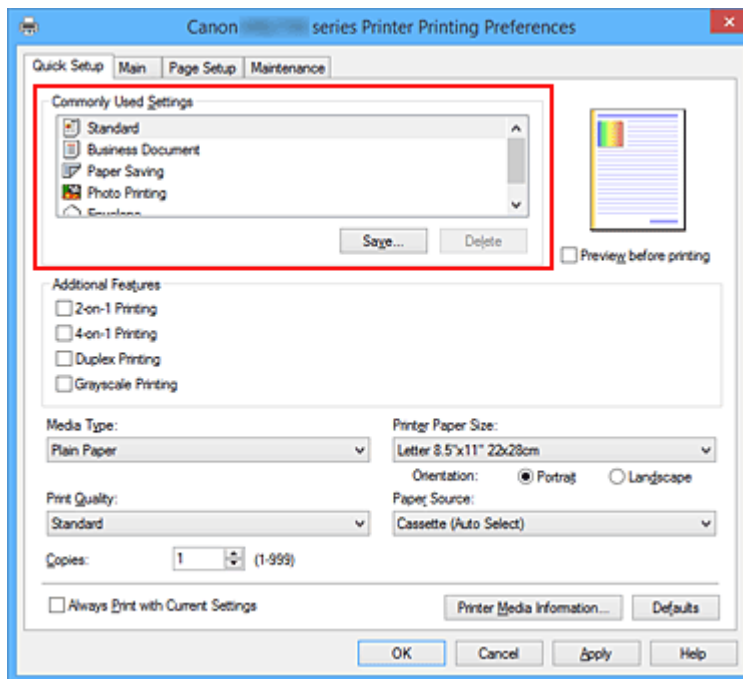

5. Select the print quality

For **Print Quality**, select **High** or **Standard** according to your purpose.

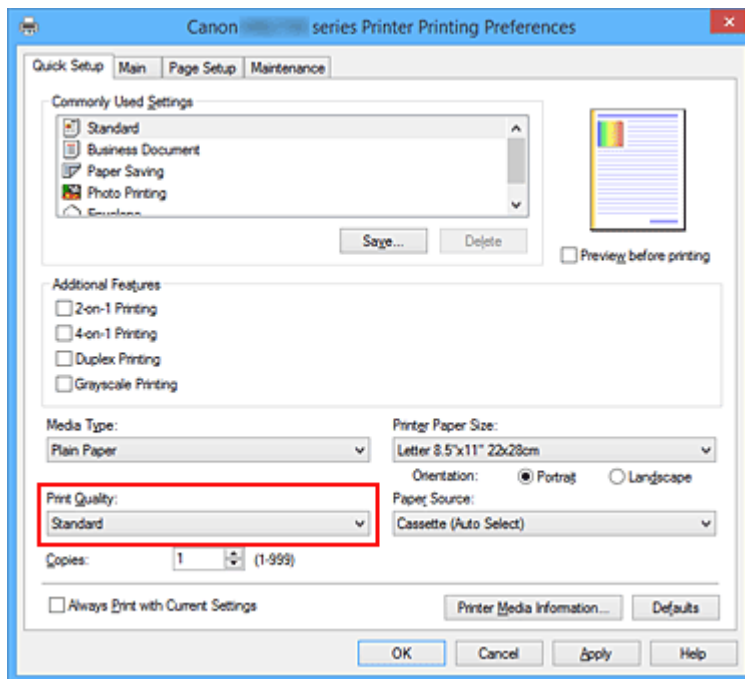

»»» Important

- The print quality settings that can be selected may differ depending on a printing profile.

6. Select the paper source

Select **Cassette (Auto Select)**, **Cassette 1**, or **Cassette 2** that matches your purpose for **Paper Source**.

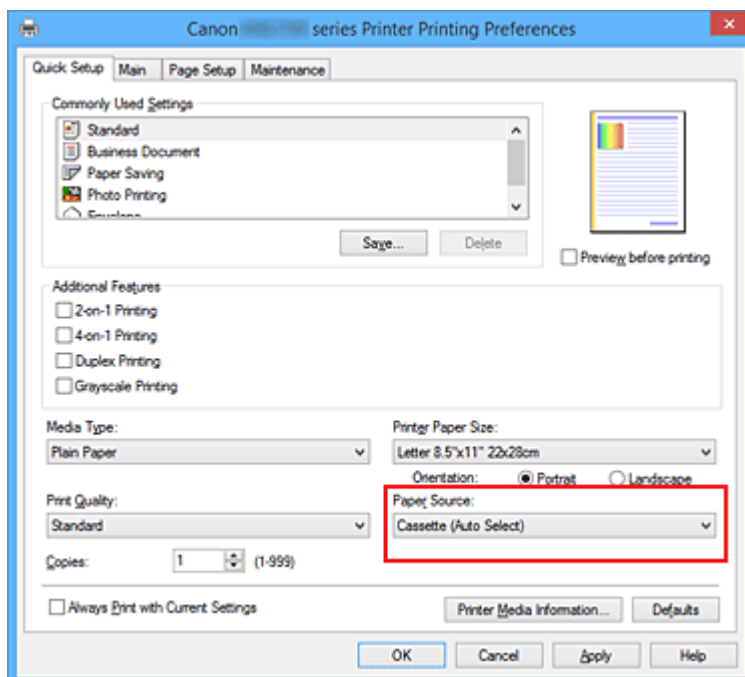

»»» Important

- The paper source settings that can be selected may differ depending on the paper type and size.

7. Complete the setup

Click **OK**.

When you execute print, the document is printed with settings that match your purpose.

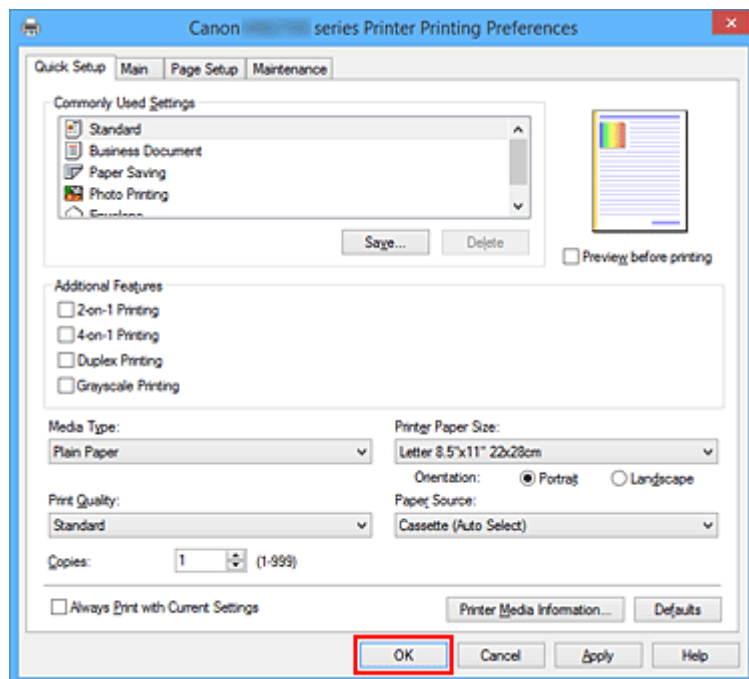

►►► Important

- When you select the **Always Print with Current Settings** check box, all settings specified on the **Quick Setup**, **Main**, and **Page Setup** tabs are saved, and you can print with the same settings from the next time as well.
- In the **Commonly Used Settings** window, click **Save...** to [register the specified settings](#).

►►► Note

- If the paper settings on the printer driver differ from the cassette paper information registered on the printer, an error may occur. For instructions on what to do if an error occurs, see "[Paper Settings](#)." To check the current printer settings or to apply the printer settings to the printer driver, click **Printer Media Information...** from the **Quick Setup** tab, and specify the settings in the dialog box that appears.
For details about the cassette paper information to be registered on the printer, see the following:
 - [Paper Settings on the Printer Driver and the Printer \(Media Type\)](#)
 - [Paper Settings on the Printer Driver and the Printer \(Paper Size\)](#)

Checking Printer Settings and Applying Settings to Printer Driver

1. Open printer driver setup window
2. Click **Printer Media Information...** on **Quick Setup** tab
The **Printer Media Information** dialog box appears.

3. Select **Paper Source**

From **Paper Source**, check the setting or select a new paper source.

The current printer settings appear in **Media Type** and **Page Size**.

4. Apply settings

To apply the printer settings to the printer driver, click **Set**.

Note

- If the media type on the printer is set to Hagaki, Ink Jet Hagaki, or Hagaki K or if the output paper size on the printer is set to 2L/5"x7"(13x18), click **Set** to display the dialog box. Select the media type and paper size that matches your purpose, and then click **OK**.
- If the media type and the output paper size are not set on the printer, **Set** will be grayed out and cannot be clicked.
- If communication with the printer is disabled, the **Printer Media Information...** does not appear or printer media information from the printer cannot be obtained.

Paper Settings on the Printer Driver and the Printer (Media Type)

When you use this printer, selecting a media type and [paper size](#) that matches the print purpose will help you achieve the best print results.

You can use the following media types on this printer.

Canon genuine papers (Document Printing)

Media name <Model No.>	Media Type in the printer driver	Paper information registered on the printer
Canon Red Label Superior <WOP111>	Plain Paper	Plain paper
Canon Océ Office Colour Paper <SAT213>	Plain Paper	Plain paper

Canon genuine papers (Photo Printing)

Media name <Model No.>	Media Type in the printer driver	Paper information registered on the printer
Photo Paper Plus Glossy II <PP-201>	Photo Paper Plus Glossy II	Plus Glossy II
Photo Paper Pro Luster <LU-101>	Photo Paper Pro Luster	Pro Luster
Photo Paper Plus Semi-gloss <SG-201>	Photo Paper Plus Semi-gloss	Plus Semi-gloss
Photo Paper Glossy <GP-501/GP-601>	Glossy Photo Paper	Glossy
Matte Photo Paper <MP-101>	Matte Photo Paper	Matte

Canon genuine papers (Business Letter Printing)

Media name <Model No.>	Media Type in the printer driver	Paper information registered on the printer
High Resolution Paper <HR-101N>	High Resolution Paper	High-Res Paper

Commercially available papers

Media name	Media Type in the printer driver	Paper information registered on the printer
Plain Paper (including recycled paper)	Plain Paper	Plain paper
Envelopes	Envelope	Envelope
Label Paper	Label Paper	Label Paper

Paper Settings on the Printer Driver and the Printer (Paper Size)

When you use this printer, selecting a paper size that matches the print purpose will help you achieve the best print results.

You can use the following paper sizes on this printer.

Printer Paper Size in the printer driver	Paper information registered on the printer
Letter 8.5"x11" 22x28cm	Letter
Legal 8.5"x14" 22x36cm	Legal
Executive 7.25"x10.5" 184.2x266.7mm	Executive
A6	A6
A5	A5
A4	A4
B5	B5
Oficio 8.5"x12.5" 215.9x317.5mm	Oficio
B-Oficio 8.5"x14" 216.0x355.0mm	B-Oficio
M-Oficio 8.50"x13.43" 216.0x341.0mm	M-Oficio
Foolscap 8.5"x13" 215.9x330.2mm	Foolscap
Legal (India) 8.46"x13.58" 215x345mm	Legal(India)
4"x6" 10x15cm	KG/4"x6"(10x15)
5"x7" 13x18cm	2L/5"x7"(13x18)
8"x10" 20x25cm	8"x10"(20x25cm)
L 89x127mm	L(89x127mm)
2L 127x178mm	2L/5"x7"(13x18)
Envelope Com 10	Envelope Com 10
Envelope DL	Envelope DL
Yougata 4 4.13"x9.25"	Yougata 4
Yougata 6 3.86"x7.48"	Yougata 6
Envelope C5	Envelope C5
Envelope Monarch 3.88"x7.5" 98.4x190.5mm	Envelope Monarch
Custom Size	Others

Various Printing Methods

- ▶ **Setting a Page Size and Orientation**
- ▶ **Setting the Number of Copies and Printing Order**
- ▶ **Setting the Stapling Margin**
- ▶ **Fit-to-Page Printing**
- ▶ **Scaled Printing**
- ▶ **Page Layout Printing**
- ▶ **Tiling/Poster Printing**
- ▶ **Booklet Printing**
- ▶ **Duplex Printing**
- ▶ **Stamp/Background Printing**
- ▶ **Registering a Stamp**
- ▶ **Registering Image Data to be Used as a Background**
- ▶ **Setting Up Envelope Printing**
- ▶ **Printing on Postcards**
- ▶ **Switching the Paper Source to Match the Purpose**
- ▶ **Displaying the Print Results before Printing**
- ▶ **Setting Paper Dimensions (Custom Size)**
- ▶ **Editing the Print Document or Reprinting from the Print History**

Setting a Page Size and Orientation

The paper size and orientation are essentially determined by the application software. When the page size and orientation set for **Page Size** and **Orientation** on the **Page Setup** tab are same as those set with the application software, you do not need to select them on the **Page Setup** tab.

When you are not able to specify them with the application software, the procedure for selecting a page size and orientation is as follows:

You can also set page size and orientation on the **Quick Setup** tab.

1. Open the [printer driver setup window](#)

2. Select the paper size

Select a page size from the **Page Size** list on the **Page Setup** tab.

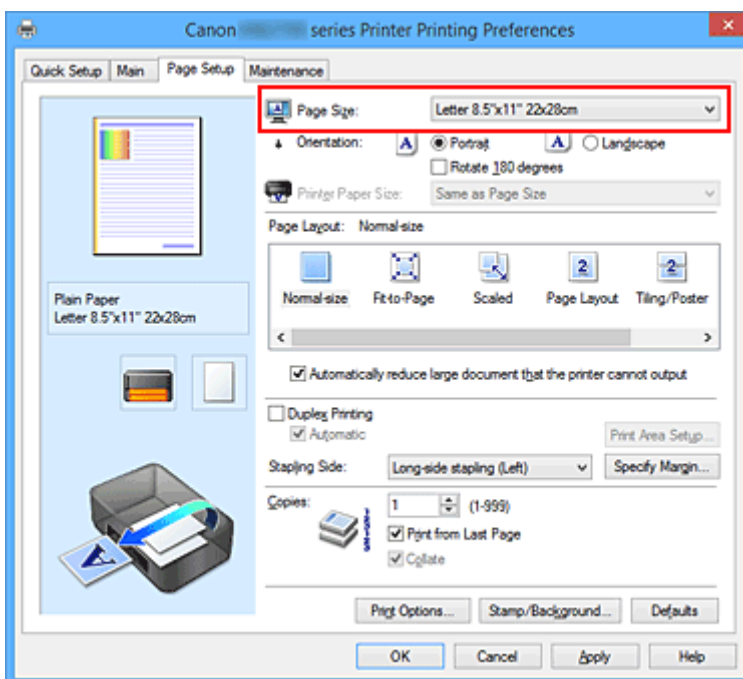

3. Set **Orientation**

Select **Portrait** or **Landscape** for **Orientation**. Check **Rotate 180 degrees** check box when you want to perform printing with the original being rotated 180 degrees.

4. Complete the setup

Click **OK**.

When you execute print, the document will be printed with the selected page size and the orientation.

►►► Note

- If **Normal-size** is selected for **Page Layout**, then **Automatically reduce large document that the printer cannot output** is displayed.

Normally, you can leave the check box checked. During printing, if you do not want to reduce large documents that cannot be printed on the printer, uncheck the check box.

Setting the Number of Copies and Printing Order

The procedure for specifying the number of copies and printing order is as follows:
You can also set the number of copies on the **Quick Setup** tab.

1. Open the [printer driver setup window](#)
2. Specify the number of copies to be printed

For **Copies** on the **Page Setup** tab, specify the number of copies to be printed.

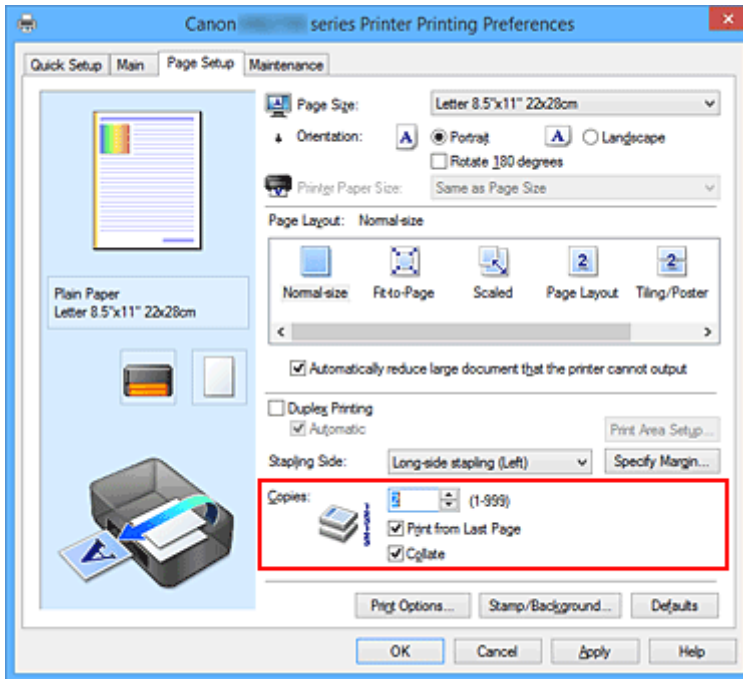

3. Specify the print order

Check the **Print from Last Page** check box when you want to print from the last page in order, and uncheck the check box when you want to print from the first page.

Check the **Collate** check box when you are printing multiple copies of a document and want to print out all pages in each copy together. Uncheck this check box when you want to print all pages with the same page number together.

- **Print from Last Page:** / **Collate:**

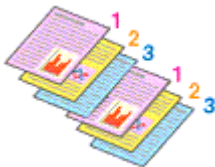

- **Print from Last Page:** / **Collate:**

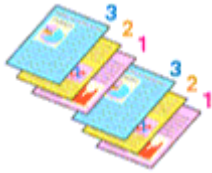

- **Print from Last Page:** / **Collate:**

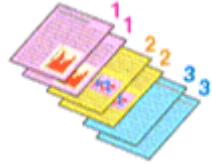

- **Print from Last Page:** / **Collate:**



4. Complete the setup

Click **OK**.

When you execute print, the specified number of copies will be printed with the specified printing order.

»» Important

- When the application software that you used to create the document has the same function, specify the settings on the printer driver. However, if the print results are not acceptable, specify the function settings on the application software. When you specify the number of copies and the printing order with both the application software and this printer driver, the number of copies may be multiplied numbers of the two settings or the specified printing order may not be enabled.
- **Print from Last Page** appears grayed out and is unavailable when **Tiling/Poster** is selected for **Page Layout**.
- When **Booklet** is selected for **Page Layout**, **Print from Last Page** and **Collate** appear grayed out and cannot be set.
- When **Duplex Printing** is selected, **Print from Last Page** appears grayed out and cannot be set.

»» Note

- By setting both **Print from Last Page** and **Collate**, you can perform printing so that papers are collated one by one starting from the last page.
These settings can be used in combination with **Normal-size**, **Fit-to-Page**, **Scaled**, and **Page Layout**.

Setting the Stapling Margin

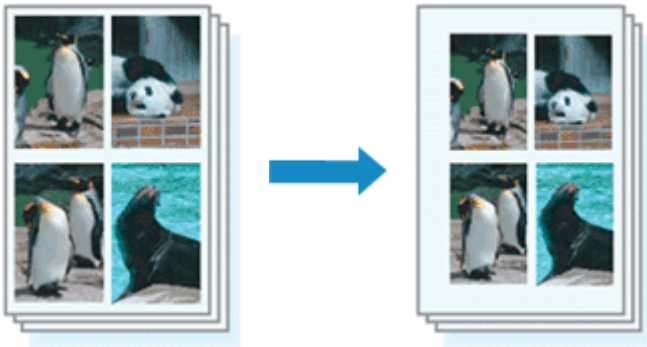

The procedure for setting the staple side and the margin width is as follows:

1. Open the [printer driver setup window](#)
2. Specify the side to be stapled

Check the position of the stapling margin from **Stapling Side** on the **Page Setup** tab.

The printer analyzes the **Orientation** and **Page Layout** settings, and automatically selects the best staple position. When you want to change the setting, select from the list.

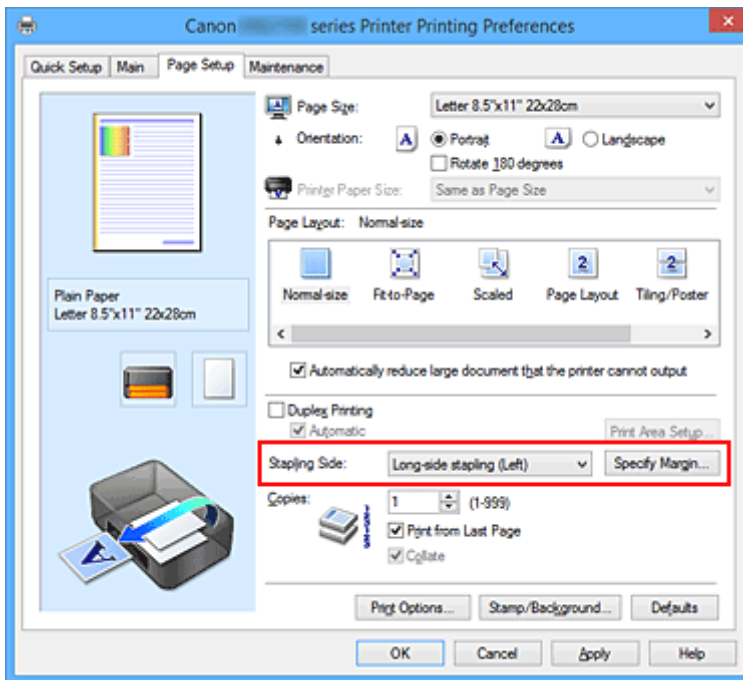

3. Set the margin width

If necessary, click **Specify Margin...** and set the margin width, and then click **OK**.

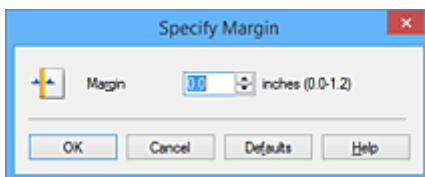

▶▶▶ Note

- The printer automatically reduces the print area depending on the staple position margin.

4. Complete the setup

Click **OK** on the **Page Setup** tab.

When you execute print, the data is printed with the specified staple side and margin width.

▶▶▶ Important

- **Stapling Side** and **Specify Margin...** appear grayed out and are unavailable when:
 - **Tiling/Poster** or **Booklet** is selected for **Page Layout**
 - **Scaled** is selected for **Page Layout** (When **Duplex Printing** is also selected, only **Stapling Side** can be specified.)

Fit-to-Page Printing



The procedure for printing a document that is automatically enlarged or reduced to fit the page size to be used is as follows:

1. Open the [printer driver setup window](#)

2. Set fit-to-page printing

Select **Fit-to-Page** from the **Page Layout** list on the **Page Setup** tab.

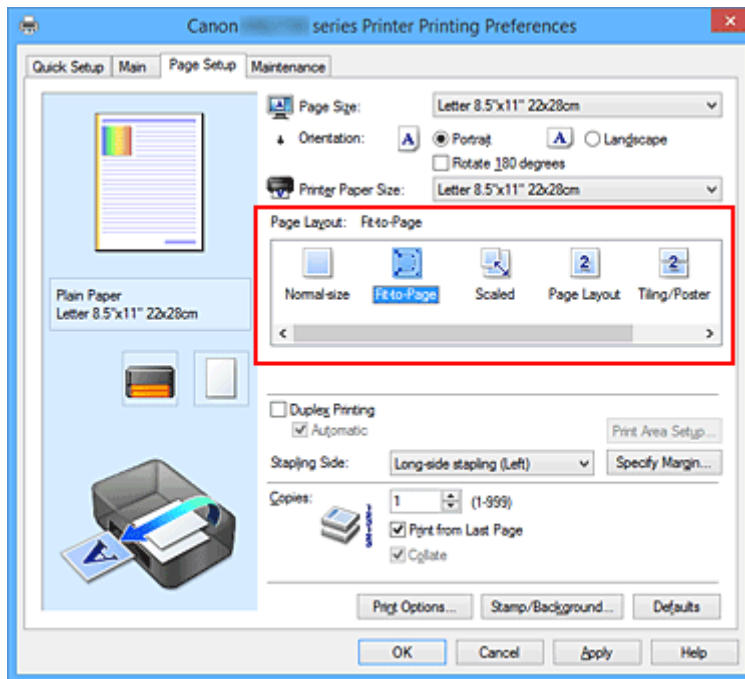

3. Select the paper size of the document

Using **Page Size**, select the page size that is set with your application software.

4. Select the print paper size

Select the size of the paper loaded in the printer from the **Printer Paper Size** list.

When the **Printer Paper Size** is smaller than the **Page Size**, the page image will be reduced. When the **Printer Paper Size** is larger than the **Page Size**, the page image will be enlarged.

The current settings are displayed in the settings preview on the left side of the printer driver.

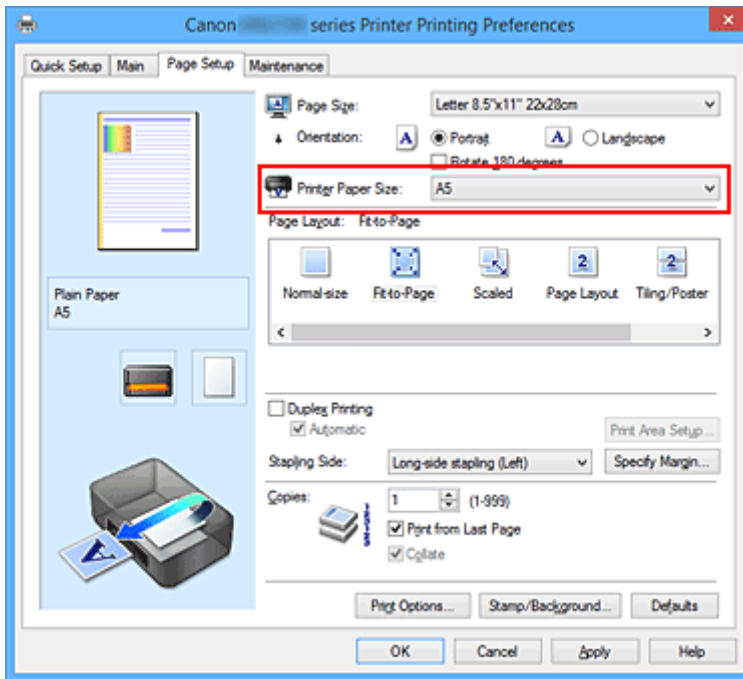

5. Complete the setup

Click **OK**.

When you execute print, the document will be enlarged or reduced to fit to the page size.

Scaled Printing

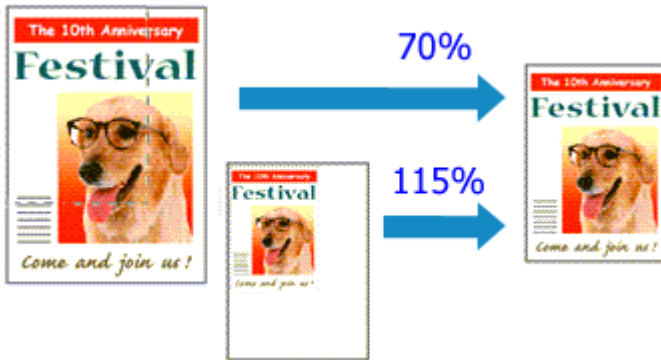

The procedure for printing a document with pages enlarged or reduced is as follows:

1. Open the [printer driver setup window](#)
2. Set scaled printing

Select **Scaled** from the **Page Layout** list on the **Page Setup** tab.

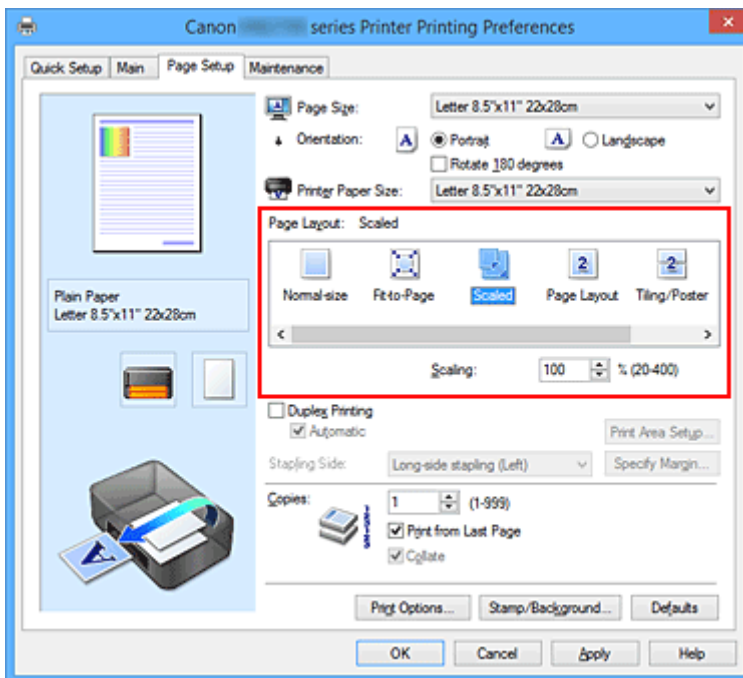

3. Select the paper size of the document

Using **Page Size**, select the page size that is set with your application software.

4. Set the scaling rate by using one of the following methods:

- Select a **Printer Paper Size**

When the printer paper size is smaller than the **Page Size**, the page image will be reduced. When the printer paper size is larger than the **Page Size**, the page image will be enlarged.

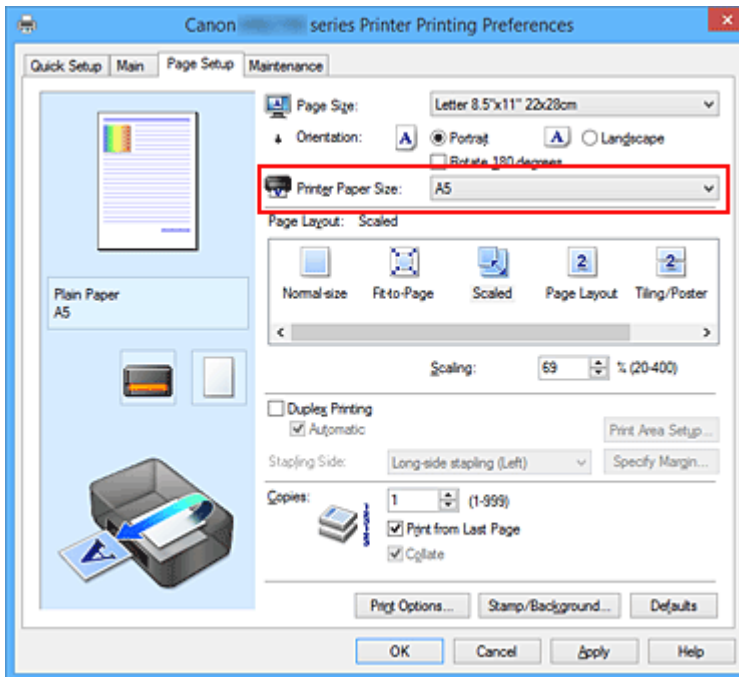

- Specify a scaling factor

Directly type in a value into the **Scaling** box.

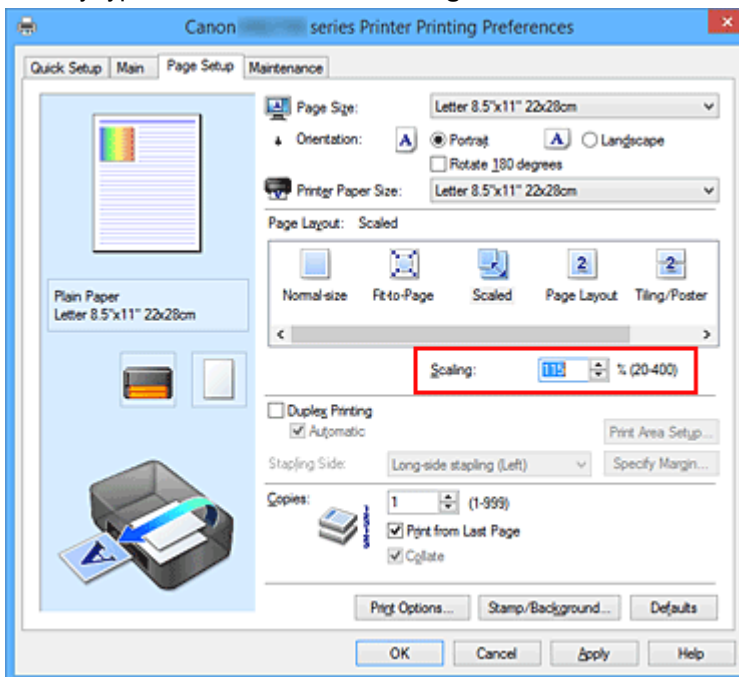

The current settings are displayed in the settings preview on the left side of the printer driver.

5. Complete the setup

Click **OK**.

When you execute print, the document will be printed with the specified scale.

»» Important

- When the application software which you used to create the original has the scaled printing function, configure the settings on your application software. You do not need to configure the same setting in the printer driver.

»» Note

- Selecting **Scaled** changes the printable area of the document.

Page Layout Printing

The page layout printing function allows you to print more than one page image on a single sheet of paper.



The procedure for performing page layout printing is as follows:

1. Open the [printer driver setup window](#)
2. Set page layout printing

Select **Page Layout** from the **Page Layout** list on the **Page Setup** tab.

The current settings are displayed in the settings preview on the left side of the printer driver.

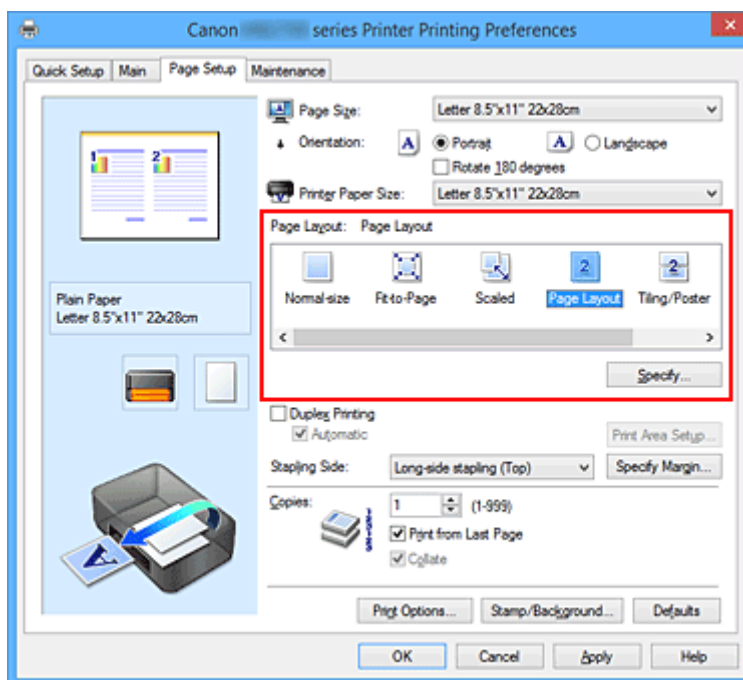

3. Select the print paper size

Select the size of the paper loaded in the printer from the **Printer Paper Size** list.

4. Set the number of pages to be printed on one sheet and the page order

If necessary, click **Specify...**, specify the following settings in the **Page Layout Printing** dialog box, and click **OK**.

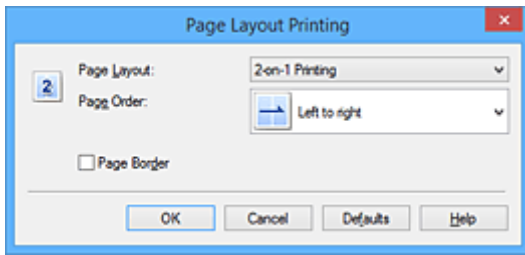

Page Layout

To change the number of pages to be printed on a single sheet of paper, select the number of pages from the list.

Page Order

To change the page arrangement order, select a placement method from the list.

Page Border

To print a page border around each document page, check this check box.

5. Complete the setup

Click **OK** on the **Page Setup** tab.

When you execute print, the specified number of pages will be arranged on each sheet of paper in the specified order.

Tiling/Poster Printing

The tiling/poster printing function allows you to enlarge image data, divide it into several pages, and print these pages on separate sheets of paper. You can also paste the pages together to create a large print like a poster.

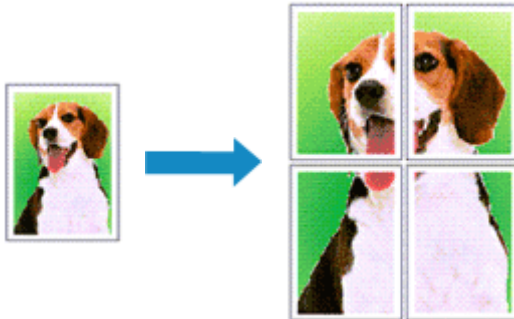

The procedure for performing tiling/poster printing is as follows:

Setting Tiling/Poster Printing

1. Open the [printer driver setup window](#)
2. Set tiling/poster printing

Select **Tiling/Poster** from the **Page Layout** list on the **Page Setup** tab.

The current settings are displayed in the settings preview on the left side of the printer driver.

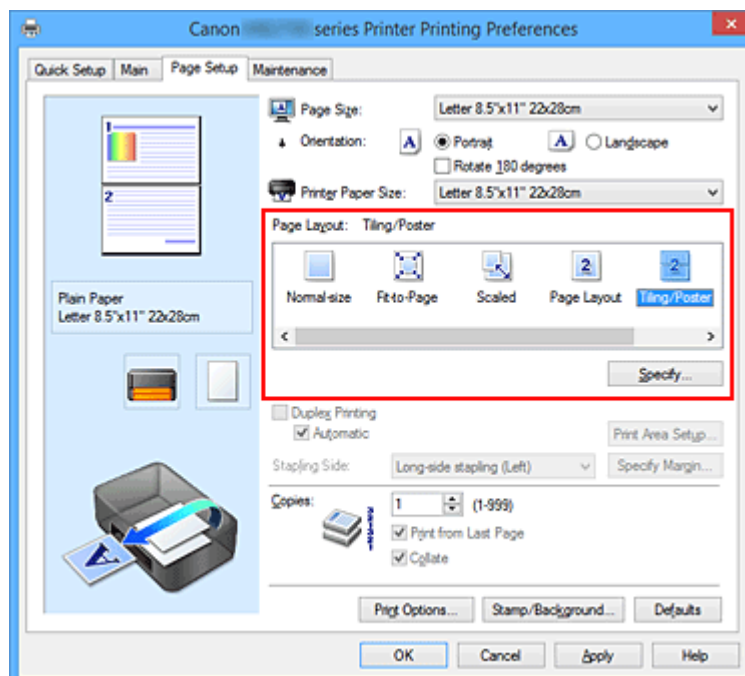

3. Select the print paper size

Select the size of the paper loaded in the printer from the **Printer Paper Size** list.

4. Set the number of image divisions and the pages to be printed

If necessary, click **Specify...**, specify the following settings in the **Tiling/Poster Printing** dialog box, and then click **OK**.

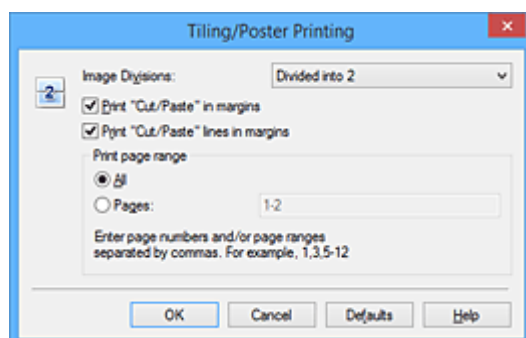

Image Divisions

Select the number of divisions (vertical x horizontal).

As the number of divisions increases, the number of sheets used for printing increases. If you are pasting pages together to create a poster, increasing the number of divisions allows you to create a larger poster.

Print "Cut/Paste" in margins

To leave out words "Cut" and "Paste", uncheck this check box.

»»» Note

- This feature may be unavailable when certain printer drivers or operating environments are used.

Print "Cut/Paste" lines in margins

To leave out cut lines, uncheck this check box.

Print page range

Specifies the printing range. Select **All** under normal circumstances.

To reprint only a specific page, select **Pages** and enter the page number you want to print. To specify multiple pages, enter the page numbers by separating them with commas or by entering a hyphen between the page numbers.

»»» Note

- You can also specify the print range by clicking the pages in the settings preview.

5. Complete the setup

Click **OK** on the **Page Setup** tab.

When you execute print, the document will be divided into several pages during printing.

Printing Only Specific Pages

If ink becomes faint or runs out during printing, you can reprint only the specific pages by following the procedure below:

1. Set the print range

In the settings preview on the left of the **Page Setup** tab, click the pages that do not need to be printed.

The pages that were clicked are deleted, and only the pages to be printed are displayed.

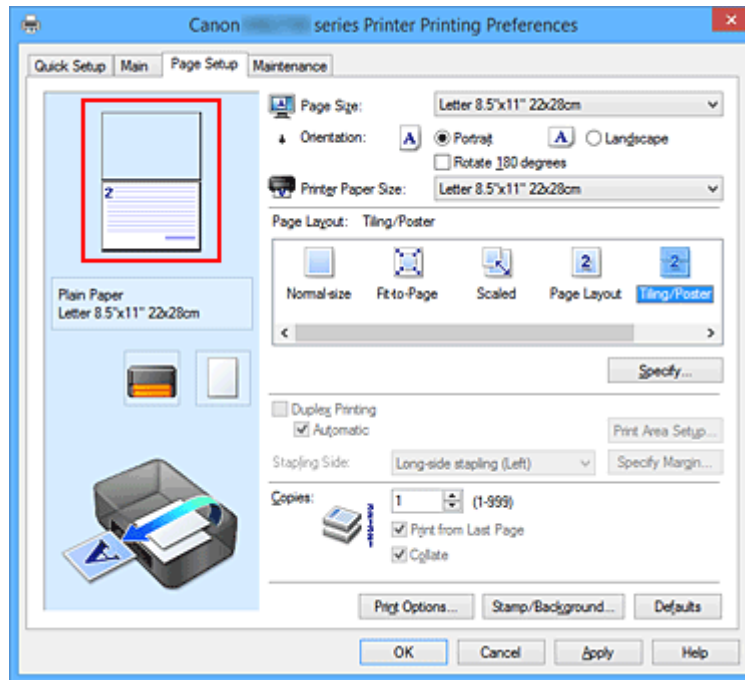

➤➤➤ Note

- Click the deleted pages to display them again.
- Right-click the settings preview to select **Print all pages** or **Delete all pages**.

2. Complete the setup

After completing the page selection, click **OK**.

When you execute print, only specified pages will be printed.

➤➤➤ Important

- Since tiling/poster printing enlarges the document when printing it, the print results may become coarse.

Booklet Printing

The booklet printing function allows you to print data for a booklet. Data is printed on both sides of the paper. This type of printing ensures that pages can be collated properly, in page number order, when the printed sheets are folded and stapled at the center.

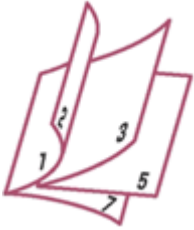

The procedure for performing booklet printing is as follows:

1. Open the [printer driver setup window](#)
2. Set booklet printing

Select **Booklet** from the **Page Layout** list on the **Page Setup** tab.

The current settings are displayed in the settings preview on the left side of the window.

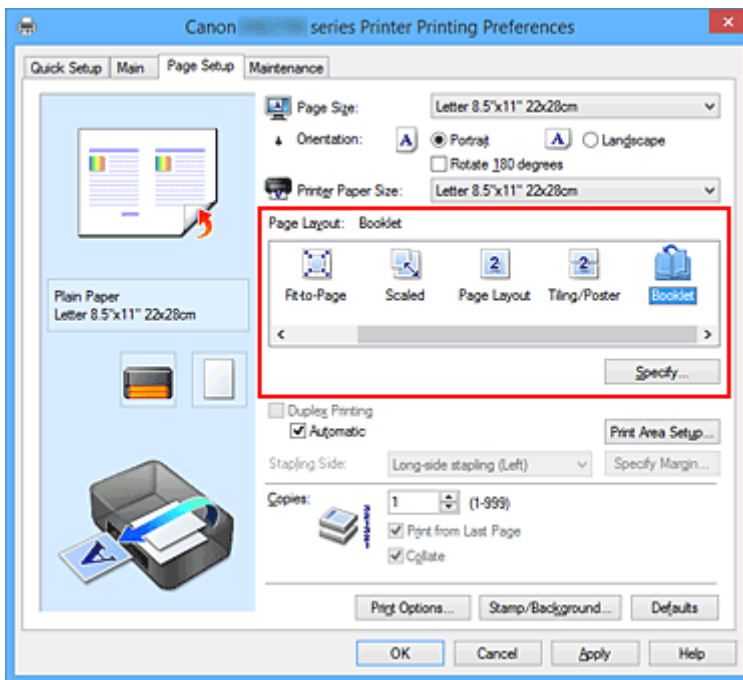

3. Select the print paper size

Select the size of the paper loaded in the printer from the **Printer Paper Size** list.

4. Set the margin for stapling and the margin width

Click **Specify...** and specify the following settings in the **Booklet Printing** dialog box, and then click **OK**.

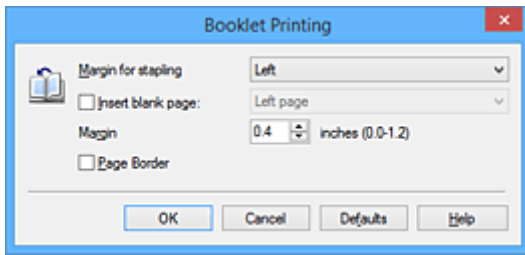

Margin for stapling

Select which side should the stapling margin be on when the booklet is completed.

Insert blank page

To leave one side of a sheet blank, check the check box, and select the page to be left blank.

Margin

Enter the margin width. The specified width from the center of the sheet becomes the margin width for one page.

Page Border

To print a page border around each document page, check the check box.

5. Complete the setup

Click **OK** on the **Page Setup** tab.

When you execute print, the document is automatically printed first on one side of a sheet of paper and then on the opposite side.

When the printing is complete, fold the paper at the center of the margin and make a booklet.

►► Important

- **Booklet** cannot be selected when a media type other than **Plain Paper** is selected for **Media Type** on the **Main** tab.

►► Note

- The stamp and background are not printed on the inserted blank sheets with the **Insert blank page** function of booklet printing.

Duplex Printing

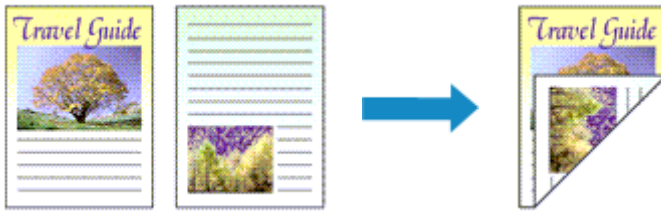

The procedure for printing data on both sides of a sheet of paper is as follows:
You can also set duplex printing in **Additional Features** on the **Quick Setup** tab.

Performing Automatic Duplex Printing

You can perform the duplex printing without having to turn over the paper.

1. Open the [printer driver setup window](#)
2. Set automatic duplex printing

Check the **Duplex Printing** check box on the **Page Setup** tab and confirm that **Automatic** is checked.

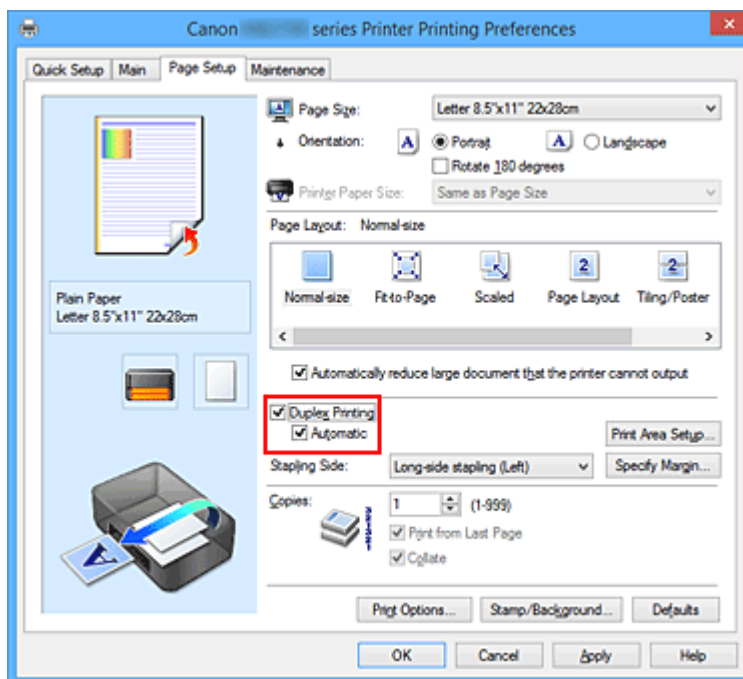

3. Select the layout
Select **Normal-size**, **Fit-to-Page**, **Scaled**, or **Page Layout** from the **Page Layout** list.
4. Set the print area

When you perform duplex printing, the print area of the document becomes slightly narrower than usual and the document may not fit on one page.

Click **Print Area Setup...**, select one of the following process methods, and then click **OK**.

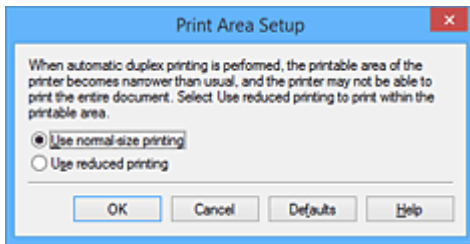

Use normal-size printing

Print without reducing the page.

Use reduced printing

Reduce the page slightly during printing.

5. Specify the side to be stapled

The best **Stapling Side** is selected automatically from the **Orientation** and **Page Layout** settings. To change the setting, select another stapling side from the list.

6. Set the margin width

If necessary, click **Specify Margin...** and set the margin width, and then click **OK**.

7. Complete the setup

Click **OK** on the **Page Setup** tab.

When you execute print, duplex printing will be started.

Performing Duplex Printing Manually

You can perform the duplex printing manually.

1. Open the [printer driver setup window](#)

2. Set duplex printing

Check the **Duplex Printing** check box and uncheck the **Automatic** check box on the **Page Setup** tab.

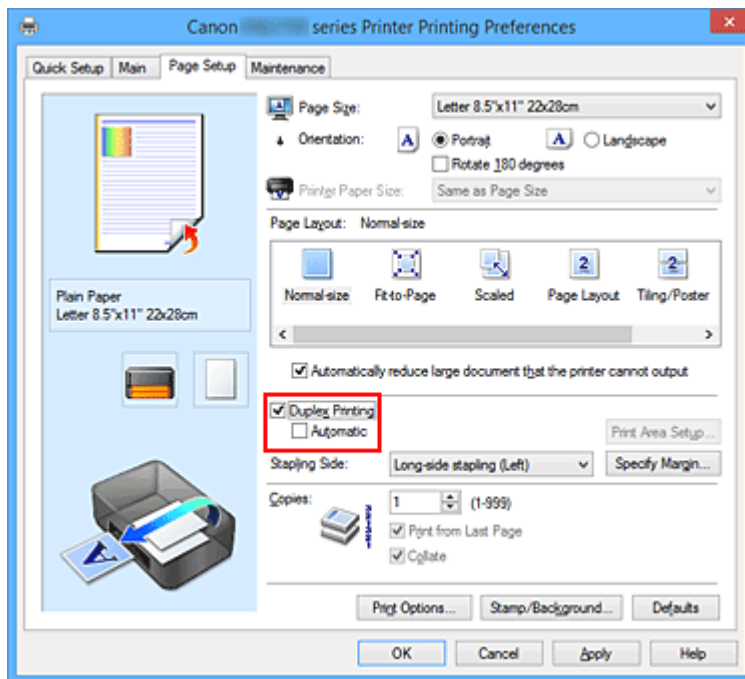

3. Select the layout

Select **Normal-size**, **Fit-to-Page**, **Scaled**, or **Page Layout** from the **Page Layout** list.

4. Specify the side to be stapled

The best **Stapling Side** is selected automatically from the **Orientation** and **Page Layout** settings. To change the setting, select another stapling side from the list.

5. Set the margin width

If necessary, click **Specify Margin...** and set the margin width, and then click **OK**.

6. Complete the setup

Click **OK** on the **Page Setup** tab.

When you execute print, the document is first printed on one side of a sheet of paper. After one side is printed, reload the paper correctly according to the message.

Then click **Start Printing** to print the opposite side.

►►► Important

- When a media type other than **Plain Paper** is selected from the **Media Type** list on the **Main** tab, **Duplex Printing** appears grayed out and is unavailable.
- When **Tiling/Poster**, or **Booklet** is selected from the **Page Layout** list, **Duplex Printing** and **Stapling Side** appear grayed out and are unavailable.
- **Duplex Printing** can be performed only when one of the following paper sizes is selected from **Page Size** on the **Page Setup** tab.
 - **Letter 8.5"x11" 22x28cm, A4**

- After printing the front page, there is an ink drying wait time before starting to print the back page (Operation stops temporarily). Do not touch the paper during this time. You can change the ink drying wait time at **Custom Settings** on the **Maintenance** tab.

Related Topic

- [Changing the Printer Operation Mode](#)

Stamp/Background Printing

Stamp or **Background** may be unavailable when certain printer drivers or operating environments are used.

The **Stamp** function allows you to print a stamp text or a bitmap over or behind document data. It also allows you to print date, time and user name. The **Background** function allows you to print a light illustration behind the document data.

The procedure for performing stamp/background printing is as follows:

Printing a Stamp

"CONFIDENTIAL," "IMPORTANT," and other stamps that are used often in companies are pre-registered.

1. Open the [printer driver setup window](#)
2. Click **Stamp/Background... (Stamp...)** on the **Page Setup** tab

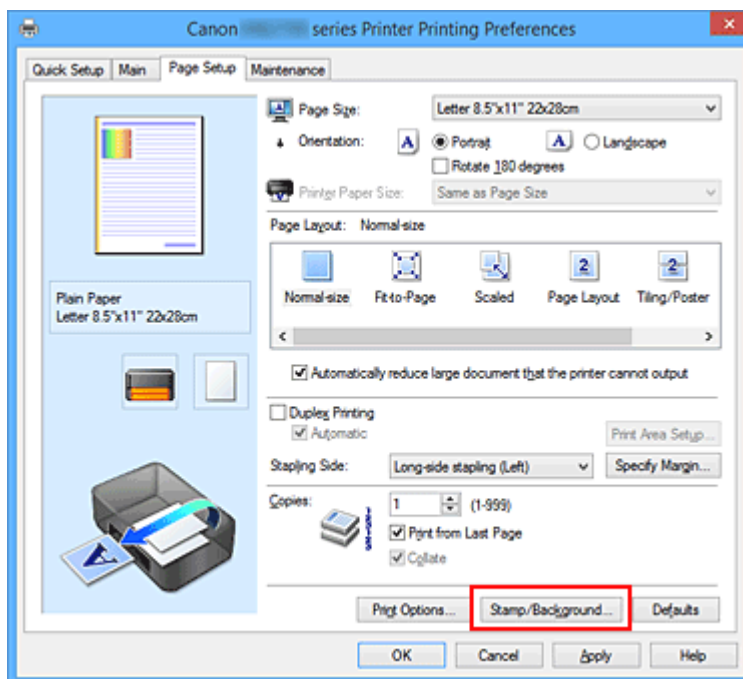

The **Stamp/Background (Stamp)** dialog box opens.

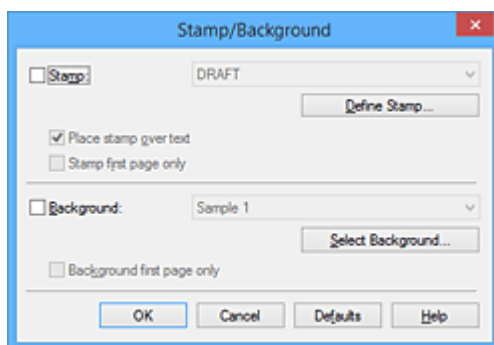

»» Note

- With the XPS printer driver, the **Stamp/Background...** button has become the **Stamp...** button and only the stamp function can be used.

3. Select a stamp

Check the **Stamp** check box, and select the stamp to be used from the list.

The current settings are displayed in the settings preview on the left side of the **Page Setup** tab.

4. Set the stamp details

If necessary, specify the following settings, and then click **OK**.

Define Stamp... button

To [change the stamp text, bitmap, or position](#), click this.

Place stamp over text

To print the stamp on the front of the document, check this check box.

»» Note

- The stamp is given priority because the stamp is printed over the document data in the sections where the stamp and the document data overlap. When this check box is unchecked, the stamp is printed behind the document data and may be hidden in the overlapping sections depending on the application software used.
- **Place stamp over text** cannot be used when the XPS printer driver is used. When the XPS printer driver is used, the stamp is normally printed in the foreground of the document.

Print semitransparent stamp

Check this check box to print a semi-transparent stamp on the document.

This function is available only when the XPS printer driver is used.

Stamp first page only

To print the stamp only on the first page, check this check box.

5. Complete the setup

Click **OK** on the **Page Setup** tab.

When you execute print, the data is printed with the specified stamp.

Printing a Background

Two bitmap files are pre-registered as samples.

1. Open the [printer driver setup window](#)
2. Click **Stamp/Background...** on the **Page Setup** tab
The **Stamp/Background** dialog box opens.
3. Select the background

Check the **Background** check box, and select the background to be used from the list.
The current settings are displayed in the settings preview on the left side of the **Page Setup** tab.

4. Set the background details

If necessary, complete the following settings, and then click **OK**.

Select Background... button

To [use another background or change the layout or density of a background](#), click this.

Background first page only

To print the background only on the first page, check this check box.

5. Complete the setup

Click **OK** on the **Page Setup** tab.

When you execute print, the data is printed with the specified background.

▶▶▶ Note

- The stamp and background are not printed on blank sheets inserted with the **Insert blank page** function of booklet printing.

Related Topics

- [Registering a Stamp](#)
- [Registering Image Data to be Used as a Background](#)

Registering a Stamp

This feature may be unavailable when certain printer drivers or operating environments are used.

You can create and register a new stamp. You can also change and re-register some of the settings of an existing stamp. Unnecessary stamps can be deleted at any time.

The procedure for registering a new stamp is as follows:

Registering a New Stamp

1. Open the [printer driver setup window](#)
2. Click **Stamp/Background... (Stamp...)** on the **Page Setup** tab

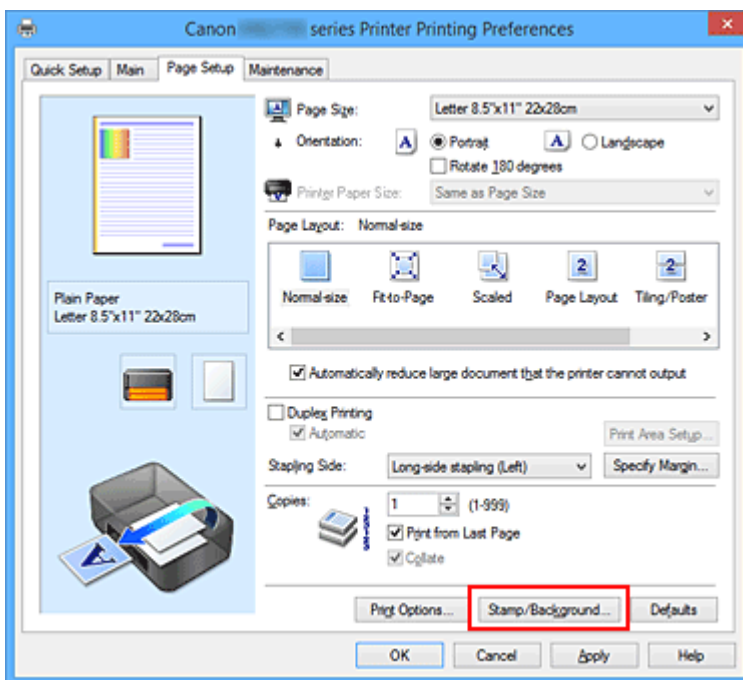

The **Stamp/Background (Stamp)** dialog box opens.

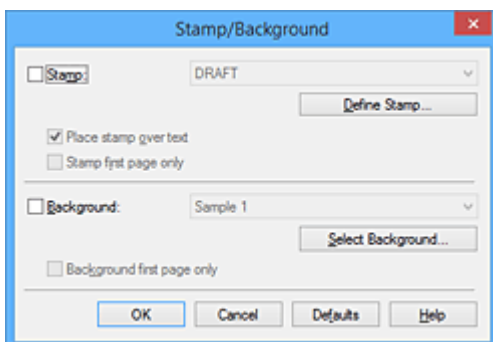

➤➤➤ Note

- With the XPS printer driver, the **Stamp/Background...** button has become the **Stamp...** button and only the stamp function can be used.

3. Click **Define Stamp...**

The **Stamp Settings** dialog box opens.

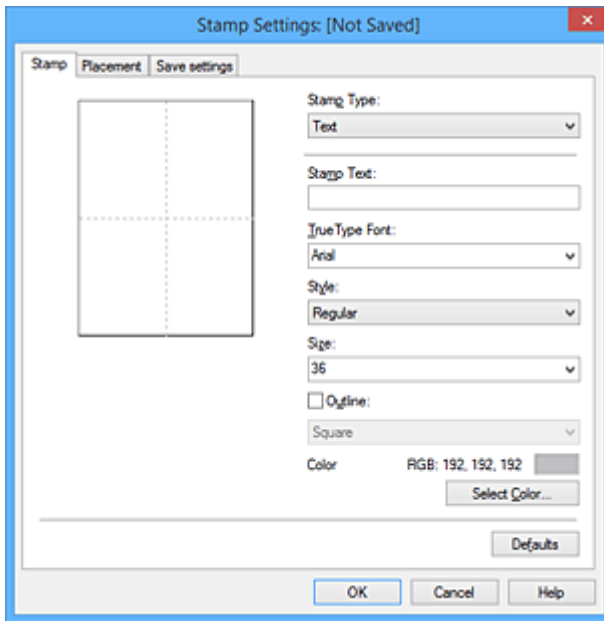

4. Configure the stamp while viewing the preview window

- **Stamp tab**

Select **Text**, **Bitmap**, or **Date/Time/User Name** that matches your purpose for **Stamp Type**.

- For **Text** registration, the characters must already be entered in **Stamp Text**. If necessary, change the **TrueType Font**, **Style**, **Size**, and **Outline** settings. You can select the color of the stamp by clicking **Select Color...**
- For **Bitmap**, click **Select File...** and select the bitmap file (.bmp) to be used. If necessary, change the settings of the **Size** and **Transparent white area**.
- For **Date/Time/User Name**, the creation date/time and user name of the printed object are displayed in **Stamp Text**. If necessary, change the settings of **TrueType Font**, **Style**, **Size**, and **Outline**. You can select the color of the stamp by clicking **Select Color...**

»»» Important

- **Stamp Text** appears grayed out and is unavailable when **Date/Time/User Name** is selected.

- **Placement tab**

Select the stamp position from the **Position** list. You can also select **Custom** from the **Position** list and specify coordinates for **X-Position** and **Y-Position**.

You can also change the stamp position by dragging the stamp in the preview window.

To change the stamp position angle, type a value in the **Orientation** box directly.

»»» Important

- **Orientation** cannot be changed when **Bitmap** is selected for **Stamp Type** on the **Stamp** tab.

5. Save the stamp

Click the **Save settings** tab and enter a title in the **Title** box, and then click **Save**.
Click **OK** when the confirmation message appears.

»» Note

- Spaces, tabs, and returns cannot be entered at the beginning or end of a title.

6. Complete the setup

Click **OK**. The **Stamp/Background (Stamp)** dialog box opens again.
The registered title appears in the **Stamp** list.

Changing and Registering Some of Stamp Settings

1. Select the stamp for which the settings are to be changed

Select the **Stamp** check box in the **Stamp/Background (Stamp)** dialog box. Then from the list, select the title of the stamp to be changed.

2. Click **Define Stamp...**

The **Stamp Settings** dialog box opens.

3. Configure the stamp while viewing the preview window

4. Overwrite save the stamp

Click **Save overwrite** on the **Save settings** tab.

When you want to save the stamp with a different title, type a new title in the **Title** box and click **Save**.
Click **OK** when the confirmation message appears.

5. Complete the setup

Click **OK**. The **Stamp/Background (Stamp)** dialog box opens again.
The registered title appears in the **Stamp** list.

Deleting an Unnecessary Stamp

1. Click **Define Stamp...** in the **Stamp/Background (Stamp)** dialog box

The **Stamp Settings** dialog box opens.

2. Select the stamp to be deleted

Select the title of the stamp you want to delete from the **Stamps** list on the **Save settings** tab. Then click **Delete**.

Click **OK** when the confirmation message appears.

3. Complete the setup

Click **OK**. The **Stamp/Background (Stamp)** dialog box opens again.

Registering Image Data to be Used as a Background

This feature may be unavailable when certain printer drivers or operating environments are used.

You can select a bitmap file (.bmp) and register it as a new background. You can also change and register some of the settings of an existing background. An unnecessary background can be deleted.

The procedure for registering image data to be used as a background is as follows:

Registering New Background

1. Open the [printer driver setup window](#)
2. Click **Stamp/Background...** on the **Page Setup** tab

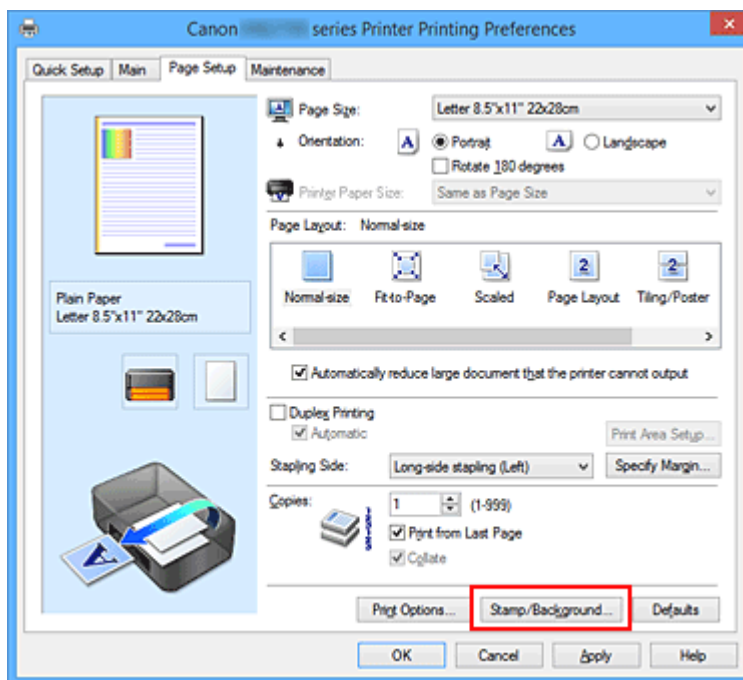

The **Stamp/Background** dialog box opens.

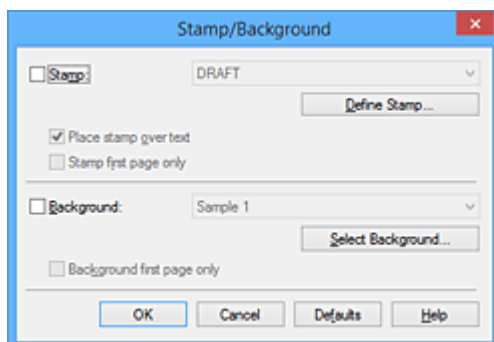

➤➤➤ Note

- With the XPS printer driver, the **Stamp/Background...** button has become the **Stamp...** button and **Background** cannot be used.

3. Click **Select Background...**

The **Background Settings** dialog box opens.

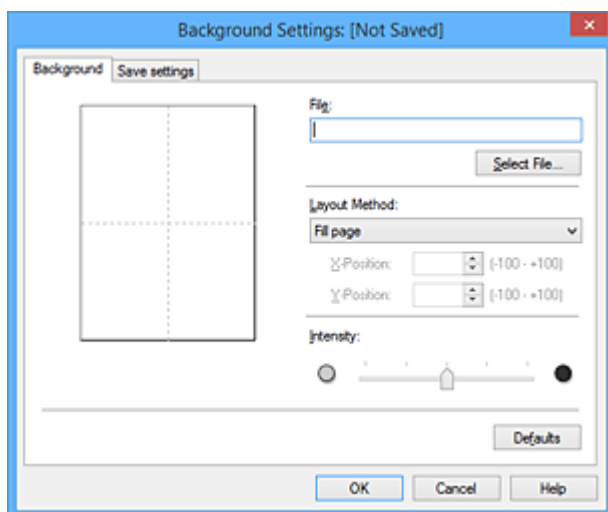

4. Select the image data to be registered to the background

Click **Select File....** Select the target bitmap file (.bmp), and then click **Open**.

5. Specify the following settings while viewing the preview window

Layout Method

Select how the background image data is to be placed.

When **Custom** is selected, you can set coordinates for **X-Position** and **Y-Position**.

You can also change the background position by dragging the image in the preview window.

Intensity

Set the intensity of the background image data with the **Intensity** slider. Moving the slider to the right darkens the background, and moving the slider to the left lightens the background. To print the background at the original bitmap intensity, move the slider to the rightmost position.

6. Save the background

Click the **Save settings** tab and enter a title in the **Title** box, and then click **Save**.

Click **OK** when the confirmation message appears.

➤➤➤ Note

- Spaces, tabs, and returns cannot be entered at the beginning or end of a title.

7. Complete the setup

Click **OK**, then it returns to **Stamp/Background** dialog box.

The registered title appears in the **Background** list.

Changing and Registering Some Background Settings

1. Select the background for which the settings are to be changed

Select the **Background** check box in the **Stamp/Background** dialog box. Then from the list, select the title of the background you want to change.

2. Click **Select Background...**

The **Background Settings** dialog box opens.

3. Specify each item on the **Background** tab while viewing the preview window

4. Save the background

Click **Save overwrite** on the **Save settings** tab. When you want to save the background with a different title, enter a new title in the **Title** box and click **Save**.

Click **OK** when the confirmation message appears.

5. Complete the setup

Click **OK**, then it returns to **Stamp/Background** dialog box.

The registered title appears in the **Background** list.

Deleting an Unnecessary Background

1. Click **Select Background...** in the **Stamp/Background** dialog box

The **Background Settings** dialog box opens.

2. Select the background to be deleted

Select the title of the background you want to delete from the **Backgrounds** list on the **Save settings** tab, and then click **Delete**.

Click **OK** when the confirmation message appears.

3. Complete the setup

Click **OK**, then it returns to **Stamp/Background** dialog box.

Setting Up Envelope Printing

The procedure for performing envelope printing is as follows:

1. [Load envelope](#) on the printer
2. Open the [printer driver setup window](#)
3. Select the media type

Select **Envelope** from **Commonly Used Settings** on the **Quick Setup** tab.

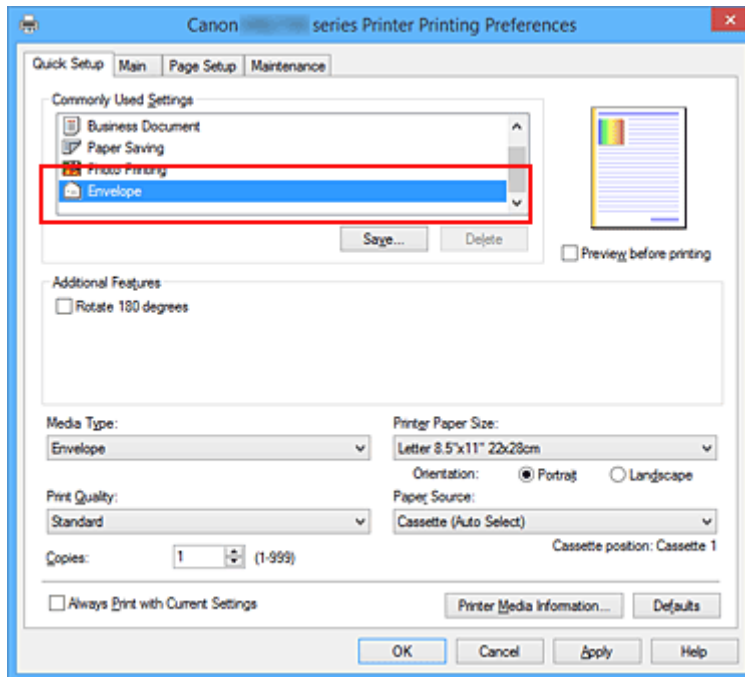

4. Select the paper size

When the **Envelope Size Setting** dialog box is displayed, select **Envelope Com 10**, **Envelope DL**, **Yougata 4 4.13"x9.25"**, **Yougata 6 3.86"x7.48"**, **Envelope C5**, or **Envelope Monarch 3.88"x7.5" 98.4x190.5mm** and then click **OK**.

5. Set the orientation

To print the addressee horizontally, select **Landscape** for **Orientation**.

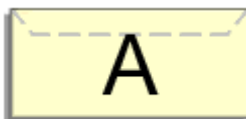

►►► Note

- If **Yougata 4 4.13"x9.25"**, **Yougata 6 3.86"x7.48"**, **Envelope Com 10**, **Envelope DL**, **Envelope C5**, or **Envelope Monarch 3.88"x7.5" 98.4x190.5mm** is selected for **Printer Paper Size**, the

printer rotates the paper 90 degrees to the left to print, regardless of the **Rotate 90 degrees left when orientation is [Landscape]** setting for **Custom Settings** on the **Maintenance** tab.

6. Select the print quality

Select **High** or **Standard** that matches your purpose for **Print Quality**.

7. Complete the setup

Click **OK**.

When you execute print, the information is printed on the envelope.

▶▶▶ Important

- When you execute envelope printing, guide messages are displayed.
To hide the guide messages, check the **Do not show this message again** check box.
To show the guide again, click the **View Printer Status** button on the **Maintenance** tab, and start the Canon IJ Status Monitor.
Then click **Envelope Printing** from **Display Guide Message** of the **Option** menu to enable the setting.

▶▶▶ Note

- If the paper settings on the printer driver differ from the cassette paper information registered on the printer, an error may occur. For instructions on what to do if an error occurs, see "[Paper Settings](#)."
To check the current printer settings or to apply the printer settings to the printer driver, click **Printer Media Information...** from the **Quick Setup** tab, and specify the settings in the dialog box that appears.
For details about the cassette paper information to be registered on the printer, see the following:
 - [Paper Settings on the Printer Driver and the Printer \(Media Type\)](#)
 - [Paper Settings on the Printer Driver and the Printer \(Paper Size\)](#)

Printing on Postcards

This section describes the procedure for postcard printing.

1. [Load postcard](#) on the printer
2. Open the [printer driver setup window](#)

3. Select commonly used settings

Display the **Quick Setup** tab, and for **Commonly Used Settings**, select **Standard**.

4. Select the media type

For **Media Type**, select **Ink Jet Hagaki (A)**, **Ink Jet Hagaki**, **Hagaki K (A)**, **Hagaki K**, **Hagaki (A)**, or **Hagaki**.

▶▶▶ Important

- This printer cannot print on postcards that have photos or stickers attached.
- When printing on each side of a postcard separately, you will get cleaner printing if you print the message side first and then print the address side.
- The paper settings on the printer driver are different, depending on whether you are printing on the address side or the message side.
To check the current printer settings or to apply the printer settings to the printer driver, click **Printer Media Information...** from the **Quick Setup** tab, and specify the settings in the dialog box that appears.
For details about the cassette paper information to be registered to the printer driver and on the printer, see the following:
 - [Paper Settings on the Printer Driver and the Printer \(Media Type\)](#)
 - [Paper Settings on the Printer Driver and the Printer \(Paper Size\)](#)

5. Select the paper size

For **Printer Paper Size**, select **Hagaki 100x148mm** or **Hagaki 2 200x148mm**.

▶▶▶ Important

- Return postcards can be used only when you print them from the computer.
- When printing a return postcard, always set the paper size to **Hagaki 2 200x148mm** from your application software or the printer driver.
- Do not fold the return postcard. If a crease is formed, the printer will not be able to feed the postcard properly, and this condition will cause line shifts or a paper jam.

6. Set the print orientation

To print the address horizontally, set **Orientation** to **Landscape**.

7. Select the print quality

For **Print Quality**, select **High** or **Standard**, according to your purpose.

8. Complete the setup

Click **OK**.

When you execute printing, the data will be printed onto the postcard.

»» Important

- When you execute postcard printing, a guide message is displayed.
When the guide message is displayed, select **Do not show this message again** if you do not want any guide messages to be displayed.
To display guide messages again, open the **Maintenance** tab and click **View Printer Status** to start the Canon IJ Status Monitor.
On the **Option** menu, choose **Display Guide Message** and click **Hagaki Printing** to enable the setting.
- When printing on media other than postcards, load the media according to usage method of that media, and click **Start Printing**.

Switching the Paper Source to Match the Purpose

In this printer, there are two paper sources, a cassette 1 and a cassette 2.

You can facilitate printing by selecting a paper source setting that matches your media type or purpose.

The procedure for setting paper source is as follows:

You can also set the paper source on the **Quick Setup** tab.

1. Open the [printer driver setup window](#)

2. Select the media type

Select the type of paper loaded in the printer from the **Media Type** list on the **Main** tab.

3. Select the paper source

From the **Paper Source** list, select the paper source that matches your purpose.

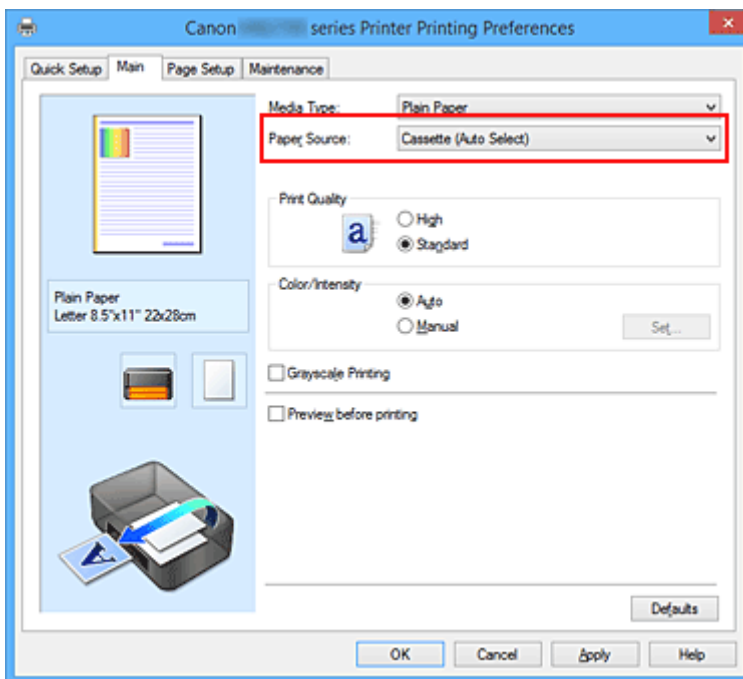

Cassette (Auto Select)

Based on the paper settings on the printer driver and the cassette paper information registered on the printer, the printer automatically determines which cassette to use and feeds paper from that cassette.

Cassette 1

Paper is fed from the cassette 1.

Cassette 2

Paper is fed from the cassette 2.

►►► Important

- When a media type other than **Plain Paper** is selected for **Media Type** on the **Main** tab, paper cannot be supplied from the cassette 2.

- When a paper size other than **Letter 8.5"x11" 22x28cm**, **Legal 8.5"x14" 22x36cm**, **A4**, **Oficio 8.5"x12.5" 215.9x317.5mm**, **B-Oficio 8.5"x14" 216.0x355.0mm**, **M-Oficio 8.50"x13.43" 216.0x341.0mm**, **Foolscap 8.5"x13" 215.9x330.2mm**, or **Legal (India) 8.46"x13.58" 215x345mm** is selected for **Page Size** on the **Page Setup** tab, paper cannot be supplied from the cassette 2.

4. Complete the setup

Click **OK**.

When you execute print, the printer uses the specified paper source to print the data.

Note

- If the paper settings on the printer driver differ from the cassette paper information registered on the printer, an error may occur. For instructions on what to do if an error occurs, see "[Paper Settings](#)."
To check the current printer settings or to apply the printer settings to the printer driver, click **Printer Media Information...** from the **Quick Setup** tab, and specify the settings in the dialog box that appears.
For details about the cassette paper information to be registered on the printer, see the following:
 - [Paper Settings on the Printer Driver and the Printer \(Media Type\)](#)
 - [Paper Settings on the Printer Driver and the Printer \(Paper Size\)](#)

Displaying the Print Results before Printing

If you are using the XPS printer driver, replace "Canon IJ Preview" with "Canon IJ XPS Preview" when reading this information.

You can display and check the print result before printing.

The procedure for displaying the print result before printing is as follows:

You can also set the print results display on the **Quick Setup** tab.

1. Open the [printer driver setup window](#)

2. Set the preview

Check the **Preview before printing** check box on the **Main** tab.

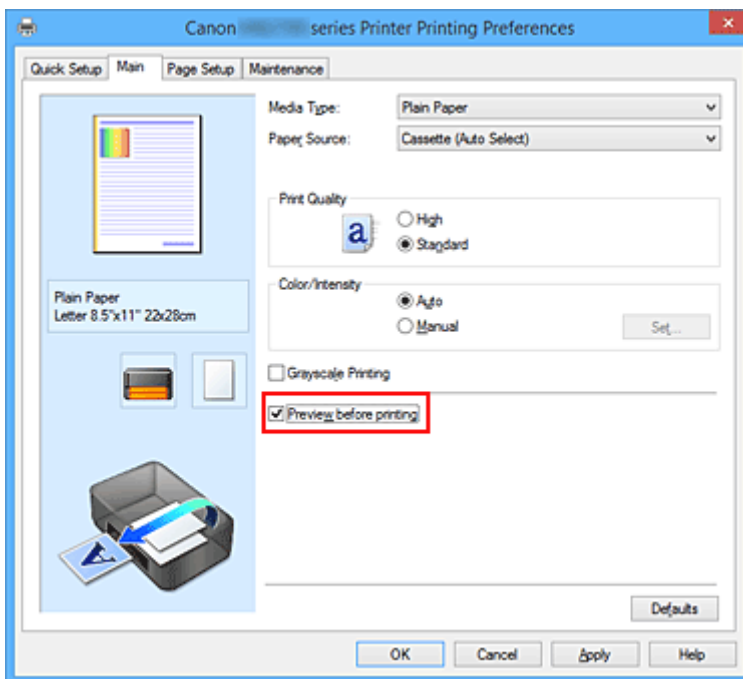

3. Complete the setup

Click **OK**.

When you execute print, the Canon IJ Preview opens and displays the print results.

Important

- In the **Manual Color Adjustment** dialog box, the **Color Adjustment** tab contains the **Print a pattern for color adjustment** check box. When this check box is selected, the **Preview before printing** appears grayed out and is unavailable.

Related Topic

- [Canon IJ Preview](#)

Setting Paper Dimensions (Custom Size)

You can specify the height and width of paper when its size cannot be selected from the **Page Size**. Such a paper size is called "custom size."

The procedure for specifying a custom size is as follows:

You can also set a custom size in **Printer Paper Size** on the **Quick Setup** tab.

1. Open the [printer driver setup window](#)
2. Select the paper size

Select **Custom...** for **Page Size** on the **Page Setup** tab.

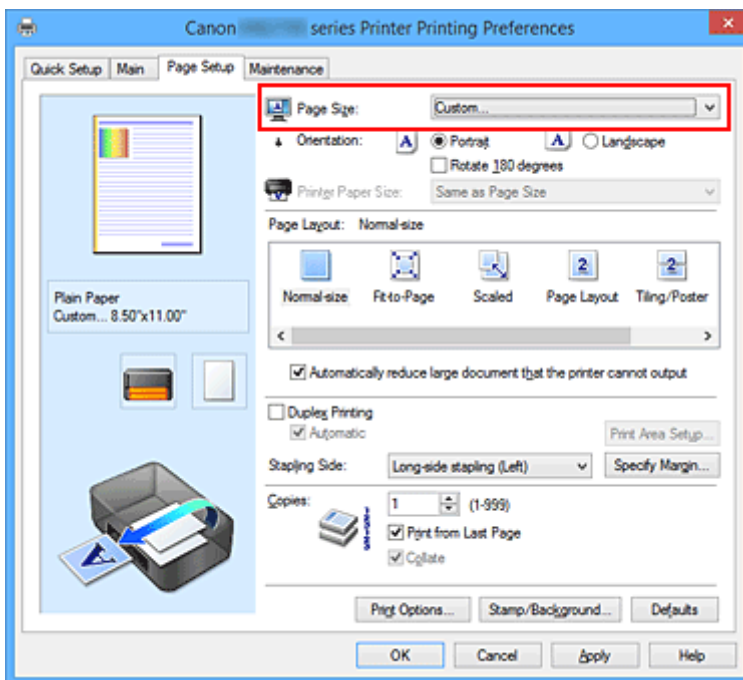

The **Custom Paper Size** dialog box opens.

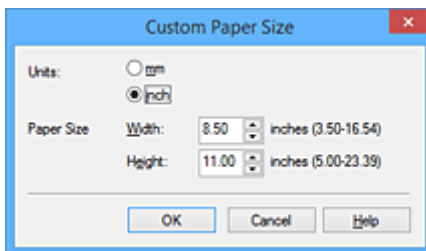

3. Set the custom paper size

Specify **Units**, and enter the **Width** and **Height** of the paper to be used. Then click **OK**.

4. Complete the setup

Click **OK** on the **Page Setup** tab.

When you execute print, the data is printed with the specified paper size.

»» Important

- If the application software that created the document has a function for specifying height and width values, use the application software to set the values. If the application software does not have such a function or if the document does not print correctly, perform the above procedure from the printer driver to set the values.
- Printing may be disabled depending on the size of the specified user-defined media. For information about printable sizes for user-defined media, see "[Supported Media Types](#)."

»» Note

- If the paper settings on the printer driver differ from the cassette paper information registered on the printer, an error may occur. For instructions on what to do if an error occurs, see "[Paper Settings](#)." To check the current printer settings or to apply the printer settings to the printer driver, click **Printer Media Information...** from the **Quick Setup** tab, and specify the settings in the dialog box that appears. For details about the cassette paper information to be registered on the printer, see the following:
 - [Paper Settings on the Printer Driver and the Printer \(Media Type\)](#)
 - [Paper Settings on the Printer Driver and the Printer \(Paper Size\)](#)

Editing the Print Document or Reprinting from the Print History

This function is unavailable when the standard IJ printer driver is used.

In the Canon IJ XPS preview window, you can edit the print document or retrieve the document print history to print the document.

The procedure for using the Canon IJ XPS Preview is as follows:

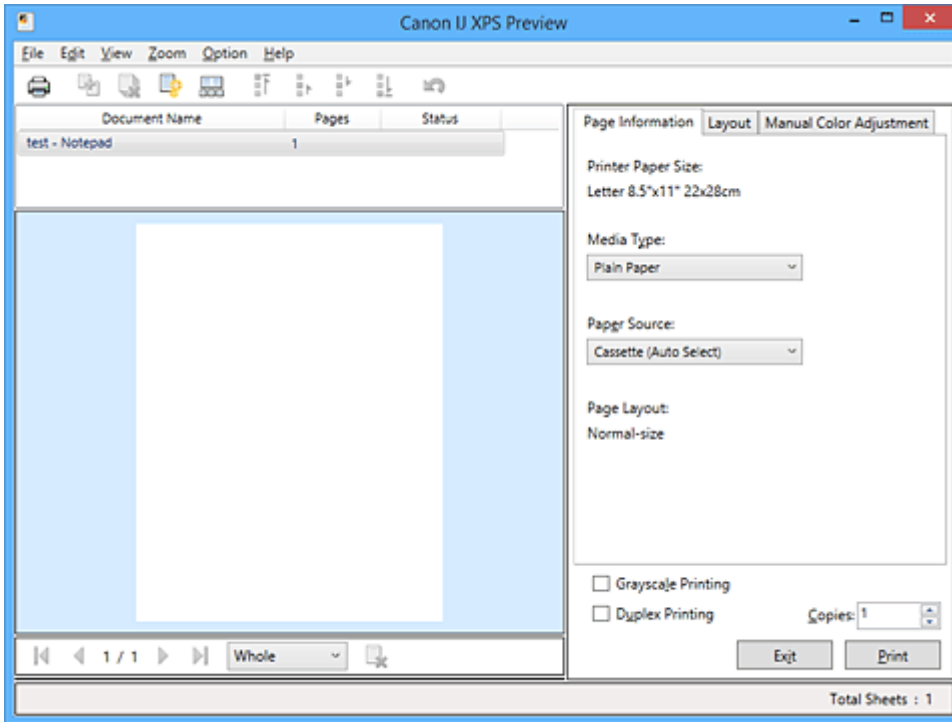

Print



Combine Documents



Delete Document



Reset Documents



View Thumbnails



Move Document



Undo





Move Page



Delete Page

▶▶▶ Note

- By clicking  **View Thumbnails**, you can display or hide thumbnails of the print documents selected in the **Document Name** list.
- Clicking  **Undo** reverses the change that just performed.

Editing and Printing a Print Document

When printing multiple documents or pages, you can combine documents, change the print sequence of the documents or pages, or delete documents or pages.

1. Open the [printer driver setup window](#)

2. Set the preview

Check the **Preview before printing** check box on the **Main** tab.

3. Complete the setup

Click **OK**.

The Canon IJ XPS Preview will start and the print result will be displayed before printing.

4. Editing print documents and print pages

- Combining print documents

You can combine multiple print documents to form a single document. By combining print documents, you can prevent blank pages from being inserted when you execute duplex printing or page layout printing.

From the **Document Name** list, select the documents to be combined. On the **Edit** menu, select **Combine Documents** from **Documents** to combine the documents in the listed sequence.

To select multiple print documents, hold down the Ctrl key and click the documents to be merged, or hold down the Shift key and press the upper arrow or lower arrow key. You can also click a blank area in the document list and drag the mouse to select multiple documents.

When you combine documents, the documents selected before the combining are deleted from the list and the combined document is added to the list.

- Changing the sequence of print documents or print pages

- To change the sequence of the print documents, go to the **Document Name** list, and select the print document to be moved. Next, on the **Edit** menu, select **Move Document** from **Documents**, and select the appropriate item. You can also click and drag a print document to change the print sequence.

- To change the sequence of the print pages, click **View Thumbnails** from the **Option** menu, and select the print page to be moved. Next, on the **Edit** menu, select **Move Page** from **Pages**, and select the appropriate item. You can also click and drag a print page to change the print sequence.

- Deleting print documents and print pages

- To delete a print document, select the target document from the **Document Name** list, and on the **Edit** menu, choose **Documents** and then **Delete Document**.
- To delete a print page, click **View Thumbnails** from the **Option** menu, and select the print page to be deleted. Next, on the **Edit** menu, select **Delete Page** from **Pages**.

- Print page recovery

You can recover pages that were deleted with **Delete Page**.

To recover pages, select the **View Deleted Pages** check box from the **Option** menu, and select

the pages to be recovered from among the displayed thumbnail pages. Then from the **Edit** menu chose **Pages** and then **Restore Page**.

After editing the print documents or print pages, you can change the print settings on the **Page Information**, **Layout** and **Manual Color Adjustment** tabs as necessary.

▶▶▶ Important

- To display the multiple documents in the list, open the preview and execute print again.
- To return the print documents to their original condition before they were edited in the preview, on the **Edit** menu, select **Reset Documents** from **Documents**.
- If the documents to be combined have different print settings, a message may be displayed. Check the contents of the displayed message before combining the documents.
- If the documents to be combined have different output paper sizes and duplex printing or page layout printing is to be performed, the printer may not produce the expected print results for certain print pages.
Check the preview before printing.
- Depending on the print settings of the print document, some functions may not be available in the Canon IJ XPS preview.

▶▶▶ Note

- You can rename **Document Name** to any name.

5. Executing print

Click **Print**.

When you execute print, the printer uses the specified settings to print the data.

Reprinting from the Print History

When you click **Save Print History** on the **File** menu to enable the setting, the document printed from the preview is saved, and you can reprint the document with the same settings.

1. Displaying the print history

Open the [printer driver setup window](#). Then on the **Maintenance** tab, select **View Print History**. The saved print document is displayed in the preview.

▶▶▶ Important

- To limit the number of print history registrations, click **History Entry Limit** on the **File** menu.
- If the limit on the number of registration is exceeded, the print history registrations are deleted starting from the oldest one.

2. Selecting a print document

From the **Document Name** list, select the document to be printed.

3. Executing print

Click **Print**.

Related Topic

- [Displaying the Print Results before Printing](#)

Changing the Print Quality and Correcting Image Data

- ▶ **Printing a Color Document in Monochrome**
- ▶ **Specifying Color Correction**
- ▶ **Optimal Photo Printing of Image Data**
- ▶ **Adjusting Colors with the Printer Driver**
- ▶ **Printing with ICC Profiles**
- ▶ **Adjusting Color Balance**
- ▶ **Adjusting Color Balance Using Sample Patterns (Printer Driver)**
- ▶ **Adjusting Brightness**
- ▶ **Adjusting Intensity**
- ▶ **Adjusting Contrast**
- ▶ **Adjusting Intensity/Contrast Using Sample Patterns (Printer Driver)**

Printing a Color Document in Monochrome

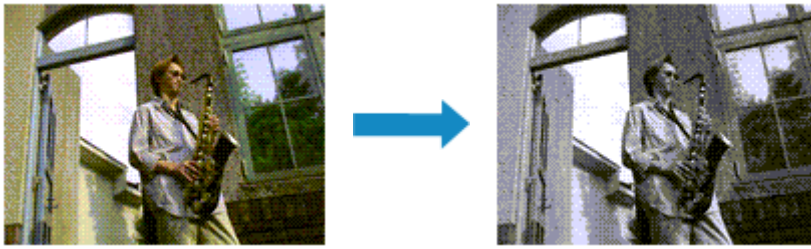

The procedure for printing a color document in monochrome is as follows:

You can also set a grayscale printing in **Additional Features** on the **Quick Setup** tab.

1. Open the [printer driver setup window](#)
2. Set grayscale printing

Check the **Grayscale Printing** check box on the **Main** tab.

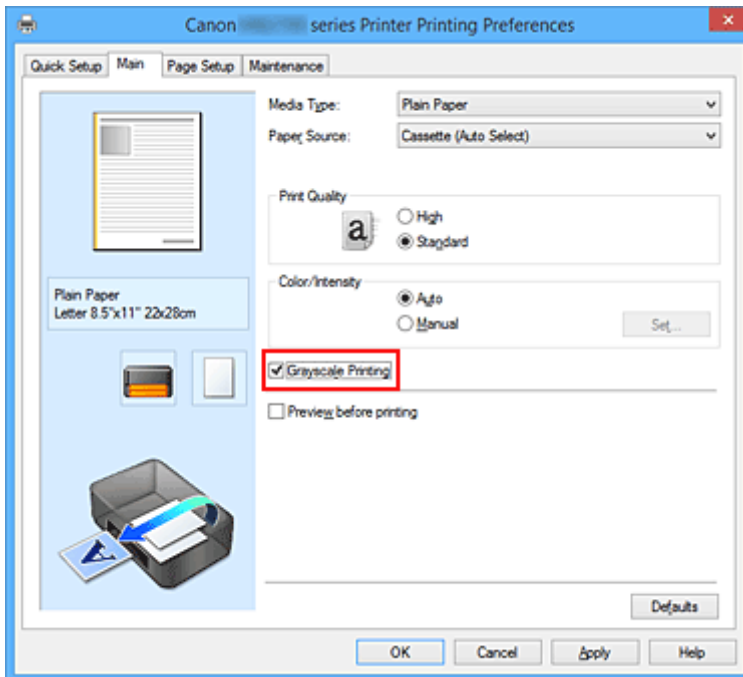

3. Complete the setup

Click **OK**.

When you execute print, the document is converted to grayscale data. It allows you to print the color document in monochrome.

►► Important

- When the **Grayscale Printing** check box is checked, the printer driver processes image data as sRGB data. In this case, actual colors printed may differ from those in the original image data. When using the grayscale printing function to print Adobe RGB data, convert the data to sRGB data using an application software.

»» Note

- During **Grayscale Printing**, inks other than black ink may be used as well.

Specifying Color Correction

You can specify the color correction method suited to the type of document to be printed.

Normally, the printer driver adjusts the colors by using Canon Digital Photo Color so that data is printed with color tints that most people prefer. This method is suitable for printing sRGB data.

When you want to print by using the color space (sRGB) of the image data effectively, select **ICM (ICC Profile Matching)**. When you want to use an application software to specify a printing ICC profile, select **None**.

The procedure for specifying color correction is as follows:

You can also set color correction on the **Quick Setup** tab by choosing **Photo Printing** under **Commonly Used Settings**, and then choosing **Color/Intensity Manual Adjustment** under **Additional Features**.

1. Open the [printer driver setup window](#)
2. Select the manual color adjustment

On the **Main** tab, select **Manual** for **Color/Intensity**, and click **Set...**

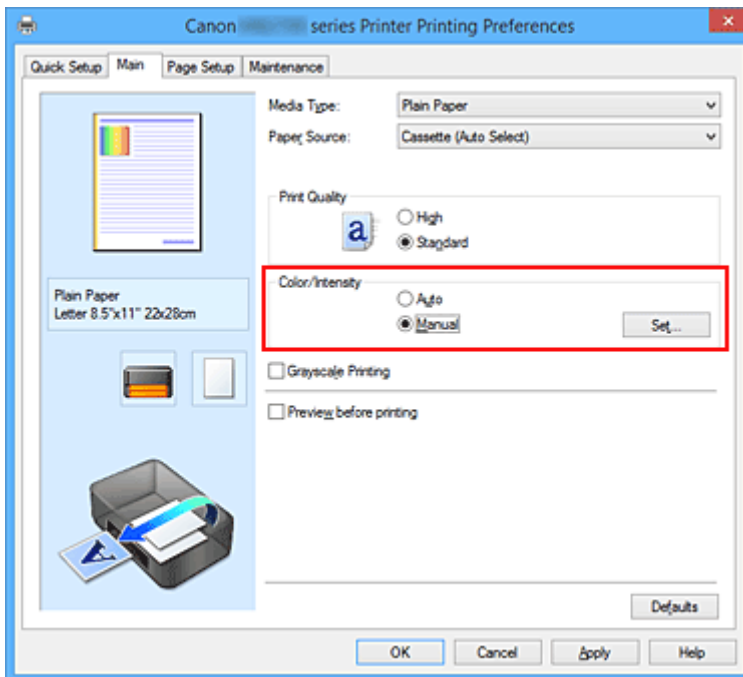

The **Manual Color Adjustment** dialog box opens.

3. Select color correction

Click **Matching** tab, select **Color Correction** setting that matches your purpose from the following, and click **OK**.

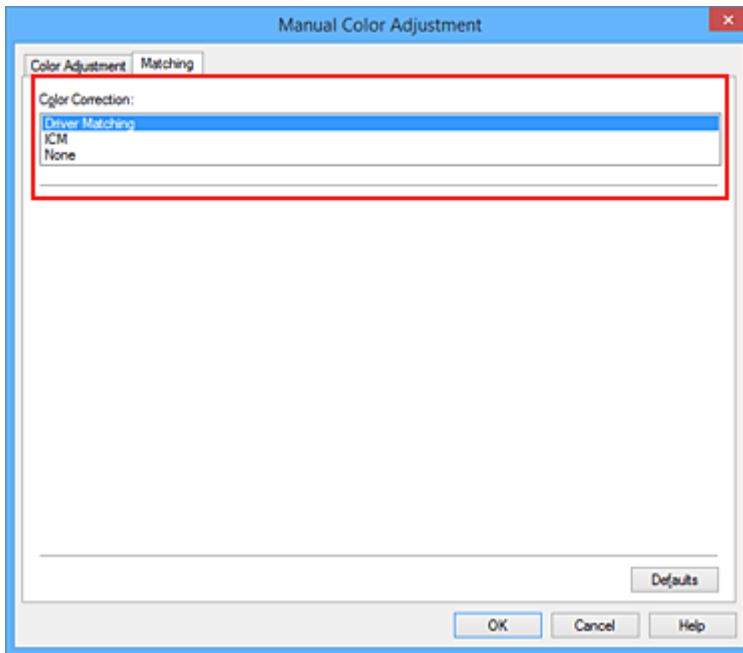

Driver Matching

With Canon Digital Photo Color, you can print sRGB data with color tints that most people prefer.

ICM (ICC Profile Matching)

Adjusts the colors by using an ICC profile when printing.

None

The printer driver does not perform color correction. Select this value when you are specifying an individually created printing ICC profile or a printing ICC profile for special Canon paper in an application software to print data.

4. Complete the setup

Click **OK** on the **Main** tab.

When you execute print, the document data is printed with the specified color correction.

▶▶▶ Important

- When ICM is disabled in the application software, **ICM** is unavailable for **Color Correction** and the printer may not be able to print the image data properly.
- When the **Grayscale Printing** check box on the **Main** tab is checked, **Color Correction** appears grayed out and is unavailable.

Related Topics

- [Optimal Photo Printing of Image Data](#)
- [Adjusting Colors with the Printer Driver](#)
- [Printing with ICC Profiles](#)

Optimal Photo Printing of Image Data

When people print images taken with digital cameras, they sometimes feel that the printed color tones differ from those of actual image or those displayed on the monitor.

To get the print results as close as possible to the desired color tones, you must select a printing method that is best suited to the application software used or to your purpose.

Color Management

Devices such as digital cameras, scanners, monitors, and printers handle color differently. Color management (color matching) is a method that manages device-dependent "colors" as a common color space.

For Windows, a color management system called "ICM" is built into the operating system. sRGB is one of the common color spaces that is frequently used.

ICC profiles convert device-dependent "colors" into a common color space. By using an ICC profile and carrying out color management, you can draw out the color space of the image data within the color reproduction area that the printer can express.

Selecting a Printing Method Suited to the Image Data

The recommended printing method depends on the color space (sRGB) of the image data or the application software to be used.

There are two typical printing methods.

Check the color space (sRGB) of the image data and the application software to be used, and then select the printing method suited to your purpose.

Adjusting Colors with the Printer Driver

Describes the procedure for printing sRGB data by using the color correction function of the printer driver.

- To print using Canon Digital Photo Color

The printer prints data with color tints that most people prefer, reproducing colors of the original image data and producing three-dimensional effects and high, sharp contrasts.

- To print by directly applying editing and touch-up results of an application software

When printing the data, the printer brings out subtle color difference between dark and light areas, while leaving the darkest and lightest areas intact.

When printing the data, the printer applies fine adjustment results, such as brightness adjustments made with an application software.

Printing with ICC Profiles

Describes the procedure for printing by using the color space of sRGB effectively.

You can print with a common color space by setting up the application software and the printer driver so that the color management matches the input ICC profile of the image data.

The method for setting up the printer driver differs depending on the application software to be used.

Adjusting Colors with the Printer Driver

You can specify the color correction function of the printer driver to print sRGB data with color tints that most people prefer through the use of Canon Digital Photo Color.

When printing from an application software that can identify ICC profiles and allows you to specify them, use a printing ICC profile in the application software, and select settings for color management.

The procedure for adjusting colors with the printer driver is as follows:

1. Open the [printer driver setup window](#)

2. Select the manual color adjustment

On the **Main** tab, select **Manual** for **Color/Intensity**, and click **Set...**

The **Manual Color Adjustment** dialog box opens.

3. Select color correction

Click **Matching** tab, and select **Driver Matching** for **Color Correction**.

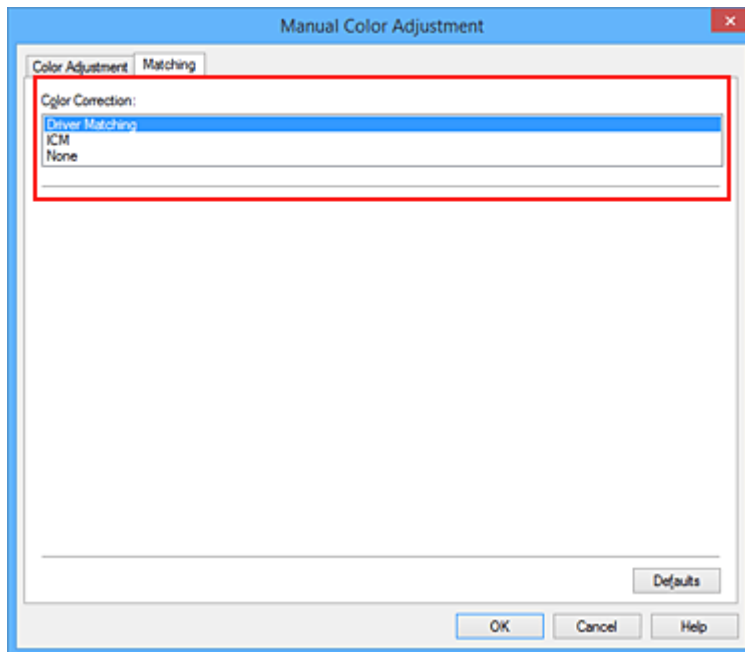

4. Set the other items

If necessary, click **Color Adjustment** tab, and adjust the color balance (**Cyan, Magenta, Yellow**) and adjust **Brightness, Intensity, and Contrast** settings, and then click **OK**.

5. Complete the setup

Click **OK** on the **Main** tab.

When you execute print, the printer driver adjusts the colors when printing the data.

Related Topics

- [Specifying Color Correction](#)

- [Adjusting Color Balance](#)
- [Adjusting Brightness](#)
- [Adjusting Intensity](#)
- [Adjusting Contrast](#)

Printing with ICC Profiles

When the image data has a specified input ICC profile, you can print by using the color space (sRGB) of the data effectively.

The printer driver setting procedure varies depending on the application software used to print.

Specify an ICC Profile from the Application Software and Print the Data

When you print the editing and touch-up results of Adobe Photoshop, Canon Digital Photo Professional, or any application software that allows you to specify input and printing ICC profiles, you print by effectively using the color space of the input ICC profile specified in the image data.

To use this printing method, use your application software to select color management items and specify an input ICC profile and a printing ICC profile in the image data.

Even if you print using a printing ICC profile that you created yourself from your application software, be sure to select color management items from your application software.

For instructions, refer to the manual of the application software you are using.

1. Open the [printer driver setup window](#)
2. Select the manual color adjustment

On the **Main** tab, select **Manual** for **Color/Intensity**, and click **Set...**

The **Manual Color Adjustment** dialog box opens.

3. Select color correction

Click **Matching** tab, and select **None** for **Color Correction**.

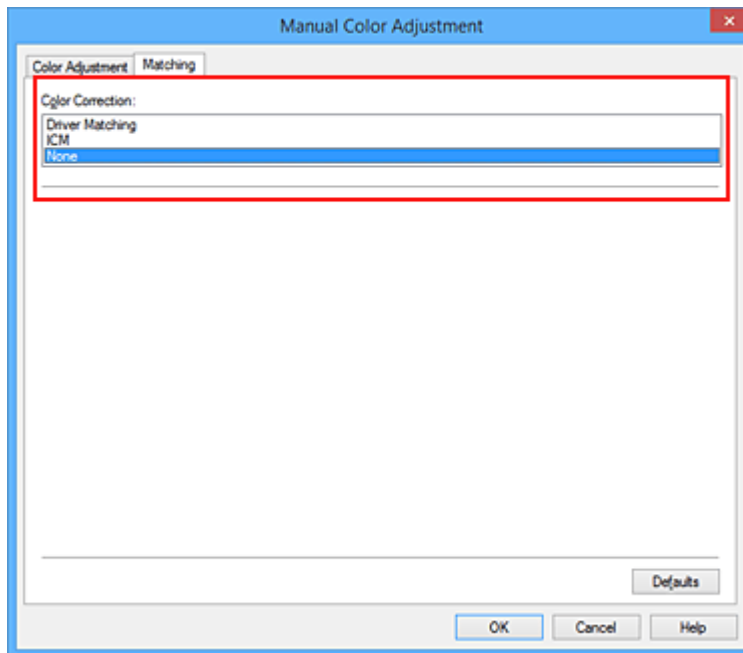

4. Set the other items

If necessary, click **Color Adjustment** tab, and adjust the color balance (**Cyan, Magenta, Yellow**) and adjust **Brightness, Intensity,** and **Contrast** settings, and then click **OK**.

5. Complete the setup

Click **OK** on the **Main** tab.

When you execute print, the printer uses the color space of the image data.

Specify an ICC Profile with the Printer Driver, and then Print

Print from an application software that cannot identify input ICC profiles or does allow you to specify one by using the color space of the input ICC profile (sRGB) found in the data.

1. Open the [printer driver setup window](#)

2. Select the manual color adjustment

On the **Main** tab, select **Manual** for **Color/Intensity**, and click **Set....**

The **Manual Color Adjustment** dialog box opens.

3. Select color correction

Click **Matching** tab, and select **ICM (ICC Profile Matching)** for **Color Correction**.

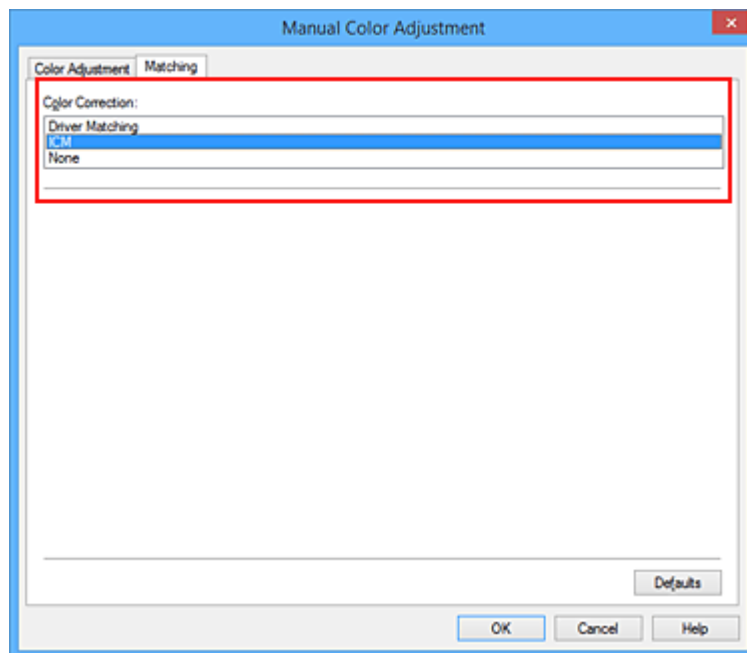

4. Set the other items

If necessary, click **Color Adjustment** tab, and adjust **Cyan, Magenta, Yellow, Brightness, Intensity,** and **Contrast** settings, and then click **OK**.

5. Complete the setup

Click **OK** on the **Main** tab.

When you execute print, the printer uses the color space of the image data.

Related Topics

- [Specifying Color Correction](#)
- [Adjusting Color Balance](#)
- [Adjusting Brightness](#)
- [Adjusting Intensity](#)
- [Adjusting Contrast](#)

Adjusting Color Balance

You can adjust the color tints when printing.

Since this function adjusts color balance of the output by changing the ink ratios of each color, it changes the total color balance of the document. Use the application software when you want to change the color balance significantly. Use the printer driver only when you want to adjust the color balance slightly.

The following sample shows the case when color balance is used to intensify cyan and to diminish yellow so that the overall colors are more uniform.



No adjustment Adjust color balance

The procedure for adjusting color balance is as follows:

You can also set color balance on the **Quick Setup** tab by choosing **Photo Printing** under **Commonly Used Settings**, and then choosing **Color/Intensity Manual Adjustment** under **Additional Features**.

1. Open the [printer driver setup window](#)
2. Select the manual color adjustment

On the **Main** tab, select **Manual** for **Color/Intensity**, and click **Set...**

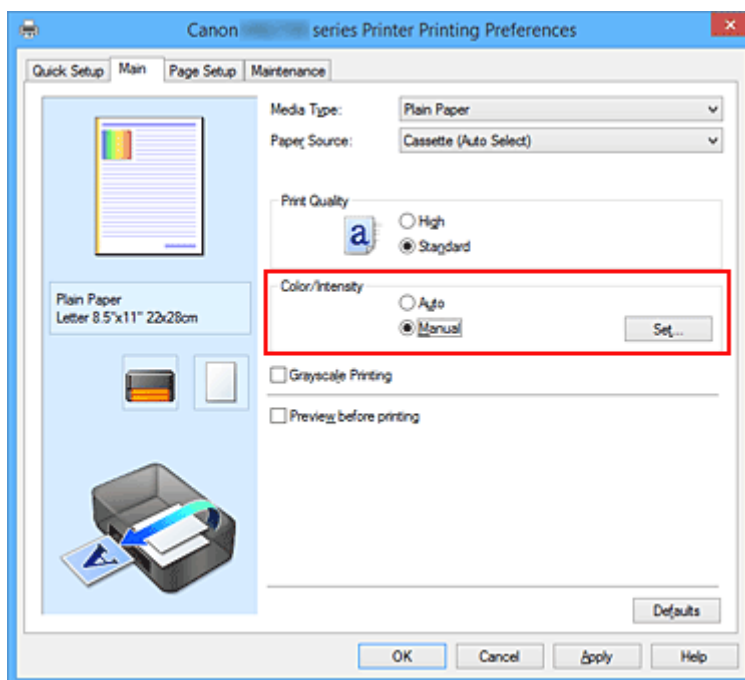

The **Manual Color Adjustment** dialog box opens.

3. Adjust color balance

There are individual sliders for **Cyan**, **Magenta**, and **Yellow**. Each color becomes stronger when the corresponding slider is moved to the right, and becomes weaker when the corresponding slider is moved to the left. For example, when cyan becomes weaker, the color red becomes stronger.

You can also directly enter a value linked to the slider. Enter a value in the range from -50 to 50. The current settings are displayed in the settings preview on the left side of the printer driver.

After adjusting each color, click **OK**.

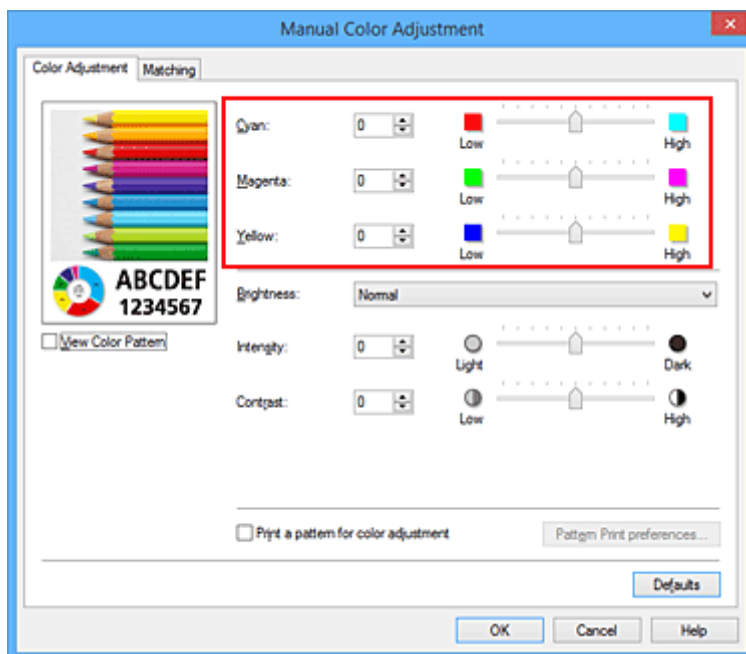

4. Complete the setup

Click **OK** on the **Main** tab.

When you execute print, the document is printed with the adjusted color balance.

▶▶▶ Important

- When the **Grayscale Printing** check box on the **Main** tab is checked, the color balance (**Cyan**, **Magenta**, **Yellow**) appear grayed out and are unavailable.

Related Topics

- [Specifying Color Correction](#)
- [Adjusting Color Balance Using Sample Patterns \(Printer Driver\)](#)
- [Adjusting Brightness](#)
- [Adjusting Intensity](#)
- [Adjusting Contrast](#)
- [Adjusting Intensity/Contrast Using Sample Patterns \(Printer Driver\)](#)

Adjusting Color Balance Using Sample Patterns (Printer Driver)

You can look at the print results of pattern print and adjust the color balance.

When you change the color balance or intensity/contrast of a document, the pattern print function prints the adjustment results in a list, together with the adjustment values.

Described below is the procedure for adjusting the color balance while looking at the pattern.

1. Open the [printer driver setup window](#)
2. Select the manual color adjustment

On the **Main** tab, select **Manual** for **Color/Intensity**, and click **Set....**

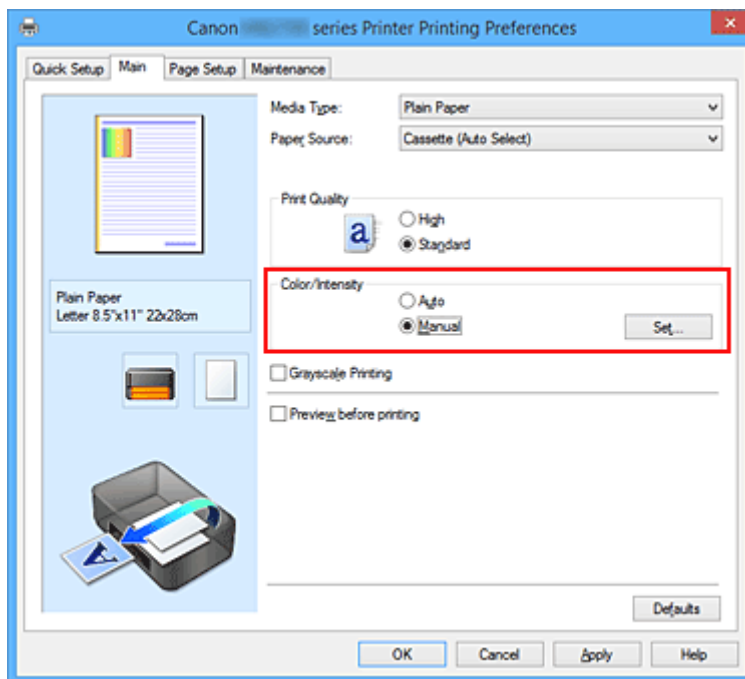

The **Manual Color Adjustment** dialog box opens.

3. Selecting pattern print

On the **Color Adjustment** tab, select the **Print a pattern for color adjustment** check box, and click **Pattern Print preferences....**

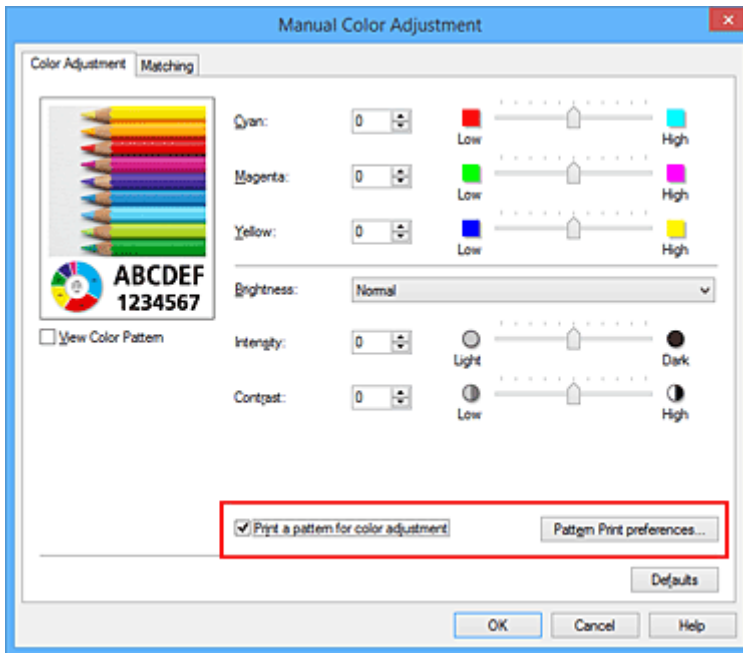

4. Setting pattern print

When the **Pattern Print** dialog box opens, set the following items, and then click **OK**.

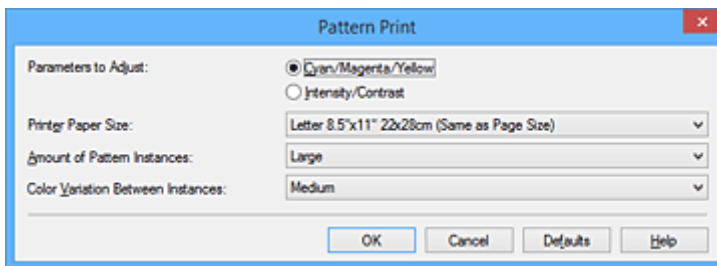

Parameters to Adjust

Select **Cyan/Magenta/Yellow**.

►►► Important

- When the **Grayscale Printing** check box on the **Main** tab is checked, **Cyan/Magenta/Yellow** appear grayed out and are unavailable.

Printer Paper Size

Select the paper size to be used for pattern printing.

►►► Note

- Depending on the paper size selected on the **Page Setup** tab, there may be sizes that cannot be selected.

Amount of Pattern Instances

Select **Largest**, **Large**, or **Small** to set the number of patterns to be printed.

►►► Note

- **Largest** and **Large** cannot be selected when certain paper sizes or output paper sizes are selected.

Color Variation Between Instances

Set the amount of color change between neighboring patterns.

►► Note

- **Large** is about double the size of **Medium**, and **Small** is about half the size of **Medium**.

5. Checking the print results of pattern print

On the **Color Adjustment** tab, select **OK** to close the **Manual Color Adjustment** dialog box.

On the **Main** tab, select **OK**, and then execute printing. The printer then prints a pattern in which the color balance that you set is the center value.



6. Adjusting the color balance

Look at the print results and select the image that you like best. Then enter the color balance numbers indicated at the bottom of that image into the **Cyan**, **Magenta**, and **Yellow** fields on the **Color Adjustment** tab.

Clear the **Print a pattern for color adjustment** check box, and click **OK**.

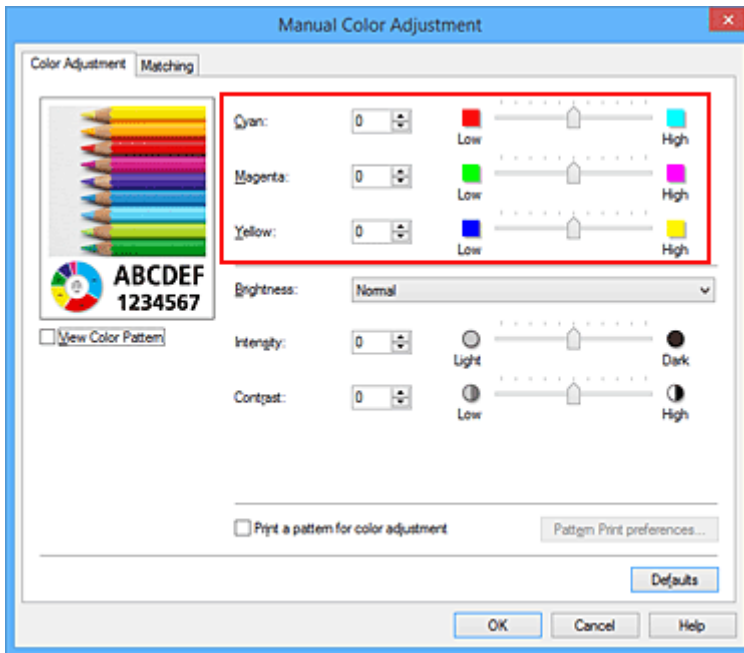

►► Note

- You can also set color balance on the **Quick Setup** tab by choosing **Photo Printing** under **Commonly Used Settings**, and then choosing **Color/Intensity Manual Adjustment** under **Additional Features**.

7. Complete the setup

Click **OK** on the **Main** tab.

Then when you execute printing, the document is printed with the color balance that was adjusted by the pattern print function.

►► Important

- When **Print a pattern for color adjustment** is selected on the **Color Adjustment** tab, the following items are grayed out and cannot be set:
 - **Preview before printing** on the **Main** tab
 - **Stapling Side** and **Specify Margin...** on the **Page Setup** tab (When **Duplex Printing** is set, only **Stapling Side** can be set.)
- When the **Print a pattern for color adjustment** on the **Color Adjustment** tab is checked, the **Page Layout** on the **Page Setup** tab is set to **Normal-size**.
- When the **Grayscale Printing** check box on the **Main** tab is checked, **Cyan**, **Magenta**, and **Yellow** appear grayed out and are unavailable.
- Depending on your application software, this function may not be available.

Related Topics

- [Adjusting Color Balance](#)
- [Adjusting Intensity](#)
- [Adjusting Contrast](#)
- [Adjusting Intensity/Contrast Using Sample Patterns \(Printer Driver\)](#)

Adjusting Brightness

You can change the brightness of the overall image data during printing.

This function does not change pure white or pure black but it changes the brightness of the intermediate colors.

The following sample shows the print result when the brightness setting is changed.



Light is selected

Normal is selected

Dark is selected

The procedure for adjusting brightness is as follows:

You can also set brightness on the **Quick Setup** tab by choosing **Photo Printing** under **Commonly Used Settings**, and then choosing **Color/Intensity Manual Adjustment** under **Additional Features**.

1. Open the [printer driver setup window](#)
2. Select the manual color adjustment

On the **Main** tab, select **Manual** for **Color/Intensity**, and click **Set...**

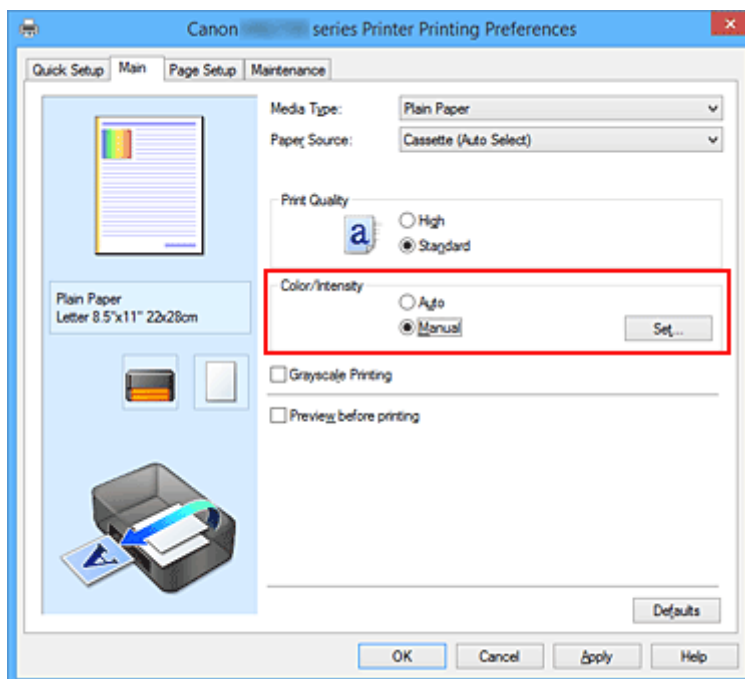

The **Manual Color Adjustment** dialog box opens.

3. Specify the brightness

Select **Light**, **Normal**, or **Dark** for **Brightness**, and click **OK**. The current settings are displayed in the settings preview on the left side of the printer driver.

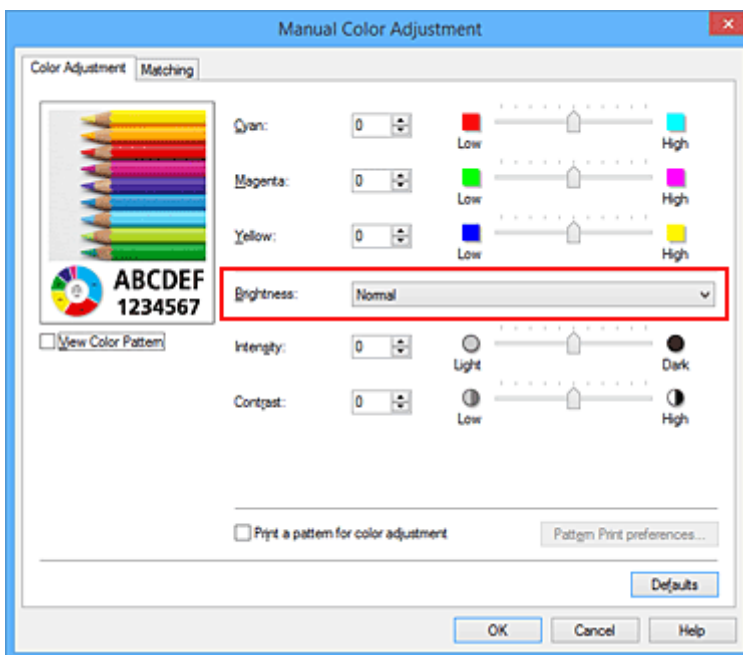

4. Complete the setup

Click **OK** on the **Main** tab.

When you execute print, the data is printed at the specified brightness.

Related Topics

- [Specifying Color Correction](#)
- [Adjusting Color Balance](#)
- [Adjusting Intensity](#)
- [Adjusting Contrast](#)

Adjusting Intensity

You can dilute (brighten) or intensify (darken) the colors of the overall image data during printing. The following sample shows the case when the intensity is increased so that all colors become more intense when the image data is printed.



No adjustment



Higher intensity

The procedure for adjusting intensity is as follows:

You can also set intensity on the **Quick Setup** tab by choosing **Photo Printing** under **Commonly Used Settings**, and then choosing **Color/Intensity Manual Adjustment** under **Additional Features**.

1. Open the [printer driver setup window](#)
2. Select the manual color adjustment

On the **Main** tab, select **Manual** for **Color/Intensity**, and click **Set...**

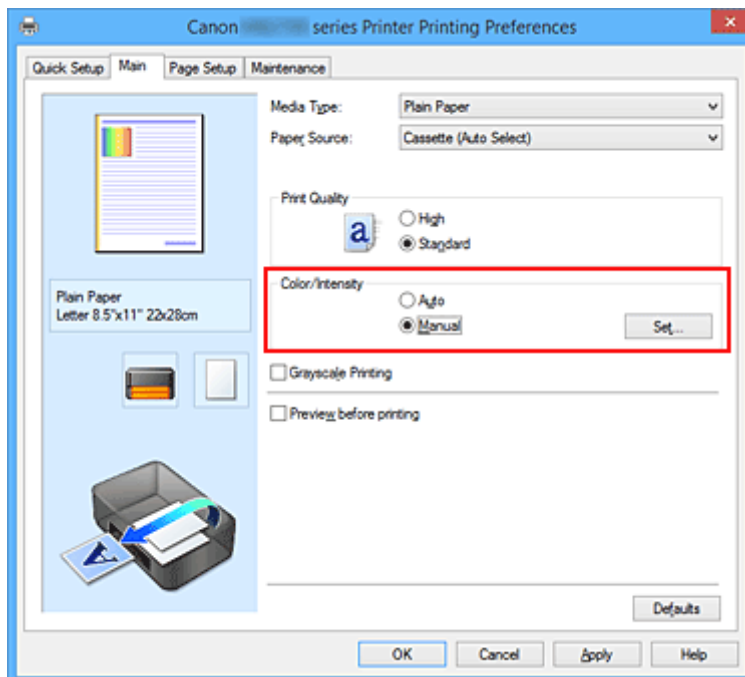

The **Manual Color Adjustment** dialog box opens.

3. Adjust intensity

Moving the **Intensity** slider to the right intensifies (darkens) the colors, and moving the slider to the left dilutes (brightens) the colors.

You can also directly enter a value linked to the slider. Enter a value in the range from -50 to 50. The current settings are displayed in the settings preview on the left side of the printer driver.

After adjusting each color, click **OK**.

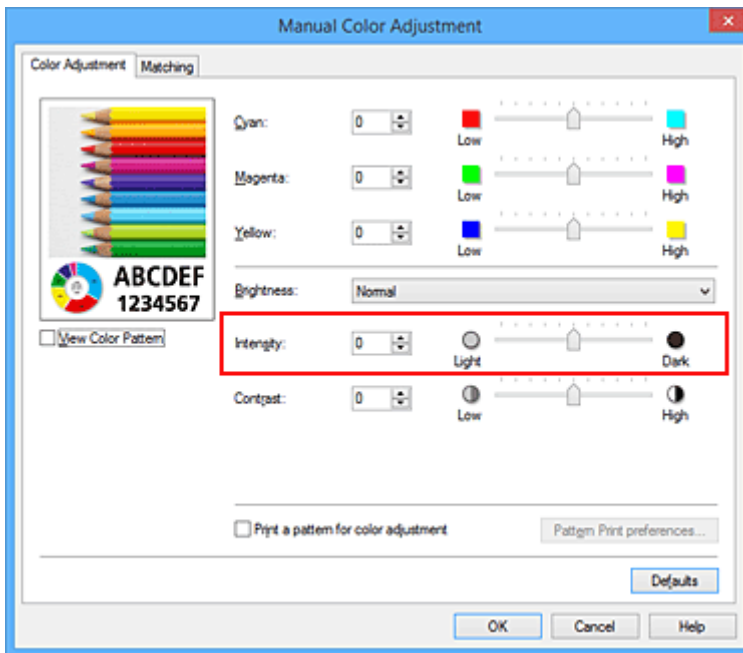

4. Complete the setup

Click **OK** on the **Main** tab.

When you execute print, the image data is printed with the adjusted intensity.

Related Topics

- [Specifying Color Correction](#)
- [Adjusting Color Balance](#)
- [Adjusting Color Balance Using Sample Patterns \(Printer Driver\)](#)
- [Adjusting Brightness](#)
- [Adjusting Contrast](#)
- [Adjusting Intensity/Contrast Using Sample Patterns \(Printer Driver\)](#)

Adjusting Contrast

You can adjust the image contrast during printing.

To make the differences between the light and dark portions of images greater and more distinct, increase the contrast. On the other hand, to make the differences between the light and dark portions of images smaller and less distinct, reduce the contrast.



No adjustment



Adjust the contrast

The procedure for adjusting contrast is as follows:

You can also set contrast on the **Quick Setup** tab by choosing **Photo Printing** under **Commonly Used Settings**, and then choosing **Color/Intensity Manual Adjustment** under **Additional Features**.

1. Open the [printer driver setup window](#)
2. Select the manual color adjustment

On the **Main** tab, select **Manual** for **Color/Intensity**, and click **Set...**

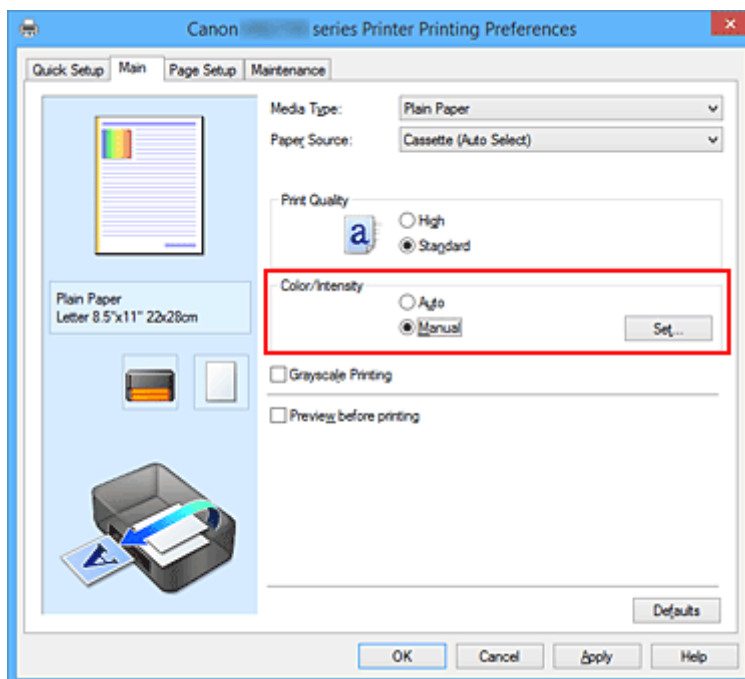

The **Manual Color Adjustment** dialog box opens.

3. Adjust the contrast

Moving the **Contrast** slider to the right increases the contrast, and moving the slider to the left decreases the contrast.

You can also directly enter a value linked to the slider. Enter a value in the range from -50 to 50. The current settings are displayed in the settings preview on the left side of the printer driver.

After adjusting each color, click **OK**.

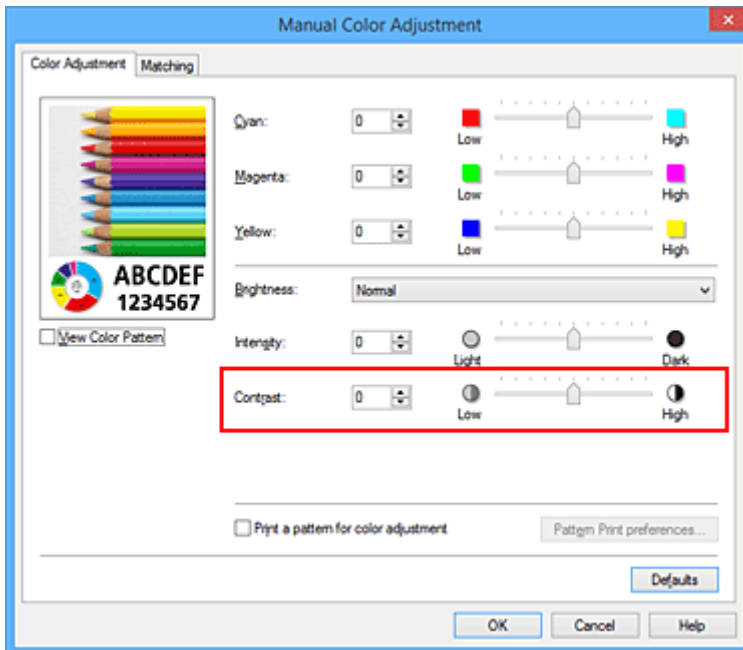

4. Complete the setup

Click **OK** on the **Main** tab.

When you execute print, the image is printed with the adjusted contrast.

Related Topics

- [Specifying Color Correction](#)
- [Adjusting Color Balance](#)
- [Adjusting Color Balance Using Sample Patterns \(Printer Driver\)](#)
- [Adjusting Brightness](#)
- [Adjusting Intensity](#)
- [Adjusting Intensity/Contrast Using Sample Patterns \(Printer Driver\)](#)

Adjusting Intensity/Contrast Using Sample Patterns (Printer Driver)

You can look at the print results of pattern print and adjust the intensity/contrast.

When you change the color balance or intensity/contrast of a document, the pattern print function prints the adjustment results in a list, together with the adjustment values.

Described below is the procedure for adjusting the intensity/contrast while looking at the pattern.

1. Open the [printer driver setup window](#)
2. Select the manual color adjustment

On the **Main** tab, select **Manual** for **Color/Intensity**, and click **Set....**

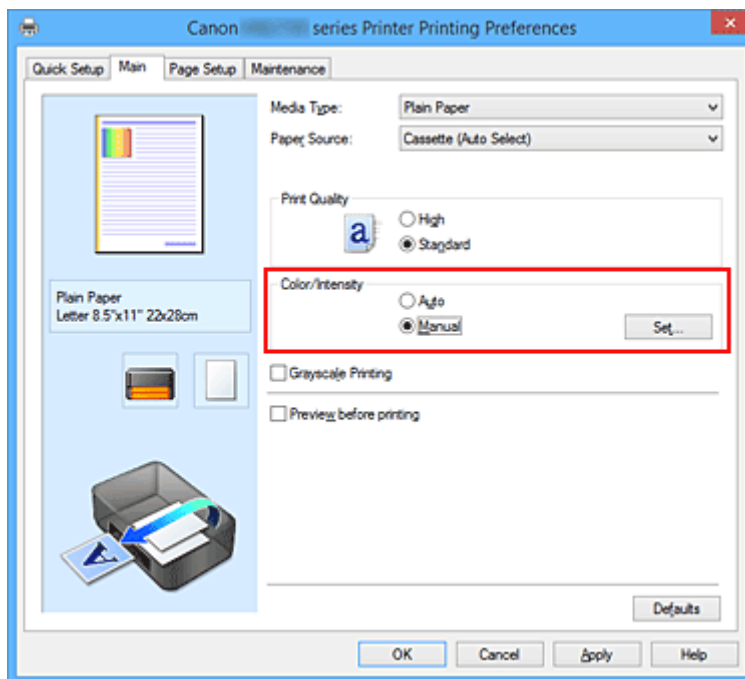

The **Manual Color Adjustment** dialog box opens.

3. Selecting pattern print

On the **Color Adjustment** tab, select the **Print a pattern for color adjustment** check box, and click **Pattern Print preferences....**

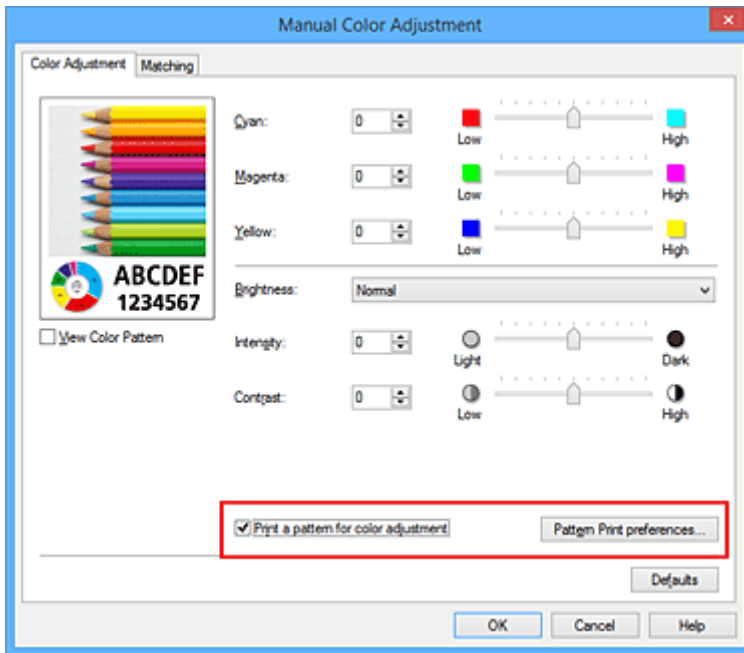

4. Setting pattern print

When the **Pattern Print** dialog box opens, set the following items, and then click **OK**.

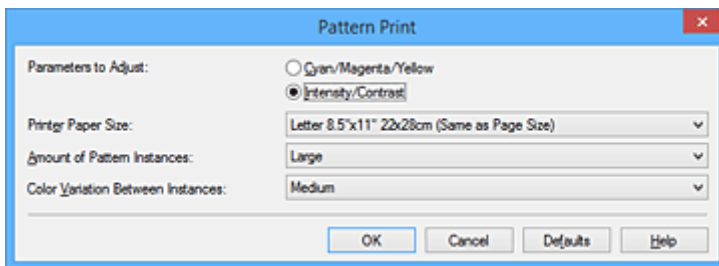

Parameters to Adjust

Select **Intensity/Contrast**.

Printer Paper Size

Select the paper size to be used for pattern printing.

►►► Note

- Depending on the paper size selected on the **Page Setup** tab, there may be sizes that cannot be selected.

Amount of Pattern Instances

Select **Largest**, **Large**, or **Small** to set the number of patterns to be printed.

►►► Note

- **Largest** and **Large** cannot be selected when certain paper sizes or output paper sizes are selected.

Color Variation Between Instances

Set the amount of color change between neighboring patterns.

►►► Note

- **Large** is about double the size of **Medium**, and **Small** is about half the size of **Medium**.

5. Checking the print results of pattern print

On the **Color Adjustment** tab, select **OK** to close the **Manual Color Adjustment** dialog box.

On the **Main** tab, select **OK**, and then execute printing. The printer then prints a pattern in which the intensity/contrast that you set is the center value.

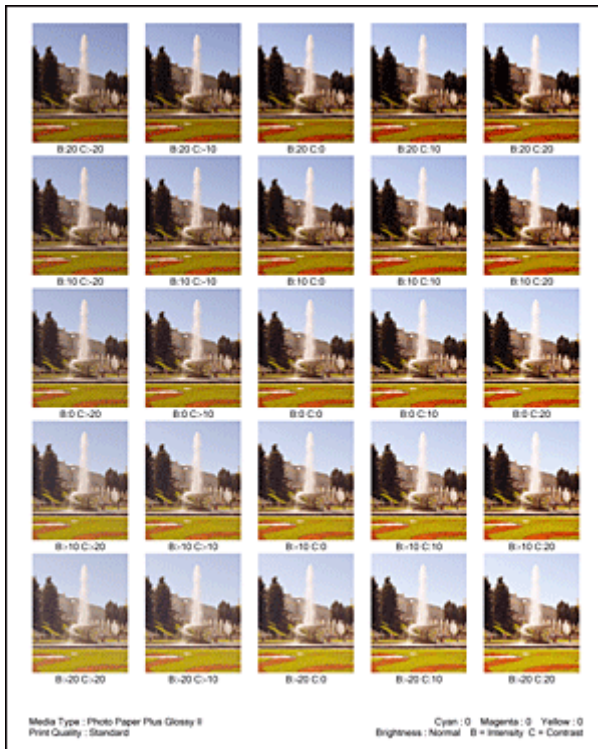

6. Adjusting the intensity/contrast

Look at the print results and select the image that you like best. Then enter the intensity/contrast numbers indicated at the bottom of that image into the **Intensity** and **Contrast** fields on the **Color Adjustment** tab.

Clear the **Print a pattern for color adjustment** check box, and click **OK**.

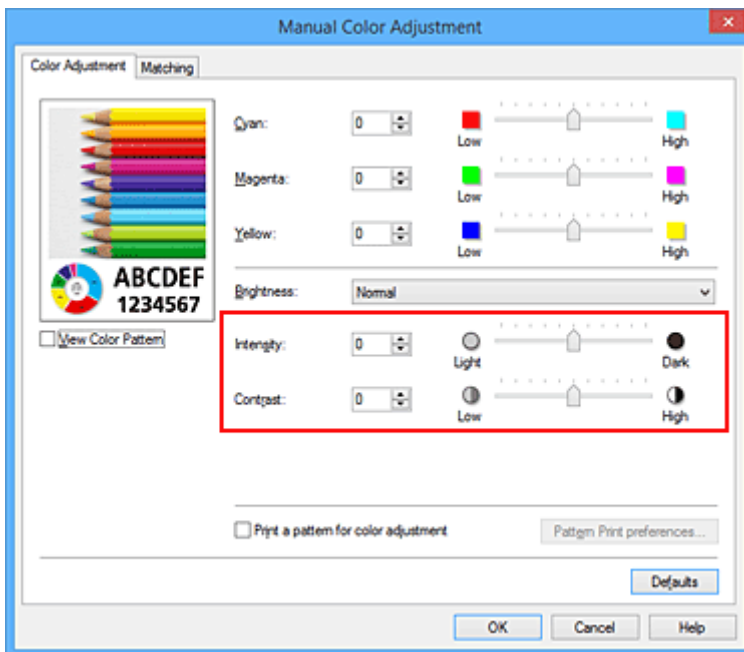

►► Note

- You can also set intensity/contrast on the **Quick Setup** tab by choosing **Photo Printing** under **Commonly Used Settings**, and then choosing **Color/Intensity Manual Adjustment** under **Additional Features**.

7. Complete the setup

Click **OK** on the **Main** tab.

Then when you execute printing, the document is printed with the intensity/contrast that was adjusted by the pattern print function.

►► Important

- When **Print a pattern for color adjustment** is selected on the **Color Adjustment** tab, the following items are grayed out and cannot be set:
 - **Preview before printing** on the **Main** tab
 - **Stapling Side** and **Specify Margin...** on the **Page Setup** tab (When **Duplex Printing** is set, only **Stapling Side** can be set.)
- You can print a pattern only if **Normal-size** is selected for **Page Layout** on the **Page Setup** tab.
- Depending on your application software, this function may not be available.

Related Topics

- [Adjusting Color Balance](#)
- [Adjusting Color Balance Using Sample Patterns \(Printer Driver\)](#)
- [Adjusting Intensity](#)
- [Adjusting Contrast](#)

Overview of the Printer Driver

- ▶ **Canon IJ Printer Driver**
- ▶ **How to Open the Printer Driver Setup Window**
- ▶ **Canon IJ Status Monitor**
- ▶ **Checking the Ink Status from Your Computer**
- ▶ **Canon IJ Preview**
- ▶ **Deleting the Undesired Print Job**
- ▶ **Instructions for Use (Printer Driver)**

Canon IJ Printer Driver

The Canon IJ printer driver (called printer driver below) is a software that is installed on your computer for printing data with this printer.

The printer driver converts the print data created by your application software into data that your printer can understand, and sends the converted data to the printer.

Because different models support different print data formats, you need a printer driver for the specific model you are using.

Printer Driver Types

On Windows Vista SP1 or later, you can install the XPS printer driver in addition to the regular printer driver.

The XPS printer driver is suited to print from an application software that supports XPS printing.

►► Important

- To use the XPS printer driver, the standard printer driver must already be installed on your computer.

Installing the Printer Driver

- To install the regular printer driver, load the Setup CD-ROM that comes with the printer, and then install the driver from **Start Setup Again**.
- To install the XPS printer driver, load the Setup CD-ROM that comes with the printer, and then select **XPS Driver** from **Add Software**.

Specifying the Printer Driver

To specify the printer driver, open the **Print** dialog box of the application software you are using, and select "XXX Printer" (where "XXX" is your model name) to specify the regular printer driver or select "XXX Printer XPS" (where "XXX" is your model name) to specify the XPS printer driver.

Displaying the Manual from the Printer Driver

To display a description of a tab in the printer driver setup window, click the **Help** button found on the tab.

Related Topic

- [How to Open the Printer Driver Setup Window](#)

How to Open the Printer Driver Setup Window

You can display the printer driver setup window from the application software in use or from the printer icon.

Open the Printer Driver Setup Window through the Application Software

Follow the procedure below to configure printing profile when printing.

1. Select the command that you perform printing on the application software

In general, select **Print** on the **File** menu to open the **Print** dialog box.

2. Select your model name and click **Preferences** (or **Properties**)

The printer driver setup window appears.

▶▶ Note

- Depending on application software you use, command names or menu names may vary and there may be more steps. For details, refer to the user's manual of your application software.

Opening the Printer Driver Setup Window from the Printer Icon

Follow the procedure below to perform printer maintenance operations such as print head cleaning, or to configure a printing profile that is common to all application software.

1. Select as described below:

- If you are using Windows 10, Windows 8.1 or Windows 8, select **Control Panel** -> **Hardware and Sound** -> **Devices and Printers**.
- If you are using Windows 7, select the **Start** menu -> **Devices and Printers**.
- If you are using Windows Vista, select the **Control Panel** -> **Hardware and Sound** -> **Printers**.

2. Right-click your model name icon, and then select **Printing preferences** from the displayed menu

The printer driver setup window appears.

▶▶ Important

- Opening the printer driver setup window through **Printer properties** (Windows 10, Windows 8.1, Windows 8, Windows 7) or **Properties** (Windows Vista) displays such tabs regarding the Windows functions as the **Ports** (or **Advanced**) tab. Those tabs do not appear when opening through **Printing preferences** or application software. For tabs regarding Windows functions, refer to the user's manual for the Windows.

Canon IJ Status Monitor

The Canon IJ Status Monitor is an application software that shows the status of the printer and the progress of printing. You will know the status of the printer with graphics, icons, and messages.

Launching the Canon IJ Status Monitor

The Canon IJ Status Monitor launches automatically when print data is sent to the printer. When launched, the Canon IJ Status Monitor appears as a button on the task bar.



Click the button of the status monitor displayed on the task bar. The Canon IJ Status Monitor appears.

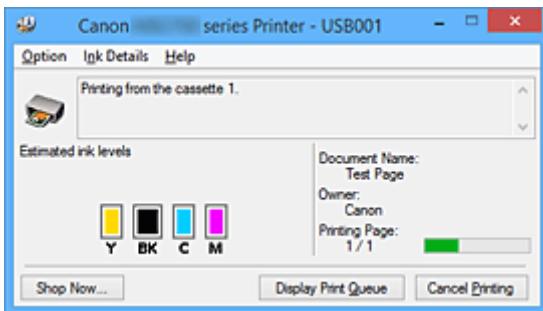

►► Note

- To open the Canon IJ Status Monitor when the printer is not printing, open the [printer driver setup window](#) and click **View Printer Status** on the **Maintenance** tab.
- The information displayed on the Canon IJ Status Monitor may differ depending on the country or region where you are using your printer.

When Errors Occur

The Canon IJ Status Monitor is automatically displayed if an error occurs (e.g., if the printer runs out of paper or if the ink is low).

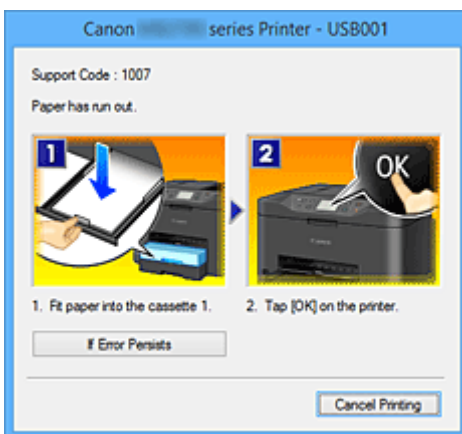

In such cases, take the appropriate action as described.

Checking the Ink Status from Your Computer

You can check the remaining ink level and the ink tank types for your model.

1. Open the [printer driver setup window](#)
2. Launching the Canon IJ Status Monitor

On the **Maintenance** tab, click **View Printer Status**.

The Canon IJ Status Monitor opens and displays an image of the ink status.

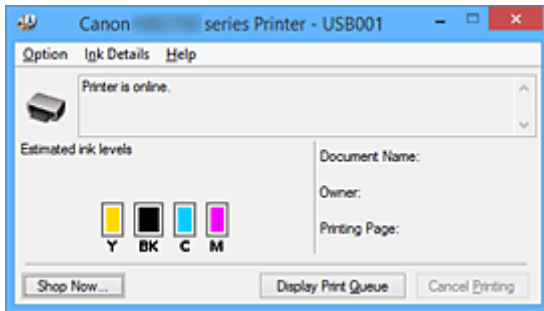

»» Note

- The information displayed on the Canon IJ Status Monitor may differ depending on the country or region where you are using your printer.

3. If necessary, click **Ink Details**

You can check the ink-related information.

If a warning or error related to the remaining ink amount occurs, a notification icon is displayed at the top of the image in the **Ink Details** dialog box.

In such cases, take the appropriate action as described on the screen.

»» Note

- You can also display the **Ink Details** dialog box by selecting the ink icon on the Canon IJ Status Monitor.

Canon IJ Preview

The Canon IJ Preview is an application software that displays what the print result will look like before a document is actually printed.

The preview reflects the information that is set within the printer driver and allows you to check the document layout, print order, and number of pages. You can also change the media type and paper source settings.

When you want to display a preview before printing, open the [printer driver setup window](#), click the **Main** tab, and check the **Preview before printing** check box.

When you do not want to display a preview before printing, uncheck the check box.

Important

- If you are using the XPS printer driver, see "[Editing the Print Document or Reprinting from the Print History](#)."

Related Topic

- [Displaying the Print Results before Printing](#)

Deleting the Undesired Print Job

If you are using the XPS printer driver, replace "Canon IJ Status Monitor" with "Canon IJ XPS Status Monitor" when reading this information.

If the printer does not start printing, canceled or failed print job data may be remaining. Delete the undesired print job by using the Canon IJ Status Monitor.

1. Display the Canon IJ Status Monitor

Click the icon of the Canon IJ Status Monitor displayed on the task bar.
The Canon IJ Status Monitor appears.

2. Display the print jobs

Click **Display Print Queue**.
The print queue window opens.

3. Delete the print jobs

Select **Cancel All Documents** from the **Printer** menu.
When the confirmation message appears, click **Yes**.
The deletion of the print job is complete.

▶▶ Important

- Users who have not been granted access permission for printer management cannot delete the print job of another user.

▶▶ Note

- When you perform this operation, all print jobs are deleted. If the print queue list contained a necessary print job, start the printing process over from the beginning.

Instructions for Use (Printer Driver)

This printer driver is subject to the following restrictions. Keep the following points in mind when using the printer driver.

Restrictions on the Printer Driver

- Depending on the document type to be printed, the paper feed method specified in the printer driver may not operate correctly.

If this happens, open the [printer driver setup window](#) from the **Print** dialog box of the application software, and check the setting in the **Paper Source** field on the **Main** tab.

- With some applications, the **Copies** setting in the **Page Setup** tab of the printer driver may not be enabled.

In this case, use the copies setting in the **Print** dialog box of the application software.

- If the selected **Language** in the **About** dialog box of the **Maintenance** tab does not match the operating system interface language, the printer driver setup window may not be displayed properly.
- Do not change the **Advanced** tab items of the printer properties. If you change any of the items, you will not be able to use the following functions correctly.

Also, if **Print to file** is selected in the **Print** dialog box of the application software and with applications that prohibit EMF spooling, such as Adobe Photoshop LE and MS Photo Editor, the following functions will not operate.

- **Preview before printing** on the **Main** tab
 - **Prevention of Print Data Loss** in the **Print Options** dialog box on the **Page Setup** tab
 - **Page Layout, Tiling/Poster, Booklet, Duplex Printing, Specify Margin..., Print from Last Page, Collate, and Stamp/Background... (Stamp...)** on the **Page Setup** tab
 - **Print a pattern for color adjustment** on the **Color Adjustment** tab in the **Manual Color Adjustment** dialog box
- Since the resolution in the preview display differs from the printing resolution, text and lines in the preview display may appear different from the actual print result.
 - With some applications, the printing is divided into multiple print jobs.
To cancel printing, delete all divided print jobs.
 - If image data is not printed correctly, display the **Print Options** dialog box from the **Page Setup** tab and change the setting of **Disable ICM required from the application software**. This may solve the problem.

▶▶▶ Note

- **Disable ICM required from the application software** cannot be used when the XPS printer driver is used.

- Do not start up the Canon IJ Network Tool while printing.
- Do not print when the Canon IJ Network Tool is running.

Points to Note About Applications with Restrictions

- There are following restrictions in Microsoft Word (Microsoft Corporation).
 - When Microsoft Word has the same printing functions as the printer driver, use Word to specify them.

- When **Fit-to-Page**, **Scaled**, or **Page Layout** is used for **Page Layout** on the **Page Setup** tab of the printer driver, the document may not print normally in certain versions of Word.
- When **Page Size** in Word is set to "XXX Enlarge/Reduce", the document may not print normally in certain versions of Word.

If this happens, follow the procedure below.

1. Open Word's **Print** dialog box.
 2. Open the [printer driver setup window](#), and on the **Page Setup** tab, set **Page Size** to the same paper size that you specified in Word.
 3. Set the **Page Layout** that you want, and then click **OK** to close the window.
 4. Without starting printing, close the **Print** dialog box.
 5. Open Word's **Print** dialog box again.
 6. Open the printer driver setup window and click **OK**.
 7. Start printing.
- If bitmap printing is enabled in Adobe Illustrator (Adobe Systems Incorporated), printing may take time or some data may not be printed. Print after unchecking the **Bitmap Printing** check box in the **Print** dialog box.

Printer Driver Description

- ▶ **Quick Setup tab Description**
- ▶ **Main tab Description**
- ▶ **Page Setup tab Description**
- ▶ **Maintenance tab Description**
- ▶ **Canon IJ Preview Description**
- ▶ **Canon IJ XPS Preview Description**
- ▶ **Canon IJ Status Monitor Description**

Quick Setup tab Description

The **Quick Setup** tab is for registering commonly used print settings. When you select a registered setting, the printer automatically switches to the preset items.

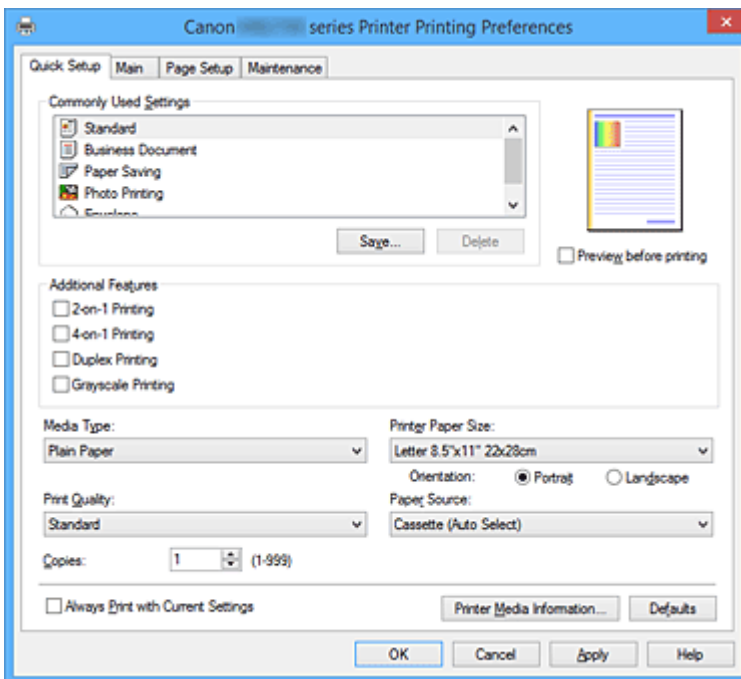

Commonly Used Settings

The names and icons of frequently used printing profiles are registered. When you select a printing profile according to the purpose of the document, settings that match the purpose are applied.

In addition, functions that are thought to be useful for the selected printing profile are displayed in

Additional Features.

You can also change a printing profile and register it under a new name. You can delete the registered printing profile.

You can rearrange the profiles either by dragging the individual profiles or by holding down the Ctrl key and pressing the up or down arrow keys.

Standard

These are the factory settings.

If **Page Size**, **Orientation**, and **Copies** were set from the application software, those settings have priority.

Business Document

Select this setting when printing a general document.

If **Page Size**, **Orientation**, and **Copies** were set from the application software, those settings have priority.

Paper Saving

Select this setting to save paper when printing a general document. The **2-on-1 Printing** and **Duplex Printing** check boxes are checked automatically.

If **Page Size**, **Orientation**, and **Copies** were set from the application software, those settings have priority.

Photo Printing

If you select this setting when printing a photo, the photo paper and photo size generally used are set.

If **Orientation** and **Copies** were set from the application software, those settings have priority.

Envelope

If you select this setting for printing an envelope, **Media Type** is set automatically to **Envelope**. In the **Envelope Size Setting** dialog box, select the size of the envelope to be used.

▶▶▶ Note

- The combination of the **Additional Features** that was displayed for the printing profile that had been selected when the added printing profile was saved is also displayed when that added printing profile is selected.

Save...

Displays the [Save Commonly Used Settings dialog box](#).

Click this button when you want to save the information that you set on the **Quick Setup**, **Main**, and **Page Setup** tabs to **Commonly Used Settings**.

Delete

Deletes a registered printing profile.

Select the name of the setting to be deleted from **Commonly Used Settings**, and click **Delete**. When a confirmation message is displayed, click **OK** to delete the specified printing profile.

▶▶▶ Note

- Printing profiles that are registered in the initial settings cannot be deleted.

Settings Preview

The paper illustration shows how the original will be laid out on a sheet of paper.

You can check an overall image of the layout.

Preview before printing

Shows what the print result will look like before you actually print the data.

Check this check box to display a preview before printing.

Uncheck this check box if you do not want to display a preview.

▶▶▶ Important

- To use the Canon IJ XPS Preview, you must have Microsoft .NET Framework 4 Client Profile installed on your computer.

Additional Features

Displays the frequently used, convenient functions for the printing profile that you selected for **Commonly Used Settings** on the **Quick Setup** tab.

When you move the mouse pointer near a function that can be changed, a description of that function is displayed.

To enable a function, check the corresponding check box.

For some functions, you can set detailed settings from the **Main** and **Page Setup** tabs.

▶▶▶ Important

- Depending on the printing profiles, certain function may be grayed out and you will not be able to change them.

2-on-1 Printing

Prints two pages of the document, side by side, on one sheet of paper.

To change the page sequence, click the **Page Setup** tab, select **Page Layout** for **Page Layout**, and click **Specify...** Then in the [Page Layout Printing dialog box](#) that appears, specify the **Page Order**.

4-on-1 Printing

Prints four pages of the document, side by side, on one sheet of paper.

To change the page sequence, click the **Page Setup** tab, select **Page Layout** for **Page Layout**, and click **Specify...** Then in the [Page Layout Printing dialog box](#) that appears, specify the **Page Order**.

Duplex Printing

Selects whether to print the document on both sides or one side of a sheet of paper.

To change the staple side or the margins, set the new values from the **Page Setup** tab.

Grayscale Printing

This function converts the data to monochrome data when printing your document.

Rotate 180 degrees

Prints the document by rotating it 180 degrees against the paper feed direction.

The width of print area and the amount of extension that are configured in other application software will be reversed vertically and horizontally.

Color/Intensity Manual Adjustment

Select when you set the **Color Correction** method and individual settings such as **Cyan**, **Magenta**, **Yellow**, **Brightness**, **Intensity**, and **Contrast**, etc.

Media Type

Selects a type of printing paper.

Select a media type that matches the paper that is loaded in the printer. This ensures that printing is carried out properly for the specified paper.

Printer Paper Size

Selects the size of paper actually loaded into the printer.

Normally, the paper size is set automatically according to the output paper size setting, and the document is printed with no scaling.

When you set **2-on-1 Printing** or **4-on-1 Printing** in **Additional Features**, you can manually set the paper size with **Page Size** on the **Page Setup** tab.

If you select a paper size that is smaller than the **Page Size**, the document size will be reduced. If you select a paper size that is larger, the document size will be enlarged.

Also if you select **Custom...**, the [Custom Paper Size dialog box](#) opens and allows you to specify any vertical and horizontal dimensions for the paper size.

Orientation

Selects the printing orientation.

If the application used to create your document has a similar function, select the same orientation that you selected in that application.

Portrait

Prints the document so that its top and bottom positions are unchanged relative to the paper feed direction. This is the default setting.

Landscape

Prints the document by rotating it 90 degrees relative to the paper feed direction.

You can change the rotation direction by going to the **Maintenance** tab, opening the **Custom Settings** dialog box, and then using **Rotate 90 degrees left when orientation is [Landscape]** check box.

To rotate the document 90 degrees to the left when printing, select the **Rotate 90 degrees left when orientation is [Landscape]** check box.

Print Quality

Selects your desired printing quality.

Select one of the following to set the print quality level that is appropriate for the purpose.

High

Gives priority to print quality over printing speed.

Standard

Prints with average speed and quality.

Paper Source

Select the source from which paper is supplied.

Cassette (Auto Select)

Based on the paper settings on the printer driver and the cassette paper information registered on the printer, the printer automatically determines which cassette to use and feeds paper from that cassette.

Cassette 1

Paper is fed from the cassette 1.

Cassette 2

Paper is fed from the cassette 2.

»» Important

- Depending on the media type and size, the **Paper Source** settings that can be selected may differ.

Copies

Specifies the number of copies you want to print. You can specify a value from 1 to 999.

»» Important

- When the application software that you used to create the document has the same function, specify the settings on the printer driver. However, if the print results are not acceptable, specify the function settings on the application software.

Always Print with Current Settings

Prints documents with the current settings starting from the next print execution.

When you select this function and then close the [printer driver setup window](#), the information that you set on the **Quick Setup**, **Main**, and **Page Setup** tabs are saved and printing with the same settings is possible starting from the next print execution.

»» Important

- If you log on with a different user name, the settings that were set when this function was enabled are not reflected in the print settings.
- If a setting was specified on the application software, it has priority.

Printer Media Information...

Displays [Printer Media Information dialog box](#).

You can check the printer settings and apply the checked settings to the printer driver.

Defaults

Restores all the settings you have changed to their default values.

Click this button to return all settings on the **Quick Setup**, **Main**, and **Page Setup** tabs to their default values (factory settings).

Save Commonly Used Settings dialog box

This dialog box allows you to save the information that you set on the **Quick Setup**, **Main**, and **Page Setup** tabs and add the information to the **Commonly Used Settings** list on the **Quick Setup** tab.

Name

Enter the name for the printing profile you wish to save.

Up to 255 characters can be entered.

The name appears, with its associated icon, in the **Commonly Used Settings** list on the **Quick Setup** tab.

Options...

Opens the [Save Commonly Used Settings dialog box](#).

Changes the details of printing profile to be saved.

Save Commonly Used Settings dialog box

Select the icons of the printing profiles to be registered to **Commonly Used Settings**, and change the items to be saved in the printing profiles.

Icon

Select the icon for the printing profile you wish to save.

The selected icon appears, with its name, in the **Commonly Used Settings** list on the **Quick Setup** tab.

Save the paper size setting

Saves the paper size to the printing profile in **Commonly Used Settings**.

To apply the saved paper size when the printing profile is selected, check this check box.

If this check box is unchecked, the paper size is not saved, and consequently the paper size setting is not applied when the printing profile is selected. Instead the printer prints with the paper size specified with the application software.

Save the orientation setting

Saves the **Orientation** to the printing profile in **Commonly Used Settings**.

To apply the saved print orientation when the printing profile is selected, check this check box.

If this check box is unchecked, the print orientation is not saved, and consequently the **Orientation** setting is not applied when the printing profile is selected. Instead the printer prints with the print orientation specified with the application software.

Save the copies setting

Saves the **Copies** setting to the printing profile in **Commonly Used Settings**.

To apply the saved copies setting when the printing profile is selected, check this check box.

If this check box is unchecked, the copies setting is not saved, and consequently the **Copies**

setting is not applied when the printing profile is selected. Instead the printer prints with the copies setting specified with the application software.

Custom Paper Size dialog box

This dialog box allows you to specify the size (width and height) of the custom paper.

Units

Select the unit for entering a user-defined paper size.

Paper Size

Specifies the **Width** and the **Height** of the custom paper. Measurement is shown according to the units specified in **Units**.

Printer Media Information dialog box

This dialog box allows you to check the printer settings and apply the checked settings to the printer driver.

Paper Source

Check the setting or select a new paper source.

Media Type

Displays the **Media Type** that is currently set on the printer.

To apply the displayed setting to the printer driver, click **Set**.

Page Size

Displays the **Page Size** that is currently set on the printer.

To apply the displayed setting to the printer driver, click **Set**.

Related Topics

- [Printing with Easy Setup](#)
- [Setting a Page Size and Orientation](#)
- [Setting the Number of Copies and Printing Order](#)
- [Duplex Printing](#)
- [Setting Up Envelope Printing](#)
- [Printing on Postcards](#)
- [Switching the Paper Source to Match the Purpose](#)
- [Displaying the Print Results before Printing](#)
- [Setting Paper Dimensions \(Custom Size\)](#)
- [Printing a Color Document in Monochrome](#)
- [Specifying Color Correction](#)
- [Adjusting Color Balance](#)
- [Adjusting Color Balance Using Sample Patterns \(Printer Driver\)](#)
- [Adjusting Brightness](#)
- [Adjusting Intensity](#)
- [Adjusting Contrast](#)
- [Adjusting Intensity/Contrast Using Sample Patterns \(Printer Driver\)](#)
- [Registering a Frequently Used Printing Profile](#)

Main tab Description

The **Main** tab allows you to create a basic print setup in accordance with the media type. Unless special printing is required, normal printing can be performed just by setting the items on this tab.

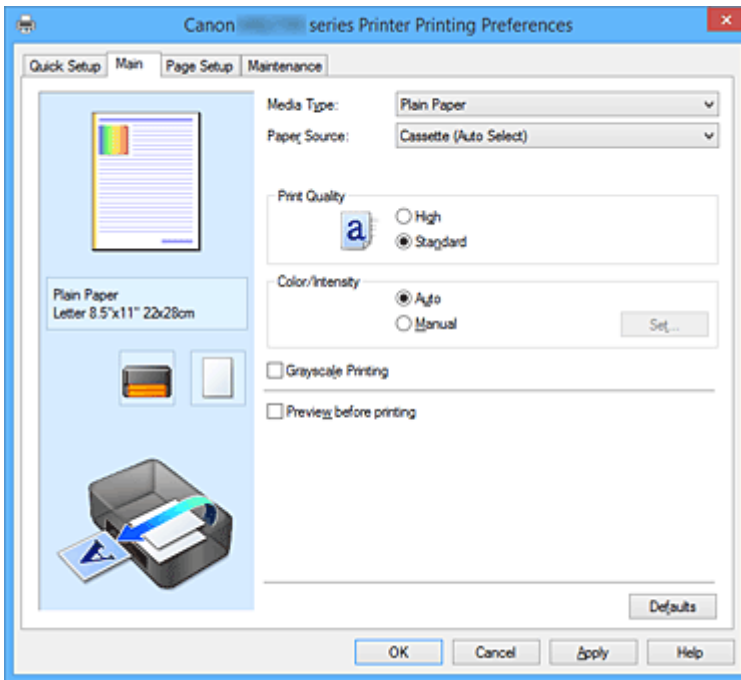

Settings Preview

The paper illustration shows how the original will be laid out on a sheet of paper.

You can check an overall image of the layout.

The printer illustration shows how to load paper to match the printer driver settings.

Check whether the printer is set up correctly by looking at the illustration before you start printing.

Media Type

Selects a type of printing paper.

Select a media type that matches the paper that is loaded in the printer. This ensures that printing is carried out properly for the specified paper.

Paper Source

Shows the source from which paper is supplied.

You may be able to switch the paper source with the printer driver.

Cassette (Auto Select)

Based on the paper settings on the printer driver and the cassette paper information registered on the printer, the printer automatically determines which cassette to use and feeds paper from that cassette.

Cassette 1

Paper is fed from the cassette 1.

Cassette 2

Paper is fed from the cassette 2.

»»» Important

- Depending on the media type and size, the **Paper Source** settings that can be selected may differ.

Print Quality

Selects your desired printing quality.

Select one of the following to set the print quality level that is appropriate for the purpose.

»» Important

- Depending on the **Media Type** settings, the same print results may be produced even if the **Print Quality** is changed.

High

Gives priority to print quality over printing speed.

Standard

Prints with average speed and quality.

Color/Intensity

Selects color adjustment method.

Auto

Cyan, Magenta, Yellow, Brightness, Intensity, and Contrast, and so on are adjusted automatically.

Manual

Select when you set the individual settings such as **Cyan, Magenta, Yellow, Brightness, Intensity, and Contrast**, etc. and **Color Correction** method.

Set...

Select **Manual** for **Color/Intensity** to enable this button.

In the **Manual Color Adjustment** dialog box, you can adjust individual color settings such as **Cyan, Magenta, Yellow, Brightness, Intensity, and Contrast** on the [Color Adjustment tab](#), and select the **Color Correction** method on the [Matching tab](#).

»» Note

- If you want to use an ICC profile to adjust colors, use the **Manual Color Adjustment** dialog box to set the profile.

Grayscale Printing

This function converts the data to monochrome data when printing your document.

Check this check box to print a color document in monochrome.

Preview before printing

Shows what the print result will look like before you actually print the data.

Check this check box to display a preview before printing.

»» Important

- To use the Canon IJ XPS Preview, you must have Microsoft .NET Framework 4 Client Profile installed on your computer.

Defaults

Restores all the settings you have changed to their default values.

Clicking this button restores all the settings on the current screen to their default values (factory settings).

Color Adjustment Tab

This tab allows you to adjust the color balance by changing the settings of the **Cyan, Magenta, Yellow, Brightness, Intensity**, and **Contrast** options.

Preview

Shows the effect of color adjustment.

The color and brightness change when each item is adjusted.

▶▶▶ Note

- The graphic is in monochrome when the **Grayscale Printing** check box is checked.

View Color Pattern

Displays a pattern for checking color changes produced by color adjustment.

If you want to display the preview image with a color pattern, check this check box.

Cyan / Magenta / Yellow

Adjusts the strengths of **Cyan, Magenta**, and **Yellow**.

Moving the slider to the right makes a color stronger, and moving the slider to the left makes a color weaker.

You can also directly enter a value linked to the slider. Enter a value in the range from -50 to 50.

This adjustment changes the relative amount of ink of each color used, which alters the total color balance of the document. Use your application if you want to change the total color balance significantly. Use the printer driver only if you want to adjust the color balance slightly.

▶▶▶ Important

- When **Grayscale Printing** is checked on the **Main** tab, **Cyan, Magenta**, and **Yellow** appear grayed out and are unavailable.

Brightness

Selects the brightness of your print.

You cannot change the levels of pure white and black. However, the brightness of the colors between white and black can be changed.

Intensity

Adjusts the overall intensity of your print.

Moving the slider to the right increases the intensity, and moving the slider to the left decreases the intensity.

You can also directly enter a value linked to the slider. Enter a value in the range from -50 to 50.

Contrast

Adjusts the contrast between light and dark in the image to be printed.

Moving the slider to the right increases the contrast, moving the slider to the left decreases the contrast.

You can also directly enter a value linked to the slider. Enter a value in the range from -50 to 50.

Print a pattern for color adjustment

When the color balance or intensity/contrast is changed, the pattern printing function prints a list of the adjustment results along with the adjustment values.

Select this function when printing a pattern for color adjustment.

Pattern Print preferences...

Check **Print a pattern for color adjustment** to enable this button.

The [Pattern Print dialog box](#) opens and allows you to set pattern printing settings.

Pattern Print dialog box

Performs the setup for printing of patterns that allow you to check the color balance and intensity/contrast of documents.

Parameters to Adjust

Select the item to be checked by pattern printing.

Cyan/Magenta/Yellow

Prints a pattern that allows you to check the cyan/magenta/yellow balance.

▶▶▶ Important

- When **Grayscale Printing** is checked on the **Main** tab, **Cyan/Magenta/Yellow** appear grayed out and are unavailable.

Intensity/Contrast

Prints a pattern that allows you to check the intensity/contrast balance.

Printer Paper Size

Selects the paper size to be used for pattern printing.

This setting is linked to **Printer Paper Size** on the **Page Setup** tab.

▶▶▶ Note

- Depending on the paper size selected on the **Page Setup** tab, there may be sizes that cannot be selected.

Amount of Pattern Instances

Sets the number of patterns to be printed.

You can select from **Largest**, **Large**, and **Small**. When you select a pattern size, the number of patterns that can be printed is as follows:

▶▶▶ Note

- **Largest** and **Large** cannot be selected when certain paper sizes or output paper sizes are selected.
- The setting preview on the **Main** tab displays an image that allows you to check the overall layout.

Largest

Cyan/Magenta/Yellow 37

Intensity/Contrast 49

Large

Cyan/Magenta/Yellow 19

Intensity/Contrast 25

Small

Cyan/Magenta/Yellow 7

Intensity/Contrast 9

Color Variation Between Instances

Sets the amount of color change between neighboring patterns.

Select from **Large**, **Medium**, and **Small**. **Large** produces a large amount of change, and **Small** produces a small amount of change.

▶▶▶ Note

- **Large** is about double the size of **Medium**, and **Small** is about half the size of **Medium**.

Matching Tab

Allows you to select the method for adjusting colors to match the type of document to be printed.

Color Correction

Allows you to select **Driver Matching**, **ICM (ICC Profile Matching)**, or **None** to match the purpose of the print operation.

▶▶▶ Important

- When **Grayscale Printing** is checked on the **Main** tab, **Color Correction** appears grayed out and is unavailable.

Driver Matching

With Canon Digital Photo Color, you can print sRGB data with color tints that most people prefer.

ICM (ICC Profile Matching)

Adjusts the colors by using an ICC profile when printing.

▶▶▶ Important

- If the application software is set so that ICM is disabled, **ICM (ICC Profile Matching)** is unavailable for **Color Correction** and the printer may not be able to print the image data properly.

None

Disables color adjustment with the printer driver.

▶▶▶ Note

- In the XPS printer driver, **ICM** has become **ICC Profile Matching**.

Related Topics

- [Adjusting Color Balance](#)
- [Adjusting Brightness](#)
- [Adjusting Intensity](#)
- [Adjusting Contrast](#)
- [Adjusting Color Balance Using Sample Patterns \(Printer Driver\)](#)
- [Adjusting Intensity/Contrast Using Sample Patterns \(Printer Driver\)](#)
- [Specifying Color Correction](#)
- [Adjusting Colors with the Printer Driver](#)
- [Printing with ICC Profiles](#)
- [Printing a Color Document in Monochrome](#)
- [Displaying the Print Results before Printing](#)

Page Setup tab Description

The **Page Setup** tab allows you to determine how a document is to be arranged on the paper. Also, this tab allows you to set the number of copies and the order of printing. If the application which created the document has a similar function, set them with the application.

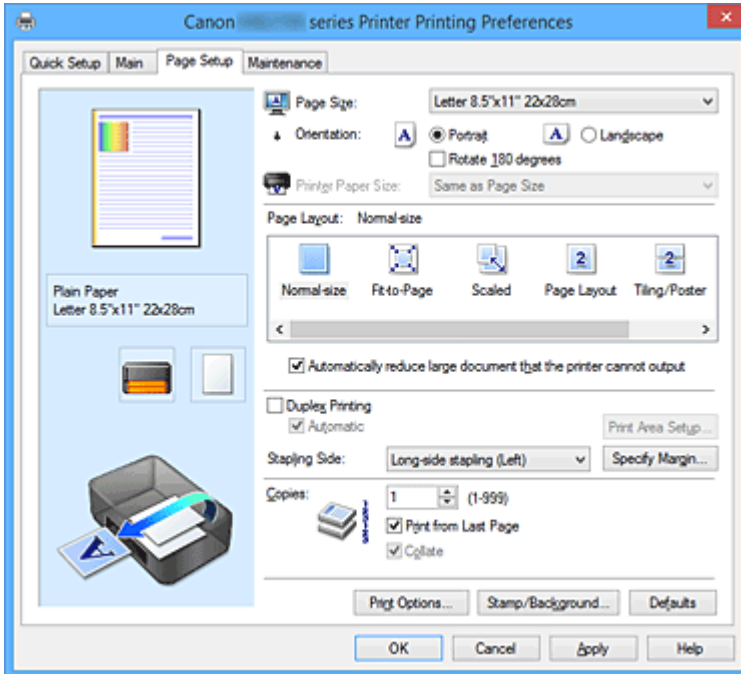

Settings Preview

The paper illustration shows how the original will be laid out on a sheet of paper.

You can check an overall image of the layout.

The printer illustration shows how to load paper to match the printer driver settings.

Check whether the printer is set up correctly by looking at the illustration before you start printing.

Page Size

Selects a page size.

Ensure that you select the same page size as you selected within the application.

If you select **Custom...**, the [Custom Paper Size dialog box](#) opens and allows you to specify any vertical and horizontal dimensions for the paper size.

Orientation

Selects the printing orientation.

If the application used to create your document has a similar function, select the same orientation that you selected in that application.

Portrait

Prints the document so that its top and bottom positions are unchanged relative to the paper feed direction. This is the default setting.

Landscape

Prints the document by rotating it 90 degrees relative to the paper feed direction.

You can change the rotation direction by going to the **Maintenance** tab, opening the **Custom Settings** dialog box, and then using **Rotate 90 degrees left when orientation is [Landscape]** check box.

To rotate the document 90 degrees to the left when printing, select the **Rotate 90 degrees left when orientation is [Landscape]** check box.

Rotate 180 degrees

Prints the document by rotating it 180 degrees against the paper feed direction.

The width of print area and the amount of extension that are configured in other application software will be reversed vertically and horizontally.

Printer Paper Size

Selects the size of paper actually loaded into the printer.

The default setting is **Same as Page Size** to perform normal-sized printing.

You can select a printer paper size when you select **Fit-to-Page**, **Scaled**, **Page Layout**, **Tiling/Poster**, or **Booklet** for **Page Layout**.

If you select a paper size that is smaller than the **Page Size**, the document size will be reduced. If you select a paper size that is larger, the document size will be enlarged.

Also if you select **Custom...**, the [Custom Paper Size dialog box](#) opens and allows you to specify any vertical and horizontal dimensions for the paper size.

Page Layout

Selects the size of the document you want to print and the type of printing.

Normal-size

This is the normal printing method. Select this when you do not specify any page layout.

Automatically reduce large document that the printer cannot output

If the printer cannot print the paper size of a document, the printer can automatically reduce the size when it prints the document.

Check this check box to reduce the size when printing the document.

Fit-to-Page

This function enables you to automatically enlarge or reduce documents to fit to the paper size loaded in the printer without changing the paper size you specified in your application software.

Scaled

Documents can be enlarged or reduced to be printed.

Specify the size in **Printer Paper Size**, or enter the scaling ratio in the **Scaling** box.

Scaling

Specifies an enlargement or reduction ratio for the document you want to print.

Page Layout

Multiple pages of document can be printed on one sheet of paper.

Specify...

Opens the [Page Layout Printing dialog box](#).

Click this button to set details on page layout printing.

Tiling/Poster

This function enables you to enlarge the image data and divide the enlarged data into several pages to be printed. You can also glue together these sheets of paper to create large printed matter, such as a poster.

Specify...

Opens the [Tiling/Poster Printing dialog box](#).

Click this button to set details on tiling/poster printing.

Booklet

The booklet printing function allows you to print data for a booklet. Data is printed on both sides of the paper. This type of printing ensures that pages can be collated properly, in page number order, when the printed sheets are folded and stapled at the center.

Specify...

Opens the [Booklet Printing dialog box](#).

Click this button to set details on booklet printing.

Duplex Printing

Selects whether to print the document automatically on both sides or one side of a sheet of paper.

Check this check box to print the document on both sides.

This function can be used only when **Plain Paper** is selected for **Media Type** and one of **Normal-size**, **Fit-to-Page**, **Scaled**, or **Page Layout** is selected.

Automatic

Selects whether duplex printing is to be performed automatically or manually.

This check box will be enabled if **Booklet** is selected from the **Page Layout** list or the **Duplex Printing** check box is checked.

To perform duplex printing automatically, check this check box.

To perform duplex printing manually, uncheck this check box.

Print Area Setup...

Opens the [Print Area Setup dialog box](#) in which you can configure the print area for automatic duplex printing.

Stapling Side

Selects the stapling margin position.

The printer analyzes the **Orientation** and **Page Layout** settings, and automatically selects the best stapling margin position. Check **Stapling Side**, and select from the list to change it.

Specify Margin...

Opens the [Specify Margin dialog box](#).

You can specify the width of the margin.

Copies

Specifies the number of copies you want to print. You can specify a value from 1 to 999.

►► Important

- If the application used to create your document has a similar function, specify the number of copies with the application without specifying it here.

Print from Last Page

Check this check box when you want to print from the last page in order. If you do this, you do not need to sort the pages into their correct order after printing.

Uncheck this check box to print your document in normal order, starting from the first page.

Collate

Check this check box to group together the pages of each copy when you want to print multiple copies.

Uncheck this check box when you want to print with all pages of the same page number grouped together.

»» Important

- When the application software that you used to create the document has the same function, give priority to the printer driver settings. However, if the print results are not acceptable, specify the function settings on the application software. When you specify the number of copies and the printing order with both the application and this printer driver, the number of copies may be multiplied numbers of the two settings or the specified printing order may not be enabled.

Print Options...

Opens the [Print Options dialog box](#).

Changes detailed printer driver settings for print data that is sent from applications.

Stamp/Background... (Stamp...)

Opens the [Stamp/Background \(Stamp\) dialog box](#).

The **Stamp** function allows you to print a stamp text or a bitmap over or behind document data. It also allows you to print date, time and user name. The **Background** function allows you to print a light illustration behind the document data.

»» Note

- With the XPS printer driver, the **Stamp/Background...** button has become the **Stamp...** button and only the stamp function can be used.

Depending on the type of printer driver you are using and the environment, **Stamp** and **Background** may not be available.

Custom Paper Size dialog box

This dialog box allows you to specify the size (width and height) of the custom paper.

Units

Select the unit for entering a user-defined paper size.

Paper Size

Specifies the **Width** and the **Height** of the custom paper. Measurement is shown according to the units specified in **Units**.

Page Layout Printing dialog box

This dialog box allows you to select the number of document pages to be placed on one sheet of paper, the page order, and whether a page border line is to be printed around each document page.

The settings specified in this dialog box can be confirmed in the settings preview on the printer driver.

Preview Icon

Shows the settings made on the **Page Layout Printing** dialog box.

You can check what the print result will look like before you actually print the data.

Page Layout

Specifies the number of document pages to fit on one sheet.

Page Order

Specifies the document orientation to be printed on a sheet of paper.

Page Border

Prints a page border line around each document page.
Check this check box to print the page border line.

Tiling/Poster Printing dialog box

This dialog box allows you to select the size of the image to be printed. You can also make settings for cut lines and paste markers which are convenient for pasting together the pages into a poster. The settings specified in this dialog box can be confirmed in the settings preview on the printer driver.

Preview Icon

Shows the settings of the **Tiling/Poster Printing** dialog box.
You can check what the print result will look like.

Image Divisions

Select the number of divisions (vertical x horizontal).
As the number of divisions increases, the number of sheets used for printing increases. If you are pasting pages together to create a poster, increasing the number of divisions allows you to create a larger poster.

Print "Cut/Paste" in margins

Specifies whether to print the words "Cut" and "Paste" in the margins. These words serve as guidelines for pasting together the pages into a poster.
Check this check box to print the words.

▶▶▶ Note

- Depending on the type of printer driver you are using and the environment, this function may not be available.

Print "Cut/Paste" lines in margins

Specifies whether to print cut lines that serve as guidelines for pasting together the pages into a poster.
Check this check box to print the cut lines.

Print page range

Specifies the printing range. Select **All** under normal circumstances.
Select **Pages** to specify a specific page or range.

▶▶▶ Note

- If some of the pages have not been printed well, specify the pages that do not need to be printed by clicking them in the settings preview of the **Page Setup** tab. Only the pages shown on the screen will be printed this time.

Booklet Printing dialog box

This dialog box allows you to set how to bind the document as a booklet. Printing only on one side and printing a page border, can also be set in this dialog box.
The settings specified in this dialog box can be confirmed in the settings preview on the printer driver.

Preview Icon

Shows the settings made on the **Booklet Printing** dialog box.
You can check what the document will look like when printed as a booklet.

Margin for stapling

Specifies which side of the booklet is to be stapled.

Insert blank page

Selects whether to print the document on one side or both sides of the booklet.
Check this check box to print the document on one side of the booklet and select the side to be left blank from the list.

Margin

Specifies the width of the stapling margin.
The specified width becomes the stapling margin from the center of the sheet.

Page Border

Prints a page border line around each document page.
Check this check box to print the page border line.

Print Area Setup dialog box

When you perform duplex printing, the print area of the document becomes slightly narrower than usual. Therefore when a document that has small margins is printed, the document may not fit on one page. This dialog box allows you to set whether the page is to be reduced when printed so that the document fits in one page.

Use normal-size printing

Prints the document pages without reducing them. This is the default setting.

Use reduced printing

Slightly reduces each document page so that it fits on one sheet of paper during printing.
Select this setting when using automatic duplex printing to print a document with small margins.

Specify Margin dialog box

This dialog box allows you to specify the margin width for the side to be stapled. If a document does not fit on one page, the document is reduced when printed.

Margin

Specifies the width of the stapling margin.
The width of the side specified by **Stapling Side** becomes the stapling margin.

Print Options dialog box

Makes changes to print data that is sent to the printer.

Depending on the type of printer driver you are using and the environment, this function may not be available.

Disable ICM required from the application software

Disables the ICM function required from the application software.
When an application software uses Windows ICM to print data, unexpected colors may be produced

or the printing speed may decrease. If these problems occur, checking this check box may resolve the problems.

▶▶▶ Important

- Uncheck this check box under normal circumstances.
- This function does not work when **ICM** is selected for **Color Correction** on the **Matching** tab of the **Manual Color Adjustment** dialog box.

▶▶▶ Note

- **Disable ICM required from the application software** tab cannot be used with the XPS printer driver.

Disable the color profile setting of the application software

Checking this check box disables information in the color profile that was set on the application software.

When the information in the color profile set on the application software is output to the printer driver, the print result may contain unexpected colors. If this happens, checking this check box may resolve the problem.

▶▶▶ Important

- Even when this check box is checked, only some of the information in the color profile is disabled, and the color profile can still be used for printing.
- Uncheck this check box under normal circumstances.

Disable the paper source setting of the application software

Disables the paper feeding method that is set by the application.

With some applications such as Microsoft Word, the data may be printed with a feeding method that differs from the printer driver setting. In this case, check this function.

▶▶▶ Important

- When this function is enabled, normally the paper feeding method cannot be changed from the Canon IJ Preview.
However, if you are using the XPS printer driver, you will be able to change the paper feeding method from the Canon IJ XPS Preview.

Ungroup Papers

Sets the display method of **Media Type**, **Page Size**, and **Printer Paper Size**.

To display the items separately, select the check box.

To display the items as a group, clear the check box.

Do not allow application software to compress print data

Compression of the application software print data is prohibited.

If the print result has missing image data or unintended colors, selecting this check box may improve the condition.

▶▶▶ Important

- Uncheck this check box under normal circumstances.

►►► Note

- **Do not allow application software to compress print data** tab cannot be used with the XPS printer driver.

Print after creating print data by page

The print data is created in page units, and printing starts after the processing of one page of print data is complete.

If a printed document contains unintended results such as streaks, selecting this check box may improve the results.

►►► Important

- Uncheck this check box under normal circumstances.

Scale images using nearest-neighbor interpolation

When an image is to be enlarged or reduced when printed, the printer uses a simple interpolation process to enlarge or reduce the image.

If the image data in a printed document is not printed clearly, selecting this check box may improve the results.

►►► Important

- Uncheck this check box under normal circumstances.

►►► Note

- **Scale images using nearest-neighbor interpolation** can be used only with the XPS printer driver.

Prevention of Print Data Loss

You can reduce the size of the print data that was created with the application software and then print the data.

Depending on the application software being used, the image data may be cut off or may not be printed properly. In such cases, select **On**. If you will not be using this function, select **Off**.

►►► Important

- When using this function, the print quality may drop depending on the print data.

Unit of Print Data Processing

Selects the processing unit of the print data to be sent to the printer.

Select **Recommended** under normal circumstances.

►►► Important

- A large amount of memory may be used for certain settings.
Do not change the setting if your computer has a small amount of memory.

►►► Note

- **Unit of Print Data Processing** tab cannot be used with the XPS printer driver.

Stamp/Background (Stamp...) dialog box

The **Stamp/Background (Stamp...)** dialog box allows you to print a stamp and/or background over or behind the document pages. In addition to the pre-registered ones, you can register and use your original stamp or background.

»» Note

- With the XPS printer driver, the **Stamp/Background...** button has become the **Stamp...** button and only the stamp function can be used.

Stamp

Stamp printing is a function that prints a stamp over a document.

Check this check box and select a title from the list to print a stamp.

Define Stamp...

Opens the [Stamp Settings dialog box](#).

You can check the details of a selected stamp or save a new stamp.

Place stamp over text

Sets how the stamp is to be printed over the document.

Check the **Stamp** check box to enable this.

Check this check box to print a stamp over the printed document page. The printed data may be hidden behind the stamp.

Uncheck this check box to print the document data over the stamp. The printed data will not be hidden behind the stamp. However, the sections of the stamp that are overlapped by the document may be hidden.

Print semitransparent stamp

Sets how the stamp is to be printed over the document.

Check the **Stamp** check box to enable this.

Check this check box to print a semi-transparent stamp over the printed document page.

Uncheck this check box to print the stamp over the document data. The printed data may be hidden behind the stamp.

»» Note

- You can use **Print semitransparent stamp** only with the XPS printer driver.

Stamp first page only

Selects whether the stamp is to be printed on the first page only or on all pages when the document has two or more pages.

Check the **Stamp** check box to enable this.

Check this check box to print a stamp on the first page only.

Background

Background printing is a function that allows you to print an illustration or a similar object (bitmap) behind the document.

Check this check box to print a background and select a title from the list.

Select Background...

Opens the [Background Settings dialog box](#).

You can register a bitmap as a background, and change layout method and intensity of the selected background.

Background first page only

Selects whether to print the background on the first page only or print on all pages when the document has two or more pages.

Check the **Background** check box to enable this.

Check this check box to print a background on the first page only.

Stamp Tab

The Stamp tab allows you to set the text and bitmap file (.bmp) to be used for a stamp.

Preview Window

Shows the status of the stamp configured in each tab.

Stamp Type

Specifies the stamp type.

Select **Text** to create a stamp with characters. Select **Bitmap** to create with a bitmap file. Select **Date/Time/User Name** to display the creation date/time and user name of the printed document.

The setting items in the **Stamp** tab change depending on the selected type.

When Stamp Type is Text or Date/Time/User Name

Stamp Text

Specifies the stamp text string.

Up to 64 characters can be entered.

For **Date/Time/User Name**, the creation date/time and user name of the printed object are displayed in **Stamp Text**.

»» Important

- **Stamp Text** appears grayed out and is unavailable if **Date/Time/User Name** is selected.

TrueType Font

Selects the font for the stamp text string.

Style

Selects the font style for the stamp text string.

Size

Selects the font size for the stamp text string.

Outline

Selects a frame that encloses the stamp text string.

If a large font size is selected for **Size**, characters may extend outside of the stamp border.

Color/Select Color...

Shows the current color for the stamp.

To select a different color, click **Select Color...** to open the **Color** dialog box, and select or create a color you wish to use as a stamp.

When Stamp Type is Bitmap

File

Specifies the name of the bitmap file to be used as the stamp.

Select File...

Opens the dialog box to open a file.

Click this button to select a bitmap file to be used as a stamp.

Size

Adjusts the size of the bitmap file to be used as a stamp.

Moving the slider to the right increases the size, moving the slider to the left decreases the size.

Transparent white area

Specifies whether to make white-filled areas of the bitmap transparent.

Check this check box to make white-filled areas of the bitmap transparent.

»» Note

- Click **Defaults** to set **Stamp Type** to text, **Stamp Text** to blank, **TrueType Font** to Arial, **Style** to Regular, **Size** to 36 points, **Outline** unchecked, and **Color** to gray with the RGB values (192, 192, 192).

Placement Tab

The Placement tab allows you to set the position where the stamp is to be printed.

Preview Window

Shows the status of the stamp configured in each tab.

Position

Specifies the stamp position on the page.

Selecting **Custom** from the list allows you to enter values for the **X-Position** and **Y-Position** coordinates directly.

Orientation

Specifies the angle of rotation for the stamp. The angle can be set by entering the number of degrees.

Negative values rotate the stamp clockwise.

»» Note

- **Orientation** is enabled only when **Text** or **Date/Time/User Name** is selected for **Stamp Type** on the **Stamp** tab.

»» Note

- Click **Defaults** to set the stamp position to **Center** and the orientation to 0.

Save settings Tab

The **Save settings** tab allows you to register a new stamp or delete an unnecessary stamp.

Title

Enter the title to save the stamp you created.

Up to 64 characters can be entered.

»» Note

- Spaces, tabs, and returns cannot be entered at the beginning or end of a title.

Stamps

Shows a list of saved stamp titles.

Specify a title to display the corresponding stamp in **Title**.

Save/Save overwrite

Saves the stamp.

Enter a title in **Title**, and then click this button.

Delete

Deletes an unnecessary stamp.

Specify the title of an unnecessary stamp from the **Stamps** list, and click this button.

Background Tab

The Background tab allows you to select a bitmap file (.bmp) to be used as a background or determine how to print the selected background.

Preview Window

Shows the status of the bitmap set on the **Background** tab.

File

Specifies the name of the bitmap file to be used as the background.

Select File...

Opens the dialog box to open a file.

Click this button to select a bitmap file (.bmp) to be used as the background.

Layout Method

Specifies how the background image is to be placed on the paper.

When **Custom** is selected, you can set coordinates for **X-Position** and **Y-Position**.

Intensity

Adjusts the intensity of the bitmap to be used as a background.

Moving the slider to the right increases the intensity, and moving the slider to the left decreases the intensity. To print the background at the original bitmap intensity, move the slider to the rightmost position.

►► Note

- Depending on the type of printer driver you are using and the environment, this function may not be available.
- Click **Defaults** to set **File** to blank, **Layout Method** to **Fill page**, and the **Intensity** slider to the middle.

Save settings Tab

The **Save settings** tab allows you to register a new background or delete an unnecessary background.

Title

Enter the title to save the background image you specified.

Up to 64 characters can be entered.

►► Note

- Spaces, tabs, and returns cannot be entered at the beginning or end of a title.

Backgrounds

Shows a list of registered background titles.

Specify a title to display the corresponding background in **Title**.

Save/Save overwrite

Saves the image data as a background.

After inserting the **Title**, click this button.

Delete

Deletes an unnecessary background.

Specify the title of an unnecessary background from the **Backgrounds** list, and then click this button.

Maintenance tab Description

The **Maintenance** tab allows you to perform printer maintenance or change the settings of the printer.

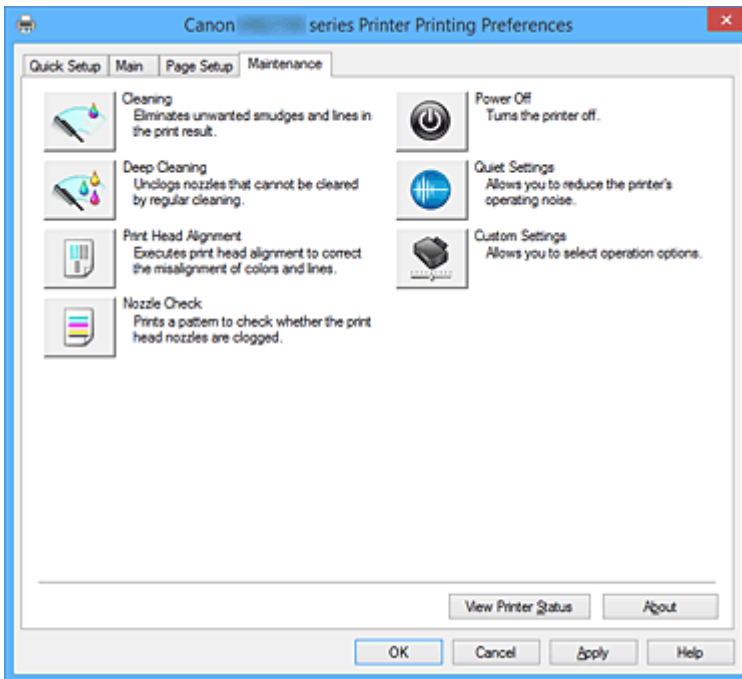

Cleaning

Performs print head cleaning.

Print head cleaning removes any blockage in the print head nozzles.

Perform cleaning when printing becomes faint, or a specific color fails to print, even though all ink levels are sufficiently high.



Deep Cleaning

Performs deep cleaning.

Perform deep cleaning when two cleaning attempts do not resolve the print head problem.

►►► Note

- **Deep Cleaning** consumes a larger amount of ink than **Cleaning**.
Cleaning the print heads frequently will rapidly deplete your printer's ink supply. Therefore, perform cleaning only when necessary.

Ink Group

When you click **Cleaning** or **Deep Cleaning**, the **Ink Group** window is displayed.

Selects the ink group that you want to clean the print head for.

Click [Initial Check Items](#) to display the items that you need to check before you execute cleaning or deep cleaning.



Print Head Alignment

Print head alignment corrects the installation positions of the print head and improves deviated colors and lines.

Align the print head immediately after installing the print head.

When you click **Print Head Alignment**, the [Start Print Head Alignment dialog box](#) is displayed.



Nozzle Check

Prints a nozzle check pattern.

Perform this function if printing becomes faint or a specific color fails to print. Print a nozzle check pattern, and check whether the print head is working properly.

If the print result for a specific color is faded, or if there are any unprinted sections, click **Cleaning** to clean the print head.

To display a list of items that you should check before printing the nozzle check pattern, click [Initial Check Items](#).

Print Check Pattern

This function prints a pattern that allows you to check whether any of the ink nozzles are clogged.

Click **Print Check Pattern**. When the confirmation message is displayed, click **OK**. The **Pattern Check** dialog box is then displayed.

Left-side bitmap (good)

The print head nozzles are not clogged.

Right-side bitmap (bad)

The print head nozzles may be clogged.

Exit

Closes the **Pattern Check** dialog box, and returns to the **Maintenance** tab.

Cleaning

Performs print head cleaning.

Print head cleaning removes any blockage in the print head nozzles.

Perform cleaning when printing becomes faint, or if a specific color fails to print, even though all ink levels are sufficiently high.



Power Off

Turns off the printer from the printer driver.

Perform this function to turn off the printer when you cannot press the ON button (POWER button) on the printer because the printer is out of your reach.

You must press the ON button (POWER button) on the printer to turn the printer on again after clicking this button. When you use this function, you will not be able to turn the printer on from the printer driver.



Quiet Settings

Opens the [Quiet Settings dialog box](#).

Quiet Settings dialog box allows you to specify a setting that reduces the operating noise of the printer.

This mode comes in handy when the operating noise of the printer becomes a concern, such when printing at night. Perform this operation when you want to change the quiet mode setting.

▶▶▶ Note

- If the printer is off or if communication between the printer and the computer is disabled, an error message may appear because the computer cannot collect the printer status.



Custom Settings

Opens the [Custom Settings dialog box](#).

Perform this function to change the settings of this printer.

▶▶▶ Note

- If the printer is off or if communication between the printer and the computer is disabled, an error message may appear because the computer cannot collect the printer status.
If this happens, click **OK** to display the most recent settings specified on your computer.

View Print History

This function starts the Canon IJ XPS preview, and displays the print history.

▶▶▶ Note

- You can use this function only with the XPS printer driver.

View Printer Status

Starts the Canon IJ Status Monitor.

Perform this function when you want to check the printer status and how a print job is proceeding.

▶▶▶ Note

- If you are using the XPS printer driver, the "Canon IJ Status Monitor" becomes the "Canon IJ XPS Status Monitor".

About

Opens the [About dialog box](#).

The version of the printer driver, plus a copyright notice, can be checked.

In addition, the language to be used can be switched.

Initial Check Items (Cleaning / Deep Cleaning)

Before running **Cleaning** or **Deep Cleaning**, check that the printer power is on, and open the cover of the printer.

Check the following items for each ink.

- [Check the amount of ink](#) remaining in the tank.
- Make sure that you push in the ink tank completely until you hear a clicking sound.
- If an orange tape is adhered to the ink tank, peel it off completely.
Any remaining tape will hinder ink output.
- Check that the ink tanks are installed in their correct positions.

Start Print Head Alignment dialog box

This dialog box allows you to adjust the attachment position for the print head, or to print the current setting value for the print head position.

Align Print Head

Aligns the print head.

Print head alignment corrects the installation positions of the print head and improves deviated colors and lines.

Align the print head immediately after installing the print head.

Print Alignment Value

Click this button to check the current setting value of the print head position.

Prints the current setting value for the print head position.

Print Head Alignment dialog box

To adjust the print head position manually, click **Align Print Head** in the **Start Print Head Alignment** dialog box, and perform the operations instructed in the messages. The **Print Head Alignment** dialog box is then displayed.

This dialog box allows you to check the printed pattern and adjust the print head position.

Preview Window

Displays the pattern of **Print Head Alignment**, and checks the position of the selected pattern.

You can also change the setting by clicking the pattern on the screen directly.

Select the Pattern Number

Compare the printed adjustment patterns, and enter the pattern number of the pattern with the least visible streaks or horizontal stripes into the corresponding box.

►► Note

- If you do not know how to analyze the printed pattern, see [Aligning the Print Head Position](#).

Initial Check Items (Nozzle Check)

Before running **Nozzle Check**, check that the printer power is on, and open the cover of the printer.

Check the following items for each ink.

- [Check the amount of ink](#) remaining in the tank.
- Make sure that you push in the ink tank completely until you hear a clicking sound.
- If an orange tape is adhered to the ink tank, peel it off completely.
Any remaining tape will hinder ink output.
- Check that the ink tanks are installed in their correct positions.

Quiet Settings dialog box

When you click **Quiet Settings**, the **Quiet Settings** dialog box is displayed.

Quiet Settings dialog box allows you to specify a setting that reduces the operating noise of the printer.

Select when you wish to reduce the operating noise of the printer at night, etc.

Using this function may lower the print speed.

Do not use quiet mode

Select this option when you wish to use the printer with volume of normal operating noise.

Always use quiet mode

Select this option when you wish to reduce the operating noise of the printer.

Use quiet mode during specified hours

Select this option when you wish to reduce the operating noise of the printer during a specified period of time.

Set the **Start time** and the **End time** of the quiet mode you wish to be activated. If both are set to the same time, the quiet mode will not function.

»» Important

- You can set the quiet mode from the operation panel of the printer, the printer driver, or ScanGear (scanner driver).
No matter how you use to set the quiet mode, the mode is applied when you perform operations from the operation panel of the printer or printing and scanning from the computer.

Custom Settings dialog box

When you click **Custom Settings**, the **Custom Settings** dialog box is displayed.

If necessary, switch between various modes of printer operation.

Prevent paper abrasion

The printer can increase the gap between the print head and the paper during high-density printing to prevent paper abrasion.

Check this check box to enable this function.

Align heads manually

Usually, the **Print Head Alignment** function on the **Maintenance** tab is set to automatic head alignment, but you can change it to manual head alignment.

If the printing results of automatic print head alignment are not satisfactory, [perform manual head alignment](#).

Check this check box to perform the manual head alignment.

Rotate 90 degrees left when orientation is [Landscape]

On the **Page Setup** tab, you can change the rotation direction of the **Landscape** in the **Orientation**.

To rotate the document 90 degrees to the left when printing, select the check box.

»» Note

- If **Yougata 4 4.13"x9.25"**, **Yougata 6 3.86"x7.48"**, **Envelope Com 10**, **Envelope DL**, **Envelope C5**, or **Envelope Monarch 3.88"x7.5" 98.4x190.5mm** is selected for **Page Size** on the **Page Setup** tab, the printer rotates the paper 90 degrees to the left to print, regardless of the **Rotate 90 degrees left when orientation is [Landscape]** setting for **Custom Settings** on the **Maintenance** tab.

Don't detect mismatch of paper settings when printing from computer

When you print documents from your computer and the paper settings on the printer driver and the cassette paper information registered on the printer do not match, this setting disables the message display and allows you to continue printing.

To disable detection of paper setting mismatches, select this check box.

Ink Drying Wait Time

The printer can pause before printing a subsequent page. Moving the slider to the right increases the pause time, and moving the slider to the left decreases the time.

If the paper gets stained because the next page is ejected before the ink on the printed page dries, increase the ink drying wait time.

Reducing the ink drying wait time speeds up printing.

About dialog box

When you click **About**, the **About** dialog box is displayed.

This dialog box displays the version, copyright, and module list of the printer driver. You can select the language to be used and switch the language displayed in the setup window.

Modules

Lists the printer driver modules.

Language

Specifies the language you wish to use in the [printer driver setup window](#).

Important

- If the font for displaying the language of your choice is not installed in your system, the characters will be garbled.

Related Topics

- [Cleaning the Print Heads](#)
- [Aligning the Print Head Position](#)
- [Printing a Nozzle Check Pattern](#)
- [Managing the Printer Power](#)
- [Reducing the Printer Noise](#)
- [Changing the Printer Operation Mode](#)

Canon IJ Preview Description

Canon IJ Preview is an application software that displays what the print result will look like before a document is actually printed.

The preview reflects the information that is set within the printer driver and allows you to check the document layout, print order, and number of pages. You can also change the media type and paper source settings.

When you want to display a preview before printing, open the [printer driver setup window](#), and check the **Preview before printing** check box on the **Main** tab.

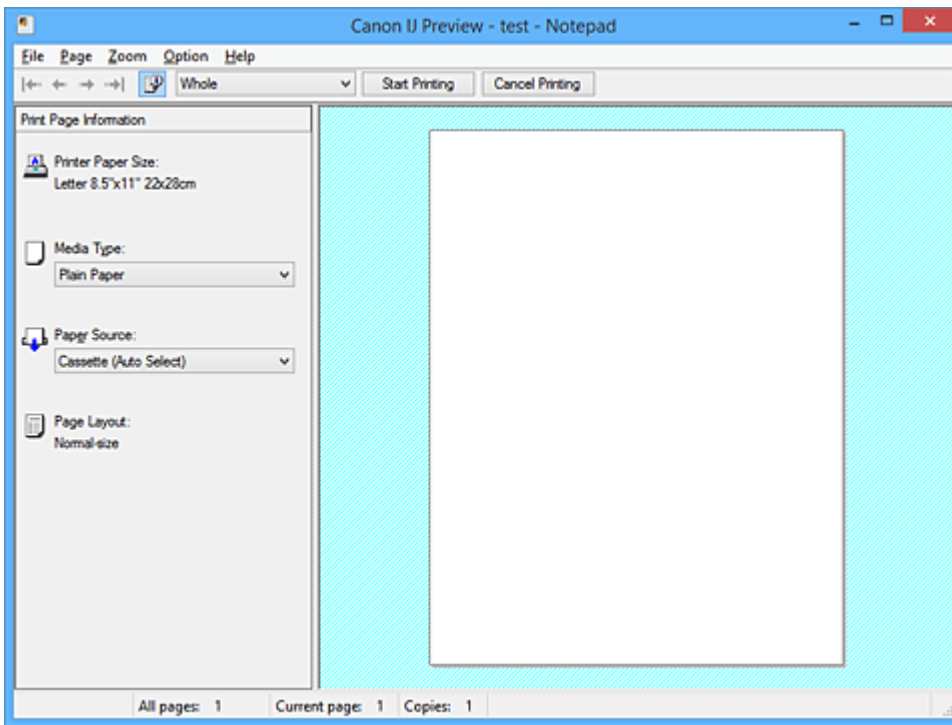

File Menu

Selects the print operation.

Start Printing

Ends the Canon IJ Preview and then starts printing the document that is displayed on the preview screen.

This command has the same function as the **Start Printing** on the toolbar.

Cancel Printing

Ends the Canon IJ Preview and cancels the printing of the document that is displayed on the preview screen.

This command has the same function as the **Cancel Printing** on the toolbar.

Exit

Ends the Canon IJ Preview.

Page Menu

This menu includes the following commands to select page to be displayed.

All of these commands except **Page Selection...** can also be selected from the toolbar.

►►► Note

- If the pages are being spooled, the last spooled page becomes the last page.

- If the **Page Layout** setting on the **Page Setup** tab is specified to **Page Layout**, **Tiling/Poster**, or **Booklet**, the number of pages is the number of sheets to be used for printing, and not the number of pages in the original document created with the application software.
- If duplex printing manually has been set, the front pages which will be printed first are all displayed together, and then the back pages are displayed.

First Page

Displays the first page of the document.

If the currently displayed page is the first page, this command is grayed out and cannot be selected.

Previous Page

Displays the page located before the currently displayed page.

If the currently displayed page is the first page, this command is grayed out and cannot be selected.

Next Page

Displays the page located after the currently displayed page.

If the currently displayed page is the last page, this command is grayed out and cannot be selected.

Last Page

Displays the last page of the document.

If the currently displayed page is the last page, this command is grayed out and cannot be selected.

Page Selection...

Displays the **Page Selection** dialog box.

This command allows you to specify the page number of the page to be displayed.

Zoom Menu

Selects the ratio of the actual size printed on the paper to the preview display size.

You can also select the ratio from the drop-down list box located on the toolbar.

Whole

Displays the entire page of data as one page.

50%

Reduces the displayed data to 50% of the actual size to be printed.

100%

Displays the data at the actual size to be printed.

200%

Enlarges the displayed data to 200% of the actual size to be printed.

400%

Enlarges the displayed data to 400% of the actual size to be printed.

Option Menu

This menu includes the following command:

Displays Print Page Information

Displays print setup information (including printer paper size, media type, and page layout) for each page at the left side of the preview screen.

This screen also allows you to change the media type and paper source settings.

Help Menu

When you select this menu item, the Help window for Canon IJ Preview is displayed, and you can check the version and copyright information.

Start Printing button

Prints the documents selected in the document list.

The printed documents are deleted from the list, and when all documents are printed, the Canon IJ XPS Preview closes.

Cancel Printing button

Ends the Canon IJ Preview, and cancels the printing of the document that is displayed on the preview screen.

You can click this button while spooling.

Print Page Information Screen

Displays print setup information for each page at the left side of the preview screen.

This screen also allows you to change the media type and paper source settings.

Important

- If the media type and paper source are set from the application software, those settings have priority and the changed settings may become ineffective.

Printer Paper Size

Displays the paper size of the document to be printed.

Media Type

You can select the media type of the document to be printed.

Paper Source

You can select the paper source of the document to be printed.

Page Layout

Displays the page layout of the document to be printed.

Canon IJ XPS Preview Description

Canon IJ XPS Preview is an application software that displays what the print result will look like before a document is actually printed.

The preview reflects the information which is set within the printer driver and allows you to check the document layout, print order, and number of pages. The preview also allows you to edit the print document, edit the print pages, change the print settings, and perform other functions.

When you want to display a preview before printing, open the [printer driver setup window](#), and check the **Preview before printing** check box on the **Main** tab.

►►► Important

- To use the Canon IJ XPS Preview, you must have Microsoft .NET Framework 4 Client Profile installed on your computer.

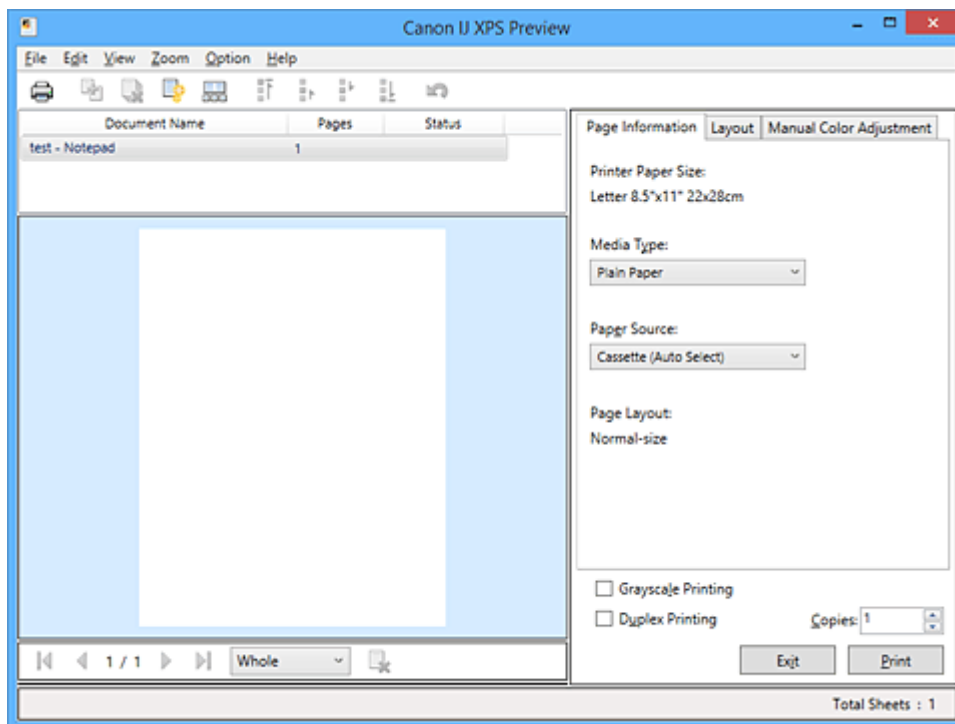

File Menu

Selects print operation and print history settings:

Print

Prints the documents selected in the document list.

The printed documents are deleted from the list, and when all documents are printed, the Canon IJ XPS Preview closes.

This command has the same function as  (Print) on the toolbar and the **Print** in the print settings area.

Print All Documents

Prints all documents in the document list and closes the Canon IJ XPS Preview.

Save Print History

Switches whether the documents printed from the Canon IJ XPS Preview are to be saved as print history entries.

History Entry Limit

Switches the maximum number of print history registrations.

Select **10 Entries**, **30 Entries**, or **100 Entries**.

Important

- If the limit on the number of registration is exceeded, the print history registrations are deleted starting from the oldest one.

Add documents from history to the list

Adds the document saved in the print history to the document list.

Exit

Ends the Canon IJ XPS Preview. The documents remaining in the document list will be deleted from the list.

This command has the same function as the **Exit** in the print settings area.

Edit Menu

Selects the method for editing multiple documents or pages.

Undo

Reverses the previous change.

If the change cannot be reversed, this function is grayed out and cannot be selected.

This command has the same function as the  (Undo) on the toolbar.

Documents

Selects the method for editing print documents.

Combine Documents

Combines the documents selected in the document list into one document.

If only one document is selected, this command is grayed out and cannot be selected.

This command has the same function as the  (Combine Documents) on the toolbar.

Reset Documents

Returns the document selected in the document list to their status before they were added to the Canon IJ XPS Preview.

The combined documents are separated, and the original documents are restored.

This command has the same function as the  (Reset Documents) on the toolbar.

Move Document

Use the following command to change the order of the documents selected in the document list.

Move to First

Moves the selected print document to the beginning of the document list.

If the currently selected document is the first document, this command is grayed out and cannot be selected.

Move Up One

Moves the selected print document one up from its current position.

If the currently selected document is the first document, this command is grayed out and cannot be selected.

Move Down One

Moves the selected print document one down from its current position.

If the currently selected document is the last document, this command is grayed out and cannot be selected.

Move to Last

Moves the selected print document to the end of the document list.

If the currently selected document is the last document, this command is grayed out and cannot be selected.

Delete Document

Deletes the selected document from the document list.

If the document list contains only one document, the document is grayed out and cannot be selected.

This command has the same function as the  (Delete Document) on the toolbar.

Grayscale Printing

Allows you to change the monochrome print settings.

This command has the same functionality as the **Grayscale Printing** check box in the print settings area.

Page Layout Printing...

Opens the **Page Layout Printing** dialog box.

This dialog box allows you to set **Page Layout Printing**, **Page Layout**, **Page Order**, and **Page Border**.

Duplex Printing...

Opens the **Duplex Printing** dialog box.

This dialog box allows you to set **Duplex Printing**, **Automatic**, **Stapling Side**, and **Margin**.

Copies...

Opens the **Copies** dialog box.

This dialog box allows you to set **Copies**, **Collate**, and **Print from Last Page**.

Pages

Selects the method for editing print pages.

Delete Page

Deletes the currently selected page.

If page layout printing is set, the pages enclosed with red frame will be deleted.

This command has the same function as the  (Delete Page) on the toolbar.

Restore Page

Restores pages that were deleted with the **Delete Page** function.

To restore pages, you must select the **View Deleted Pages** check box on the **Option** menu and display the deleted pages as thumbnails.

Move Page

Use the following command to change the order of the currently selected pages.

Move to First

Moves the currently selected page to the beginning of the document.

If the currently selected page is the first page, this command is grayed out and cannot be selected.

Move Forward One

Moves the currently selected page one position in front of its current position.

If the currently selected page is the first page, this command is grayed out and cannot be selected.

Move Backward One

Moves the currently selected page one position after its current position.

If the currently selected page is the last page, this command is grayed out and cannot be selected.

Move to Last

Moves the currently selected page to the end of the document.

If the currently selected page is the last page, this command is grayed out and cannot be selected.

View Menu

Selects the documents and pages to be displayed.

Documents

Use the following command to select the document to display.

First Document

Displays the first document in the document list.

If the currently selected document is the first document, this command is grayed out and cannot be selected.

Previous Document

Displays the document located before the currently displayed document.

If the currently selected document is the first document, this command is grayed out and cannot be selected.

Next Document

Displays the document located after the currently displayed document.

If the currently selected document is the last document, this command is grayed out and cannot be selected.

Last Document

Displays the last document in the document list.

If the currently selected document is the last document, this command is grayed out and cannot be selected.

Pages

Use the following command to select the page to be displayed.

»» Note

- If the **Page Layout** setting in the printer driver is specified to **Tiling/Poster**, or **Booklet**, the number of pages is the number of sheets to be used for printing, and not the number of pages in the original document created with the application software.

First Page

Displays the first page of the document.

If the currently displayed page is the first page, this command is grayed out and cannot be selected.

Previous Page

Displays the page located before the currently displayed page.

If the currently displayed page is the first page, this command is grayed out and cannot be selected.

Next Page

Displays the page located after the currently displayed page.

If the currently displayed page is the last page, this command is grayed out and cannot be selected.

Last Page

Displays the last page of the document.

If the currently displayed page is the last page, this command is grayed out and cannot be selected.

Page Selection...

Displays the **Page Selection** dialog box.

This command allows you to specify the page number of the page to be displayed.

Zoom Menu

Selects the ratio of the actual size printed on the paper to the preview display size.

You can also select the ratio from the drop-down list box located on the toolbar.

Whole

Displays the entire page of data as one page.

50%

Reduces the displayed data to 50% of the actual size to be printed.

100%

Displays the data at the actual size to be printed.

200%

Enlarges the displayed data to 200% of the actual size to be printed.

400%

Enlarges the displayed data to 400% of the actual size to be printed.

Option Menu

Toggles the show / hide status of the following information.

View Thumbnails

Reduces all pages in the document selected in the document list and displays them at the bottom of the preview window.

This command has the same function as the  (View Thumbnails) on the toolbar.

View Document List

Displays the print document list at the top of the preview window.

View Print Settings Area

Displays the print settings area at the right side of the preview window.

View Deleted Pages

When the thumbnails are displayed, this function displays pages that were deleted with the **Delete Page** function.

To check deleted pages, you must first select the **View Thumbnails** check box.

Keep printed documents on the list

Leaves the printed document in the document list.

Print Settings Displayed at Startup

Switches the tab of the print settings area to be displayed when the Canon IJ XPS Preview is started.

Select **Page Information**, **Layout**, or **Manual Color Adjustment**.

Help Menu

When you select this menu item, the Help window for Canon IJ XPS Preview is displayed, and you can check the version and copyright information.



(Print)

Prints the documents selected in the document list.

The printed documents are deleted from the list, and when all documents are printed, the Canon IJ XPS Preview closes.



(Combine Documents)

Combines the documents selected in the document list into one document.

If only one document is selected, this command is grayed out and cannot be selected.



(Delete Document)

Deletes the selected document from the document list.

If the document list contains only one document, the document is grayed out and cannot be selected.



(Reset Documents)

Returns the document selected in the document list to their status before they were added to the Canon IJ XPS Preview.

The combined documents are separated, and the original documents are restored.



(View Thumbnails)

Reduces all pages in the document selected in the document list and displays them at the bottom of the preview window.

To hide the print pages, click **View Thumbnails** again.



(Move to First)

Moves the selected print document to the beginning of the document list.

If the currently selected document is the first document, this command is grayed out and cannot be selected.



(Move Up One)

Moves the selected print document one up from its current position.

If the currently selected document is the first document, this command is grayed out and cannot be selected.



(Move Down One)

Moves the selected print document one down from its current position.

If the currently selected document is the last document, this command is grayed out and cannot be selected.

(Move to Last)

Moves the selected print document to the end of the document list.

If the currently selected document is the last document, this command is grayed out and cannot be selected.

(Undo)

Reverses the previous change.

If the change cannot be reversed, this function is grayed out and cannot be selected.

(Delete Page)

Deletes the currently selected page.

If page layout printing is set, the pages enclosed with red frame will be deleted.

Document list

Displays the list of the print documents.

The document selected in the document list becomes the target for preview display and editing.

Document Name

Displays the name of the print document.

If you click the name of the selected print document, a text box is displayed, and you can rename the document to any name.

Pages

Displays the number of pages in the print document.

Important

- The number displayed in **Pages** and the output page count are different.
- To check the output page count, check the status bar at the bottom of the preview window.

Status

Displays the status of the print documents.

Documents that are undergoing data processing are displayed as **Processing data**.

Important

- Documents showing **Processing data** cannot be printed or edited.
Wait until the data processing ends.

Print Settings Area Screen

Allows you to check and change the print settings of the documents selected in the document list.

Print Settings Area is displayed on the right side of the preview window.

Page Information tab

The print settings are displayed for each page.

You can change the media type and paper source settings.

Printer Paper Size

Displays the paper size of the document to be printed.

Media Type

Allows you to select the media type of the document to be printed.

Paper Source

Allows you to select the paper source of the document to be printed.

Page Layout

Displays the page layout of the document to be printed.

Layout tab

You can specify settings for page layout printing.

To apply the specified settings, click **Apply**.

If the page layout print settings cannot be changed for the print document, the individual items are grayed out and cannot be selected.

Manual Color Adjustment tab

This tab allows you to adjust the color balance by changing the settings of the **Cyan, Magenta, Yellow, Brightness, Intensity, and Contrast** options.

Cyan/Magenta/Yellow

Adjusts the strengths of **Cyan, Magenta, and Yellow**.

Moving the slider to the right makes a color stronger, and moving the slider to the left makes a color weaker.

You can also directly enter a value linked to the slider. Enter a value in the range from -50 to 50.

This adjustment changes the relative amount of ink of each color used, which alters the total color balance of the document.

Use your application software if you want to change the total color balance significantly. Use the printer driver only if you want to adjust the color balance slightly.

»» Important

- When **Grayscale Printing** is checked, **Cyan, Magenta, and Yellow** appear grayed out and are unavailable.

Brightness

Selects the brightness of your print.

Pure white and black will not change, but colors between white and black will change.

Intensity

Adjusts the overall intensity of your print.

Moving the slider to the right increases the intensity, and moving the slider to the left decreases the intensity.

You can also directly enter a value linked to the slider. Enter a value in the range from -50 to 50.

Contrast

Adjusts the contrast between light and dark in the image to be printed.

Moving the slider to the right increases the contrast, moving the slider to the left decreases the contrast.

You can also directly enter a value linked to the slider. Enter a value in the range from -50 to 50.

Defaults

Restores all the settings you have changed to their default values.

Clicking this button restores all the settings on this tab to their default values (factory settings).

Grayscale Printing

Allows you to change the monochrome print settings.

Duplex Printing

Selects whether to print the document on both sides or one side of a sheet of paper.

If the duplex print settings cannot be changed for the print document, this item is grayed out and is unavailable.

»» Important

- When you select **Booklet** for **Page Layout**, **Duplex Printing** of the print settings area will be set automatically. In this case, **Duplex Printing** is grayed out and is unavailable.

Copies

Specifies the number of copies you want to print. You can specify a value from 1 to 999.

If the numbers of copies cannot be changed for the print document, this item is grayed out and is unavailable.

Exit

Ends the Canon IJ XPS Preview.

The documents remaining in the document list will be deleted from the list.

Print

Prints the documents selected in the document list.

The printed documents are deleted from the list, and when all documents are printed, the Canon IJ XPS Preview closes.

Canon IJ Status Monitor Description

The Canon IJ Status Monitor displays the status of the printer and the printing progress. The monitor uses graphics, icons, and messages to let you know the printer status.

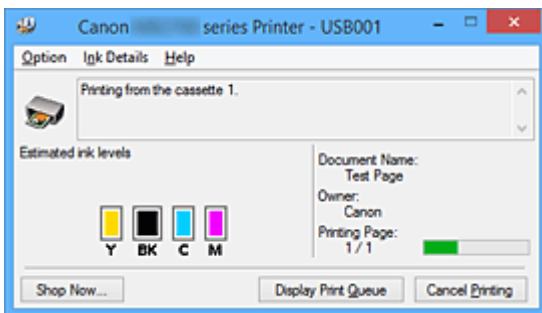

Canon IJ Status Monitor Features

The Canon IJ Status Monitor offers the following advantages:

You can check the status of the printer on the screen.

The status of the printer is shown on the screen in real time.

You can check the printing progress of each printing document (print job).

Error types and solutions are shown on the screen.

Shown when a printer error occurs.

You can immediately check how to respond.

You can check the ink status.

This function displays graphics showing the ink tank type and the estimated ink levels.

Icons and messages are displayed when ink is running low (ink level warning).

Canon IJ Status Monitor Overview

Canon IJ Status Monitor allows you to check the status of the printer and ink with graphics and messages.

You can check the information on the printing document and the printing progress during printing.

When a printer error occurs, it shows the cause and solution. Follow the instruction in the message.

Printer

Canon IJ Status Monitor shows an icon when a warning or error occurs to the printer.

⚠ : Indicates that a warning (operator call error) has occurred or the printer is working.

✖ : There has been an error which requires a service.

Ink Tank

Canon IJ Status Monitor shows an icon when a low ink warning or a no ink error occurs.

In addition, this function displays graphics showing the estimated ink levels of the ink tank.

In this case, click the graphics to open the **Ink Details** dialog box. You can check the detail information such as the remaining ink level and the ink tank types for your printer.

Document Name

Shows the name of the document to be printed.

Owner

Shows the owner's name of the document to be printed.

Printing Page

Shows the number of printing page and total printing pages.

Display Print Queue

Shows the print window used to manage the print job that is being printed or being in the print queue.

Cancel Printing

Cancels the current print job.

Important

- The **Cancel Printing** button is enabled only while print data is being sent to the printer. Once the print data has been sent, the button is grayed out and becomes unavailable.

Option Menu

If you select **Enable Status Monitor**, when a printer related message is generated the Canon IJ Status Monitor starts.

When **Enable Status Monitor** is selected, following commands are available.

Always Display Current Job

Displays the Canon IJ Status Monitor during printing.

Always Display on Top

Displays the Canon IJ Status Monitor in front of other windows.

Display Guide Message

Displays the guide for operations in which how to set paper is complicated.

Envelope Printing

Displays the guide message when envelope printing starts.

To hide this guide message, select the **Do not show this message again** check box.

To display the guide messages again, click **Envelope Printing** on the **Display Guide Message** in the **Option** menu and enable this setting.

Hagaki Printing

Displays the guide message before the printer begins hagaki printing.

To hide this guide message, select the **Do not show this message again** check box.

To display the guide messages again, click **Hagaki Printing** on the **Display Guide Message** in the **Option** menu and enable this setting.

Display Warning Automatically

When a Low Ink Warning Occurs

Starts the Canon IJ Status Monitor window automatically and displays it in front of the other windows when a low ink warning occurs.

Start when Windows is Started

Starts the Canon IJ Status Monitor automatically when you start Windows.

Ink Details Menu

Select this menu to display the **Ink Details** dialog box. Check the detail information such as the remaining ink level and the ink tank types for your printer.

Ink Details dialog box

This function displays graphics and messages showing the ink tank type and the estimated ink levels.

Ink Information (displayed at left)

Shows the ink tank types with graphics.

If a warning or error related to the remaining ink level occurs, the printer driver displays an icon to let you know.

If the icon is displayed, operate the printer according to the instructions displayed on the screen.

Message (displayed at right)

Shows information such as the ink status and ink colors with sentences.

Ink Model Number

Shows the ink tank types for your printer.

Close

Closes the **Ink Details** dialog box to return to Canon IJ Status Monitor.

Help Menu

When you select this menu item, the Help window for Canon IJ Status Monitor is displayed, and you can check the version and copyright information.

Updating the MP Drivers

- **Obtaining the Latest MP Drivers**
- **Deleting the Unnecessary MP Drivers**
- **Before Installing the MP Drivers**
- **Installing the MP Drivers**

Obtaining the Latest MP Drivers

The MP Drivers include a printer driver, ScanGear (scanner driver), and fax driver.

By updating the MP Drivers to the latest version of the MP Drivers, unresolved problems may be solved.

You can access our website and download the latest MP Drivers for your model.

»» Important

- You can download the MP Drivers for free, but any Internet access charges incurred are your responsibility.
- Before installing the latest MP Drivers, [delete the previously installed version](#).

Related Topics

- [Before Installing the MP Drivers](#)
- [Installing the MP Drivers](#)

Deleting the Unnecessary MP Drivers

The MP Drivers which you no longer use can be deleted.

When deleting the MP Drivers, first exit all programs that are running.

The procedure to delete the unnecessary MP Drivers is as follows:

1. Start the uninstaller

Select **Control Panel** -> **Programs** -> **Programs and Features**.

From the program list, select "XXX MP Drivers" (where "XXX" is your model name) and then click **Uninstall**.

The confirmation window for uninstalling the model appears.

»»» Important

- A confirmation/warning dialog box may appear when starting, installing or uninstalling software. This dialog box appears when administrative rights are required to perform a task. When you are logged on to an administrator account, click **Yes** (or **Continue**, **Allow**) to continue. Some applications require an administrator account to continue. In such cases, switch to an administrator account, and restart the operation from the beginning.

2. Execute the uninstaller

Click **Execute**. When the confirmation message appears, click **Yes**.

When all the files have been deleted, click **Complete**.

The deletion of the MP Drivers is complete.

»»» Important

- Printer driver, XPS printer driver, ScanGear (scanner driver), and fax driver will be deleted when you uninstall the MP Drivers.

Before Installing the MP Drivers

This section describes the items that you should check before installing the MP Drivers. You should also refer to this section if the MP Drivers cannot be installed.

Checking the Printer Status

- Turn off the printer.

Checking the Personal Computer Settings

- Terminate all running applications.
- Log on as a user who has the administrator account.

»» Important

- Before installing the latest MP Drivers, [delete the previously installed version](#).

Related Topics

- [Obtaining the Latest MP Drivers](#)
- [Installing the MP Drivers](#)

Installing the MP Drivers

You can access our web site through the Internet and download the latest MP Drivers and XPS printer driver for your model.

The procedure for installing the downloaded MP Drivers is as follows:

1. Turn off the printer

2. Start the installer

Double-click the icon of the downloaded file.

The installation program starts.

▶▶▶ Important

- A confirmation/warning dialog box may appear when starting, installing or uninstalling software. This dialog box appears when administrative rights are required to perform a task. When you are logged on to an administrator account, click **Yes** (or **Continue**, **Allow**) to continue. Some applications require an administrator account to continue. In such cases, switch to an administrator account, and restart the operation from the beginning.

3. Install the MP Drivers

Take the appropriate action as described on the screen.

4. Complete the installation

Click **Complete**.

Depending on the environment you are using, a message prompting you to restart the computer may be displayed. To complete the installation properly, restart the computer.

▶▶▶ Important

- You can install the XPS printer driver with the same procedure for installing the MP Drivers. However, when installing the XPS printer driver, first complete installation of the MP Drivers.
- You can download the MP Drivers and XPS printer driver for free, but any Internet access charges incurred are your responsibility.
- Before installing the latest MP Drivers, [delete the previously installed version](#).

Related Topics

- [Obtaining the Latest MP Drivers](#)
- [Deleting the Unnecessary MP Drivers](#)
- [Before Installing the MP Drivers](#)

Printing Using a Web Service

- **Using PIXMA/MAXIFY Cloud Link**
- **Printing with Google Cloud Print**

Using PIXMA/MAXIFY Cloud Link

By using PIXMA/MAXIFY Cloud Link, you can connect your printer to a cloud service, such as CANON IMAGE GATEWAY, Evernote, or Twitter, and use the following functions without using a computer:

- Print images from a photo-sharing service
- Print documents from a data management service
- Save scanned images to a data management service.
- Use Twitter to report the printer status, such as no paper or low ink levels.

In addition, you can use various functions by adding and registering apps that are linked with various cloud services.

■ [Using PIXMA/MAXIFY Cloud Link from Your Printer](#)

■ [Using PIXMA/MAXIFY Cloud Link from Your Smartphone, Tablet, or Computer](#)



▶▶▶ Important

- In certain countries, PIXMA/MAXIFY Cloud Link may not be available or the available apps may be different.
- Some apps require that you have an account before you use those apps. For such apps, please set up an account beforehand.
- To find out which models support PIXMA/MAXIFY Cloud Link check the Canon homepage.
- The screen display may change without prior notice.

Printing with Google Cloud Print

The printer is compatible with Google Cloud Print™ (Google Cloud Print is a service provided by Google Inc.).

By using Google Cloud Print, you can print from anywhere with applications or services supporting Google Cloud Print.

Sending Print Data and Printing via Internet



Once you register the printer to Google Cloud Print, you can print from applications or services supporting Google Cloud Print without internet connection.

Sending Print Data and Printing without Going through Internet



»» Important

- This function may not be available depending on the country or region you live in.
- To use Google Cloud Print, you need to get Google account and register the printer with Google Cloud Print in advance.

Additionally, LAN connection with the printer and internet connection are required to register the printer to Google Cloud Print. Internet connection fees apply.

1. [Getting Google Account](#)
2. [Registering Printer with Google Cloud Print](#)
3. [Printing from Computer or Smartphone with Google Cloud Print](#)

»» Important

- When the printer owner changes, delete its registration from Google Cloud Print.

■ [Deleting Printer from Google Cloud Print](#)

LAN connection with the printer and internet connection are required to delete the printer from Google Cloud Print. Internet connection fees apply.

Getting Google Account

To print with Google Cloud Print, you need to get Google account and register the printer with Google Cloud Print in advance.

▶▶▶ Note

- If you already have Google account, register the printer to Google Cloud Print.

■ [Registering Printer with Google Cloud Print](#)

Access to Google Cloud Print with the web browser on the computer or the mobile device and register the required information.

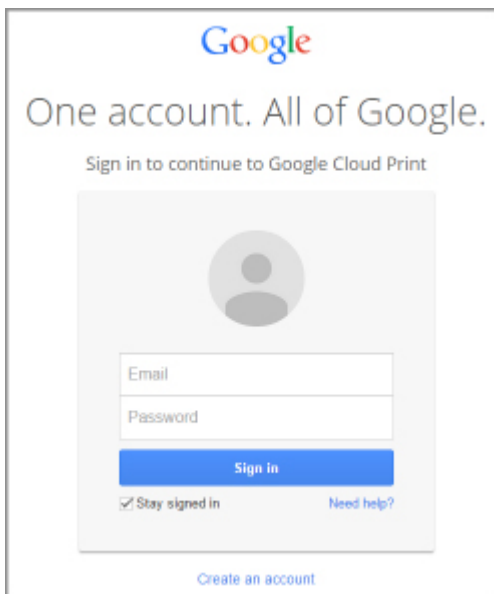

The image shows a screenshot of a Google sign-in page. At the top is the Google logo. Below it is the text "One account. All of Google." followed by "Sign in to continue to Google Cloud Print". In the center is a grey circle representing a user profile. Below that are two input fields: "Email" and "Password". A blue "Sign in" button is positioned below the password field. At the bottom left of the sign-in area is a checkbox labeled "Stay signed in" which is checked, and a link "Need help?". At the very bottom of the page is a link "Create an account".

* The screen above may change without prior notice.

Registering Printer with Google Cloud Print

The printer can be registered to Google Cloud Print with the following two methods.



■ [Registration Using Google Chrome](#)

■ [Registration Using Printer](#)

▶▶▶ Important

- If you have not gotten Google account, get it.
 - [Getting Google Account](#)
- When the printer owner changes, delete its registration from Google Cloud Print.
 - [Deleting Printer from Google Cloud Print](#)
- LAN connection with the printer and internet connection are required to register the printer to Google Cloud Print and to delete it. Internet connection fees apply.

Registration Using Google Chrome

1. Start Google Chrome browser on your computer.
2. Select **Sign in to Chrome...** from  (Chrome menu).
3. Log in to your Google account.
4. Select **Settings** from  (Chrome menu).
5. Select **Show advanced settings...** to display information.
6. Select **Manage** for **Google Cloud Print**.
7. When **Canon MB5400 series** and **Add printers** button are displayed, select **Add printers**.
8. When confirmation message for registering printer appears, select **OK**.
9. When register confirmation screen is displayed on printer's touch screen, tap **Yes**.
Printer registration is complete.

Registration Using Printer

▶▶▶ Important

- Entering the administrator password may be required depending on the range of administrator password.

1. [Make sure printer is turned on.](#)

2. Flick HOME screen and tap  **Setup.**

■ [Using the Operation Panel](#)

3. Tap  **Web service setup.**

4. Tap **Web service connection setup** -> **Google Cloud Print setup** -> **Register with Google Cloud Print.**

▶▶▶ Note

- If you have already registered the printer with Google Cloud Print, the confirmation message to re-register the printer is displayed.

5. When confirmation screen to register printer is displayed, tap **Yes.**

6. When message to select language on print setting screen of Google Cloud Print is displayed, tap **Next.**

7. Tap a display language on print setting screen of Google Cloud Print.

The confirmation message to print the authentication URL is displayed.

8. Load A4 or Letter-sized plain paper and tap **OK.**

The authentication URL is printed.

9. Make sure authentication URL is printed, tap **Yes.**

10. Perform authentication process using web browser on computer or mobile device.

Access to the URL using the web browser on the computer or the mobile device and perform the authentication process following the on-screen instructions.

▶▶▶ Important

- Accessing to printed URL and performing the authentication process have to be carried out quickly.
- If you exceed time limit of the authentication process, an error message is displayed on the touch screen. Tap **OK.** When the confirmation message to print the authentication URL is displayed, try again from step 8.

»» Note

- Perform the authentication process with your Google account which you have gotten in advance.

11. When message that registration is complete is displayed on printer's touch screen, tap **OK**.

When authentication process is complete properly, the registration items are displayed. When authentication process is complete, you can print the data with Google Cloud Print.

Printing from Computer or Smartphone with Google Cloud Print

When you send print data with Google Cloud Print, the printer receives the print data and prints it automatically.

When printing from a smartphone, tablet, computer, or other external device by using Google Cloud Print, load paper into the printer in advance.

You can print with Google Cloud Print with the following two methods.

- Printing via internet

LAN connection with the printer and internet connection are required.

■ [Sending Print Data via Internet](#)

- Printing without going through internet

Local network connection with the printer or enabling printer's direct connection is required. Enabling Bonjour on the printer is required.

■ [Sending Print Data without Going through Internet](#)

▶▶▶ Note

- Depending on the communication status, it may take a while to print the print data or the printer may not receive the print data.
- While printing with Google Cloud Print, the printing may be canceled depending on the printer's status, such as when the printer is being operated or an error has occurred. To resume printing, check the printer's status and print with Google Cloud Print again.
- For print settings:
 - If you select the media type other than plain paper or if you select the paper size other than A4 or Letter size, the print data is printed in single-sided even when you select the duplex print setting.
 - If you select plain paper as media type or if you select B5/A5-size as paper size, the print data is printed with border even when you select the borderless print setting.
 - The print results may differ from the print image depending on the print data.
 - Depending on the device sending the print data, you may not select the print settings when sending the print data with Google Cloud Print.

Sending Print Data via Internet

This section describes the operation to send print data from Google Chrome browser on the computer. The operation differs depending on the device, applications, or services.



▶▶▶ Important

- LAN connection with the printer and internet connection are required to sending print data via internet. Internet connection fees apply.

1. [Make sure printer is turned on.](#)

»» Note

- If the printer's Auto Power On function is enabled, the printer is turned on automatically when it receives the print data.

2. Start Google Chrome browser on your computer.
3. Select **Sign in to Chrome...** from  (Chrome menu).
4. Log in to your Google account.
5. Select **Print...** from  (Chrome menu).

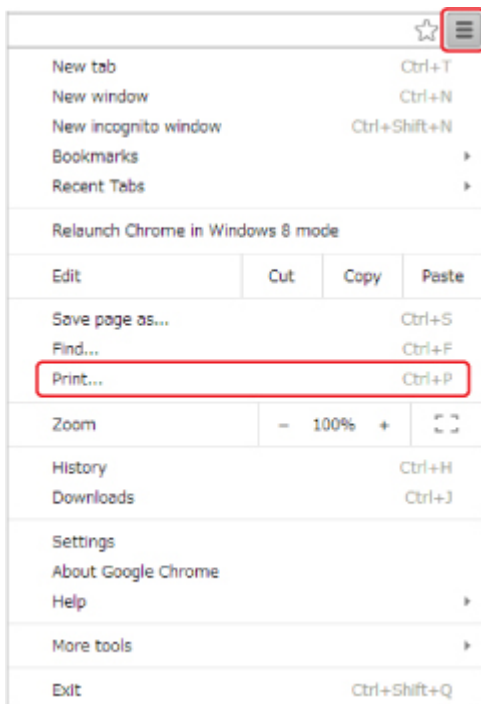

6. Select **Change...** next **Destination**.

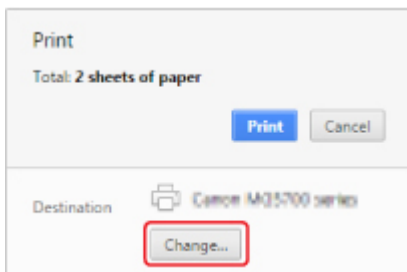

7. Select **Canon MB5400 series** in **Google Cloud Print**.
8. Select **Print**.

When the preparation for printing with Google Cloud Print is complete, the printer receives the print data and prints it automatically.

When you want to print from Google Cloud Print immediately

When the printer cannot receive the print data, or you want to start printing immediately, you can check whether there is a print job on the Google Cloud Print and start printing manually.

Follow the steps below.

1. [Make sure printer is turned on.](#)

2. Flick HOME screen and tap  **Setup**.

■ [Using the Operation Panel](#)

3. Tap  **Web service inquiry**.

▶▶▶ Note

- If you have not registered the printer with Google Cloud Print, **Web service inquiry** is not displayed.

4. Tap **Print from Google Cloud Print**.

The confirmation screen to check is displayed.

5. Tap **Yes**.

If there is the print data, the printer receives the print data and prints it.

Sending Print Data without Going through Internet

This section describes the operation to send print data from Google Chrome browser on the computer. The operation differs depending on the device, applications, or services.



▶▶▶ Important

- Local network connection with the printer or enabling printer's direct connection is required.
- Enabling Bonjour on the printer is required.

1. [Make sure printer is turned on.](#)

▶▶▶ Note

- If the printer's Auto Power On function is enabled, the printer is turned on automatically when it receives the print data.

2. Start Google Chrome browser on your computer.
3. Select **Sign in to Chrome...** from  (Chrome menu).
4. Log in to your Google account.
5. Select **Print...** from  (Chrome menu).

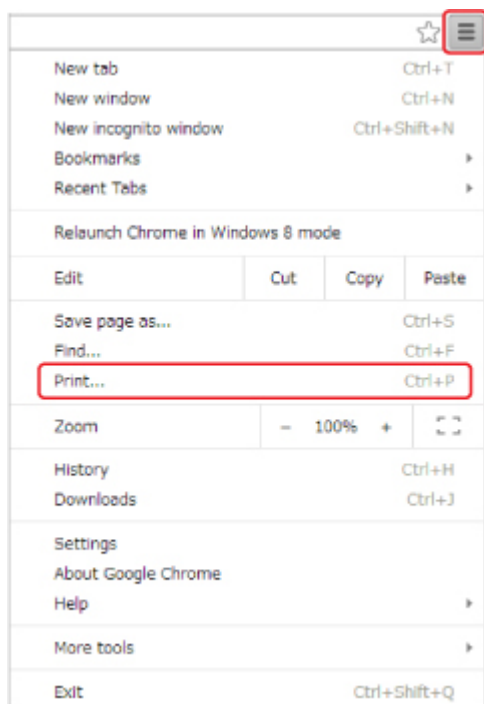

6. Select **Change...** next **Destination**.

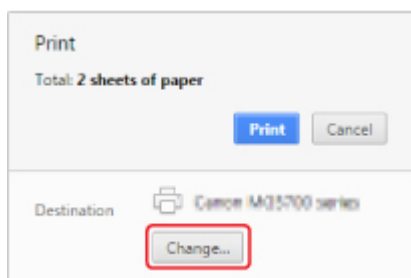

7. Select **Canon MB5400 series** in **Local Destinations**.
8. Select **Print**.

When the preparation for printing with Google Cloud Print is complete, the printer receives the print data and prints it automatically.

Deleting Printer from Google Cloud Print

If the printer's owner changes or if you want to re-register the printer, delete it from Google Cloud Print by following the steps below.

The printer can be deleted from Google Cloud Print with the following two methods.



■ [Deletion Using Google Chrome](#)

■ [Deletion Using Printer](#)

»» Important

- LAN connection with the printer and internet connection are required to delete the printer from Google Cloud Print. Internet connection fees apply.

Deletion Using Google Chrome

1. Start Google Chrome browser on your computer.
2. Select **Sign in to Chrome...** from  (Chrome menu).
3. Log in to your Google account.
4. Select **Settings** from  (Chrome menu).
5. Select **Show advanced settings...** to display information.
6. Select **Manage** for **Google Cloud Print**.
7. Select **Manage** next **Canon MB5400 series** on device list.
8. Select **Delete**.
9. When confirmation message for deleting printer appears, select **OK**.

Deletion Using Printer

»» Important

- Entering the administrator password may be required depending on the range of administrator password.

1. [Make sure printer is turned on.](#)

2. Flick HOME screen and tap  **Setup**.

■ [Using the Operation Panel](#)



3. Tap  **Web service setup**.
4. Tap **Web service connection setup** -> **Google Cloud Print setup** -> **Delete from Google Cloud Print**.
5. When confirmation screen to delete printer is displayed, tap **Yes**.
6. When message that deletion is complete is displayed, tap **OK**.

Printing from an AirPrint-enabled Printer with Mac

Using AirPrint to print from your iPhone, iPad, iPod touch, or Mac.

AirPrint enables you to print photos, email, Web pages and documents from iPhone, iPad, iPod touch, and Mac without the need to install drivers, or download apps or software.

▶▶▶ Note

- If you want to print using AirPrint from iOS device, see below.

■ [Printing from an AirPrint-enabled Printer with iOS Device](#)



Checking Your Environment

First, check your environment.

- **AirPrint Operation Environment**
 - iPhone, iPad, and iPod touch running the latest version of iOS
 - Mac running the latest version of Mac OS

- **Requirement**

The iOS device or Mac and the printer must be connected to the same network over a LAN or connected directly without wireless router.

Adding Printer as AirPrint Printer to Your Mac

1. Open **System Preferences**, and select **Printers & Scanners (Print & Scan)** on your Mac.
2. Select **+** to display the printer list.
3. Select the printer's name listed as **Bonjour Multifunction**.
4. Select **Secure AirPrint** or **AirPrint** from **Use**.
5. Select **Add**.

Printing with AirPrint from Mac

1. [Make sure printer is turned on.](#)

▶▶▶ Note

- If the printer's Auto Power On function is enabled, the printer is turned on automatically when it receives the print data.

2. [Load paper.](#)

3. Perform printing on your application software.

Print dialog appears.

4. Select your model name added as AirPrint printer from the **Printer** list in the Print Dialog.

5. Set the paper size, media type, and other settings as needed.

6. Select **Print**.

When you execute printing, the printer prints according to the specified settings.

▶▶▶ Note

- For wireless LAN connection:
 - After you turn on the printer, it may take few minutes before the printer can communicate through a wireless LAN connection. Make sure the printer is connected to the wireless LAN and try printing.
 - If Bonjour on the printer is disabled, AirPrint cannot be used. Check the LAN settings on the printer, and enable Bonjour.
- For other AirPrint troubleshooting, see below.

■ [Cannot Print Using AirPrint](#)

Checking Print Status

- Display the Printing Status Screen

Deleting Print Job

To delete a print job with AirPrint, use one of the following two methods:

- From printer: Use **Stop** button to cancel the print job.
- From iOS device: Deleting the Undesired Print Job

Printing from a Device Equipped with Windows 10 Mobile

You can print from a device equipped with Windows 10 Mobile.

This function enables you to print photos, email, Web pages and documents from Windows 10 without the need to install drivers, or download apps or software.

Checking Your Environment

First, check your environment.

- **Operation Environment**

Windows 10

- **Requirement**

The Windows device and the printer must be connected to the same network over a LAN or connected directly without wireless router.

Adding Printer to Your Windows Device

To add the printer, refer to Windows 10 help.

Printing from Windows Device

1. [Make sure printer is turned on.](#)

▶▶▶ **Note**

- If the printer's Auto Power On function is enabled, the printer is turned on automatically when it receives the print data.

2. [Load paper.](#)
3. Select command that you perform printing on application software.
In general, select **Print** on the **File** menu to open the **Print** dialog box.
4. Select your model name.
5. Set the paper size, media type, and other settings as needed.
6. Select **Print**.

When you execute printing, the printer prints according to the specified settings.

Printing from Smartphone/Tablet

- ▶ **Printing Directly from Smartphone/Tablet**
- ▶ **Printing Using a Web Service**

Printing Directly from Smartphone/Tablet

- ▶ **Android Print**
- ▶ **Printing from an AirPrint-enabled Printer with iOS Device**
- ▶ **Printing from a Device Equipped with Windows 10 Mobile**
- ▶ **Using Machine with Direct Connection**

Android Print

You can print to a Canon printer from your Android smartphone or tablet by installing a printing plug-in.

Installing Printing Plug-in

- Installing Canon Print Service

Canon Print Service is a printing plug-in for Android 4.4.2 or later, and is available for free on Google Play. Install the plug-in and activate it.

■ [Printing Using Canon Print Service](#)

- Installing Mopria Print Service

Mopria Print Service is a plug-in that allows printing to a Mopria authentication printer from Android 4.0 or later, and is available for free on Google Play. Install the plug-in and activate it.

See the Mopria homepage (<http://www.mopria.org>) for details.

■ [Printing Using Mopria Print Service](#)

▶▶ Important

- Internet connection is required to download the printing plug-in. Internet connection fees apply.

Printing Using Canon Print Service

▶▶ Important

- The operation may differ depending on your Android device or your application.
- Activate the plug-in after installing it to your Android device. The service is not enabled immediately after installing.
- You can print using Canon Print Service with wireless LAN.

1. [Make sure printer is turned on.](#)
2. [Load paper.](#)
3. Perform print operation on your application of Android device.
4. Select printer on your application of Android device.
Select the printer that is displayed with your printer's name and "Canon Print Service".
5. Specify number of copies, paper size, etc if necessary.
6. Start printing.
When you execute printing, the printer prints according to the specified settings.

Printing Using Mopria Print Service

»» Important

- The operation may differ depending on your Android device or your application.
- Activate the plug-in after installing it to your Android device. The service is not enabled immediately after installing.
- You can print using Mopria Print Service with wireless LAN or with the printer's direct connection.

1. [Make sure printer is turned on.](#)
2. [Load paper.](#)
3. Perform print operation on your application of Android device.
4. Select printer on your application of Android device.
Select the printer that is displayed with your printer's name and "Mopria Print Service".
5. Specify number of copies, paper size, etc if necessary.
6. Start printing.
When you execute printing, the printer prints according to the specified settings.

Printing from an AirPrint-enabled Printer with iOS Device

Using AirPrint to print from your iPhone, iPad, iPod touch, or Mac.

AirPrint enables you to print photos, email, Web pages and documents from iPhone, iPad, iPod touch, and Mac without the need to install drivers, or download apps or software.

▶▶▶ Note

- If you want to print using AirPrint from Mac, see below.

■ [Printing from an AirPrint-enabled Printer with Mac](#)



Checking Your Environment

First, check your environment.

- **AirPrint Operation Environment**
 - iPhone, iPad, and iPod touch running the latest version of iOS
 - Mac running the latest version of Mac OS

- **Requirement**

The iOS device or Mac and the printer must be connected to the same network over a LAN or connected directly without wireless router.

Printing with AirPrint from iOS Device

1. [Make sure printer is turned on.](#)

▶▶▶ Note

- If the printer's Auto Power On function is enabled, the printer is turned on automatically when it receives the print data.

2. [Load paper.](#)
3. Tap operation icon to display menu options from applications of your iOS device.

The figure below is an example of when printing from the iPad web browser. The screen differs depending on the devices or applications.



4. Tap **Print** from menu options.



5. Select your model name from **Printer** on **Printer Options**.

➤➤➤ **Important**

- Because some applications do not support AirPrint, **Printer Options** may not be displayed. If an application does not let you use printer options, you cannot print from that application.

▶▶▶ Note

- **Printer Options** differ depending on the application that you are using.

6. When printing file type that has multiple pages, such as PDF file, tap **Range** and tap **All Pages** or select range of pages to be printed.
7. For **1 Copy**, tap **+** or **-** to set number of required copies.
8. For **Duplex Printing**, tap **On** to enable duplex printing or tap **Off** to disable function.
9. Tap **Print**.

When you execute printing, the printer prints according to the specified settings.

▶▶▶ Note

- For wireless LAN connection:
 - After you turn on the printer, it may take few minutes before the printer can communicate through a wireless LAN connection. Make sure the printer is connected to the wireless LAN and try printing.
 - If Bonjour on the printer is disabled, AirPrint cannot be used. Check the LAN settings on the printer, and enable Bonjour.
- For other AirPrint troubleshooting, see below.

■ [Cannot Print Using AirPrint](#)

Paper Size

With AirPrint, the paper size is selected automatically according to the application being used on the iOS device and the region in which AirPrint is used.

When you use the photo application, the default paper size is L size in Japan, and 4"x6" or KG in other countries and regions.

When you use the document application, the default paper size is letter size in the U.S. region, and A4 in Japan and Europe.

▶▶▶ Important

- Depending on the device or operation system, the default paper size is different from above size.
We recommend you perform test printing.
- Your application may support different paper sizes.

Printing of Envelopes

For printing on the envelope from iOS device with AirPrint, refer to the following.

Print result image	Orientation of print data	Orientation of loading envelope
--------------------	---------------------------	---------------------------------

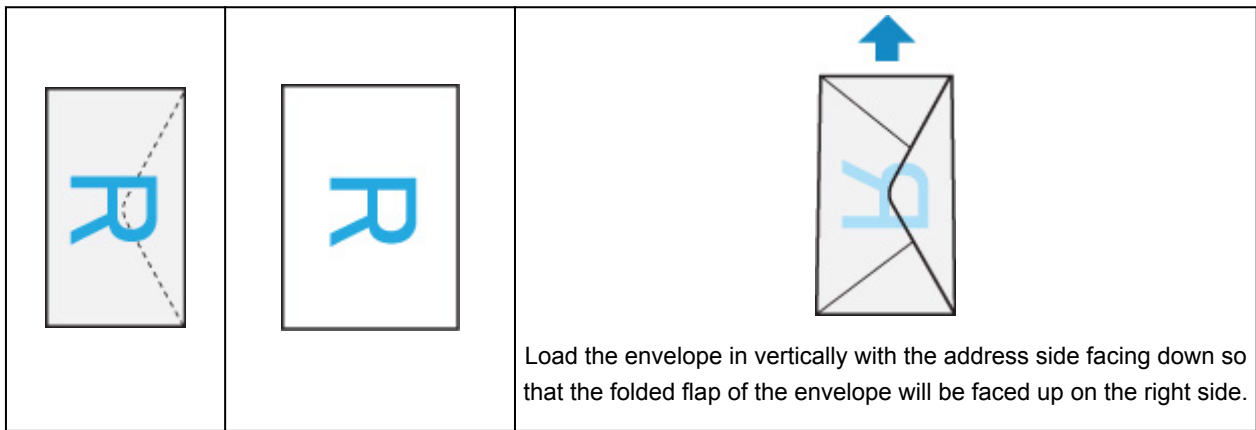

Checking Print Status

During printing, a **Print Center** icon is displayed in the list of recently used applications and you can use it to check the print progress.

Press the Home button on the iOS device twice to set the **Multitasking** mode. Then swipe to the right to display the **Print Center** icon and a **Print Summary**.

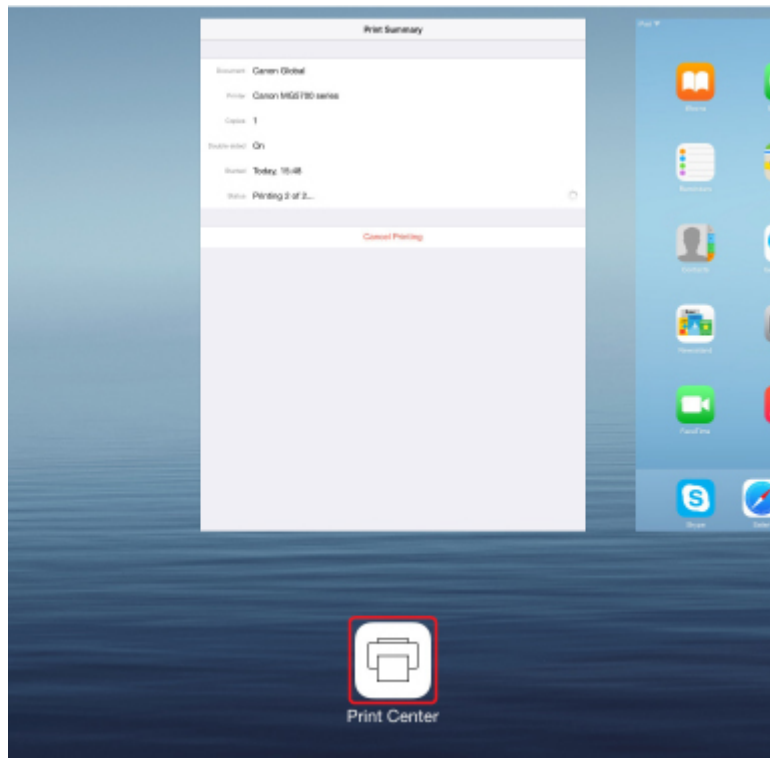

Deleting Print Job

To delete a print job with AirPrint, use one of the following two methods:

- From printer: Use **Stop** button to cancel the print job.
- From iOS device: Press the Home button on the iOS device twice to set the **Multitasking** mode and swipe to the right. Tap the **Print Center** icon to display a **Print Summary**. Tap the print job to be canceled and tap **Cancel Printing**.

Using Machine with Direct Connection

You can connect devices (e.g. smartphone, or tablet) to the printer by two methods below.

- Wireless connection (connecting devices via a wireless router)
- Direct wireless connection (connecting devices using direct connection)

This section describes direct connection, which allows you to print or scan by connecting the devices to the printer directly.

Follow the procedure below to use direct connection.

1. [Enable direct connection.](#)
2. [Connect devices to printer.](#)
3. [Perform printing or scanning operation.](#)

This section also describes changing direct connection to wireless LAN.

■ [Changing Printer Setting to Use Wireless LAN](#)

▶▶▶ Important

- The administrator password is required to change settings if it is enabled for changing settings using the operation panel.
- You can connect up to 5 devices to the printer at the same time.
- Check the usage restrictions and switch the printer to the direct connection.

■ Restrictions

Preparing for Direct Connection

Change settings below to prepare for direct connection.

- Printer's LAN settings
 - [Changing Printer's Settings](#)
- Settings of a device to connect
 - [Changing Settings of a Device and Connecting It to the Printer](#)

Changing Printer's Settings

1. [Make sure printer is turned on.](#)
2. Tap icon on lower left of HOME screen.

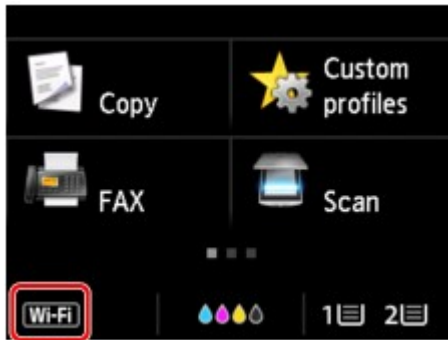

Ex. When the wireless LAN connection is enabled:

The **Change LAN** screen is displayed.

➤➤➤ **Note**

- You can also display the **Change LAN** screen following the procedure below.

1. Flick HOME screen and tap  **Setup**.

■ [Using the Operation Panel](#)

2. Tap  **Device settings**.
3. Tap **LAN settings**.
4. Tap **Change LAN**.

3. Tap **Activate direct connect..**

4. Tap **Yes**.

The identifier (SSID) for direct connection appears.

The device detects the printer by the identifier (SSID).

➤➤➤ **Note**

- If you tap **Details** and tap **Yes**, the following items appear.
 - Security setting
 - Password
 - Printer's name which appears on a Wi-Fi Direct compatible device

The password is required when connecting a device to the printer. Depending on the device you are using, no password is required.

When you connect a Wi-Fi Direct compatible device to the printer, select the device name displayed on the touch screen from your device.

- The identifier (SSID) and the security setting are specified automatically. To update them, see below.

■ [Changing Direct Connection Setting](#)

5. Tap **OK**.

The direct connection is enabled and a device can be connected to the printer wirelessly.

Changing Settings of a Device and Connecting It to the Printer

1. Turn on wireless communication on your device.

Enable "Wi-Fi" on your device's "Setting" menu.

For more on turning on wireless communication, see your device's instruction manual.

2. Select "DIRECT-XXXX-MB5400series" ("X" represents alphanumeric characters) from list displayed on device.

▶▶▶ Note

- If "DIRECT-XXXX-MB5400series" does not appear on the list, direct connection is not enabled.

See [Changing Printer's Settings](#) to enable direct connection.

3. Enter password.

Your device is connected to the printer.

▶▶▶ Note

- Check the password for the direct connection.

Check by one of the following methods.

- Display on the touch screen.

■ [LAN settings](#)

- Print the network settings.

■ [Printing Network Settings](#)

- Depending on the device you are using, entering the password is required to connect a device to the printer via wireless LAN. Enter the password specified for the printer.
- If your Wi-Fi Direct compatible device is set to prioritize using Wi-Fi Direct and it is connecting to the printer, the printer displays a confirmation screen asking if you allow the device to connect to the printer.

Make sure the name on the touch screen is the same as that of your wireless communication device and tap **Yes**.

Printing/Scanning with Direct Connection

Connect a device and the printer and start printing/scanning.

▶▶▶ Note

- For more on printing or scanning from a device via wireless LAN, refer to the device's or application's instruction manual.

- You can print/scan from your smartphone or tablet by installing Canon PRINT Inkjet/SELPHY. Download it from App Store and Google Play.

■ For iOS

■ For Android

Changing Printer Setting to Use Wireless LAN

Follow the procedure below to change the printer setting to use wireless LAN.

1. Tap  icon on lower left on HOME screen.

The **Change LAN** screen is displayed.

▶▶▶ Note

- You can also display the **Change LAN** screen following the procedure below.

1. Flick HOME screen and tap  **Setup**.

■ [Using the Operation Panel](#)

2. Tap  **Device settings**.

3. Tap **LAN settings**.

4. Tap **Change LAN**.

2. Tap **Activate wireless LAN**.

If you do not use the printer over wireless LAN, select **Activate wired LAN** or **Disable LAN**.

Changing Direct Connection Setting

Change the settings for the direct connection following the procedure below.

1. [Make sure printer is turned on](#).

2. Flick HOME screen and tap  **Setup**.

■ [Using the Operation Panel](#)

3. Tap  **Device settings**.

4. Tap **LAN settings**.

5. Tap **Other settings**.

6. Tap **Direct connection settings**.

7. Change settings as necessary.



- To update the identifier (SSID) and the password for direct connection

Tap A to display the confirmation screen. To update the identifier (SSID) and the password, tap **Yes**.

To check the security setting and the updated password, tap **Details** and tap **Yes** on the screen displayed next.

- To change the printer's name displayed on the Wi-Fi Direct compatible device

Tap B to display the printer's name (device name) displayed on a Wi-Fi Direct compatible device.

Follow the procedure below to change the name.

1. Tap touch screen.
2. Enter device name (up to 32 characters).
3. Tap **OK** to finish entering device name.
4. Tap **OK** to finish specifying device name.

- To change the confirmation screen setting when a Wi-Fi Direct compatible device is connecting to the printer

Tap C to display the confirmation screen. If you want the printer to display the screen to inform you a Wi-Fi direct compatible device is connecting to the printer, tap **Yes**.

▶▶▶ Important

- To prevent an unauthorized access, we recommend you should not change the setting from the default.

When you finished performing the settings, the printer returns to the **Direct connection settings** screen.

8. Press **HOME** button.

The HOME screen is displayed.

▶▶▶ Note

- If you change the direct connection setting of the printer, also change the wireless router setting of the device.

Printing Using a Web Service

- **Using PIXMA/MAXIFY Cloud Link**
- **Printing with Google Cloud Print**

Using PIXMA/MAXIFY Cloud Link

By using PIXMA/MAXIFY Cloud Link, you can connect your printer to a cloud service, such as CANON IMAGE GATEWAY, Evernote, or Twitter, and use the following functions without using a computer:

- Print images from a photo-sharing service
- Print documents from a data management service
- Save scanned images to a data management service.
- Use Twitter to report the printer status, such as no paper or low ink levels.

In addition, you can use various functions by adding and registering apps that are linked with various cloud services.

■ [Using PIXMA/MAXIFY Cloud Link from Your Printer](#)

■ [Using PIXMA/MAXIFY Cloud Link from Your Smartphone, Tablet, or Computer](#)



▶▶▶ Important

- In certain countries, PIXMA/MAXIFY Cloud Link may not be available or the available apps may be different.
- Some apps require that you have an account before you use those apps. For such apps, please set up an account beforehand.
- To find out which models support PIXMA/MAXIFY Cloud Link check the Canon homepage.
- The screen display may change without prior notice.

Printing with Google Cloud Print

The printer is compatible with Google Cloud Print™ (Google Cloud Print is a service provided by Google Inc.).

By using Google Cloud Print, you can print from anywhere with applications or services supporting Google Cloud Print.

Sending Print Data and Printing via Internet



Once you register the printer to Google Cloud Print, you can print from applications or services supporting Google Cloud Print without internet connection.

Sending Print Data and Printing without Going through Internet



»» Important

- This function may not be available depending on the country or region you live in.
- To use Google Cloud Print, you need to get Google account and register the printer with Google Cloud Print in advance.

Additionally, LAN connection with the printer and internet connection are required to register the printer to Google Cloud Print. Internet connection fees apply.

1. [Getting Google Account](#)
2. [Registering Printer with Google Cloud Print](#)
3. [Printing from Computer or Smartphone with Google Cloud Print](#)

»» Important

- When the printer owner changes, delete its registration from Google Cloud Print.

■ [Deleting Printer from Google Cloud Print](#)

LAN connection with the printer and internet connection are required to delete the printer from Google Cloud Print. Internet connection fees apply.

Printing Using Operation Panel

- [Printing Photo Data](#)
- [Printing Documents \(PDF File\) Saved on USB Flash Drive](#)

Printing Photo Data

- ▶ **Printing Photographs Saved on USB Flash Drive**
- ▶ **Setting Items for Photo Printing Using Operation Panel**
- ▶ **Using Useful Display Functions**

Printing Photographs Saved on USB Flash Drive

You can print the photograph saved on the USB flash drive easily.

1. [Make sure printer is turned on.](#)
2. [Load photo paper.](#)
3. [Insert USB flash drive into USB flash drive port.](#)

▶▶▶ Important

- If you already insert the USB flash drive to save the received faxes automatically, you cannot print the photographs even when the USB flash drive which contains the photo data is set.

In this case, set **Auto save setting** in **FAX settings** to **OFF** and remove the USB flash drive for saving faxes, and then insert the USB flash drive which contains the photo data.

4. Flick HOME screen and tap  **Access medium.**

■ [Using the Operation Panel](#)

The photo selection screen is displayed.

▶▶▶ Note

- When the message informing you that the operation restriction is enabled, ask the administrator of the printer you are using.
- If both photo files and PDF files are saved on the USB flash drive, the confirmation screen to select which file you print is displayed. Tap **Print photos** in the displayed screen.
- If no printable photo data is saved on the USB flash drive, **Data of supported types are not saved.** is displayed on the touch screen.
- If more than 2,000 photo data are saved on the USB flash drive, the photo data is split by group per 2,000 photos in reverse chronological order (date last modified) automatically. Check the message displayed on the touch screen and tap **OK**.

5. Specify settings as necessary.

- To select the photo to print:

Flick horizontally to select the photo.

You can also select the photo by tapping "A".

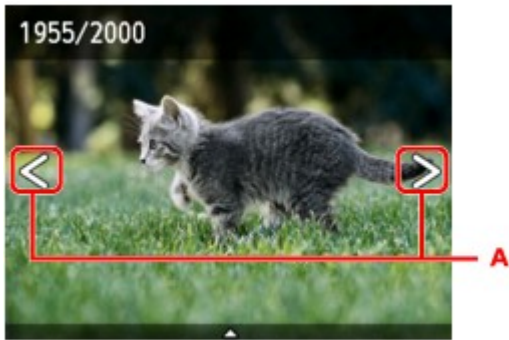

You can print a copy of the displayed photo by pressing the **Color** button.

- To change the display method, the number of copies, or the print settings:
Tap near the center of the displayed photo to display menus.

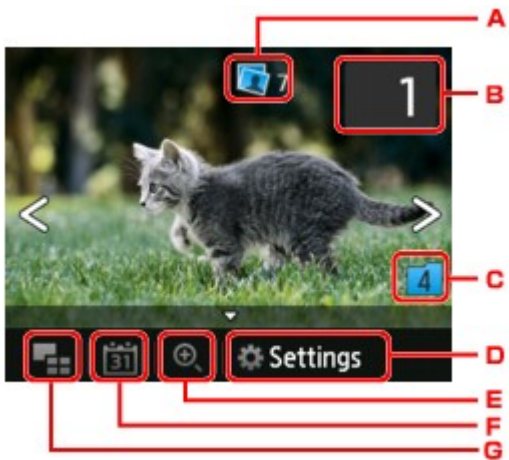

A. Total number of copies

Total number of copies is displayed.

When tapping, the **Check total no. of copies** screen is displayed and you can check the number of copies for each photo. On the **Check total no. of copies** screen, you can change the number of copies for each photo.

B. Number of copies

Tap to specify the number of copies.

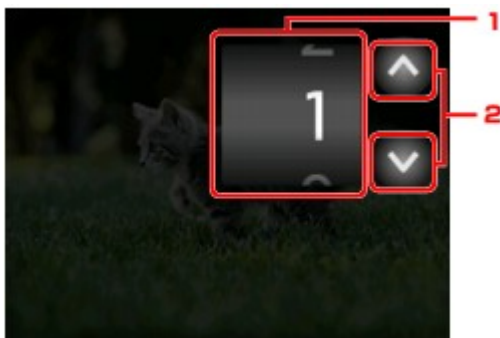

1. Flick vertically to specify the number of copies.

Tap to display the photo selection screen.

2. Tap to specify the number of copies.

Touch and hold to specify the number of copies by 10 copies.

▶▶ Note

- You can specify the number of copies for each photo. Display the photo you want to print and specify the number of copies when the desired photo is displayed.

C. Switching group

Tap to switch the photo group.

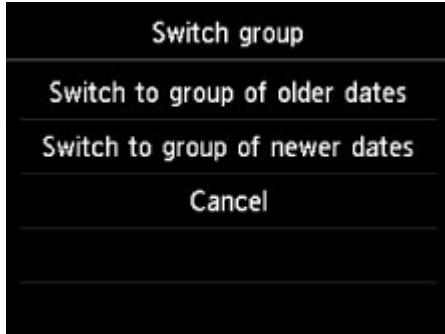

For details:

- [Using Useful Display Functions](#)

D. Settings

Tap to display the **Settings** screen.

You can change the settings of page size, media type, and print quality and so on.

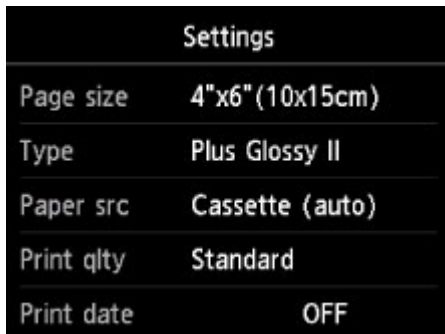

For more on the setting items:

- [Setting Items for Photo Printing Using Operation Panel](#)

E. Zooming in

Tap to zoom in on the photo.

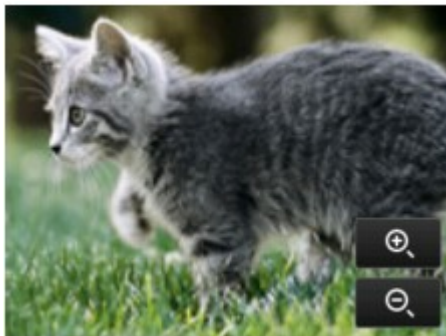

For details:

■ ■ [Using Useful Display Functions](#)

F. Date specification

Tap to select photo with specifying the date (last modified date of data).



For details:

■ ■ [Using Useful Display Functions](#)

G. Multi display

Tap to display the multiple photos at once.



For more on the display method:

■ ■ [Using Useful Display Functions](#)

6. Press **Color** button.

The printer starts printing.

▶▶▶ **Note**

- To cancel printing, press the **Stop** button.
- While processing the print job, you can add the print job (Reserve photo print).

■ ■ [Adding Print Job](#)

Adding Print Job

You can add the print job (Reserve photo print) while printing photos.

Follow the procedure below to add the print job.

1. Flick photo while printing to select next photo.

▶▶▶ Note

- While you select the photo, the printer prints the reserved photos.

- The  reserved photo icon appears on the photo included in the print job.

2. Specify the number of copies for each photo.

▶▶▶ Note

- While processing the print job, you cannot change the setting for **Page size** or **Type** on print settings confirmation screen. The setting is the same as the setting for the photo included in the print job.

3. Press **Color** button.

The reserved photo is printed next to the photo that has already been started printing.

If you want to print more photos, operate from step 1 again.

▶▶▶ Note

- While processing the print job, you cannot display the HOME screen, change the print menu, or print from the computer or other devices.
- While processing the print job, the photo in other group is not selected.
- If you press the **Stop** button while processing the print job, the screen to select a method to cancel reservation is displayed. If you tap **Cancel all reservations**, you can cancel printing all photos. If you tap **Cancel the last reservation**, you can cancel the last printing job.
- If there are many print jobs, **Cannot reserve more print jobs. Please wait a while and redo the operation.** may be displayed on the touch screen. In this case, wait a while and add the print job.



Setting Items for Photo Printing Using Operation Panel

You can specify the setting of page size, media type, photo fix and so on to print the photos saved on the USB flash drive.

Settings	
Page size	4"x6" (10x15cm) 1
Type	Plus Glossy II 2
Paper src	Cassette (auto) 3
Print qlty	Standard 4
Print date	OFF 5

Tap the setting item to display the settings. Tap to specify the setting.

▶▶▶ Note

- Some settings cannot be specified in combination with the other setting items or the print menus. If the setting which cannot be specified in combination is selected,  and **Error details** are displayed on the touch screen. In this case, tap  on the upper left on the touch screen to confirm the message and change the setting.
- The settings of the page size, media type, etc. are retained even if another print menu is selected or the printer is turned off.

1. Page size

Select the page size of the loaded paper.

▶▶▶ Note

- Only the page sizes selectable from the operation panel are displayed.

2. Type (Media type)

Select the media type of the loaded paper.

▶▶▶ Note

- Only the media types selectable from the operation panel are displayed.

3. Paper src (Paper source)

Select the cassette to feed paper.

Selecting **Cassette (auto)** allows the printer to feed paper from the cassette 2 when the cassette 1 runs out of paper under the following conditions.

- A4, Letter, or Legal sized plain paper is loaded in the cassette 1 and cassette 2.
- **Yes** is selected for **Auto feed switch** in **Cassette settings**.

4. Print qlty (Print quality)

Select print quality according to the photo.

5. Print date

Activates/deactivates to print the date (shooting date) on a photo.

▶▶ Note

- The shooting date is printed according to the settings of **Date display format** in **Device user settings** under **Device settings** under **Setup**.

■ [Device user settings](#)

Using Useful Display Functions

You can display the multiple photos at once, specify the date (last modified date of data) to select photos, and switch the photo group.

- [Viewing Multiple Photos to Select Photo](#)
- [Specifying Date to Select Photo](#)
- [Zooming in on Photo](#)
- [Switching Photo Group](#)

Viewing Multiple Photos to Select Photo

The following screen is displayed by tapping  on the photo selection screen.



- A. Tap the photo you want to print, the touch screen returns to single photo display.
- B. Tap to display photo with specifying the date.
 - [Specifying Date to Select Photo](#)
- C. Tap to increase the display photos. (54 photos display)
- D. Drag to switch the number of display photos to 6 photos, 15 photos, or 54 photos.
- E. Tap to decrease the display photos. (6 photos display)

Specifying Date to Select Photo

The following screen is displayed by tapping  on the photo selection screen.



- A. Tap to select the date (last modified date of data).

B. Tap the date to display.

The photos on date specified are displayed.

»» Note

- The date is displayed according to the settings of **Date display format** in **Device user settings** under **Device settings** under **Setup**.

■ [Device user settings](#)

Zooming in on Photo

The following screen is displayed by tapping  on the photo selection screen.



A. Tap to switch the display magnification.

B. Drag to move the display position.

Switching Photo Group

»» Note

- If more than 2,000 photo data are saved on the USB flash drive, the photo data is split by group per 2,000 photos in reverse chronological order (date last modified) automatically.

The following screen is displayed by tapping  on the photo selection screen.

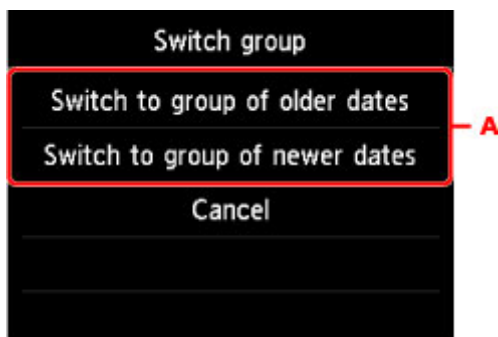

A. Tap to switch the photo group.

Printing Documents (PDF File) Saved on USB Flash Drive

You can print following PDF files (Extension: .pdf) using the operation panel of the printer.

- PDF files scanned using the operation panel of the printer and saved on a USB flash drive
 - [Saving Scanned Data on USB Flash Drive](#)
- PDF files saved on a USB flash drive when receiving faxes
 - [Saving Document in Printer's Memory to USB Flash Drive](#)
 - [Saving Received Faxes Automatically on USB Flash Drive](#)
- PDF files made using Canon IJ Scan Utility

For Windows:

- [Scanning Documents](#)

For Mac OS:

- Scanning Documents

- For more on PDF files you cannot print from the printer:

- [PDF Files You Cannot Print](#)

Follow the procedure below to print a PDF file.

1. [Make sure printer is turned on.](#)
2. [Load A4, Letter, or Legal-sized plain paper.](#)
3. [Insert USB flash drive into USB flash drive port.](#)

▶▶▶ Important

- If you already insert the USB flash drive to save the received faxes automatically, you cannot print the documents even when the USB flash drive which contains the document data is set.

In this case, set **Auto save setting** in **FAX settings** to **OFF** and remove the USB flash drive for saving faxes, and then insert the USB flash drive which contains the document data.

4. Flick HOME screen and tap  **Access medium.**

- [Using the Operation Panel](#)

The document list is displayed.

▶▶▶ Note



- When the message informing you that the operation restriction is enabled, ask the administrator of the printer you are using.
- If both photo files and PDF files are saved on USB flash drive, the confirmation screen to select which file you print is displayed. Tap **Print documents** in the displayed screen.
- If no printable document (PDF files) is saved on the USB flash drive, **Data of supported types are not saved.** is displayed on the touch screen.

5. Select document to print.

File name list

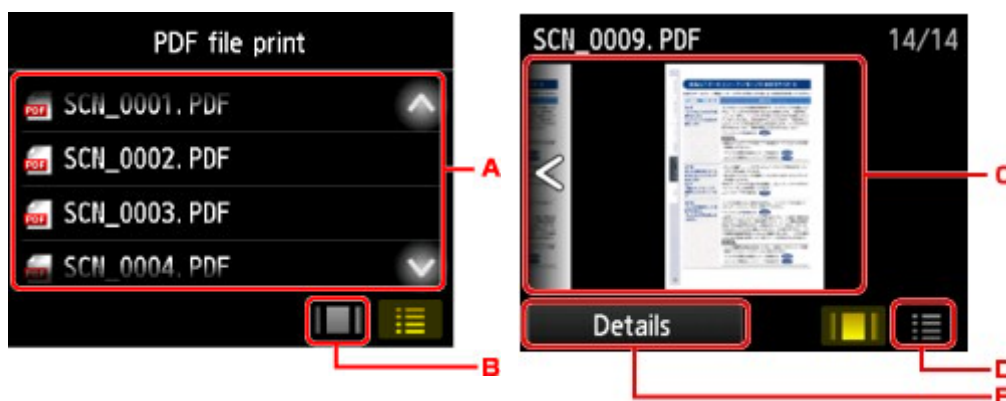
Preview display



- A. Flick vertically or tap   to display the name of documents and tap document to print.
- B. Tap to switch to the preview display.
- C. Flick to display document preview and tap document to print.
- D. Tap to switch to the file name list.
- E. Tap to display the **Details** screen.

Note

- File names may not be displayed properly on the document list if the file name is long or includes incompatible characters.
- On the preview screen, the first page of each PDF file is displayed on the touch screen. Also, if a document is in landscape format, it will be displayed rotated by 90 degrees.
- For some PDF files, it may take longer to display the preview or part of the preview may be cropped.
- The name of the PDF files is displayed even though the PDF files cannot be printed using the operation panel of the printer. If one of the following conditions is applicable to the PDF files, they are not printable.
 - PDF files saved using application software other than Canon IJ Scan Utility (application software compatible with the printer)
 - PDF files for which the preview screen is not available ("?" is displayed on the preview screen.)
- We recommend you display the **Details** screen and make sure whether a PDF file is printable. If one of the following conditions is applicable to the PDF file, it is not printable.
 - Information on the **Details** screen cannot be displayed.
 - Characters other than the printer name or **IJ Scan Utility** are displayed on **Created with**.
- The PDF files made using application software other than Canon IJ Scan Utility (application software compatible with the printer) are not printable even if they are saved using Canon IJ Scan Utility.

6. Specify settings as necessary.

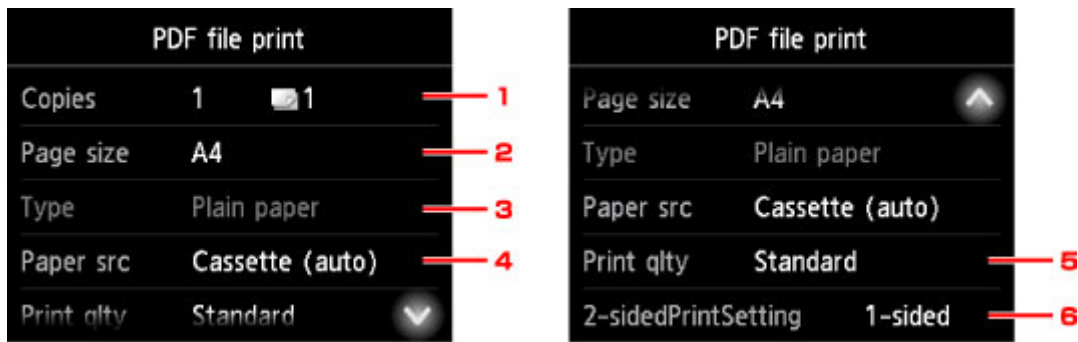

1. Copies

Specify the number of copies.

2. Page size

Select the page size depending on the loaded paper.

»» Note

- Only the page sizes selectable from the operation panel are displayed.

3. Type (Media type)

The paper type is set to **Plain paper**.

4. Paper src (Paper source)

Select the cassette to feed paper.

Selecting **Cassette (auto)** allows the printer to feed paper from the cassette 2 when the cassette 1 runs out of paper under the following conditions.

- A4, Letter, or Legal sized plain paper is loaded in the cassette 1 and cassette 2.
- **Yes** is selected for **Auto feed switch** in **Cassette settings**.

5. Print qlty (Print quality)

Specify the print quality.

6. 2-sidedPrintSetting

Select two-sided printing or single-sided printing.

If you tap **Advanced** with **2-sided** selected, you can specify the orientation and the stapling side of the document.

»» Note

- When the printer name or **IJ Scan Utility** is displayed in **Created with** on the **Details** screen, you can select **2-sided** to print onto the both sides of a single sheet of paper.

7. Press **Color** button for color printing, or **Black** button for black & white printing.

The printer starts printing.

»» Note

- You can print up to 250 pages at a time. If you try to print more than 250 pages of a PDF file, **The specified PDF file contains too many pages. The pages exceeding the number of printable pages**

will not be printed. Continue? is displayed on the touch screen. To start printing, tap **Yes**. If you need to print more than 250 pages of a PDF file, print them from a computer.

- Depending on the PDF file, it may be printed rotated by 90 degrees.
- If the document size is larger than the page size specified on the printer, the document will be printed at a reduced size. In this case, thin lines on the document may not be printed or images may be misaligned.
- For some PDF files, an error message may be displayed before printing starts or while printing is in progress.

For details, see [Message Appears](#).

PDF Files You Cannot Print

You cannot print the following PDF files even though the name of the PDF files is displayed on the list.

- Files scanned using the operation panel of the printer and saved on a USB flash drive with **Format** set to other than **PDF** or **Compact PDF**
- Files made using Canon IJ Scan Utility and one of the following conditions is applied
 - Encrypted data
 - Data more than 2 GB
 - Data including images scanned at 9601 pixels or more in the vertical and horizontal directions

Paper Settings

By registering the paper size and the media type loaded in the cassette, you can prevent the printer from misprinting by displaying the message before printing starts when the paper size or the media type of the loaded paper differs from the print settings.

▶▶▶ Note

- The default display setting is different between when you print or copy from the operation panel of the printer and when you print using the printer driver.

- [Default Setting for Displaying the Message which Prevents Misprinting](#)

- **When you insert the cassette with paper loaded:**



The screen to register the cassette paper information is displayed.

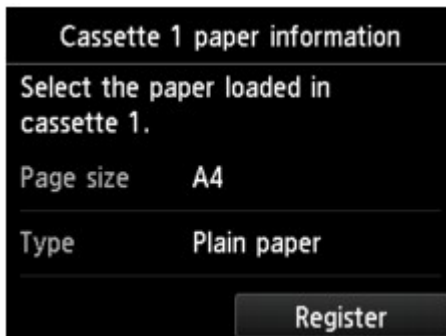

Register the paper size and the media type according to the loaded paper.

▶▶▶ Important

- For copying, specify the paper settings for copying so that they match the cassette paper information.
- For more on the proper combination of paper settings you can specify by the printer driver or on the touch screen:
 - For Windows:
 - [Paper Settings on the Printer Driver and the Printer \(Media Type\)](#)
 - [Paper Settings on the Printer Driver and the Printer \(Paper Size\)](#)

- For Mac OS:

- Paper Settings on the Printer Driver and the Printer (Media Type)
- Paper Settings on the Printer Driver and the Printer (Paper Size)

▶▶▶ Note

- Depending on the registered cassette paper information, the screen to make sure whether you apply the registered information to the paper settings for copying is displayed. If you tap **Yes**, the information is applied to the paper settings for copying.

- **When the paper settings for printing or copying are different from the cassette paper information registered to the printer:**

Ex:

- Paper setting for printing or copying: A5
- Cassette paper information registered to the printer: A4

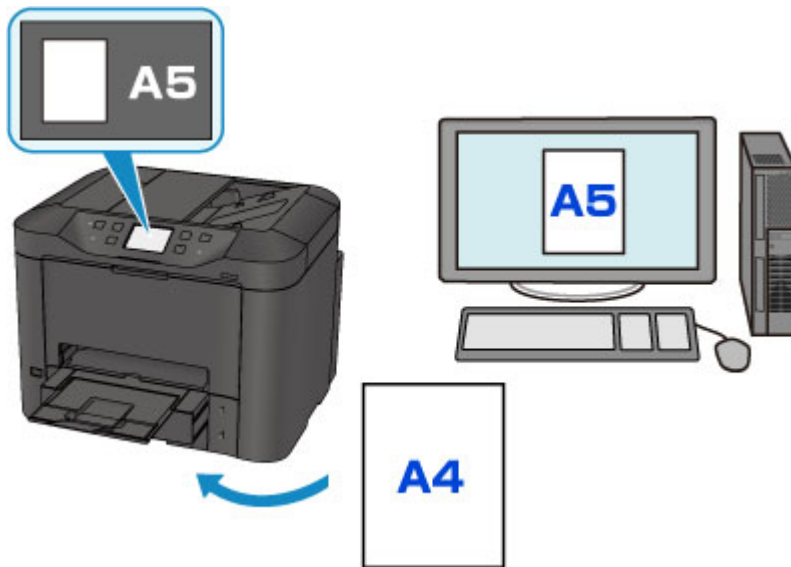

When you start printing or copying, a message is displayed.

Tapping **OK** on the touch screen displays the paper setting specified for printing or copying under the message.

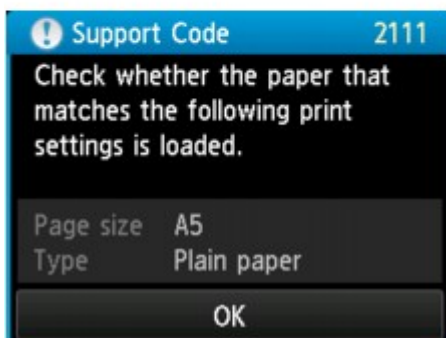
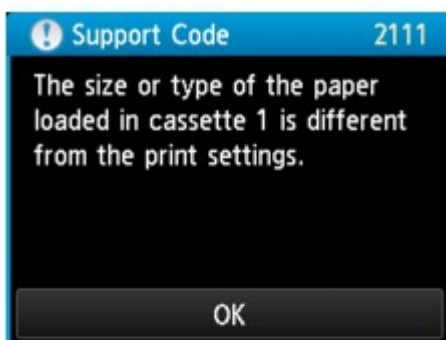

Check the message and tap **OK**. When the screen to select the operation is displayed, select one of the operations below.

»» Note

- Depending on the setting, the choices below may not be displayed.

Print with the loaded paper.

Select if you want to print on the paper loaded in the cassette without changing the paper settings.

For example, when the paper setting for printing or copying is A5 and the cassette paper information registered to the printer is A4, the printer starts printing or copying with A5 on the paper loaded in the cassette.

Replace the paper and print

Select if you want to print after replacing the paper of the cassette.

For example, when the paper setting for printing or copying is A5 and the cassette paper information registered to the printer is A4, you load A5 sized paper in the cassette before you start printing or copying.

The cassette paper information registration screen is displayed after replacing the paper and inserting the cassette. Register the cassette paper information according to the paper you loaded in the cassette.

»» Note

- If you do not know what paper information to register to the printer, press the **Back** button when the screen to select the operation is displayed. When the previous screen is displayed, check the paper size and the media type and register them to the printer.
- For more on the proper combination of paper settings you can specify by the printer driver or on the touch screen:
 - For Windows:

- [Paper Settings on the Printer Driver and the Printer \(Media Type\)](#)

- [Paper Settings on the Printer Driver and the Printer \(Paper Size\)](#)

- For Mac OS:

- Paper Settings on the Printer Driver and the Printer (Media Type)

- Paper Settings on the Printer Driver and the Printer (Paper Size)

Cancel

Cancels printing.

Select when you change the paper settings specified for printing or copying. Change the paper settings and try printing again.

Default Setting for Displaying the Message which Prevents Misprinting

- **When you print using the operation panel of the printer:**

The message which prevents misprinting is enabled by default.

To change the display setting when you copy or print using the operation panel of the printer:

- [Cassette settings](#)

- **When you print using the printer driver:**

The message which prevents misprinting is disabled by default.

To change the display setting when you print using the printer driver:

- For Windows:

- [Changing the Printer Operation Mode](#)

- For Mac OS:

- Changing the Printer Operation Mode

▶▶ Important

- When the message which prevents misprinting is disabled:

The printer starts printing or copying even though the paper settings for printing or copying and the cassette paper information registered to the printer are different.

Copying



Making Copies  **Basics**



Reducing/Enlarging Copies



Two-Sided Copying



Special Copy Menu

Making Copies

This section describes the procedure to copy with **Copy**.

1. [Make sure printer is turned on.](#)
2. [Load paper.](#)

3. Flick HOME screen and tap  **Copy**.

■ [Using the Operation Panel](#)

The Copy standby screen is displayed.

4. [Load original document on platen glass or in ADF.](#)
5. Specify settings as necessary.



- A. The scanning method and copy layout are displayed.

Switch the scanning method from the ADF and layout (single-sided/two-sided).

- B. Tap to specify the number of copies.



1. Tap the numbers to specify the number of copies.

2. Tap to confirm the number of copies.

- C. Tap to register the current print settings as a custom setting.

■ [Registering Favorite Settings \(Custom profiles\)](#)

D. Tap to display the print setting items.



For more on the setting items:

■ [Setting Items for Copying](#)

E. Tap to preview an image of the printout on the preview screen.

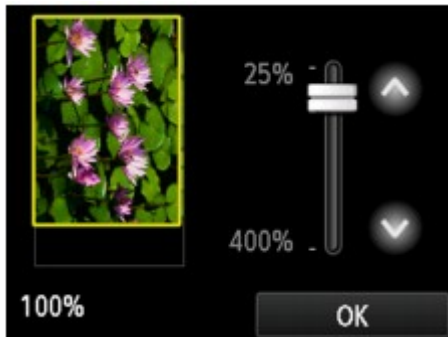

For details:

■ [Displaying Preview Screen](#)

F. Tap to specify the page size.

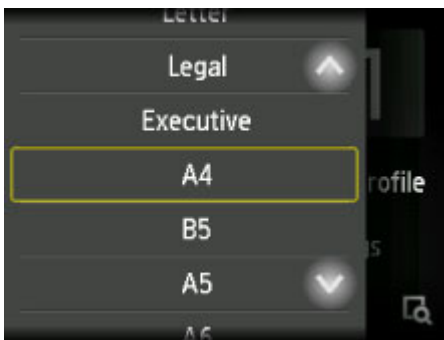

6. Press **Color** button for color copying, or **Black** button for black & white copying.

The printer starts copying.

Remove the original on the platen glass or from the document output slot after copying is complete.

▶▶▶ **Important**

- If you load the original on the platen glass, do not open the document cover or remove the original while **Scanning document...** is displayed on the touch screen.
- If you load the original in the ADF, do not move the original until copying is complete.

»» Note

- To cancel copying, press the **Stop** button.
- If you load the original on the platen glass, you can add the copying job while printing.
 - [Adding Copying Job \(Reserve copy\)](#)
- When the message informing you that the operation restriction is enabled, ask the administrator of the printer you are using.

Adding Copying Job (Reserve copy)

If you load the original on the platen glass, you can add the copying job while printing (Reserve copy).

The screen below is displayed when you can add the copying job.



Load the original on the platen glass and press the same button (the **Color** button or the **Black** button) as the one which you previously pressed.



»» Important

- When you load the original on the platen glass, move the document cover gently.

»» Note

- When **Print qlty** (print quality) is set **High**, or you load the original in the ADF, you cannot add the copying job.
- When you add the copying job, the number of copies or the settings such as the page size or media type cannot be changed.
- If you press the **Stop** button while reserve copying is in progress, the screen to select the method to cancel copying is displayed. If you tap **Cancel all reservations**, you can cancel copying all scanned data. If you tap **Cancel the last reservation**, you can cancel the last copying job.
- If you set a document of too many pages to add the copying job, **Cannot add more copy jobs. Please wait a while and redo the operation.** may appear on the touch screen. Tap **OK** and wait a while, and then try copying again.
- If **Failed to reserve the copy job. Start over from the beginning.** appears on the touch screen when scanning, tap **OK** and press the **Stop** button to cancel copying. After that, copy the documents that have not been finished copying.

Displaying Preview Screen

When  is displayed on the Copy standby screen, tapping  allows you to preview an image of the printout on the preview screen.

»» Important

- The preview screen is not available when you load the original in the ADF.
- In the following conditions,  is not displayed when the Copy standby screen is displayed.
 - **2-sided** is selected for **2-sidedPrintSetting**.
 - **2-on-1 copy** or **4-on-1 copy** is selected for **Layout**.
 - **ON** is selected for **Collate**.

When **2-sided**, **2-on-1 copy**, or **4-on-1 copy** is selected and the original is loaded on the platen glass, you can set to display the preview screen after scanning the original is finished.

- [Two-Sided Copying](#)
- [Copying Two Pages onto Single Page](#)
- [Copying Four Pages onto Single Page](#)

- The original will be scanned to display the preview image. Therefore, do not open the document cover until the preview screen is displayed.
- Originals are rescanned after displaying the preview screen and before copying starts. Therefore, do not open the document cover or remove the original from the platen glass while **Scanning document...** is displayed.

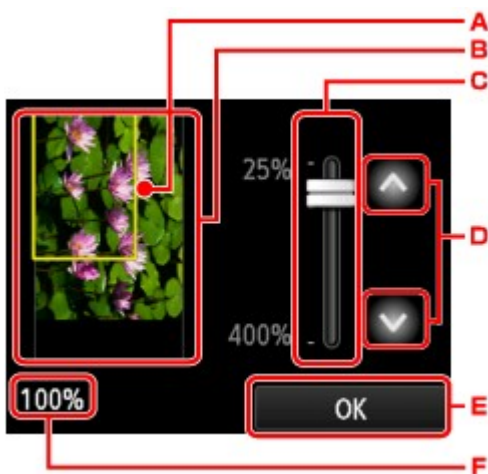

- A. A frame showing the selected page size appears over the image. The inside of the frame will be printed.
- B. The original that is set on the platen glass is displayed. Tap to select **Fit to page**. If the displayed image is skewed, refer to [Loading Originals](#) and reset the original properly, display the preview screen again and then preview the original.
- C. The magnification setting, which was set when the preview screen was displayed, is displayed. If the setting other than **Fit to page** is selected, you can change the magnification setting by dragging the bar on the touch screen.
- D. Tap to specify the magnification.



If you keep touching, the magnification is changed by 10 %.

E. Tap to return to the Copy standby screen.

F. The magnification currently specified is displayed. Tap to select **Fit to page**.



Setting Items for Copying

The following screen is displayed by tapping **Settings** on the Copy standby screen.

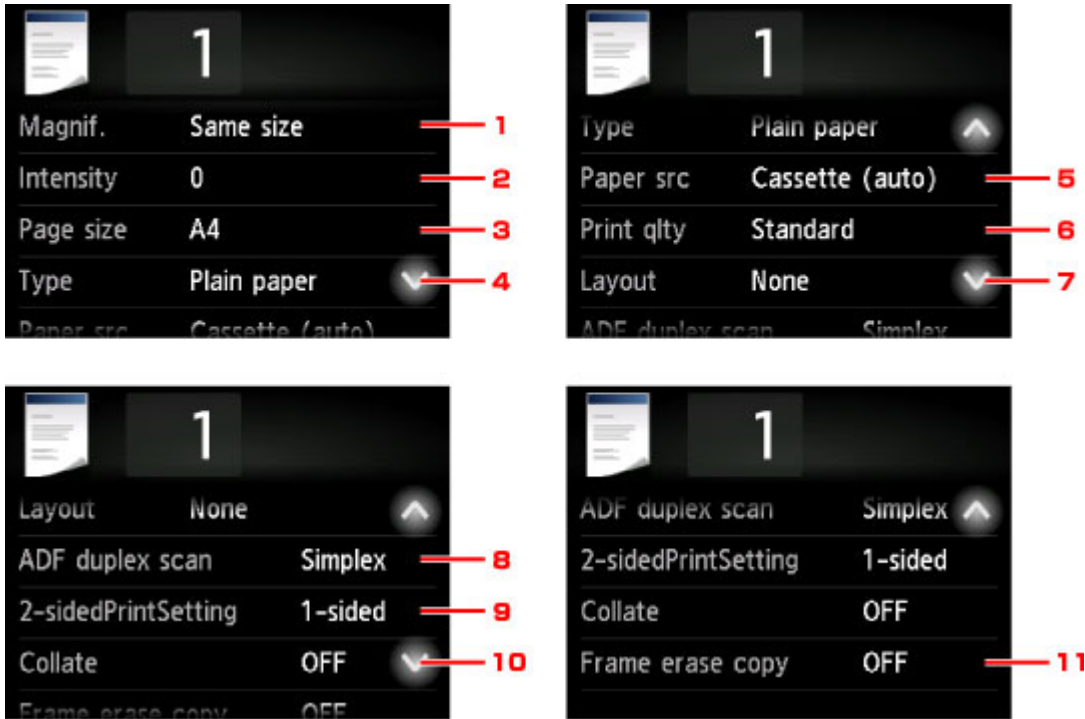
Flick vertically or tap   to display setting items and tap the setting item to display the settings. Tap to specify the setting.



▶▶▶ Note

- Some settings cannot be specified in combination with the setting of other setting item or the copy menu. If the setting which cannot be specified in combination is selected,  and **Error details** are displayed on the touch screen. In this case, tap  on the upper left on the touch screen to confirm the message and change the setting.
- The settings of the page size, media type, etc. are retained even if the printer is turned off.
- When copying starts in the copy menu that is not available with the specified setting, **The specified function is not available with current settings.** is displayed on the touch screen. Change the setting, following the on-screen instructions.

1. **Magnif.** (Magnification)

Specify the reduction/enlargement method.

 [Reducing/Enlarging Copies](#)

2. **Intensity**

Specify the intensity.



A. Tap to activate/deactivate automatic intensity adjustment.

When **ON** is selected, the intensity is adjusted automatically according to the originals loaded on the platen glass.

B. Drag to specify the intensity.

C. Tap to confirm the intensity setting.

▶▶▶ Note

- When **Auto** is selected, load the original on the platen glass. You cannot use the ADF.

3. Page size

Select the page size of the loaded paper.

▶▶▶ Note

- Only the page sizes selectable from the operation panel are displayed.

4. Type (Media type)

Select the media type of the loaded paper.

▶▶▶ Note

- Only the media types selectable from the operation panel are displayed.

5. Paper src (Paper source)

Select the cassette to feed paper.

Selecting **Cassette (auto)** allows the printer to feed paper from the cassette 2 when the cassette 1 runs out of paper under the following conditions.

- A4, Letter, or Legal sized plain paper is loaded in the cassette 1 and cassette 2.
- **Yes** is selected for **Auto feed switch** in **Cassette settings**.

6. Print qlty (Print quality)

Adjust print quality according to the original.

▶▶▶ Important

- If you use **Standard** with **Type** set to **Plain paper** and the quality is not as good as expected, select **High** for **Print qlty** and try copying again.

- Select **High** for **Print qlty** to copy in grayscale. Grayscale renders tones in a range of grays instead of black or white.

7. Layout

Select the layout.

- [Copying Two Pages onto Single Page](#)
- [Copying Four Pages onto Single Page](#)
- [Copying ID Card to Fit onto Single Page](#)

8. ADF duplex scan

Select whether to perform duplex scanning from the ADF.

- [Two-Sided Copying](#)

9. 2-sidedPrintSetting

Select whether to perform two-sided copying.

- [Two-Sided Copying](#)

10. Collate

Select whether to obtain sorted printouts when making multiple copies of a multi-paged original.

- [Collated Copying](#)

11. Frame erase copy

When copying thick originals such as books, you can make a copy without black margins around the image and gutter shadows.

- [Copying Thick Originals Such as Books](#)

Reducing/Enlarging Copies

You can specify the magnification optionally or select the preset-ratio copying or fit-to-page copying.

The screen below is displayed when you tap **Settings** in the Copy standby screen and tap **Magnif.** to select the reduction/enlargement method.

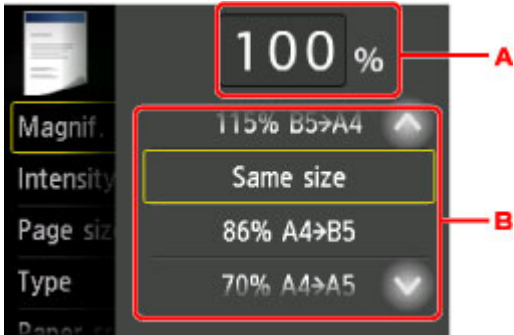

A. Tap to display the screen below.

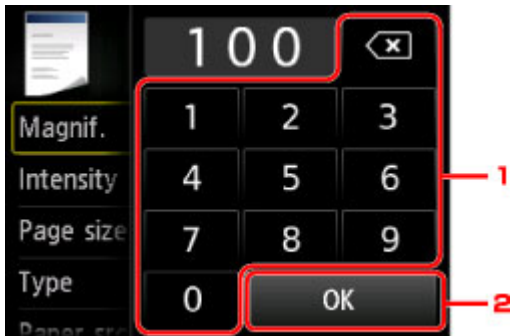

1. Tap the numbers to specify the magnification.

■ [Ratio specified copy](#)

2. Tap to confirm the magnification.

B. Flick vertically or tap   to specify the magnification.

■ [Preset ratio](#)

Reduction/enlargement Method

▶▶▶ Note

- Some of the reduction/enlargement methods are not available depending on the copy menu.

- Fit to page

The printer automatically reduces or enlarges the image to fit the page size.



The setting in **Magnif.:** **Fit to page**

►►► Note

- When you select **Fit to page**, the page size may not be detected correctly depending on the original. In this case, select the setting other than **Fit to page**.

- Ratio specified copy

You can specify the copy ratio as a percentage to reduce or enlarge copies.

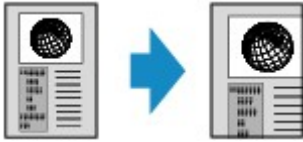

- Preset ratio

You can select one of the preset ratios to reduce or enlarge copies.

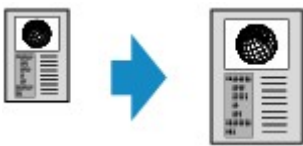

Select the appropriate ratio for size of original and page size.

The setting in **Magnif.:** **70% A4->A5/86% A4->B5/94% A4->LTR/115% B5->A4/141% A5->A4/156% 5x7->LTR/183% 4x6->LTR**

►►► Note

- Some of the preset ratios are not available depending on the country or region of purchase.

►►► Note

- **400% MAX** (maximum copy ratio) and **25% MIN** (minimum copy ratio) are selectable.
- If you make a copy at the same size as the original, select **Same size**.

Two-Sided Copying

When you select **2-sided** for **2-sidedPrintSetting** in **Copy**, you can copy two original pages onto the both sides of a single sheet of paper.

In addition, when you select **Duplex** for **ADF duplex scan**, you can perform duplex scanning.

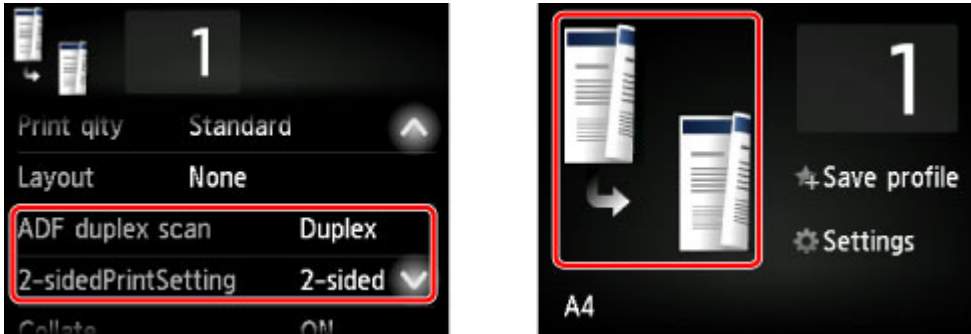

Specify the place to load originals or copy settings according to the two-sided copying method.

- **Single-sided to Two-sided**

Place to load the original: platen glass or ADF

ADF duplex scan: Simplex

2-sidedPrintSetting: 2-sided

When you tap **Advanced** after tapping **2-sided** for **2-sidedPrintSetting**, you can select the orientation and the stapling side of the paper. Also, you can select whether to display the preview screen when you load the original on the platen glass.

- When you select **Orientation: Portrait** and **Output: Long side bind**:



- When you select **Orientation: Portrait** and **Output: Short side bind**:



- When you select **Orientation: Landscape** and **Output: Long side bind**:



- When you select **Orientation: Landscape** and **Output: Short side bind**:



- **Two-sided to Single-sided**

Place to load the original: ADF

ADF duplex scan: Duplex

2-sidedPrintSetting: 1-sided

When you tap **Advanced** after tapping **Duplex** for **ADF duplex scan**, you can select the orientation and the stapling side of the original.

- When you select **Orientation: Portrait** and **Original: Long side bind**:



- When you select **Orientation: Portrait** and **Original: Short side bind**:



- When you select **Orientation: Landscape** and **Original: Long side bind**:



- When you select **Orientation: Landscape** and **Original: Short side bind**:



- **Two-sided to Two-sided**

Place to load the original: ADF

ADF duplex scan: Duplex

2-sidedPrintSetting: 2-sided

When you select **Duplex** for **ADF duplex scan** and tap **Advanced**, you can select the orientation and the stapling side of the original. When you select **2-sided** for **2-sidedPrintSetting** and tap **Advanced**, you can select the orientation and the stapling side of the paper.

- When you select **Orientation: Portrait** for the orientation and **Original: Long side bind** and **Output: Long side bind** for the stapling side:

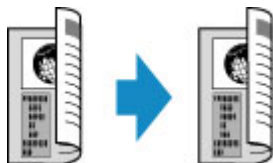

- When you select **Orientation: Portrait** for the orientation and **Original: Short side bind** and **Output: Short side bind** for the stapling side:



- When you select **Orientation: Landscape** for the orientation and **Original: Long side bind** and **Output: Long side bind** for the stapling side:



- When you select **Orientation: Landscape** for the orientation and **Original: Short side bind** and **Output: Short side bind** for the stapling side:



When the stapling sides specified for **Duplex** and **2-sided** are different, the originals are copied so that the page is flipped vertically.

Ex: When you select **Orientation: Landscape**, **Original: Long side bind**, and **Output: Short side bind**:



After selecting the stapling side, you can select whether you use the preview screen. If you tap **ON**, the preview screen is displayed so that you can check the orientation.

▶▶▶ Note

- Two-sided copy setting can be used in combination with **2-on-1 copy** or **4-on-1 copy**.
 - [Copying Two Pages onto Single Page](#)
 - [Copying Four Pages onto Single Page](#)
- If you are copying in black & white, print intensity of the Two-sided copy may differ from that of a single-sided copy.

When Loading the Original on the platen glass:

- **Before scanning:**

When you select **2-sided** for **2-sidedPrintSetting** and the preview function is activated, the printer starts pre-scanning before scanning the original. When pre-scanning is finished, the screen below (preview screen) the screen below (preview screen) appears on the touch screen.

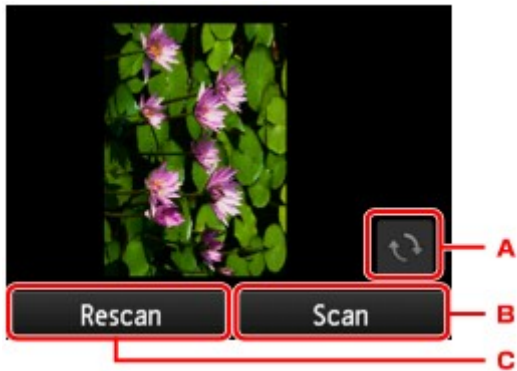

- A. Tap to rotate the original by 180 degrees.
- B. Tap to start scanning the original.
- C. Tap to rescan the original.

• **After scanning:**

The screen below appears after scanning each sheet of original.

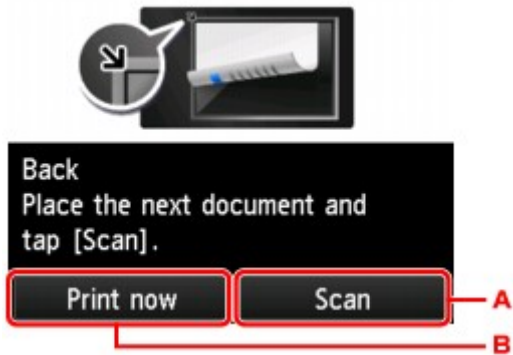

- A. Tap to start scanning the original.

Remove the sheet of original from the platen glass after scanning and load the next sheet on the platen glass and tap **Scan**.

- B. Tap to start copying the original already scanned.

»» **Note**

- You can add the copying job while printing.

■ [Adding Copying Job \(Reserve copy\)](#)

Special Copy Menu

- **Copying Two Pages onto Single Page**
- **Copying Four Pages onto Single Page**
- **Copying Thick Originals Such as Books**
- **Copying ID Card to Fit onto Single Page**
- **Collated Copying**

Copying Two Pages onto Single Page

When you select **2-on-1 copy** for **Layout** in **Copy**, you can copy two original pages onto a single sheet of paper by reducing each image.

Tap **Settings** on the Copy standby screen to display the print settings screen and select **2-on-1 copy** for **Layout**.

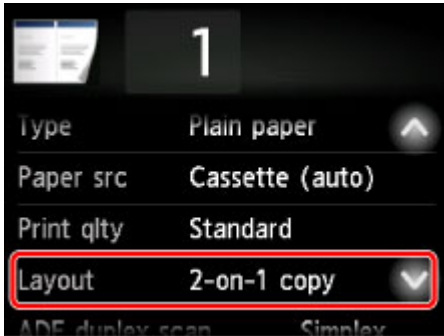

Select **2-on-1 copy** and tap **OK**.

If you tap **Advanced** with **2-on-1 copy** selected, you can specify the orientation and the order of the original.

- When you select **Orientation: Portrait** and **Left to right**:



- When you select **Orientation: Portrait** and **Right to left**:



- When you select **Orientation: Landscape** and **Top to bottom**:

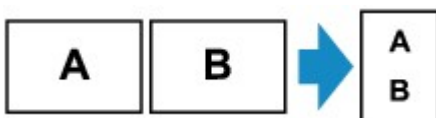

- When you select **Orientation: Landscape** and **Bottom to top**:

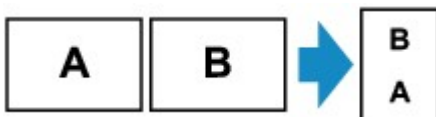

After selecting the order, you can select whether you use the preview screen. If you tap **ON**, the preview screen is displayed so that you can check the orientation.

»» Note

- This function can be used in combination with Two-sided copy.

If you use this function in combination, you can copy four original pages on one sheet of paper. In this case, two original pages are copied on each side of paper.

If you use this function in combination, select the two-sided copy setting for **ADF duplex scan** and **2-sidedPrintSetting** and select the stapling side of print paper on the Print settings screen.

For more on two-sided copy function:

■ [Two-Sided Copying](#)

When Loading the Original on the platen glass:

• Before scanning:

When the preview function is activated, the printer starts pre-scanning before scanning the original. When pre-scanning is finished, the screen below (preview screen) appears on the touch screen.

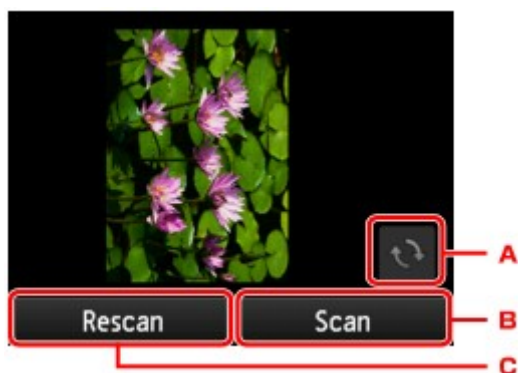

A. Tap to rotate the original by 180 degrees.

B. Tap to start scanning the original.

C. Tap to rescan the original.

• After scanning:

The screen below appears after scanning each sheet of original.

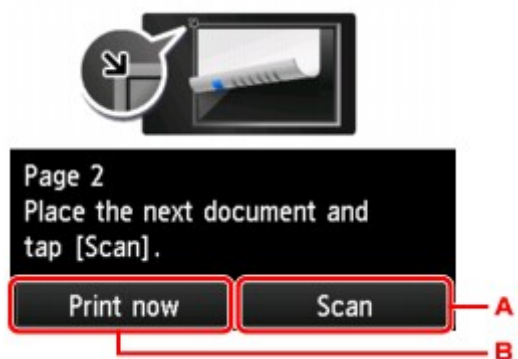

A. Tap to start scanning the original.

Remove the sheet of original from the platen glass after scanning and load the next sheet on the platen glass and tap **Scan**.

B. Tap to start copying the original already scanned.

▶▶▶ Note

- You can add the copying job while printing.

■ [Adding Copying Job \(Reserve copy\)](#)

- If you use this function in combination with Two-sided copy, the screen above is displayed after scanning the second sheet of original is complete. Follow the on-screen instructions to scan the third and fourth sheet of original.
-

Copying Four Pages onto Single Page

When you select **4-on-1 copy** for **Layout** in **Copy**, you can copy four original pages onto a single sheet of paper by reducing each image. Four different layouts are available.

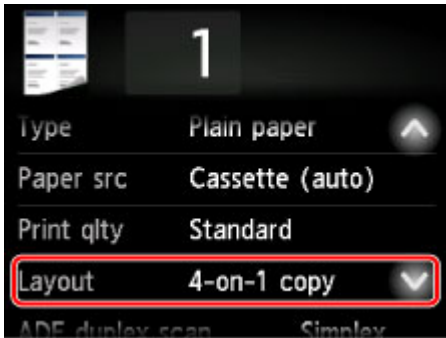

Select **4-on-1 copy** and tap **OK**.

If you tap **Advanced** with **4-on-1 copy** selected, you can specify the orientation and the order of the original.

▶▶▶ Note

- The order is the same regardless of the orientation.

- When you select **Upper-left to right**

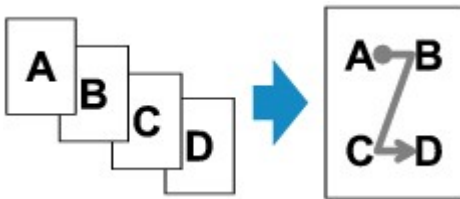

- When you select **Upper-right to left**

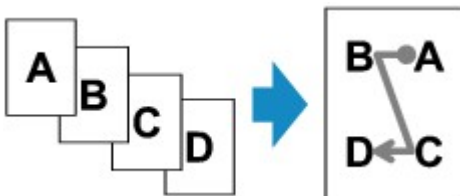

- When you select **Upper-left to bottom**

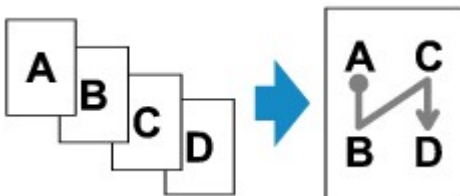

- When you select **Upper-right to bottom**

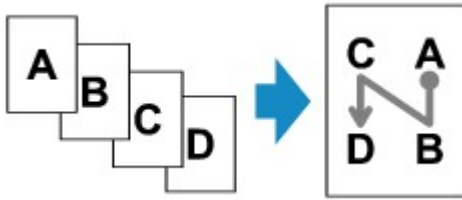

After selecting the order, you can select whether you use the preview screen. If you tap **ON**, the preview screen is displayed so that you can check the orientation.

▶▶▶ Note

- This function can be used in combination with Two-sided copy.

If you use this function in combination, you can copy eight original pages on one sheet of paper. In this case, four original pages are copied on each side of paper.

If you use this function in combination, select the two-sided copy setting for **ADF duplex scan** and **2-sidedPrintSetting** and select the stapling side of print paper on the Print settings screen.

For more on two-sided copy function:

■ [Two-Sided Copying](#)

When Loading the Original on the platen glass:

- **Before scanning:**

When the preview function is activated, the printer starts pre-scanning before scanning the original. When pre-scanning is finished, the screen below (preview screen) appears on the touch screen.

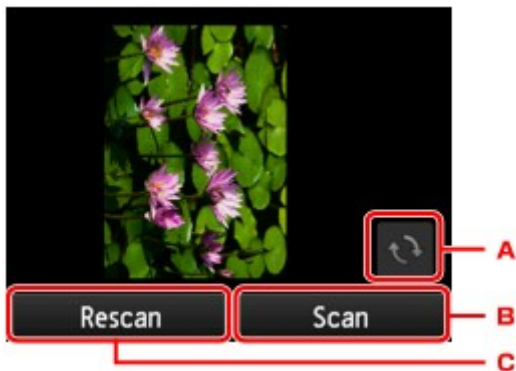

- A. Tap to rotate the original by 180 degrees.
- B. Tap to start scanning the original.
- C. Tap to rescan the original.

- **After scanning:**

The screen below appears after scanning each sheet of original.

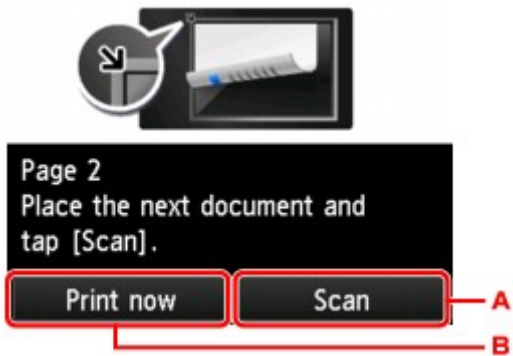

A. Tap to start scanning the original.

Remove the sheet of original from the platen glass after scanning and load the next sheet on the platen glass and tap **Scan**.

B. Tap to start copying the original already scanned.

▶▶▶ Note

- You can add the copying job while printing.
 - [Adding Copying Job \(Reserve copy\)](#)
- If you use this function in combination with Two-sided copy, the screen above is displayed after scanning the fourth sheet of original is complete. Follow the on-screen instructions to scan the rest of originals.

Copying Thick Originals Such as Books

When **ON** is selected for **Frame erase copy** in **Copy**, you can make a copy without black margins around the image and gutter shadows in copying thick originals such as books. Using this function, you can reduce unnecessary ink consumption.

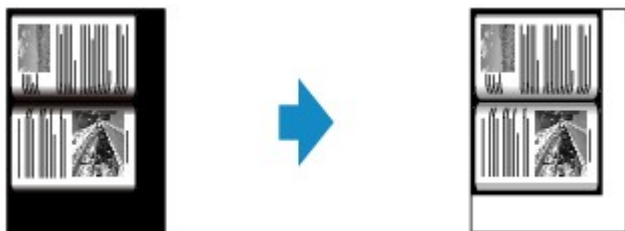

▶▶ Note

- When you use this function, load the original on the platen glass and close the document cover.
- When the Copy standby screen is displayed, tapping  allows you to preview an image of the printout on the preview screen.
 - [Displaying Preview Screen](#)
- There may be a narrow black margin that appears around the image. This function removes the dark margins only. If a scanned book is too thin or when the printer is used near a window or in a bright environment, a faint black frame may remain. Also, if the color of an original is dark, the printer cannot distinguish the document color from the shadow and this may cause slight cropping or a shadow on the crease.

Copying ID Card to Fit onto Single Page

When you select **ID card copy** for **Layout** in **Copy**, you can copy a card sized original such as an ID card onto a single sheet of paper.

Tap **Settings** on the Copy standby screen to display the print settings screen and select **ID card copy** for **Layout**.

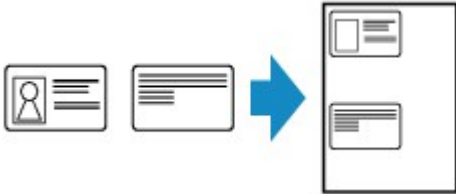

Check the message and tap **OK**.

You can check printing result of the front side using the preview screen.

■ [Using Preview Screen to Check Printing Result of Front Side](#)

▶▶▶ Note

- When you use this function, load the original on the platen glass.

Pressing the **Color** or **Black** button displays the screen below.

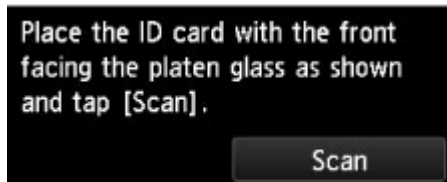

Load the original on the platen glass following the on-screen instructions and tap **Scan**.

When the front side has been scanned, the screen below appears.

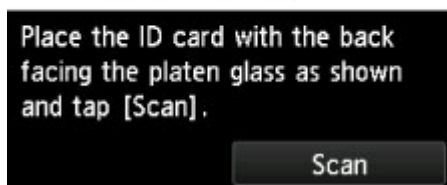

Load the original on the platen glass following the on-screen instructions and tap **Scan**.

The printer starts copying.

Remove the original on the platen glass after copying is complete.

Using Preview Screen to Check Printing Result of Front Side

Tapping  before loading the original on the platen glass displays how to load the original on the touch screen. Loading the original following the on-screen instructions and tapping **Scan** displays the preview screen to check the printing result of the front side. Pressing the **Color** or **Black** button starts scanning the front side.

▶▶▶ Note

- Tapping **OK** on the preview screen returns to Copy standby screen.

When the front side has been scanned, the screen below appears.

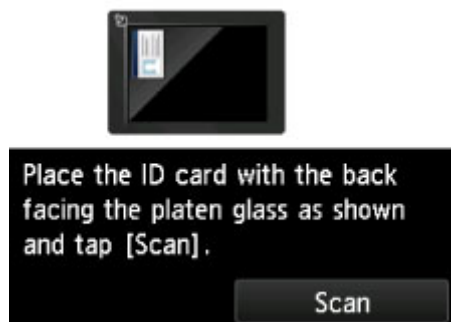

Load the original on the platen glass following the on-screen instructions and tap **Scan**.

The printer starts copying.

Remove the original on the platen glass after copying is complete.

Collated Copying

You can obtain sorted printouts when making multiple copies of a multi-paged original.

When you select **ON** for **Collate** in **Copy**, you can obtain sorted printouts when making multiple copies of a multi-paged original. In addition, you can copy originals on both sides of paper.

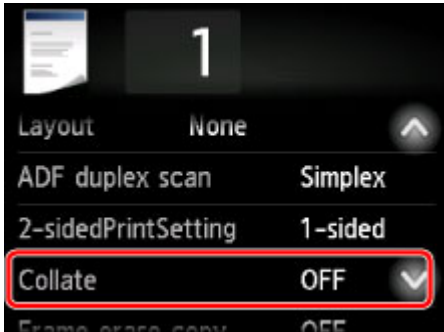

- When **ON** is selected:

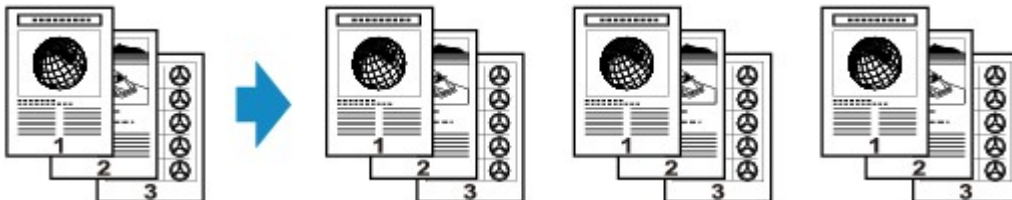

- When **OFF** is selected:



▶▶▶ Note

- When you use this function, load the original in the ADF.
- The number of pages the printer can read varies with the document. If **Device memory is full. Cannot continue process.** appears on the touch screen when scanning, reduce the number of document pages to scan and try copying again.

Collated Copying in Combination with Two-Sided Copying

Collated copying is also available when two-sided copying is selected.

If you use this function in combination, select the two-sided copy setting for **ADF duplex scan** and **2-sidedPrintSetting** and select the stapling side of print paper on the Print settings screen.



See [Two-Sided Copying](#) for two-sided copying.

Copying from Smartphone/Tablet

Installing Canon PRINT Inkjet/SELPHY on your smartphone/tablet allows you to perform copy settings or operations from your smartphone/tablet.

Canon PRINT Inkjet/SELPHY is a Canon-made application and can be downloaded from App Store and Google Play.

- For iOS
- For Android

1. [Make sure machine is turned on.](#)
2. [Load paper.](#)
3. Connect machine and your smartphone/tablet.
 - Connection with a wireless router:
 - [Wireless Connection](#)
 - Connection without a wireless router:
 - [Using Machine with Direct Connection](#)
4. Start application "Canon PRINT Inkjet/SELPHY" from your smartphone/tablet.
5. Make sure your machine is selected.

If not, select your machine.
6. Tap **Copy** on application.
7. Specify settings as necessary.

The setting items below are available.

 - **Copies**
 - **Paper Size**
 - **Media Type**
 - **Magnification**
 - **Copy Intensity**
 - **Print Quality**
8. [Load original document on platen glass.](#)
9. Tap **Color** on application for color copying or **Black** for black & white copying.

10. If screen asking you to enter password is displayed, enter password and tap **OK** on application.

The machine starts copying.

»» Important

- The password is set at the time of purchase. The password is the printer serial number. The printer serial number is printed on the sticker attached on the printer. It consists of 9 alphanumeric characters (four alphabets followed by five numbers).

For details on setting password, see [Setting Password](#).

Scanning

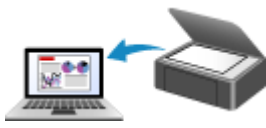

Scanning from Computer (Windows)



Scanning from Computer (Mac OS)



Scanning from Operation Panel



Scanning Using Smartphone/Tablet

Scanning from Computer (Windows)

- ▶ **Using IJ Scan Utility**
- ▶ **Scanning Using Application Software (ScanGear)**
- ▶ **Other Scanning Methods**
- ▶ **IJ Network Scanner Selector EX2 Menu and Setting Screen**
- ▶ **Scanning Tips**
- ▶ **Positioning Originals (Scanning from Computer)**
- ▶ **Network Scan Settings**

Using IJ Scan Utility

- ▶ **What Is IJ Scan Utility (Scanner Software)?**
- ▶ **Starting IJ Scan Utility**
- ▶ **Scanning Documents** ▼ **Basics**
- ▶ **Scanning Photos**
- ▶ **Scanning with Favorite Settings**
- ▶ **Scanning Originals Larger than the Platen (Image Stitch)**
 - **Adjusting Cropping Frames in the Image Stitch Window**
- ▶ **Extracting Text from Scanned Images (OCR)**
- ▶ **Sending Scanned Images via E-mail**
- ▶ **Scanning Multiple Originals at One Time**
- ▶ **Scanning Multiple Documents at One Time from the ADF (Auto Document Feeder)**
- ▶ **Scanning Both Sides of Each Document at One Time**
- ▶ **Saving after Checking Scan Results**
- ▶ **IJ Scan Utility Screens**

What Is IJ Scan Utility (Scanner Software)?

IJ Scan Utility is an application that allows you to easily scan documents, photos, etc.

You can complete from scanning to saving at one time by simply clicking the corresponding icon in the IJ Scan Utility main screen.

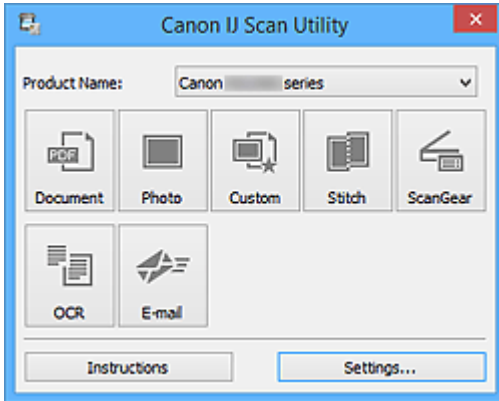

What You Can Do with IJ Scan Utility

Scan Easily according to Purposes

You can scan by simply clicking an icon such as **Document** to sharpen text in a document or magazine for better readability, or **Photo** to scan with settings suitable for photos, according to the item type or your purpose.

►►► Note

- Refer to "[IJ Scan Utility Main Screen](#)" for details on the IJ Scan Utility main screen.

Save Scanned Images Automatically

Scanned images are automatically saved in a preset folder. You can change the folder as required.

►►► Note

- The default save folders are as follows.
 - **Windows 10/Windows 8.1/Windows Vista:**
Documents folder
 - **Windows 8/Windows 7:**
My Documents folder
- Refer to "[Settings Dialog Box](#)" for how to specify a folder.

Integrate with Applications

You can utilize scanned images through integration with other applications; display scanned images in your favorite application, attach them to e-mails, extract text from images, and more.

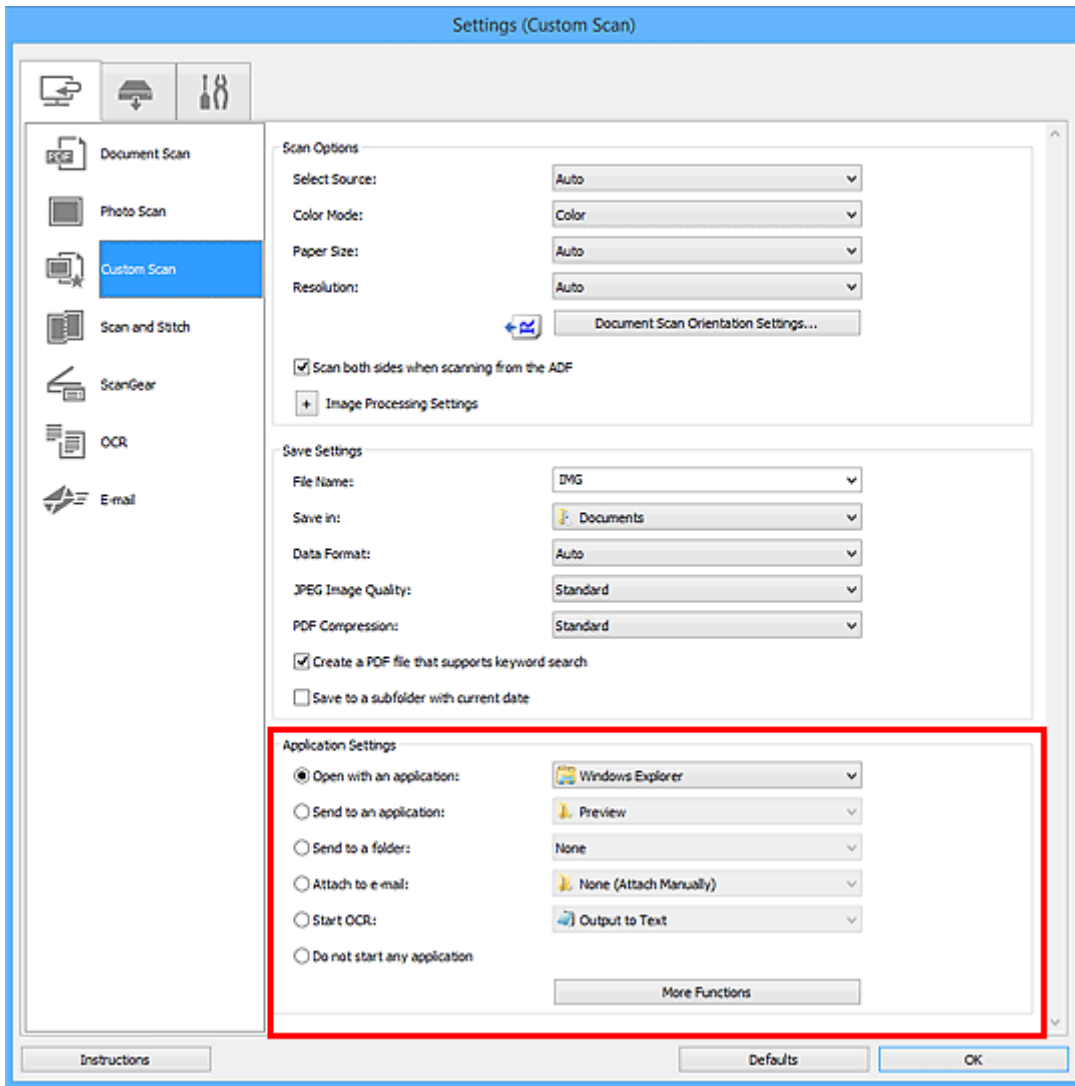

►►► **Note**

- Refer to "[Settings Dialog Box](#)" for how to set the applications to integrate with.

Starting IJ Scan Utility

▶▶▶ Note

- If you have more than one scanner or have changed the connection from USB connection to network connection, set up the network environment from IJ Scan Utility.

■ [Network Scan Settings](#)

Follow the steps below to start IJ Scan Utility.

Windows 10:

From **Start** menu, select **All apps > Canon Utilities > IJ Scan Utility**.

Windows 8.1/Windows 8:

Select **IJ Scan Utility** on the Start screen.

If **IJ Scan Utility** is not displayed on the Start screen, select the **Search** charm, and then search for "IJ Scan Utility".

Windows 7/Windows Vista:

From **Start** menu, select **All Programs > Canon Utilities > IJ Scan Utility > IJ Scan Utility**.

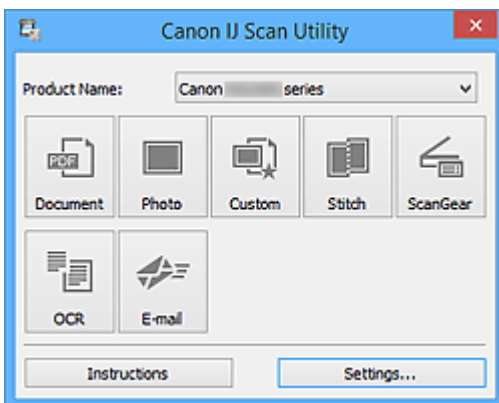

Scanning Documents

You can scan items placed on the platen with settings suitable for documents.

1. Place the item on the platen.

■ [Positioning Originals \(Scanning from Computer\)](#)

2. [Start IJ Scan Utility.](#)

3. Click **Settings...**, then set the paper size, resolution, etc. in the [Settings \(Document Scan\) dialog box](#) as required.

When setting is completed, click **OK**.

4. Click **Document**.

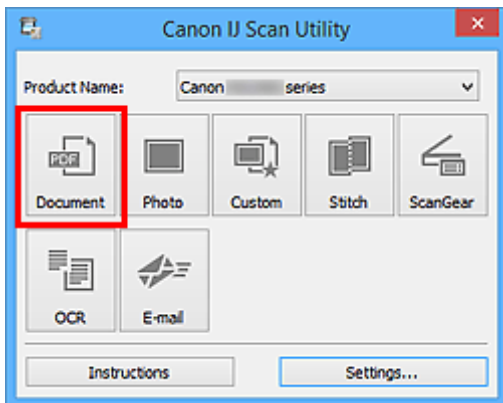

Scanning starts.

▶▶▶ Note

- Click **Cancel** to cancel the scan.
- Scanned images are saved in the folder set for **Save in** in the [Settings \(Document Scan\) dialog box](#) displayed by clicking **Settings...**. In the **Settings (Document Scan)** dialog box, you can also make advanced scan settings.

Scanning Photos

You can scan photos placed on the platen with settings suitable for photos.

1. Place the photo on the platen.

■ [Positioning Originals \(Scanning from Computer\)](#)

2. [Start IJ Scan Utility.](#)

3. Click **Settings...**, then set the paper size, resolution, etc. in the [Settings \(Photo Scan\) dialog box](#) as required.

When setting is completed, click **OK**.

4. Click **Photo**.

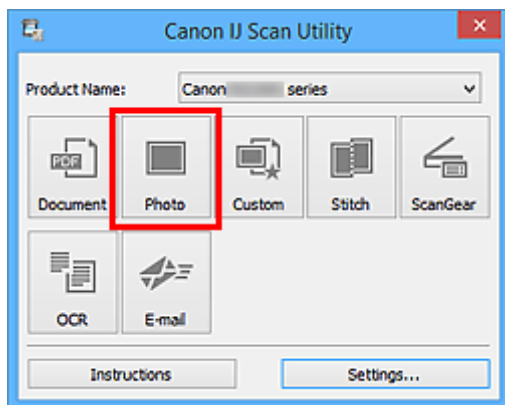

Scanning starts.

▶▶▶ Note

- Click **Cancel** to cancel the scan.
- Scanned images are saved in the folder set for **Save in** in the [Settings \(Photo Scan\) dialog box](#) displayed by clicking **Settings...**. In the **Settings (Photo Scan)** dialog box, you can also make advanced scan settings.

Scanning with Favorite Settings

You can scan items placed on the platen with your favorite settings saved beforehand.

This is convenient for saving frequently used settings or when specifying scan settings in detail.

1. [Start IJ Scan Utility](#).
2. Click **Settings...**, then set the item type, resolution, etc. in the [Settings \(Custom Scan\) dialog box](#) as required.

When setting is completed, click **OK**.

▶▶▶ Note

- Once the settings are made, you can scan with the same settings from the next time.

3. Place the item on the platen.

■ [Positioning Originals \(Scanning from Computer\)](#)

4. Click **Custom**.

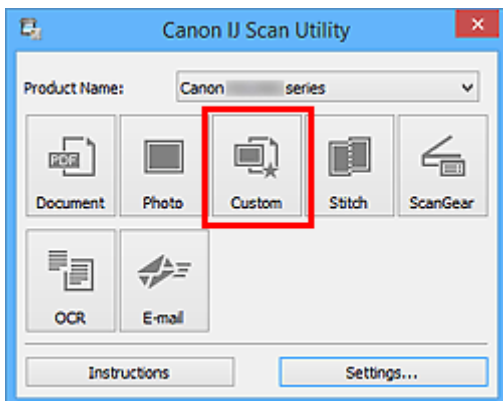

Scanning starts.

▶▶▶ Note

- Click **Cancel** to cancel the scan.
- Scanned images are saved in the folder set for **Save in** in the [Settings \(Custom Scan\) dialog box](#) displayed by clicking **Settings...**. In the **Settings (Custom Scan)** dialog box, you can also make advanced scan settings.

Scanning Originals Larger than the Platen (Image Stitch)

You can scan the left and right halves of an item larger than the platen and combine them back into one image. Items up to approximately twice as large as the platen are supported.

»»» Note

- The following explains how to scan from the item to be placed on the left side.

1. [Start IJ Scan Utility](#).
2. Click **Settings...**, then set the item type, resolution, etc. in the [Settings \(Scan and Stitch\) dialog box](#) as required.

When setting is completed, click **OK**.

3. Click **Stitch**.

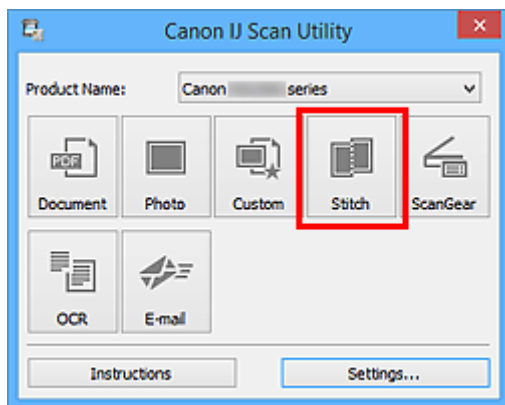

The **Image Stitch** window appears.

4. In **Select Output Size**, select an output size according to the paper size.

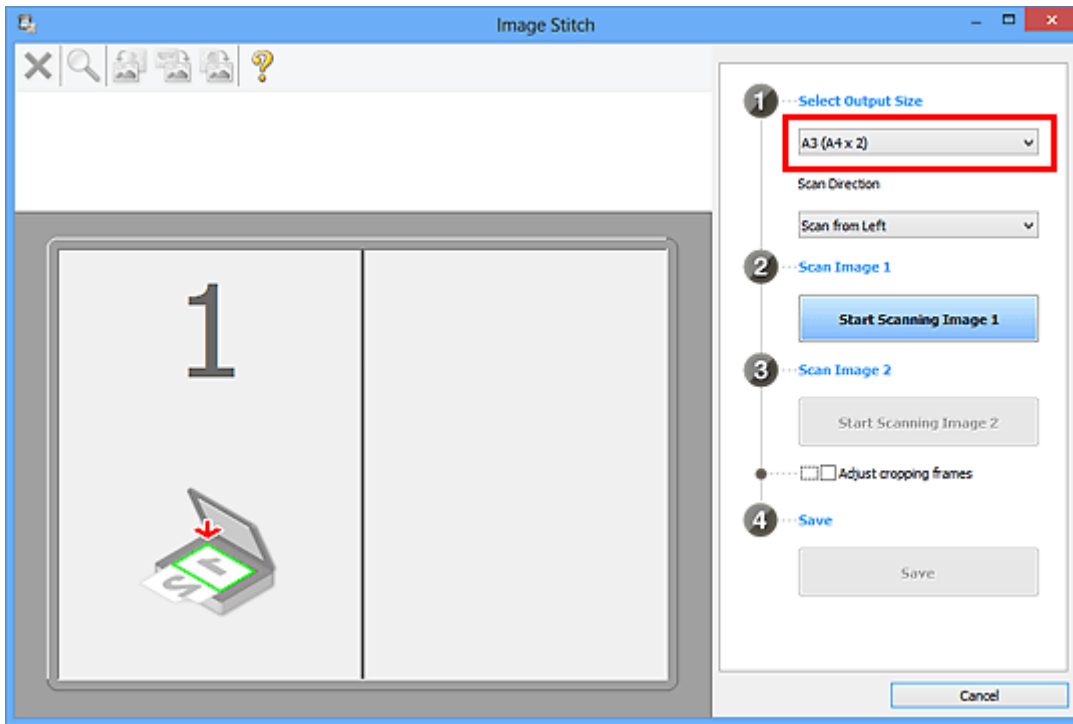

5. Make sure that **Scan from Left** is selected in **Scan Direction**.

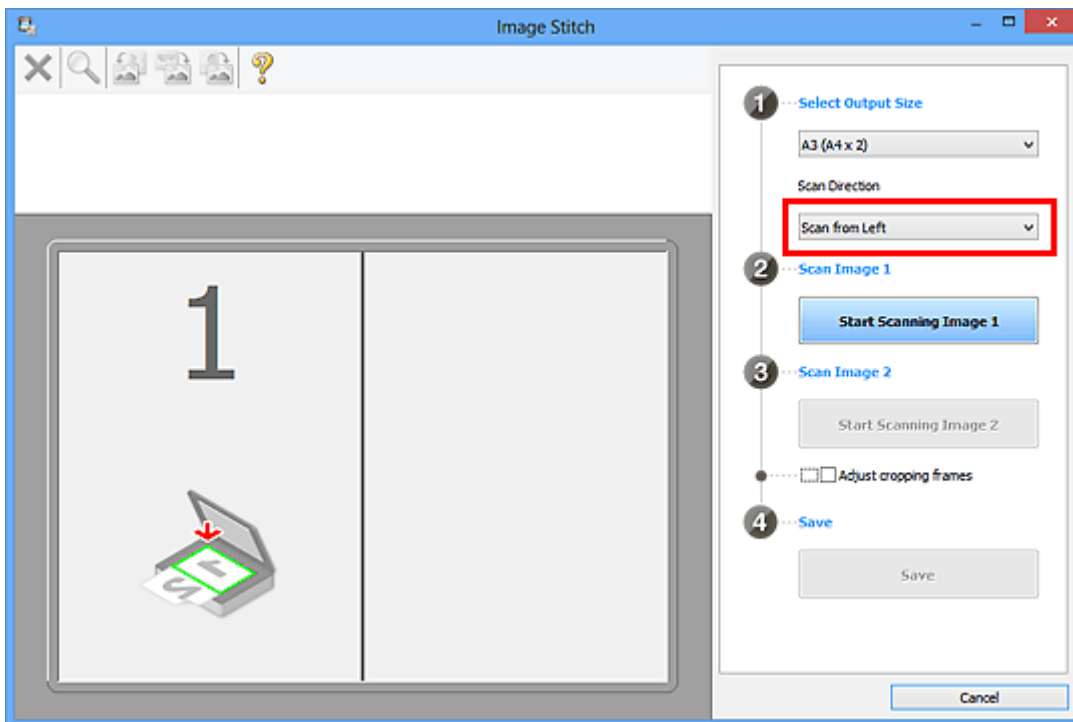

6. Place the item that is to be displayed on the left side of the screen face-down on the platen.

7. Click **Start Scanning Image 1**.

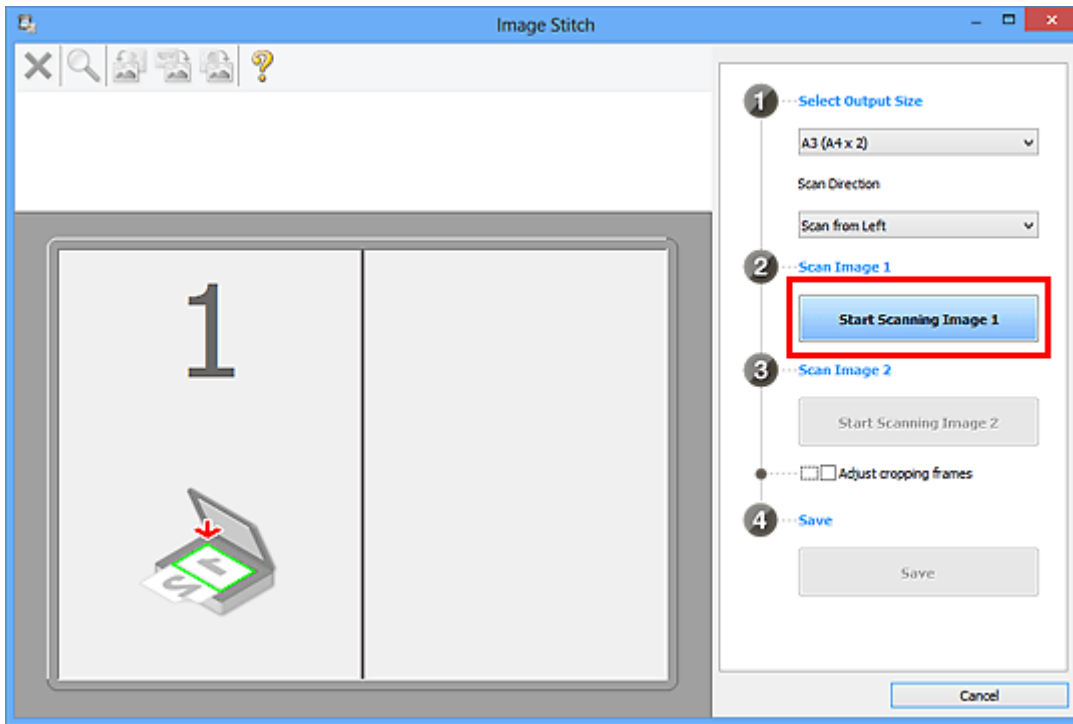

The first item is scanned and appears in 1.

►► Note

- Click **Cancel** to cancel the scan.

8. Place the item that is to be displayed on the right side of the screen face-down on the platen.

9. Click **Start Scanning Image 2**.

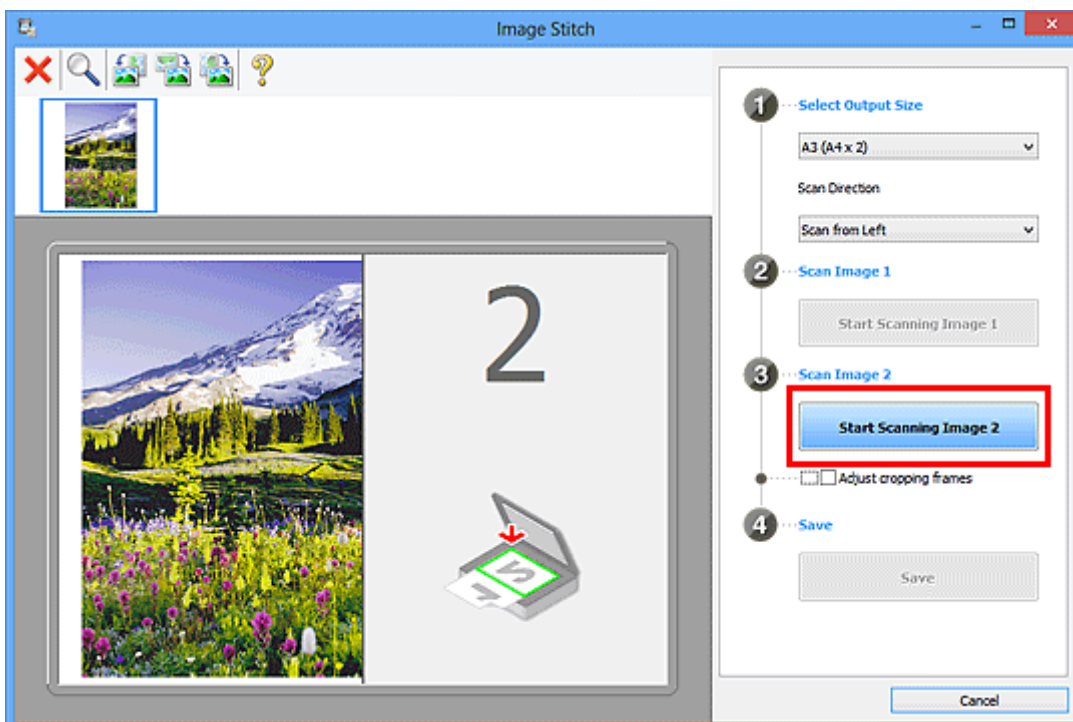

The second item is scanned and appears in **2**.

►►► Note

- Click **Cancel** to cancel the scan.

10. Adjust the scanned images as required.

Use the Toolbar to rotate or zoom in/out, or drag the images to adjust their positions.

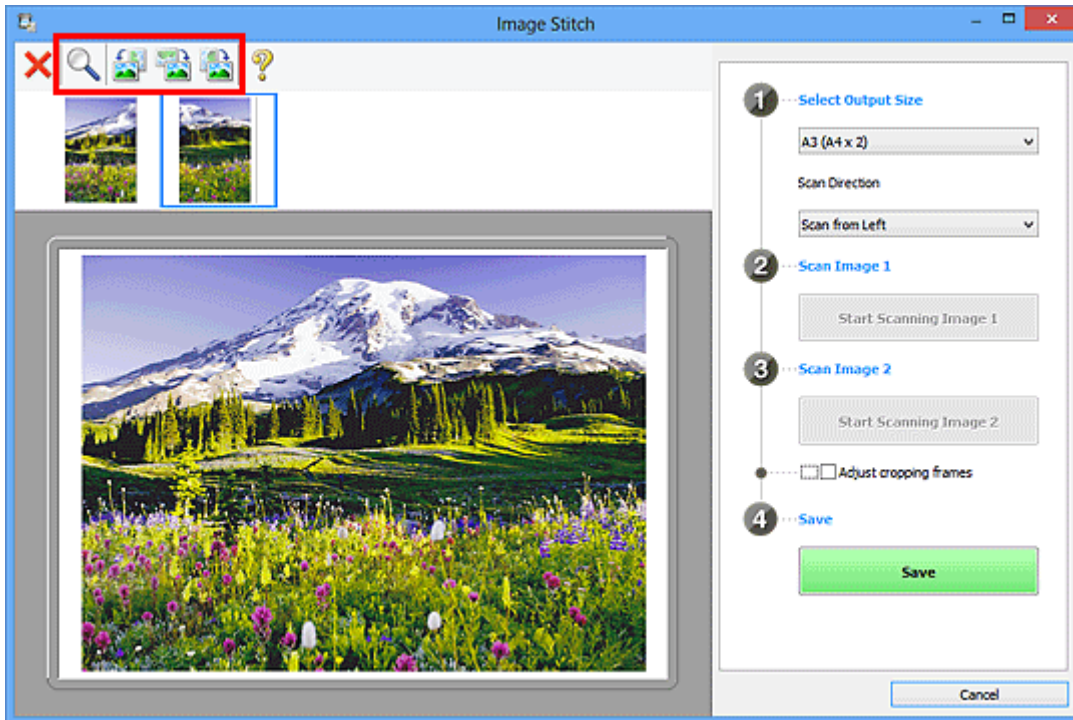

►►► Note

- Select the **Adjust cropping frames** checkbox to specify the area to be saved.
 - [Adjusting Cropping Frames in the Image Stitch Window](#)
- To scan an item again, select the image in the Preview area or the thumbnail at the top of the screen, then click  (Delete). The selected image is deleted, allowing you to scan the item again.

11. Click **Save**.

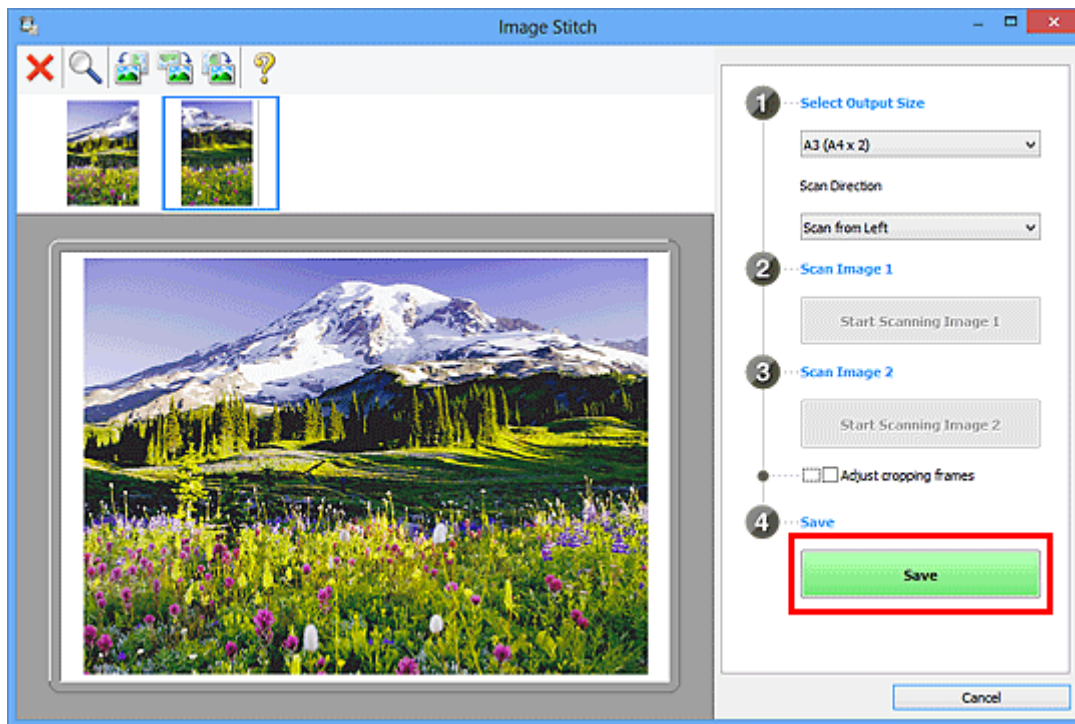

The combined image is saved.

▶▶▶ Note

- Refer to "[Image Stitch Window](#)" for details on the **Image Stitch** window.
- You can make advanced scan settings in the [Settings \(Scan and Stitch\) dialog box](#) displayed by clicking **Settings...**

Adjusting Cropping Frames in the Image Stitch Window

"Cropping" is the act of selecting the area you want to keep in an image and discarding the rest when scanning it.

In the **Image Stitch** window, you can specify a cropping frame on the image displayed in the Preview area.

▶▶▶ Note

- Refer to "Adjusting Cropping Frames (ScanGear)" for your model from Home of the Online Manual for how to adjust cropping frames with ScanGear (scanner driver).

Initial Cropping Frame

No cropping frame is specified. When you select the **Adjust cropping frames** checkbox, an active cropping frame is automatically specified around the image in the Preview area. You can drag the cropping frame to specify the area.

When you perform a scan, the image in the area specified with the cropping frame will be scanned.

Adjusting a Cropping Frame

The cursor will change into  (Arrow) when it is positioned over a cropping frame. Click and drag the mouse to expand or contract the cropping frame.



The cursor will change into  (Crosshair Arrow) when it is positioned within a cropping frame. Click and drag the mouse to move the entire cropping frame.



Deleting Cropping Frames

To delete the cropping frame, deselect the **Adjust cropping frames** checkbox.

Extracting Text from Scanned Images (OCR)

Click **OCR** in the IJ Scan Utility main screen to scan text in scanned magazines and newspapers and display it in a specified application.

▶▶▶ Note

- You can also extract text from **Document**, **Custom**, or **ScanGear**.

1. [Start IJ Scan Utility](#).
2. Click **Settings...**, then set the document type, resolution, etc. in the [Settings \(OCR\) dialog box](#), and then select the application in which you want to display the result.

When setting is completed, click **OK**.

▶▶▶ Note

- For **Resolution**, only **300 dpi** or **400 dpi** can be set.
- If a compatible application is not installed, the text in the image is extracted and appears in your text editor.
Text to be displayed is based on **Document Language** in the [Settings \(General Settings\) dialog box](#). Select the language you want to extract in **Document Language** and scan.
- You can add the application from the pull-down menu.

3. Click **OCR**.

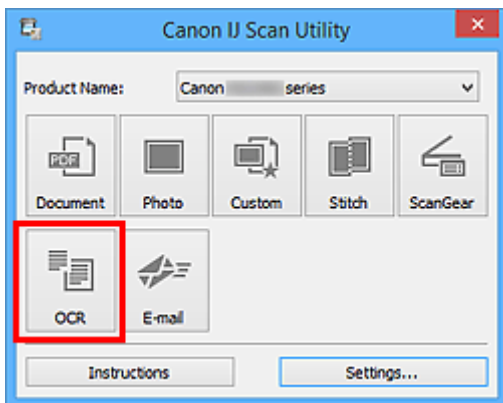

Scanning starts.

When scanning is completed, the scanned images are saved according to the settings, and the extracted text appears in the specified application.

▶▶▶ Note

- Click **Cancel** to cancel the scan.
- Text displayed in your text editor is for guidance only. Text in the image of the following types of documents may not be detected correctly.
 - Documents containing text with font size outside the range of 8 points to 40 points (at 300 dpi)
 - Slanted documents

- Documents placed upside down or documents with text in the wrong orientation (rotated characters)
 - Documents containing special fonts, effects, italics, or hand-written text
 - Documents with narrow line spacing
 - Documents with colors in the background of text
 - Documents containing multiple languages
-

Sending Scanned Images via E-mail

You can send scanned images via e-mail easily by simply clicking **E-mail** in the IJ Scan Utility main screen.

▶▶▶ Note

- You can also send scanned images via e-mail from **Document**, **Photo**, **Custom**, or **ScanGear**.

1. [Start IJ Scan Utility](#).
2. Click **Settings...**, then set the item type, resolution, etc. in the [Settings \(E-mail\) dialog box](#), and then select an e-mail client.

When setting is completed, click **OK**.

3. Place the item on the platen.

■ [Positioning Originals \(Scanning from Computer\)](#)

4. Click **E-mail**.

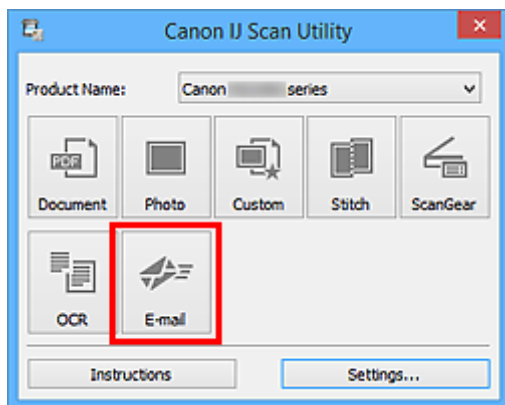

Scanning starts.

When scanning is completed, the specified e-mail client starts and the images will be attached to a new message.

▶▶▶ Note

- Click **Cancel** to cancel the scan.
- The scanned images are saved according to the settings made in the Settings dialog box.
- If the **Check scan results and specify save settings** checkbox is selected in the Settings dialog box, the [Save Settings dialog box](#) appears. After you set the save options and click **OK**, the scanned images are saved and automatically attached to a new message of the specified e-mail client.

5. Specify the recipient, enter the subject and message, then send e-mail.

Refer to the manual of your e-mail client for e-mail settings.

Scanning Multiple Originals at One Time

You can scan two or more photos (small items) placed on the platen at one time and save each image individually.

▶▶▶ Important

- The following types of items may not be scanned correctly. In that case, adjust the cropping frames (scan areas) in whole image view of ScanGear (scanner driver) and scan again.
 - Photos that have a whitish background
 - Items printed on white paper, hand-written documents, business cards, etc.
 - Thin items
 - Thick items

Refer to "Scanning Multiple Documents at One Time with ScanGear (Scanner Driver)" for your model from Home of the Online Manual for details.

▶▶▶ Note

- The screens for scanning with favorite settings are used as examples in the following descriptions.

1. Place the items on the platen.

■ [Positioning Originals \(Scanning from Computer\)](#)

2. [Start IJ Scan Utility](#).

3. Click **Settings...**

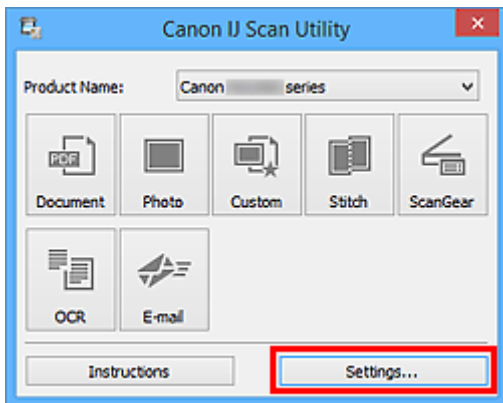

The Settings dialog box appears.

4. Click **Custom Scan**.

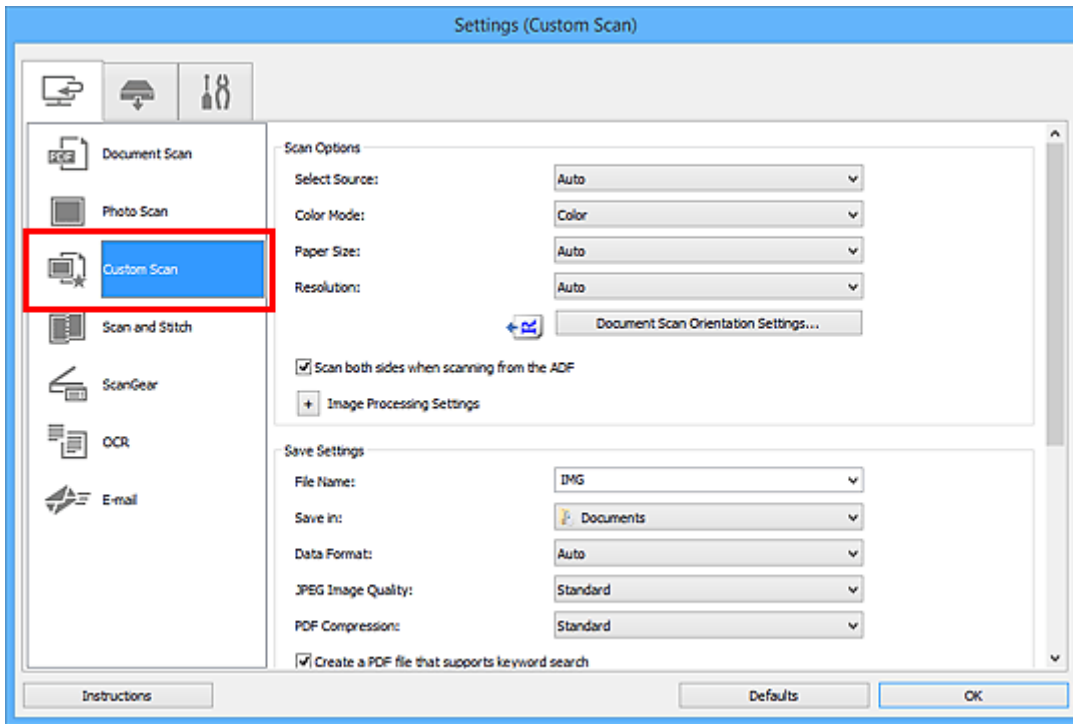

5. Select **Select Source** according to the items to be scanned.

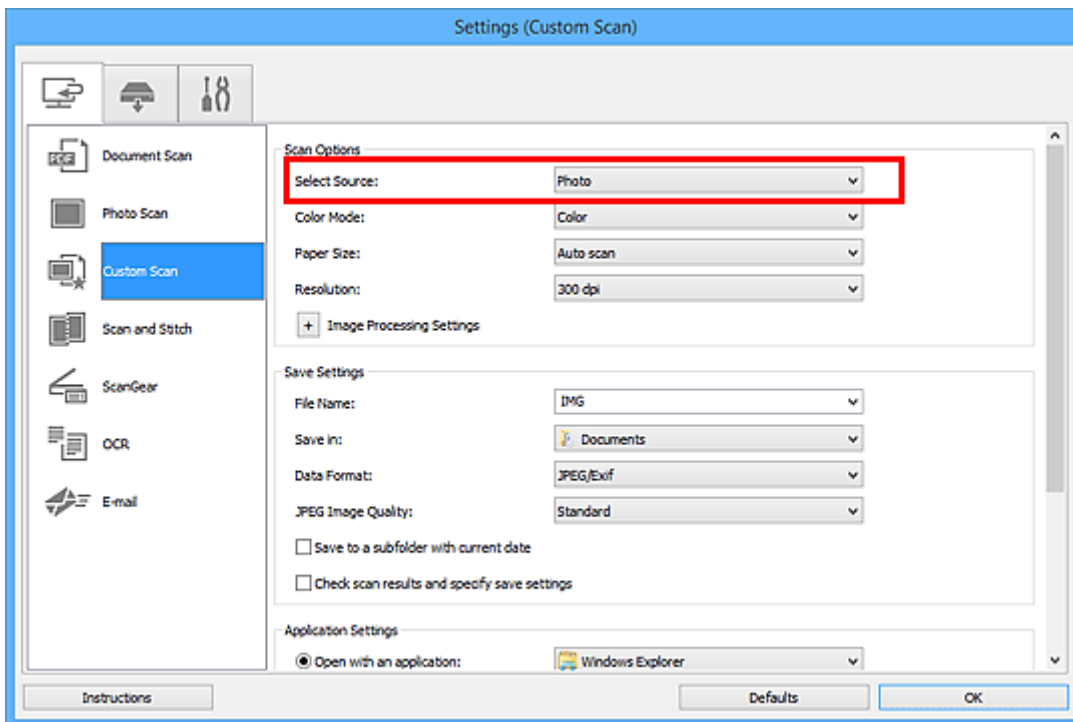

6. Select **Auto scan** for **Paper Size**, then click **OK**.

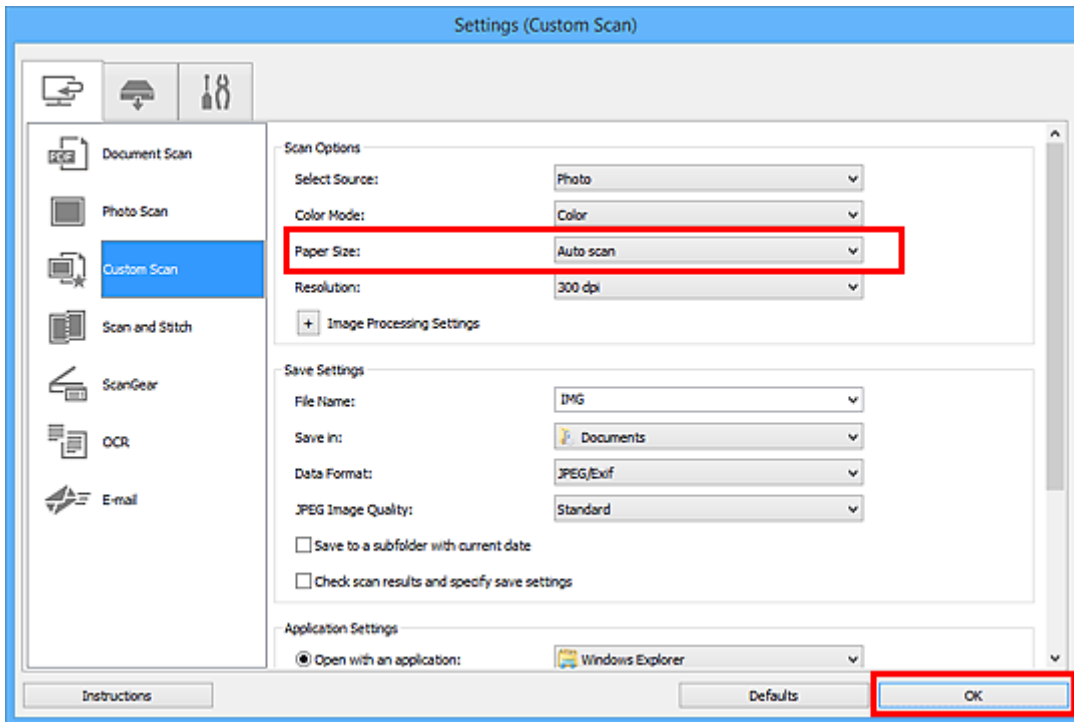

The IJ Scan Utility main screen appears.

►►► Note

- Refer to the following pages for details on the setting items in the Settings dialog box.

- [Settings \(Document Scan\) Dialog Box](#)
- [Settings \(Photo Scan\) Dialog Box](#)
- [Settings \(Custom Scan\) Dialog Box](#)
- [Settings \(OCR\) Dialog Box](#)
- [Settings \(E-mail\) Dialog Box](#)

7. Click **Custom**.

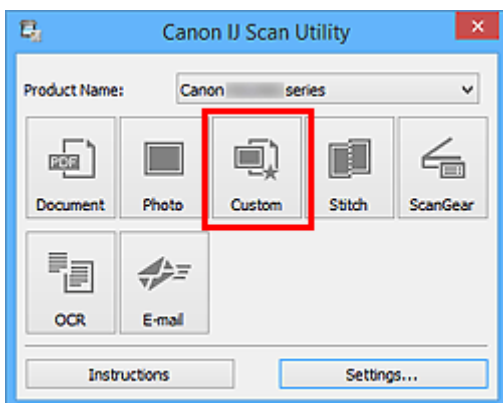

Multiple items are scanned at one time.

►►► Note

- Click **Cancel** to cancel the scan.

- Scanned images are saved in the folder set for **Save in** in the corresponding Settings dialog box displayed by clicking **Settings....** In each Settings dialog box, you can also make advanced scan settings.

Scanning Multiple Documents at One Time from the ADF (Auto Document Feeder)

Place multiple documents on the ADF (Auto Document Feeder) and scan at one time.

This section explains how to scan one side of the documents at a time. To scan both sides of the documents automatically, refer to "[Scanning Both Sides of Each Document at One Time](#)".

▶▶▶ Note

- You can scan multiple documents at one time from the ADF when scanning via **Document**, **Custom**, **ScanGear**, **OCR**, or **E-mail**.
Refer to "Scanning Using Application Software (ScanGear)" for your model from Home of the Online Manual for how to scan using ScanGear (scanner driver).
- The screens for scanning documents are used as examples in the following descriptions.

1. Place the documents on the ADF.

■ [Placing Documents \(ADF \(Auto Document Feeder\)\)](#)

2. [Start IJ Scan Utility](#).

3. Click **Settings....**

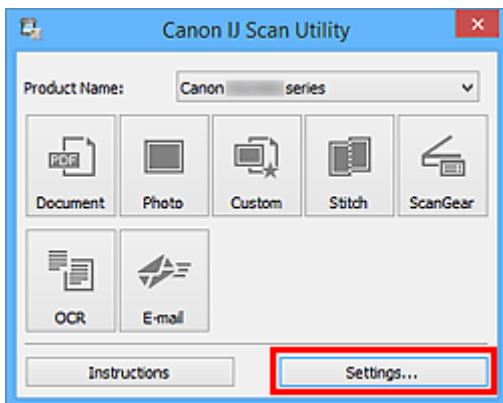

The Settings dialog box appears.

4. Click **Document Scan**.

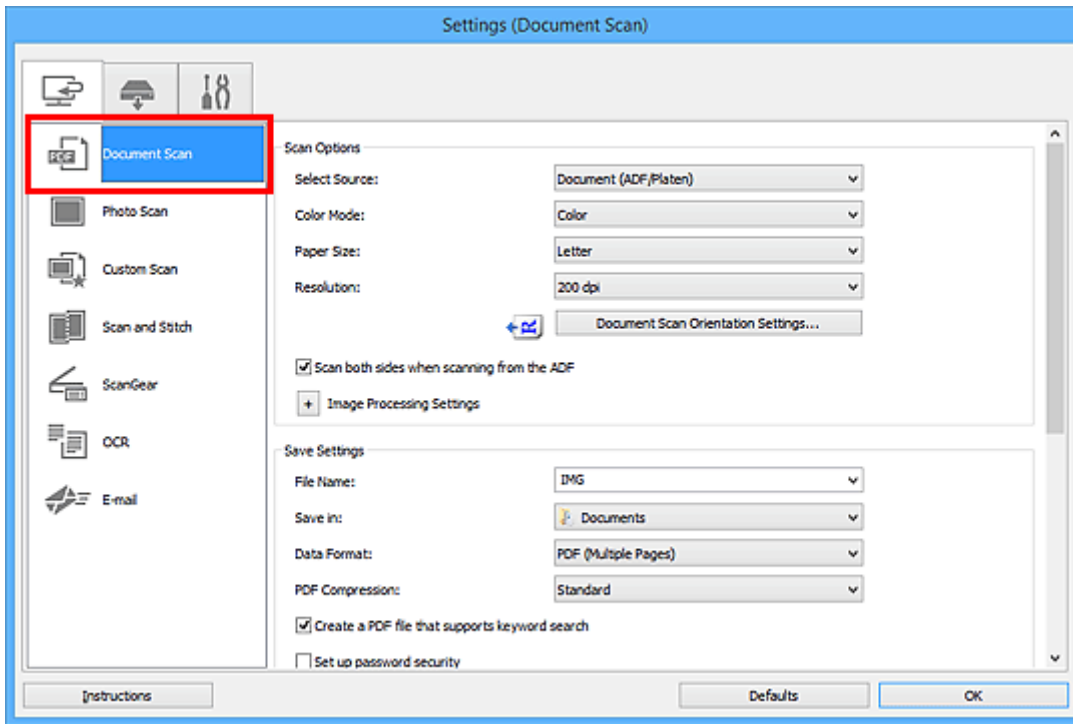

5. Select **Select Source** according to the documents to be scanned.

To scan only the front side of each document, select **Document (ADF/Platen)** or **Document (ADF Simplex)**.

To scan the front side then the back side of each document, select **Document (ADF Manual Duplex)**.

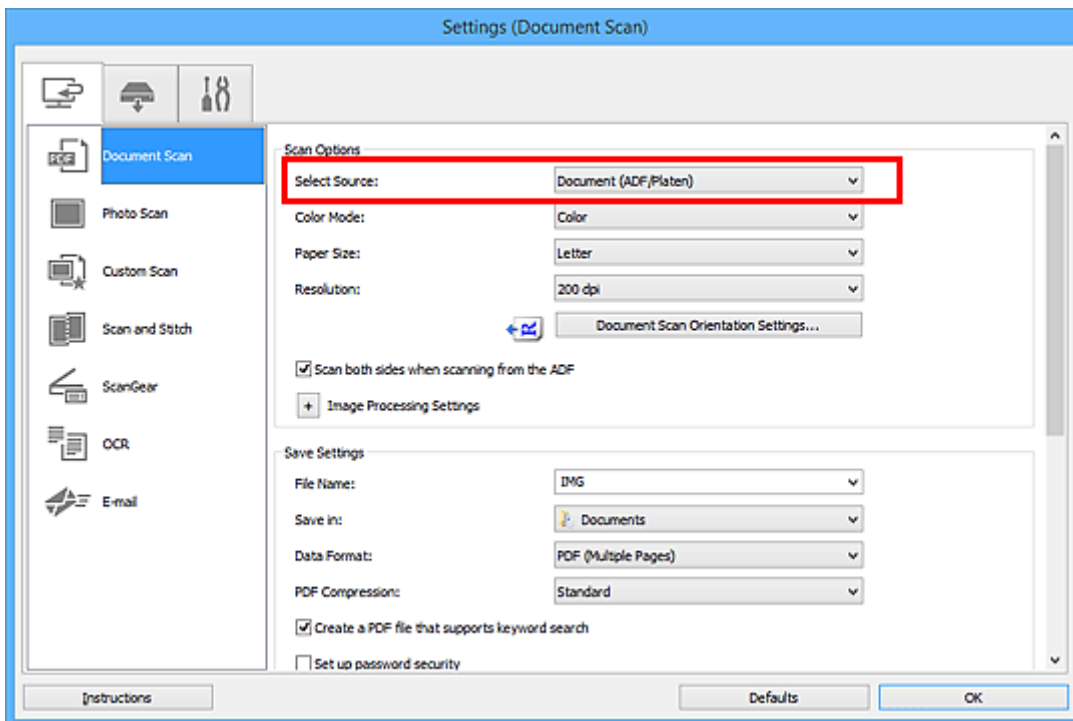

6. Set the color mode, document size, and scanning resolution as required.

Click **Document Scan Orientation Settings...** to specify the orientation of the documents to be scanned. In the displayed dialog box, you can specify the **Orientation** and **Binding Side**. How to place the documents when scanning the back sides depends on the **Binding Side**.

When setting is completed, click **OK**.

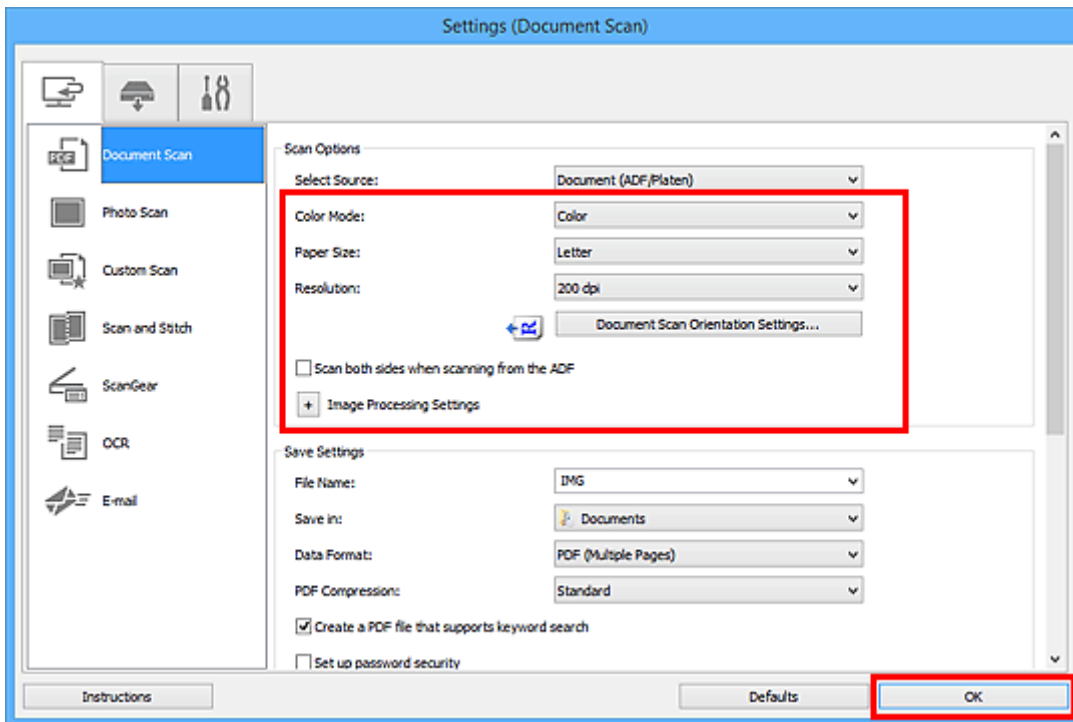

The IJ Scan Utility main screen appears.

►►► Note

- Refer to the following pages for details on the setting items in the Settings dialog box.

- [Settings \(Document Scan\) Dialog Box](#)
- [Settings \(Custom Scan\) Dialog Box](#)
- [Settings \(OCR\) Dialog Box](#)
- [Settings \(E-mail\) Dialog Box](#)

7. Click **Document**.

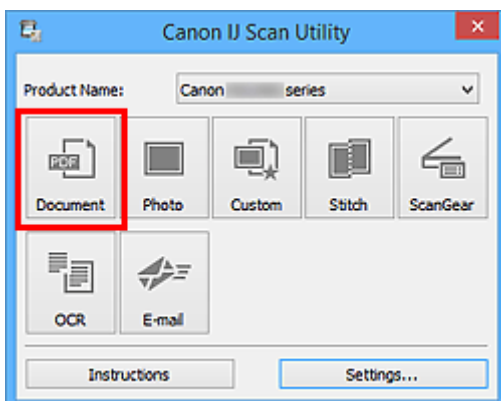

Scanning starts.

»» Note

- Click **Cancel** to cancel the scan.

When **Document (ADF Manual Duplex)** is selected for **Select Source**, proceed to Step 8.

»» Note

- When **Document (ADF Duplex)** is selected for **Select Source**, the **Manual Duplex Scanning** dialog box does not appear; both sides of the documents are scanned automatically. Refer to "[Scanning Both Sides of Each Document at One Time](#)" for details.

8. Follow the on-screen instructions to place the documents.

»» Note

- The screens for scanning with **Orientation** set to **Portrait** are used as examples in the following descriptions.

When Long edge is Selected for Binding Side in Document Scan Orientation Settings...:

Place the documents after rotating the output documents 180 degrees.

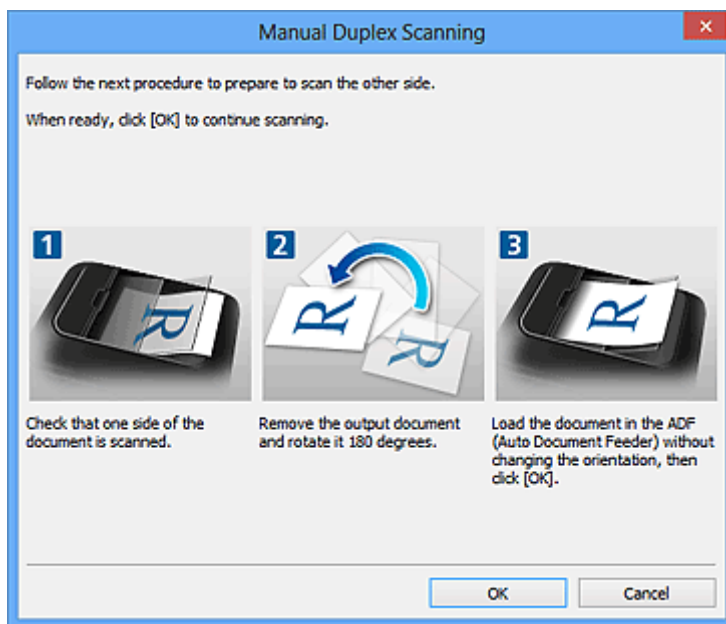

When Short edge is Selected for Binding Side in Document Scan Orientation Settings...:

Place the documents without changing the orientation of the output documents.

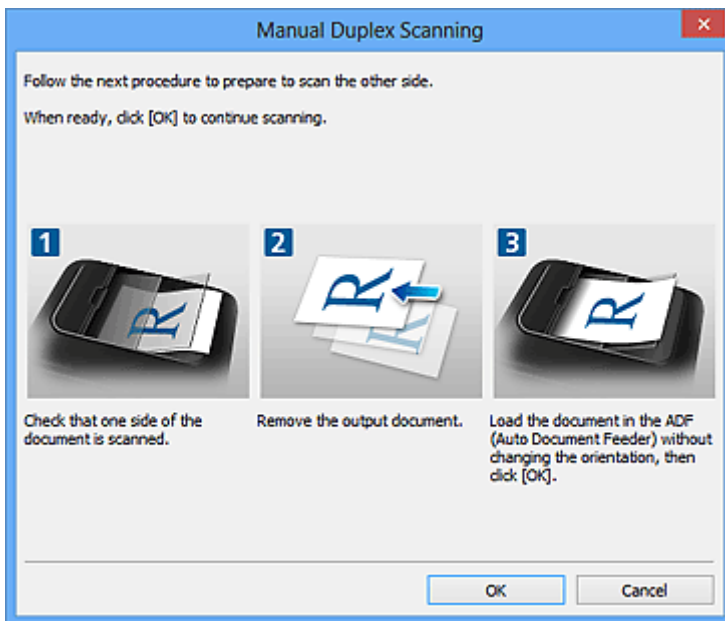

9. Click **OK**.

Scanning starts.

▶▶▶ Note

- Click **Cancel** to cancel the scan.
- Scanned images are saved in the folder set for **Save in** in the corresponding Settings dialog box displayed by clicking **Settings...** In each Settings dialog box, you can also make advanced scan settings.

Scanning Both Sides of Each Document at One Time

Scan both sides of each document at one time using the ADF (Auto Document Feeder).

▶▶▶ Note

- You can scan multiple documents at one time from the ADF when scanning via **Document**, **Custom**, **ScanGear**, **OCR**, or **E-mail**.
Refer to "Scanning Using Application Software (ScanGear)" for your model from Home of the Online Manual for how to scan using ScanGear (scanner driver).
- The screens for scanning documents are used as examples in the following descriptions.

1. Place the documents on the ADF.

■ [Placing Documents \(ADF \(Auto Document Feeder\)\)](#)

2. [Start IJ Scan Utility](#).

3. Click **Settings....**

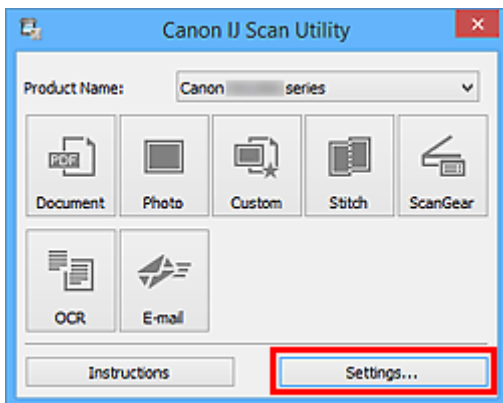

The Settings dialog box appears.

4. Click **Document Scan**.

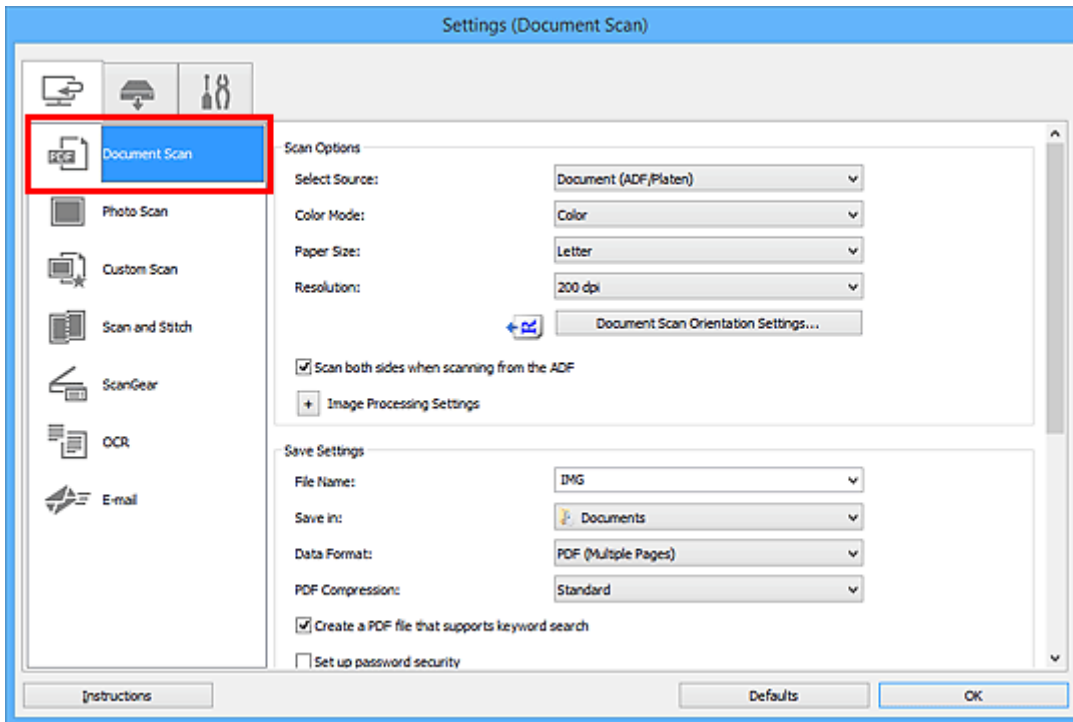

5. Select **Document (ADF/Platen)** or **Document (ADF Duplex)** for **Select Source**.

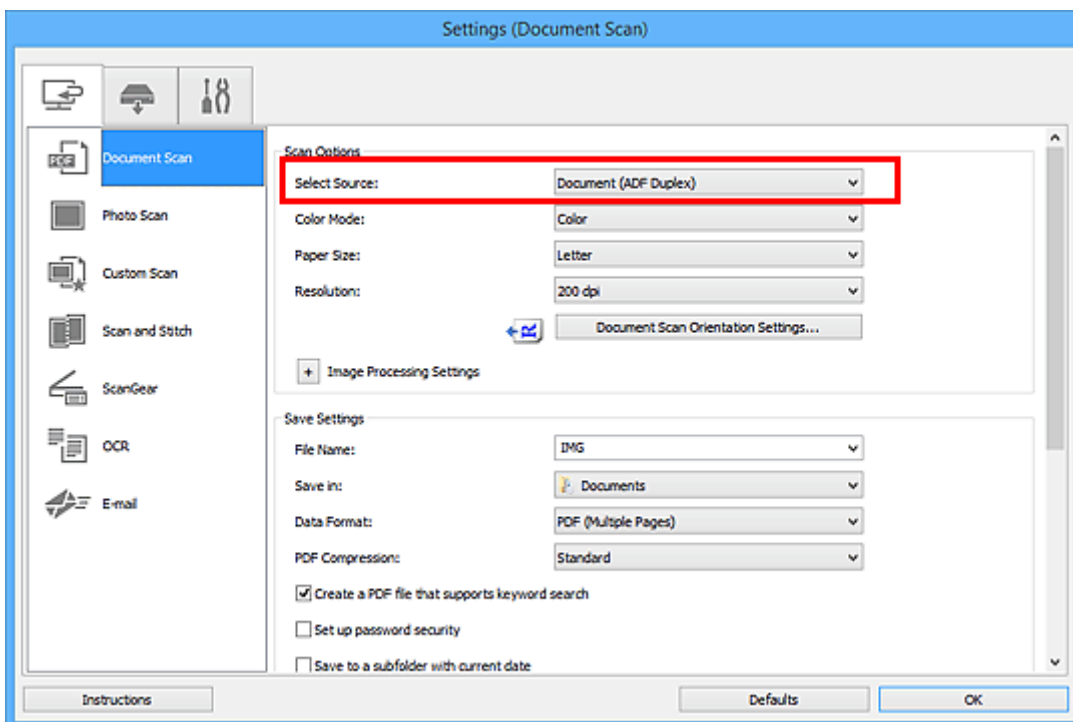

►►► Note

- Select the **Scan both sides when scanning from the ADF** checkbox in **Scan Options** when scanning via **Document (ADF/Platen)**.

6. Set the color mode, document size, and scanning resolution as required.

Click **Document Scan Orientation Settings...** to specify the orientation of the documents to be scanned. In the displayed dialog box, you can specify the **Orientation** and **Binding Side**.

When setting is completed, click **OK**.

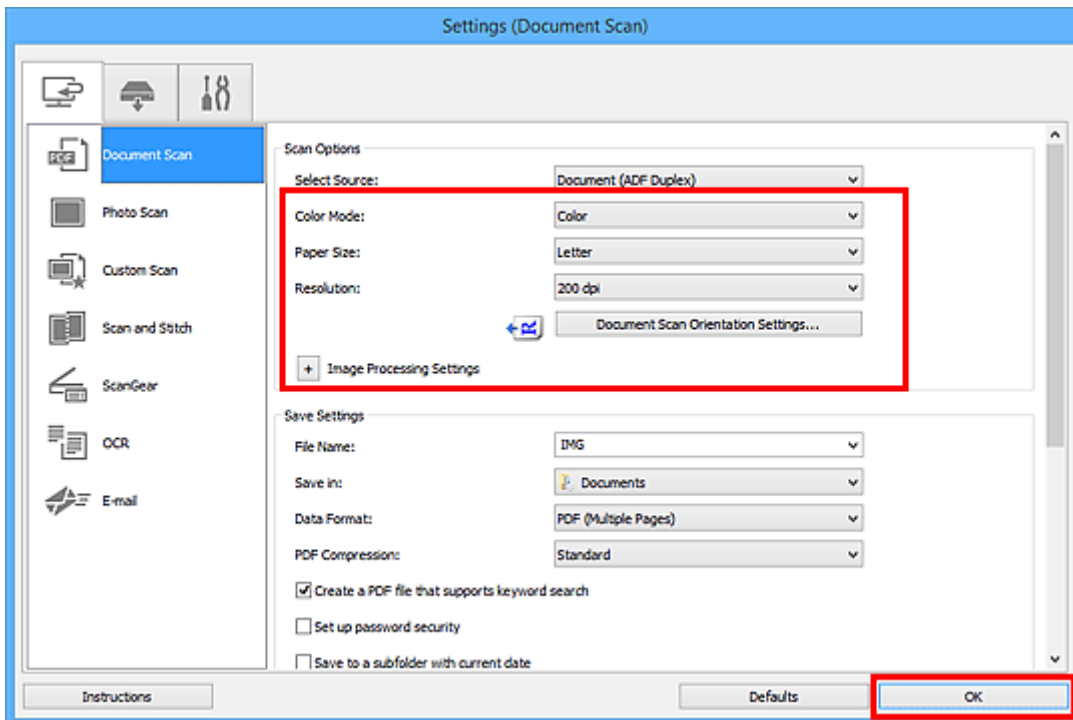

The IJ Scan Utility main screen appears.

►►► Note

- Refer to the following pages for details on the setting items in the Settings dialog box.

- [Settings \(Document Scan\) Dialog Box](#)
- [Settings \(Custom Scan\) Dialog Box](#)
- [Settings \(OCR\) Dialog Box](#)
- [Settings \(E-mail\) Dialog Box](#)

7. Click **Document**.

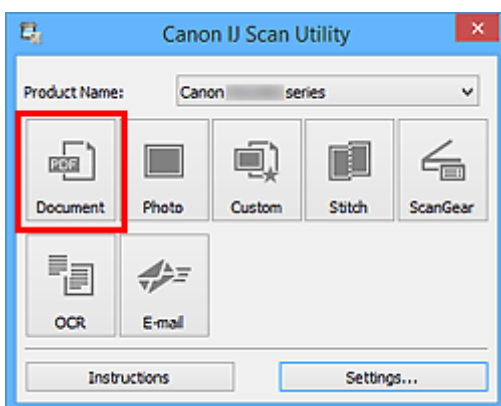

Both sides of the documents are scanned automatically.

»» **Note**

- Click **Cancel** to cancel the scan.
- Scanned images are saved in the folder set for **Save in** in the corresponding Settings dialog box displayed by clicking **Settings....** In each Settings dialog box, you can also make advanced scan settings.

Saving after Checking Scan Results

You can check the scan results, then save the images to a computer.

Important

- You cannot check the scan results before saving when scanned using the operation panel.

Note

- The screens for scanning photos are used as examples in the following descriptions.

1. [Start IJ Scan Utility.](#)
2. Click **Settings....**

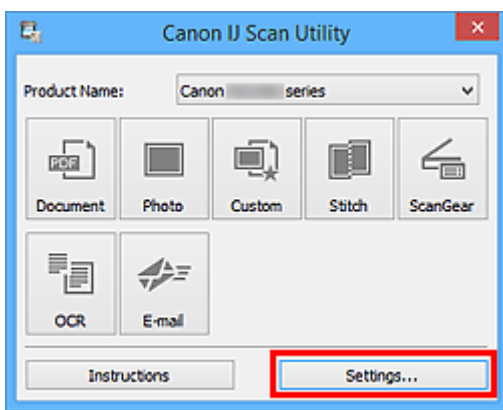

The [Settings dialog box](#) appears.

3. Click **Photo Scan.**

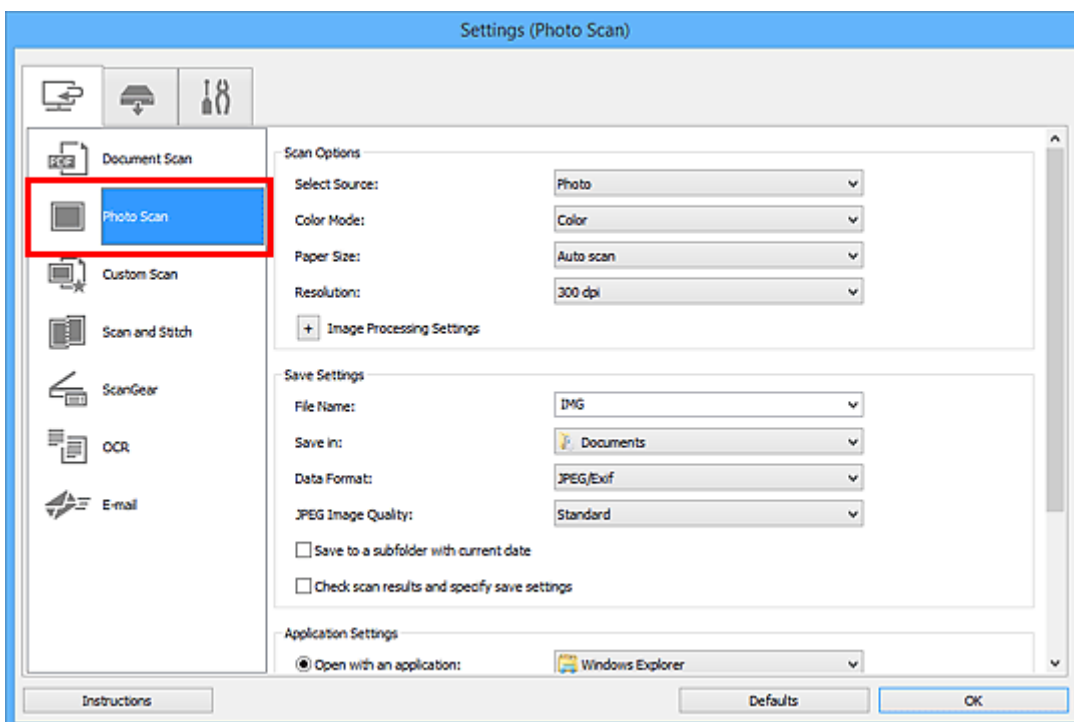

4. Select **Check scan results and specify save settings** checkbox, and then click **OK**.

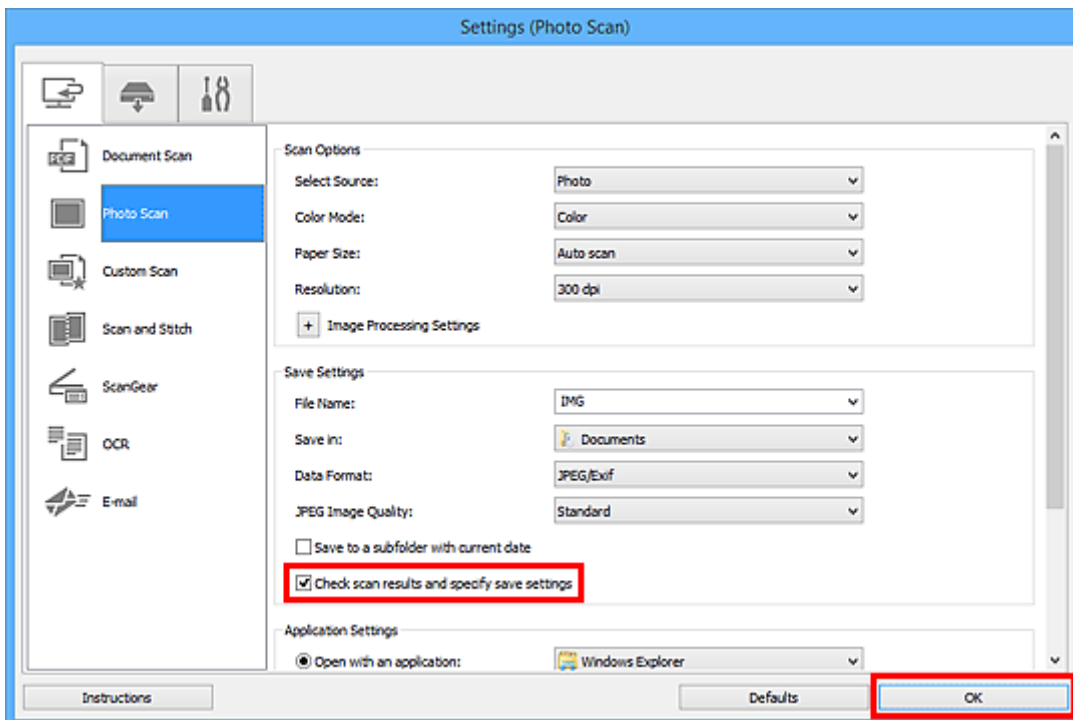

The IJ Scan Utility main screen appears.

▶▶▶ Note

- Refer to the following pages for details on the setting items in the Settings dialog box.

- [Settings \(Document Scan\) Dialog Box](#)
- [Settings \(Photo Scan\) Dialog Box](#)
- [Settings \(Custom Scan\) Dialog Box](#)
- [Settings \(Scan and Stitch\) Dialog Box](#)
- [Settings \(ScanGear\) Dialog Box](#)
- [Settings \(OCR\) Dialog Box](#)
- [Settings \(E-mail\) Dialog Box](#)

5. Click **Photo**.

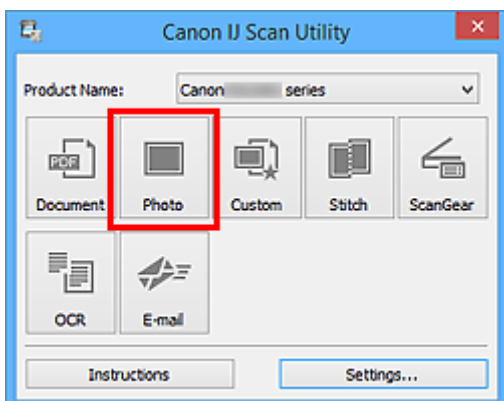

Scanning starts.

When scanning is completed, the **Save Settings** dialog box appears.

▶▶▶ **Note**

- Click **Cancel** to cancel the scan.

6. Change the image order or file save options as required.

You can change the image order or file save options in the [Save Settings dialog box](#).

▶▶▶ **Note**

- The default save folders are as follows.
 - **Windows 10/Windows 8.1/Windows Vista:**
Documents folder
 - **Windows 8/Windows 7:**
My Documents folder

7. Click **OK**.

Scanned images are saved according to the settings.

IJ Scan Utility Screens

- ▶ **IJ Scan Utility Main Screen**
- ▶ **Settings Dialog Box**
 - **Settings (Document Scan) Dialog Box**
 - **Settings (Photo Scan) Dialog Box**
 - **Settings (Custom Scan) Dialog Box**
 - **Settings (Scan and Stitch) Dialog Box**
 - **Settings (ScanGear) Dialog Box**
 - **Settings (OCR) Dialog Box**
 - **Settings (E-mail) Dialog Box**
 - **Settings (Save to PC (Document)) Dialog Box**
 - **Settings (Save to PC (Photo)) Dialog Box**
 - **Settings (Attach to E-mail (Document)) Dialog Box**
 - **Settings (Attach to E-mail (Photo)) Dialog Box**
 - **Settings (General Settings) Dialog Box**
- ▶ **Save Settings Dialog Box**
- ▶ **Password Security Settings Dialog Box**
- ▶ **Image Stitch Window**

IJ Scan Utility Main Screen

Follow the steps below to start IJ Scan Utility.

Windows 10:

From **Start** menu, select **All apps > Canon Utilities > IJ Scan Utility** to start IJ Scan Utility.

Windows 8.1/Windows 8:

Select **IJ Scan Utility** on Start screen to start IJ Scan Utility.

If **IJ Scan Utility** is not displayed on the Start screen, select the **Search** charm, and then search for "IJ Scan Utility".

Windows 7/Windows Vista:

From **Start** menu, select **All Programs > Canon Utilities > IJ Scan Utility > IJ Scan Utility** to start IJ Scan Utility.

You can complete from scanning to saving at one time by simply clicking the corresponding icon.

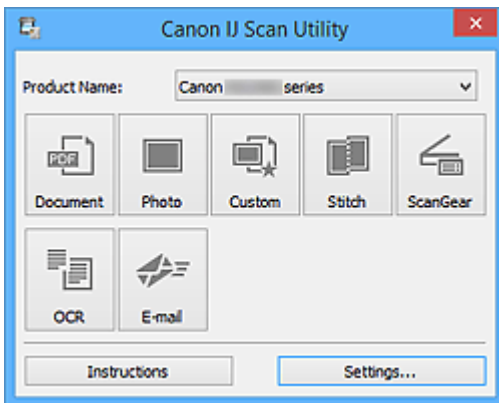

Product Name

Displays the name of the product that IJ Scan Utility is currently set to use.

If the displayed product is not the one you want to use, select the desired product from the list.

In addition, for network connection, select one with "Network" after the product name.

►►► Note

- Refer to "[Network Scan Settings](#)" for how to set up a network environment.

Document

Scans items as documents and saves them to a computer.

Scan/save settings and the response after scanning can be specified in the [Settings \(Document Scan\) dialog box](#).

Photo

Scans items as photos and saves them to a computer.

Scan/save settings and the response after scanning can be specified in the [Settings \(Photo Scan\) dialog box](#).

Custom

Scans items with your favorite settings and saves the images to a computer. The item type can be automatically detected.

Scan/save settings and the response after scanning can be specified in the [Settings \(Custom Scan\) dialog box](#).

Stitch

Displays the **Image Stitch** window in which you can scan the left and right halves of an item larger than the platen and combine the scanned images back into one image.

Scan/save settings and the response after scanning can be specified in the [Settings \(Scan and Stitch\) dialog box](#).

ScanGear

Starts ScanGear (scanner driver) in which you can make image corrections and color adjustments when scanning.

Scan/save settings and applications can be specified in the [Settings \(ScanGear\) dialog box](#).

OCR

Scan text in scanned magazines and newspapers and display it in a specified application.

Scan/save settings and applications can be specified in the [Settings \(OCR\) dialog box](#).

E-mail

You can send scanned images via e-mail.

Scan/save settings and applications can be specified in the [Settings \(E-mail\) dialog box](#).



Instructions

Opens this guide.

Settings...

Displays the [Settings dialog box](#) in which you can specify the scan/save settings and the response after scanning.

Settings Dialog Box

There are three tabs in the Settings dialog box:  (Scanning from a Computer),  (Scanning from the Operation Panel), and  (General Settings). When you click a tab, the view in the red frame switches and you can make advanced settings to functions on each tab.

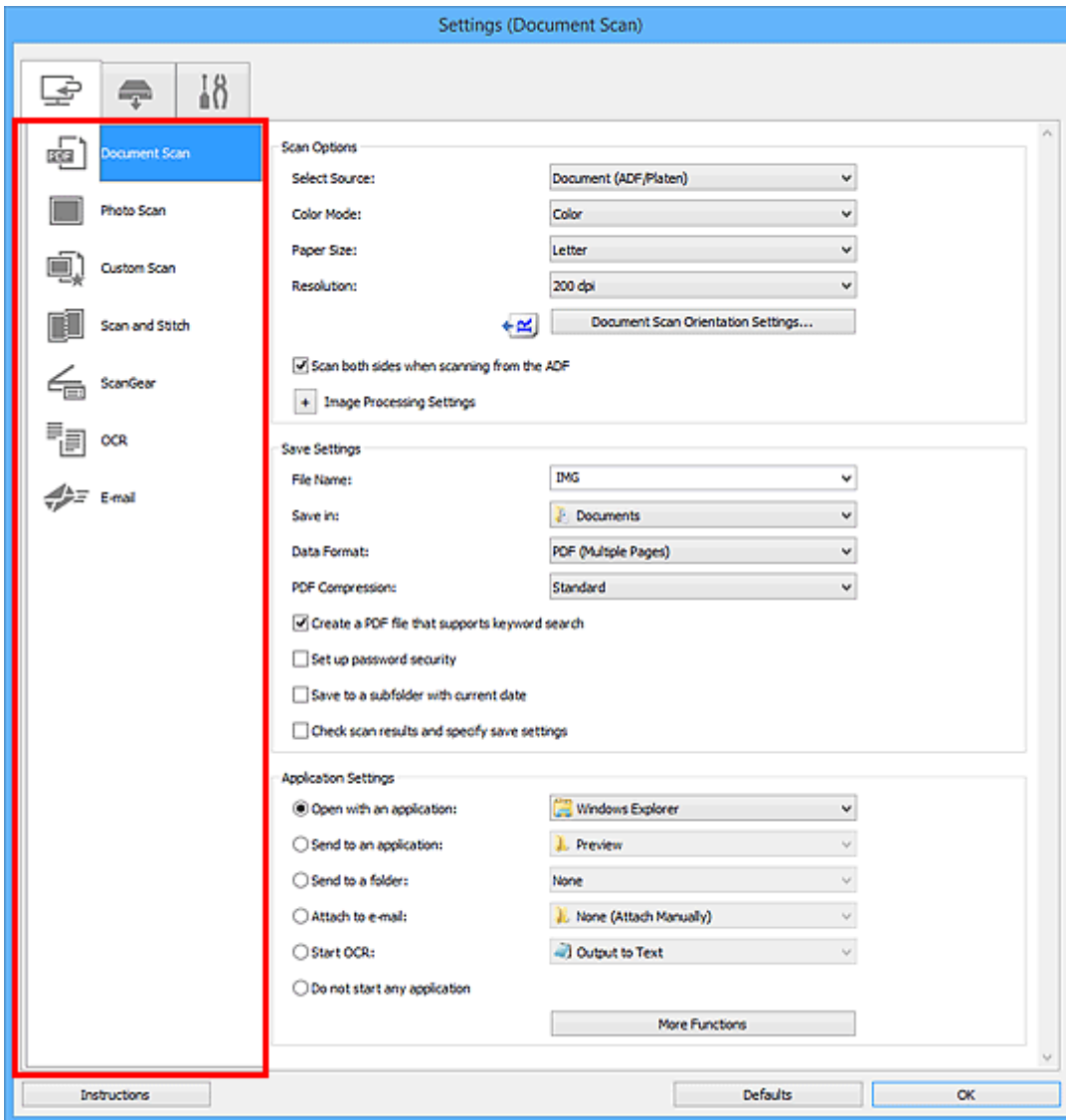

(Scanning from a Computer) Tab

You can specify how to respond when scanning from IJ Scan Utility.

- [Settings \(Document Scan\) Dialog Box](#)
- [Settings \(Photo Scan\) Dialog Box](#)
- [Settings \(Custom Scan\) Dialog Box](#)
- [Settings \(Scan and Stitch\) Dialog Box](#)
- [Settings \(ScanGear\) Dialog Box](#)
- [Settings \(OCR\) Dialog Box](#)
- [Settings \(E-mail\) Dialog Box](#)



(Scanning from the Operation Panel) Tab

You can specify how to respond when scanning from the operation panel.

- [Settings \(Save to PC \(Document\)\) Dialog Box](#)
- [Settings \(Save to PC \(Photo\)\) Dialog Box](#)
- [Settings \(Attach to E-mail \(Document\)\) Dialog Box](#)
- [Settings \(Attach to E-mail \(Photo\)\) Dialog Box](#)



(General Settings) Tab

You can set the product to use, file size restriction on e-mail attachment, language to detect text in images, and folder in which to save images temporarily.

- [Settings \(General Settings\) Dialog Box](#)

Settings (Document Scan) Dialog Box

Click **Document Scan** on the  (Scanning from a Computer) tab to display the **Settings (Document Scan)** dialog box.

In the **Settings (Document Scan)** dialog box, you can make advanced scan settings to scan items as documents.

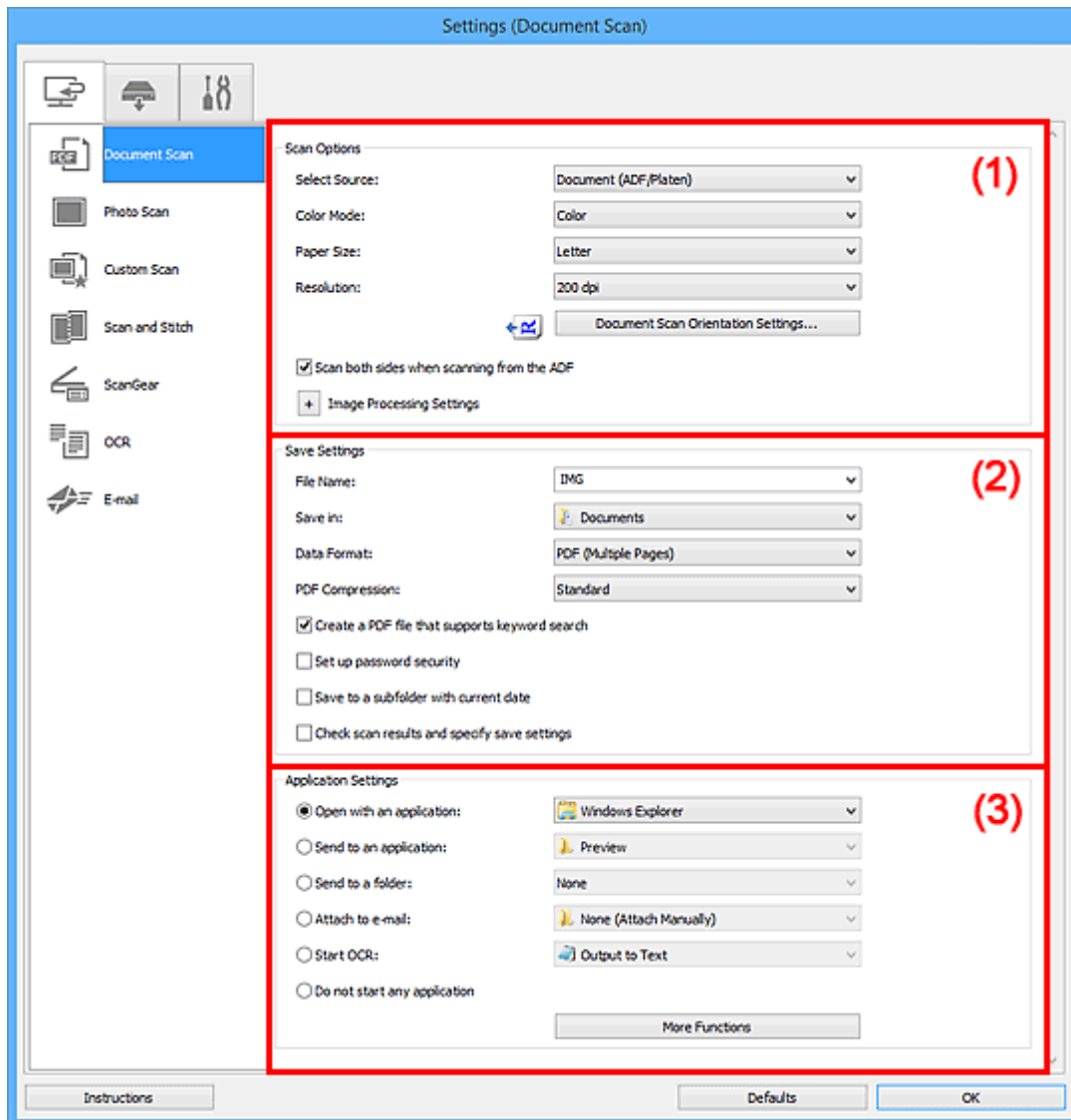

- [\(1\) Scan Options Area](#)
- [\(2\) Save Settings Area](#)
- [\(3\) Application Settings Area](#)

(1) Scan Options Area

Select Source

Select the type of item to be scanned.

- Scanning documents: **Document** or **Document (ADF/Platen)**
- Scanning magazines: **Magazine**

- Scanning documents from the ADF (Auto Document Feeder): **Document (ADF Simplex)**, **Document (ADF Manual Duplex)**, **Document (ADF Duplex)**, or **Document (ADF/Platen)**

»»» Note

- When **Document (ADF/Platen)** is selected and documents are placed both on the platen and ADF, those placed on the ADF will be scanned.

Color Mode

Select the color mode in which to scan the item.

Paper Size

Select the size of the item to be scanned.

When you select **Custom**, a screen in which you can specify the paper size appears. Select a **Unit**, then enter the **Width** and **Height**, and then click **OK**.

»»» Note

- Click **Defaults** to restore the specified settings to the default settings.

Resolution

Select the resolution of the item to be scanned.

The higher the resolution (value), the more detail in your image.

■ [Resolution](#)

»»» Note

- Only **300 dpi** or **400 dpi** can be set when **Start OCR** is selected in **Application Settings**.

Document Scan Orientation Settings...

This appears when you select ADF for **Select Source**.

Click to display the **Document Scan Orientation Settings** dialog box in which you can set the orientation and binding side of the documents to be scanned from the ADF.

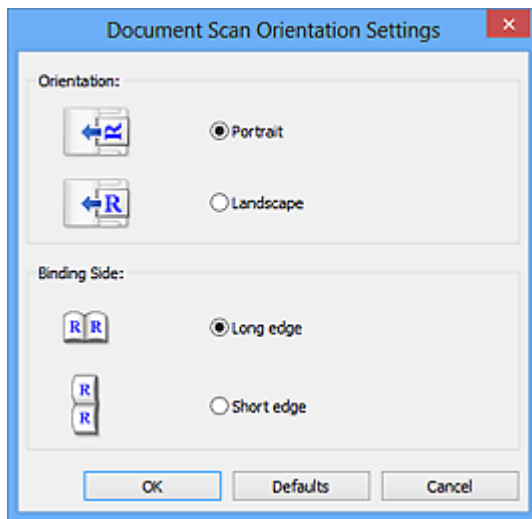

»»» Important

- **Binding Side** cannot be specified when scanning only the front side of each document.

Scan both sides when scanning from the ADF

This appears when you select **Document (ADF/Platen)** for **Select Source**. Scans both sides of the documents placed on the ADF.

Image Processing Settings

Click  (Plus) to set the following.

»»» Note

- The displayed items vary by **Select Source** and **Color Mode**.

Apply Auto Document Fix

Select this checkbox to sharpen text in a document or magazine for better readability.

»»» Important

- The color tone may differ from the source image due to corrections. In that case, deselect the checkbox and scan.

»»» Note

- Scanning takes longer than usual when you enable this function.

Sharpen outline

Emphasizes the outline of the subjects to sharpen the image.

Reduce show-through

Sharpens text in an item or reduces show-through in newspapers, etc.

Reduce moire

Reduces moire patterns.

Printed materials are displayed as a collection of fine dots. "Moire" is a phenomenon where uneven gradation or a stripe pattern appears when such photos or pictures printed with fine dots are scanned.

▶▶▶ Note

- Scanning takes longer than usual when you enable **Reduce moire**.

Reduce gutter shadow/Reduce gutter shadow (platen)

Reduces gutter shadows that appear between pages when scanning open booklets.

▶▶▶ Important

- This function is available only when scanning from the platen.

▶▶▶ Note

- Use ScanGear (scanner driver)'s **Advanced Mode** tab to correct gutter shadows when scanning non-standard size items or specified areas.
Refer to "Gutter Shadow Correction" for your model from Home of the Online Manual for details.
- When you enable this function, scanning may take longer than usual with network connection.

Correct slanted text document

Detects the scanned text and corrects the angle (within -0.1 to -10 degrees or +0.1 to +10 degrees) of the document.

▶▶▶ Important

- The following types of documents may not be corrected properly since the text cannot be detected correctly.
 - Documents in which the text lines are inclined more than 10 degrees or the angles vary by line
 - Documents containing both vertical and horizontal text
 - Documents with extremely large or small fonts
 - Documents with small amount of text
 - Documents containing figures/images
 - Hand-written text
 - Documents containing both vertical and horizontal lines (tables)

▶▶▶ Note

- Scanning takes longer than usual when you enable **Correct slanted text document**.

Detect the orientation of text document and rotate image

Automatically rotates the image to the correct orientation by detecting the orientation of text in the scanned document.

▶▶▶ Important

- Only text documents written in the language selected from **Document Language** in the **Settings (General Settings) dialog box** are supported.
- The orientation may not be detected for the following types of settings or documents since the text cannot be detected correctly.
 - Resolution is outside the range of 300 dpi to 600 dpi
 - Font size is outside the range of 8 points to 48 points

- Documents containing special fonts, effects, italics, or hand-written text
- Documents with patterned backgrounds

In that case, select the **Check scan results and specify save settings** checkbox, and then rotate the image in the [Save Settings dialog box](#).

(2) Save Settings Area

File Name

Enter the file name of the image to be saved. When you save a file, the date and four digits are appended to the set file name in the "_20XX0101_0001" format.

▶▶▶ Note

- When you select the **Save to a subfolder with current date** checkbox, the date and four digits are appended to the set file name.

Save in

Displays the folder in which to save the scanned images. To add a folder, select **Add...** from the pull-down menu, then click **Add** in the displayed **Select Destination Folder** dialog box and specify the destination folder.

The default save folders are as follows.

- **Windows 10/Windows 8.1/Windows Vista:**
Documents folder
- **Windows 8/Windows 7:**
My Documents folder

Data Format

Select the data format in which to save the scanned images.

You can select **JPEG/Exif**, **TIFF**, **PNG**, **PDF**, or **PDF (Multiple Pages)**.

▶▶▶ Important

- You cannot select **JPEG/Exif** when **Color Mode** is **Black and White**.
- When **Start OCR** is selected in **Application Settings**, you cannot select **PDF** or **PDF (Multiple Pages)**.

▶▶▶ Note

- With network connection, scanning may take longer than usual when you set **TIFF** or **PNG** in **Data Format**.

PDF Compression

Select the compression type for saving PDF files.

Standard

It is recommended that you normally select this setting.

High

Compresses the file size when saving, allowing you to reduce the load on your network/server.

»»» Important

- This appears only when **PDF** or **PDF (Multiple Pages)** is selected in **Data Format**.
- When **Black and White** is selected in **Color Mode**, this option does not appear.

JPEG Image Quality

You can specify the image quality of JPEG files.

»»» Important

- This appears only when **JPEG/Exif** is selected in **Data Format**.

Create a PDF file that supports keyword search

Select this checkbox to convert text in images into text data and create PDF files that support keyword search.

»»» Important

- This appears only when **PDF** or **PDF (Multiple Pages)** is selected in **Data Format**.

»»» Note

- If text cannot be searched correctly, we recommend that you select 300 dpi or higher for **Resolution**.
- PDF files that are searchable in the language selected in **Document Language** on the  (General Settings) tab of the Settings dialog box are created.

Set up password security

Select this checkbox to display the [Password Security Settings dialog box](#).

»»» Important

- This appears only when **PDF** or **PDF (Multiple Pages)** is selected in **Data Format**.

Save to a subfolder with current date

Select this checkbox to create a current date folder in the folder specified in **Save in** and save scanned images in it. The folder will be created with a name such as "20XX_01_01" (Year_Month_Date).

If this checkbox is not selected, files are saved directly in the folder specified in **Save in**.

Check scan results and specify save settings

Displays the [Save Settings dialog box](#) after scanning.

(3) Application Settings Area

Open with an application

Select this when you want to enhance or correct the scanned images.

You can specify the application from the pull-down menu.

Send to an application

Select this when you want to use the scanned images as they are in an application that allows you to browse or organize images.

You can specify the application from the pull-down menu.

Send to a folder

Select this when you also want to save the scanned images to a folder other than the one specified in **Save in**.

You can specify the folder from the pull-down menu.

Attach to e-mail

Select this when you want to send e-mails with the scanned images attached.

You can specify the e-mail client you want to start from the pull-down menu.

Start OCR

Select this when you want to convert text in the scanned image into text data.

You can specify the application from the pull-down menu.

Do not start any application

Saves to the folder specified in **Save in**.

»» Note

- To add an application or folder to the pull-down menu, select **Add...** from the pull-down menu, then click **Add** in the displayed **Select Application** or **Select Destination Folder** dialog box and specify the application or folder.

Instructions

Opens this guide.

Defaults

You can restore the settings in the displayed screen to the default settings.

Settings (Photo Scan) Dialog Box

Click **Photo Scan** on the  (Scanning from a Computer) tab to display the **Settings (Photo Scan)** dialog box.

In the **Settings (Photo Scan)** dialog box, you can make advanced scan settings to scan items as photos.

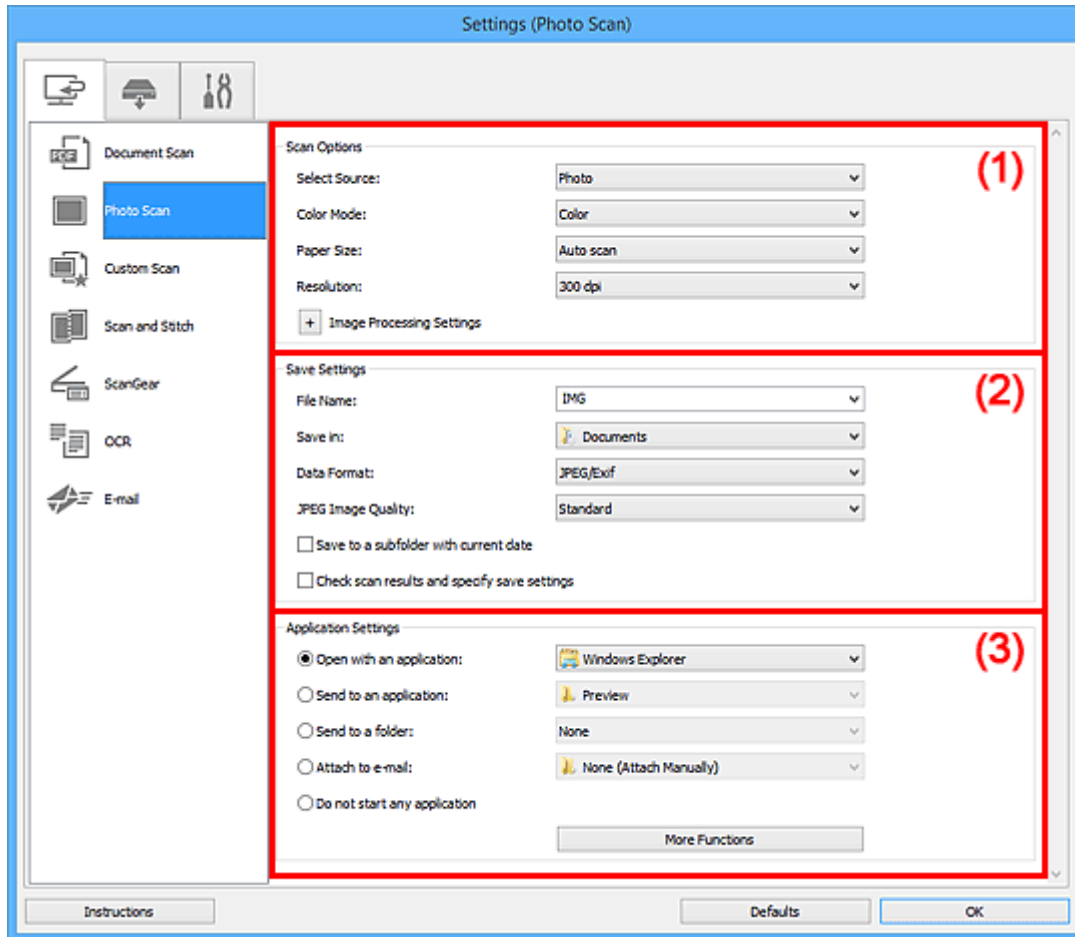

- [\(1\) Scan Options Area](#)
- [\(2\) Save Settings Area](#)
- [\(3\) Application Settings Area](#)

(1) Scan Options Area

Select Source

Photo is selected.

Color Mode

Select the color mode in which to scan the item.

Paper Size

Select the size of the item to be scanned.

When you select **Custom**, a screen in which you can specify the paper size appears. Select a **Unit**, then enter the **Width** and **Height**, and then click **OK**.

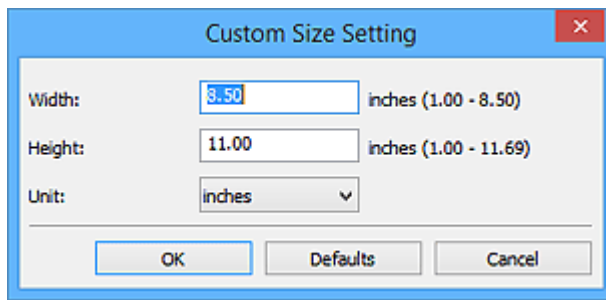

►►► Note

- Click **Defaults** to restore the specified settings to the default settings.

Resolution

Select the resolution of the item to be scanned.

The higher the resolution (value), the more detail in your image.

■ Resolution

Image Processing Settings

Click (Plus) to set the following.

►►► Important

- When **Color Mode** is **Black and White**, **Image Processing Settings** is not available.

Sharpen outline

Emphasizes the outline of the subjects to sharpen the image.

(2) Save Settings Area

File Name

Enter the file name of the image to be saved. When you save a file, the date and four digits are appended to the set file name in the "_20XX0101_0001" format.

►►► Note

- When you select the **Save to a subfolder with current date** checkbox, the date and four digits are appended to the set file name.

Save in

Displays the folder in which to save the scanned images. To add a folder, select **Add...** from the pull-down menu, then click **Add** in the displayed **Select Destination Folder** dialog box and specify the destination folder.

The default save folders are as follows.

- **Windows 10/Windows 8.1/Windows Vista:**
Documents folder
- **Windows 8/Windows 7:**
My Documents folder

Data Format

Select the data format in which to save the scanned images.

You can select **JPEG/Exif**, **TIFF**, or **PNG**.

►►► Important

- You cannot select **JPEG/Exif** when **Color Mode** is **Black and White**.

►►► Note

- With network connection, scanning may take longer than usual when you set **TIFF** or **PNG** in **Data Format**.

JPEG Image Quality

You can specify the image quality of JPEG files.

►►► Important

- This appears only when **JPEG/Exif** is selected in **Data Format**.

Save to a subfolder with current date

Select this checkbox to create a current date folder in the folder specified in **Save in** and save scanned images in it. The folder will be created with a name such as "20XX_01_01" (Year_Month_Date).

If this checkbox is not selected, files are saved directly in the folder specified in **Save in**.

Check scan results and specify save settings

Displays the [Save Settings dialog box](#) after scanning.

(3) Application Settings Area

Open with an application

Select this when you want to enhance or correct the scanned images.

You can specify the application from the pull-down menu.

Send to an application

Select this when you want to use the scanned images as they are in an application that allows you to browse or organize images.

You can specify the application from the pull-down menu.

Send to a folder

Select this when you also want to save the scanned images to a folder other than the one specified in **Save in**.

You can specify the folder from the pull-down menu.

Attach to e-mail

Select this when you want to send e-mails with the scanned images attached.

You can specify the e-mail client you want to start from the pull-down menu.

Do not start any application

Saves to the folder specified in **Save in**.

▶▶ Note

- To add an application or folder to the pull-down menu, select **Add...** from the pull-down menu, then click **Add** in the displayed **Select Application** or **Select Destination Folder** dialog box and specify the application or folder.

Instructions

Opens this guide.

Defaults

You can restore the settings in the displayed screen to the default settings.

Settings (Custom Scan) Dialog Box

Click **Custom Scan** on the  (Scanning from a Computer) tab to display the **Settings (Custom Scan)** dialog box.

In the **Settings (Custom Scan)** dialog box, you can make advanced scan settings to scan according to your preference.

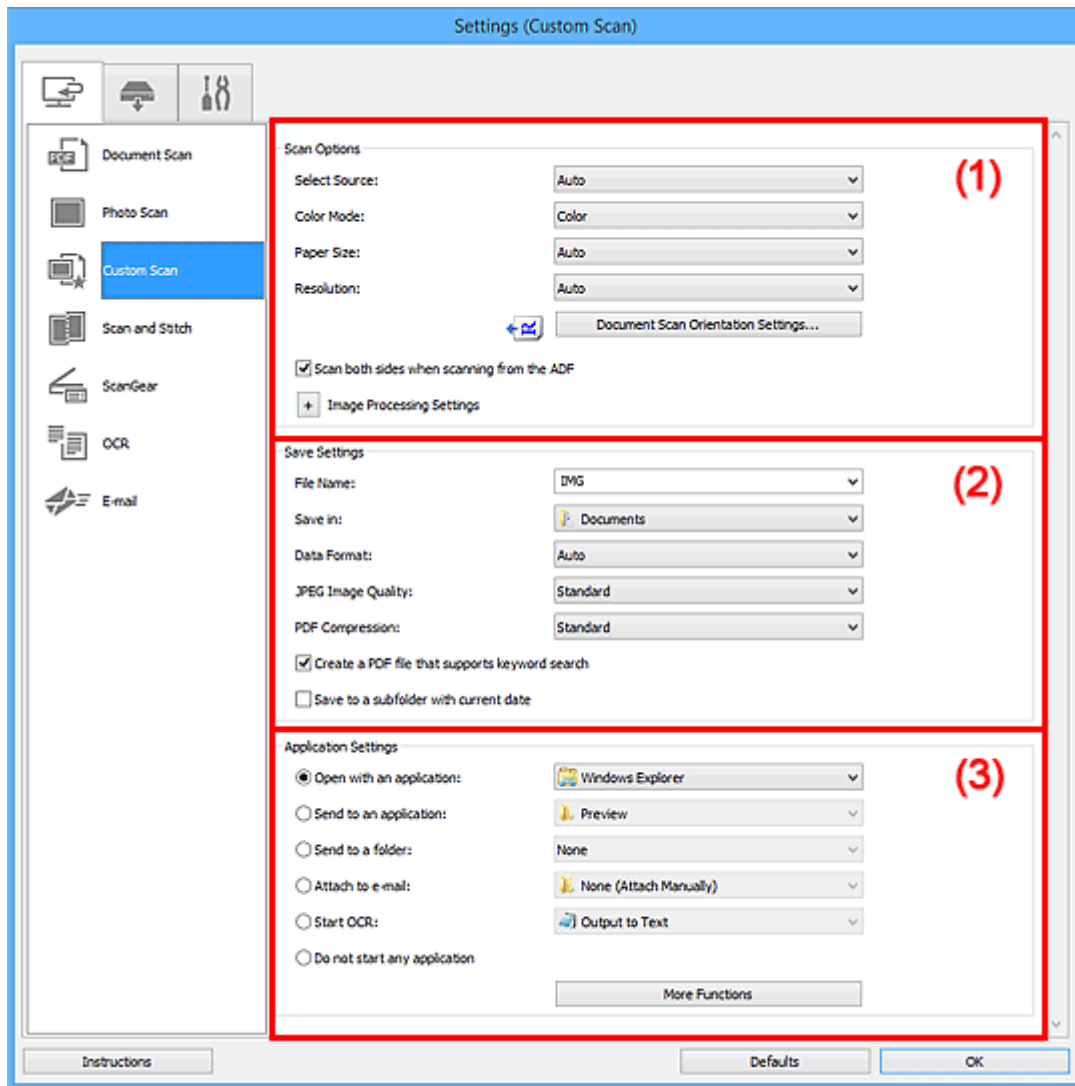

- [\(1\) Scan Options Area](#)
- [\(2\) Save Settings Area](#)
- [\(3\) Application Settings Area](#)

(1) Scan Options Area

Select Source

Select the type of item to be scanned. Select **Auto** to detect the item type automatically and to set **Color Mode**, **Paper Size**, and **Resolution** automatically as well.

»»» Important

- Item types supported by **Auto** are photos, postcards, business cards, magazines, newspapers, documents, and BD/DVD/CD.

- To scan the following types of items, specify the item type or size. You cannot scan correctly with **Auto**.

- A4 size photos
- Text documents smaller than 2L (5 inches x 7 inches) (127 mm x 178 mm), such as paperback pages with the spine cut off
- Items printed on thin white paper
- Long narrow items such as panoramic photos
- Reflective disc labels may not be scanned as expected.
- Place items correctly according to the type of item to be scanned. Otherwise, items may not be scanned correctly.

Refer to "[Positioning Originals \(Scanning from Computer\)](#)" for how to place items.

- When scanning two or more documents from the ADF (Auto Document Feeder), place documents of the same size even if **Auto** is set.

►►► Note

- To convert text in the image into text data after scanning, specify **Select Source** instead of selecting **Auto**.
- To reduce moire, set **Select Source** to **Magazine** or select the **Reduce moire** checkbox in **Image Processing Settings**.

Color Mode

Select the color mode in which to scan the item.

►►► Note

- Only **Color** is available when **Select Source** is **Auto**.

Paper Size

Select the size of the item to be scanned.

When you select **Custom**, a screen in which you can specify the paper size appears. Select a **Unit**, then enter the **Width** and **Height**, and then click **OK**.

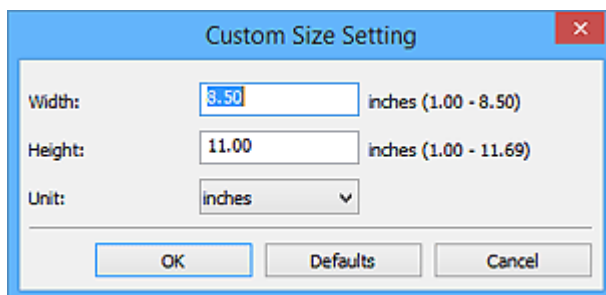

►►► Note

- Only **Auto** is available when **Select Source** is **Auto**.
- Click **Defaults** in the screen in which you can specify the paper size to restore the specified settings to the default settings.

Resolution

Select the resolution of the item to be scanned.

The higher the resolution (value), the more detail in your image.

■ Resolution

»»» Note

- Only **Auto** is available when **Select Source** is **Auto**.
- Only **300 dpi** or **400 dpi** can be set when **Start OCR** is selected in **Application Settings**.

Document Scan Orientation Settings...

This appears when you select ADF or **Auto** for **Select Source**.

Click to display the **Document Scan Orientation Settings** dialog box in which you can set the orientation and binding side of the documents to be scanned from the ADF.

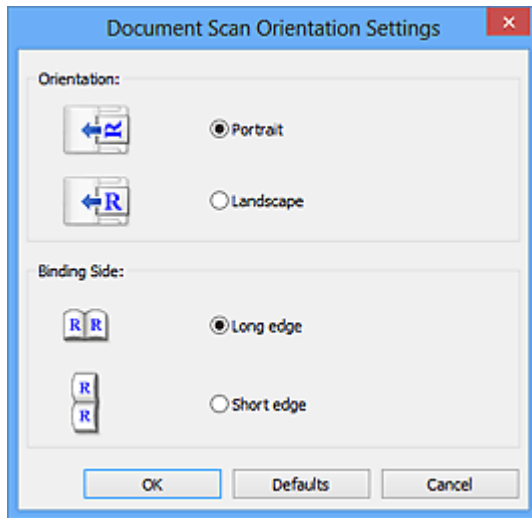

»»» Important

- **Binding Side** cannot be specified when scanning only the front side of each document.

Scan both sides when scanning from the ADF

This appears when you select **Auto** for **Select Source**. Scans both sides of the documents placed on the ADF.

Image Processing Settings

Click  (Plus) to set the following. Available setting items vary by **Select Source**.

- **When Select Source is Auto:**

Apply recommended image correction

Applies suitable corrections automatically based on the item type.

»»» Important

- The color tone may differ from the source image due to corrections. In that case, deselect the checkbox and scan.

»»» Note

- Scanning takes longer than usual when you enable this function.

- **When Select Source is Photo:**

▶▶▶ Important

- When **Color Mode** is **Black and White**, **Image Processing Settings** is not available.

Sharpen outline

Emphasizes the outline of the subjects to sharpen the image.

- **When Select Source is Magazine or Document:**

▶▶▶ Note

- The displayed items vary by **Select Source** and **Color Mode**.

Apply Auto Document Fix

Select this checkbox to sharpen text in a document or magazine for better readability.

▶▶▶ Important

- The color tone may differ from the source image due to corrections. In that case, deselect the checkbox and scan.

▶▶▶ Note

- Scanning takes longer than usual when you enable this function.

Sharpen outline

Emphasizes the outline of the subjects to sharpen the image.

Reduce show-through

Sharpens text in an item or reduces show-through in newspapers, etc.

Reduce moire

Reduces moire patterns.

Printed materials are displayed as a collection of fine dots. "Moire" is a phenomenon where uneven gradation or a stripe pattern appears when such photos or pictures printed with fine dots are scanned.

▶▶▶ Note

- Scanning takes longer than usual when you enable **Reduce moire**.

Reduce gutter shadow

Reduces gutter shadows that appear between pages when scanning open booklets.

▶▶▶ Important

- This function is available only when scanning from the platen.

▶▶▶ Note

- Use ScanGear (scanner driver)'s **Advanced Mode** tab to correct gutter shadows when scanning non-standard size items or specified areas.
Refer to "Gutter Shadow Correction" for your model from Home of the Online Manual for details.

- When you enable this function, scanning may take longer than usual with network connection.

Correct slanted text document

Detects the scanned text and corrects the angle (within -0.1 to -10 degrees or +0.1 to +10 degrees) of the document.

»» Important

- The following types of documents may not be corrected properly since the text cannot be detected correctly.
 - Documents in which the text lines are inclined more than 10 degrees or the angles vary by line
 - Documents containing both vertical and horizontal text
 - Documents with extremely large or small fonts
 - Documents with small amount of text
 - Documents containing figures/images
 - Hand-written text
 - Documents containing both vertical and horizontal lines (tables)

»» Note

- Scanning takes longer than usual when you enable **Correct slanted text document**.

Detect the orientation of text document and rotate image

Automatically rotates the image to the correct orientation by detecting the orientation of text in the scanned document.

»» Important

- Only text documents written in languages that can be selected from **Document Language** in the [Settings \(General Settings\) dialog box](#) are supported.
- The orientation may not be detected for the following types of settings or documents since the text cannot be detected correctly.
 - Resolution is outside the range of 300 dpi to 600 dpi
 - Font size is outside the range of 8 points to 48 points
 - Documents containing special fonts, effects, italics, or hand-written text
 - Documents with patterned backgrounds

In that case, select the **Check scan results and specify save settings** checkbox, and then rotate the image in the [Save Settings dialog box](#).

(2) Save Settings Area

File Name

Enter the file name of the image to be saved. When you save a file, the date and four digits are appended to the set file name in the "_20XX0101_0001" format.

»»» Note

- When you select the **Save to a subfolder with current date** checkbox, the date and four digits are appended to the set file name.

Save in

Displays the folder in which to save the scanned images. To add a folder, select **Add...** from the pull-down menu, then click **Add** in the displayed **Select Destination Folder** dialog box and specify the destination folder.

The default save folders are as follows.

- **Windows 10/Windows 8.1/Windows Vista:**
Documents folder
- **Windows 8/Windows 7:**
My Documents folder

Data Format

Select the data format in which to save the scanned images.

You can select **JPEG/Exif**, **TIFF**, **PNG**, **PDF**, **PDF (Multiple Pages)**, or **Auto**.

»»» Important

- You cannot select **JPEG/Exif** when **Color Mode** is **Black and White**.
- When **Start OCR** is selected in **Application Settings**, you cannot select **PDF** or **PDF (Multiple Pages)**.

»»» Note

- **Auto** appears only when **Auto** is selected for **Select Source**.
- With network connection, scanning may take longer than usual when you set **TIFF** or **PNG** in **Data Format**.

JPEG Image Quality

You can specify the image quality of JPEG files.

»»» Important

- This appears only when **JPEG/Exif** or **Auto** is selected in **Data Format**.

PDF Compression

Select the compression type for saving PDF files.

Standard

It is recommended that you normally select this setting.

High

Compresses the file size when saving, allowing you to reduce the load on your network/server.

»»» Important

- This appears only when **PDF**, **PDF (Multiple Pages)**, or **Auto** is selected in **Data Format**.
- When **Black and White** is selected in **Color Mode**, this option does not appear.

Create a PDF file that supports keyword search

Select this checkbox to convert text in images into text data and create PDF files that support keyword search.

▶▶▶ Important

- This appears only when **PDF**, **PDF (Multiple Pages)**, or **Auto** is selected in **Data Format**.

▶▶▶ Note

- PDF files that are searchable in the language selected in **Document Language** on the  (General Settings) tab of the Settings dialog box are created.

Set up password security

Select this checkbox to display the [Password Security Settings dialog box](#).

▶▶▶ Important

- This appears only when **PDF** or **PDF (Multiple Pages)** is selected in **Data Format**.

Save to a subfolder with current date

Select this checkbox to create a current date folder in the folder specified in **Save in** and save scanned images in it. The folder will be created with a name such as "20XX_01_01" (Year_Month_Date).

If this checkbox is not selected, files are saved directly in the folder specified in **Save in**.

Check scan results and specify save settings

Displays the [Save Settings dialog box](#) after scanning.

▶▶▶ Important

- This does not appear when **Select Source** is **Auto**.

(3) Application Settings Area

Open with an application

Select this when you want to enhance or correct the scanned images.

You can specify the application from the pull-down menu.

Send to an application

Select this when you want to use the scanned images as they are in an application that allows you to browse or organize images.

You can specify the application from the pull-down menu.

Send to a folder

Select this when you also want to save the scanned images to a folder other than the one specified in **Save in**.

You can specify the folder from the pull-down menu.

Attach to e-mail

Select this when you want to send e-mails with the scanned images attached.

You can specify the e-mail client you want to start from the pull-down menu.

Start OCR

Select this when you want to convert text in the scanned image into text data.

You can specify the application from the pull-down menu.

Do not start any application

Saves to the folder specified in **Save in**.

»» Note

- To add an application or folder to the pull-down menu, select **Add...** from the pull-down menu, then click **Add** in the displayed **Select Application** or **Select Destination Folder** dialog box and specify the application or folder.

Instructions

Opens this guide.

Defaults

You can restore the settings in the displayed screen to the default settings.

Settings (Scan and Stitch) Dialog Box

Click **Scan and Stitch** on the  (Scanning from a Computer) tab to display the **Settings (Scan and Stitch)** dialog box.

In the **Settings (Scan and Stitch)** dialog box, you can make advanced scan settings for scanning items larger than the platen.

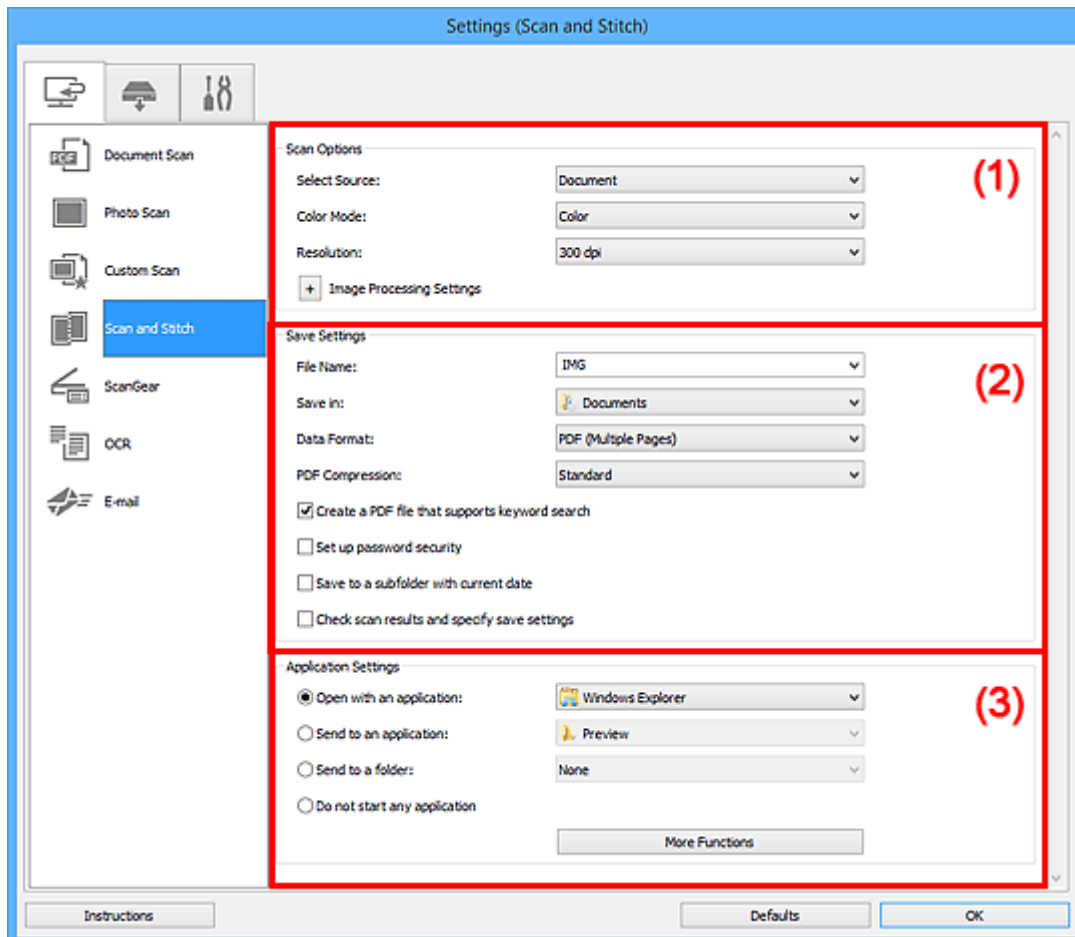

- (1) [Scan Options Area](#)
- (2) [Save Settings Area](#)
- (3) [Application Settings Area](#)

(1) Scan Options Area

Select Source

Select the type of item to be scanned.

- Scanning photos: **Photo**
- Scanning documents: **Document**
- Scanning magazines: **Magazine**

»»» Note

- To reduce moire, set **Select Source** to **Magazine** or select the **Reduce moire** checkbox in **Image Processing Settings**.

Color Mode

Select the color mode in which to scan the item.

Resolution

Select the resolution of the item to be scanned.

The higher the resolution (value), the more detail in your image.

■ Resolution

Image Processing Settings

Click  (Plus) to set the following. Available setting items vary by **Select Source**.

▶▶▶ Important

- When **Color Mode** is **Black and White**, **Image Processing Settings** is not available.

- **When Select Source is Photo:**

Sharpen outline

Emphasizes the outline of the subjects to sharpen the image.

- **When Select Source is Magazine or Document:**

Sharpen outline

Emphasizes the outline of the subjects to sharpen the image.

Reduce show-through

Sharpens text in an item or reduces show-through in newspapers, etc.

Reduce moire

Reduces moire patterns.

Printed materials are displayed as a collection of fine dots. "Moire" is a phenomenon where uneven gradation or a stripe pattern appears when such photos or pictures printed with fine dots are scanned.

▶▶▶ Note

- Scanning takes longer than usual when you enable **Reduce moire**.

(2) Save Settings Area

File Name

Enter the file name of the image to be saved. When you save a file, the date and four digits are appended to the set file name in the "_20XX0101_0001" format.

▶▶▶ Note

- When you select the **Save to a subfolder with current date** checkbox, the date and four digits are appended to the set file name.

Save in

Displays the folder in which to save the scanned images. To add a folder, select **Add...** from the pull-down menu, then click **Add** in the displayed **Select Destination Folder** dialog box and specify the destination folder.

The default save folders are as follows.

- **Windows 10/Windows 8.1/Windows Vista:**

Documents folder

- **Windows 8/Windows 7:**

My Documents folder

Data Format

Select the data format in which to save the scanned images.

You can select **JPEG/Exif**, **TIFF**, **PNG**, **PDF**, or **PDF (Multiple Pages)**.

▶▶▶ Important

- You cannot select **JPEG/Exif** when **Color Mode** is **Black and White**.

▶▶▶ Note

- With network connection, scanning may take longer than usual when you set **TIFF** or **PNG** in **Data Format**.

PDF Compression

Select the compression type for saving PDF files.

Standard

It is recommended that you normally select this setting.

High

Compresses the file size when saving, allowing you to reduce the load on your network/server.

▶▶▶ Important

- This appears only when **PDF** or **PDF (Multiple Pages)** is selected in **Data Format**.
- When **Black and White** is selected in **Color Mode**, this option does not appear.

JPEG Image Quality

You can specify the image quality of JPEG files.

▶▶▶ Important

- This appears only when **JPEG/Exif** is selected in **Data Format**.

Create a PDF file that supports keyword search

Select this checkbox to convert text in images into text data and create PDF files that support keyword search.

▶▶▶ Important

- This appears only when **PDF** or **PDF (Multiple Pages)** is selected in **Data Format**.

▶▶▶ Note

- PDF files that are searchable in the language selected in **Document Language** on the  (General Settings) tab of the Settings dialog box are created.

Set up password security

Select this checkbox to display the [Password Security Settings dialog box](#).

»» Important

- This appears only when **PDF** or **PDF (Multiple Pages)** is selected in **Data Format**.

Save to a subfolder with current date

Select this checkbox to create a current date folder in the folder specified in **Save in** and save scanned images in it. The folder will be created with a name such as "20XX_01_01" (Year_Month_Date).

If this checkbox is not selected, files are saved directly in the folder specified in **Save in**.

Check scan results and specify save settings

Displays the [Save Settings dialog box](#) after scanning.

(3) Application Settings Area

Open with an application

Select this when you want to enhance or correct the scanned images.

You can specify the application from the pull-down menu.

Send to an application

Select this when you want to use the scanned images as they are in an application that allows you to browse or organize images.

You can specify the application from the pull-down menu.

Send to a folder

Select this when you also want to save the scanned images to a folder other than the one specified in **Save in**.

You can specify the folder from the pull-down menu.

Do not start any application

Saves to the folder specified in **Save in**.

»» Note

- To add an application or folder to the pull-down menu, select **Add...** from the pull-down menu, then click **Add** in the displayed **Select Application** or **Select Destination Folder** dialog box and specify the application or folder.

Instructions

Opens this guide.

Defaults

You can restore the settings in the displayed screen to the default settings.

Settings (ScanGear) Dialog Box

Click **ScanGear** on the  (Scanning from a Computer) tab to display the **Settings (ScanGear)** dialog box.

In the **Settings (ScanGear)** dialog box, you can specify how to save images when scanning items by starting ScanGear (scanner driver) and how to respond after saving them.

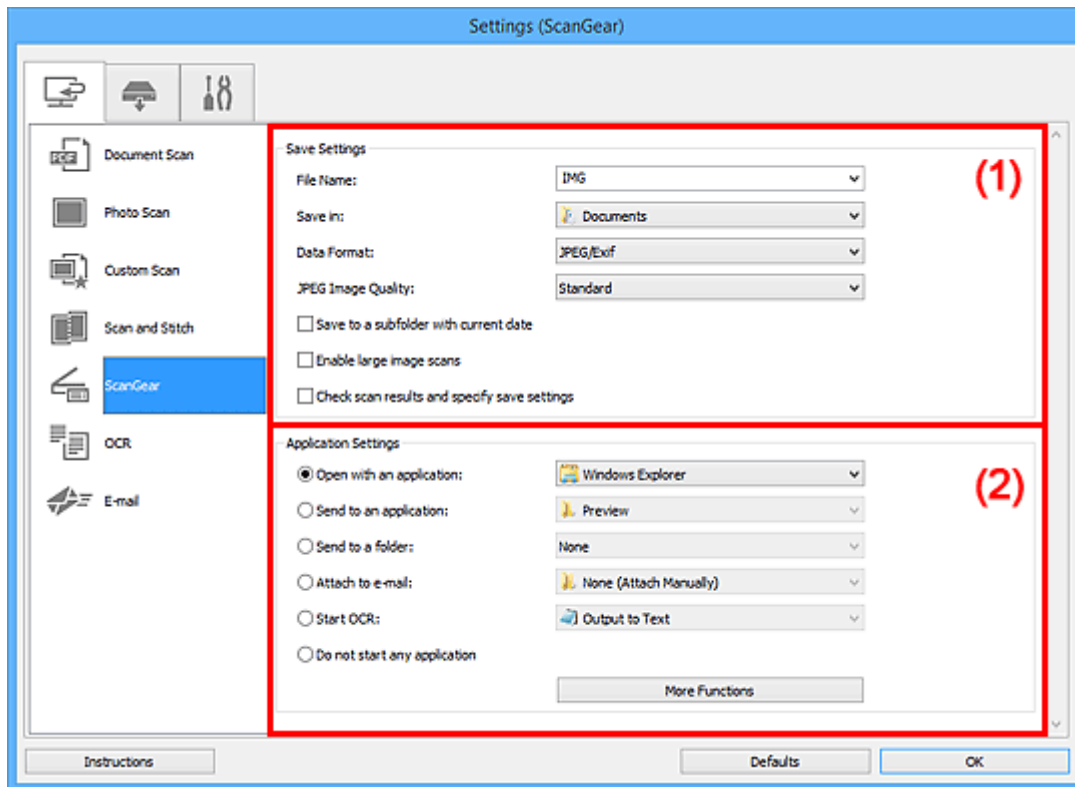

■ (1) Save Settings Area

■ (2) Application Settings Area

(1) Save Settings Area

File Name

Enter the file name of the image to be saved. When you save a file, the date and four digits are appended to the set file name in the "_20XX0101_0001" format.

►►► Note

- When you select the **Save to a subfolder with current date** checkbox, the date and four digits are appended to the set file name.

Save in

Displays the folder in which to save the scanned images. To add a folder, select **Add...** from the pull-down menu, then click **Add** in the displayed **Select Destination Folder** dialog box and specify the destination folder.

The default save folders are as follows.

- **Windows 10/Windows 8.1/Windows Vista:**

Documents folder

- **Windows 8/Windows 7:**

My Documents folder

Data Format

Select the data format in which to save the scanned images.

You can select **JPEG/Exif**, **TIFF**, **PNG**, **PDF**, or **PDF (Multiple Pages)**.

►►► Note

- When **PDF** or **PDF (Multiple Pages)** is selected, images up to 9600 pixels x 9600 pixels can be scanned.
- When the **Enable large image scans** checkbox is selected in **Save Settings**, or when **Start OCR** is selected in **Application Settings**, you can select **JPEG/Exif**, **TIFF**, or **PNG**.
- With network connection, scanning may take longer than usual when you set **TIFF** or **PNG** in **Data Format**.

JPEG Image Quality

You can specify the image quality of JPEG files.

►►► Important

- This appears only when **JPEG/Exif** is selected in **Data Format**.

PDF Compression

Select the compression type for saving PDF files.

Standard

It is recommended that you normally select this setting.

High

Compresses the file size when saving, allowing you to reduce the load on your network/server.

►►► Important

- This appears only when **PDF** or **PDF (Multiple Pages)** is selected in **Data Format**.

Create a PDF file that supports keyword search

Select this checkbox to convert text in images into text data and create PDF files that support keyword search.

►►► Important

- This appears only when **PDF** or **PDF (Multiple Pages)** is selected in **Data Format**.

►►► Note

- PDF files that are searchable in the language selected in **Document Language** on the  (General Settings) tab of the Settings dialog box are created.

Set up password security

Select this checkbox to display the [Password Security Settings dialog box](#).

»»» Important

- This appears only when **PDF** or **PDF (Multiple Pages)** is selected in **Data Format**.

Save to a subfolder with current date

Select this checkbox to create a current date folder in the folder specified in **Save in** and save scanned images in it. The folder will be created with a name such as "20XX_01_01" (Year_Month_Date).

If this checkbox is not selected, files are saved directly in the folder specified in **Save in**.

Enable large image scans

Select this checkbox to scan images up to 21000 pixels x 30000 pixels and 1.8 GB.

»»» Important

- When this checkbox is selected, you cannot select **Send to an application**, **Send to a folder**, **Attach to e-mail**, or **Start OCR**.

»»» Note

- When this checkbox is not selected, images up to 10208 pixels x 14032 pixels can be scanned.

Check scan results and specify save settings

Displays the [Save Settings dialog box](#) after scanning.

(2) Application Settings Area

Open with an application

Select this when you want to enhance or correct the scanned images.

You can specify the application from the pull-down menu.

Send to an application

Select this when you want to use the scanned images as they are in an application that allows you to browse or organize images.

You can specify the application from the pull-down menu.

Send to a folder

Select this when you also want to save the scanned images to a folder other than the one specified in **Save in**.

You can specify the folder from the pull-down menu.

Attach to e-mail

Select this when you want to send e-mails with the scanned images attached.

You can specify the e-mail client you want to start from the pull-down menu.

Start OCR

Select this when you want to convert text in the scanned image into text data.

You can specify the application from the pull-down menu.

Do not start any application

Saves to the folder specified in **Save in**.

▶▶ Note

- To add an application or folder to the pull-down menu, select **Add...** from the pull-down menu, then click **Add** in the displayed **Select Application** or **Select Destination Folder** dialog box and specify the application or folder.

Instructions

Opens this guide.

Defaults

You can restore the settings in the displayed screen to the default settings.

Settings (OCR) Dialog Box

Click **OCR** on the  (Scanning from a Computer) tab to display the **Settings (OCR)** dialog box.

In the **Settings (OCR)** dialog box, you can make advanced settings for extracting text from scanned images.

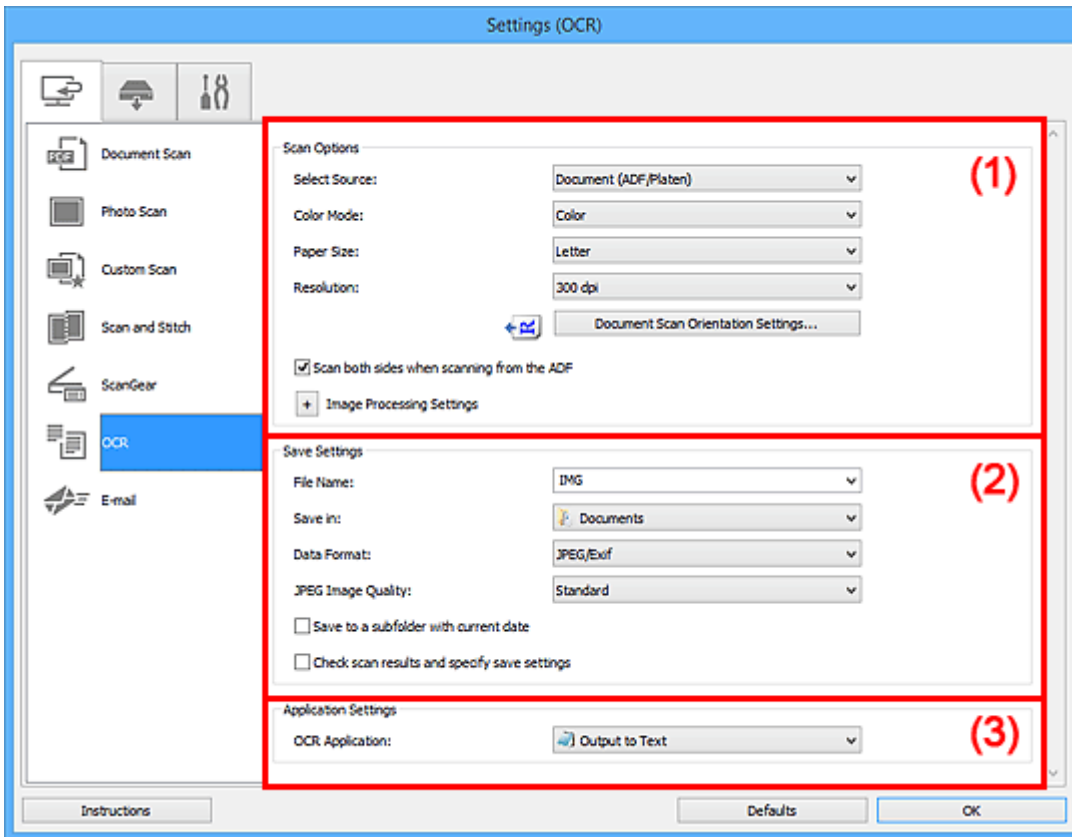

- [\(1\) Scan Options Area](#)
- [\(2\) Save Settings Area](#)
- [\(3\) Application Settings Area](#)

(1) Scan Options Area

Select Source

Select the type of item to be scanned.

- Scanning documents: **Document** or **Document (ADF/Platen)**
- Scanning magazines: **Magazine**
- Scanning documents from the ADF (Auto Document Feeder): **Document (ADF Simplex)**, **Document (ADF Manual Duplex)**, **Document (ADF Duplex)**, or **Document (ADF/Platen)**

»»» Note

- When **Document (ADF/Platen)** is selected and documents are placed both on the platen and ADF, those placed on the ADF will be scanned.

Color Mode

Select the color mode in which to scan the item.

Paper Size

Select the size of the item to be scanned.

When you select **Custom**, a screen in which you can specify the paper size appears. Select a **Unit**, then enter the **Width** and **Height**, and then click **OK**.

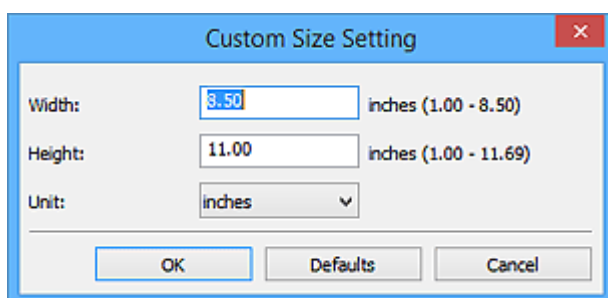

Important

- **Custom** cannot be selected depending on the **Select Source** setting.

Note

- Click **Defaults** to restore the specified settings to the default settings.

Resolution

Select the resolution of the item to be scanned.

The higher the resolution (value), the more detail in your image.

Resolution

Note

- For **Resolution**, only **300 dpi** or **400 dpi** can be set.

Document Scan Orientation Settings...

This appears when you select ADF for **Select Source**.

Click to display the **Document Scan Orientation Settings** dialog box in which you can set the orientation and binding side of the documents to be scanned from the ADF.

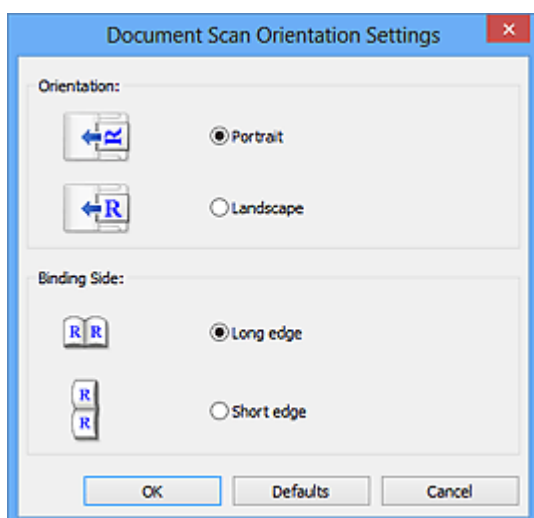

►►► Important

- **Binding Side** cannot be specified when scanning only the front side of each document.

Scan both sides when scanning from the ADF

This appears when you select **Document (ADF/Platen)** for **Select Source**. Scans both sides of the documents placed on the ADF.

Image Processing Settings

Click  (Plus) to set the following.

►►► Note

- The displayed items vary by **Select Source** and **Color Mode**.

Apply Auto Document Fix

Select this checkbox to sharpen text in a document or magazine for better readability.

►►► Important

- The color tone may differ from the source image due to corrections. In that case, deselect the checkbox and scan.

►►► Note

- Scanning takes longer than usual when you enable this function.

Sharpen outline

Emphasizes the outline of the subjects to sharpen the image.

Reduce show-through

Sharpens text in an item or reduces show-through in newspapers, etc.

Reduce moire

Reduces moire patterns.

Printed materials are displayed as a collection of fine dots. "Moire" is a phenomenon where uneven gradation or a stripe pattern appears when such photos or pictures printed with fine dots are scanned.

►►► Note

- Scanning takes longer than usual when you enable **Reduce moire**.

Reduce gutter shadow/Reduce gutter shadow (platen)

Reduces gutter shadows that appear between pages when scanning open booklets.

►►► Important

- This function is available only when scanning from the platen.

►►► Note

- Use ScanGear (scanner driver)'s **Advanced Mode** tab to correct gutter shadows when scanning non-standard size items or specified areas.
Refer to "Gutter Shadow Correction" for your model from Home of the Online Manual for details.

- When you enable this function, scanning may take longer than usual with network connection.

Correct slanted text document

Detects the scanned text and corrects the angle (within -0.1 to -10 degrees or +0.1 to +10 degrees) of the document.

»» Important

- The following types of documents may not be corrected properly since the text cannot be detected correctly.
 - Documents in which the text lines are inclined more than 10 degrees or the angles vary by line
 - Documents containing both vertical and horizontal text
 - Documents with extremely large or small fonts
 - Documents with small amount of text
 - Documents containing figures/images
 - Hand-written text
 - Documents containing both vertical and horizontal lines (tables)

»» Note

- Scanning takes longer than usual when you enable **Correct slanted text document**.

Detect the orientation of text document and rotate image

Automatically rotates the image to the correct orientation by detecting the orientation of text in the scanned document.

»» Important

- Only text documents written in languages that can be selected from **Document Language** in the [Settings \(General Settings\) dialog box](#) are supported.
- The orientation may not be detected for the following types of settings or documents since the text cannot be detected correctly.
 - Resolution is outside the range of 300 dpi to 600 dpi
 - Font size is outside the range of 8 points to 48 points
 - Documents containing special fonts, effects, italics, or hand-written text
 - Documents with patterned backgrounds

In that case, select the **Check scan results and specify save settings** checkbox, and then rotate the image in the [Save Settings dialog box](#).

(2) Save Settings Area

File Name

Enter the file name of the image to be saved. When you save a file, the date and four digits are appended to the set file name in the "_20XX0101_0001" format.

»» Note

- When you select the **Save to a subfolder with current date** checkbox, the date and four digits are appended to the set file name.

Save in

Displays the folder in which to save the scanned images. To add a folder, select **Add...** from the pull-down menu, then click **Add** in the displayed **Select Destination Folder** dialog box and specify the destination folder.

The default save folders are as follows.

- **Windows 10/Windows 8.1/Windows Vista:**
Documents folder
- **Windows 8/Windows 7:**
My Documents folder

Data Format

Select the data format in which to save the scanned images.

You can select **JPEG/Exif**, **TIFF**, or **PNG**.

»» Important

- You cannot select **JPEG/Exif** when **Color Mode** is **Black and White**.

»» Note

- With network connection, scanning may take longer than usual when you set **TIFF** or **PNG** in **Data Format**.

JPEG Image Quality

You can specify the image quality of JPEG files.

»» Important

- This appears only when **JPEG/Exif** is selected in **Data Format**.

Save to a subfolder with current date

Select this checkbox to create a current date folder in the folder specified in **Save in** and save scanned images in it. The folder will be created with a name such as "20XX_01_01" (Year_Month_Date).

If this checkbox is not selected, files are saved directly in the folder specified in **Save in**.

Check scan results and specify save settings

Displays the [Save Settings dialog box](#) after scanning.

(3) Application Settings Area

OCR Application

Displays the extracted text in a specified application.

▶▶ Note

- To add an application to the pull-down menu, select **Add...** from the pull-down menu, then click **Add** in the displayed **Select Application** dialog box and specify the application.

Instructions

Opens this guide.

Defaults

You can restore the settings in the displayed screen to the default settings.

Settings (E-mail) Dialog Box

Click **E-mail** on the  (Scanning from a Computer) tab to display the **Settings (E-mail)** dialog box.

In the **Settings (E-mail)** dialog box, you can specify how to respond when attaching images to an e-mail after scanning them using the scanner button.

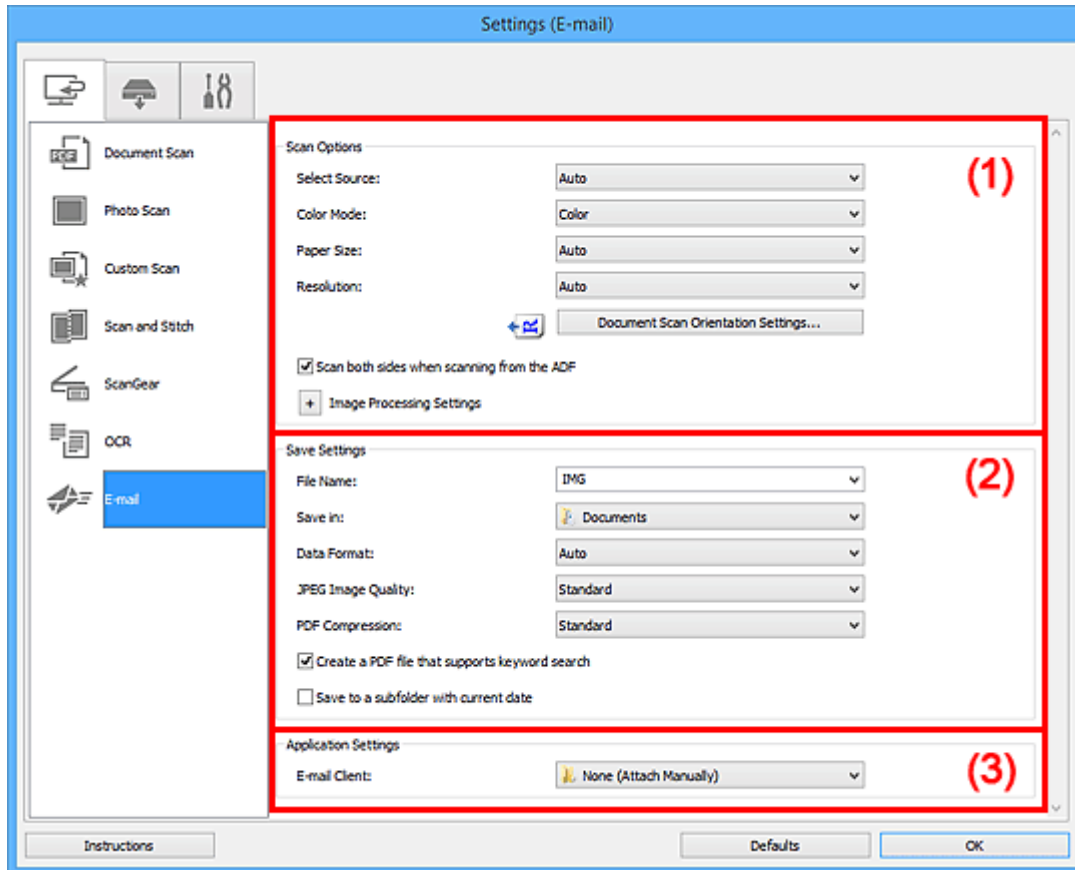

- [\(1\) Scan Options Area](#)
- [\(2\) Save Settings Area](#)
- [\(3\) Application Settings Area](#)

(1) Scan Options Area

Select Source

Select the type of item to be scanned. Select **Auto** to detect the item type automatically and to set **Color Mode**, **Paper Size**, and **Resolution** automatically as well.

►►► Important

- Item types supported by **Auto** are photos, postcards, business cards, magazines, newspapers, documents, and BD/DVD/CD.
- To scan the following types of items, specify the item type or size. You cannot scan correctly with **Auto**.
 - A4 size photos
 - Text documents smaller than 2L (5 inches x 7 inches) (127 mm x 178 mm), such as paperback pages with the spine cut off
 - Items printed on thin white paper

- Long narrow items such as panoramic photos
- Reflective disc labels may not be scanned as expected.
- Place items correctly according to the type of item to be scanned. Otherwise, items may not be scanned correctly.

Refer to "[Positioning Originals \(Scanning from Computer\)](#)" for how to place items.

- When scanning two or more documents from the ADF (Auto Document Feeder), place documents of the same size even if **Auto** is set.

»»» Note

- To reduce moire, set **Select Source** to **Magazine** or select the **Reduce moire** checkbox in **Image Processing Settings**.

Color Mode

Select the color mode in which to scan the item.

»»» Note

- Only **Color** is available when **Select Source** is **Auto**.

Paper Size

Select the size of the item to be scanned.

When you select **Custom**, a screen in which you can specify the paper size appears. Select a **Unit**, then enter the **Width** and **Height**, and then click **OK**.

»»» Note

- Only **Auto** is available when **Select Source** is **Auto**.
- Click **Defaults** in the screen in which you can specify the paper size to restore the specified settings to the default settings.

Resolution

Select the resolution of the item to be scanned.

The higher the resolution (value), the more detail in your image.

■ [Resolution](#)

»»» Note

- Only **Auto** is available when **Select Source** is **Auto**.

Document Scan Orientation Settings...

This appears when you select ADF or **Auto** for **Select Source**.

Click to display the **Document Scan Orientation Settings** dialog box in which you can set the orientation and binding side of the documents to be scanned from the ADF.

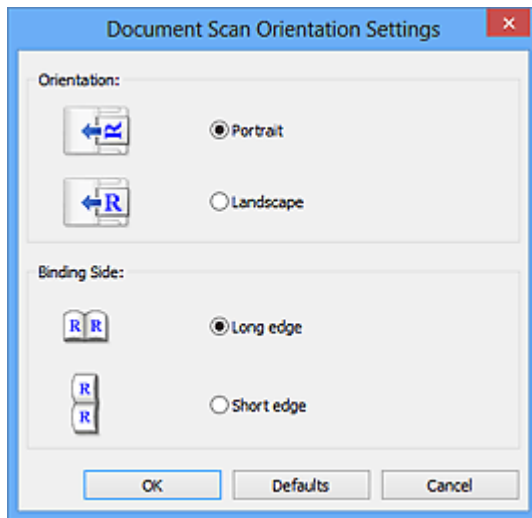

»»» Important

- **Binding Side** cannot be specified when scanning only the front side of each document.

Scan both sides when scanning from the ADF

This appears when you select **Auto** for **Select Source**. Scans both sides of the documents placed on the ADF.

Image Processing Settings

Click  (Plus) to set the following. Available setting items vary by **Select Source**.

- **When Select Source is Auto:**

Apply recommended image correction

Applies suitable corrections automatically based on the item type.

»»» Important

- The color tone may differ from the source image due to corrections. In that case, deselect the checkbox and scan.

»»» Note

- Scanning takes longer than usual when you enable this function.

- **When Select Source is Photo:**

»»» Important

- When **Color Mode** is **Black and White**, **Image Processing Settings** is not available.

Sharpen outline

Emphasizes the outline of the subjects to sharpen the image.

- **When Select Source is Magazine or Document:**

»»» Note

- The displayed items vary by **Select Source** and **Color Mode**.

Apply Auto Document Fix

Select this checkbox to sharpen text in a document or magazine for better readability.

►►► Important

- The color tone may differ from the source image due to corrections. In that case, deselect the checkbox and scan.

►►► Note

- Scanning takes longer than usual when you enable this function.

Sharpen outline

Emphasizes the outline of the subjects to sharpen the image.

Reduce show-through

Sharpens text in an item or reduces show-through in newspapers, etc.

Reduce moire

Reduces moire patterns.

Printed materials are displayed as a collection of fine dots. "Moire" is a phenomenon where uneven gradation or a stripe pattern appears when such photos or pictures printed with fine dots are scanned.

►►► Note

- Scanning takes longer than usual when you enable **Reduce moire**.

Reduce gutter shadow

Reduces gutter shadows that appear between pages when scanning open booklets.

►►► Important

- This function is available only when scanning from the platen.

►►► Note

- Use ScanGear (scanner driver)'s **Advanced Mode** tab to correct gutter shadows when scanning non-standard size items or specified areas.
Refer to "Gutter Shadow Correction" for your model from Home of the Online Manual for details.
- When you enable this function, scanning may take longer than usual with network connection.

Correct slanted text document

Detects the scanned text and corrects the angle (within -0.1 to -10 degrees or +0.1 to +10 degrees) of the document.

►►► Important

- The following types of documents may not be corrected properly since the text cannot be detected correctly.
 - Documents in which the text lines are inclined more than 10 degrees or the angles vary by line
 - Documents containing both vertical and horizontal text

- Documents with extremely large or small fonts
- Documents with small amount of text
- Documents containing figures/images
- Hand-written text
- Documents containing both vertical and horizontal lines (tables)

►►► Note

- Scanning takes longer than usual when you enable **Correct slanted text document**.

Detect the orientation of text document and rotate image

Automatically rotates the image to the correct orientation by detecting the orientation of text in the scanned document.

►►► Important

- Only text documents written in languages that can be selected from **Document Language** in the [Settings \(General Settings\) dialog box](#) are supported.
- The orientation may not be detected for the following types of settings or documents since the text cannot be detected correctly.
 - Resolution is outside the range of 300 dpi to 600 dpi
 - Font size is outside the range of 8 points to 48 points
 - Documents containing special fonts, effects, italics, or hand-written text
 - Documents with patterned backgrounds

In that case, select the **Check scan results and specify save settings** checkbox, and then rotate the image in the [Save Settings dialog box](#).

(2) Save Settings Area

File Name

Enter the file name of the image to be saved. When you save a file, the date and four digits are appended to the set file name in the "_20XX0101_0001" format.

►►► Note

- When you select the **Save to a subfolder with current date** checkbox, the date and four digits are appended to the set file name.

Save in

Displays the folder in which to save the scanned images. To add a folder, select **Add...** from the pull-down menu, then click **Add** in the displayed **Select Destination Folder** dialog box and specify the destination folder.

The default save folders are as follows.

- **Windows 10/Windows 8.1/Windows Vista:**
Documents folder
- **Windows 8/Windows 7:**
My Documents folder

Data Format

Select the data format in which to save the scanned images.

You can select **JPEG/Exif**, **TIFF**, **PNG**, **PDF**, **PDF (Multiple Pages)**, or **Auto**.

Important

- You cannot select **JPEG/Exif** when **Color Mode** is **Black and White**.

Note

- **Auto** appears only when **Auto** is selected for **Select Source**.
- With network connection, scanning may take longer than usual when you set **TIFF** or **PNG** in **Data Format**.

JPEG Image Quality

You can specify the image quality of JPEG files.

Important

- This appears only when **JPEG/Exif** or **Auto** is selected in **Data Format**.

PDF Compression

Select the compression type for saving PDF files.

Standard

It is recommended that you normally select this setting.

High

Compresses the file size when saving, allowing you to reduce the load on your network/server.

Important

- This appears only when **PDF** or **PDF (Multiple Pages)** is selected in **Data Format**.
- When **Black and White** is selected in **Color Mode**, this option does not appear.

Create a PDF file that supports keyword search

Select this checkbox to convert text in images into text data and create PDF files that support keyword search.

Important

- This appears only when **PDF**, **PDF (Multiple Pages)**, or **Auto** is selected in **Data Format**.

Note

- PDF files that are searchable in the language selected in **Document Language** on the  (General Settings) tab of the Settings dialog box are created.

Set up password security

Select this checkbox to display the [Password Security Settings dialog box](#).

Important

- This appears only when **PDF** or **PDF (Multiple Pages)** is selected in **Data Format**.

Save to a subfolder with current date

Select this checkbox to create a current date folder in the folder specified in **Save in** and save scanned images in it. The folder will be created with a name such as "20XX_01_01" (Year_Month_Date).

If this checkbox is not selected, files are saved directly in the folder specified in **Save in**.

Check scan results and specify save settings

Displays the [Save Settings dialog box](#) after scanning.

▶▶▶ Important

- This does not appear when **Select Source** is **Auto**.

(3) Application Settings Area

E-mail Client

Specify the e-mail client to use for attaching scanned images.

▶▶▶ Note

- To add an e-mail client to the pull-down menu, select **Add...** from the pull-down menu, then click **Add** in the displayed **Select Application** dialog box and specify the e-mail client.

Instructions

Opens this guide.

Defaults

You can restore the settings in the displayed screen to the default settings.

Settings (Save to PC (Photo)) Dialog Box

Click **Save to PC (Photo)** on the  (Scanning from the Operation Panel) tab to display the **Settings (Save to PC (Photo))** dialog box.

In the **Settings (Save to PC (Photo))** dialog box, you can specify how to respond when saving images to a computer as photos after scanning them from the operation panel.

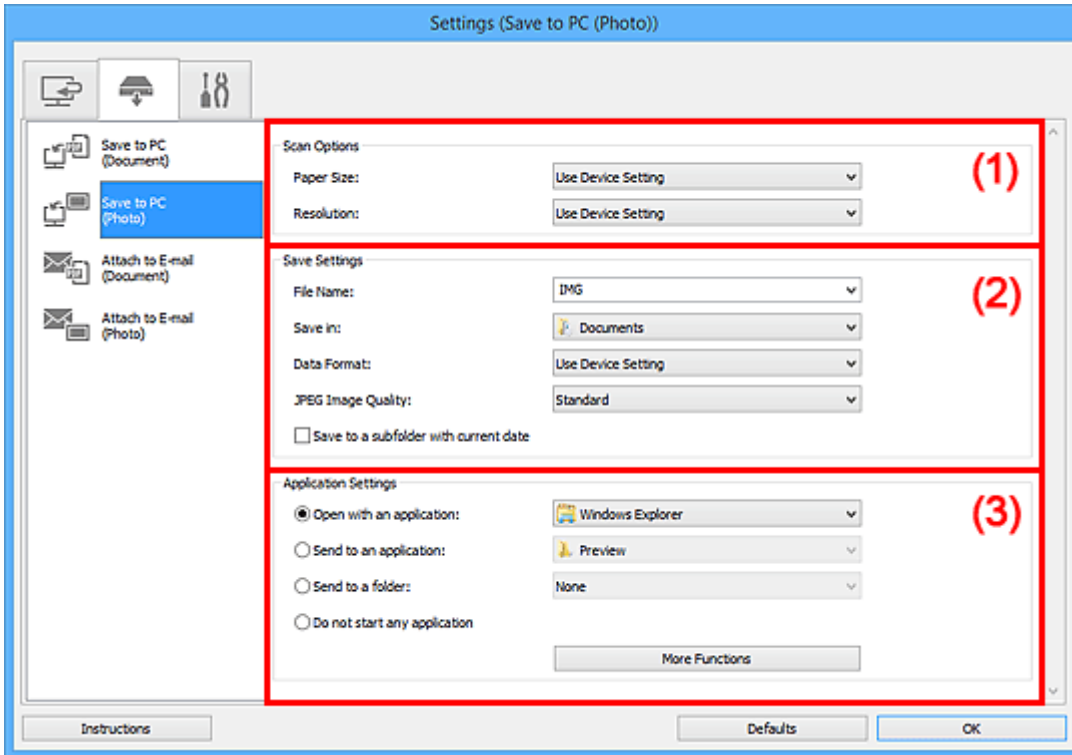

- [\(1\) Scan Options Area](#)
- [\(2\) Save Settings Area](#)
- [\(3\) Application Settings Area](#)

(1) Scan Options Area

Paper Size

Set from the operation panel.

Resolution

Set from the operation panel.

(2) Save Settings Area

File Name

Enter the file name of the image to be saved. When you save a file, the date and four digits are appended to the set file name in the "_20XX0101_0001" format.

►►► Note

- When you select the **Save to a subfolder with current date** checkbox, the date and four digits are appended to the set file name.

Save in

Displays the folder in which to save the scanned images. To add a folder, select **Add...** from the pull-down menu, then click **Add** in the displayed **Select Destination Folder** dialog box and specify the destination folder.

The default save folders are as follows.

- **Windows 10/Windows 8.1/Windows Vista:**
Documents folder
- **Windows 8/Windows 7:**
My Documents folder

Data Format

Set from the operation panel.

JPEG Image Quality

You can specify the image quality of JPEG files.

Save to a subfolder with current date

Select this checkbox to create a current date folder in the folder specified in **Save in** and save scanned images in it. The folder will be created with a name such as "20XX_01_01" (Year_Month_Date).

If this checkbox is not selected, files are saved directly in the folder specified in **Save in**.

(3) Application Settings Area

Open with an application

Select this when you want to enhance or correct the scanned images.

You can specify the application from the pull-down menu.

Send to an application

Select this when you want to use the scanned images as they are in an application that allows you to browse or organize images.

You can specify the application from the pull-down menu.

Send to a folder

Select this when you also want to save the scanned images to a folder other than the one specified in **Save in**.

You can specify the folder from the pull-down menu.

Do not start any application

Saves to the folder specified in **Save in**.

▶▶▶ Note

- To add an application or folder to the pull-down menu, select **Add...** from the pull-down menu, then click **Add** in the displayed **Select Application** or **Select Destination Folder** dialog box and specify the application or folder.

Instructions

Opens this guide.

Defaults

You can restore the settings in the displayed screen to the default settings.

Settings (Save to PC (Document)) Dialog Box

Click **Save to PC (Document)** on the  (Scanning from the Operation Panel) tab to display the **Settings (Save to PC (Document))** dialog box.

In the **Settings (Save to PC (Document))** dialog box, you can specify how to respond when saving images to a computer as documents after scanning them from the operation panel.

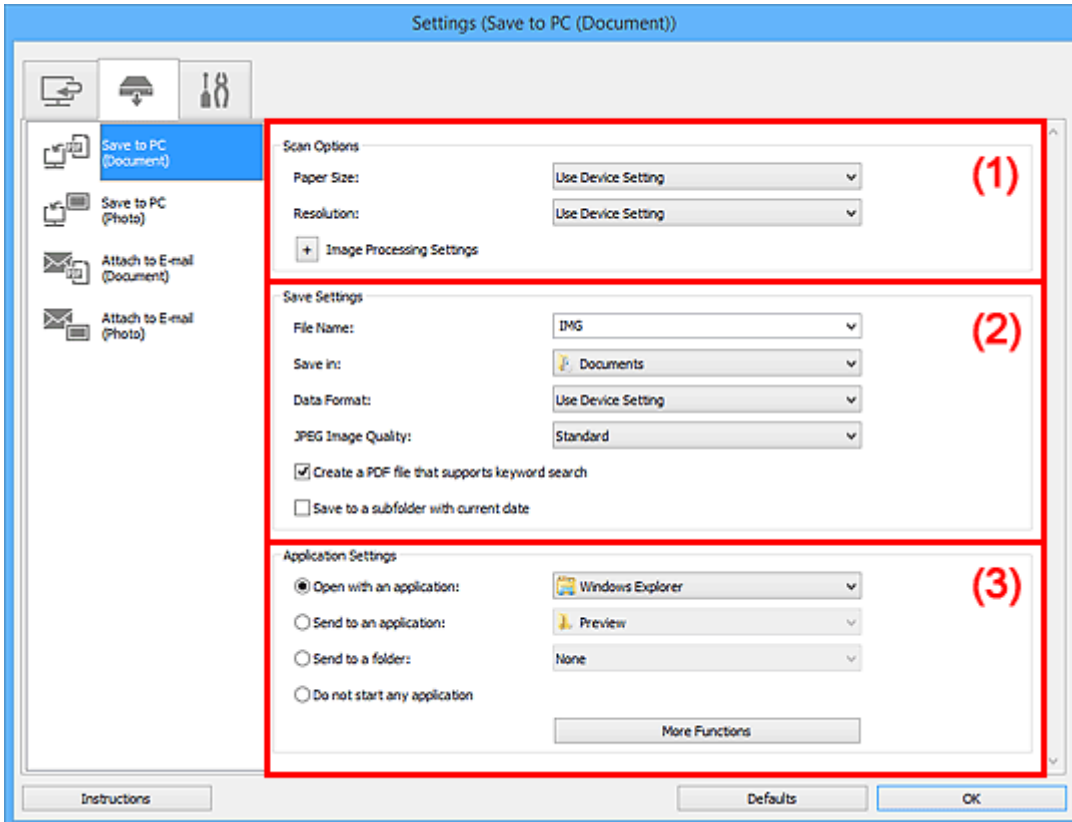

- [\(1\) Scan Options Area](#)
- [\(2\) Save Settings Area](#)
- [\(3\) Application Settings Area](#)

(1) Scan Options Area

Paper Size

Set from the operation panel.

Resolution

Set from the operation panel.

Image Processing Settings

Click  (Plus) to set the following.

Apply Auto Document Fix

Select this checkbox to sharpen text in a document or magazine for better readability.

Important

- The color tone may differ from the source image due to corrections. In that case, deselect the checkbox and scan.

▶▶▶ Note

- Scanning takes longer than usual when you enable this function.

Reduce gutter shadow (platen)

Reduces gutter shadows that appear between pages when scanning open booklets.

▶▶▶ Important

- This function is available only when scanning from the platen.

▶▶▶ Note

- When you enable this function, scanning may take longer than usual with network connection.

Correct slanted text document

Detects the scanned text and corrects the angle (within -0.1 to -10 degrees or +0.1 to +10 degrees) of the document.

▶▶▶ Important

- The following types of documents may not be corrected properly since the text cannot be detected correctly.
 - Documents in which the text lines are inclined more than 10 degrees or the angles vary by line
 - Documents containing both vertical and horizontal text
 - Documents with extremely large or small fonts
 - Documents with small amount of text
 - Documents containing figures/images
 - Hand-written text
 - Documents containing both vertical and horizontal lines (tables)

▶▶▶ Note

- Scanning takes longer than usual when you enable **Correct slanted text document**.

Detect the orientation of text document and rotate image

Automatically rotates the image to the correct orientation by detecting the orientation of text in the scanned document.

▶▶▶ Important

- Only text documents written in languages that can be selected from **Document Language** in the [Settings \(General Settings\) dialog box](#) are supported.
- The orientation may not be detected for the following types of settings or documents since the text cannot be detected correctly.
 - Resolution is outside the range of 300 dpi to 600 dpi
 - Font size is outside the range of 8 points to 48 points
 - Documents containing special fonts, effects, italics, or hand-written text
 - Documents with patterned backgrounds

(2) Save Settings Area

File Name

Enter the file name of the image to be saved. When you save a file, the date and four digits are appended to the set file name in the "_20XX0101_0001" format.

▶▶▶ Note

- When you select the **Save to a subfolder with current date** checkbox, the date and four digits are appended to the set file name.

Save in

Displays the folder in which to save the scanned images. To add a folder, select **Add...** from the pull-down menu, then click **Add** in the displayed **Select Destination Folder** dialog box and specify the destination folder.

The default save folders are as follows.

- **Windows 10/Windows 8.1/Windows Vista:**
Documents folder
- **Windows 8/Windows 7:**
My Documents folder

Data Format

Set from the operation panel.

JPEG Image Quality

You can specify the image quality of JPEG files.

Create a PDF file that supports keyword search

Select this checkbox to convert text in images into text data and create PDF files that support keyword search.

▶▶▶ Note

- PDF files that are searchable in the language selected in **Document Language** on the  (General Settings) tab of the Settings dialog box are created.

Save to a subfolder with current date

Select this checkbox to create a current date folder in the folder specified in **Save in** and save scanned images in it. The folder will be created with a name such as "20XX_01_01" (Year_Month_Date).

If this checkbox is not selected, files are saved directly in the folder specified in **Save in**.

(3) Application Settings Area

Open with an application

Select this when you want to enhance or correct the scanned images.

You can specify the application from the pull-down menu.

Send to an application

Select this when you want to use the scanned images as they are in an application that allows you to browse or organize images.

You can specify the application from the pull-down menu.

Send to a folder

Select this when you also want to save the scanned images to a folder other than the one specified in **Save in**.

You can specify the folder from the pull-down menu.

Do not start any application

Saves to the folder specified in **Save in**.

»» Note

- To add an application or folder to the pull-down menu, select **Add...** from the pull-down menu, then click **Add** in the displayed **Select Application** or **Select Destination Folder** dialog box and specify the application or folder.

Instructions

Opens this guide.

Defaults

You can restore the settings in the displayed screen to the default settings.

Settings (Attach to E-mail (Photo)) Dialog Box

Click **Attach to E-mail (Photo)** on the  (Scanning from the Operation Panel) tab to display the **Settings (Attach to E-mail (Photo))** dialog box.

In the **Settings (Attach to E-mail (Photo))** dialog box, you can specify how to respond when attaching images to an e-mail as photos after scanning them from the operation panel.

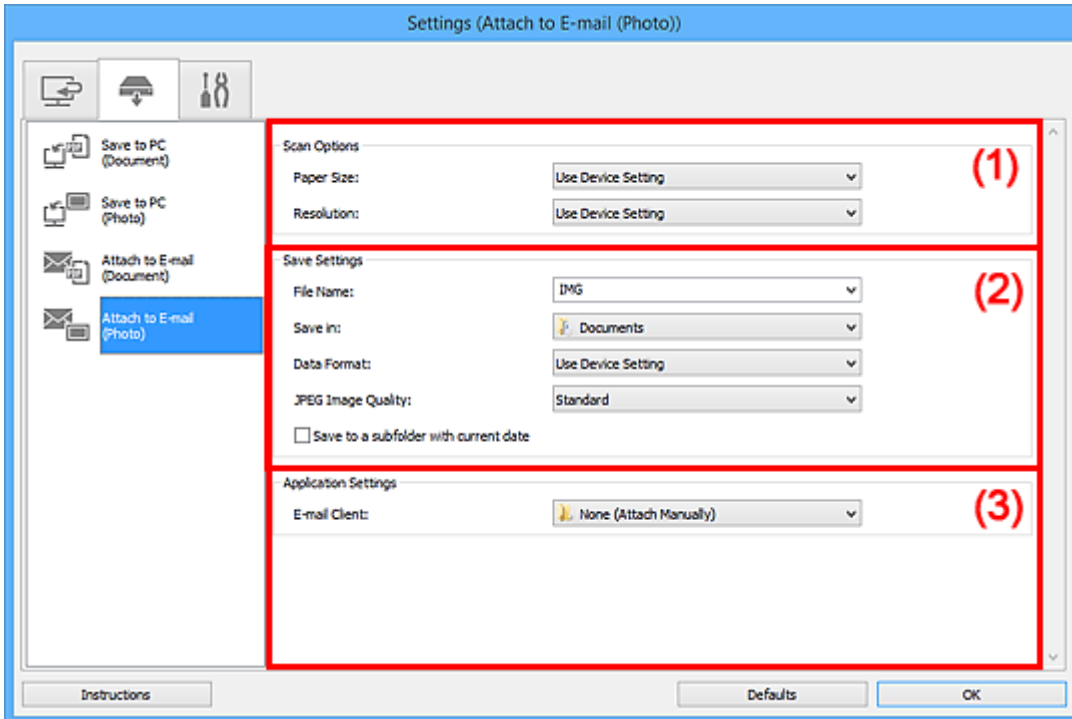

- [\(1\) Scan Options Area](#)
- [\(2\) Save Settings Area](#)
- [\(3\) Application Settings Area](#)

(1) Scan Options Area

Paper Size

Set from the operation panel.

Resolution

Set from the operation panel.

(2) Save Settings Area

File Name

Enter the file name of the image to be saved. When you save a file, the date and four digits are appended to the set file name in the "_20XX0101_0001" format.

►►► Note

- When you select the **Save to a subfolder with current date** checkbox, the date and four digits are appended to the set file name.

Save in

Displays the folder in which to save the scanned images. To add a folder, select **Add...** from the pull-down menu, then click **Add** in the displayed **Select Destination Folder** dialog box and specify the destination folder.

The default save folders are as follows.

- **Windows 10/Windows 8.1/Windows Vista:**
Documents folder
- **Windows 8/Windows 7:**
My Documents folder

Data Format

Set from the operation panel.

JPEG Image Quality

You can specify the image quality of JPEG files.

Save to a subfolder with current date

Select this checkbox to create a current date folder in the folder specified in **Save in** and save scanned images in it. The folder will be created with a name such as "20XX_01_01" (Year_Month_Date).

If this checkbox is not selected, files are saved directly in the folder specified in **Save in**.

(3) Application Settings Area

E-mail Client

Specify the e-mail client to use for attaching scanned images.

You can specify the e-mail client you want to start from the pull-down menu.

▶▶ Note

- To add an e-mail client to the pull-down menu, select **Add...** from the pull-down menu, then click **Add** in the displayed **Select Application** dialog box and specify the e-mail client.

Instructions

Opens this guide.

Defaults

You can restore the settings in the displayed screen to the default settings.

Settings (Attach to E-mail (Document)) Dialog Box

Click **Attach to E-mail (Document)** on the  (Scanning from the Operation Panel) tab to display the **Settings (Attach to E-mail (Document))** dialog box.

In the **Settings (Attach to E-mail (Document))** dialog box, you can specify how to respond when attaching images to an e-mail as documents after scanning them from the operation panel.

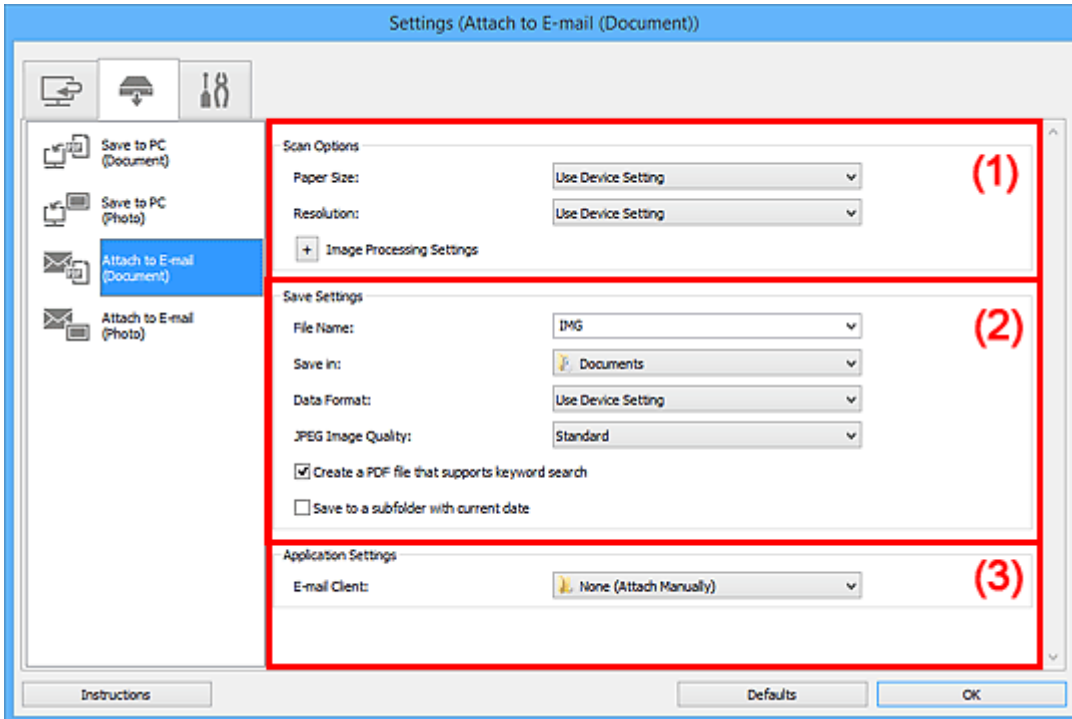

- [\(1\) Scan Options Area](#)
- [\(2\) Save Settings Area](#)
- [\(3\) Application Settings Area](#)

(1) Scan Options Area

Paper Size

Set from the operation panel.

Resolution

Set from the operation panel.

Image Processing Settings

Click  (Plus) to set the following.

Apply Auto Document Fix

Select this checkbox to sharpen text in a document or magazine for better readability.

►►► Important

- The color tone may differ from the source image due to corrections. In that case, deselect the checkbox and scan.

»» Note

- Scanning takes longer than usual when you enable this function.

Reduce gutter shadow (platen)

Reduces gutter shadows that appear between pages when scanning open booklets.

»» Important

- This function is available only when scanning from the platen.

»» Note

- When you enable this function, scanning may take longer than usual with network connection.

Correct slanted text document

Detects the scanned text and corrects the angle (within -0.1 to -10 degrees or +0.1 to +10 degrees) of the document.

»» Important

- The following types of documents may not be corrected properly since the text cannot be detected correctly.
 - Documents in which the text lines are inclined more than 10 degrees or the angles vary by line
 - Documents containing both vertical and horizontal text
 - Documents with extremely large or small fonts
 - Documents with small amount of text
 - Documents containing figures/images
 - Hand-written text
 - Documents containing both vertical and horizontal lines (tables)

»» Note

- Scanning takes longer than usual when you enable **Correct slanted text document**.

Detect the orientation of text document and rotate image

Automatically rotates the image to the correct orientation by detecting the orientation of text in the scanned document.

»» Important

- Only text documents written in languages that can be selected from **Document Language** in the [Settings \(General Settings\) dialog box](#) are supported.
- The orientation may not be detected for the following types of settings or documents since the text cannot be detected correctly.
 - Resolution is outside the range of 300 dpi to 600 dpi
 - Font size is outside the range of 8 points to 48 points
 - Documents containing special fonts, effects, italics, or hand-written text
 - Documents with patterned backgrounds

(2) Save Settings Area

File Name

Enter the file name of the image to be saved. When you save a file, the date and four digits are appended to the set file name in the "_20XX0101_0001" format.

▶▶▶ Note

- When you select the **Save to a subfolder with current date** checkbox, the date and four digits are appended to the set file name.

Save in

Displays the folder in which to save the scanned images. To add a folder, select **Add...** from the pull-down menu, then click **Add** in the displayed **Select Destination Folder** dialog box and specify the destination folder.

The default save folders are as follows.

- **Windows 10/Windows 8.1/Windows Vista:**
Documents folder
- **Windows 8/Windows 7:**
My Documents folder

Data Format

Set from the operation panel.

JPEG Image Quality

You can specify the image quality of JPEG files.

Create a PDF file that supports keyword search

Select this checkbox to convert text in images into text data and create PDF files that support keyword search.

▶▶▶ Note

- PDF files that are searchable in the language selected in **Document Language** on the  (General Settings) tab of the Settings dialog box are created.

Save to a subfolder with current date

Select this checkbox to create a current date folder in the folder specified in **Save in** and save scanned images in it. The folder will be created with a name such as "20XX_01_01" (Year_Month_Date).

If this checkbox is not selected, files are saved directly in the folder specified in **Save in**.

(3) Application Settings Area

E-mail Client

Specify the e-mail client to use for attaching scanned images.

You can specify the e-mail client you want to start from the pull-down menu.

▶▶ Note

- To add an e-mail client to the pull-down menu, select **Add...** from the pull-down menu, then click **Add** in the displayed **Select Application** dialog box and specify the e-mail client.

Instructions

Opens this guide.

Defaults

You can restore the settings in the displayed screen to the default settings.

Settings (General Settings) Dialog Box

Click the  (General Settings) tab to display the **Settings (General Settings)** dialog box.

In the **Settings (General Settings)** dialog box, you can set the product to use, file size restriction on e-mail attachment, language to detect text in images, and folder in which to save images temporarily.

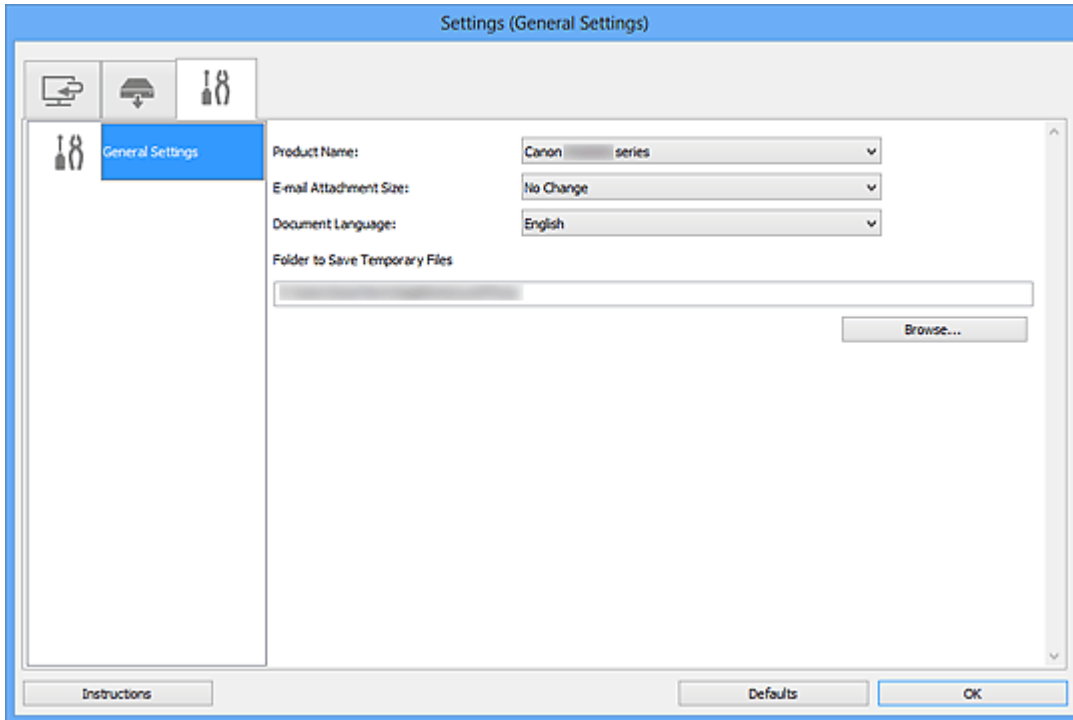

Product Name

Displays the name of the product that IJ Scan Utility is currently set to use.

If the displayed product is not the one you want to use, select the desired product from the list.

In addition, for network connection, select one with "Network" after the product name.

►► Note

- With network connection, **Select** appears on the right side of the product name. Click **Select** to display IJ Network Scanner Selector EX from which you can change the scanner to use. Refer to "[Network Scan Settings](#)" for the setting procedure.

E-mail Attachment Size

You can restrict the size of scanned images to be attached to an e-mail.

You can select **Small (Suitable for 640 x 480 Windows)**, **Medium (Suitable for 800 x 600 Windows)**, **Large (Suitable for 1024 x 768 Windows)**, or **No Change**.

Document Language

You can select the language for detecting text in images and for use with search when a PDF file that supports keyword search is created.

Folder to Save Temporary Files

Displays the folder in which to save images temporarily. Click **Browse...** to specify the destination folder.

Instructions

Opens this guide.

Defaults

You can restore the settings in the displayed screen to the default settings.

Save Settings Dialog Box

Select the **Check scan results and specify save settings** checkbox in **Save Settings** of the Settings dialog box to display the **Save Settings** dialog box after scanning.

You can specify the data format and destination while viewing the thumbnails of scan results.

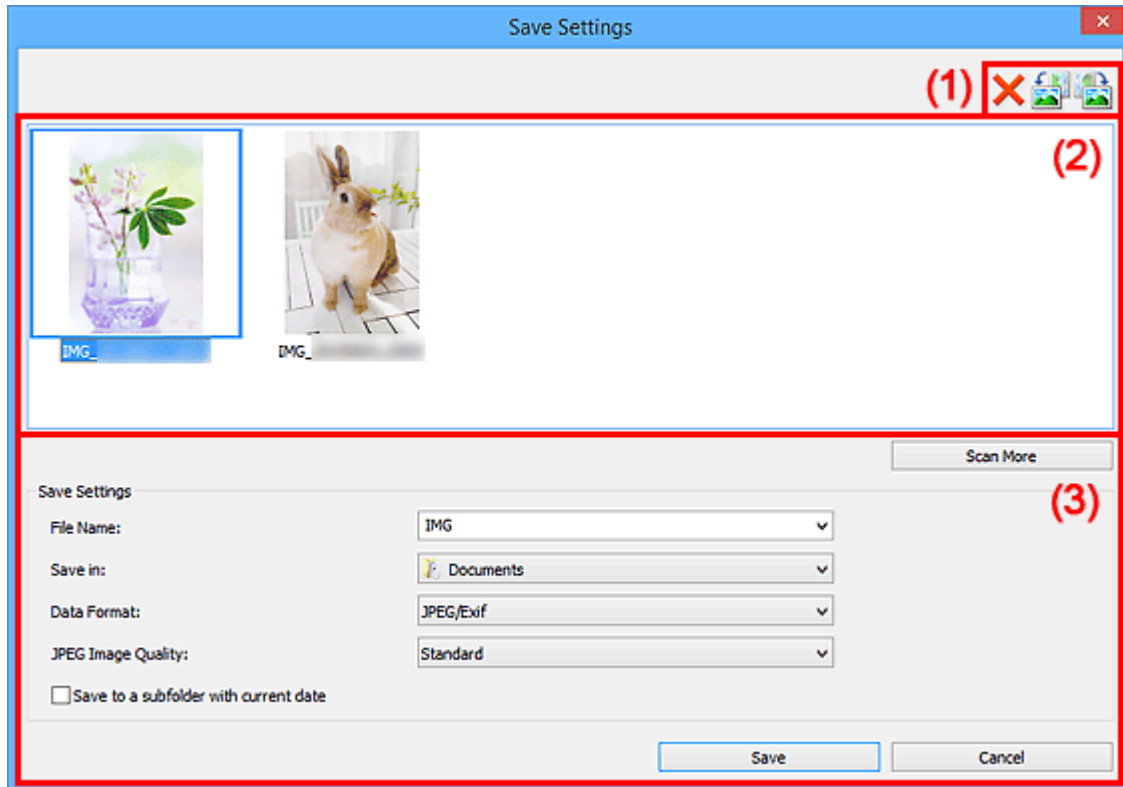

- [\(1\) Preview Operation Buttons](#)
- [\(2\) Scan Results Area](#)
- [\(3\) Save Settings Area](#)

(1) Preview Operation Buttons

 **(Delete)**

Deletes the image selected in the Scan Results area.

 /  **(Rotate Left 90°)/(Rotate Right 90°)**

Rotates scanned images 90 degrees counter-clockwise or clockwise.

Select the image you want to rotate, then click  (Rotate Left 90°) or  (Rotate Right 90°).

»» Important

- The preview operation buttons do not appear when the **Enable large image scans** checkbox is selected in the **Settings (ScanGear)** dialog box.

(2) Scan Results Area

Displays the thumbnails of the scanned images. You can change the save order of images via drag-and-drop. The file names for saving appear below the thumbnails.

Double-click a thumbnail to enlarge the view of the scanned image.



(3) Save Settings Area

Scan More

Starts scanning again, and then adds the image to the Scan Results area.

File Name

Enter the file name of the image to be saved. When you save a file, the date and four digits are appended to the set file name in the "_20XX0101_0001" format.

»»» Note

- When you select the **Save to a subfolder with current date** checkbox, the date and four digits are appended to the set file name.

Save in

Displays the folder in which to save the scanned images. To add a folder, select **Add...** from the pull-down menu, then click **Add** in the displayed **Select Destination Folder** dialog box and specify the destination folder.

The default save folders are as follows.

- **Windows 10/Windows 8.1/Windows Vista:**
Documents folder
- **Windows 8/Windows 7:**
My Documents folder

Data Format

Select the data format in which to save the scanned images.

You can select **JPEG/Exif**, **TIFF**, **PNG**, **PDF**, or **PDF (Multiple Pages)**.

Important

- You cannot select **PDF** or **PDF (Multiple Pages)** in the following cases.
 - When scanned by clicking **Photo** in the IJ Scan Utility main screen
 - The **Enable large image scans** checkbox is selected in **Save Settings** of the **Settings (ScanGear)** dialog box
 - **Start OCR** is selected in **Application Settings** of the **Settings (Document Scan)**, **Settings (Custom Scan)**, or **Settings (ScanGear)** dialog box
- You cannot select **JPEG/Exif** when **Color Mode** is **Black and White**.

Note

- With network connection, scanning may take longer than usual when you set **TIFF** or **PNG** in **Data Format**.

JPEG Image Quality

You can specify the image quality of JPEG files.

Important

- This appears only when **JPEG/Exif** is selected in **Data Format**.

PDF Compression

Select the compression type for saving PDF files.

Standard

It is recommended that you normally select this setting.

High

Compresses the file size when saving, allowing you to reduce the load on your network/server.

Important

- This appears only when **PDF** or **PDF (Multiple Pages)** is selected in **Data Format**.

Create a PDF file that supports keyword search

Select this checkbox to convert text in images into text data and create PDF files that support keyword search.

Important

- This appears only when **PDF** or **PDF (Multiple Pages)** is selected in **Data Format**.

Note

- PDF files that are searchable in the language selected in **Document Language** on the  (General Settings) tab of the Settings dialog box are created.

Set up password security

Select this checkbox to display the [Password Security Settings dialog box](#).

»» Important

- This appears only when **PDF** or **PDF (Multiple Pages)** is selected in **Data Format**.

Save to a subfolder with current date

Select this checkbox to create a current date folder in the folder specified in **Save in** and save scanned images in it. The folder will be created with a name such as "20XX_01_01" (Year_Month_Date).

If this checkbox is not selected, files are saved directly in the folder specified in **Save in**.

Save

Saves the scanned images.

Cancel

Cancels saving.

Password Security Settings Dialog Box

Set passwords for opening or printing/editing PDF files.

Display the **Password Security Settings** dialog box by one of the following operations.

- Select the **Set up password security** checkbox in the [Settings dialog box](#), and then scan
- Select the **Set up password security** checkbox in the [Save Settings dialog box](#), and then save

▶▶▶ Note

- The **Save Settings** dialog box appears after scanning with the **Check scan results and specify save settings** checkbox selected in **Save Settings** of the Settings dialog box.

▶▶▶ Important

- You will not be able to open or edit the PDF file if you forget the password. It is recommended that you write down the passwords and keep them in a safe place for future reference.
- Password-protected PDF files cannot be opened in applications that do not support security settings for PDF files.



Require a password to open the document

You can specify whether to require a password to open the PDF file. Select this checkbox to enter characters in **Document Open Password**.

Document Open Password

Enter a password for opening the PDF file.

Password (Confirmation)

Enter the password set in **Document Open Password**.

Require a password to print or edit the document

You can specify whether to require a password to print or edit the PDF file. Select this checkbox to enter characters in **Permissions Password**.

Permissions Password

Enter a password for printing or editing the PDF files.

Password (Confirmation)

Enter the password set in **Permissions Password**.

»» Important

- Enter a password of up to 32 characters using single-byte letters, numbers, and/or symbols (!"#\$\$%&'()*+,-./:;<=>@[^_`{|}~). Passwords are case sensitive.
- To set both **Document Open Password** and **Permissions Password**, select both checkboxes and specify a different password for each.

OK

OK can be clicked after entering **Document Open Password** and **Password (Confirmation)**, or **Permissions Password** and **Password (Confirmation)**. Click **OK** to scan or save.

Cancel

After scanning with Set up password security checkbox selected in Settings dialog box:

The IJ Scan Utility main screen reappears.

After saving with Set up password security checkbox selected in Save Settings dialog box:

A confirmation screen appears; click **Cancel** to return to the **Password Security Settings** dialog box. Click **OK** to save the scanned images without setting a password.

Image Stitch Window

Click **Stitch** in the IJ Scan Utility main screen to display the **Image Stitch** window.

You can scan the left and right halves of an item larger than the platen and combine them back into one image. You can scan items up to approximately twice as large as the platen.

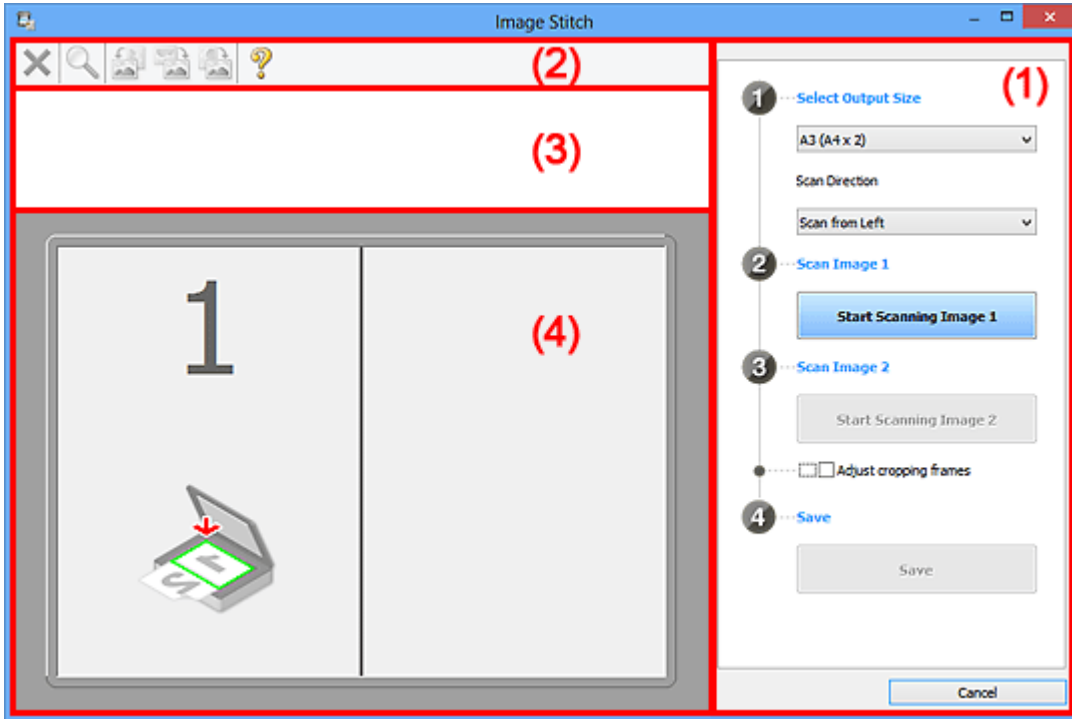

- [\(1\) Settings and Operation Buttons](#)
- [\(2\) Toolbar](#)
- [\(3\) Thumbnail View Area](#)
- [\(4\) Preview Area](#)

▶▶▶ Note

- The displayed items vary depending on the select source and view.

(1) Settings and Operation Buttons

Select Output Size

B4 (B5 x 2)

Scans the left and right halves of a B4 size item separately.

A3 (A4 x 2)

Scans the left and right halves of an A3 size item separately.

11 x 17 (Letter x 2)

Scans the left and right halves of an item twice as large as Letter size separately.

Full Platen x 2

Scans the left and right halves of an item twice as large as the platen separately.

Scan Direction

Scan from Left

Displays the first scanned image on the left side.

Scan from Right

Displays the first scanned image on the right side.

Scan Image 1

Start Scanning Image 1

Scans the first item.

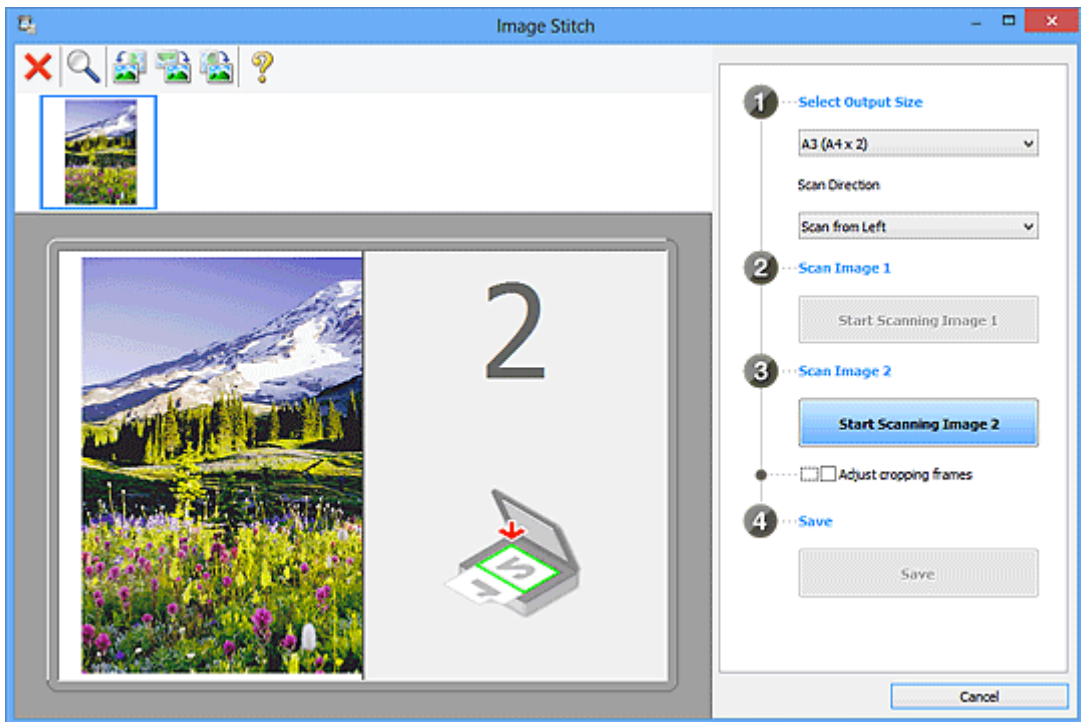

Scan Image 2

Start Scanning Image 2

Scans the second item.

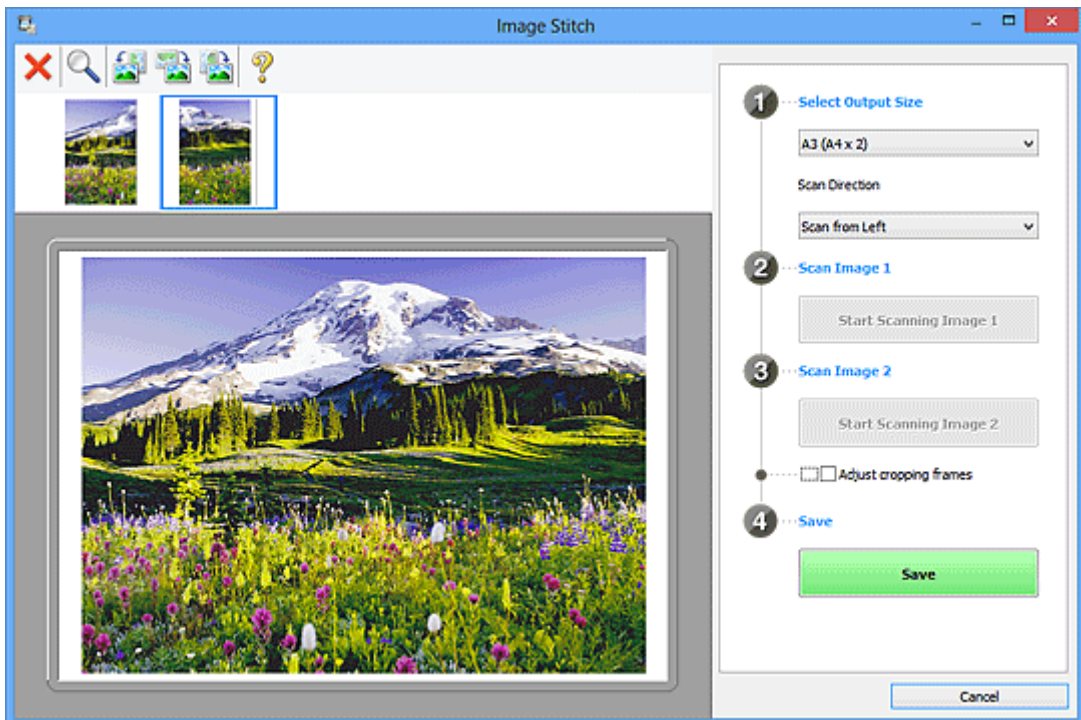

Adjust cropping frames

You can adjust the scan area in preview.

If no area is specified, the image of the size selected in **Select Output Size** will be saved. If an area is specified, only the image in the cropping frame will be scanned and saved.

■ [Adjusting Cropping Frames in the Image Stitch Window](#)

Save

Save

Saves the two scanned images as one image.

Cancel

Cancels **Stitch** scan.

(2) Toolbar

You can delete the scanned images or adjust the previewed images.



(Delete)

Deletes the image selected in the Thumbnail View area.



(Enlarge/Reduce)

Allows you to enlarge or reduce the preview image.

Clicking the Preview area enlarges the displayed image.

Right-clicking the Preview area reduces the displayed image.



(Rotate Left)

Rotates the preview image 90 degrees counter-clockwise.



(Rotate 180°)

Rotates the preview image 180 degrees.



(Rotate Right)

Rotates the preview image 90 degrees clockwise.



(Open Guide)

Opens this page.

(3) Thumbnail View Area

Displays the thumbnails of the scanned images. Appears blank if none has been scanned.

(4) Preview Area

Displays the scanned images. You can adjust the layout by dragging the scanned image or check the results of the settings made in "[\(1\) Settings and Operation Buttons.](#)"

When no image has been scanned:

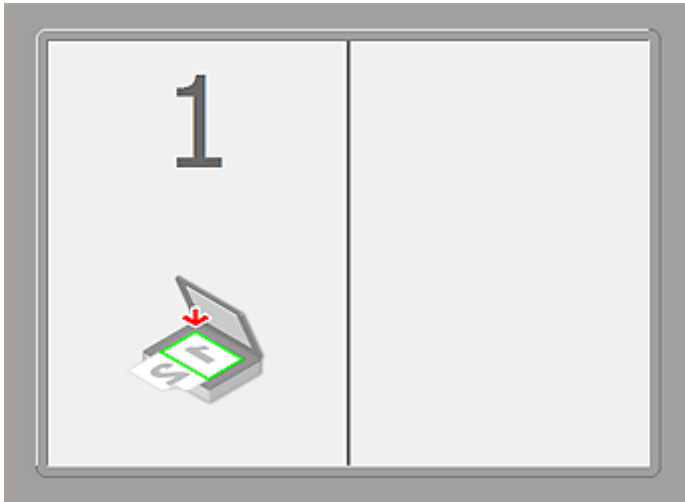

After scanning the first item by clicking Start Scanning Image 1:

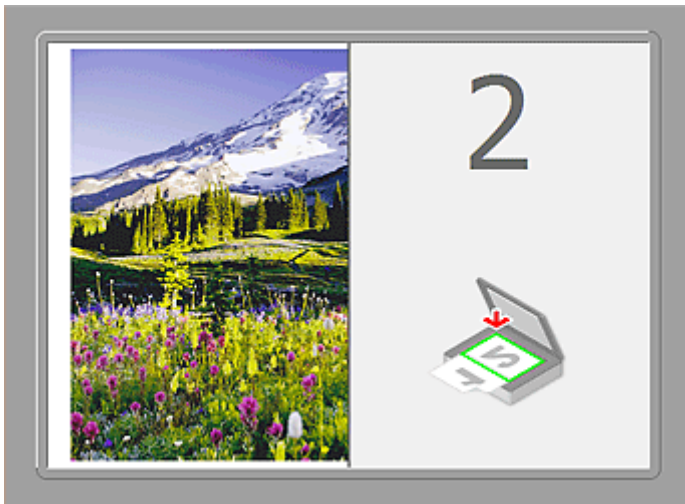

The image is scanned in the direction specified in **Scan Direction**, and **2** appears next to it.

After scanning the second item by clicking Start Scanning Image 2:



The two scanned images appear.

Related Topic

- [Scanning Originals Larger than the Platen \(Image Stitch\)](#)

Scanning Using Application Software (ScanGear)

- ▶ **What Is ScanGear (Scanner Driver)?**
- ▶ **Scanning with Advanced Settings Using ScanGear (Scanner Driver)**
- ▶ **Starting ScanGear (Scanner Driver)**
- ▶ **Scanning in Basic Mode**
- ▶ **Scanning in Advanced Mode**
- ▶ **Scanning Multiple Documents from the ADF (Auto Document Feeder) in Advanced Mode**
- ▶ **Scanning Multiple Documents at One Time with ScanGear (Scanner Driver)**
- ▶ **Correcting Images and Adjusting Colors with ScanGear (Scanner Driver)**
- ▶ **ScanGear (Scanner Driver) Screens**
- ▶ **Positioning Originals (Scanning from Computer)**
- ▶ **Adjusting Cropping Frames (ScanGear)**
- ▶ **General Notes (Scanner Driver)**

▶▶ Important

- Available functions and settings vary depending on your scanner or printer.

What Is ScanGear (Scanner Driver)?

ScanGear (scanner driver) is software required for scanning documents. It enables you to specify the output size and make image corrections when scanning.

ScanGear can be started from IJ Scan Utility or applications that are compatible with a standard interface called TWAIN. (ScanGear is a TWAIN-compatible driver.)

What You Can Do with This Software

This software enables you to preview scan results or set document type and output size, etc. when scanning documents. It is useful when you want to scan in a specific color tone, as it allows you to make various corrections and adjust brightness, contrast, etc.

Screens

There are two modes: Basic Mode and Advanced Mode.

Switch modes by clicking a tab on the upper right of the screen.

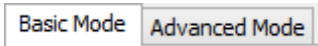

►► Note

- ScanGear starts in the last used mode.
- Settings are not retained when you switch modes.

Basic Mode

Use the **Basic Mode** tab to scan easily by following three simple on-screen steps (1 , 2 , and 3).

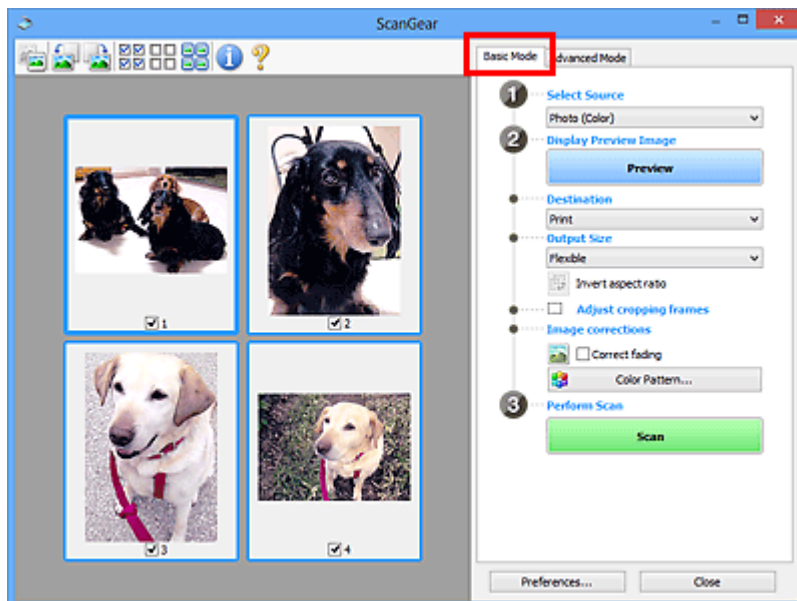

Advanced Mode

Use the **Advanced Mode** tab to specify the color mode, output resolution, image brightness, color tone, etc. when scanning.

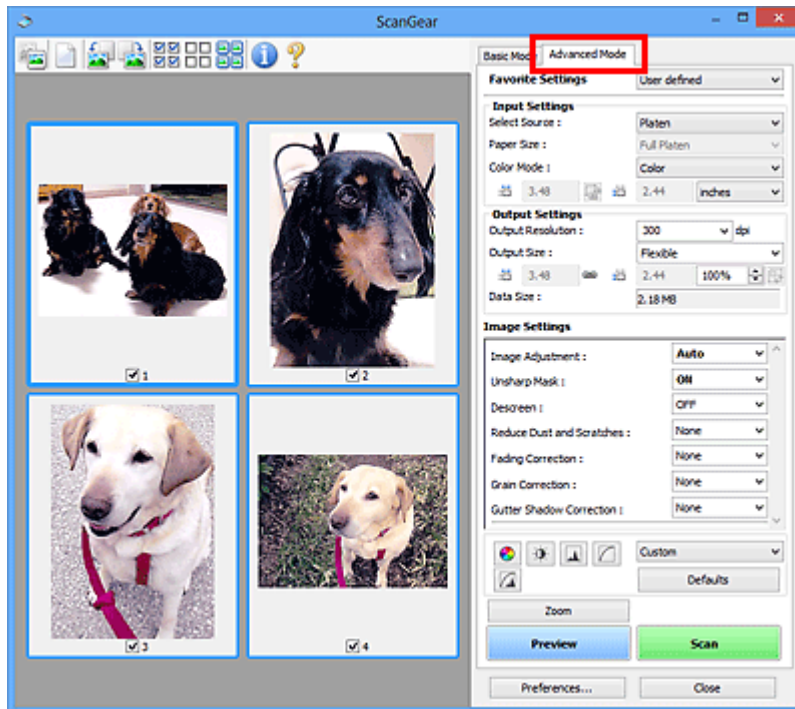

Scanning with Advanced Settings Using ScanGear (Scanner Driver)

- ▶ **Starting ScanGear (Scanner Driver)**
- ▶ **Scanning in Basic Mode**
- ▶ **Scanning in Advanced Mode**
- ▶ **Scanning Multiple Documents from the ADF (Auto Document Feeder) in Advanced Mode**
- ▶ **Scanning Multiple Documents at One Time with ScanGear (Scanner Driver)**

Starting ScanGear (Scanner Driver)

Use ScanGear (scanner driver) to make image corrections and color adjustments when scanning. ScanGear can be started from IJ Scan Utility or other applications.

▶▶▶ Note

- Set up the network environment if you have more than one scanner or have a network compatible model and changed the connection from USB connection to network connection.

Starting IJ Scan Utility

Follow these steps to start ScanGear from IJ Scan Utility.

1. Start IJ Scan Utility.

Refer to "Starting IJ Scan Utility" for your model from Home of the Online Manual for how to start IJ Scan Utility.

2. Click ScanGear in the IJ Scan Utility main screen.

The ScanGear screen appears.

Starting from an Application

Follow these steps (example) to start ScanGear from an application.

The procedure varies depending on the application. For details, refer to the application's manual.

1. Start the application.
2. On the menu of the application, select the machine.

▶▶▶ Note

- When you want to use a network compatible model by connecting to a network, select one with "Network" displayed after the product name.

3. Select the command to scan a document.

The ScanGear screen appears.

Scanning in Basic Mode

Use the **Basic Mode** tab to scan easily by following the on-screen steps.

Refer to "[Scanning Multiple Documents at One Time with ScanGear \(Scanner Driver\)](#)" to scan multiple documents at one time from the Platen.

When scanning from the ADF (Auto Document Feeder), documents are scanned without preview.

▶▶ Important

- The following types of documents may not be scanned correctly. In that case, click  (Thumbnail) on the Toolbar to switch to whole image view and scan.
 - Photos that have a whitish background
 - Documents printed on white paper, hand-written text, business cards, etc.
 - Thin documents
 - Thick documents
- The following types of documents may not be scanned correctly.
 - Documents smaller than 1.2 inches (3 cm) square
 - Photos that have been cut to various shapes

▶▶ Note

- When using a model supporting ADF duplex scanning, you can scan both sides of the documents automatically from the ADF.

1. Place the document on the Platen or ADF, then start ScanGear (scanner driver).

- [Positioning Originals \(Scanning from Computer\)](#)
- [Starting ScanGear \(Scanner Driver\)](#)

2. Set **Select Source** according to the document placed on the Platen or ADF.

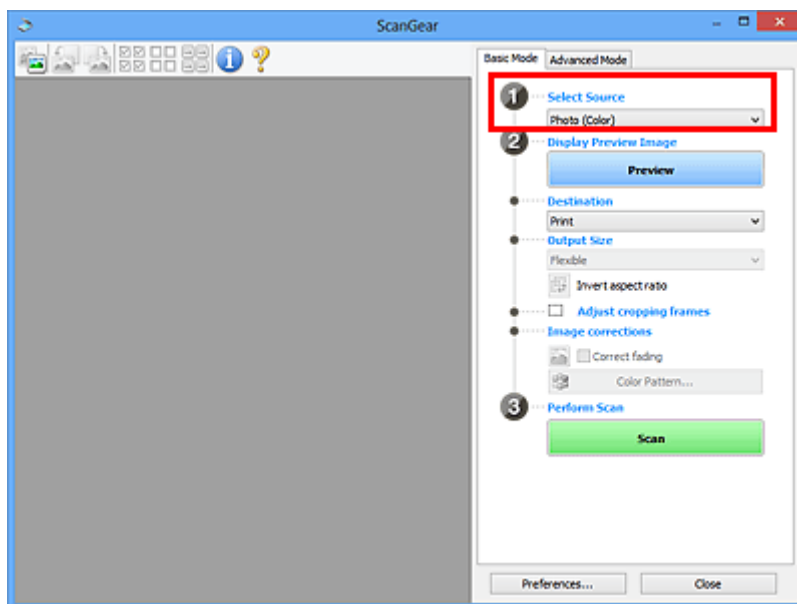

►►► Important

- Some applications do not support continuous scanning from the ADF. For details, refer to the application's manual.

►►► Note

- To scan magazines containing many color photos, select **Magazine (Color)**.

3. Click **Preview**.

Preview image appears in the Preview area.

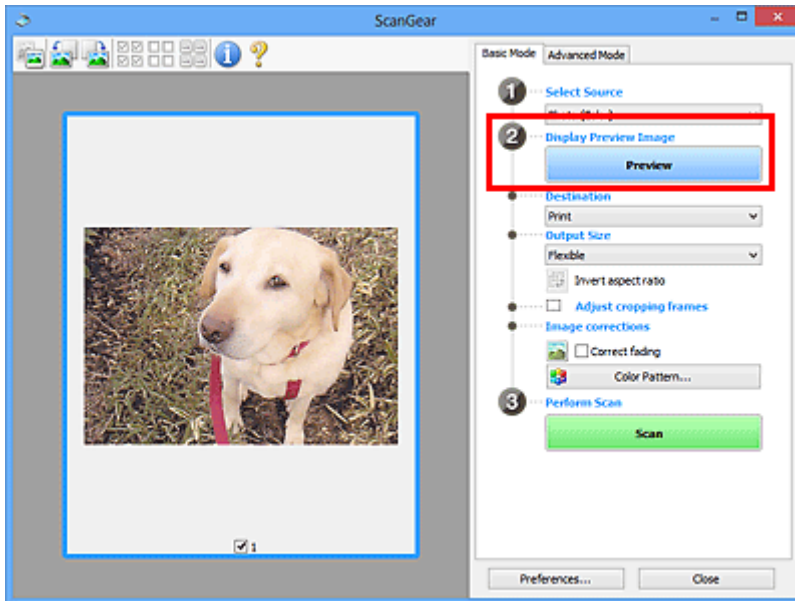

►►► Important

- **Preview** is not displayed when an ADF type is selected for **Select Source**.

►►► Note

- Colors are adjusted based on the document type selected in **Select Source**.

4. Set **Destination**.

►►► Note

- Skip ahead to Step 7 when an ADF type is selected for **Select Source**.

5. Set **Output Size** according to purpose.

Output size options vary by the item selected in **Destination**.

6. Adjust the cropping frames (scan areas) as required.

Adjust the size and position of the cropping frames on the preview image.

■ [Adjusting Cropping Frames \(ScanGear\)](#)

7. Set **Image corrections** as required.

8. Click **Scan**.

Scanning starts.

▶▶▶ Note

- Click  (Information) to open a dialog box in which you can check the current scan settings (document type, etc.).
- A response of ScanGear after scanning can be specified in **Status of ScanGear dialog after scanning** on the [Scan tab](#) of the **Preferences** dialog box.

Related Topic

- [Basic Mode Tab](#)

Scanning in Advanced Mode

Use the **Advanced Mode** tab to specify the color mode, output resolution, image brightness, color tone, etc. when scanning.

Refer to "[Scanning Multiple Documents at One Time with ScanGear \(Scanner Driver\)](#)" to scan multiple documents at one time.

Refer to "[Scanning Multiple Documents from the ADF \(Auto Document Feeder\) in Advanced Mode](#)" to scan multiple documents placed on the ADF (Auto Document Feeder).

►► Important

- The following types of documents may not be scanned correctly. In that case, click  (Thumbnail) on the Toolbar to switch to whole image view and scan.
 - Photos that have a whitish background
 - Documents printed on white paper, hand-written text, business cards, etc.
 - Thin documents
 - Thick documents
- The following types of documents may not be scanned correctly.
 - Documents smaller than 1.2 inches (3 cm) square
 - Photos that have been cut to various shapes

1. Place the document on the Platen, then start ScanGear (scanner driver).

■ [Positioning Originals \(Scanning from Computer\)](#)

■ [Starting ScanGear \(Scanner Driver\)](#)

2. Click the **Advanced Mode** tab.

The tab switches to **Advanced Mode**.

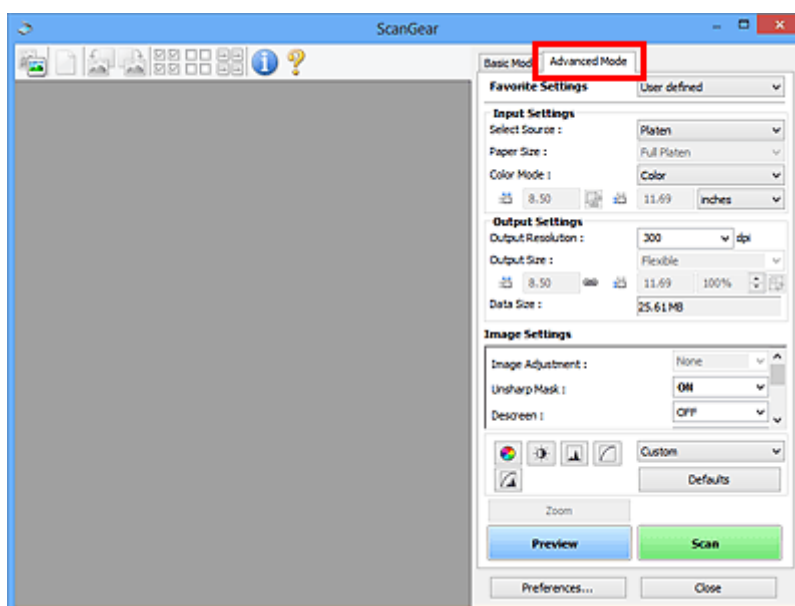

►►► Note

- Settings are not retained when you switch modes.

3. Set [Input Settings](#) according to the document or purpose.

4. Click **Preview**.

Preview images appear in the Preview area.

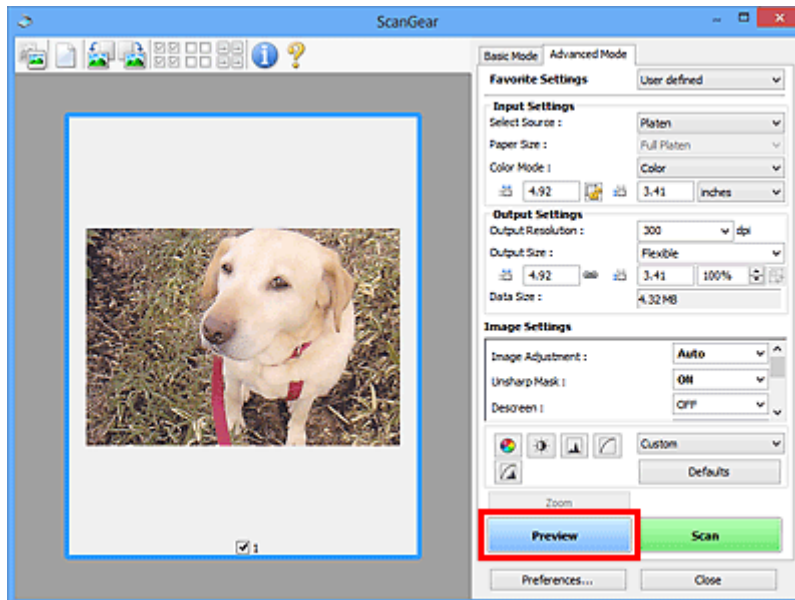

5. Set [Output Settings](#).

6. Adjust the cropping frame (scan area), correct image, and adjust colors as required.

- [Adjusting Cropping Frames \(ScanGear\)](#)
- [Image Settings](#)
- [Color Adjustment Buttons](#)

7. Click **Scan**.

Scanning starts.

►►► Note

- Click  (Information) to open a dialog box in which you can check the current scan settings (document type, etc.).
- A response of ScanGear after scanning can be specified in **Status of ScanGear dialog after scanning** on the [Scan tab](#) of the **Preferences** dialog box.

Related Topic

- [Advanced Mode Tab](#)

Scanning Multiple Documents from the ADF (Auto Document Feeder) in Advanced Mode

Use the **Advanced Mode** tab to specify the image brightness, color tone, etc. and scan multiple documents placed on the ADF (Auto Document Feeder) at one time. When using a model supporting ADF duplex scanning, you can scan both sides of the documents automatically from the ADF.

When scanning from the ADF, documents are scanned without preview.

1. Place the documents on the ADF of the machine, then start ScanGear (scanner driver).

- [Placing Documents \(ADF \(Auto Document Feeder\)\)](#)
- [Starting ScanGear \(Scanner Driver\)](#)

2. Click the **Advanced Mode** tab and select **Document (ADF Simplex)** or **Document (ADF Duplex)** for **Select Source**.

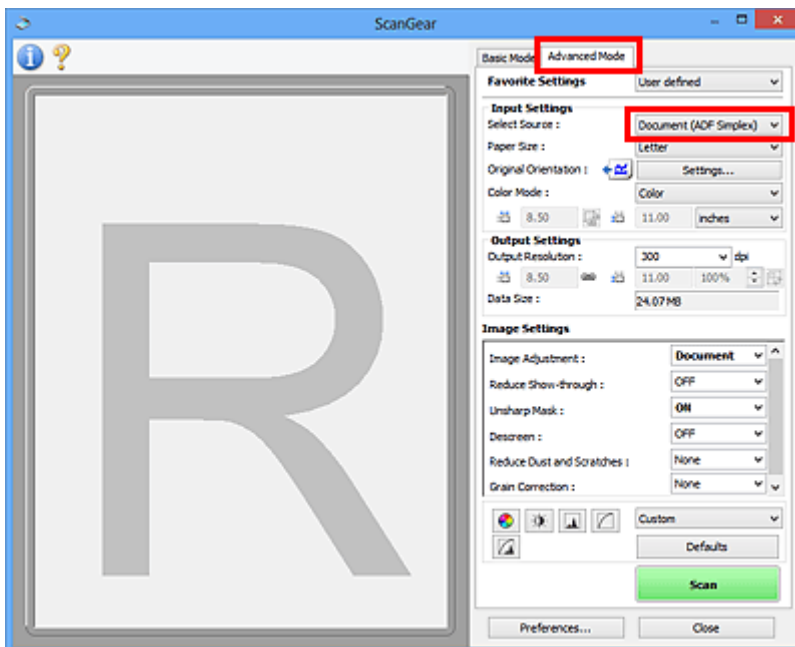

▶▶▶ Note

- Settings are not retained when you switch modes.
- You can select **Document (ADF Duplex)** when using a model supporting ADF duplex scanning.

3. Set [Input Settings](#) according to the document or purpose.
4. Set [Output Settings](#).
5. Make image corrections and color adjustments as required.

- [Image Settings](#)
- [Color Adjustment Buttons](#)

6. Click **Scan**.

Scanning starts.

▶▶▶ Note

- Click  (Information) to open a dialog box in which you can check the current scan settings (document type, etc.).
- A response of ScanGear after scanning can be specified in **Status of ScanGear dialog after scanning** on the [Scan tab](#) of the **Preferences** dialog box.

Related Topic

- [Advanced Mode Tab](#)

Scanning Multiple Documents at One Time with ScanGear (Scanner Driver)

You can scan two or more photos (small documents) on the Platen at one time on the **Basic Mode** tab and **Advanced Mode** tab.

This section explains how to scan multiple documents from the **Basic Mode** tab.

▶▶ Important

- To scan multiple documents as a single image, scan in whole image view.
- The following types of documents may not be cropped correctly. In that case, adjust the cropping frames (scan areas) in whole image view and scan.
 - Photos that have a whitish background
 - Documents printed on white paper, hand-written text, business cards, etc.
 - Thin documents
 - Thick documents
- [Scanning Multiple Documents in Whole Image View](#)
- The following types of documents may not be scanned correctly.
 - Documents smaller than 1.2 inches (3 cm) square
 - Photos that have been cut to various shapes

▶▶ Note

- You can also scan multiple documents at one time from the **Advanced Mode** tab. Use the **Advanced Mode** tab to make advanced scan settings such as the color mode, output resolution, image brightness, and color tone.
- Refer to the corresponding sections below for details on the **Basic Mode** tab and **Advanced Mode** tab.
 - [Basic Mode Tab](#)
 - [Advanced Mode Tab](#)

1. Place the document on the Platen, then start ScanGear (scanner driver).

- [Positioning Originals \(Scanning from Computer\)](#)
- [Starting ScanGear \(Scanner Driver\)](#)

2. Set **Select Source** according to the document placed on the Platen.

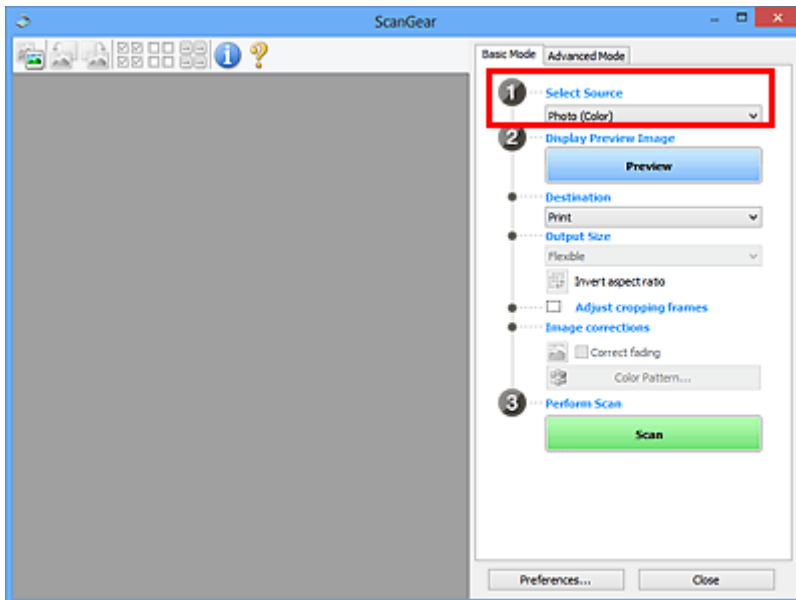

3. Click **Preview**.

Thumbnails of the preview images appear in the Preview area. Cropping frames are specified automatically according to the document size.

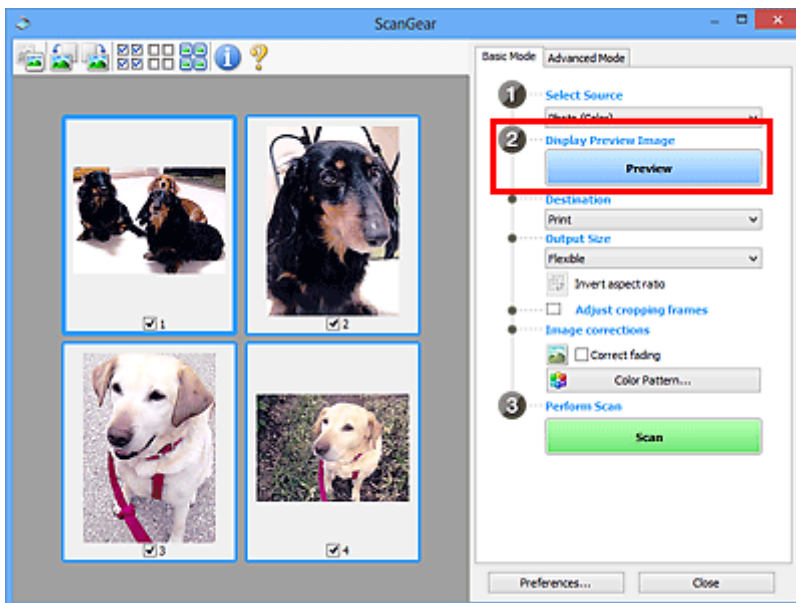

4. Set **Destination**.

5. Set **Output Size** according to purpose.

6. Adjust the cropping frames and set **Image corrections** as required.

►►► **Note**

- You can correct each image separately. Select the frame you want to correct.
- In thumbnail view, you can only create one cropping frame per image. To create multiple cropping frames in an image, scan in whole image view.

7. Select the images you want to scan.

Select the checkboxes of the images you want to scan.

8. Click **Scan**.

Scanning Multiple Documents in Whole Image View

Follow these steps if thumbnails are not displayed correctly when previewed or if you want to scan multiple documents as a single image.

►► Note

- Positions of slanted documents are not corrected in whole image view.

1. After previewing images, click  (Thumbnail) on the Toolbar.

Switch to whole image view.

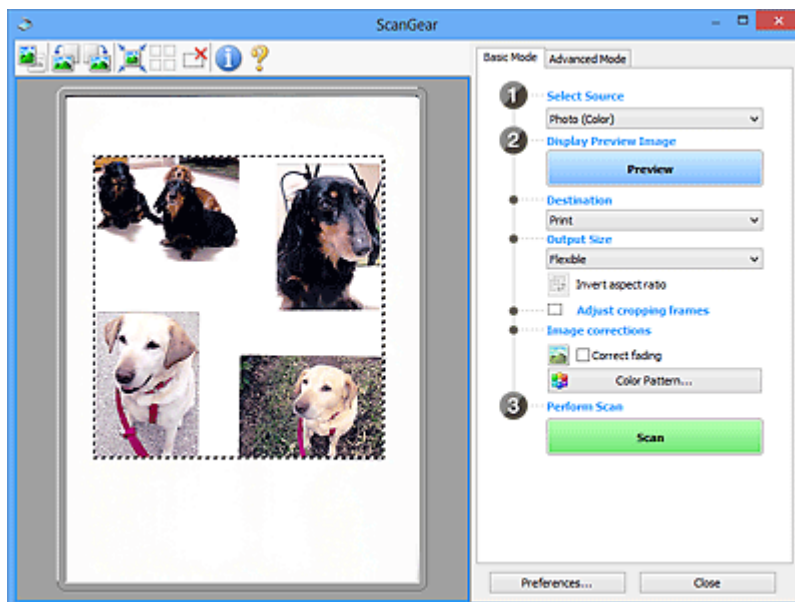

►► Note

- When the whole image is displayed, the icon changes to  (Whole Image).

2. Set **Destination**.

3. Set **Output Size** according to purpose.

Invert aspect ratio will be enabled when **Output Size** is set to anything but **Flexible**. Click this button to rotate the cropping frame. Click again to return it to the original orientation.

4. Adjust the cropping frames.

Adjust the size and position of the cropping frames on the preview image. You can also create two or more cropping frames.

If an area is not specified, the document will be scanned at the document size (Auto Crop). If an area is specified, only the portion in the specified area will be scanned.

■ [Adjusting Cropping Frames \(ScanGear\)](#)

5. Set **Image corrections** as required.

6. Click **Scan**.

Areas framed by broken lines are scanned.

▶▶▶ **Note**

- A response of ScanGear after scanning can be specified in **Status of ScanGear dialog after scanning** on the [Scan tab](#) of the **Preferences** dialog box.

Correcting Images and Adjusting Colors with ScanGear (Scanner Driver)

- ▶ **Correcting Images (Unsharp Mask, Reduce Dust and Scratches, Fading Correction, etc.)**
- ▶ **Adjusting Colors Using a Color Pattern**
- ▶ **Adjusting Saturation and Color Balance**
- ▶ **Adjusting Brightness and Contrast**
- ▶ **Adjusting Histogram**
- ▶ **Adjusting Tone Curve**
- ▶ **Setting Threshold**

Correcting Images (Unsharp Mask, Reduce Dust and Scratches, Fading Correction, etc.)

The **Image Settings** functions on the **Advanced Mode** tab of ScanGear (scanner driver) allow you to enhance the outline of the subjects, reduce dust/scratches, and correct faded colors when scanning images.

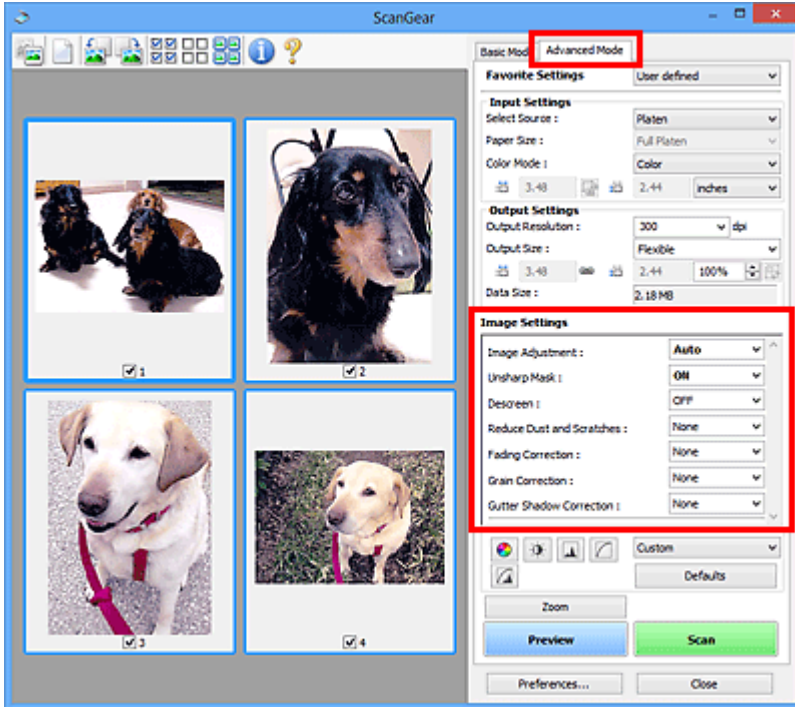

Setting Items

Click  (Arrow) of a function and select an item from the pull-down menu.



►►► Important

- Do not apply these functions to images without moire, dust/scratches, or faded colors. The color tone may be adversely affected.
- Refer to "[Image Settings](#)" for details and precautions on each function.

►►► Note

- Refer to "[Scanning in Advanced Mode](#)" to start the **Advanced Mode** tab of ScanGear and scan.

Adjusting the image brightness and color tone

Set **Image Adjustment** to **Auto**, **Photo**, **Magazine**, or **Document** according to the document type.

None	Auto
------	------



Reducing show-through in text documents or lightening the base color in recycled paper, newspapers, etc. when scanning documents

Set **Reduce Show-through** to **ON**.

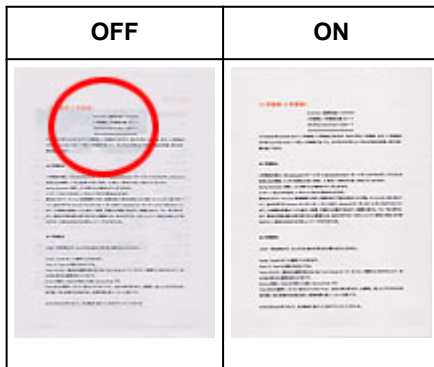

Sharpening slightly out-of-focus images

Set **Unsharp Mask** to **ON**.

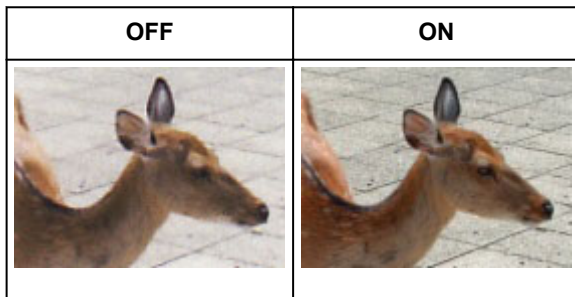

Reducing gradations and stripe patterns

Set **Descreen** to **ON**.

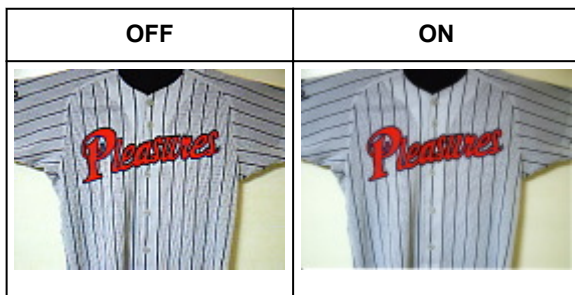

►► Note

- Printed photos and pictures are displayed as a collection of fine dots. "Moire" is a phenomenon where uneven gradation or a stripe pattern appears when such photos or pictures printed with fine dots are scanned. **Descreen** is the function for reducing this moire effect.

Reducing dust and scratches

Set **Reduce Dust and Scratches** to **Low**, **Medium**, or **High** according to the degree of dust and scratches.

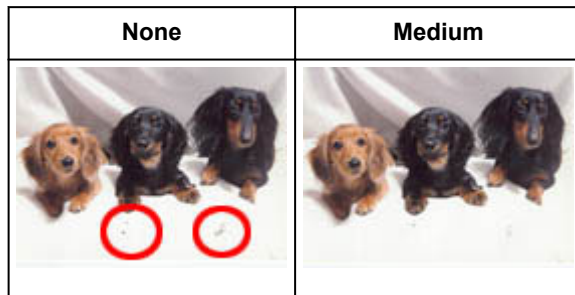

Correcting photos that have faded with time or due to colorcast

Set **Fading Correction** to **Low**, **Medium**, or **High** according to the degree of fading or colorcast.

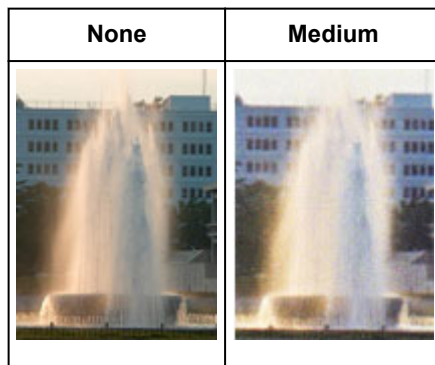

Reducing graininess

Set **Grain Correction** to **Low**, **Medium**, or **High** according to the degree of graininess.

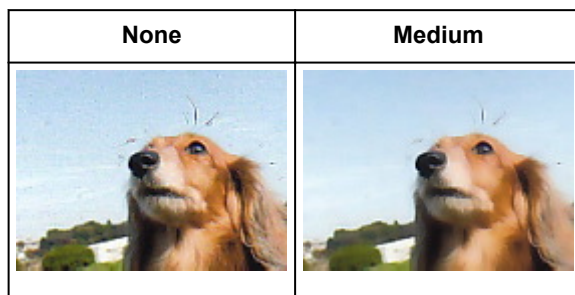

Correcting shadows that appear between pages when scanning open booklets

Set **Gutter Shadow Correction** to **Low**, **Medium**, or **High** according to the degree of shadows.

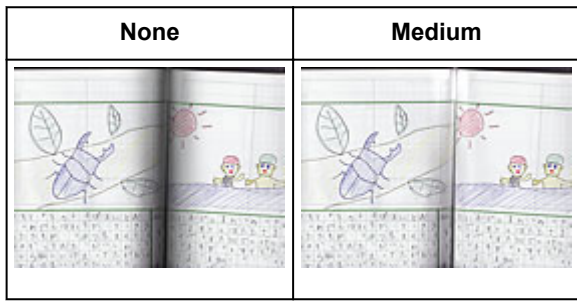

Adjusting Colors Using a Color Pattern

You can preview color changes and reproduce natural colors by using the color pattern function in ScanGear (scanner driver)'s **Basic Mode** tab.

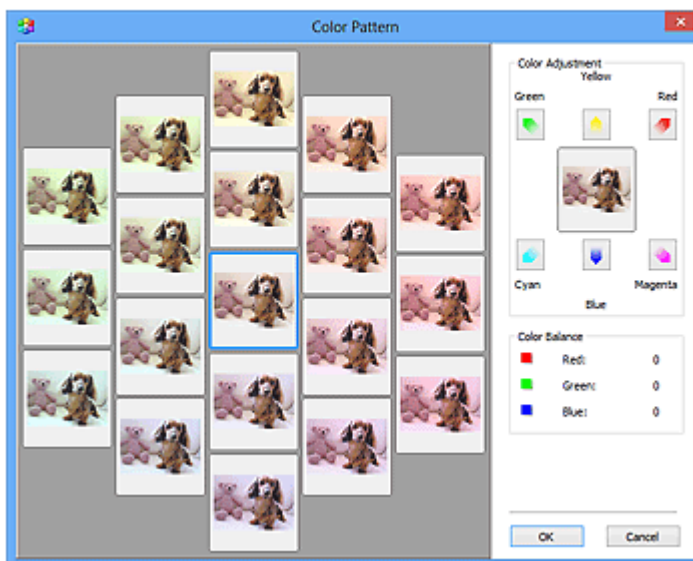
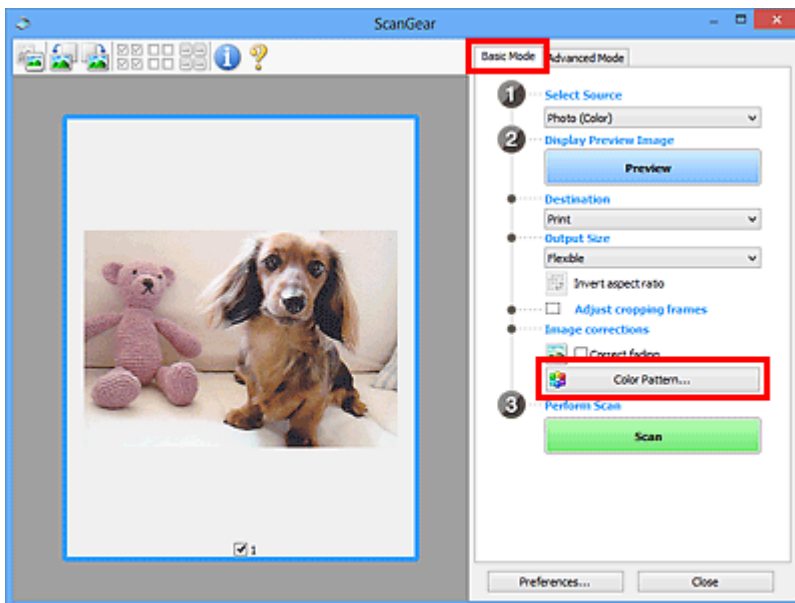

Color Adjustment

Correct colors that have faded with time or due to colorcast. "Colorcast" is a phenomenon where a specific color affects the entire picture due to the weather or ambient strong colors.

Click an arrow in **Color Adjustment** to emphasize the corresponding color.

Cyan & red, magenta & green, and yellow & blue are complementary color pairs (each pair produces a shade of gray when mixed). You can reproduce the natural colors of the scene by reducing the cast color and increasing the complementary color.

It is recommended that you find a portion in the image where it should be white, and adjust the colors so that the portion turns white.

Preview image appears in the center. Preview image colors change as you adjust them.

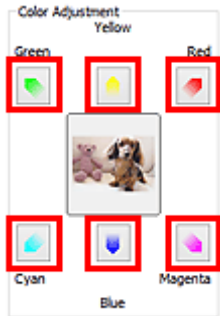

Below is an example of correcting a bluish image.

Since **Blue** and **Green** are too strong, click the **Yellow** and **Magenta** arrows to correct.



»» Note

- Color adjustments are applied only to the cropping frames (scan areas) or the frame selected in thumbnail view.
- You can select multiple frames or cropping frames by clicking them while pressing the Ctrl key.
- You can also select a color tone from the color pattern displayed on the left of the **Color Pattern** screen.
- You can also use this function to add a specific tint to an image. Increase the magenta to add a warm tint, and increase the blue to add a cool tint.

Adjusting Saturation and Color Balance

You can brighten colors that have faded with time or due to colorcast by using  (Saturation/Color Balance) in ScanGear (scanner driver)'s **Advanced Mode** tab.

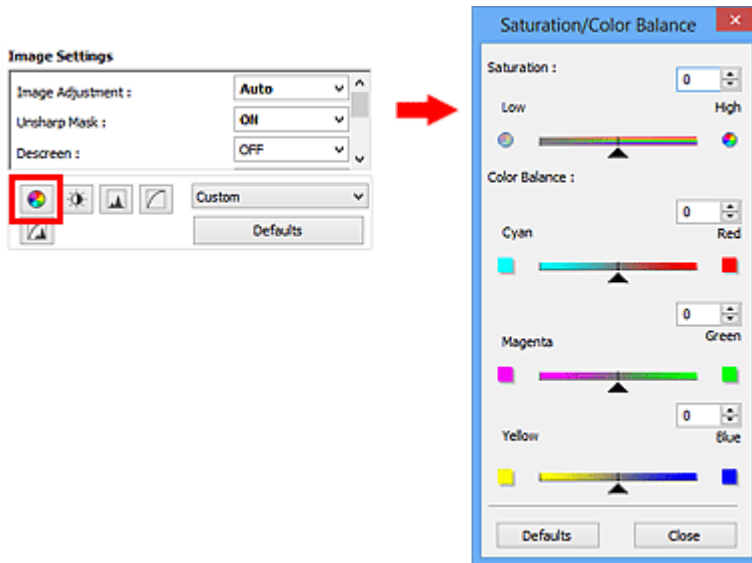

▶▶▶ Note

- Click **Defaults** to reset all adjustments in the current window.

Saturation

Adjust the image's saturation (vividness). You can brighten colors that have faded with time, etc.

Move ▲ (Slider) under **Saturation** to the left to decrease the saturation (darken the image), and to the right to increase the saturation (brighten the image). You can also enter a value (-127 to 127).



Saturation decreased	Original image	Saturation increased
		

▶▶▶ Note

- The natural color tone of the original image may be lost if you increase saturation too much.

Color Balance

Adjust images that have a colorcast. "Colorcast" is a phenomenon where a specific color affects the entire picture due to the weather or ambient strong colors.

Move ▲ (Slider) under **Color Balance** to the left or right to emphasize the corresponding color.

Cyan & Red

Magenta & Green

Yellow & Blue



These are complementary color pairs (each pair produces a shade of gray when mixed). You can reproduce the natural colors of the scene by reducing the cast color and increasing the complementary color.

It is usually difficult to correct the image completely by adjusting only one color pair. It is recommended that you find a portion in the image where it should be white, and adjust all three color pairs so that the portion turns white.

You can also enter a value (-127 to 127).

Below is an example of an image in which the "Cyan & Red" pair has been adjusted.





Cyan is increased	Red is increased
	

Adjusting Brightness and Contrast

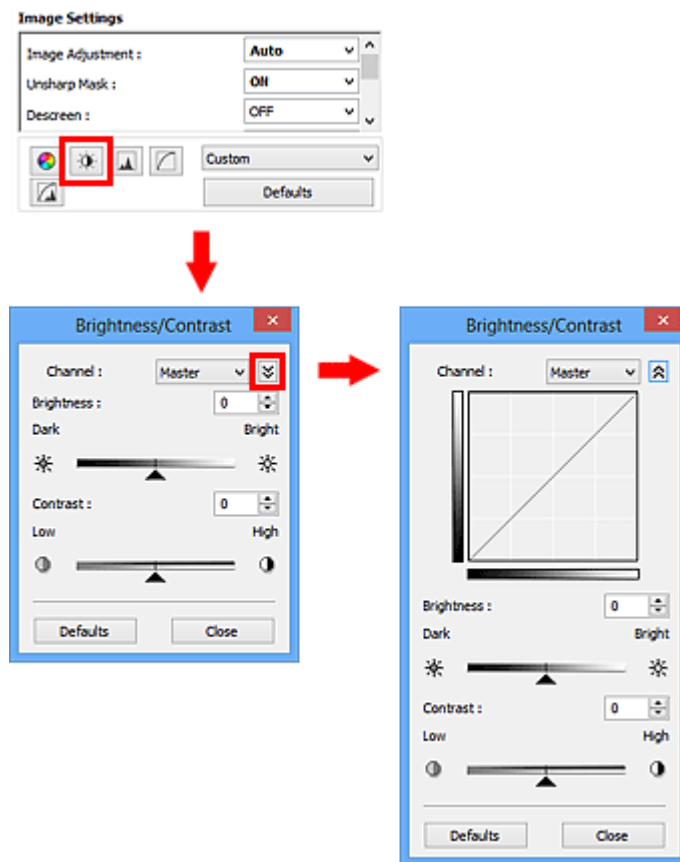
You can adjust images that are too dark or bright, or too flat due to lack of contrast by using (Brightness/Contrast) in ScanGear (scanner driver)'s **Advanced Mode** tab.



►►► Note

- Click  (Down arrow) to switch to detailed view. Click  (Up arrow) to return to the previous view.
- Click **Defaults** to reset all adjustments in the current window.

Channel

Each dot of an image is a mixture of Red, Green, and Blue in various proportions (gradation). These colors can be adjusted individually as a "channel."

Master

Adjust the Red, Green, and Blue combined.

Red

Adjust the Red channel.

Green

Adjust the Green channel.

Blue

Adjust the Blue channel.

►► Note

- Only **Grayscale** will be displayed in **Channel** when **Color Mode** is **Grayscale**.

Brightness

Adjust the image brightness.

Move ▲ (Slider) under **Brightness** to the left to darken and right to brighten the image. You can also enter a value (-127 to 127).



►► Note

- Highlights may be lost if you brighten the image too much, and shadows may be lost if you darken the image too much.

Contrast

"Contrast" is the degree of difference between the brighter and darker parts of an image. Increasing contrast will increase the difference, thus sharpening the image. Decreasing contrast will decrease the difference, thus softening the image.

Move ▲ (Slider) under **Contrast** to the left to decrease and right to increase the contrast of the image. You can also enter a value (-127 to 127).



»» Note

- Increasing the contrast is effective in adding a three-dimensional feel to soft images. However, shadows and highlights may be lost if you increase the contrast too much.

Adjusting Histogram

You can adjust the image color tone by using a graph (histogram) showing brightness distribution, via (Histogram) in ScanGear (scanner driver)'s **Advanced Mode** tab. 

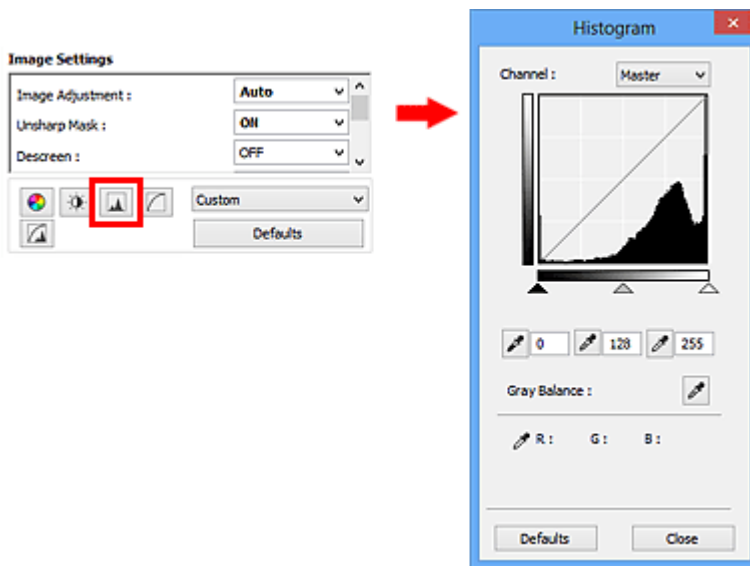

►►► Note

- Click **Defaults** to reset all adjustments in the current window.

Channel

Each dot of an image is a mixture of Red, Green, and Blue in various proportions (gradation). These colors can be adjusted individually as a "channel."

Master

Adjust the Red, Green, and Blue combined.

Red

Adjust the Red channel.

Green

Adjust the Green channel.

Blue

Adjust the Blue channel.

►►► Note

- Only **Grayscale** will be displayed in **Channel** when **Color Mode** is **Grayscale**.

Reading Histograms

You can see the histogram of a specified area for each **Channel**. The higher the histogram peak, the more data is distributed to that level.

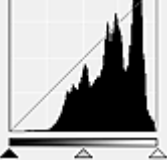
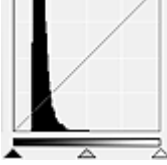
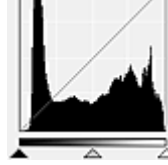

(1) Bright area	(2) Dark area	(3) Whole image
		
More data is distributed to the high-light side.	More data is distributed to the shadow side.	Data is widely distributed between the highlight and shadow.

Adjusting Histograms (Using the Slider)

Select a **Channel**, then move ▲ (Black-point Slider) or △ (White-point Slider) to specify the level to be set as the shadow or highlight.

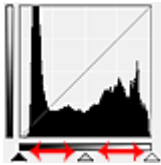

- All parts to the left of ▲ (Black-point Slider) will be black (level 0).
- The parts at △ (Mid-point Slider) will turn to the color exactly between the black-point and white-point.
- All parts to the right of △ (White-point Slider) will turn white (level 255).

When **Image Adjustment** is set to anything but **None**, the adjustments shown below are performed automatically.

Moving the Black-point and White-point Sliders

Move the Black-point Slider or White-point Slider to adjust brightness.

Images with more data distributed to the highlight side

Move the Black-point Slider toward the highlight side.

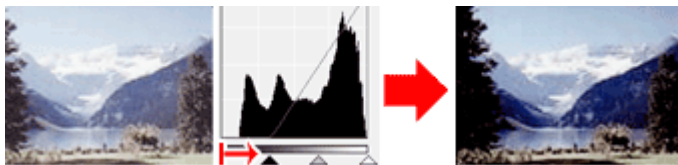

Images with more data distributed to the shadow side

Move the White-point Slider toward the shadow side.

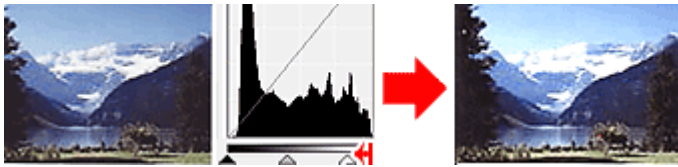

Images with widely distributed data

Move the Black-point Slider toward the highlight side, and White-point Slider toward the shadow side.

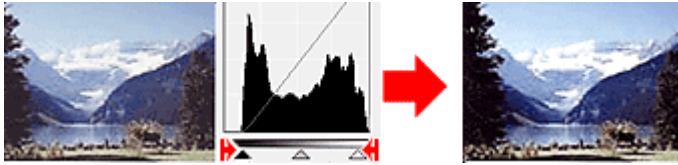

Moving the Mid-point Slider

Move the Mid-point Slider to specify the level to be set as the middle of the tonal range.

Images with more data distributed to the highlight side

Move the Mid-point Slider toward the highlight side.

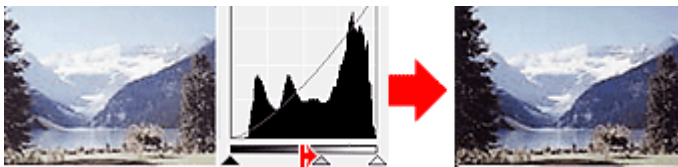

Images with more data distributed to the shadow side



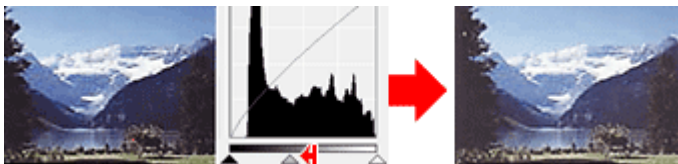

Move the Mid-point Slider toward the shadow side.

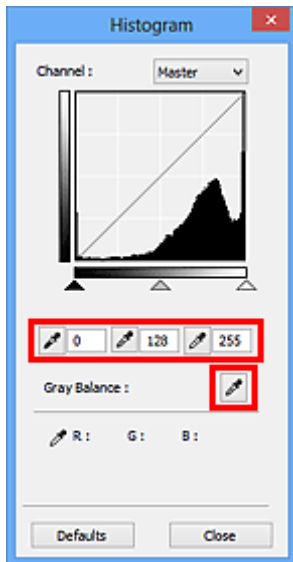

Adjusting Histograms (Using the Droppers)

When you select a **Channel** and click the Black-point, Mid-point, or White-point Dropper, the mouse pointer on the preview image changes to a dropper. Click a Dropper displayed below the histogram to change the setting.



- The point clicked with  (Black-point Dropper) will be the darkest point. You can also enter a value (0 to 245).
- The point clicked with  (Mid-point Dropper) will be the middle of the tonal range. You can also enter a value (5 to 250).
- The point clicked with  (White-point Dropper) will be the brightest point. You can also enter a value (10 to 255).
- Click  (Dropper) for **Gray Balance** and click the area you want to adjust the color in the preview image.

The clicked point will be set as the achromatic color reference, and the rest of the image is adjusted accordingly. For instance, if snow in a photo appears bluish, click the bluish part to adjust the whole image and reproduce natural colors.

Adjusting Tone Curve

You can adjust the brightness of an image by selecting the type of graph (tone curve) showing the balance of tone input and output, via  (Tone Curve Settings) in ScanGear (scanner driver)'s **Advanced Mode** tab.

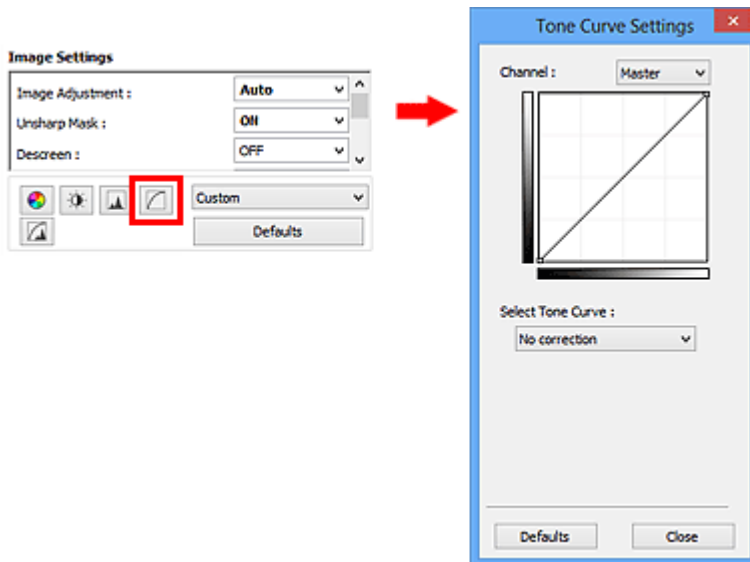

►►► Note

- Click **Defaults** to reset all adjustments in the current window.

Channel

Each dot of an image is a mixture of Red, Green, and Blue in various proportions (gradation). These colors can be adjusted individually as a "channel."

Master

Adjust the Red, Green, and Blue combined.

Red

Adjust the Red channel.

Green

Adjust the Green channel.

Blue

Adjust the Blue channel.

►►► Note

- Only **Grayscale** will be displayed in **Channel** when **Color Mode** is **Grayscale**.

Reading Tone Curves

With ScanGear, scanning images via a scanner is the input, and displaying to a monitor is the output. "Tone Curve" shows the balance of tone input and output for each **Channel**.

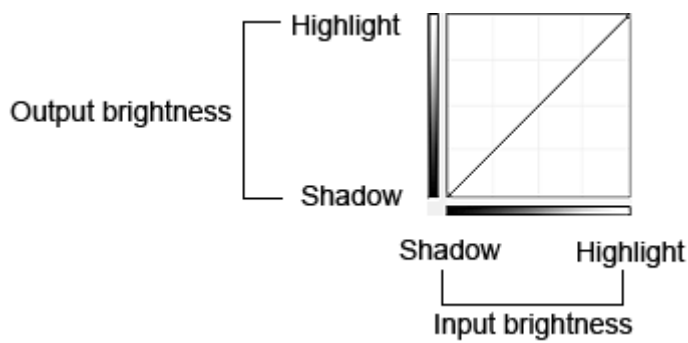

Adjusting Tone Curve

In **Select Tone Curve**, select a tone curve from **No correction**, **Overexposure**, **Underexposure**, **High contrast**, **Reverse the negative/positive image**, and **Edit custom curve**.

No correction (No adjustment)

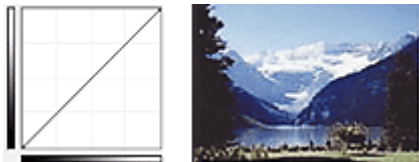

Overexposure (Convex curve)

The midtone data of the input side is stretched toward the highlight of the output side, resulting in a bright-toned image when viewed on a monitor.



Underexposure (Concave curve)

The midtone data of the input side is stretched toward the shadow of the output side, resulting in a dark-toned image when viewed on a monitor.

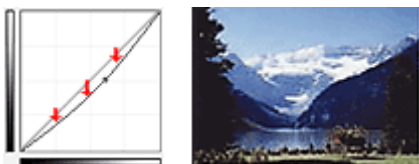

High contrast (S curve)

The highlight and shadow of the input side are enhanced, resulting in a high-contrast image.

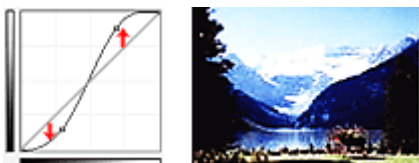

Reverse the negative/positive image (Downward-sloping line)

The input and output sides are reversed, resulting in a negative-positive inverted image.

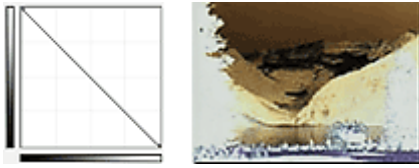

Edit custom curve

You can drag specific points on the Tone Curve to freely adjust the brightness of the corresponding areas.

Setting Threshold

You can sharpen text in a document or reduce show-through in newspapers by adjusting the threshold level via  (Threshold) in ScanGear (scanner driver)'s **Advanced Mode** tab.

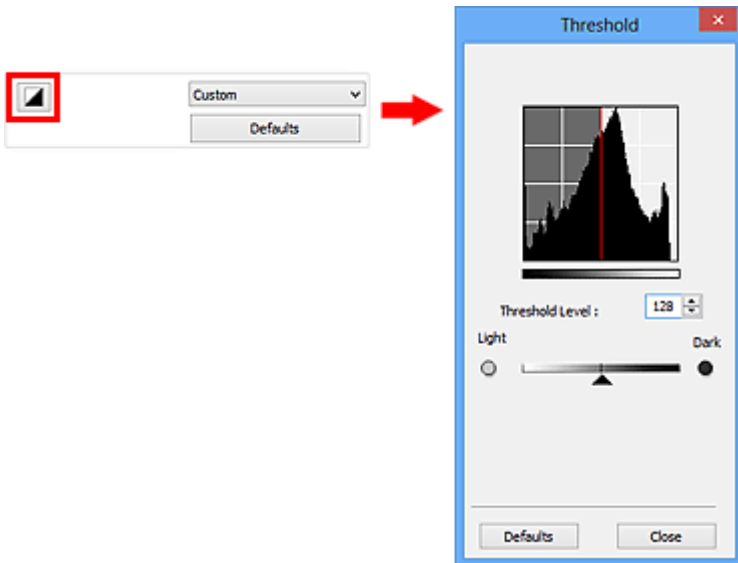

►► Note

- This function is available when **Color Mode** is **Black and White**.
- Click **Defaults** to reset all adjustments in the current window.

Adjusting Threshold

The brightness of color and grayscale images is expressed in a value between 0 and 255. However, in creating black and white images, all colors are mapped to either black (0) or white (255). "Threshold" is the borderline value that determines a color as black or white.

Move ▲ (Slider) to the right to increase the threshold value and thus increase the black areas. Move the slider to the left to decrease the value and thus increase the white areas. You can also enter a value (0 to 255).



ScanGear (Scanner Driver) Screens

- ▶ **Basic Mode Tab**
- ▶ **Advanced Mode Tab**
 - **Input Settings**
 - **Output Settings**
 - **Image Settings**
 - **Color Adjustment Buttons**
- ▶ **Preferences Dialog Box**
 - **Scanner Tab**
 - **Preview Tab**
 - **Scan Tab**
 - **Color Settings Tab**

Basic Mode Tab

This mode allows you to scan easily by following the on-screen steps.

This section describes the settings and functions available on the **Basic Mode** tab.

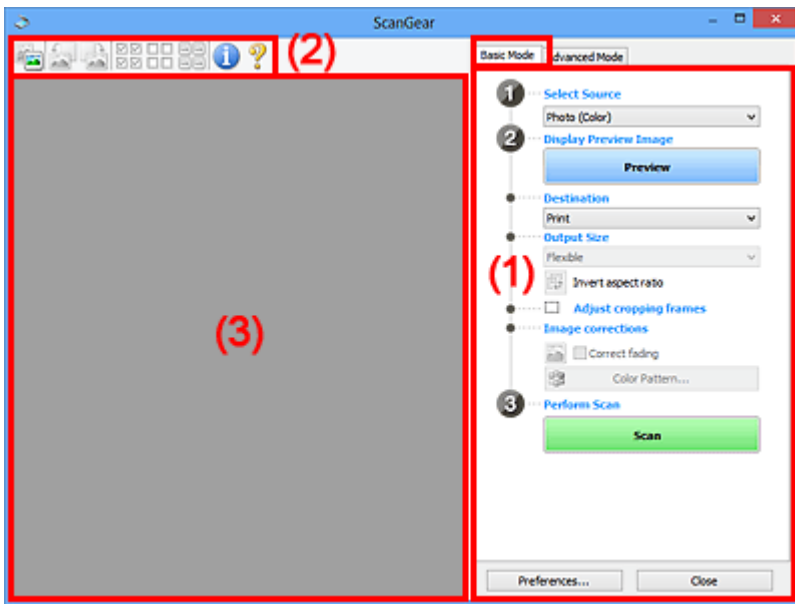

- [\(1\) Settings and Operation Buttons](#)
- [\(2\) Toolbar](#)
- [\(3\) Preview Area](#)

▶▶▶ Note

- The displayed items vary by document type and view.
- The preview function is not available when scanning from the ADF (Auto Document Feeder).

(1) Settings and Operation Buttons

Select Source

Photo (Color)

Scan color photos.

Magazine (Color)

Scan color magazines.

Document (Color)

Scan documents in color.

Document (Grayscale)

Scan documents in black and white.

Document (Color) ADF Simplex

Scan documents from the ADF in color.

Document (Grayscale) ADF Simplex

Scan documents from the ADF in black and white.

Document (Color) ADF Duplex (only for models supporting ADF duplex scanning)

Scan both sides of documents from the ADF in color.

Document (Grayscale) ADF Duplex (only for models supporting ADF duplex scanning)

Scan both sides of documents from the ADF in black and white.

►►► Important

- Some applications do not support continuous scanning from the ADF. For details, refer to the application's manual.

►►► Note

- When you select a document type, the unsharp mask function will be active.
- When you select an option other than the ADF types, the image adjustment function which adjusts images based on the document type will also be active.
- If you select **Magazine (Color)**, the descreen function will be active.

Display Preview Image

Preview

Performs a trial scan.

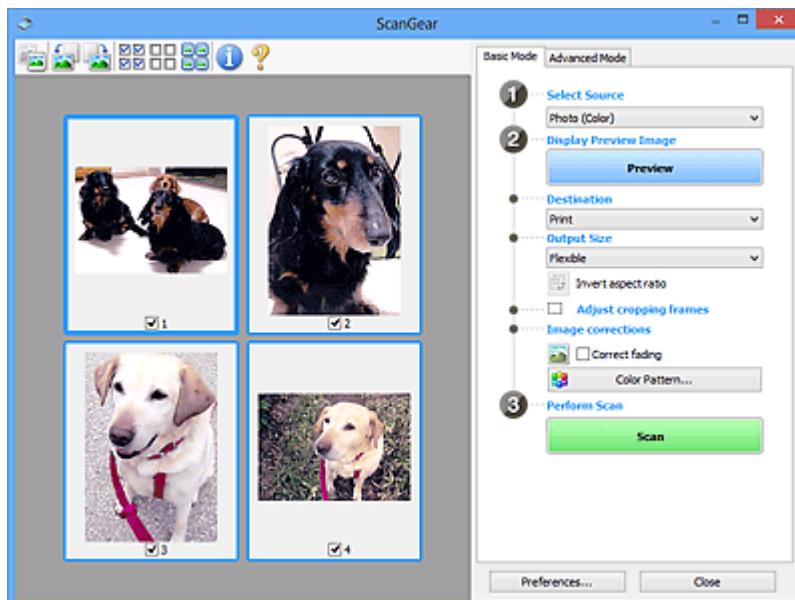

►►► Note

- When using the machine for the first time, scanner calibration starts automatically. Wait a while until the preview image appears.

Destination

Select what you want to do with the scanned image.

Print

Select this to print the scanned image on a printer.

Image display

Select this to view the scanned image on a monitor.

OCR

Select this to use the scanned image with OCR software.

"OCR software" is software that converts text scanned as an image into text data that can be edited in word processors and other programs.

Output Size

Select an output size.

Output size options vary by the item selected in **Destination**.

Flexible

Allows you to freely adjust the cropping frames (scan areas).

In thumbnail view:

Drag the mouse over a thumbnail to display a cropping frame. When a cropping frame is displayed, the portion within the cropping frame will be scanned. When no cropping frame is displayed, each frame is scanned individually.

In whole image view:

When no cropping frame is displayed, the entire Preview area will be scanned. When a cropping frame is displayed, the portion within the cropping frame will be scanned.

Paper Size (L, A4, etc.)

Select an output paper size. The portion within the cropping frame will be scanned at the size of the selected paper size. You can drag the cropping frame to enlarge/reduce it while maintaining the aspect ratio.

Monitor Size (1024 x 768 pixels, etc.)

Select an output size in pixels. A cropping frame of the selected monitor size will be displayed and the portion within the cropping frame will be scanned. You can drag the cropping frame to enlarge/reduce it while maintaining the aspect ratio.

Add/Delete...

Opens the **Add/Delete the Output Size** dialog box, in which you can specify custom output sizes. You can select this option when **Destination** is **Print** or **Image display**.

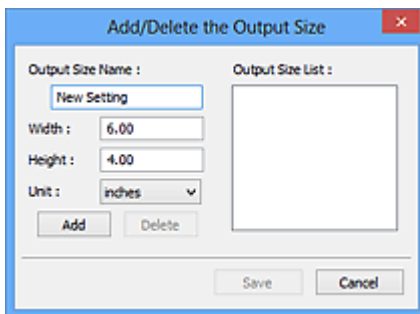

In the **Add/Delete the Output Size** dialog box, you can specify multiple output sizes and save them at one time. Saved items will be registered to the **Output Size** list and can be selected, along with the predefined items.

Adding:

Enter **Output Size Name**, **Width**, and **Height**, then click **Add**. For **Unit**, you can select **inches** or **mm** when **Destination** is **Print** but you can only select **pixels** when **Destination** is **Image display**. The name of the added size appears in **Output Size List**. Click **Save** to save the items listed in **Output Size List**.

Deleting:

Select the output size you want to delete in **Output Size List**, then click **Delete**. Click **Save** to save the items listed in **Output Size List**.

►►► Important

- You cannot delete predefined output sizes such as **A4** and **1024 x 768 pixels**.

►►► Note

- Save up to 10 items.
- An error message appears when you enter a value outside the setting range. Enter a value within the setting range.

►►► Note

- For details on whether or how the cropping frame is initially displayed on a preview image, refer to **Cropping Frame on Previewed Images** in "[Preview Tab](#)" (**Preferences** dialog box).



Invert aspect ratio

Available when **Output Size** is set to anything but **Flexible**.

Click this button to rotate the cropping frame. Click again to return it to the original orientation.

Adjust cropping frames

You can adjust the scan area within the Preview area.

If an area is not specified, the document will be scanned at the document size (Auto Crop). If an area is specified, only the portion in the cropping frame will be scanned.

- [Adjusting Cropping Frames \(ScanGear\)](#)

Image corrections

Allows you to apply corrections to images.

►►► Important

- **Apply Auto Document Fix** and **Correct fading** are available when **Recommended** is selected on the **Color Settings** tab of the **Preferences** dialog box.

►►► Note

- Available functions vary by the document type selected in **Select Source**.

Apply Auto Document Fix

Sharpens text in a document or magazine for better readability.

►►► Important

- Scanning may take longer than usual when this checkbox is selected.
- The color tone may change from the source image due to corrections. In that case, deselect the checkbox and scan.
- Correction may not be applied properly if the scan area is too small.

Correct fading

Corrects and scans photos that have faded with time or have a colorcast.

Reduce gutter shadow

Corrects shadows that appear between pages when scanning open booklets.

►►► Important

- For precautions on using this function, refer to "[Gutter Shadow Correction](#)."

Color Pattern...

Allows you to adjust the image's overall color. You can correct colors that have faded due to colorcast, etc. and reproduce natural colors while previewing color changes.

■ [Adjusting Colors Using a Color Pattern](#)

►►► Important

- This setting is not available when you select **Color Matching** on the **Color Settings** tab of the **Preferences** dialog box.

Perform Scan

Scan

Starts scanning.

►►► Note

- When scanning starts, the progress will be displayed. Click **Cancel** to cancel the scan.

Preferences...

Opens the [Preferences dialog box](#) in which you can make scan/preview settings.

Close

Closes ScanGear (scanner driver).

(2) Toolbar

You can adjust or rotate preview images. The buttons displayed on the Toolbar vary by view.

In thumbnail view:



In whole image view:



Switches the view in the Preview area.

■ [\(3\) Preview Area](#)



(Rotate Left)

Rotates the preview image 90 degrees counter-clockwise.

- The result will be reflected in the scanned image.
- The image returns to its original state when you preview again.

**(Rotate Right)**

Rotates the preview image 90 degrees clockwise.

- The result will be reflected in the scanned image.
- The image returns to its original state when you preview again.

**(Auto Crop)**

Displays and adjusts the cropping frame automatically to the size of the document displayed in the Preview area. The scan area is reduced every time you click this button if there are croppable areas within the cropping frame.

**(Check All Frames)**

Available when two or more frames are displayed.

Selects the checkboxes of the image in thumbnail view.

**(Uncheck All Frames)**

Available when two or more frames are displayed.

Deselects the checkboxes of the image in thumbnail view.

**(Select All Frames)**

Available when two or more frames are displayed.

Selects the images in thumbnail view and outlines them in blue.

**(Select All Cropping Frames)**

Available when two or more cropping frames are specified.

Turns the cropping frames into thick broken lines and applies the settings to all of them.

**(Remove Cropping Frame)**

Removes the selected cropping frame.

**(Information)**

Displays the version of ScanGear and the current scan settings (document type, etc.).

**(Open Guide)**

Opens this page.

(3) Preview Area



This is where a trial image appears after you click **Preview**. You can also check the results of the settings (image corrections, color adjustments, etc.) made in "[\(1\) Settings and Operation Buttons](#)."

**When (Thumbnail) is displayed on the Toolbar:**

Cropping frames are specified according to the document size, and thumbnails of scanned images are displayed. Only the images with the checkbox selected will be scanned.



►► Note

- When multiple images are previewed, different outlines indicate different selection status.
 - Focus Frame (thick blue outline): The displayed settings will be applied.
 - Selected Frame (thin blue outline): The settings will be applied to the Focus Frame and Selected Frames simultaneously. You can select multiple images by clicking them while pressing the Ctrl key.
 - Unselected (no outline): The settings will not be applied.
- Double-click a frame to zoom in on the image. Click   (Frame Advance) at the bottom of the screen to display the previous or next frame. Double-click the frame again to return the display to its non-magnified state.

When  (Whole Image) is displayed on the Toolbar:

Items on the Platen are scanned and displayed as a single image. All portions in the cropping frames will be scanned.



▶▶ Note

- You can specify the cropping frame on the displayed image. In thumbnail view, you can only create one cropping frame per image. In whole image view, you can create multiple cropping frames.

■ [Adjusting Cropping Frames \(ScanGear\)](#)

Related Topic

■ [Scanning in Basic Mode](#)

Advanced Mode Tab

This mode allows you to make advanced scan settings such as the color mode, output resolution, image brightness, and color tone.

This section describes the settings and functions available on the **Advanced Mode** tab.

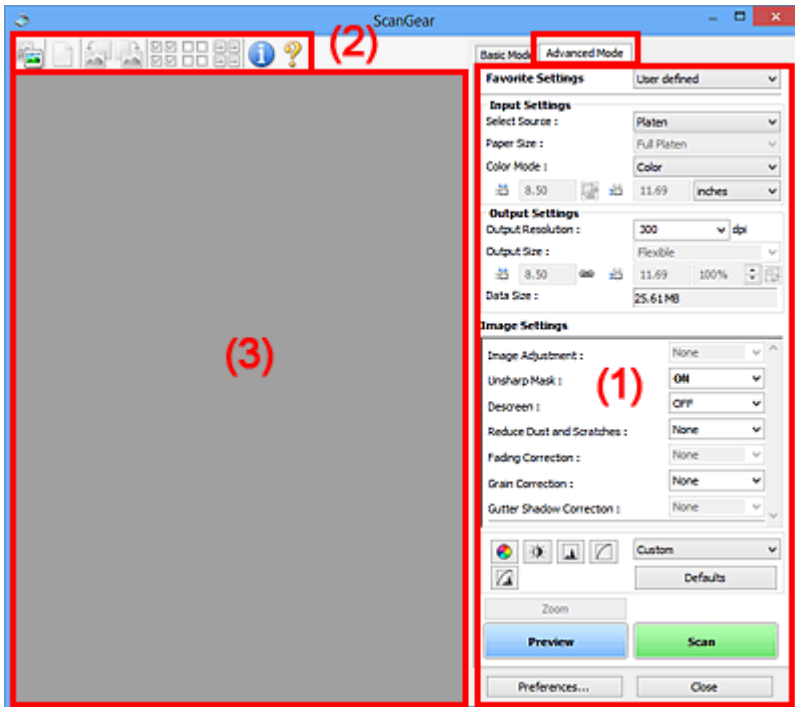

- [\(1\) Settings and Operation Buttons](#)
- [\(2\) Toolbar](#)
- [\(3\) Preview Area](#)

▶▶▶ Note

- The displayed items vary by document type and view.
- The preview function is not available when scanning from the ADF (Auto Document Feeder).

(1) Settings and Operation Buttons

Favorite Settings

You can name and save a group of settings (Input Settings, Output Settings, Image Settings, and Color Adjustment Buttons) on the **Advanced Mode** tab, and load it as required. It is convenient to save a group of settings if you will be using it repeatedly. You can also use this to reload the default settings.

Select **Add/Delete...** from the pull-down menu to open the **Add/Delete Favorite Settings** dialog box.



Enter **Setting Name** and click **Add**; the name appears in **Favorite Settings List**.

When you click **Save**, the item appears in the **Favorite Settings** list and can be selected, along with the predefined items.

To delete an item, select it in **Favorite Settings List** and click **Delete**. Click **Save** to save the settings displayed in **Favorite Settings List**.

▶▶▶ Note

- You can set **Add/Delete...** in **Favorite Settings** after preview.
- Save up to 10 items.

Input Settings

Specify the input settings such as the document type and size.

Output Settings

Specify the output settings such as the output resolution and size.

Image Settings

Enable/disable various image correction functions.

Color Adjustment Buttons

Fine corrections to the image brightness and color tones can be made including adjustments to the image's overall brightness or contrast and adjustments to its highlight and shadow values (histogram) or balance (tone curve).

Zoom

Zooms in on a frame, or zooms in on the image in the area specified with a cropping frame (scan area). When zoomed in, **Zoom** changes to **Undo**. Click **Undo** to return the display to its non-magnified state.

In thumbnail view:

When multiple images are displayed in thumbnail view, clicking this button zooms in on the selected frame. Click  (Frame Advance) at the bottom of the screen to display the previous or next frame.

▶▶▶ Note

- You can also zoom in on an image by double-clicking the frame. Double-click the frame again to return the display to its non-magnified state.

In whole image view:

Rescans the image in the area specified with a cropping frame at higher magnification.

►►► Note

- **Zoom** rescans the document and displays high-resolution image in Preview.
-  (Enlarge/Reduce) on the Toolbar zooms in on the preview image quickly. However, the resolution of the displayed image will be low.

Preview

Performs a trial scan.

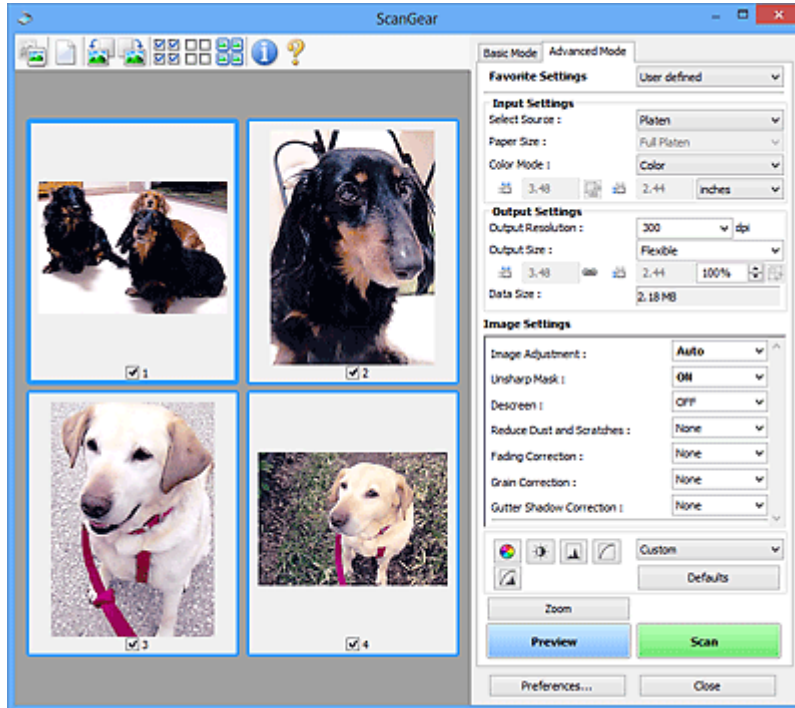

Scan

Starts scanning.

►►► Note

- When scanning starts, the progress will be displayed. Click **Cancel** to cancel the scan.
- When scanning is completed, a dialog box prompting you to select the next action may appear. Follow the prompt to complete. For details, refer to **Status of ScanGear dialog after scanning** in [Scan Tab \(Preferences dialog box\)](#).
- It will take time to process the images if the total size of the scanned images exceeds a certain size. In that case, a warning message appears; it is recommended that you reduce the total size. To continue, scan in whole image view.

Preferences...

Opens the [Preferences dialog box](#) in which you can make scan/preview settings.

Close

Closes ScanGear (scanner driver).

(2) Toolbar

You can adjust or rotate preview images. The buttons displayed on the Toolbar vary by view.

In thumbnail view:



In whole image view:



Switches the view in the Preview area.

■ [\(3\) Preview Area](#)



(Clear)

Deletes the preview image from the Preview area.

It also resets the Toolbar and color adjustment settings.



(Crop)

Allows you to specify the scan area by dragging the mouse.



(Move Image)

Allows you to drag the image until the part you want to see is displayed when an image enlarged in the Preview area does not fit in the screen. You can also move the image using the scroll bars.



(Enlarge/Reduce)

Allows you to zoom in on the Preview area by clicking the image. Right-click the image to zoom out.



(Rotate Left)

Rotates the preview image 90 degrees counter-clockwise.

- The result will be reflected in the scanned image.
- The image returns to its original state when you preview again.



(Rotate Right)

Rotates the preview image 90 degrees clockwise.

- The result will be reflected in the scanned image.
- The image returns to its original state when you preview again.



(Auto Crop)

Displays and adjusts the cropping frame automatically to the size of the document displayed in the Preview area. The scan area is reduced every time you click this button if there are croppable areas within the cropping frame.



(Check All Frames)

Available when two or more frames are displayed.

Selects the checkboxes of the image in thumbnail view.



(Uncheck All Frames)

Available when two or more frames are displayed.

Deselects the checkboxes of the image in thumbnail view.



(Select All Frames)

Available when two or more frames are displayed.

Selects the images in thumbnail view and outlines them in blue.



(Select All Cropping Frames)

Available when two or more cropping frames are specified.

Turns the cropping frames into thick broken lines and applies the settings to all of them.



(Remove Cropping Frame)

Removes the selected cropping frame.



(Information)

Displays the version of ScanGear and the current scan settings (document type, etc.).



(Open Guide)

Opens this page.

(3) Preview Area

This is where a trial image appears after you click **Preview**. You can also check the results of the settings (image corrections, color adjustments, etc.) made in "[\(1\) Settings and Operation Buttons.](#)"



When (Thumbnail) is displayed on the Toolbar:

Cropping frames are specified according to the document size, and thumbnails of scanned images are displayed. Only the images with the checkbox selected will be scanned.



►► Note

- When multiple images are previewed, different outlines indicate different selection status.
 - Focus Frame (thick blue outline): The displayed settings will be applied.
 - Selected Frame (thin blue outline): The settings will be applied to the Focus Frame and Selected Frames simultaneously. You can select multiple images by clicking them while pressing the Ctrl key.
 - Unselected (no outline): The settings will not be applied.

When (Whole Image) is displayed on the Toolbar:

Items on the Platen are scanned and displayed as a single image. All portions in the cropping frames will be scanned.



►► Note

- You can specify the cropping frame on the displayed image. In thumbnail view, you can only create one cropping frame per image. In whole image view, you can create multiple cropping frames.
 - [Adjusting Cropping Frames \(ScanGear\)](#)

Related Topic

- [Scanning in Advanced Mode](#)
- [Scanning Multiple Documents from the ADF \(Auto Document Feeder\) in Advanced Mode](#)

Input Settings

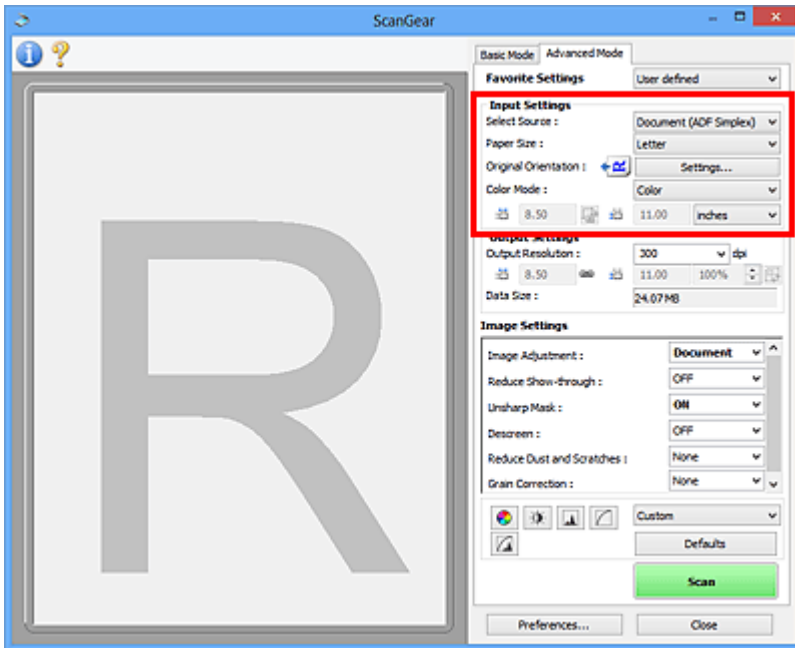

Input Settings allows you to set the following items:

Select Source

The type of document to be scanned is displayed. To scan from the Platen, select **Platen**; to scan from the ADF (Auto Document Feeder), select **Document (ADF Simplex)** or **Document (ADF Duplex)**.

►►► Important

- Some applications do not support continuous scanning from the ADF. For details, refer to the application's manual.

►►► Note

- You can select **Document (ADF Duplex)** when using a model supporting ADF duplex scanning.

Paper Size



Select the size of the document to be scanned. This setting is available in whole image view only.

When you select a size, the Preview area size changes accordingly.

►►► Important

- Some applications have a limit to the amount of scan data they can receive. Available scan range is as follows.
 - 21000 pixels x 30000 pixels or less
- If you change **Paper Size** after previewing, the preview image will be deleted.

►►► Note

- If you are not sure which size you should select for **Paper Size**, set **Paper Size** to **Full Platen**, then measure the size of the document and enter the values into  (Width) and  (Height).

Original Orientation

Set the orientation and stapling side of the documents to scan from the ADF.

Click **Settings...** to open the **Orientation** dialog box.

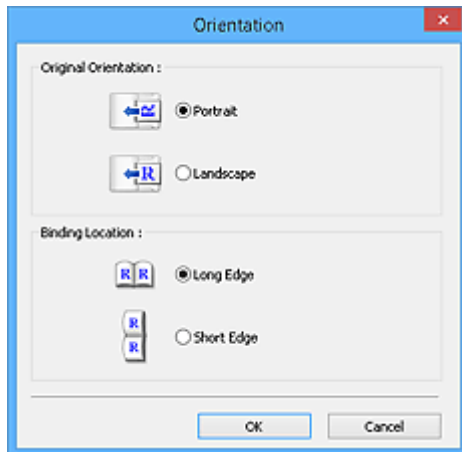

»»» Important

- The **Orientation** dialog box can only be opened when **Select Source** is **Document (ADF Simplex)** or **Document (ADF Duplex)**.
- **Binding Location** is displayed when using a model supporting ADF duplex scanning.
- **Binding Location** cannot be specified when **Select Source** is **Document (ADF Simplex)**.

Color Mode

Select how to scan the document.

Color

Select this mode to scan color documents or to create color images. This mode renders the image in 256 levels (8 bit) of R(ed), G(reen), and B(lue).

Grayscale

Select this mode to scan black and white photos or to create black and white images. This mode renders the image in 256 levels (8 bit) of black and white.

Black and White



Select this mode to scan photos and documents in black and white. This mode renders the image in black and white. The contrast in the image is divided at certain levels (threshold level) into black and white and is rendered in two colors. The threshold level can be set with  (Threshold).

Input Size

In thumbnail view, the cropped document size is displayed after preview.

In whole image view, the **Paper Size** is displayed before preview, and the cropping frame (scan area) size is displayed after preview.

You can adjust the cropping frame size by entering the values into  (Width) and  (Height).

Click  (Change Aspect Ratio) and change it to  (Keep Aspect Ratio) to maintain the aspect ratio when you specify the cropping frame size.

»» Important

- Input size settings are available only when **Output Size** in **Output Settings** is **Flexible**. If you select a size other than **Flexible**, a cropping frame calculated from **Output Size** and **Output Resolution** is displayed, and its aspect ratio is fixed.

»» Note

- The values you can enter will be within the range of the selected document size. The minimum size is 96 pixels x 96 pixels when **Output Resolution** is 600 dpi, scaled at 100 %.
- When Auto Crop is performed in whole image view, the aspect ratio will not be maintained since the size will be prioritized.
- Refer to "[Adjusting Cropping Frames \(ScanGear\)](#)" for details on cropping frames.

Output Settings

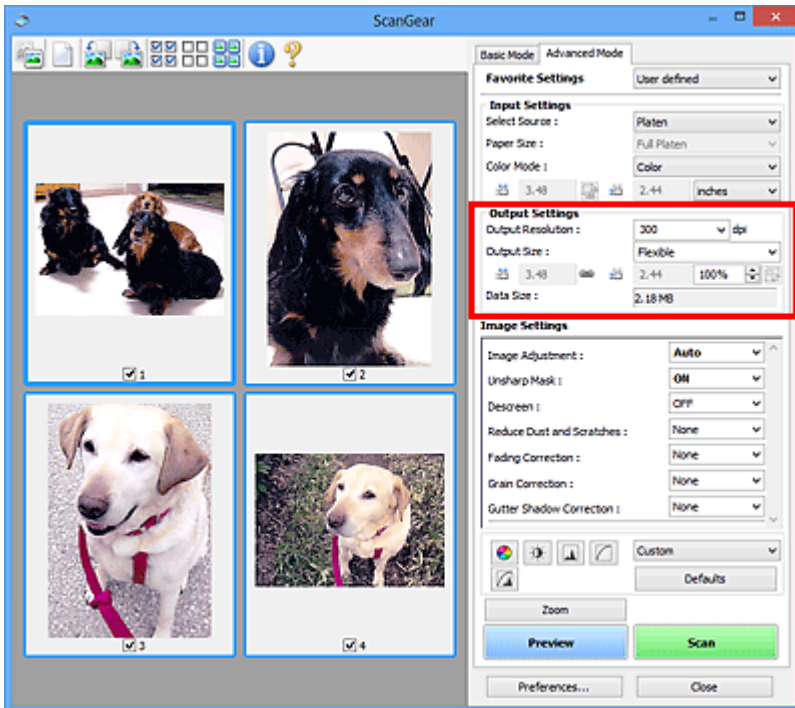

Output Settings allows you to set the following items:

Output Resolution

Select the resolution to scan at.

The higher the resolution (value), the more detail in your image.

Select a resolution from the options displayed by clicking the button, or enter a value in 1 dpi increments.

Refer to "Resolution" for your model from Home of the Online Manual for details.

When Select Source is Platen:

You can enter a value within the range of 25 dpi to 19200 dpi.

When Select Source is Document (ADF Simplex) or Document (ADF Duplex):

You can enter a value within the range of 25 dpi to 600 dpi.

Output Size

Select an output size.

Select **Flexible** to set custom sizes or select a size for printing or displaying. Select **Add/Delete...** to set custom size and save it as a new output size option.

Flexible

You can specify the output resolution and scale, and adjust the cropping frames (scan areas).



In thumbnail view:

Drag the mouse over a thumbnail to display a cropping frame. When a cropping frame is displayed, the portion within the cropping frame will be scanned. When no cropping frame is displayed, each frame is scanned individually.



In whole image view:

When no cropping frame is displayed, the entire Preview area will be scanned. When a cropping frame is displayed, the portion within the cropping frame will be scanned.

►►► Note

- To enlarge/reduce the scanned image, enter values into  (Width) and  (Height) in **Output Settings** or specify a value (by 1 %) for %. Although the maximum value available for % depends on the **Output Resolution**, it can be specified for up to 19200 dpi (the maximum available output resolution).

Paper Size (L, A4, etc.) & Monitor Size (1024 x 768 pixels, etc.)

 (Width),  (Height), and scale cannot be specified. The preview image will be cropped according to the selected output size and resolution. The portion within the cropping frame will be scanned at the size of the selected paper/monitor size. You can drag the cropping frame to enlarge, reduce, or move it while maintaining the aspect ratio.

Add/Delete...

Opens the **Add/Delete the Output Size** dialog box, in which you can specify custom output sizes.

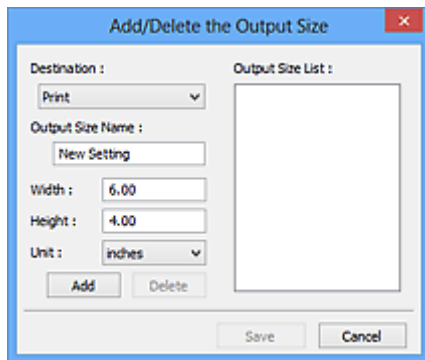

In the **Add/Delete the Output Size** dialog box, you can specify multiple output sizes and save them at one time. Saved items will be registered to the **Output Size List** and can be selected, along with the predefined items.

Adding:

Select **Print** or **Image display** for **Destination**, then enter **Output Size Name**, **Width**, and **Height**, then click **Add**. For **Unit**, you can select **inches** or **mm** when **Destination** is **Print** but you can only select **pixels** when **Destination** is **Image display**. The name of the added size appears in **Output Size List**. Click **Save** to save the items listed in **Output Size List**.

Deleting:

Select the output size you want to delete in **Output Size List**, then click **Delete**. Click **Save** to save the items listed in **Output Size List**.

►►► Important

- You cannot delete predefined output sizes such as **A4** and **1024 x 768 pixels**.

►►► Note

- Save up to 10 items for each destination.

- An error message appears when you enter a value outside the setting range. Enter a value within the range displayed in the message.

»» Note

- Refer to "[Adjusting Cropping Frames \(ScanGear\)](#)" for details on cropping frames.
- For details on whether or how the cropping frame is initially displayed on a preview image, refer to **Cropping Frame on Previewed Images** in "[Preview Tab](#)" (**Preferences** dialog box).



(Switch Aspect Ratio)

Available when **Output Size** is set to anything but **Flexible**.

Click this button to rotate the cropping frame. Click again to return it to the original orientation.

Data Size

The data size when scanned with the current settings is displayed.

»» Note

- When the data size exceeds a certain size, the value appears in red. In that case, a warning message appears when you click **Scan**. It is recommended that you adjust the settings to reduce **Data Size**. To continue, scan in whole image view.

Image Settings

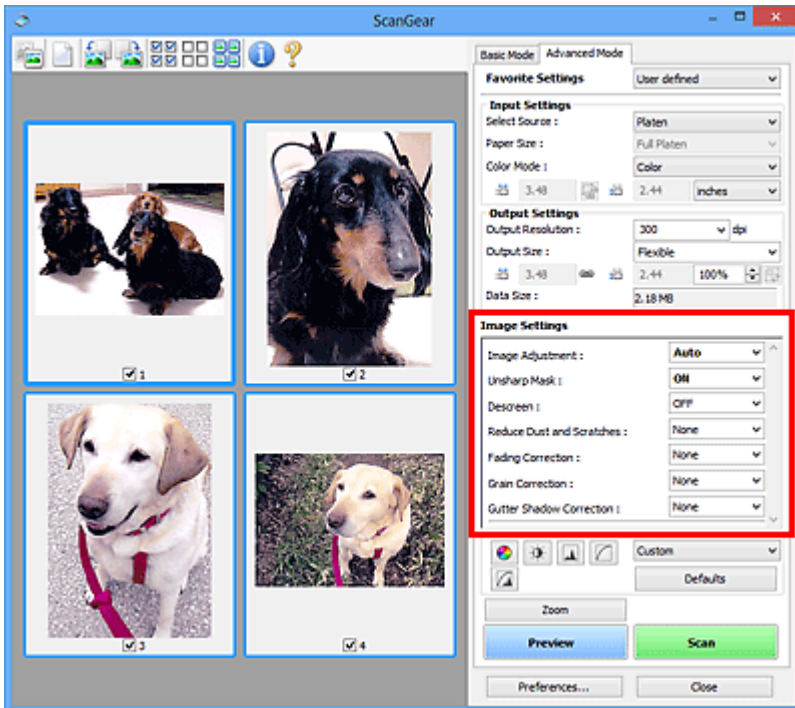

►►► Important

- Do not apply these functions to images without moire, dust/scratches, or faded colors. The color tone may be adversely affected.
- Image correction results may not be reflected in the preview image.

►►► Note

- Selectable settings depend on **Color Mode** settings.
- Scanning may take longer than usual when you use **Image Settings**.

Image Settings allows you to set the following items:

Image Adjustment

When Image Adjustment is set, the brightness of the specified portion of the image is optimized. Images can be adjusted according to the automatically detected document type or the specified document type. The result of the adjustment will be reflected in the entire image.

None

Image Adjustment will not be applied.

Auto

Applies Image Adjustment by automatically detecting the document type. It is recommended that you normally select this setting.

Photo

Applies Image Adjustment suitable for photos.

Magazine

Applies Image Adjustment suitable for magazines.

Document

Applies Image Adjustment suitable for text documents.

»» Important

- You can set **Image Adjustment** after preview.
- You can set this setting when **Recommended** is selected on the **Color Settings** tab of the **Preferences** dialog box.

»» Note

- If the image is not adjusted properly with **Auto**, specify the document type.
- The color tone may change from the source image due to the Image Adjustment. In that case, set **Image Adjustment** to **None**.

Reduce Show-through

Use this function to reduce show-through in duplex documents or lighten the base color in recycled paper and other colored paper when scanning documents.

OFF

Show-through will not be reduced.

ON

Select this to reduce show-through in duplex documents or lighten the base color. It is recommended that you normally select this setting.

»» Important

- **Reduce Show-through** can be set when **Recommended** is selected on the **Color Settings** tab of the **Preferences** dialog box and **Document** or **Magazine** is selected for **Image Adjustment**.

Unsharp Mask

Emphasizes the outline of the subjects to sharpen the image when scanning photos.

OFF

Unsharp Mask will not be applied.

ON

Emphasizes the outline of the subjects to sharpen the image. It is recommended that you normally select this setting.

Descreen

Printed photos and pictures are displayed as a collection of fine dots. "Moire" is a phenomenon where uneven gradation or a stripe pattern appears when such photos or pictures printed with fine dots are scanned. **Descreen** is the function for reducing this moire effect.

OFF

Moire will not be reduced.

ON

Reduces moire. It is recommended that you normally select this setting.

»» Note

- Even if **Descreen** is set to **ON**, some moire effects may remain if **Unsharp Mask** is set to **ON**. In that case, set **Unsharp Mask** to **OFF**.

Reduce Dust and Scratches

Scanned photos may contain white dots caused by dust or scratches. Use this function to reduce such noise.

None

Dust and scratches will not be reduced.

Low

Select this to reduce small dust particles and scratches. Large ones may remain.

Medium

It is recommended that you normally select this setting.

High

Select this to reduce large dust particles and scratches; however, evidence of the reduction process may remain or delicate parts of the image may be removed.

►►► Important

- This function may not be effective for some types of photos.

►►► Note

- It is recommended that you select **None** when scanning printed materials.

Fading Correction

Use this function to correct photos that have faded with time or have a colorcast. "Colorcast" is a phenomenon where a specific color affects the entire picture due to the weather or ambient strong colors.

None

Fading Correction will not be applied.

Low

Select this to correct a small amount of fading and colorcast.

Medium

It is recommended that you normally select this setting.

High

Select this to correct a large amount of fading and colorcast. This can affect the tone of the image.

►►► Important

- You can set **Fading Correction** after preview.
- You can set this setting when **Recommended** is selected on the **Color Settings** tab of the **Preferences** dialog box.
- Correction may not be applied properly if the scan area is too small.

Grain Correction

Use this function to reduce graininess (roughness) in photos taken with high-speed or sensitized film.

None

Graininess will not be reduced.

Low

Select this when the photo is slightly grainy.

Medium

It is recommended that you normally select this setting.

High

Select this when the photo is very grainy. This can affect the gradation and sharpness of the image.

»» Important

- Correction may not be applied properly if the scan area is too small.

Gutter Shadow Correction

Use this function to correct shadows that appear between pages when scanning open booklets.

When you set the **Gutter Shadow Correction** setting in the preview image, the result will be reflected. Preview the effects before scanning, as results vary depending on the type of document and how it is pressed.

Unclear or blurred text/lines caused by curved pages are not corrected.

None

Gutter shadow will not be corrected.

Low

Select this when the effect level is too strong with the medium setting.

Medium

It is recommended that you normally select this setting.

High

Select this when the effect level is too weak with the medium setting.

»» Important

- You can set **Gutter Shadow Correction** after preview.
- Do not place objects that weigh 4.4 lbs (2.0 kg) or more on the platen. Also, do not press on the document with a force exceeding 4.4 lbs (2.0 kg). If you press heavily, the scanner may not work correctly or you might break the glass.
- Align the document with the edge of the Platen. If not, the shadow will not be corrected properly.



- Shadows may not be corrected properly depending on the document. If the page background is not white, shadows may not be detected correctly or may not be detected at all.
- While scanning, press down on the spine with the same amount of pressure you used to preview the scan. If the binding part is not even, the shadow will not be corrected properly.

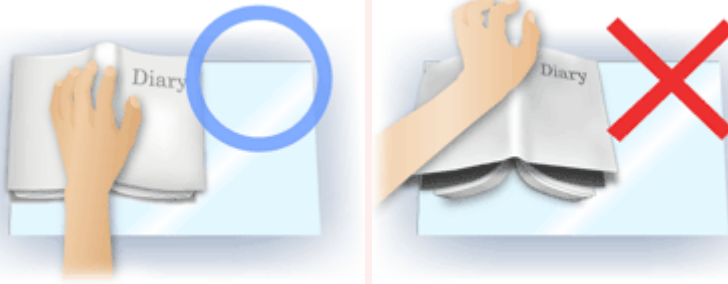

- How to place the document depends on your model and the document to be scanned.

►► Note

- Cover the document with black cloth if white spots, streaks, or colored patterns appear in scan results due to ambient light entering between the document and the Platen.
- If the shadow is not corrected properly, adjust the cropping frame (scan area) on the preview image.

■ [Adjusting Cropping Frames \(ScanGear\)](#)

Color Adjustment Buttons

The Color Adjustment Buttons allow you to make fine corrections to the image brightness and color tones including adjustments to the image's overall brightness or contrast and adjustments to its highlight and shadow values (histogram) or balance (tone curve).

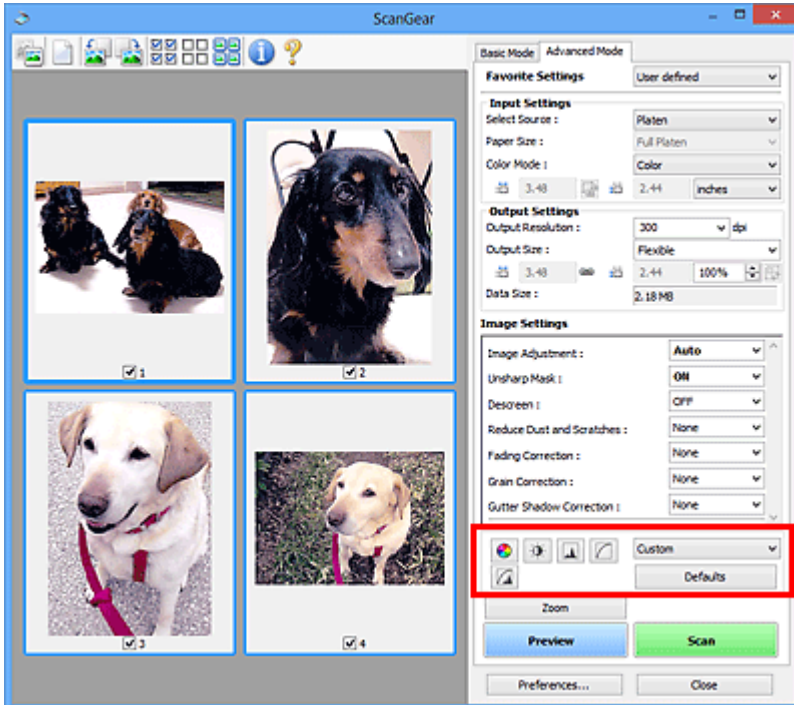

►►► Important

- The Color Adjustment Buttons are not available when you select **Color Matching** on the **Color Settings** tab of the **Preferences** dialog box.

►►► Note

- Selectable settings depend on **Color Mode** settings.
- When you adjust the image via the Color Adjustment Buttons, the results will be reflected in the preview image.

Click a Color Adjustment Button to set the following items:



(Saturation/Color Balance)

Adjust the saturation (vividness) and color tone of the image. Use this function to brighten colors that have faded with time or due to colorcast. "Colorcast" is a phenomenon where a specific color affects the entire picture due to the weather or ambient strong colors.

■ [Adjusting Saturation and Color Balance](#)



(Brightness/Contrast)

Adjust the brightness and contrast of the image. If the image is too dark or too bright, or if the image quality is flat due to lack of contrast, you can adjust the levels of brightness and contrast.

■ [Adjusting Brightness and Contrast](#)



(Histogram)

A histogram allows you to see the data concentration at each brightness level of an image. You can specify the brightest level (highlight) and darkest level (shadow) within an image, cut the levels and expand the middle of the tonal range of the image.

■ [Adjusting Histogram](#)



(Tone Curve Settings)

Adjust the brightness of an image by selecting the type of graph (tone curve) showing the balance of tone input and output. You can make fine adjustments to the brightness of a specific area.

■ [Adjusting Tone Curve](#)



(Final Review)

Make a final check of color adjustments. The final synthesized tone curve and the histogram derived from the subsequent image processing will be displayed. There are no settings to make in this screen.

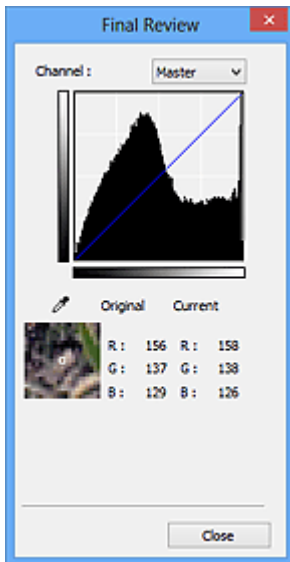

- For a color image, select a color in **Channel** to check either **Red**, **Green**, or **Blue**, or select **Master** to check three colors together.
- If you place the cursor on the preview image, the portion will be enlarged and its RGB values (only L when **Color Mode** is **Grayscale**) before and after the adjustments will be displayed.



(Threshold)

Set the boundary (threshold) at which black and white are divided. By adjusting the threshold level, you can sharpen text in a document or reduce show-through in newspapers.

■ [Setting Threshold](#)

Custom

You can name and save a set of tone curve and threshold settings of the Color Adjustment Buttons.

Select **Add/Delete...** from the pull-down menu; when **Color Mode** is set to anything but **Black and White**, the **Add/Delete Tone Curve Settings** dialog box opens; when **Color Mode** is **Black and White**, the **Add/Delete Threshold Settings** dialog box opens.

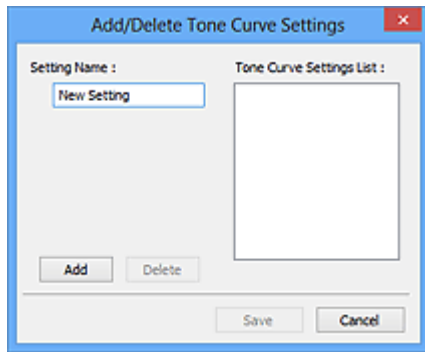

Enter **Setting Name** and click **Add**; the name appears in **Tone Curve Settings List** or **Threshold Settings List**. Click **Save** to save.

To delete an item, select it in **Tone Curve Settings List** or **Threshold Settings List** and click **Delete**. Click **Save** to save the settings displayed in **Tone Curve Settings List** or **Threshold Settings List**.

You can load and apply the saved tone curve/threshold settings to a preview image. To load the settings, select the saved item from the pull-down menu.

»» Note

- Save up to 20 items.

Defaults

Reset all adjustments (saturation/color balance, brightness/contrast, histogram, and tone curve).

Preferences Dialog Box

In the **Preferences** dialog box, you can make advanced settings to ScanGear (scanner driver) functions via the **Scanner**, **Preview**, **Scan**, and **Color Settings** tabs.

Click **Preferences...** in the ScanGear screen to open the **Preferences** dialog box.

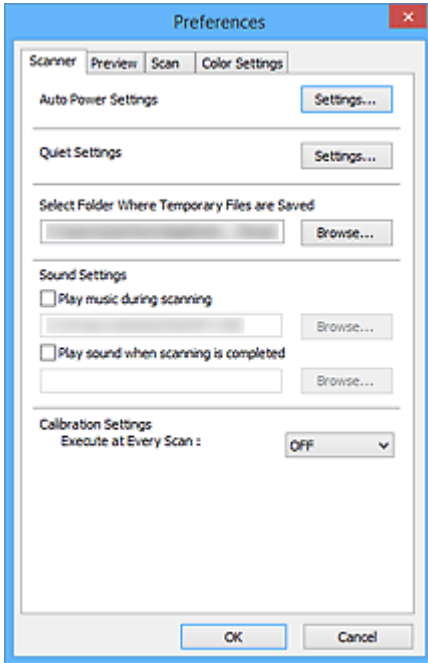

Scanner Tab

Allows you to set the auto power settings, specify the folder in which to save images temporarily, and set the music file to play during or at the end of a scan.

Preview Tab

Allows you to select what to do with Preview when ScanGear is started, how to display cropping frames after previewing images, and the cropping size for thumbnails of scanned documents.

Scan Tab

Allows you to select what to do with ScanGear after scanning image.

Color Settings Tab

Allows you to select how to adjust color, and specify the monitor gamma value.

Scanner Tab

On the **Scanner** tab, you can specify the following settings.

▶▶▶ Important

- Available functions and settings vary depending on your scanner or printer.

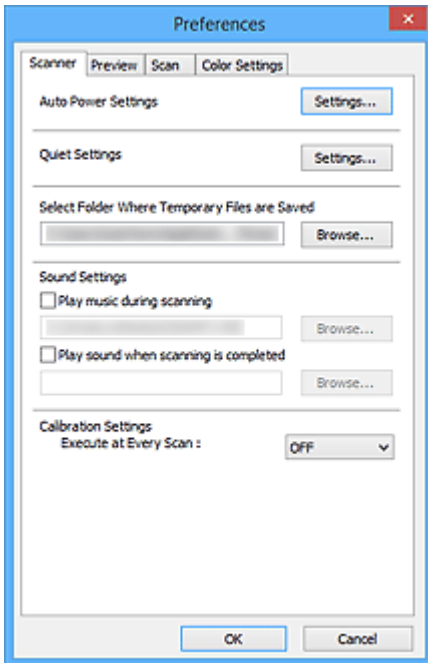

Auto Power Settings

You can set to turn the machine on or off automatically.

Click **Settings...** to display the **Auto Power Settings** dialog box.

▶▶▶ Note

- If the machine is off or bi-directional communication is disabled, a message may appear because the computer cannot collect the machine status. In that case, click **OK** to exit ScanGear (scanner driver).

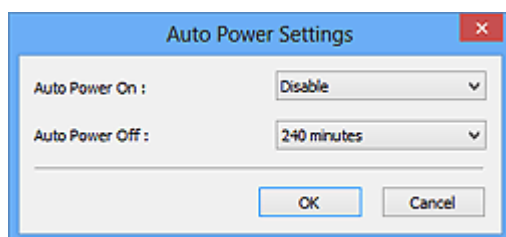

Auto Power On

Select **Enable** to turn on the machine automatically when data is received.

Auto Power Off

Specify the amount of time you want to set from the list. When this time lapses without any data being received, the machine turns off automatically.

»» Important

When connected to the network, depending on your model, the power does not turn off automatically even if **Auto Power Off** is set.

Refer to "Function Support List by Model (Auto Power Off)" to check if your model supports the Auto Power Off function.

Quiet Settings

The silent function allows you to reduce the operating noise of this machine. Use this when you wish to reduce the operating noise such as when scanning or printing at night.

Click **Settings...** to set the quiet mode.

»» Note

- You can set the quiet mode from the operation panel of the machine, the printer driver, or ScanGear.
No matter how the setting is made, it applies to operations from the operation panel of the machine or when printing/scanning from a computer, etc.
- Scanning or printing may take longer than usual when this function is used.

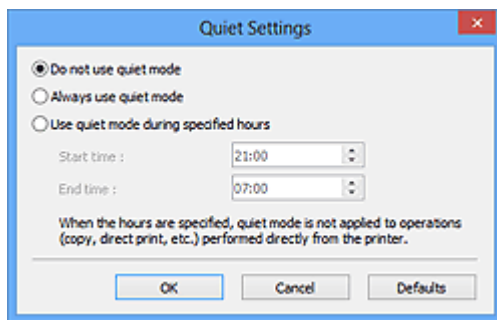

Do not use quiet mode

Select this option when you wish to use the machine with volume of normal operating noise.

Always use quiet mode

Select this option when you wish to reduce the operating noise of the machine.

Use quiet mode during specified hours

Select this option when you wish to reduce the operating noise of the machine during a specified period of time.

Set the **Start time** and **End time** during which quiet mode is to be activated.

»» Important

- The time specified in **Start time** and in **End time** must be different.
- If your scanner or printer does not support fax functions, quiet mode is not applied to operations (copy, direct print, etc.) performed directly from the machine even if the hours are specified.

Select Folder Where Temporary Files are Saved

Displays the folder in which to save images temporarily. To change the folder, click **Browse...** to specify another one.

Sound Settings

You can set the machine to play music during/at the end of a scan.

Select the **Play music during scanning** or **Play sound when scanning is completed** checkbox, then click **Browse...** and specify a sound file.

You can specify the following files.

- MIDI file (*.mid, *.rmi, *.midi)
- Audio file (*.wav, *.aif, *.aiff)
- MP3 file (*.mp3)

Calibration Settings

When you set **Execute at Every Scan** to **ON**, the scanner will be calibrated every time before previewing and scanning, to reproduce correct color tones in scanned images.

▶▶ Note

- Even when **Execute at Every Scan** is set to **OFF**, the scanner may be calibrated automatically in some cases (such as immediately after you turn the machine on).
- Calibration may take time depending on your computer.

Preview Tab

On the **Preview** tab, you can specify the following settings.

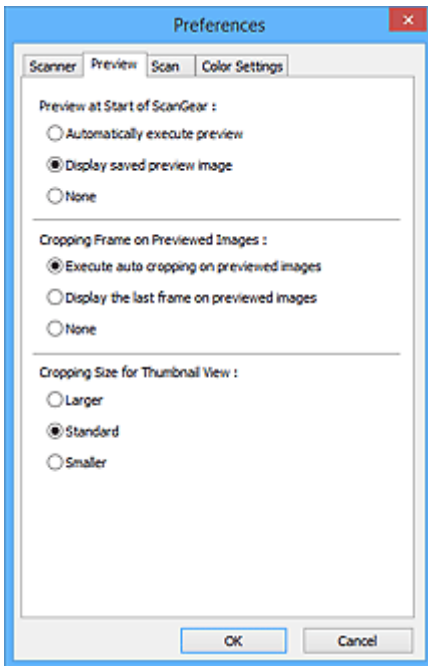

Preview at Start of ScanGear

Select what to do with Preview when ScanGear (scanner driver) is started.

Automatically execute preview

ScanGear will automatically start previewing at startup.

Display saved preview image

The previously previewed image will be displayed.

The Color Adjustment Button settings, the Toolbar settings, and the **Advanced Mode** tab settings are also saved.

None

No preview image will be displayed at startup.

►►► Note

- Select **None** if you do not want to save the preview image.

Cropping Frame on Previewed Images

Select how to display cropping frames after previewing images.

Execute auto cropping on previewed images

The cropping frame (scan area) will automatically be displayed in the document size after previewing.

Display the last frame on previewed images

A cropping frame of the same size as the last used cropping frame will be displayed after previewing.

None

No cropping frame will be displayed after previewing.

Cropping Size for Thumbnail View

Select the cropping size for thumbnails of scanned documents.

Larger

Displays 105 % (in width and height) of the area displayed for the standard size.

Standard

The standard size.

Smaller

Displays 95 % (in width and height) of the area displayed for the standard size.

▶▶ Note

- When you change the **Cropping Size for Thumbnail View** setting, the preview images will be refreshed and cropped to the new size. As the preview images are refreshed, the color adjustments and other settings applied to them are reset.

Scan Tab

On the **Scan** tab, you can specify the following settings.

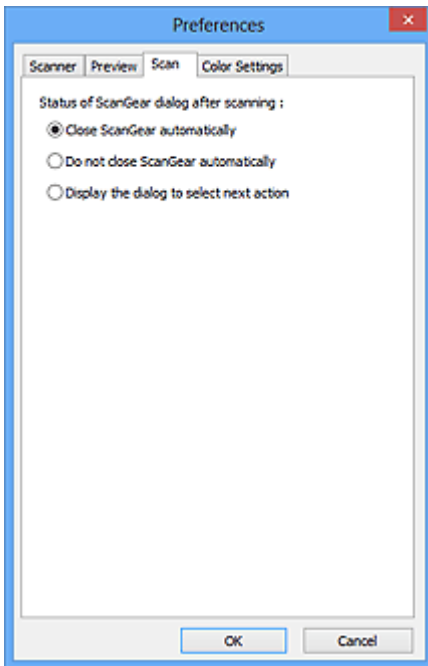

Status of ScanGear dialog after scanning

Select what to do with ScanGear (scanner driver) after scanning images.

Close ScanGear automatically

Select this to return to the original application when scanning is completed.

Do not close ScanGear automatically

Select this to return to the ScanGear screen for another scan when scanning is completed.

Display the dialog to select next action

Select this to open a screen and select what to do when scanning is completed.

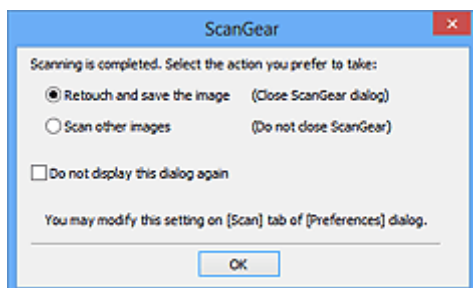

►►► Note

- Even if **Do not close ScanGear automatically** or **Display the dialog to select next action** is set, some applications may not support it.

Color Settings Tab

On the **Color Settings** tab, you can specify the following settings.

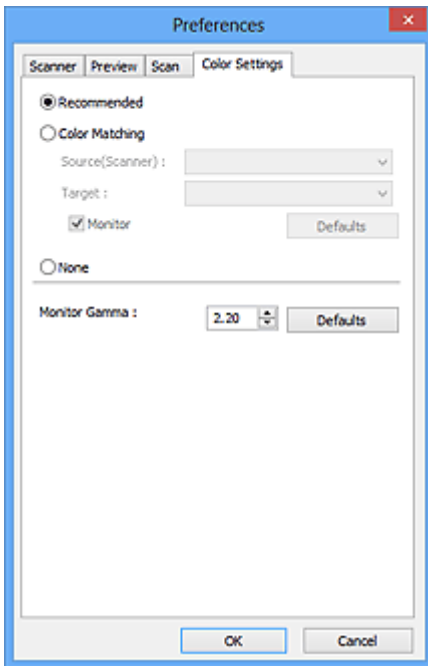

Color Adjustment

Select one of the following.

Recommended

Select this to vividly reproduce the tone of a document on the screen. It is recommended that you normally select this setting.

Color Matching

Select this to automatically match the scanner, monitor, and color printer colors, thus reducing time and trouble to manually match the monitor and printer colors.

Source(Scanner)

Select scanner profile.

Target

Select target profile.

Monitor

Select this checkbox to display preview image with optimum correction for monitor.

Defaults

Returns to the default **Color Matching** settings.

►►► Note

- The Color Adjustment Buttons on the **Advanced Mode** tab are not available when you select **Color Matching**.
- This function is available when **Color Mode** is **Color**.

None

Select this to disable color correction provided by ScanGear (scanner driver).

▶▶▶ Note

- Depending on your scanner or printer, this setting may not be available when scanning from the ADF (Auto Document Feeder).
- You can select one when **Color Mode** is **Color** or **Grayscale**.
- Color Matching is available when ScanGear, monitor, color management-compliant application (such as Adobe Photoshop), and printer are set up correctly.

Refer to the corresponding manual for the monitor, printer, and application settings.

Monitor Gamma

By setting the gamma value of a monitor, you can adjust the input data to the brightness characteristics of the monitor. Adjust the value if your monitor's gamma value does not match the default value set in ScanGear, and the colors of the original image are not accurately reflected in the monitor.

Click **Defaults** to return to the default Monitor Gamma value (2.20).

▶▶▶ Note

- Refer to the manual of your monitor to check its gamma value. If it is not written in the manual, contact the manufacturer.

Positioning Originals (Scanning from Computer)

Learn how to place items on the platen or ADF (Auto Document Feeder) of your scanner or printer. Place items correctly according to the type of item to be scanned. Otherwise, items may not be scanned correctly.

▶▶▶ Important

- Do not place objects on the document cover. When you open the document cover, the objects may fall into your scanner or printer, resulting in malfunction.
- Close the document cover when scanning.
- Do not touch the operation panel buttons or LCD (Liquid Crystal Display) when opening/closing the document cover. May result in unintended operation.

■ [Placing Items \(Platen\)](#)

■ [Placing Documents \(ADF \(Auto Document Feeder\)\)](#)

Placing Items (Platen)

Place items as described below to scan by detecting the item type or size automatically.

▶▶▶ Important

- When scanning by specifying the paper size in IJ Scan Utility or ScanGear (scanner driver), align an upper corner of the item with the corner at the arrow (alignment mark) of the platen.
- Photos that have been cut to various shapes and items smaller than 1.2 inches (3 cm) square cannot be cropped accurately when scanning.
- Reflective disc labels may not be scanned as expected.

For Photos, Postcards, Business Cards, or BD/DVD/CD	For Magazines, Newspapers, or Documents
<div data-bbox="220 1234 724 1361" data-label="Image"> </div> <p data-bbox="188 1413 440 1442">Placing a Single Item:</p> <p data-bbox="188 1460 829 1599">Place the item face-down on the platen, with 0.4 inch (1 cm) or more space between the edges (diagonally striped area) of the platen and the item. Portions placed on the diagonally striped area cannot be scanned.</p> <div data-bbox="188 1615 695 1984" data-label="Diagram"> </div>	<div data-bbox="932 1234 1315 1361" data-label="Image"> </div> <p data-bbox="847 1402 1423 1541">Place the item face-down on the platen and align an upper corner of the item with the corner at the arrow (alignment mark) of the platen. Portions placed on the diagonally striped area cannot be scanned.</p> <div data-bbox="847 1556 1355 1921" data-label="Diagram"> </div>

▶▶▶ Important

- Large items (such as A4 size photos) that cannot be placed away from the edges/arrow (alignment mark) of the platen may be saved as PDF files. To save in a format other than PDF, scan by specifying the data format.

Placing Multiple Items:

Allow 0.4 inch (1 cm) or more space between the edges (diagonally striped area) of the platen and items, and between items. Portions placed on the diagonally striped area cannot be scanned.

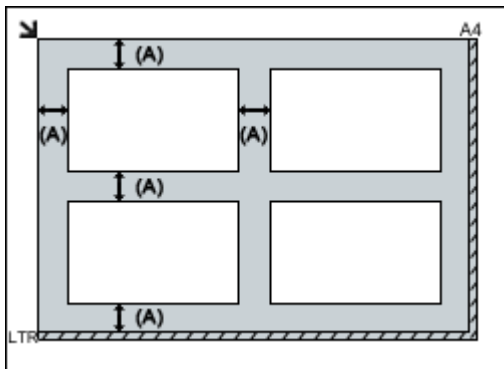

(A) more than 0.4 inch (1 cm)

▶▶▶ Note

- You can place up to 12 items.
- You can place up to four items when the **Compress scanned images upon transfer** checkbox is selected in the Settings dialog box of IJ Scan Utility.
- With network connection, items may not be scanned correctly when five or more items are placed. In that case, reduce the number of items placed on the platen to four or less, then scan again.
- Positions of slanted items (10 degrees or less) are corrected automatically.

▶▶▶ Important

- Refer to "Loading Originals" for your model from Home of the Online Manual for details on the portions in which items cannot be scanned.

Placing Documents (ADF (Auto Document Feeder))

▶▶▶ Important

- Do not leave thick items on the platen when scanning from the ADF. May result in paper jam.
- Place and align documents of the same size when scanning two or more documents.
- Refer to "Originals You Can Load" for your model from Home of the Online Manual for details on supported document sizes when scanning from the ADF.

1. Open the document tray.

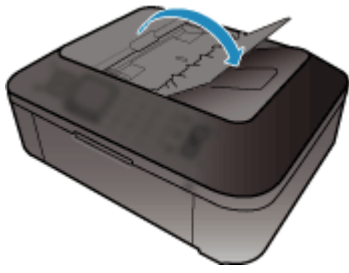

2. Place the documents on the ADF, then adjust the document guides to the width of the documents.

Insert the documents face-up until a beep sounds.

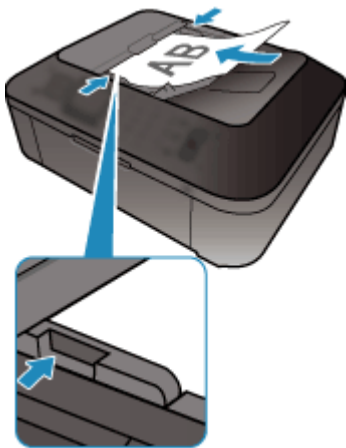

▶▶▶ Note

- When scanning duplex documents, place the front sides facing up. They will not be scanned in the correct page order if placed the other way around.

Adjusting Cropping Frames (ScanGear)

"Cropping" is the act of selecting the area you want to keep in an image and discarding the rest when scanning it.

On the **Basic Mode** tab and **Advanced Mode** tab, you can specify cropping frames (scan areas) on the image(s) displayed in the Preview area of the screen.

When you perform a scan, each area specified with a cropping frame will be scanned as a separate image.

»» Note

- In whole image view, you can specify multiple cropping frames on the preview image.
- Refer to "Adjusting Cropping Frames in the Image Stitch Window" for your model from Home of the Online Manual for how to adjust cropping frames with IJ Scan Utility.

Initial Cropping Frame

In thumbnail view:

No cropping frame is specified. You can drag the mouse over a thumbnail to specify a cropping frame.

In whole image view:

An active cropping frame is automatically specified around the preview image. You can drag the cropping frame in the Preview area to specify the area.

»» Note

- You can change the auto crop setting in the **Preferences** dialog box. Refer to **Cropping Frame on Previewed Images** in "[Preview Tab](#)" for details.

Cropping Frame Types

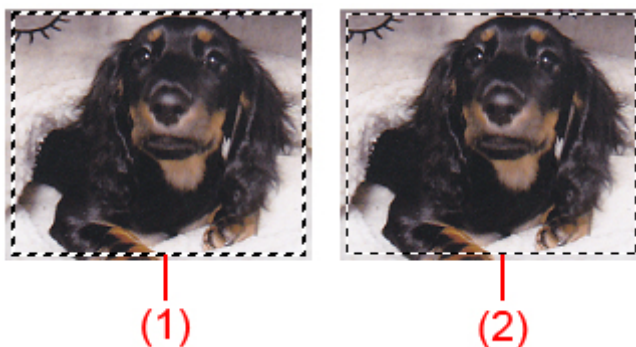

(1) Thick cropping frame (rotating or stationary)

Represents a selected cropping frame. Appears only in whole image view. You can select multiple cropping frames by clicking them while pressing the Ctrl key. Output size, image corrections, and other settings on the **Basic Mode** tab or **Advanced Mode** tab will be applied to all the selected cropping frames.

(2) Thin cropping frame

In thumbnail view:

Output size, image corrections, and other settings on the **Basic Mode** tab or **Advanced Mode** tab will be applied.

In whole image view:

Represents an unselected cropping frame. The settings on the **Basic Mode** tab or **Advanced Mode** tab will not be applied.

Adjusting a Cropping Frame





The cursor will change into  (Arrow) when it is positioned over a cropping frame. If you click and drag the mouse in the direction of the arrow, the cropping frame will expand or contract accordingly.



The cursor will change into  (Crosshair Arrow) when it is positioned within a cropping frame. Click and drag the mouse to move the entire cropping frame.



►► Note

- On the **Advanced Mode** tab, you can specify the cropping frame size by entering the values into  (Width) and  (Height) in [Input Settings](#).
- You can rotate a cropping frame 90 degrees by clicking  (Switch Aspect Ratio). However,  (Switch Aspect Ratio) is not available when **Output Size** is **Flexible**.

Creating Multiple Cropping Frames

In thumbnail view:

You can only create one cropping frame per image.

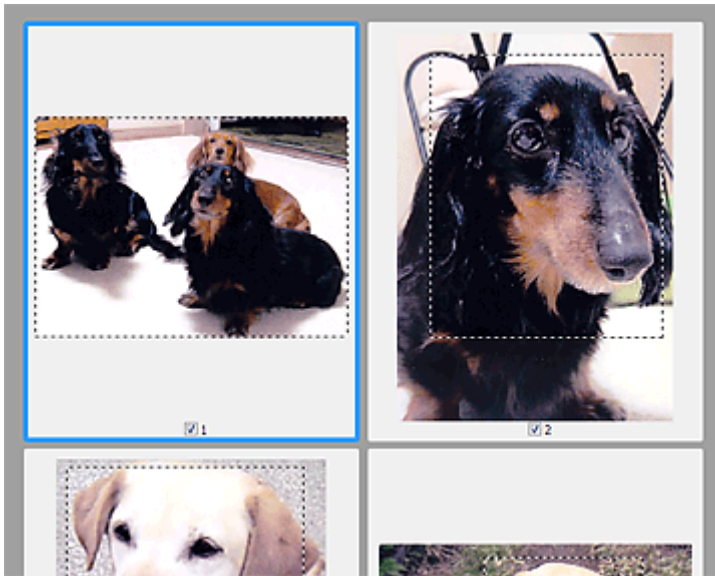

In whole image view:

Click and drag the mouse in a space outside the existing cropping frame to create a new cropping frame in the Preview area. The new cropping frame will be the active cropping frame, and the old cropping frame will be the unselected cropping frame.

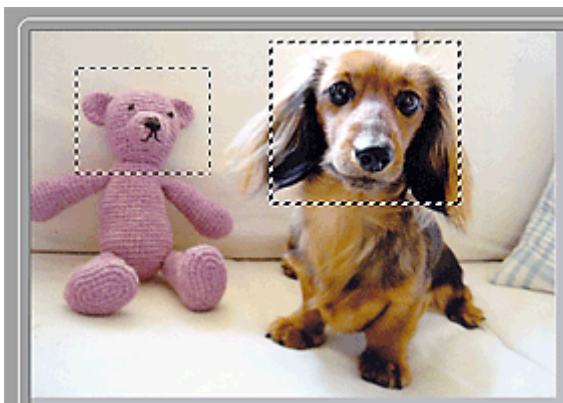

You can create multiple cropping frames and apply different scan settings to each cropping frame.

You can also select multiple cropping frames by clicking them while pressing the Ctrl key.

If you select multiple cropping frames and change the settings on a tab at the right of ScanGear, the settings will be applied to all the selected cropping frames.

When you create a new cropping frame, it retains the settings of the latest cropping frame.

►► Note

- Create up to 12 cropping frames.
- Scanning takes longer than usual when multiple cropping frames are selected.

Deleting Cropping Frames

In thumbnail view:

To delete a cropping frame, click an area outside the cropping frame on an image.

In whole image view:

To delete a cropping frame, select it and click  (Remove Cropping Frame) on the Toolbar. Alternatively, press the Delete key.

When there are multiple cropping frames, all the selected cropping frames (active cropping frame and selected cropping frames) are deleted simultaneously.

General Notes (Scanner Driver)

ScanGear (scanner driver) is subject to the following restrictions. Keep these points in mind when using it.

Scanner Driver Restrictions

- When using the NTFS file system, the TWAIN data source may not be invoked. This is because the TWAIN module cannot be written to the winnt folder for security reasons. Contact the computer's administrator for help.
- Some computers (including laptops) connected to the machine may not resume correctly from standby mode. In that case, restart the computer.
- Do not connect two or more scanners or multifunction printers with scanner function to the same computer simultaneously. If multiple scanning devices are connected, you cannot scan from the operation panel of the machine and also may experience errors while accessing the devices.
- Scanning may fail if the computer has resumed from sleep or standby mode. In that case, follow these steps and scan again.
 1. Turn off the machine.
 2. Exit ScanGear, then disconnect the USB cable from the computer and reconnect it.
 3. Turn on the machine.
- ScanGear cannot be opened in multiple applications at the same time. Within an application, ScanGear cannot be opened for the second time when it is already open.
- Be sure to close the ScanGear window before closing the application.
- When using a network compatible model by connecting to a network, the machine cannot be accessed from multiple computers at the same time.
- When using a network compatible model by connecting to a network, scanning takes longer than usual.
- Make sure that you have adequate disk space available when scanning large images at high resolutions. For example, at least 300 MB of free space is required to scan an A4 document at 600 dpi in full-color.
- ScanGear and WIA driver cannot be used at the same time.
- Do not enter the computer into sleep or hibernate state during scanning.

Applications with Restrictions on Use

- If you start Media Center included in Windows XP Media Center Edition 2005, you may not be able to scan using the operation panel of the machine. In that case, restart the computer.
- You cannot scan images with Media Center included in Windows XP Media Center Edition 2005. Scan with other applications such as IJ Scan Utility.
- Some applications may not display the TWAIN user interface. In that case, refer to the application's manual and change the settings accordingly.
- Some applications do not support continuous scanning of multiple documents. In some cases, only the first scanned image is accepted, or multiple images are scanned as one image. For such applications, do not scan multiple documents from the ADF (Auto Document Feeder).
- To import scanned images into Microsoft Office 2000, first save them using IJ Scan Utility, then import the saved files from the **Insert** menu.

- When scanning Platen size images into Microsoft Office 2003 (Word, Excel, PowerPoint, etc.), click **Custom Insert** in the **Insert Picture from Scanner or Camera** screen. Otherwise, images may not be scanned correctly.
- When scanning images into Microsoft Office 2007/Microsoft Office 2010 (Word, Excel, PowerPoint, etc.), use Microsoft Clip Organizer.
- Images may not be scanned correctly in some applications. In that case, increase the operating system's virtual memory and retry.
- When image size is too large (such as when scanning large images at high resolution), your computer may not respond or the progress bar may remain at 0 % depending on the application. In that case, cancel the action (for example by clicking **Cancel** on the progress bar), then increase the operating system's virtual memory or reduce the image size/resolution and retry. Alternatively, scan the image via IJ Scan Utility first, then save and import it into the application.

Other Scanning Methods

- ▶ [Scanning with WIA Driver](#)

Scanning with WIA Driver

You can scan an item from a WIA (Windows Image Acquisition)-compliant application.

The procedure varies depending on the application. The following procedures are examples only.

Refer to the application's manual for details.

►►► Important

- Some applications do not support continuous scanning from the ADF (Auto Document Feeder). Refer to the application's manual for details.
- Follow these steps to enable scanning over a network.

- **Windows 10/Windows 8.1/Windows 8:**

1. Right-click **Start** menu, and then select **File Explorer > Network**.
2. In **Network** menu of displayed screen, select **Add devices and printers**.
3. In screen for adding device, select **XXX_MAC address** (where "XXX" is model name), and then click **Next**.

- **Windows 7/Windows Vista:**

1. Follow the procedure below to open **Network**.
 - Windows 7: From **Start** menu, select **Computer > Network**.
 - Windows Vista: From **Start** menu, select **Network**.
2. Right-click **XXX_MAC address** (where "XXX" is model name) in the displayed screen, then select **Install**.

The setting may have been completed already depending on your environment. In that case, **Uninstall** appears.

Scanning with WIA Driver 2.0

The following is an example of scanning using "Windows Fax and Scan."

1. Place the item on the platen or ADF.

- [Positioning Originals \(Scanning from Computer\)](#)

2. Select **New** on the **File** menu of "**Windows Fax and Scan**," then click **Scan....**

The scan setting screen appears.

►►► Note

- If you have more than one scanner or printer, a scanner selection screen may appear. Double-click the scanner you want to use.
 - For USB connection: **Canon XXX series** (where "XXX" is the model name)
 - For network connection: **XXX series_MAC address** (where "XXX" is the model name)

3. Specify the settings.

Scanner

The currently set product name is displayed. To change the scanner, click **Change...** and select the product you want to use.

Profile

Select **Photo (Default)** or **Documents** according to the type of item to be scanned. To save a new **Profile**, select **Add profile...** You can specify the details in the **Add New Profile** dialog box.

Source

Select a scanner type. To scan from the platen, select **Flatbed**. To scan from the ADF, select **Feeder (Scan one side)** or **Feeder (Scan both sides)**.

Paper size

Select the paper size. **Paper size** can be set only when **Source** is **Feeder (Scan one side)** or **Feeder (Scan both sides)**.

Color format

Select the color mode in which to scan the item.

File type

Select a data format from JPEG, BMP, PNG, and TIFF.

Resolution (DPI)

Enter the resolution. Specify a value between 50 dpi and 600 dpi.

■ [Resolution](#)

▶▶▶ Note

- When using the scanner or printer with network connection, the following resolutions can be specified.
150 dpi / 300 dpi / 600 dpi

Brightness

Move the slider to adjust the brightness. Move it to the left to darken and right to brighten the image. You can also enter a value (-100 to 100).

Contrast

Move the slider to adjust the contrast. Moving it to the left will decrease the contrast of the image, thus softening the image. Moving it to the right will increase the contrast of the image, thus sharpening the image. You can also enter a value (-100 to 100).

Preview or scan images as separate files

Select this checkbox to preview or scan multiple images as separate files.

▶▶▶ Important

- When using the scanner or printer with network connection, you cannot specify **Brightness**, **Contrast**, and **Preview or scan images as separate files**.

4. Click **Preview** to preview the image.

The preview image appears on the right.

▶▶▶ Important

- With network connection, scan without preview when scanning documents from the ADF. If you preview, place the document again and scan.

If there is document left in the ADF after previewing, press the **OK** button on the operation panel and remove the document.

5. Click **Scan**.

Scanning starts, then the scanned image appears in the application.

Scanning with WIA Driver 1.0

The following is an example of scanning using "Paint."

1. Place the item on the platen or ADF.

■ [Positioning Originals \(Scanning from Computer\)](#)

2. Click **From scanner or camera** from the **File** menu of Paint. (Select the command to scan an item in the application.)

▶▶▶ Note

- If you have more than one scanner or printer, a scanner selection screen may appear. Double-click the scanner you want to use.
 - For USB connection: **Canon XXX series** (where "XXX" is the model name)
 - For network connection: **XXX series_MAC address** (where "XXX" is the model name)

3. Select the paper source and type of picture according to the item to be scanned.

To scan from the platen, select **Flatbed** for **Paper source**. To scan from the ADF, select **Document Feeder**.

Select the type of picture from **Color picture**, **Grayscale picture**, **Black and white picture or text**, and **Custom Settings**.

▶▶▶ Note

- When using the scanner or printer with network connection, the options for the type of picture may differ from those displayed with USB connection.
- To scan with the values previously set in **Adjust the quality of the scanned picture**, select **Custom Settings**.
- Selecting **Document Feeder** for **Paper source** enables you to select **Page size**.

4. Click **Adjust the quality of the scanned picture** and set the preferences as required.

Brightness

Move the slider to adjust the brightness. Move it to the left to darken and right to brighten the image. You can also enter a value (-127 to 127).

Contrast

Move the slider to adjust the contrast. Moving it to the left will decrease the contrast of the image, thus softening the image. Moving it to the right will increase the contrast of the image, thus sharpening the image. You can also enter a value (-127 to 127).

Resolution (DPI)

Enter the resolution. Specify a value between 50 dpi and 600 dpi.

■ [Resolution](#)

▶▶▶ Note

- When using the scanner or printer with network connection, the following resolutions can be specified.
150 dpi / 300 dpi / 600 dpi

Picture type

Select the type of scan you want for your item.

Reset

Click to restore the original settings.

▶▶▶ Important

- When using the scanner or printer with network connection, you cannot specify **Brightness** and **Contrast**.

5. Click **Preview** to preview the image.

The preview image appears on the right. Drag to specify the scan area.

▶▶▶ Important

- With network connection, scan without preview when scanning documents from the ADF. If you preview, place the document again and scan.
If there is document left in the ADF after previewing, press the **OK** button on the operation panel and remove the document.

6. Click **Scan**.

Scanning starts, then the scanned image appears in the application.

IJ Network Scanner Selector EX2 Menu and Setting Screen

IJ Network Scanner Selector EX2 allows you to select the scanners or printers to be used for scanning or printing over a network from your computer or the operation panel.

After installation, IJ Network Scanner Selector EX2 appears in the notification area on the desktop.

▶▶▶ Important

- If you cannot scan over a network, download and upgrade to the latest MP Drivers from our website.
- While IJ Network Scanner Selector EX2 is enabled, it periodically transmits packets to check whether it can communicate with your scanner or printer over the network. When using the computer in a network environment other than the one used to set up your scanner or printer, disable IJ Network Scanner Selector EX2.

▶▶▶ Note

- If the icon is not displayed in the notification area on the desktop, follow the procedure below to start.
 - **Windows 10:**
From **Start** menu, click **All apps > Canon Utilities > IJ Network Scanner Selector EX2**.
 - **Windows 8.1/Windows 8:**
Click **IJ Network Scanner Selector EX2** on the Start screen.
If **IJ Network Scanner Selector EX2** is not displayed on the Start screen, select the **Search** charm, then search for "IJ Network Scanner Selector EX2".
 - **Windows 7/Windows Vista:**
From the **Start** menu, click **All Programs > Canon Utilities > IJ Network Scanner Selector EX2 > IJ Network Scanner Selector EX2**.

Menu

Displays a menu when you right-click  (IJ Network Scanner Selector EX2) in the notification area on the desktop.

Disable Canon IJ Network Scanner Selector EX2 / Enable Canon IJ Network Scanner Selector EX2

Enables or disables IJ Network Scanner Selector EX2.

When you select **Disable Canon IJ Network Scanner Selector EX2**, you will not be able to scan over a network from the operation panel.

Enabled:  , Disabled: 

▶▶▶ Important

- When using a model with which you cannot scan over a network from the operation panel, you cannot scan using the operation panel even if this setting is enabled.

Settings...



The Scan-from-PC Settings screen appears. You can select the model you want to use.

About

Displays the version information.

In the displayed dialog box, you can change the language to be used in the application. The change will be reflected after restarting the computer.

Exit

Exits IJ Network Scanner Selector EX2;  (Enabled) or  (Disabled) disappears from the notification area on the desktop.

Scan-from-PC Settings Screen

Right-click the icon from the notification area on the desktop, then select **Settings...** to display the Scan-from-PC Settings screen.

Your scanner or printer must be selected with IJ Network Scanner Selector EX2 before scanning over a network.

Scanners

MAC addresses of the scanners or printers that can be used over the network are displayed.

You can select one scanner or printer per model. Selecting a scanner or printer automatically enables scanning from the operation panel.

Instructions

Opens this guide.

Scan-from-Operation-Panel Settings

The Scan-from-Operation-Panel Settings screen appears. You can select up to three scanners and printers in total for scanning from the operation panel. You can scan items using the operation panel of the selected scanner or printer, and send the scanned images to your computer over a network.

Important

- When using a model with which you cannot scan over a network from the operation panel, that model does not appear in **Scanners** and the setting is not available.

Scan-from-Operation-Panel Settings Screen

Click **Scan-from-Operation-Panel Settings** in the Scan-from-PC Settings screen to display the Scan-from-Operation-Panel Settings screen.

Scanners

MAC addresses of the scanners or printers that can be used over the network are displayed.

You can select up to three scanners and printers in total at the same time. Selecting a scanner or printer automatically enables scanning from the operation panel.

Instructions

Opens this guide.

▶▶ Important

- When using a model with which you cannot scan over a network from the operation panel, **Scan-from-Operation-Panel Settings** may appear in the Scan-from-PC Settings screen; however, the setting is not available.

▶▶ Note

- If your scanner or printer does not appear, check the following, click **OK** to close the screen, then reopen it and try selecting again.

- MP Drivers is installed
- Network settings of your scanner or printer is completed after installing the MP Drivers
- Network communication between your scanner or printer and computer is enabled

If your scanner or printer still does not appear, refer to "Problems with Network Communication" for your model from Home of the Online Manual.

- You do not need to use this software when scanning via USB. Refer to "[Uninstalling IJ Network Scanner Selector EX2](#)" to delete it. You can scan via USB even if it is not deleted.

Uninstalling IJ Network Scanner Selector EX2

Follow the procedure below to uninstall IJ Network Scanner Selector EX2 from your computer.

►► Important

- You cannot scan over a network after uninstalling IJ Network Scanner Selector EX2.
- Log into a user account with administrator privilege.

1. Click **Control Panel > Programs > Programs and Features**.
2. Select **Canon IJ Network Scanner Selector EX2**, then click **Uninstall/Change**.

►► Note

- If the **User Account Control** screen appears, click **Continue**.

3. Click **Yes** when the confirmation message appears.
4. When uninstallation is complete, click **OK**.

►► Note

- When the message prompting you to restart your computer appears, click **OK** to restart your computer.

Scanning Tips

- ▶ **Resolution**
- ▶ **Data Formats**
- ▶ **Color Matching**

Resolution

The data in the image you have scanned is a collection of dots carrying information about brightness and color. The density of these dots is called "resolution," and resolution will determine the amount of detail your image contains. The unit of resolution is dots per inch (dpi). Dpi is the number of dots per inch (2.5 cm).

The higher the resolution (value), the more detail in your image; the lower the resolution (value), the less detail.

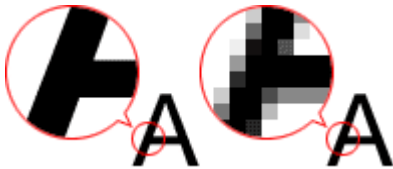

How to Set the Resolution

You can set the resolution in the following screens.

IJ Scan Utility:

Resolution on the  (Scanning from a Computer) tab of the Settings dialog box

ScanGear (Scanner Driver):

Output Resolution in **Output Settings** on the **Advanced Mode** tab

Appropriate Resolution Settings

Set the resolution according to the use of the scanned image.

Item Type	Use	Color Mode	Appropriate Resolution
Color photo	Copying (Printing)	Color	300 dpi
	Creating a postcard	Color	300 dpi
	Saving to a computer	Color	300 dpi
	Using on a website or attaching to e-mail	Color	150 dpi
Black and white photo	Saving to a computer	Grayscale	300 dpi
	Using on a website or attaching to e-mail	Grayscale	150 dpi
Text document (document or magazine)	Copying	Color, Grayscale, or Black and White	300 dpi
	Attaching to e-mail	Color, Grayscale, or Black and White	150 dpi
	Scanning text using OCR	Color or Grayscale	300 dpi

▶▶ Important

- If you double the resolution, the data size of the scanned image quadruples. If the file is too large, the processing speed will slow down significantly, and you will experience inconvenience such as lack of memory. Set the minimum required resolution according to the use of the image.

▶▶ Note

- When you will be printing the scanned image by enlarging it, scan by setting a higher resolution than the recommended one above.

Data Formats

You can select a data format when saving scanned images. You should specify the most suitable data format according to how you want to use the image on which application.

Available data formats vary by application and operating system (Windows or Mac OS).

See below for the characteristics of each image data format.

PNG (Standard File Extension: .png)

A data format often used on websites.

PNG is suitable for editing saved images.

JPEG (Standard File Extension: .jpg)

A data format often used on websites and for digital camera images.

JPEG features high compression rates. JPEG images slightly degrade every time they are saved, and cannot be returned to their original state.

JPEG is not available for black and white images.

TIFF (Standard File Extension: .tif)

A data format featuring a relatively high compatibility between various computers and applications.

TIFF is suitable for editing saved images.

»» Note

- Some TIFF files are incompatible.
- IJ Scan Utility supports the following TIFF file formats.
 - Uncompressed, black and white binary
 - Uncompressed, RGB (8 bits per channel)
 - Uncompressed, Grayscale

PDF (Standard File Extension: .pdf)

A data format for electronic documents, developed by Adobe Systems Incorporated.

It can be used on various computers and operating systems, and fonts can be embedded as well; therefore, people in different environments can exchange the files without being aware of the differences.

Color Matching

"Color Matching" is the act of making adjustments so that the color tones match between the original item, the monitor display, and the color printout. On your scanner or printer, the color tones are adjusted as shown below.

Example: When sRGB is selected as the output profile (target):

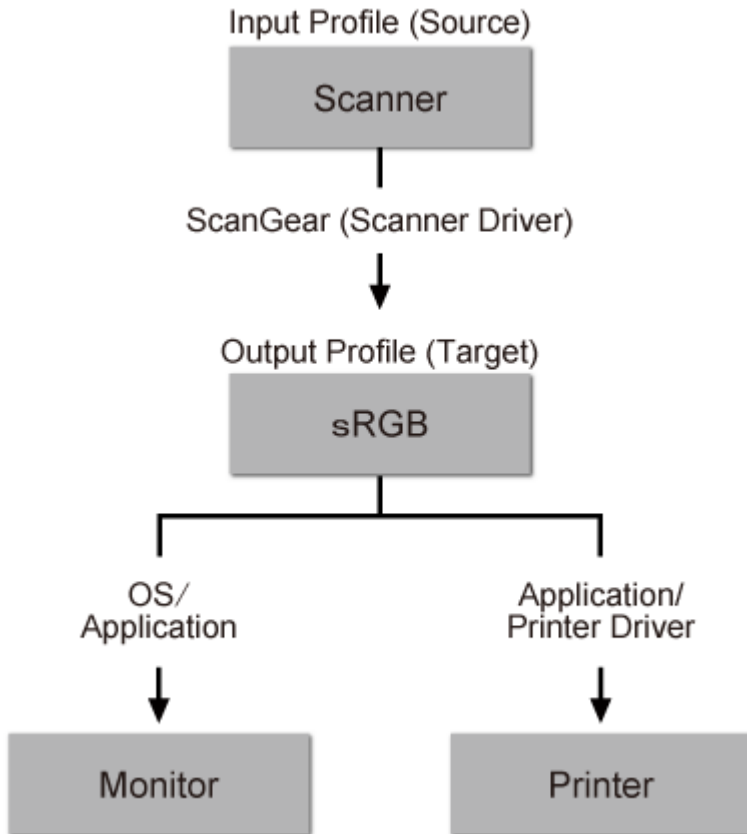

The image's color space is converted from the scanner's color space to sRGB by ScanGear.

When displaying on a monitor, the image's color space is converted from sRGB to the monitor's color space based on the operating system's monitor settings and the application's working space settings.

When printing, the image's color space is converted from sRGB to the printer's color space based on the application's print settings and the printer driver's settings.

Positioning Originals (Scanning from Computer)

Learn how to place items on the platen or ADF (Auto Document Feeder) of your scanner or printer. Place items correctly according to the type of item to be scanned. Otherwise, items may not be scanned correctly.

►► Important

- Do not place objects on the document cover. When you open the document cover, the objects may fall into your scanner or printer, resulting in malfunction.
- Close the document cover when scanning.
- Do not touch the operation panel buttons or LCD (Liquid Crystal Display) monitor when opening/closing the document cover. May result in unintended operation.

■ [Placing Items \(Platen\)](#)

■ [Placing Documents \(ADF \(Auto Document Feeder\)\)](#)

Placing Items (Platen)

Place items as described below to scan by detecting the item type or size automatically.

►► Important

- When scanning by specifying the paper size in IJ Scan Utility or ScanGear (scanner driver), align an upper corner of the item with the corner at the arrow (alignment mark) of the platen.
- Photos that have been cut to various shapes and items smaller than 1.2 inches (3 cm) square cannot be cropped accurately when scanning.
- Reflective disc labels may not be scanned as expected.

For Photos, Postcards, Business Cards, or BD/DVD/CD



Placing a Single Item:

Place the item face-down on the platen, with 0.4 inch (1 cm) or more space between the edges (diagonally striped area) of the platen and the item. Portions placed on the diagonally striped area cannot be scanned.

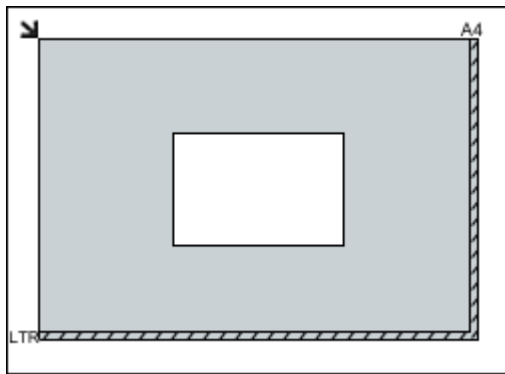

For Magazines, Newspapers, or Documents



Place the item face-down on the platen and align an upper corner of the item with the corner at the arrow (alignment mark) of the platen. Portions placed on the diagonally striped area cannot be scanned.

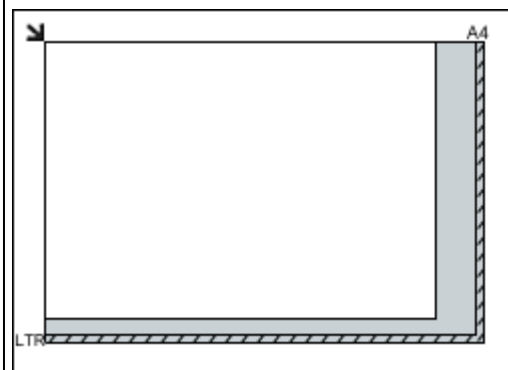

▶▶▶ Important

- Large items (such as A4 size photos) that cannot be placed away from the edges/arrow (alignment mark) of the platen may be saved as PDF files. To save in a format other than PDF, scan by specifying the data format.

Placing Multiple Items:

Allow 0.4 inch (1 cm) or more space between the edges (diagonally striped area) of the platen and items, and between items. Portions placed on the diagonally striped area cannot be scanned.

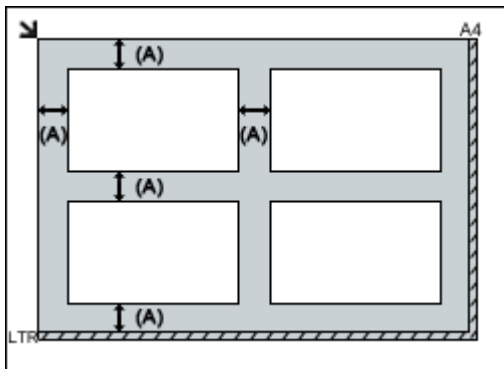

(A) more than 0.4 inch (1 cm)

▶▶▶ Note

- You can place up to 12 items.
- Positions of slanted items (10 degrees or less) are corrected automatically.

▶▶▶ Important

- For the portions in which items cannot be scanned, see [Loading Originals](#).

Placing Documents (ADF (Auto Document Feeder))

▶▶▶ Important

- Do not leave thick items on the platen when scanning from the ADF. May result in paper jam.
- Place and align documents of the same size when scanning two or more documents.
- For supported document sizes when scanning from the ADF, see [Supported Originals](#).

1. Open the document tray.



2. Place the documents on the ADF, then adjust the document guides to the width of the documents.

Insert the documents face-up until a beep sounds.

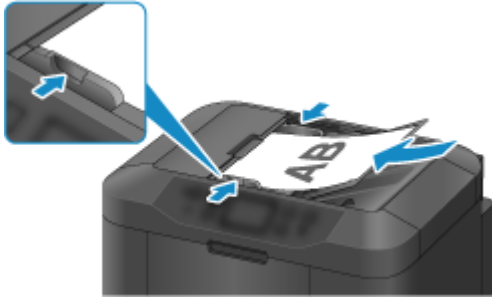

▶▶ Note

- When scanning duplex documents, place the front sides facing up. They will not be scanned correctly if placed the other way around.

Network Scan Settings

You can connect your scanner or printer to a network to share it among multiple computers or scan images into a specified computer.

»» Important

- Multiple users cannot scan at the same time.

»» Note

- Complete the network settings of your scanner or printer beforehand from the Setup CD-ROM or by following the instructions our website.
- With network connection, scanning takes longer than USB connection.

Complete the following settings to enable scanning over a network.

Specifying Your Scanner or Printer

Use IJ Network Scanner Selector EX to specify the scanner you want to use. By specifying the scanner, you can scan over a network from your computer or the operation panel.

»» Important



- If the product you want to use is changed with IJ Network Scanner Selector EX, the product used for scanning with IJ Scan Utility changes as well. The product for scanning from the operation panel also changes.

If your scanner or printer is not selected in IJ Scan Utility, check that it is selected with IJ Network Scanner Selector EX.

Refer to "IJ Network Scanner Selector EX2 Menu and Setting Screen" for your model from Home of the Online Manual for details.

- To scan from the operation panel, specify your scanner or printer with IJ Network Scanner Selector EX beforehand.

1. Check that IJ Network Scanner Selector EX is running.

If IJ Network Scanner Selector EX is running,  (IJ Network Scanner Selector EX2) appears in the notification area on the desktop. Click  to check the hidden icons as well.

»» Note

- If the icon is not displayed in the notification area on the desktop, follow the procedure below to start.

- **Windows 10:**

- From the **Start** menu, click **All apps > Canon Utilities > IJ Network Scanner Selector EX2**.

- **Windows 8.1/Windows 8:**

- Click **IJ Network Scanner Selector EX2** on the Start screen.

If **IJ Network Scanner Selector EX2** is not displayed on the Start screen, select the **Search** charm, then search for "IJ Network Scanner Selector EX".

- **Windows 7/Windows Vista:**

From the **Start** menu, click **All Programs > Canon Utilities > IJ Network Scanner Selector EX2 > IJ Network Scanner Selector EX2**.

The icon appears in the notification area on the desktop, and the Scan-from-PC Settings screen appears. In that case, skip ahead to Step 3.

2. In the notification area on the desktop, right-click  (IJ Network Scanner Selector EX2), then select **Settings....**

The Scan-from-PC Settings screen appears.

3. Select your scanner or printer from **Scanners**.

Normally, the MAC address of your scanner or printer is already selected after the network setup. In that case, you do not need to select it again.

Important

- If multiple scanners exist on the network, multiple model names appear. In that case, you can select one scanner per model.

4. Click **OK**.

Note

- The scanner selected in the Scan-from-PC Settings screen will be automatically selected in the Scan-from-Operation-Panel Settings screen as well.

Setting for Scanning with IJ Scan Utility

To scan from IJ Scan Utility using a scanner or printer connected to a network, specify your scanner or printer with IJ Network Scanner Selector EX, then follow the steps below to change the connection status between it and the computer.

1. [Start IJ Scan Utility](#).
2. Select "Canon XXX series Network" (where "XXX" is the model name) for **Product Name**.
3. Click **Settings...** to use another scanner connected to a network.
4. Click  (General Settings), then click **Select** in **Product Name**.

The Scan-from-PC Settings screen of IJ Network Scanner Selector EX appears.

Select the scanner you want to use and click **OK**.

5. In the **Settings (General Settings)** dialog box, click **OK**.

The IJ Scan Utility main screen reappears. You can scan via a network connection.

Setting for Scanning from the Operation Panel



You can make the setting for scanning from the operation panel.

►► Important

- Set IJ Scan Utility to use your scanner or printer via a network connection beforehand.

■ [Setting for Scanning with IJ Scan Utility](#)

1. Check that IJ Network Scanner Selector EX is running.

If IJ Network Scanner Selector EX is running,  (IJ Network Scanner Selector EX2) appears in the notification area on the desktop. Click  to check the hidden icons as well.

►► Note

- If the icon is not displayed in the notification area on the desktop, follow the procedure below to start.

- **Windows 10:**

From the **Start** menu, click **All apps > Canon Utilities > IJ Network Scanner Selector EX2**.

- **Windows 8.1/Windows 8:**

Click **IJ Network Scanner Selector EX2** on the Start screen.

If **IJ Network Scanner Selector EX2** is not displayed on the Start screen, select the **Search** charm, then search for "IJ Network Scanner Selector EX".

- **Windows 7/Windows Vista:**

From the **Start** menu, click **All Programs > Canon Utilities > IJ Network Scanner Selector EX2 > IJ Network Scanner Selector EX2**.

The icon appears in the notification area on the desktop, and the Scan-from-PC Settings screen appears. In that case, skip ahead to Step 3.

2. In the notification area on the desktop, right-click  (IJ Network Scanner Selector EX2), then select **Settings....**

The Scan-from-PC Settings screen appears.

3. Click **Scan-from-Operation-Panel Settings**.

The Scan-from-Operation-Panel Settings screen appears.

4. Select your scanner or printer from **Scanners** and click **OK**.

Select the MAC address of your scanner or printer.

▶▶▶ Note

- When multiple scanners are connected via a network, you can select up to three scanners.

5. In the Scan-from-PC Settings screen, click **OK**.

▶▶▶ Note

- If your scanner or printer does not appear, check the following, click **OK** to close the screen, then reopen it and try selecting again.
 - MP Drivers is installed
 - Network settings of your scanner or printer is completed after installing the MP Drivers
 - Network communication between your scanner or printer and computer is enabled

If the problem is still not solved, see [Network Communication Problems](#).

Scanning from Computer (Mac OS)

- ▶ **Using IJ Scan Utility**
- ▶ **Using Scanner Driver**
- ▶ **Scanning Tips**
- ▶ **Positioning Originals (Scanning from Computer)**
- ▶ **Network Scan Settings**

Scanning from Operation Panel

- ▶ **Forwarding Scanned Data to Computer Using Operation Panel**  **Basics**
- ▶ **Sending Scanned Data as E-Mail from Computer**
- ▶ **Sending Scanned Data as E-Mail from Machine**
- ▶ **Saving Scanned Data on USB Flash Drive**
- ▶ **Forwarding Scanned Data to Shared Folder on Computer**
- ▶ **Deleting Scanned Data on USB Flash Drive**
- ▶ **Setting Items for Scanning Using Operation Panel**
- ▶ **Setting Up Operation Panel with IJ Scan Utility (Windows)**
- ▶ **Setting Up Operation Panel with IJ Scan Utility (Mac OS)**

Forwarding Scanned Data to Computer Using Operation Panel

Before forwarding scanned data to the computer, check the following:

- **MP Drivers are installed. (Windows)**

If MP Drivers are not yet installed, install MP Drivers with the Setup CD-ROM or install them from the Canon website.

- **The scanner driver is installed. (Mac OS)**

If the scanner driver is not yet installed, install the scanner driver from the Canon website.

- **The printer is connected to a computer correctly.**

Make sure the printer is connected to the computer correctly.

Do not plug in or unplug the USB cable or LAN cable while the printer is in operation, or when the computer is in the sleep or standby mode.

If you perform scanning via a network connection, make sure all the required settings have been specified.

- For Windows:

- [Network Scan Settings](#)

- For Mac OS:

- Network Scan Settings

- **The destination and the file name are specified in Canon IJ Scan Utility.**

You can specify the destination and the file name in Canon IJ Scan Utility. For more on settings of Canon IJ Scan Utility:

- For Windows:

- [Settings Dialog Box](#)

- For Mac OS:

- Settings Dialog

For Mac OS X 10.11, starting Canon IJ Scan Utility is required to forward the scanned data to your computer.

Follow the procedure below to forward scanned data to the computer.

1. [Make sure printer is turned on.](#)

2. Flick HOME screen and tap  **Scan.**

- [Using the Operation Panel](#)

The screen for selecting to which you save the data is displayed.



3. Tap  **PC**.

4. Tap the computer to forward the scanned data.

Tap **Local (USB)** for a USB-connected computer, or tap the computer to forward the scanned data for a network-connected computer.



The Scan standby screen is displayed.

Note

- When you forward the scanned data to the computer using WSD (one of the network protocols supported in Windows 10, Windows 8.1, Windows 8, Windows 7, and Windows Vista), select **Enable** for **WSD scan from this device** on **WSD setting** on **Other settings** in **LAN settings** under **Device settings**.

 [WSD setting](#)

If you tap **Search again**, the printer starts searching for the connected computers again.

5. Specify settings as necessary.

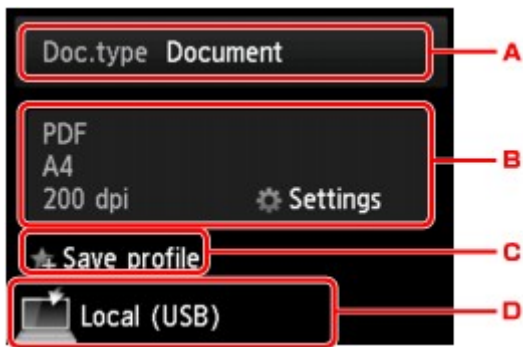

- A. Tap to select the document type.

▶▶▶ Note

- When you forward the scanned data to the computer searched using WSD, you cannot select the document type.

Document

Scans the original on the platen glass or in the ADF as a document data applying the settings specified in **Scan settings**.

Photo

Scans the original on the platen glass as a photo data applying the settings specified in **Scan settings**.

- B. Tap to display **Scan settings** screen.

For more on the setting items:

- [Setting Items for Scanning Using Operation Panel](#)

- C. Tap to register the current scan settings as a custom setting.

- [Registering Favorite Settings \(Custom profiles\)](#)

- D. Tap to display the screen to select the destination.

6. [Load original document on platen glass or in ADF.](#)

7. Press **Color** button for color scanning, or **Black** button for black & white scanning.

▶▶▶ Note

- When you forward the scanned data to the computer using WSD, press the **Color** button.
- If the original is not loaded properly, a message is displayed on the touch screen. Load the original on the platen glass or in the ADF according to the scan settings.

- **If you load the original in the ADF:**

The printer starts scanning and scanned data is forwarded to the computer.

- **If you load the original on the platen glass:**

- When you select **JPEG** or **TIFF** for **Format** on the scan setting screen, the printer starts scanning and scanned data is forwarded to the computer.

- When you select **PDF** or **Compact PDF** for **Format** on the scan setting screen, the confirmation screen asking you if you continue scanning is displayed after scanning is complete.

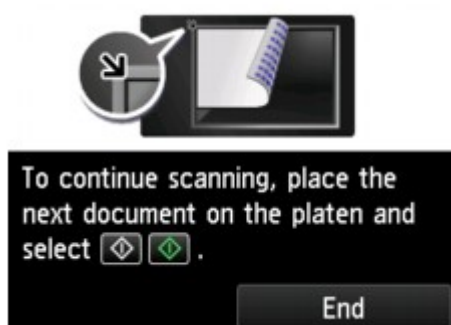

If you continue scanning, load the original on the platen glass and start scanning.

If you do not continue scanning, tap **End**. The scanned data is forwarded to the computer.

Scanned data is forwarded to the computer according to the settings specified in Canon IJ Scan Utility.

Remove the original on the platen glass or from the document output slot after scanning is complete.

If program selection screen appears (Windows):

The program selection screen may be displayed after pressing the **Color** or **Black** button. In this case, select **Canon IJ Scan Utility** and click **OK**.

If you want to scan originals with advanced settings, or if you want to edit or print scanned images:

If you scan originals from a computer, you can edit the scanned images, such as optimizing or trimming.

In addition, you can edit or print the scanned images using the compatible application software to make better use of them.

■ [Using IJ Scan Utility](#)

▶▶▶ Note

- For Windows:
 - You can use a WIA-compliant application software to scan originals with this printer.

For details:

■ [Scanning with WIA Driver](#)

- If you want to convert a scanned document to text:

■ [Extracting Text from Scanned Images \(OCR\)](#)

Sending Scanned Data as E-Mail from Computer

Before attaching scanned data to an e-mail, check the following:

- **MP Drivers are installed. (Windows)**

If MP Drivers are not yet installed, install MP Drivers with the Setup CD-ROM or install them from the Canon website.

- **The scanner driver is installed. (Mac OS)**

If the scanner driver is not yet installed, install the scanner driver from the Canon website.

- **The printer is connected to a computer correctly.**

Make sure the printer is connected to the computer correctly.

Do not plug in or unplug the USB or LAN cable while the printer is in operation, or when the computer is in the sleep or standby mode.

If you perform scanning via a network connection, make sure all the required settings have been specified.

- For Windows:

- [Network Scan Settings](#)

- For Mac OS:

- Network Scan Settings

- **The mail software and the file name are specified in Canon IJ Scan Utility.**

You can specify the destination and the file name in Canon IJ Scan Utility. For more on settings of Canon IJ Scan Utility:

- For Windows:

- [Settings Dialog Box](#)

- For Mac OS:

- Settings Dialog

For Mac OS X 10.11, starting Canon IJ Scan Utility is required to forward the scanned data to your computer.

Follow the procedure below to send the scanned data as an e-mail from the computer.

1. [Make sure printer is turned on.](#)

2. Flick HOME screen and tap  **Scan.**

- [Using the Operation Panel](#)

The screen for selecting to which you save the data is displayed.



3. Tap  **Attach to E-mail.**

4. Tap  **E-mail from PC.**

5. Tap computer to forward scanned data.

Tap **Local (USB)** for a USB-connected computer, or tap the computer to forward the scanned data for a network-connected computer.



The Scan standby screen is displayed.

6. Specify settings as necessary.

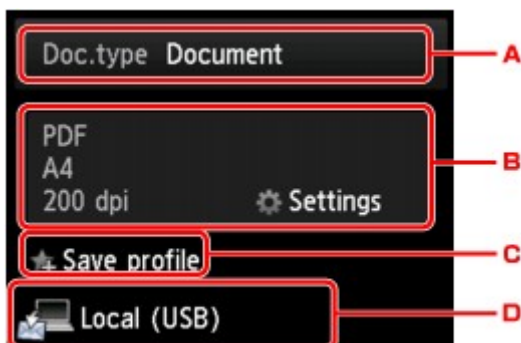

A. Tap to select the document type.

Document

Scans the original on the platen glass or in the ADF as a document data applying the settings specified in **Scan settings**.

Photo

Scans the original on the platen glass as a photo data applying the settings specified in **Scan settings**.

B. Tap to display **Scan settings** screen.

For more on the setting items:

■ [Setting Items for Scanning Using Operation Panel](#)

C. Tap to register the current scan settings as a custom setting.

■ [Registering Favorite Settings \(Custom profiles\)](#)

D. Tap to display the screen to select the destination.

7. [Load original document on platen glass or in ADF.](#)

8. Press **Color** button for color scanning, or **Black** button for black & white scanning.

▶▶▶ Note

- If the original is not loaded properly, a message is displayed on the touch screen. Load the original on the platen glass or in the ADF according to the scan settings.

- **If you load the original in the ADF:**

The printer starts scanning and scanned data is forwarded to the computer and attached to an e-mail.

- **If you load the original on the platen glass:**

- When you select **JPEG** for **Format** on the scan setting screen, the printer starts scanning and scanned data is forwarded to the computer and attached to an e-mail.
- When you select **PDF** or **Compact PDF** for **Format** on the scan setting screen, the confirmation screen asking you if you continue scanning is displayed after scanning is complete.

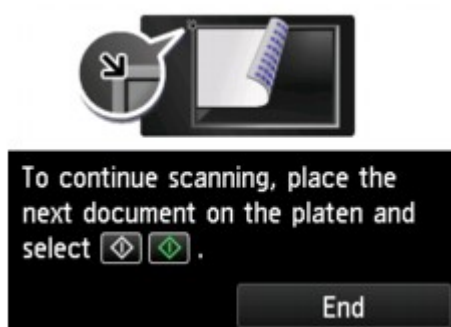

If you continue scanning, load the original on the platen glass and start scanning.

If you do not continue scanning, tap **End**. The scanned data is forwarded to the computer.

Scanned data is forwarded to the computer and attached to an e-mail according to the settings specified in Canon IJ Scan Utility.

For the settings or how to send an e-mail, refer to the mail software's instruction manual.

Remove the original on the platen glass or from the document output slot after scanning is complete.

If program selection screen appears (Windows):

The program selection screen may be displayed after pressing the **Color** or **Black** button. In this case, select **Canon IJ Scan Utility** and click **OK**.

Sending Scanned Data as E-Mail from Machine

- ▶ **Sending Scanned Data as E-Mail from Machine**
- ▶ **Registering Recipients' E-Mail Address**
- ▶ **Registering Recipients in Group E-Mail**
- ▶ **Changing Registered Information**
- ▶ **Deleting Registered Information**
- ▶ **Importing/Exporting E-Mail Address Book**

Sending Scanned Data as E-Mail from Machine

You can send scanned data as an e-mail from the printer.

Before you use this function, check the following.

- **The printer is connected to a LAN.**

Make sure the printer is connected to a LAN correctly.

- **Mail server settings are completed using Remote UI.**

■ [Setting Mail Server](#)

- **Settings for sending scanned data as an e-mail are specified using Remote UI.**

■ [Specifying Mail Setting for Sending Scanned Data](#)

Follow the procedure below to send the scanned data as an e-mail from the printer.

1. [Make sure printer is turned on.](#)

2. Flick HOME screen and tap  **Scan.**

■ [Using the Operation Panel](#)

The screen for selecting to which you save the data is displayed.



3. Tap  **Attach to E-mail.**

4. Tap  **E-mail directly from device.**

5. Tap **Select recipients.**

6. Specify recipient(s).

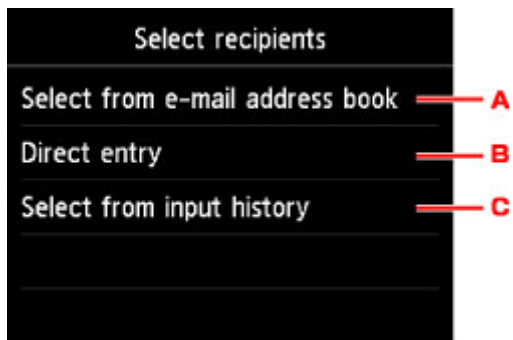

- A. Tap to select the recipient(s) from the address book.
- B. Tap to enter recipient's e-mail address.
- C. Tap to select the recipient(s) from the input history.

7. Perform mail sending settings.

The screen below appears.

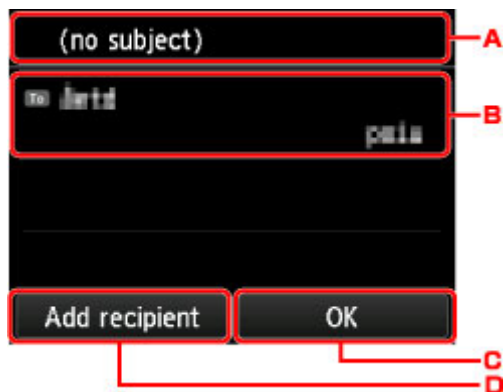

- A. Tap to enter the subject.
- B. Tap to select the items below.

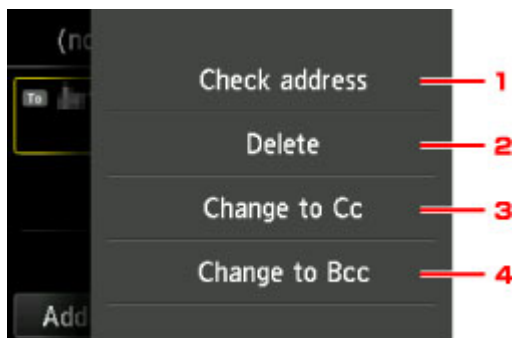

- 1. Tap to check the address. Tapping **Edit** allows you to change the address.
- 2. Tapping here and selecting **Yes** deletes the recipient.
- 3. Tap to change to Cc (carbon copy).
- 4. Tap to change to Bcc (blind carbon copy).

»» Note

- To change Cc or Bcc to To, tap the recipient and tap **Change to To**.

- C. Tap to complete specifying the recipient.
- D. Tap to add the recipient.

8. Specify settings as necessary.

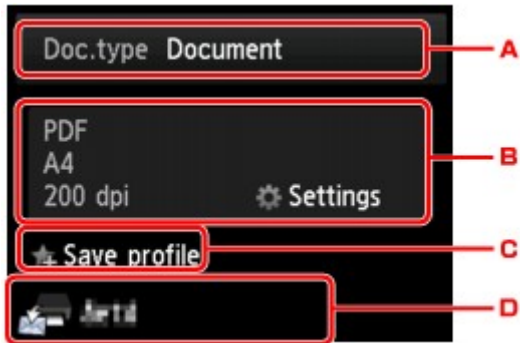

- A. Tap to select the document type.

Document

Scans the original on the platen glass or in the ADF as a document data applying the settings specified in **Scan settings**.

Photo

Scans the original on the platen glass as a photo data applying the settings specified in **Scan settings**.

- B. Tap to display **Scan settings** screen.

For more on the setting items:

- [Setting Items for Scanning Using Operation Panel](#)

- C. Tap to register the current scan settings as a custom setting.

- [Registering Favorite Settings \(Custom profiles\)](#)

- D. Tap to display the screen to select the destination.

9. [Load original document on the platen glass or in ADF.](#)

10. Press **Color** button for color scanning, or **Black** button for black & white scanning.

▶▶▶ Note

- If the original is not loaded properly, a message is displayed on the touch screen. Load the original on the platen glass or in the ADF according to the scan settings.

- If you select **ON** for **Preview** on the scan setting screen:

The preview screen is displayed before sending the scanned original as an e-mail.

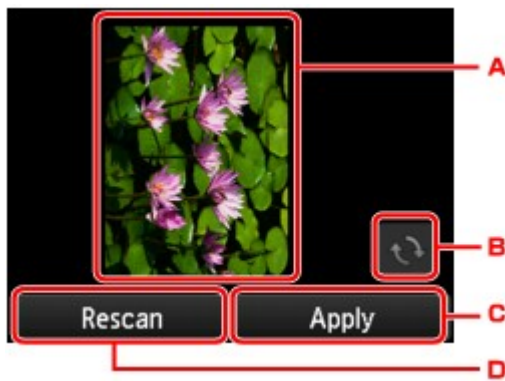

A. The preview screen of the scanning data is displayed.

B. Tap to rotate the preview screen.

Displayed when you select **PDF** or **Compact PDF** for **Format** on the scan setting screen.

C. Tap to send the scanned original as an e-mail.

D. Tap to rescan the original.

- **If you load the original in the ADF:**

The printer starts scanning and scanned data is sent as an e-mail.

- **If you load the original on the platen glass:**

- When you select **JPEG** for **Format** on the scan setting screen, the printer starts scanning and scanned data is sent as an e-mail.
- When you select **PDF** or **Compact PDF** for **Format** on the scan setting screen, the confirmation screen asking you if you continue scanning is displayed after scanning is complete.

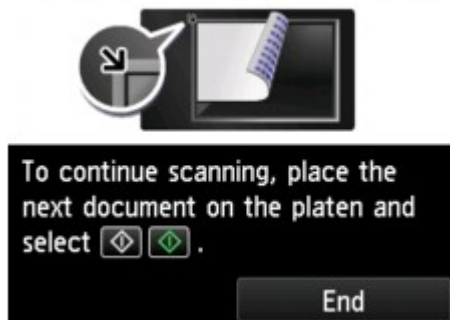

If you continue scanning, load the original on the platen glass and start scanning.

If you do not continue scanning, tap **End**. The scanned data is sent as an e-mail.

Remove the original on the platen glass or from the document output slot after scanning is complete.

Checking Send Log

Tapping **Check send log** on **E-mail directly from device** displays the items below.

- **Display send log**

Displays the send log of the printer (up to 100). Tap the item to check more information.

- **Print send log**

Prints out the send log of the printer. Tap **Yes** to start printing.

Registering Recipients' E-Mail Address

Before you can use the printer's address book, you need to register the recipients' e-mail address. Follow the procedure below to register the recipients' e-mail address.

1. [Make sure printer is turned on.](#)

2. Flick HOME screen and tap  **Scan.**

■ ■ [Using the Operation Panel](#)

The screen for selecting to which you save the data is displayed.



3. Tap  **Attach to E-mail.**

4. Tap  **E-mail directly from device.**

5. Tap **Edit e-mail address book.**

6. Tap **Display e-mail address book.**

The screen to select an ID number is displayed.

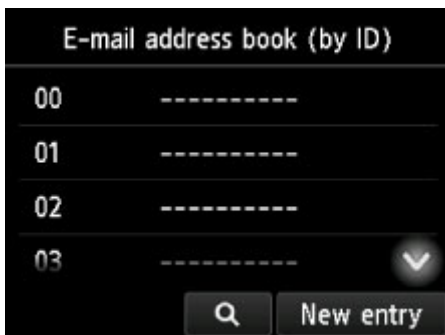

»»» **Note**

- If you already registered the recipients, the recipients' name is displayed next to the ID number. If you already registered the group mail, the  icon and the group name are displayed next to the ID number.

7. Select unregistered ID number.

»»» **Note**

- If you already registered the recipients and they are displayed by name, tap **Switch view**. The registered recipients are displayed by ID number.
- If you tap **New entry**, an unregistered ID number will be selected in numerical order.

8. Tap **Register e-mail address**.

9. Select registration method.

- **Direct entry**

The screen to register the recipient's e-mail address and name is displayed. Go to next step.

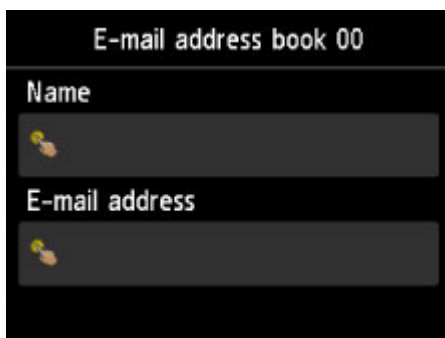

- **Select from send log**

When you select this registration method, the screen to select the e-mail address from the send logs is displayed.

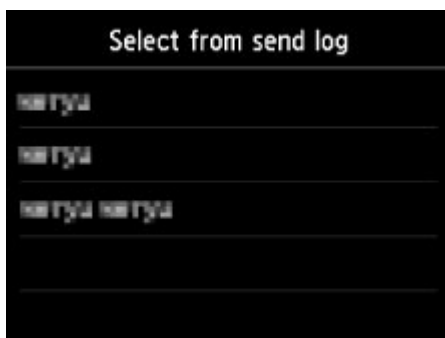

Selecting an e-mail address from the send logs, the screen to register the recipient's e-mail address and name is displayed. Go to next step.

10. Enter recipient's name.

1. Tap entry field of name.

The screen to enter the character is displayed.

2. Enter recipient's name.

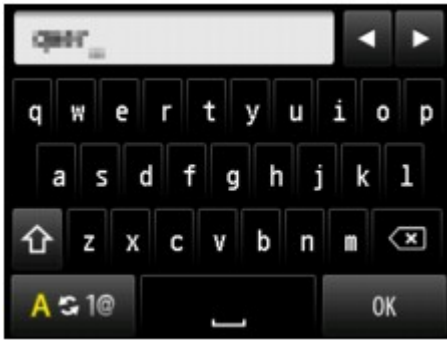

3. Tap **OK**.

▶▶▶ Note

- You can enter the name up to 16 characters, including spaces.

■ [Entering Numbers, Letters, and Symbols](#)

11. Enter recipient's e-mail address.

If you select an e-mail address on **Select from send log**, the e-mail address is already entered. If you do not change the e-mail address, go to next step.

1. Tap entry field of e-mail address.
2. Enter recipient's mail address.

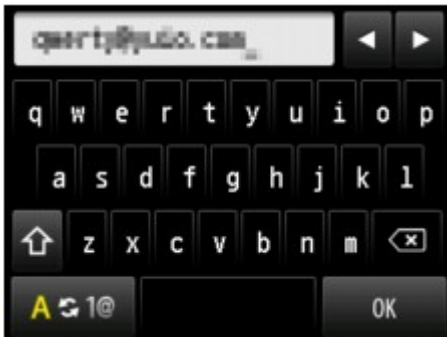

3. Tap **OK**.

▶▶▶ Note

- You can enter the e-mail address up to 60 characters (40 characters for the US, Canada, Korea and some regions of Latin America), including spaces.

■ [Entering Numbers, Letters, and Symbols](#)

12. Tap **Register** to finalize registration.

▶▶▶ Note

- To register another recipient's number and name, select an unregistered ID number and operate in the same procedure.

Registering Recipients in Group E-Mail

If you register two or more registered e-mail address to a group e-mail, you can send the same mail successively to all recipients registered to the group e-mail.

1. [Make sure printer is turned on.](#)

2. Flick HOME screen and tap  **Scan.**

■ ■ [Using the Operation Panel](#)

The screen for selecting to which you save the data is displayed.



3. Tap  **Attach to E-mail.**

4. Tap  **E-mail directly from device.**

5. Tap **Edit e-mail address book.**

6. Tap **Display e-mail address book.**

The screen to select an ID number is displayed.



»» Note

- If you already registered the recipients, the recipients' name is displayed next to the ID number. If you already registered the group mail, the  icon and the group name are displayed next to the ID number.

7. Select unregistered ID number.

»» Note

- If you already registered the recipients and they are displayed by name, tap **Switch view**. The registered recipients are displayed by ID number.
- If you tap **New entry**, an unregistered ID number will be selected in numerical order.

8. Tap **Register group e-mail**.

The screen to register the group name and the member of the group is displayed.

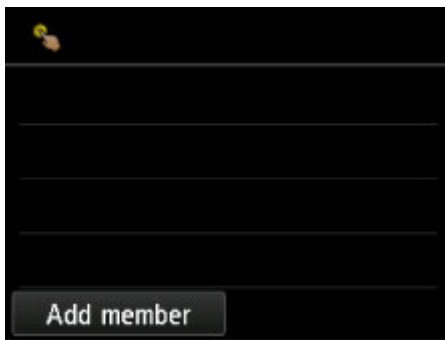

9. Enter group name.

1. Tap entry field of group name.

The screen to enter the character is displayed.

2. Enter group name.



3. Tap **OK**.

»» Note

- You can enter the name up to 16 characters, including spaces.

 [Entering Numbers, Letters, and Symbols](#)

10. Register the registered recipient as a member of the group e-mail.

1. Tap **Add member**.

The address book is displayed.

Display by name

Display by ID number

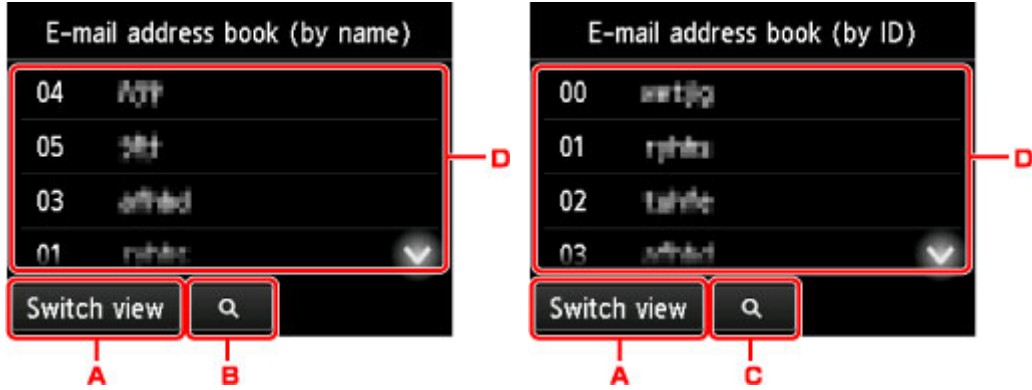

- A. Tap to switch the display by name and by ID number.
- B. Tap to display the screen to select an initial. You can search the registered recipient by initial.



By selecting the initial, the registered recipients are displayed in alphabetical order from the selected character.

- C. Tap to display the screen to select an ID number of the registered recipient. You can search the registered recipient by ID number.



By entering the ID number and tapping **OK**, the registered recipients are displayed in order from the recipient of the ID number selected.

- D. The recipients that can be registered are displayed.
2. Tap recipient to register as group member.

The member to register is displayed on the list.



»» Note

- To delete the recipient from the group e-mail, tap a recipient that you want to delete from the list. After the confirmation screen is displayed, tap **Yes** to delete the recipient from the group e-mail.

3. To add another member, tap **Add member** again.

The address book is displayed.

4. Tap recipient to register as group member.

The member to register is displayed on the list.



Repeat the procedure to register another member to the same group e-mail.

11. Tap **Complete** to finalize registration.

»» Note

- To register another group, select an unregistered ID number and operate in the same procedure.

Changing Registered Information

To change information registered for recipient and group e-mail, follow the procedure below.

1. [Make sure printer is turned on.](#)

2. Flick HOME screen and tap  **Scan**.

 [Using the Operation Panel](#)

The screen for selecting to which you save the data is displayed.



3. Tap  **Attach to E-mail**.

4. Tap  **E-mail directly from device**.

5. Tap **Edit e-mail address book**.

6. Tap **Display e-mail address book**.

7. Tap recipient or group e-mail to change.

8. Change registered information.

- To change an individual recipient:

1. Tap **Edit e-mail address**.

The registered information screen of the selected recipient is displayed.

2. Tap entry field of name or entry field of e-mail addresses.

The each edit screen is displayed.

3. Change name or e-mail addresses.

4. Tap **OK**.

The touch screen returns to the registered information screen.

5. Tap **Register**.
- To change a group e-mail:
 1. Tap **Edit group e-mail**.

The registered information screen of the group e-mail is displayed.
 2. To change group name, tap entry field of name.

When edit screen of group name is displayed, change the group name then tap **OK**.
 3. To add member, tap **Add member**.

When the printer's directory is displayed, tap the recipient you want to add.
 4. To delete member, tap recipient on list.

When the confirmation screen is displayed, tap **Yes** to delete the recipient from the group e-mail.
 5. Tap **Complete** to finalize changing.

Deleting Registered Information

To delete information registered for recipient and group e-mail, follow the procedure below.

1. [Make sure printer is turned on.](#)

2. Flick HOME screen and tap  **Scan**.

■ [Using the Operation Panel](#)

The screen for selecting to which you save the data is displayed.



3. Tap  **Attach to E-mail**.

4. Tap  **E-mail directly from device**.

5. Tap **Edit e-mail address book**.

6. Tap **Display e-mail address book**.

7. Tap recipient or group e-mail to delete.

8. Tap **Delete e-mail address** or **Delete group e-mail**.

9. When confirmation screen is displayed, tap **Yes** to delete.

Importing/Exporting E-Mail Address Book

You can import an e-mail address book saved on a USB flash drive, or export the e-mail address book saved on the printer to a USB flash drive.

■ [Importing E-Mail Address Book](#)

■ [Exporting E-Mail Address Book](#)

Importing E-Mail Address Book

Follow the procedure below to import the e-mail address book.

1. [Make sure printer is turned on.](#)

2. Flick HOME screen and tap  **Scan**.

■ [Using the Operation Panel](#)

The screen for selecting to which you save the data is displayed.



3. [Insert USB flash drive into USB flash drive port.](#)

4. Tap  **Attach to E-mail**.

5. Tap  **E-mail directly from device**.

6. Tap **Edit e-mail address book**.

7. Tap **Import e-mail address book**.

8. Check message that is displayed and tap **Yes**.

The address book saved on the USB flash drive is imported and the address book on the printer is overwritten. (The address book name is "EMAIL_ADDRESS.BIN").

Exporting E-Mail Address Book

Follow the procedure below to export the e-mail address book.

1. [Make sure printer is turned on.](#)

2. Flick HOME screen and tap  **Scan**.

■ ■ [Using the Operation Panel](#)

The screen for selecting to which you save the data is displayed.



3. [Insert USB flash drive into USB flash drive port.](#)

▶▶▶ **Note**

- To avoid overwriting the e-mail address book, you cannot save the book on a USB flash drive which already includes it.
Delete the book from the USB flash drive or use the one which includes no book.
- The folder name which includes the e-mail address book is "CANON_SC_ \EMAIL_ADDRESS.BIN".

4. Tap  **Attach to E-mail**.

5. Tap  **E-mail directly from device**.

6. Tap **Edit e-mail address book**.

7. Tap **Export e-mail address book**.

8. Check message that is displayed and tap **Yes**.

The address book on the printer is saved on the USB flash drive.

Saving Scanned Data on USB Flash Drive

You can save scanned data on the USB flash drive directly.

▶▶ Important

- Do not remove the USB flash drive from the printer under the following conditions:
 - While scanning is in progress
 - Before saving the scanned data
- For safety reasons, we recommend backing up the scanned data saved on a USB flash drive to another media periodically to avoid unexpected accidents.
- We assume no responsibility for damage to or loss of data for whatever reason even within the warranty period.

1. [Make sure printer is turned on.](#)

2. Flick HOME screen and tap  **Scan.**

■ [Using the Operation Panel](#)

The screen for selecting to which you save the data is displayed.



3. [Insert USB flash drive into USB flash drive port.](#)

4. Tap  **USB flash drive.**

▶▶ Note

- When the message informing you that the operation restriction is enabled, ask the administrator of the printer you are using.

5. Tap  **Save to USB flash drive.**

The Scan standby screen is displayed.

6. Adjust settings as necessary.

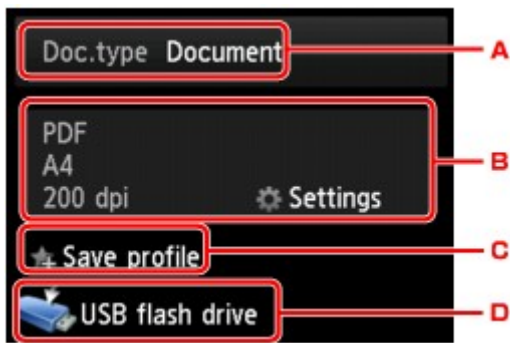

A. Tap to select the document type.

Document

Scans the original on the platen glass or the ADF as a document data applying the settings specified in **Scan settings**.

Photo

Scans the original on the platen glass as a photo data applying the settings specified in **Scan settings**.

B. Tap to display **Scan settings** screen.

For more on the setting items:

- [Setting Items for Scanning Using Operation Panel](#)

C. Tap to register the current scan settings as a custom setting.

- [Registering Favorite Settings \(Custom profiles\)](#)

D. Tap to display the screen to select the destination.

7. [Load original document on platen glass or in ADF.](#)

8. Press **Color** button for color scanning, or **Black** button for black & white scanning.

»» **Note**

- If the original is not loaded properly, a message is displayed on the touch screen. Load the original on the platen glass or in the ADF according to the scan settings.

- If you select **ON** for **Preview** on the scan setting screen:

The preview screen is displayed before saving the scanned original on the USB flash drive.

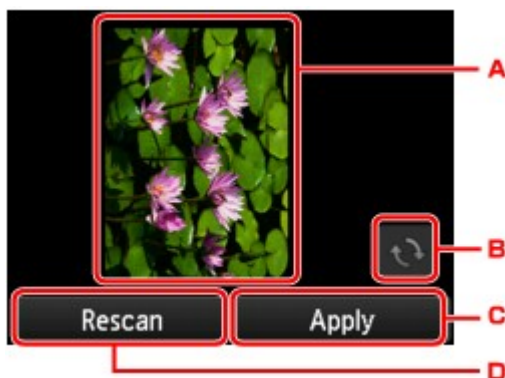

- A. The preview screen of the scanning data is displayed.
- B. Tap to rotate the preview screen.
Displayed when you select **PDF** or **Compact PDF** for **Format** on the scan setting screen.
- C. Tap to save the scanned original on the USB flash drive.
- D. Tap to rescan the original.

- **If you load the original in the ADF:**

The printer starts scanning and scanned data is saved on the USB flash drive.

- **If you load the original on the platen glass:**

- When you select **JPEG** for **Format** on the scan settings screen, the printer starts scanning and scanned data is saved on the USB flash drive.
- When you select **PDF** or **Compact PDF** for **Format** on the scan settings screen, the confirmation screen asking you if you continue scanning is displayed after scanning is complete.

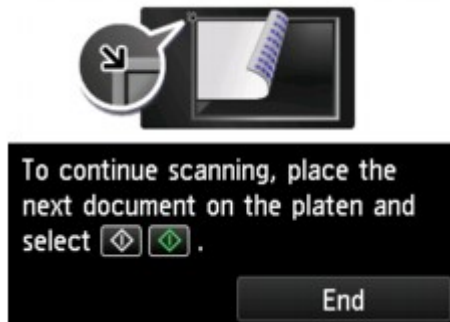

If you continue scanning, load the original on the platen glass and start scanning.

If you do not continue scanning, tap **End**. The scanned data is saved on the USB flash drive in one PDF file.

When you scan the originals continuously, you can save up to 100 pages of images in one PDF file.

Remove the original on the platen glass or from the document output slot after scanning is complete.

▶▶▶ Note

- If the USB flash drive becomes full while scanning images is in progress, only the images already scanned can be saved.
- You can save up to 2000 files of scanned data in both PDF and JPEG data format.
- The folder and file name of scanned data saved on the USB flash drive is as follows:
 - Folder name: (file extension: PDF): CANON_SC\DOCUMENT\0001
 - Folder name: (file extension: JPG): CANON_SC\IMAGE\0001
 - File name: Running numbers, starting from SCN_0001
 - File date: The date and time of saving as set in the printer.

For details on how to set the date and time:

■ [Setting Sender Information](#)

- Importing the Scanned Data Saved on USB Flash Drive to the Computer

You can import the scanned data saved on a USB flash drive to the computer. After scanning the data, connect the USB flash drive to the computer and import the data.

Forwarding Scanned Data to Shared Folder on Computer

Before forwarding scanned data on the shared folder on the computer, confirm the following:

- **MP Drivers and Canon Quick Utility Toolbox are installed. (Windows)**

If MP Drivers and Canon Quick Utility Toolbox are not yet installed, install them with the Setup CD-ROM or install them from our website.

- **The scanner driver and Canon Quick Utility Toolbox are installed. (Mac OS)**

If the scanner driver and Canon Quick Utility Toolbox are not yet installed, install them from our website.

- **The printer is connected to a computer via a LAN correctly.**

- **The destination folder is registered using Canon Quick Utility Toolbox in advance.**

You can register the destination folder using Canon Quick Utility Toolbox. For more on settings of Canon Quick Utility Toolbox:

- For Windows:

- Destination Folder Settings

- For Mac OS:

- Destination Folder Settings

Follow the procedure below to forward scanned data to the shared folder on the computer.

1. [Make sure the printer is turned on.](#)

2. Flick the HOME screen and tap  **Scan.**

- [Using the Operation Panel](#)

The screen for selecting to which you save the data is displayed.



3. Tap  **Destination folder.**

▶▶▶ Note

- When the message informing you that the operation restriction is enabled, ask the administrator of the printer you are using.

4. Tap the folder to save scanned data on the **Select folder** screen.

▶▶▶ **Note**

- When you specify a PIN code for a registered folder, a screen asking you to enter a PIN code is displayed. Entering the PIN code allows you to assign the shared folder as the destination.

5. Specify settings as necessary.

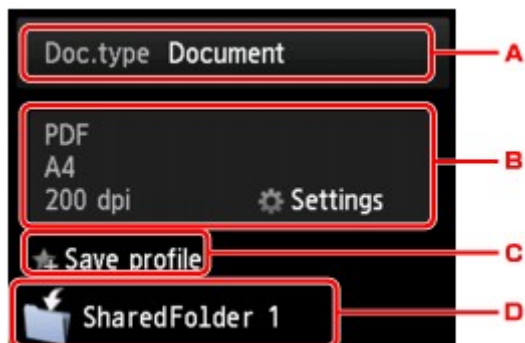

- A. Tap to select the document type.

Document

Scans the original on the platen glass or in the ADF as a document data applying the settings specified in **Scan settings**.

Photo

Scans the original on the platen glass as a photo data applying the settings specified in **Scan settings**.

- B. Tap to display **Scan settings** screen.

For details on the setting items:

- [Setting Items for Scanning Using Operation Panel](#)

- C. Tap to register the current scan settings as a custom setting.

- [Registering Favorite Settings \(Custom profiles\)](#)

- D. Tap to display the screen to select the destination.

6. [Load original document on platen glass or in ADF.](#)

7. Press **Color** button for color scanning, or **Black** button for black & white scanning.

▶▶▶ **Note**

- If the original is not loaded properly, a message is displayed on the touch screen. Load the original on the platen glass or in the ADF according to the scan settings.

- If you select **ON** for **Preview** on the scan setting screen:

The preview screen is displayed before forwarding the scanned original to the shared folder on the computer.

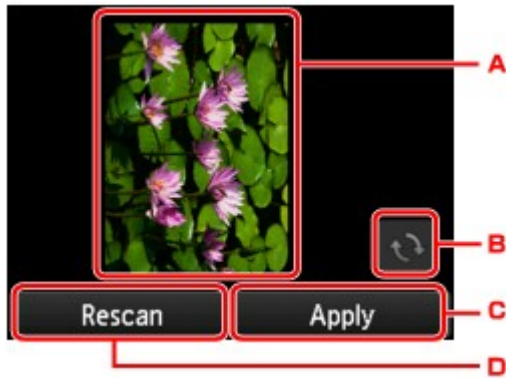

A. The preview screen of the scanning data is displayed.

B. Tap to rotate the preview screen.

Displayed when you select **PDF** or **Compact PDF** for **Format** on the scan setting screen.

C. Tap to forward the scanned original to the shared folder on the computer.

D. Tap to rescan the original.

◦ **If you load the original in the ADF:**

The printer starts scanning and scanned data is forwarded to the shared folder of the computer.

◦ **If you load the original on the platen glass:**

- When you select **JPEG** for **Format** on the scan setting screen, the printer starts scanning and scanned data is saved on the shared folder of the computer.
- When you select **PDF** or **Compact PDF** for **Format** on the scan setting screen, the confirmation screen asking you if you continue scanning is displayed after scanning is complete.

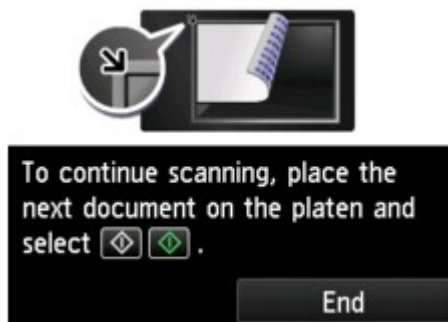

If you continue scanning, load the original on the platen glass and start scanning.

If you do not continue scanning, tap **End**. The scanned data is forwarded to the shared folder on the computer in one PDF file.

Scanned data is forwarded to the shared folder on the computer according to the settings specified in Canon Quick Utility Toolbox.

Remove the original on the platen glass or from the document output slot after scanning is complete.

Deleting Scanned Data on USB Flash Drive

You can delete scanned data on the USB flash drive using the operation panel.

1. [Make sure printer is turned on.](#)

2. Flick HOME screen and tap  **Scan.**

 [Using the Operation Panel](#)

The screen for selecting to which you save the data is displayed.

3. [Insert USB flash drive into USB flash drive port.](#)

4. Tap  **USB flash drive.**

▶▶ Note

- When the message informing you that the operation restriction is enabled, ask the administrator of the printer you are using.

5. Tap  **Delete saved data.**

The file list is displayed.

6. Select data to delete.

File name list

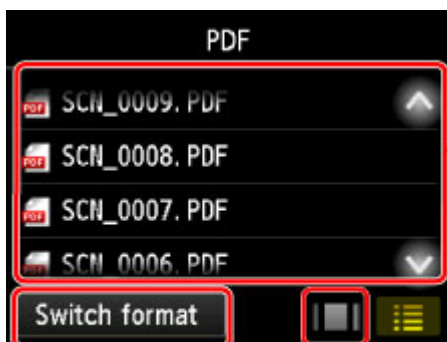

Preview screen

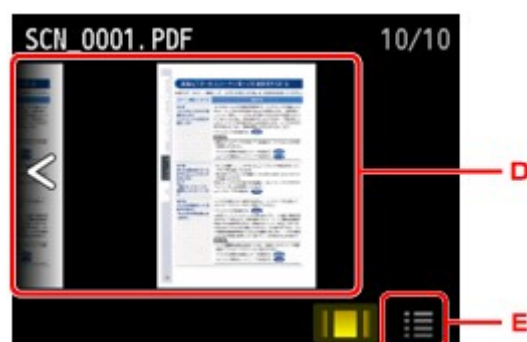

- A. Flick vertically or tap   to display the file name and tap to delete the data.

When the format for PDF data is selected, only the first page of the PDF data is displayed on the touch screen.

- B. Tap to display the preview screen.

When the format for PDF data is selected, only the first page of the PDF data is displayed on the touch screen.

- C. Tap to switch the file type displayed on the touch screen.
- D. Flick to display the data and tap to delete the data.
- E. Tap to display the file name list.

7. Tap **Yes** on confirmation screen.

The printer starts deleting the file.

Setting Items for Scanning Using Operation Panel

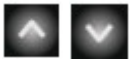

You can change the scan settings such as the scan size, resolution, or data format.

When the Scan standby screen is displayed, tap **Settings** to select the setting item. Flick vertically or tap



to display setting items and tap the setting item to display the settings. Tap to specify the setting.

▶▶▶ Note

- When you forward the scanned data to the computer using WSD (one of the network protocols supported in Windows 10, Windows 8.1, Windows 8, Windows 7, and Windows Vista), you cannot specify the scan setting.
- Depending on the destination, some setting items cannot be selected. This section describes the setting items when you select **USB flash drive** on the screen for selecting to which you save the data. The setting item which cannot be selected is displayed grayed out.
- Some settings cannot be specified in combination with the setting of other setting item, the document type selected for **Doc.type**, or the scan menu on the screen for selecting to which you save the data. If the setting which cannot be specified in combination is selected,  and **Error details** are displayed on the touch screen. In this case, tap  on the upper left on the touch screen to check the message and change the setting.
- The specified scan settings other than **ADF orientation** and **ADF duplex scan** such as the scan size, resolution, and data format are retained even if the printer is turned off.
- When scanning starts in the scan menu that is not available with the specified setting, **The specified function is not available with current settings.** is displayed on the touch screen. Change the setting, following the on-screen instructions.
- For setting items or procedure for scanning from the computer:
 - For Windows:
 - [Settings Dialog Box](#)
 - [Using IJ Scan Utility](#)
 - For Mac OS:
 - Settings Dialog
 - Using IJ Scan Utility

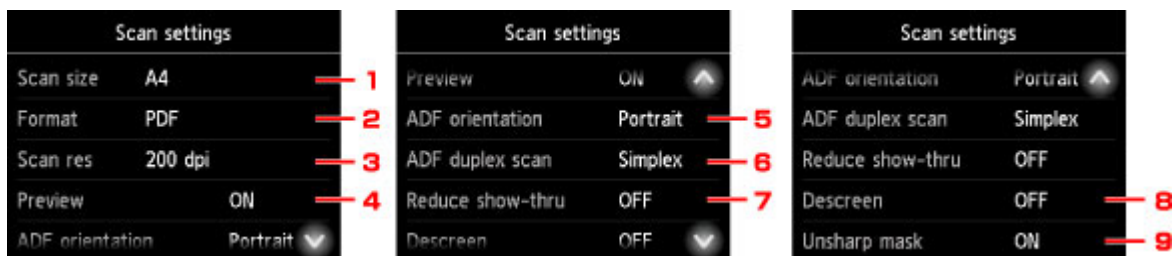

1. Scan size

Select the size of the original.

2. Format

Select the data format of the scanned data.

3. **Scan res** (Scan resolution)

Select the resolution for scanning.

4. **Preview**

Select to preview the scanned data or not when saving the data on a USB flash drive or forwarding to a shared folder.

5. **ADF orientation**

Select the orientation of the original document.

This setting item is not available when **Photo** is selected for **Doc.type**.

6. **ADF duplex scan**

Select the scanning method when using ADF. When you select **Duplex**, tap **Advanced** to select the stapling side.

This setting item is not available when **Photo** is selected for **Doc.type**.

7. **Reduce show-thru** (Reducing show-through)

Characters on the back may show through when scanning a thin document such as a newspaper. Select **ON** if characters seem to show through on the scanned document.

This setting item is not available when **Photo** is selected for **Doc.type**.

8. **Descreen**

A printout consists of minute dots to make characters or graphs. Interfering with each dot may result in uneven shades or a striped pattern. Select **ON** if you notice any uneven shades or a striped pattern on the scanned image.

This setting item is not available when **Photo** is selected for **Doc.type**.

Note

- Even if **ON** is selected for this setting, some moire effects may remain if **Unsharp mask** is set to **ON**. In that case, select **OFF** for **Unsharp mask**.

9. **Unsharp mask**

The outline of small characters or thin objects such as a hair or leaves on a photo can be accentuated. Select **ON** if you want to accentuate the outline of the scanned data.

Setting Up Operation Panel with IJ Scan Utility (Windows)

IJ Scan Utility allows you to specify how to respond when scanning from the operation panel.

▶▶▶ Note

- The screens for scanning photos from the operation panel are used as examples in the following descriptions.

1. [Start IJ Scan Utility.](#)
2. Click **Settings...**

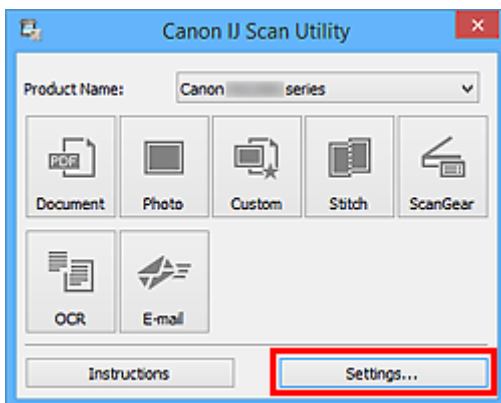

The Settings dialog box appears.

3. Select a scan mode on the  (Scanning from the Operation Panel) tab.

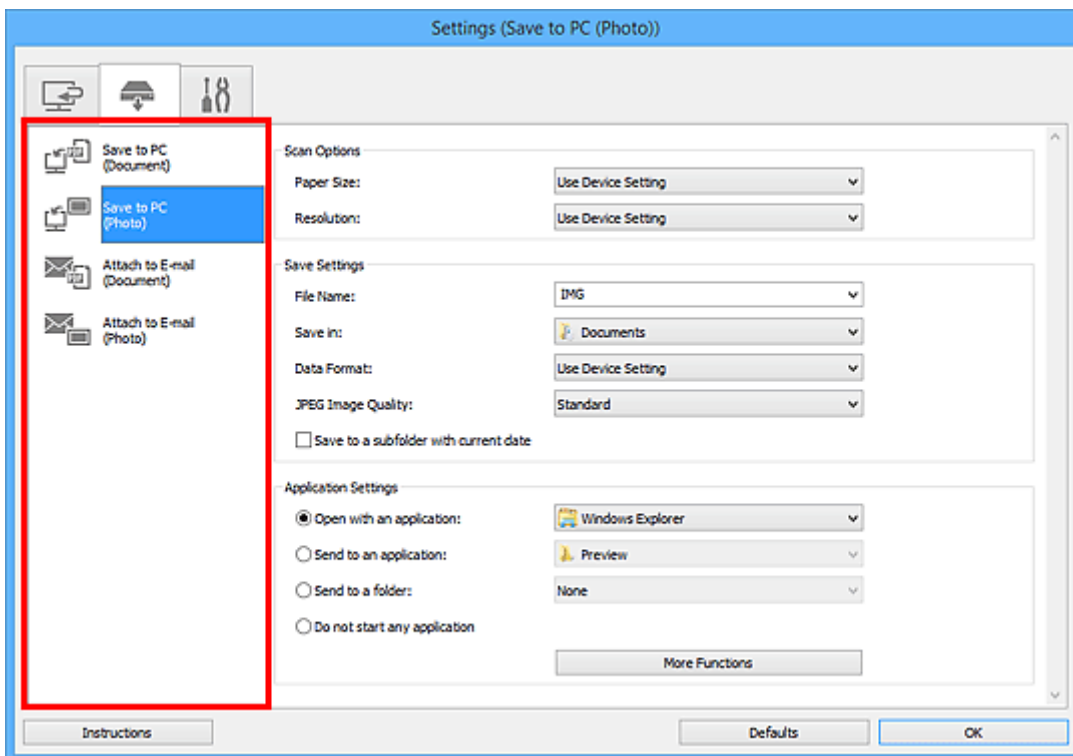

»»» Note

- Refer to the following for details.
 - [Settings \(Save to PC \(Document\)\) Dialog Box](#)
 - [Settings \(Save to PC \(Photo\)\) Dialog Box](#)
 - [Settings \(Attach to E-mail \(Document\)\) Dialog Box](#)
 - [Settings \(Attach to E-mail \(Photo\)\) Dialog Box](#)

4. Set **Scan Options**.

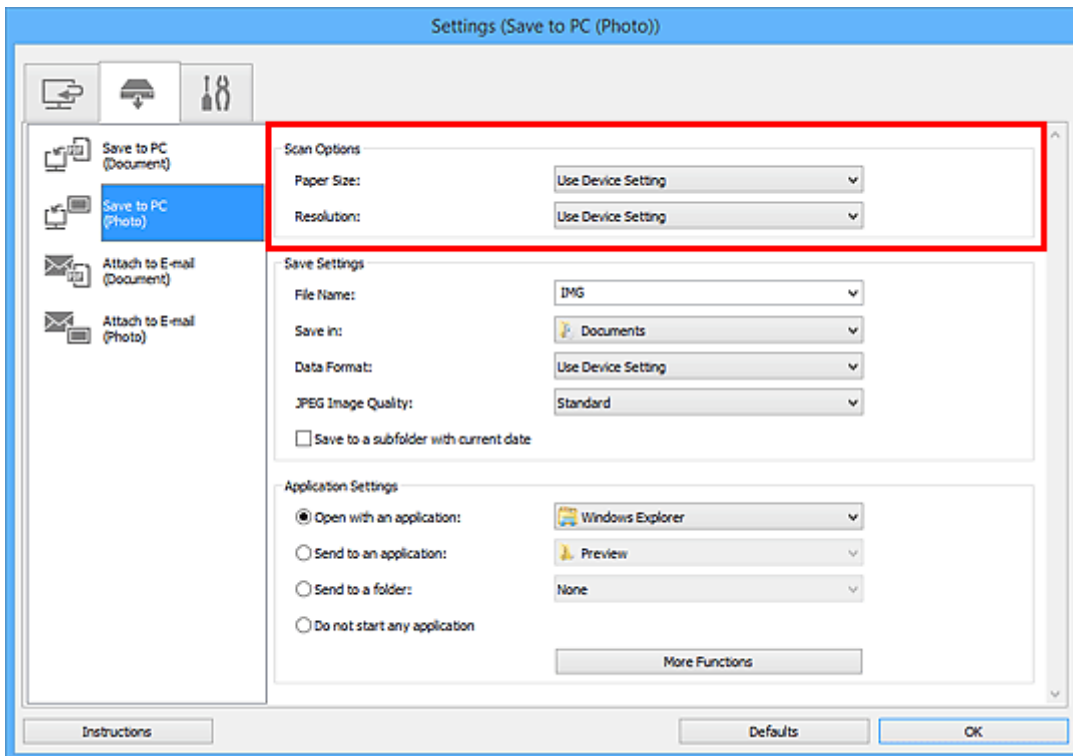

5. Specify the file name and other settings in **Save Settings**.

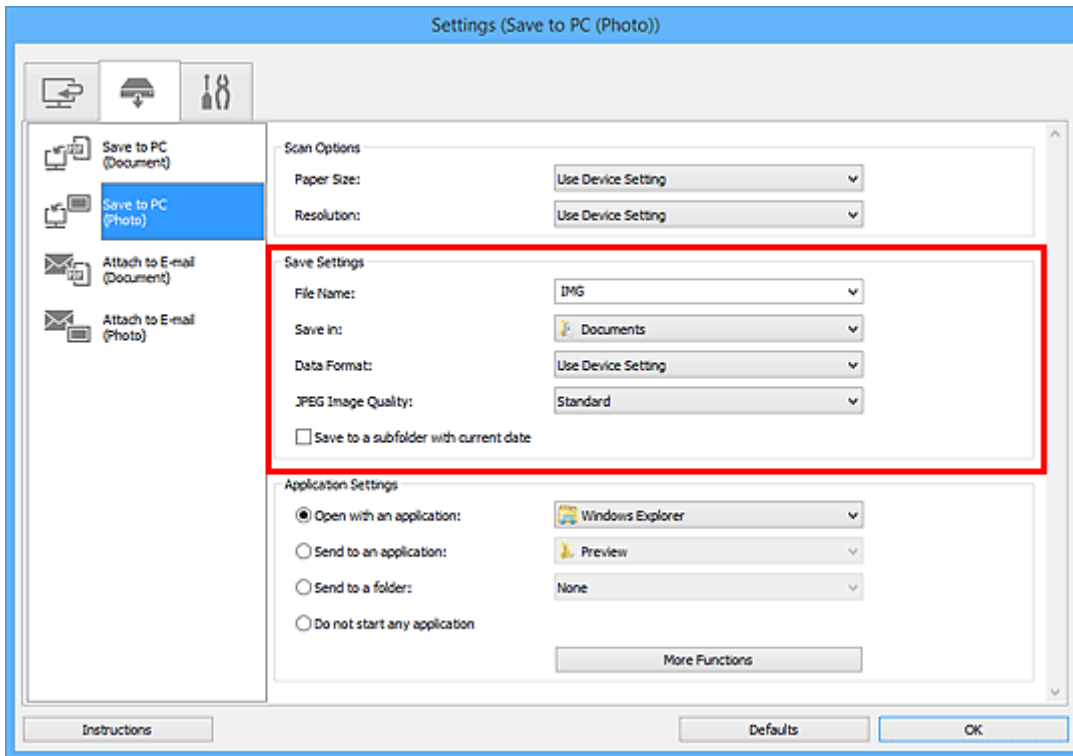

6. Select the application you want to start after scanning in **Application Settings**.

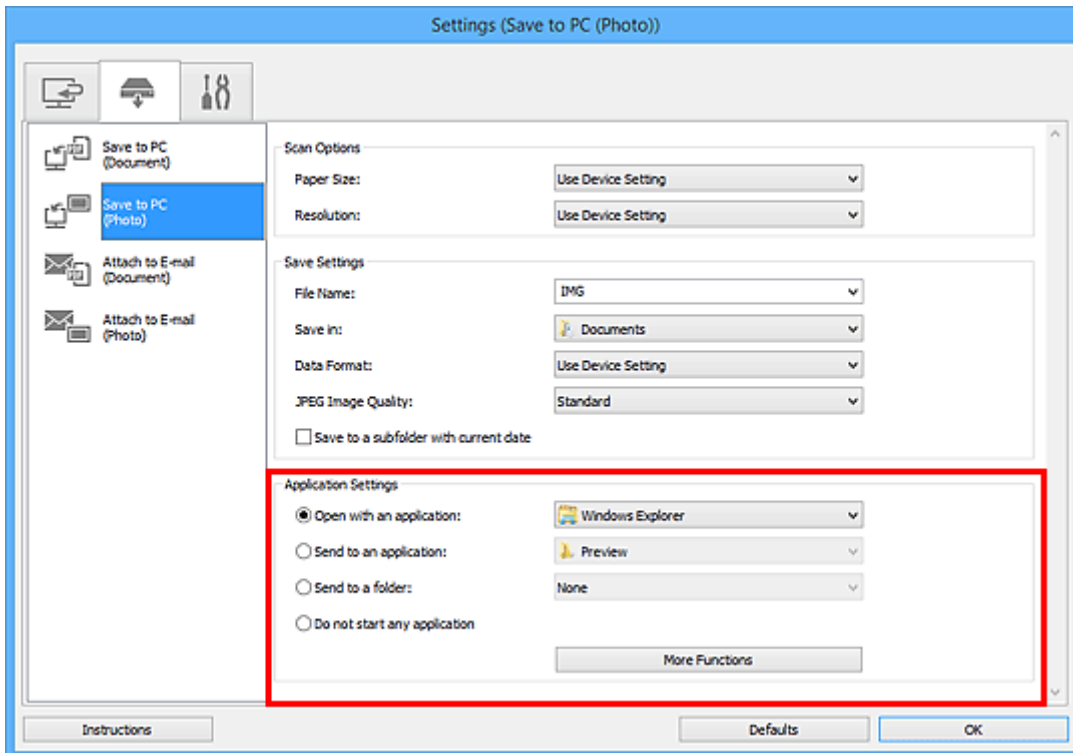

7. Click **OK**.

The responses will be executed according to the specified settings when you start scanning from the operation panel.

Scanning Using Smartphone/Tablet

This machine supports the following scan functions.

PIXMA/MAXIFY Cloud Link

PIXMA/MAXIFY Cloud Link is a web service provided by Canon. Save scanned images to data storage services through integration with various cloud services without using a computer.

- [Using PIXMA/MAXIFY Cloud Link](#)

Using PIXMA/MAXIFY Cloud Link

By using PIXMA/MAXIFY Cloud Link, you can connect your printer to a cloud service, such as CANON IMAGE GATEWAY, Evernote, or Twitter, and use the following functions without using a computer:

- Print images from a photo-sharing service
- Print documents from a data management service
- Save scanned images to a data management service.
- Use Twitter to report the printer status, such as no paper or low ink levels.

In addition, you can use various functions by adding and registering apps that are linked with various cloud services.

■ [Using PIXMA/MAXIFY Cloud Link from Your Printer](#)

■ [Using PIXMA/MAXIFY Cloud Link from Your Smartphone, Tablet, or Computer](#)



▶▶▶ Important

- In certain countries, PIXMA/MAXIFY Cloud Link may not be available or the available apps may be different.
- Some apps require that you have an account before you use those apps. For such apps, please set up an account beforehand.
- To find out which models support PIXMA/MAXIFY Cloud Link check the Canon homepage.
- The screen display may change without prior notice.

Faxing

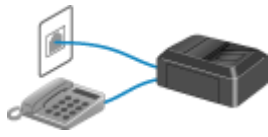

Preparing for Faxing



Sending Faxes Using Operation Panel of Printer



Registering Recipients



Receiving Faxes



Other Useful Fax Functions



Sending Faxes from Computer (Windows)



Sending Faxes from Computer (Mac OS)

Preparing for Faxing

Connect the printer to the telephone line and set up the printer before using the faxing functions. Then specify the basic setting such as sender information, date/time, and daylight saving time.

▶▶▶ Important

- If the Power Disconnects:

If there is a power failure or if you accidentally unplug the power cord, the date/time settings will be reset.

- The settings for user information and directory will be retained.
- All faxes stored in the printer's memory, such as unsent and received faxes, will be lost.

If the power disconnects, the following will apply:

- You will not be able to send or receive faxes, make copies, or scan originals.
- When you are connecting the telephone, whether or not you can use it depends upon your telephone line or telephone.

Setting Up Printer

The printer must be set up depending on your telephone line and use of the faxing function. Follow the procedure below to set up the printer.

1. [Connecting Telephone Line](#)
2. [Setting Telephone Line Type](#)
3. [Setting Receive Mode](#)

▶▶▶ Note

- You can set the fax setting according to the instruction on the touch screen.

■ [Easy setup](#)

If you set up according to the instruction on the touch screen, the receive mode is set to **TEL priority mode** or **FAX only mode**. To receive faxes with **DRPD** or **Network switch**, change the receive mode.

■ [Setting Receive Mode](#)

Specifying Basic Settings for Faxing

- [Setting Sender Information](#)

Connecting Telephone Line

The connection method differs depending on your telephone line.

- If you connect the printer to wall telephone line directly/If you connect the printer with the xDSL splitter:

- [Basic Connection](#)

- If you connect the printer to another line such as an xDSL:

- [Connecting Various Lines](#)

If the connection is incorrect, the printer cannot send/receive faxes. Connect the printer correctly.

▶▶▶ Important

- Do not connect fax devices and/or telephones in parallel (US and Canada only).

If two or more fax devices and/or telephones are connected in parallel, the following problems may occur and the printer may not operate properly.

- If you pick up the handset of the telephone that is connected in parallel during fax transmission or reception, the fax image may be corrupted or a communication error may occur.
- Such services as Caller ID, etc. may not operate properly on the telephone.

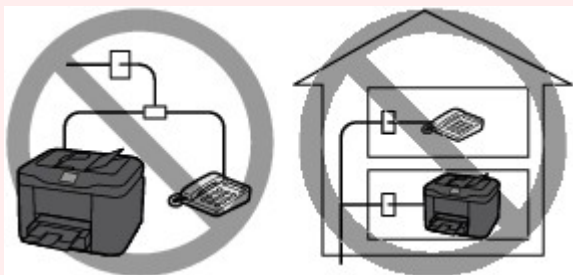

If you cannot avoid parallel connections, set the receive mode to **TEL priority mode**, understanding that the above problems may occur. You will only be able to receive faxes manually.

Basic Connection

Make sure that the printer is turned off, connect one end of supplied telephone line cable to the telephone line jack near the "LINE" mark of the printer, and then connect the other end to the telephone line jack on the wall or to the telephone line jack of the xDSL splitter.

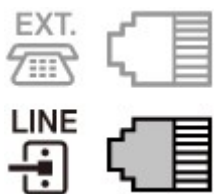

When you connect the telephone to the printer, make sure that the printer is turned off, connect one end of the modular cable to the external device jack near the "EXT." mark of the printer, and then connect the other end to the telephone line jack of the telephone.

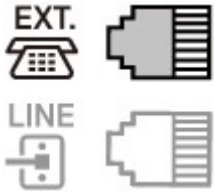

►►► Important

- Be sure to connect the telephone line before the printer is turned on.
If you connect the telephone line when the printer is turned on, turn the printer off and unplug the power cord. Wait for 1 minute, and then connect the telephone line and power plug.

►►► Note

- Refer to [Rear View](#) for the position of the telephone line jack and the external device jack.
- Before connecting a telephone or answering machine, remove the Telephone connector cap.
- **For users in the UK:**
If the connector of the external device cannot be connected to the jack on the printer, you will need to purchase a B.T. adapter to connect as follows:
Attach the B.T. adapter to the modular cable connecting the external device, and then connect the B.T. adapter to the external device jack.

Connecting Various Lines

This section introduces how to connect various lines.

These are examples and could not be guaranteed to suit every connecting condition. For details, refer to the instruction manual supplied with the network device (control devices such as an xDSL (Digital Subscriber Line) modem or terminal adapter) you are connecting to this printer.

►►► Note

- xDSL is the generic term for the high speed digital communication technology with telephone line such as ADSL/HDSL/SDSL/VDSL.

• Connecting to an Internet Telephone

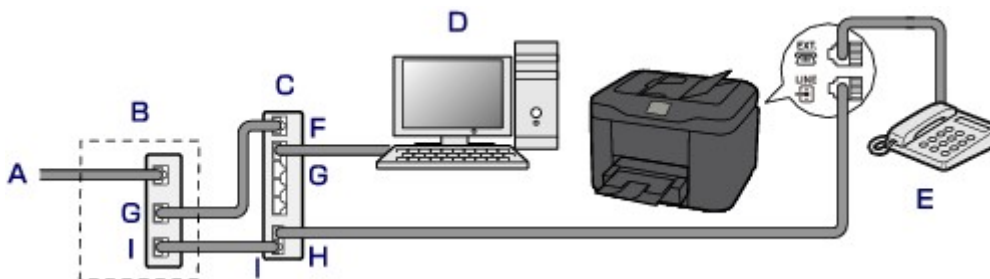

- A. Digital Subscriber Line
- B. xDSL modem (splitter may not be built-in to the modem)
- C. Broadband router compatible with Internet Telephone
- D. Computer

- E. Telephone or answering machine
- F. WAN (Wide Area Network) port
- G. LAN (Local Area Network) port
- H. TEL port
- I. LINE port

* Port configurations and names may vary depending on the product.

▶▶▶ Note

- When connecting to the xDSL line, select the same line type as you are subscribing to in **Telephone line type**.

■ [Setting Telephone Line Type](#)

• Connecting to an xDSL

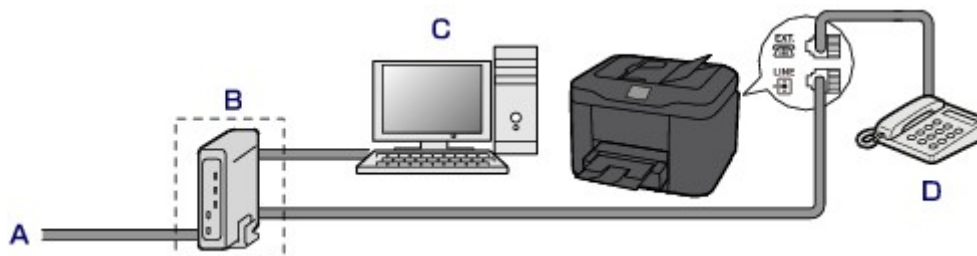

- A. Analog Subscriber Line
- B. xDSL modem (splitter may not be built-in to the modem)
- C. Computer
- D. Telephone or answering machine

▶▶▶ Important

- When the splitter is not built-in to the modem, do not branch the telephone line before the splitter (wall side). And also, do not connect splitters in parallel. The printer may not be able to operate properly.

▶▶▶ Note

- When connecting to the xDSL line, select the same line type as you are subscribing to in **Telephone line type**.

■ [Setting Telephone Line Type](#)

• Connecting to an ISDN Line

For details on ISDN (Integrated Service Digital Network) connection and settings, refer to the manuals supplied with your terminal adapter or dial-up router.

Setting Telephone Line Type

Before using your printer, make sure you set the correct telephone line type for your telephone line. If you are unsure of your telephone line type, contact your telephone company. For xDSL or ISDN connections, contact the telephone company or service provider to confirm your line type.

▶▶▶ Important

- **For users in China:**

After plugging the power cord and turning on the printer, the telephone line type is selected automatically. However, if the printer is connected to the control device such as an xDSL modem or terminal adapter, the telephone line type may not be selected correctly.

In this case, set the line type manually.

For details on how to set the Telephone line type manually in China:

■ [Setting the Telephone Line Type Manually in China](#)

▶▶▶ Note

- **Telephone line type** will not appear in countries or regions where **Rotary pulse** is not supported.
- You can print USER'S DATA LIST to check the current setting.

■ [Summary of Reports and Lists](#)

1. [Make sure that printer is turned on.](#)

2. Flick HOME screen, and then tap  **Setup**.

■ [Using the Operation Panel](#)

3. Tap  **Device settings**.

4. Tap **FAX settings**.

5. Tap **FAX user settings**.

6. Tap **Telephone line type**.

7. Tap a telephone line type.

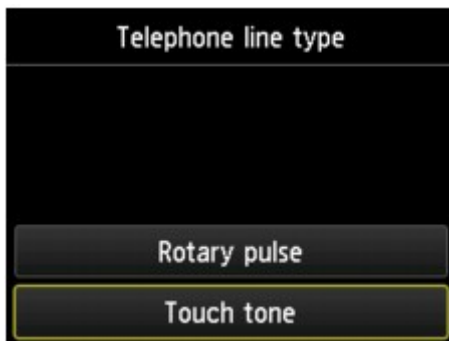

Rotary pulse

Select when your telephone line type is pulse dialing.

Touch tone

Select when your telephone line type is tone dialing.

Setting the Telephone Line Type Manually in China

This section describes the procedure to set the telephone line type manually in China.

1. [Make sure that printer is turned on.](#)

2. Flick HOME screen, and then tap  **Setup**.

■ [Using the Operation Panel](#)

3. Tap  **Device settings**.

4. Tap **FAX settings**.

5. Tap **FAX user settings**.

6. Tap **Telephone line auto selection**.

The current telephone line type is displayed.

7. Check current telephone line type, and then tap **OK**.

▶▶ Note

- If you do not need to change the telephone line type, press the **HOME** button to return to the HOME screen.

8. Tap **OFF**.

9. Tap a telephone line type.

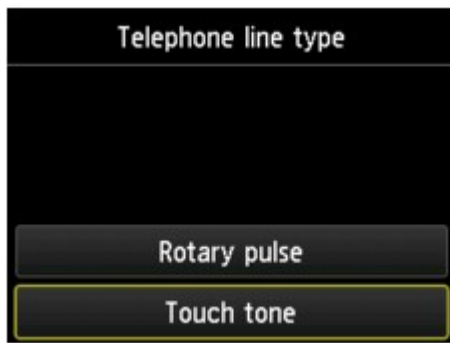

Rotary pulse

Select when your telephone line type is pulse dialing.

Touch tone

Select when your telephone line type is tone dialing.

Setting Receive Mode

Set the receiving operation (receiving mode).

For details on how to set the receive mode:

- [Setting Receive Mode](#)

You can select the appropriate mode.

For details on the selectable receive mode:

- [About Receive Mode](#)

For details on the advanced settings of the receive mode:

- [Advanced Settings of Receive Mode](#)

▶▶▶ Note

- The receiving operation procedure varies depending on the selected receive mode.

For details on receiving method depending on each receive mode:

- [Receiving Faxes](#)

- If you want to use a single telephone line for faxes and voice calls, you need to connect a telephone or an answering machine to the external device jack of this printer.

For details on how to connect the telephone or the answering machine to the printer:

- [Basic Connection](#)

Setting Receive Mode

This section describes the procedure to select the receive mode.

1. [Make sure that printer is turned on.](#)

2. Flick HOME screen, and then tap  **FAX**.

- [Using the Operation Panel](#)

3. Tap **Function list**.
4. The **Function list** screen is displayed.
5. Tap **Receive mode settings**.
6. Tap a receive mode, and then tap **OK**.

▶▶▶ Note

- By tapping **Advanced**, you can specify the advanced settings of each receive mode.

For details on the advanced settings of the receive mode:

■ [Advanced Settings of Receive Mode](#)

- For details on the receive mode:

■ [About Receive Mode](#)

- **DRPD** is available only in the US and Canada.
- **Network switch** may not be available depending on the country or region of purchase.
- Refer to [Receiving Faxes](#) for information on receiving faxes or the procedure for each receive mode.

About Receive Mode

You can select the receive mode suitable for your fax use conditions: whether you use a dedicated line for fax, etc.

Receive mode	Your fax use condition	Receiving operation
TEL priority mode	When mainly receiving voice calls (with a telephone or answering machine connected to the printer):	<p>When a call incomes, the telephone will ring.</p> <p>Pick up the handset.</p> <p>If the call is a voice call, talk on the telephone.</p> <p>If the call is a fax, hang up the handset after the printer starts receiving the fax.</p> <p>▶▶▶ Note</p> <ul style="list-style-type: none"> • The telephone may not ring when a call incomes even if it is connected to the printer, depending on the type or settings of the telephone.
DRPD or Network switch	When receiving voice calls (with a telephone or answering machine connected to the printer) and subscribing to a ring pattern detection service provided by your telephone company:	<p>When a call incomes, the telephone will ring. The printer detects a fax call by the fax ring pattern.</p> <p>If the call is a fax, the printer will receive the fax automatically.</p> <p>If the printer does not detect the fax ring pattern, the telephone will continue ringing.</p> <p>▶▶▶ Note</p> <ul style="list-style-type: none"> • The telephone may not ring when a call incomes even if it is connected to the printer, depending on the type or settings of the telephone.
FAX only mode	When not receiving voice calls:	When a fax incomes, the printer will receive the fax automatically.

Advanced Settings of Receive Mode

You can specify the advanced settings of each receive mode.

- **Advanced setting in TEL priority mode**

You can specify the following setting items.

- **Manual/auto switch: ON/Manual/auto switch: OFF**

If you select **Manual/auto switch: ON**, the printer automatically receives faxes after the external device rang a specified length of time.

You can specify the length of time until automatic reception is started.

- **RX start time**

You can specify the length of time until automatic reception is started when **Manual/auto switch: ON** is selected. Specify the length of time and tap **OK**.

- **User-friendly RX: ON/User-friendly RX: OFF**

If you select **User-friendly RX: ON**, the printer automatically switches from telephone calling to fax reception by detecting the fax signal (CNG signal) when you lift the handset of the telephone or the answering machine answers. When you have an answering machine connected to the printer, select **User-friendly RX: ON** to switch to fax reception automatically after the answering machine answers.

If you select **User-friendly RX: OFF**, the printer does not switch from telephone calling to fax reception automatically even if the printer detects the fax signal (CNG signal). Select **User-friendly RX: OFF** if you want the printer not to switch automatically during a call.

▶▶ Note

- If you subscribe to Duplex Ringing service in Hong Kong, the number of times the external device rings specified with **Ring count** in **FAX only mode** is available in **TEL priority mode**.

If you want to specify the number of times the external device rings in **TEL priority mode**, select **FAX only mode** on the **Receive mode settings** screen, specify the number of times the external device rings with **Ring count**, and then switch to **TEL priority mode** in **Receive mode settings**.

- If you subscribe to Duplex Ringing service in Hong Kong, we recommend that you select **Manual/auto switch: OFF**.

- **Advanced setting in FAX only mode**

You can specify the following setting item.

- **Ring count**

You can specify the number of times the external device rings when incoming.

Specify the number of time and tap **OK**.

- **Advanced setting in DRPD**

You can specify the following setting items.

- Ring pattern (**Normal ring/Double ring/Short-short-long/Short-long-short**)

Sets the distinctive ring pattern of a call that the printer assumes is a fax call.

If you subscribe to a DRPD service, set the ring pattern to match the pattern assigned by your telephone company.

■ [Setting DRPD Ring Pattern \(US and Canada only\)](#)

- **Ring count**

You can specify the number of times the external device rings when incoming.

Specify the number of time and tap **OK**.

- **Advanced setting in Network switch**

You can specify the following setting item.

- **Ring count**

You can specify the number of times the external device rings when incoming.

Specify the number of time and tap **OK**.

Setting DRPD Ring Pattern (US and Canada only)

If you have subscribed to a Distinctive Ring Pattern Detection (DRPD) service provided by your telephone company, your telephone company will assign two or more telephone numbers with distinctive ring patterns to your single telephone line, allowing you to have different numbers for fax calls and voice calls using only one telephone line. Your printer will automatically monitor the ring pattern, and will automatically receive the fax if the ring pattern is a fax call.

To use DRPD, follow the procedure below to set the fax ring pattern that matches the pattern assigned by your telephone company.

▶▶▶ Note

- Contact your local telephone company for detailed information on this service.

1. [Make sure that printer is turned on.](#)

2. Flick HOME screen, and then tap  **FAX**.

■ [Using the Operation Panel](#)

3. Tap **Function list**.

The **Function list** screen is displayed.

4. Tap **Receive mode settings**.

5. Tap **DRPD**.

6. Tap **Advanced**.

7. Select ring pattern that your telephone company assigned to your fax number.



8. Specify number of time and tap **OK**.

9. Tap **OK**.

The **Function list** screen is displayed.

Setting Sender Information

You can set the sender information such as date/time, unit name, and unit fax/telephone number.

- [About Sender Information](#)
- [Setting Date and Time](#)
- [Setting Daylight Saving Time \(Summer Time\)](#)
- [Registering User Information](#)

About Sender Information

If the unit name and unit fax/telephone number are registered, they are printed with date and time as sender information on the recipient's fax.

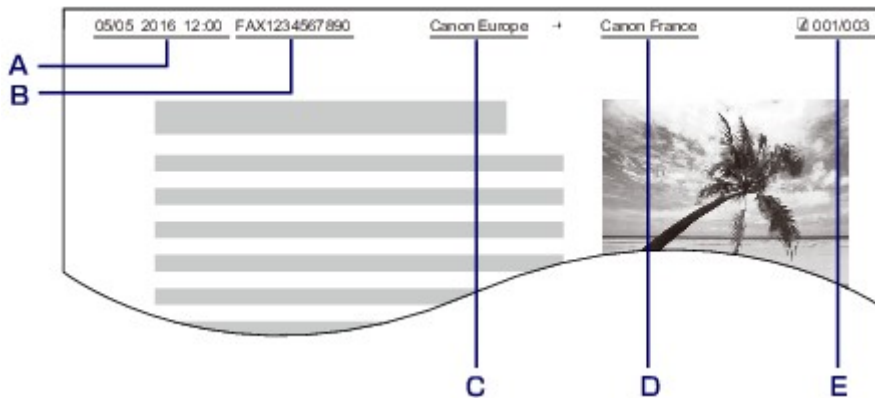

- A. Date and time of transmission
- B. Unit fax/telephone number
- C. Unit name
- D. The registered recipient's name is printed when sending faxes.
- E. Page number

►►► Note

- You can print USER'S DATA LIST to confirm the sender information you have registered.
 - [Summary of Reports and Lists](#)
- When sending faxes in black & white, you can select whether to print the sender information inside or outside the image area.

Specify the setting on **TTI position** in **Advanced FAX settings** under **FAX settings**.

 - [Advanced FAX settings](#)
- You can select the date print format from three formats: **YYYY/MM/DD**, **MM/DD/YYYY**, and **DD/MM/YYYY**.

Select the date print format on **Date display format** under **Device user settings**.

 - [Device user settings](#)

Setting Date and Time

This section describes the procedure to set the date and time.

1. [Make sure that printer is turned on.](#)

2. Flick HOME screen, and then tap  **Setup**.

■ [Using the Operation Panel](#)

3. Tap  **Device settings**.

4. Tap **Device user settings**.

5. Tap **Date/time setting**.

6. Set date.

1. Tap a setting item to change.

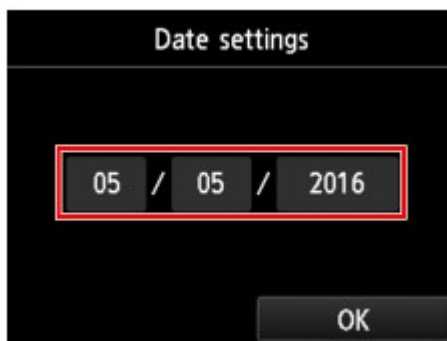

2. Tap number to enter.



Enter only the last two digits of the year.

3. Tap **OK**.
 4. Tap **OK** again when all settings are completed.
7. Set time.

1. Tap a setting item to change.

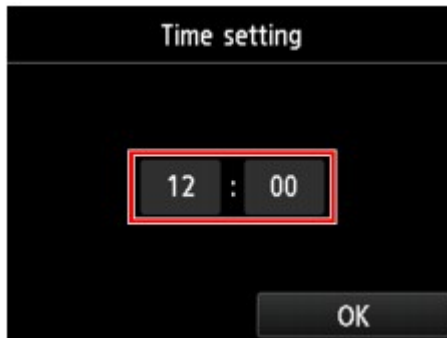

2. Tap number to enter.



Enter the date and time in 24-hour format.

3. Tap **OK**.
 4. Tap **OK** again when all settings are completed.
-
8. Press **HOME** button to return to HOME screen.

Setting Daylight Saving Time (Summer Time)

Some countries adopt the daylight saving time (summer time) system that shifts the clock time forward at certain periods of the year.

You can set your printer to automatically change the time by registering the date and time that daylight saving time (summer time) begins and ends.

»» Important

- Not all the latest information of all countries or regions is applied for **Daylight saving time setting** by default. You need to change the default setting according to the latest information of your country or region.

»» Note

- This setting may not be available depending on the country or region of purchase.

1. [Make sure that printer is turned on.](#)

2. Flick HOME screen, and then tap  **Setup**.

■ [Using the Operation Panel](#)

3. Tap  **Device settings**.

4. Tap **Device user settings**.

5. Tap **Daylight saving time setting**.

6. Tap **ON**.

To disable summer time, tap **OFF**.

7. Set date and time when summer time starts.

1. Set date when summer time starts.

Tap a setting item to change, and then specify the setting. Tap **OK** again when all settings are completed.

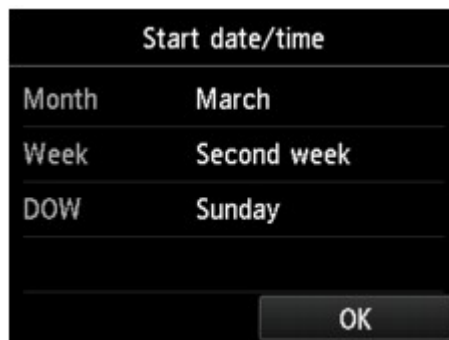

2. Set time (in 24-hour format) when summer time starts.

Tap a setting item to change, and then specify the setting. Tap **OK** again when all settings are completed.

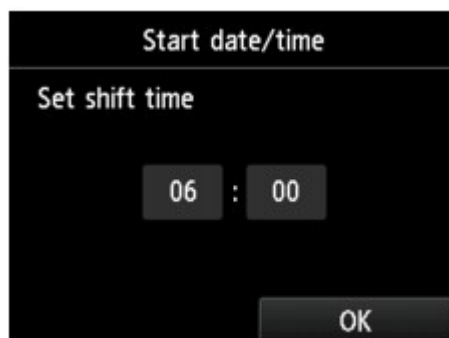

8. Set date and time when summer time ends.

1. Set date when summer time ends.

Tap a setting item to change, and then specify the setting. Tap **OK** again when all settings are completed.

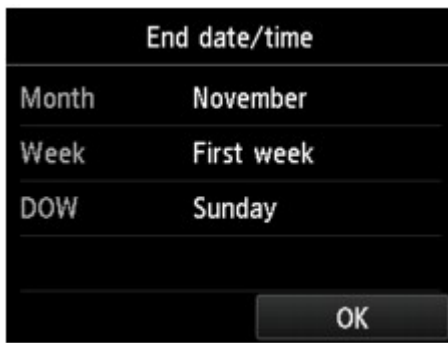

2. Set time (in 24-hour format) when summer time ends.

Tap a setting item to change, and then specify the setting. Tap **OK** again when all settings are completed.

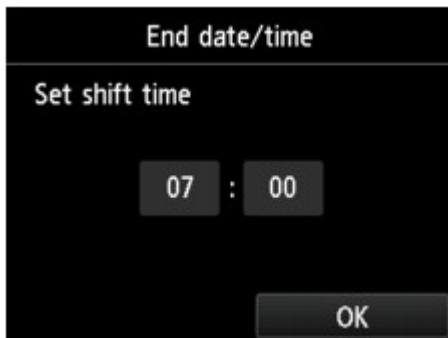

9. Press **HOME** button to return to HOME screen.

Registering User Information

This section describes the procedure to register the user information.

▶▶ Note

- Before sending a fax, be sure to enter your name and fax/telephone number in **Unit name** and **Unit TEL** on the **User information settings** screen (for US only).

1. [Make sure that printer is turned on.](#)

2. Flick HOME screen, and then tap  **Setup**.

■ [Using the Operation Panel](#)

3. Tap  **Device settings**.

4. Tap **FAX settings**.

5. Tap **FAX user settings**.

6. Tap **User information settings**.

The screen to register the unit name and the unit fax/telephone number is displayed.



7. Enter unit name.

1. Tap entry field under **Unit name**.

The screen to enter the character is displayed.

2. Enter unit name.

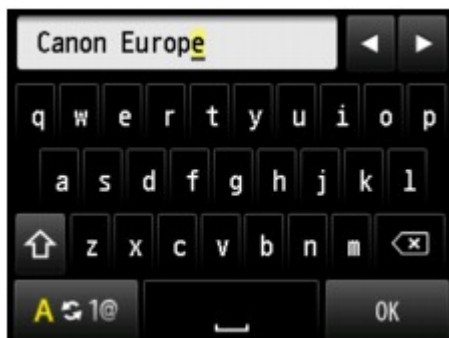

3. Tap **OK**.

▶▶▶ Note

- You can enter the name up to 24 characters, including spaces.
- For details on how to enter or delete characters:
 - [Entering Numbers, Letters, and Symbols](#)

8. Enter unit fax/telephone number.

1. Tap entry field under **Unit TEL**.

The screen to enter the number is displayed.

2. Enter unit fax/telephone number.



3. Tap **OK**.

▶▶ Note

- You can enter the fax/telephone number up to 20 digits, including spaces.
- For details on how to enter or delete characters:
 - [Entering Numbers, Letters, and Symbols](#)

9. Tap **Register** to finalize registration.

Sending Faxes Using Operation Panel of Printer

- ▶ **Sending Faxes by Entering Fax/Telephone Number**
- ▶ **Resending Faxes (Redialing Busy Number)**
- ▶ **Setting Items for Sending Faxes**
- ▶ **Sending Faxes Using Useful Functions**

Sending Faxes by Entering Fax/Telephone Number

This section describes dialing and sending faxes directly by entering the fax/telephone numbers.

▶▶▶ Important

- It may be possible that faxes will reach unintended recipients due to the misdialing or incorrect registration of fax/telephone numbers. When you send important documents, we recommend that you send them after speaking on the telephone.

■ [Sending Fax after Speaking on Telephone](#)

1. [Make sure that printer is turned on.](#)
2. [Load documents on platen glass or in ADF.](#)

▶▶▶ Note

- For details on the types, conditions of document, and how to load the document:

■ [Loading Originals](#)

3. Flick HOME screen, and then tap  **FAX**.

■ [Using the Operation Panel](#)

The Fax standby screen is displayed.

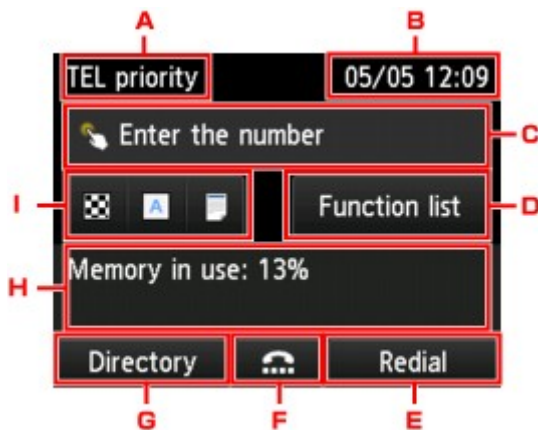

A. Receive mode

The receive mode selected currently is displayed.

B. Date and time

The date and time are displayed.

C. Entry field of fax/telephone numbers

Tap to display the screen to enter the fax/telephone numbers.

D. Function list

You can use the each fax function and change the setting for the fax.

E. Redial

Tap to send faxes with redialing.

- [Resending Faxes \(Redialing Busy Number\)](#)

F. On hook dial

Tap to send faxes with the on hook dial function.

- [Using On Hook Dial Function](#)

G. Directory

You can select a registered fax/telephone number.

- [Sending Fax to Registered Recipient](#)

H. Current state

The current state is displayed.

I. Send Settings

- [Setting Items for Sending Faxes](#)

»» Note

- If you have not set up the printer for sending/receiving faxes yet, the message for setup is displayed on the touch screen when you tap **FAX** on the HOME screen for the first time. When you set up for faxing, follow the procedure according to the instructions on the touch screen.

4. Dial recipient's fax/telephone number.

1. Tap entry field of fax/telephone numbers.

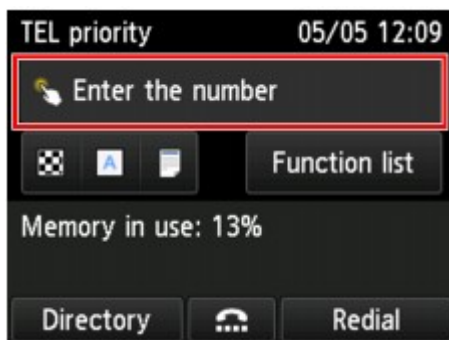

2. Enter fax/telephone number.



- A. Numeric keys

Enters the number.

B. **Pause**

Enters a pause "P".

C. **Delete**

Deletes the entered number.

D. **Blank space**

Enters a blank space.

3. Tap **OK**.



The touch screen returns to the Fax standby screen.

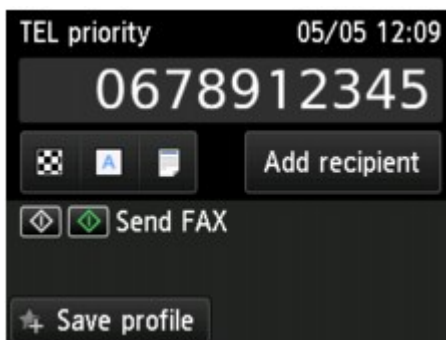

▶▶▶ **Note**

- By tapping **Save profile**, you can register the current print settings as a custom setting.

■ [Registering Favorite Settings \(Custom profiles\)](#)

5. Press **Color** button for color transmission, or **Black** button for black & white transmission.

The printer starts scanning the document.

▶▶▶ **Important**

- Color transmission is available only when the recipient's fax device supports color faxing.
- Do not open the document cover until scanning is completed.

6. Start sending.

- **If you load the document in the ADF:**

The printer scans the document automatically and starts sending the fax.

»» Note

- To cancel a fax transmission, press the **Stop** button. To cancel a fax transmission while it is in progress, press the **Stop** button, and then follow the instructions on the touch screen.
- If documents remain in the ADF after the **Stop** button is pressed while scanning is in progress, **Document in ADF. Tap [OK] to eject document.** is displayed on the touch screen. By tapping **OK**, the remaining documents are automatically ejected.

- **If you load the document on the platen glass:**

After scanning the document, the confirmation screen asking you if you load the next document is displayed.

To send the scanned document, tap **Send now** to start sending it.

To send two or more pages, follow the message to load the next page, and tap **Scan**. After scanning all pages, tap **Send now** to start sending.

»» Note

- To cancel sending the fax, press the **Stop** button.

»» Note

- When your printer is connected to a PBX (Private Branch Exchange) system, refer to the operating instructions of the system for details on dialing the recipient's fax/telephone number.
- In case the printer was not able to send a fax, such as when the recipient's line was busy, it has the function to automatically redial the number after a specified interval. Automatic redialing is enabled by default.
 - [Automatic Redialing](#)
- Unsent documents, such as those pending redial, are stored in the printer's memory. They are not stored in the case of a sending error.
 - [Document Stored in Printer's Memory](#)
- Do not unplug the power cord until all documents are sent. If you unplug the power cord, all unsent documents stored in the printer's memory are lost.

Resending Faxes (Redialing Busy Number)

There are two methods of redialing: Automatic redialing and Manual redialing.

- Automatic Redialing

If you send a document and the recipient's line is busy, the printer will redial the number after a specified interval.

■ [Automatic Redialing](#)

- Manual Redialing

You can redial to the recipients dialed by entering the fax/telephone numbers.

■ [Manual Redialing](#)

▶▶▶ Important

- It may be possible that faxes will reach unintended recipients due to the misdialing or incorrect registration of fax/telephone numbers. When you send important documents, we recommend that you send them after speaking on the telephone.

■ [Sending Fax after Speaking on Telephone](#)

▶▶▶ Note

- Automatic redialing is enabled by default.
- For details on the basic sending operations:

■ [Sending Faxes by Entering Fax/Telephone Number](#)

Automatic Redialing

You can enable or disable automatic redialing. If you enable automatic redialing, you can specify the maximum number of redial attempts and the length of time the printer waits between redial attempts.

Enable and specify the automatic redialing setting on **Auto redial** in **Advanced FAX settings** under **FAX settings**.

■ [Advanced FAX settings](#)

▶▶▶ Important

- While automatic redialing, the unsent fax is stored in the printer's memory temporarily until the sending fax is complete. If a power failure occurs or you unplug the power cord before automatic redialing is complete, all faxes stored in the printer's memory are deleted and not sent.

▶▶▶ Note

- To cancel automatic redialing, wait until the printer starts redialing, and then press the **Stop** button.
- To cancel automatic redialing, delete the unsent fax from the printer's memory while the printer is on-standby for a redial operation. For details, see [Deleting Document in Printer's Memory](#).

Manual Redialing

Follow the procedure below for manual redialing.

1. [Make sure that printer is turned on.](#)
2. [Load documents on platen glass or in ADF.](#)

3. Flick HOME screen, and then tap  **FAX**.

■ [Using the Operation Panel](#)

The Fax standby screen is displayed.

4. Change send settings as necessary.

■ [Setting Items for Sending Faxes](#)

5. Tap **Redial**.

The **Redial** screen is displayed.

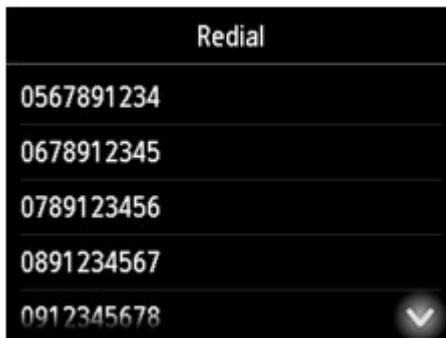

6. Tap a recipient's number to redial.
7. Press **Color** button for color transmission, or **Black** button for black & white transmission.

▶▶ **Important**

- Color transmission is available only when the recipient's fax device supports color faxing.

▶▶ **Note**

- For manual redialing, the printer memorizes up to 10 recent recipients dialed by entering the fax/telephone numbers. Note that the printer does not memorize any recipients dialed using the redial function or selecting from the directory.
- To cancel manual redialing, press the **Stop** button. To cancel a fax transmission while it is in progress, press the **Stop** button, and then follow the instructions on the touch screen.
- If documents remain in the ADF after the **Stop** button is pressed while scanning is in progress, **Document in ADF. Tap [OK] to eject document.** is displayed on the touch screen. By tapping **OK**, the remaining documents are automatically ejected.

Setting Items for Sending Faxes

You can change the send settings such as the scan contrast or the scan resolution on the Fax standby screen.



Tap to change the send settings.

- **ScanRes.**

The following settings of the scan resolution are selectable.

Standard

Suitable for text-only documents.

Fine

Suitable for fine-print documents.

Extra fine

Suitable for detailed illustration or fine-print quality documents.

If the recipient's fax device is not compatible with **Extra fine** (300 x 300 dpi), the fax will be sent in the **Standard** or **Fine** resolution.

Photo

Suitable for photographs.

▶▶▶ **Note**

- When sending a color fax, documents are always scanned in the same resolution (200 x 200 dpi). The image quality (compression rate) is determined by which scan resolution is selected, except that **Extra fine** and **Photo** provide the same image quality.

- **Contrast**

Select a setting of the scan contrast from **Lower**, **Standard**, and **Higher**.

- **ADF duplex scan**

Select a scanning method when loading document in the ADF.

▶▶▶ **Note**

- After sending a fax with **Duplex**, this setting returns to **Simplex** automatically.

The touch screen returns to the Fax standby screen when you finish specifying the setting and tapping **OK**.

Sending Faxes Using Useful Functions

- ▶ **Sending Fax after Speaking on Telephone**
- ▶ **Sending Fax to Registered Recipient**
- ▶ **Sending Same Document to Several Recipients (Sequential Broadcasting)**
- ▶ **Preventing Mistransmission of Faxes**
- ▶ **Using On Hook Dial Function**

Sending Fax after Speaking on Telephone

If you want to speak to the recipient before sending a fax, or if the recipient does not have a fax device that can receive faxes automatically, send a fax manually after speaking to the recipient on the telephone to check whether the recipient can receive faxes.

▶▶▶ Important

- It may be possible that faxes will reach unintended recipients due to the misdialing or incorrect registration of fax/telephone numbers. When you send important documents, we recommend that you send them after speaking on the telephone. See below for the procedure to send a fax manually.
- With manual transmission, you cannot use the platen glass to load documents. Load the documents in the ADF.

When loading document on the platen glass, send a fax with automatic transmission.

■ [Sending Faxes by Entering Fax/Telephone Number](#)

- To speak to the recipient before sending a fax, you need to connect a telephone to the printer.

For details on how to connect the telephone to the printer:

■ [Basic Connection](#)

▶▶▶ Note

- For details on the basic sending operations:

■ [Sending Faxes by Entering Fax/Telephone Number](#)

1. [Make sure that printer is turned on.](#)

2. [Load documents in ADF.](#)

3. Flick HOME screen, and then tap  **FAX**.

■ [Using the Operation Panel](#)

The Fax standby screen is displayed.

4. Change send settings as necessary.

■ [Setting Items for Sending Faxes](#)

5. Lift handset of telephone connected to printer.

6. Use telephone to dial recipient's fax/telephone number.

7. Speak to recipient.

When you hear a high-pitched signal instead of the recipient's voice, you cannot check whether the recipient can receive faxes. If you want to stop sending the fax, replace the handset. If you want to send the fax, go to step 8.

8. Ask recipient to set recipient's fax device to receive faxes.

9. When you hear a high-pitched signal, press **Color** button or **Black** button.

Press the **Color** button for color transmission, or the **Black** button for black & white transmission.

Important

- Color transmission is available only when the recipient's fax device supports color faxing.

10. Hang up handset.

Note

- To cancel a fax transmission, press the **Stop** button. To cancel a fax transmission while it is in progress, press the **Stop** button, and then follow the instructions on the touch screen.
- If documents remain in the ADF after the **Stop** button is pressed while scanning is in progress, **Document in ADF. Tap [OK] to eject document.** is displayed on the touch screen. By tapping **OK**, the remaining documents are automatically ejected.

Sending Fax to Registered Recipient

Registering recipient's fax/telephone number and name in the printer's directory enables you to send faxes easily.

▶▶ Important

- It may be possible that faxes will reach unintended recipients due to the misdialing or incorrect registration of fax/telephone numbers. When you send important documents, we recommend that you send them after speaking on the telephone.

■ [Sending Fax after Speaking on Telephone](#)

▶▶ Note

- For details on the basic sending operations:

■ [Sending Faxes by Entering Fax/Telephone Number](#)

1. [Make sure that printer is turned on.](#)
2. [Load documents on platen glass or in ADF.](#)

3. Flick HOME screen, and then tap  **FAX**.

■ [Using the Operation Panel](#)

The Fax standby screen is displayed.

4. Change send settings as necessary.

■ [Setting Items for Sending Faxes](#)

5. Tap **Directory**.

The screen to select a registered recipient is displayed.

6. Select a registered recipient.

Display by name

Display by ID number

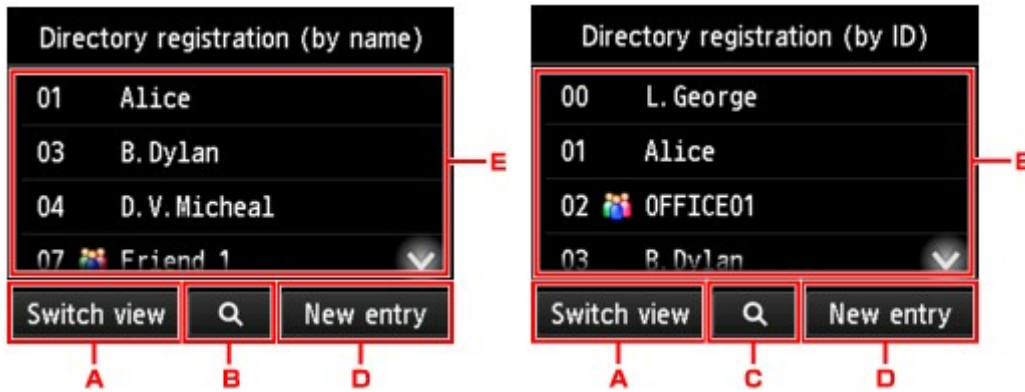

- A. Tap to switch the display by name and by ID number.
- B. Tap to display the screen to select an initial. You can search the registered recipient by initial.



By selecting the initial, the registered recipients are displayed in alphabetical order from the selected character.

- C. Tap to display the screen to select an ID number of the registered recipient. You can search the registered recipient by ID number.



By enter the ID number and tapping **OK**, the registered recipients are displayed in order from the recipient of the ID number selected.

- D. Tap to register a new recipient or a new group dial.
 - [Registering Fax/Telephone Number of Recipients](#)
 - [Registering Recipients in Group Dial](#)
- E. Tap to select a registered recipient.

7. Tap **Send FAX** as operation for selected recipient.

The touch screen returns to the Fax standby screen.

▶▶▶ Note

- You can edit or delete a selected recipient.

■ [Changing Registered Information](#)

■ [Deleting Registered Information](#)

8. Press **Color** button for color transmission, or **Black** button for black & white transmission.

▶▶▶ Important

- Color transmission is available only when the recipient's fax device supports color faxing.

▶▶▶ Note

- To cancel a fax transmission, press the **Stop** button. To cancel a fax transmission while it is in progress, press the **Stop** button, and then follow the instructions on the touch screen.
- If documents remain in the ADF after the **Stop** button is pressed while scanning is in progress, **Document in ADF. Tap [OK] to eject document.** is displayed on the touch screen. By tapping **OK**, the remaining documents are automatically ejected.
- In case the printer was not able to send a fax, such as when the recipient's line was busy, it has the function to automatically redial the number after a specified interval. Automatic redialing is enabled by default.

■ [Automatic Redialing](#)

To cancel automatic redialing, wait until the printer starts redialing, and then press the **Stop** button.

Sending Same Document to Several Recipients (Sequential Broadcasting)

This printer allows you to prepare for sending the same document to a maximum of 101 recipients in one operation. The recipients can be specified by entering the fax/telephone numbers and selecting the registered recipients (the particular recipient's number and the group dial) in combination.

The following number of recipients can be specified in combination.

- The recipient registered to the printer:
Up to 100 (total of the particular recipient's number and the group dial)
- Entering the fax/telephone numbers or redialing:
1

▶▶ Important

- It may be possible that faxes will reach unintended recipients due to the misdialing or incorrect registration of fax/telephone numbers. When you send important documents, we recommend that you send them one by one after speaking on the telephone.

■ [Sending Fax after Speaking on Telephone](#)

▶▶ Note

- If you frequently send documents to the same group of recipients, you can group these numbers for group dialing. This will allow you to send documents to all the recipients in the group by simply operation.

■ [Registering Recipients in Group Dial](#)

- For details on the basic sending operations:

■ [Sending Faxes by Entering Fax/Telephone Number](#)

1. [Make sure that printer is turned on.](#)
2. [Load documents on platen glass or in ADF.](#)
3. Flick HOME screen, and then tap  FAX.

■ [Using the Operation Panel](#)

The Fax standby screen is displayed.

4. Change send settings as necessary.

■ [Setting Items for Sending Faxes](#)

5. Specify first recipient.

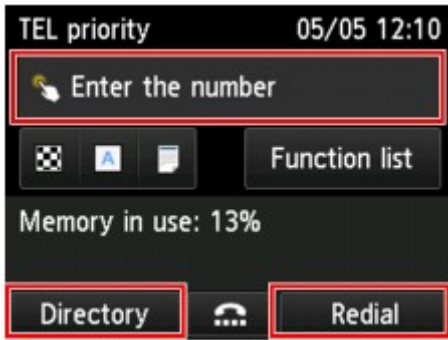

Specify the first recipient with the one of the following methods.

- By specifying with the recipient registered to the printer:
Tap **Directory** and specify the recipient.
 - [Sending Fax to Registered Recipient](#)
- By entering the fax/telephone numbers:
Tap the entry field of fax/telephone numbers and enter the number.
 - [Sending Faxes by Entering Fax/Telephone Number](#)

▶▶▶ **Note**

- If **FAX number re-entry** in **Security control** under **FAX settings** is set to **ON**, enter the number again.

- [Security control](#)

- By redialing:
Tap **Redial** and select a number in the outgoing call logs.
 - [Manual Redialing](#)

6. Add recipient.

1. Tap **Add recipient**.

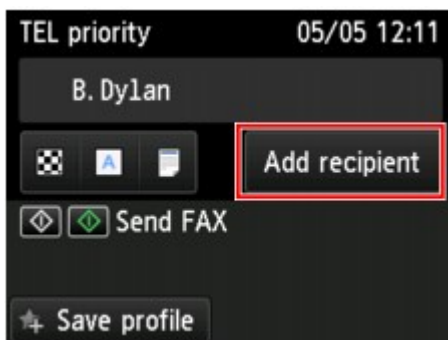

The list of the recipients is displayed.

2. Select a method to add recipient.

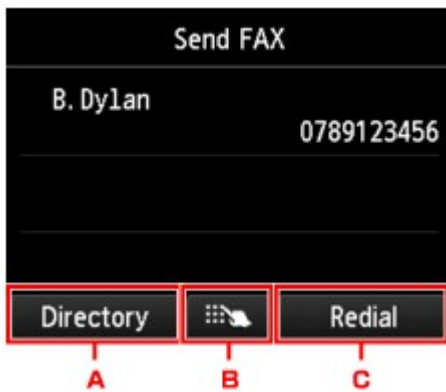

- A. Adds the recipient from the registered recipients.
 - B. Adds the recipient by entering the fax/telephone numbers if you specified a first recipient from the registered recipients.
 - C. Adds the recipient by selecting a number from the outgoing call logs if you specified a first recipient from the registered recipients.
3. Add a recipient.
Add a recipient according to the selected method.

The **Sequential broadcasting** screen is displayed after specifying the multiple recipients.

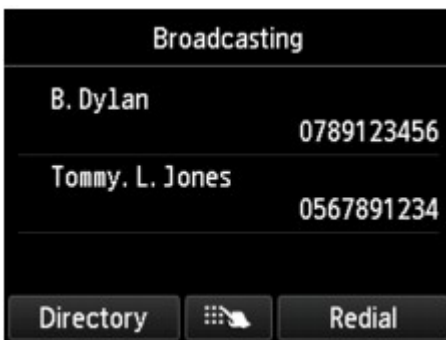

- 4. If you want to add recipient further, repeat same procedure.

▶▶▶ Note

- You can specify the recipient either by entering the fax/telephone number or by selecting a number from the outgoing call logs.
- If you want to delete the recipient, tap a recipient that you want to delete from the list. After the confirmation screen is displayed, tap **Yes** to delete the recipient.

- 7. Press **Color** button for color transmission, or **Black** button for black & white transmission.

▶▶▶ Important

- Color transmission is available only when the recipient's fax device supports color faxing.

▶▶▶ Note

- To cancel a fax transmission, press the **Stop** button. To cancel a fax transmission while it is in progress, press the **Stop** button, and then follow the instructions on the touch screen.

When you press the **Stop** button, fax transmission to all the recipients specified will be canceled. You cannot cancel a fax transmission to only one recipient.

- If documents remain in the ADF after the **Stop** button is pressed while scanning is in progress, **Document in ADF. Tap [OK] to eject document.** is displayed on the touch screen. By tapping **OK**, the remaining documents are automatically ejected.

Preventing Mistransmission of Faxes

This printer has two functions for preventing the mistransmission of faxes.

- Sending faxes after entering the fax/telephone number twice

This function requires you to re-enter the fax/telephone number after entering the number, so that the printer prevents you from misdialing.

- [Sending Faxes after Dialing Twice \(Fax Number Re-entry\)](#)

- Sending faxes after the printer checks the recipient's fax device information

Before sending a fax, the printer checks whether the recipient's fax device information matches the dialed number.

- [Sending Faxes after Checking Information \(Checking Recipient's Information\)](#)

Sending Faxes after Dialing Twice (Fax Number Re-entry)

Set **FAX number re-entry** to **ON** following the procedure below.

1. [Make sure that printer is turned on.](#)

2. Flick the HOME screen, and then tap  **Setup**.

- [Using the Operation Panel](#)

3. Tap  **Device settings**.

4. Tap **FAX settings**.

5. Tap **Security control**.

6. Tap **FAX number re-entry**.

7. Tap **ON**.

If you send a fax with this function, the following screen is displayed after entering the recipient's fax/telephone number.

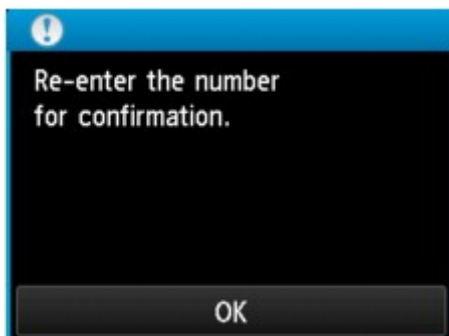

Enter the recipient's fax/telephone number again.

Sending Faxes after Checking Information (Checking Recipient's Information)

Set **Check RX FAX information** to **ON** following the procedure below.

▶▶▶ Important

- This function is not available when you send a fax manually.

■ [Sending Fax after Speaking on Telephone](#)

1. [Make sure that printer is turned on.](#)

2. Flick the HOME screen, and then tap  **Setup**.

■ [Using the Operation Panel](#)

3. Tap  **Device settings**.

4. Tap **FAX settings**.

5. Tap **Security control**.

6. Tap **Check RX FAX information**.

7. Tap **ON**.

▶▶▶ Important

- Transmission will be canceled if the printer fails to receive the recipient's fax information or if the received information does not match the fax/telephone number.

Using On Hook Dial Function

Follow the procedure below to send faxes with the on hook dial function.

▶▶ Important

- It may be possible that faxes will reach unintended recipients due to the misdialing or incorrect registration of fax/telephone numbers. When you send important documents, we recommend that you send them after speaking on the telephone.

- [Sending Fax after Speaking on Telephone](#)

- With manual transmission, you cannot use the platen glass to load documents. Load the documents in the ADF.

When loading document on the platen glass, send a fax with automatic transmission.

- [Sending Faxes by Entering Fax/Telephone Number](#)

▶▶ Note

- You can use the on hook dial function only when **Hook key setting** in **Security control** under **FAX settings** is set to **Enable**.

- [Security control](#)

- For details on the basic sending operations:

- [Sending Faxes by Entering Fax/Telephone Number](#)

1. [Make sure that printer is turned on.](#)

2. [Load documents in ADF.](#)

3. Flick HOME screen, and then tap  **FAX**.

- [Using the Operation Panel](#)

The Fax standby screen is displayed.

4. Change send settings as necessary.

- [Setting Items for Sending Faxes](#)

5. Tap .

6. Specify a recipient.

Specify the recipient with the one of the following methods.

- By specifying with the recipient registered to the printer:

Select the registered recipient by tapping **Directory**.

- [Sending Fax to Registered Recipient](#)

- By entering the fax/telephone numbers:

Tap the entry field of fax/telephone numbers and enter the number.

■ [Sending Faxes by Entering Fax/Telephone Number](#)

- Manual redialing:

Tap **Redial** and select a number in the outgoing call logs.

■ [Manual Redialing](#)

7. When you hear a high-pitched signal, press **Color** button or **Black** button.

Press the **Color** button for color transmission, or the **Black** button for black & white transmission.

▶▶▶ Important

- Color transmission is available only when the recipient's fax device supports color faxing.

▶▶▶ Note

- To cancel a fax transmission, press the **Stop** button. To cancel a fax transmission while it is in progress, press the **Stop** button, and then follow the instructions on the touch screen.
- If documents remain in the ADF after the **Stop** button is pressed while scanning is in progress, **Document in ADF. Tap [OK] to eject document.** is displayed on the touch screen. By tapping **OK**, the remaining documents are automatically ejected.

Registering Recipients

- ▶ **Registering Recipients Using Operation Panel of Printer**
- ▶ **Registering Recipients Using Speed Dial Utility2 (Windows)**
- ▶ **Registering Recipients Using Speed Dial Utility2 (Mac OS)**

Registering Recipients Using Operation Panel of Printer

Registering recipients in the printer's directory in advance allows you to dial fax/telephone numbers simply.

The following methods to register are available:

- Recipient registration

Registering the recipient's fax/telephone number and name allows you to send a fax by selecting a registered recipient in the printer directory.

- [Registering Fax/Telephone Number of Recipients](#)

- Group dial registration

You can combine two or more recipients registered in advance into a group. You can send the same document to all the registered recipients in the group.

- [Registering Recipients in Group Dial](#)

You can register up to 100 recipients in total of individual recipients and group dials.

▶▶▶ Note

- To change the registered information of the recipient or the group dial, see [Changing Registered Information](#).
- To delete the registered information of the recipient or the group dial, see [Deleting Registered Information](#).
- To print a list of the recipient's fax/telephone numbers and names registered, see [Printing List of Registered Destinations](#).
- You can register, change, or delete the registered information of the recipient or the group dial using Speed Dial Utility2 on the computer.
 - For Windows:
 - [Registering Recipients Using Speed Dial Utility2 \(Windows\)](#)
 - For Mac OS:
 - [Registering Recipients Using Speed Dial Utility2 \(Mac OS\)](#)

Registering Fax/Telephone Number of Recipients

Before you can use the printer's directory, you need to register the recipients' fax/telephone numbers. Follow the procedure below to register the recipients' fax/telephone numbers.

1. [Make sure that printer is turned on.](#)

2. Flick HOME screen, and then tap  **FAX**.

■ [Using the Operation Panel](#)

The Fax standby screen is displayed.

3. Tap **Function list**.

The **Function list** screen is displayed.

4. Tap **TEL number registration**.

5. Tap **Directory registration**.

The screen to select an ID number is displayed.



▶▶▶ Note

- If you already registered the recipients, the recipients' name is displayed next to the ID number. If you already registered the group dial, the  icon and the group name are displayed next to the ID number.

6. Select an unregistered ID number.

▶▶▶ Note

- If you already registered the recipients and they are displayed by name, tap **Switch view**. The registered recipients are displayed by ID number.
- If you tap **New entry**, an unregistered ID number will be selected in numerical order.

7. Tap **Register recipient**.

- 8. Select a registration method.
- 9. Register recipients' fax/telephone number.

Register the recipients' fax/telephone number depending on the registration method selected.

- **By entering the number**

The screen to register the recipient's fax/telephone number and name is displayed. Go to next step.

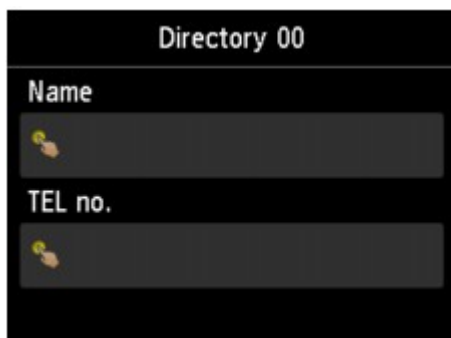

- **From outgoing call log**

When you select this registration method, the screen to select the fax/telephone number from the outgoing call logs is displayed.



Selecting a fax/telephone number from the outgoing call logs, the screen to register the recipient's fax/telephone number and name is displayed. Go to next step.

- **From incoming call log**

When you select this registration method, the screen to select the fax/telephone number or the name from the incoming call logs is displayed.



Select a fax/telephone number or name from the incoming call logs, the screen to register the recipient's fax/telephone number and name is displayed. Go to next step.

»» Note

- This registration method may not be available depending on the country or region of purchase.

10. Enter recipient's name.

If you select **From incoming call log** as a registration method, the recipient's name may be already entered. If you do not change the name, go to next step.

1. Tap entry field of name.

The screen to enter the character is displayed.

2. Enter recipient's name.

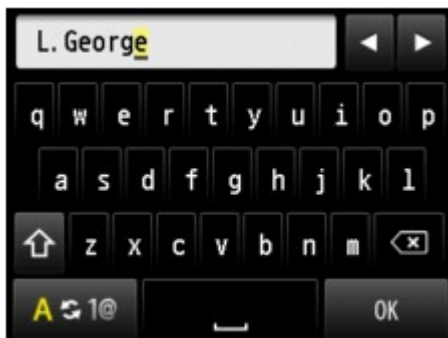

3. Tap **OK**.

»» Note

- You can enter the name up to 16 characters, including spaces.

■ [Entering Numbers, Letters, and Symbols](#)

11. Enter recipient's fax/telephone number.

If you select a fax/telephone number on **From outgoing call log** or **From incoming call log**, the fax/telephone number is already entered. If you do not change the fax/telephone number, go to next step.

1. Tap entry field of fax/telephone numbers.

The screen to enter the number is displayed.

2. Enter recipient's fax/telephone number.



3. Tap **OK**.

»» Note

- You can enter the fax/telephone number up to 60 digits (40 digits for the US, Canada, Korea and some regions of Latin America), including spaces.
 - [Entering Numbers, Letters, and Symbols](#)
- When **Telephone line type** in **FAX user settings** under **FAX settings** is set to **Rotary pulse**, you can enter a tone ("T") by tapping the Tone key.

12. Tap **Register** to finalize registration.

»» Note

- To register another recipient's number and name, select an unregistered ID number and operate in the same procedure.
- You can check the recipient's numbers and names you have registered by printing RECIPIENT TELEPHONE NUMBER LIST.
 - [Printing List of Registered Destinations](#)

Registering Recipients in Group Dial

If you register two or more registered recipients to a group dial, you can send the same document successively to all recipients registered to the group dial.

1. [Make sure that printer is turned on.](#)

2. Flick HOME screen, and then tap  **FAX**.

■ [Using the Operation Panel](#)

The Fax standby screen is displayed.

3. Tap **Function list**.

The **Function list** screen is displayed.

4. Tap **TEL number registration**.

5. Tap **Directory registration**.

The screen to select an ID number is displayed.

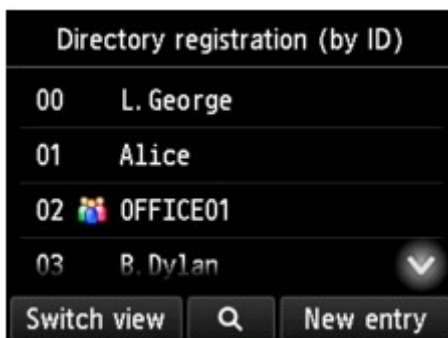

▶▶▶ Note

- If you already registered the recipients, the recipients' name is displayed next to the ID number. If you already registered the group dial, the  icon and the group name are displayed next to the ID number.

6. Select an unregistered ID number.

▶▶▶ Note

- If you already registered the recipients and they are displayed by name, tap **Switch view**. The registered recipients are displayed by ID number.
- If you tap **New entry**, an unregistered ID number will be selected in numerical order.

7. Tap **Group dial registration**.

The screen to register the group name and the member of the group is displayed.

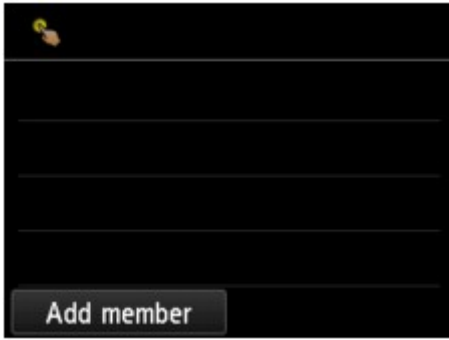

8. Enter group name.

1. Tap entry field of group name.
The screen to enter the character is displayed.
2. Enter group name.



3. Tap **OK**.

»» **Note**

- You can enter the name up to 16 characters, including spaces.

■ [Entering Numbers, Letters, and Symbols](#)

9. Register registered recipient as a member of group dial.

1. Tap **Add member**.
The printer's directory is displayed.

Display by name

Display by ID number

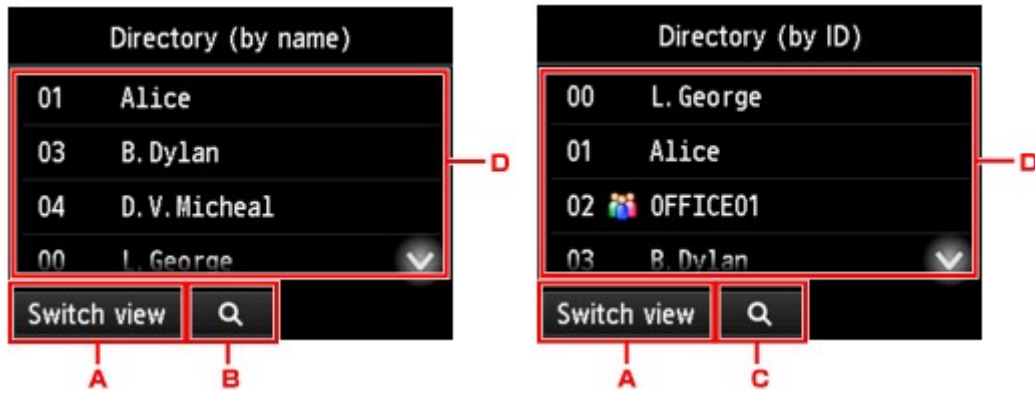

- A. Tap to switch the display by name and by ID number.
- B. Tap to display the screen to select an initial. You can search the registered recipient by initial.



By selecting the initial, the registered recipients are displayed in alphabetical order from the selected character.

- C. Tap to display the screen to select an ID number of the registered recipient. You can search the registered recipient by ID number.



By enter the ID number and tapping **OK**, the registered recipients are displayed in order from the recipient of the ID number selected.

- D. The recipients that can be registered are displayed.
2. Tap a recipient to register as group member.
The member to register is displayed on the list.



»» Note

- To delete the recipient from the group dial, tap a recipient that you want to delete from the list. After the confirmation screen is displayed, tap **Yes** to delete the recipient from the group dial.

3. To add another member, tap **Add member** again.

The printer's directory is displayed.

4. Tap a recipient to register as group member.

The member to register is displayed on the list.



Repeat the procedure to register another member to the same group dial.

10. Tap **Complete** to finalize registration.

»» Note

- To register another group, select an unregistered ID number and operate in the same procedure.
- You can check the recipients you have registered to the group dial by printing GROUP DIAL TELEPHONE NO. LIST.

■ [Printing List of Registered Destinations](#)

Changing Registered Information

To change information registered for recipient and group dial, follow the procedure below.

1. [Make sure that printer is turned on.](#)

2. Flick HOME screen, and then tap  **FAX**.

■ [Using the Operation Panel](#)

The Fax standby screen is displayed.

3. Tap **Function list**.

The **Function list** screen is displayed.

4. Tap **TEL number registration**.

5. Tap **Directory registration**.

6. Tap a recipient or a group dial to change.

7. Change registered information.

- To change an individual recipient:

1. Tap **Edit recipient**.

The registered information screen of the selected recipient is displayed.

2. Tap entry field of name or entry field of fax/telephone numbers.

The each edit screen is displayed.

3. Change name or fax/telephone numbers.

4. Tap **OK**.

The touch screen returns to the registered information screen.

5. Tap **Register**.

- To change a group dial:

1. Tap **Edit group dial**.

The registered information screen of the group dial is displayed.

2. To change group name, tap entry field of name.

When edit screen of group name is displayed, change the group name, and then tap **OK**.

3. To add member, tap **Add member**.

When the printer's directory is displayed, tap the recipient you want to add.

4. To delete member, tap recipient on list.

When the confirmation screen is displayed, tap **Yes** to delete the recipient from the group dial.

5. Tap **Complete** to finalize changing.

Deleting Registered Information

To delete information registered for recipient and group dial, follow the procedure below.

1. [Make sure that printer is turned on.](#)

2. Flick HOME screen, and then tap  **FAX**.

■ [Using the Operation Panel](#)

The Fax standby screen is displayed.

3. Tap **Function list**.

The **Function list** screen is displayed.

4. Tap **TEL number registration**.

5. Tap **Directory registration**.

6. Tap a recipient or a group dial to delete.

7. Delete registered information.

- To delete an individual recipient:
 1. Tap **Delete recipient**.
 2. When confirmation screen is displayed, tap **Yes** to delete.
- To delete a group dial:
 1. Tap **Delete group dial**.
 2. When confirmation screen is displayed, tap **Yes** to delete.

Printing List of Registered Destinations

You can print a list of the fax/telephone numbers and can keep it near the printer to refer to when dialing.

1. [Make sure that printer is turned on.](#)

2. [Load paper.](#)

3. Flick HOME screen, and then tap  **FAX**.

■ [Using the Operation Panel](#)

The Fax standby screen is displayed.

4. Tap **Function list**.

The **Function list** screen is displayed.

5. Tap **Print reports/lists**.

6. Tap **Directory list**.

7. Tap an item to print.

- If you selected **Recipient**:

The confirmation screen to select whether to print the list in alphabetical order is displayed.

If you tap **Yes**: Prints RECIPIENT TELEPHONE NUMBER LIST in alphabetical order.

If you tap **No**: Prints RECIPIENT TELEPHONE NUMBER LIST in the order of the ID number.

- If you selected **Group dial**:

The printing confirmation screen is displayed. Tap **Yes** to print GROUP DIAL TELEPHONE NO. LIST.

Registering Recipients Using Speed Dial Utility2 (Windows)

About Speed Dial Utility2

Speed Dial Utility2 is a utility for forwarding the telephone directory registered on the printer to a computer and registering/changing it on the computer. In addition, you can register the telephone directory edited on the computer to the printer. You can also save them on the computer as a backup.

For safety reasons, it is recommended that you backup the registered data on the computer using Speed Dial Utility2.

- [Starting Up Speed Dial Utility2](#)
- [Speed Dial Utility2 Dialog box](#)
- [Saving Registered Telephone Directory on Printer to Your Computer](#)
- [Registering a Fax/telephone Number Using Speed Dial Utility2](#)
- [Changing a Fax/telephone Number Using Speed Dial Utility2](#)
- [Deleting a Fax/telephone Number Using Speed Dial Utility2](#)
- [Changing Sender Information Using Speed Dial Utility2](#)
- [Registering/Changing Rejected Number Using Speed Dial Utility2](#)
- [Registering Telephone Directory Has been Saved on Your Computer to Printer](#)

Starting Up Speed Dial Utility2

»» Important

- Before starting up Speed Dial Utility2, make sure that the printer is connected to the computer correctly.
- Do not plug in or unplug any cables while the printer is in operation, or when the computer is in sleep or standby mode.
- If your printer is compatible with LAN connection, make sure that the printer is connected to the computer with LAN connection to use Speed Dial Utility2 via LAN connection.
- The password entry screen may appear during startup or operation. If it appears, enter the administrator password, and then click **OK**. If you do not know the administrator password, contact the administrator of the printer.

Follow the procedure below to start up Speed Dial Utility2.

1. Make sure printer is turned on.
2. Start up Speed Dial Utility2.
 - For Windows 10, click **Start** button and select **All apps, Canon Utilities**, and then **Speed Dial Utility2**.
 - For Windows 8.1 or Windows 8, select **Speed Dial Utility2** on the **Start** screen to start Speed Dial Utility2. If **Speed Dial Utility2** is not displayed on the **Start** screen, select the **Search** charm, and then search for "Speed Dial Utility2".
 - For Windows 7 or Windows Vista, click **Start** and select **All programs, Canon Utilities, Speed Dial Utility2**, and then **Speed Dial Utility2**.

Speed Dial Utility2 starts up.

»» Note

- You can also start up Speed Dial Utility2 from Quick Utility Toolbox.

Speed Dial Utility2 Dialog box

The following items are on the **Speed Dial Utility2** dialog box.

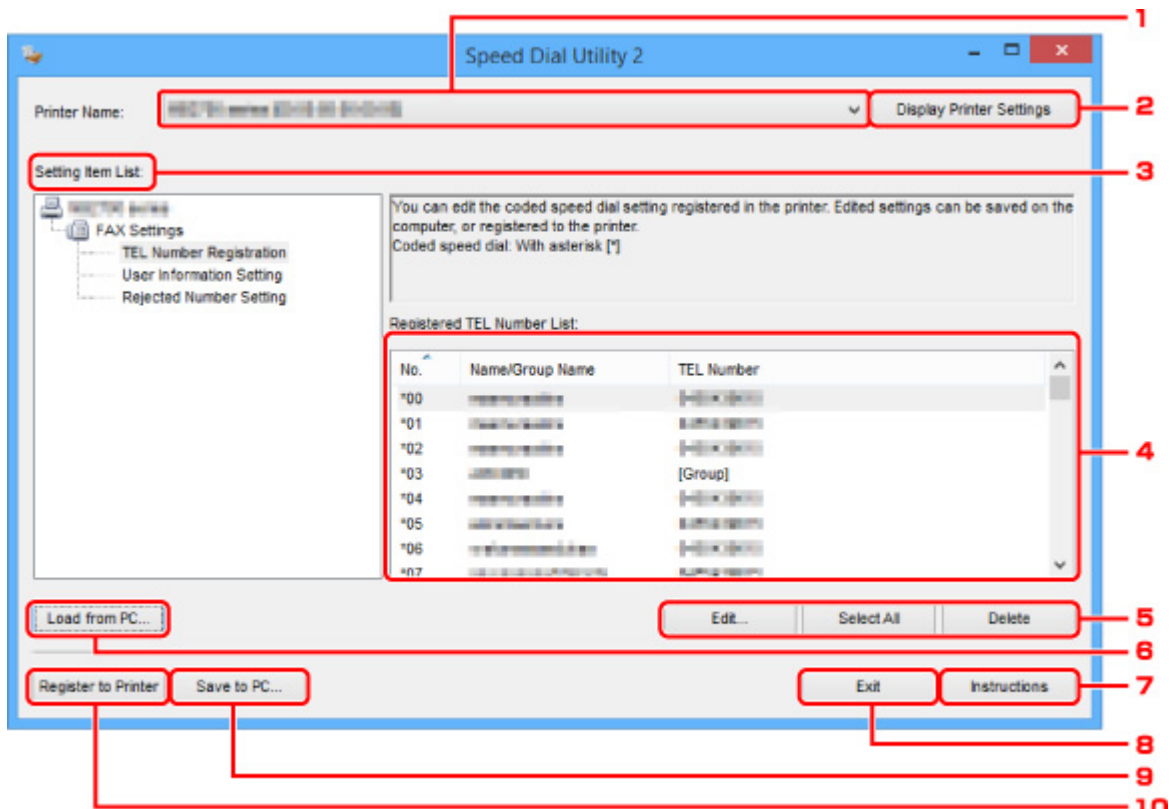

1. Printer Name:

Selects the printer for editing the telephone directory using Speed Dial Utility2.

Behind printer name, printer's MAC address is displayed.

▶▶▶ Note

- For checking printer's MAC address, refer to "Checking Network Information" for your model from Home of the Online Manual.
- For printer that supports both wireless LAN connection and wired LAN connection, MAC address of wired LAN connection is displayed regardless of the connection method.

2. Display Printer Settings

Loads the telephone directory registered on the printer that selected for **Printer Name:** into Speed Dial Utility2.

3. Setting Item List:

Selects a setting item for editing. Choose one item from **TEL Number Registration**, **User Information Setting**, and **Rejected Number Setting**.

4. Registered information list

Displays the registered information selected for **Setting Item List:**.

»» Note

- By clicking on the item name, you can sort the display order.

5. **Edit.../Select All/Delete**

Edits the item that selected for **Setting Item List:**, or deletes the item, or selects all the items.

When multiple items on the registered information list are selected, you cannot use the **Edit...** button.

6. **Load from PC...**

Displays the telephone directory saved on the computer.

7. **Instructions**

Displays this guide.

8. **Exit**

Quits Speed Dial Utility2. Information registered or edited using Speed Dial Utility2 is neither saved on the computer nor registered on the printer.

9. **Save to PC...**

Saves the telephone directory edited using Speed Dial Utility2 on the computer.

10. **Register to Printer**

Registers the telephone directory edited using Speed Dial Utility2 to the printer.

Saving Registered Telephone Directory on Printer to Your Computer

Follow the procedure below to save the telephone directory (includes recipients' name, recipients' fax/telephone number, group dial, user's name, user's fax/telephone number, and rejected numbers) that registered on the printer to the computer.

1. [Start up Speed Dial Utility2.](#)
2. Select a printer from **Printer Name:** list box, and then click **Display Printer Settings.**
3. Click **Save to PC....**
4. Enter file name on displayed screen, and then click **Save.**

▶▶▶ Note

- The data of the telephone directory (RSD file, *.rsd) can be imported to other printer.

■ [Registering Telephone Directory Has been Saved on Your Computer to Printer](#)

Registering a Fax/telephone Number Using Speed Dial Utility2

Follow the procedure below to register fax/telephone numbers.

►► Note

Before you register fax/telephone numbers using Speed Dial Utility2, make sure that no fax operations are in progress.

1. [Start up Speed Dial Utility2.](#)
2. Select a printer from **Printer Name:** list box, and then click **Display Printer Settings.**
3. Click **TEL Number Registration** from **Setting Item List:**
The list of registered fax/telephone numbers is displayed.
4. Select an unoccupied code from list, and then click **Edit....**
The **Individual or Group Selection** dialog box is displayed.
5. Click **Register individual TEL number** or **Register group dial**, and then click **Next...**
 - If **Register individual TEL number** is selected:

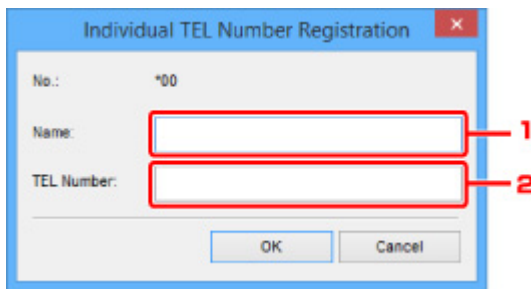

1. Enter name.
 2. Enter fax/telephone number.
- If **Register group dial** is selected:

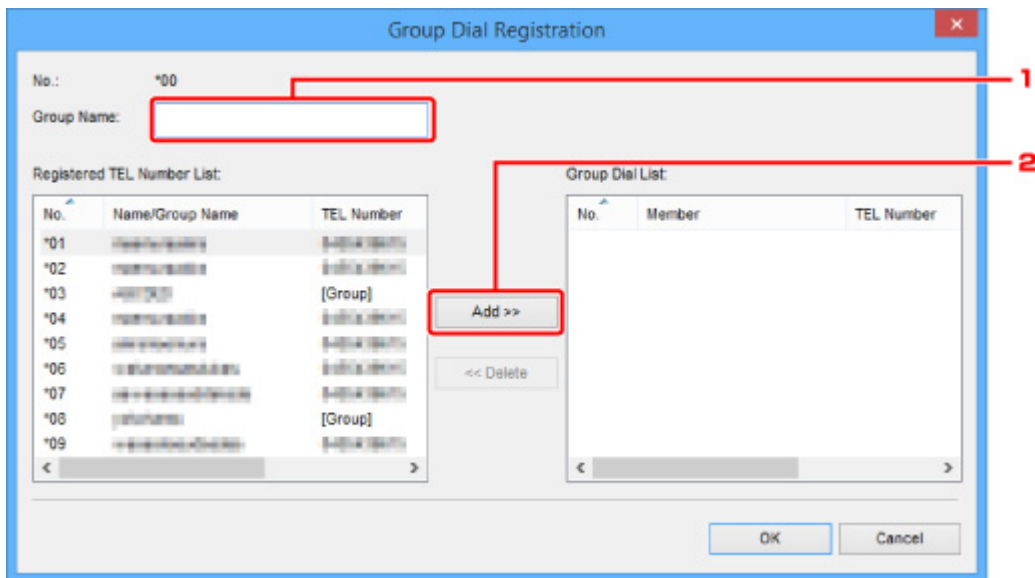

1. Enter group name.
2. Select a code you want to add to group dial, and then click **Add >>**.

➤➤➤ Note

- You can only add the numbers that have already been registered.

6. Click **OK**.

To continue registering fax/telephone numbers or a group dial, repeat steps 4 to 6.

- To save the registered information on the computer.
 1. Click **Save to PC....**
 2. Enter file name on displayed screen, and then click **Save**.
- To register the registered information to the printer:
 1. Click **Register to Printer**.
 2. When message appears, check it and click **OK**.

The information is registered to the printer.

Changing a Fax/telephone Number Using Speed Dial Utility2

Follow the procedure below to change fax/telephone numbers.

►►► Note

- Before you change fax/telephone numbers using Speed Dial Utility2, make sure that no fax operations are in progress.

1. [Start up Speed Dial Utility2.](#)
2. Select a printer from **Printer Name:** list box, and then click **Display Printer Settings.**
3. Click **TEL Number Registration** from **Setting Item List:**.
The list of registered fax/telephone numbers is displayed.
4. Select a code to change from list, and then click **Edit....**

- If an individual fax/telephone number is selected:

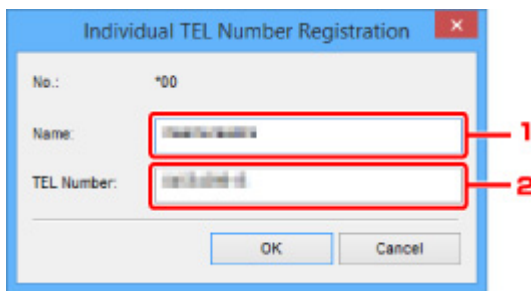

1. Enter a new name.
2. Enter a new fax/telephone number.

- If a group dial is selected:

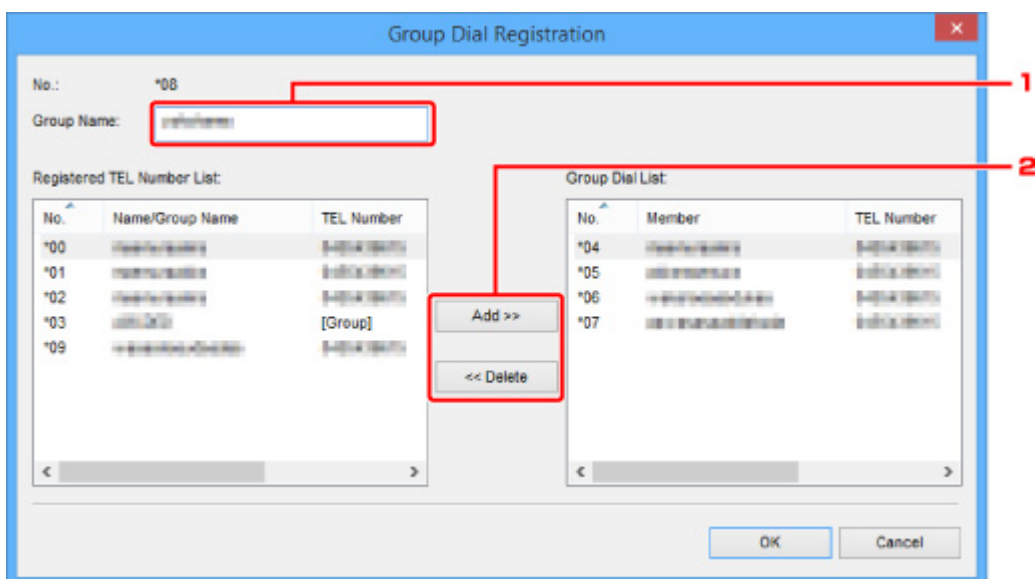

No.	Name/Group Name	TEL Number
*00	test/telephone	00000000
*01	test/telephone	00000000
*02	test/telephone	00000000
*03	test/phone	[Group]
*09	test/telephone+0000	00000000

No.	Member	TEL Number
*04	test/telephone	00000000
*05	test/telephone	00000000
*06	test/telephone+0000	00000000
*07	test/telephone+0000	00000000

1. Enter a new group name.

2. Add or delete a member to/from group dial.

To add a member:

Select a code to add to group dial, and then click **Add >>**.

To delete a member:

Select a code to delete from group dial, and then click **<< Delete**.

5. Click **OK**.

To continue changing fax/telephone numbers or group dials, repeat steps 4 and 5.

- To save the edited information on the computer.

1. Click **Save to PC...**

2. Enter file name on displayed screen, and then click **Save**.

- To register the edited information to the printer:

1. Click **Register to Printer**.

2. When message appears, check it and click **OK**.

The information is registered to the printer.

Deleting a Fax/telephone Number Using Speed Dial Utility2

Follow the procedure below to delete fax/telephone numbers.

▶▶▶ Note

- Before you delete fax/telephone numbers using Speed Dial Utility2, make sure that no fax operations are in progress.

1. [Start up Speed Dial Utility2.](#)
2. Select a printer from **Printer Name:** list box, and then click **Display Printer Settings.**
3. Click **TEL Number Registration** from **Setting Item List:**.
The list of registered fax/telephone numbers is displayed.
4. Select a code to delete from list, and then click **Delete.**

▶▶▶ Note

- To delete all fax/telephone numbers on the list, click **Select All**, and then **Delete.**

5. When confirmation screen appears, click **OK.**

The selected fax/telephone number is deleted.

To continue deleting fax/telephone numbers, repeat steps 4 and 5.

- To save the edited information on the computer.
 1. Click **Save to PC....**
 2. Enter file name on the displayed screen, and then click **Save.**
- To register the edited information to the printer:
 1. Click **Register to Printer.**
 2. When message appears, check it and click **OK.**

The information is registered to the printer.

Changing Sender Information Using Speed Dial Utility2

Follow the procedure below to change the user's name or fax/telephone number.

1. [Start up Speed Dial Utility2.](#)
2. Select a printer from **Printer Name:** list box, and then click **Display Printer Settings.**
3. Click **User Information Setting** from **Setting Item List:**.
The user's information is displayed.
4. Select an item to change, and then click **Edit....**
The **User Information** dialog box is displayed.
5. Enter new user's name on **User Name** and new fax/telephone number in **TEL Number**, and then click **OK.**
 - To save the edited information on the computer:
 1. Click **Save to PC....**
 2. Enter file name on displayed screen, and then click **Save.**
 - To register the edited information to the printer:
 1. Click **Register to Printer.**
 2. When message appears, check it and click **OK.**
The information is registered to the printer.

Registering/Changing Rejected Number Using Speed Dial Utility2

Follow the procedure below to register, change, or delete rejected numbers.

1. [Start up Speed Dial Utility2.](#)
2. Select a printer from **Printer Name:** list box, and then click **Display Printer Settings.**
3. Click **Rejected Number Setting** from **Setting Item List:**.

The list of rejected numbers is displayed.

- To register a rejected number:
 1. Select an unoccupied code from list, and then click **Edit...**
 2. Enter fax/telephone number in **Rejected Number** dialog box, and then click **OK.**
- To change a rejected number:
 1. Select a code to change from list, and then click **Edit...**
 2. Enter fax/telephone number in **Rejected Number** dialog box, and then click **OK.**
- To delete a rejected number:
 1. Select a code to delete from list, and then click **Delete.**

The selected fax/telephone number is deleted.

▶▶ Note

- To delete all fax/telephone numbers on the list, click **Select All**, and then **Delete.**

Registering Telephone Directory Has been Saved on Your Computer to Printer

You can load the data of the telephone directory (RSD file, *.rsd) and register it to your printer.

The data of the telephone directory (RSD file, *.rsd) that is exported from other printer can be loaded and registered to your printer.

▶▶▶ Note

- In Speed Dial Utility2, the data of the telephone directory (RSD file, *.rsd) that is exported using Speed Dial Utility can be loaded.

1. [Start up Speed Dial Utility2.](#)
2. Select a printer from **Printer Name:** list box, and then click **Display Printer Settings.**
3. Click **Load from PC....**
4. Select a data of telephone directory (RSD file, *.rsd) to register to your printer.
5. Click **Open** on dialog box.

The selected telephone directory is displayed.

▶▶▶ Note

- If you select the data of the telephone directory (RSD file, *.rsd) that is exported from other printer, the confirmation message appears. Click **OK.**

6. Click **Register to Printer.**

The telephone directory that has been saved on the computer is registered to your printer.

Receiving Faxes

- ▶ **Receiving Faxes**
- ▶ **Changing Paper Settings**
- ▶ **Memory Reception**
- ▶ **Receiving Faxes Using Useful Functions**

Receiving Faxes

This section describes the preparation necessary for receiving a fax and how to receive a fax.

Preparing for Receiving Fax

Prepare for receiving a fax according to the following procedure.

1. [Make sure that printer is turned on.](#)

2. Flick HOME screen, and then tap  **FAX**.

■ [Using the Operation Panel](#)

The Fax standby screen is displayed.

3. Check receive mode setting.

Check the receive mode setting displayed on the Fax standby screen.

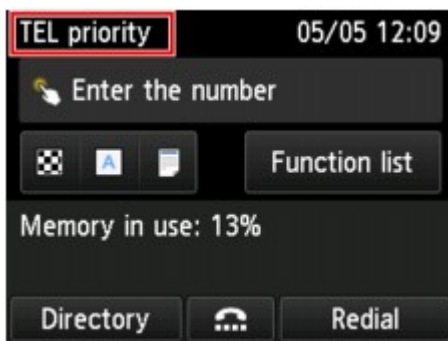

➤➤➤ **Note**

- For details on how to change the receive mode:

■ [Setting Receive Mode](#)

4. [Load paper.](#)

Load the sheets of plain paper.

5. Specify paper settings as necessary.

■ [Changing Paper Settings](#)

This completes the preparation for receiving fax.

When a fax is received, it is printed on the loaded paper automatically.

Receiving Fax

Depending on the selected receive mode, the receive operation varies.

►► Note

- For details on the receive mode:

- [Setting Receive Mode](#)

- You can specify the advanced settings of each receive mode.

For details on the advanced settings of the receive mode:

- [Advanced Settings of Receive Mode](#)

- If the printer was not able to print a received fax, the printer stores the unprinted fax temporarily in its memory (memory receiving).

- [Memory Reception](#)

- When receiving a fax, you can save received faxes on a USB flash drive as PDF files automatically or forward received faxes to the shared folder on the computer as PDF files automatically.

- [Saving Received Faxes Automatically on USB Flash Drive](#)

- [Forwarding Received Faxes Automatically to Shared Folder on Computer](#)

When TEL priority mode is selected:

- **When the call is a fax:**

The telephone will ring when a call comes.

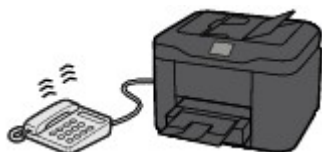

Pick up the handset. If you hear the fax tone, wait for at least 5 seconds after it stops, and then hang up the handset.



The printer will receive the fax.



►► Note

- If the printer will not switch to fax reception, select **FAX** again on the HOME screen, and then the **Color** or **Black** button to receive the fax.
- To receive a fax without picking up the handset, select **Manual/auto switch: ON** in **Advanced**. **RX start time** allows you to specify the number of seconds until the printer switches to fax reception.

- If you have subscribed to Duplex Ringing service in Hong Kong, the telephone will ring a specified number of times when there is an incoming call with a fax distinctive ring pattern. Then, the printer will switch to fax reception automatically without the handset being picked up. The number of times to ring the telephone until switching to fax reception can be changed.
- Set the printer to enable you to initiate fax reception from a connected telephone (remote reception).

■ [Remote Reception](#)

- **When the answering machine is connected to the printer:**

- If the answering machine is set to the answering mode, select **User-friendly RX: ON** in **Advanced**. If the call is a fax, the printer will receive the fax automatically.
- If the answering mode is turned off on the answering machine, pick up the handset. If you hear the fax tone, wait for at least 5 seconds after it stops, and then hang up the handset.
- If **Manual/auto switch: ON** is selected in **Advanced**, set **RX start time** to longer than the time before the answering machine starts playing the answering message. After making this setting, we recommend that you call the answering machine using a mobile phone, etc. to confirm that messages are recorded successfully in the answering machine.
- Set your answering machine to answering mode and adjust it as follows:
 - The entire message should be no longer than 15 seconds.
 - In the message, tell your callers how to send a fax.

- **When the call is a voice call:**

The telephone will ring when a call comes.

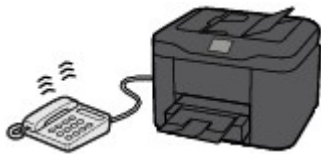

Pick up the handset, and talk on the telephone.



▶▶ Note

- If the printer unexpectedly switches to fax reception during telephone calls, select **User-friendly RX: OFF** in **Advanced**.
- If **Manual/auto switch: ON** is selected in **Advanced**, you must answer an incoming call by picking up the handset within the time specified in **RX start time**. Otherwise the printer will switch to fax reception.

When FAX only mode is selected:

- **When the call is a fax:**

The printer will receive the fax automatically.



►► Note

- If a telephone is connected to the printer, the telephone will ring when a call comes in.
- You can change the number of times to ring the telephone with **Ring count** in **Advanced**.

When DRPD or Network switch is selected:

- **When the call is a fax:**

The telephone will ring when a call comes in.

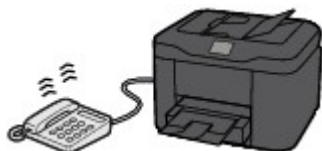

The printer will receive the fax automatically when the fax ring pattern is detected.



►► Note

- You can change the number of times to ring the telephone.

■ [Advanced Settings of Receive Mode](#)

- **When the call is a voice call:**

The telephone will ring when a call comes in.

When the printer does not detect the fax ring pattern, the telephone will continue ringing.

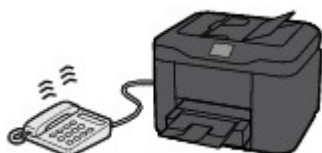

Pick up the handset, and talk on the telephone.



►► Note

- To use this feature, you need to subscribe to a compatible service provided by your telephone company.

- **For DRPD**

You need to select the appropriate ring pattern on the printer.

■ [Setting DRPD Ring Pattern \(US and Canada only\)](#)

- **For Network switch**

The name of this service varies depending on the country or region of purchase. This setting may not be also available depending on the country or region of purchase.

Changing Paper Settings

This printer prints received faxes to paper loaded in the printer beforehand. You can use the operation panel to change the paper settings for printing faxes. Make sure that the settings are appropriate for the loaded paper.

▶▶ Important

- If the size of loaded paper is different from that specified in the paper size setting, the received faxes are stored in the printer's memory and **Check the page size and tap [OK]**. is displayed on the touch screen. In this case, load the same size of paper as that specified in the paper size setting, and then tap **OK**.

You can also press the **Stop** button to close the message and print the stored documents in the printer's memory later.

■ [Printing Document in Printer's Memory](#)

- If no paper is loaded, or paper has run out while printing is in progress, the received faxes are stored in the printer's memory and the error message for no paper is displayed on the touch screen. In this case, load paper and tap **OK**.

You can also press the **Stop** button to close the message and print the stored documents in the printer's memory later.

■ [Printing Document in Printer's Memory](#)

▶▶ Note

- If the sender sends a document that is larger than Letter-size or Legal-size, such as 11 x 17 inches, the sender's device may send the fax automatically reduced in size or divided, or send only a part of the original.

1. [Make sure that printer is turned on.](#)

2. Flick HOME screen, and then tap  **FAX**.

■ [Using the Operation Panel](#)

The Fax standby screen is displayed.

3. Tap **Function list**.

The **Function list** screen is displayed.

4. Tap **FAX paper settings**.

The **FAX paper settings** screen is displayed.

5. Specify settings.

FAX paper settings		
Page size	A4	A
Type	Plain paper	B
Paper src	Cassette (auto)	C
2-sidedPrintSetting	1-sided	D

A. Page size

Select the page size from **A4**, **Letter**, or **Legal**.

B. Type (Media type)

The paper type is set to **Plain paper**.

C. Paper src (Paper source)

Select the cassette to feed paper.

Selecting **Cassette (auto)** allows the printer to feed paper from the cassette 2 when the cassette 1 runs out of paper under the following conditions.

- A4, Letter, or Legal sized plain paper is loaded in the cassette 1 and cassette 2.
- **Yes** is selected for **Auto feed switch** in **Cassette settings**.

D. 2-sidedPrintSetting

Select two-sided printing or single-sided printing.

Two sided printing is available for black & white faxes. Color faxes are printed on the single-side of paper regardless of this setting.

After **2-sided** is selected for **2-sidedPrintSetting**, tap **Advanced** to specify the stapling side.

»» Note

- When **Page size** is set to **A4** or **Letter**, the received faxes are printed on the two-sides of paper.

6. Press **Back** button twice to return to Fax standby screen.

Memory Reception

If the printer was not able to print the received fax, the received fax is stored in the printer's memory. The **FAX Memory** lamp is lit and **Received in memory.** is displayed at the Fax standby screen.

▶▶▶ Important

- If you unplug the power cord, all faxes stored in the printer's memory are deleted. The next time you turn the printer on, tap **OK** after a confirmation screen is displayed. The list of the faxes deleted from the printer's memory (MEMORY CLEAR REPORT) will be printed.

If the printer receives a fax under one of the following conditions, the received fax will be automatically stored in the printer's memory.

- **The printer is set to store received faxes in its memory:**

When **Do not print** is selected for **Received documents** in **Auto print settings** under **FAX settings**, the received faxes are stored in the printer's memory.

You can print the faxes stored in the printer's memory from the **Memory reference** screen in the Fax menu.

- [Printing Document in Printer's Memory](#)

▶▶▶ Note

- To print the received faxes automatically, select **Print** for **Received documents** in **Auto print settings** under **FAX settings**.

- [Auto print settings](#)

- **An error has occurred on the printer:**

If you select **Print** for **Received documents** in **Auto print settings** under **FAX settings**, a received fax will be printed automatically. However, if any of the following errors occurs, the received fax will not be printed. It will instead be stored in the printer's memory.

When the error is resolved, the fax stored in the printer's memory is printed automatically.

- The amount of remaining ink is insufficient to print a fax:

Replace the ink tank.

- [Replacing Ink Tanks](#)

▶▶▶ Note

- You can set the printer to forcibly print a received fax even if the ink has run out.

Set **Print when out of ink** in **Auto print settings** under **FAX settings** to **Print**.

However, part or all of the fax may not be printed since the ink has run out.

Also, the contents of the fax will not be stored in the printer's memory.

If the ink has already run out, we recommend that **Do not print** be selected for **Received documents** in **Auto print settings** under **FAX settings** to store the received fax in the printer's memory. After you replace the ink tank and select **Print** for **Received documents** in **Auto print settings**, the fax stored in the printer's memory will be printed automatically.

■ [Auto print settings](#)

- Paper has run out:

Load the paper and tap **OK** on the touch screen.

- A different size of paper from that specified by **Page size** in **FAX paper settings** is loaded:

Load the same size of paper as that specified by **Page size** in **FAX paper settings**, and then tap **OK** on the touch screen.

- **You pressed the Stop button to cancel printing of a fax:**

Press the **HOME** button and tap **FAX** to resume printing of the fax.

▶▶ Note

- The printer can store up to max. 250 pages* (max. 30 documents) of faxes in the printer's memory.

* When using ITU-T No.1 chart (Standard mode)

- If the printer's memory becomes full during memory reception, only pages which already have been received are stored in the memory. Print the received faxes stored in the printer's memory, save them on the USB flash drive, or forward received faxes to the shared folder on the computer, and then delete them from the printer's memory and have the sender resend the faxes.

■ [Document Stored in Printer's Memory](#)

Receiving Faxes Using Useful Functions

- ▶ **Saving Received Faxes Automatically on USB Flash Drive**
- ▶ **Forwarding Received Faxes Automatically to Shared Folder on Computer**
- ▶ **Remote Reception**
- ▶ **Rejecting Fax Reception**
- ▶ **Using Caller ID Service to Reject Calls**

Saving Received Faxes Automatically on USB Flash Drive

You can save received faxes on a USB flash drive as PDF files automatically when receiving a fax.

This section describes the procedure to enable the printer to save received faxes on a USB flash drive automatically.

▶▶▶ Important

- Do not remove the USB flash drive from the printer when the printer is set to save received faxes on a USB flash drive automatically.
- For safety reasons, we recommend backing up faxes saved on a USB flash drive to another media periodically to avoid unexpected accidents.
- We assume no responsibility for damage to or loss of data for whatever reason even within the warranty period.
- **Awaiting document processing.** is displayed on the Fax standby screen and the faxes are stored in the printer's memory when the received faxes are not saved on the USB flash drive because the USB flash drive is not inserted or because it is not writable.

You can save the faxes stored in the printer's memory to the USB flash drive manually. Delete the unnecessary fax from printer's memory after saving to the USB flash drive.

- [Saving Document in Printer's Memory to USB Flash Drive](#)
- [Deleting Document in Printer's Memory](#)

1. [Make sure that printer is turned on.](#)
2. [Insert USB flash drive into USB flash drive port.](#)

3. Flick HOME screen, and then tap  **Setup**.

- [Using the Operation Panel](#)

4. Tap  **Device settings**.

5. Tap **FAX settings**.

6. Tap **Auto save setting**.

7. Tap **ON**.

8. Tap **USB flash drive**.

▶▶▶ Note

- You can save up to 250 pages of fax as one PDF file.
- You can save up to 2000 PDF files on a USB flash drive.

- If the USB flash drive is removed or becomes full while saving faxes is in progress, the error message is displayed on the touch screen. Tap **OK** to dismiss the error.
- The folder and file name of faxes saved on the USB flash drive is as follows:
 - Folder name: CANON_SC\FAXDOC\0001
 - File name (file extension: PDF): Running numbers, starting from FAX_0001
 - File date: The date and time of saving as set in the printer.

For details on how to set the date and time:

■ [Setting Date and Time](#)

- When removing the USB flash drive, set **Auto save setting** to **OFF**.

Forwarding Received Faxes Automatically to Shared Folder on Computer

You can forward received faxes to the shared folder on the computer as PDF files automatically.

This section describes the procedure to enable the printer to forward received faxes to the shared folder on the computer automatically.

▶▶▶ Important

- Do not disconnect the printer with the computer when the printer is set to forward received faxes to the shared folder on the computer automatically.
- We assume no responsibility for damage to or loss of data for whatever reason even within the warranty period.
- **Awaiting document processing.** is displayed on the Fax standby screen and the faxes are stored in the printer's memory when the received faxes are not forward to the shared folder because the printer is not connected with the computer or because the shared folder setting is changed.
- You can forward the faxes stored in the printer's memory to the shared folder on the computer manually. Delete the unnecessary fax from printer's memory after forwarding to the shared folder.

■ [Forwarding Document in Printer's Memory to Shared Folder on Computer](#)

■ [Deleting Document in Printer's Memory](#)

▶▶▶ Note

- Register the destination folder using Quick Utility Toolbox in advance.

For details on how to register the destination folder:

- For Windows:

■ [Destination Folder Settings](#)

- For Mac OS:

■ [Destination Folder Settings](#)

1. [Make sure that printer is turned on.](#)
2. Make sure that printer is connected with destination computer.

3. Flick HOME screen, and then tap  **Setup.**

■ [Using the Operation Panel](#)

4. Tap  **Device settings.**

5. Tap **FAX settings.**

6. Tap **Auto save setting.**

7. Tap **ON**.

8. Tap **Destination folder**.

9. Select a shared folder.

▶▶▶ Note

- When you specify a PIN code for a registered folder, a screen asking you to enter a PIN code is displayed. Entering the PIN code allows you to assign the shared folder as the destination.

▶▶▶ Note

- You can forward up to 250 pages of fax as one PDF file.
- You can forward up to 2000 PDF files to the shared folder on the computer.
- If the printer is disconnected with the computer or if the writing error occurs on the computer while saving faxes is in progress, the error message is displayed on the touch screen. Tap **OK** to dismiss the error.
- The faxes forwarded to the shared folder are named with the serial number from FAX_0001 (file extension: PDF).
- When disconnecting the printer with the computer, set **Auto save setting** to **OFF**.

Remote Reception

If the printer is located away from the telephone, pick up the handset of the telephone connected to the printer and dial 25 (the remote reception ID) to receive faxes (remote reception).

- If you use a rotary pulse line, temporarily switch your telephone to tone dialing. For details on how to switch to tone dialing, refer to your telephone's instruction manual.
- If you have an answering machine connected to the printer that can carry out remote control operations, the security code for this function may be the same as the remote reception ID. In this case, change the remote reception ID in **Remote RX ID** in **Remote RX** in **Advanced FAX settings** under **FAX settings**.

■ [Advanced FAX settings](#)

Remote reception can be disabled.

Rejecting Fax Reception

You can set the printer to reject faxes with no sender information or those from specific senders.

Select one of the following conditions to reject faxes.

- Faxes with no caller identification.
- Faxes from senders not registered in the printer's directory.
- Faxes from senders registered in the printer as rejected numbers.

Select a fax rejection condition following the procedure below.

1. [Make sure that printer is turned on.](#)

2. Flick HOME screen, and then tap  **Setup**.

 [Using the Operation Panel](#)

3. Tap  **Device settings**.

4. Tap **FAX settings**.

5. Tap **Security control**.

6. Tap **FAX reception reject**.

7. Tap **ON**.

8. Select a condition of rejecting fax reception.

No sender info.

Rejects faxes with no caller identification.

Not in directory

Rejects faxes from the senders not registered in the printer's directory.

Rejected numbers

Rejects faxes from the senders registered in the printer as rejected numbers.

For details on how to register the rejected number, see [Registering Rejected Number](#).

Note

- When the printer rejects reception, **Reception rejected.** is displayed on The Fax standby screen.
- Faxes with no caller identification are also rejected when the setting other than **No sender info.** is selected.

Registering Rejected Number

Register the rejected number following the procedure below.

1. When confirmation screen to register rejected number is displayed, tap **Yes**.
2. Select a registration number.
3. Select a registration method.
4. Register rejected number.

Register the rejected number depending on the registration method.

- **By entering the number**

When you select this registration method, the screen to register the fax/telephone number is displayed.

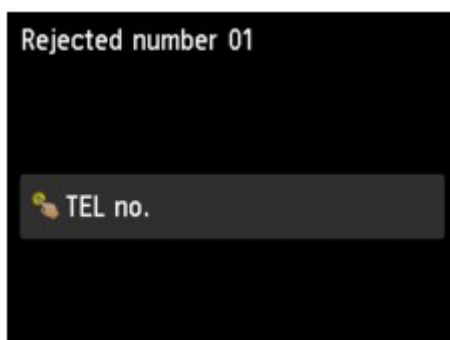

Tap the entry field of fax/telephone numbers to display the screen to enter the fax/telephone number. Enter the fax/telephone number you want to register, and then tap **OK**.

- **From outgoing call log**

When you select this registration method, the screen to select the fax/telephone number from the outgoing call logs is displayed.



Tap a fax/telephone number you want to register.

- **From incoming call log**

When you select this registration method, the screen to select the fax/telephone number or the name from the incoming call logs is displayed.



Tap a fax/telephone number or a name you want to register.

▶▶▶ **Note**

- This registration method may not be available depending on the country or region of purchase.

5. Tap **Register** to finalize registration.

▶▶▶ **Note**

- To register another rejected number, select another registration number, and then register the rejected number.
You can register up to 10 rejected numbers.
- You can print the list of rejected numbers (REJECTED NUMBER LIST).
[■ Summary of Reports and Lists](#)
- To change the registered rejected number:
 1. Select a registered rejected number you want to change.
 2. Tap **Edit**.
 3. Tap entry field of fax/telephone numbers.
The screen to change the registered rejected number is displayed.
 4. Change registered rejected number in same procedure when you register.
 5. Finalize registration in same procedure when you register.
- To delete the registered rejected number:
 1. Select a registered rejected number you want to delete.
 2. Tap **Delete**.
The confirmation screen is displayed.
 3. Tap **Yes**.
- You can also register the rejected number by tapping **Function list** on the Fax standby screen, and then selecting **Rejected numbers** under **TEL number registration**.

Using Caller ID Service to Reject Calls

If you subscribe to the Caller ID service, the printer detects the sender's Caller ID. If the sender's ID matches the condition specified in this setting, the printer rejects the phone call or fax reception from the sender.

▶▶ Note

- This setting may not be supported depending on the country or region of purchase.
Contact your telephone company to confirm whether it provides this service.

Specify the setting following the procedure below.

1. [Make sure that printer is turned on.](#)

2. Flick HOME screen, and then tap  **Setup**.

 [Using the Operation Panel](#)

3. Tap  **Device settings**.

4. Tap **FAX settings**.

5. Tap **Security control**.

6. Tap **Caller rejection**.

7. Tap **Yes**.

The **Caller rejection conditions** screen is displayed.

8. Specify rejection conditions.

Tap a setting item and select **Accept** or **Reject**.

Anonymous no.

Selects whether to reject a phone call or fax reception from an anonymous number.

Out of area no.

Selects whether to reject a phone call or fax reception out of the subscribed service area.

Rejected numbers

Selects whether to reject a phone call or fax reception from the specified numbers.

9. Tap **OK** to finish specifying rejection conditions.

If you select **Reject** for **Rejected numbers**, **Register rejected numbers?** is displayed on the touch screen. Tap **Yes**, and then register the rejected number.

For details on how to register the rejected number, see [Registering Rejected Number](#).

»» Note

- Even if you select **Reject**, the printer rings once.

(The printer may not ring depending on the country or region of purchase.)

Other Useful Fax Functions

- ▶ **Using Information Services**
- ▶ **Transmission/Reception of Faxes Using ECM**
- ▶ **Document Stored in Printer's Memory**
- ▶ **Summary of Reports and Lists**

Using Information Services

You can use various information services such as provided by banks, and make airline reservations or hotel reservations. Since these services require tone dialing to use their services, you need to temporarily switch to tone dialing if your printer is connected to a rotary pulse line.

- [Using Touch Tone Line](#)
- [Using Rotary Pulse Line](#)

▶▶▶ Important

- You may need to contract with the service providers for some information services. For details, contact the service providers.

Using Touch Tone Line

- **Dialing by Using the On Hook Dial Function**

▶▶▶ Note



- You can use the on hook dial function only when **Hook key setting** in **Security control** under **FAX settings** is set to **Enable**.
 - [Security control](#)

1. [Make sure that printer is turned on.](#)

2. Flick HOME screen, and then tap  **FAX**.

- [Using the Operation Panel](#)

The Fax standby screen is displayed.

3. Tap .
4. Dial number of information service.
5. When recorded message for information service answers, tap numbers using Numeric key in accordance with message.
6. Tap  to finish using service.

- **Dialing by Using the Telephone Connected to the Printer**

1. [Make sure that printer is turned on.](#)

2. Flick HOME screen, and then tap  **FAX**.

- [Using the Operation Panel](#)

The Fax standby screen is displayed.

3. Lift handset of telephone.
4. Use telephone to dial number of information service.

5. When recorded message for information service answers, use telephone to press numbers in accordance with message.
6. Hang up handset to finish using service.

Using Rotary Pulse Line

• Dialing by Using the On Hook Dial Function

▶▶▶ Note

- You can use the on hook dial function only when **Hook key setting** in **Security control** under **FAX settings** is set to **Enable**.



■ [Security control](#)

1. [Make sure that printer is turned on.](#)

2. Flick HOME screen, and then tap  **FAX**.

■ [Using the Operation Panel](#)

The Fax standby screen is displayed.

3. Tap .
4. Dial number of information service.
5. When recorded message for information service answers, tap Tone key to switch to tone dialing.
6. Tap numbers using Numeric key in accordance with message.
7. Tap  to finish using service.

• Dialing by Using the Telephone Connected to the Printer

1. [Make sure that printer is turned on.](#)

2. Flick HOME screen, and then tap  **FAX**.

■ [Using the Operation Panel](#)

The Fax standby screen is displayed.

3. Lift handset of telephone.
4. Use telephone to dial number of information service.
5. When recorded message for information service answers, use telephone to switch to tone dialing.
When you dial the number of the information service using the telephone connected to the printer, you cannot use the printer to switch to tone dialing. For instructions on how to switch to tone dialing, refer to your telephone's instruction manual.
6. Use telephone to press numbers in accordance with message.
7. Hang up handset to finish using service.

Transmission/Reception of Faxes Using ECM

This printer is set to send/receive faxes in Error Correction Mode (ECM). If the recipient's fax device is compatible with ECM, ECM automatically corrects errors and resends the fax.

»» Note

- If the sender's or recipient's fax device is not compatible with ECM, the fax will be sent/received without automatic error correction.
- To receive color faxes, make sure that **ECM RX** in **Adv. communication settings** in **Advanced FAX settings** under **FAX settings** is set to **ON**.

■ [Advanced FAX settings](#)

To disable ECM transmission/reception, set **ECM TX** and **ECM RX** in **Adv. communication settings** to **OFF**.

- Transmission may take longer when ECM is enabled.

Document Stored in Printer's Memory

If the sending faxes is not complete or the printer was not able to print the received faxes, these faxes are stored in the printer's memory.

If an error occurred during a fax transmission, the document is not stored in the printer's memory.

In the following cases, the printer is not able to print the received fax and will automatically store the fax in its memory.

- The amount of remaining ink is insufficient to print a fax.
- Paper has run out.
- A different size of paper from that specified by **Page size** in **FAX paper settings** is loaded.
- **Do not print** is selected for **Received documents** in **Auto print settings** under **FAX settings**.
- You pressed the **Stop** button to cancel printing of a received fax.

►► Important

- If you unplug the power cord of the printer, all faxes stored in the printer's memory are deleted.
For details on how to unplug the power cord, refer to [Unplugging the Machine](#).

You can print or delete the faxes stored in the printer's memory. You can also save the received faxes stored in the printer's memory on the USB flash drive or forward the received faxes stored in the printer's memory to the shared folder on the computer.

- To print a document in the printer's memory:
 - [Printing Document in Printer's Memory](#)
- To delete a document in the printer's memory:
 - [Deleting Document in Printer's Memory](#)
- To save a document on a USB flash drive
 - [Saving Document in Printer's Memory to USB Flash Drive](#)
- To forward a document to the shared folder on the computer
 - [Forwarding Document in Printer's Memory to Shared Folder on Computer](#)

►► Note

- When confirming, printing, or deleting a document stored in the printer's memory, you specify it by its transaction number. If you do not know the transaction number for your target document, print the list of documents (MEMORY LIST) first.
For details on how to print MEMORY LIST, see [Printing Document in Printer's Memory](#).

Printing Document in Printer's Memory

You can print a specified document in the printer's memory or print all the received documents in its memory at a time.

When printing a specified document, you specify it by its transaction number. If you do not know the transaction number for your target document, print the list of documents (MEMORY LIST) first.

1. [Make sure that printer is turned on.](#)
2. [Load paper.](#)

3. Flick HOME screen, and then tap  **FAX**.

■ [Using the Operation Panel](#)

The Fax standby screen is displayed.

4. Tap **Function list**.

The **Function list** screen is displayed.

5. Tap **Memory reference**.

The memory list is displayed.



A. Date and time of transaction and fax/telephone number

B. Transaction number (TX/RX NO.)

A transaction number from "0001" to "4999" indicates a document being sent.

A transaction number from "5001" to "9999" indicates a document being received.

C. Color information

Color is displayed for color transmission/reception. Nothing is displayed for black & white transmission/reception.

▶▶ Note

- If no document is stored in the printer's memory, **There is no document in memory.** is displayed. Tap **OK** to return to the previous screen.

6. Select a print menu.

- To print the memory list (MEMORY LIST):

You can print a list of the documents in the printer's memory by tapping **Print doc. list**.

When the print confirmation screen is displayed, tap **Yes**. The printing starts.

MEMORY LIST shows the transaction number of the unsent or unprinted fax (TX/RX NO.), transaction mode, recipient's number, and the date and time of the transaction.

A transaction number from "0001" to "4999" on MEMORY LIST indicates a document being sent. A transaction number from "5001" to "9999" on MEMORY LIST indicates a document being received.

- To specify a document to print:

Select a document to print on the **Memory list** screen, tap **Print specified document**.

▶▶▶ Note

- If the specified document is not stored in the printer's memory, **There is no document that can be printed.** is displayed. Tap **OK** to return to the previous screen.

The confirmation screen to select whether to print only the first page of the document is displayed.

If you select **Yes**, only the first page of the document will be printed. The document is still stored in the printer's memory.

If you select **No**, all pages of the document will be printed. The screen to confirm whether to delete the printed document in the printer's memory is displayed after printing.

- To print all the received documents stored in the printer's memory:

Tap **Batch process**, and then tap **Print all RX documents**.

When the print confirmation screen is displayed, tap **Yes**. All the documents in the printer's memory are printed.

Each time a document is printed, the screen to confirm whether to delete the printed document in the printer's memory is displayed.

If you tap **Yes**, the printed document in the printer's memory is deleted.

Deleting Document in Printer's Memory

You can delete a specified document in the printer's memory or delete all the documents in its memory at a time.

▶▶▶ Note

- When deleting a specified document, you specify it by its transaction number. If you do not know the transaction number for your target document, print the list of documents (MEMORY LIST) first.

■ [Printing Document in Printer's Memory](#)

1. [Make sure that printer is turned on.](#)



2. Flick HOME screen, and then tap **FAX**.

■ [Using the Operation Panel](#)

The Fax standby screen is displayed.

3. Tap **Function list**.

The **Function list** screen is displayed.

4. Tap **Memory reference**.

The memory list is displayed.



A. Date and time of transaction and fax/telephone number

B. Transaction number (TX/RX NO.)

A transaction number from "0001" to "4999" indicates a document being sent.

A transaction number from "5001" to "9999" indicates a document being received.

C. Color information

Color is displayed for color transmission/reception. Nothing is displayed for black & white transmission/reception.

▶▶▶ Note

- If no document is stored in the printer's memory, **There is no document in memory.** is displayed. Tap **OK** to return to the previous screen.

5. Select a delete menu.

- To specify a document to delete:

Select a document to delete on the **Memory list** screen, tap **Delete specified doc..**

»» Note

- If the specified document is not stored in the printer's memory, **There is no document that can be deleted.** is displayed. Tap **OK** to return to the previous screen.

The confirmation screen is displayed.

If you select **Yes**, the specified document is deleted from printer's memory.

- To delete all documents stored in the printer's memory:

Tap **Batch process**, and then tap **Delete all documents**.

The confirmation screen is displayed.

If you select **Yes**, all documents are deleted from printer's memory.

Saving Document in Printer's Memory to USB Flash Drive

You can save the received faxes stored in the printer's memory to the USB flash drive as PDF files using the operation panel of the printer.

You can save a specified document in the printer's memory to the USB flash drive or save all the documents in its memory to the USB flash drive at a time.

▶▶▶ Important

- Do not remove the USB flash drive from the printer until saving is complete.
- For safety reasons, we recommend backing up faxes saved on a USB flash drive to another media periodically to avoid unexpected accidents.
- We assume no responsibility for damage to or loss of data for whatever reason even within the warranty period.

▶▶▶ Note

- When saving a specified document, you specify it by its transaction number. If you do not know the transaction number for your target document, print the list of documents (MEMORY LIST) first.
 - [Printing Document in Printer's Memory](#)
- After saving the fax in the printer's memory to the USB flash drive, the fax is still stored in the printer's memory.

For details on how to delete the fax in the printer's memory, see [Deleting Document in Printer's Memory](#).

1. [Make sure that printer is turned on.](#)
2. [Insert USB flash drive into USB flash drive port.](#)

3. Flick HOME screen, and then tap  **FAX**.

- [Using the Operation Panel](#)

The Fax standby screen is displayed.

4. Tap **Function list**.

The **Function list** screen is displayed.
5. Tap **Memory reference**.

The memory list is displayed.



A. Date and time of transaction and fax/telephone number

B. Transaction number (TX/RX NO.)

A transaction number from "0001" to "4999" indicates a document being sent.

A transaction number from "5001" to "9999" indicates a document being received.

C. Color information

Color is displayed for color transmission/reception. Nothing is displayed for black & white transmission/reception.

»» Note

- If no document is stored in the printer's memory, **There is no document in memory.** is displayed. Tap **OK** to return to the previous screen.

6. Select a save menu.

- To specify a document to save on the USB flash drive:

Select a document to save on the **Memory list** screen, tap **Save specified document**.

»» Note

- If the specified document is not stored in the printer's memory, **There is no document that can be saved.** is displayed. Tap **OK** to return to the previous screen.

Tap **USB flash drive** as the destination. The specified document is saved on the USB flash drive.

- To save all the received documents stored in the printer's memory on the USB flash drive:

Tap **Batch process**, and then tap **Save all RX documents**.

Tap **USB flash drive** as the destination. All documents are saved on the USB flash drive.

»» Note

- You can save up to 250 pages of fax as one PDF file.
- You can save up to 2000 PDF files on a USB flash drive.
- Faxes are saved according to the order of the transaction number when **Save all RX documents** is selected.
- If the USB flash drive is removed or becomes full while saving faxes is in progress, the error message is displayed on the touch screen. Tap **OK** to dismiss the error.
- The folder and file name of faxes saved on the USB flash drive is as follows:
 - Folder name: CANON_SC\FAXDOC\0001
 - File name (file extension: PDF): Running numbers, starting from FAX_0001

- File date: The date and time of saving as set in the printer.

For details on how to set the date and time:

■ [Setting Date and Time](#)

Forwarding Document in Printer's Memory to Shared Folder on Computer

You can forward the received faxes stored in the printer's memory to the shared folder on the computer as PDF files using the operation panel of the printer.

You can forward a specified document in the printer's memory to the shared folder on the computer or forward all the documents in its memory to the shared folder on the computer at a time.

▶▶▶ Important

- Do not disconnect the printer with the computer when the printer forwards received faxes to the shared folder on the computer.
- We assume no responsibility for damage to or loss of data for whatever reason even within the warranty period.

▶▶▶ Note

- Register the destination folder using Quick Utility Toolbox in advance.

For details on how to register the destination folder:

- For Windows:
 - Destination Folder Settings
- For Mac OS:
 - Destination Folder Settings
- When forwarding a specified document, you specify it by its transaction number. If you do not know the transaction number for your target document, print the list of documents (MEMORY LIST) first.
 - [Printing Document in Printer's Memory](#)
- After forwarding the fax in the printer's memory to the shared folder on the computer, the fax is still stored in the printer's memory.

For details on how to delete the fax in the printer's memory, see [Deleting Document in Printer's Memory](#).

1. [Make sure that printer is turned on.](#)
2. Make sure that printer is connected with destination computer.

3. Flick HOME screen, and then tap  **FAX**.

- [Using the Operation Panel](#)

The Fax standby screen is displayed.

4. Tap **Function list**.

The **Function list** screen is displayed.

5. Tap **Memory reference**.

The memory list is displayed.



A. Date and time of transaction and fax/telephone number

B. Transaction number (TX/RX NO.)

A transaction number from "0001" to "4999" indicates a document being sent.

A transaction number from "5001" to "9999" indicates a document being received.

C. Color information

Color is displayed for color transmission/reception. Nothing is displayed for black & white transmission/reception.

►►► **Note**

- If no document is stored in the printer's memory, **There is no document in memory.** is displayed. Tap **OK** to return to the previous screen.

6. Select a forward menu.

- To specify a document to forward to the shared folder on the computer:

Select a document to forward on the **Memory list** screen, tap **Save specified document**.

►►► **Note**

- If the specified document is not stored in the printer's memory, **There is no document that can be forwarded.** is displayed. Tap **OK** to return to the previous screen.

Tap **Destination folder** as the destination.

Tap a destination folder to forward the specified document to the shared folder on the computer.

►►► **Note**

- When you specify a PIN code for a registered folder, a screen asking you to enter a PIN code is displayed. Entering the PIN code allows you to assign the shared folder as the destination.

- To forward all the received documents stored in the printer's memory to the shared folder on the computer:

Tap **Batch process**, and then tap **Save all RX documents**.

Tap **Destination folder** as the destination.

Tap a destination folder to forward all documents to the shared folder on the computer.

»» Note

- When you specify a PIN code for a registered folder, a screen asking you to enter a PIN code is displayed. Entering the PIN code allows you to assign the shared folder as the destination.

»» Note

- You can forward up to 250 pages of fax as one PDF file.
- You can forward up to 2000 PDF files on a USB flash drive.
- Faxes are forwarded according to the order of the transaction number when **Save all RX documents** is selected.
- If the printer is disconnected with the computer or if the writing error occurs on the computer while forwarding faxes is in progress, the error message is displayed on the touch screen. Tap **OK** to dismiss the error.
- The faxes forwarded to the shared folder are named with the serial number from FAX_0001 (file extension: PDF).



Summary of Reports and Lists

The printer prints the report of sending or receiving a fax automatically. You can print the list of the fax/ telephone number or the current settings.

- [Type of Reports and Lists](#)
- [Printing Report or List](#)

Type of Reports and Lists

Report or List	Description
ACTIVITY REPORT	<p>Shows recent fax transactions at sight.</p> <ul style="list-style-type: none"> • You can print ACTIVITY REPORT manually. <p>For details on the procedure to print, see Printing Report or List.</p> <ul style="list-style-type: none"> • The * (asterisk) is appended to the history already printed on ACTIVITY REPORT. • If you select Print for Activity report in Auto print settings under FAX settings, the printer prints ACTIVITY REPORT for the 20 histories of sent and received faxes automatically. <p>■ Auto print settings</p>
Directory list <ul style="list-style-type: none"> • RECIPIENT TELEPHONE NUMBER LIST • GROUP DIAL TELEPHONE NO. LIST 	<p>Lists the numbers and names registered.</p> <p>You can print the lists of the recipient and group dial.</p> <p>For details on the procedure to print, see Printing Report or List.</p>
USER'S DATA LIST	<p>Lists the current settings of the printer and the registered sender information.</p> <p>For details on the procedure to print, see Printing Report or List.</p>
MEMORY LIST	<p>Lists the documents currently stored in the printer's memory.</p> <p>For details on the procedure to print, see Printing Report or List.</p> <p>▶▶▶ Note</p> <ul style="list-style-type: none"> • After selecting Memory reference to display the Memory list screen, you can print MEMORY LIST by tapping Print doc. list. <p>■ Printing Document in Printer's Memory</p>
REJECTED NUMBER LIST	<p>Lists the rejected numbers.</p> <p>For details on the procedure to print, see Printing Report or List.</p>
CALLER HISTORY	<p>Lists the caller history.</p> <p>This list is available when Caller ID service is subscribed.</p> <p>For details on the procedure to print, see Printing Report or List.</p> <p>This list may not be supported depending on the country or region of purchase.</p>

TX REPORT/ERROR TX REPORT	<p>Either of these reports is printed after each fax transmission.</p> <ul style="list-style-type: none"> At the time of purchase, ERROR TX REPORT is set to be printed only when a transmission error occurred. <p>You can set the printer to print TX REPORT each time it sends a document, or disable printing of the report by selecting TX report in Auto print settings under FAX settings.</p> <p>You can also specify the print setting so that the first page of the fax is printed along with the report.</p> <p> Auto print settings</p> <p> Note</p> <hr/> <ul style="list-style-type: none"> The first page of the fax is not printed in color transmission. <ul style="list-style-type: none"> MULTI TRANSMISSION REPORT is printed after sequential broadcasting of a document. If an error occurs when you send a fax, the error number is printed on ERROR TX REPORT (there are some errors for which the cause is also printed). <p>For details on the error number, see Errors When You Send Fax.</p>
MULTI TRANSMISSION REPORT	<p>This report is printed after sequential broadcasting of a document.</p> <p>Confirms whether the transmission to all the recipients has been completed successfully.</p> <p>The procedure to print and the error number is same as TX REPORT.</p>
RX REPORT	<p>This report is printed after each fax reception.</p> <ul style="list-style-type: none"> At the time of purchase, the printer is set so that RX REPORT is not printed at all. <p>You can set the printer to print RX REPORT each time it receives a document, or only when an error occurs by selecting RX report in Auto print settings under FAX settings.</p> <p> Auto print settings</p> <ul style="list-style-type: none"> If an error occurs when you receive a fax, the error number is printed on RX REPORT (there are some errors for which the cause is also printed). <p>For details on the error number, see Errors When You Receive Fax.</p>
MEMORY CLEAR REPORT	<p>Lists the deleted faxes in the printer's memory if the faxes stored in the printer's memory are deleted by a power failure or unplugging the power cord.</p> <p>When the printer is turned on, The power cord has been unplugged and unsent/received docs in memory have been lost. Load paper and tap [OK] to print a list of the lost docs. is displayed on the touch screen. MEMORY CLEAR REPORT is printed by tapping OK on the touch screen.</p>

Printing Report or List

This section describes the procedure to print the report or the list manually.

Print the following report or list manually.

- ACTIVITY REPORT
- Directory list (RECIPIENT TELEPHONE NUMBER LIST/GROUP DIAL TELEPHONE NO. LIST)
- USER'S DATA LIST
- MEMORY LIST
- REJECTED NUMBER LIST
- CALLER HISTORY

►► Note

- CALLER HISTORY may not be supported depending on the country or region of purchase.

1. [Make sure that printer is turned on.](#)

2. [Load paper.](#)

3. Flick HOME screen, and then tap  **FAX**.

■ [Using the Operation Panel](#)

The Fax standby screen is displayed.

4. Tap **Function list**.

The **Function list** screen is displayed.

5. Tap **Print reports/lists**.

6. Select a report or a list you want to print to start printing.

- When you select **Directory list**:

Select **Recipient** or **Group dial**.

If you select **Recipient**, select whether to print RECIPIENT TELEPHONE NUMBER LIST in alphabetical order. If you select **Yes**, the printer prints RECIPIENT TELEPHONE NUMBER LIST in alphabetical order. If you select **No**, the printer prints RECIPIENT TELEPHONE NUMBER LIST in numerical order.

If you select **Group dial**, the confirmation screen is displayed. Select **Yes**. The printer prints GROUP DIAL TELEPHONE NO. LIST.

- When you select an item other than **Directory list**:

Select **Yes** when the confirmation screen is displayed.



The printer prints the selected report or list.

Errors When You Send Fax

If an error occurs when you send a fax, the error number is printed on ERROR TX REPORT or ACTIVITY REPORT (there are some errors for which the cause is also printed).

The causes corresponding to the error numbers are as follows.

No.	Cause	Action
#001	Document is jammed in the ADF.	The document is jammed in the ADF. When the error is cleared, redo the operation.

#003	Document is too long.	You attempted to send a document longer than 15.75 inches / 400 mm. You cannot send a document longer than 15.75 inches / 400 mm from the ADF. "#003" is also printed if it takes time to send a page. Divide the document or set the image quality (Fax resolution) to a lower setting, and then resend it.
#005	No answer.	The recipient's fax device does not respond. Contact the recipient and have the recipient check that the telephone line is connected correctly.
#012	No paper is in the recipient's fax device.	There is no paper in the recipient's fax device. Contact the recipient and have the recipient load paper.
#017	No tone is detected.	The printer could not detect the dial tone. Dial tone detect in Advanced FAX settings under FAX settings is set to ON . Set to OFF .  Advanced FAX settings
#018	Line was busy.	The fax/telephone number you dialed is busy. Try dialing again after waiting for a moment.
#022	Number is deleted.	The fax/telephone number registered in the printer's directory is incorrect. Check the recipient's fax/telephone number, correct the fax/telephone number registered in the printer's directory, and then send the document again.  Changing Registered Information
#037	Memory is full.	The printer could not send a fax because its memory is full. Delete contents in memory, and then send a fax again.  Document Stored in Printer's Memory
#059	Transmission has been canceled due to a fax information mismatch.	Transmission has been canceled because the printer could not detect the recipient's fax device information or the information did not match the dialed number. This message is displayed when Check RX FAX information in Security control under FAX settings is set to ON . For details, see Sending Faxes after Checking Information (Checking Recipient's Information) .
#085	Try again in black & white transmission.	The recipient's fax device is not color-compatible. Resend the document in black & white.
#099	The Stop button was pressed during transmission.	The Stop button was pressed to cancel transmission of the document. Resend it if necessary.
#412	The fax could not be sent from the computer.	The fax could not be sent from the computer. Ensure that the printer is connected with the computer correctly and redo operation.
#995	The unsent fax was deleted while automatic redialing.	While automatic redialing, the unsent fax is stored in the printer's memory temporarily until the sending fax is complete. If a power failure occurs or you unplug the power

	cord before automatic redialing is complete, all faxes stored in the printer's memory are deleted and not sent. Resend the document.
--	---

Errors When You Receive Fax

If an error occurs when you receive a fax, the error number is printed on RX REPORT or ACTIVITY REPORT (there are some errors for which the cause is also printed).

The causes corresponding to the error numbers are as follows.

No.	Cause	Action
#003	It takes too long to receive a page.	Contact the sender and have the sender divide the fax or set the image quality (Fax resolution) to a lower setting and resend it.
#005	No answer.	When receiving a fax manually, the printer could not detect the signals from the sender's fax device. Contact the sender and have the sender resend it, or set the printer to receive the fax automatically.
#037	Memory is full.	The printer could not receive a fax because its memory is full. Delete contents in memory, and then ask the sender to resend the fax. See Document Stored in Printer's Memory .
#046	Reception has been rejected due to the specified fax rejection condition.	Reception has been rejected because the fax matches the fax rejection condition specified by FAX reception reject in Security control under FAX settings . For details, see Rejecting Fax Reception .
#099	The Stop button was pressed during reception.	The Stop button was pressed to cancel reception of the fax. Contact the sender and have the sender resend it if necessary.
#995	The received fax was deleted.	The received fax was deleted before being saved to the USB flash drive, forwarded to the shared folder on the computer, or printed. Contact the sender and have the sender resend it if necessary.

Sending Faxes from Computer (Windows)

- ▶ **Sending a FAX (Fax Driver)  Basic**
- ▶ **Creating an Address Book (Fax Driver)**
- ▶ **Edit or Remove a Recipient from an Address Book (Fax Driver)**
- ▶ **Search for a Recipient in an Address Book (Fax Driver)**
- ▶ **Cannot Send Faxes from Computer**
- ▶ **How to Open the Setting Screen of the Fax Driver**
- ▶ **General Notes (Fax Driver)**

Sending a FAX (Fax Driver)

You can send faxes using the fax driver from applications that support document printing.

►►► Note

- Only black and white transmission is supported.

1. Make sure that the machine is turned on.
2. Open the document you want to fax with an application (such as Notepad), and then click the Print command. (The command is **Print...** on the **File** menu.)
3. In **Select Printer** or **Name** in the **Print** dialog box, select **Canon XXX series FAX** (where "XXX" is the model name).
4. Click **Print** or **OK**.

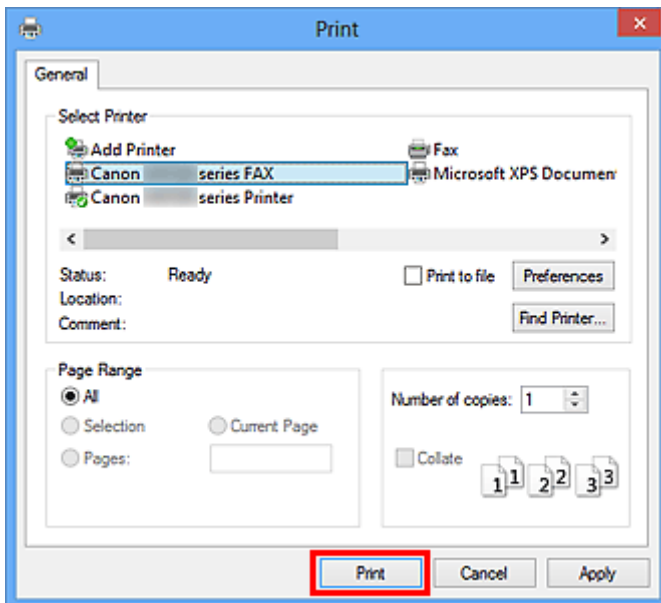

* **Print** dialog box in Notepad

►►► Note

- Click **Preferences** or **Properties** in the **Print** dialog box to open the print settings dialog box of the fax driver in which you can set the paper size and print orientation. For details on how to open the print settings dialog box of the fax driver, see "[How to Open the Setting Screen of the Fax Driver.](#)"

5. Click **Display Address Book...** in **Set Recipient** in the **Send FAX** dialog box.

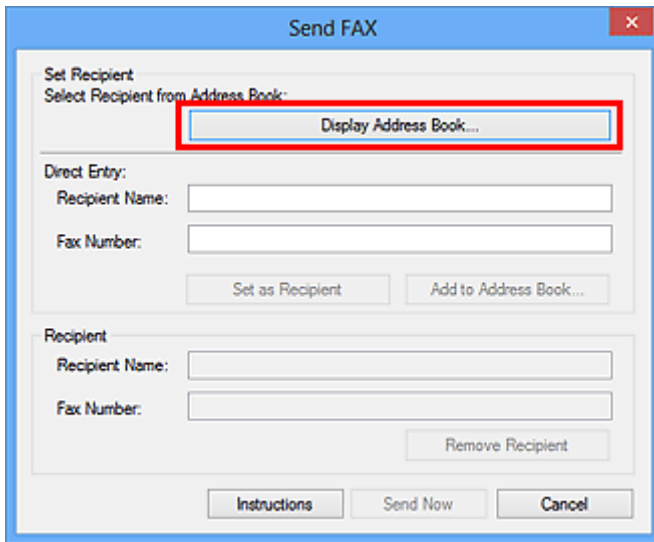

6. Select a recipient from **Recipient Name** in the **Select Recipient from Address Book** dialog box, then click **Set as Recipient**.

The selected recipient is reflected in **Recipient** in the **Send FAX** dialog box.

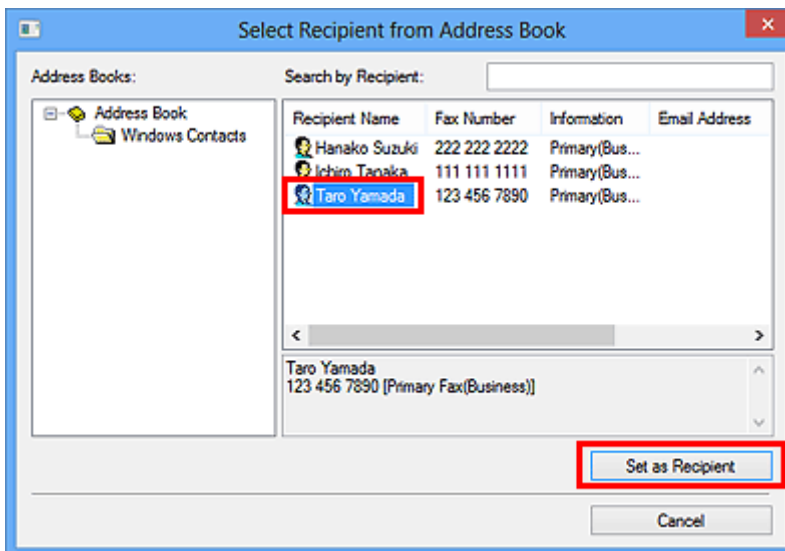

▶▶▶ Important

- You cannot specify a recipient if there is no recipient registered in the address book. Register the recipient in the address book and reopen the address book.
For details on how to register recipients in the address book, see "[Creating an Address Book \(Fax Driver\)](#)."
- If the recipient's fax/telephone number is entered incorrectly or the registered fax/telephone number is incorrect, the fax may be sent to an unexpected recipient. When sending an important fax, it is recommended that you send it after confirming the entered information and recipient's status.

»» Note

- You can also specify **Recipient** by entering the **Recipient Name** and **Fax Number** in **Direct Entry** in the **Send FAX** dialog box and then clicking **Set as Recipient**.
 - For details on valid characters, see "[General Notes \(Fax Driver\)](#)."
 - You can send faxes even if only the **Fax Number** is entered.
 - You can register the recipient you entered to the address book by clicking **Add to Address Book...** For details on how to register recipients in the address book, see "[Creating an Address Book \(Fax Driver\)](#)."
- Add the outside line access number before the fax number as needed.
(Example: When the outside line access number is "0" and the fax number is "XXX-XXXX", enter "0XXX-XXXX".)

7. Click **Send Now**.

When a confirmation message is displayed, click **OK**.

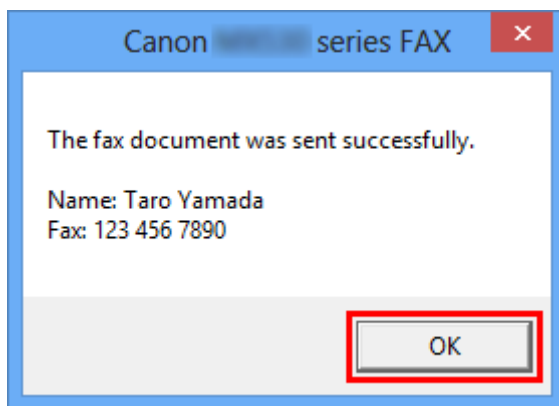

»» Important

- If you cannot send a fax due to line failure or other problem, see "[Cannot Send Faxes from Computer](#)."

Canceling Transmission

If you click **Send Now** in the **Send FAX** dialog box, the printer icon is displayed in the taskbar. Double-click this icon to display the list of fax jobs awaiting transmission or being sent.

Right-clicking a job and selecting **Cancel** stops transmission.

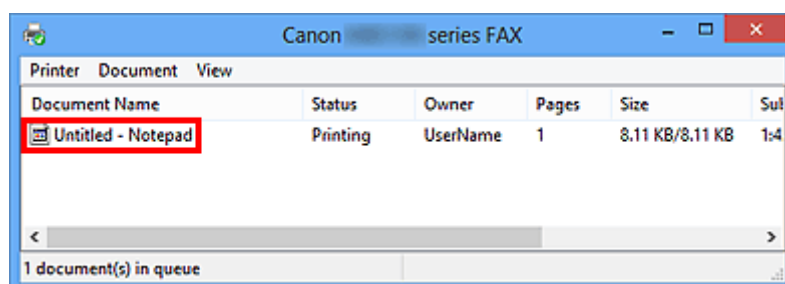

Creating an Address Book (Fax Driver)

By using the address book, you can send a fax by simply specifying a recipient from it.

You can register the recipient's name, fax number and other information in the address book.

Registering a recipient (WAB contact) in the address book

You can register an individual recipient (Contact) in the address book.

1. [Open the print settings dialog box of the fax driver.](#)
2. Click **Address Book...** in the displayed dialog box.

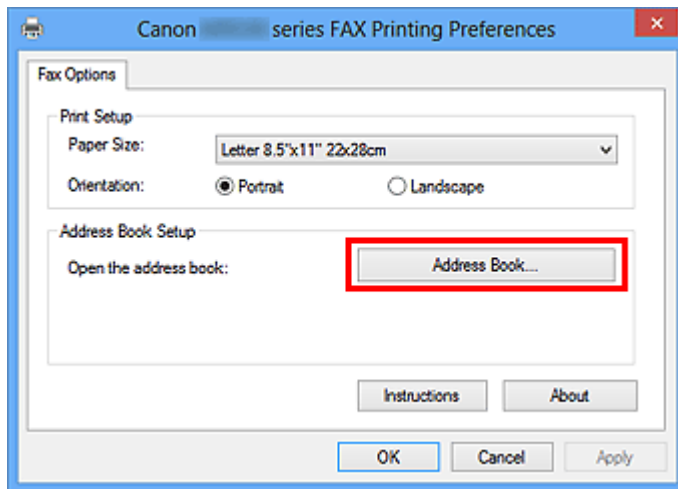

▶▶▶ Note

- Once an individual recipient (Contact) is registered in the address book folder (Windows Contacts) as an address book file (.contact file), it can be used in multiple applications. However, you cannot change the address book you use, as only one address book can be created per user.

Follow the steps below to open Windows Contacts.

- **Windows 8.1/Windows 8:**
Select the **Search** charm, then search for "Contacts".
- **Windows 7/Windows Vista:**
Select **XXXX (user name)** from the **Start** menu, then double-click **Contacts**.

3. In the **Address Book** dialog box, click **New....**

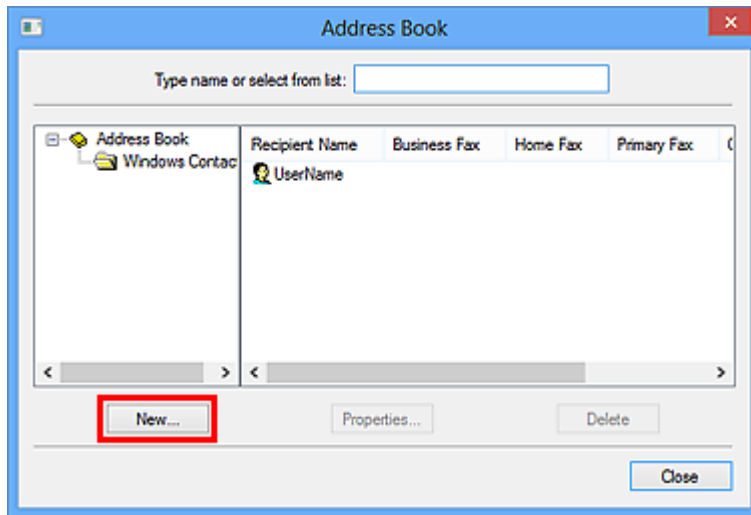

4. Select **Contact** in the **New Entry** dialog box, then click **OK**.

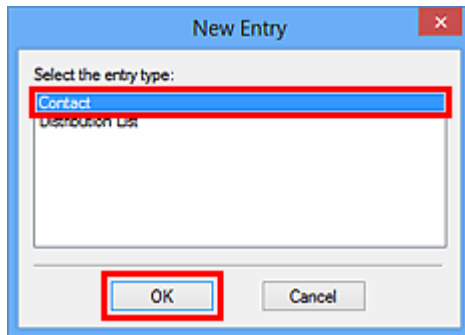

➤➤➤ Note

- For faxing, you can only specify the **Contact** (one recipient). You cannot specify a **Distribution List**.

5. On **Name and E-mail** tab of Properties dialog box, enter **First** and **Last**.
The recipient's name will be printed at the top of the fax received by the recipient.

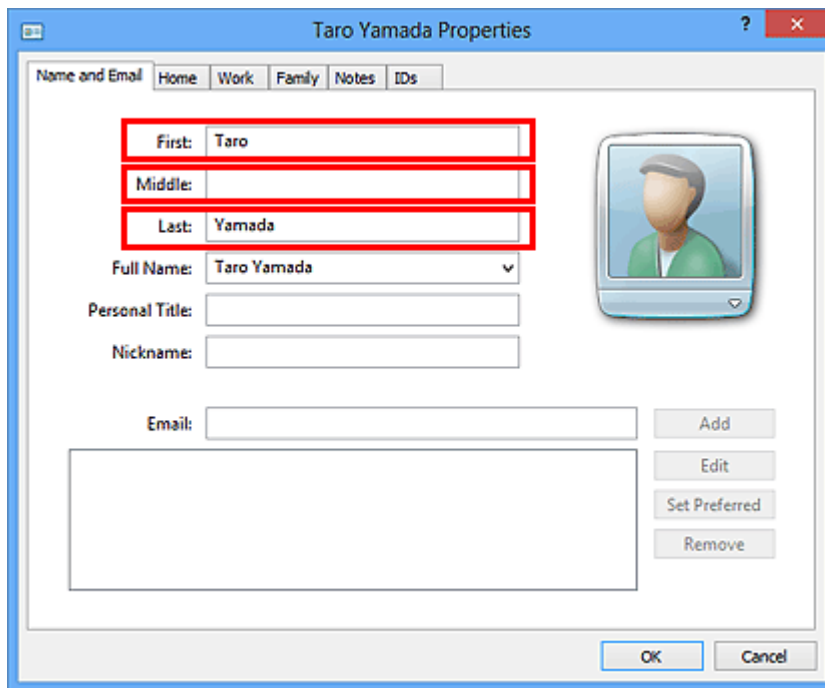

6. Enter the fax number on the **Home** or **Work** tab, then click **OK**.

An individual recipient (Contact) is registered in the address book.

➤➤➤ Note

- You can also register a recipient by clicking the **Add to Address Book...** button on the **Send FAX** dialog box after entering the recipient.

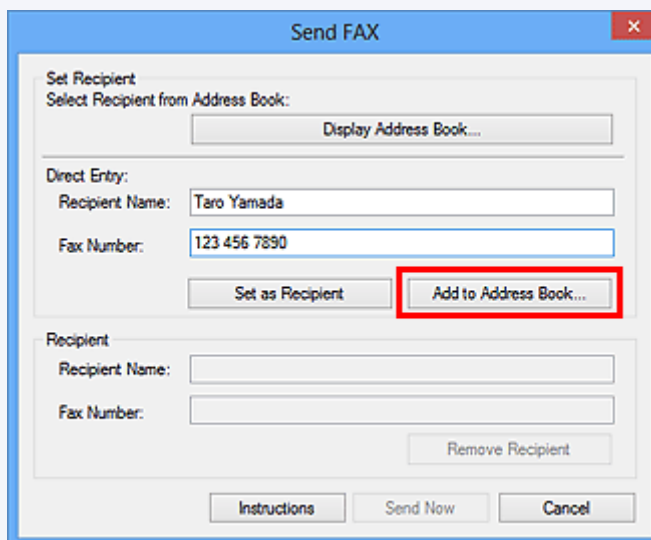

- Add the outside line access number before the fax number as needed.
(Example: When the outside line access number is "0" and the fax number is "XXX-XXXX", enter "0XXX-XXXX".)
- If you upgrade from Windows XP to Windows Vista, the address book you created in Windows XP may not be reflected in Windows Vista. In this case, open the address book in the following procedure and reflect the information to a new address book.

1. From the **Start** menu, select **Control Panel > Appearance and Personalization > Folder Options**.
2. Click the **View** tab of the **Folder Options** dialog box, select **Show hidden files and folders** in **Advanced settings**, then click **OK**.
3. From the **Start** menu, select **XXXX (user name)**, then double-click **AppData > Roaming > Canon > MP5** to open the folder.
4. Double-click the ".wab" file.

The address book will be reflected in Windows Vista automatically.

Related Topic

- [Edit or Remove a Recipient from an Address Book \(Fax Driver\)](#)
- [Search for a Recipient in an Address Book \(Fax Driver\)](#)

Edit or Remove a Recipient from an Address Book (Fax Driver)

You can change the recipients' names, fax numbers and other information, or delete recipients registered in the address book.

Editing Recipients in an address book

1. [Open the print settings dialog box of the fax driver.](#)
2. Click **Address Book...** in the displayed dialog box.

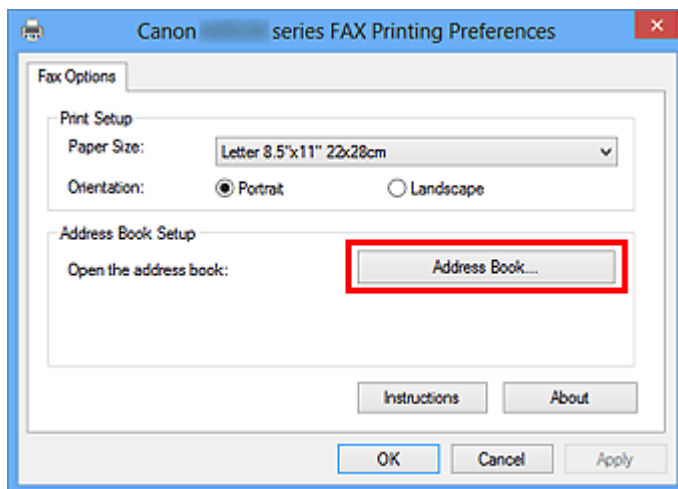

3. Select the recipient you want to edit from the **Address Book** dialog box, then click **Properties....**

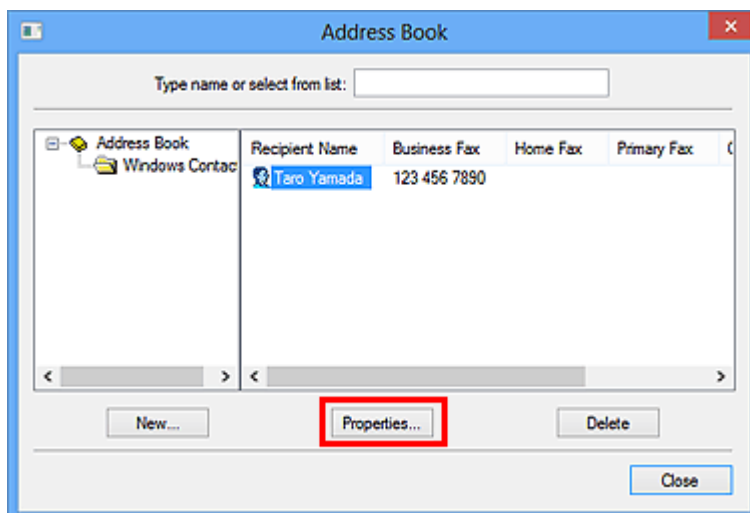

4. Change information as needed on the Properties dialog box, then click **OK**.

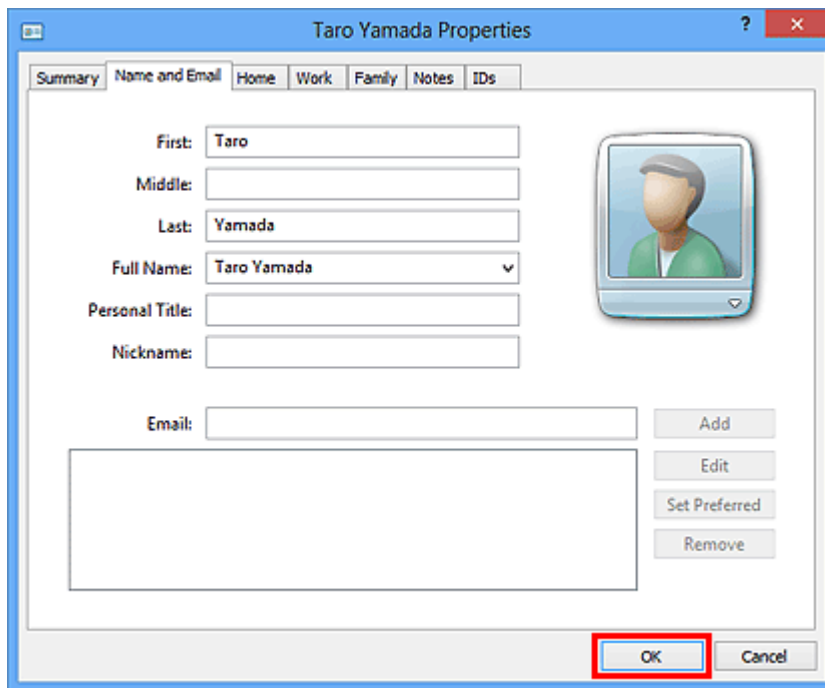

Removing Recipients from an address book

1. [Open the print settings dialog box of the fax driver.](#)
2. Click **Address Book...** in the displayed dialog box.

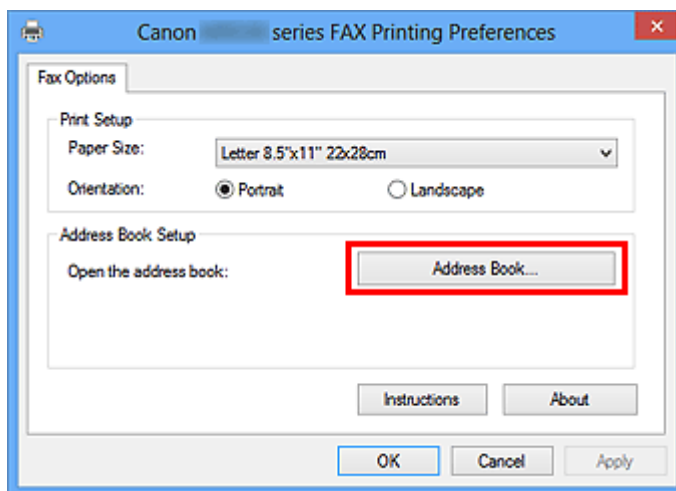

3. Select the recipient you want to delete from the **Address Book** dialog box, then click **Delete**.

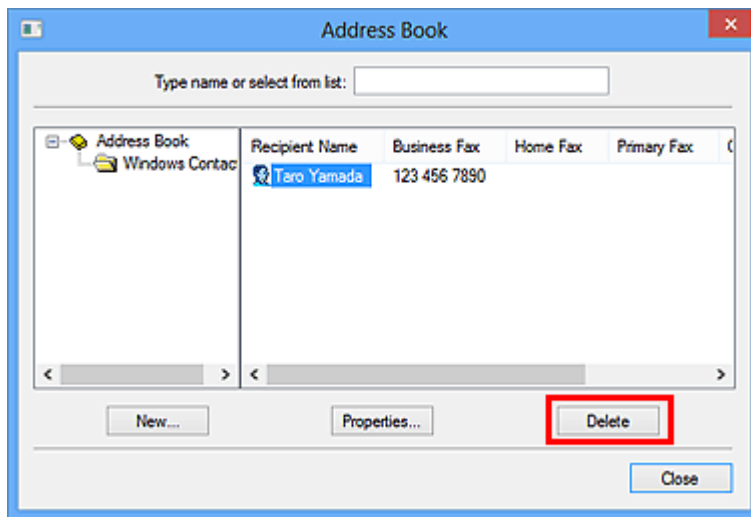

4. When a confirmation message is displayed, click **Yes**.

Search for a Recipient in an Address Book (Fax Driver)

You can search for recipients registered in the address book by name.

1. Open the document you want to fax with an application (such as Notepad), and then click the Print command. (The command is **Print...** on the **File** menu.)
2. In **Select Printer** or **Name** in the **Print** dialog box, select **Canon XXX series FAX** (where "XXX" is the model name).
3. Click **Print** or **OK**.

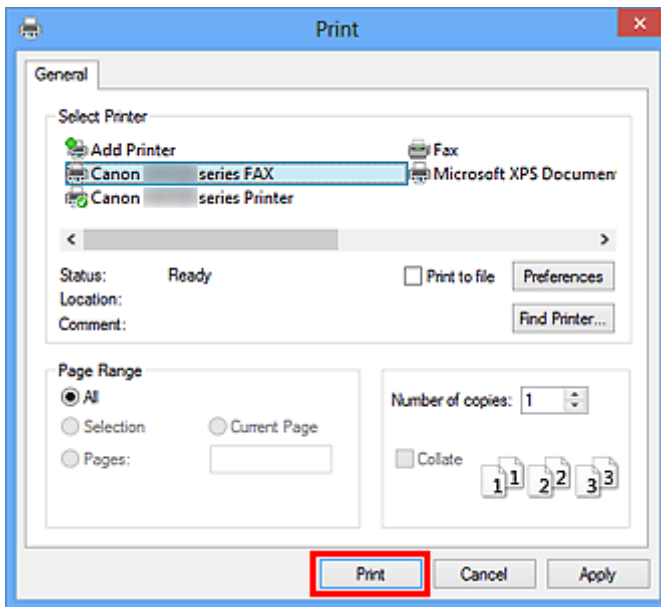

* **Print** dialog box in Notepad

4. Click **Display Address Book...** in **Set Recipient** in the **Send FAX** dialog box.

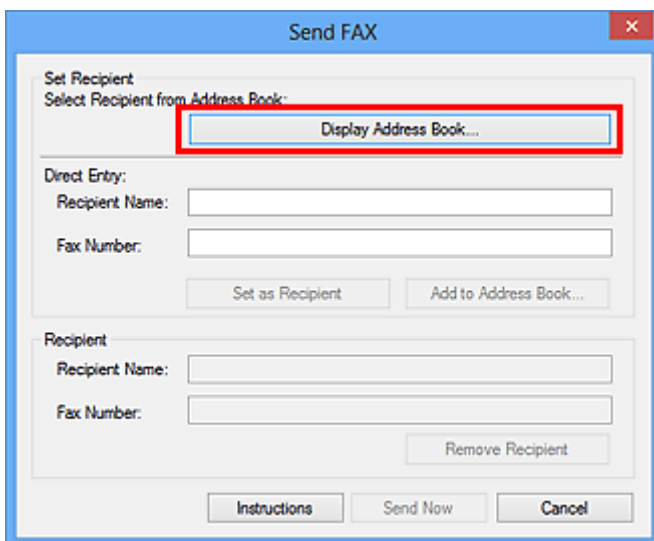

5. Enter the name of the recipient you want to search for in **Search by Recipient** in the **Select Recipient from Address Book** dialog box.

If the entered name is found, the recipient will be displayed in the contact list with its name selected.

While the name is selected, click **Set as Recipient** to enter it as the recipient.

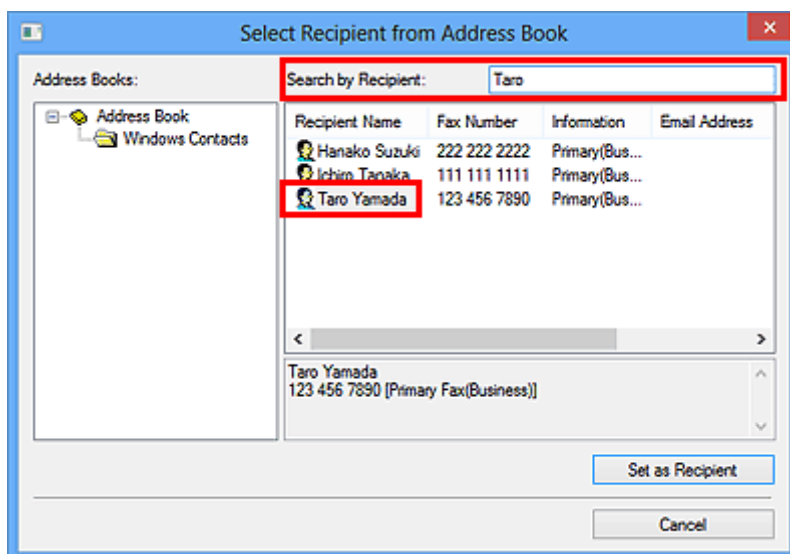

▶▶▶ Important

- You cannot search by criteria other than name.



Cannot Send Faxes from Computer



Check 1 Is the power turned on?

You cannot send faxes if the power is turned off. Press the **ON** button to turn the power on.

If you disconnected the power cord without turning off the power (one of the buttons on the operation panel is lit), reconnecting it turns on the power.

If you disconnected the power cord after pressing the **ON** button to turn off the power (no buttons on the operation panel are lit), reconnect it, then press the **ON** button to turn on the power.

If the power was turned off due to power failure, etc., the power is automatically turned on when the power failure is resolved.

▶▶▶ Important

- Confirm that all lamps on the operation panel are off before unplugging the power cord, then unplug the power cord.

If a power failure occurs or you unplug the power cord, all faxes stored in the machine's memory are deleted.

▶▶▶ Note

- If the faxes stored in the machine's memory are deleted by a power failure or unplugging the power cord, the list of the faxes deleted from the machine's memory will be printed after turning the machine on.

Check 2 Is a document being sent from memory or a fax being received into memory?

When the message for the transmission/reception is displayed on the machine's LCD (Liquid Crystal Display) monitor, a fax is being sent from/received into machine's memory. Wait until the transmission/reception is complete.

Check 3 Is the telephone line type set correctly?

Check the telephone line type setting and change it as necessary.

Check 4 Is **Dial tone detect** set to **ON**?

Resend the fax after a while.

If you still cannot send the fax, select **OFF** for **Dial tone detect** in **Advanced FAX settings** under **FAX settings**.

Check 5 Is the recipient's fax number correct?

Check the recipient's fax number, then send the document again.

■ [Sending a FAX \(Fax Driver\)](#)

▶▶ Note

- For details on how to change the recipients registered in the address book, see "[Edit or Remove a Recipient from an Address Book \(Fax Driver\)](#)."

Check 6 Does an error occur during transmission?

Check if a message is displayed in the computer screen.

If displayed, check the message, then resolve the error.

Check 7 Does a printer error occur?

Check if a message is displayed on the LCD monitor.

If a support code is displayed, see "Support Code List" for your model from Home of the Online Manual.

If no support code is displayed, see "A Message Is Displayed" for your model from Home of the Online Manual.

If you are in a hurry, press the **Stop** button to close the message, then send the fax.

Check 8 Is the telephone line connected correctly?

Reconnect the telephone line cable to the telephone line jack.

If the telephone line is connected correctly, then there is a problem with your telephone line. Contact your telephone company and the manufacturer of your terminal adapter or telephone adapter.

How to Open the Setting Screen of the Fax Driver

The following explains how to display the print settings dialog box or the Properties dialog box of the fax driver from your application or from the fax/printer icon.

Opening the Print Settings Dialog Box of the Fax Driver from an Application

1. Click the Print command in the application.

In general, you can open the **Print** dialog box by selecting Print from the File menu.

2. Select "your model name," then click **Preferences** (or **Properties**).

The print settings dialog box of the fax driver appears.

Opening the Print Settings Dialog Box of the Fax Driver from the Fax/Printer Icon

• Windows 8.1/Windows 8:

1. Click the **Settings** charm > **Control Panel** > **Hardware and Sound** > **Devices and Printers**.
2. Right-click the **Canon XXX series Printer** icon or **Canon XXX series FAX** icon and select **Printing Preferences**, then **Canon XXX series FAX**. (Where "XXX" is the model name.)

• Windows 7:

1. From the **Start** menu, select **Control Panel** > **Hardware and Sound** > **Devices and Printers**.
2. Right-click the **Canon XXX series Printer** icon or **Canon XXX series FAX** icon and select **Printing Preferences**, then **Canon XXX series FAX**. (Where "XXX" is the model name.)

• Windows Vista:

1. From the **Start** menu, select **Control Panel** > **Hardware and Sound** > **Printers**.
2. Right-click the **Canon XXX series FAX** icon (where "XXX" is the model name) and select **Printing Preferences....**

Opening the Properties Dialog Box of the Fax Driver from the Fax/Printer Icon

- **Windows 8.1/Windows 8:**

1. Click the **Settings** charm > **Control Panel** > **Hardware and Sound** > **Devices and Printers**.
2. Right-click the **Canon XXX series Printer** icon or **Canon XXX series FAX** icon and select **Printer Properties**, then **Canon XXX series FAX**. (Where "XXX" is the model name.)

- **Windows 7:**

1. From the **Start** menu, select **Control Panel** > **Hardware and Sound** > **Devices and Printers**.
2. Right-click the **Canon XXX series Printer** icon or **Canon XXX series FAX** icon and select **Printer Properties**, then **Canon XXX series FAX**. (Where "XXX" is the model name.)

- **Windows Vista:**

1. From the **Start** menu, select **Control Panel** > **Hardware and Sound** > **Printers**.
2. Right-click the **Canon XXX series FAX** icon (where "XXX" is the model name) and select **Properties**.

General Notes (Fax Driver)

This fax driver is subject to the following restrictions.

Keep the following points in mind when using the fax driver.

- The fax driver may not work correctly when sending a Microsoft Excel 2002 document as a fax with the **Allow A4/Letter Paper Resizing** option checked in Microsoft Excel 2002. Follow the instructions below to solve the problem:
 1. Click **Options...** from the **Tools** menu.
 2. Uncheck the **Allow A4/Letter Paper Resizing** option on the **International** tab.
- When using a network compatible printer, you cannot send faxes from multiple computers at the same time. If you try to send a fax from a computer while a fax is being sent from another computer, a message appears and your fax cannot be sent.

Make sure that a fax is not being sent from another computer.

- If you assign the fax driver to the Bluetooth port, you cannot send a fax from the computer.
- You can use the following characters for **Fax Number**:

Character	Explanation
0 - 9 * #	For use in telephone and fax numbers.
, p	To place a pause between numbers.
P	To place a pause at the end of a sequence of numbers.
T	Numbers after the T will be sent as a tone signal.
+ - (), space	To make the number easier to read. You cannot insert a space at the front of a number.

*You cannot use ".", "R", "M", or "E".

- You can enter the following number of characters in **Recipient Name** and **Fax Number**.

Recipient Name: Up to 16 characters

Fax Number: Up to 60 characters

* The number of characters you can enter differs in some regions.

- The fax driver does not work correctly if you uncheck the **Enable printer pooling** option on the **Ports** tab of the **Canon XXX series FAX Properties** dialog box (where "XXX" is the model name). Check that the option is checked.

For details on how to open the **Canon XXX series FAX Properties** dialog box, see "[Opening the Properties Dialog Box of the Fax Driver from the Fax/Printer Icon.](#)"

Sending Faxes from Computer (Mac OS)

- ▶ **Sending a Fax**
- ▶ **General Notes**

Sending a Fax

You can send the faxes using the printer from Mac.

To sending the fax from Mac, add your printer as AirPrint printer to Mac.

Checking Your Environment

First, check your environment.

- **AirPrint Operation Environment**

Mac running the latest version of Mac OS

- **Requirement**

Mac and the printer must be connected to the same network over a LAN.

Adding Printer as AirPrint Printer to Your Mac

1. Open **System Preferences**, and select **Printers & Scanners (Print & Scan)** on your Mac.
2. Select **+** to display the printer list.
3. Select the printer's name listed as **Bonjour Multifunction**.
4. Select **Secure AirPrint** or **AirPrint** from **Use**.
5. Select **Add**.

Sending a Fax from Mac

▶▶▶ Note

- This function supports only monochrome transmission.

1. [Make sure printer is turned on.](#)
2. Open document you want to fax with an application.
3. Open Print dialog.
To open the Print dialog, you typically select **Print...** from the **File** menu of your application software.
4. Select **Canon XXX series - Fax** (where "XXX" is your printer's name) from **Printer** list.

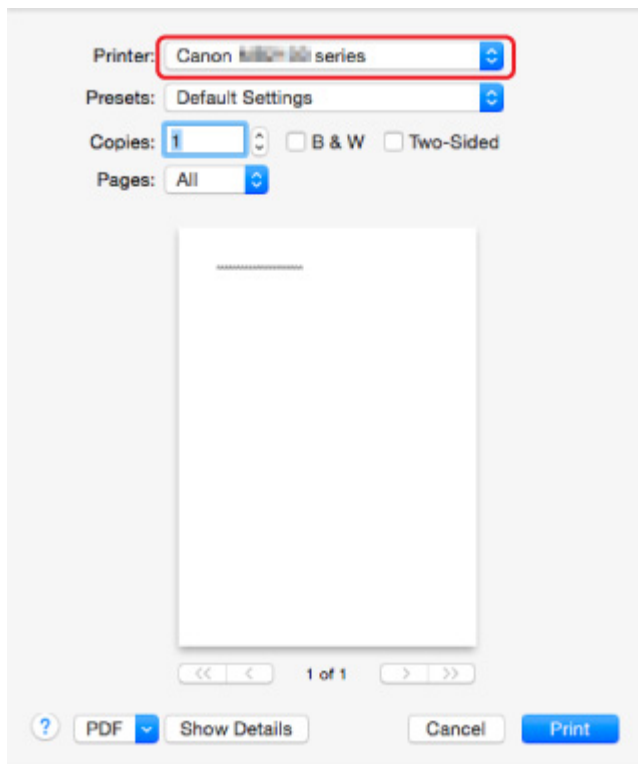

5. Specify fax paper settings as needed.

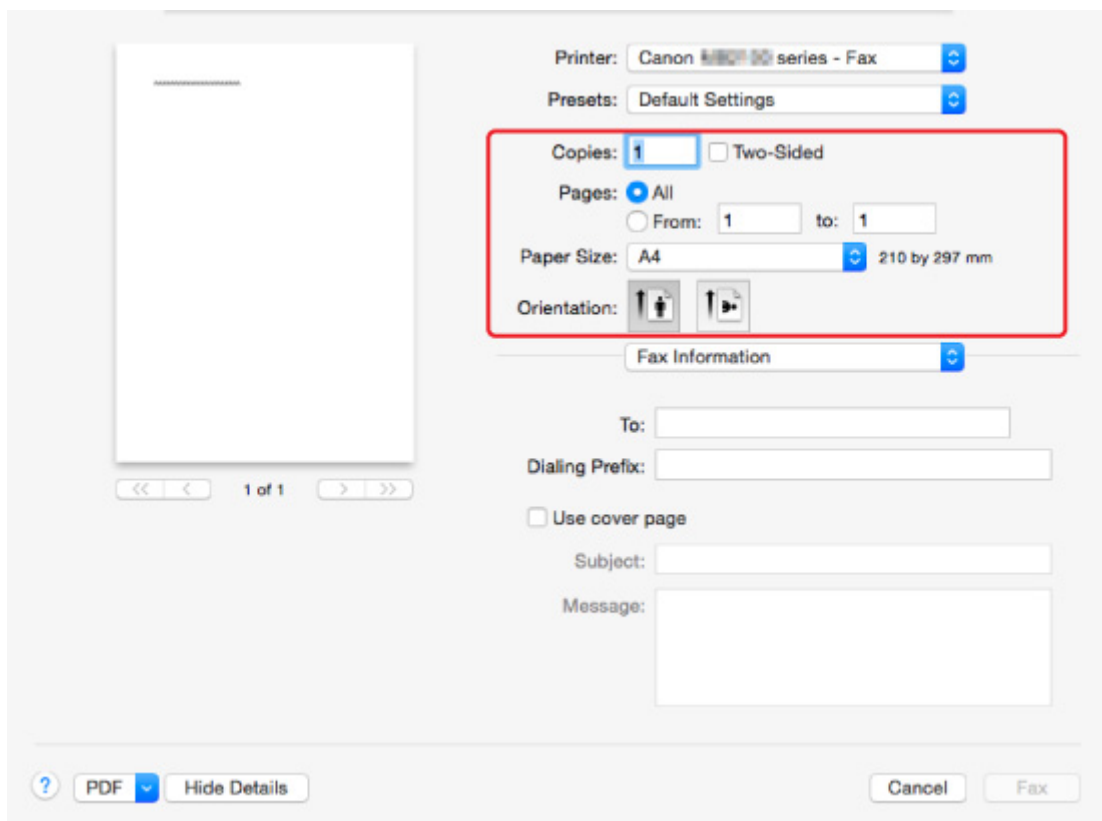

6. Enter fax/telephone numbers in **To:**.

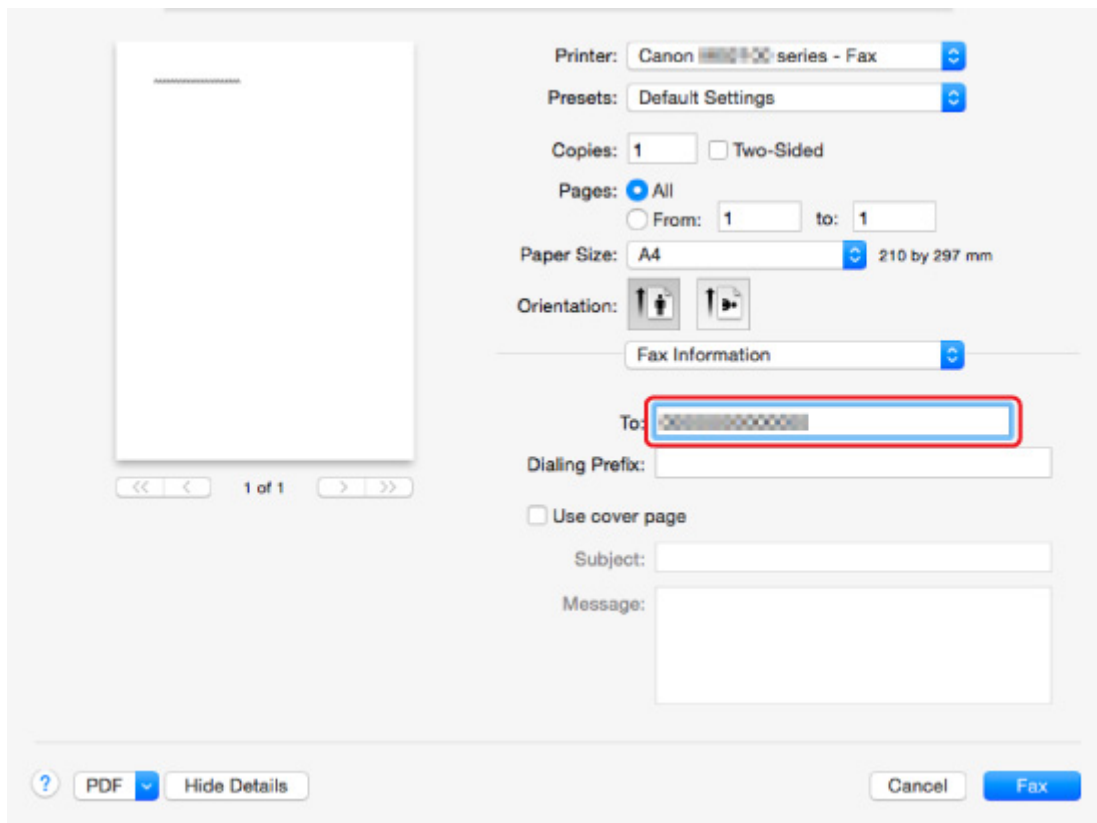

Enter the dialing prefix and specify the cover page settings as needed.

7. Select **Fax**.

The printer dials automatically and sends the fax.

►►► **Note**

- To cancel sending the fax, press the printer's **Stop** button.

Automatic Redialing

The printer redials automatically according to the automatic redialing setting of the printer.

You can enable or disable automatic redialing. If you enable automatic redialing, you can specify the maximum number of redial attempts and the length of time the printer waits between redial attempts.

■ [FAX settings](#)

►►► **Note**

- To cancel automatic redialing, wait until the printer starts redialing, and then press the printer's **Stop** button.

General Notes

Sending faxes from Mac is subject to the following restrictions.

- Enter the characters in **To:** and **Dialing Prefix:** so that the total number of characters is within 60 characters. If the total number of characters exceeds 60, the printer dials only the first 60 characters.
- You can use the following characters for **To:**.

Character	Explanation
0 - 9 * #	For use in telephone and fax numbers.
+ space	To make the number easier to read. You cannot insert a space at the front of a number.

- You can use the following characters for **Dialing Prefix:**.

Character	Explanation
0 - 9 * #	For use in telephone and fax numbers.
p	To place a pause between numbers.
T	Numbers after the T will be sent as a tone signal.
+ space	To make the number easier to read. You cannot insert a space at the front of a number.

Troubleshooting

Frequently Asked Questions

- [Cannot Find Machine on Network](#)
- [Cannot Find Machine while Using Wireless LAN](#)
- [Printing Does Not Start](#)
- [Paper Is Blank/Printing Is Blurry/Colors Are Wrong/White Streaks Appear](#)
- [An Error Occurs](#)
- [Print Results Are Unsatisfactory](#)
- [Message Appears](#)
- [Cannot Install MP Drivers](#)
- [Network Key Unknown](#)
- [Paper Jams](#)
- [Cannot Send a Fax](#)
- [Cannot Receive a Fax, Cannot Print a Fax](#)
- [List of Support Code for Error](#)

Examples of Problems

- **Printer Does Not Move**
 - [Power Does Not Come On](#)
 - [Machine Suddenly Cannot Be Used](#)
 - [Printing Does Not Start](#)
 - [Paper Jams](#)
 - [Scanning Problems \(Windows\)](#)
 - [Scanning Problems \(Mac OS\)](#)
 - [Cannot Print/Scan from Smartphone/Tablet](#)
 - [Cannot Print Using AirPrint](#)
- **Cannot Set Correctly**
 - [Cannot Find Machine on Check Printer Settings Screen](#)
 - [Message Appears on Computer During Setup](#)
 - [Cannot Find Machine while Using Wireless LAN](#)
 - [Cannot Find Machine while Using Wired LAN](#)
 - [USB Connection Problems](#)
 - [Cannot Communicate with Machine via USB](#)
 - [Network Key Unknown](#)
 - [Machine Cannot Be Used After Replacing Wireless Router or Changing Its Settings](#)
 - [Administrator Password Set for Machine Unknown](#)
 - [Checking Network Information](#)
 - [Restoring to Factory Defaults](#)
 - [Cannot Install MP Drivers](#)
 - [Easy-WebPrint EX Does Not Start or Easy-WebPrint EX Menu Does Not Appear \(Windows\)](#)
 - [Updating MP Drivers in Network Environment \(Windows\)](#)

- **Print/Scan Results Are Unsatisfactory**
 - [Printing Does Not Start](#)
 - [Printing Is Slow](#)
 - [Copying/Printing Stops](#)
 - [Print Results Are Unsatisfactory](#)
 - [No Ink Comes Out](#)
 - [Paper Jams](#)
 - [Paper Does Not Feed Properly/"No Paper" Error](#)
 - [Automatic Duplex Printing Problems](#)
 - [Scan Results Are Unsatisfactory \(Windows\)](#)
 - [Scan Results Are Unsatisfactory \(Mac OS\)](#)

- **Error or Message Appears**
 - [An Error Occurs](#)
 - [Display on Touch Screen Is Off](#)
 - [Touch Screen Shows Wrong Language](#)
 - [Message Appears](#)
 - [List of Support Code for Error](#)
 - [A Message for Faxing Is Displayed on Fax Standby Screen](#)
 - [IJ Scan Utility Error Messages \(Windows\)](#)
 - [IJ Scan Utility Error Messages \(Mac OS\)](#)
 - [ScanGear \(Scanner Driver\) Error Messages](#)
 - [Scanner Driver Error Messages](#)

Operation Problems

- [Network Communication Problems](#)
- [Printing Problems](#)
- [Problems while Printing/Scanning from Smartphone/Tablet](#)
- [Scanning Problems \(Windows\)](#)
- [Scanning Problems \(Mac OS\)](#)
- [Faxing Problems](#)
- [Mechanical Problems](#)
- [Installation and Download Problems](#)
- [Errors and Messages](#)
- [If You Cannot Solve a Problem](#)

Network Communication Problems

- **Cannot Find Machine on Network**
- **Network Connection Problems**
- **Other Network Problems**

Cannot Find Machine on Network

While performing printer setup:

- ▶ **Cannot Find Machine on Check Printer Settings Screen**
- ▶ **Cannot Find Machine after Searching it on Printer Detection Screen During Setup**
- ▶ **Searching Machine by IP Address or Host Name During Setup (Windows)**
- ▶ **Cannot Proceed beyond Printer Connection Screen/Connect Cable Screen**

While using printer:

- ▶ **Cannot Find Machine while Using Wireless LAN**
- ▶ **Cannot Find Machine while Using Wired LAN**

▶▶ Note

- You cannot use the wireless LAN and the wired LAN at the same time.

Cannot Find Machine on Check Printer Settings Screen

- **For Windows:**

If the printer cannot be found and the **Check Printer Settings** screen appears after searching the printer by **Automatic search** on the **Search for Printers** screen, click **Redetect** and search for the printer again by the IP address on the **Search for Printers** screen.

If the printer has not been found after searching it by the IP address, check network settings.

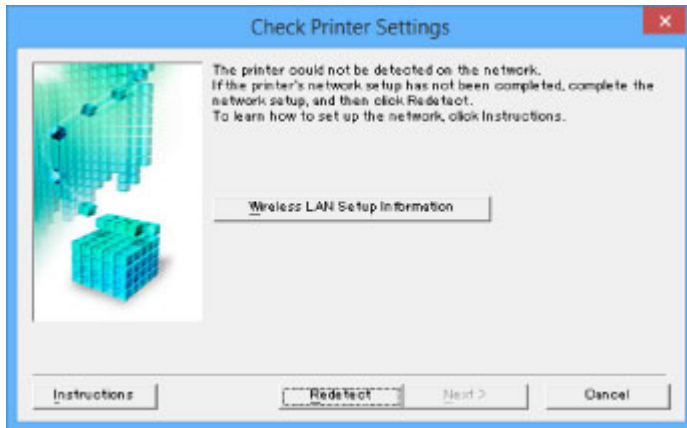

- **For Mac OS:**

If the printer cannot be found on the **Check Printer Settings** screen, check network settings before redetecting the printer.

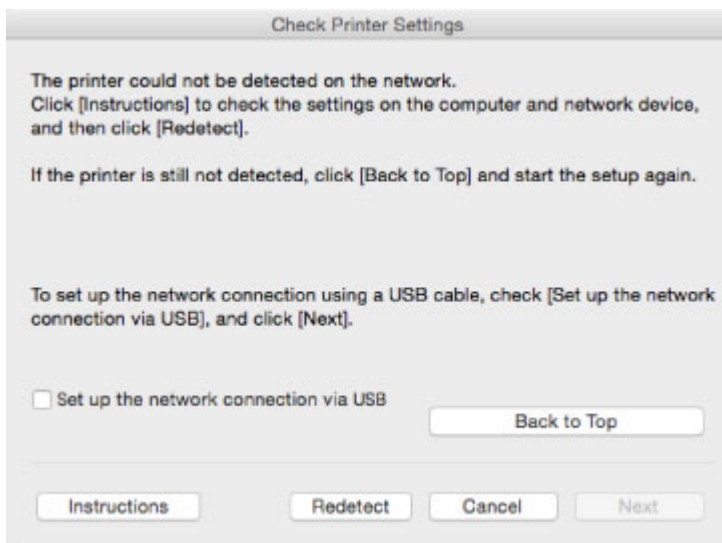

■ [Check 1: Cannot Find Machine on Check Printer Settings Screen During Wireless LAN Setup](#)

■ [Check 1: Cannot Find Machine on Check Printer Settings Screen During Wired LAN Setup](#)



Check 1: Cannot Find Machine on Check Printer Settings Screen During Wireless LAN Setup



Are printer and network device (router, etc.) turned on?

Make sure the printer is turned on.

■ [Confirming that the Power Is On](#)

Make sure network device (router, etc.) is turned on.

If printer or network device is off:

Turn on printer or network device.

It may take a while for the printer and network device to become ready for use once they are turned on.

Wait a while after turning on the printer or network device, and then click **Redetect** on the **Check Printer Settings** screen to redetect the printer.

If the printer is found, follow the instructions on the screen to continue to set up network communication.

If printer and network device are on:

If the network devices are on, turn them off and on again. If the printer cannot be found after that, go to Check 2.

■ [Check 2: Cannot Find Machine on Check Printer Settings Screen During Wireless LAN Setup](#)



Check 2: Cannot Find Machine on Check Printer Settings Screen During Wireless LAN Setup



Is printer set to allow wireless communication?

Make sure the  or  icon is displayed on the touch screen.

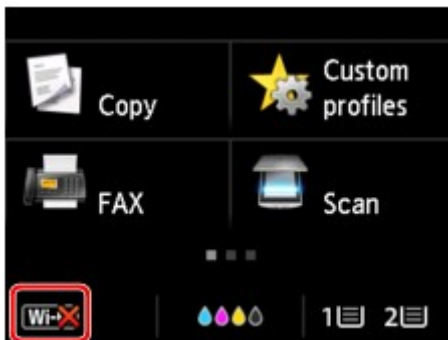

If icon is not displayed:

- For Windows:

The printer is not set to allow wireless communication. Click **Wireless LAN Setup Information** on the **Check Printer Settings** screen to check the status and turn on wireless communication on the printer.

- For Mac OS:

The printer is not set to allow wireless communication. Turn on wireless communication on the printer.

After enabling the wireless LAN setting, click **Back to Top** on the **Check Printer Settings** screen to try to set up the network communication from the beginning.

If icon is displayed:

Go to check 3.

- [Check 3: Cannot Find Machine on Check Printer Settings Screen During Wireless LAN Setup](#)



Check 3: Cannot Find Machine on Check Printer Settings Screen During Wireless LAN Setup



Is printer connected to wireless router?

Use the icon on the touch screen to make sure the printer is connected to the wireless router.

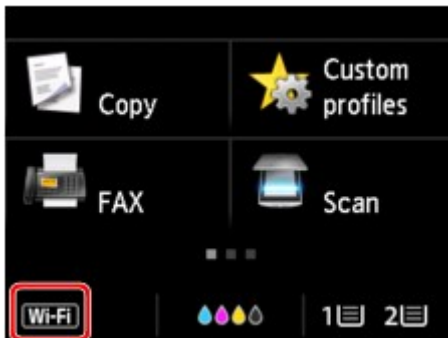

If icon is displayed:

- Checking wireless router location

After checking the wireless router setting, make sure the printer is not placed far away from the wireless router.

The printer can be up to 50 m (164 ft) from the wireless router indoors. Make sure the printer is close enough to the wireless router to be used.

Place the wireless router and printer where there are no obstacles between them. Wireless communication between different rooms or floors is generally poor. Wireless communication can be impeded by building materials containing metal or concrete. If the printer cannot communicate with the computer over a wireless LAN due to a wall, place the printer and the computer in the same room.

In addition, if a device like a microwave oven that emits radio waves of the same frequency bandwidth as a wireless router is nearby, it may cause interference. Place the wireless router as far away from interference sources as possible.

- Checking wireless router settings

The printer and wireless router should be connected using 2.4 GHz bandwidth. Make sure the wireless router for the printer's destination is configured to use 2.4 GHz bandwidth.

Check the SSID of the wireless router for the printer on the touch screen.

Tap the icon on the lower left and select **See settings**.

For more on the wireless router, refer to the instruction manual supplied with the wireless router or contact its manufacturer.

After taking measures above, click **Redetect** on the **Check Printer Settings** screen to redetect the printer.

If the printer is found, follow the instructions on the screen to continue to set up network communication.

If the printer cannot be detected, the printer is not connected to the wireless router. Connect the printer to the wireless router.

After connecting the printer to the wireless router, set up the network communication from the beginning.

If  icon is displayed:

Go to check 4.

- [Check 4: Cannot Find Machine on Check Printer Settings Screen During Wireless LAN Setup](#)



Check 4: Cannot Find Machine on Check Printer Settings Screen During Wireless LAN Setup



Is printer's IP address specified correctly?

If printer's IP address is not specified correctly, the printer may not be found. Make sure whether printer's IP address is not used for another device.

To check the printer's IP address, print out the network settings information or use the operation panel to display it.

- Display on the touch screen.

- [LAN settings](#)

- Print the network settings.

- [Printing Network Settings](#)

If the IP address is not specified correctly:

See [If an error screen appears](#): and specify the IP address.

If the IP address is specified correctly:

Go to check 5.

- [Check 5: Cannot Find Machine on Check Printer Settings Screen During Wireless LAN Setup](#)



Check 5: Cannot Find Machine on Check Printer Settings Screen During Wireless LAN Setup



Disable block in firewall function temporarily.

The firewall of your security software or operation system for computer may limit communication between the printer and your computer. Check the firewall setting of your security software or operation system or the message shown on your computer and disable block temporarily.

If firewall interferes with setup:

- **If message appears:**

If a message appears warning that Canon software is attempting to access the network, set the security software to allow access.

After allowing the software to access, click **Redetect** on the **Check Printer Settings** screen to redetect the printer.

If the printer is found, follow the instructions on the screen to continue to set up the network communication.

- **If no message appears:**

Cancel the setup, and then set the security software to allow Canon software below to access the network.

- For Windows:

Setup.exe or **Setup64.exe** in the **win > Driver > DrvSetup** folder on the Setup CD-ROM

- For Mac OS:

Setup.app, **Canon IJ Network Tool.app**, **canonijnetwork.bundle**, **CIJScannerRegister.app**, **Canon IJ Scan Utility2.app**, and **CIJSUAgent.app**

After setting the security software, redo the network communication setup from the beginning.

After setup is completed, enable firewall.

▶▶ Note

- For more on firewall settings of your operating system or security software, see instruction manual or contact its manufacturer.

If firewall settings are not causing problem:

Go to check 6.

- [Check 6: Cannot Find Machine on Check Printer Settings Screen During Wireless LAN Setup](#)



Check 6: Cannot Find Machine on Check Printer Settings Screen During Wireless LAN Setup



Check wireless router settings.

Check wireless router network connection settings, such as IP address filtering, MAC address filtering, and DHCP function.

Make sure the same radio channel is assigned to the wireless router and the printer.

To check the settings of the wireless router, see the instruction manual supplied with the wireless router or contact the manufacturer.

After checking the wireless router settings, click **Redetect** on the **Check Printer Settings** screen to redetect the printer.

If the printer is found, follow the instructions on the screen to continue to set up network communication.



Check 1: Cannot Find Machine on Check Printer Settings Screen During Wired LAN Setup



Is LAN cable connected, and are printer and router on?

Make sure the LAN cable is connected.

Make sure the printer is turned on.

■ [Confirming that the Power Is On](#)

Make sure the router is turned on.

If LAN cable is connected and printer or network device is off:

Turn on printer or network device.

It may take a while for the printer and network device to become ready for use once they are turned on.

Wait a while after turning on the printer or network device, and then click **Redetect** on the **Check Printer Settings** screen to redetect the printer.

If the printer is found, follow the instructions on the screen to continue to set up the network communication.

If LAN cable is connected and printer and network device are on:

If the printer cannot not be found after trying to redetect it, even though the printer and the network device are on, go to Check 2.

■ [Check 2: Cannot Find Machine on Check Printer Settings Screen During Wired LAN Setup](#)



Check 2: Cannot Find Machine on Check Printer Settings Screen During Wired LAN Setup



Can you view any web pages on your computer?

Make sure the computer and network device (router, etc.) are configured and the computer is connected to the network.

If you cannot view any web pages:

Click **Cancel** on the **Check Printer Settings** screen to cancel to set up the network communication.

After that, configure the computer and network device.

For the procedures, refer to the instruction manuals supplied with the computer and network device, or contact their manufacturers.

If you can view web pages after configuring the computer and network device, try to set up the network communication from the beginning.

If you can view web pages:

Go to check 3.

- [Check 3: Cannot Find Machine on Check Printer Settings Screen During Wired LAN Setup](#)



Check 3: Cannot Find Machine on Check Printer Settings Screen During Wired LAN Setup



Is printer set to allow wired communication?

Make sure the  icon is displayed on the touch screen.

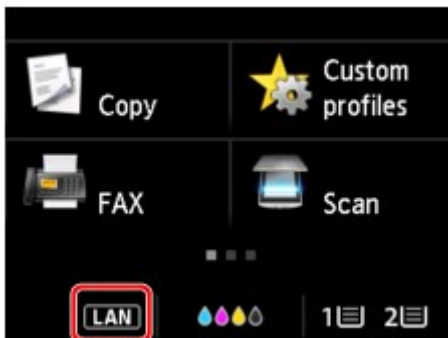

If icon is not displayed:

The printer is not set to allow wired communication. Turn on wired communication on the printer. Once you have turned on wired communication, redo the network communication setup from the beginning.

If icon is displayed:

Go to check 4.

- [Check 4: Cannot Find Machine on Check Printer Settings Screen During Wired LAN Setup](#)



Check 4: Cannot Find Machine on Check Printer Settings Screen During Wired LAN Setup



Is printer's IP address specified correctly?

If printer's IP address is not specified correctly, the printer may not be found. Make sure whether printer's IP address is not used for another device.

To check the printer's IP Address, print out the network settings information or use the operation panel to display it.

- Display on the touch screen.

- [LAN settings](#)

- Print the network settings.

- [Printing Network Settings](#)

If the IP address is not specified correctly:

See [If an error screen appears](#): and specify the IP address.

If the IP address is specified correctly:

Go to check 5.

- [Check 5: Cannot Find Machine on Check Printer Settings Screen During Wired LAN Setup](#)



Check 5: Cannot Find Machine on Check Printer Settings Screen During Wired LAN Setup



Disable block in firewall function temporarily.

The firewall of your security software or operation system for computer may limit communication between the printer and your computer. Check the firewall setting of your security software or operation system or the message shown on your computer and disable block temporarily.

If firewall interferes with setup:

- **If message appears:**

If a message appears warning that Canon software is attempting to access the network, set the security software to allow access.

After allowing the software to access, click **Redetect** on the **Check Printer Settings** screen to redetect the printer.

If the printer is found, follow the instructions on the screen to continue to set up the network communication.

- **If no message appears:**

Cancel the setup, and then set the security software to allow Canon software below to access the network.

- For Windows:

Setup.exe or **Setup64.exe** in the **win > Driver > DrvSetup** folder on the Setup CD-ROM

- For Mac OS:

Setup.app, **Canon IJ Network Tool.app**, **canonijnetwork.bundle**, **CIJScannerRegister.app**, **Canon IJ Scan Utility2.app**, and **CIJSUAgent.app**

After setting the security software, redo the network communication setup from the beginning.

After setup is completed, enable firewall.

▶▶▶ Note

- For more on firewall settings of your operating system or security software, see instruction manual or contact its manufacturer.

If firewall settings are not causing problem:

Go to check 6.

- [Check 6: Cannot Find Machine on Check Printer Settings Screen During Wired LAN Setup](#)



Check 6: Cannot Find Machine on Check Printer Settings Screen During Wired LAN Setup



Check router settings.

Check router network connection settings such as IP address filtering, MAC address filtering, and DHCP function.

For more on checking the settings of the router, refer to the instruction manual supplied with the router or contact its manufacturer.

After checking the router settings, click **Redetect** on the **Check Printer Settings** screen to redetect the printer.

If the printer is found, follow the instructions on the screen to continue to set up network communication.



Cannot Find Machine after Searching it on Printer Detection Screen During Setup



- **For Windows:**

The printer could not be detected with the current setup method.

Select the **Set up the network connection according to the guide** radio button and click **Next**. The screen to show another setup method is displayed.

Canon PRO iXXX series

1 2 3 4

Select Printer

Select from the list
The serial number can be found on the Letter of Guarantee and on the printer.

IPv4 Address IPv6 Address

Serial Number	IP Address	MAC Address
---------------	------------	-------------

Serial Number Location Update

Specify the IP address and run the search

Set up the network connection according to the guide.
Select this option if the printer is not displayed on the list or if it cannot be found by specifying the IP address.

Back to Top Next

Perform setup following the instructions on the screen.

►►► Note

- You can search for printers by an IP address or host name.

■ [Searching Machine by IP Address or Host Name During Setup \(Windows\)](#)

- **For Mac OS:**

The printer could not be detected with the current setup method.

Select the **Setting printer could not be found on the list** check box and click **Next**. The screen to show another setup method is displayed.

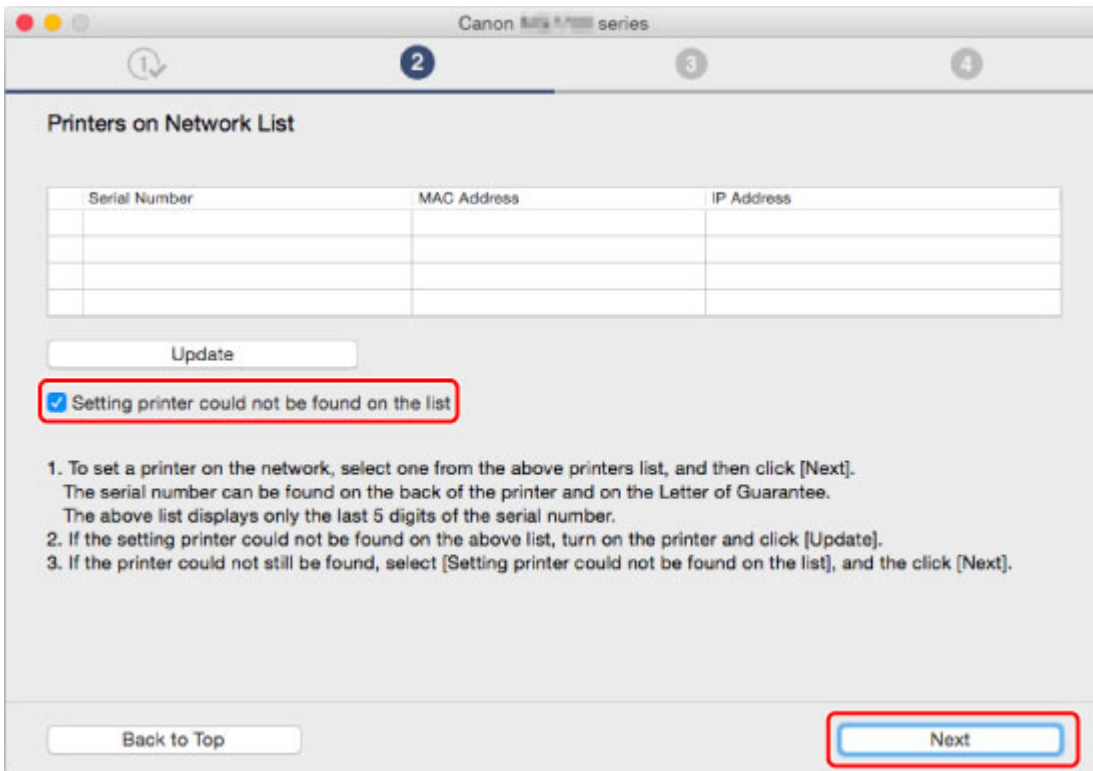

Perform setup following the instructions on the screen.

Searching Machine by IP Address or Host Name During Setup (Windows)

If the printer cannot be found on the **Select Printer** screen, search for the printer by an IP address or host name. Select **Specify the IP address and run the search** radio button and click **Next**. The screen to select searching criteria appears.

1. Check printer's IP address or host name.

To check the printer's IP Address or host name, print out the network settings information or use the operation panel to display it.

- Display on the touch screen.
 - [LAN settings](#)
- Print the network settings.
 - [Printing Network Settings](#)

▶▶▶ Note

- If you use the printer in an office, ask the network administrator.

2. Specify searching method.

Select one of the method below.

1. Search by IPv4 address

Select to search for printers by IPv4 address.

2. Search by IPv6 address

Select to search for printers by IPv6 address.

3. **Search by host name**

Select to search for printers by host name. A host name is referred to as LLMNR host name or Bonjour name.

3. Enter IP address or host name and click **Next**.

Machine search starts.

If an error screen appears:

Resolve the error according to the instruction on the screen.

If the IP address you entered is already used for another device, follow the procedure below to specify printer's IP address.

1. Flick HOME screen and tap  **Setup**.

■ [Using the Operation Panel](#)

2. Tap  **Device settings**.

3. Tap **LAN settings**.

If you specify the administrator password, enter the password.

4. Tap **Other settings**.

5. Tap **TCP/IP settings**.

If you specify IPv4 address:

1. Tap **IPv4**.
2. Tap **OK** on the displayed screen.
3. Tap **IP address**.
4. Tap **Manual setup**.

Tapping **Auto setup** specifies the IP address automatically.

5. Enter IP address.
6. Tap **OK**.
7. Enter subnet mask.
8. Tap **OK**.
9. Enter default gateway.
10. Tap **OK**.

The IPv4 address has been specified.

If you specify IPv6 address:

1. Tap **IPv6**.
2. Tap **OK** on the displayed screen.
3. Tap **Enable/disable IPv6**.
4. Tap **Enable**.

The IPv6 address has been specified.

»» Important

- If firewall is enabled on the computer, printers on a different subnet may not be detected. Disable firewall.

If firewall interferes with printer search:

• **If message appears:**

If a message appears warning that Canon software is attempting to access the network, set the security software to allow access.

After allowing the software to access, specify the IP address or host name and search for printers again.

If the printer is found, follow the instructions on the screen to continue to set up the network communication.

• **If no message appears:**

Cancel searching printers, and then set the security software to allow Canon software below to access the network.

Setup.exe or **Setup64.exe** in the **win > Driver > DrvSetup** folder on the Setup CD-ROM

After setting the security software, specify the IP address or host name and search for printers again.

»» Note

- For more on firewall settings of your operating system or security software, see instruction manual or contact its manufacturer.



Cannot Proceed beyond Printer Connection Screen/Connect Cable Screen



If you cannot proceed beyond the **Printer Connection** screen or the **Connect Cable** screen, check the following.

Check1 Make sure USB cable is securely plugged in to printer and computer.

Connect the printer and the computer using a USB cable as the illustration below. The USB port is located at the back of the printer.

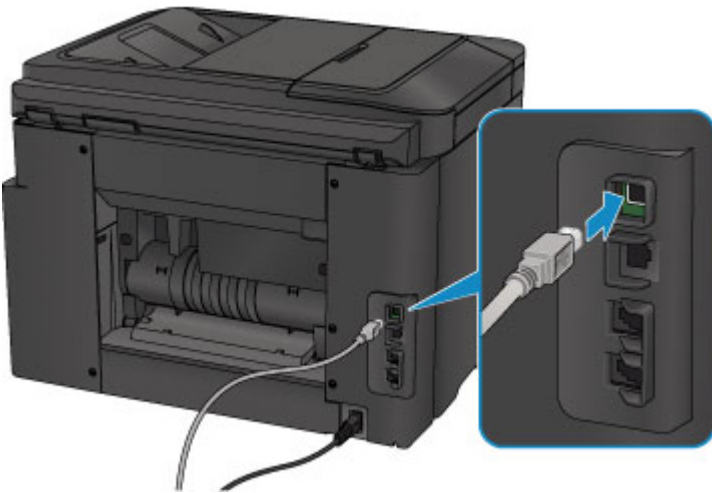

Check the items below only if you cannot proceed beyond the Printer Connection screen.

Check2 Follow procedure below to connect printer and computer again.

Important

- For Mac OS, make sure the lock icon is on the lower left of the **Printers & Scanners** screen (**Print & Scan** screen in Mac OS X v10.8 or Mac OS X v10.7).

If the  icon (locked) is displayed, click the icon to unlock. (The administrator name and the password are necessary to unlock.)

1. Turn off printer.
2. Unplug USB cable from printer and computer and connect it again.
3. Turn on printer.

Check3 If you cannot resolve problem, follow procedure below to reinstall MP Drivers.

- For Windows:
 1. Click **Cancel**.

- If the **Installation Failure** screen appears:
 1. Click **Start Over**.
 2. Click **Exit** on **Start Setup** screen and finish setup.
- If the **Connection failed.** screen appears:
 1. Click **Next**.
 2. Click **Next** on displayed screen.
 3. Click **Back to Top** on **Select Printer** screen.
 4. Click **Exit** on **Start Setup** screen and finish setup.
- 3. Turn off printer.
- 4. Restart computer.
- 5. Make sure you have no application software running.
- 6. Redo setup according to instructions on Canon website.

▶▶▶ Note

- You can use the Setup CD-ROM to redo setup.

- For Mac OS:
 1. Click **Next**.
 2. Click **Exit** on displayed screen and finish setup.
 3. Turn off printer.
 4. Restart computer.
 5. Make sure you have no application software running.
 6. Redo setup according to instructions on Canon website.



Cannot Find Machine while Using Wireless LAN



Check1 Make sure the printer is turned on.

Check2 Is  icon displayed on touch screen?



If the icon is not displayed, tap the icon on the lower left and select **Activate wireless LAN** on the **Change LAN** screen.

Check3 Make sure printer setup is complete.

If it is not, perform setup.

- For Windows:
Use the Setup CD-ROM or follow the instructions on the Canon website.
- For Mac OS:
Follow the instructions on the Canon website.

Check4 Look for printer again.

- For Windows:
 [IJ Network Device Setup Utility Screen](#)
- For Mac OS:
 Canon IJ Network Tool Screen

Check5 Make sure printer and wireless router network settings match.



Make sure the network settings of the printer (e.g. wireless router name, SSID, network key, etc.) are identical with those of the wireless router.

To check the settings of the wireless router, refer to the instruction manual provided with it or contact its manufacturer.

To check the current network settings of the printer, print out the network setting information.

 [Printing Network Settings](#)

If the printer network settings do not match with those of the wireless router, change the network settings of the printer to match with those of the wireless router.

-  [Network Settings \(IJ Network Device Setup Utility\) \(Windows\)](#)
-  Network Communication (Mac OS)

Check6 Make sure the printer is not placed too far away from the wireless router.

Place the wireless router and printer where there are no obstacles between them. Wireless communication between different rooms or floors is generally poor. Wireless communication can be impeded by building materials containing metal or concrete. If the printer cannot communicate with the computer over a wireless LAN due to a wall, place the printer and the computer in the same room.

In addition, if a device like a microwave oven that emits radio waves of the same frequency bandwidth as a wireless router is nearby, it may cause interference. Place the wireless router as far away from interference sources as possible.

Check7 Make sure wireless signal is strong. Monitor signal status and move printer and wireless router as necessary.

To check the radio status,

- For Windows:
 - [Checking Wireless Network Status](#)
- For Mac OS:
 - [Monitoring Wireless Network Status](#)

Check8 Make sure the computer is connected to the wireless router.

For more on how to check the computer settings or connection status, see your computer instruction manual or contact its manufacturer.

Check9 Make sure **Enable bidirectional support** is selected in the **Ports** sheet of the properties dialog box of the printer driver. (Windows)

Check10 Make sure security software's firewall is off.

If your security software's firewall is on, a message may appear warning you that Canon software is attempting to access the network. If this warning message appears, set security software to always allow access.

If you are using any programs that switch between network environments, check their settings. Some programs use a firewall by default.

Check11 If printer is connected to an AirPort Base Station via LAN, use alphanumeric characters for network identifier (SSID). (Mac OS)

If the problem is not resolved, redo setup.

- For Windows:
 - Use the Setup CD-ROM or follow the instructions on the Canon website.
- For Mac OS:
 - Follow the instructions on the Canon website.



Cannot Find Machine while Using Wired LAN



Check1 Make sure printer is turned on.

Check2 Is  icon displayed on touch screen?

If the icon is not displayed, tap the icon on the lower left, then select **Activate wired LAN** on the **Change LAN** screen.

Check3 Make sure LAN cable is connected properly.

Make sure the printer is connected to the router with the LAN cable. If the LAN cable is loose, connect the cable properly.

If the LAN cable is connected to the WAN side of the router, connect the cable to the LAN side of the router.

Network Connection Problems

- **Machine Suddenly Cannot Be Used**
- **Network Key Unknown**
- **Administrator Password Set for Machine Unknown**
- **Machine Cannot Be Used After Replacing Wireless Router or Changing Its Settings**
- **Printing Is Slow**
- **Cannot Access to Internet on Wireless LAN from Communication Device**
- **Ink Level Not Shown on Printer Status Monitor (Windows)**

Machine Suddenly Cannot Be Used

- [Cannot Communicate with Printer Following Network Settings Change](#)
- [Cannot Communicate with Printer via Wireless LAN](#)
- [Cannot Communicate with Printer Using Direct Connection](#)
- [Cannot Communicate with Printer via Wired LAN](#)
- [Cannot Print, Scan, or Fax from a Computer Connected to the Network](#)



Cannot Communicate with Printer Following Network Settings Change



It may take a while for the computer to obtain an IP address, or you may need to restart your computer. Make sure the computer has obtained a valid IP address, and try again to find the printer.



Cannot Communicate with Printer via Wireless LAN



Check1 Make sure the printer is turned on.

Check2 Make sure the printer and wireless router network settings match.

Make sure the network settings of the printer (e.g. wireless router name, SSID, network key, etc.) are identical with those of the wireless router.

To check the settings of the wireless router, refer to the instruction manual provided with it or contact its manufacturer.

To check the current network settings of the printer, print out the network setting information.

- [Printing Network Settings](#)

If the printer network settings do not match with those of the wireless router, change the network settings of the printer to match with those of the wireless router.

- [Network Settings \(IJ Network Device Setup Utility\) \(Windows\)](#)
- Network Communication (Mac OS)

Check3 Make sure the printer is not placed too far away from the wireless router.

Place the wireless router and printer where there are no obstacles between them. Wireless communication between different rooms or floors is generally poor. Wireless communication can be impeded by building materials containing metal or concrete. If the printer cannot communicate with the computer over a wireless LAN due to a wall, place the printer and the computer in the same room.

In addition, if a device like a microwave oven that emits radio waves of the same frequency bandwidth as a wireless router is nearby, it may cause interference. Place the wireless router as far away from interference sources as possible.

Check4 Make sure wireless signal is strong. Monitor signal status and move printer and wireless router as necessary.

- For Windows:
 - [Checking Wireless Network Status](#)
- For Mac OS:
 - [Monitoring Wireless Network Status](#)

Check5 Make sure the computer is connected to the wireless router.

For more on how to check the computer settings or connection status, see your computer instruction manual or contact its manufacturer.

Check6 Make sure you are using a valid channel.

Usable wireless channels may be limited depending on wireless network device used by your computer. See the instruction manual provided with your computer or wireless network device to check usable wireless channels.

Check7 Make sure channel set on wireless router is a usable channel as confirmed in Check 6.

If it is not, change the channel set on the wireless router.

Check8 Make sure security software's firewall is off.

If your security software's firewall is on, a message may appear warning you that Canon software is attempting to access the network. If this warning message appears, set security software to always allow access.

If you are using any programs that switch between network environments, check their settings. Some programs use a firewall by default.

Check9 If printer is connected to an AirPort Base Station via LAN, use alphanumeric characters for network identifier (SSID). (Mac OS)

If the problem is not resolved, redo setup.

- For Windows:
 - Use the Setup CD-ROM or follow the instructions on the Canon website.
- For Mac OS:
 - Follow the instructions on the Canon website.
- **Positioning:**
 - Make sure there are no obstacles between the wireless router and the printer.



Cannot Communicate with Printer Using Direct Connection



Check1 Make sure the printer is turned on.

Check2 Is the  icon displayed on the touch screen?

If the icon is not displayed, tap the icon on the lower left and select **Activate direct connect.** on the **Change LAN** screen.

Check3 Make sure printer is selected as connection for device (e.g. smartphone or tablet).

Select the identifier for direct connection (SSID) specified for the printer as the connection destination for devices.

Check4 Have you entered the proper password specified for the direct connection?

If the security setting of the direct connection is enabled, you need to enter the password to connect your device to the printer.

To check the password specified for the printer, display it using the operation panel of the printer or print out the network setting information of the printer.

- Display on the touch screen.

 [LAN settings](#)

- Print the network settings.

 [Printing Network Settings](#)

Check5 Make sure the printer is not placed too far away from the device.

Place the device and printer where there are no obstacles between them. Wireless communication between different rooms or floors is generally poor. Wireless communication can be impeded by building materials containing metal or concrete. If the printer cannot communicate with the computer over a wireless LAN due to a wall, place the printer and the computer in the same room.

In addition, if a device like a microwave oven that emits radio waves of the same frequency bandwidth as a wireless router is nearby, it may cause interference. Place the wireless router as far away from interference sources as possible.

Place devices a suitable distance from the printer.

Check6 Make sure 5 devices are already connected.

Direct Connection does not allow more than 5 devices to be connected.



Cannot Communicate with Printer via Wired LAN



Check1 Make sure the printer is turned on.

Check2 Make sure the LAN cable is connected properly.

Make sure the printer is connected to the router with the LAN cable. If the LAN cable is loose, connect the cable properly.

If the LAN cable is connected to the WAN side of the router, connect the cable to the LAN side of the router.

If the problem is not resolved, redo setup.

- For Windows:

Use the Setup CD-ROM or follow the instructions on the Canon website to redo setup.

- For Mac OS:

Follow the instructions on the Canon website.



Cannot Print, Scan, or Fax from a Computer Connected to the Network



Check1 Make sure the computer is connected to the wireless router.

For more on how to check the computer settings or connection status, see your computer instruction manual or contact its manufacturer.

Check2 If MP Drivers are not installed, install them.

- For Windows:

Install the MP Drivers using the Setup CD-ROM or install them from the Canon website.

- For Mac OS:

Install the MP Drivers from the Canon website.

Check3 When using wireless LAN, make sure wireless router does not restrict which computers can access it.

For more on connecting to and setting up your wireless router, see the wireless router instruction manual or contact its manufacturer.

➤➤ Note

- To check the MAC address or IP address of your computer, see [Checking Computer IP Address or MAC Address](#).

Network Key Unknown

- [WPA/WPA2 or WEP Key Set for Wireless Router Unknown, Cannot Connect](#)
- [Setting an Encryption Key](#)

WPA/WPA2 or WEP Key Set for Wireless Router Unknown, Cannot Connect

A

For more on setting up a wireless router, see the instruction manual provided with the wireless router or contact its manufacturer. Make sure your computer can communicate with the wireless router.

Set up the printer to match the wireless router settings using IJ Network Device Setup Utility (for Windows) or IJ Network Tool (for Mac OS).

Setting an Encryption Key

A

For more on setting up a wireless router, see the instruction manual provided with the wireless router or contact its manufacturer. Make sure your computer can communicate with the wireless router.

Set up the printer to match the wireless router settings using IJ Network Device Setup Utility (for Windows) or IJ Network Tool (for Mac OS).

- **Using WPA/WPA2**

The authentication method, passphrase, and dynamic encryption type must be the same for the wireless router, the printer, and your computer.

Enter the passphrase configured on the wireless router (a sequence of between 8 and 63 alphanumeric characters, or a 64-character hexadecimal number).

Either TKIP (basic encryption) or AES (secure encryption) is selected automatically as the dynamic encryption method.

- For Windows:

For details, see [If WPA/WPA2 Details Screen Appears](#).

- For Mac OS:

For details, see [Changing WPA or WPA2 Detailed Settings](#).

Note

- This printer supports WPA/WPA2-PSK (WPA/WPA2-Personal) and WPA2-PSK (WPA2-Personal).
-

- **Using WEP**

The key length, key format, key to use (one of 1 to 4), and authentication method must be the same for the wireless router, the printer, and your computer.

To communicate with a wireless router that uses automatically generated WEP keys, you must set the printer to use the key generated by the wireless router, entering it in hexadecimal format.

- For Windows:

When the **WEP Details** screen appears after you click **Search...** on the **Protocol Settings (Wireless LAN)** screen, follow the on-screen instructions to set the WEP key length, format, and the number.

For details, see [If WEP Details Screen Appears](#).

- For Mac OS:

Normally, select **Auto** for the authentication method. Otherwise, select **Open System** or **Shared Key** depending on the wireless router's settings.

When the **WEP Details** screen appears after you click **Set** on the **Wireless Routers** screen, follow the on-screen instructions and set the key length, the key format, the key number, and the authentication method to enter a WEP key.

For details, see [Changing WEP Detailed Settings](#).

▶▶ Note

- If the printer is connected to an AirPort Base Station via LAN:

If the printer is connected to an AirPort Base Station via a LAN, check the settings in **Wireless Security of AirPort Utility**.

- Select **64 bit** if **WEP 40 bit** is selected for key length in AirPort Base Station.
- Select **1** for **Key ID**. Otherwise, computer will not be able to communicate with printer via the wireless router.



Administrator Password Set for Machine Unknown



Initialize the printer settings.

Select **Reset all** to restore administrator password to default.

■ [Reset setting](#)

After initializing the printer settings, redo setup.

- For Windows:
Use the Setup CD-ROM or follow the instructions on the Canon website.
- For Mac OS:
Follow the instructions on the Canon website.



Machine Cannot Be Used After Replacing Wireless Router or Changing Its Settings



When you replace a wireless router, redo the network setup for the printer.

- For Windows:
Use the Setup CD-ROM or follow the instructions on the Canon website.
- For Mac OS:
Follow the instructions on the Canon website.

If this does not solve the problem, see below.

- [Cannot Communicate with Printer After Enabling MAC/IP Address Filtering or Encryption Key on Wireless Router](#)
- [With Encryption On, Cannot Communicate with Printer After Changing Encryption Type at Wireless Router](#)



Cannot Communicate with Printer After Enabling MAC/IP Address Filtering or Encryption Key on Wireless Router



Check1 Check wireless router setting.

To check the wireless router setting, see the instruction manual provided with the wireless router or contact its manufacturer. Make sure the computer and the wireless router can communicate with each other under this setting.

Check2 If filtering MAC addresses or IP addresses at wireless router, check that MAC addresses or IP addresses for computer, network device, and printer are registered.

Check3 If using WPA/WPA2 or WEP key, make sure encryption key for computer, network device, and printer matches key set for wireless router.

Not only the WEP key itself, but also the key length, key format, the key ID to use, and the authentication method must be the same for the printer, the wireless router, and the computer.

For details, see [Setting an Encryption Key](#).

Q With Encryption On, Cannot Communicate with Printer After Changing Encryption Type at Wireless Router

A

If you change the encryption type for the printer and it subsequently cannot communicate with the computer, make sure the encryption type for the computer and the wireless router matches the type set for the printer.

- [Cannot Communicate with Printer After Enabling MAC/IP Address Filtering or Encryption Key on Wireless Router](#)



Printing Is Slow



Check1 Printer may be printing or scanning a large job from another computer.

Check2 When using wireless LAN, make sure the printer is not placed too far away from the wireless router.

Place the wireless router and printer where there are no obstacles between them. Wireless communication between different rooms or floors is generally poor. Wireless communication can be impeded by building materials containing metal or concrete. If the printer cannot communicate with the computer over a wireless LAN due to a wall, place the printer and the computer in the same room.

In addition, if a device like a microwave oven that emits radio waves of the same frequency bandwidth as a wireless router is nearby, it may cause interference. Place the wireless router as far away from interference sources as possible.

Check3 When using wireless LAN, make sure wireless signal is strong. Monitor signal status and move printer and wireless router as necessary.

- For Windows:

-  [Checking Wireless Network Status](#)

- For Mac OS:

-  [Monitoring Wireless Network Status](#)



Cannot Access to Internet on Wireless LAN from Communication Device



Check1 Is your device connected to printer using direct connection?

If your device is connected to the printer using direct connection, you cannot access to the Internet. Turn off direct connection and connect your device to the wireless router.

For details, see the instruction manual provided with your device and wireless router.

Check2 Is wireless router on?

Check3 Is wireless router configured properly?

For more on checking wireless router settings, see the instruction manual provided with the wireless router or contact its manufacturer.

Check4 Check your device and wireless router location.

Check the distance between your device and wireless router, and check for obstruction or source of radio wave interference nearby.



Ink Level Not Shown on Printer Status Monitor (Windows)



Use the printer driver with bidirectional communication.

Select **Enable bidirectional support** in the **Ports** sheet of the properties dialog box of the printer driver.

- [How to Open the Printer Driver Setup Window](#)

Other Network Problems

- **Message Appears on Computer During Setup**
- **Packets Are Sent Constantly (Windows)**
- **Checking Network Information**
- **Restoring to Factory Defaults**

Message Appears on Computer During Setup

- [Screen to Enter Password Appears During Setup](#)
- [Encryption Settings Screen Appears When Wireless Router Selected](#)
- ["You have connected the printer to the non encrypted wireless network" Appears](#)

Q Screen to Enter Password Appears During Setup

A

The following screen appears if the printer is set up for use with a network and an administrator password has been set.

- For Windows:



- For Mac OS:



Enter the administrator password set for the printer.

»»» Note

- An administrator password is already set for the printer at the time of purchase.

For details:

- [Administrator Password](#)

For improved security, we recommend that you change the administrator password.

- For Windows:

- [Changing Administrator Password](#)

- For Mac OS:

- [Changing Settings in Admin Password Sheet](#)

Encryption Settings Screen Appears When Wireless Router Selected

A

This screen appears automatically if the selected wireless router is encrypted. Set the same encryption settings as those set for the wireless router.

- For Windows:
For more on encryption settings, see [Performing/Changing Wireless LAN Settings](#).
- For Mac OS:
For more on encryption settings, see Changing Settings in Wireless LAN Sheet.

"You have connected the printer to the non encrypted wireless network" Appears

A

Security is not configured on the wireless router. The printer can still be used, so continue the setup procedure and complete it.

Important

- If you connect to a network that is not protected with security measures, there is a risk of disclosing data such as your personal information to a third party.



Packets Are Sent Constantly (Windows)



When IJ Network Scanner Selector EX2 is enabled, it periodically transmits packets to check communication with the printer over the network. If you are using your computer in a network environment other than the one used to set up the printer, disable IJ Network Scanner Selector EX2.

To disable IJ Network Scanner Selector EX2, right-click the  icon on the notification area on the desktop and select **Disable Canon IJ Network Scanner Selector EX2**.

Checking Network Information

- [Checking Printer IP Address or MAC Address](#)
- [Checking Computer IP Address or MAC Address](#)
- [Checking Communication Between the Computer, the Printer, and the Wireless Router](#)
- [Checking Network Setting Information](#)

Checking Printer IP Address or MAC Address

A

To check the printer's IP Address or MAC address, print out the network settings information or use the operation panel to display it.

- Display on the touch screen.

- [LAN settings](#)

- Print the network settings.

- [Printing Network Settings](#)

You can check the network setting information on the computer screen.

- For Windows:

- [IJ Network Device Setup Utility Screen](#)

- For Mac OS:

- Canon IJ Network Tool Menus

You can display the printer's MAC address on the touch screen.

- [System information](#)

Checking Computer IP Address or MAC Address

A

To check the IP Address or MAC address of your computer, follow the instructions below.

- For Windows:

1. Select **Command Prompt** as shown below.

In Windows 10, right-click **Start** button and select **Command Prompt**.

In Windows 8.1 or Windows 8, select **Command Prompt** from the **Start** screen. If **Command Prompt** is not displayed on the **Start** screen, select the **Search** charm and search for "**Command Prompt**".

In Windows 7 or Windows Vista, click **Start** > **All Programs** > **Accessories** > **Command Prompt**.

2. Enter "ipconfig/all" and press **Enter**.

The IP address and MAC address of your computer appear. If your computer is not connected to a network, the IP address does not appear.

- For Mac OS:

1. Select **System Preferences** from Apple menu, and then click **Network**.
2. Make sure network interface used by computer is selected, and then click **Advanced**.

When you are using wireless LAN on your computer, make sure **Wi-Fi** is selected as network interface. When you are using wired LAN, make sure **Ethernet** is selected.

3. Check the IP address or MAC address.

Click **TCP/IP** to check the IP address.

Click **Hardware** to check the MAC address.

Checking Communication Between the Computer, the Printer, and the Wireless Router

Perform a ping test to check if communication is taking place.

- For Windows:

1. Select **Command Prompt** as shown below.

In Windows 10, right-click **Start** button and select **Command Prompt**.

In Windows 8.1 or Windows 8, select **Command Prompt** from the **Start** screen. If **Command Prompt** is not displayed on the **Start** screen, select the **Search** charm and search for "**Command Prompt**".

In Windows 7 or Windows Vista, click **Start** > **All Programs** > **Accessories** > **Command Prompt**.

2. Type the ping command and press **Enter**.

The ping command is as follows: ping XXX.XXX.XXX.XXX

"XXX.XXX.XXX.XXX" is the IP address of the target device.

If communication is taking place, a message like the one shown below appears.

Reply from XXX.XXX.XXX.XXX: bytes=32 time=10ms TTL=255

If **Request timed out** appears, communication is not taking place.

- For Mac OS:

1. Start **Network Utility** as shown below.

In Mac OS X v10.11, Mac OS X v10.10, or Mac OS X v10.9, select **Computer** from **Go** menu of Finder, double-click **Macintosh HD** > **System** > **Library** > **CoreServices** > **Applications** > **Network Utility**.

In Mac OS X v10.8 or Mac OS X v10.7, open **Utilities** folder in **Applications** folder, then double-click **Network Utility**.

2. Click **Ping**.
3. Make sure **Send only XX pings** (XX are numbers) is selected.
4. Enter IP address of target printer or target wireless router in **Enter the network address to ping**.
5. Click **Ping**.

"XXX.XXX.XXX.XXX" is the IP address of the target device.

A message such as the following appears.

```
64 bytes from XXX.XXX.XXX.XXX: icmp_seq=0 ttl=64 time=3.394 ms
```

```
64 bytes from XXX.XXX.XXX.XXX: icmp_seq=1 ttl=64 time=1.786 ms
```

```
64 bytes from XXX.XXX.XXX.XXX: icmp_seq=2 ttl=64 time=1.739 ms
```

```
--- XXX.XXX.XXX.XXX ping statistics ---
```

```
3 packets transmitted, 3 packets received, 0% packet loss
```

If packet loss is 100%, communication is not taking place. Otherwise, computer is communicating with target device.

Checking Network Setting Information

To check the printer's network settings information, print out the network settings information or use the operation panel to display it.

- Display on the touch screen.
 - [LAN settings](#)
- Print the network settings.
 - [Printing Network Settings](#)



Restoring to Factory Defaults



»» Important

- For Windows:

Initialization erases all network settings on the printer, making printing, scanning, or faxing operation from a computer over a network impossible. To use the printer over a network again after restoring it to the factory defaults, use the Setup CD-ROM or follow the instructions on the Canon website to redo setup.

- For Mac OS:

Initialization erases all network settings on the printer, making printing, scanning, or faxing operation from a computer over a network impossible. To use the printer over a network again after restoring it to the factory defaults, follow the instructions on the Canon website to redo setup.

Initialize the network setting using the printer's operation panel.

- [Reset setting](#)

Problems while Printing/Scanning from Smartphone/Tablet

- ▶ **Cannot Print/Scan from Smartphone/Tablet**

Cannot Print/Scan from Smartphone/Tablet

If you cannot print/scan from your smartphone/tablet, it is possible that your smartphone/tablet cannot communicate with the printer.

Check the cause of your problem according to the connection method.

- [Cannot Communicate with Printer over Wireless LAN](#)
- [Cannot Communicate with Printer while It Is in Direct Connection](#)

▶▶▶ Note

- For problems on printing with other connection methods or more on performing settings of each connection method:
 - [Using PIXMA/MAXIFY Cloud Link](#)
 - [Printing with Google Cloud Print](#)
 - [Printing from an AirPrint-enabled Printer with iOS Device](#)



Cannot Communicate with Printer over Wireless LAN



If your smartphone/tablet cannot communicate with the printer, check the following.

Check1 Make sure printer is turned on.

Check2 Is  icon displayed on touch screen?

If the icon is not displayed, tap the icon on the upper right, and then select **Activate wireless LAN** on the **Change LAN** screen.

If the  icon is displayed, the printer is not connected to the wireless router.

Check3 Are network settings of printer identical with those of wireless router?

Make sure the network settings of the printer (e.g. wireless router name, SSID, network key, etc.) are identical with those of the wireless router.

To check the settings of the wireless router, refer to the instruction manual provided with it or contact its manufacturer.

To check the current network settings of the printer, print out the network setting information.

- [Printing Network Settings](#)

If the network settings of the printer are not identical with those of the wireless router, match the network settings of the printer to those of the wireless router.

Check4 Are network settings of your smartphone/tablet identical with those of wireless router?

Make sure the network settings of your smartphone/tablet (e.g. wireless router name, SSID, network key, etc.) are identical with those of the wireless router.

To check the settings of your smartphone/tablet, refer to the instruction manual provided with it.

If the network settings of your smartphone/tablet are not identical with those of the wireless router, change the network settings of it to match with those of the wireless router.

Check5 Make sure printer is not too far away from wireless router.

Locate the printer close enough to communicate with the wireless router.

Check6 Check for obstructions.

Wireless communication between different rooms or floors is generally poor. Move the printer and wireless router as necessary.

Check7 Make sure there is no source of radio wave interference nearby.

If a device like a microwave oven that emits radio waves of the same frequency bandwidth as a wireless router is nearby, it may cause interference. Place the wireless router as far away from the interference source as possible.

Cannot Communicate with Printer while It Is in Direct Connection

A

If your smartphone/tablet cannot communicate with the printer in the direct connection, check the following.

Check1 Make sure printer is turned on.

Check2 Is  icon displayed on touch screen?

If the icon is not displayed, tap the icon on the upper right, and then select **Activate direct connect.** on the **Change LAN** screen.

Check3 Check settings of your smartphone/tablet.

Make sure your smartphone/tablet can use the wireless LAN.

For more on performing setting of the wireless LAN, refer to the instruction manual provided with your smartphone/tablet.

Check4 Have you selected printer as destination of your smartphone/tablet?

Select the access point name (SSID) of the printer with your smartphone/tablet.

Check5 Have you entered proper password specified for direct connection?

If the security setting of the direct connection is enabled, you need to enter the password to connect your smartphone/tablet to the printer.

Check6 Make sure printer is not too far away.

Locate your smartphone/tablet close enough to communicate with the printer.

Check7 Check for obstructions.

Wireless communication between different rooms or floors is generally poor. Move the printer as necessary.

Check8 Make sure there is no source of radio wave interference nearby.

If a device like a microwave oven that emits radio waves of the same frequency bandwidth as a wireless router is nearby, it may cause interference. Place the printer as far away from the interference source as possible.

Check9 Make sure 5 devices are already connected.

Direct connection does not allow more than 5 devices to be connected.

Printing Problems

- ▶ **Printing Does Not Start**
- ▶ **Paper Jams**
- ▶ **Print Results Are Unsatisfactory**
- ▶ **No Ink Comes Out**
- ▶ **Paper Does Not Feed Properly/"No Paper" Error**
- ▶ **Automatic Duplex Printing Problems**
- ▶ **Copying/Printing Stops**
- ▶ **Cannot Print Using AirPrint**



Printing Does Not Start



Check1 Make sure printer is securely plugged in and press **ON** button to turn it on.

The **POWER** lamp flashes while the printer is initializing. Wait until the **POWER** lamp stops flashing and remains lit.

▶▶▶ Note

- If you are printing large data such as photos or other graphics, printing may take longer to start. The **POWER** lamp flashes while the computer is processing data and sending it to the printer. Wait until printing starts.

Check2 Make sure printer is properly connected to computer.

If you are using a USB cable, make sure it is securely connected to both the printer and the computer. When the USB cable is securely plugged in, check the following:

- If you are using a relay device such as a USB hub, disconnect it, connect the printer directly to the computer, and retry the printing. If printing starts normally, there is a problem with the relay device. Contact the vendor of the relay device.
- There could also be a problem with the USB cable. Replace the USB cable and retry the printing.

If you use the printer over a LAN, make sure the printer is connected to the network with a LAN cable or is correctly set up for network use.

Check3 Is direct connection enabled?

To print using a mode other than the direct connection, disable the direct connection first.

■ [Using Machine with Direct Connection](#)

Check4 Make sure paper settings match information set for cassette.

If the paper settings do not match the information set for the cassette, an error message appears on the touch screen. Follow the instructions on the touch screen to solve the problem.

■ [Paper Settings](#)

▶▶▶ Note

- You can select whether the message which prevents misprinting is displayed.
 - To change the message view setting when printing or copying using the printer's operation panel:
 - [Cassette settings](#)
 - To change the message view setting when printing using the printer driver:
 - [Changing the Printer Operation Mode](#) (Windows)

Check5 If printing from a computer, delete unnecessary print jobs.

- For Windows:

■ [Deleting the Undesired Print Job](#)

- For Mac OS:

■ [Deleting the Undesired Print Job](#)

Check6 Is your printer's printer driver is selected when printing?

The printer will not print properly if you are using a printer driver for a different printer.

- For Windows:

Make sure "Canon XXX series Printer" (where "XXX" is your printer's name) is selected in the Print dialog box.

▶▶▶ **Note**

- To make the printer the one selected by default, select **Set as Default Printer**.

- For Mac OS:

Make sure your printer's name is selected in **Printer** in the Print dialog.

▶▶▶ **Note**

- To make the printer the one selected by default, select the printer for **Default printer**.

Check7 Set correct printer port. (Windows)

Make sure the correct printer port is set.

1. Log in using an account with administrator privileges.
2. Make the following settings.
 - In Windows 10, right-click **Start** button and select **Control Panel > View devices and printers**.
 - In Windows 8.1 or Windows 8, select **Control Panel** from **Settings** charm on **Desktop > Hardware and Sound > Devices and Printers**.
 - In Windows 7, select **Devices and Printers** from **Start** menu.
 - In Windows Vista, select **Start** menu > **Control Panel > Hardware and Sound > Printers**.
3. Open printer driver properties.
 - In Windows 10, Windows 8.1, Windows 8, or Windows 7, right-click "Canon XXX series Printer" icon (where "XXX" is your printer's name), and then select **Printer properties**.
 - In Windows Vista, right-click "Canon XXX series Printer" icon (where "XXX" is your printer's name), and then select **Properties**.
4. Click **Ports** tab to check port settings.

Make sure a port named "USBnnn" (where "n" is a number) with "Canon XXX series Printer" appearing in **Printer** column is selected for **Print to the following port(s)**.

 - If setting is incorrect:

Reinstall the MP Drivers from the Setup CD-ROM or the Canon website.

- If printing does not start even though the printer is connected to the computer using a USB cable and the port named "USBnnn" is selected:

In Windows 8.1 or Windows 8, select **My Printer** on **Start** screen to start **My Printer**. If **My Printer** is not displayed on **Start** screen, select **Search** charm, and then search for "**My Printer**".

Set the correct printer port on **Diagnose and Repair Printer**. Follow the on-screen instructions to set the correct printer port, and then select your printer's name.

In Windows 7 or Windows Vista, click **Start** and select **All programs, Canon Utilities, Canon My Printer, Canon My Printer**, and then select **Diagnose and Repair Printer**. Follow the on-screen instructions to set the correct printer port, and then select your printer's name.

If the problem is not resolved, reinstall the MP Drivers from the Setup CD-ROM or the Canon website.

Check8 Is print data extremely large? (Windows)

Click **Print Options** on **Page Setup** sheet of the printer driver. Then set **Prevention of Print Data Loss** to **On** in the dialog that appears.

* This may reduce print quality.

Check9 If printing from your computer, restart computer.



Paper Jams



When paper jams, a troubleshooting message appears automatically. Take the appropriate action described in the message.

- **When a Support Code and a Message Are Displayed on Computer Screen:**

- For Windows:

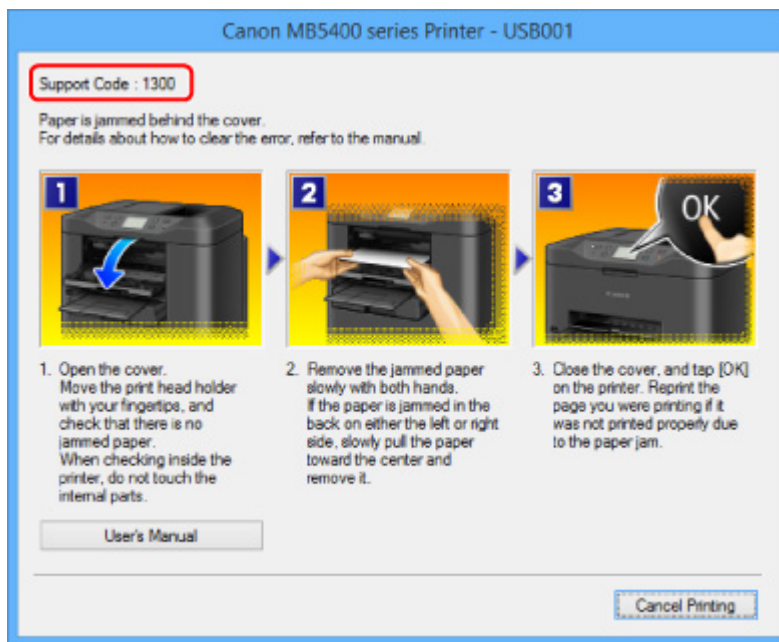

- For Mac OS:

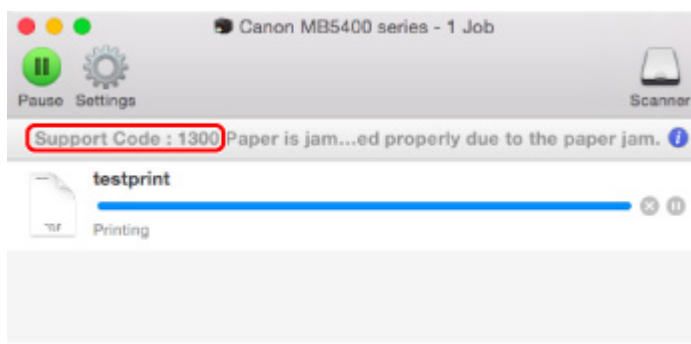

* The screen differs depending on the OS you are using.

- When a Support Code and a Message Are Displayed on Touch Screen:



To remove the jammed paper, see [List of Support Code for Error \(Paper Jams\)](#).

»» Note

- You can also search for details on resolving the errors indicated by the support code shown.

■ [Search](#)



Print Results Are Unsatisfactory



If the print results are unsatisfactory due to white streaks, misaligned lines, or uneven colors, check the paper and print quality settings first.

Check1 Do page size and media type settings match size and type of loaded paper?

If these settings do not match, it is not possible to obtain the proper result.

If you are printing a photograph or an illustration, an incorrect paper type setting may reduce the quality of the printout color.

Also, if you print with an incorrect paper type setting, the printed surface may be scratched.

The method for checking the paper and print quality settings differs depending on what you are using your printer for.

Copying	Check the settings using the operation panel. ■ Setting Items for Copying
Printing from USB flash drive	Check the settings using the operation panel. ■ Setting Items for Photo Printing Using Operation Panel
Printing from your computer	Check the settings using the printer driver. • For Windows: ■ Printing with Easy Setup • For Mac OS: ■ Printing with Easy Setup

Check2 Make sure appropriate print quality is selected (see table above).

Select a print quality suited to the paper and to what you are printing. If you notice blurs or uneven colors, increase the print quality setting and retry the printing.

Check3 If problem is not resolved, check other causes.

See also the sections below:

- [Cannot Complete Printing](#)
- [Part of Page Is Not Printed \(Windows\)](#)
- [Paper Is Blank/Printing Is Blurry/Colors Are Wrong/White Streaks Appear](#)
- [Lines Are Misaligned](#)
- [Lines Incomplete or Missing \(Windows\)](#)
- [Images Incomplete or Missing \(Windows\)](#)
- [Ink Blots / Paper Curl](#)
- [Paper Is Smudged / Printed Surface Is Scratched](#)

- ■ [Back of Paper Is Smudged](#)
- ■ [Uneven or Streaked Colors](#)



Cannot Complete Printing



Check1 Select setting not to compress printing data. (Windows)

If you select the setting not to compress the printing data with an application software you are using, the printing result may be improved.

Click **Print Options** on **Page Setup** sheet of the printer driver. Select **Do not allow application software to compress print data** check box and click **OK**.

* Clear the check box once printing is complete.

Check2 Is print data extremely large? (Windows)

Click **Print Options** on **Page Setup** sheet of the printer driver. Then set **Prevention of Print Data Loss** to **On** in the dialog that appears.

* This may reduce print quality.

Check3 Your hard disk may not have sufficient free space to store job.

Delete unnecessary files to free up disk space.



Part of Page Is Not Printed (Windows)



Check Are you using automatic duplex printing?

If you are using automatic duplex printing, the printable area at the top of the page will be 0.08 inches / 2 mm shorter than usual.

Therefore, the bottom of the page may not be printed. To prevent this, set reduced printing on the printer driver.

►► Important

- Reducing the printing size may affect the layout of your document.

If the application you used to create your document has a zoom function, set the reduced size in the application.

1. Open printer driver setup window.
 - [How to Open the Printer Driver Setup Window](#)
2. Check **Duplex Printing** check box in **Page Setup** sheet.
3. Click **Print Area Setup** and select **Use reduced printing**.



Paper Is Blank/Printing Is Blurry/Colors Are Wrong/White Streaks Appear

❖ Paper Is Blank



❖ Printing Is Blurry

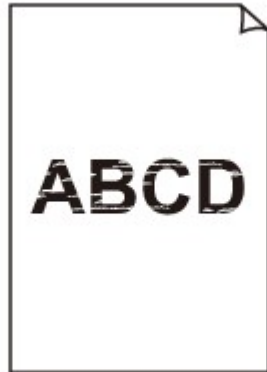

❖ Colors Are Wrong

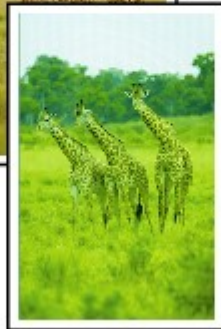

White Streaks Appear

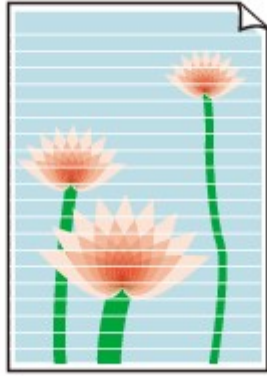

A

Check1 Check paper and print quality settings.

■ [Print Results Are Unsatisfactory](#)

Check2 Check status of ink tanks. Replace ink tank if ink has run out.

■ [Replacing Ink Tanks](#)

Check3 Print nozzle check pattern and perform any necessary maintenance operations such as print head cleaning.

Print the nozzle check pattern to determine whether the ink ejects properly from the print head nozzles.

For details on printing the nozzle check pattern, print head cleaning, and print head deep cleaning, see [If Printing Is Faint or Uneven](#).

- If nozzle check pattern is not printed correctly:

Check if the ink tank for the problem color is empty.

If the ink tank is not empty, perform print head cleaning and try printing the nozzle check pattern again.

- If problem is not resolved after performing print head cleaning twice:

Perform print head deep cleaning.

If the problem is not resolved after performing print head deep cleaning, turn off the printer and perform print head deep cleaning again 24 hours later. When you turn the printer off, do not unplug it.

- If problem is not resolved after performing print head deep cleaning twice:

If print head deep cleaning does not resolve the problem, the print head may be damaged. Contact your nearest Canon service center to request a repair.

Check4 When using paper with one printable surface, make sure paper is loaded with printable side facing down.

Printing on the wrong side of such paper may cause unclear prints or prints with reduced quality.

Load paper with the printable side facing down.

Refer to the instruction manual supplied with the paper for detailed information on the printable side.

- **When copying, see also the sections below:**

Check5 Is platen glass or glass of ADF dirty?

Clean the platen glass or the glass of ADF.

- [Cleaning the Platen Glass and Document Cover](#)

▶▶▶ Note

- If the glass of ADF is dirty, black streaks appear on the paper as shown below.



Check6 Make sure original is loaded correctly on platen glass or in ADF.

- [Loading Originals](#)

Check7 Is original document is loaded with proper side facing up/down?

When loading the original on the platen glass, the side to be copied should be face down. When loading the original in the ADF, the side to be copied should be face up.

Check8 Did you copy a printout done by this printer?

If you use a printout done by this printer as the original, print quality may be reduced depending on the condition of the original.

Print from the printer directly, or reprint from the computer if you can reprint from it.



Lines Are Misaligned



Check1 Check paper and print quality settings.

■ [Print Results Are Unsatisfactory](#)

Check2 Perform print head alignment.

If printed lines are misaligned or print results are otherwise unsatisfactory, adjust the print head position.

■ [Aligning the Print Head](#)

►► Note

- If the problem is not resolved after performing the print head alignment, perform print head alignment manually. See [Aligning the Print Head Manually](#).

Check3 Increase print quality and try printing again.

Increasing the print quality using the operation panel or the printer driver may improve the print result.

Check4 If lines are misaligned with manual duplex printing, perform automatic duplex printing. (Windows)



Lines Incomplete or Missing (Windows)



Check1 Are you using Page Layout Printing or Binding Margin function?

When the Page Layout Printing or Binding margin function is in use, thin lines may not be printed. Try thickening the lines in the document.

Check2 Is print data extremely large?

Click **Print Options** on **Page Setup** sheet of the printer driver. Then set **Prevention of Print Data Loss** to **On** in the dialog that appears.

* This may reduce print quality.



Images Incomplete or Missing (Windows)



Check1 Select setting not to compress printing data.

If you select the setting not to compress the printing data with an application software you are using, the printing result may be improved.

Click **Print Options** on **Page Setup** sheet of the printer driver. Select **Do not allow application software to compress print data** check box and click **OK**.

* Clear the check box once printing is complete.

Check2 Is print data extremely large?

Click **Print Options** on **Page Setup** sheet of the printer driver. Then set **Prevention of Print Data Loss** to **On** in the dialog that appears.

* This may reduce print quality.



Ink Blots / Paper Curl

Ink Blots



Paper Curl



Check1 Check paper and print quality settings.

 [Print Results Are Unsatisfactory](#)

Check2 If intensity is set high, reduce intensity setting and try printing again.

If you are printing with a high intensity setting on plain paper, the paper may absorb too much ink and become wavy, causing paper abrasion.

- Printing from your computer

Check the intensity setting in the printer driver.

- For Windows:

 [Adjusting Intensity](#)

- For Mac OS:

 [Adjusting Intensity](#)

- Copying

 [Setting Items for Copying](#)

Check3 Use Photo Paper to print photos.

To print data with high color saturation such as photographs or images with dark colors, we recommend that you use Photo Paper Plus Glossy II or other Canon specialty paper.

 [Supported Media Types](#)



Paper Is Smudged / Printed Surface Is Scratched

Paper Is Smudged

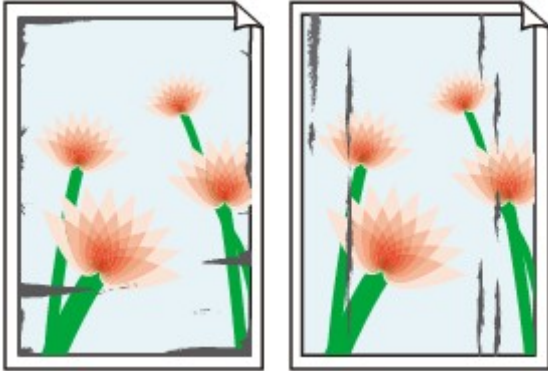

Smudged Edges

Smudged Surface



Printed Surface Is Scratched



Check1 Check paper and print quality settings.

 [Print Results Are Unsatisfactory](#)

Check2 Check paper type.

Make sure you are using the right paper for what you are printing.

 [Supported Media Types](#)

Check3 Correct curl before loading paper.

When using Photo Paper Plus Semi-gloss, even if the sheet is curled, load one sheet at a time as it is. Rolling this paper in the opposite direction to flatten it may crack the paper surface and reduce the print quality.

We recommend putting unused paper back into the package and storing it flat.

- Plain Paper

Turn the paper over and reload it to print on the other side.

- Other Paper

If the paper corners curl more than 0.1 inch / 3 mm (A) in height, the paper may smudge or may not feed properly. Follow the instructions below to correct the paper curl.



1. Roll up paper in opposite direction to paper curl as shown below.



2. Check that paper is now flat.

We recommend printing curl-corrected paper one sheet at a time.

►► Note

- Depending on paper type, the paper may smudge or may not feed properly even if it is not curled inward. Follow the instructions below to curl the paper outward up to 0.1 inch / 3 mm (B) in height before printing. This may improve the print result.

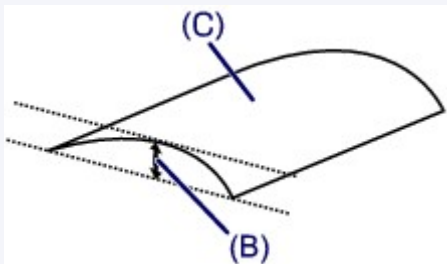

(C) Print side

We recommend feeding paper that has been curled outward one sheet at a time.

Check4 Set printer to prevent paper abrasion.

Adjusting the setting to prevent paper abrasion will widen the clearance between the print head and the paper. If you notice abrasion even with the media type set correctly to match the paper, set the printer to prevent paper abrasion using the operation panel or the computer.

This may reduce the print speed.

* Once you have finished printing, undo this setting. Otherwise, it will apply to subsequent print jobs.

- From operation panel

Press the **HOME** button, select **Setup**, **Device settings**, and **Print settings**, and then set **Prevent paper abrasion** to **ON**.

■ [Changing Settings from Operation Panel](#)

- From computer

- For Windows:

Open the printer driver setup window, select **Custom Settings** in **Maintenance** sheet, select **Prevent paper abrasion** check box, and then click **OK**.

To open the printer driver setup window, see [How to Open the Printer Driver Setup Window](#).

- For Mac OS:

In the Canon IJ Printer Utility, select **Custom Settings** in the pop-up menu, select **Prevent paper abrasion** check box, and then click **Apply**.

To open the Canon IJ Printer Utility, see Opening the Canon IJ Printer Utility.

Check5 If intensity is set high, reduce intensity setting and try printing again.

If you are printing with a high intensity setting on plain paper, the paper may absorb too much ink and become wavy, causing paper abrasion.

- Printing from your computer

Check the intensity setting in the printer driver.

- For Windows:

■ [Adjusting Intensity](#)

- For Mac OS:

■ [Adjusting Intensity](#)

- Copying

■ [Setting Items for Copying](#)

Check6 Do not print outside recommended printing area.

If you print outside the recommended printing area of your paper, ink may stain the lower edge of the paper.

Resize the document using application software.

■ [Print Area](#)

Check7 Is platen glass or glass of ADF dirty?

Clean the platen glass or the glass of ADF.

■ [Cleaning the Platen Glass and Document Cover](#)

▶▶▶ Note

- If the glass of ADF is dirty, black streaks appear on the paper as shown below.



Check8 Is paper feed roller dirty?

Clean the paper feed roller.

■ [Cleaning Paper Feed Rollers](#)

▶▶▶ Note

- Cleaning the paper feed roller abrades it, so do this only when necessary.

Check9 Is inside of printer dirty?

During duplex printing, ink may stain the inside of the printer, smudging the printout. Perform the bottom plate cleaning to clean the inside of the printer.

■ [Cleaning Inside the Machine \(Bottom Plate Cleaning\)](#)

▶▶▶ Note

- To prevent staining inside the printer, be sure to set the correct paper size.

Check10 Set longer ink drying time.

This allows the printed surface to dry, preventing smudges and scratches.

- For Windows:
 1. Make sure printer is turned on.
 2. Open printer driver setup window.
 - [How to Open the Printer Driver Setup Window](#)
 3. Click **Maintenance** tab and **Custom Settings**.
 4. Drag **Ink Drying Wait Time** slide bar to set wait time and click **OK**.
 5. Check message and click **OK**.
- For Mac OS:
 1. Make sure printer is turned on.
 2. Open Canon IJ Printer Utility.
 - [Opening the Canon IJ Printer Utility](#)
 3. Select **Custom Settings** in pop-up menu.
 4. Drag **Ink Drying Wait Time**: slide bar to set wait time and click **Apply**.
 5. Check message and click **OK**.



Back of Paper Is Smudged

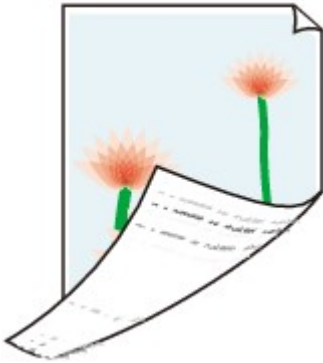

Check1 Check paper and print quality settings.

■ [Print Results Are Unsatisfactory](#)

Check2 Perform bottom plate cleaning to clean inside of printer.

■ [Cleaning Inside the Machine \(Bottom Plate Cleaning\)](#)

»» Note

- During duplex printing or too much printing, ink may stain the inside of the printer.

Q

Uneven or Streaked Colors

▣ Uneven Colors



▣ Streaked Colors



A

Check1 Check paper and print quality settings.

■ [Print Results Are Unsatisfactory](#)

Check2 Print nozzle check pattern and perform any necessary maintenance operations such as print head cleaning.

Print the nozzle check pattern to determine whether the ink ejects properly from the print head nozzles.

For details on printing the nozzle check pattern, print head cleaning, and print head deep cleaning, see [If Printing Is Faint or Uneven](#).

- If nozzle check pattern is not printed correctly:
 - Check if the ink tank for the problem color is empty.

If the ink tank is not empty, perform print head cleaning and try printing the nozzle check pattern again.

- If problem is not resolved after performing print head cleaning twice:

Perform print head deep cleaning.

If the problem is not resolved after performing print head deep cleaning, turn off the printer and perform print head deep cleaning again 24 hours later. When you turn the printer off, do not unplug it.

- If problem is not resolved after performing print head deep cleaning twice:

If print head deep cleaning does not resolve the problem, the print head may be damaged. Contact your nearest Canon service center to request a repair.

Check3 Perform print head alignment.

[Aligning the Print Head](#)

Note

- If the problem is not resolved after performing the print head alignment, perform print head alignment manually. See [Aligning the Print Head Manually](#).



No Ink Comes Out



Check1 Has ink run out?

Check the support code on the touch screen and take the appropriate action to resolve the error.

■ [List of Support Code for Error](#)

Check2 Are print head nozzles clogged?

Print the nozzle check pattern to determine whether the ink ejects properly from the print head nozzles.

For details on printing the nozzle check pattern, print head cleaning, and print head deep cleaning, see [If Printing Is Faint or Uneven](#).

- If nozzle check pattern is not printed correctly:
Check if the ink tank for the problem color is empty.
If the ink tank is not empty, perform print head cleaning and try printing the nozzle check pattern again.
- If problem is not resolved after performing print head cleaning twice:
Perform print head deep cleaning.
If the problem is not resolved after performing print head deep cleaning, turn off the printer and perform print head deep cleaning again 24 hours later. When you turn the printer off, do not unplug it.
- If problem is not resolved after performing print head deep cleaning twice:
If print head deep cleaning does not resolve the problem, the print head may be damaged. Contact your nearest Canon service center to request a repair.



Paper Does Not Feed Properly/"No Paper" Error



Check1 Make sure paper is loaded.

■ [Loading Paper](#)

Check2 When loading paper, consider the following.

- When loading two or more sheets of paper, flip through the paper before loading it. In addition, when you load paper with some paper remaining in the cassette, flip through the remaining paper and the newly loaded paper before loading.



- When loading two or more sheets of paper, align the edges of the sheets before loading the paper.
- When loading two or more sheets of paper, make sure the paper stack does not exceed the paper load limit.

However, paper may not feed correctly at the maximum capacity, depending on the type of paper or environmental conditions (very high or low temperature and humidity). In such cases, reduce the amount of paper you load at a time to less than half of the paper load limit.

- Always load the paper in portrait orientation, regardless of the printing orientation.

■ [Loading Paper](#)

»» Important

- When loading paper in the cassette, slide the paper guide on the front side to align with the corresponding mark of page size. Load the paper with the print side facing DOWN, load the paper stack in the center of the cassette and slide the paper guides to align with the both edges of the paper stack.

■ [Loading Paper](#)

Check3 Is paper too thick or curled?

■ [Unsupported Media Types](#)

Check4 When loading postcards or envelopes, consider the following:

- If a postcard is curled, it may not feed properly even though the paper stack does not exceed the paper load limit.

Load Japanese postcards with their postcode column toward the far end of the cassette 1.

- When printing on envelopes, see [Loading Paper](#), and prepare the envelopes before printing.

Once you have prepared the envelopes, load them in portrait orientation. If the envelopes are placed in landscape orientation, they will not feed properly.

Check5 Make sure media type and paper size settings match with loaded paper.

Check6 Clean paper feed roller.

■ [Cleaning Paper Feed Rollers](#)

▶▶▶ Note

- Cleaning the paper feed roller abrades it, so do this only when necessary.

Check7 If two or more sheets of paper feed from cassette at once, clean inside of cassette.

For information on cleaning the inside of the cassette, see [Cleaning Cassette Pads](#).

If the measures above do not solve the problem, contact your nearest Canon service center to request a repair.



Automatic Duplex Printing Problems



Check1 Is automatic duplex printing selected?

- For Windows:

Make sure **Duplex Printing** and **Automatic** check boxes are selected on **Page Setup** sheet in the printer driver setup window.



- For Mac OS:

Make sure **Two-Sided** check box is selected on the Print dialog.



Check2 Make sure loaded paper size is suitable for automatic duplex printing.

The paper sizes suitable for automatic two-sided printing are A4 and Letter.

Load paper of suitable size and tap **OK** on the touch screen.

Check3 Make sure paper size setting is correct.

Make sure the paper size setting is appropriate for automatic duplex printing.

Check the paper size setting in the application software.

Then, check the paper size setting in the printer driver.

- For Windows:

Check **Page Size** setting in **Page Setup** sheet in the printer driver setup window.

- For Mac OS:

Check **Paper Size** in the Page Setup dialog.

▶▶▶ Note

- Duplex printing may not be available depending on the version of the application software.

Check4 Make sure media type setting is correct.

Make sure the media type setting is appropriate for automatic duplex printing.

- For Windows:

Make sure the loaded paper is suited to automatic duplex printing in **Main** sheet in the printer driver setup window.

- For Mac OS:

Make sure the loaded paper is suited to automatic duplex printing in **Quality & Media** sheet in the Print dialog.

▶▶▶ Note

- For Windows:

To switch to manual duplex printing, follow the procedure below.

Open the printer driver setup window, clear **Automatic** check box on **Page Setup** sheet, and reprint.

When performing manual duplex printing, note the following.

- If you are printing three or more pages of a document with manual duplex printing, one side of each sheet is printed first. Turn over and reload the paper to print the reverse sides. Do not change the order of the sheets.
 - The procedure for turning the paper over varies depending on the staple side and printing orientation. Follow the on-screen instructions.
- For Mac OS:
Manual duplex printing is not available.



Copying/Printing Stops



Check1 Is paper loaded?

Make sure paper is loaded.

If necessary, load paper.

Check2 Do documents to be printed have many photographs or illustrations?

It takes time for the printer and the computer to process large data such as photos or other graphics, so it may seem that the printer is not working.

Also, if you are printing data that requires a lot of ink on successive sheets of plain paper, the printer may pause temporarily. In either case, wait until the process is complete.

▶▶▶ Note

- If you are printing a document with a large printing area or printing several copies, printing may pause to allow the ink to dry.

Check3 Has printer been printing continuously for a long period?

If the printer has been printing continuously for a long time, the print head or other parts around it may overheat. The printer may stop printing at a line break for a period of time and then resume printing.

In this case, wait a while without doing anything. If the printing does not resume, interrupt your print session and turn the printer off for at least 15 minutes.

⚠ Caution

- Print head and surrounding area can become extremely hot. Never touch print head or nearby components.



Cannot Print Using AirPrint



Check1 Make sure printer is turned on.

If the printer is turned on, turn it off and back on, and then check whether the issue is resolved.

Check2 Make sure printer is connected by LAN to same network subnet as AirPrint compliant device when printing over LAN.

Check3 Make sure printer has enough paper and ink.

Check4 Make sure no error message is displayed on printer's touch screen.

If the problem is not resolved, use the printer driver on your computer to execute printing and check whether the document can be printed normally on the printer.

Scanning Problems (Windows)

- ▶ **Scanning Problems**
- ▶ **Scan Results Are Unsatisfactory**
- ▶ **Software Problems**
- ▶ **IJ Scan Utility Error Messages**
- ▶ **ScanGear (Scanner Driver) Error Messages**

Scanning Problems

- ▶ **Scanner Does Not Work**
- ▶ **ScanGear (Scanner Driver) Does Not Start**
- ▶ **Error Message Appears and the ScanGear (Scanner Driver) Screen Does Not Appear**
- ▶ **Cannot Scan Multiple Originals at One Time**
- ▶ **Slow Scanning Speed**
- ▶ **"There is not enough memory." Message Is Displayed**
- ▶ **Computer Stops Operating during Scanning**
- ▶ **Scanner Does Not Work after Upgrading Windows**
- ▶ **Scanned Image Does Not Open**



Scanner Does Not Work



Check 1 Make sure that your scanner or printer is turned on.

Check 2 Connect the USB cable to a different USB port on the computer.

Check 3 If the USB cable is connected to a USB hub, remove it from the USB hub and connect it to a USB port on the computer.

Check 4 Restart the computer.



ScanGear (Scanner Driver) Does Not Start



Check 1 Make sure that MP Drivers is installed.

If not installed, install MP Drivers from the Setup CD-ROM or our website.

Check 2 Select your scanner or printer on the application's menu.

▶▶▶ Important

- If your scanner or printer name is displayed multiple times, select the one that does not include WIA.

▶▶▶ Note

- The operation may differ depending on the application.
- Use the WIA driver when scanning from a WIA-compliant application.

■ [Scanning with WIA Driver](#)

Check 3 Make sure that the application supports TWAIN.

You cannot start ScanGear (scanner driver) from applications not supporting TWAIN.

Check 4 Scan and save images with IJ Scan Utility and open the files in your application.



Error Message Appears and the ScanGear (Scanner Driver) Screen Does Not Appear



Check 1 Make sure that your scanner or printer is turned on.

Check 2 Turn off your scanner or printer, then reconnect the USB cable and replug the power cord.

Check 3 Connect the USB cable to a different USB port on the computer.

Check 4 If the USB cable is connected to a USB hub, remove it from the USB hub and connect it to a USB port on the computer.

Check 5 Make sure that MP Drivers is installed.

If not installed, install MP Drivers from the Setup CD-ROM or our website.

Check 6 Select your scanner or printer on the application's menu.

»» Note

- The operation may differ depending on the application.

Check 7 Make sure that the application supports TWAIN.

You cannot start ScanGear (scanner driver) from applications not supporting TWAIN.

Check 8 Exit ScanGear if it is running on another application.



Cannot Scan Multiple Originals at One Time



Check 1 Make sure that the items are placed correctly.

■ [Positioning Originals \(Scanning from Computer\)](#)

Check 2 Check if you can properly scan one item.

Some applications do not support multiple image scanning. In that case, scan each item individually.



Slow Scanning Speed



Check 1 To view the image on a monitor, set the output resolution to around 150 dpi. To print, set it to around 300 dpi.

■ [Resolution](#)

Check 2 Set **Fading Correction**, **Grain Correction**, etc. to **None**.

Refer to "Image Settings" for your model from Home of the Online Manual for details.

Check 3 In IJ Scan Utility, deselect the **Correct slanted text document / Detect the orientation of text document and rotate image** checkbox and scan again.

■ [Settings \(Document Scan\) Dialog Box](#)

■ [Settings \(Custom Scan\) Dialog Box](#)



"There is not enough memory." Message Is Displayed



Check 1 Exit other applications and try again.

Check 2 Reduce the resolution or output size and scan again.

■ [Resolution](#)



Computer Stops Operating during Scanning



Check 1 Restart the computer, reduce the output resolution in ScanGear (scanner driver) and scan again.

Refer to "Output Settings" for your model from Home of the Online Manual for details.

Check 2 Delete unnecessary files to obtain sufficient free hard disk space, then scan again.

Error message may appear if there is not enough hard disk space to scan and save, when the image size is too large (such as when scanning a large item at high resolution).

Check 3 In **Folder to Save Temporary Files** of IJ Scan Utility, specify a folder on a drive with sufficient free space.

■ [Settings \(General Settings\) Dialog Box](#)

Check 4 Multiple devices may be connected to USB ports.

Disconnect devices other than your scanner or printer.



Scanner Does Not Work after Upgrading Windows



Check Disconnect the USB cable, then uninstall (delete) and reinstall MP Drivers and IJ Scan Utility.

Step 1: Uninstall MP Drivers.

For how to delete MP Drivers, see [Deleting the Unnecessary MP Drivers](#).

Step 2: Uninstall IJ Scan Utility.

1. Click **Control Panel > Programs > Programs and Features**.
2. Select **Canon IJ Scan Utility** and click **Uninstall/Change**.
3. When a confirmation appears, click **Yes**.
4. When uninstallation is complete, click **OK**.

IJ Scan Utility is deleted.

Note

- A confirmation or warning dialog box may appear when installing, uninstalling, or starting up software. This dialog box appears when administrative rights are required to perform a task. If you are logged on to an administrator account, follow the on-screen instructions.

Step 3: Reinstall MP Drivers and IJ Scan Utility.

Reinstall MP Drivers and IJ Scan Utility from the Setup CD-ROM or our website.



Scanned Image Does Not Open



Check If the data format is not supported by the application, scan the image again and select a popular data format such as JPEG when saving it.

Refer to the application's manual for details. If you have any questions, contact the manufacturer of the application.

Scan Results Are Unsatisfactory

- **Moire Appears in Scan Results**
- **Scan Quality (Image Displayed on the Monitor) Is Poor**
- **Scanned Image Is Surrounded by Extra White Areas**
- **Cannot Scan at the Correct Size**
- **Position or Size of the Image Cannot be Detected Correctly When Scanning from the Operation Panel**
- **Original Is Placed Correctly, but the Scanned Image Is Slanted**
- **Scanned Image Is Enlarged (Reduced) on the Computer Monitor**



Moire Appears in Scan Results



Check 1 Increase the scanning resolution.

■ [Resolution](#)

Check 2 Take the following measures and scan again.

- Set one of the following settings in the **Settings (Document Scan)** dialog box, **Settings (Custom Scan)** dialog box, **Settings (Scan and Stitch)** dialog box, **Settings (OCR)** dialog box or **Settings (E-mail)** dialog box of IJ Scan Utility, then scan from the IJ Scan Utility main screen.

- Set **Select Source** to **Magazine** and set **Color Mode** to **Color**
- Select the **Reduce moire** checkbox in **Image Processing Settings**

■ [Settings \(Document Scan\) Dialog Box](#)

■ [Settings \(Custom Scan\) Dialog Box](#)

■ [Settings \(Scan and Stitch\) Dialog Box](#)

■ [Settings \(OCR\) Dialog Box](#)

■ [Settings \(E-mail\) Dialog Box](#)

- On the **Basic Mode** tab of ScanGear (scanner driver), select **Magazine (Color)** in **Select Source**.
Refer to "Basic Mode Tab" for your model from Home of the Online Manual for details.
- On the **Advanced Mode** tab of ScanGear, set **Descreen** in **Image Settings** to **ON**.
Refer to "Image Settings" for your model from Home of the Online Manual for details.

▶▶▶ Note

- If moire appears when you scan a digital print photo, take the above measures and scan again.



Scan Quality (Image Displayed on the Monitor) Is Poor



Check 1 If the image is jagged, increase the scanning resolution, or select **TIFF** or **PNG** in **Data Format** of the Settings dialog box.

- [Resolution](#)
- [Settings Dialog Box](#)

Check 2 Set the display size to 100 %.

Some applications do not display images clearly if the display size is too small.

Check 3 If moire (stripe pattern) appears, take the following measures and scan again.

- Set one of the following settings in the **Settings (Document Scan)** dialog box, **Settings (Custom Scan)** dialog box, or **Settings (Scan and Stitch)** dialog box of IJ Scan Utility, then scan from the IJ Scan Utility main screen.
 - Set **Select Source** to **Magazine** and set **Color Mode** to **Color**
 - Select the **Reduce moire** checkbox in **Image Processing Settings**

- [Settings \(Document Scan\) Dialog Box](#)
- [Settings \(Custom Scan\) Dialog Box](#)
- [Settings \(Scan and Stitch\) Dialog Box](#)

- On the **Basic Mode** tab of ScanGear (scanner driver), select **Magazine (Color)** in **Select Source**.
Refer to "Basic Mode Tab" for your model from Home of the Online Manual for details.
- On the **Advanced Mode** tab of ScanGear, set **Descreen** in **Image Settings** to **ON**.
Refer to "Image Settings" for your model from Home of the Online Manual for details.

▶▶▶ Note

- If moire appears when you scan a digital print photo, take the above measures and scan again.

Check 4 Check the monitor's color depth.

Refer to Help of Windows or the monitor's manual for details on how to check the monitor's color depth.

Check 5 Clean the platen and document cover.

Check 6 If the document is in poor condition (dirty, faded, etc.), then set **Reduce Dust and Scratches**, **Fading Correction**, **Grain Correction**, etc. in **Image Settings** on the **Advanced Mode** tab of ScanGear.

Refer to "Image Settings" for your model from Home of the Online Manual for details.

Check 7 If the color tone of images is different from the original document, take the following measures and scan again.

- On the **Advanced Mode** tab of ScanGear, set **Image Adjustment** in **Image Settings** to **None**.
Refer to "Image Settings" for your model from Home of the Online Manual for details.
- On the **Color Settings** tab in the **Preferences** dialog box of ScanGear, set **Color Matching**.
Refer to "Color Settings Tab" for your model from Home of the Online Manual for details.



Scanned Image Is Surrounded by Extra White Areas



Check Specify the scan area.



Click  (Auto Crop) in whole image view of ScanGear (scanner driver) to automatically display the cropping frame (scan area) according to the item size.

You can also manually specify the scan area in thumbnail view or when there are white margins along the item (for example, in photos), or when you want to create custom cropping frames.

■ [Adjusting Cropping Frames in the Image Stitch Window](#)

▶▶▶ Note

- Refer to "Adjusting Cropping Frames (ScanGear)" for your model from Home of the Online Manual for how to adjust cropping frames with ScanGear (scanner driver).



Cannot Scan at the Correct Size



Check Make sure that the items are placed correctly.

- [Positioning Originals \(Scanning from Computer\)](#)



Position or Size of the Image Cannot be Detected Correctly When Scanning from the Operation Panel



Check 1 Make sure that the items are placed correctly.

- [Positioning Originals \(Scanning from Computer\)](#)

Check 2 Check that the settings match the item to be scanned.

If you cannot scan properly by automatically detecting the item type, specify the item type and size.

When Scanning from the Operation Panel:

For the setting items when scanning from the operation panel, see [Setting Items for Scanning Using Operation Panel](#).

When Scanning with IJ Scan Utility:

- [Scanning Documents](#)
- [Scanning Photos](#)
- [Scanning with Favorite Settings](#)



Original Is Placed Correctly, but the Scanned Image Is Slanted



Check When Document or **Magazine** is selected for **Select Source**, deselect the **Correct slanted text document** checkbox and scan the item again.

■ [Settings \(Document Scan\) Dialog Box](#)

■ [Settings \(Custom Scan\) Dialog Box](#)



Scanned Image Is Enlarged (Reduced) on the Computer Monitor



Check 1 Change the display setting in the application.

Refer to the application's manual for details. If you have any questions, contact the manufacturer of the application.

Note

- You cannot reduce the image size in Paint. To reduce the display size, open the images in an application.

Check 2 Change the resolution setting in ScanGear (scanner driver) and scan again.

The higher the resolution, the larger the resulting image will be.

 [Resolution](#)

Software Problems

- ▶ **The E-mail Client You Want to Use Does Not Appear in the Screen for Selecting an E-mail Client**



The E-mail Client You Want to Use Does Not Appear in the Screen for Selecting an E-mail Client



Check Check that the e-mail client's MAPI is enabled.

Refer to the e-mail client's manual for how to set MAPI.

If the problem is not solved even when MAPI is enabled, select **None (Attach Manually)** in the screen for selecting an e-mail client, then manually attach the image to the outgoing e-mail.

IJ Scan Utility Error Messages

If an error message for IJ Scan Utility appears, check the error code and follow the corresponding solution.

Error Code	Error Message	Solution
152	There is not enough memory. Exit other applications to increase available memory.	<ul style="list-style-type: none"> The memory required to start IJ Scan Utility cannot be obtained; exit other applications.
153	The image you attempted to scan is in a size that cannot be opened in the specified application. Change the settings so that the image size is reduced.	<ul style="list-style-type: none"> Reduce the resolution or output size and scan again.
201	A required file is missing or corrupted, or settings are incorrect. Try the installation again.	<ul style="list-style-type: none"> Delete MP Drivers, then re-install MP Drivers from the Setup CD-ROM or our website. <p>For how to delete MP Drivers, see Deleting the Unnecessary MP Drivers.</p>
202	An internal error has occurred. Take the following measures. <ul style="list-style-type: none"> - Check the scanner status. - Restart the scanner. - Restart the computer, then try again. - Reinstall the scanner driver. 	<ul style="list-style-type: none"> An internal error has occurred. Take the following measures. <ul style="list-style-type: none"> ◦ Check the scanner status. ◦ Restart the scanner. ◦ Restart the computer, then try again. ◦ Reinstall MP Drivers.
230	A scanner driver supporting this software is not installed. Install it and try again.	<ul style="list-style-type: none"> Reinstall MP Drivers from the Setup CD-ROM or our website.
231	Cannot complete the scan. The disk space is insufficient.	<ul style="list-style-type: none"> Delete unnecessary files on the hard disk and scan again.
232	Cannot save the file. The disk is write-protected. Cancel the protection or use another disk.	<ul style="list-style-type: none"> Cancel the write protection on the disk.
234	This scan function is not supported by the selected model. Select a different scan function.	<ul style="list-style-type: none"> Select a different scan function.
242	Cannot write file.	<ul style="list-style-type: none"> Check the access permission on the folder in Folder to Save Temporary Files in the Settings (General Settings) dialog box or Save in

		in the corresponding Settings dialog box.
243	Cannot read file.	<ul style="list-style-type: none"> • Check the access permission on the folder in Folder to Save Temporary Files in the Settings (General Settings) dialog box or Save in in the corresponding Settings dialog box.
244	You do not have the required privileges to access the specified folder.	<ul style="list-style-type: none"> • Grant access permission to the specified folder.
245	Text could not be detected. Make sure that the following conditions do not apply. <ul style="list-style-type: none"> - The Document Language setting does not match the document language. - There is no text in the document. - Text that is not supported for detection is scanned. 	<ul style="list-style-type: none"> • Make sure the Document Language in the Settings (General Settings) dialog box matches the document language. • Make sure there is text in the document.

ScanGear (Scanner Driver) Error Messages

If an error message for ScanGear (scanner driver) appears, check the error code and follow the corresponding solution.

Error Code	Error Message	Solution
1 4 10 122 151 175 176 177	Error in scanner. Turn off scanner and follow instructions in User's Guide. Scanner driver will be closed.	<ul style="list-style-type: none"> • Make sure that your scanner or printer and the computer are connected correctly. • Delete MP Drivers, then reinstall MP Drivers from the Setup CD-ROM or our website. <p>For how to delete MP Drivers, see Deleting the Unnecessary MP Drivers.</p> <ul style="list-style-type: none"> • Your scanner or printer may be damaged. <p>Restart the computer, then reconnect your scanner or printer. If the same error message still appears, contact the service center.</p>
140	Printer is in use or an error has occurred. Check status. Scanner driver will be closed.	<ul style="list-style-type: none"> • Wait for the device operation to finish, then scan.
145	Cannot communicate with scanner for these reasons: - Scanner is turned off. - Scanner is disconnected. (It is disconnected from LAN, if using on LAN.) Please check and try again. Scanner driver will be closed.	<ul style="list-style-type: none"> • Make sure that your scanner or printer is turned on. • Delete MP Drivers, then reinstall MP Drivers from the Setup CD-ROM or our website. <p>For how to delete MP Drivers, see Deleting the Unnecessary MP Drivers.</p>
155	Cannot communicate with scanner. Cable may be disconnected or scanner may be turned off. Check status. Scanner driver will be closed.	<ul style="list-style-type: none"> • Make sure that the selected application source is correct. Refer to the application's manual for details.
156	Cannot communicate with scanner for these reasons: - Scanner is turned off. - USB cable is disconnected. Please check and try again. Scanner driver will be closed.	<ul style="list-style-type: none"> • Check the printer status. • With USB connection, check the connection of the USB cable and reconnect as required. • With network connection, check the connection status and reconnect as required.
157	Cannot communicate with scanner for these reasons: - Scanner is turned off. - (If using Wired LAN connection) It is disconnected from Wired LAN. - (If using wireless LAN connection) Signal strength is poor due to obstructions. - Network connection is prohibited by security software. - Different scanner on the network is selected.	<ul style="list-style-type: none"> • With network connection, specify the scanner to use with IJ Network Scanner Selector EX. <p>Refer to "Network Scan Settings" for the setting procedure.</p>

	<p>Please check and try again. Click [Scanner Selection] if you want to select another scanner. Scanner driver will be closed.</p>	
152	<p>Running out of memory. Increase available memory. Scanner driver will be closed.</p>	<ul style="list-style-type: none"> • The memory required to start ScanGear (scanner driver) cannot be obtained; exit other applications.
201	<p>A required file is missing or corrupted, or settings are incorrect. Try the installation again. Scanner driver will be closed.</p>	<ul style="list-style-type: none"> • Delete MP Drivers, then reinstall MP Drivers from the Setup CD-ROM or our website. <p>For how to delete MP Drivers, see Deleting the Unnecessary MP Drivers.</p>
202	<p>An internal error has occurred. Scanner driver will be closed. Take the following measures.</p> <ul style="list-style-type: none"> - Check the scanner status. - Restart the scanner. - Restart the computer, then try again. - Reinstall the scanner driver. 	<ul style="list-style-type: none"> • An internal error has occurred. Take the following measures. <ul style="list-style-type: none"> ◦ Check the scanner status. ◦ Restart the scanner. ◦ Restart the computer, then try again. ◦ Reinstall MP Drivers. • Click Control Panel > System and Security > Administrative Tools, and then double-click Services to check if WIA (Windows Image Acquisition) is running or in started state. • There may be interference with other drivers; delete unnecessary drivers. • Your application may not properly comply with TWAIN. Scan using another application.
203	<p>There is not enough free disk space to complete the scan. Scanner driver will be closed.</p>	<ul style="list-style-type: none"> • Delete unnecessary files on the hard disk and scan again.
206	<p>The scanner is not available while in use by another application or user.</p>	<ul style="list-style-type: none"> • Exit the ScanGear in use.
207	<p>Scanner is not selected. Click [Scanner Selection] to select scanner. Scanner driver will be closed.</p>	<ul style="list-style-type: none"> • With network connection, specify the scanner to use with IJ Network Scanner Selector EX. <p>Refer to "Network Scan Settings" for the setting procedure.</p>
208	<p>IJ Network Scanner Selector cannot be found. Reinstall scanner driver. Scanner driver will be closed.</p>	<ul style="list-style-type: none"> • Delete MP Drivers, then reinstall MP Drivers from the Setup CD-ROM or our website.

		For how to delete MP Drivers, see Deleting the Unnecessary MP Drivers .
250	An error has occurred. Turn the device off and then back on. Scanner driver will be closed.	<ul style="list-style-type: none"> • Turn the device off and then back on.
252	Cannot write or read file.	<ul style="list-style-type: none"> • Exit running applications, check that there is sufficient free space on the hard disk, then scan again.

Faxing Problems

- ▶ **Problems Sending Faxes**
- ▶ **Problems Receiving Faxes**
- ▶ **Cannot Send a Fax Clearly**
- ▶ **Telephone Problems**

Problems Sending Faxes

- ▶ **Cannot Send a Fax**
- ▶ **Cannot Perform Sequential Broadcasting by Redialing, or Cannot Dial by Entering Numbers**
- ▶ **Errors Often Occur When You Send a Fax**



Cannot Send a Fax



Check1 Is power turned on?

- You cannot send faxes if the power is turned off. Press the **ON** button to turn the power on.
- If you unplugged the power cord without turning off the power (the **POWER** lamp is lit), reconnecting it turns on the power automatically.
- If you unplugged the power cord after pressing the **ON** button to turn off the power (the **POWER** lamp is off), reconnect it, and then press the **ON** button to turn on the power.
- If the power was turned off due to power failure, etc., the power is automatically turned on when the power failure is resolved.

▶▶ Important

- Confirm that the **POWER** lamp is off before unplugging the power cord, and then unplug the power cord. If a power failure occurs or you unplug the power cord, all faxes stored in the printer's memory are deleted. For details on how to unplug the power cord, refer to [Unplugging the Machine](#).

▶▶ Note

- If the faxes stored in the printer's memory are deleted by a power failure or unplugging the power cord, the list of the faxes deleted from the printer's memory (MEMORY CLEAR REPORT) will be printed after turning the printer on. For details, see [Summary of Reports and Lists](#).

Check2 Is document being sent from memory or the fax being received into memory?

When the message for the transmission/reception is displayed on the Fax standby screen, a fax is being sent from/received into printer's memory. Wait until the transmission/reception is complete.

Check3 Is printer's memory full?

Delete contents in memory, and then send a fax again.

- [Document Stored in Printer's Memory](#)

Check4 Is telephone line type set correctly?

Check the telephone line type setting and change it as necessary.

- [Setting Telephone Line Type](#)

Check5 Is Hook key setting set to Disable?

When you send a fax manually, dial the number with **Enable** selected for **Hook key setting** in **Security control** under **FAX settings**, or dial the number using the telephone connected to the printer.

■ [FAX settings](#)

Check6 Is **Dial tone detect** set to **ON**?

Resend the fax after a while.

If you still cannot send the fax, select **OFF** for **Dial tone detect** in **Advanced FAX settings** under **FAX settings**.

■ [FAX settings](#)

Check7 Is fax number registered correctly in printer's directory?

Check the recipient's fax/telephone number, correct the fax/telephone number registered in the printer's directory, and then send the document again.

■ [Changing Registered Information](#)

▶▶▶ **Note**

- You can check the registered information in the printer's directory by printing RECIPIENT TELEPHONE NUMBER LIST.

■ [Summary of Reports and Lists](#)

Check8 Does an error occur during transmission?

- Ensure that a message is displayed on the Fax standby screen. When a message is displayed on the Fax standby screen, check the cause.

■ [A Message for Faxing Is Displayed on Fax Standby Screen](#)

- Print ACTIVITY REPORT and check for an error.

■ [Summary of Reports and Lists](#)

Check9 Is document loaded properly?

Remove the document, and then reload it on the platen glass or in the ADF.

■ [Loading Originals](#)

Check10 Does a printer error occur?

Ensure that an error message is displayed on the touch screen. When an error message is displayed on the touch screen, check the cause.

When the error message with the support code is displayed, refer to [List of Support Code for Error](#).

When the error message without the support code is displayed, refer to [Message Appears](#).

If you are in a hurry, press the **Stop** button to close the message, and then send the fax.

Check11 Is telephone line connected correctly?

Reconnect the telephone line cable to the telephone line jack.

■ [Connecting Telephone Line](#)

If the telephone line is connected correctly, there is a problem with your telephone line. Contact your telephone company and the manufacturer of your terminal adapter or telephone adapter.



Cannot Perform Sequential Broadcasting by Redialing, or Cannot Dial by Entering Numbers



Check Have you already selected recipient from redial history, or already dialed a number by entering the fax/telephone numbers?

You can dial one recipient by selecting from the redial history or by entering the fax/telephone numbers as the recipient of sequential broadcasting.

If you already have dialed by selecting from the redial history or by entering the fax/telephone numbers, select the recipient from the printer's directory.



Errors Often Occur When You Send a Fax



Check Check telephone line condition or connection.

If the telephone line or connection is poor, reducing the transmission start speed may correct the error.

Reduce the transmission start speed on **TX start speed** in **Adv. communication settings** in **Advanced FAX settings** under **FAX settings**.

■ [FAX settings](#)

Problems Receiving Faxes

- **Cannot Receive a Fax, Cannot Print a Fax**
- **Printer Does Not Switch Automatically between Voice and Fax Calls**
- **Quality of Received Fax is Poor**
- **Cannot Receive a Color Fax**
- **Errors Often Occur When You Receive a Fax**



Cannot Receive a Fax, Cannot Print a Fax



Check1 Is the power turned on?

- You cannot receive faxes if the power is turned off. Press the **ON** button to turn the power on.
- If you unplugged the power cord without turning off the power (the **POWER** lamp is lit), reconnecting it turns on the power automatically.
- If you unplugged the power cord after pressing the **ON** button to turn off the power (the **POWER** lamp is off), reconnect it, and then press the **ON** button to turn on the power.
- If the power was turned off due to power failure, etc., the power is automatically turned on when the power failure is resolved.

Important

- Confirm that the **POWER** lamp is off before unplugging the power cord, and then unplug the power cord. If a power failure occurs or you unplug the power cord, all faxes stored in the printer's memory are deleted. For details on how to unplug the power cord, refer to [Unplugging the Machine](#).

Note

- If the faxes stored in the printer's memory are deleted by a power failure or unplugging the power cord, the list of the faxes deleted from the printer's memory (MEMORY CLEAR REPORT) will be printed after turning the printer on. For details, see [Summary of Reports and Lists](#).

Check2 Is the printer's memory full?

Print the received faxes stored in the printer's memory, save them on the USB flash drive, or forward them to the shared folder on the computer, and then delete them from the printer's memory and have the sender resend the faxes.

- [Document Stored in Printer's Memory](#)

Check3 Does an error occur during reception?

- Ensure that a message is displayed on the Fax standby screen. When a message is displayed on the Fax standby screen, check the cause.
 - [A Message for Faxing Is Displayed on Fax Standby Screen](#)
- Print ACTIVITY REPORT and check for an error.
 - [Summary of Reports and Lists](#)

Check4 Is telephone line cable connected to external device jack?

Reconnect it to the telephone line jack.

■ [Connecting Telephone Line](#)

Check5 Is a different size of paper from that specified by **Page size** in **FAX paper settings** loaded?

If a different size of paper from that specified by **Page size** is loaded for printing faxes, the received faxes will not be printed and will be stored in the printer's memory (Memory Reception). Load the same size of paper as that specified by **Page size**, and then tap **OK** on the touch screen.

Check6 Is paper loaded?

If paper is not loaded, received faxes will be stored in the printer's memory without being printed (Memory Reception). Load paper, and then tap **OK** on the touch screen.

Check7 Is amount of remaining ink sufficient to print a fax?

If the amount of remaining ink is insufficient to print, received faxes will be stored in the printer's memory without being printed (Memory Reception). Replace the ink tank, and then print the faxes in the printer's memory.

■ [Document Stored in Printer's Memory](#)

▶▶▶ Note

- If the printer was receiving faxes in the fax mode, printing will start automatically after the ink tank is replaced.

■ [Replacing Ink Tanks](#)

- When the printer receives black & white faxes in the printer's memory, if **2-sided** is selected for **2-sidedPrintSetting** in **FAX paper settings**, selecting **1-sided** may print the faxes.
- You can set the printer to forcibly print a received fax even if the ink has run out.

Set **Print when out of ink** in **Auto print settings** under **FAX settings** to **Print**.

However, part or all of the fax may not be printed since the ink has run out.

Also, the contents of the fax will not be stored in the printer's memory.

If the ink has already run out, we recommend that **Do not print** be selected for **Received documents** in **Auto print settings** under **FAX settings** to store the received fax in the printer's memory. After you replace the ink tank and select **Print** for **Received documents** in **Auto print settings**, the fax stored in the printer's memory will be printed automatically.

■ [FAX settings](#)

Check8 Is printer set to appropriate receive mode?

Check the receive mode setting and change it to a mode suited to your connection if necessary.

■ [Setting Receive Mode](#)

Check9 Is **FAX reception reject** set to **ON**?

Select **OFF** for **FAX reception reject** in **Security control** under **FAX settings**.

For details on how to set, see [Rejecting Fax Reception](#).

Check10 Are there setting items set **Reject** in **Caller rejection**?

If you select **Reject** for any setting items in **Caller rejection** in **Security control** under **FAX settings**, the printer rejects calls for setting item selected **Reject**.

For details on how to set, see [Using Caller ID Service to Reject Calls](#).



Printer Does Not Switch Automatically between Voice and Fax Calls



Check Is receive mode set to **FAX only mode**?

If **FAX only mode** is selected for **Receive mode settings**, there will be no automatic switching between voice and fax calls.

Set the receive mode to **TEL priority mode**, **DRPD***1, or **Network switch***2.

If the receive mode is **TEL priority mode** and an answering machine is connected to the printer, check whether a proper message is played back when the answering machine answers.

 [Setting Receive Mode](#)

*1 This setting is available only in the US and Canada.

*2 This setting may not be available depending on the country or region of purchase.



Quality of Received Fax is Poor



Check1 Check scan settings of sender's fax device.

Ask the sender to adjust the scan settings of the fax device.

Check2 Is **ECM RX** set to **OFF**?

Select **ON** for **ECM RX** in **Adv. communication settings** in **Advanced FAX settings** under **FAX settings**.

If **ECM RX** is enabled, the sender's fax device resends the fax after correcting errors automatically.

■ [FAX settings](#)

Check3 Is sender's original document or scanning area of sender's fax device dirty?

The image quality of the fax is mainly determined by the sender's fax device. Contact the sender and ask the sender to check whether the scanning area of the fax device is dirty.

Check4 Is ECM transmission/reception enabled although line/connection is poor, or is sender's fax device compatible with ECM?

- Select **ON** for **ECM RX** in **Adv. communication settings** in **Advanced FAX settings** under **FAX settings**.

■ [FAX settings](#)

- Contact the sender and ask the sender to check whether the fax device is set to enable ECM transmission.

If the sender's or recipient's fax device is not compatible with ECM, the fax will be sent/received without automatic error correction.

- Reduce the reception start speed on **RX start speed** in **Adv. communication settings** in **Advanced FAX settings** under **FAX settings**.

■ [FAX settings](#)

Check5 Did you confirm paper and print quality settings?

■ [Print Results Are Unsatisfactory](#)



Cannot Receive a Color Fax



Check Is **ECM RX** set to **OFF**?

If **OFF** is select for **ECM RX** in **Adv. communication settings** in **Advanced FAX settings** under **FAX settings**, the printer cannot receive color faxes. The printer will disconnect the telephone line or receive color faxes in black & white according to the setting of the sender's fax device.

Set **ECM RX** to **ON**.

■ [FAX settings](#)



Errors Often Occur When You Receive a Fax



Check1 Check telephone line condition or connection.

If the telephone line or connection is poor, reducing the reception start speed may correct the error.

Reduce the reception start speed on **RX start speed** in **Adv. communication settings** in **Advanced FAX settings** under **FAX settings**.

■ [FAX settings](#)

Check2 Is sender's fax device operating normally?

Contact the sender and ask the sender to check whether the fax device is operating normally.



Cannot Send a Fax Clearly



Check1 Is document loaded correctly?

Remove the document, and then reload it on the platen glass or in the ADF.

■ [Loading Originals](#)

Check2 Is platen glass and/or inner side of document cover and/or glass of ADF dirty?

Clean the platen glass and/or the inner side of the document cover and/or the glass of ADF, and then reload the document.

■ [Cleaning the Platen Glass and Document Cover](#)

▶▶▶ Note

- If the glass of ADF is dirty, black streaks appear on the paper as shown below.



Check3 Is image quality setting or scan contrast setting suitable for document?

On the touch screen, select an image quality setting and a scan contrast setting that are suitable for the document.

■ [Setting Items for Sending Faxes](#)

Check4 Is original document loaded with wrong side facing upwards or downwards?

When loading a document on the platen glass, the side to be scanned should be face down.

When loading a document in the ADF, the side to be scanned should be face up.

Check5 Are you scanning thick or curled documents?

Thick or curled documents may not be sent as good quality faxes, because of a shadow or distortion caused when such documents are scanned.

When loading a document on the platen glass, press on the document cover with your hand when scanning.

Telephone Problems

- ▶ **Cannot Dial**
- ▶ **Telephone Disconnects During a Call**



Cannot Dial



Check1 Is telephone line cable connected correctly?

Check that the telephone line cable is connected correctly.

■ [Connecting Telephone Line](#)

Check2 Is telephone line type of printer or external device set correctly?

Check the telephone line type setting and change it as necessary.

■ [Setting Telephone Line Type](#)



Telephone Disconnects During a Call



Check Is telephone line cable or telephone (or a peripheral device such as an external telephone, an answering machine, or a computer modem) connected correctly?

Check that the telephone line cable and the telephone (or a peripheral device such as an external telephone, an answering machine, or a computer modem) are connected correctly.

■ [Connecting Telephone Line](#)

Mechanical Problems

- ▶ **Power Does Not Come On**
- ▶ **USB Connection Problems**
- ▶ **Cannot Communicate with Machine via USB**
- ▶ **Display on Touch Screen Is Off**
- ▶ **Touch Screen Shows Wrong Language**
- ▶ **Print Head Holder Does Not Move to Replacement Position**
- ▶ **Printer Status Monitor Not Displayed (Windows)**



Power Does Not Come On



Check1 Press **ON** button.

Check2 Make sure power plug is securely connected to printer, and then turn it back on.

Check3 Unplug printer, leave it for at least 2 minutes, and then plug it back in and turn it on again.

If this does not solve the problem, contact your nearest Canon service center to request a repair.

USB Connection Problems

Q Printing or Scanning Is Slow/Hi-Speed USB Connection Does Not Work/"This device can perform faster" Message Appears (Windows)

A

If your system environment does not support Hi-Speed USB, the printer operates at the slower speed of USB 1.1. In this case, the printer works properly but printing or scanning speed may slow down due to the communication speed.

Check

Check following to make sure your system environment supports Hi-Speed USB connection.

- Does the USB port on your computer support Hi-Speed USB connection?
- Does the USB cable or the USB hub support Hi-Speed USB connection?

Be sure to use a certified Hi-Speed USB cable. We recommend that the USB cable be no longer than 10 feet / 3 meters or so.

- Does the operating system of your computer support Hi-Speed USB connection?

Install the latest update for your computer.

- Is the Hi-Speed USB driver working properly?

If necessary, obtain and install the latest version of the Hi-Speed USB driver for your computer.

»» Important

- For more information, contact the manufacturer of your computer, USB cable, or USB hub.



Cannot Communicate with Machine via USB



Check1 Make sure printer is turned on.

Check2 Connect USB cable properly.

As the illustration below, the USB port is at the back of the printer.

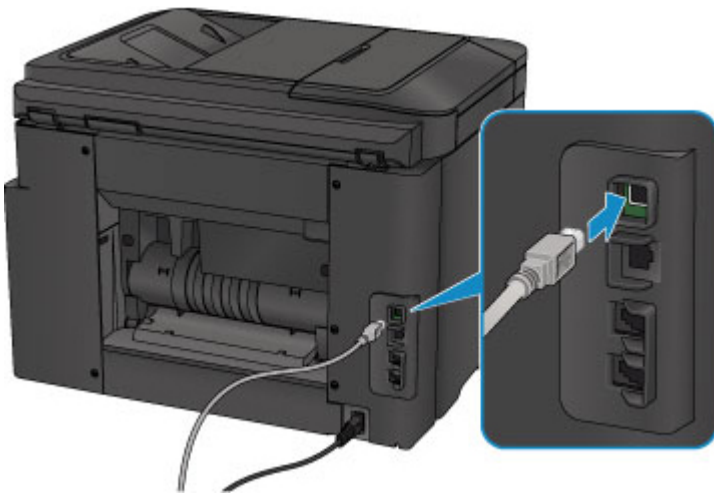

Check3 Do not start IJ Network Tool while printing. (Mac OS)

Check4 Do not print while IJ Network Tool is running. (Mac OS)

Check5 Make sure **Enable bidirectional support** is selected in **Ports** sheet of properties dialog box of printer driver. (Windows)

■ [How to Open the Printer Driver Setup Window](#)



Display on Touch Screen Is Off



- If **POWER** lamp is off:
The printer is not on. Check that the power cord is connected and press the **ON** button.
- If **POWER** lamp is lit:
The touch screen may be in screen-saver mode. Tap the touch screen.



Touch Screen Shows Wrong Language



Follow the instructions below to select your language.

1. Press **HOME** button and wait for about 5 seconds.

2. Flick HOME screen and tap  **Setup**.

■ [Using the Operation Panel](#)

3. Tap  **Device settings**.

4. Tap fifth setting item from top.

5. Tap a language for touch screen.



Print Head Holder Does Not Move to Replacement Position



»» Important

- The print head holder moves to the position for replacing only when an ink tank runs out of ink. If no ink tanks run out of ink, the print head holder does not move even though you open the front cover.

Check1 Is **POWER** lamp off?

Check if the **POWER** lamp is lit.

The **POWER** lamp flashes while the printer is initializing. Wait until the **POWER** lamp stops flashing and remains lit, and then open the front cover again.

Check2 Is an error message displayed on touch screen?

Close the front cover, follow the support code (error number) displayed in the error message to resolve the error, and then reopen it. For details on resolving the error, see [List of Support Code for Error](#).

Check3 Has front cover been left open for 60 minutes or longer?

If the front cover is left open for more than 60 minutes, the print head holder moves to the position to protect it to prevent the print head from drying out. Close and reopen the front cover to return the print head holder to the position for replacing.

The print head holder will not move unless the power is on. If the **POWER** lamp is off, close the front cover and turn the printer on.



Printer Status Monitor Not Displayed (Windows)



Check1 Is printer status monitor enabled?

Make sure **Enable Status Monitor** is selected on the **Option** menu of the printer status monitor.

1. Open printer driver setup window.
 - [How to Open the Printer Driver Setup Window](#)
2. On **Maintenance** sheet, click **View Printer Status**.
3. Select **Enable Status Monitor** on **Option** menu if it is not selected.

Installation and Download Problems

- ▶ **Cannot Install MP Drivers**
- ▶ **Easy-WebPrint EX Does Not Start or Easy-WebPrint EX Menu Does Not Appear (Windows)**
- ▶ **Updating MP Drivers in Network Environment (Windows)**



Cannot Install MP Drivers



■ [For Windows:](#)

■ [For Mac OS:](#)

For Windows:

- **If installation does not start when you insert Setup CD-ROM:**

Follow the instructions below to start the installation.

1. Make the following settings.

- In Windows 10, click **Start** button > **File Explorer**, and then click **This PC** from list on left.
- In Windows 8.1 or Windows 8, select **Explorer** icon in **Taskbar** on **Desktop**, and then select **This PC (Computer for Windows 8)** from list on left.
- In Windows 7 or Windows Vista, click **Start**, and then click **Computer**.

2. Double-click  **CD-ROM** icon in the window that appears.

If the contents of the CD-ROM appear, double-click **MSETUP4.EXE**.

If you cannot install the MP Drivers with the Setup CD-ROM, install them from the Canon website.

▶▶▶ Note

- If the CD-ROM icon does not appear, try the following:
 - Remove the CD-ROM from your computer and reinsert it.
 - Restart your computer.

If the icon still does not appear, try a different disc and see if it appears. If it does, there is a problem with the Setup CD-ROM. Contact your nearest Canon service center to request a repair.

- If you cannot get past the Printer Connection screen:



■ [Cannot Proceed beyond Printer Connection Screen/Connect Cable Screen](#)

- Other cases:

Reinstall the MP Drivers.

If the MP Drivers were not installed correctly, uninstall the MP Drivers, restart your computer, and then reinstall the MP Drivers.

■ [Deleting the Unnecessary MP Drivers](#)

Reinstall the MP Drivers with the Setup CD-ROM or install them from the Canon website.

▶▶▶ **Note**

- If the installer was stopped due to a Windows error, Windows operation may be unstable, and you may not be able to install the drivers. Restart your computer and then reinstall the drivers.

For Mac OS:

Download the driver from the support page of Canon website and reinstall it.



Easy-WebPrint EX Does Not Start or Easy-WebPrint EX Menu Does Not Appear (Windows)



If Easy-WebPrint EX does not start or its menu does not appear on Internet Explorer, check the following.

Check1 Is **Canon Easy-WebPrint EX** displayed on **Toolbars** menu in Internet Explorer's **View** menu?

If **Canon Easy-WebPrint EX** is not displayed, Easy-WebPrint EX is not installed on your computer. Install the latest version of Easy-WebPrint EX from the Canon website.

▶▶▶ Note

- If Easy-WebPrint EX is not installed, a message asking you to install it may appear in the notification area on the desktop. Click the message and follow the instructions to install Easy-WebPrint EX.
- Internet access is required to install or download Easy-WebPrint EX.

Check2 Is **Canon Easy-WebPrint EX** selected on **Toolbars** menu in Internet Explorer's **View** menu?

If **Canon Easy-WebPrint EX** is not selected, Easy-WebPrint EX is disabled. Select **Canon Easy-WebPrint EX** to enable it.



Updating MP Drivers in Network Environment (Windows)



Download the latest MP Drivers.

The latest MP Drivers for your model are available for download on the Canon website.

Uninstall the existing MP Drivers and follow the installation instructions to install the latest MP Drivers that you downloaded. In the connection method selection screen, select **Use the printer with wireless LAN connection** or **Use the printer with wired LAN connection** according to the connection method you use. The printer is detected automatically in the network.

Make sure the printer was found, and install the MP Drivers following the on-screen instructions.

Note

- The network settings on the printer are not affected, so the printer can be used on the network without redoing settings.

Errors and Messages

- ▶ **An Error Occurs**
- ▶ **A Message for Faxing Is Displayed on Fax Standby Screen**
- ▶ **Message Appears**

An Error Occurs

If an error occurs in printing, for example if the paper runs out or jams, a troubleshooting message appears automatically. Take the appropriate action described in the message.

If an error occurs, a support code (error number) appears on the computer screen or the touch screen.

When a Support Code and a Message Are Displayed on Computer Screen:

- For Windows:

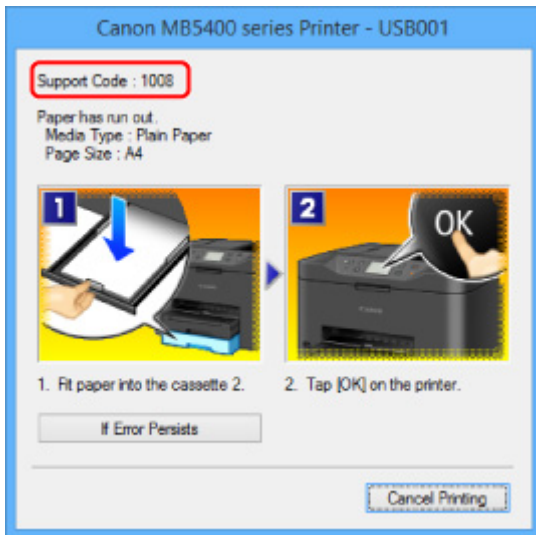

- For Mac OS:

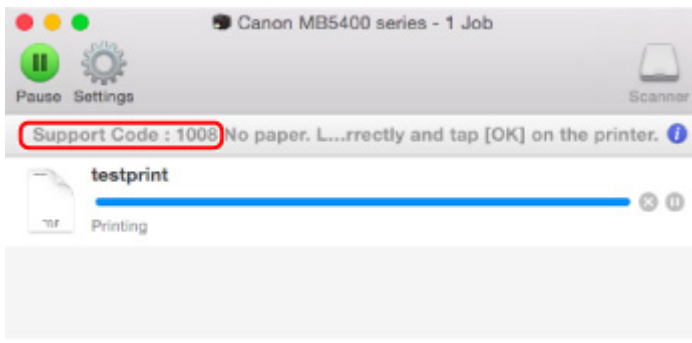

* The screen differs depending on the OS you are using.

When a Support Code and a Message Are Displayed on Touch Screen:

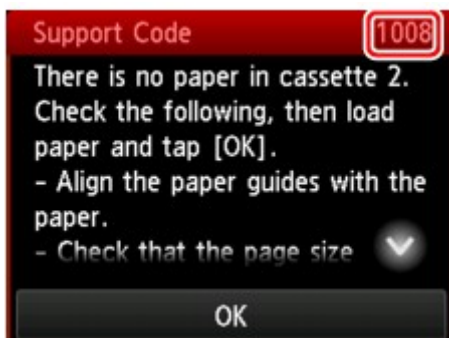

For more on resolving errors with support codes, see [List of Support Code for Error](#).

▶▶ Note

- You can also search for details on resolving the errors indicated by the support code shown.

■ [Search](#)

To resolve errors that do not have support codes, see [An Error Occurs](#).



A Message for Faxing Is Displayed on Fax Standby Screen



If a message is displayed on the Fax standby screen, take the corresponding action described below.

Message	Action
Auto re-dial	<p>The printer is waiting to redial the recipient's number because the line was busy or the recipient did not answer when you tried to send a document. Wait for the printer to automatically redial the number. If you want to cancel automatic redialing, wait until the printer starts dialing the number, and then press the Stop button. You can also delete the document from printer's memory to cancel automatic redialing.</p> <p>■ Resending Faxes (Redialing Busy Number)</p>
This group dial cannot be used. Directory ##	<p>* "##" represents a two-digit number.</p> <p>The group dial cannot be specified in the on hook dial function.</p> <p>Specify the individual recipient.</p>
Replace the receiver.	<p>The handset is not placed in the handset cradle correctly.</p> <p>Replace the handset correctly.</p>
Try again in black & white.	<p>The recipient's fax device is not color-compatible.</p> <p>Press the Black button to resend the fax.</p> <p>Alternatively, you select Send in black & white for Color transmission in Advanced FAX settings under FAX settings. The printer converts color documents into black & white data if the recipient's fax device does not support color faxing.</p> <p>■ FAX settings</p>
Failed to connect.	<p>The telephone line cable with a modular plug may not be plugged in properly.</p> <p>Make sure that the cable is plugged in properly, and resend the fax after a while. If you still cannot send the fax, select OFF for Dial tone detect in Advanced FAX settings under FAX settings.</p> <p>■ FAX settings</p>
Received in memory.	<p>If the printer receives a fax under one of the following conditions, the printer will not be able to print the received fax and will store it in the printer's memory. When the problem is resolved as described, the fax stored in the printer's memory is printed automatically.</p> <ul style="list-style-type: none"> The amount of remaining ink is insufficient to print a fax: <ul style="list-style-type: none"> Replace the ink tank. ■ Replacing Ink Tanks <p>➤➤➤ Note</p> <hr/> <ul style="list-style-type: none"> You can set the printer to forcibly print a received fax even if the ink has run out.

Set **Print when out of ink** in **Auto print settings** under **FAX settings** to **Print**.

However, part or all of the fax may not be printed since the ink has run out.

Also, the contents of the fax will not be stored in the printer's memory.

If the ink has already run out, we recommend that **Do not print** be selected for **Received documents** in **Auto print settings** under **FAX settings** to store the received fax in the printer's memory. After you replace the ink tank and select **Print** for **Received documents** in **Auto print settings**, the fax stored in the printer's memory will be printed automatically.

■ [FAX settings](#)

- Paper has run out:

Load the paper and tap **OK** on the touch screen.

- A different size of paper from that specified by **Page size** in **FAX paper settings** is loaded:

Load the same size of paper as that specified by **Page size**, and then tap **OK** on the touch screen.

- You pressed the **Stop** button to cancel printing of a fax:

Press the **HOME** button and tap **FAX** to resume printing of the fax.

- **Do not print** is selected for **Received documents** in **Auto print settings** under **FAX settings**:

You can print the faxes stored in the printer's memory from the **Memory reference** screen in the Fax menu.

■ [Printing Document in Printer's Memory](#)

➤➤➤ Note

- To print the received faxes automatically, select **Print** for **Received documents** in **Auto print settings** under **FAX settings**.

■ [FAX settings](#)

- If you did not print the fax stored in the printer's memory (e.g., if you did not resolve the problem by pressing the **Stop** button), you can delete or print the fax stored in the printer's memory later.

■ [Document Stored in Printer's Memory](#)

Busy/no signal

- The recipient's number you dialed is busy.

Try dialing again after waiting for a moment.

■ [Resending Faxes \(Redialing Busy Number\)](#)

- The fax/telephone number dialed is incorrect.

Check the fax/telephone number and dial again.

- The recipient's fax device did not respond (after all automatic redialing attempts).

Contact the recipient and have the recipient check the fax device. For an overseas call, add pauses to the registered number.

- The recipient is not using a G3 printer.

The printer cannot send or receive documents to/from a fax device that is incompatible with the G3 standard. Contact the recipient and ask the recipient to check whether the fax device is G3 compatible.

- The touch tone/rotary pulse setting on the printer is incorrect.

Set the printer to match the telephone line you are using.

■ [Setting Telephone Line Type](#)

<p>Memory is full.</p>	<p>The printer's memory is full because it has sent/received too many documents, or a detailed document.</p> <p>Print the faxes stored in the printer's memory or save them on the USB flash drive, and delete them from the printer's memory.</p> <ul style="list-style-type: none"> ■ Document Stored in Printer's Memory <p>When sending a fax, resend it. If this message still appears, delete the faxes stored in the printer's memory, divide the faxes for sending, and send them again.</p> <p>When receiving a fax, have the sender resend the faxes.</p>
<p>Awaiting document processing.</p>	<ul style="list-style-type: none"> • The received faxes were not saved on the USB flash drive automatically because the USB flash drive was not inserted or because it was not writable. <p>The received faxes are stored in the printer's memory. Insert the writable USB flash drive, and then save the received faxes to the USB flash drive manually.</p> <ul style="list-style-type: none"> ■ Saving Document in Printer's Memory to USB Flash Drive <ul style="list-style-type: none"> • The received faxes were not forward to the shared folder on the computer because the printer is not connected with the computer or because the shared folder setting is changed. <p>The received faxes are stored in the printer's memory. Connect the printer with the computer, and then forward the received faxes to the shared folder on the computer manually.</p> <ul style="list-style-type: none"> ■ Forwarding Document in Printer's Memory to Shared Folder on Computer <p>Delete the unnecessary fax from printer's memory after saving to the USB flash drive, forwarding to the shared folder on the computer, or printing.</p> <ul style="list-style-type: none"> ■ Deleting Document in Printer's Memory
<p>FAX info does not match.</p>	<p>Transmission has been canceled because the printer could not detect the recipient's fax device information or the information did not match the dialed number. This message is displayed when Check RX FAX information in Security control under FAX settings is set to ON.</p> <p>For details, see Preventing Mistransmission of Faxes.</p>
<p>Reception rejected.</p>	<p>Reception has been rejected because the fax matches the fax rejection condition specified by FAX reception reject in Security control under FAX settings.</p> <p>For details, see Rejecting Fax Reception.</p>
<p>Waiting for report output...</p>	<p>If the printer receives a fax under one of the following conditions, the printer will not be able to print the reports. When the problem is resolved as described, the reports are printed automatically.</p> <ul style="list-style-type: none"> • The amount of remaining ink is insufficient to print a report: <ul style="list-style-type: none"> Replace the ink tank. ■ Replacing Ink Tanks • Paper has run out: <ul style="list-style-type: none"> Load the paper and tap OK on the touch screen. • A different size of paper from that specified by Page size in FAX paper settings is loaded: <ul style="list-style-type: none"> Load the same size of paper as that specified by Page size, and then tap OK on the touch screen. • You pressed the Stop button to cancel printing of a report: <ul style="list-style-type: none"> Press the HOME button and tap FAX to resume printing of the report.

Message Appears

This section describes some of the errors and messages that may appear.

►► Note

- A support code (error number) is displayed on the computer or on the touch screen for some errors. For details on errors that have support code, see [List of Support Code for Error](#).

If a message appears on the touch screen, see below.

■ [Message Appears on Touch Screen](#)

If a message appears on the computer, see below.

- [Error Regarding Automatic Duplex Printing Is Displayed](#)
- [Error Regarding Power Cord Being Unplugged Is Displayed \(Windows\)](#)
- [Writing Error/Output Error/Communication Error \(Windows\)](#)
- [Other Error Messages \(Windows\)](#)
- [Inkjet Printer/Scanner/Fax Extended Survey Program Screen Is Displayed \(Windows\)](#)
- [Inkjet Printer/Scanner/Fax Extended Survey Program Icon Appears \(Mac OS\)](#)

Message Appears on Touch Screen

Check the message and take an appropriate action.

- **Data of supported types are not saved.**
 - There is no image data or document saved on the USB flash drive that can be read by this printer.
 - The printer may not recognize the file if the file name or folder path contain certain characters. Use only alphanumeric characters.
 - Photo data edited or processed on a computer must be printed from the computer.

►► Note

- When a photo which has been processed on a computer is selected, "?" is displayed on the touch screen.

- **Cannot print the specified PDF file. An error has occurred while scanning the file, or the format is not supported, or the file is too large.**

- Make sure the PDF file is printable from a USB flash drive. For more information, see [Printing Documents \(PDF File\) Saved on USB Flash Drive](#).

►► Note

- The names of the PDF files are displayed even though they cannot be printed from the USB flash drive. We recommend that you check whether they are printable. If one of the following conditions applies to the PDF files, they are not printable.
 - The **Details** screen is not displayed for the PDF file you want to print.

- Characters other than printer name or **IJ Scan Utility** are displayed on **Created with** on the **Details** screen.
- "?" is displayed on the preview screen.

◦ Data edited or processed on a computer must be printed from the computer.

- **The specified PDF file contains unprintable data. Some portions may not be printed.**

PDF file which contain lot of graphics or hi-resolution images may lose that data or stop before printing is completed. In this case, print from the computer.

- **Check the page size and tap [OK].**

The size of the loaded paper is different from that specified in the paper size setting.

Load the same size of paper as that specified in the paper size setting and tap **OK**.

- **Power was not turned off correctly the last time. Press the  button when turning power off.**

The printer may have been unplugged while the power was still on.

Tap **OK** on the touch screen.

Note

- See [Unplugging the Machine](#) to unplug the printer correctly.

- **The power cord has been unplugged and unsent/received docs in memory have been lost.**

A power failure has occurred or the power cord has been unplugged when the faxes are stored in the printer's memory.

Important

- If a power failure occurs or the printer is unplugged, all faxes stored in the printer's memory are deleted.

See [Unplugging the Machine](#) to unplug the printer.

Tap **OK** on the touch screen.

After tapping **OK**, the list of the faxes deleted from the printer's memory (MEMORY CLEAR REPORT) will be printed.

For details, see [Summary of Reports and Lists](#).

- **Cannot connect to the server. Please wait a while and try again.**

The printer cannot connect to the server due to a communication error.

Tap **OK** on the touch screen and try again after a while.

Error Regarding Automatic Duplex Printing Is Displayed

Check See [Automatic Duplex Printing Problems](#) and take the appropriate action.

Error Regarding Power Cord Being Unplugged Is Displayed (Windows)

The printer may have been unplugged while it was on.

Check the error message that appears on the computer and click **OK**.

The printer starts printing.

See [Unplugging the Machine](#) for unplugging the power cord.

Important

- If the printer is unplugged, all the faxes stored in the printer's memory are deleted.

Writing Error/Output Error/Communication Error (Windows)

Check1 If **POWER** lamp is off, make sure printer is plugged in and turn it on.

The **POWER** lamp flashes while the printer is initializing. Wait until the **POWER** lamp stops flashing and remains lit.

Check2 Make sure correct printer port is set in printer driver.

* In the following instructions, "XXX" signifies your printer's name.

1. Log in using an account with administrator privileges.
2. Make the following settings.
 - In Windows 10, right-click **Start** button and select **Control Panel > View devices and printers**.
 - In Windows 8.1 or Windows 8, select **Control Panel** from **Settings** charm on **Desktop > Hardware and Sound > Devices and Printers**.
 - In Windows 7, select **Devices and Printers** from **Start** menu.
 - In Windows Vista, select **Start** menu > **Control Panel > Hardware and Sound > Printers**.
3. Open printer driver properties.
 - In Windows 10, Windows 8.1, Windows 8, or Windows 7, right-click "Canon XXX series Printer" icon (where "XXX" is your printer's name), and then select **Printer properties**.

- In Windows Vista, right-click "Canon XXX series Printer" icon (where "XXX" is your printer's name), and then select **Properties**.

4. Click **Ports** tab to check port settings.

Make sure a port named "USBnnn" (where "n" is a number) with "Canon XXX series Printer" appearing in **Printer** column is selected for **Print to the following port(s)**.

- If setting is incorrect:

Reinstall the MP Drivers from the Setup CD-ROM or the Canon website.

- If printing does not start even though the printer is connected to the computer using a USB cable and the port named "USBnnn" is selected:

In Windows 8.1 or Windows 8, select **My Printer** on **Start** screen to start **My Printer**. If **My Printer** is not displayed on **Start** screen, select **Search** charm, and then search for "**My Printer**".

Set the correct printer port on **Diagnose and Repair Printer**. Follow the on-screen instructions to set the correct printer port, and then select your printer's name.

In Windows 7 or Windows Vista, click **Start** and select **All programs, Canon Utilities, Canon My Printer, Canon My Printer**, and then select **Diagnose and Repair Printer**. Follow the on-screen instructions to set the correct printer port, and then select your printer's name.

If the problem is not resolved, reinstall the MP Drivers from the Setup CD-ROM or the Canon website.

Check3 Make sure printer is properly connected to computer.

If you are using a USB cable, make sure it is securely connected to both the printer and the computer. When the USB cable is securely plugged in, check the following:

- If you are using a relay device such as a USB hub, disconnect it, connect the printer directly to the computer, and retry the printing. If printing starts normally, there is a problem with the relay device. Contact the vendor of the relay device.
- There could also be a problem with the USB cable. Replace the USB cable and retry the printing.

If you use the printer over a LAN, make sure the printer is connected to the network with a LAN cable or is correctly set up for network use.

Check4 Make sure MP Drivers are installed correctly.

Uninstall the MP Drivers following the procedure described in [Deleting the Unnecessary MP Drivers](#) and reinstall them from the Setup CD-ROM or the Canon website.

Check5 When printer is connected to your computer with a USB cable, check device status from your computer.

Follow the procedure below to check the device status.

1. Open the Device Manager on your computer as shown below.

If the **User Account Control** screen appears, follow the on-screen instructions.

- In Windows 10, right-click **Start** button and select **Device Manager**.
- In Windows 8.1 or Windows 8, select **Control Panel** from **Settings** charm on **Desktop > Hardware and Sound > Device Manager**.
- In Windows 7 or Windows Vista, click **Control Panel, Hardware and Sound, and Device Manager**.

2. Double-click **Universal Serial Bus controllers** and **USB Printing Support**.

If the **USB Printing Support Properties** screen does not appear, make sure the printer is correctly connected to the computer.

■ Check3 [Make sure printer is properly connected to computer.](#)

3. Click **General** tab and check for a device problem.

If a device error is shown, see Windows Help to resolve it.

Other Error Messages (Windows)

Check If an error message appears outside printer status monitor, check the following:

- **"Could not spool successfully due to insufficient disk space"**
Delete any unnecessary files to increase the amount of free space on the disk.
- **"Could not spool successfully due to insufficient memory"**
Close other applications to increase the available memory.
If you still cannot print, restart your computer and retry the printing.
- **"Printer driver could not be found"**
Uninstall the MP Drivers following the procedure described in [Deleting the Unnecessary MP Drivers](#) and reinstall them from the Setup CD-ROM or the Canon website.
- **"Could not print Application name - File name"**
Try printing again once the current job is complete.

Inkjet Printer/Scanner/Fax Extended Survey Program Screen Is Displayed (Windows)

If the Inkjet Printer/Scanner/Fax Extended Survey Program is installed, a screen appears asking for permission to send the printer and application usage information every month for about ten years.

Read the information on the screen and follow the instructions below.

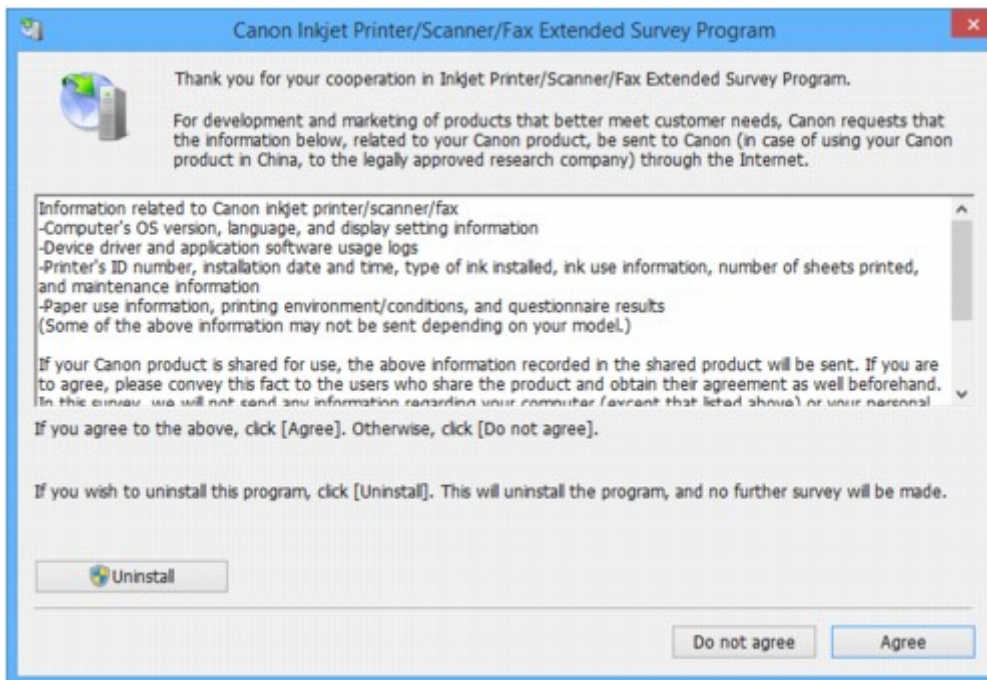

- **If you agree to participate in survey program:**

Click **Agree** and follow the on-screen instructions. The printer usage information is sent via the Internet. Once you have completed the procedure, the information is subsequently sent automatically and the confirmation screen does not reappear.

▶▶▶ Note

- When the information is being sent, a warning such as an Internet security message may appear. Make sure the program name is "IJPLMUI.exe" and allow it.
- If you clear **Send automatically from the next time** check box, the information will not be sent automatically from next time and a confirmation screen will appear at the time of the next survey. To send the information automatically, see [Changing confirmation screen setting](#).

- **If you do not agree to participate in survey program:**

Click **Do not agree**. The confirmation screen closes and the survey is skipped. The confirmation screen will reappear one month later.

- **To uninstall Inkjet Printer/Scanner/Fax Extended Survey Program:**

To uninstall the Inkjet Printer/Scanner/Fax Extended Survey Program, click **Uninstall** and follow the on-screen instructions.

- **Changing confirmation screen setting:**

1. Make the following settings.

- In Windows 10, right-click **Start** button and select **Programs and Features**.
- In Windows 8.1 or Windows 8, select **Control Panel** from **Settings** charm on **Desktop** > **Programs** > **Programs and Features**.
- In Windows 7, or Windows Vista, select **Start** menu > **Control Panel** > **Programs** > **Programs and Features**.

»» Note

- A confirmation/warning dialog box may appear when installing, uninstalling or starting up software.

This dialog box appears when administrative rights are required to perform a task.

If you are logged in on an account with administrator privileges, follow the on-screen instructions.

2. Select **Canon Inkjet Printer/Scanner/Fax Extended Survey Program**.
3. Select **Change**.

If you select **Yes** after you have followed the on-screen instructions, the confirmation screen will appear at the time of the next survey.

If you select **No**, the information will be sent automatically.

»» Note

- If you select **Uninstall**, the Inkjet Printer/Scanner/Fax Extended Survey Program is uninstalled. Follow the on-screen instructions.

Inkjet Printer/Scanner/Fax Extended Survey Program Icon Appears (Mac OS)

A

If the Inkjet Printer/Scanner/Fax Extended Survey Program is installed, the printer and application software usage information is sent every month for about ten years. The **Inkjet Printer/Scanner/Fax Extended Survey Program** icon appears in the Dock when it is time to send the printer usage information.

Click the icon, read the information that appears, and then follow the instructions below.

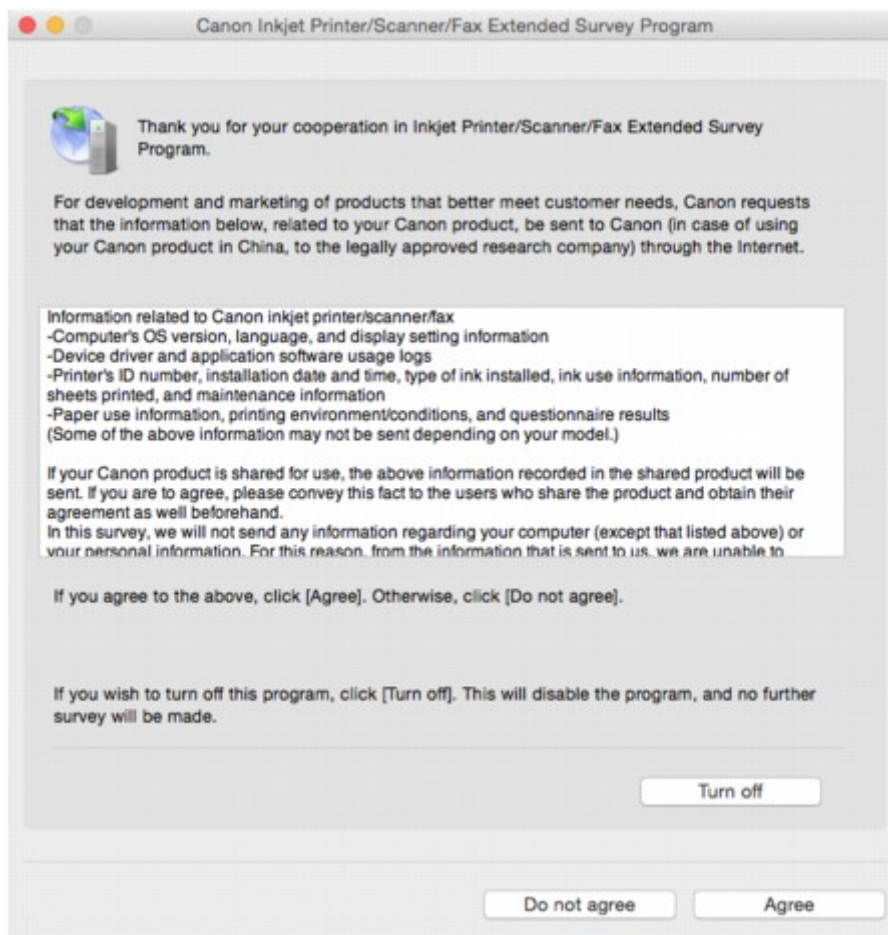

- **If you agree to participate in survey program:**

Click **Agree** and follow the on-screen instructions. The printer usage information is sent via the Internet. Once you have completed the procedure, the information is subsequently sent automatically and the confirmation screen does not reappear.

▶▶▶ **Note**

- If you clear **Send automatically from the next time** check box, the information will not be sent automatically the next time and the **Inkjet Printer/Scanner/Fax Extended Survey Program** icon will appear in the dock at the time of the next survey.

- **If you do not agree to participate in survey program:**

Click **Do not agree**. The confirmation screen closes and the survey is skipped. The confirmation screen will reappear one month later.

- **To stop sending information:**

Click **Turn off**. This stops the Inkjet Printer/Scanner/Fax Extended Survey Program, and information is not sent. To resume the survey, see [Changing setting:](#).

- **To uninstall Inkjet Printer/Scanner/Fax Extended Survey Program:**

1. Stop Inkjet Printer/Scanner/Fax Extended Survey Program.

■ [Changing setting:](#)

2. Select **Applications** from **Go** menu of Finder, double-click **Canon Utilities** folder and **Inkjet Extended Survey Program** folder.
3. Move **Canon Inkjet Printer/Scanner/Fax Extended Survey Program.app** file to **Trash**.
4. Restart computer.
Empty **Trash** and restart your computer.

- **Changing setting:**

To display the confirmation screen every time the printer usage information is sent or to resume surveying, follow the procedure below.

1. Select **Applications** from **Go** menu of Finder, double-click **Canon Utilities** folder and **Inkjet Extended Survey Program** folder.
2. Double-click **Canon Inkjet Printer/Scanner/Fax Extended Survey Program** icon.

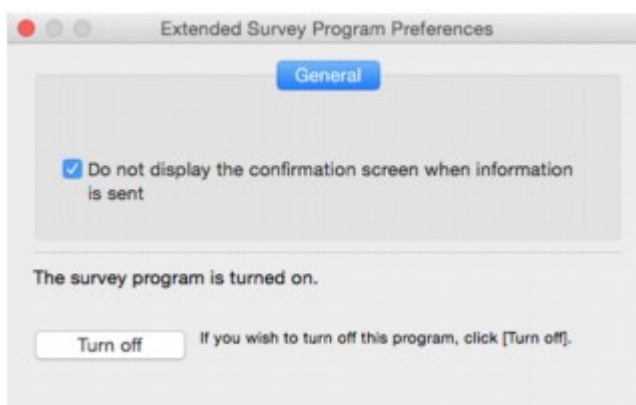

- **Do not display the confirmation screen when information is sent:**

If the check box is selected, the information will be sent automatically.

If the check box is not selected, **Inkjet Printer/Scanner/Fax Extended Survey Program** icon will appear in the Dock at the time of the next survey. Click the icon and follow the on-screen instructions.

- **Turn off/Turn on** button:

Click the **Turn off** button to stop the Inkjet Printer/Scanner/Fax Extended Survey Program.

Click the **Turn on** button to restart the Inkjet Printer/Scanner/Fax Extended Survey Program.

If You Cannot Solve a Problem

If there is a problem that you cannot solve following the instructions in this chapter, contact Canon through the Support page of the Canon website or contact your nearest Canon service center.

Canon support staff are trained to be able to provide technical support to satisfy customers.

Caution

- If the printer emits any unusual sound, smoke, or odor, turn it off immediately. Unplug the printer and contact the seller you bought it from or your nearest Canon service center. Never attempt to repair or disassemble the printer yourself.
- If you attempt to repair or take apart the printer, your warranty will be invalidated even if it has not expired.

Before contacting the service center, note the following:

- Product name
(Your printer's name is written on the front cover of the setup manual.)
- Serial number (see setup manual)
- Details of problem
- What you tried to solve the problem, and what happened

List of Support Code for Error

Support code appears on the touch screen and your computer screen when errors occur.

A "support code" is an error number, and appears along with an error message.

When an error occurs, check the support code displayed on the touch screen and computer screen and take the appropriate action in response.

Support Code Appears on Touch Screen and Computer Screen

- **1000 to 1ZZZ**

[1007](#) [1008](#) [1200](#) [1300](#) [1303](#) [1309](#)

[1310](#) [1313](#) [1314](#) [1319](#) [1575](#) [1600](#)

[1660](#) [1688](#) [1700](#) [1701](#) [1754](#) [1755](#)

[1872](#) [1873](#) [1874](#) [1890](#)

- **2000 to 2ZZZ**

[2001](#) [2002](#) [2111](#) [2112](#) [2113](#) [2121](#)

[2122](#) [2500](#) [2700](#) [2801](#) [2802](#) [2803](#)

[2805](#)

- **3000 to 3ZZZ**

[3401](#) [3402](#) [3403](#) [3404](#) [3405](#) [3406](#)

[3407](#) [3408](#) [3410](#) [3411](#) [3412](#) [3413](#)

[3414](#) [3415](#) [3416](#) [3417](#) [3418](#) [3419](#)

[3420](#) [3421](#) [3422](#) [3423](#) [3424](#) [3425](#)

[3426](#) [3427](#) [3428](#) [3429](#) [3430](#) [3431](#)

[3432](#) [3433](#)

- **4000 to 4ZZZ**

[4100](#) [4103](#) [4104](#)

- **5000 to 5ZZZ**

[5011](#) [5012](#) [5040](#) [5050](#) [5051](#) [5100](#)

[5102](#) [5103](#) [5104](#) [5105](#) [5200](#) [5203](#)

[5204](#) [5205](#) [5206](#) [5207](#) [5208](#) [5209](#)

[5400](#) [5500](#) [5501](#) [5B00](#) [5B01](#) [5C01](#)

• **6000 to 6ZZZ**

[6000](#) [6500](#) [6502](#) [6700](#) [6701](#) [6800](#)

[6801](#) [6900](#) [6901](#) [6902](#) [6910](#) [6911](#)

[6920](#) [6921](#) [6930](#) [6931](#) [6932](#) [6933](#)

[6936](#) [6937](#) [6938](#) [6939](#) [693A](#) [6940](#)

[6941](#) [6942](#) [6943](#) [6944](#) [6945](#) [6946](#)

• **7000 to 7ZZZ**

[7100](#) [7200](#) [7201](#) [7202](#) [7203](#) [7204](#)

[7205](#)

• **9000 to 9ZZZ**

[9000](#) [9500](#)

• **A000 to ZZZZ**

[B202](#) [B203](#) [B204](#) [B205](#) [B502](#) [B503](#)

[B504](#) [C000](#)

For paper jam support codes, see also [List of Support Code for Error \(Paper Jams\)](#).

List of Support Code for Error (Paper Jams)

If paper jams, remove it following the appropriate procedure as shown below.

- If the paper is jammed inside the front cover:
 - [1300](#)
- If the paper is jammed inside the rear cover:
 - [1303](#)
- If the paper is jammed inside the rear cover as the printer pulled in the printed paper:
 - [1313](#)
- If the paper is jammed inside the rear cover during automatic duplex printing:
 - [1314](#)
- If the document is jammed in the ADF:
 - [2801](#)
- Cases other than above:
 - [Other Cases](#)

1300

Cause

Paper is jammed inside front cover.

What to Do

If the paper is jammed inside the front cover, remove the paper by following these steps.

▶▶▶ Important

- The printer cannot be turned off while it is sending or receiving a fax, or when the received fax or the unsent fax are stored in the printer's memory.

Turn off the printer after making sure it has completed sending or receiving all the faxes. Do not unplug when turning off the printer.

If you unplug the power cord, all the faxes stored in the printer's memory are deleted.

▶▶▶ Note

- If paper becomes jammed during printing and you need to turn off the printer to remove it, press the **Stop** button to stop the printing before you turn off the printer.

1. Open front cover.

▶▶▶ Important

- Do not touch clear film (A) or white belt (B).

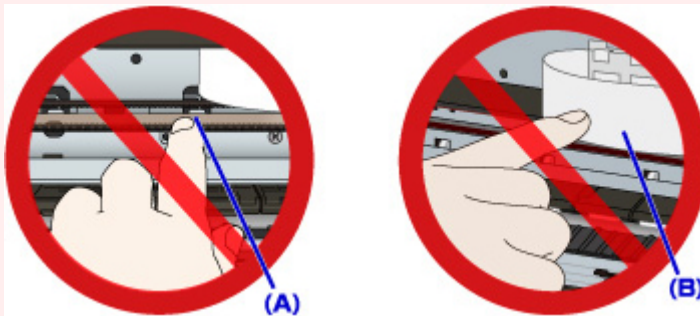

If you soil or scratch these parts by touching them with paper or your hand, it could damage the printer.

2. Make sure jammed paper is not under print head holder.

If the jammed paper is under the print head holder, move the print head holder to the far right or left, whichever makes it easier to remove the paper.

When moving the print head holder, press either the right side or the left side of the print head holder with your fingertips and slide it slowly to the far right or left.

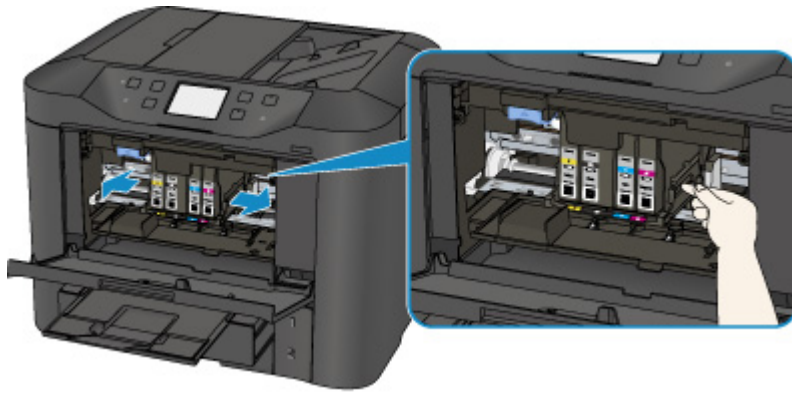

3. Hold jammed paper firmly in both hands.

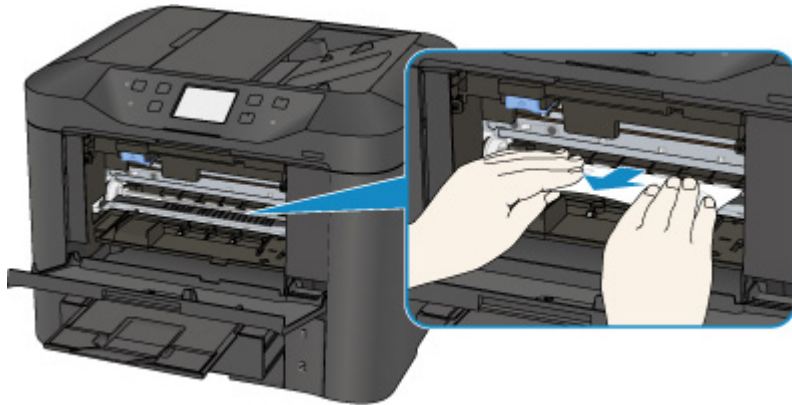

If the paper is rolled up, pull out it.

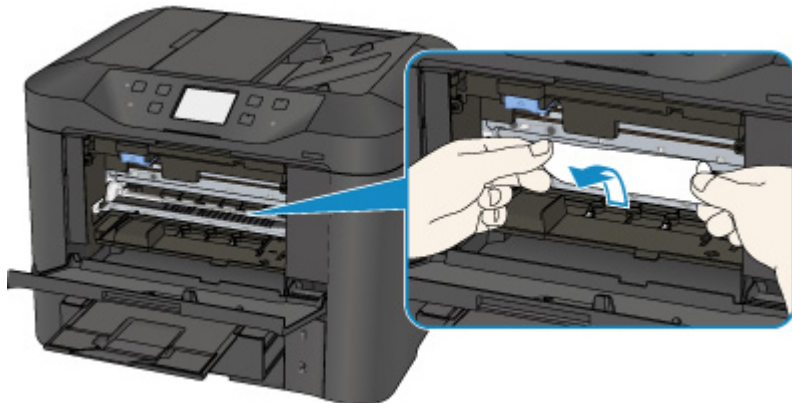

4. Pull paper out slowly, so as not to tear it.

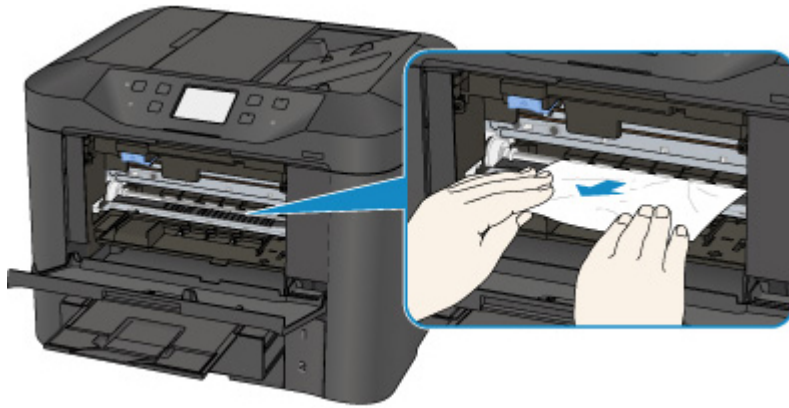

5. Make sure all jammed paper is removed.

If the paper tears when you pull it out, a bit of paper may remain in the printer. Check the following and remove any remaining paper.

- Any paper left under the print head holder?
- Any small bits of paper left in the printer?
- Any paper left in the left and right empty spaces (C) in the printer?

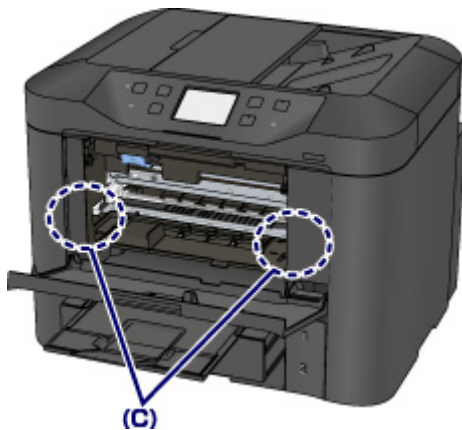

6. Close front cover.

7. Tap **OK** on printer's touch screen.

- If the paper is jammed while printing the faxes or the fax report in progress:
After clearing the paper jam error and tapping **OK** on the touch screen of the printer, the printer resumes printing from the page where the paper was jammed.
- If the paper is jammed while printing from a computer or copying in progress:
After clearing the paper jam error and tapping **OK** on the touch screen of the printer, the printer resumes printing from the next page where the paper was jammed.
As the page where the paper was jammed is not printed, reprint if necessary.
When the paper is jammed while duplex printing or duplex copying is in progress, it is possible that the printing or copying order is not as you expect if you resume printing after clearing the paper jam error. In this case, cancel printing and reprint from the beginning.

When the paper is jammed while layout printing, 2 on 1 copying, or 4 on 1 copying is in progress, it is possible that some pages are not printed if you resume printing after clearing the paper jam error. In this case, cancel printing and reprint from the beginning.

- If you turned off the printer while taking the appropriate action of the paper jam error:

All jobs in the print queue are canceled. Redo the printing.

▶▶ Note

- When reloading the paper, make sure you are using suitable paper and loading it correctly.
Align the paper guides with the both edges of the paper when you load paper.
- If the message about paper jam is displayed on the touch screen of the printer or on the computer screen when you resume printing after removing all the jammed paper, a piece of paper may remain inside the printer. In this case, make sure no piece of paper remains inside the printer.
- We recommend using paper sizes other than A5/A6 to print documents with photos or graphics. A5/A6 paper may curl and jam as it leaves the printer.

If the measures above do not solve the problem, contact your nearest Canon service center to request a repair.

1303

Cause

Paper is jammed inside rear cover.

What to Do

If the paper is jammed inside the rear cover, follow these steps to remove the paper.

▶▶▶ Important

- The printer cannot be turned off while it is sending or receiving a fax, or when the received fax or the unsent fax are stored in the printer's memory.

Turn off the printer after making sure it has completed sending or receiving all the faxes. Do not unplug when turning off the printer.

If you unplug the power cord, all the faxes stored in the printer's memory are deleted.

▶▶▶ Note

- If paper becomes jammed during printing and you need to turn off the printer to remove it, press the **Stop** button to stop the printing before you turn off the printer.

1. Rotate printer so that rear side of printer faces toward you.

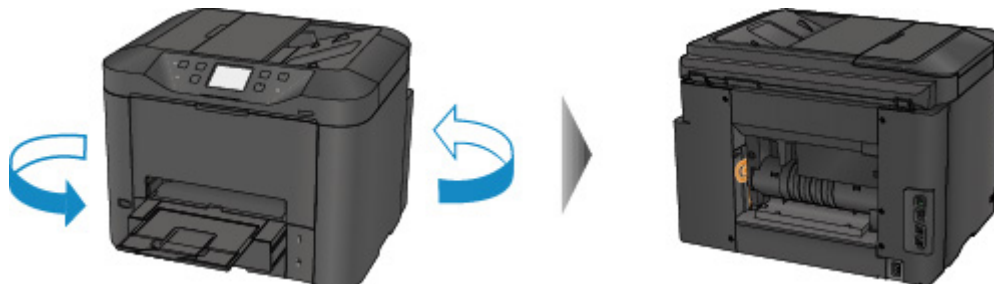

2. If protective material for rear cover remains attached, remove it.

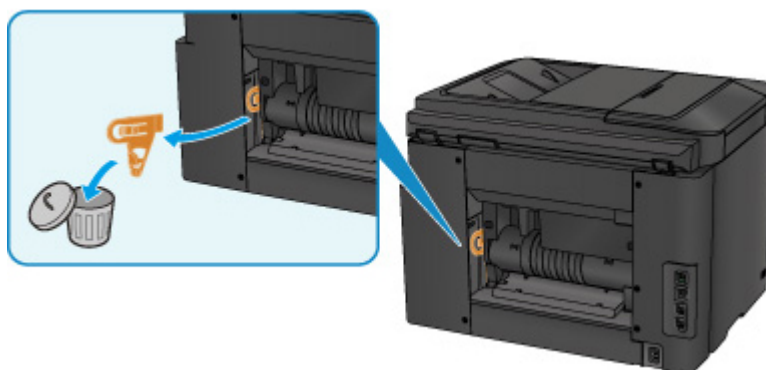

3. Open rear cover.

Slide the rear cover to the left then open it.

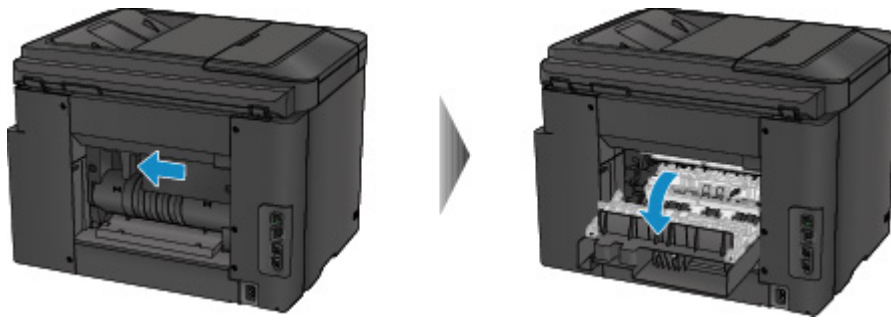

4. Pull out paper slowly.

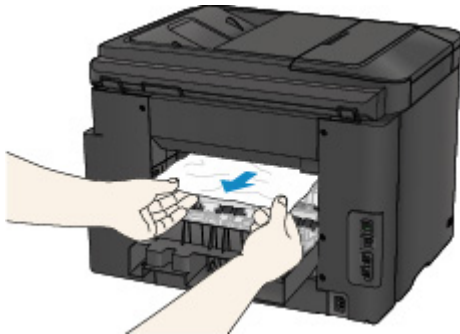

▶▶▶ Note

- Do not touch the inner parts of the printer.
- If you cannot pull the paper out, try the following.
 - Turn the printer off and turn it back on.
The paper may be ejected automatically.
 - Pull out the paper output tray.
It becomes easy to pull out the paper.

5. Close rear cover slowly.

Close the rear cover then slide it to the right.

Slide the rear cover so that the Δ mark on the rear cover aligns with the ∇ mark on the printer.

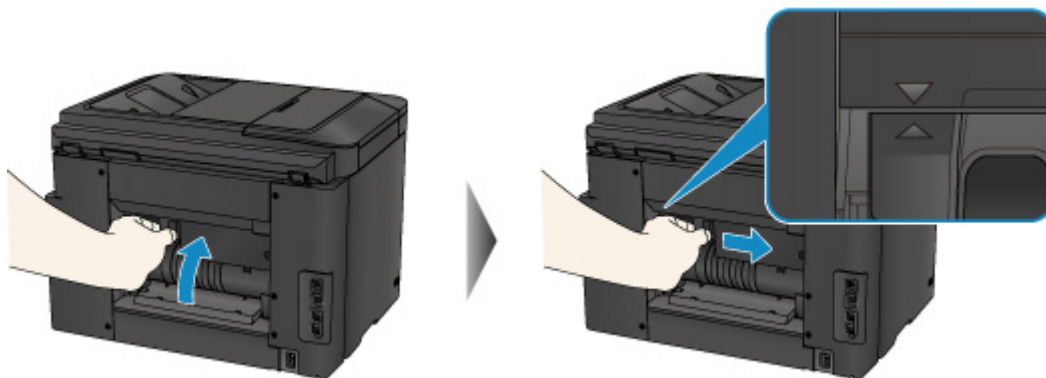

6. Reload paper and tap **OK** on printer's touch screen.

- If the paper is jammed while printing the faxes or the fax report in progress:
After clearing the paper jam error and tapping **OK** on the touch screen of the printer, the printer resumes printing from the page where the paper was jammed.
- If the paper is jammed while printing from a computer or copying in progress:
After clearing the paper jam error and tapping **OK** on the touch screen of the printer, the printer resumes printing from the next page where the paper was jammed.
As the page where the paper was jammed is not printed, reprint if necessary.
When the paper is jammed while duplex printing or duplex copying is in progress, it is possible that the printing or copying order is not as you expect if you resume printing after clearing the paper jam error. In this case, cancel printing and reprint from the beginning.
When the paper is jammed while layout printing, 2 on 1 copying, or 4 on 1 copying is in progress, it is possible that some pages are not printed if you resume printing after clearing the paper jam error. In this case, cancel printing and reprint from the beginning.
- If you turned off the printer while taking the appropriate action of the paper jam error:
All jobs in the print queue are canceled. Redo the printing.

Note

- When reloading the paper, make sure you are using suitable paper and loading it correctly.
Align the paper guides with the both edges of the paper when you load paper.
- We recommend using paper sizes other than A5/A6 to print documents with photos or graphics.
A5/A6 paper may curl and jam as it leaves the printer.

If the measures above do not solve the problem, contact your nearest Canon service center to request a repair.

1313

Cause

Paper is jammed inside rear cover as printer pulled in printed paper.

What to Do

If the paper is jammed inside the rear cover as the printer pulled in the printed paper, remove the paper by following these steps.

▶▶▶ Important

- If the printed paper piles up on the paper output slot, the printer may pull it in and the paper is jammed inside the printer. Remove the printed paper from the paper output tray before it amounts to 75 sheets.
- The printer cannot be turned off while it is sending or receiving a fax, or when the received fax or the unsent fax are stored in the printer's memory.

Turn off the printer after making sure it has completed sending or receiving all the faxes. Do not unplug when turning off the printer.

If you unplug the power cord, all the faxes stored in the printer's memory are deleted.

▶▶▶ Note

- If paper becomes jammed during printing and you need to turn off the printer to remove it, press the **Stop** button to stop the printing before you turn off the printer.

1. Rotate printer so that rear side of printer faces toward you.

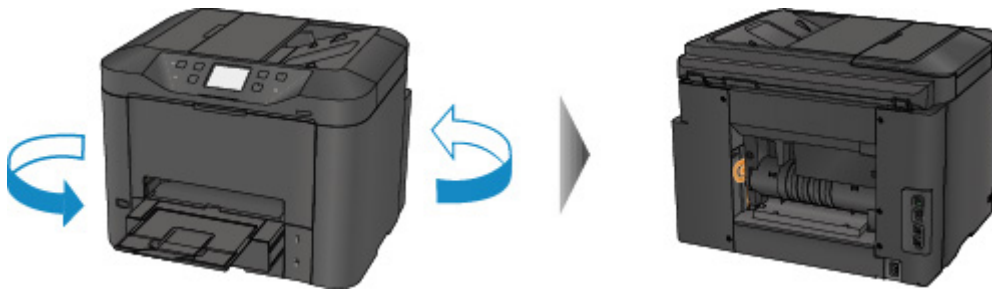

2. If protective material for rear cover remains attached, remove it.

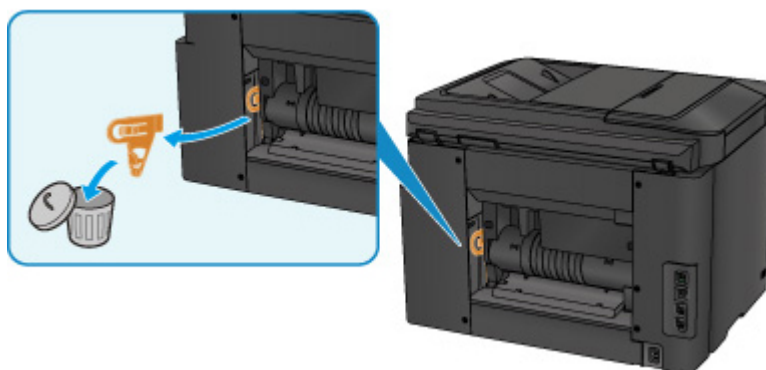

3. Open rear cover.

Slide the rear cover to the left then open it.

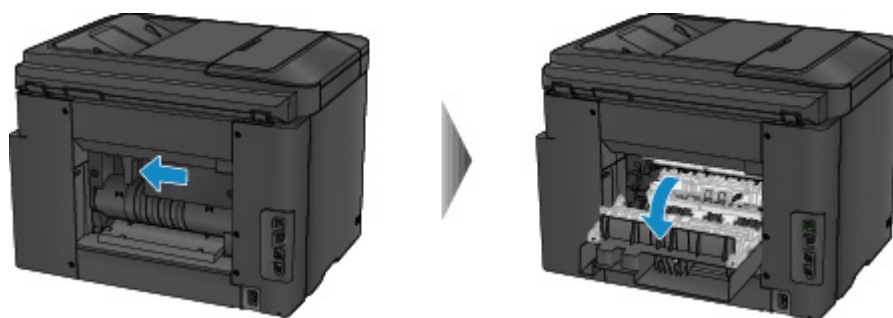

4. Pull out paper slowly.

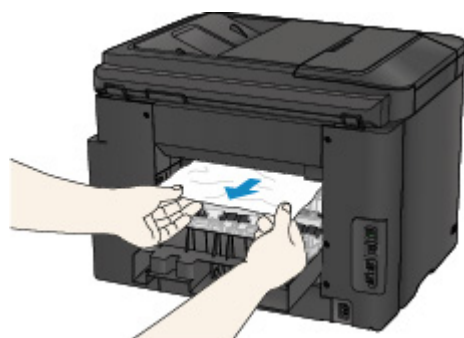

▶▶▶ Note

- Do not touch the inner parts of the printer.
- If you cannot pull the paper out, try the following.
 - Turn the printer off and turn it back on.
The paper may be ejected automatically.
 - Pull out the paper output tray.
It becomes easy to pull out the paper.

5. Close rear cover slowly.

Close the rear cover then slide it to the right.

Slide the rear cover so that the Δ mark on the rear cover aligns with the ∇ mark on the printer.

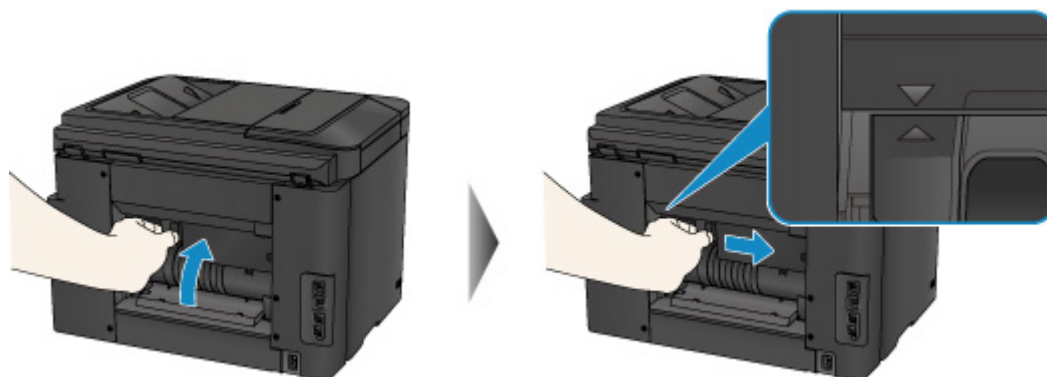

6. Reload paper and tap **OK** on printer's touch screen.

- If the paper is jammed while printing the faxes or the fax report in progress:

After clearing the paper jam error and tapping **OK** on the touch screen of the printer, the printer resumes printing from the page where the paper was jammed.

- If the paper is jammed while printing from a computer or copying in progress:

After clearing the paper jam error and tapping **OK** on the touch screen of the printer, the printer resumes printing from the next page where the paper was jammed.

As the page where the paper was jammed is not printed, reprint if necessary.

When the paper is jammed while duplex printing or duplex copying is in progress, it is possible that the printing or copying order is not as you expect if you resume printing after clearing the paper jam error. In this case, cancel printing and reprint from the beginning.

When the paper is jammed while layout printing, 2 on 1 copying, or 4 on 1 copying is in progress, it is possible that some pages are not printed if you resume printing after clearing the paper jam error. In this case, cancel printing and reprint from the beginning.

- If you turned off the printer while taking the appropriate action of the paper jam error:

All jobs in the print queue are canceled. Redo the printing.

Note

- When reloading the paper, make sure you are using suitable paper and loading it correctly.
Align the paper guides with the both edges of the paper when you load paper.

If the measures above do not solve the problem, contact your nearest Canon service center to request a repair.

1314

Cause

Paper is jammed inside rear cover during automatic duplex printing.

What to Do

If the paper is jammed inside the rear cover when performing automatic duplex printing, remove the paper by following these steps.

▶▶▶ Important

- The printer cannot be turned off while it is sending or receiving a fax, or when the received fax or the unsent fax are stored in the printer's memory.

Turn off the printer after making sure it has completed sending or receiving all the faxes. Do not unplug when turning off the printer.

If you unplug the power cord, all the faxes stored in the printer's memory are deleted.

▶▶▶ Note

- If paper becomes jammed during printing and you need to turn off the printer to remove it, press the **Stop** button to stop the printing before you turn off the printer.

1. Rotate printer so that rear side of printer faces toward you.

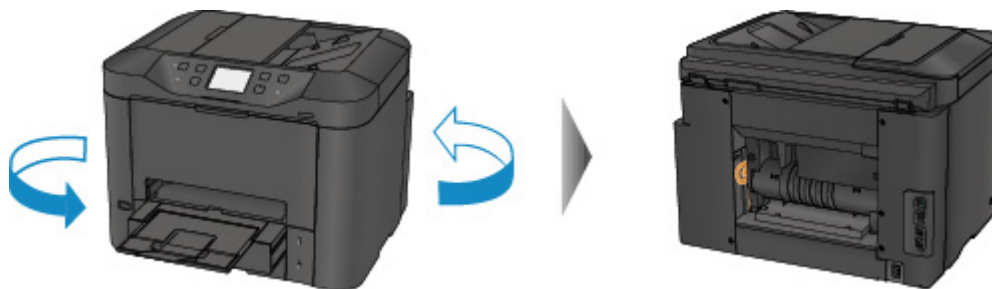

2. If protective material for rear cover remains attached, remove it.

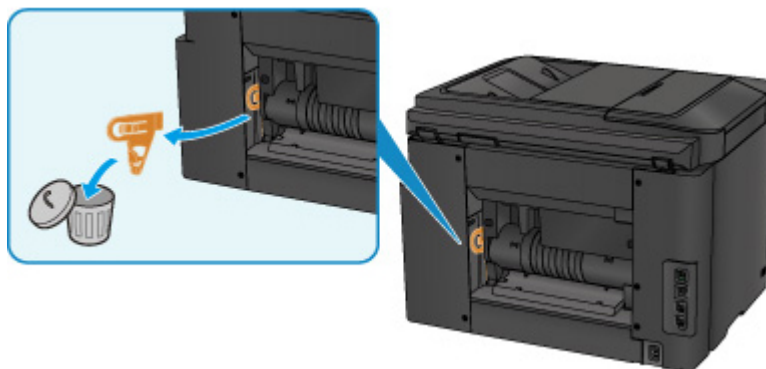

3. Open rear cover.

Slide the rear cover to the left then open it.

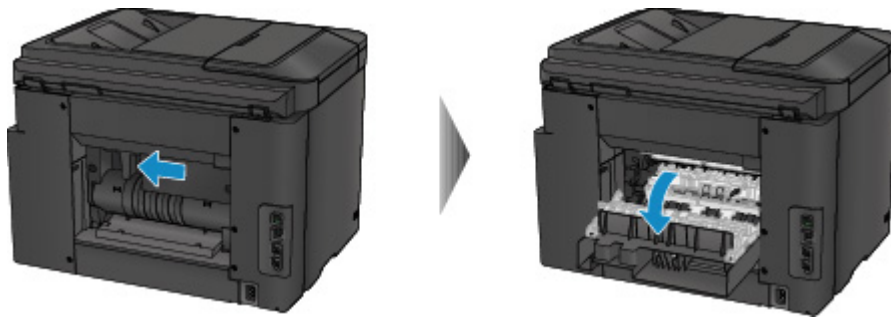

4. Pull out paper slowly.

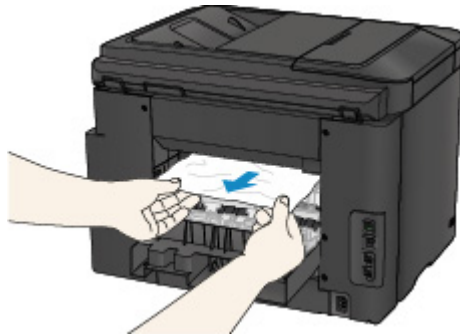

▶▶▶ Note

- Do not touch the inner parts of the printer.
- If you cannot pull the paper out, try the following.
 - Turn the printer off and turn it back on.
The paper may be ejected automatically.
 - Pull out the paper output tray.
It becomes easy to pull out the paper.

5. Close rear cover slowly.

Close the rear cover then slide it to the right.

Slide the rear cover so that the Δ mark on the rear cover aligns with the ∇ mark on the printer.

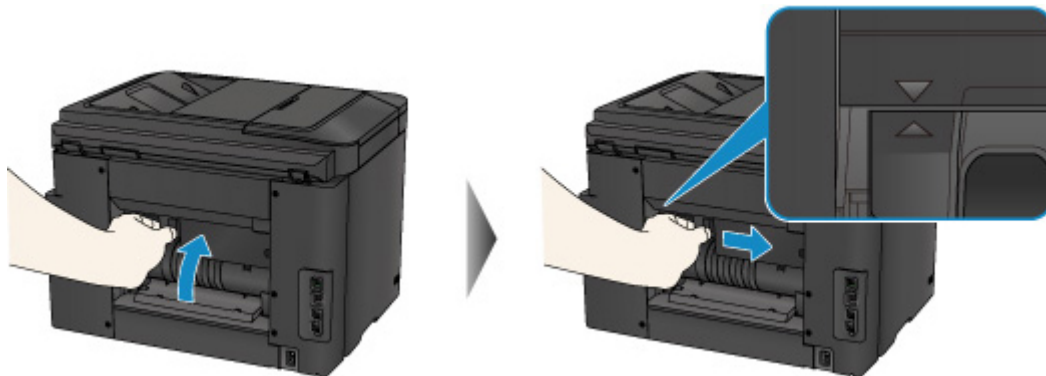

6. Reload paper and tap **OK** on printer's touch screen.

- If the paper is jammed while printing the faxes or the fax report in progress:
After clearing the paper jam error and tapping **OK** on the touch screen of the printer, the printer resumes printing from the page where the paper was jammed.
- If the paper is jammed while printing from a computer or copying in progress:
After clearing the paper jam error and tapping **OK** on the touch screen of the printer, the printer resumes printing from the next page where the paper was jammed.
As the page where the paper was jammed is not printed, reprint if necessary.
When the paper is jammed while duplex printing or duplex copying is in progress, it is possible that the printing or copying order is not as you expect if you resume printing after clearing the paper jam error. In this case, cancel printing and reprint from the beginning.
When the paper is jammed while layout printing, 2 on 1 copying, or 4 on 1 copying is in progress, it is possible that some pages are not printed if you resume printing after clearing the paper jam error. In this case, cancel printing and reprint from the beginning.
- If you turned off the printer while taking the appropriate action of the paper jam error:
All jobs in the print queue are canceled. Redo the printing.

Note

- When reloading the paper, make sure you are using suitable paper and loading it correctly.
Align the paper guides with the both edges of the paper when you load paper.

If the measures above do not solve the problem, contact your nearest Canon service center to request a repair.

2801

Cause

Document is jammed in ADF.

What to Do

Remove the document following the procedure below.

»» Important

- The printer cannot be turned off while it is sending or receiving a fax, or when the received fax or the unsent fax are stored in the printer's memory.

Turn off the printer after making sure it has completed sending or receiving all the faxes. Do not unplug when turning off the printer.

If you unplug the power cord, all the faxes stored in the printer's memory are deleted.

- **If the original remains in the ADF by pressing the Stop button while the printer is scanning the document:**

If you press the **Stop** button during scanning then the document remained in the ADF, the message about the paper remained in the ADF appears on the touch screen. Tap **OK** so that the remaining document is automatically fed out.

- **If the original is jammed in the ADF:**

Remove the document following the procedure below.

1. If printing is in progress, press **Stop** button.
2. Turn off printer.
3. If a multi-page document is loaded, remove any pages other than jammed page from ADF and open document feeder cover.

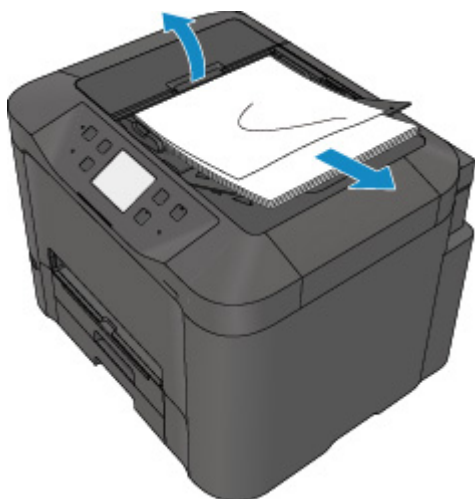

4. Pull out jammed document from ADF.



5. Close document feeder cover and turn on printer.

When rescanning the document after clearing the error, rescan it from the first page.

If you cannot remove the document or the document tears inside the printer, or if the document jam error continues after removing the document, contact your nearest Canon service center to request a repair.

▶▶▶ Note

- The document may not feed properly depending on the media type, or your environment, such as when the temperature and humidity are either too high or too low.

In this case, reduce the number of document pages to approximately half of the loading capacity.

If the document still jams, use the platen glass instead.

• If the original is jammed in the ADF (from the paper feed side):

If the document is jammed in the document output slot, close the document tray as shown in the figure below and pull out the document.

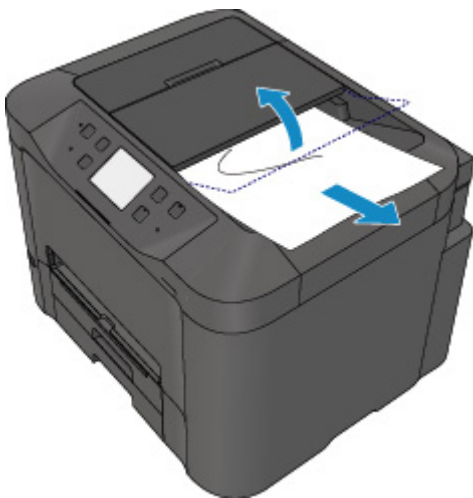

When rescanning the document after clearing the error, rescan it from the first page.

If you cannot remove the document or the document tears inside the printer, or if the document jam error continues after removing the document, contact your nearest Canon service center to request a repair.

Other Cases

Check the following:

Check1 Is anything blocking paper output slot?

Check2 Is rear cover attached properly?

Check3 Is paper curled?

Correct curl before loading paper.

1007

Cause

Possible causes include the following.

- There is no paper in the cassette 1.
- Paper is not loaded in the cassette 1 properly.

What to Do

Take the corresponding actions below.

- Load paper in the cassette 1.
- Align the paper guides with the both edges of the paper when you load paper in the cassette 1.

After carrying out the above measures, tap **OK** on the touch screen.

▶▶ Note

- The loadable paper differs depending on the paper source.
A4, Letter, Legal, Oficio, B-Oficio, M-Oficio, Foolscap, or Legal (India)-sized plain paper can be loaded in both the cassette 1 and the cassette 2.
- To cancel printing, press the printer's **Stop** button.

1008

Cause

Possible causes include the following.

- There is no paper in the cassette 2.
- Paper is not loaded in the cassette 2 properly.

What to Do

Take the corresponding actions below.

- Load paper in the cassette 2.
- Align the paper guides with the both edges of the paper when you load paper in the cassette 2.

After carrying out the above measures, tap **OK** on the touch screen.

▶▶ Important

- The loadable paper differs depending on the paper source.

The loadable paper in the cassette 2 is A4, Letter, Legal, Oficio, B-Oficio, M-Oficio, Foolscap, or Legal (India)-sized plain paper.

▶▶ Note

- To cancel printing, press the printer's **Stop** button.

1200

Cause

Front cover is open.

What to Do

Close the front cover and wait for a while.

Do not close it while you are replacing an ink tank.

1309

Cause

Paper size that is not compatible with automatic duplex printing is specified.

What to Do

The sizes of media suitable for auto duplex printing are A4 and Letter.

Press the printer's **Stop** button to cancel printing.

Then change the print settings and retry printing.

1310

Cause

Size of paper may not be compatible with automatic duplex printing.

What to Do

The sizes of media suitable for auto duplex printing are A4 and Letter. Make sure paper of the correct size is loaded. Tap **OK** on the touch screen to eject the paper and restart printing from the front of the next piece of paper. The reverse side of the ejected sheet is not printed.

1319

Cause

Size of paper is not compatible with automatic duplex printing.

What to Do

The sizes of media suitable for auto duplex printing are A4 and Letter.

Press the printer's **Stop** button to cancel printing.

Then change the print settings and retry printing.

1575

Cause

Ink cannot be correctly detected.

What to Do

If an ink tank becomes empty, replace it.

An ink tank cannot be replaced until it becomes empty.

Please be advised that Canon shall not be liable for any malfunction or trouble caused by continuation of printing under the ink out condition.

1600

Cause

Ink may have run out.

What to Do

Replacing the ink tank is recommended.

If printing is in progress and you want to continue printing, tap **OK** on the machine with the ink tank installed. Then printing can continue. Replacing the ink tank is recommended after the printing. The machine may be damaged if printing is continued under the ink out condition.

Since the information contained in the fax may be lost if it is printed in this condition, the received fax will not be printed and will be stored in the machine's memory until the ink is replaced. You must manually print out faxes that were stored in the memory. You can change the setting so that the received fax is forcibly printed out instead of being stored in the memory, but all or part of the fax information may not be printed because of the ink out condition.

»» Important

- Do not remove an ink tank until a new one is prepared to be installed.
 - Once you remove an ink tank, the machine will not operate until a new one is installed.
 - Once you remove an ink tank, the machine will not operate even if the removed ink tank is just reinstalled.

1660

Cause

An ink tank is not installed.

What to Do

Install the ink tank.

1688

Cause

The ink has run out.

What to Do

Replace the ink tank and close the front cover.

Printing under the current condition may damage the machine.

If you want to continue printing in this condition, you need to disable the function for detecting the remaining ink level. Press and hold the machine's **Stop** button for at least 5 seconds, and then release it.

With this operation, disabling the function for detecting the remaining ink level is memorized. Please be advised that Canon shall not be liable for any malfunction or trouble caused by continuation of printing under the ink out condition.

▶▶▶ Important

- Do not remove an ink tank until a new one is prepared to be installed.
 - Once you remove an ink tank, the machine will not operate until a new one is installed.
 - Once you remove an ink tank, the machine will not operate even if the removed ink tank is just reinstalled.

▶▶▶ Note

- Since the information contained in the fax may be lost if it is printed in this condition, the received fax will not be printed and will be stored in the printer's memory until the ink is replaced. You must manually print out faxes that were stored in the memory. You can change the setting so that the received fax is forcibly printed out instead of being stored in the memory, but all or part of the fax information may not be printed because of the ink out condition.

1700

Cause

Ink absorber is almost full.

What to Do

Tap **OK** on the touch screen to continue printing. Contact your nearest Canon service center to request a repair.

1701

Cause

Ink absorber is almost full.

What to Do

Tap **OK** on the touch screen to continue printing. Contact your nearest Canon service center to request a repair.

1754

Cause

The ink tank is not installed properly.

What to Do

Open the front cover.

Then push the ink tank.

After installing the ink tank properly, close the front cover.

If this does not solve the problem, contact your nearest Canon service center to request a repair.

▶▶ Important

- The ink tank that was once installed cannot be removed until the ink runs out.

1755

Cause

The ink has run out.

What to Do

To maintain both machine and print quality, the machine cannot continue printing under the ink out condition.

Cancel printing and replace the ink tank before printing again.

►► Important

- Do not remove an ink tank until a new one is prepared to be installed.
 - Once you remove an ink tank, the machine will not operate until a new one is installed.
 - Once you remove an ink tank, the machine will not operate even if the removed ink tank is just reinstalled.

►► Note

- Since the information contained in the fax may be lost if it is printed in this condition, the received fax will not be printed and will be stored in the printer's memory until the ink is replaced. You must manually print out faxes that were stored in the memory.

1872

Cause

Cassette 1 is not inserted.

What to Do

Insert the cassette 1.

▶▶ Note

- Once the cassette 1 is installed, the screen for setting cassette paper information appears. Set the paper information for the paper in the cassette 1.
- To cancel printing, press the printer's **Stop** button.

1873

Cause

Cassette 2 is not inserted.

What to Do

Insert the cassette 2.

▶▶ Note

- Once the cassette 2 is installed, the screen for setting cassette paper information appears. Set the paper information for the paper in the cassette 2.
- To cancel printing, press the printer's **Stop** button.

1874

Cause

Cassette 1 and cassette 2 are not inserted.

What to Do

Insert the both cassettes.

▶▶ Note

- Once the cassette is installed, the screen for setting cassette paper information appears. Set the paper information for the paper in the cassette 1 and the cassette 2.
- To cancel printing, press the printer's **Stop** button.

1890

Cause

Protective material or tape may still be attached to print head holder.

What to Do

Open the front cover and make sure the protective material and tape have been removed from the print head holder.

If the protective material or tape is still there, remove it and close the front cover.

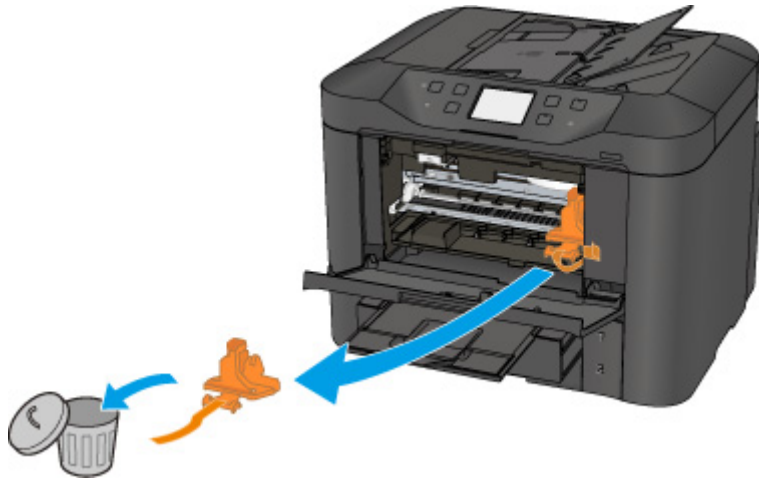

If this does not solve the problem, contact your nearest Canon service center to request a repair.

2001

Cause

An incompatible device is connected.

What to Do

Check the device connected to the USB flash drive port. Printing photos directly is possible with a USB flash drive.

2002

Cause

An unsupported USB hub is connected.

What to Do

If a USB flash drive is connected to the printer through the USB hub, disconnect the hub from the printer.

Connect a USB flash drive directly to the printer.

2111

Cause

Paper settings for printing or copying differ from cassette paper information set on printer.

▶▶▶ Note

- See below for the correct correspondence between paper settings made on the printer driver or on the touch screen.
 - [Paper Settings on the Printer Driver and the Printer \(Media Type\) \(Windows\)](#)
 - Paper Settings on the Printer Driver and the Printer (Media Type) (Mac OS)
 - [Paper Settings on the Printer Driver and the Printer \(Paper Size\) \(Windows\)](#)
 - Paper Settings on the Printer Driver and the Printer (Paper Size) (Mac OS)
- For copying, make the copy paper settings to match the cassette paper information set on the printer.
- See below for more on the cassette paper information that is set on the printer.
 - [Paper Settings](#)

If the print or copy paper settings do not match the cassette paper information set on the printer, as shown below, a message appears on the touch screen.

- Print settings specified on the printer driver:
 - Paper size: A5
 - Media type: Plain paper
- Cassette paper information set on the printer:
 - Paper size: A4
 - Media type: Plain paper

After tapping **OK** on the touch screen, the print or copy paper settings appear below the message.

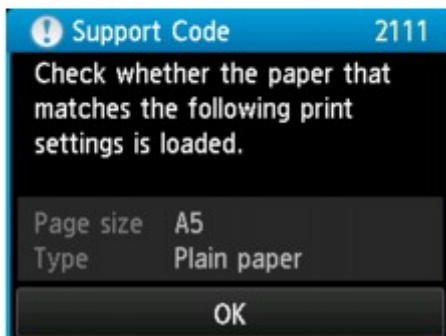
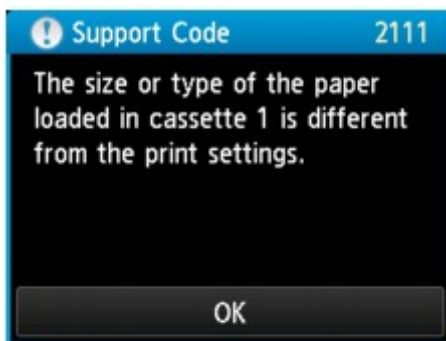

What to Do

Tapping **OK** on the touch screen again, the screen below appears.

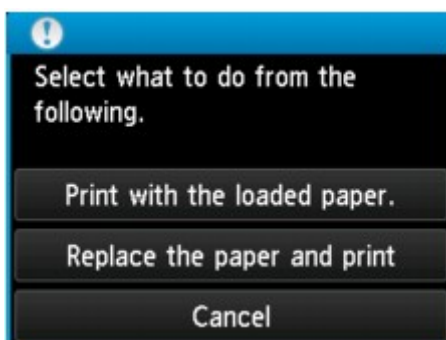

Select the appropriate action.

»» Note

- All of the options below may not appear, depending on the setting.

Print with the loaded paper.

Select this option to print or copy on the paper in the cassette 1, without changing the paper settings.

For example, if the paper setting is A5, and A4 is set in the cassette paper information, the A5 size setting is used to print or copy on the A4 paper in the cassette 1.

Replace the paper and print

Select this option to print after changing the paper in the cassette 1.

For example, if the paper setting is A5, and A4 is set in the cassette paper information, change the paper in the cassette 1 to A5 paper and proceed with printing or copying.

Once you have changed the paper, the screen for setting the cassette paper information appears. Set the paper information for the paper in the cassette 1.

▶▶▶ Note

- If you do not know what paper information to set, press the **Back** button. The previous screen appears, showing the paper size and media type. Check the paper settings and set them as the cassette paper information.
- See below for the correct correspondence between paper settings made on the printer driver or on the touch screen.
 - [Paper Settings on the Printer Driver and the Printer \(Media Type\)](#) (Windows)
 - Paper Settings on the Printer Driver and the Printer (Media Type) (Mac OS)
 - [Paper Settings on the Printer Driver and the Printer \(Paper Size\)](#) (Windows)
 - Paper Settings on the Printer Driver and the Printer (Paper Size) (Mac OS)

Cancel

Cancels printing.

Select this option to change the print or copy paper settings. Change the paper settings and retry the printing.

▶▶▶ Note

- To suppress the misprint prevention message, change the setting as described below. When you suppress the message, the printer uses the paper settings to print or copy on the paper in the cassette 1, even if the paper does not match the settings.
 - To change the message view setting when printing or copying using the operation panel of the printer:
 - [Cassette settings](#)
 - To change the message view setting when printing using the printer driver:
 - [Changing the Printer Operation Mode](#) (Windows)
 - Changing the Printer Operation Mode (Mac OS)

2112

Cause

Paper settings for printing or copying differ from cassette paper information set on printer.

▶▶▶ Note

- See below for the correct correspondence between paper settings made on the printer driver or on the touch screen.
 - [Paper Settings on the Printer Driver and the Printer \(Media Type\) \(Windows\)](#)
 - Paper Settings on the Printer Driver and the Printer (Media Type) (Mac OS)
 - [Paper Settings on the Printer Driver and the Printer \(Paper Size\) \(Windows\)](#)
 - Paper Settings on the Printer Driver and the Printer (Paper Size) (Mac OS)
- For copying, make the copy paper settings to match the cassette paper information set on the printer.
- See below for more on the cassette paper information that is set on the printer.
 - [Paper Settings](#)

If the print or copy paper settings do not match the cassette paper information set on the printer, as shown below, a message appears on the touch screen.

- Print settings specified on the printer driver:
 - Paper size: A4
 - Media type: Plain paper
- Cassette paper information set on the printer:
 - Paper size: Legal
 - Media type: Plain paper

After tapping **OK** on the touch screen, the print or copy paper settings appear below the message.

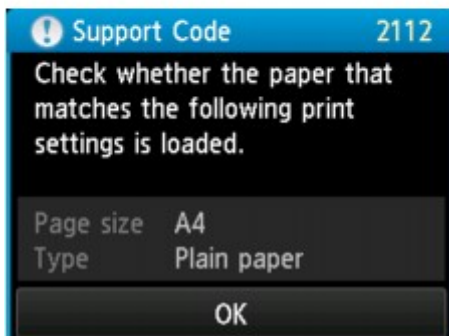
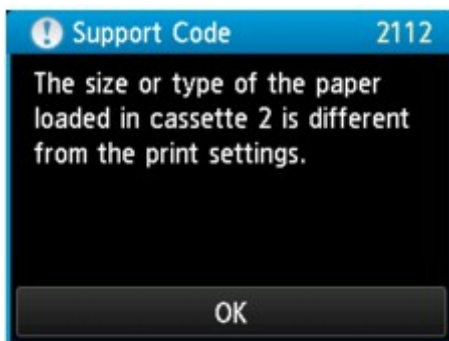

What to Do

Tapping **OK** on the touch screen again, the screen below appears.

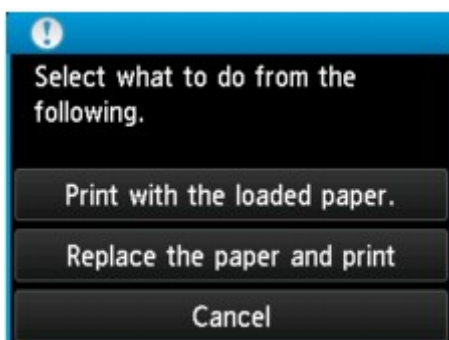

Select the appropriate action.

»» Note

- All of the options below may not appear, depending on the setting.

Print with the loaded paper.

Select this option to print or copy on the paper in the cassette 2, without changing the paper settings.

For example, if the paper setting is A4, and Legal is set in the cassette paper information, the A4 size setting is used to print or copy on the Legal paper in the cassette 2.

Replace the paper and print

Select this option to print after changing the paper in the cassette 2.

For example, if the paper setting is A4, and Legal is set in the cassette paper information, change the paper in the cassette 2 to A4 paper and proceed with printing or copying.

Once you have changed the paper, the screen for setting the cassette paper information appears. Set the paper information for the paper in the cassette 2.

▶▶ Note

- If you do not know what paper information to set, press the **Back** button. The previous screen appears, showing the paper size and media type. Check the paper settings and set them as the cassette paper information.
- See below for the correct correspondence between paper settings made on the printer driver or on the touch screen.
 - [Paper Settings on the Printer Driver and the Printer \(Media Type\)](#) (Windows)
 - Paper Settings on the Printer Driver and the Printer (Media Type) (Mac OS)
 - [Paper Settings on the Printer Driver and the Printer \(Paper Size\)](#) (Windows)
 - Paper Settings on the Printer Driver and the Printer (Paper Size) (Mac OS)

Cancel

Cancels printing.

Select this option to change the print or copy paper settings. Change the paper settings and retry the printing.

▶▶ Note

- To suppress the misprint prevention message, change the setting as described below. When you suppress the message, the printer uses the paper settings to print or copy on the paper in the cassette 2, even if the paper does not match the settings.
 - To change the message view setting when printing or copying using the operation panel of the printer:
 - [Cassette settings](#)
 - To change the message view setting when printing using the printer driver:
 - [Changing the Printer Operation Mode](#) (Windows)
 - Changing the Printer Operation Mode (Mac OS)

2113

Cause

Paper settings for printing or copying differ from cassette paper information set on printer.

▶▶▶ Note

- See below for the correct correspondence between paper settings made on the printer driver or on the touch screen.
 - [Paper Settings on the Printer Driver and the Printer \(Media Type\) \(Windows\)](#)
 - Paper Settings on the Printer Driver and the Printer (Media Type) (Mac OS)
 - [Paper Settings on the Printer Driver and the Printer \(Paper Size\) \(Windows\)](#)
 - Paper Settings on the Printer Driver and the Printer (Paper Size) (Mac OS)
- For copying, make the copy paper settings to match the cassette paper information set on the printer.
- See below for more on the cassette paper information that is set on the printer.
 - [Paper Settings](#)

If the print or copy paper settings do not match the cassette paper information set on the printer, as shown below, a message appears on the touch screen.

- Print settings specified on the printer driver:
 - Paper size: A4
 - Media type: Plain paper
- Cassette paper information set on the printer:
 - Paper size: Legal
 - Media type: Plain paper

After tapping **OK** on the touch screen, the print or copy paper settings appear below the message.

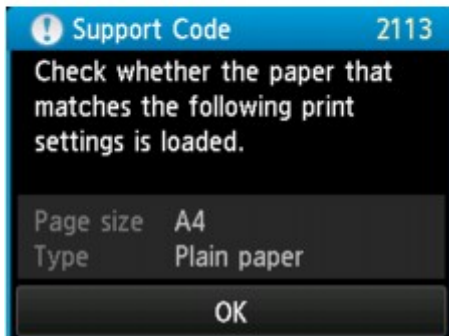
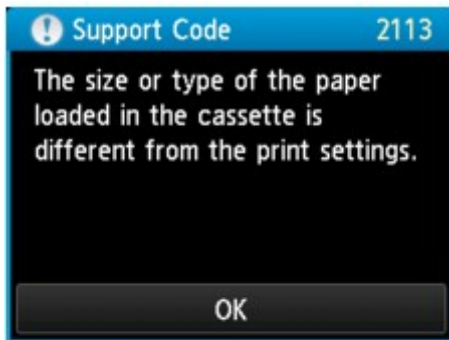

What to Do

Tapping **OK** on the touch screen again, the screen below appears.

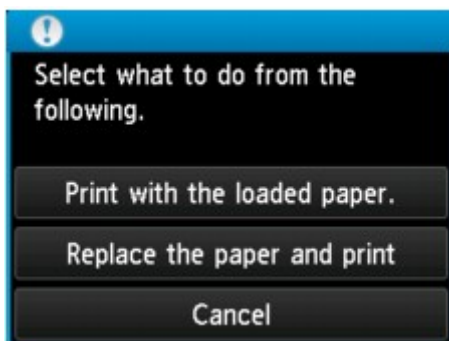

Select the appropriate action.

»» Note

- All of the options below may not appear, depending on the setting.

Print with the loaded paper.

Select this option to print or copy on the paper in the cassette 1 and the cassette 2, without changing the paper settings.

For example, if the paper setting is A4, and Legal is set in the cassette paper information, the A4 size setting is used to print or copy on the Legal paper in the cassette 1 and the cassette 2.

Replace the paper and print

Select this option to print after changing the paper in the cassette 1 and the cassette 2.

For example, if the paper setting is A5, and A4 is set in the cassette paper information, change the paper in the cassette 1 and the cassette 2 to A5 paper and proceed with printing or copying.

Once you have changed the paper, the screen for setting the cassette paper information appears. Set the paper information for the paper in the cassette 1 and in cassette 2.

▶▶▶ Note

- If you do not know what paper information to set, press the **Back** button. The previous screen appears, showing the paper size and media type. Check the paper settings and set them as the cassette paper information.
- See below for the correct correspondence between paper settings made on the printer driver or on the touch screen.
 - [Paper Settings on the Printer Driver and the Printer \(Media Type\)](#) (Windows)
 - Paper Settings on the Printer Driver and the Printer (Media Type) (Mac OS)
 - [Paper Settings on the Printer Driver and the Printer \(Paper Size\)](#) (Windows)
 - Paper Settings on the Printer Driver and the Printer (Paper Size) (Mac OS)

Cancel

Cancels printing.

Select this option to change the print or copy paper settings. Change the paper settings and retry the printing.

▶▶▶ Note

- To suppress the misprint prevention message, change the setting as described below. When you suppress the message, the printer uses the paper settings to print or copy on the paper in the cassette 1 and in the cassette 2, even if the paper does not match the settings.
 - To change the message view setting when printing or copying using the operation panel of the printer:
 - [Cassette settings](#)
 - To change the message view setting when printing using the printer driver:
 - [Changing the Printer Operation Mode](#) (Windows)
 - Changing the Printer Operation Mode (Mac OS)

2121

Cause

Cassette 1 paper settings are incomplete.

What to Do

If screen below is shown, the cassette 1 paper settings are incomplete.

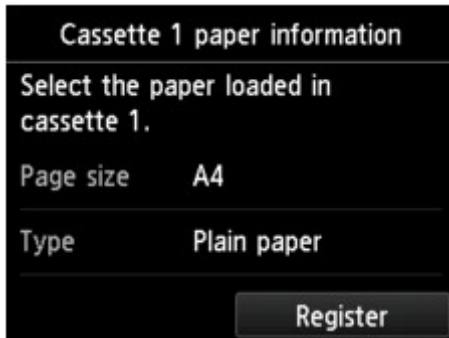

Tap **Register** on the touch screen of the printer to finish setting the cassette 1 paper settings.

2122

Cause

Cassette 2 paper settings are incomplete.

What to Do

If screen below is shown, the cassette 2 paper settings are incomplete.

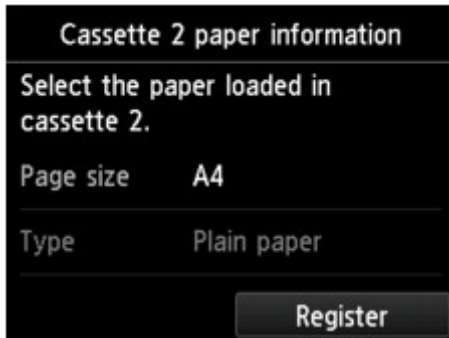

Tap **Register** on the touch screen of the printer to finish setting the cassette 2 paper settings.

2500

Cause

Cause of following may have occurred failure of automatic print head alignment.

- Print head nozzles are clogged.
- Paper of size other than A4 or Letter is loaded in the cassette 1.
- Paper output slot is exposed to strong light.

What to Do

Tap **OK** on the touch screen and take the corresponding actions below.

- Check the print head condition by printing the nozzle check pattern.
- Load one sheet of A4/Letter-sized plain paper in the cassette 1 and perform automatic print head alignment again.

For automatic print head alignment, always load paper in the cassette 1.

- Adjust your operating environment and/or the position of the printer so that the paper output slot is not exposed directly to strong light.

After carrying out the above measures, if the problem continues after aligning the print head again, tap **OK** on the touch screen, and then perform manual print head alignment.

2700

Cause

Possible causes include the following.

- An error occurred during copying and some time elapsed.
- Document is remained in ADF.
- An error occurred during scanning and the document is remained in ADF.

What to Do

Take the corresponding actions below.

- When you copy, tap **OK** on the touch screen and retry copying.
- When the document is remained in the ADF, tap **OK** on the touch screen to feed out the document.
- When you scan, press the **Stop** button to cancel the scanning, and try to scan again.

2802

Cause

No document in ADF.

What to Do

Tap **OK** on the touch screen to resolve the error and operate again after loading documents.

2803

Cause

Document is too long or is jammed in ADF.

What to Do

Tap **OK** on the touch screen. Then make sure the document you are loading meets the printer's requirements before redoing the operation.

If the document is jammed, remove the jammed document following the procedure below.

»» Important

- The printer cannot be turned off while it is sending or receiving a fax, or when the received fax or the unsent fax are stored in the printer's memory.

Turn off the printer after making sure it has completed sending or receiving all the faxes. Do not unplug when turning off the printer.

If you unplug the power cord, all the faxes stored in the printer's memory are deleted.

- **If the original is jammed in the ADF:**

Remove the document following the procedure below.

1. If printing is in progress, press **Stop** button.
2. Turn off printer.
3. If a multi-page document is loaded, remove any pages other than jammed page from ADF and open document feeder cover.

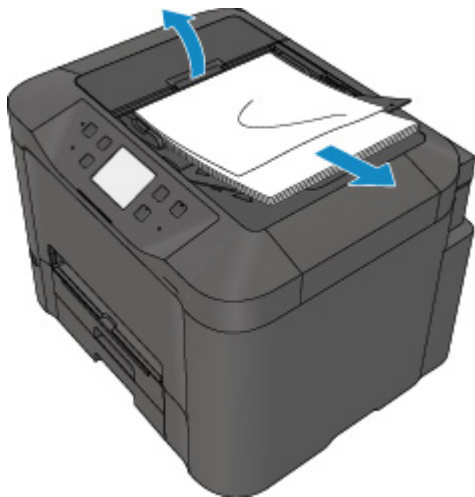

4. Pull out jammed document from ADF.



5. Close document feeder cover and turn on printer.

When rescanning the document after clearing the error, rescan it from the first page.

If you cannot remove the document or the document tears inside the printer, or if the document jam error continues after removing the document, contact your nearest Canon service center to request a repair.

▶▶▶ Note

- The document may not feed properly depending on the media type, or your environment, such as when the temperature and humidity are either too high or too low.

In this case, reduce the number of document pages to approximately half of the loading capacity.

If the document still jams, use the platen glass instead.

• If the original is jammed in the ADF (from the paper feed side):

If the document is jammed in the document output slot, close the document tray as shown in the figure below and pull out the document.

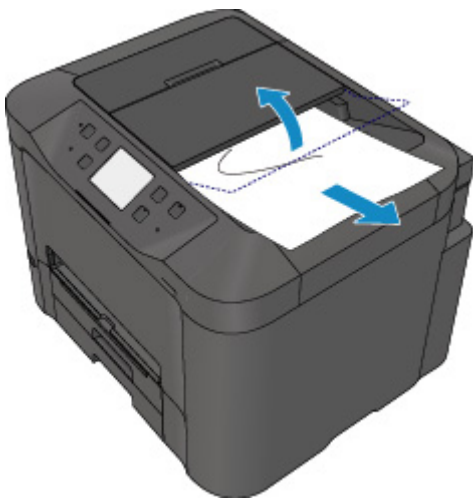

When rescanning the document after clearing the error, rescan it from the first page.

If you cannot remove the document or the document tears inside the printer, or if the document jam error continues after removing the document, contact your nearest Canon service center to request a repair.

2805

Cause

Document cover is open.

What to Do

Close the document cover and tap **OK** on the touch screen of the printer.

3401

Cause

Reserve copy is canceled.

What to Do

Tap **OK** on the touch screen of the printer.

3402

Cause

Printer could not make copies because its memory is full.

What to Do

Tap **OK** on the touch screen of the printer.

Wait for a while and retry copying.

3403

Cause

Printer could not make copies because its memory is full.

What to Do

Tap **OK** on the touch screen of the printer.

Wait for a while and retry copying.

3404

Cause

Document is remained in ADF.

What to Do

Wait for a while. Copying will start.

3405

Cause

Printer could not make copies because its memory is full.

What to Do

Tap **OK** on the touch screen of the printer.

Wait for a while and retry copying.

3406

Cause

Printer could not make copies because its memory is full.

What to Do

Tap **OK** on the touch screen of the printer.

Wait for a while and retry copying.

3407

Cause

Loading next sheet is required.

What to Do

Load the next sheet and tap **OK** on the touch screen of the printer.

3408

Cause

Preview screen is displayed on printer's touch screen.

What to Do

After seeing the preview, tap **OK** on the touch screen of the printer.

3410

Cause

Cannot reserve copying job because printer is scanning a sheet.

What to Do

Wait for a while and reserve copying job.

3411

Cause

You can reserve copying job.

What to Do

If you reserve a copying job, load the original and press the printer's **Color** button for color copying or the printer's **Black** button for black & white copying.

3412

Cause

Scanning original has failed.

What to Do

Tap **OK** on the touch screen of the printer, and then follow the actions below.

- Make sure that the original is placed on the platen glass.
- Make sure that the original is set in the correct position and orientation.

After carrying out the above actions, retry scanning or copying.

If the error is still not resolved, specify the size of the original.

►► Important

- The original that is smaller than 1.2 inches (3 cm) square may not be scanned correctly.

3413

Cause

Prevent paper abrasion has been set.

What to Do

If you continue printing in the current setting, tap **Yes**.

Prevent paper abrasion may reduce the print speed.

If you disable this setting, tap **No**. Touch the **HOME** button, select **Setup, Device settings, and Print settings**, and then set **Prevent paper abrasion** to **OFF**.

3414

Cause

Communication with mail server failed.

What to Do

Tap **OK** on the touch screen of the printer.

Make sure that the address and port number of the outgoing mail server (SMTP server) in mail server settings are correct with Remote UI.

■ [Setting Mail Server](#)

If the error is not resolved, check your mail server condition.

For settings and condition of your mail server, contact the administrator of mail server.

3415

Cause

Communication with mail server failed.

What to Do

Tap **OK** on the touch screen of the printer.

Make sure that the address and port number of the incoming mail server (POP3 server) in mail server settings are correct with Remote UI.

■ [Setting Mail Server](#)

If the error is not resolved, check your mail server condition.

For settings and condition of your mail server, contact the administrator of mail server.

3416

Cause

Communication with mail server failed.

What to Do

Tap **OK** on the touch screen of the printer.

Make sure that the settings for secure connection (SSL) of your mail server and printer are match.

For printer's settings for secure connection (SSL), use Remote UI.

■ [Setting Mail Server](#)

For setting for secure connection (SSL) of your mail server, contact the administrator of mail server.

3417

Cause

Communication with mail server failed.

What to Do

Tap **OK** on the touch screen of the printer.

Make sure that the settings for secure connection (SSL) of your mail server and printer are match.

For printer's settings for secure connection (SSL), use Remote UI.

■ [Setting Mail Server](#)

For setting for secure connection (SSL) of your mail server, contact the administrator of mail server.

3418

Cause

Communication with mail server failed.

What to Do

Tap **OK** on the touch screen of the printer.

Make sure that the settings item for the outgoing mail server (SMTP server) are correct with Remote UI.

■ [Setting Mail Server](#)

If the error is not resolved, check your mail server condition.

For settings and condition of your mail server, contact the administrator of mail server.

3419

Cause

Communication with mail server failed.

What to Do

Tap **OK** on the touch screen of the printer.

Make sure that the outgoing account and outgoing password in mail server settings are correct with Remote UI.

■ [Setting Mail Server](#)

If the error is not resolved, check your mail server condition.

For settings and condition of your mail server, contact the administrator of mail server.

3420

Cause

Communication with mail server failed.

What to Do

Tap **OK** on the touch screen of the printer.

Make sure that the settings item for the incoming mail server (POP3 server) are correct with Remote UI.

■ [Setting Mail Server](#)

If the error is not resolved, check your mail server condition.

For settings and condition of your mail server, contact the administrator of mail server.

3421

Cause

Communication with mail server failed.

What to Do

Tap **OK** on the touch screen of the printer.

Make sure that the incoming account and incoming password in mail server settings are correct with Remote UI.

■ [Setting Mail Server](#)

If the error is not resolved, check your mail server condition.

For settings and condition of your mail server, contact the administrator of mail server.

3422

Cause

Communication with mail server failed.

What to Do

Tap **OK** on the touch screen of the printer.

Make sure that the APOP authentication settings of your mail server and printer are match.

For printer's APOP authentication setting, use Remote UI.

■ [Setting Mail Server](#)

If the error is not resolved, check your mail server condition.

For APOP authentication setting of your mail server, contact the administrator of mail server.

3423

Cause

Communication with mail server failed.

What to Do

Tap **OK** on the touch screen of the printer.

Make sure that the mail server settings are correct with Remote UI.

■ [Setting Mail Server](#)

If the error is not resolved, check your mail server condition.

For settings and condition of your mail server, contact the administrator of mail server.

3424

Cause

Sending mail failed.

What to Do

Tap **OK** on the touch screen of the printer.

Specify the correct destination's mail address, and then retry sending mail.

3425

Cause

Cause of following may have occurred failure of sending mail.

- File size of scanned data is too large.
- Printer's memory is full.

What to Do

Tap **OK** on the touch screen of the printer.

Take the corresponding actions below.

- Lower the resolution and retry to scanning.
- Reduce the documents and retry to scanning.

If the error is not resolved, take the corresponding actions below.

- Check the maximum attachment file size for sending the scanned data.

You can set the maximum attachment file size with Remote UI.

■ [Specifying Mail Setting for Sending Scanned Data](#)

- Check your mail server condition.

3426

Cause

First side printing is complete when manual duplex printing.

What to Do

Prepare to print the other side.

Keeping the printed side facing up, rotate the paper 180 degrees so that the front edge of the printed paper faces away from you and fit the paper back into the cassette 1.

When ready, tap **OK** on the touch screen of the printer.

3427

Cause

First side printing is complete when manual duplex printing.

What to Do

Prepare to print the other side.

Keeping the printed side facing up, fit the paper back into the cassette 1 without changing its orientation.

When ready, tap **OK** on the touch screen of the printer.

3428

Cause

First side printing is complete when manual duplex printing.

What to Do

Prepare to print the other side.

Keeping the printed side facing up, fit the paper back into the cassette 1 without changing its orientation.

When ready, tap **OK** on the touch screen of the printer.

3429

Cause

First side printing is complete when manual duplex printing.

What to Do

Prepare to print the other side.

Keeping the printed side facing up, rotate the paper 180 degrees so that the front edge of the printed paper faces away from you and fit the paper back into the cassette 1.

When ready, tap **OK** on the touch screen of the printer.

3430

Cause

First side printing is complete when manual duplex printing.

What to Do

Prepare to print the other side.

Keeping the printed side facing up, rotate the paper 180 degrees so that the front edge of the printed paper faces away from you and fit the paper back into the cassette 2.

When ready, tap **OK** on the touch screen of the printer.

3431

Cause

First side printing is complete when manual duplex printing.

What to Do

Prepare to print the other side.

Keeping the printed side facing up, fit the paper back into the cassette 2 without changing its orientation.

When ready, tap **OK** on the touch screen of the printer.

3432

Cause

First side printing is complete when manual duplex printing.

What to Do

Prepare to print the other side.

Keeping the printed side facing up, fit the paper back into the cassette 2 without changing its orientation.

When ready, tap **OK** on the touch screen of the printer.

3433

Cause

First side printing is complete when manual duplex printing.

What to Do

Prepare to print the other side.

Keeping the printed side facing up, rotate the paper 180 degrees so that the front edge of the printed paper faces away from you and fit the paper back into the cassette 2.

When ready, tap **OK** on the touch screen of the printer.

4100

Cause

Specified data cannot be printed.

What to Do

If you are printing CREATIVE PARK PREMIUM contents, check the message shown your computer, make sure genuine Canon ink tanks are installed properly for all colors, and retry the printing.

4103

Cause

Cannot perform printing with current print settings.

What to Do

Press the printer's **Stop** button to cancel printing.

Then change the print settings and retry printing.

4104

Cause

Paper size or media type that cannot be fed from cassette 2 is specified.

What to Do

Press the printer's **Stop** button to cancel printing.

Specify the paper size setting to A4, Letter, or Legal and specify the media type setting to Plain Paper. Then print again.

▶▶ Note

- If you will not change the paper size setting or the media type setting, select the cassette 1 as the paper source. If this is the case, register the cassette 1 paper information properly.

5011

Cause

Printer error has occurred.

What to Do

Turn off the printer and unplug it.

Plug in the printer again and turn it back on.

If this does not solve the problem, contact your nearest Canon service center to request a repair.

Important

- If you unplug, all the faxes stored in the printer's memory are deleted.

5012

Cause

Printer error has occurred.

What to Do

Turn off the printer and unplug it.

Plug in the printer again and turn it back on.

If this does not solve the problem, contact your nearest Canon service center to request a repair.

»» Important

- If you unplug, all the faxes stored in the printer's memory are deleted.

5040

Cause

Printer error has occurred.

What to Do

Turn off the printer and unplug it.

Plug in the printer again and turn it back on.

If this does not solve the problem, contact your nearest Canon service center to request a repair.

Important

- If you unplug, all the faxes stored in the printer's memory are deleted.

5050

Cause

Printer error has occurred.

What to Do

Turn off the printer and unplug it.

Plug in the printer again and turn it back on.

If this does not solve the problem, contact your nearest Canon service center to request a repair.

▶▶ Important

- If you unplug, all the faxes stored in the printer's memory are deleted.

5051

Cause

Printer error has occurred.

What to Do

Turn off the printer and unplug it.

Plug in the printer again and turn it back on.

If this does not solve the problem, contact your nearest Canon service center to request a repair.

Important

- If you unplug, all the faxes stored in the printer's memory are deleted.

5100

Cause

Printer error has occurred.

What to Do

Cancel printing and turn off the printer.

Check the following:

- Make sure print head holder motion is not impeded by stabilizer, jammed paper, etc.

Remove any impediment.

- Make sure the ink tanks are properly installed.

Press ink tanks until they click into place.

Turn the printer back on.

If this does not solve the problem, contact your nearest Canon service center to request a repair.

▶▶ Important

- When clearing an impediment to print head holder motion, be careful not to touch clear film (A) or white belt (B).

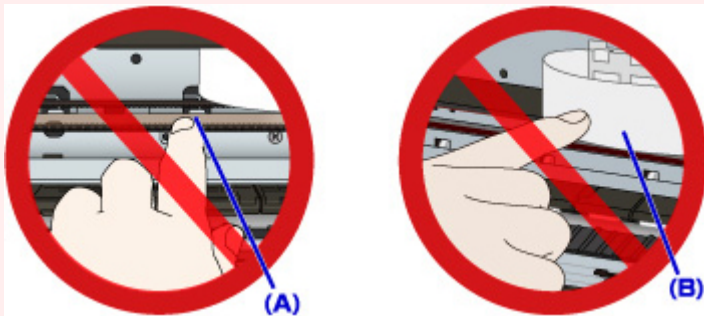

If you soil or scratch these parts by touching them with paper or your hand, it could damage the printer.

- If you unplug, all the faxes stored in the printer's memory are deleted.

5102

Cause

Printer error has occurred.

What to Do

Cancel printing and turn off the printer.

Check the following:

- Make sure print head holder motion is not impeded by stabilizer, jammed paper, etc.

Remove any impediment.

- Make sure the ink tanks are properly installed.

Press ink tanks until they click into place.

Turn the printer back on.

If this does not solve the problem, contact your nearest Canon service center to request a repair.

▶▶ Important

- When clearing an impediment to print head holder motion, be careful not to touch clear film (A) or white belt (B).

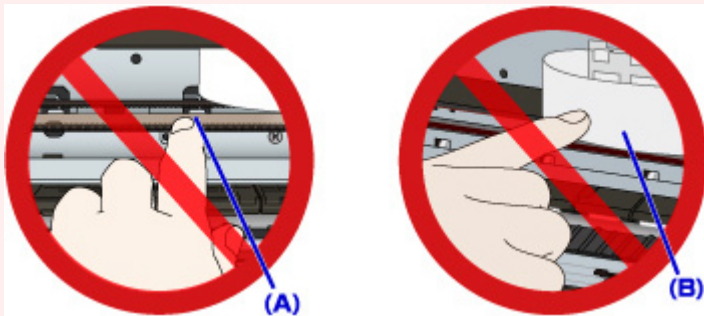

If you soil or scratch these parts by touching them with paper or your hand, it could damage the printer.

- If you unplug, all the faxes stored in the printer's memory are deleted.

5103

Cause

Printer error has occurred.

What to Do

Cancel printing and turn off the printer.

Check the following:

- Make sure print head holder motion is not impeded by stabilizer, jammed paper, etc.

Remove any impediment.

- Make sure the ink tanks are properly installed.

Press ink tanks until they click into place.

Turn the printer back on.

If this does not solve the problem, contact your nearest Canon service center to request a repair.

▶▶ Important

- When clearing an impediment to print head holder motion, be careful not to touch clear film (A) or white belt (B).

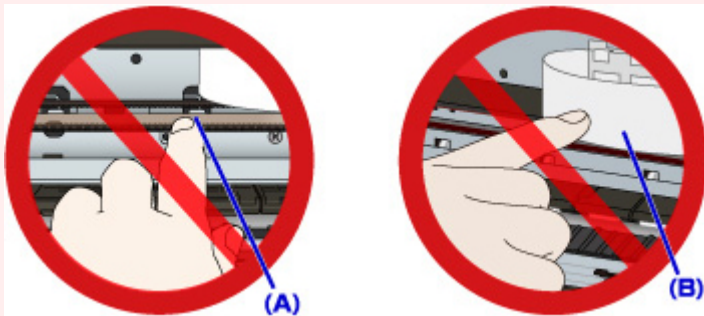

If you soil or scratch these parts by touching them with paper or your hand, it could damage the printer.

- If you unplug, all the faxes stored in the printer's memory are deleted.

5104

Cause

Printer error has occurred.

What to Do

Cancel printing and turn off the printer.

Check the following:

- Make sure print head holder motion is not impeded by stabilizer, jammed paper, etc.

Remove any impediment.

- Make sure the ink tanks are properly installed.

Press ink tanks until they click into place.

Turn the printer back on.

If this does not solve the problem, contact your nearest Canon service center to request a repair.

▶▶ Important

- When clearing an impediment to print head holder motion, be careful not to touch clear film (A) or white belt (B).

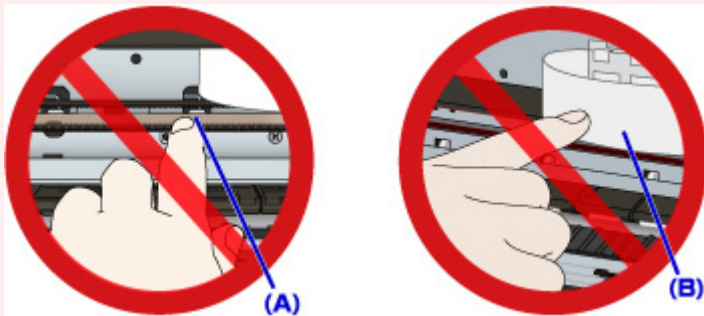

If you soil or scratch these parts by touching them with paper or your hand, it could damage the printer.

- If you unplug, all the faxes stored in the printer's memory are deleted.

5105

Cause

Printer error has occurred.

What to Do

Cancel printing and turn off the printer.

Check the following:

- Make sure print head holder motion is not impeded by stabilizer, jammed paper, etc.

Remove any impediment.

- Make sure the ink tanks are properly installed.

Press ink tanks until they click into place.

Turn the printer back on.

If this does not solve the problem, contact your nearest Canon service center to request a repair.

▶▶ Important

- When clearing an impediment to print head holder motion, be careful not to touch clear film (A) or white belt (B).

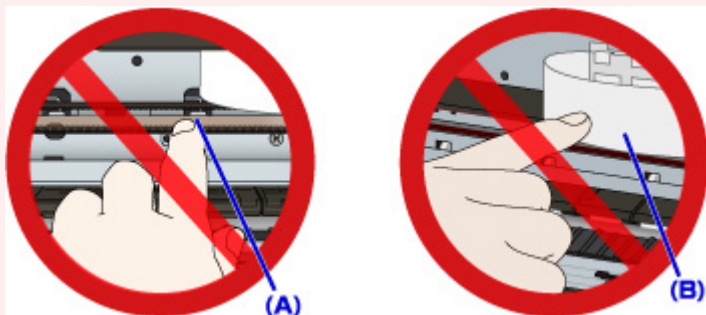

If you soil or scratch these parts by touching them with paper or your hand, it could damage the printer.

- If you unplug, all the faxes stored in the printer's memory are deleted.

5200

Cause

Printer error has occurred.

What to Do

Turn off the printer and unplug it.

Plug in the printer again and turn it back on.

If this does not solve the problem, contact your nearest Canon service center to request a repair.

▶▶ Important

- If you unplug, all the faxes stored in the printer's memory are deleted.

5203

Cause

Printer error has occurred.

What to Do

Turn off the printer and unplug it.

Plug in the printer again and turn it back on.

If this does not solve the problem, contact your nearest Canon service center to request a repair.

▶▶ Important

- If you unplug, all the faxes stored in the printer's memory are deleted.

5204

Cause

Printer error has occurred.

What to Do

Turn off the printer and unplug it.

Plug in the printer again and turn it back on.

If this does not solve the problem, contact your nearest Canon service center to request a repair.

Important

- If you unplug, all the faxes stored in the printer's memory are deleted.

5205

Cause

Printer error has occurred.

What to Do

Turn off the printer and unplug it.

Plug in the printer again and turn it back on.

If this does not solve the problem, contact your nearest Canon service center to request a repair.

»» Important

- If you unplug, all the faxes stored in the printer's memory are deleted.

5206

Cause

Printer error has occurred.

What to Do

Turn off the printer and unplug it.

Plug in the printer again and turn it back on.

If this does not solve the problem, contact your nearest Canon service center to request a repair.

Important

- If you unplug, all the faxes stored in the printer's memory are deleted.

5207

Cause

Printer error has occurred.

What to Do

Turn off the printer and unplug it.

Plug in the printer again and turn it back on.

If this does not solve the problem, contact your nearest Canon service center to request a repair.

»» Important

- If you unplug, all the faxes stored in the printer's memory are deleted.

5208

Cause

Printer error has occurred.

What to Do

Turn off the printer and unplug it.

Plug in the printer again and turn it back on.

If this does not solve the problem, contact your nearest Canon service center to request a repair.

▶▶ Important

- If you unplug, all the faxes stored in the printer's memory are deleted.

5209

Cause

Printer error has occurred.

What to Do

Turn off the printer and unplug it.

Plug in the printer again and turn it back on.

If this does not solve the problem, contact your nearest Canon service center to request a repair.

»» Important

- If you unplug, all the faxes stored in the printer's memory are deleted.

5400

Cause

Printer error has occurred.

What to Do

Turn off the printer and unplug it.

Plug in the printer again and turn it back on.

If this does not solve the problem, contact your nearest Canon service center to request a repair.

»» Important

- If you unplug, all the faxes stored in the printer's memory are deleted.

5500

Cause

Ink tank has not been properly recognized.

What to Do

Contact the service center.

5501

Cause

Ink tank has not been properly recognized.

What to Do

Contact the service center.

5B00

Cause

Printer error has occurred.

What to Do

Contact your nearest Canon service center to request a repair.

5B01

Cause

Printer error has occurred.

What to Do

Contact your nearest Canon service center to request a repair.

5C01

Cause

Printer error has occurred.

What to Do

Turn off the printer and unplug it.

Plug in the printer again and turn it back on.

If this does not solve the problem, contact your nearest Canon service center to request a repair.

»» Important

- If you unplug, all the faxes stored in the printer's memory are deleted.

6000

Cause

Printer error has occurred.

What to Do

Turn off the printer and unplug it.

Plug in the printer again and turn it back on.

If this does not solve the problem, contact your nearest Canon service center to request a repair.

»» Important

- If you unplug, all the faxes stored in the printer's memory are deleted.

6500

Cause

Printer error has occurred.

What to Do

Turn off the printer and unplug it.

Plug in the printer again and turn it back on.

If this does not solve the problem, contact your nearest Canon service center to request a repair.

▶▶ Important

- If you unplug, all the faxes stored in the printer's memory are deleted.

6502

Cause

Printer error has occurred.

What to Do

Turn off the printer and unplug it.

Plug in the printer again and turn it back on.

If this does not solve the problem, contact your nearest Canon service center to request a repair.

▶▶ Important

- If you unplug, all the faxes stored in the printer's memory are deleted.

6700

Cause

Printer error has occurred.

What to Do

Turn off the printer and unplug it.

Plug in the printer again and turn it back on.

If this does not solve the problem, contact your nearest Canon service center to request a repair.

»» Important

- If you unplug, all the faxes stored in the printer's memory are deleted.

6701

Cause

Printer error has occurred.

What to Do

Turn off the printer and unplug it.

Plug in the printer again and turn it back on.

If this does not solve the problem, contact your nearest Canon service center to request a repair.

Important

- If you unplug, all the faxes stored in the printer's memory are deleted.

6800

Cause

Printer error has occurred.

What to Do

Turn off the printer and unplug it.

Plug in the printer again and turn it back on.

If this does not solve the problem, contact your nearest Canon service center to request a repair.

Important

- If you unplug, all the faxes stored in the printer's memory are deleted.

6801

Cause

Printer error has occurred.

What to Do

Turn off the printer and unplug it.

Plug in the printer again and turn it back on.

If this does not solve the problem, contact your nearest Canon service center to request a repair.

Important

- If you unplug, all the faxes stored in the printer's memory are deleted.

6900

Cause

Printer error has occurred.

What to Do

Turn off the printer and unplug it.

Plug in the printer again and turn it back on.

If this does not solve the problem, contact your nearest Canon service center to request a repair.

▶▶ Important

- If you unplug, all the faxes stored in the printer's memory are deleted.

6901

Cause

Printer error has occurred.

What to Do

Turn off the printer and unplug it.

Plug in the printer again and turn it back on.

If this does not solve the problem, contact your nearest Canon service center to request a repair.

Important

- If you unplug, all the faxes stored in the printer's memory are deleted.

6902

Cause

Printer error has occurred.

What to Do

Turn off the printer and unplug it.

Plug in the printer again and turn it back on.

If this does not solve the problem, contact your nearest Canon service center to request a repair.

»» Important

- If you unplug, all the faxes stored in the printer's memory are deleted.

6910

Cause

Printer error has occurred.

What to Do

Turn off the printer and unplug it.

Plug in the printer again and turn it back on.

If this does not solve the problem, contact your nearest Canon service center to request a repair.

»» Important

- If you unplug, all the faxes stored in the printer's memory are deleted.

6911

Cause

Printer error has occurred.

What to Do

Turn off the printer and unplug it.

Plug in the printer again and turn it back on.

If this does not solve the problem, contact your nearest Canon service center to request a repair.

Important

- If you unplug, all the faxes stored in the printer's memory are deleted.

6920

Cause

Printer error has occurred.

What to Do

Turn off the printer and unplug it.

Plug in the printer again and turn it back on.

If this does not solve the problem, contact your nearest Canon service center to request a repair.

Important

- If you unplug, all the faxes stored in the printer's memory are deleted.

6921

Cause

Printer error has occurred.

What to Do

Turn off the printer and unplug it.

Plug in the printer again and turn it back on.

If this does not solve the problem, contact your nearest Canon service center to request a repair.

Important

- If you unplug, all the faxes stored in the printer's memory are deleted.

6930

Cause

Printer error has occurred.

What to Do

Turn off the printer and unplug it.

Plug in the printer again and turn it back on.

If this does not solve the problem, contact your nearest Canon service center to request a repair.

▶▶ Important

- If you unplug, all the faxes stored in the printer's memory are deleted.

6931

Cause

Printer error has occurred.

What to Do

Turn off the printer and unplug it.

Plug in the printer again and turn it back on.

If this does not solve the problem, contact your nearest Canon service center to request a repair.

»» Important

- If you unplug, all the faxes stored in the printer's memory are deleted.

6932

Cause

Printer error has occurred.

What to Do

Turn off the printer and unplug it.

Plug in the printer again and turn it back on.

If this does not solve the problem, contact your nearest Canon service center to request a repair.

»» Important

- If you unplug, all the faxes stored in the printer's memory are deleted.

6933

Cause

Printer error has occurred.

What to Do

Turn off the printer and unplug it.

Plug in the printer again and turn it back on.

If this does not solve the problem, contact your nearest Canon service center to request a repair.

Important

- If you unplug, all the faxes stored in the printer's memory are deleted.

6936

Cause

Printer error has occurred.

What to Do

Turn off the printer and unplug it.

Plug in the printer again and turn it back on.

If this does not solve the problem, contact your nearest Canon service center to request a repair.

Important

- If you unplug, all the faxes stored in the printer's memory are deleted.

6937

Cause

Printer error has occurred.

What to Do

Turn off the printer and unplug it.

Plug in the printer again and turn it back on.

If this does not solve the problem, contact your nearest Canon service center to request a repair.

▶▶ Important

- If you unplug, all the faxes stored in the printer's memory are deleted.

6938

Cause

Printer error has occurred.

What to Do

Turn off the printer and unplug it.

Plug in the printer again and turn it back on.

If this does not solve the problem, contact your nearest Canon service center to request a repair.

Important

- If you unplug, all the faxes stored in the printer's memory are deleted.

6939

Cause

Printer error has occurred.

What to Do

Turn off the printer and unplug it.

Plug in the printer again and turn it back on.

If this does not solve the problem, contact your nearest Canon service center to request a repair.

Important

- If you unplug, all the faxes stored in the printer's memory are deleted.

693A

Cause

Printer error has occurred.

What to Do

Turn off the printer and unplug it.

Plug in the printer again and turn it back on.

If this does not solve the problem, contact your nearest Canon service center to request a repair.

▶▶ Important

- If you unplug, all the faxes stored in the printer's memory are deleted.

6940

Cause

Printer error has occurred.

What to Do

Turn off the printer and unplug it.

Plug in the printer again and turn it back on.

If this does not solve the problem, contact your nearest Canon service center to request a repair.

Important

- If you unplug, all the faxes stored in the printer's memory are deleted.

6941

Cause

Printer error has occurred.

What to Do

Turn off the printer and unplug it.

Plug in the printer again and turn it back on.

If this does not solve the problem, contact your nearest Canon service center to request a repair.

»» Important

- If you unplug, all the faxes stored in the printer's memory are deleted.

6942

Cause

Printer error has occurred.

What to Do

Turn off the printer and unplug it.

Plug in the printer again and turn it back on.

If this does not solve the problem, contact your nearest Canon service center to request a repair.

▶▶ Important

- If you unplug, all the faxes stored in the printer's memory are deleted.

6943

Cause

Printer error has occurred.

What to Do

Turn off the printer and unplug it.

Plug in the printer again and turn it back on.

If this does not solve the problem, contact your nearest Canon service center to request a repair.

▶▶ Important

- If you unplug, all the faxes stored in the printer's memory are deleted.

6944

Cause

Printer error has occurred.

What to Do

Turn off the printer and unplug it.

Plug in the printer again and turn it back on.

If this does not solve the problem, contact your nearest Canon service center to request a repair.

»» Important

- If you unplug, all the faxes stored in the printer's memory are deleted.

6945

Cause

Printer error has occurred.

What to Do

Turn off the printer and unplug it.

Plug in the printer again and turn it back on.

If this does not solve the problem, contact your nearest Canon service center to request a repair.

Important

- If you unplug, all the faxes stored in the printer's memory are deleted.

6946

Cause

Printer error has occurred.

What to Do

Turn off the printer and unplug it.

Plug in the printer again and turn it back on.

If this does not solve the problem, contact your nearest Canon service center to request a repair.

▶▶ Important

- If you unplug, all the faxes stored in the printer's memory are deleted.

7100

Cause

Printer error has occurred.

What to Do

Turn off the printer and unplug it.

Plug in the printer again and turn it back on.

If this does not solve the problem, contact your nearest Canon service center to request a repair.

»» Important

- If you unplug, all the faxes stored in the printer's memory are deleted.

7200

Cause

Printer error has occurred.

What to Do

Turn off the printer and unplug it.

Plug in the printer again and turn it back on.

If this does not solve the problem, contact your nearest Canon service center to request a repair.

»» Important

- If you unplug, all the faxes stored in the printer's memory are deleted.

7201

Cause

Printer error has occurred.

What to Do

Turn off the printer and unplug it.

Plug in the printer again and turn it back on.

If this does not solve the problem, contact your nearest Canon service center to request a repair.

Important

- If you unplug, all the faxes stored in the printer's memory are deleted.

7202

Cause

Printer error has occurred.

What to Do

Turn off the printer and unplug it.

Plug in the printer again and turn it back on.

If this does not solve the problem, contact your nearest Canon service center to request a repair.

Important

- If you unplug, all the faxes stored in the printer's memory are deleted.

7203

Cause

Printer error has occurred.

What to Do

Turn off the printer and unplug it.

Plug in the printer again and turn it back on.

If this does not solve the problem, contact your nearest Canon service center to request a repair.

»» Important

- If you unplug, all the faxes stored in the printer's memory are deleted.

7204

Cause

Printer error has occurred.

What to Do

Turn off the printer and unplug it.

Plug in the printer again and turn it back on.

If this does not solve the problem, contact your nearest Canon service center to request a repair.

»» Important

- If you unplug, all the faxes stored in the printer's memory are deleted.

7205

Cause

Printer error has occurred.

What to Do

Turn off the printer and unplug it.

Plug in the printer again and turn it back on.

If this does not solve the problem, contact your nearest Canon service center to request a repair.

»» Important

- If you unplug, all the faxes stored in the printer's memory are deleted.

9000

Cause

Printer error has occurred.

What to Do

Turn off the printer and unplug it.

Plug in the printer again and turn it back on.

If this does not solve the problem, contact your nearest Canon service center to request a repair.

»» Important

- If you unplug, all the faxes stored in the printer's memory are deleted.

9500

Cause

Printer error has occurred.

What to Do

Turn off the printer and unplug it.

Plug in the printer again and turn it back on.

If this does not solve the problem, contact your nearest Canon service center to request a repair.

»» Important

- If you unplug, all the faxes stored in the printer's memory are deleted.

B202

Cause

An error requiring a repair has occurred.

What to Do

Turn off the printer and unplug it.

Contact your nearest Canon service center to request a repair.

Important

- If you unplug, all the faxes stored in the printer's memory are deleted.

B203

Cause

An error requiring a repair has occurred.

What to Do

Turn off the printer and unplug it.

Contact your nearest Canon service center to request a repair.

Important

- If you unplug, all the faxes stored in the printer's memory are deleted.

B204

Cause

An error requiring a repair has occurred.

What to Do

Turn off the printer and unplug it.

Contact your nearest Canon service center to request a repair.

Important

- If you unplug, all the faxes stored in the printer's memory are deleted.

B205

Cause

An error requiring a repair has occurred.

What to Do

Turn off the printer and unplug it.

Contact your nearest Canon service center to request a repair.

Important

- If you unplug, all the faxes stored in the printer's memory are deleted.

B502

Cause

Printer error has occurred.

What to Do

Turn off the printer and unplug it.

Plug in the printer again and turn it back on.

If this does not solve the problem, contact your nearest Canon service center to request a repair.

Important

- If you unplug, all the faxes stored in the printer's memory are deleted.

B503

Cause

Printer error has occurred.

What to Do

Turn off the printer and unplug it.

Plug in the printer again and turn it back on.

If this does not solve the problem, contact your nearest Canon service center to request a repair.

▶▶ Important

- If you unplug, all the faxes stored in the printer's memory are deleted.

B504

Cause

Printer error has occurred.

What to Do

Turn off the printer and unplug it.

Plug in the printer again and turn it back on.

If this does not solve the problem, contact your nearest Canon service center to request a repair.

Important

- If you unplug, all the faxes stored in the printer's memory are deleted.

C000

Cause

Printer error has occurred.

What to Do

Cancel printing and turn off the printer.

Check the following:

- Make sure print head holder motion is not impeded by stabilizer, jammed paper, etc.

Remove any impediment.

- Make sure the ink tanks are properly installed.

Press ink tanks until they click into place.

Turn the printer back on.

If this does not solve the problem, contact your nearest Canon service center to request a repair.

▶▶ Important

- When clearing an impediment to print head holder motion, be careful not to touch clear film (A) or white belt (B).

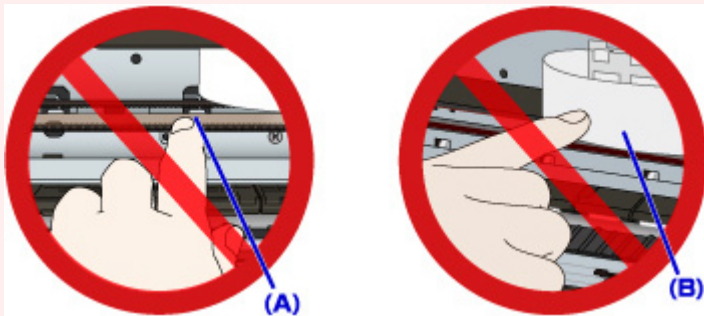

If you soil or scratch these parts by touching them with paper or your hand, it could damage the printer.

- If you unplug, all the faxes stored in the printer's memory are deleted.