

Veritas NetBackup™ 5330 Appliance Hardware Installation Guide

Release 2.7.2

VERITAS™

Documentation version: 2.7.2

Legal Notice

Copyright © 2016 Veritas Technologies LLC. All rights reserved.

Veritas and the Veritas Logo are trademarks or registered trademarks of Veritas Technologies LLC or its affiliates in the U.S. and other countries. Other names may be trademarks of their respective owners.

This product may contain third party software for which Veritas is required to provide attribution to the third party ("Third Party Programs"). Some of the Third Party Programs are available under open source or free software licenses. The License Agreement accompanying the Software does not alter any rights or obligations you may have under those open source or free software licenses. Please see the Third Party Legal Notice Appendix to this Documentation or TPIP ReadMe File accompanying this product for more information on the Third Party Programs.

The product described in this document is distributed under licenses restricting its use, copying, distribution, and decompilation/reverse engineering. No part of this document may be reproduced in any form by any means without prior written authorization of Veritas Technologies LLC and its licensors, if any.

THE DOCUMENTATION IS PROVIDED "AS IS" AND ALL EXPRESS OR IMPLIED CONDITIONS, REPRESENTATIONS AND WARRANTIES, INCLUDING ANY IMPLIED WARRANTY OF MERCHANTABILITY, FITNESS FOR A PARTICULAR PURPOSE OR NON-INFRINGEMENT, ARE DISCLAIMED, EXCEPT TO THE EXTENT THAT SUCH DISCLAIMERS ARE HELD TO BE LEGALLY INVALID. VERITAS TECHNOLOGIES LLC SHALL NOT BE LIABLE FOR INCIDENTAL OR CONSEQUENTIAL DAMAGES IN CONNECTION WITH THE FURNISHING, PERFORMANCE, OR USE OF THIS DOCUMENTATION. THE INFORMATION CONTAINED IN THIS DOCUMENTATION IS SUBJECT TO CHANGE WITHOUT NOTICE.

The Licensed Software and Documentation are deemed to be commercial computer software as defined in FAR 12.212 and subject to restricted rights as defined in FAR Section 52.227-19 "Commercial Computer Software - Restricted Rights" and DFARS 227.7202, et seq. "Commercial Computer Software and Commercial Computer Software Documentation," as applicable, and any successor regulations, whether delivered by Veritas as on premises or hosted services. Any use, modification, reproduction release, performance, display or disclosure of the Licensed Software and Documentation by the U.S. Government shall be solely in accordance with the terms of this Agreement.

Veritas Technologies LLC
500 E Middlefield Road
Mountain View, CA 94043
<http://www.veritas.com>

Technical Support

Technical Support maintains support centers globally. Technical Support's primary role is to respond to specific queries about product features and functionality. The Technical Support group also creates content for our online Knowledge Base. The Technical Support group works collaboratively with the other functional areas within the company to answer your questions in a timely fashion.

Our support offerings include the following:

- A range of support options that give you the flexibility to select the right amount of service for any size organization
- Telephone and/or Web-based support that provides rapid response and up-to-the-minute information
- Upgrade assurance that delivers software upgrades
- Global support purchased on a regional business hours or 24 hours a day, 7 days a week basis
- Premium service offerings that include Account Management Services

For information about our support offerings, you can visit our website at the following URL:

www.veritas.com/support

All support services will be delivered in accordance with your support agreement and the then-current enterprise technical support policy.

Contacting Technical Support

Customers with a current support agreement may access Technical Support information at the following URL:

www.veritas.com/support

Before contacting Technical Support, make sure you have satisfied the system requirements that are listed in your product documentation. Also, you should be at the computer on which the problem occurred, in case it is necessary to replicate the problem.

When you contact Technical Support, please have the following information available:

- Product release level
- Hardware information
- Available memory, disk space, and NIC information

- Operating system
- Version and patch level
- Network topology
- Router, gateway, and IP address information
- Problem description:
 - Error messages and log files
 - Troubleshooting that was performed before contacting Technical Support
 - Recent software configuration changes and network changes

Licensing and registration

If your product requires registration or a license key, access our technical support Web page at the following URL:

www.veritas.com/support

Customer service

Customer service information is available at the following URL:

www.veritas.com/support

Customer Service is available to assist with non-technical questions, such as the following types of issues:

- Questions regarding product licensing or serialization
- Product registration updates, such as address or name changes
- General product information (features, language availability, local dealers)
- Latest information about product updates and upgrades
- Information about upgrade assurance and support contracts
- Advice about technical support options
- Nontechnical presales questions
- Issues that are related to CD-ROMs, DVDs, or manuals

Support agreement resources

If you want to contact us regarding an existing support agreement, please contact the support agreement administration team for your region as follows:

Worldwide (except Japan)

CustomerCare@veritas.com

Japan

CustomerCare_Japan@veritas.com

Contents

Technical Support	4	
Chapter 1	Hardware overview	9
	NetBackup 5330 compute node overview	9
	NetBackup 5330 compute node PCIe card configurations	10
	NetBackup 5330 compute node Ethernet port configurations	11
	NetBackup 5330 storage shelves and disk drives	13
	NetBackup 5330 cables and connectors	15
	Required reading	16
	Understanding hardware scenarios	16
	Understanding the NetBackup 5330 hardware installation sequence	17
	About IPMI configuration	19
	Product documentation	21
Chapter 2	Hardware pre-installation requirements	23
	Package contents for NetBackup 5330 hardware	23
	Customer-provided items for a NetBackup 5330 hardware installation	24
	Unpacking a Primary Shelf or an Expansion Shelf	25
	Unpacking a NetBackup 5330 compute node	27
	Determining rack locations for NetBackup 5330 hardware	29
	Determining SAS cable length	30
	Prerequisites for IPMI configuration	31
Chapter 3	Hardware installation procedures	33
	Installing a Primary Shelf or an Expansion Shelf	34
	Installing disk drives into a Primary Shelf or an Expansion Shelf	41
	Installing the NetBackup 5330 compute node	44
	Installing the SFPs into the Fibre Channel (FC) ports	47
	Removing SFP end caps	48
	Connecting a NetBackup 5330 compute node to a Primary Shelf	49
	Connecting one Expansion Shelf to a Primary Shelf	51

Performing a soft shutdown before adding a new Expansion Shelf	54
Connecting a second Expansion Shelf to an existing 3TB Expansion Shelf and a 3TB Primary Shelf	55
Connecting the power cords to the hardware	66
Turning on the hardware and verifying operation	68
Configuring the IPMI from the NetBackup Appliance Shell Menu	76
Accessing and using the Remote Management interface	78
Appendix A Adding the disk space of a new Expansion Storage Shelf	81
Prerequisites for adding the disk space of new Expansion shelves	81
Adding the disk space of an Expansion Storage Shelf from the NetBackup Appliance Web Console	85
Adding the disk space of an Expansion Storage Shelf from the NetBackup Appliance Shell Menu	87
Index	89

Hardware overview

This chapter includes the following topics:

- NetBackup 5330 compute node overview
- NetBackup 5330 compute node PCIe card configurations
- NetBackup 5330 compute node Ethernet port configurations
- NetBackup 5330 storage shelves and disk drives
- NetBackup 5330 cables and connectors
- Required reading
- Understanding hardware scenarios
- Understanding the NetBackup 5330 hardware installation sequence
- About IPMI configuration
- Product documentation

NetBackup 5330 compute node overview

The front panel of the compute node contains 12 disk drive slots. The slots are numbered from zero (lower left slot) to 11 (upper right slot).



The NetBackup 5330 compute node contains 8 disk drives. Slots 0 through 5 contain mirrored volumes for the operating system and system logs, and two hot-spares.

NetBackup 5330 compute node PCIe card configurations

Slots 6 and 7 are currently unconfigured and reserved for future use. Slots 8 through 11 contain blank carriers to maintain airflow.

The rear panel of the compute node contains embedded ports and PCIe card slots.

The embedded ports include the following (with numbers associating the ports to the items in the bulleted list):

- Four 1Gb Ethernet ports (Item 1)
- One Video Graphics Array (VGA) port (Item 2)
- One serial port (for Veritas Technical Support use only) (Item 3)
- Three USB ports (Item 4)
- One Intelligent Platform Management Interface (IPMI) port for remote management (Item 5)
- Two 10Gb Ethernet ports (Item 6)

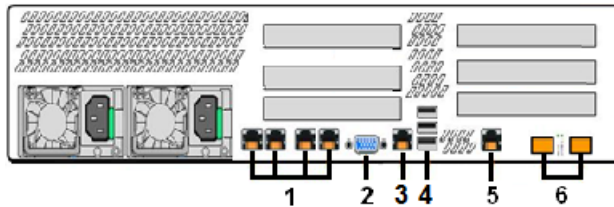

Two power supply modules are installed in the lower left corner of the rear panel. One of the power supplies must be operational at all times. Turn off the device if both power supplies are not working properly.

Input power for the compute node can be 120VAC or 220VAC.

NetBackup 5330 compute node PCIe card configurations

The rear panel of the compute node contains six PCIe slots that are numbered 1 to 6. Slots 1, 2, and 3 are located in PCIe Riser Assembly 2. Slots 4, 5, and 6 are located in PCIe Riser Assembly 1.

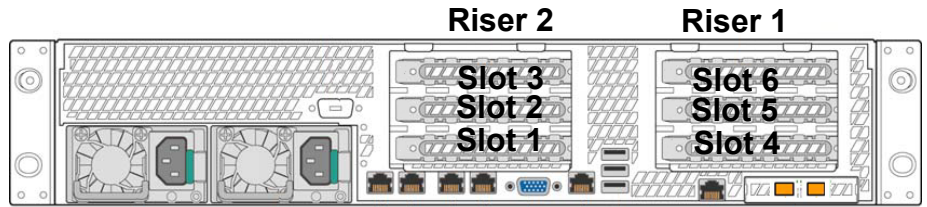

All PCIe slots are factory-populated. Each slot contains either a Fibre Channel (FC) host bus adapter (HBA) card or an Ethernet network interface card (NIC). Slots 1 and 4 are reserved exclusively for attachment to the Primary Storage Shelf.

The PCIe card configurations for the NetBackup 5330 compute node are shown in the table.

Table 1-1 Available PCIe slot configurations for the NetBackup 5330 compute node

Option	Slot 1	Slot 2	Slot 3	Slot 4	Slot 5	Slot 6
A	8 Gb FC HBA	10 GbE NIC	10 GbE NIC	8 Gb FC HBA	10 GbE NIC	10 GbE NIC
B	8 Gb FC HBA	10 GbE NIC	10 GbE NIC	8 Gb FC HBA	10 GbE NIC	8 Gb FC HBA
C	8 Gb FC HBA	10 GbE NIC	10 GbE NIC	8 Gb FC HBA	8 Gb FC HBA	8 Gb FC HBA
D	8 Gb FC HBA	8 Gb FC HBA	10 GbE NIC	8 Gb FC HBA	8 Gb FC HBA	8 Gb FC HBA
E	8 Gb FC HBA	8 Gb FC HBA	8 Gb FC HBA	8 Gb FC HBA	8 Gb FC HBA	8 Gb FC HBA

NetBackup 5330 compute node Ethernet port configurations

The rear panel of the NetBackup 5330 compute node contains six PCIe slots, which are populated according to five different supported configurations. The PCIe slot configuration determines the number of Ethernet ports that are available.

Note the locations of each Ethernet port that is located on the rear panel of the compute node.

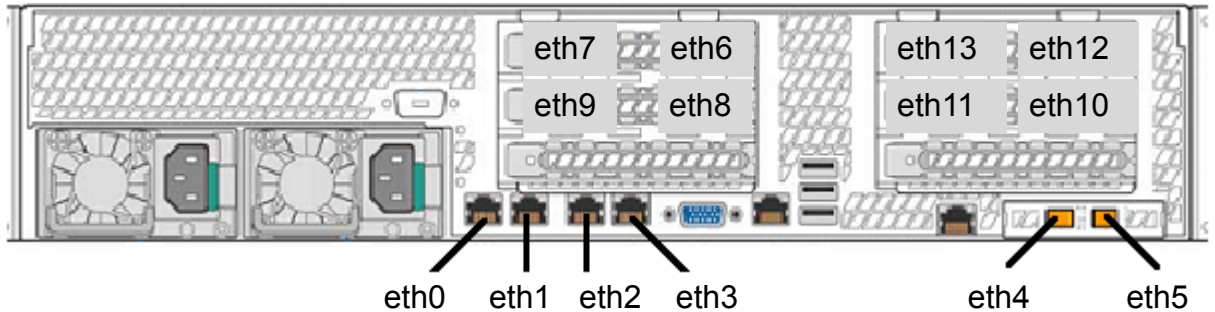
NetBackup 5330 compute node Ethernet port configurations

All NetBackup 5330 Appliances include the following ports, which are built in along the base of the rear panel:

- 1-GbE ports: eth0, eth1, eth2, and eth3
- 10-GbE ports: eth4 and eth5

The 10-Gb Ethernet network interface cards that are installed in the PCIe slots contain additional ports. The number of ports depends on the PCIe slot configuration of your compute node.

Table 1-2 shows the available Ethernet ports for each PCIe slot configuration.

Table 1-2 NetBackup 5330 compute node PCIe Ethernet port configurations

Option	Slot and Ethernet port numbers
A (four 10-Gb Ethernet cards)	<ul style="list-style-type: none"> ■ Slot 2: eth8 (right), eth9 (left) ■ Slot 3: eth6 (right), eth7 (left) ■ Slot 5: eth10 (right), eth11 (left) ■ Slot 6: eth12 (right), eth13 (left)
B (three 10-Gb Ethernet cards)	<ul style="list-style-type: none"> ■ Slot 2: eth8 (right), eth9 (left) ■ Slot 3: eth6 (right), eth7 (left) ■ Slot 5: eth10 (right), eth11 (left)
C (two 10-Gb Ethernet cards)	<ul style="list-style-type: none"> ■ Slot 2: eth8 (right), eth9 (left) ■ Slot 3: eth6 (right), eth7 (left)
D (one 10-Gb Ethernet card)	<ul style="list-style-type: none"> ■ Slot 3: eth6 (right), eth7 (left)
E (no 10-Gb Ethernet cards)	N/A

NetBackup 5330 storage shelves and disk drives

The NetBackup 5330 compute node supports two types of external disk drive storage as follows:

- Primary Storage Shelf
- Expansion Storage Shelf

Note: A 220VAC power supply is required for the Primary Storage Shelf and the Expansion Storage Shelf.

Each NetBackup 5330 compute node requires one Primary Storage Shelf. One 6TB disk drive Expansion Shelf can be added to a 3TB drive Expansion Shelf and a 3TB drive Primary Shelf to provide additional storage capacity.

Due to weight considerations, the storage shelves should be installed at or as close to the bottom of the rack as is possible. When the storage shelves and the compute node have been installed, the Fibre Channel (FC), SAS, and power cables are connected between the units. The FC cables connect the compute node to the Primary Storage Shelf. The SAS cables connect a Primary Storage Shelf to an Expansion Storage Shelf. When all connections are completed, turn on the storage shelves and the compute node to initialize and synchronize the units.

Note: If more than one Expansion Storage Shelf is used, turn on the shelf furthest from the Primary Shelf first. Then turn on the Expansion shelf that is connected to the Primary Shelf. Next, turn on the Primary Shelf. Finally, turn on the compute node.

To help reduce the weight of the units during installation, the disk drives are not factory-installed into the storage shelves. The disks are shipped in separate packages, with ten disks in each package. Six packages are required to fully populate each storage shelf. Each individual disk is wrapped in an anti-static bag. Disks must be installed into the storage shelves by opening the storage shelf drawers and inserting each disk into a slot. Best practices recommend that you start at the bottom drawer and move up. Insert the disks into one drawer at a time.

The drawers for each shelf are numbered from 1 to 5 starting at the top of the shelf.



The disk slots in each drawer are numbered from 1 to 12 starting at the left side of the drawer.

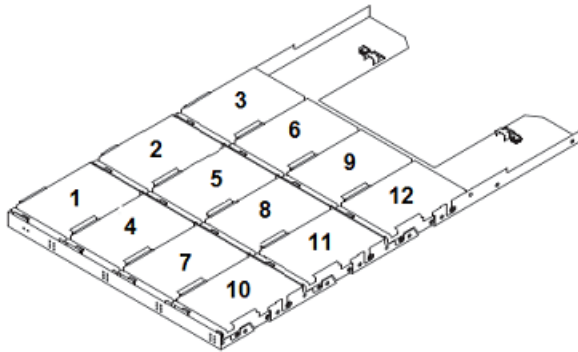

Three LEDs on the front of each drawer provide information about each column of three slots.



See “Installing disk drives into a Primary Shelf or an Expansion Shelf” on page 41.

NetBackup 5330 cables and connectors

The following types of cables and connectors are provided:

- Power cords that connect each device to AC power distribution units (PDUs) in the rack.

Note: A 220VAC power supply is required for the Primary Storage Shelf and the Expansion Storage Shelf. The NetBackup 5330 compute node can accommodate a 120VAC or 220VAC input power supply.

The following lists the voltages of the power connectors for the compute node and storage shelves. The green pin denotes the ground.

The compute node uses the following outlet (C-13) and inlet (C-14) connectors.



These connectors provide the following values:

- Voltage: 230, 125 - 250 VAC
- Current: 10CE, 15UL (amps)

The storage shelves use the following outlet (C-19) and inlet (C-20) connectors.

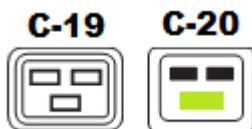

These connectors provide the following values:

- Voltage: 230, 125-250 VAC, although the storage shelves only operate at 200-240 VAC.
- Current: 16CE, 20UL (amps)
- Fiber Channel (FC) cables that connect the compute node to the Primary Storage Shelf.
- SAS cables that connect the Primary Storage Shelf to the Expansion Storage Shelf.

- Small Form-factor Pluggable (SFP) modules for FC and 10GbE ports.
SFPs are factory-installed in the cards in the PCIe risers.
Two SFPs are provided for use with the 10GbE ports on the rear panel of the compute node.

You may need to obtain the following types of cables depending on the I/O configuration of your compute node:

- Ethernet cables between the 1Gb Ethernet and the 10Gb Ethernet ports on the compute node rear panel and your network.
- Ethernet cable between the Intelligent Program Management Interface (IPMI) port on the compute node rear panel and your network for remote access.
- Additional FC cables between the 8Gb FC HBA ports on the compute node rear panel and your network for connection to tape or other devices.

Required reading

Read the following sections before proceeding. Information in these sections helps you determine the hardware you have already installed and any additional hardware that you need to install.

- See “Understanding hardware scenarios” on page 16.
- See “Performing a soft shutdown before adding a new Expansion Shelf” on page 54.
- See “NetBackup 5330 cables and connectors” on page 15.

Understanding hardware scenarios

The NetBackup 5330 Appliance Release 2.7.1 introduced the use of 6TB disk drives in the storage shelves. Previous releases provided storage disk drives at 3TB. However, you cannot mix 3TB and 6TB drives in a single storage shelf.

This following list describes the instructions that are available in this guide.

- Installing and connecting a compute node and a Primary Shelf.
- Installing and connecting an Expansion Shelf to a Primary Shelf and a compute node.
- Installing a second Expansion Shelf and connecting it to an existing Expansion Shelf, Primary Shelf, and compute node.

Caution: When you add a second Expansion Shelf to an operational appliance system, best practices recommend that you turn off the compute node, the Primary Shelf, and the existing Expansion Shelf.

Note: Before you add a second Expansion Shelf to your system, you must upgrade to NetBackup Appliance Release 2.7.1, or later. Refer to the *NetBackup Appliance Upgrade Guide for Release 2.7.x - RedHat Enterprise Linux (RHEL) Operating System*, which is located at the following web site.
https://veritas.com/support/en_US/article.DOC2792.html

Understanding the NetBackup 5330 hardware installation sequence

For easier installation and cabling between units, the installation of the compute node and the storage shelves must be performed in a specific sequence.

The recommended installation sequence is as follows:

- Storage shelves
 - Expansion Storage Shelves - install in the lowest available 4RU rack spaces.
 - Primary Storage Shelf - install in the next available 4RU rack space above the Expansion Storage Shelves.

The storage shelves are the heaviest units. They are physically similar and both use the same rail type for mounting. For easier installation, do not install the disk drives until after the units are installed into the rack.

The estimated time to install one storage shelf is about 2.5 hours.
- NetBackup 5330 compute node - install in the next available 2RU rack space above the Primary Storage Shelf.

The estimated time to install one compute node is about 1.25 hours.

Table 1-3 describes the installation steps and includes a link to the specific procedure for that step.

Table 1-3 Storage shelf and compute node hardware installation sequence

Step	Description
1	Unpack the storage shelves. See "Unpacking a Primary Shelf or an Expansion Shelf" on page 25.

Table 1-3 Storage shelf and compute node hardware installation sequence
(continued)

Step	Description
2	<p>Unpack the compute node.</p> <p>See “Unpacking a NetBackup 5330 compute node” on page 27.</p>
3	<p>Determine the rack locations for the storage shelves and the compute node.</p> <p>See “Determining rack locations for NetBackup 5330 hardware” on page 29.</p>
4	<p>Mount the storage shelf rails in the rack and install the storage shelves.</p> <p>Install all Expansion shelves below the Primary Shelf.</p> <p>The following topic can be used for both the Expansion Shelf and the Primary Shelf.</p> <p>See “Installing a Primary Shelf or an Expansion Shelf” on page 34.</p>
5	<p>Install the disk drives into each storage shelf. Be sure to install only 3TB or 6TB disks into one shelf. You cannot put both types of disks into a single shelf.</p> <p>See “Installing disk drives into a Primary Shelf or an Expansion Shelf” on page 41.</p>
6	<p>Mount the compute node rails in the rack and install the compute node.</p> <p>See “Installing the NetBackup 5330 compute node” on page 44.</p>
7	<p>Connect the four fiber channel cables between the Primary Storage Shelf and the compute node.</p> <p>See “Connecting a NetBackup 5330 compute node to a Primary Shelf” on page 49.</p>
8	<p>If you are installing one Expansion shelf to a Primary Shelf and a compute node: Connect four SAS cables between the Expansion Shelf and the Primary Shelf.</p> <p>See “Connecting one Expansion Shelf to a Primary Shelf” on page 51.</p>
9	<p>If you are adding a second Expansion Shelf to an existing Expansion Shelf, a Primary Shelf, and a compute node: Connect two new SAS cables between the two Expansion shelves. Then, disconnect one end of two SAS cables from the existing Expansion Shelf and connect them to the new Expansion Shelf.</p> <p>See “Connecting a second Expansion Shelf to an existing 3TB Expansion Shelf and a 3TB Primary Shelf” on page 55.</p>
10	<p>Connect the Power Distribution Unit (PDU) cords between the compute node and the power distribution outlets in the rack.</p> <p>See “Connecting the power cords to the hardware” on page 66.</p>

Table 1-3 Storage shelf and compute node hardware installation sequence
(continued)

Step	Description
11	Connect the Power Distribution Unit (PDU) cords between each storage shelf and the power distribution outlets in the rack. The storage shelves require 220 VAC. See "Connecting the power cords to the hardware" on page 66.
12	Turn on power to the storage shelves and the compute node. Be sure to use the correct sequence. See "Turning on the hardware and verifying operation" on page 68.
13	Configure IPMI and the NIC1 (eth0) interface from the NetBackup Appliance Shell Menu. See "Configuring the IPMI from the NetBackup Appliance Shell Menu" on page 76.

About IPMI configuration

The Intelligent Platform Management Interface (or IPMI) provides management and monitoring capabilities independently of the host system's CPU, firmware, and operating system. You can configure the IPMI sub-system for your appliances. The IPMI sub-system can be connected by using the remote management port, located on the rear panel of the appliance.

The following figure shows the remote management port (or the IPMI port) on the rear panel of a 5330 appliance:

The IPMI is beneficial after an unexpected power outage shuts down the connected system. In case the appliance is not accessible after the power is restored, you can use a laptop or desktop computer to access the appliance remotely by using a network connection to the hardware rather than to an operating system or login shell. This enables you to control and monitor the appliance even if it is powered down, unresponsive, or without any operating system.

The following diagram illustrates how IPMI works:

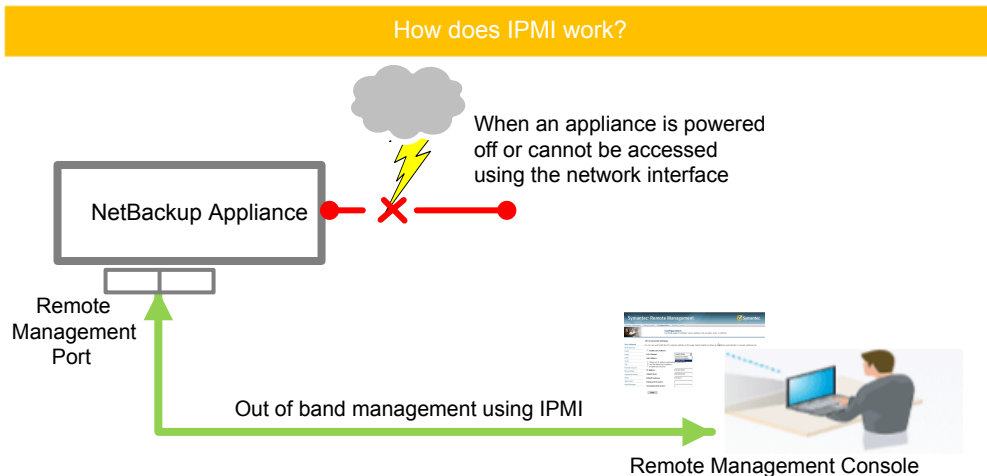

Some of the main uses of IPMI are the following:

- Manage an appliance that is powered off or unresponsive. Using the IPMI, you can power on, power off, or restart the appliance from a remote location.
- Provides out-of-band management and help manage situations where local physical access to the appliance is not possible or preferred like branch offices and remote data center.
- In case the appliance is not accessible using regular network interfaces, you can access the NetBackup Appliance Shell Menu remotely using IPMI.

Note: Only the NetBackup Appliance Shell Menu can be accessed by using the IPMI interface. The NetBackup Appliance Web Console cannot be accessed by using the IPMI interface.

- Reimage the appliance from the IPMI interface by using ISO redirection.
- Monitor hardware health of the appliance from a remote location.
- Avoid messy cabling and hardware like keyboard, monitor, and mouse (KVM) solutions.

See "Configuring the IPMI from the NetBackup Appliance Shell Menu" on page 76.

See "Accessing and using the Remote Management interface" on page 78.

Product documentation

Documents for the NetBackup 5330 compute node and Storage Shelf are listed in the following table.

Table 1-4 NetBackup 5330 Appliance documentation

Document	Description
<i>NetBackup Appliance 5330 Product Description Guide</i>	Describes all aspects of the NetBackup 5330 compute node and the attached storage shelves.
<i>NetBackup 5330 Appliance Initial Configuration Guide</i>	Provides guidelines and checklists for the initial configuration of the compute node. Describes the initial configuration through the NetBackup Appliance Web Console.

The following documents are also available.

- *NetBackup Appliance 52xx and 5330 Safety and Maintenance Guide*
- *NetBackup Appliance Administrator Guide*
- *NetBackup Appliance Command Reference Guide*
- *NetBackup Appliance Release Notes*

You can find hardware and software documentation for the NetBackup 5330 appliance at the following URL.

https://veritas.com/support/en_US/article.DOC2792.html

Hardware pre-installation requirements

This chapter includes the following topics:

- Package contents for NetBackup 5330 hardware
- Customer-provided items for a NetBackup 5330 hardware installation
- Unpacking a Primary Shelf or an Expansion Shelf
- Unpacking a NetBackup 5330 compute node
- Determining rack locations for NetBackup 5330 hardware
- Determining SAS cable length
- Prerequisites for IPMI configuration

Package contents for NetBackup 5330 hardware

The compute node and each storage shelf are shipped in separate containers. Each container includes other boxes and contents. The disk drives for the storage shelves are shipped in additional boxes.

Table 2-1 describes the contents of the shipping containers for a NetBackup 5330 appliance system.

Table 2-1 NetBackup 5330 appliance container contents

Container	Contents
compute node	<ul style="list-style-type: none"> ■ Installation flip cards ■ Installation poster ■ Cabling poster ■ Safety manual ■ Left and right rack rails ■ Rack rail mounting template ■ Compute node ■ Bezel ■ Two SAS cables ■ Two power cords ■ Screwdriver, cable straps ■ Envelope containing the following: <ul style="list-style-type: none"> ■ USB stick(s) with factory reset files. ■ Warranty and license information
Primary Storage Shelf	<ul style="list-style-type: none"> ■ Left and right rack rails with mounting hardware ■ Rack rail mounting template ■ Bezel ■ Primary Storage Shelf ■ Four Fiber Channel cables ■ Four SFPs ■ Two SAS cables ■ Two power cords
Expansion Storage Shelf	<ul style="list-style-type: none"> ■ Left and right rack rails with mounting hardware ■ Rack rail mounting template ■ Bezel ■ Expansion Storage Shelf ■ Two SAS cables ■ Two power cords

Customer-provided items for a NetBackup 5330 hardware installation

The following describes the necessary personnel and equipment that are needed at the installation site:

- At least two people or a mechanical lift to move the storage shelves.

- A keyboard and a monitor to connect to the compute node.
- Ethernet and Fiber Channel (FC) cables to connect the compute node to your corporate network.
- A 19-inch rack with dual Power Distribution Units (PDUs).
 - 220VAC power supply for the Primary Storage Shelf and the Expansion Storage Shelf
 - 120VAC or 220VAC power supply for the compute node

Unpacking a Primary Shelf or an Expansion Shelf

Each storage shelf is shipped in a separate container. Veritas recommends that you have a table nearby where you can safely place the contents of the container.

Due to weight considerations the storage shelves ship without any disk drives installed.

Warning: Each empty storage shelf weighs 80kg (176 lbs). To help prevent personal injury, three persons or a mechanical lift are required to unpack and to move a storage shelf.

To unpack a storage shelf

- 1 DO NOT slice open the top of the cardboard container.



- 2 Remove the white, plastic inserts from the sides of the container.



- 3 Lift up the top of the container and off of the contents of the container.



- 4 Lower and flatten the sides of the container so that you can access the storage shelf.

- 5 Remove the front and the rear rack templates. You will use these to locate holes in the rack where screws and pins are placed.

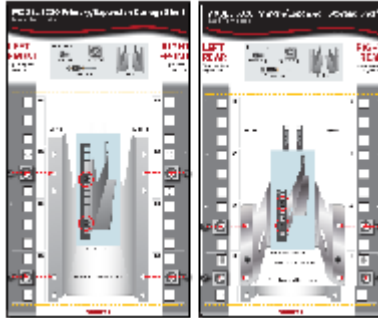

- 6 Remove any foam, air bags, or other cushioning materials.
- 7 Remove the extension bracket and screws.

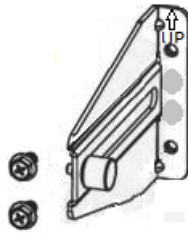

- 8 Remove the bezel and set it aside.
- 9 Remove the mounting rails and set them aside.
- 10 Remove the four metal handles and set them aside.
- 11 Remove any fasteners, power cords, and cables and set them aside.
- 12 Remove the storage shelf from the shipping container.

Unpacking a NetBackup 5330 compute node

The compute node is shipped in a separate container from the storage shelves. Both types of devices are shrink-wrapped together. Veritas recommends that you have a table nearby where you can safely place the contents of the container.

Warning: The compute node weighs 30kg (66 lbs). Be sure that you have adequate personnel or a mechanical lift to move the compute node.

To unpack the compute node

- 1 Open the cardboard container.



- 2 Remove the Open Me First box and the posters at the top of the container.
- 3 Remove the rail templates from the Open Me First box.

The template shows where the left-hand rail and the right-hand rail fit into the front and the rear of the rack.

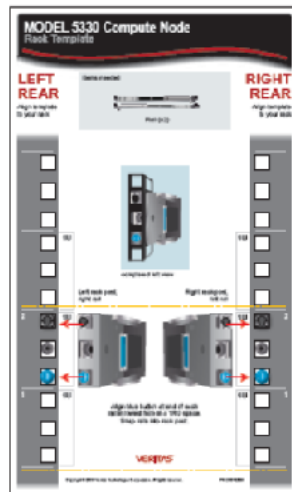

- 4 Remove the bezel.
- 5 Remove the mounting rails.

- 6 Remove the large accessory box that contains the fasteners, the power cords, and other contents.
- 7 Remove the compute node from the shipping container.

Determining rack locations for NetBackup 5330 hardware

The height of the compute node and the storage shelves require a different rack unit (RU) space. The compute node needs 2RU rack space and each storage shelf needs 4RU.

To help you identify RU spacing, many rack manufacturers typically use a system of lines and sequential numbers starting at the bottom of the rack. The front and the rear of the rack are marked the same to ensure that the rails are installed straight and level.

One RU has three holes. The holes for one RU are typically marked with a line below the bottom hole and another line above the top hole. A number at the center hole identifies where the RU appears in the rack.

Figure 2-1 shows the markings as described.

Figure 2-1 Rack RU space markings



Use the compute node and storage shelf Rack Templates to determine the mounting locations.

Best practices for hardware installation are as follows:

- When you install the rails, be sure to use complete RUs. Do not use holes from different RUs.
- The storage shelves are much heavier than the compute node and should be installed as close to the bottom of the rack as possible.
- The compute node should always be installed above the storage shelves.
- Do not leave any spaces between the compute node and a storage shelf, or between two storage shelves.
- When you add a second Expansion Shelf to an operational appliance system, turn off the compute node, the Primary Shelf, and the existing Expansion Shelf.

To determine rack locations for the hardware

- 1 Determine the total number of rack units (RUs) that you need as follows:
 - Compute node (2RU) and Primary Storage Shelf (4RU)
Systems that contain these two units require a total of six RUs.
 - Compute node (2RU), Primary Storage Shelf (4RU), Expansion Storage Shelf (4RU)
Systems that contain these three units require a total of ten RUs.
- 2 Use the Rack Templates that are provided with the hardware to determine RU locations.
- 3 Record the rack positions to help you locate them easily when mounting the hardware.

See “Installing a Primary Shelf or an Expansion Shelf” on page 34.

Determining SAS cable length

Before you add an Expansion Shelf, be sure to verify that the location of the shelf accommodates the length of the SAS cables. Each SAS cable is 1 meter (3.28 feet) long. A 2 meter (6.56 feet) SAS cable is available separately. Contact Veritas Technical Support, if needed.

To determine adequate cable length

- 1 Locate a 4U space as close to the Primary Shelf as possible.
- 2 Verify that the SAS cables that ship with the Expansion Shelf easily connect to the Primary Shelf.

Best practices recommend that you physically hold the SAS cables between the Primary Shelf and the intended Expansion Shelf location. Visually confirm that the cables are long enough.

Prerequisites for IPMI configuration

Verify the following configuration prerequisites:

- Ensure that you have a dedicated network infrastructure. The remote management port is 1 Gbps for NetBackup 5330 appliances.
- The remote management port can auto-negotiate its link speed of up to 1 Gbps.

Note: If the IPMI is connected to a managed switch port, it is recommended that you configure the switch port to auto-negotiation.

- If a firewall exists between the appliance and the remote devices that manage an appliance (like a laptop computer), open the following ports:

22	SSH
80	HTTP
162	SNMP
443	HTTPS
623	KVM
5120	RMM ISO/CD
5123	RMM floppy
5124	CD
5127	SSL
5900	KVM CLI
7578	RMM CLI
7582	SSL

Note: If you have a private internal network, remember to configure the settings accordingly in your network address translation (NAT).

- The remote management port must be configured as a DHCP or static address.

See “About IPMI configuration” on page 19.

Hardware installation procedures

This chapter includes the following topics:

- Installing a Primary Shelf or an Expansion Shelf
- Installing disk drives into a Primary Shelf or an Expansion Shelf
- Installing the NetBackup 5330 compute node
- Installing the SFPs into the Fibre Channel (FC) ports
- Removing SFP end caps
- Connecting a NetBackup 5330 compute node to a Primary Shelf
- Connecting one Expansion Shelf to a Primary Shelf
- Performing a soft shutdown before adding a new Expansion Shelf
- Connecting a second Expansion Shelf to an existing 3TB Expansion Shelf and a 3TB Primary Shelf
- Connecting the power cords to the hardware
- Turning on the hardware and verifying operation
- Configuring the IPMI from the NetBackup Appliance Shell Menu
- Accessing and using the Remote Management interface

Installing a Primary Shelf or an Expansion Shelf

This installation procedure can be used for either storage shelf. For the systems that include an Expansion Shelf, install that unit first followed by the Primary Shelf.

There must be a minimum depth of 76 cm (30 in.) between the front of the rack and the rear of the rack.

Veritas recommends that two people install the rails; one person at the back of the rack and one at the front. Veritas also recommends that three people lift and place the storage shelf into the mounted rails.

Warning: To avoid potential equipment damage and personal injury, do not install disk drives into the storage shelves before mounting them into the rack. The added weight of the disk drives hinders the ability to safely install the storage shelves.



≥ 32 kg (70.5 lb)

To install the storage shelf into the rack

- 1 Locate the left and the right rails.
- 2 Using a Phillips screwdriver, remove the four screws from the front of the rail and the two screws from the rear. Set the screws aside.

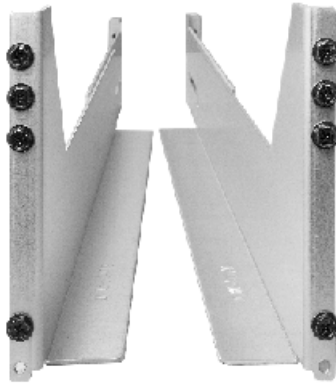

- 3 Identify the front, taller end of each rail.

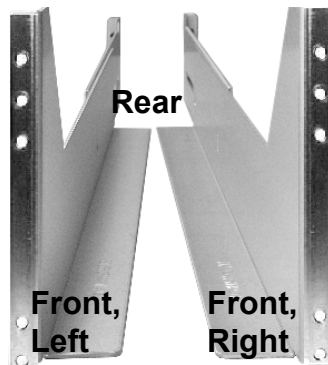

Note the ledge that is perpendicular to the main part of the rail. The storage shelf sits on this ledge.

- 4 Locate the spacers and place them near the rail screws.



Note: Two types of spacers may ship with the storage shelves. Some spacers are round, while other spacers are square. Both types of spacers are galvanized steel. Both types of spacers have the same usage and functionality.

- 5 To align the rail with the front and the rear RUs, do the following:
 - Locate the RUs on the front and the rear of the rack that you plan to use.



Note: The rear of the rack only uses the two lower RUs for installation. The front of the rack uses three RUs.

- Use a flathead screwdriver to loosen the inside screws of the rail.

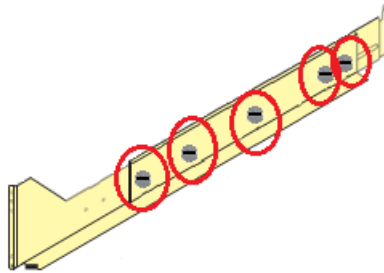

- Extend the rail so that it fits inside the front and the rear rack posts.

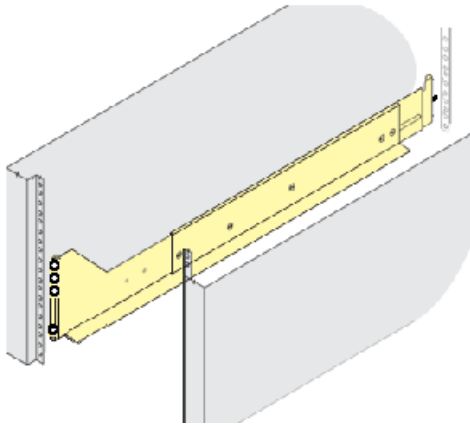

- Insert the guide pin on the rear of the rail into the top hole of the lowest rear RU that you plan to use.



- 6 You can use the flathead screws on the inside of the rail to extend or shorten it to fit into the rack.
- 7 You can also use an expansion bracket if you need to reinforce the rear of the rack.

Use the UP arrow to determine whether the bracket should be attached to the rear of the left or the right rail.

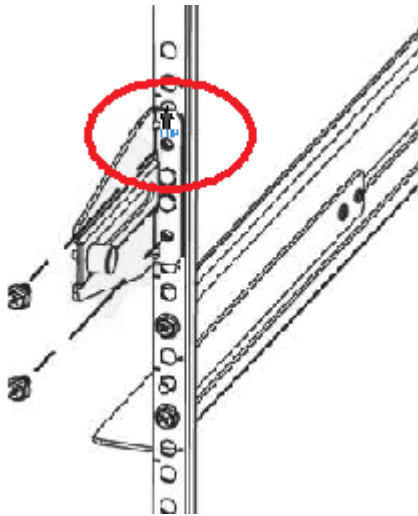

- 8 To secure the rail to the rack, do the following:
 - Place one spacer, each, on two screws. The following illustrations show square and round spacers. Either type of spacer may ship with the storage shelf.

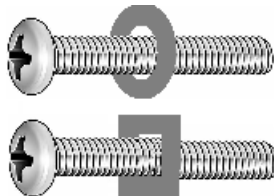

- If you have round spacers insert the raised portion of the spacer into the rack hole from the rack front. The spacer centers the screw for rail installation. The raised side of the round spacer is shown at the top of the following picture.



- Position the rail behind the rack holes.
- On the front of the rack, install one spacer and one screw in the lowest hole in the rack. Then install another spacer and a screw in the middle of the third RU in the rack.



The two remaining screws are used later to attach the shelf to the rack.

- On the rear of the rack, install a spacer and a screw in the middle rack holes of the two lowest RUs.
- 9** Be sure to tighten the flathead screws on the inside of the rail. The rail should fit snugly, without any room for movement.

10 Repeat the previous steps to install the right-hand rail.



Front, right Rear, right

11 To prepare for storage shelf installation, attach the four metal handles to the sides of the storage shelf as follows:

- Push the top tabs on the handles into the slots on the shelf (1).
- Angle the handles and insert the bottom tabs (2).
- Push the entire handle towards the side of the shelf (3).
- Pull the handles up to secure them into place (4).

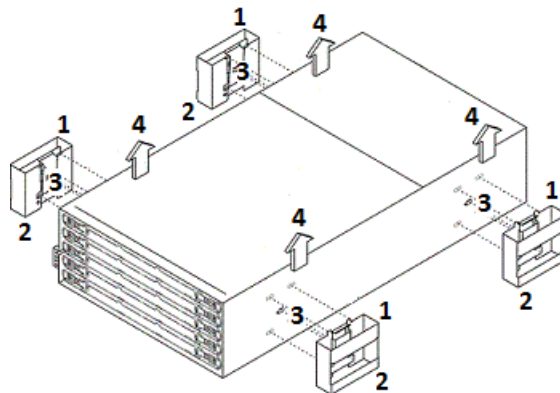

- 12 With one person on each side and one person in front, carefully lift the storage shelf.
- 13 Place the rear of the shelf into the rear of the extended rails.
- 14 Slide the shelf partially into the rack and remove the two rear metal handles.
- 15 Lift the front of the storage shelf up slightly, then slide it completely into the rack until it engages securely.
- 16 Remove the two front metal handles.
- 17 Repeat the previous steps to install the Primary Storage Shelf.

See “Determining rack locations for NetBackup 5330 hardware” on page 29.

Installing disk drives into a Primary Shelf or an Expansion Shelf

The disk drive installation procedure is the same for both storage shelves. Power should not be applied to the storage shelves when you initially install all of the drives, such as when installing a new shelf.

Each storage shelf has 5 disk drawers, and each drawer holds 12 disks. All 60 disk drives must be installed.

To help reduce the installation time, Veritas recommends that two people perform the disk installation. One person should unwrap the disk drive and lift the handle, then hand it to the other person to install it into the drawer. Both people should wear ESD protection.

Note: If disks are not installed correctly when power is turned on later, errors are shown in the hardware monitoring systems. The first place to look for information is the NetBackup Appliance Web Console. Go to the **Monitor > Hardware** page.

To install the disk drives into a storage shelf

- 1 Move all disk drive boxes to the storage shelf location and open each box. Do not remove any disks or their protective sleeves at this time.
- 2 Attach an ESD protective (anti-static) wrist strap to one wrist and connect the other end to the rack.

- 3 Starting with the bottom drawer (5), use your thumbs to pull out the two orange latches towards the sides of the rack. Then, grasp the latches and pull out the drawer until you can see all of the disk slots. Do not pull the drawer out further.



The front of each drawer identifies the disk drive slot numbering inside the drawer. The numbering is the same in all drawers, as follows:

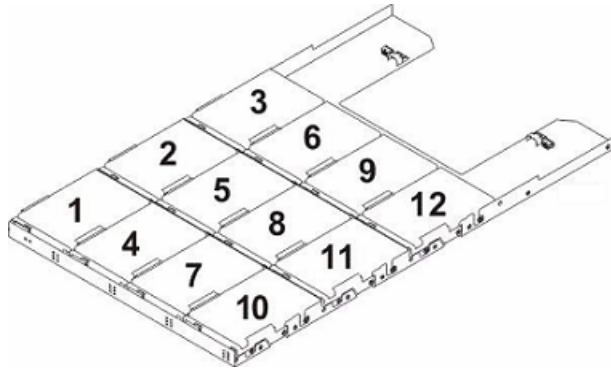

- 4 Take a disk drive from a box and remove its protective sleeve.
- 5 Pull up the disk latch and use it as a handle to install the disk into disk space number 1 as follows:
 - Insert the disk straight down into the slot.
 - Align the two raised buttons on each side of the disk with matching gaps in the slot.

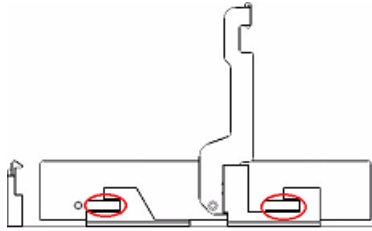

- Make sure that the bottom of the disk is seated completely.



- Push down slightly and start to pull the disk latch towards you. This action moves the disk backwards. The connector on the right, rear, of the disk fits into the pins in the rear of the slot.

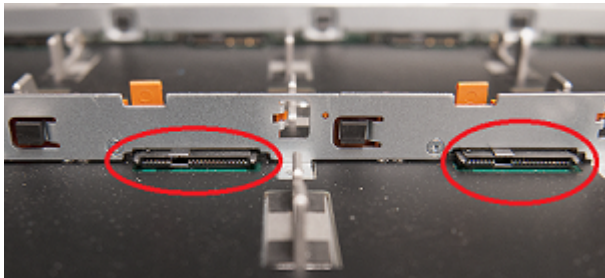

- Continue pulling the latch all the way down until it snaps in place under the orange tab in the front.

Repeat this step for the remaining disk slots in the drawer.

- 6** After all 12 disks are installed, push the drawer back into the shelf and push the orange latches inward to secure the drawer.
- 7** Repeat steps 4 - 6 for the remaining drawers in the following order:
Drawer 4, 3, 2, and then 1.

Installing the NetBackup 5330 compute node

The NetBackup 5330 requires two RU rack spaces. Veritas recommends that you install the compute node in the space directly that is above the Primary Shelf.

The rails require one RU rack space and must be installed in the upper RU of the two required for the compute node.

To install the compute node

- 1 Use the rack rail templates that are provided with the compute node.

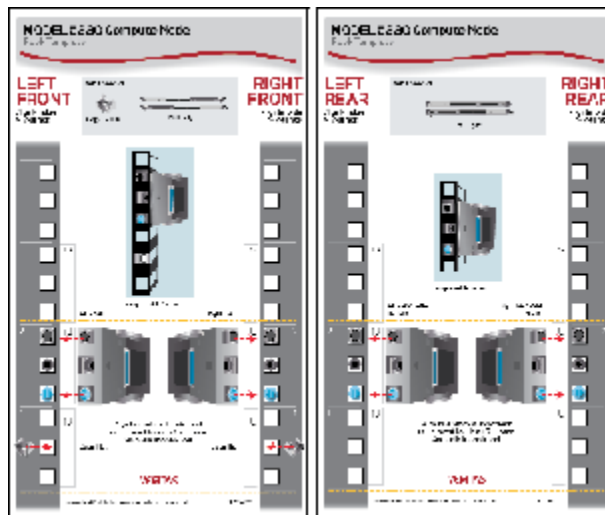

- Determine which 2 RUs to use.
 - Determine which rack holes to use for pins and screws.
- 2 Locate the RUs on the front and the rear of the rack that you plan to use.
- 3 At the front of the rack, install a cage nut in the center hole of the lower RU on each side.
This hole is used later to secure the compute node to the rack.
- 4 Locate the left rail, marked with an **L** on the side near the front. Note the following:
 - The marked side of the rail must face the side of the rack cabinet when mounted, not the side of the compute node.

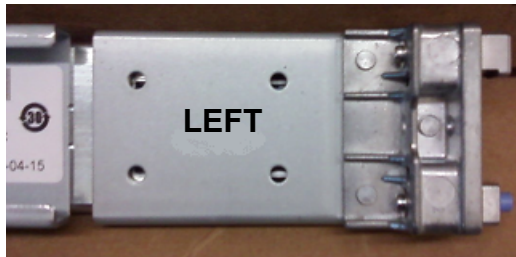

- The rail ends contain unique points for engagement in the rack. The square protrusion at the top should be placed in the top hole of the RU. The round blue protrusion at the bottom should be placed in the bottom hole of the RU.



- 5 At the rear upper RU of the rack, insert the rear of the rail into the top and the bottom holes of the RU.
- 6 Extend the rail toward the front of the rack and insert it into the top and the bottom holes of the RU.
- 7 Repeat steps 5 and 6 to install the right rail.



- 8 Make sure that both rails are parallel and secure.
- 9 Fully extend both rails forward until the release buttons click.
- 10 Carefully lift the compute node and tilt the rear down towards the back of the rails.
- 11 Locate the slots at the back of each rail.



- 12 Insert the two rear standoff pegs that extend from the side of the compute node into the last rail slots.

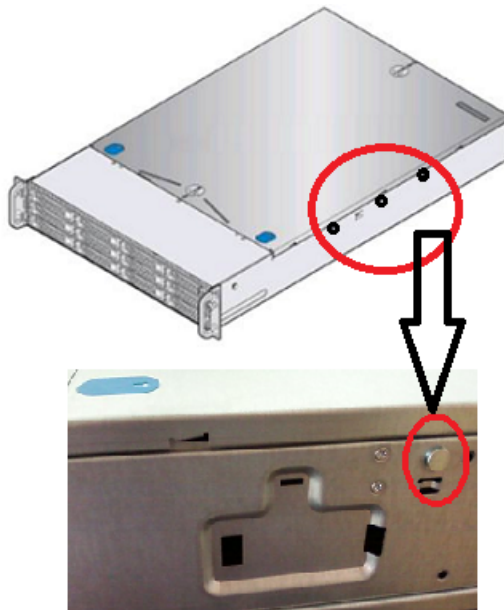

- 13 Lower the front of the compute node into the rail slots at the front of the rail extenders. A peg in the middle and a peg at the front of the compute node fit into the rail slots.

- 14 Lift up on the rail release buttons and slide the compute node completely into the rack.
- 15 Secure the compute node to the rack on each side by tightening the thumbscrew on the front.

Installing the SFPs into the Fibre Channel (FC) ports

Four small form-factor pluggable (SFP) transceivers are provided. You must insert them into the four Fibre Channel (FC) ports in slots 1 and 4 in the compute node rear panel.



To install the SFPs

- 1 Locate the SFPs.



- 2 Identify the FC ports in slots 1 and 4.

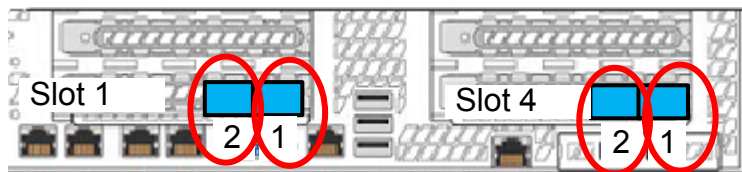

- 3 Insert an SFP partially into a port.

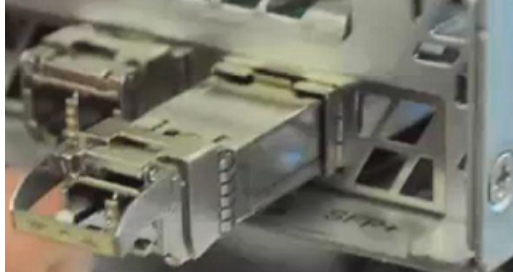

- 4 Be sure that the metal handle on the end of the SFP is on the top. You do not need to lift up the handle.
- 5 Verify that the SFP is seated properly.



- 6 Remove any endcaps from the ports.



Removing SFP end caps

The PCIe riser assemblies in the compute node contain Fibre Channel (FC) or 10Gb Ethernet cards, depending on the configuration.



The cards in the PCIe risers include SFP transceivers with protective end caps. The end caps need to be removed before a cable is inserted.

To remove an SFP end cap

- 1 Grasp the top and bottom of an end cap.
- 2 Pull the end cap straight back. Do not twist the end cap.
- 3 Keep the end caps in a dust-free location in case you need them at another time.

Connecting a NetBackup 5330 compute node to a Primary Shelf

The compute node ships with four, 1 meter, Fibre Channel (FC) cables. FC cables connect the compute node to the Primary Shelf canisters. To ensure communication redundancy, connect the units exactly as described in this topic.

Note: If you have a 6TB Primary Shelf, you must upgrade to NetBackup Appliance Release 2.7.1, or later. Refer to the *NetBackup Appliance Upgrade Guide for Release 2.7.x - RedHat Enterprise Linux (RHEL) Operating System*, which is located at the following site. https://veritas.com/support/en_US/article.DOC2792.html

The following diagrams and tables show the locations of the FC ports on both components.

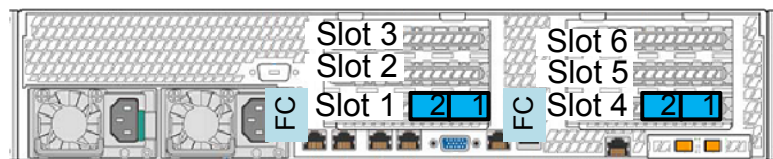

Table 3-1 Compute node FC ports

Compute node FC ports
Slot 1; ports 1 and 2
Slot 4; ports 1 and 2

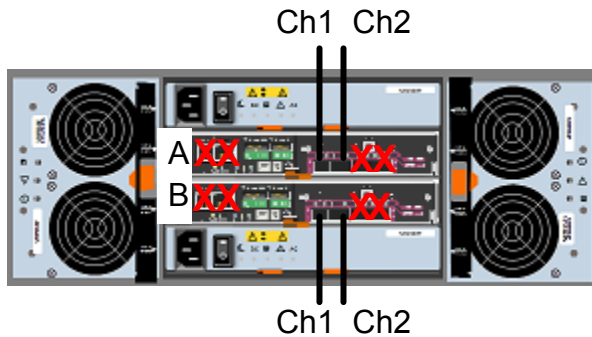

Table 3-2 Primary Shelf FC ports

Primary Storage Shelf FC ports
Canister A; FC Ch1 and FC Ch2
Canister B; FC Ch1 and FC Ch2

To connect the compute node to the Primary Shelf

- 1 Connect the slot 1 FC ports on the compute node to the appropriate Primary Shelf canister FC ports as follows:
 - Connect compute node slot 1, port 2 to Primary Shelf canister B, FC Ch1
 - Connect compute node slot 1, port 1 to Primary Shelf canister A, FC Ch1
- 2 Connect the slot 4 FC ports on the compute node to the appropriate Primary Shelf canister FC ports as follows:
 - Connect compute node slot 4, port 2 to Primary Shelf canister B, FC Ch2

- Connect compute node slot 4, port 1 to Primary Shelf canister A, FC Ch2
- 3 Verify that the connections match the ports in the following diagram.

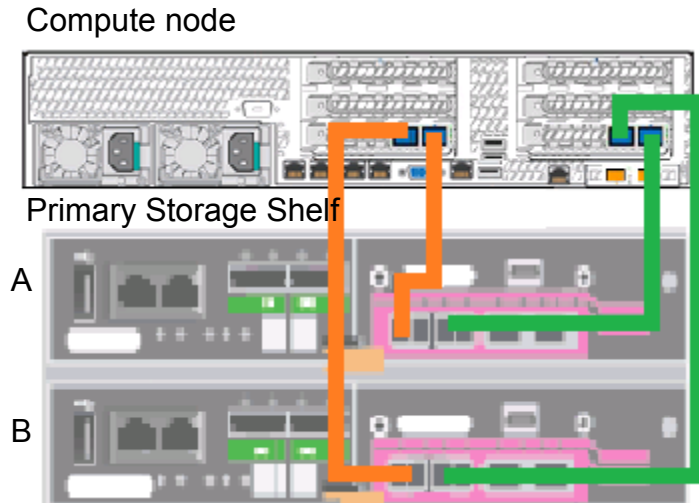

Connecting one Expansion Shelf to a Primary Shelf

This topic describes the process of adding one new Expansion Shelf to an existing Primary Shelf and Compute Node.

You can also use these instructions to install and connect an Expansion Shelf at the same time you install a Primary Shelf and a compute node.

Note: If you have a 6TB Expansion Shelf with a 6TB or 3TB Primary Shelf, you must upgrade to NetBackup Appliance Release 2.7.1, or later. Refer to the *NetBackup Appliance Upgrade Guide for Release 2.7.x - RedHat Enterprise Linux (RHEL) Operating System*, which is located at the following site.
https://veritas.com/support/en_US/article.DOC2792.html

It is not required to turn off an operational compute node and the Primary Shelf before you add one Expansion Shelf.

If you are installing a compute node, a Primary Shelf, and an Expansion Shelf at the same time, keep the power off to all devices until all of the cabling is complete. Use the provided sequence to turn on the devices.

Caution: Be sure to install the SAS cables correctly before you turn on the Expansion Shelf. If you need to disconnect and reconnect cables on an operational Expansion Shelf, there is a risk that the Primary Shelf cannot recognize the new configuration.

Prerequisites for adding an Expansion Shelf

- Be sure that you have 4U of rack space for each new shelf. One shelf must be close to the Primary Shelf.
- Refer to the following section to verify that cable lengths are adequate for your rack installation.
See “Determining SAS cable length” on page 30.
- Be sure that you have 220VAC power input for the storage shelf.
- Verify that the compute node and the Primary Shelf are connected correctly.

Compute node

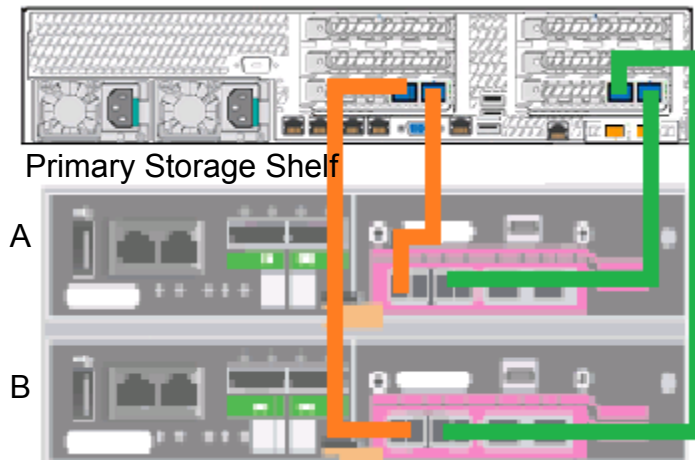

To connect one new Expansion Shelf to a Primary Shelf

- 1 Connect the two SAS ports on canister A of the Primary Shelf to the left SAS ports on canisters A and B of the Expansion Shelf

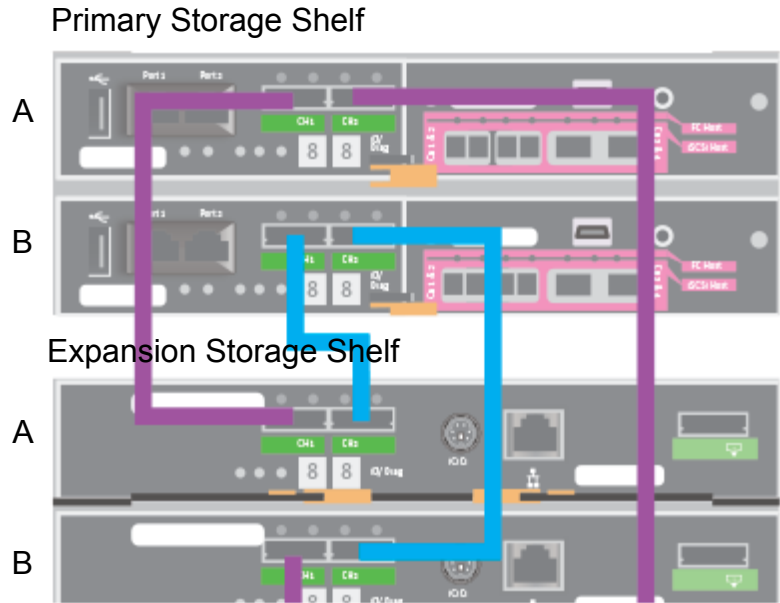

- 2 Connect the two SAS ports on canister B of the Primary Shelf to the two SAS ports on the Expansion Shelf. Do not use the single SAS port on the right-hand side of each Expansion Shelf canister.
- 3 Connect two power cords to the Expansion Shelf.

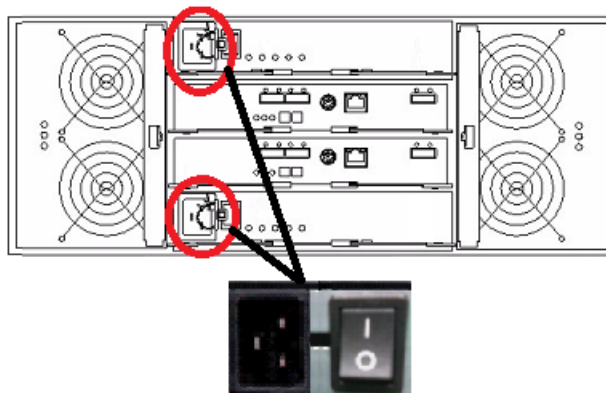

Performing a soft shutdown before adding a new Expansion Shelf

- 4 Turn on both power switches.
- 5 Wait for the 00 display on the Expansion Shelf.

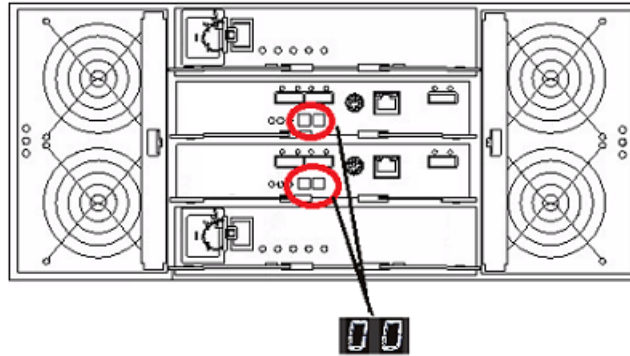

Refer to the following sections as needed.

- Turn on the devices and verify operations.
See “Turning on the hardware and verifying operation” on page 68.
- Add the new disk space from the Expansion Shelves.
See “Adding the disk space of an Expansion Storage Shelf from the NetBackup Appliance Web Console” on page 85.
See “Adding the disk space of an Expansion Storage Shelf from the NetBackup Appliance Shell Menu” on page 87.

Performing a soft shutdown before adding a new Expansion Shelf

Best practices recommend that the compute node is turned off before you install and connect a second Expansion Shelf. A soft shutdown preserves data and functionality of the compute node. The addition of a new Expansion Shelf to an operating compute node can cause the Primary Shelf to shutdown unless the soft shutdown procedure is performed. After the compute node is shut down, the Primary Shelf is also shut down.

Warning: You should never perform a hard shutdown by using the power button to turn off the NetBackup Appliance. Using the power button to turn off the NetBackup Appliance can cause data corruption to occur.

Connecting a second Expansion Shelf to an existing 3TB Expansion Shelf and a 3TB Primary Shelf

A soft shutdown informs the NetBackup Appliance operating system to stop and close all active processes. A soft shutdown also stops all communications to the attached storage shelf. After the operating system stops all of the processes, the compute node powers itself off. All attached storage shelves should be turned off with the power switches on the rear panel of each shelf.

Note: When you add one Expansion Shelf to an existing compute node and a Primary Shelf, you do not have to turn off the power.

To perform a soft shutdown

- 1 Ensure that all backup or restore operations have been completed.
- 2 Log in to the NetBackup Appliance Shell Menu and issue the command, `Support > Shutdown.`

Connecting a second Expansion Shelf to an existing 3TB Expansion Shelf and a 3TB Primary Shelf

You can add one Expansion Shelf that uses 6TB disk drives to an existing appliance system that has 3TB disk drives.

Note: Before you add a second Expansion Shelf to your system, you must upgrade to NetBackup Appliance Release 2.7.1, or later. Refer to the *NetBackup Appliance Upgrade Guide for Release 2.7.x - RedHat Enterprise Linux (RHEL) Operating System*, which is located at the following site.
https://veritas.com/support/en_US/article.DOC2792.html

Caution: When you add a second Expansion Shelf to an operational appliance system, best practices recommend that you turn off the compute node, the Primary Shelf, and the existing Expansion Shelf.

However, it is possible to add an Expansion Shelf to a functioning system while the power remains on. If you need to keep the power on, contact Technical Support for assistance. Ask your representative to reference Article 000097607.

Turn off the compute node, the Primary Shelf, and the existing Expansion Shelf in that order. Refer to the following link for background information as needed.

See “Performing a soft shutdown before adding a new Expansion Shelf” on page 54.

Connecting a second Expansion Shelf to an existing 3TB Expansion Shelf and a 3TB Primary Shelf

To turn off an operating system

- 1 First, turn off the compute node from the NetBackup Appliance Shell Menu.
- 2 Enter `Support` and then `shutdown`.
- 3 Next, turn off the Primary Shelf.
- 4 Turn off both AC power switches on the rear panel of the Primary Shelf.

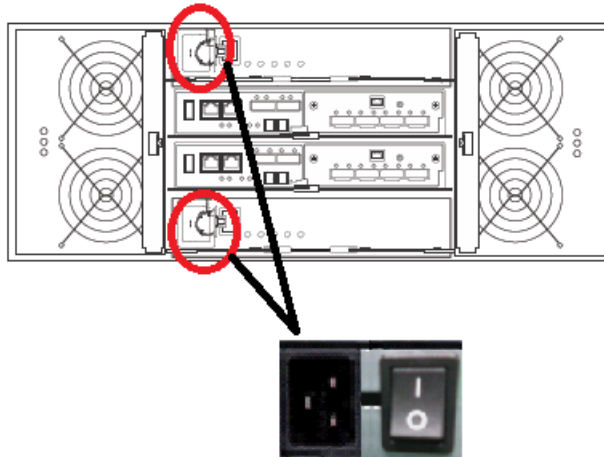

- 5 Turn off both AC power switches on the rear panel of the existing Expansion Shelf.

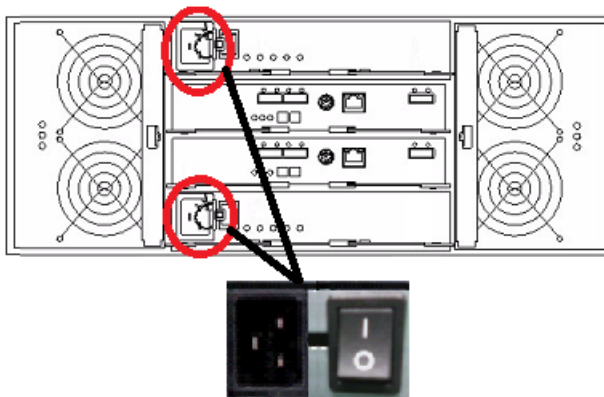

Connecting a second Expansion Shelf to an existing 3TB Expansion Shelf and a 3TB Primary Shelf

To connect a second Expansion Shelf to an existing Expansion Shelf

- 1 Verify that the compute node, the Primary Shelf, and the existing Expansion Shelf are turned off.
- 2 Verify that your existing Primary Shelf and Expansion Shelf are cabled correctly, as shown.

Four SAS cables connect the Primary Shelf to the Expansion Shelf.

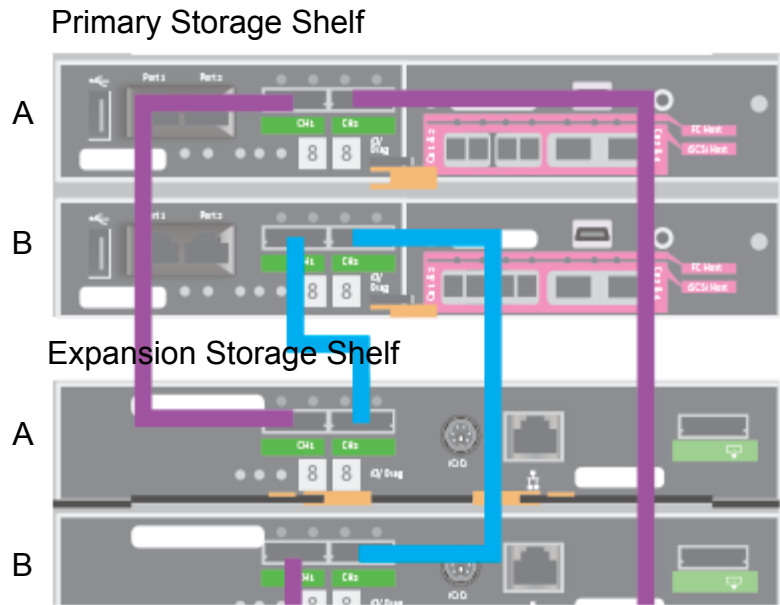

Note: The following illustrations show only the specific cable and action(s) required. Cables that are already connected are shown in black. The cable for each step is shown in color. A yellow circle represents a new connection. A red circle indicates a cable that needs to be removed from a specified port.

- 3 Connect one new SAS cable as shown in yellow.

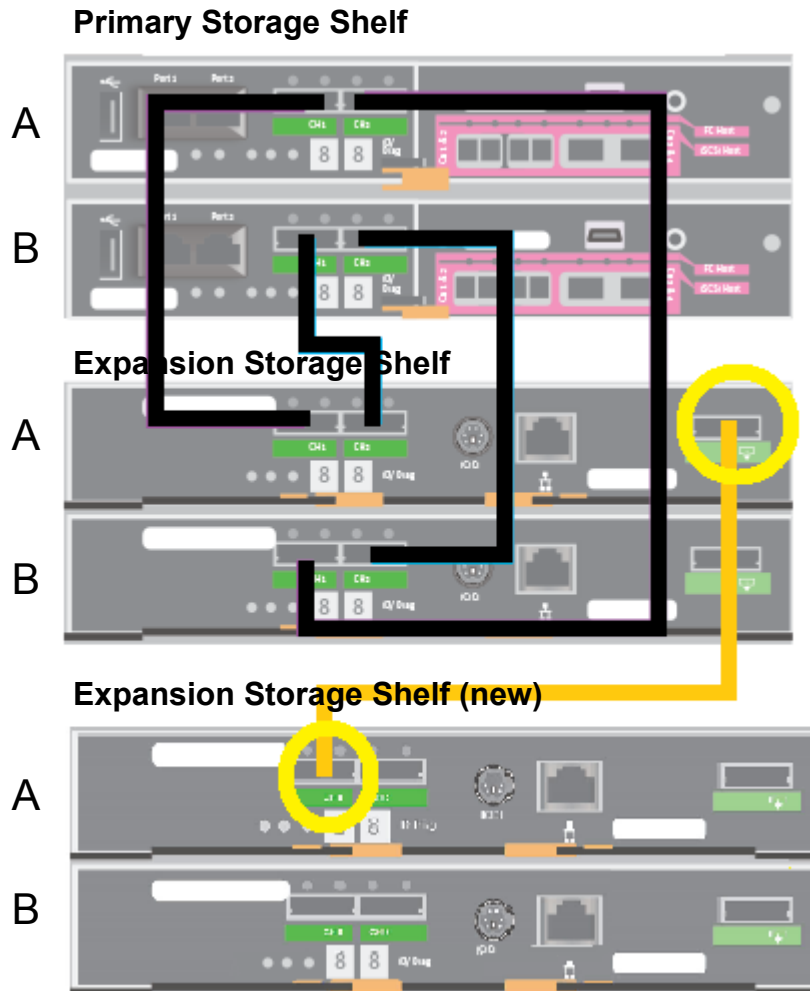

Connecting a second Expansion Shelf to an existing 3TB Expansion Shelf and a 3TB Primary Shelf

- 4 Connect the other new SAS cable to canister B of the new Expansion Shelf. Use the SAS port on the right-hand side of canister B as shown in yellow.

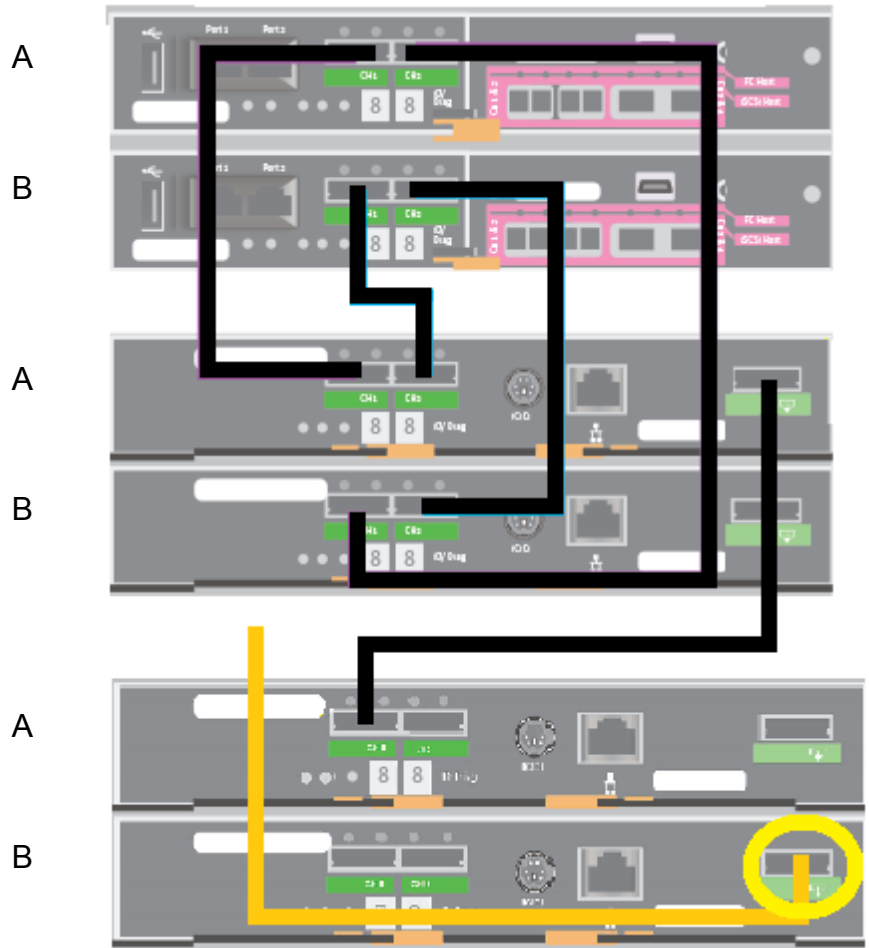

The other end of this new SAS cable is connected later.

Connecting a second Expansion Shelf to an existing 3TB Expansion Shelf and a 3TB Primary Shelf

- 5 Disconnect the cable from the left-most SAS port in canister B in the existing Expansion Shelf, as shown.

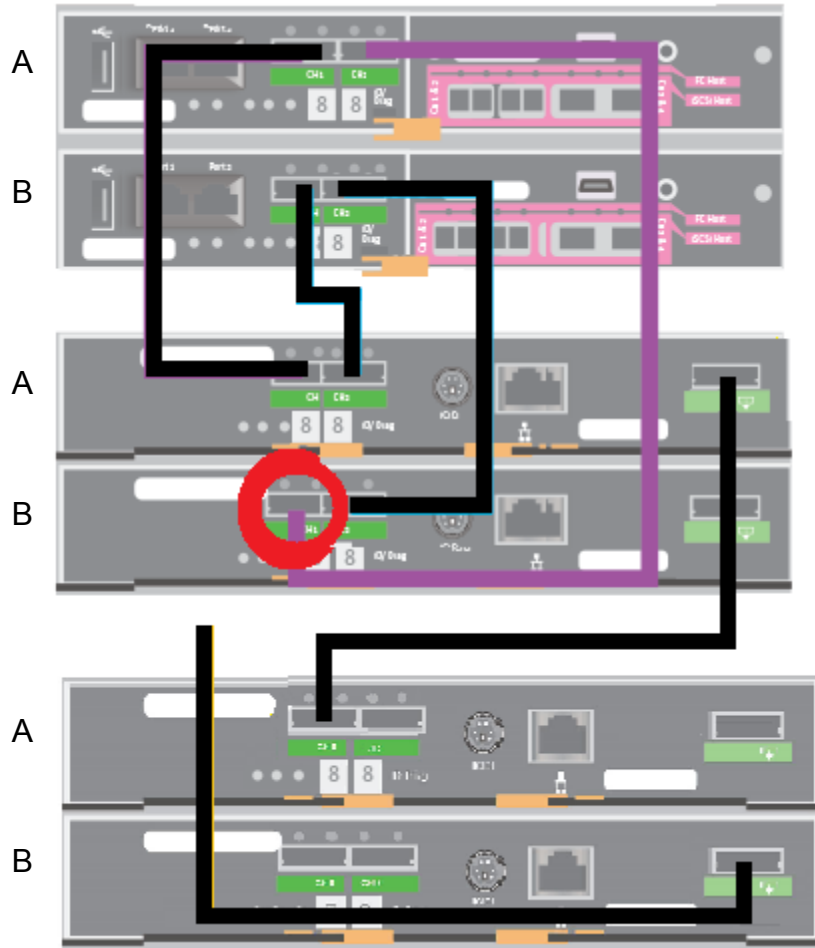

Connecting a second Expansion Shelf to an existing 3TB Expansion Shelf and a 3TB Primary Shelf

- 6 Connect the cable that was not completely connected to the left-most SAS port to canister B in the existing Expansion Shelf as shown.

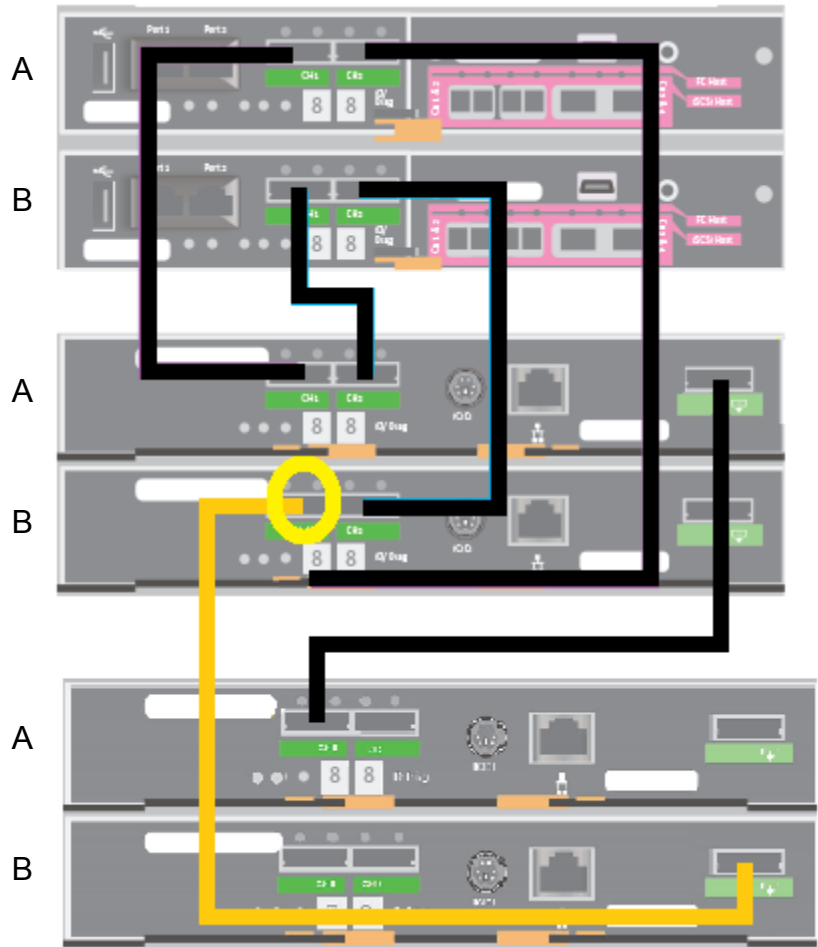

Connecting a second Expansion Shelf to an existing 3TB Expansion Shelf and a 3TB Primary Shelf

- 7 Connect the cable that was disconnected from canister B of the existing Expansion Shelf to the left port in canister B of the second Expansion Shelf.

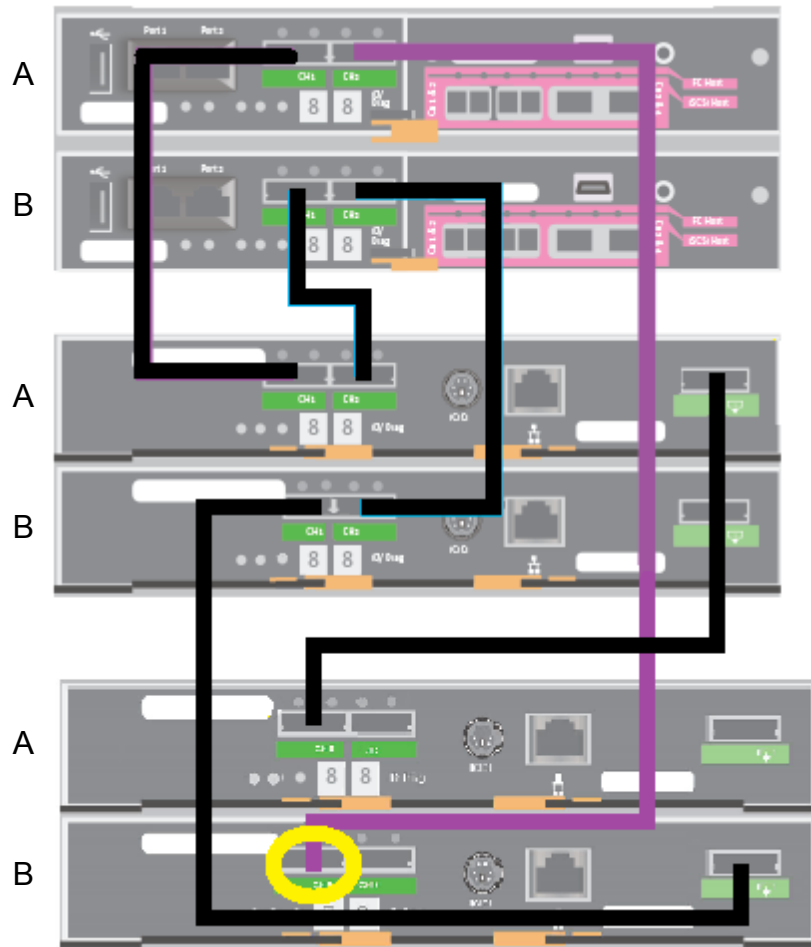

Connecting a second Expansion Shelf to an existing 3TB Expansion Shelf and a 3TB Primary Shelf

- 8 Disconnect the cable from the existing Expansion Shelf, canister B, port 1.

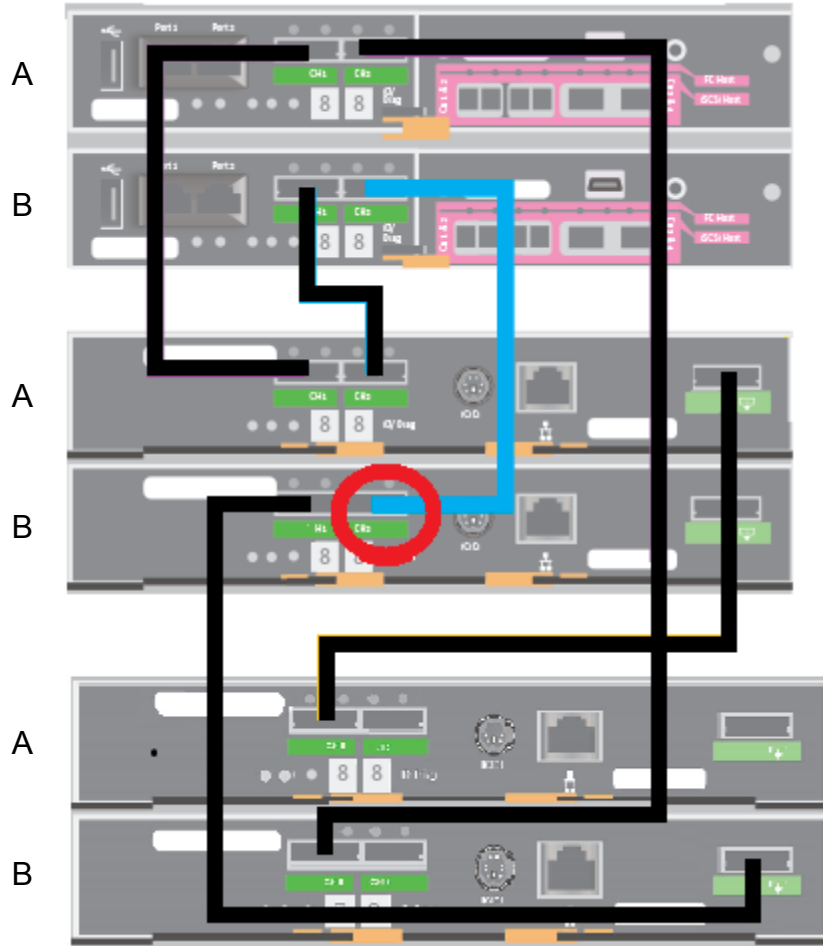

- 9 Connect the cable to the second Expansion Shelf, canister B, port 1, as shown.

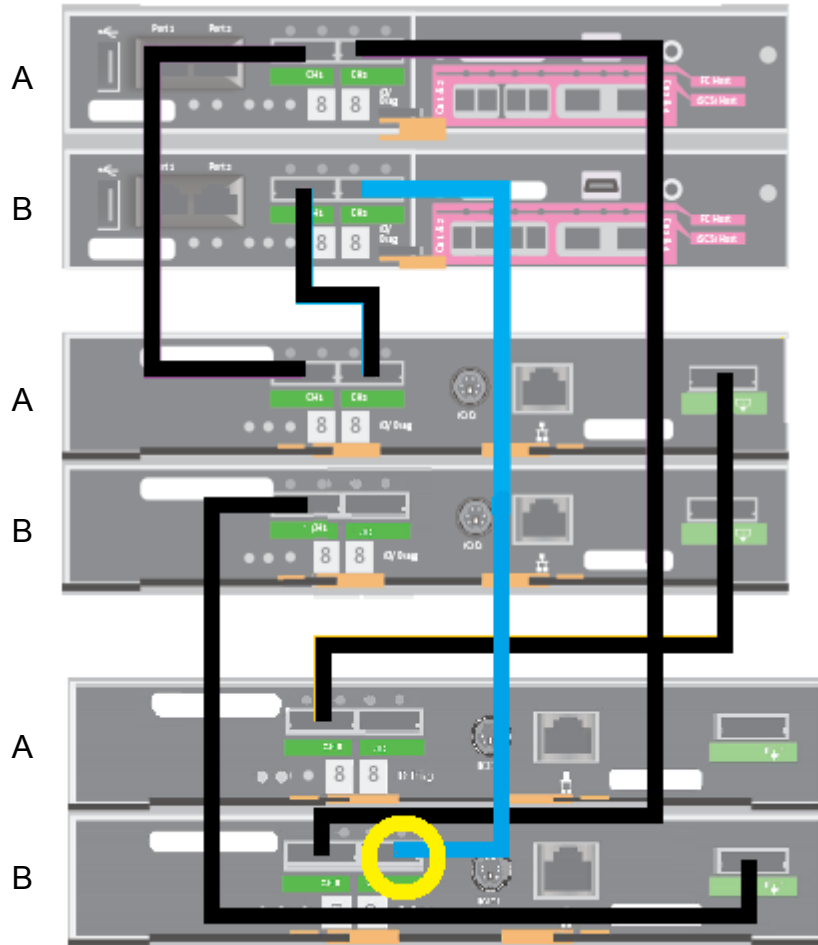

Connecting a second Expansion Shelf to an existing 3TB Expansion Shelf and a 3TB Primary Shelf

- 10** Verify that all cables are connected correctly, as shown in the following two illustrations.

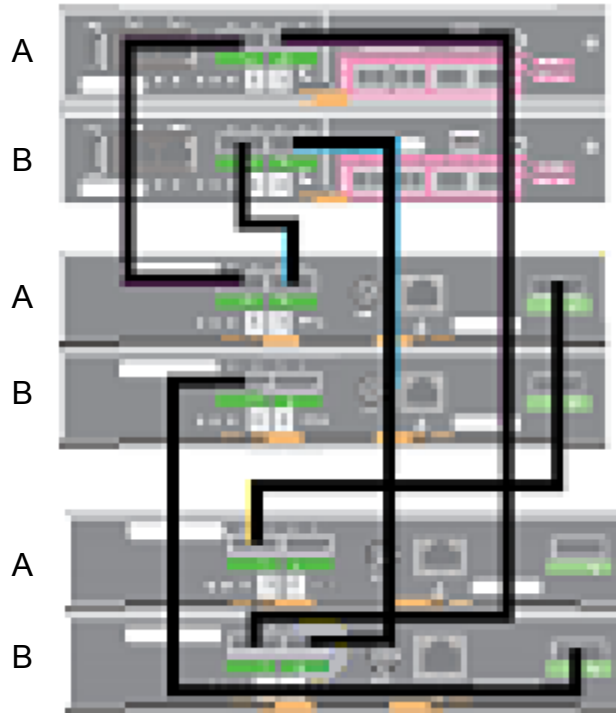

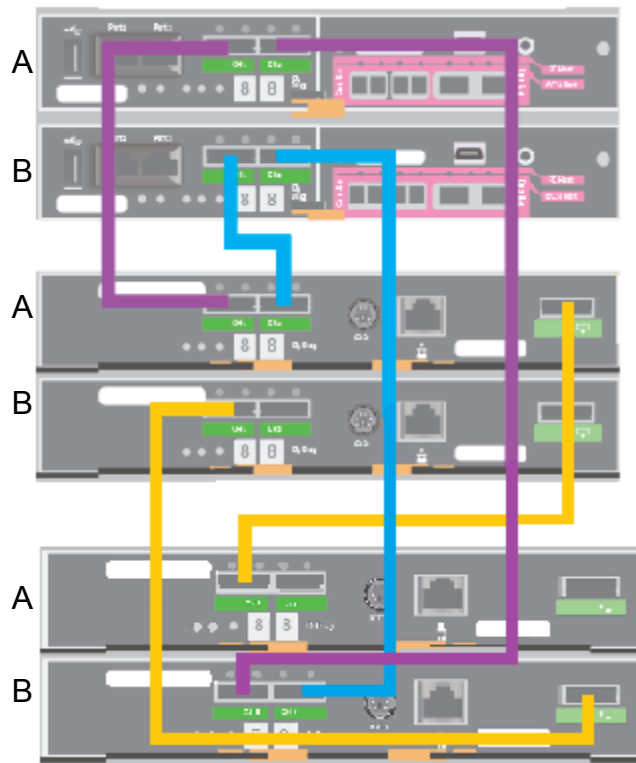

- 11** Refer to the following section to turn on all devices in the proper order. It is very important to turn on the devices in the correct sequence; second Expansion Shelf, initial Expansion Shelf, Primary Shelf, compute node.
See “Turning on the hardware and verifying operation” on page 68.
- 12** When all devices are operational, add the storage disk space to the appliance system.
See “Adding the disk space of a new Expansion Storage Shelf” on page 81.

Connecting the power cords to the hardware

Each compute node and each storage shelf contain two AC power supplies. To ensure power redundancy, connect the power supplies on each component to different AC power sources.

Typically, the rear of a rack is configured with a Power Distribution Unit (PDU) on each side. The PDU on each side is from a different source to provide power redundancy.

Caution: Do not turn on the power to any components while connecting the power cords. The components must be turned on in a specific sequence to ensure correct communication. Instructions that are referenced at the end of this topic contain the sequence that you must follow.

To connect the power cables

- 1 Refer to the following section for a description of C-13/C-14 and C-19/C-20 power cable connectors as needed.
See “NetBackup 5330 cables and connectors” on page 15.
- 2 Verify that the AC power supply input for the compute node is within one of these ranges:
 - 100 - 127 VAC at 50/60 Hz, 8.2 A
 - 200 - 240 VAC at 50/60 Hz, 4.4 A
- 3 Verify that the AC power supply input for the storage shelves is within the range of 200 - 240 VAC at 50/60 Hz, 9.13 - 10.95 A.
- 4 For each component, obtain two power cords that are appropriate for your region and equipment.
- 5 On the compute node, connect a power cord to each power supply socket. Connect the other end of each cord to a different PDU.

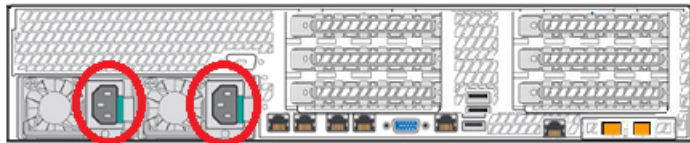

- 6 On the Primary Shelf, connect a power cord to each power supply socket. Connect the other end of each cord to a different PDU.

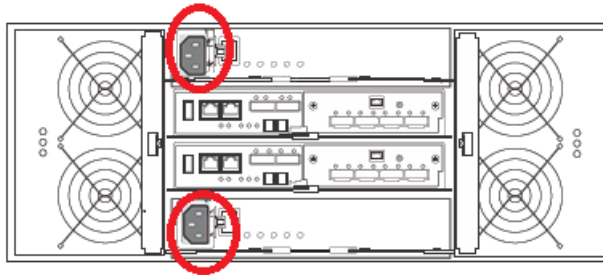

- 7 On the Expansion Shelf, connect a power cord to each power supply socket. Connect the other end of each cord to a different PDU.

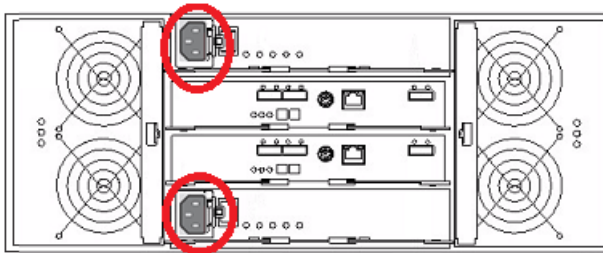

See “Turning on the hardware and verifying operation” on page 68.

Turning on the hardware and verifying operation

The hardware components must be turned on in a specific sequence to ensure correct communication between them.

The correct sequence is as follows:

1. Expansion Storage Shelf (if installed)
2. Primary Storage Shelf
3. NetBackup 5330 compute node

To turn on the components and verify operation

- 1 Check and verify that the following cables are connected properly and securely:
 - Data and network cables on the compute node

- Fiber Channel (FC) cables between the compute node and the Primary Shelf
 - SAS cables between the Primary Shelf and the Expansion Shelf
 - Power cords from each component to the appropriate Power Distribution Unit (PDU) in the rack
- 2 On the rear of the Expansion Shelf, turn on both power switches.

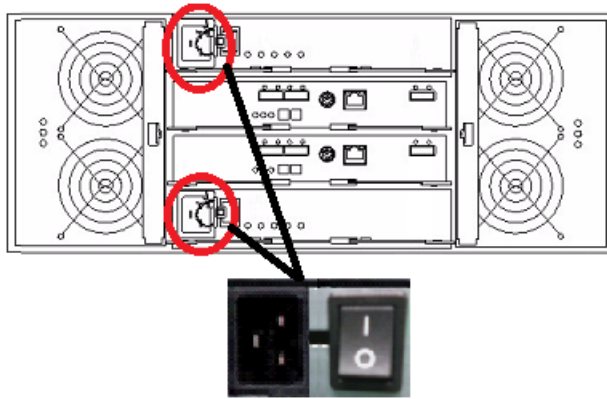

- 3 Verify that the left-most LEDs on both power canisters are green.

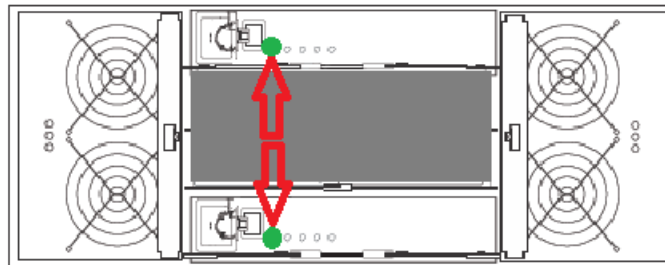

- 4 Verify that the Power LED on the front, left, of the shelf is green.

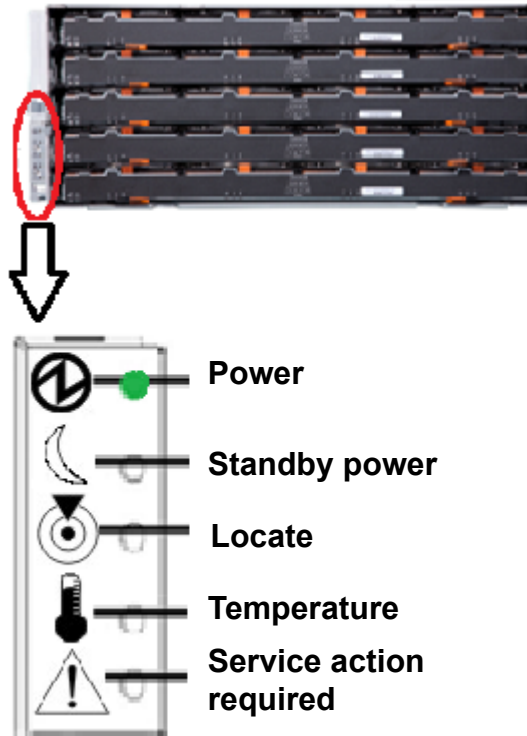

- 5 After approximately 5 to 10 minutes, verify that the shelf has fully initialized as follows:
 - The 12 disk LEDs on the front of each drawer are green.



- The blue Service Action Allowed LED is not lit.

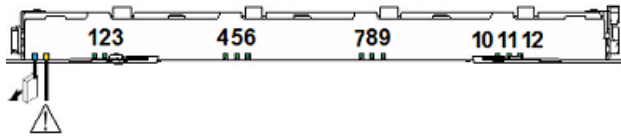

- The amber Service Action Required LED is not lit.

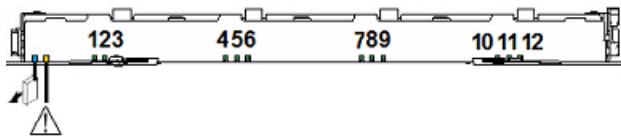

- The two seven-segment numbers on the rear of the shelf show the shelf ID.

For the new Expansion Storage Shelf, this number should be 01.

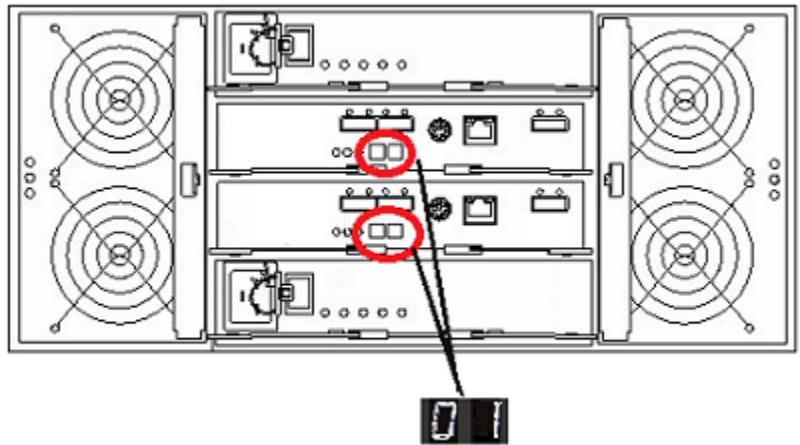

For the original Expansion Storage Shelf, this number should be 00.

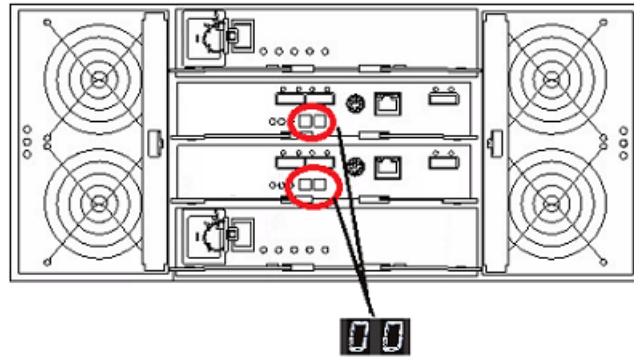

- 6 On the rear of the Primary Shelf, turn on both power switches.

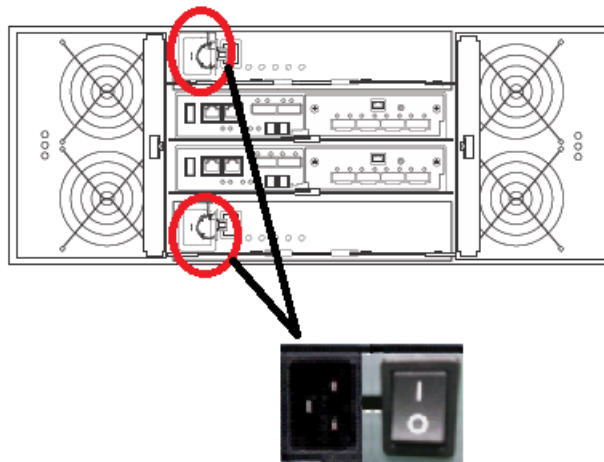

- 7 Verify that the left-most LEDs on both power canisters are green.

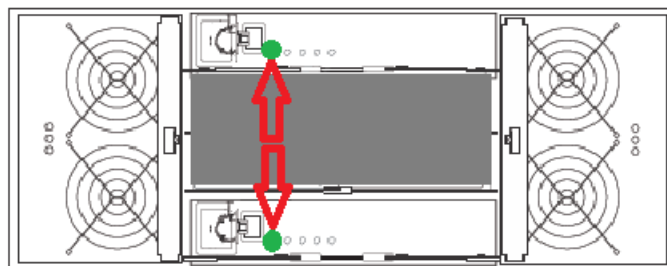

- 8 Verify that the Power LED on the front, left, of the shelf is green.

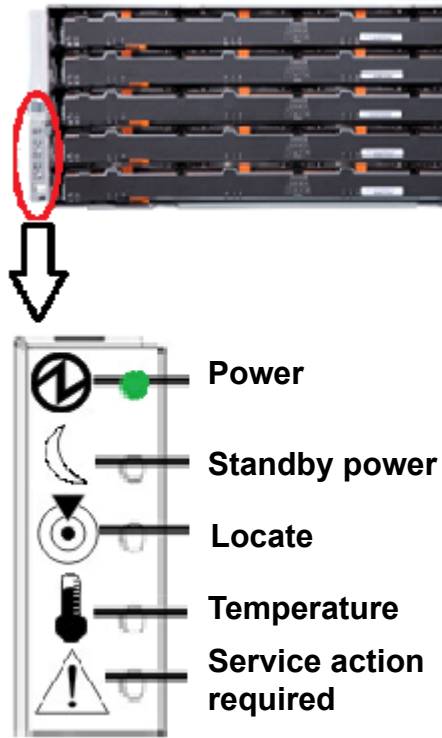

- 9 After approximately 5 to 10 minutes, verify that the shelf has fully initialized as follows:

- The 12 disk LEDs on the front of each drawer are green.



- The blue Service Action Allowed LED is not lit.

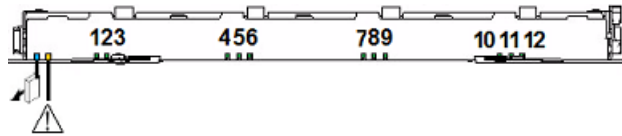

- The amber Service Action Required LED is not lit.

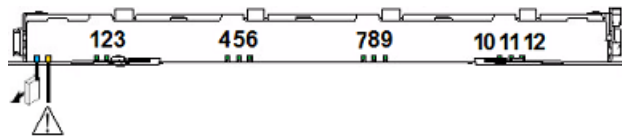

- 10 The two seven-segment numbers on the rear of the shelf show the shelf ID. For the Primary Storage Shelf, this number should be 99.

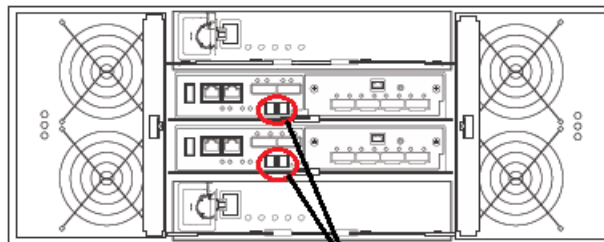

99

- 11 On the front right panel of the compute node, press the power button to turn on the compute node.

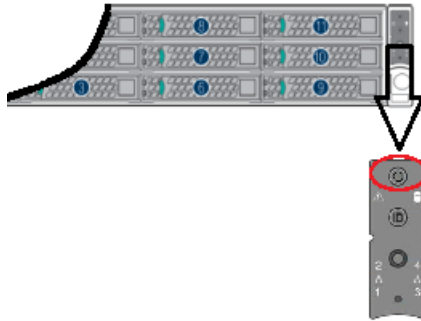

- 12 After a few minutes, verify that the compute node has fully initialized as follows:

- On the right front panel of the compute node, locate the triangular Status LED near the top of the LED panel. The LED should be green during normal operations.

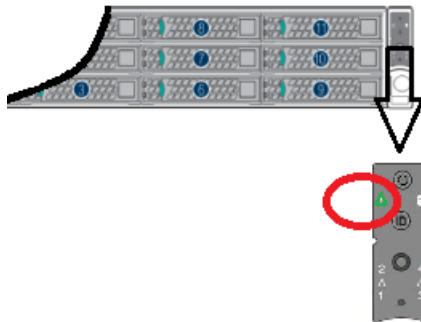

- Verify that the disk drive LEDs have initialized properly as follows:



The Status LED (1) should not be lit. The following indications are also possible:

- A solid, amber, LED indicates a disk fault.

- A blinking, amber LED indicates that a RAID rebuild is in progress. The Activity LED (2) indicates the following:
 - The LED is not lit when the disk has spun down, although power is still on.
 - The LED is solid green when there is no disk activity, although power is still on.
 - The LED blinks green when the disk spins up.
 - The LED blinks green occasionally when commands are processed.
- 13** Launch the NetBackup Appliance Web Console and verify that all devices appear on the **Monitor > Hardware** page. If the devices do not appear, check the cable connections and make sure that the power is on.
- 14** Proceed to the initial configuration of the appliance. Refer to instructions at the following site: https://veritas.com/support/en_US/article.DOC2792.html

Configuring the IPMI from the NetBackup Appliance Shell Menu

This section explains how to configure IPMI from the NetBackup Appliance Shell Menu.

To configure IPMI from the NetBackup Appliance Shell Menu

- 1** Before starting the IPMI configuration, obtain the following information for the appliance for which you want to configure the IPMI:

IP address	IP address for the remote management port so that the default static IP address of the remote management port can be changed.
Subnet mask	Enable connectivity between your network computer and the remote management port.
Gateway IP address	Enable connectivity between your network computer and the remote management port.

Also review the following section on IPMI prerequisites.

See “Prerequisites for IPMI configuration” on page 31.

- 2** Log on to the NetBackup Appliance Shell Menu.
- 3** Enter the username and password for the appliance. By default, the user name is `admin` and the password is `P@ssw0rd` where 0 is the number zero.

4 At the **Main_Menu** prompt, type **Support** to navigate to the **Support** menu.

5 From the **Main_Menu > Support** view, enter the following command to configure the remote management port:

```
IPMI Network Configure <IPAddress> <Netmask> <GatewayIPAddress>
```

where *IP address* is the new IP address of the remote management port. The Subnet mask and Gateway enable connectivity between your network computer and the remote management port.

The remote management port must be configured as a DHCP or static address.

At any point in time, you can run the following command to see the IPMI network details:

```
IPMI Network Show
```

6 Enter the following command if you want to add a new user to access the IPMI sub-system:

```
IPMI User Add <User_Name>
```

At the **New Password** prompt, enter a password for the user.

The default user name is **sysadmin**. The default password is **P@ssw0rd**, where **0** is the number zero.

At any point in time, you can run the following command to view the users who can access the IPMI:

```
IPMI User List
```

7 Type **Return** to return to the **Main_Menu** prompt.

8 Use a Cat5 cable to connect the IPMI port to the network.

9 The appliance is ready for initial configuration. See the *NetBackup Appliance Initial Configuration Guide* for the appropriate platform for information about initial configuration requirements and procedures.

See “About IPMI configuration” on page 19.

See “Configuring the IPMI from the NetBackup Appliance Shell Menu” on page 76.

See “Accessing and using the Remote Management interface” on page 78.

Accessing and using the Remote Management interface

The IPMI Web interface is known as Remote Management in NetBackup 5220 and later appliances: You can use the Remote Management interface to log on to the NetBackup Appliance Shell Menu.

Before you use the Remote Management interface, the following prerequisites must be met:

- The Remote Management interface must first be configured using the NetBackup Appliance Shell Menu.
- At least one power cable must be connected to a functioning power source.
- At least one user must be enabled to use the LAN channel(s).

To access and use the IPMI Web interface from a remote computer

- 1 Log on to a remote computer in the network and open a supported Windows browser.
- 2 Enter the remote management port IP address assigned to the remote management port. The following page appears:

Remote Management



Please log in to access the device.

Username

Password

Login

- 3 Enter your login information. The default user name is **sysadmin**. The default password is **P@ssw0rd**, where **0** is the number zero.
Click **Login**.

- The **Remote Control** section lets you remotely monitor and control the server. Click **Launch Console** under the **Console Redirection** tab to launch the appliance NetBackup Appliance Shell Menu.

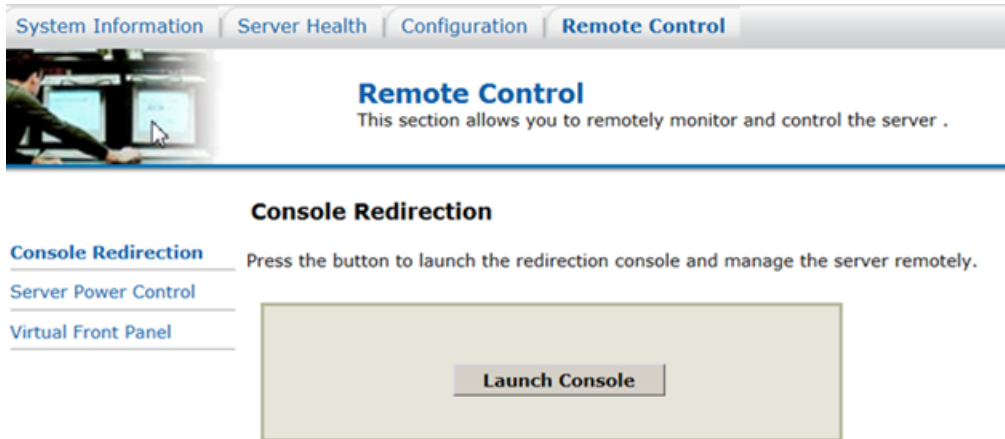

- This opens a JViewer application that enables you to remotely monitor and control the appliance. This requires Java Runtime Environment (JRE) version 6.0 or later. Install Java (as needed).

Caution: Starting with Java 7 update 45, you may receive a security warning when you launch the KVM remote console from the appliance IPMI port. The warning states that you do not have proper permissions and prevents appliance access from the IPMI port. For information about how to resolve this issue, refer to the following document:

<http://www.veritas.com/support/TECH212531>

- You can now access and log on to the shell menu. Enter the user name and password for the NetBackup appliance.

By default, the user name `admin` has the password, `P@ssw0rd` where 0 is the number zero.

See “About IPMI configuration” on page 19.

See “Configuring the IPMI from the NetBackup Appliance Shell Menu” on page 76.

Adding the disk space of a new Expansion Storage Shelf

This appendix includes the following topics:

- Prerequisites for adding the disk space of new Expansion shelves
- Adding the disk space of an Expansion Storage Shelf from the NetBackup Appliance Web Console
- Adding the disk space of an Expansion Storage Shelf from the NetBackup Appliance Shell Menu

Prerequisites for adding the disk space of new Expansion shelves

Verifying functionality

Before you add the disk space of a new Expansion Shelf you must make sure that the entire appliance system operates correctly.

To verify appliance functionality

- 1 Verify that the compute node power supply LEDs are green.

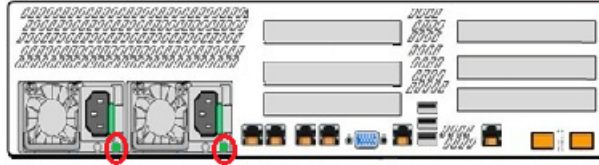

- 2 Verify that the compute node disk drive LEDs are green.



- 3 Verify that the compute node LEDs on the front panel are green.

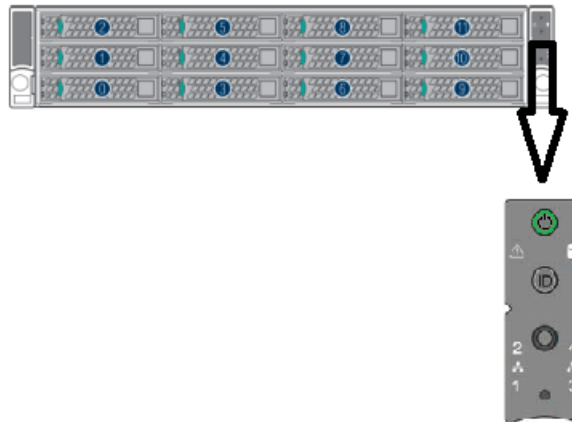

- 4 Verify that Primary and Expansion Shelf front panel LEDs are green.

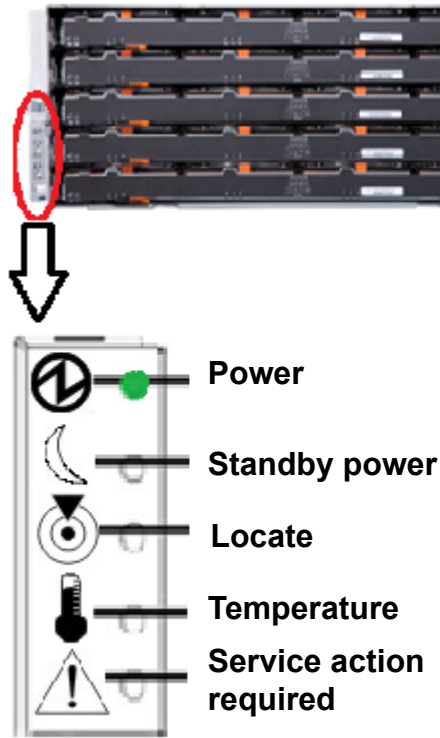

- 5 Verify that Primary and Expansion Shelf drawer LEDs are green.



- 6 Verify that Primary and Expansion Shelf power canister LEDs are green.

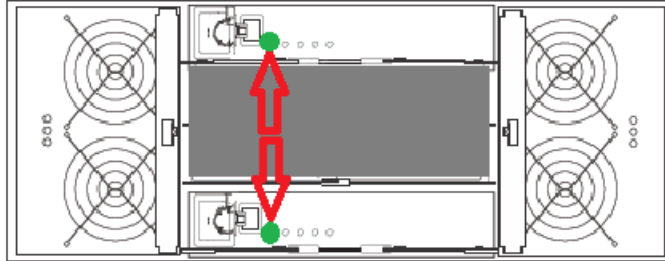

- 7 Verify that Primary and Expansion Shelf fan canister LEDs are green.
- 8 Verify that the Primary Shelf displays 99.

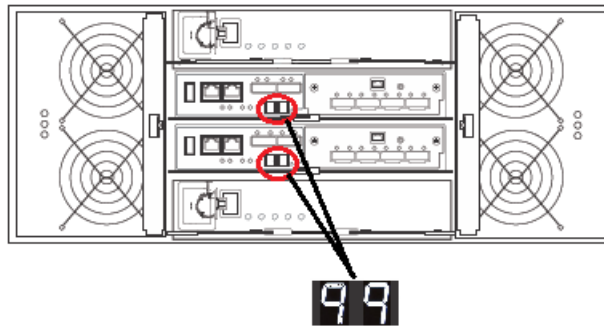

- 9 Verify that the first Expansion Shelf displays 00.

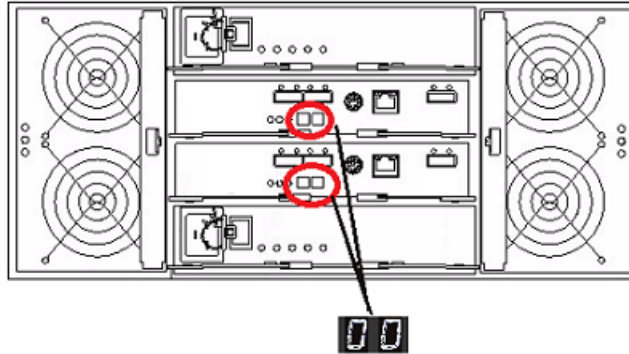

- 10 Verify that the second Expansion Shelf displays 01.

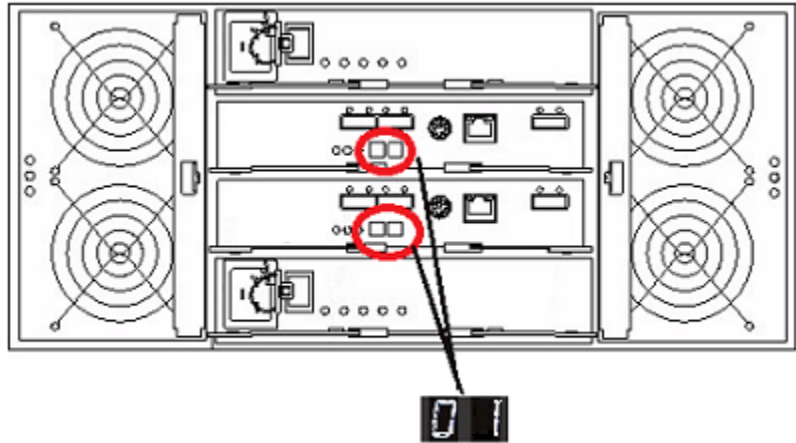

Adding the disk space of an Expansion Storage Shelf from the NetBackup Appliance Web Console

The following procedure describes how to add new storage shelf disk space to an operational 5330 NetBackup appliance using the NetBackup Appliance Web Console.

To add the disk space of an expansion shelf from the NetBackup Appliance Web Console

- 1 Launch the NetBackup Appliance Web Console and verify that the new storage device appears on the **Monitor > Hardware** page. If the new storage device does not appear, check the cable connections and make sure that the power is on.
- 2 Click **Manage > Storage**.
- 3 Select the **Disks** tab.
- 4 Click **Scan**.
- 5 In the **Do you want to scan for new disks?** dialog box, click **Yes** to start the scan.
- 6 When the scan is complete, click **OK** to refresh the **Disks** tab.

In the **Disk** column, new ID's should appear for the new Expansion Shelf. 6 new Data disks and 1 new Meta disk is displayed. The data disks have the following attributes:

- **Type = Data.**
- **Status = New Available**

The Meta disk has the following attributes:

- **Type = Meta**
- **Status = New Available**

- 7 Click **Add** for each newly available disk to activate the storage.
- 8 In the **Confirmation** dialog box, click **Yes** to continue.

When the process completes, the following message should appear:

Adding disk <disk ID>. Succeeded.

- 9 Click **OK** to refresh the system.

Repeat steps 7 through 9 to add each new disk.

After the disks have been added, the **Disks** tab should show the following attributes for the new disks:

- **Status = In Use**
- **Unallocated = n TB**

Where n is the usable volume or disk space available in the new disk.

Adding the disk space of an Expansion Storage Shelf from the NetBackup Appliance Shell Menu

The following procedure describes how to add new storage shelf disk space to a 5330 appliance using the NetBackup Appliance Shell Menu.

To add the disk space of an expansion shelf from the NetBackup Appliance Shell Menu

- 1 Use PuTTY to start an SSH session to access the NetBackup Appliance Shell Menu.

Note: You can also connect a laptop, keyboard and monitor, or KVM to the appliance to access the NetBackup Appliance Shell Menu.

- 2 Log in to the NetBackup Appliance Shell Menu. The **Main_Menu** prompt appears.
- 3 Navigate to the **Monitor** menu as follows:
Enter `Monitor` and press `Enter`.
- 4 Type `Hardware ShowHealth` and press `Enter`.
Information about the system appears. Browse to the **Primary Storage Shelf to Expansion Storage Shelf Connection information**. The **Status** column should say **Connected**.
- 5 At the prompt, type **return** to return to the Main menu.
- 6 Perform a scan as follows:
 - At the **Main_Menu** prompt, type `Manage` and press `Enter`.
 - Type `Storage` and press `Enter`.
 - Type `Scan` and press `Enter`.The scan takes a couple of minutes to complete.
- 7 View the available storage space as follows:
 - Navigate to the **Storage** menu.
 - At the prompt, type `Show Disk` and press `Enter`.
Note that you can add the disks with status **New Available**.
- 8 From the **Storage** menu, enter `Add` and press `Enter`. It displays the disks that are in a **New Available** state and can be added. Copy a disk ID that is displayed.

Adding the disk space of an Expansion Storage Shelf from the NetBackup Appliance Shell Menu

- 9 At the prompt, enter **add <disk ID>** and press `Enter`. <disk ID> is the disk ID that you copied.

Repeat step 8 and 9 to add each disk ID that is displayed.

- 10 View the available storage space as follows:

- Navigate to the **Storage** menu.
- At the prompt, enter `Show Disk` and press `Enter`.
The status of the newly added disks is displayed as **In Use** and space in the **Unallocated** column is the disk space available for the new disk.

Index

A

- add disk space of additional storage shelf
 - from NetBackup Appliance Shell Menu 87
 - from NetBackup Appliance Web Console 85

B

- best practices
 - hardware installation 30
 - turning off the power 55

C

- compute node
 - connecting to Primary Shelf 49
 - installation 44
 - unpacking 27
- configure
 - IPMI 76
- connectors
 - C-13 and C-14 15
 - C-19 and C-20 15
- customer-provided items 24

D

- disk drives
 - NetBackup 5330 compute node 9
 - NetBackup 5330 Primary and Expansion shelves 13
 - slot numbers
 - storage system 41
 - storage shelf
 - installing 41
 - storage shelves
 - layout 41

E

- Ethernet ports
 - NetBackup 5330 configurations 11

H

- hardware
 - correct turn on sequence 68
 - rack locations 29
 - verifying operation 68

I

- installation
 - compute node 44
 - customer-provided items 24
 - Expansion Shelf 34
 - Primary Shelf 34
 - storage shelf disks 41
 - storage shelf into rails 40
 - storage shelf rails 36
- installation sequence
 - NetBackup 5330 hardware 17
- installation time
 - NetBackup 5330 compute node 17
 - NetBackup 5330 storage shelves 17
- IPMI configuration 76
 - about 19
 - prerequisites 31

N

- NetBackup 5330 compute node
 - PCIe add-in cards 10
- NetBackup 5330 hardware
 - installation sequence 17

P

- PCIe add-in cards
 - NetBackup 5330 compute node configurations 10
- power cords
 - connecting to compute node 66
 - connecting to storage shelves 66
- power supply
 - NetBackup 5330 compute node input voltage 10
 - NetBackup 5330 Primary and Expansion shelves 13, 15

Primary Shelf
 connecting to compute node 49

R

rack locations 29

S

SAS cable 30

shipping container contents 23

storage shelves

 disk drives

 installing 41

 layout 41

 slot numbers 41

 unpacking 25

U

unpack

 compute node 27

 storage shelves 25