

# Veritas Access 3340 Appliance Hardware Installation Guide

# Veritas Access 3340 Appliance Hardware Installation Guide

Last updated: 2018-03-05

## Legal Notice

Copyright © 2018 Veritas Technologies LLC. All rights reserved.

Veritas and the Veritas Logo are trademarks or registered trademarks of Veritas Technologies LLC or its affiliates in the U.S. and other countries. Other names may be trademarks of their respective owners.

This product may contain third-party software for which Veritas is required to provide attribution to the third party ("Third-party Programs"). Some of the Third-party Programs are available under open source or free software licenses. The License Agreement accompanying the Software does not alter any rights or obligations you may have under those open source or free software licenses. Refer to the Third-party Legal Notices document accompanying this Veritas product or available at:

<https://www.veritas.com/about/legal/license-agreements>

The product described in this document is distributed under licenses restricting its use, copying, distribution, and decompilation/reverse engineering. No part of this document may be reproduced in any form by any means without prior written authorization of Veritas Technologies LLC and its licensors, if any.

THE DOCUMENTATION IS PROVIDED "AS IS" AND ALL EXPRESS OR IMPLIED CONDITIONS, REPRESENTATIONS AND WARRANTIES, INCLUDING ANY IMPLIED WARRANTY OF MERCHANTABILITY, FITNESS FOR A PARTICULAR PURPOSE OR NON-INFRINGEMENT, ARE DISCLAIMED, EXCEPT TO THE EXTENT THAT SUCH DISCLAIMERS ARE HELD TO BE LEGALLY INVALID. VERITAS TECHNOLOGIES LLC SHALL NOT BE LIABLE FOR INCIDENTAL OR CONSEQUENTIAL DAMAGES IN CONNECTION WITH THE FURNISHING, PERFORMANCE, OR USE OF THIS DOCUMENTATION. THE INFORMATION CONTAINED IN THIS DOCUMENTATION IS SUBJECT TO CHANGE WITHOUT NOTICE.

The Licensed Software and Documentation are deemed to be commercial computer software as defined in FAR 12.212 and subject to restricted rights as defined in FAR Section 52.227-19 "Commercial Computer Software - Restricted Rights" and DFARS 227.7202, et seq. "Commercial Computer Software and Commercial Computer Software Documentation," as applicable, and any successor regulations, whether delivered by Veritas as on premises or hosted services. Any use, modification, reproduction release, performance, display or disclosure of the Licensed Software and Documentation by the U.S. Government shall be solely in accordance with the terms of this Agreement.

Veritas Technologies LLC  
500 E Middlefield Road  
Mountain View, CA 94043

<http://www.veritas.com>

## Technical Support

Technical Support maintains support centers globally. All support services will be delivered in accordance with your support agreement and the then-current enterprise technical support policies. For information about our support offerings and how to contact Technical Support, visit our website:

<https://www.veritas.com/support>

You can manage your Veritas account information at the following URL:

<https://my.veritas.com>

If you have questions regarding an existing support agreement, please email the support agreement administration team for your region as follows:

Worldwide (except Japan)

[CustomerCare@veritas.com](mailto:CustomerCare@veritas.com)

Japan

[CustomerCare\\_Japan@veritas.com](mailto:CustomerCare_Japan@veritas.com)

## Documentation

Make sure that you have the current version of the documentation. Each document displays the date of the last update on page 2. The latest documentation is available on the Veritas website:

<https://sort.veritas.com/documents>

## Documentation feedback

Your feedback is important to us. Suggest improvements or report errors or omissions to the documentation. Include the document title, document version, chapter title, and section title of the text on which you are reporting. Send feedback to:

[APPL.docs@veritas.com](mailto:APPL.docs@veritas.com)

You can also see documentation information or ask a question on the Veritas community site:

<http://www.veritas.com/community/>

## Veritas Services and Operations Readiness Tools (SORT)

Veritas Services and Operations Readiness Tools (SORT) is a website that provides information and tools to automate and simplify certain time-consuming administrative tasks. Depending on the product, SORT helps you prepare for installations and upgrades, identify risks in your datacenters, and improve operational efficiency. To see what services and tools SORT provides for your product, see the data sheet:

[https://sort.veritas.com/data/support/SORT\\_Data\\_Sheet.pdf](https://sort.veritas.com/data/support/SORT_Data_Sheet.pdf)

# Contents

<b>Chapter 1</b>	<b>Overview</b> .....	<b>6</b>
	Access 3340 compute node and 5U84 storage shelves .....	6
	Access 3340 compute node disk drives .....	7
	Access 3340 compute node control panel .....	8
	Access 3340 compute node rear panel .....	9
	5U84 storage shelf drawers and disk drives .....	11
	5U84 storage shelf control panel .....	12
	5U84 storage shelf rear panel .....	14
	5U84 storage shelf RAID controller .....	14
	5U84 storage shelf Expansion module .....	15
	Cables and connectors .....	15
<b>Chapter 2</b>	<b>Pre-installation requirements</b> .....	<b>17</b>
	Customer-provided environment and supplies .....	17
	Storage shelf shipping container contents .....	18
	Compute node shipping container contents .....	19
	Dimensions and determining rack locations .....	19
	Best practices for rack installation .....	23
	Heat dissipation guidelines .....	24
	Cable length verification .....	25
	Prerequisites for IPMI configuration .....	25
<b>Chapter 3</b>	<b>Hardware installation procedures</b> .....	<b>27</b>
	Overview .....	27
	Installing a storage shelf .....	28
	Installing disk drives into a storage shelf .....	38
	Installing the compute node rack rails .....	41
	Installing the compute node into a rack .....	46
	Connecting the hardware to two nodes .....	48
	Connecting to the network .....	64
	Connecting the power cords to the hardware .....	66
	Turning on the hardware and verifying operation .....	68
	Configuring the IPMI port from the Access Appliance shell menu .....	71
	Accessing and using the Veritas Remote Management interface .....	74

Appendix A	Configuring the disk space after adding one or more new Expansion Storage Shelves .....	76
	Adding the disk space of an Expansion Storage Shelf from the Access 3340 Appliance shell menu .....	76

# Overview

This chapter includes the following topics:

- [Access 3340 compute node and 5U84 storage shelves](#)
- [Access 3340 compute node disk drives](#)
- [Access 3340 compute node control panel](#)
- [Access 3340 compute node rear panel](#)
- [5U84 storage shelf drawers and disk drives](#)
- [5U84 storage shelf control panel](#)
- [5U84 storage shelf rear panel](#)
- [5U84 storage shelf RAID controller](#)
- [5U84 storage shelf Expansion module](#)
- [Cables and connectors](#)

## Access 3340 compute node and 5U84 storage shelves

The Veritas 5U84 storage shelves provide storage capacity to the two Access 3340 compute nodes. You must have a Primary Storage Shelf that connects to the compute nodes. You can use up to three optional Expansion Storage Shelves for additional storage.

With the required 5U84 Primary Storage Shelf, the compute nodes operate at 220 VAC at 3.1 A with C13 and C14 connectors. The storage shelves require 200 - 220 VAC at 6.67 A with C19 and C20 connectors.

Before you install the hardware, refer to the following section for important details about the dimensions of the hardware.

See “[Dimensions and determining rack locations](#)” on page 19.

Each compute node is two rack units (2RU) high.



Each storage shelf is 5RU high and contains 2 drawers with 42 disk drive slots per drawer.



The rear of the Primary shelf includes two redundant RAID controller I/O modules. The controller modules connect the Primary shelf to the compute nodes. Each module has a SAS3 Expansion port for connection to Expansion Storage Shelves.

The Expansion shelves contain two I/O modules for connectivity to the Primary shelf and to other Expansion shelves.

Refer to the *Veritas Access 3340 Appliance Product Description* at the following site for details about usable storage capacity.

[Appliance documentation](#)

## Access 3340 compute node disk drives

The front panel of the compute node contains 12 disk drive slots. The slots are numbered from zero in the lower left corner to 11 in the upper right corner.



The disk drive functions are as follows.

- Slots 0 and 1 - RAID-1 OS volume
- Slot 2 - hot spare
- Slots 3 through 11 - blank

The disk drives in the compute node do not provide usable storage capacity.

## Access 3340 compute node control panel

A control panel is located on the right front side of the compute node. The following table describes the components of the control panel.

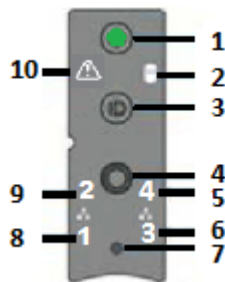

Number	Component	Description
1	Power button with integrated LED	The System Status LED uses the colors green and amber to display the health of the compute node.
2	Hard Drive Activity LED	The drive activity LED on the front panel indicates drive activity from the on-board hard disk controllers.
3	System ID button with integrated LED	The System ID button toggles on the integrated ID LED and the blue server board LED and off. The system ID LED identifies the system for maintenance when it is racked with similar server systems.



<b>Number</b>	<b>Component</b>	<b>Description</b>
4	System Cold Reset Button (recessed, tool required)	When depressed, the System Cold Reset button restarts and re-initializes the appliance. Veritas recommends that you do not use this button.
5	NIC-4 Activity LED	The NIC LEDs represent a network interface controller. When network links are detected on the controllers, the LEDs are activated and remain on. The LEDs blink when network activity occurs. The amount of network activity determines the rate of blinking.
6	NIC-3 Activity LED	
8	NIC-1 Activity LED	
9	NIC-2 Activity LED	
7	NMI button (recessed, a tool is required for use)	When the NMI button is depressed, the appliance goes into a halt state, and issues a non-maskable interrupt (NMI). This feature is useful when you perform diagnostics for a given issue where a memory dump is necessary to help determine the cause of the problem. To prevent an inadvertent system halt, the NMI button is located behind the front control panel faceplate. It is only accessible with the use of a small-tipped tool.
10	System Status LED	<p>The System Status LED is bi-color indicator that uses the colors green and amber to display the current health of the compute node.</p> <p>Two locations are provided for you to monitor the health of the system. You can find the first location on the front control panel. The second location is located on the back edge of the server board. It is viewable from the rear of the appliance. Both LEDs show the same state of health.</p>

## Access 3340 compute node rear panel

The rear panel of the compute node contains several components and default ports.

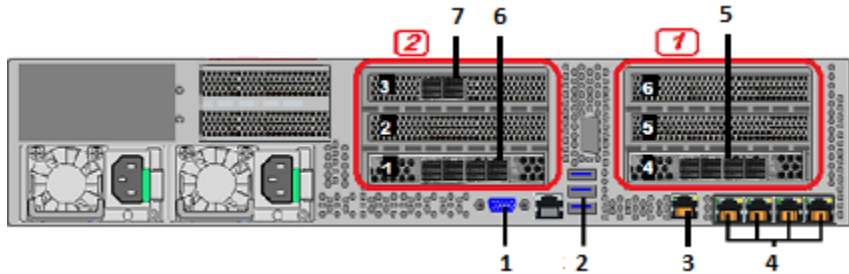

The PCIe riser assemblies that are outlined in red are numbered 1 and 2 from right to left. Slots 1 through 6 are shown in the risers.

The following list describes the numbered items.

1. VGA port
2. Three USB ports
3. IPMI remote management port
4. Four copper, RJ45, 1Gb Ethernet\* ports, NIC1/eth0, NIC2/eth1, NIC3/eth2, and NIC4/eth3, left to right.
5. Riser Assembly 1, Slot 4, contains a SAS3 HBA card that connects to the SAS3 ports on the Primary Storage Shelf.
6. Riser Assembly 2, Slot 1, contains a SAS3 HBA card that connects to the SAS3 ports on the Primary Storage Shelf.
7. One two-port 10GbE network interface card (NIC). From left to right the ports are NIC5/eth4 and NIC6/eth5.

The following diagram shows the location of the Ethernet ports, from 0 to 5.

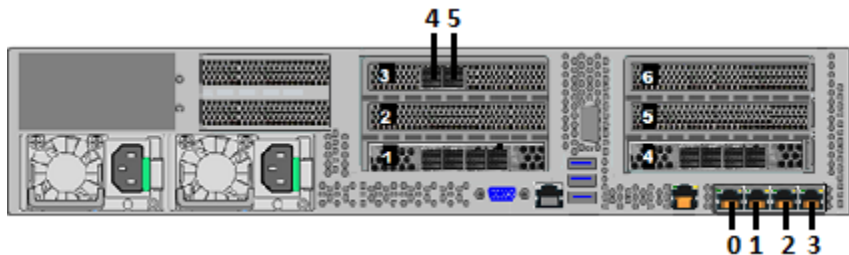

---

**Note:** \* The embedded Ethernet ports are copper. PCIe Ethernet ports are fibre. You cannot bond the copper ports and the fibre ports to each other.

---

# 5U84 storage shelf drawers and disk drives

Each storage shelf includes 2 drawers with 42 disk drive slots each for a total of 84 slots. The following diagrams describe the disk layout for the top drawer and the bottom drawer. The slot numbers start at the front left side of the drawer. Slot numbers end in the last row at the right rear of the drawer. The top drawer contains slots 0 through 41. The bottom drawer contains slots 42 through 83.

The following diagrams show all of the slots in each drawer. The photographs show the number of the first slot in each drawer.

In the top drawer, slot 41 contains a blank carrier instead of a carrier with a disk drive. The blank carrier is shown in blue.

Top drawer, rear

28	29	30	31	32	33	34	35	36	37	38	39	40	41
14	15	16	17	18	19	20	21	22	23	24	25	26	27
0	1	2	3	4	5	6	7	8	9	10	11	12	13

Top drawer, front

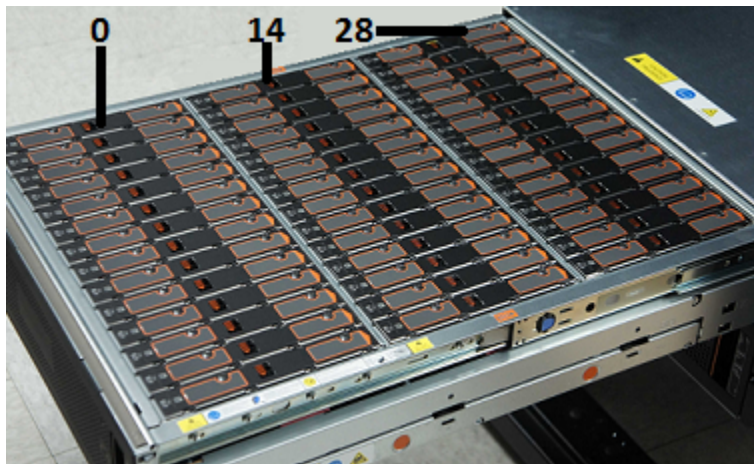

In the bottom drawer, slot 83 contains a blank carrier instead of a carrier with a disk drive. The blank carrier is shown in blue.

Bottom drawer, rear

70	71	72	73	74	75	76	77	78	79	80	81	82	83
56	57	58	59	60	61	62	63	64	65	66	67	68	69
42	43	44	45	46	47	48	49	50	51	52	53	54	55

Bottom drawer, front



Disk drives are not preconfigured prior to shipping. Any drive can be placed into any slot. After you have configured the nodes and storage shelves you cannot move disk drives to new locations.

Each disk drive is encased in a carrier. A label at the top, front end of the carrier identifies the storage capacity of the disk that is inside the carrier. Carriers that contain blanks are labelled "BLANK."

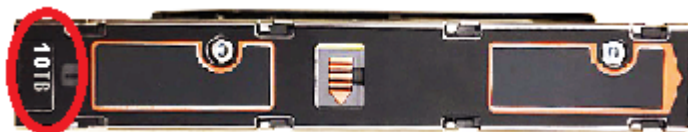

## 5U84 storage shelf control panel

The following table explains the components in the storage shelf control panel.

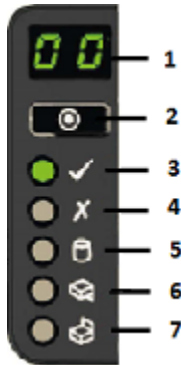

Number	Component	Description
1	Unit identification (ID) display	A numerical display that helps when setting up and maintaining multiple storage shelves. The Primary shelf has a default value of 00. The first Expansion shelf has a value of 01. Subsequent Expansion shelves have a value of 02 and 03.
2	Input switch	Used to set the unit identification display.
3	Power LED	Amber when the system is in standby mode. Green when the system is on.
4	Module fault LED	Amber when there is a system hardware fault.  An LED may be lit on a power supply, drawer, disk carrier, cooling module, or I/O module to identify which component is at fault.
5	Logical status LED	Shows a change of status or a fault. Typically these changes of status or faults are associated with the shelf's disk drives. However, the Logical Status LED can also indicate an issue with an internal RAID controller or external RAID controller, or with a host bus adapter.
6	Drawer 1 fault LED	Indicates a drive, cable, or sideplane fault in Drawer 1, the top drawer.
7	Drawer 2 fault LED	Indicates a drive, cable, or sideplane fault in Drawer 2, the bottom drawer.

## 5U84 storage shelf rear panel

The rear panel of a 5U84 storage shelf contains the following components:

- Two I/O module slots, which contain either redundant RAID controllers or Expansion modules. (Item 1)
- Five cooling modules (Item 2)
- Two power supply units (PSUs) (Item 3)

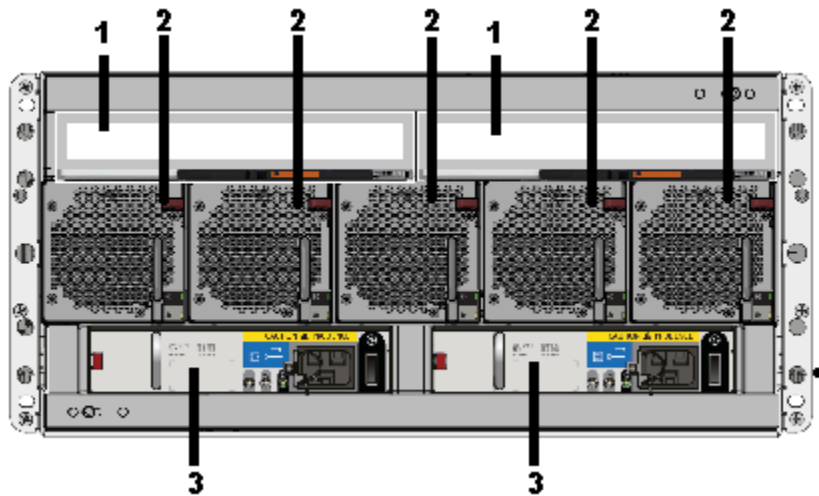

Each cooling module contains two fans. Cooling modules can be individually replaced but cannot be taken apart to replace only one fan.

Refer to the following sections for information about the I/O modules.

See [“5U84 storage shelf Expansion module”](#) on page 15.

## 5U84 storage shelf RAID controller

The Primary Storage Shelf contains two RAID controllers in I/O module slots. The controllers are labeled A and B, from left to right as you look at the rear panel of a shelf. Each controller has two sets of SAS3 ports. From left to right the SAS3 ports for each controller are labeled 3, 2, 1, and 0. The single SAS3 port on the left side of each RAID controller connects to a SAS3 port on the Expansion shelf.



## 5U84 storage shelf Expansion module

Each Expansion Storage Shelf contains two I/O modules. The modules are labeled A and B, from left to right as you look at the rear panel of a shelf. Each module has three SAS3 ports that are labeled A, B, and C from left to right.

A yellow label states that port B is for attachment to a server only. You cannot use this port without permission and assistance from Veritas Technical Support.

The SAS3 ports connect to the SAS port on each RAID controller on the Primary Shelf and to other Expansion Shelves.

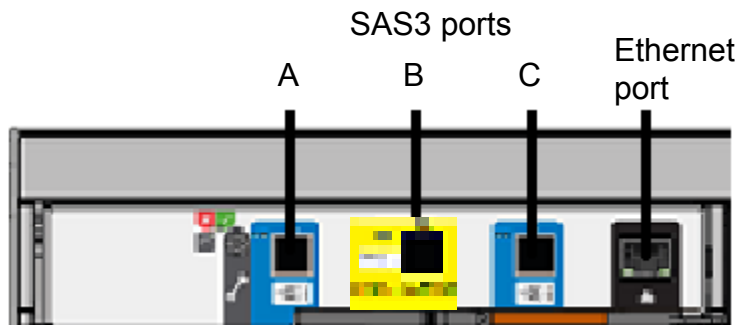

## Cables and connectors

Compute nodes connect to each other with 1G Ethernet cables.

The compute nodes connect to the Primary Storage Shelf with SAS3 cables.

The Primary Storage Shelf connects to Expansion Storage Shelf I/O modules with SAS3 cables.

Expansion Storage Shelves connect to each other with SAS3 cables.

The power connector that attaches to a storage shelf has a right-angled form factor.



A security tie assures continued connection between the power cable and the storage shelf.



# Pre-installation requirements

This chapter includes the following topics:

- [Customer-provided environment and supplies](#)
- [Storage shelf shipping container contents](#)
- [Compute node shipping container contents](#)
- [Dimensions and determining rack locations](#)
- [Best practices for rack installation](#)
- [Heat dissipation guidelines](#)
- [Cable length verification](#)
- [Prerequisites for IPMI configuration](#)

## Customer-provided environment and supplies

The storage shelf rails can extend from 713mm (28.07in) to 884mm (33.23in) in length. Be sure that your racks accommodate these rails.

For best ventilation, the rack cabinet:

- Should be at least 100 cm (4 feet) from walls
- Should be at least 100 cm (4 feet) from other cabinets on the front and back of the compute node and the storage shelves

The following list describes the necessary personnel and equipment that are needed at the installation site:

- At least one person or a mechanical lift to move the compute node.
- Three people or a mechanical lift to move each storage shelf.
- A magnetic Philips-head screw driver to install the storage shelf rails into the rack.
- A Torx T20 screwdriver to lock each of the two drawers in a storage shelf.
- Cables to connect the compute node to your corporate network.
- A USB-keyboard and a monitor to connect to the compute node.
- A 19-inch rack with dual Power Distribution Units (PDUs) with 120VAC or 220VAC power input for the compute node.
- A 19-inch rack with dual Power Distribution Units (PDUs) with 220VAC power input for the storage shelves.

Refer to the following section for more details.

See [“Heat dissipation guidelines”](#) on page 24.

## Storage shelf shipping container contents

Each storage shelf container includes other boxes and contents as follows.

- Open Me First envelope, containing:
  - Deployment plan that provides basic information and links to detailed information
  - Cable straps
- Envelope, containing:
  - Warranty agreement
  - Environmental compliance statement
- Hardware cable connections poster
- Rack templates
- Rack rails and mounting hardware
- Two SAS-3 cables with each Expansion shelf
- Two power cords
- One bezel for each drawer

The disk drives ship separately from the storage shelves. Each disk drive shipping container includes 42 disk drive slots.

Each Access 3340 storage disk drive box includes one carrier with a blank. In the top drawer this blank carrier is inserted into slot 41. In the bottom drawer this blank carrier is inserted into slot 83.

After you have installed the storage shelves into a rack, you should install the disk drives into the drawer.

## Compute node shipping container contents

Each compute node and each storage shelf is shipped in separate containers. Each container includes other boxes and contents. The disk drives are installed into the compute node at the factory.

The following items ship within the compute node box.

Open Me First envelope, containing:

- Deployment plan that provides basic information and links to detailed information
- Cable straps

Envelope containing:

- Warranty agreement
- Environmental compliance statement
- USB drive with factory image

Hardware such as:

- Hardware cable connections poster
- Rack templates
- Rack rails and mounting hardware
- Four SAS3 cables
- Two power cords
- Bezel

## Dimensions and determining rack locations

Physical specifications for the compute node include the following.

- Each node is two rack units (2RU) high.
- Node measurements are listed below.
  - Height: 8.89cm (3.5")

- Width: 48.26cm (19")
- Length/depth: 79.38cm (31.25")
- The compute node rails are extensible to 914mm (36in). This distance is the maximum depth that is allowed between rack posts.

Physical specifications for the 5U84 storage shelves include the following.

- Each storage shelf is 5RU high.
- Storage shelf measurements are listed below.
  - Height: 22.23cm (8.75")
  - Width: 48.26cm (19")
  - Length/depth: 93.35cm (36.75") from the rear of the front flanges to the extreme rear of the storage shelf chassis.

---

**Note:** The 5U84 storage shelf is longer than a standard IEC-compliant rack. Be sure that your rack cabinet and Power Distribution Units accommodate the length of the storage shelves.

---

- The storage shelf rails measure 71.3cm to 88.4cm (28" to 34.8") in length. Be sure that your rack accommodates this distance from the inside of the front post to the inside of the rear post. Plan for additional space to accommodate power strips, power cords, and other cables.

When you plan the installation be sure to allocate enough space for all of the hardware. A typical installation has the storage shelves on the bottom and the compute node(s) at the top.

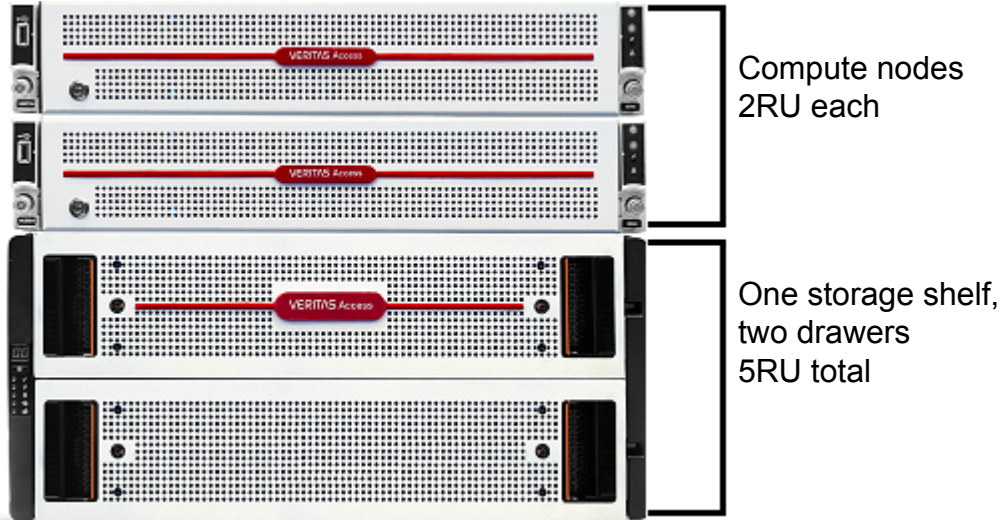

To help you identify RU spacing, many rack manufacturers use a system of lines and sequential numbers starting at the bottom of the rack. The front and the rear of the rack are marked the same to ensure that the rails are installed straight and level. One RU has three holes. The holes for one RU are typically marked with a line below the bottom hole and another line at the top hole.

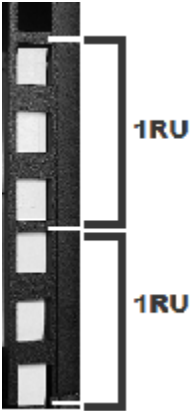

Use the rack templates to determine the mounting locations for all devices.

**To determine rack locations for the hardware**

- 1 Determine the total number of rack units (RUs) that you need as follows:

- Two compute nodes (2RU each) and one storage shelf (5RU) require 9RUs of height in the rack.
  - Two compute nodes (2RU each) and four storage shelves (5RUs) require 24RUs of height in the rack.
- 2 Use the rack templates to determine RU locations.
  - 3 Fold the compute node templates at the horizontal yellow lines.
  - 4 Use the following graphics to determine where pins and screws for the storage shelves fit into the rack.
    - The front of each rail includes four pins that insert into the rear of the front rack post. One screw fits into the middle hole of the middle RU.

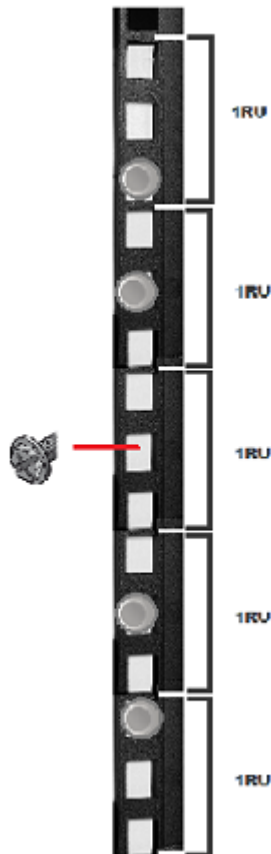

- The rear of each rail includes four pins that insert into the inside of the rear rack post. Two screws insert into the front of the rear rack post. The screws install into the middle hole in the first and the fifth RU.

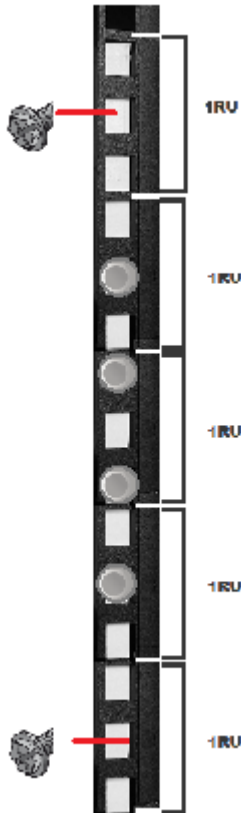

- 5 Record the rack positions to help you locate them easily when mounting the hardware.

## Best practices for rack installation

Prepare for the hardware installation by following these recommendations.

- The storage shelves are heavier than the compute node and should be installed as close to the bottom of the rack as possible.
- Determine device order and cabling limits.

- Install one set of rails. Then install the device. Do not install all of the rails at one time as you may not leave enough room for the devices.
- Be aware of the depth of the rails and the devices. Ensure that the distance between cabinet posts accommodates the rails, devices, cables, extending ears, and PDU strips.
- Hold a 1m SAS3 cable between the compute nodes and the Primary Storage Shelf and between the Primary Shelf and the last Expansion Storage Shelf. Visually confirm that the cables are long enough.

## Heat dissipation guidelines

Air flows from the front of each unit and exits from the rear of each unit. You can install the optional compute node bezel without disruption to the airflow.

For best ventilation, the rack cabinet should:

- Be at least 100 cm (4 feet) from walls.
- Be at least 100 cm (4 feet) from other cabinets on the front and back of the compute node and the storage shelves.

---

**Note:** Data centers with two-foot spaces in the front and in the back of the compute nodes are acceptable with proper cooling and ventilation.

---

The following requirements ensure sufficient cooling to the devices.

- Veritas requires that you install the devices in a National Engineering Manufacturer's Association (NEMA)-certified or equivalent rack.

---

**Note:** The 5U84 storage shelf is as long as a standard IEC-compliant rack. Be sure that your rack cabinet and Power Distribution Units (PDUs) accommodate the length of the storage shelves.

---

- A minimum of 3 inches (7.6 cm) of space must be between the front of a compute node and the cabinet door or other air block.
- A minimum of 6 inches (15.2 cm) of space must be between the rear of a compute node and the cabinet rear or other air block.
- A minimum of 1 inch (2.5 cm) of space must be between the front of a storage shelf and the cabinet door or other air block.
- A minimum of 2 inches (5.0 cm) of space must be between the rear of a storage shelf and the cabinet rear or other air block.



Refer to the *Access 3340 Appliance Product Description* for specifications about temperature and cooling.

[Appliance documentation site](#)

## Cable length verification

Before you install and connect the hardware, be sure to verify that you have the correct length of cables for your setup.

Each rack unit (RU) is 44.50 mm (1.752 inches) in height. The compute node is 2RU high and the 5U84 Storage Shelves are 5RU high.

Four 1-meter SAS3 cables ship with each compute node and connect to the Primary Storage Shelf.

Two SAS3 cables ship with each Expansion Storage Shelf. Each SAS3 cable is 1-meter (3.28 feet) long. SAS3 cables that are 2 meters (6.56 feet) long can be ordered separately. The 2-meter cable is long enough to connect the Primary Storage Shelf to the third Expansion Storage Shelf when you use the recommended configuration.

---

**Note:** If you must have Expansion shelves in different racks be sure that the SAS3 cables are long enough. Do not stretch the cables too tightly or try to use adapters or extensions.

---

## Prerequisites for IPMI configuration

Verify the following configuration prerequisites:

- The remote management port auto-negotiates its link speed to 1 Gbps.

---

**Note:** If the IPMI port is connected to a managed switch port, it is recommended that you configure the switch port to auto-negotiation.

---

- If a firewall exists between the appliance and the remote devices that manage an appliance (like a laptop computer), open the following ports:

22	SSH
80	HTTP
162	SNMP

443	HTTPS
623	KVM
5120	RMM ISO/CD
5123	RMM floppy
5124	CD
5127	SSL
5900	KVM CLI
7578	RMM CLI
7582	SSL

---

**Note:** If you have a private internal network, remember to configure the settings accordingly in your network address translation (NAT).

---

- The remote management port must be configured as a DHCP or static address.

# Hardware installation procedures

This chapter includes the following topics:

- [Overview](#)
- [Installing a storage shelf](#)
- [Installing disk drives into a storage shelf](#)
- [Installing the compute node rack rails](#)
- [Installing the compute node into a rack](#)
- [Connecting the hardware to two nodes](#)
- [Connecting to the network](#)
- [Connecting the power cords to the hardware](#)
- [Turning on the hardware and verifying operation](#)
- [Configuring the IPMI port from the Access Appliance shell menu](#)
- [Accessing and using the Veritas Remote Management interface](#)

## Overview

This chapter describes the procedures to install two Access 3340 compute nodes, one 5U84 Primary Shelf, and up to three optional 5U84 Expansion Shelves.

## Installing a storage shelf

You can use this installation procedure for a Primary Storage Shelf and up to three Expansion Storage Shelves. For the systems that include one or more Expansion Shelves, install those units first followed by the Primary Shelf. Always load hardware into a rack from the bottom to ensure personal safety and proper weight distribution of equipment.

From the inside of the front post to the inside of the rear post the rails measure 713mm to 884mm (28in to 34.8in). Be sure that your rack accommodates this distance. Allow extra space to accommodate power strips, power cords, and other cables.

---

**Warning:** A storage shelf without disk drives weighs up to 61.65kg (135.72lbs). To avoid potential equipment damage and personal injury, do not install disk drives into the storage shelves before mounting them into the rack. The added weight of the disk drives hinders the ability to safely install the storage shelves. Use the lifting straps that are provided with the shelf to remove the shelf from the shipping container. Use a mechanical lift or have three people raise the shelf into position. The rear of the shelf is heavier than the front of the shelf.

---

### To install the storage shelf rails

Veritas recommends that two people install the rails. One person works at the back of the rack and one person is at the front of the rack.

A magnetic Philips-head screwdriver is required to install screws into the storage shelf rails.

- 1 The storage shelf rails are extended to full length in the shipping container. It is easier to install the rails when they are at their shortest length.
- 2 Use the four adjuster screws on the inside of the rail to increase or decrease the rail length.

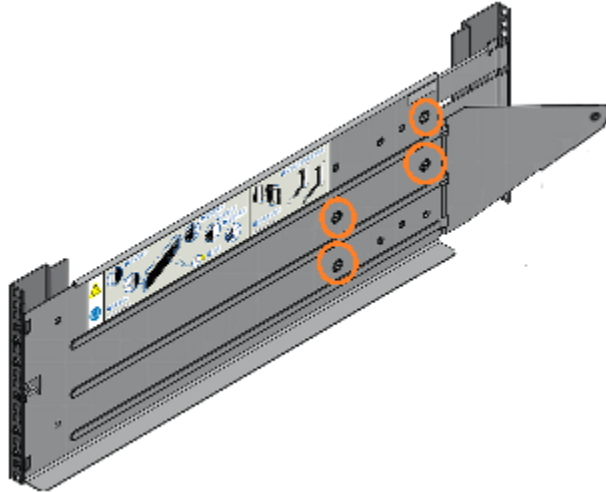

- 3 Identify the left and the right rails which are labeled LH (left-hand) or RH (right-hand) on the front inside of the rail.



Note the ledge at the bottom of each rail. The storage shelf sits on the ledges which must be positioned on the inside of the rack. The ledges must not be located between the rail and the rack wall.

- 4 Locate the pins on the front and the rear of the rails.

- 5 Use the rack templates that are provided with the hardware. One side of the template shows the front of the rail. The other side of the template shows the rear of the rail. The template shows the five rack units (RUs) to scale.

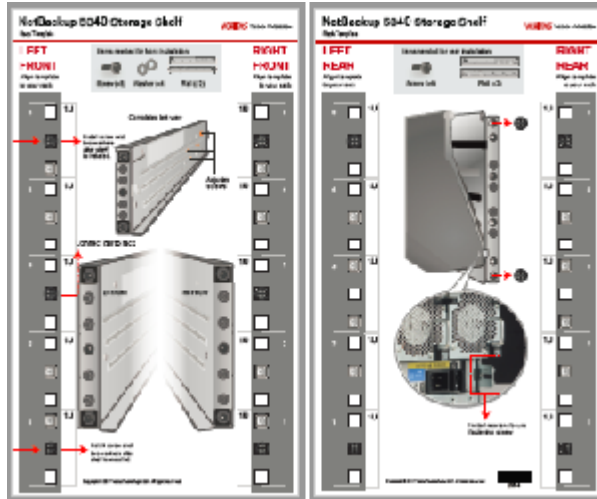

- 6 Start with the left rail. Place the rail pins inside the front of the rack.

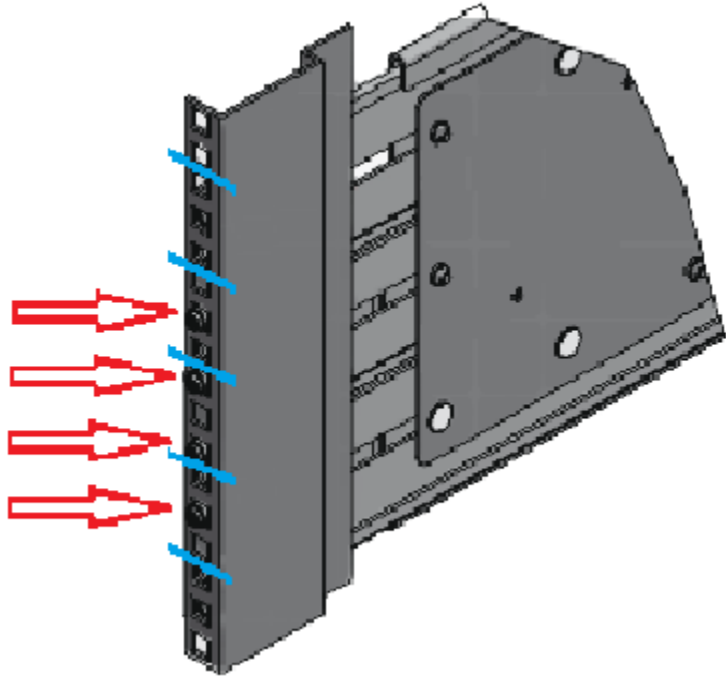

- 7 Extend the rail assembly to enable the rear rail pins to engage.

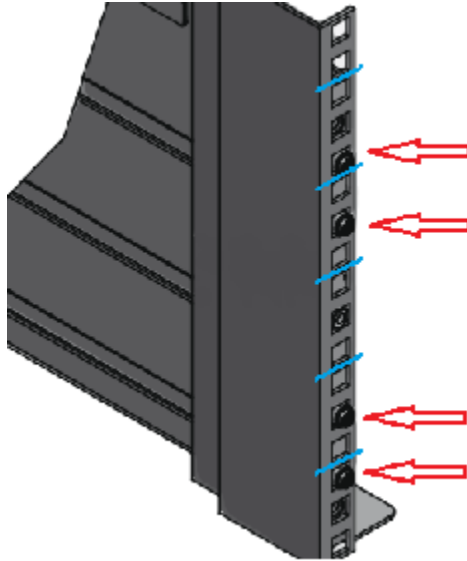

- 8 Verify that the pins are fully seated in the holes in the rack posts.
- 9 Secure the four adjuster screws as needed. Do not over-torque.
- 10 Repeat the process for the right rail.
- 11 Verify that the left rails and the right rails use the same rack holes and are parallel.



**12** Identify the three different types of screws.

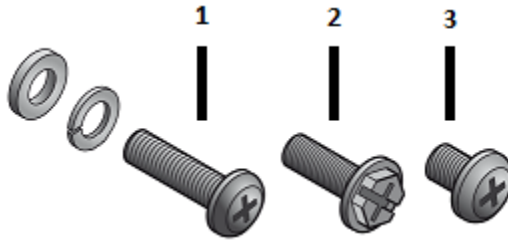

Descriptions of the screws are provided in the following table.

Number	Description	Rack location(s)	Rail location(s)
1	Long fastening screw with two washers - for use after shelf is installed in rails. Install the washer with the gap first.	Front: Center holes in first and fifth rack units (RUs). Rear: N/A	Front: Top and bottom holes. Rear: N/A
2	Medium-sized clamping screw	Front: Center hole of third rack unit (RU). Rear: Center holes in first and fifth rack units (RUs).	Front: Center hole. Rear: Top and bottom holes.
3	Small rear fastening screw	Front: N/A Rear: N/A	Front: N/A Rear: Connects from chassis lock tab to hole in triangular end of rail.

- 13** Install the medium-sized clamping screws from the outside of the rack posts so that they engage the rails and the rack.

The front of the rail requires one clamping screw in the center hole of the center RU.

The rear of the rail requires two clamping screws. Insert these screws in the middle hole in the first and the fifth RU.

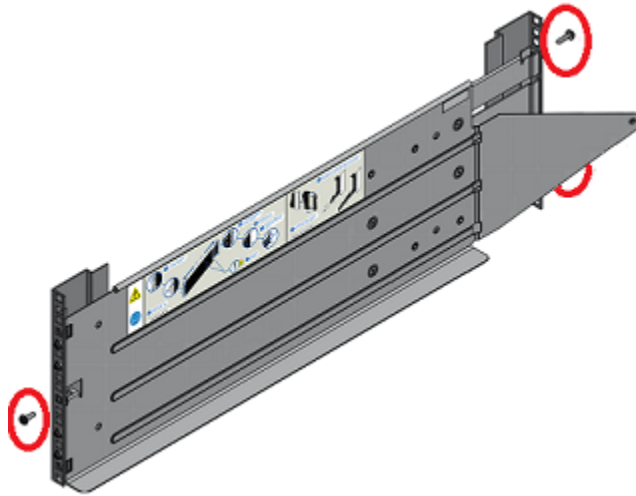

- 14** Remove any plastic film from the front and sides of the shelf.  
Do not remove the front plate or bezel from either drawer.

- 15 Remove the hub caps from both sides of the front of the storage shelf.



The caps snap off without any tools.

- 16 **Warning:** The shelf weighs 61.56kg (135.72lbs) without disk drives. Use a mechanical lift or have at least three people hold the lifting straps. Do not discard the straps in case you need to move the shelf later.

---

**Warning:** The back end of the storage shelf is heavier than the front end.

---

From the front of the rack, carefully lower the storage shelf onto the rail ledges in the rack.

- 17 Push the shelf into the back of the rack.
- 18 On the front of the rack, use a long screw and two washers in the top and the bottom holes.

Place the washer with a gap onto the screw first.

- 19 Locate the lock tabs on the left and right rear corners of the storage shelf chassis.



- 20** Insert a small screw through the lock tab into the hole in the triangular end of the rail. Secure the screw.

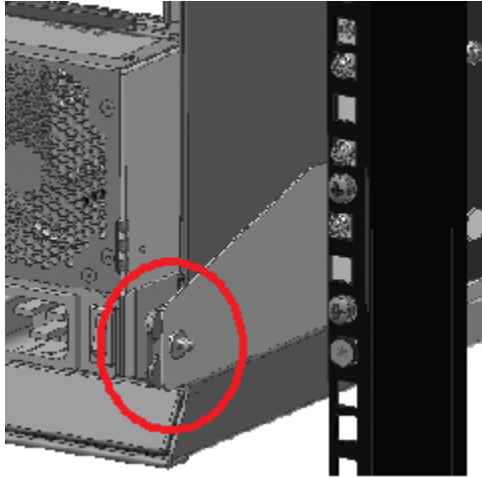

- 21** On the front of the storage shelf reattach the left and the right hub caps. The left cap contains the control panel. The right cap contains spaces for two latches which connect to the storage shelf.



# Installing disk drives into a storage shelf

The Primary Storage Shelf and the Expansion Storage Shelf use 10-TB disk drives.

---

**Note:** It is helpful to have two people install the disks. Both people can move the latches to unlock the carriers. One person can remove two or three disks from the shipping box and hand them to the other person. The first person should orient the disk drives in the direction of installation. The second person installs the disks. Both people can press the carriers down and lock them forward. Less than 5 minutes are required to fill an entire drawer.

---

## To install the disk drives into the storage shelf slots

- 1 Examine the two anti-tamper locks on the front of each drawer.

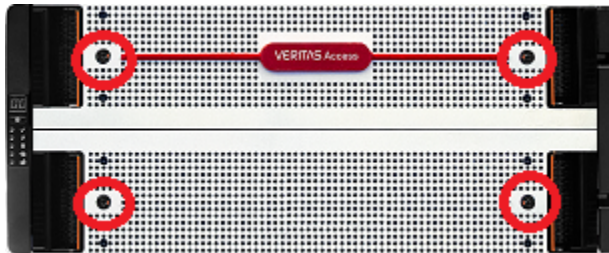

The red arrows in the locks point to the center of the drawer if the locks are not engaged.

- 2 If the locks are engaged, use a Torx T20 screwdriver to rotate the locks counterclockwise.
- 3 Pull the bottom drawer forward as far as possible without damaging the hardware.

- 4** Locate and open the box or boxes that contain the Disk Drive In Carrier (DDIC) units.

All carriers contain a 10GB disk drive except for the carriers in slots 41 and 83 which contain blanks. In the following diagrams the blank carriers are shown in light blue.

28	29	30	31	32	33	34	35	36	37	38	39	40	41
14	15	16	17	18	19	20	21	22	23	24	25	26	27
0	1	2	3	4	5	6	7	8	9	10	11	12	13

70	71	72	73	74	75	76	77	78	79	80	81	82	83
56	57	58	59	60	61	62	63	64	65	66	67	68	69
42	43	44	45	46	47	48	49	50	51	52	53	54	55

- 5** Before removing the disk drives from a shipping box, prepare each disk drive carrier for drawer installation.

Do the following for each disk drive carrier:

- Identify the release latch in the middle of the top of a carrier.



- Push the release latch to the right in the direction of the arrow. A yellow line appears to the left of the latch when the carrier is unlocked.



- 6** After unlocking all of the carriers, install each carrier into the bottom drawer. Do the following for each of the carriers that you want to install:
- Insert the carrier into one slot and push it down until it stops.
  - Place one thumb on each of the two pads that are shown by the red arrows.

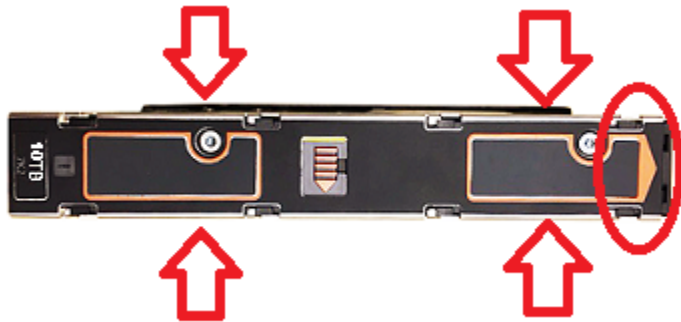

- Push the carrier forward towards the rear of the slot, in the direction of the circled end of the carrier.
  - The release latch clicks into place and moves to the left. The yellow line is no longer visible.
  - Repeat the process for each carrier in the bottom drawer of the shelf.
- 7** Verify that all disks are properly seated in the slots.
- 8** Slide the bottom drawer into the storage shelf.
- 9** Engage the anti-tamper locks on the top drawer as needed.
- 10** Pull the top drawer forward as far as possible without damaging the hardware.
- 11** Install the disk drive carriers into the top storage shelf drawer.



- 12 Slide the top drawer into the shelf.
- 13 If you need to remove a disk drive, slide the release latch to the right. The disk pops up.



- 14 Engage the anti-tamper locks as needed.

## Installing the compute node rack rails

Veritas recommends the following.

- The compute node requires two RUs of space. Install the node in the space that is directly above the storage shelves.
- Always install the heavier storage shelves at the bottom of the rack. Best practices recommend that you install hardware at the bottom of a rack first. Then work your way up the rack.
- Two people should install the rails; one person at the back of the rack and one at the front.

**To install the compute node rails**

- 1 Identify the front and the rear of each rail. The following illustration shows the front of the left-hand and the right-hand rails. The front of the left rail is labeled A. The front of the right rail is labeled B. The labeled sides face the rack wall when the rails are installed.

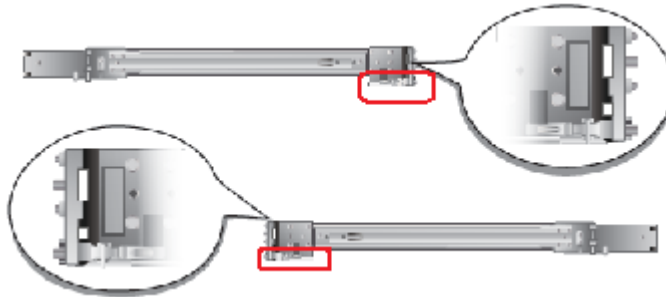

The small metal extensions that are outlined in the illustration must point down, towards the floor of the rack.

---

**Note:** The information in this document supersedes any of the information in the printed installation materials.

---

- 2 Use the rack templates to align the rails with the rack holes.  
Fold the template along the yellow dotted lines to create an exact, physical match to the rack.



Be sure to use the same holes on each side of the rack.

- 3 Place one rail inside the rack.
  - The rack holes and the rail pins should match the template.
  - Use the same 1RU space and holes in the front and the rear of the rack.
  - Align the pins in the top holes and the bottom holes of the top RU.
  - Move the rail front and back to fit into the rack.
  - Slide the rail forward until the pins click into the rack holes.

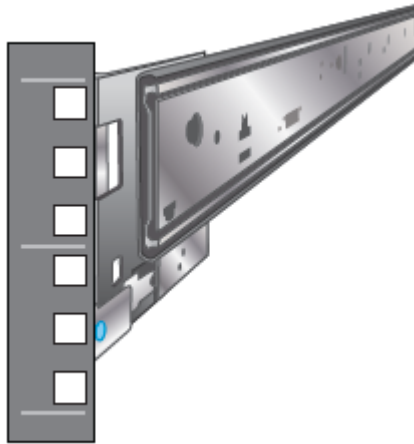

- 4 Secure the rear of the rail.
  - Push the blue lock toward the rack wall and toward the back of the rail.
  - The lock must be behind the rack post.
  - Ensure that the lock clicks into place.

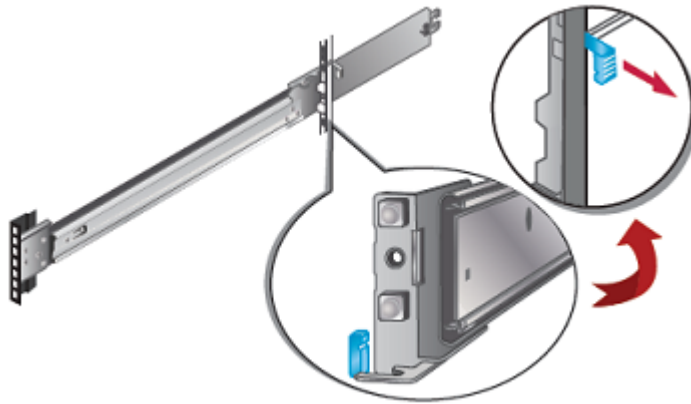

- 5** Insert a washer and a screw into the middle hole of the top RU in the rear of the rack.



- 6** Repeat steps 3 through 5 for the other rail.
- 7** Identify the three different rails in each rail assembly.
- Components in this illustration are as follows.
- 1 - Outer rail
  - 2 - Intermediate rail
  - 3 - Inner rail

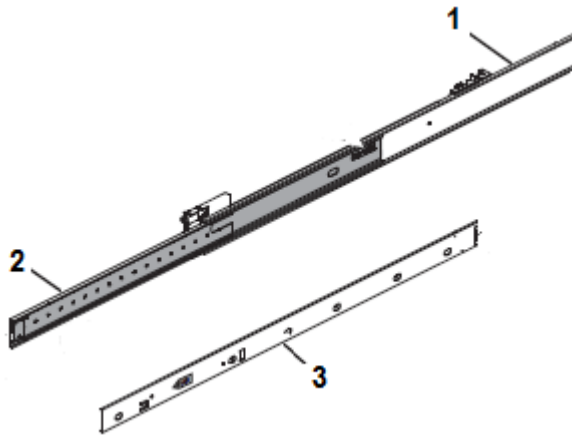

- 8 Pull the white tab forward to release the inner rail from the outer and the intermediate rail.

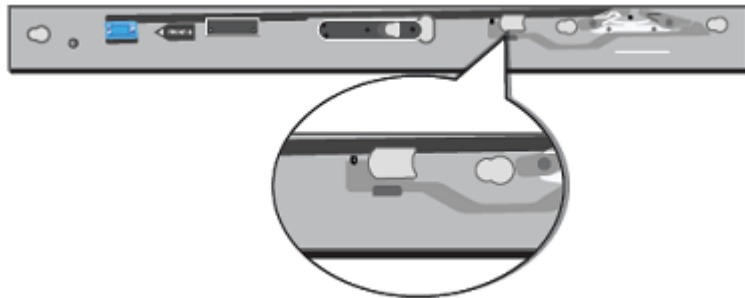

- 9 Separate the inner rail from the other rail components in the rack.
- 10 Attach the inner rail to the left and the right sides of the chassis at the four attachment locations.

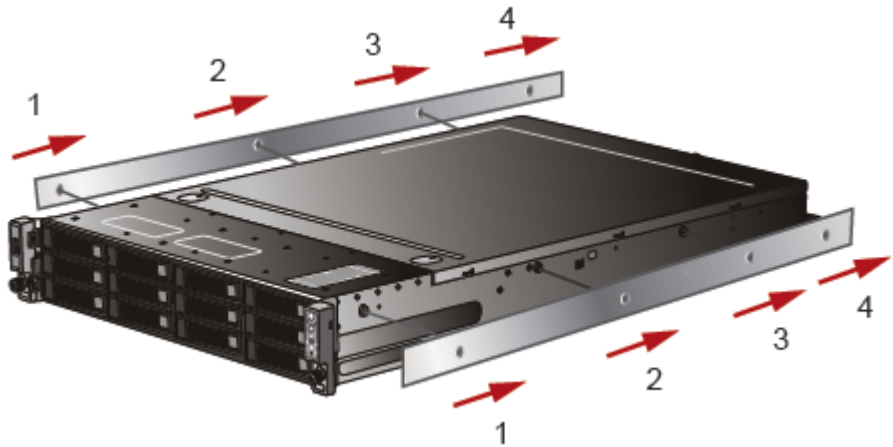

The rails click into place when properly installed.

## Installing the compute node into a rack

After the storage shelves and the compute node rails have been installed, you can install the compute node into the rack.

### To install the compute node into the rack

- 1 Verify that the rails are securely attached.
  - Verify that the outer rail is securely attached to the rack.
  - Pull the intermediate rail forward. Ensure that the ball bearing retainer is locked forward.
  - Verify that the inner rail is securely attached to the compute node.
- 2 Place the hardware in the front of the rack.

- 3 Slide the blue tab forward to unlock the intermediate rail.

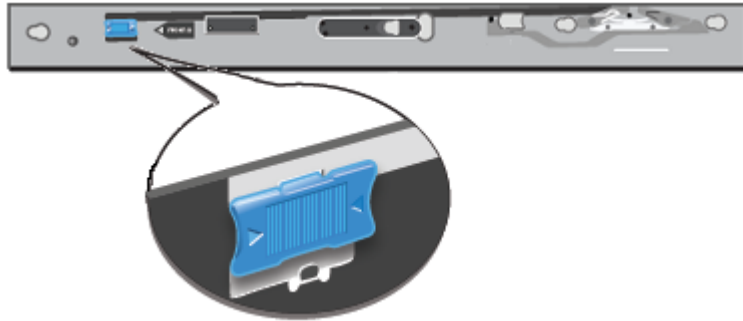

- 4 Pull the intermediate portion of rail the rail forward. Ensure that the ball bearing retainer on the intermediate rail is locked forward.

---

**Note:** You do not need to extend the rails as far as they can possibly extend. You only need sufficient space to place the hardware into the rails.

---



- 5 Align the compute node inner rail to the intermediate rail in the rack. Slide the compute node forward into the rack.

The rail has a lock mechanism that prevents the hardware from being fully pushed into the rack.

- 6 Slide the blue tab to unlock the rails and continue the sliding of the compute node into the rack.

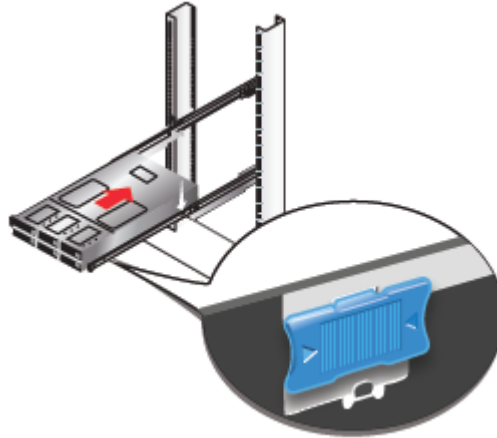

- 7 Secure the captive screws on the compute node ears.

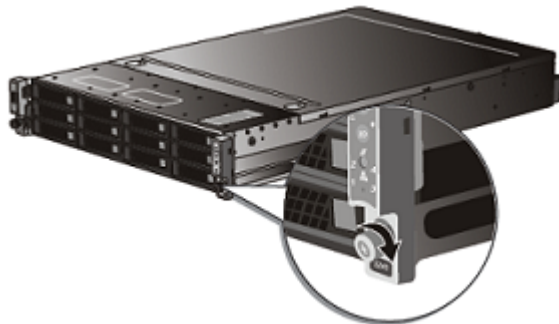

## Connecting the hardware to two nodes

This section provides cabling information for a Veritas Access 3340 Appliance that includes two compute nodes, one Primary Storage Shelf, and up to three Expansion Storage Shelves. If you have only one node you can disregard the instructions to connect the two nodes.

Expansion Storage Shelves connect to the Primary shelf and to other Expansion shelves with two SAS3 cables.



Each compute node is connected to the Primary Storage Shelf with four SAS3 cables.

The compute nodes connect to each other with two Ethernet cables.

The Primary shelf has a single SAS3 port on the left side of each RAID controller I/O module. This port connects to SAS3 port A in the Expansion I/O modules.

**To connect two compute nodes to a Primary shelf**

- 1 Obtain two Ethernet cables.
- 2 Identify the two Ethernet ports on the far right of the compute node rear panels.

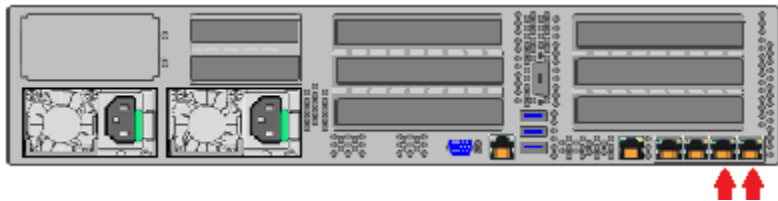

- 3 Connect the cables between the ports as shown.

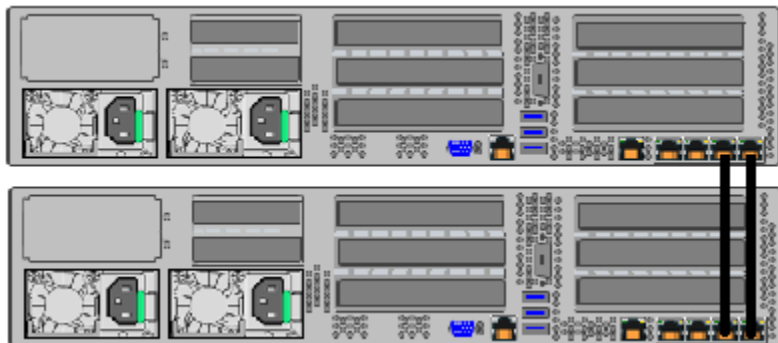

- 4 Obtain four SAS3 cables for each compute node.

- 5 Identify the SAS3 ports in slot 1 and slot 4 of the compute node that is closest to the Primary shelf.

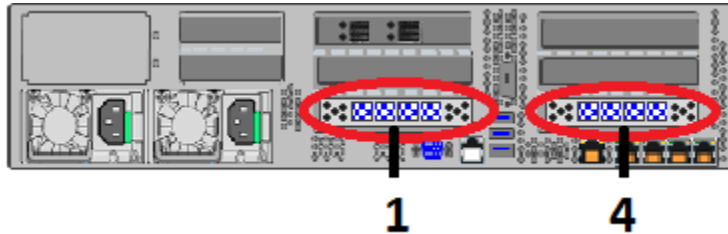

The ports in each slot are labeled 3, 2, 1, and 0 from left to right.

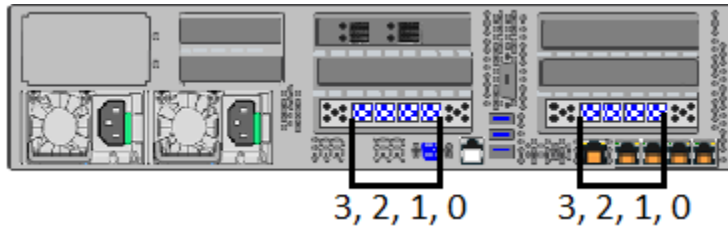

- 6 Identify the four SAS3 ports in each Primary shelf controller.

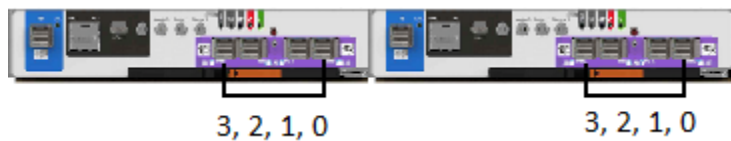

The left-hand controller is labeled A and the right-hand controller is labeled B.

The ports in each controller are labeled 3, 2, 1, and 0 from left to right.

---

**Note:** The colors of the cables in the following diagrams are for demonstration purposes only.

---

- 7 On the compute node that is closest to the Primary shelf connect Slot 1, Port 3 to controller B, Port 2 on the Primary shelf.

The blue tab on the SAS3 cable must point up towards the top of the shelf.



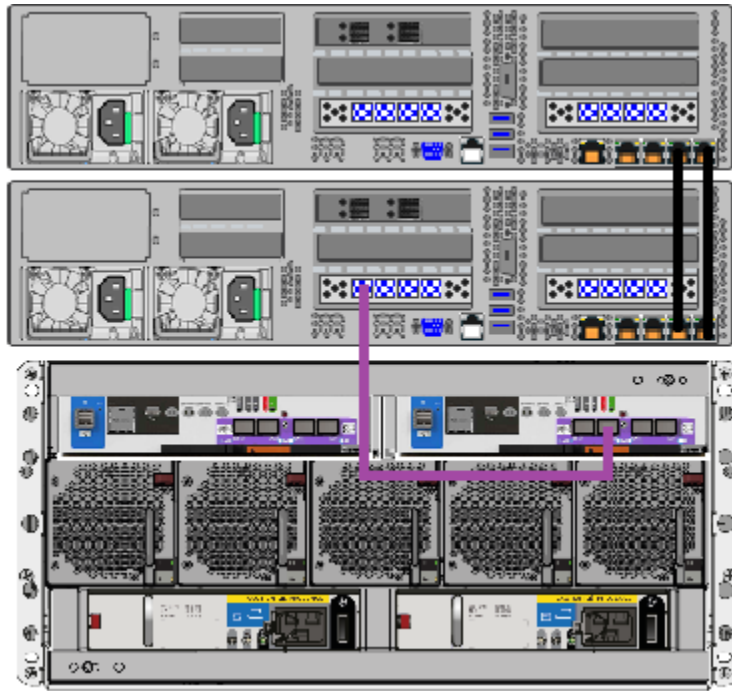

- 8 On the same compute node connect Slot 1, Port 2 to controller A, Port 2 on the Primary shelf.

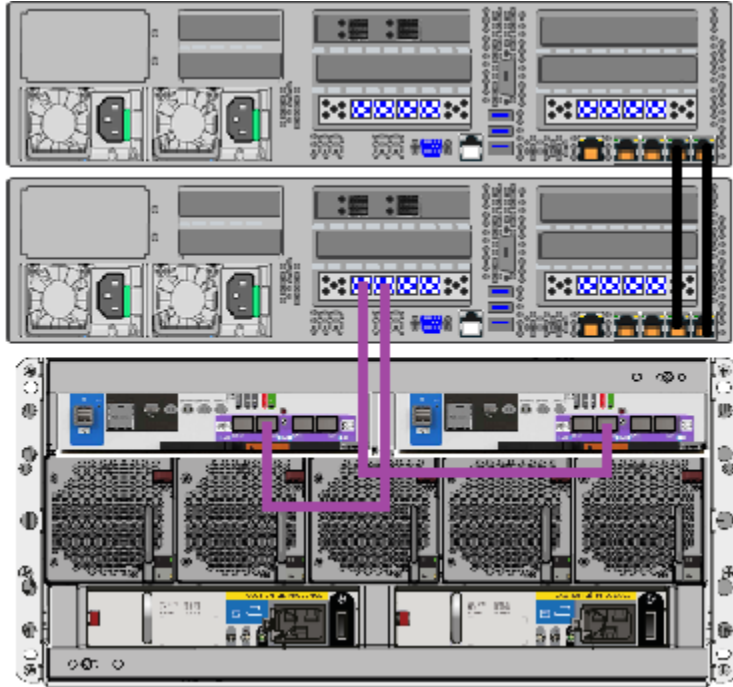

- 9 On the same compute node connect Slot 4, Port 3 to controller B, Port 3 on the Primary shelf.

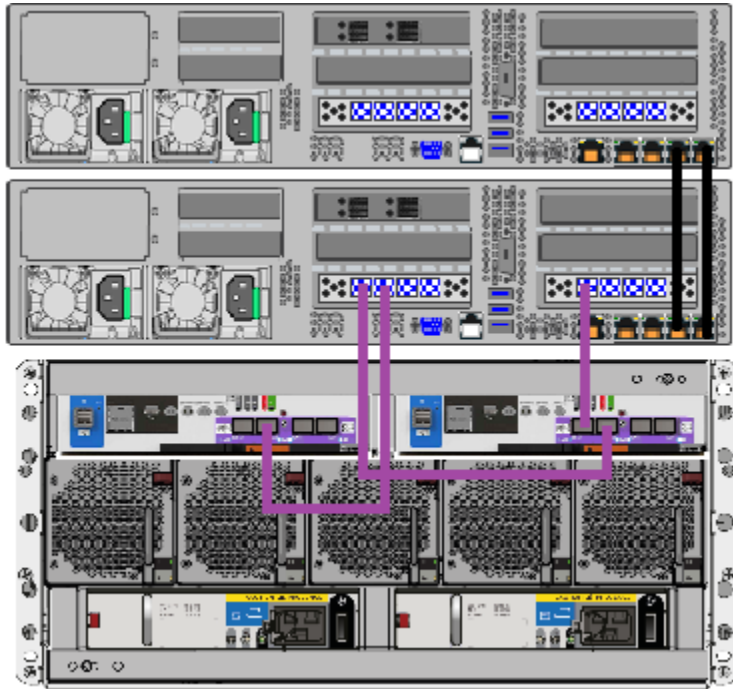

- 10 On the same compute node connect Slot 4, Port 2 to controller A, Port 3 on the Primary shelf.

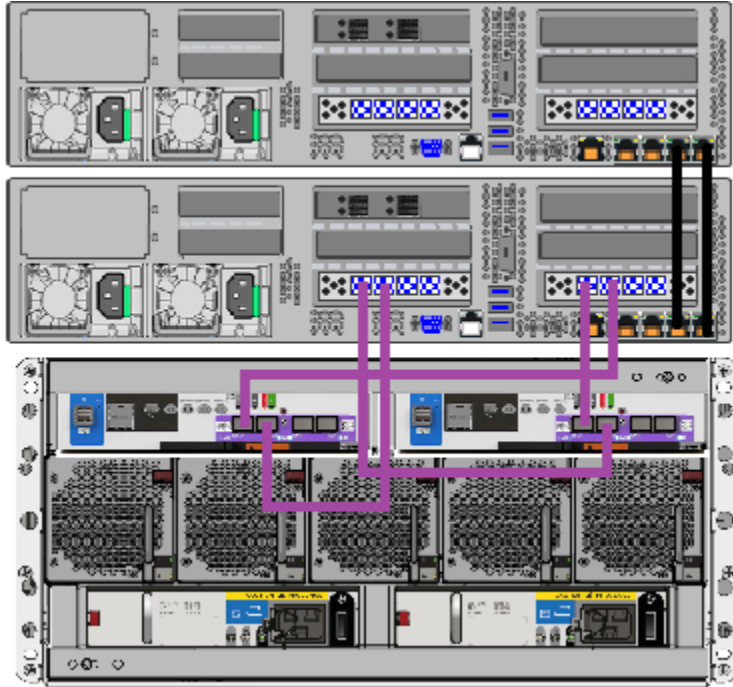

- 11 On the other compute node connect Slot 1, Port 3 to controller B, Port 0 on the Primary shelf.

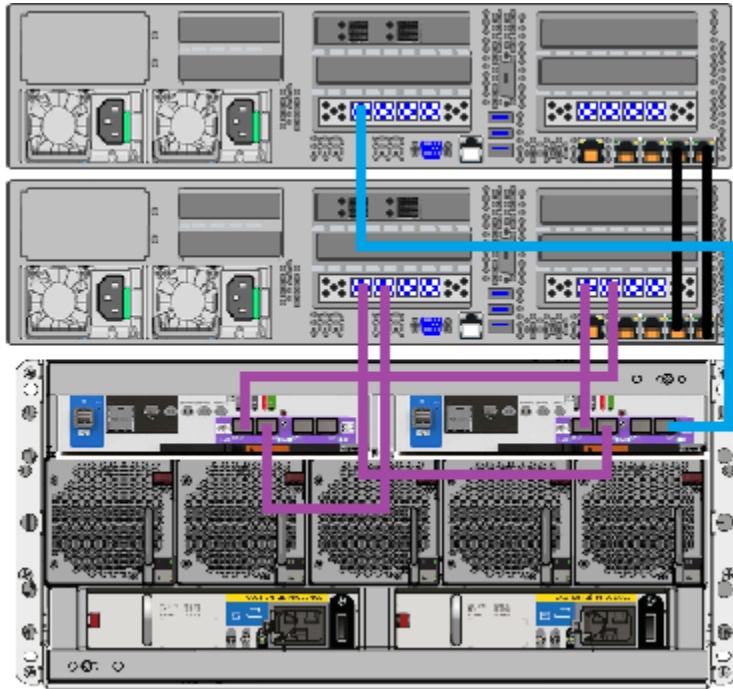



- 12 On this compute node connect Slot 1, Port 2 to controller A, Port 0 on the Primary shelf.

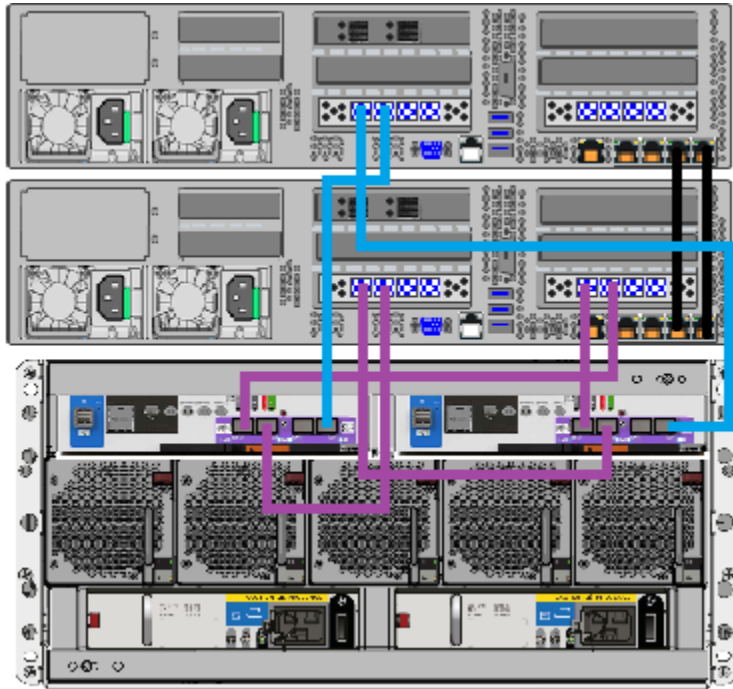

- 13 On this compute node connect Slot 4, Port 3 to controller B, Port 1 on the Primary shelf.

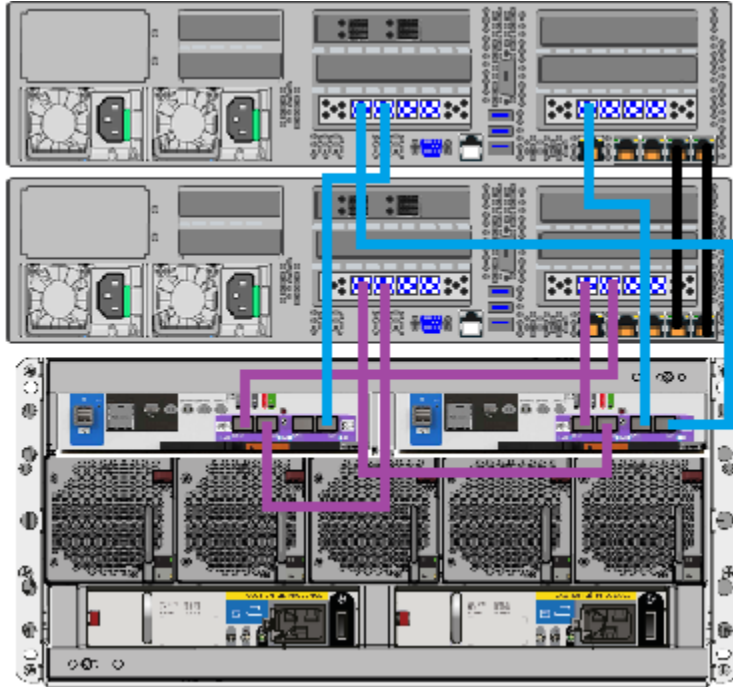

- 14** On this compute node connect Slot 4, Port 2 to controller A, Port 1 on the Primary shelf.

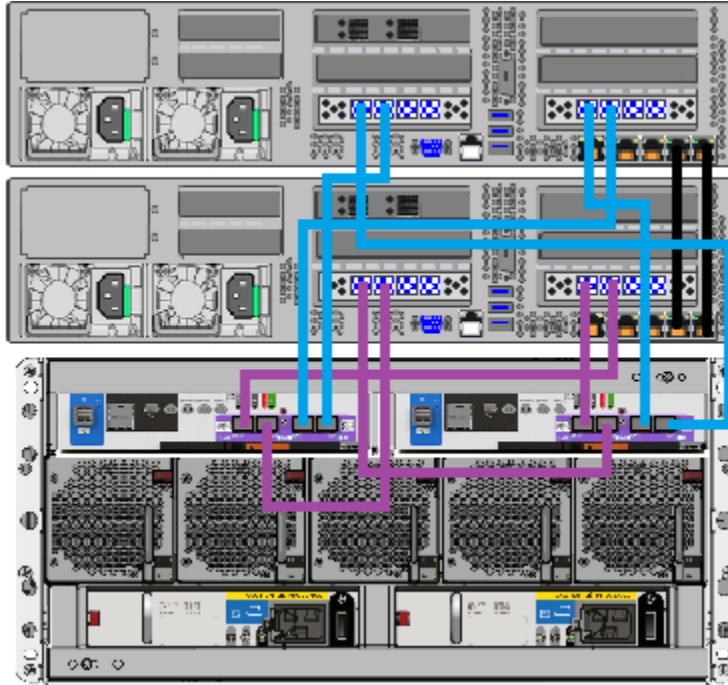

- 15** Use the following procedure to connect Expansion Storage Shelves to the Primary shelf.

See [“To connect Expansion Storage Shelves to a Primary shelf”](#) on page 59.

If you do not have any Expansion shelves at this time, proceed to the following section to connect power cords to the hardware.

See [“Connecting the power cords to the hardware”](#) on page 66.

**To connect Expansion Storage Shelves to a Primary shelf**

- 1** Do the following if you have one Expansion shelf.
  - Connect one end of two SAS3 cables to the SAS3 port on the left hand side of each RAID controller in the Primary shelf.  
 The blue tab on the cable must face down in the SAS3 port.



- Connect the other end of the SAS3 cables to port A in each of the I/O modules in the Expansion shelf. The blue tab on the cable must face down in the Expansion shelf.

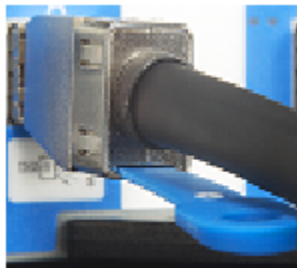

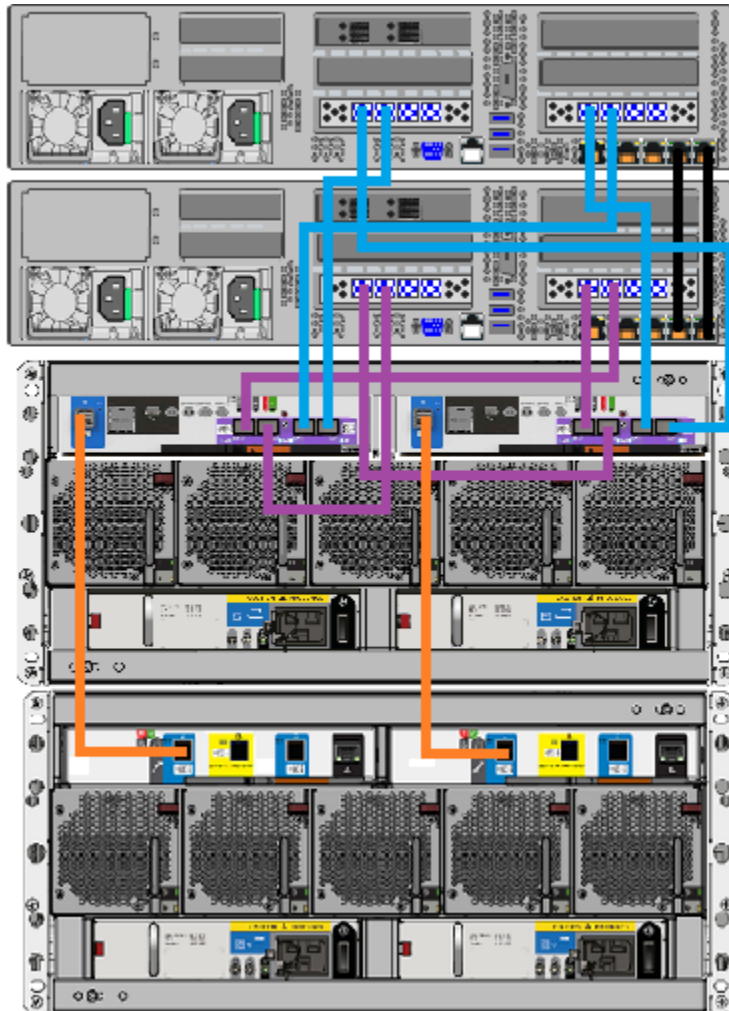

- 2 Do the following if you have two Expansion shelves.
  - Connect one end of the two SAS3 cables to the SAS3 port on the left hand side of each RAID controller in the Primary shelf.
  - Connect the other end of the SAS3 cable in RAID controller A to port A in the nearest Expansion shelf I/O module on the left side of the shelf.
  - Connect the other end of the SAS3 cable in RAID controller B to port A in the right-hand I/O module in the lower Expansion shelf.

- Connect port C in I/O module A of the upper Expansion shelf to port A in I/O module A of the lower Expansion shelf.
- Connect port A in I/O module B of the upper Expansion shelf to port C in I/O module B of the lower Expansion shelf.

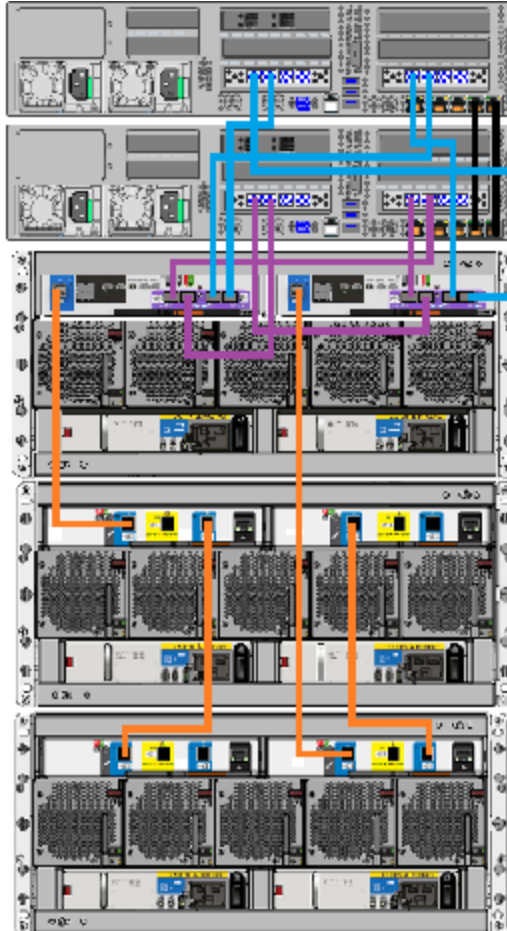

- 3 Do the following if you have three Expansion shelves.
  - Connect one end of the two SAS3 cables to the SAS3 port on the left hand side of each RAID controller in the Primary shelf.
  - Connect the other end of the SAS3 cable in RAID controller A to port A in the nearest Expansion shelf I/O module on the left side of the shelf.

- Connect the other end of the SAS3 cable in RAID controller B to port A in the right-hand I/O module in the lowest Expansion shelf.
- Connect port C in I/O module A of the upper Expansion shelf to port A in I/O module A of the middle Expansion shelf.
- Connect port A in I/O module B of the upper Expansion shelf to port C in I/O module B of the middle Expansion shelf.
- Connect port C in I/O module A of the middle Expansion shelf to port A in I/O module A of the lowest Expansion shelf.
- Connect port A in I/O module B of the middle Expansion shelf to port C in I/O module B of the lowest Expansion shelf.

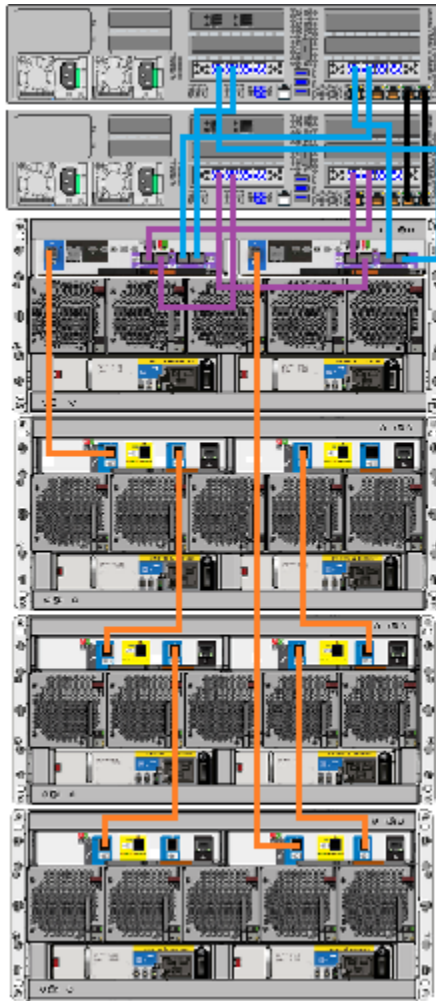

## Connecting to the network

This section provides information about connecting the network ports on both compute nodes to your network. Network ports on the rear panel of the compute node are shown in the following diagram.



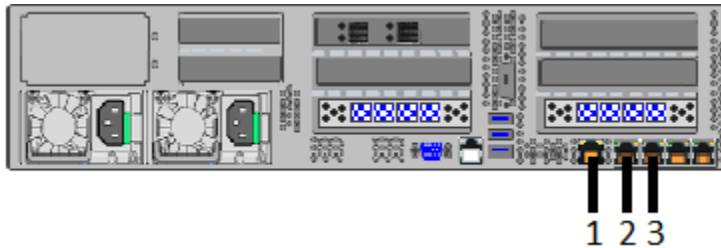

- Item 1 - IPMI (remote management) port
- Item 2 - eth0/NIC1 port (for laptop connection)
  - Required for the initial configuration and operation of the Access cluster.
  - The default IP address for this private network port is 192.168.229.233.
  - The default login credentials are:  
User name: **admin**  
Password: **P@ssw0rd**
- Item 3 - eth1/NIC2 port

Each of these ports requires a Cat5 (minimum) Ethernet cable.

Use the Access appliance shell menu to configure, manage, and monitor the appliance-specific software and hardware of each node and the storage. The Access appliance shell menu is accessed locally or remotely on each node using the following methods:

- SSH
- Veritas Remote Management Console (virtual KVM)
- Physical keyboard and monitor

The common tasks that you can perform in the Access appliance shell menu include:

- Initial configuration
- Network configuration
- Appliance management

Veritas recommends using the IPMI port to establish remote access to the appliance.

The private network address for the eth0/NIC1 port is reserved to provide a direct connection from a laptop to perform the initial configuration. NIC1 (eth0) is typically not connected to your network environment.

After initial configuration you can change the NIC1 (eth0) IP address to repurpose the port.

**To connect the nodes to the customer network**

- 1 Choose which ports and method you want to use to connect to your network.
- 2 Plug an Ethernet cable into the IPMI port on each node.
- 3 Plug the other end of each Ethernet cable into a network switch.

Refer to the *Veritas Access Appliance Getting Started Guide* for details about the initial configuration requirements and procedures.

## Connecting the power cords to the hardware

Typically, the rear of a rack is configured with a Power Distribution Unit (PDU) on each side. The PDU on each side is from a different source to provide power redundancy.

---

**Caution:** Do not turn on the power to any components while connecting the power cords. The components must be turned on in a specific sequence to ensure correct communication.

---

Refer to the following section for a description of the power cable connectors. If you have more than one compute node the instructions apply in the same manner as for one node.

**To connect the power cables**

- 1 For each component, obtain two power cords that are appropriate for your region and equipment.
- 2 On the compute node, connect a power cord to each power supply socket. Connect the other end of each cord to a different PDU.

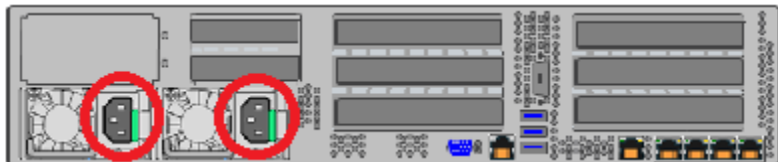

- 3 On each storage shelf, connect a power cord to each power supply socket. Connect the other end of each cord to a different PDU socket.

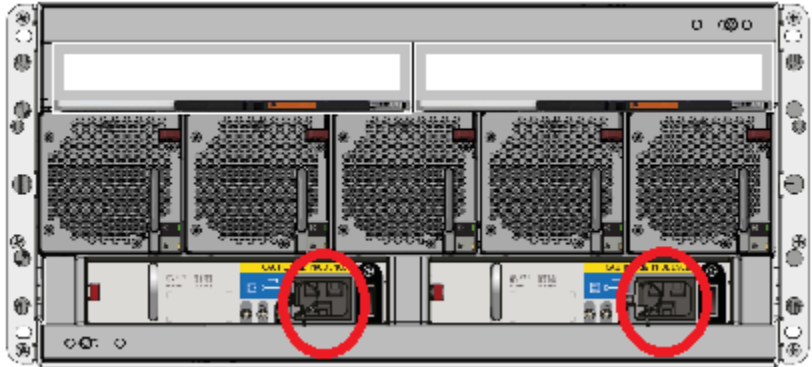

- 4 Verify that your power cable connections match the connections in the following diagram.

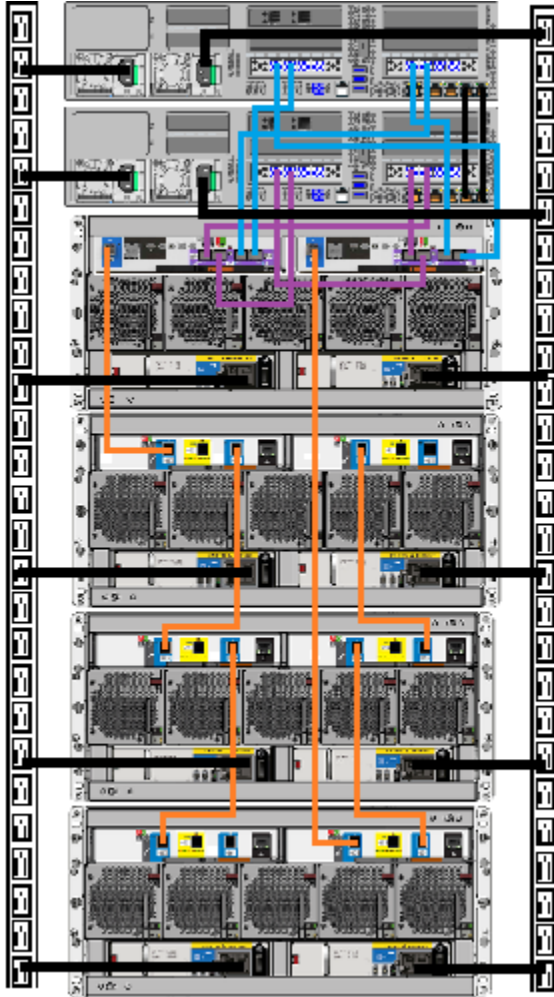

## Turning on the hardware and verifying operation

The hardware components must be turned on in a specific sequence to ensure correct communication between them.

The correct sequence is as follows:

- Expansion Storage Shelves (if installed)
- Primary Storage Shelf
- Compute node(s)

**To turn on the components and verify operation**

- 1 Verify that the following cables are connected properly and securely:
  - Ethernet cables between two nodes.
  - SAS cables between the compute node(s) and the Primary Shelf
  - SAS cables between the Primary Shelf and the Expansion Shelf
  - SAS cables between the Expansion shelves (if installed)
  - Power cords from each component to the appropriate Power Distribution Unit (PDU) sockets in the rack
- 2 On the rear of the Expansion Shelf that is farthest from the compute node, turn on both power switches.

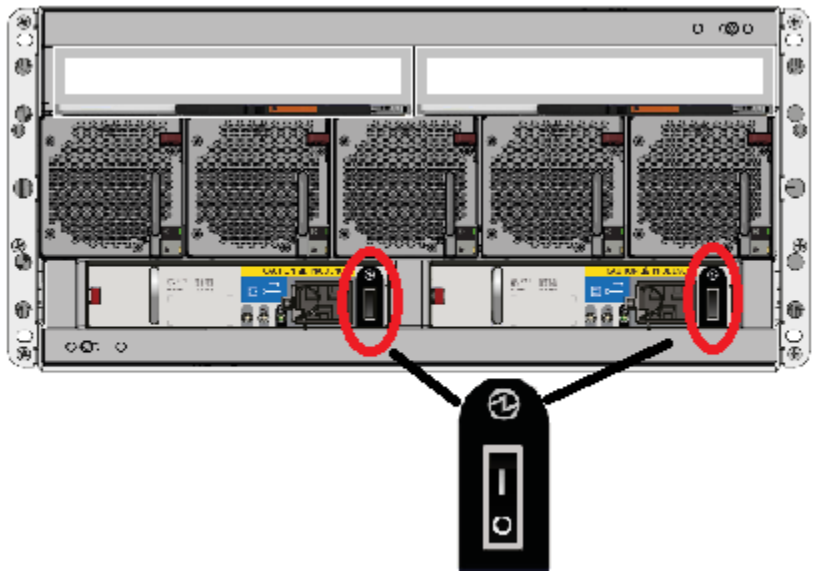

- 3 Wait 2 minutes or 3 minutes for the shelf to initialize. The shelf is quieter when it has initialized.

- 4 Verify that the Power OK LEDs on both power supplies are green.

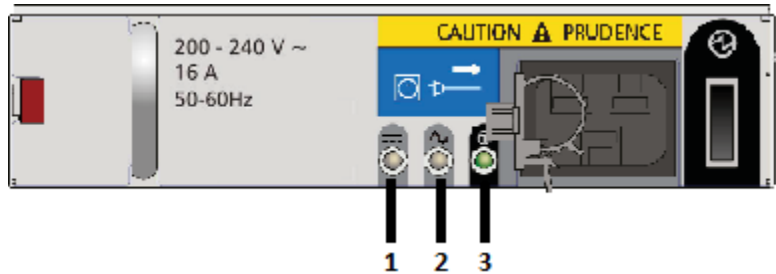

Number	Description
1	PSU failure
2	AC failure
3	Power OK

- 5 Verify that the Power on (standby) LED on the front, left, of the shelf is green.

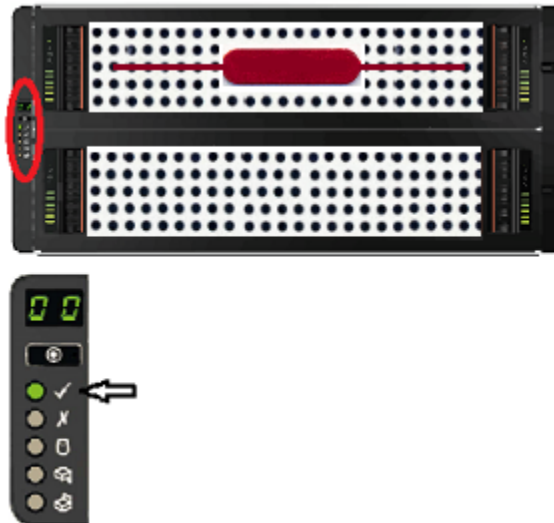

- 6 Turn on the next Expansion shelf and let it initialize.
  - Verify that the Power OK LEDs on the power supply modules are green.

- Verify that the Power On LED on the control panel on the front of the shelf is green.
- 7 If you have three Expansion shelves, turn on the third shelf.
- Verify that the Power OK LEDs on the power supply modules are green.
  - Verify that the Power On LED on the control panel on the front of the shelf is green.
- 8 Turn on the Primary Storage Shelf. Verify that the Power OK LEDs on the power supply modules are green.
- Verify that the Power OK LEDs on the power supply modules are green.
  - Verify that the Power On LED on the control panel on the front of the shelf is green.
- 9 Turn on the compute node with the power button on the front right side.

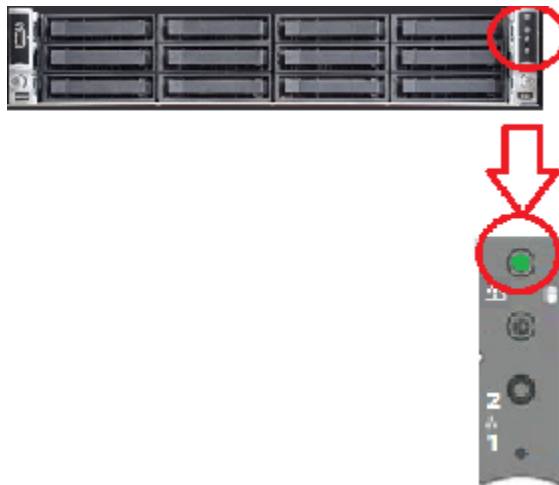

- 10 Verify that the LED under the button is green.

## Configuring the IPMI port from the Access Appliance shell menu

This section explains how to configure IPMI from the Access Appliance shell menu.

If you have more than one node in your system you must configure each node's IPMI port individually.

Before starting the IPMI configuration, obtain the following information for the appliance for which you want to configure the IPMI:

IP address	IP address for the remote management port so that the default static IP address of the remote management port can be changed.
Subnet mask	Enable connectivity between your network computer and the remote management port.
Gateway IP address	Enable connectivity between your network computer and the remote management port.

The defaults for the remote management port are:

- IP Address: 192.168.0.10
- Subnet Mask: 255.255.255.0

Also review the following section on the IPMI prerequisites.

See [“Prerequisites for IPMI configuration”](#) on page 25.

### **To configure the IPMI port by using a keyboard and monitor**

- 1** Connect the following components to the appropriate ports on the rear panel of the appliance:
  - A standard video cable between the VGA (Video Graphics Array) port and a computer monitor.
  - A USB keyboard to a USB port on the appliance.
- 2** Verify that the appliance is turned on.  
 Once the startup process is complete, a login prompt appears.
- 3** Enter the username and password for the appliance. By default, the user name is `admin` and the password is `P@ssw0rd` where 0 is the number zero.
- 4** At the **Main\_Menu** prompt, type **Support** to navigate to the **Support** menu.



- 5 From the **Main\_Menu > Support** view, enter the following command to configure the remote management port:

```
IPMI Network Configure <IPAddress> <Netmask> <GatewayIPAddress>
```

where *IP address* is the new IP address of the remote management port. The Subnet mask and Gateway enable connectivity between your network computer and the remote management port.

The remote management port must be configured as a DHCP or static address.

At any point in time, you can run the following command to see the IPMI network details:

```
IPMI Network Show
```

- 6 Enter the following command if you want to add a new user to access the IPMI sub-system. Note that this is an optional step.

```
IPMI User Add <User_Name>
```

At the **New Password** prompt, enter a password for the user.

The default user name is **sysadmin**. The default password is **P@ssw0rd**, where **0** is the number zero.

At any point in time, you can run the following command to view the users who can access the IPMI:

```
IPMI User List
```

- 7 Type **Return** to return to the **Main\_Menu** prompt.
- 8 Use a Cat5 or a Cat6 cable to connect the remote management port to the network.
- 9 Make sure you can reach the Veritas Remote Management Console over the network by using the new address in a web browser.
- 10 The appliance is ready for initial configuration. See the *Access Appliance Appliance Initial Configuration Guide* for the appropriate platform for information about initial configuration requirements and procedures.

---

**Note:** Once the initial configuration has been completed, you can connect NIC1 (eth0) to an administrative network that does not provide any backup data transfer.

---

# Accessing and using the Veritas Remote Management interface

The IPMI web interface is known as Veritas Remote Management interface. You can use Veritas Remote Management interface to log on to the Access Appliance shell menu.

---

**Note:** The built-in alert configuration tools in the Veritas Remote Management interface are not supported. To configure hardware and software alerts, use the **Settings > Alerts** commands in the Access appliance shell menu. For details, see the **Main > Settings > Alerts** commands section in the *Veritas Access Appliance Commands Reference Guide*.

---

Before you use the Remote Management interface, the following prerequisites must be met:

- The Remote Management interface must first be configured using the Access Appliance shell menu.
- At least one power cable must be connected to a functioning power source.
- At least one user must be enabled to use the LAN channel(s).

## To access and use the IPMI web interface from a remote computer

- 1 Log on to a remote computer in the network and open a supported Windows browser.
- 2 Enter the remote management port IP address that is assigned to the remote management port. The following page appears:



Logged out. Please log in again to access the device.

Username

Password

Login

- 3 Enter your login information. The default user name is **sysadmin**. The default password is **P@ssw0rd**, where **0** is the number zero.

Click **Login**.

- 4 The **Remote Control** section lets you remotely monitor and control the server. Click **Launch Console** under the **Console Redirection** tab to launch the appliance Access Appliance shell menu.

- 5 A JViewer application opens that enables you to remotely monitor and control the appliance. This application requires Java Runtime Environment (JRE) version 6.0 or later. Install Java (as needed).

---

**Caution:** Starting with Java 7 update 45, you may receive a security warning when you launch the KVM remote console from the appliance IPMI port. The warning states that you do not have proper permissions and prevents appliance access from the IPMI port. For information about how to resolve this issue, refer to the following document:

<http://www.veritas.com/support/TECH212531>

---

- 6 You can now access and log on to the Access Appliance shell menu. Enter the user name and password for the appliance.

By default, the user name `admin` has the password, `P@ssw0rd` where 0 is the number zero.

# Configuring the disk space after adding one or more new Expansion Storage Shelves

This appendix includes the following topics:

- [Adding the disk space of an Expansion Storage Shelf from the Access 3340 Appliance shell menu](#)

## Adding the disk space of an Expansion Storage Shelf from the Access 3340 Appliance shell menu

The following procedure describes how to add new storage shelf disk space to an Access 3340 appliance from the Access Appliance shell menu.

### To add the disk space from the Access Appliance shell menu

- 1 You can reach the shell menu in two ways:
  - Use PuTTY to start an SSH session.
  - Connect a laptop, keyboard and monitor, or KVM to the appliance.
- 2 Log on to the shell menu. The **Main\_Menu** prompt appears.
- 3 Perform a scan as follows:
  - Type `Manage` and press **Enter**.
  - Type `Storage` and press **Enter**.

- Type `scan` and press **Enter**.

The scan takes a couple of minutes to complete.

- 4 View the available storage space as follows:
  - Navigate to the **Storage** menu.
  - At the prompt, type `Show Disk` and press **Enter**.
- 5 Navigate from the Access Appliance Shell Menu, `Main_Menu`, to the Access CLISH or the Access GUI.