



# **B2546, B2650, M1246, MS521, MS621**

---

## **User's Guide**

**April 2018**

**[www.lexmark.com](http://www.lexmark.com)**

---

Machine type(s):

4600

Model(s):

630, 690, 830

# Contents

- Safety information..... 5**
  - Conventions..... 5
  - Product statements..... 5
  
- Learning about the printer..... 8**
  - Finding information about the printer..... 8
  - Selecting a location for the printer..... 9
  - Printer configurations..... 11
  - Attaching cables..... 11
  - Using the control panel..... 12
  - Understanding the status of the power button and indicator light..... 13
  
- Loading paper and specialty media..... 14**
  - Setting the size and type of the specialty media..... 14
  - Configuring Universal paper settings..... 14
  - Loading trays..... 14
  - Loading the multipurpose feeder..... 16
  - Linking trays..... 17
  
- Paper support..... 18**
  - Supported paper sizes..... 18
  - Supported paper types..... 19
  - Supported paper weights..... 20
  
- Printing..... 21**
  - Printing from a computer..... 21
  - Printing from a mobile device..... 21
  - Printing from a flash drive..... 22
  - Supported flash drives and file types..... 23
  - Printing a font sample list..... 24
  - Printing a directory list..... 24
  
- Understanding the printer menus..... 25**
  - Menu map..... 25
  - Device..... 26

Print..... 33

Paper..... 41

Network/Ports..... 43

USB Drive..... 55

Security..... 57

Reports..... 60

Help..... 61

Troubleshooting..... 62

Printing the Menu Settings Page..... 62

**Securing the printer..... 63**

Locating the security slot..... 63

Erasing printer memory..... 63

Restoring factory default settings..... 64

Statement of Volatility..... 64

**Maintaining the printer..... 65**

Networking..... 65

Cleaning the printer..... 66

Ordering parts and supplies..... 67

Replacing parts and supplies..... 71

Moving the printer..... 81

Saving energy and paper..... 82

Recycling..... 83

**Clearing jams..... 85**

Avoiding jams..... 85

Identifying jam locations..... 86

Paper jam in door A..... 87

Paper jam in the rear door..... 90

Paper jam in the standard bin..... 91

Paper jam in the duplex unit..... 92

Paper jam in trays..... 93

Paper jam in the multipurpose feeder..... 93

**Troubleshooting..... 95**

Network connection problems..... 95

Issues with supplies..... 97  
Paper feed problems.....98  
Printing problems.....101  
Contacting customer support..... 128

**Upgrading and migrating.....129**

Hardware..... 129  
Software..... 134  
Firmware.....136

**Notices..... 137**

**Index..... 149**

# Safety information





## Conventions

**Note:** A *note* identifies information that could help you.







**Warning:** A *warning* identifies something that could damage the product hardware or software.









**CAUTION:** A *caution* indicates a potentially hazardous situation that could injure you.

Different types of caution statements include:

-  **CAUTION—POTENTIAL INJURY:** Indicates a risk of injury.
-  **CAUTION—SHOCK HAZARD:** Indicates a risk of electrical shock.
-  **CAUTION—HOT SURFACE:** Indicates a risk of burn if touched.
-  **CAUTION—TIPPING HAZARD:** Indicates a crush hazard.
-  **CAUTION—PINCH HAZARD:** Indicates a risk of being caught between moving parts.

## Product statements

-  **CAUTION—POTENTIAL INJURY:** To avoid the risk of fire or electrical shock, connect the power cord to an appropriately rated and properly grounded electrical outlet that is near the product and easily accessible.
-  **CAUTION—POTENTIAL INJURY:** To avoid the risk of fire or electrical shock, use only the power cord provided with this product or the manufacturer's authorized replacement.
-  **CAUTION—POTENTIAL INJURY:** Do not use this product with extension cords, multioutlet power strips, multioutlet extenders, or UPS devices. The power capacity of these types of accessories can be easily overloaded by a laser printer and may result in a risk of fire, property damage, or poor printer performance.
-  **CAUTION—POTENTIAL INJURY:** Only a Lexmark Inline Surge Protector that is properly connected between the printer and the power cord provided with the printer may be used with this product. The use of non-Lexmark surge protection devices may result in a risk of fire, property damage, or poor printer performance.
-  **CAUTION—SHOCK HAZARD:** To avoid the risk of electrical shock, do not place or use this product near water or wet locations.
-  **CAUTION—SHOCK HAZARD:** To avoid the risk of electrical shock, do not set up this product or make any electrical or cabling connections, such as the power cord, fax feature, or telephone, during a lightning storm.
-  **CAUTION—POTENTIAL INJURY:** Do not cut, twist, bind, crush, or place heavy objects on the power cord. Do not subject the power cord to abrasion or stress. Do not pinch the power cord between objects such as furniture and walls. If any of these things happen, a risk of fire or electrical shock results. Inspect the power cord regularly for signs of such problems. Remove the power cord from the electrical outlet before inspecting it.

-  **CAUTION—SHOCK HAZARD:** To avoid the risk of electrical shock, make sure that all external connections (such as Ethernet and telephone system connections) are properly installed in their marked plug-in ports.
-  **CAUTION—SHOCK HAZARD:** To avoid the risk of electrical shock, if you are accessing the controller board or installing optional hardware or memory devices sometime after setting up the printer, then turn the printer off, and unplug the power cord from the electrical outlet before continuing. If you have any other devices attached to the printer, then turn them off as well, and unplug any cables going into the printer.
-  **CAUTION—SHOCK HAZARD:** To avoid the risk of electrical shock when cleaning the exterior of the printer, unplug the power cord from the electrical outlet and disconnect all cables from the printer before proceeding.
-  **CAUTION—POTENTIAL INJURY:** If the printer weight is greater than 18 kg (40 lb), then it requires two or more trained personnel to lift it safely.
-  **CAUTION—POTENTIAL INJURY:** When moving the printer, follow these guidelines to avoid personal injury or printer damage:
- Make sure that all doors and trays are closed.
  - Turn off the printer, and then unplug the power cord from the electrical outlet.
  - Disconnect all cords and cables from the printer.
  - If the printer has separate floor-standing optional trays or output options attached to it, then disconnect them before moving the printer.
  - If the printer has a caster base, then carefully roll it to the new location. Use caution when passing over thresholds and breaks in flooring.
  - If the printer does not have a caster base but is configured with optional trays or output options, then remove the output options and lift the printer off the trays. Do not try to lift the printer and any options at the same time.
  - Always use the handholds on the printer to lift it.
  - Any cart used to move the printer must have a surface able to support the full footprint of the printer.
  - Any cart used to move the hardware options must have a surface able to support the dimensions of the options.
  - Keep the printer in an upright position.
  - Avoid severe jarring movements.
  - Make sure that your fingers are not under the printer when you set it down.
  - Make sure that there is adequate clearance around the printer.
-  **CAUTION—TIPPING HAZARD:** Installing one or more options on your printer or MFP may require a caster base, furniture, or other feature to prevent instability causing possible injury. For more information on supported configurations, see [www.lexmark.com/multifunctionprinters](http://www.lexmark.com/multifunctionprinters).
-  **CAUTION—TIPPING HAZARD:** To reduce the risk of equipment instability, load each tray separately. Keep all other trays closed until needed.
-  **CAUTION—HOT SURFACE:** The inside of the printer might be hot. To reduce the risk of injury from a hot component, allow the surface to cool before touching it.
-  **CAUTION—PINCH HAZARD:** To avoid the risk of a pinch injury, use caution in areas marked with this label. Pinch injuries may occur around moving parts, such as gears, doors, trays, and covers.

 **CAUTION—POTENTIAL INJURY:** This product uses a laser. Use of controls or adjustments or performance of procedures other than those specified in the *User's Guide* may result in hazardous radiation exposure.

 **CAUTION—POTENTIAL INJURY:** The lithium battery in this product is not intended to be replaced. There is a danger of explosion if a lithium battery is incorrectly replaced. Do not recharge, disassemble, or incinerate a lithium battery. Discard used lithium batteries according to the manufacturer's instructions and local regulations.

This product is designed, tested, and approved to meet strict global safety standards with the use of specific manufacturer's components. The safety features of some parts may not always be obvious. The manufacturer is not responsible for the use of other replacement parts.

Refer service or repairs, other than those described in the user documentation, to a service representative.

This product uses a printing process that heats the print media, and the heat may cause the media to release emissions. You must understand the section in your operating instructions that discusses the guidelines for selecting print media to avoid the possibility of harmful emissions.

This product may produce small amounts of ozone during normal operation, and may be equipped with a filter designed to limit ozone concentrations to levels well below the recommended exposure limits. To avoid high ozone concentration levels during extensive usage, install this product in a well-ventilated area and replace the ozone and exhaust filters if instructed to do so in the product maintenance instructions. If there are no references to filters in the product maintenance instructions, then there are no filters requiring replacement for this product.

**SAVE THESE INSTRUCTIONS.**

# Learning about the printer

## Finding information about the printer

What are you looking for?	Find it here
Initial setup instructions: <ul style="list-style-type: none"> <li>• Connecting the printer</li> <li>• Installing the printer software</li> </ul>	See the setup documentation that came with the printer or go to <a href="http://support.lexmark.com">http://support.lexmark.com</a> .
More setup and instructions for using the printer: <ul style="list-style-type: none"> <li>• Selecting and storing paper and specialty media</li> <li>• Loading paper</li> <li>• Configuring printer settings</li> <li>• Viewing and printing documents and photos</li> <li>• Setting up and using the printer software</li> <li>• Configuring the printer on a network</li> <li>• Caring for and maintaining the printer</li> <li>• Troubleshooting and solving problems</li> </ul>	<i>Information Center</i> —Go to <a href="http://infoserve.lexmark.com">http://infoserve.lexmark.com</a> . <i>Help Menu Pages</i> —Access the guides on the printer firmware or go to <a href="http://support.lexmark.com">http://support.lexmark.com</a> . <i>Touch Screen Guide</i> —Go to <a href="http://support.lexmark.com">http://support.lexmark.com</a> . Product videos—Go to <a href="http://infoserve.lexmark.com/idv/">http://infoserve.lexmark.com/idv/</a> .
Information on setting up and configuring the accessibility features of your printer	<i>Lexmark Accessibility Guide</i> —Go to <a href="http://support.lexmark.com">http://support.lexmark.com</a> .
Help using the printer software	Help for Microsoft® Windows® or Macintosh operating systems—Open a printer software program or application, and then click <b>Help</b> .  Click  to view context-sensitive information.  <b>Notes:</b> <ul style="list-style-type: none"> <li>• Help is automatically installed with the printer software.</li> <li>• Depending on the operating system, the printer software is located in the printer program folder or on the desktop.</li> </ul>



What are you looking for?	Find it here
<p>The latest supplemental information, updates, and customer support:</p> <ul style="list-style-type: none"> <li>• Documentation</li> <li>• Driver downloads</li> <li>• Live chat support</li> <li>• E-mail support</li> <li>• Voice support</li> </ul>	<p>Go to <a href="http://support.lexmark.com">http://support.lexmark.com</a>.</p> <p><b>Note:</b> Select your country or region, and then select your product to view the appropriate support site.</p> <p>Support contact information for your country or region can be found on the website or on the printed warranty that came with the printer.</p> <p>Have the following information ready when you contact customer support:</p> <ul style="list-style-type: none"> <li>• Place and date of purchase</li> <li>• Machine type and serial number</li> </ul> 
<ul style="list-style-type: none"> <li>• Safety information</li> <li>• Regulatory information</li> <li>• Warranty information</li> <li>• Environmental information</li> </ul>	<p>Warranty information varies by country or region:</p> <ul style="list-style-type: none"> <li>• <b>In the U.S.</b>—See the Statement of Limited Warranty included with the printer, or go to <a href="http://support.lexmark.com">http://support.lexmark.com</a>.</li> <li>• <b>In other countries and regions</b>—See the printed warranty that came with the printer.</li> </ul> <p><i>Product Information Guide</i>—See the documentation that came with the printer or go to <a href="http://support.lexmark.com">http://support.lexmark.com</a>.</p>

## Selecting a location for the printer

- Leave enough room to open trays, covers, and doors and to install hardware options.
- Set up the printer near an electrical outlet.

 **CAUTION—POTENTIAL INJURY:** To avoid the risk of fire or electrical shock, connect the power cord to an appropriately rated and properly grounded electrical outlet that is near the product and easily accessible.

 **CAUTION—SHOCK HAZARD:** To avoid the risk of electrical shock, do not place or use this product near water or wet locations.

- Make sure that airflow in the room meets the latest revision of the ASHRAE 62 standard or the CEN Technical Committee 156 standard.
- Provide a flat, sturdy, and stable surface.
- Keep the printer:
  - Clean, dry, and free of dust
  - Away from stray staples and paper clips
  - Away from the direct airflow of air conditioners, heaters, or ventilators
  - Free from direct sunlight and humidity extremes
- Observe the recommended temperatures and avoid fluctuations.

Ambient temperature	10 to 32°C (50 to 90°F)
Storage temperature	0 to 40°C (32 to 104°F)

- Allow the following recommended amount of space around the printer for proper ventilation:

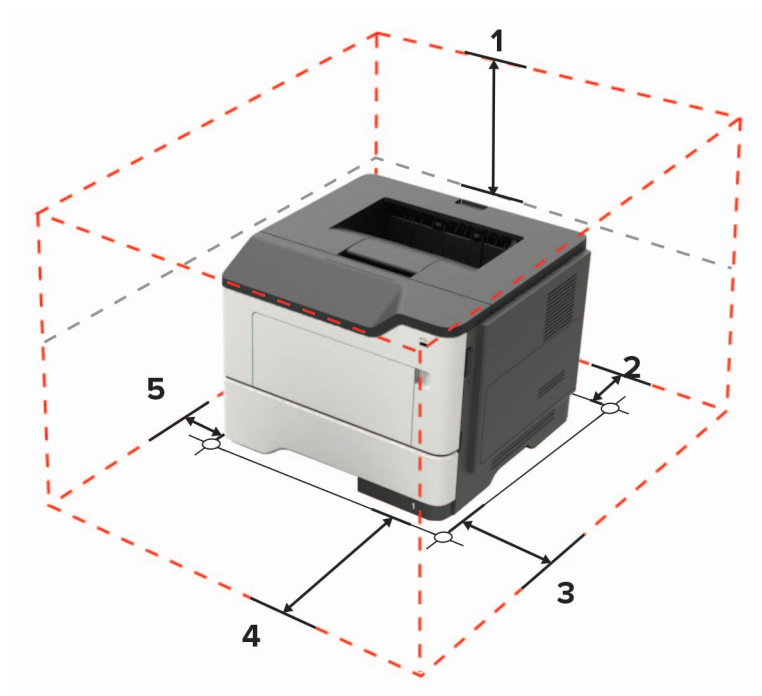

<b>1</b>	Top	305 mm (12 in.)
<b>2</b>	Rear	100 mm (3.94 in.)
<b>3</b>	Right side	110 mm (4.33 in.)
<b>4</b>	Front	305 mm (12 in.) <b>Note:</b> The minimum space needed in front of the printer is 76 mm (3 in.).
<b>5</b>	Left side	65 mm (2.56 in.)

## Printer configurations

**CAUTION—TIPPING HAZARD:** Installing one or more options on your printer or MFP may require a caster base, furniture, or other feature to prevent instability causing possible injury. For more information on supported configurations, see [www.lexmark.com/multifunctionprinters](http://www.lexmark.com/multifunctionprinters).

**CAUTION—TIPPING HAZARD:** To reduce the risk of equipment instability, load each tray separately. Keep all other trays closed until needed.

You can configure your printer by adding optional 250- or 550-sheet trays. For more information, see [“Installing optional trays” on page 133](#).



1	Control panel
2	Standard bin
3	Controller board access cover
4	Standard 250- or 550-sheet tray <b>Note:</b> The standard tray may vary depending on your printer model.
5	Optional 250- or 550-sheet tray
6	Multipurpose feeder
7	Door A

## Attaching cables

**CAUTION—SHOCK HAZARD:** To avoid the risk of electrical shock, do not set up this product or make any electrical or cabling connections, such as the power cord, fax feature, or telephone, during a lightning storm.

**CAUTION—POTENTIAL INJURY:** To avoid the risk of fire or electrical shock, connect the power cord to an appropriately rated and properly grounded electrical outlet that is near the product and easily accessible.

**CAUTION—POTENTIAL INJURY:** To avoid the risk of fire or electrical shock, use only the power cord provided with this product or the manufacturer's authorized replacement.

**Warning—Potential Damage:** To avoid loss of data or printer malfunction, do not touch the USB cable, any wireless network adapter, or the printer in the areas shown while actively printing.

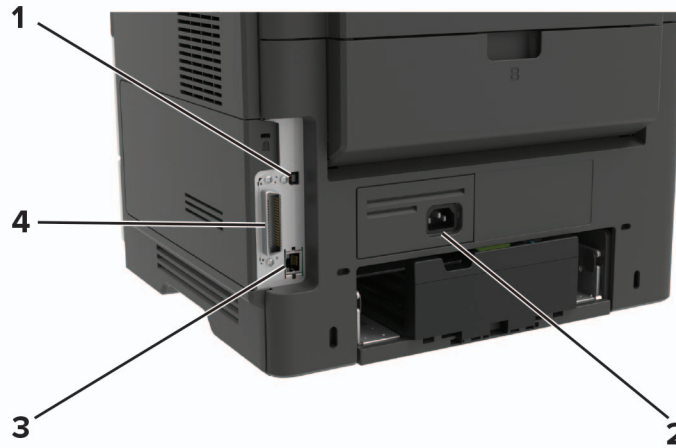

	Use the	To
1	USB printer port	Connect the printer to a computer.
2	Power cord socket	Connect the printer to an electrical outlet.
3	Ethernet port	Connect the printer to a network.
4	Parallel port	Connect the printer to a computer.

## Using the control panel

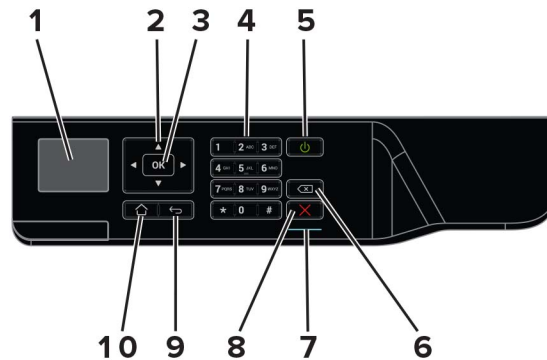

	Use the	To
1	Display	View printing options, printer status, and error messages.
2	Arrow buttons	Scroll through menus or move between screens and menu options.

	Use the	To
3	Select button	<ul style="list-style-type: none"> <li>Select menu options.</li> <li>Save the setting.</li> </ul>
4	Numeric keypad	Enter numbers or symbols in an input field.
5	Power button	Turn on or turn off the printer. <b>Note:</b> To turn off the printer, press and hold the power button for five seconds.
6	Backspace button	Move the cursor backward and delete a character in an input field.
7	Indicator light	Check the printer status.
8	Stop or Cancel button	Stop the current printer task.
9	Back button	Return to the previous screen.
10	Home button	Go to the home screen.

## Understanding the status of the power button and indicator light

Indicator light	Printer status
Off	The printer is off or in Hibernate mode.
Blue	The printer is ready or processing data.
Red	The printer requires user intervention.

Power button light	Printer status
Off	The printer is off, ready, or processing data.
Solid amber	The printer is in Sleep mode.
Blinking amber	The printer is in Hibernate mode.

# Loading paper and specialty media

## Setting the size and type of the specialty media

1 From the control panel, navigate to:

 > **Settings** >  > **Paper** >  > **Tray Configuration** >  > **Paper Size/Type** > 

2 Select a paper source, and then configure the size and type of the specialty media.

## Configuring Universal paper settings

1 From the control panel, navigate to:

 > **Settings** >  > **Paper** >  > **Media Configuration** >  > **Universal Setup** > 

2 Select **Portrait Width** or **Portrait Height**, and then press .

3 Adjust the settings, and then press .

## Loading trays

 **CAUTION—TIPPING HAZARD:** To reduce the risk of equipment instability, load each tray separately. Keep all other trays closed until needed.

1 Remove the tray.

**Note:** To avoid paper jams, do not remove trays while the printer is busy.

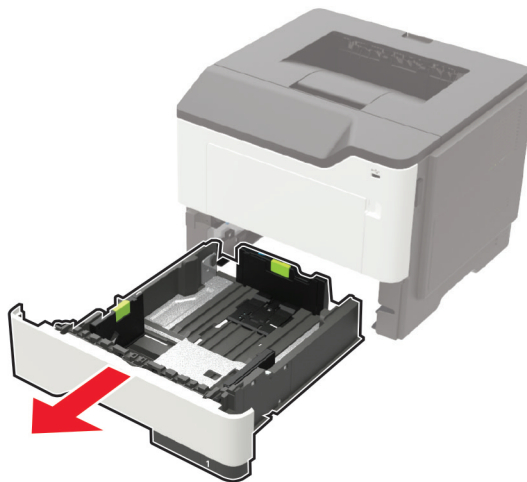

- 2** Adjust the paper guides to match the size of the paper that you are loading.

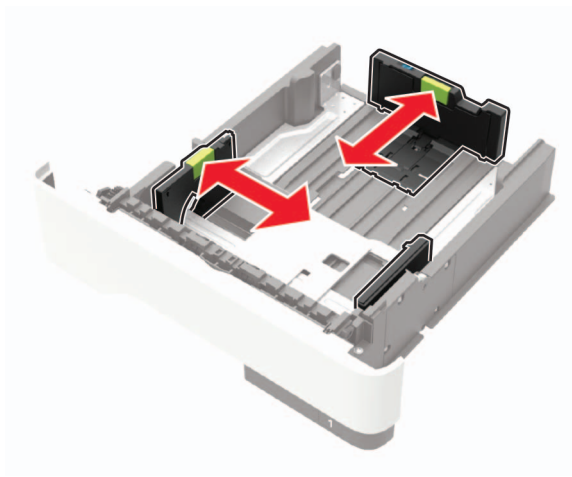

- 3** Flex, fan, and align the paper edges before loading.

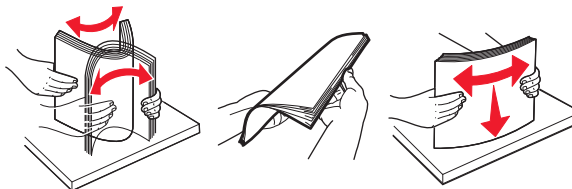

- 4** Load the paper stack with the printable side facedown, and then make sure that the side guides fit snugly against the paper.

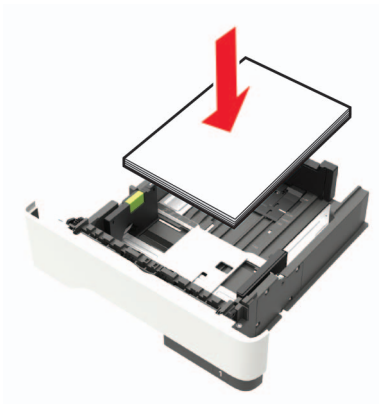

**Notes:**

- Load letterhead facedown with the top edge of the sheet toward the front of the tray for one-sided printing.
- Load letterhead faceup with the bottom edge of the sheet toward the front of the tray for two-sided printing.
- Do not slide paper into the tray.
- To avoid paper jams, make sure that the stack height is below the maximum paper fill indicator.

- 5** Insert the tray.

If necessary, set the paper size and paper type from the control panel to match the paper loaded.

## Loading the multipurpose feeder

- 1 Open the multipurpose feeder.

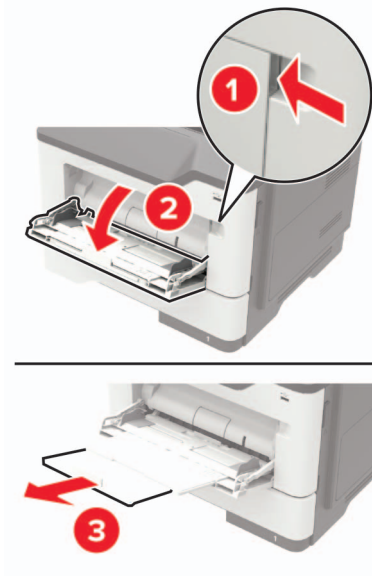

- 2 Adjust the guide to match the size of the paper that you are loading.

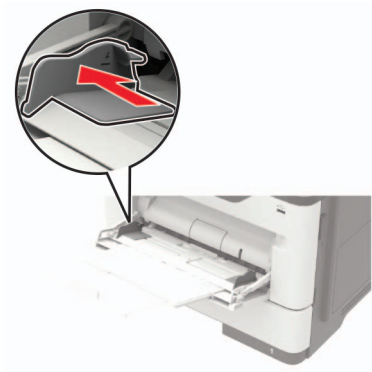

- 3 Flex, fan, and align the paper edges before loading.

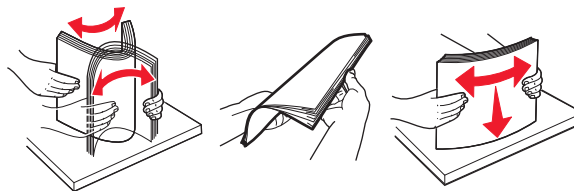

- 4 Load paper with the printable side faceup.

**Notes:**

- Load letterhead faceup with the top edge of the sheet toward the front of the tray for one-sided printing.
- Load letterhead facedown with the bottom edge of the sheet toward the front of the tray for two-sided printing.
- Load envelopes with the flap facedown on the left side.



- Load European envelopes with the flap facedown and entering the printer first.

**Warning—Potential Damage:** Do not use envelopes with stamps, clasps, snaps, windows, coated linings, or self-stick adhesives.

- 5 From the control panel, set the paper size and paper type to match the paper loaded.

## Linking trays

- 1 Open a web browser, and then type the printer IP address in the address field.

**Notes:**

- View the printer IP address on the printer home screen. The IP address appears as four sets of numbers separated by periods, such as 123.123.123.123.
- If you are using a proxy server, then temporarily disable it to load the web page correctly.

- 2 Click **Settings > Paper > Tray Configuration**.
- 3 Set the same paper size and paper type for the trays that you are linking.
- 4 Save the settings.
- 5 Click **Settings > Device > Maintenance > Configuration Menu > Tray Configuration**.
- 6 Set Tray Linking to **Automatic**.
- 7 Save the settings.

To unlink trays, make sure that no trays have the same paper size and paper type settings.

**Warning—Potential Damage:** The temperature of the fuser varies according to the specified paper type. To avoid printing issues, match the paper type setting in the printer with the paper loaded in the tray.

# Paper support

## Supported paper sizes

Paper size	Tray	Multipurpose feeder	Two-sided printing
<b>A4</b> 210 x 297 mm (8.3 x 11.7 in.)	✓	✓	✓
<b>A5</b> 210 x 148 mm (5.8 x 8.3 in.)	✓	✓	X
<b>A5 LEF*</b> 148 x 210 mm (5.8 x 8.3 in.)	✓	✓	X
<b>A6*</b> 105 x 148 mm (4.1 x 5.8 in.)	✓	✓	X
<b>JIS B5</b> 182 x 257 mm (7.2 x 10.1 in.)	✓	✓	X
<b>Oficio (Mexico)</b> 216 x 340 mm (8.5 x 13.4 in.)	✓	✓	✓
<b>Hagaki</b> 100 x 148 mm (3.9 x 5.8 in.)	X	✓	X
<b>Statement</b> 140 x 216 mm (5.5 x 8.5 in.)	✓	✓	X
<b>Executive</b> 184 x 267 mm (7.3 x 10.5 in.)	✓	✓	X
<b>Letter</b> 216 x 279 mm (8.5 x 11 in.)	✓	✓	✓
<b>Legal</b> 216 x 356 mm (8.5 x 14 in.)	✓	✓	✓
<b>Folio</b> 216 x 330 mm (8.5 x 13 in.)	✓	✓	✓
<b>Universal</b> 76.2 x 127 mm (3 x 5 in.) to 216 x 356 mm (8.5 x 14 in.)	✓	✓	X
<b>7 3/4 Envelope (Monarch)</b> 98 x 191 mm (3.9 x 7.5 in.)	X	✓	X
<b>9 Envelope</b> 98 x 225 mm (3.9 x 8.9 in.)	X	✓	X
<b>10 Envelope</b> 105 x 241 mm (4.1 x 9.5 in.)	X	✓	X

\* This paper size is not supported in the optional tray.

Paper size	Tray	Multipurpose feeder	Two-sided printing
<b>DL Envelope</b> 110 x 220 mm (4.3 x 8.7 in.)	X	✓	X
<b>C5 Envelope</b> 162 x 229 mm (6.4 x 9 in.)	X	✓	X
<b>B5 Envelope</b> 176 x 250 mm (6.9 x 9.8 in.)	X	✓	X
<b>Other Envelope</b> 76.2 x 127 mm (3 x 5 in.) to 216 x 356 mm (8.5 x 14 in.)	X	✓	X

\* This paper size is not supported in the optional tray.

## Supported paper types

Paper type	Tray	Multipurpose feeder	Two-sided printing
<b>Plain paper</b>	✓	✓	✓
<b>Card stock</b>	X	✓	X
<b>Transparency</b>	✓	✓	X
<b>Recycled</b>	✓	✓	✓
<b>Paper labels<sup>1</sup></b>	✓	✓	X
<b>Bond<sup>2</sup></b>	✓	✓	✓
<b>Letterhead</b>	✓	✓	✓
<b>Preprinted</b>	✓	✓	✓
<b>Colored Paper</b>	✓	✓	✓
<b>Light Paper</b>	✓	✓	✓
<b>Heavy Paper<sup>2</sup></b>	✓	✓	✓
<b>Rough/Cotton</b>	✓	✓	✓
<b>Envelope</b>	X	✓	X

<sup>1</sup> One-sided paper labels designed for laser printers are supported for occasional use. It is recommended to print 20 or fewer pages of paper labels per month. Vinyl, pharmacy, and two-sided labels are not supported.

<sup>2</sup> Bond and Heavy Paper are supported in two-sided printing up to 90-g/m<sup>2</sup> (24-lb) paper weight.

Paper type	Tray	Multipurpose feeder	Two-sided printing
<b>Rough envelope</b>	<b>X</b>	✓	<b>X</b>

<sup>1</sup> One-sided paper labels designed for laser printers are supported for occasional use. It is recommended to print 20 or fewer pages of paper labels per month. Vinyl, pharmacy, and two-sided labels are not supported.

<sup>2</sup> Bond and Heavy Paper are supported in two-sided printing up to 90-g/m<sup>2</sup> (24-lb) paper weight.

## Supported paper weights

	Tray	Multipurpose feeder	Two-sided printing
Paper weight	60–120 g/m <sup>2</sup> (16–32 lb)	60–216 g/m <sup>2</sup> (16–58 lb)	60–90 g/m <sup>2</sup> (16–24 lb)

# Printing

## Printing from a computer

**Note:** For labels, card stock, and envelopes, set the paper size and type in the printer before printing the document.

- 1 From the document that you are trying to print, open the Print dialog.
- 2 If necessary, adjust the settings.
- 3 Print the document.

## Printing from a mobile device

### Printing from a mobile device using Lexmark Mobile Print

Lexmark™ Mobile Print allows you to send documents and images directly to a supported Lexmark printer.

- 1 Open the document, and then send or share the document to Lexmark Mobile Print.

**Note:** Some third-party applications may not support the send or share feature. For more information, see the documentation that came with the application.

- 2 Select a printer.
- 3 Print the document.

### Printing from a mobile device using Google Cloud Print

Google Cloud Print™ is a mobile printing service that allows enabled applications on mobile devices to print to any Google Cloud Print-ready printer.

- 1 From the home screen of your mobile device, launch an enabled application.
- 2 Tap **Print**, and then select a printer.
- 3 Print the document.

### Printing from a mobile device using Mopria Print Service

Mopria® Print Service is a mobile printing solution for mobile devices running on Android version 4.4 or later. It allows you to print directly to any Mopria-certified printer.

**Note:** Before printing, make sure that the Mopria Print Service is enabled.

- 1 From the home screen of your mobile device, launch a compatible application.
- 2 Tap **Print**, and then select a printer.
- 3 Print the document.

## Printing from a mobile device using AirPrint

AirPrint is a mobile printing solution that allows you to print directly from Apple devices to an AirPrint-certified printer.

**Note:** This application is supported only in some Apple devices.

- 1 From the home screen of your mobile device, launch a compatible application.
- 2 Select an item to print, and then tap the share icon.
- 3 Tap **Print**, and then select the printer.
- 4 Send the print job.

## Printing from a flash drive

This feature is available only in some printer models.

- 1 Insert the flash drive.

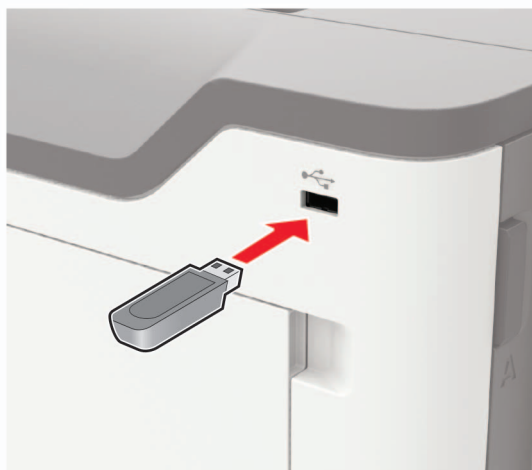

### Notes:

- If you insert the flash drive when an error message appears, then the printer ignores the flash drive.
- If you insert the flash drive while the printer is processing other print jobs, then **Busy** appears on the display.

- 2 Select the document that you want to print.

If necessary, configure other print settings.

- 3 Print the document.

To print another document, select **USB Drive**.

**Warning—Potential Damage:** To avoid loss of data or printer malfunction, do not touch the flash drive or the printer in the area shown while actively printing, reading, or writing from the memory device.



## Supported flash drives and file types

### Flash drives

- Lexar JumpDrive S70 (16GB and 32GB)
- SanDisk Cruzer (16GB and 32GB)
- PNY Attaché (16GB and 32GB)

### Notes:

- The printer supports high-speed USB flash drives with full-speed standard.
- USB flash drives must support the File Allocation Table (FAT) system.

### File types

Documents:

- .doc or .docx
- .xls or .xlsx
- .ppt or .pptx
- .pdf
- .xps

Images:

- .dcx
- .gif
- .jpeg or .jpg
- .bmp
- .pcx
- .tiff or .tif
- .png

## Printing a font sample list

1 From the control panel, navigate to:

 > **Settings** >  > **Reports** >  > **Print** >  > **Print Fonts**

2 Select **PCL Fonts** or **PostScript Fonts**, and then press .

## Printing a directory list

1 From the control panel, navigate to:

 > **Settings** >  > **Reports** >  > **Print** > 

2 Select **Print Directory**, and then press .



# Understanding the printer menus

## Menu map

<b>Device</b>	<ul style="list-style-type: none"> <li>• <a href="#">Preferences</a></li> <li>• <a href="#">Remote Operator Panel</a></li> <li>• <a href="#">Notifications</a></li> <li>• <a href="#">Power Management</a></li> </ul>	<ul style="list-style-type: none"> <li>• <a href="#">Information Sent to Lexmark</a></li> <li>• <a href="#">Restore Factory Defaults</a></li> <li>• <a href="#">Maintenance</a></li> <li>• <a href="#">About This Printer</a></li> </ul>
<b>Print</b>	<ul style="list-style-type: none"> <li>• <a href="#">Layout</a></li> <li>• <a href="#">Setup</a></li> <li>• <a href="#">Quality</a></li> <li>• <a href="#">Job Accounting</a></li> <li>• <a href="#">XPS</a></li> </ul>	<ul style="list-style-type: none"> <li>• <a href="#">PDF</a></li> <li>• <a href="#">PostScript</a></li> <li>• <a href="#">PCL</a></li> <li>• <a href="#">HTML</a></li> <li>• <a href="#">Image</a></li> </ul>
<b>Paper</b>	<ul style="list-style-type: none"> <li>• <a href="#">Tray Configuration</a></li> </ul>	<ul style="list-style-type: none"> <li>• <a href="#">Media Configuration</a></li> </ul>
<b>Network/Ports</b>	<ul style="list-style-type: none"> <li>• <a href="#">Network Overview</a></li> <li>• <a href="#">Wireless</a></li> <li>• <a href="#">Ethernet</a></li> <li>• <a href="#">TCP/IP</a></li> <li>• <a href="#">SNMP</a></li> <li>• <a href="#">IPSec</a></li> <li>• <a href="#">802.1x</a></li> </ul>	<ul style="list-style-type: none"> <li>• <a href="#">LPD Configuration</a></li> <li>• <a href="#">HTTP/FTP Settings</a></li> <li>• <a href="#">ThinPrint</a></li> <li>• <a href="#">USB</a></li> <li>• <a href="#">Google Cloud Print</a></li> <li>• <a href="#">Wi-Fi Direct</a></li> </ul>
<b>Reports</b>	<ul style="list-style-type: none"> <li>• <a href="#">Menu Settings Page</a></li> <li>• <a href="#">Device</a></li> </ul>	<ul style="list-style-type: none"> <li>• <a href="#">Print</a></li> <li>• <a href="#">Network</a></li> </ul>
<b>Security</b>	<ul style="list-style-type: none"> <li>• <a href="#">Security Audit Log</a></li> <li>• <a href="#">Login Restrictions</a></li> <li>• <a href="#">Confidential Print Setup</a></li> </ul>	<ul style="list-style-type: none"> <li>• <a href="#">Solutions LDAP Settings</a></li> <li>• <a href="#">Mobile Services Management</a></li> <li>• <a href="#">Miscellaneous</a></li> </ul>
<b><a href="#">Help</a></b>	<ul style="list-style-type: none"> <li>• Print All Guides</li> <li>• Mono Quality Guide</li> <li>• Connection Guide</li> <li>• Information Guide</li> </ul>	<ul style="list-style-type: none"> <li>• Media Guide</li> <li>• Moving Guide</li> <li>• Print Quality Guide</li> <li>• Supplies Guide</li> </ul>
<b><a href="#">Troubleshooting</a></b>	<ul style="list-style-type: none"> <li>• Print Quality Test Pages</li> </ul>	

# Device

## Preferences

Menu item	Description
<b>Display Language</b> [List of languages]	Set the language of the text that appears on the display. <b>Note:</b> Not all languages are available for all printer models. You may need to install special hardware for some languages to appear.
<b>Country/Region</b> [List of countries]	Identify the country that the printer is configured to operate.
<b>Run Initial Setup</b> Yes No*	Run the setup wizard.
<b>Displayed information</b> Display Text 1 (IP Address*) Display Text 2 (Date/Time*) Custom Text 1 Custom Text 2	Specify the information to appear on the home screen. <b>Note:</b> Custom Text 1 and Custom Text 2 appear only in some printer models.
<b>Date and Time</b> Configure Current Date and Time Manually Set Date and Time Network Time Protocol Enable NTP NTP Server	Configure the printer date and time. <b>Notes:</b> <ul style="list-style-type: none"> <li>• Enable Authentication appears only in some printer models.</li> <li>• When Enable Authentication is set to MD5 key, Key ID and Password appear.</li> </ul>
<b>Paper Sizes</b> U.S.* Metric	Specify the unit of measurement for paper sizes. <b>Note:</b> The country or region selected in the initial setup wizard determines the initial paper size setting.
<b>Flash Drive Access</b> Enabled* Disabled	Enable access to the flash drive. <b>Note:</b> This menu item appears only in some printer models.
<b>Screen Timeout</b> 10–300 (60*)	Set the idle time in seconds before the display shows the home screen, or before the printer logs off a user account automatically.

**Note:** An asterisk (\*) next to a value indicates the factory default setting.

## Remote Operator Panel

Menu item	Description
<b>External VNC Connection</b> Don't Allow* Allow	Connect an external Virtual Network Computing (VNC) client to the remote control panel.
<b>Authentication Type</b> None* Standard Authentication	Set the authentication type when accessing the VNC client server.
<b>VNC Password</b>	Specify the password to connect to the VNC client server. <b>Note:</b> This menu item appears only if Authentication Type is set to Standard Authentication.
<b>Note:</b> An asterisk (*) next to a value indicates the factory default setting.	

## Notifications

Menu item	Description
<b>Supplies</b> Show Supply Estimates Show estimates* Do not show estimates	Show the estimated supply status information.
<b>Error Prevention</b> Auto Continue Disabled 5–255 (5*)	Let the printer continue processing or printing a job automatically after clearing certain attendance conditions.
<b>Error Prevention</b> Jam Assist Off On*	Set the printer to check for jammed paper automatically.
<b>Error Prevention</b> Auto Reboot Auto Reboot Reboot always* Reboot never Reboot when idle	Set the printer to restart when an error occurs.
<b>Error Prevention</b> Auto Reboot Max Auto Reboots 1–20 (2*)	Set the number of automatic reboots that the printer can perform.
<b>Note:</b> An asterisk (*) next to a value indicates the factory default setting.	

Menu item	Description
<b>Error Prevention</b> Auto Reboot Auto Reboot Window 1–525600 (720*)	Set the number of seconds before the printer performs an automatic reboot.
<b>Error Prevention</b> Auto Reboot Auto Reboot Counter	Show a read-only information of the reboot counter.
<b>Error Prevention</b> Display Short Paper Error Auto-clear* On	Set the printer to show a message when a short paper error occurs.  <b>Note:</b> Short paper refers to the size of the paper loaded.
<b>Error Prevention</b> Page Protect Off* On	Set the printer to process the entire page into the memory before printing it.
<b>Jam Content Recovery</b> Jam Recovery Off On Auto*	Set the printer to reprint jammed pages.
<b>Note:</b> An asterisk (*) next to a value indicates the factory default setting.	

## Power Management

Menu item	Description
<b>Sleep Mode Profile</b> Print with Display off Allow printing with display off* Display on when printing	Allow printing with the display turned off.
<b>Timeouts</b> Sleep Mode 1–120 minutes (15*)	Set the idle time before the printer begins operating in Sleep mode.
<b>Note:</b> An asterisk (*) next to a value indicates the factory default setting.	

Menu item	Description
<p><b>Timeouts</b></p> <ul style="list-style-type: none"> <li>Hibernate Timeout                             <ul style="list-style-type: none"> <li>Disabled</li> <li>1 hour</li> <li>2 hours</li> <li>3 hours</li> <li>6 hours</li> <li>1 day</li> <li>2 days</li> <li>3 days*</li> <li>1 week</li> <li>2 weeks</li> <li>1 month</li> </ul> </li> </ul>	<p>Set the time before the printer enters Hibernate mode.</p>
<p><b>Timeouts</b></p> <ul style="list-style-type: none"> <li>Hibernate Timeout on Connection                             <ul style="list-style-type: none"> <li>Hibernate</li> <li>Do Not Hibernate*</li> </ul> </li> </ul>	<p>Set the printer to Hibernate mode even when an active Ethernet connection exists.</p>
<p><b>Eco-Mode</b></p> <ul style="list-style-type: none"> <li>Off*</li> <li>Energy</li> <li>Energy/Paper</li> <li>Paper</li> </ul>	<p>Minimize the use of energy, paper, or specialty media.</p> <p><b>Note:</b> Setting Eco-Mode to Energy or Paper may affect printer performance, but not print quality.</p>
<p><b>Note:</b> An asterisk (*) next to a value indicates the factory default setting.</p>	

### Restore Factory Defaults

Menu item	Description
<p><b>Restore Settings</b></p> <ul style="list-style-type: none"> <li>Restore all settings</li> <li>Restore printer settings</li> <li>Restore network settings</li> </ul>	<p>Restore the printer factory default settings.</p>

## Information Sent to Lexmark

Menu item	Description
<b>Information Sent to Lexmark</b> Save Supplies and Page Usage (Anonymous) Device Performance (Anonymous) Device Interaction (Anonymous) None of the Above* More Information	Send printer usage and performance information to Lexmark. <b>Note:</b> Information Send Time and User Information - Level appear only when you select any of the settings in Information Sent to Lexmark, except None of the Above.
<b>Information Send Time</b> Start Time Stop Time	
<b>User Information - Level</b> Anonymous Session Information Only* Session Information with Generic User Information Session Information with Actual User IDs	
<b>Note:</b> An asterisk (*) next to a value indicates the factory default setting.	

## Maintenance

### Config Menu

Menu item	Description
<b>USB Configuration</b> USB PnP 1* 2	Change the USB driver mode of the printer to improve its compatibility with a personal computer.
<b>USB Configuration</b> USB Speed Full Auto*	Set the USB port to run at full speed and disable its high-speed capabilities.
<b>Tray Configuration</b> Tray Linking Automatic* Off	Set the printer to link the trays that have the same paper type and paper size settings.
<b>Tray Configuration</b> Show Tray Insert Message Off Only for unknown sizes* Always	Show the <b>Tray Insert</b> message.
<b>Note:</b> An asterisk (*) next to a value indicates the factory default setting.	

Menu item	Description
<b>Tray Configuration</b> A5 Loading Short Edge* Long Edge	Specify the page orientation when loading A5-size paper.
<b>Tray Configuration</b> Paper Prompts Auto* Multipurpose Feeder Manual Paper Envelope Prompts Auto* Multipurpose Feeder Manual Envelope	Set the paper source that the user fills when a prompt to load paper or envelope appears.  <b>Note:</b> For Multipurpose Feeder to appear, set Configure MP to Cassette from the Paper menu.
<b>Tray Configuration</b> Action for Prompts Prompt user* Continue Use current	Set the printer to resolve paper- or envelope-related change prompts.
<b>Reports</b> Menu Settings Page Event Log Event Log Summary HealthCheck Statistics	Print reports about printer menu settings, printer events, and event logs.
<b>Supply Usage And Counters</b> Clear Supply Usage History Reset Maintenance Counter	Reset the supply page counter or view the total printed pages.
<b>Printer Emulations</b> PPDS Emulation Off* On	Set the printer to recognize and use the PPDS data stream.
<b>Print Configuration</b> Font Sharpening 0–150 (24*)	Set a text point-size value below which the high-frequency screens are used when printing font data.  For example, if the value is 24, then all fonts sized 24 points or less use the high-frequency screens.
<b>Print Configuration</b> Print Density 1–5 (3*)	Adjust the toner density when printing or copying documents.
<b>Device Operations</b> Quiet Mode Off* On	Set the amount of noise that the printer produces.  <b>Note:</b> Enabling this setting slows the printer performance.
<b>Note:</b> An asterisk (*) next to a value indicates the factory default setting.	

Menu item	Description
<b>Device Operations</b> Panel Menus Off On*	Enable access to the control panel menus.
<b>Device Operations</b> Safe Mode Off* On	Set the printer to operate in a special mode, in which it attempts to continue offering as much functionality as possible, despite known issues.  For example, when set to On, and the duplex motor is nonfunctional, the printer performs one-sided printing of the documents even if the job is two-sided printing.
<b>Device Operations</b> Clear Custom Status Off On*	Erase user-defined strings for the Default or Alternate custom messages.
<b>Device Operations</b> Clear all remotely-installed messages	Erase messages that were remotely installed.
<b>Device Operations</b> Automatically Display Error Screens On* Off	Show existing error messages on the display after the printer remains inactive on the home screen for a length of time equal to the Screen Timeout setting.
<b>Device Operations</b> Custom Supply Levels Off* On	Let <i>printservice</i> read and edit values from the Embedded Web Server.

**Note:** An asterisk (\*) next to a value indicates the factory default setting.

### Out of Service Erase

Menu item	Description
<b>Erase Printer Memory</b> Printer Memory Last Sanitized Sanitize all information on non-volatile memory	Clear all settings and applications that are stored in the printer hard disk.

### Visible Home Screen Icons

Menu	Description
Change Language Bookmarks Held Jobs USB	Specify which icons to show on the home screen.  <b>Note:</b> USB appears only in the 4702P printer model.



## About this Printer

Menu item	Description
<b>Asset Tag</b>	Show the serial number of the printer.
<b>Printer's Location</b>	Identify the printer location. Maximum length is 63 characters.
<b>Contact</b>	Personalize the printer name. Maximum length is 63 characters.
<b>Export Configuration File to USB</b>	Export configuration files to a flash drive.
<b>Export Compressed Logs to USB</b>	Export compressed log files to a flash drive.

## Print

### Layout

Menu item	Description
<b>Sides</b> 1-sided* 2-sided	Specify whether to print on one side or two sides of the paper.
<b>Flip Style</b> Long Edge* Short Edge	Determine which side of the paper (long edge or short edge) is bound when performing two-sided printing.  <b>Note:</b> Depending on the option selected, the printer automatically offsets each printed information of the page to bind the job correctly.
<b>Blank Pages</b> Print Do Not Print*	Print blank pages that are included in a print job.
<b>Collate</b> Off [1,1,1,2,2,2]* On [1,2,1,2,1,2]	Keep the pages of a print job stacked in sequence, particularly when printing multiple copies of the job.
<b>Separator Sheets</b> None* Between Copies Between Jobs Between Pages	Insert blank separator sheets when printing.
<b>Separator Sheet Source</b> Tray [x] (1*) Multipurpose Feeder	Specify the paper source for the separator sheet.  <b>Note:</b> The multipurpose feeder is available only in some printer models.
<b>Note:</b> An asterisk (*) next to a value indicates the factory default setting.	

Menu item	Description
<b>Pages per Side</b> Off* 2 pages per side 3 pages per side 4 pages per side 6 pages per side 9 pages per side 12 pages per side 16 pages per side	Print multiple page images on one side of a sheet of paper.
<b>Pages per Side Ordering</b> Horizontal* Reverse Horizontal Vertical Reverse Vertical	Specify the positioning of multiple page images when using Pages per Side. <b>Note:</b> The positioning depends on the number of page images and their page orientation.
<b>Pages per Side Orientation</b> Auto* Landscape Portrait	Specify the orientation of a multiple-page document when using Pages per Side.
<b>Pages per Side Border</b> None* Solid	Print a border around each page image when using Pages per Side.
<b>Copies</b> 1–9999 (1*)	Specify the number of copies for each print job.
<b>Print Area</b> Normal* Fit to page Whole Page	Set the printable area on a sheet of paper.
<b>Note:</b> An asterisk (*) next to a value indicates the factory default setting.	

## Setup

Menu item	Description
<b>Printer Language</b> PCL Emulation* PS Emulation	Set the printer language. <b>Note:</b> Setting a default printer language does not prevent a software program from sending print jobs that use another printer language.
<b>Note:</b> An asterisk (*) next to a value indicates the factory default setting.	

Menu item	Description
<b>Resource Save</b> Off* On	Set the printer to handle temporary downloads when it receives a job that requires more than the available memory.  <b>Notes:</b> <ul style="list-style-type: none"> <li>• Off sets the printer to retain downloads only until memory is needed. Downloads are deleted to process print jobs.</li> <li>• When set to On and the printer runs out of memory, a <b>Memory Full [38]</b> appears on the display but downloads are not deleted.</li> </ul>
<b>Print All Order</b> Alphabetical* Oldest First Newest First	Specify the order in which held and confidential jobs are printed when Print All is selected.
<b>Note:</b> An asterisk (*) next to a value indicates the factory default setting.	

## Quality

Menu item	Description
<b>Print Resolution</b> 600 dpi* 1200 Image Q 2400 Image Q 1200 dpi 300 dpi	Set the resolution for the text and images on the printed output.  <b>Note:</b> Resolution is determined in dots per inch or image quality.
<b>Pixel Boost</b> Off* Fonts Horizontally Vertically Both directions	Enable more pixels to print in clusters for clarity, in order to enhance text and images.
<b>Toner Darkness</b> 1–10 (8*)	Determine the lightness or darkness of text images.
<b>Halftone</b> Normal* Detail	Enhance the printed output to have smoother lines with sharper edges.
<b>Brightness</b> -6 to 6 (0*)	Adjust the brightness of the printed output.
<b>Contrast</b> 0 to 5 (0*)	Adjust the contrast of the printed output.
<b>Gray Correction</b> Off Auto*	Adjust the contrast enhancement applied to images.
<b>Note:</b> An asterisk (*) next to a value indicates the factory default setting.	

## Job Accounting

**Note:** This menu appears only when a printer hard disk is installed.

Menu item	Description
<b>Job Accounting</b> Off* On	Set the printer to create a log of the print jobs that it receives.
<b>Accounting Log Frequency</b> Daily Weekly Monthly*	Specify how often the printer creates a log file.
<b>Log Action at End of Frequency</b> None* E-mail Current Log E-mail & Delete Current Log Post Current Log Post & Delete Current Log	Specify how the printer responds when the frequency threshold expires. <b>Note:</b> The value defined in Accounting Log Frequency determines when this action is triggered.
<b>Log Near Full Level</b> Off* On	Specify the maximum size of the log file before the printer executes the Log Action at Near Full.
<b>Log Action at Near Full</b> None* E-mail Current Log E-mail & Delete Current Log E-mail & Delete Oldest Log Post Current Log Post & Delete Current Log Post & Delete Oldest Log Delete Current Log Delete Oldest Log Delete All But Current Delete All Logs	Specify how the printer responds when the hard disk is nearly full. <b>Note:</b> The value defined in Log Near Full Level determines when this action is triggered.
<b>Log Action at Full</b> None* E-mail & Delete Current Log E-mail & Delete Oldest Log Post & Delete Current Log Post & Delete Oldest Log Delete Current Log Delete Oldest Log Delete All But Current Delete All Logs	Specify how the printer responds when disk usage reaches the maximum limit (100MB).

**Note:** An asterisk (\*) next to a value indicates the factory default setting.

Menu item	Description
<b>URL to Post Log</b>	Specify where the printer posts job accounting logs.
<b>E-mail Address to Send Logs</b>	Specify the e-mail address to which the printer sends job accounting logs.
<b>Log File Prefix</b>	Specify the prefix for the log file name. <b>Note:</b> The current host name defined in the TCP/IP menu is used as the default log file prefix.
<b>Note:</b> An asterisk (*) next to a value indicates the factory default setting.	

## XPS

Menu item	Description
<b>Print Error Pages</b> Off* On	Print a test page that contains information on errors, including XML markup errors.
<b>Minimum Line Width</b> 1–30 (2*)	Set the minimum stroke width of any job printed in 1200 dpi.
<b>Note:</b> An asterisk (*) next to a value indicates the factory default setting.	

## PDF

Menu item	Description
<b>Scale to Fit</b> Off* On	Scale the page content to fit the selected paper size.
<b>Annotations</b> Print Do Not Print*	Specify whether to print annotations in the PDF.
<b>Note:</b> An asterisk (*) next to a value indicates the factory default setting.	

## PostScript

Menu item	Description
<b>Print PS Error</b> On Off*	Print a test page that contains the PostScript error.
<b>Minimum Line Width</b> 1–30 (2*)	Set the minimum stroke width of any job printed in 1200 dpi.
<b>Lock PS Startup Mode</b> On Off*	Disable the SysStart file.
<b>Note:</b> An asterisk (*) next to a value indicates the factory default setting.	

Menu item	Description
<b>Font Priority</b> Resident* Flash/Disk	Establish the font search order.  <b>Notes:</b> <ul style="list-style-type: none"> <li>Resident sets the printer to search its memory for the requested font before searching the flash memory.</li> <li>Flash/Disk sets the printer to search the flash memory for the requested font before searching the printer memory.</li> <li>This menu item appears only when a flash memory is installed.</li> </ul>
<b>Wait Timeout</b> Disabled 15–65535 (40*)	Set the printer to wait for additional data before canceling a print job.
<b>Note:</b> An asterisk (*) next to a value indicates the factory default setting.	

## PCL

Menu item	Description
<b>Font Source</b> Resident* Disk Download Flash All	Choose the source which contains the default font selection.  <b>Notes:</b> <ul style="list-style-type: none"> <li>Flash and Disk appear only in some printer models.</li> <li>For Flash and Disk to appear, make sure that they are not read- or write-protected.</li> </ul>
<b>Font Name</b> [List of available fonts]	Select a font from the specified font source.
<b>Symbol Set</b> [List of available symbol set]	Specify the symbol set for each font name.  <b>Note:</b> A symbol set is a set of alphabetic and numeric characters, punctuation, and special symbols. Symbol sets support the different languages or specific programs such as math symbols for scientific text.
<b>Pitch</b> 0.08–100 (10*)	Specify the font pitch for scalable monospaced fonts.  <b>Note:</b> Pitch refers to the number of fixed-space characters in a horizontal inch of type.
<b>Orientation</b> Portrait* Landscape	Specify the orientation of text and graphics on the page.
<b>Note:</b> An asterisk (*) next to a value indicates the factory default setting.	

Menu item	Description
<b>Lines per Page</b> 1–255	Specify the number of lines of text for each page printed through the PCL® datastream.  <b>Notes:</b> <ul style="list-style-type: none"> <li>• This menu item activates vertical escapement that causes the selected number of requested lines to print between the default margins of the page.</li> <li>• 60 is the U.S. factory default setting. 64 is the international factory default setting.</li> </ul>
<b>PCL5 Minimum Line Width</b> 1–30 (2*)	Set the initial minimum stroke width.  <b>Notes:</b>
<b>PCLXL Minimum Line Width</b> 1–30 (2*)	<ul style="list-style-type: none"> <li>• Jobs printed in 1200 dpi use the value directly.</li> <li>• Jobs printed in 4800CQ use half the value.</li> </ul>
<b>A4 Width</b> 198 mm* 203 mm	Set the width of the logical page on A4-size paper.  <b>Note:</b> Logical page is the space on the physical page where data is printed.
<b>Auto CR after LF</b> Off* On	Set the printer to perform a carriage return after a line feed control command.  <b>Note:</b> Carriage return is a mechanism that commands the printer to move the position of the cursor to the first position on the same line.
<b>Auto LF after CR</b> Off* On	Set the printer to perform a line feed after a carriage return control command.
<b>Tray Renumber</b> Assign MP Feeder Off* None 0–201 Assign Tray [x] Off* None 0–201 Assign Manual Paper Off* None 0–201 Assign Manual Envelope Off* None 0–201	Configure the printer to work with print drivers or applications that use different source assignments for the paper source.

**Note:** An asterisk (\*) next to a value indicates the factory default setting.

Menu item	Description
<b>Tray Renumber</b> View Factory Defaults Restore Defaults	Show the factory default setting assigned for each paper source.
<b>Tray Renumber</b> Restore Defaults	Return all tray assignments to factory default values.
<b>Print Timeout</b> Disabled 1–255 (90*)	Set the printer to end a print job after it has been idle for the specified amount of time in seconds.
<b>Note:</b> An asterisk (*) next to a value indicates the factory default setting.	

## HTML

Menu item	Description
<b>Font Name</b> [List of fonts] (Times*)	Set the font to use for HTML documents.
<b>Font Size</b> 1–255 (12*)	Set the font size to use for HTML documents.
<b>Scale</b> 1–400% (100*)	Scale HTML documents.
<b>Orientation</b> Portrait* Landscape	Set the page orientation for HTML documents.
<b>Margin Size</b> 8–255 mm (19*)	Set the page margin for HTML documents.
<b>Backgrounds</b> Do Not Print Print*	Print background information or graphics for HTML documents.
<b>Note:</b> An asterisk (*) next to a value indicates the factory default setting.	

## Image

Menu item	Description
<b>Auto Fit</b> Off On*	Select the best available paper size and orientation setting for an image. <b>Note:</b> When set to On, this menu item overrides the scaling and orientation settings for the image.
<b>Invert</b> Off* On	Invert bitonal monochrome images. <b>Note:</b> This menu item does not apply to GIF or JPEG image formats.
<b>Note:</b> An asterisk (*) next to a value indicates the factory default setting.	



Menu item	Description
<b>Scaling</b> Best Fit* Anchor Top Left Anchor Center Fit Height/Width Fit Height Fit Width	Adjust the image to fit the printable area. <b>Note:</b> When Auto Fit is set to On, Scaling is automatically set to Best Fit.
<b>Orientation</b> Portrait* Landscape Reverse Portrait Reverse Landscape	Specify the orientation of text and graphics on the page.
<b>Note:</b> An asterisk (*) next to a value indicates the factory default setting.	

## Paper

### Tray Configuration

Menu item	Description
<b>Default Source</b> Tray [x] (1*) MP Feeder Manual Paper Manual Envelope	Set the paper source for all print jobs. <b>Note:</b> Multipurpose Feeder only appears when Configure MP is set to Cassette.
<b>Paper Size/Type</b> Tray [x] MP Feeder Manual Paper Manual Envelope	Specify the paper size or paper type loaded in each paper source.
<b>Substitute Size</b> Off Statement/A5 Letter/A4 All Listed*	Set the printer to substitute a specified paper size if the requested size is not loaded in any paper source. <b>Notes:</b> <ul style="list-style-type: none"> <li>• Off prompts the user to load the required paper size.</li> <li>• Statement/A5 prints A5-size document on statement when loading statement and statement-size jobs on A5 paper size when loading A5.</li> <li>• Letter/A4 prints A4-size document on letter when loading letter and letter-size jobs on A4 paper size when loading letter.</li> <li>• All Listed substitutes Letter/A4.</li> </ul>
<b>Note:</b> An asterisk (*) next to a value indicates the factory default setting.	

Menu item	Description
<p><b>Configure MP</b></p> <p>Cassette*</p> <p>Manual</p> <p>First</p>	<p>Set the printer when to pick paper loaded in the multipurpose feeder.</p> <p><b>Notes:</b></p> <ul style="list-style-type: none"> <li>• When set to Cassette, the printer treats the multipurpose feeder like a tray.</li> <li>• When set to Manual, the printer treats the multipurpose feeder like a manual feeder.</li> <li>• When set to First, the printer picks paper from the multipurpose feeder until it is empty, regardless of the required paper source or paper size.</li> </ul>
<p><b>Note:</b> An asterisk (*) next to a value indicates the factory default setting.</p>	

## Media Configuration menu

### Universal Setup

Menu item	Description
<p><b>Units of Measure</b></p> <p>Inches</p> <p>Millimeters</p>	<p>Specify the unit of measurement for the universal paper.</p> <p><b>Note:</b> Inches is the U.S. factory default setting. Millimeters is the international factory default setting.</p>
<p><b>Portrait Width</b></p> <p>3–14.17 inches (8.50*)</p> <p>76–359.91 mm (216*)</p>	<p>Set the portrait width of the universal paper.</p>
<p><b>Portrait Height</b></p> <p>3–14.17 inches (14*)</p> <p>76–359.91 mm (356*)</p>	<p>Set the portrait height of the universal paper.</p>
<p><b>Feed Direction</b></p> <p>Short Edge*</p> <p>Long Edge</p>	<p>Set the printer to pick paper from the short edge or long edge direction.</p> <p><b>Note:</b> Long Edge appears only when the longest edge is shorter than the maximum width supported.</p>
<p><b>Note:</b> An asterisk (*) next to a value indicates the factory default setting.</p>	

## Media Types

Menu item	Description
Plain	Specify the texture and weight of the paper loaded.
Card Stock	Select from the following options: Paper Texture Smooth Normal* Rough Paper Weight Light Normal* Heavy
Transparency	
Recycled	
Labels	
Bond	
Envelope	
Rough Envelope	
Letterhead	
Preprinted	
Colored Paper	
Light	
Heavy	
Rough/Cotton	
Custom Type [x]	

**Note:** An asterisk (\*) next to a value indicates the factory default setting.

## Network/Ports

### Network Overview

Menu item	Description
<b>Active Adapter</b> Auto* Standard Network	Specify how a network is connected.
<b>Network Status</b>	Show the connection status of the printer network.
<b>Display Network Status on Printer</b> On* Off	Show the network status on the display.
<b>Speed, Duplex</b>	Show the speed of the currently active network card.
<b>IPv4</b>	Show the IPv4 address.
<b>All IPv6 Addresses</b>	Show all IPv6 addresses.
<b>Reset Print Server</b>	Reset all active network connections to the printer. <b>Note:</b> This setting removes all network configuration settings.
<b>Network Job Timeout</b> Off On* (90 seconds)	Set the time before the printer cancels a network print job.

**Note:** An asterisk (\*) next to a value indicates the factory default setting.

Menu item	Description
<b>Banner Page</b> Off* On	Print a banner page.
<b>Note:</b> An asterisk (*) next to a value indicates the factory default setting.	

## Wireless

**Note:** This menu is available only in printers connected to a Wi-Fi network or printers that have a wireless network adapter.

Menu item	Description
<b>Setup Using Mobile App</b>	Configure the Wi-Fi connection using Lexmark Mobile Assistant.
<b>Setup On Printer Panel</b> Choose Network Add Wi-Fi Network Network Name Network Mode Infrastructure Wireless Security Mode Disabled* WEP WPA2/WPA - Personal WPA2 - Personal 802.1x - RADIUS	Configure the Wi-Fi connection using the control panel. <b>Note:</b> 802.1x - RADIUS can be configured only from the Embedded Web Server.
<b>Wi-Fi Protected Setup</b> WPS Auto Detect Off On* Start Push Button Method Start PIN Method	Establish a Wi-Fi network and enable network security. <b>Notes:</b> <ul style="list-style-type: none"> <li>• WPS Auto Detect appears only when the Wireless Security Mode is set to WEP.</li> <li>• Start Push-Button Method connects the printer to a Wi-Fi network when buttons on both the printer and the access point (wireless router) are pressed within a given time.</li> <li>• Start PIN Method connects the printer to a Wi-Fi network when a PIN on the printer is entered into the wireless settings of the access point.</li> </ul>
<b>Network Mode</b> BSS Type Infrastructure*	Specify the network mode.
<b>Enable Wi-Fi Direct</b> On Off*	Enable Wi-Fi Direct-capable devices to connect directly to the printer.

Menu item	Description
<b>Compatibility</b> 802.11b/g/n (2.4GHz)* 802.11a/b/g/n/ac (2.4GHz/5GHz) 802.11a/n/ac (5GHz)	Specify the standard for the Wi-Fi network. <b>Note:</b> 802.11a/b/g/n/ac (2.4GHz/5GHz) and 802.11a/n/ac (5GHz) only appear when a Wi-Fi option is installed.
<b>Wireless Security Mode</b> Disabled* WEP WPA2/WPA-Personal WPA2-Personal 802.1x - RADIUS	Set the security mode for connecting the printer to Wi-Fi devices. <b>Note:</b> 802.1x - RADIUS can be configured only from the Embedded Web Server.
<b>WEP Authentication Mode</b> Auto* Open Shared	Set the type of Wireless Encryption Protocol (WEP) for the printer. <b>Note:</b> This menu item appears only when the Wireless Security Mode is set to WEP.
<b>Set WEP Key</b>	Specify a WEP password for secure Wi-Fi connection.
<b>WPA2/WPA Personal</b> AES	Enable Wi-Fi security through Wi-Fi Protected Access (WPA). <b>Note:</b> This menu item appears only when the Wireless Security Mode is set to WPA2/WPA-Personal.
<b>Set Pre-Shared Key</b>	Set the password for secure Wi-Fi connection.
<b>WPA2-Personal</b> AES	Enable Wi-Fi security through WPA2. <b>Note:</b> This menu item appears only when the Wireless Security Mode is set to WPA2-Personal.
<b>802.1x Encryption Mode</b> WPA+ WPA2*	Enable Wi-Fi security through 802.1x standard. <b>Notes:</b> <ul style="list-style-type: none"> <li>• This menu item appears only when the Wireless Security Mode is set to 802.1x - RADIUS.</li> <li>• 802.1x - RADIUS can be configured only from the Embedded Web Server.</li> </ul>
<b>IPv4</b> Enable DHCP On* Off Set Static IP Address IP Address Netmask Gateway	Enable and configure IPv4 settings in the printer.

Menu item	Description
<b>IPv6</b> Enable IPv6 On* Off Enable DHCPv6 On Off* Stateless Address Autoconfiguration On* Off DNS Server Address Manually Assigned IPv6 Address Manually Assigned IPv6 Router Address Prefix All IPv6 Addresses All IPv6 Router Addresses	Enable and configure IPv6 settings in the printer.
<b>Network Address</b> UAA LAA	View the network addresses.
<b>PCL SmartSwitch</b> Off On*	Set the printer to switch automatically to PCL emulation when a print job requires it, regardless of the default printer language.  <b>Note:</b> If PCL SmartSwitch is off, then the printer does not examine incoming data and uses the default printer language specified in the Setup menu.
<b>PS SmartSwitch</b> Off On*	Set the printer to switch automatically to PS emulation when a print job requires it, regardless of the default printer language.  <b>Note:</b> If PS SmartSwitch is off, then the printer does not examine incoming data and uses the default printer language specified in the Setup menu.
<b>Job Buffering</b> On Off*	Temporarily store print jobs in the printer hard disk before printing.  <b>Note:</b> This menu item appears only when a hard disk is installed.
<b>Mac Binary PS</b> Auto* On Off	Set the printer to process Macintosh binary PostScript print jobs.  <b>Notes:</b> <ul style="list-style-type: none"> <li>• On processes raw binary PostScript print jobs.</li> <li>• Off filters print jobs using the standard protocol.</li> </ul>

## Ethernet

Menu item	Description
<b>Network Speed</b>	Show the speed of an active network adapter.
<b>Note:</b> An asterisk (*) next to a value indicates the factory default setting.	

Menu item	Description
<b>IPv4</b> Enable DHCP On* Off	Enable Dynamic Host Configuration Protocol (DHCP). <b>Note:</b> DHCP is a standard protocol that allows a server to dynamically distribute IP addressing and configuration information to clients.
<b>IPv4</b> Set Static IP Address IP Address Netmask Gateway	Set the static IP address of your printer.
<b>Enable IPv6</b> On* Off	Configure IPv6 in the printer.
<b>Enable DHCPv6</b> On Off*	Run DHCPv6 in an IPv6 network.
<b>Stateless Address Autoconfiguration</b> On* Off	Set the network adapter to accept the automatic IPv6 address configuration entries provided by a router.
<b>DNS Address</b>	Specify the DNS server address, IP address, and the router for IPv6 network.
<b>Manually Assigned IPv6 Address</b>	
<b>Manually Assigned IPv6 Router</b>	
<b>Address Prefix</b> 0–128 (64*)	
<b>All IPv6 Addresses</b>	Show all IP and router addresses used in an IPv6 network.
<b>All IPv6 Router Addresses</b>	
<b>Network Address</b> UAA LAA	Show the printer Media Access Control (MAC) addresses: Locally Administered Address (LAA) and Universally Administered Address (UAA). <b>Note:</b> You can change the printer LAA manually.
<b>PCL SmartSwitch</b> On* Off	Set the printer to switch automatically to PCL emulation when a print job requires it, regardless of the default printer language. <b>Note:</b> If PCL SmartSwitch is off, then the printer does not examine incoming data and uses the default printer language specified in the Setup menu.
<b>PS SmartSwitch</b> On* Off	Set the printer to switch automatically to PS emulation when a print job requires it, regardless of the default printer language. <b>Note:</b> If PS SmartSwitch is off, then the printer does not examine incoming data and uses the default printer language specified in the Setup menu.
<b>Note:</b> An asterisk (*) next to a value indicates the factory default setting.	

Menu item	Description
<b>Mac Binary PS</b> Auto* On Off	Set the printer to process Macintosh binary PostScript print jobs.  <b>Notes:</b> <ul style="list-style-type: none"> <li>• On processes raw binary PostScript print jobs.</li> <li>• Off filters print jobs using the standard protocol.</li> </ul>
<b>Energy Efficient Ethernet</b> On* Off	Reduce power consumption when the printer receives no data from the Ethernet network.
<b>Note:</b> An asterisk (*) next to a value indicates the factory default setting.	

## TCP/IP

**Note:** This menu appears only in network printers or printers attached to print servers.

Menu item	Description
<b>Set Hostname</b>	Set the current TCP/IP host name.
<b>Domain Name</b>	Set the domain name.
<b>Allow DHCP/BOOTP to update NTP server</b> On* Off	Allow the DHCP and BOOTP clients to update the NTP settings of the printer.
<b>Zero Configuration Name</b>	Specify a service name for the zero configuration network.
<b>Enable Auto IP</b> On* Off	Assign an IP address automatically.
<b>DNS Address</b>	Specify the current Domain Name System (DNS) server address.
<b>Backup DNS Address</b>	Specify the backup DNS server addresses.
<b>Backup DNS Address 2</b>	
<b>Backup DNS Address 3</b>	
<b>Domain Search Order</b>	Specify a list of domain names to locate the printer and its resources that reside in different domains on the network.
<b>Enable DDNS</b> On* Off	Update Dynamic DNS settings.
<b>DDNS TTL</b>	Specify the current DDNS settings.
<b>Default TTL</b>	
<b>DDNS Refresh Time</b>	
<b>Note:</b> An asterisk (*) next to a value indicates the factory default setting.	



Menu item	Description
<b>Enable mDNS</b> Off On*	Update multicast DNS settings.
<b>WINS Address</b>	Specify a server address for Windows Internet Name Service (WINS).
<b>Enable BOOTP</b> Off* On	Allow the BOOTP to assign a printer IP address.
<b>Restricted Server List</b>	Specify an IP address for the TCP connections.  <b>Notes:</b> <ul style="list-style-type: none"> <li>• Use a comma to separate each IP address.</li> <li>• You can add up to 50 IP addresses.</li> </ul>
<b>Restricted Server List Options</b> Block All Ports* Block Printing Only Block Printing and HTTP Only	Specify how the IP addresses in the list can access the printer functionality.
<b>MTU</b>	Specify a maximum transmission unit (MTU) parameter for the TCP connections.
<b>Raw Print Port</b> 1–65535 (9100*)	Specify a raw port number for printers connected on a network.
<b>Outbound Traffic Maximum Speed</b> Off* 100 to 1000000	Enable the printer maximum transfer rate.
<b>Enhanced TLS Security</b> On Off*	Enhance printer privacy and data integrity.
<b>Note:</b> An asterisk (*) next to a value indicates the factory default setting.	

## SNMP

**Note:** This menu appears only in network printers or printers that are attached to print servers.

Menu item	Description
<b>SNMP Versions 1 and 2c</b> Enabled Off On* Allow SNMP Set Off On* Enable PPM MIB Off On* SNMP Community	Configure Simple Network Management Protocol (SNMP) versions 1 and 2c to install print drivers and applications.
<b>SNMP Version 3</b> Enabled Off On* Set Read/Write Credentials User Name Password Set Read-only Credentials User Name Password Authentication Hash MD5 SHA1* Minimum Authentication Level No Authentication, No Privacy Authentication, No Privacy Authentication, Privacy* Privacy Algorithm DES AES-128*	Configure SNMP version 3 to install and update printer security.
<b>Note:</b> An asterisk (*) next to a value indicates the factory default setting.	

## 802.1x

**Note:** This menu appears only in network printers or printers that are attached to print servers.

Menu item	Description
<b>Active</b> Off* On	Let the printer join networks that require authentication before allowing access.  <b>Note:</b> To configure the settings of this menu item, access the Embedded Web Server.
<b>Note:</b> An asterisk (*) next to a value indicates the factory default setting.	

## IPSec

**Note:** This menu appears only in network printers or printers that are attached to print servers.

Menu item	Description
<b>Enable IPSec</b> Off* On	Enable Internet Protocol Security (IPSec).
<b>Base Configuration</b> Default* Compatibility Secure	Set the IPSec base configuration. <b>Note:</b> This menu item appears only when Enable IPSec is set to On.
<b>DH (Diffie-Hellman) Group Proposal</b> modp2048 (14)* modp3072 (15) modp4069 (16) modp6144 (17) modp8192 (18)	Set the IPSec encryption. <b>Note:</b> This menu item appears only when Base Configuration is set to Compatibility.
<b>IKE SA Lifetime (Hours)</b> 1 2 4 8 24*	Set the amount of time before a new authentication key is generated. <b>Note:</b> These menu items appear only when Base Configuration is set to Secure.
<b>IPSec SA Lifetime (Hours)</b> 1 2 4 8 24*	
<b>Proposed Encryption Method</b> 3DES AES*	Specify the encryption and authentication methods to connect to a network securely. <b>Note:</b> These menu items appear only when Base Configuration is set to Compatibility.
<b>Proposed Authentication Method</b> SHA1 SHA256* SHA512	
<b>IPSec Device Certificate</b>	Specify an IPSec certificate. <b>Note:</b> This menu item appears only when Base Configuration is set to Compatibility.
<b>Note:</b> An asterisk (*) next to a value indicates the factory default setting.	

Menu item	Description
<b>Pre-Shared Key Authenticated Connections</b> Host [x] Address Key	Configure the authenticated connections of the printer. <b>Note:</b> These menu items appear only when Enable IPsec is set to On.
<b>Certificate Authenticated Connections</b> Host [x] Address[/subnet] Address[/subnet]	
<b>Note:</b> An asterisk (*) next to a value indicates the factory default setting.	

## LPD Configuration

**Note:** This menu appears only in network printers or printers that are attached to print servers.

Menu item	Description
<b>LPD Timeout</b> 0–65535 seconds (90*)	Set the time-out value to stop the Line Printer Daemon (LPD) server from waiting indefinitely for hung or invalid print jobs.
<b>LPD Banner Page</b> Off* On	Print a banner page for all LPD print jobs. <b>Note:</b> A banner page is the first page of a print job used as a separator of print jobs and to identify the originator of the print job request.
<b>LPD Trailer Page</b> Off* On	Print a trailer page for all LPD print jobs. <b>Note:</b> A trailer page is the last page of a print job.
<b>LPD Carriage Return Conversion</b> Off* On	Enable carriage return conversion. <b>Note:</b> Carriage return is a mechanism that commands the printer to move the position of the cursor to the first position on the same line.
<b>Note:</b> An asterisk (*) next to a value indicates the factory default setting.	

## HTTP/FTP Settings

**Note:** This menu appears only in network printers or printers attached to print servers.

Menu item	Description
<b>Enable HTTP Server</b> Off On*	Access the Embedded Web Server to monitor and manage the printer.
<b>Enable HTTPS</b> Off On*	Configure the Hypertext Transfer Protocol Secure (HTTPS) settings.
<b>Note:</b> An asterisk (*) next to a value indicates the factory default setting.	

Menu item	Description
<b>Enable FTP/TFTP</b> Off On*	Send files using FTP.
<b>Local Domains</b>	Specify domain names for HTTP and FTP servers. <b>Note:</b> This menu item appears only in some printer models.
<b>HTTP Proxy IP Address</b>	Configure the HTTP and FTP server settings. <b>Note:</b> These menu items appear only in some printer models.
<b>FTP Proxy IP Address</b>	
<b>HTTP Default IP Port</b> 1–65535 (80*)	
<b>HTTPS Device Certificate</b>	
<b>FTP Default IP Port</b> 1–65535 (21*)	
<b>Timeout for HTTP/FTP Requests</b> 1–299 (30*)	Specify the amount of time before the server connection stops.
<b>Retries for HTTP/FTP Requests</b> 1–299 (3*)	Set the number of retries to connect to the HTTP/FTP server.
<b>Note:</b> An asterisk (*) next to a value indicates the factory default setting.	

## ThinPrint

Menu item	Description
<b>Enable ThinPrint</b> Off On*	Print using ThinPrint.
<b>Port Number</b> 4000–4999 (4000*)	Set the port number for the ThinPrint server.
<b>Bandwidth (bits/sec)</b> 0* 100–1000000	Set the speed to transmit data in a ThinPrint environment.
<b>Packet Size (kbytes)</b> 0–64000 (0*)	Set the packet size for data transmission.
<b>Note:</b> An asterisk (*) next to a value indicates the factory default setting.	

## USB

Menu item	Description
<b>PCL SmartSwitch</b> On* Off	Set the printer to switch to PCL emulation when a print job received through a USB port requires it, regardless of the default printer language.  <b>Note:</b> If PCL SmartSwitch is off, then the printer does not examine incoming data and uses the default printer language specified in the Setup menu.
<b>PS SmartSwitch</b> On* Off	Set the printer to switch to PS emulation when a print job received through a USB port requires it, regardless of the default printer language.  <b>Note:</b> If PS SmartSwitch is off, then the printer does not examine incoming data and uses the default printer language specified in the Setup menu.
<b>Mac Binary PS</b> Auto* On Off	Set the printer to process Macintosh binary PostScript print jobs.  <b>Notes:</b> <ul style="list-style-type: none"> <li>• On processes raw binary PostScript print jobs.</li> <li>• Off filters print jobs using the standard protocol.</li> </ul>
<b>Enable USB Port</b> Enable* Disable	Enable the standard USB port.
<b>Note:</b> An asterisk (*) next to a value indicates the factory default setting.	

## Google Cloud Print

Menu item	Description
<b>Registration</b> Register	Register the printer to the Google Cloud Print server.
<b>Options</b> Enable Google Cloud Print Off On*	Print directly from your Google account.
<b>Options</b> Enable Local Discovery Off On*	Allow the registered user and other users on the same subnet to send jobs to the printer locally.
<b>Options</b> Enable SSL Peer Verification Off On*	Verify authenticity of the peer certificate to connect to your Google account.
<b>Options</b> Always Print As Image Off* On	Set the printer to process PDF files as an image for faster printing.
<b>Note:</b> An asterisk (*) next to a value indicates the factory default setting.	

## Wi-Fi Direct

**Note:** This menu appears only when a direct Wi-Fi network is the active network.

Menu item	Description
<b>SSID</b>	Specify the service set identifier (SSID) of the Wi-Fi network.
<b>Set Preshared Key</b>	Set the preshared key (PSK) to authenticate and validate users on a Wi-Fi connection.
<b>Show PSK on Setup Page</b> On* Off	Show the PSK on the Network Setup Page.
<b>Group Owner IP Address</b>	Specify the IP address of the group owner.
<b>Auto-Accept Push Button Requests</b> On Off*	Accept requests to connect to the network automatically. <b>Note:</b> Accepting clients automatically is not secured.
<b>Note:</b> An asterisk (*) next to a value indicates the factory default setting.	

## USB Drive

**Note:** This menu appears only in some printer models.

## Flash Drive Print

Menu item	Description
<b>Number of Copies</b> 1–9999 (1*)	Set the number of copies.
<b>Paper Source</b> Tray [x] (1*) Multipurpose Feeder Manual Paper Manual Envelope	Set the paper source for the print job. <b>Note:</b> The multipurpose feeder is available only in some printer models.
<b>Collate</b> (1,1) (2,2,2) (1,2,3) (1,2,3)*	Print multiple copies in sequence.
<b>Sides</b> 1-Sided* 2-Sided	Specify whether to print on one side or two sides of the paper.
<b>Flip Style</b> Long Edge* Short Edge	Determine which side of the paper (long edge or short edge) is bound when performing two-sided printing. <b>Note:</b> Depending on the option selected, the printer automatically offsets each printed information of the page to bind the job correctly.
<b>Note:</b> An asterisk (*) next to a value indicates the factory default setting.	

Menu item	Description
<p><b>Pages per Side</b>                      Off*                      2 pages per side                      3 pages per side                      4 pages per side                      6 pages per side                      9 pages per side                      12 pages per side                      16 pages per side</p>	<p>Print multiple page images on one side of a sheet of paper.</p>
<p><b>Pages per Side Ordering</b>                      Horizontal*                      Reverse Horizontal                      Reverse Vertical                      Vertical</p>	<p>Specify the positioning of multiple page images when using Pages per Side.  <b>Note:</b> The positioning depends on the number of page images and their page orientation.</p>
<p><b>Pages per Side Orientation</b>                      Auto*                      Landscape                      Portrait</p>	<p>Specify the orientation of a multiple-page document when using Pages per Side.</p>
<p><b>Pages per Side Border</b>                      None*                      Solid</p>	<p>Print a border around each page image when using Pages per Side.</p>
<p><b>Separator Sheets</b>                      Off*                      Between Copies                      Between Jobs                      Between Pages</p>	<p>Specify whether to insert blank separator sheets when printing.</p>
<p><b>Separator Sheet Source</b>                      Tray [x] (1*)                      Multipurpose Feeder</p>	<p>Specify the paper source for the separator sheet.  <b>Note:</b> The multipurpose feeder is available only in some printer models.</p>
<p><b>Blank Pages</b>                      Do Not Print*                      Print</p>	<p>Specify whether to print blank pages in a print job.</p>
<p><b>Note:</b> An asterisk (*) next to a value indicates the factory default setting.</p>	



# Security

## Security Audit Log

Menu item	Description
<b>Enable Audit</b> Off* On	Record the events in the secure audit log and remote syslog.
<b>Enable Remote Syslog</b> Off* On	Send audit logs to a remote server.
<b>Remote Syslog Server</b>	Specify the remote syslog server.
<b>Remote Syslog Facility</b> 0 - Kernel Messages 1 - User-Level Messages 2 - Mail System 3 - System Daemons 4 - Security/Authorization Messages* 5 - Messages Generated Internally by Syslogs 6 - Line Printer Subsystem 7 - Network News Subsystem 8 - UUCP Subsystem 9 - Clock Daemon 10 - Security/Authorization Messages 11 - FTP Daemon 12 - NTP Subsystem 13 - Log Audit 14 - Log Alert 15 - Clock Daemon 16 - Local Use 0 (local0) 17 - Local Use 1 (local1) 18 - Local Use 2 (local2) 19 - Local Use 3 (local3) 20 - Local Use 4 (local4) 21 - Local Use 5 (local5) 22 - Local Use 6 (local6) 23 - Local Use 7 (local7)	Specify a facility code that the printer uses when sending log events to a remote server.

**Note:** An asterisk (\*) next to a value indicates the factory default setting.

Menu item	Description
<b>Severity of Events to Log</b> 0 - Emergency 1 - Alert 2 - Critical 3 - Error 4 - Warning* 5 - Notice 6 - Informational 7 - Debug	Specify the priority level cutoff for logging messages and events.  <b>Notes:</b> <ul style="list-style-type: none"> <li>• 0 - Emergency is the highest severity. 7 - Debug is the lowest.</li> <li>• The selected severity level and anything higher are logged. For example, selecting 4 - Warning logs the severity levels from 0 to 4.</li> </ul>
<b>Clear Log</b> Start	Delete all audit logs.
<b>Export Log</b> Syslog (RFC 5424)* Syslog (RFC 3164) CSV	Export a security log to a flash drive.
<b>Note:</b> An asterisk (*) next to a value indicates the factory default setting.	

## Login Restrictions

Menu item	Description
<b>Login failures</b> 1–10 (3*)	Specify the number of failed login attempts before the user gets locked out.
<b>Failure time frame</b> 1–60 minutes (5*)	Specify the time frame between failed login attempts before the user gets locked out.
<b>Lockout time</b> 1–60 minutes (5*)	Specify the lockout duration.
<b>Web Login Timeout</b> 1–120 minutes (10*)	Specify the delay for a remote login before the user is logged off automatically.
<b>Note:</b> An asterisk (*) next to a value indicates the factory default setting.	

## Confidential Print Setup

Menu item	Description
<b>Max Invalid PIN</b> 2–10	Set the number of times an invalid PIN can be entered.  <b>Notes:</b> <ul style="list-style-type: none"> <li>• A value of zero turns off this setting.</li> <li>• When the limit is reached, the print jobs for that user name and PIN are deleted.</li> <li>• This menu item appears only when a hard disk is installed.</li> </ul>
<b>Note:</b> An asterisk (*) next to a value indicates the factory default setting.	

Menu item	Description
<b>Confidential Job Expiration</b> Off* 1 Hour 4 Hours 24 Hours 1 Week	Set the expiration time for confidential print jobs.  <b>Notes:</b> <ul style="list-style-type: none"> <li>• If this menu item is changed while confidential print jobs reside in the printer memory or hard disk, then the expiration time for those print jobs does not change to the new default value.</li> <li>• If the printer is turned off, then all confidential jobs held in the printer memory are deleted.</li> </ul>
<b>Repeat Job Expiration</b> Off* 1 Hour 4 Hours 24 Hours 1 Week	Set the expiration time for a print job that you want to repeat.
<b>Verify Job Expiration</b> Off* 1 Hour 4 Hours 24 Hours 1 Week	Set the expiration time that the printer prints a copy for the user to examine its quality, before printing the remaining copies.
<b>Reserve Job Expiration</b> Off* 1 Hour 4 Hours 24 Hours 1 Week	Set the expiration time that the printer stores print jobs for printing later.
<b>Require All Jobs to be Held</b> Off* On	Set the printer to hold all print jobs.
<b>Keep duplicate documents</b> Off* On	Set the printer to print other documents with the same file name without overwriting any of the print jobs.
<b>Note:</b> An asterisk (*) next to a value indicates the factory default setting.	

## Solutions LDAP Settings

Use	To
<b>Follow LDAP Referrals</b> Off* On	Search the different servers in the domain for the logged-in user account.
<b>LDAP Certificate Verification</b> No* Yes	Enable verification of LDAP certificates.

## Mobile Services Management

Use	To
<b>AirPrint</b> Print Scan Fax	Enable functions in the AirPrint software feature.

## Miscellaneous

Menu item	Description
<b>Protected Features</b> Show Hide*	Show secured applications or functions on the home screen. <b>Note:</b> This menu item appears only in some printer models.
<b>Print Permission</b> Off* On	Allow users to print.
<b>Default Print Permission Login</b>	Set the login credentials that allow users to print. <b>Note:</b> This menu item appears only in some printer models.
<b>Security Reset Jumper</b> Enable "Guest" access* No Effect	Specify the effect of using the security reset jumper. <b>Notes:</b> <ul style="list-style-type: none"> <li>The jumper is located beside a lock icon on the controller board.</li> <li>Enable "Guest" access provides guests with full access control.</li> <li>No Effect means that the reset has no effect on the printer security configuration.</li> </ul>
<b>Minimum Password Length</b> 0–32 (0*)	Specify the minimum characters allowed for a password.
<b>Note:</b> An asterisk (*) next to a value indicates the factory default setting.	

## Reports

### Menu Settings Page

Menu item	Description
<b>Menu Settings Page</b>	Print a report that contains the printer preferences, settings, and configurations.

### Device

Menu item	Description
<b>Device Information</b>	Print a report that contains information about the printer.
<b>Device Statistics</b>	Print a report about printer usage and supply status.

Menu item	Description
<b>Profiles List</b>	Print a list of profiles that are stored in the printer.

## Print

Menu item	Description
<b>Print Fonts</b> PCL Fonts PS Fonts	Print samples and information about the fonts that are available in each printer language.
<b>Print Directory</b>	Print the resources that are stored in the flash drive or printer hard disk. <b>Note:</b> This menu item appears only when a flash drive or printer hard disk is installed.

## Network

Menu item	Description
<b>Network Setup Page</b>	Print a page that shows the configured network and wireless settings on the printer. <b>Note:</b> This menu item appears only in network printers or printers connected to print servers.

## Help

Menu item	Description
Print All Guides	Prints all the guides
Media Guide	Provides information about loading paper and specialty media
Print Quality Guide	Provides information about solving print quality issues
Mono Quality Guide	Provides information about mono print quality settings
Information Guide	Provides more information sources about the printer
Connection Guide	Provides information about connecting the printer locally (USB) or to a network
Moving Guide	Provides information about moving, locating, or shipping the printer
Supplies Guide	Provides information about ordering supplies

# Troubleshooting

## Troubleshooting

Menu item	Description
<b>Print Quality Test Pages</b>	Print sample pages to identify and correct print quality defects.

## Printing the Menu Settings Page

1 From the control panel, navigate to:

 > **Settings** >  > **Reports** > 

2 Select **Menu Settings Page**, and then press .

# Securing the printer

## Locating the security slot

The printer is equipped with a security lock feature. Attach a security lock compatible with most laptop computers in the location shown to secure the printer in place.

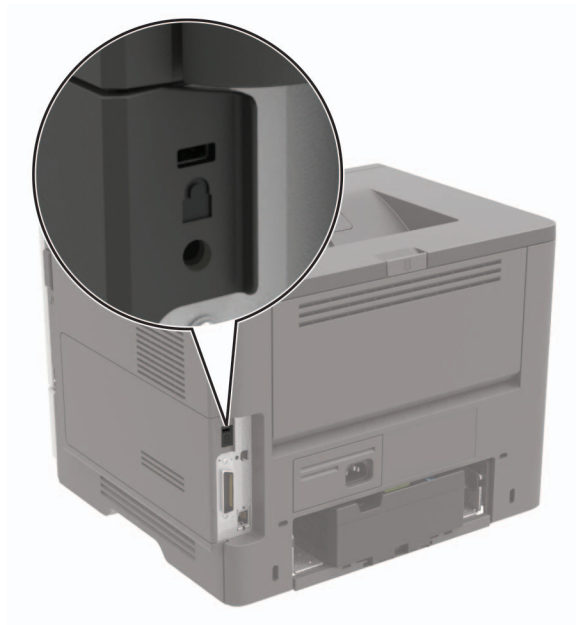

## Erasing printer memory

To erase volatile memory or buffered data, turn off the printer.

To erase non-volatile memory or individual settings, device and network settings, security settings, and embedded solutions, do the following:

- 1 From the control panel, navigate to:

 > **Settings** >  > **Device** >  > **Maintenance** >  > **Out of Service Erase** > 

- 2 Select **Sanitize all information on nonvolatile memory**, and then press .

- 3 To start the job, select **Continue**, and then press .

- 4 Follow the instructions on the display.

## Restoring factory default settings

1 From the control panel, navigate to:



2 Select **Restore all settings**, and then press **[OK]**.

3 Select **RESTORE**, and then press **[OK]**.

For a more comprehensive method of restoring the factory default settings, see [“Erasing printer memory” on page 63](#).

## Statement of Volatility

Type of memory	Description
Volatile memory	The printer uses standard random access memory (RAM) to buffer temporarily user data during simple print and copy jobs.
Non-volatile memory	The printer may use two forms of non-volatile memory: EEPROM and NAND (flash memory). Both types are used to store the operating system, printer settings, network information, scanner and bookmark settings, and embedded solutions.
Hard disk memory	Some printers may have a hard disk drive installed. The printer hard disk is designed for printer-specific functionality. The hard disk lets the printer retain buffered user data from complex print jobs, form data, and font data.

Erase the content of any installed printer memory in the following circumstances:

- The printer is decommissioned.
- The printer hard disk is replaced.
- The printer is moved to a different department or location.
- The printer is serviced by someone from outside your organization.
- The printer is removed from your premises for service.
- The printer is sold to another organization.

### Disposing of a printer hard disk

- **Degaussing**—Flushes the hard disk with a magnetic field that erases stored data
- **Crushing**—Physically compresses the hard disk to break component parts and render them unreadable
- **Milling**—Physically shreds the hard disk into small metal bits

**Note:** To guarantee that all data are completely erased, destroy physically each hard disk where data is stored.



# Maintaining the printer

**Warning—Potential Damage:** Failure to maintain optimum printer performance, or to replace parts and supplies, may cause damage to your printer.

## Networking

### Connecting the printer to a Wi-Fi network

- 1 From the printer control panel, navigate to:

**Settings > Network/Ports > Wireless**

For non-touch-screen printer models, press  to navigate through the settings.

- 2 Select **Setup On Printer Panel** and then follow the instructions on the display.

**Note:** For Wi-Fi-network-ready printer models, a prompt for Wi-Fi network setup appears during initial setup.

### Connecting the printer to a wireless network using Wi-Fi Protected Setup (WPS)

Before you begin, make sure that:

- The access point (wireless router) is WPS-certified or WPS-compatible. For more information, see the documentation that came with your access point.
- A wireless network adapter is installed in your printer. For more information, see the instructions that came with the adapter.

#### Using the Push Button method

- 1 From the control panel, navigate to:

 > **Settings** >  > **Network/Ports** >  > **Wireless** > 

- 2 Select **Wi-Fi Protected Setup**, and then press .

- 3 Select **Start Push Button Method**, and then press .

- 4 Follow the instructions on the display.

#### Using the personal identification number (PIN) method

- 1 From the control panel, navigate to:

 > **Settings** >  > **Network/Ports** >  > **Wireless** > 

- 2 Select **Wi-Fi Protected Setup**, and then press .

- 3 Select **Start PIN Method**, and then press .
- 4 Copy the eight-digit WPS PIN.
- 5 Open a web browser, and then type the IP address of your access point in the address field.

**Notes:**

- View the printer IP address on the printer home screen. The IP address appears as four sets of numbers separated by periods, such as 123.123.123.123.
  - If you are using a proxy server, then temporarily disable it to load the web page correctly.
- 6 Access the WPS settings. For more information, see the documentation that came with your access point.
  - 7 Enter the eight-digit PIN, and then save the changes.

## Deactivating the Wi-Fi network

- 1 From the printer control panel, navigate to:  
**Settings > Network/Ports > Network Overview > Active Adapter > Standard Networking**

For non-touch-screen printer models, press  to navigate through the settings.

- 2 Follow the instructions on the display.

## Cleaning the printer

 **CAUTION—SHOCK HAZARD:** To avoid the risk of electrical shock when cleaning the exterior of the printer, unplug the power cord from the electrical outlet and disconnect all cables from the printer before proceeding.

**Notes:**

- Perform this task after every few months.
- Damage to the printer caused by improper handling is not covered by the printer warranty.

- 1 Turn off the printer, and then unplug the power cord from the electrical outlet.
- 2 Remove paper from the standard bin and multipurpose feeder.
- 3 Remove any dust, lint, and pieces of paper around the printer using a soft brush or vacuum.
- 4 Wipe the outside of the printer with a damp, soft, lint-free cloth.

**Notes:**

- Do not use household cleaners or detergents, as they may damage the finish of the printer.
- Make sure that all areas of the printer are dry after cleaning.

- 5 Connect the power cord to the electrical outlet, and then turn on the printer.

 **CAUTION—POTENTIAL INJURY:** To avoid the risk of fire or electrical shock, connect the power cord to an appropriately rated and properly grounded electrical outlet that is near the product and easily accessible.

## Ordering parts and supplies

To order parts and supplies in the U.S., contact 1-800-539-6275 for information about Lexmark authorized dealers in your area. In other countries or regions, go to [www.lexmark.com](http://www.lexmark.com) or contact the place where you purchased the printer.

**Note:** All life estimates for printer supplies assume printing on letter- or A4-size plain paper.

## Checking the status of parts and supplies

From the control panel, navigate to:



## Using genuine Lexmark parts and supplies

Your Lexmark printer is designed to function best with genuine Lexmark parts and supplies. Use of third-party supplies or parts may affect the performance, reliability, or life of the printer and its imaging components. It can also affect warranty coverage. Damage caused by the use of third-party parts and supplies is not covered by the warranty. All life indicators are designed to function with Lexmark parts and supplies, and may deliver unpredictable results if third-party parts and supplies are used. Imaging component usage beyond the intended life may damage your Lexmark printer or its associated components.

## Ordering a toner cartridge

**Notes:**

- The estimated cartridge yield is based on the ISO/IEC 19752 standard.
- Extremely low print coverage for extended periods of time may negatively affect actual yield.

### MS521 and MS621 Return Program toner cartridges

Item	United States and Canada	European Economic Area	Rest of Asia Pacific	Latin America	Rest of Europe, Middle East, and Africa	Australia and New Zealand
Return Program toner cartridge	56F1000	56F2000	56F3000	56F4000	56F5000	56F6000
High yield Return Program toner cartridge	56F1H00	56F2H00	56F3H00	56F4H00	56F5H00	56F6H00
Extra high yield Return Program toner cartridge	56F1X00	56F2X00	56F3X00	56F4X00	56F5X00	56F6X00

\* These cartridges are available only for contract-managed printers. For more information, contact your Lexmark representative or system administrator.

Item	United States and Canada	European Economic Area	Rest of Asia Pacific	Latin America	Rest of Europe, Middle East, and Africa	Australia and New Zealand
Ultra high yield Return Program toner cartridge	56F1U00	56F2U00	56F3U00	56F4U00	56F5U00	56F6U00
High yield Corporate Return Program toner cartridge*	56F1H0E	56F2H0E	56F3H0E	56F4H0E	56F5H0E	56F6H0E
Extra high yield Corporate Return Program toner cartridge*	56F1X0E	56F2X0E	56F3X0E	56F4X0E	56F5X0E	56F6X0E
Ultra high yield Corporate Return Program toner cartridge*	56F1U0E	56F2U0E	56F3U0E	56F4U0E	56F5U0E	56F6U0E

\* These cartridges are available only for contract-managed printers. For more information, contact your Lexmark representative or system administrator.

**MS521 and MS621 regular toner cartridge**

Item	Worldwide
Ultra high yield regular toner cartridge	56F0UA0

**M1246 Return Program toner cartridge**

Item	United States, Canada, Australia, and New Zealand	European Economic Area	Rest of Asia Pacific	Latin America
Return Program toner cartridge	24B6886	24B6889	24B6892	24B6895

**B2546 and B2650 Return Program toner cartridges**

Item	United States and Canada	European Economic Area	Rest of Asia Pacific	Latin America Distribution	Rest of Europe, Middle East, and Africa	Australia and New Zealand
Return Program toner cartridge	SB231000	SB232000	SB233000	SB234000	SB235000	SB236000
High yield Return Program toner cartridge	SB241H00	SB242H00	SB243H00	SB244H00	SB245H00	SB246H00
Extra high yield Return Program toner cartridge	SB251X00	SB252X00	SB253X00	SB254X00	SB255X00	SB256X00
Ultra high yield Return Program toner cartridge*	SB261U00	SB262U00	SB263U00	SB264U00	SB265U00	SB266U00

\* This toner cartridge is supported only in B2650 printer model.

**B2546 and B2650 regular toner cartridges**

Item	Worldwide
B2546 Extra high yield regular toner cartridge	SB250XA0
B2650 Ultra high yield regular toner cartridge	SB260UA0

**Ordering an imaging unit**

Extremely low print coverage for extended periods of time may cause imaging unit parts to fail before the toner is exhausted.

Item	Part Number
Return Program imaging unit	56F0Z00
Regular imaging unit	56F0ZA0
Corporate Return Program imaging unit*	56F0Z0E

\* This imaging unit is available only for contract-managed printers. For more information, contact your Lexmark representative or system administrator.

**Ordering a maintenance kit**

Match the maintenance kit to the printer voltage.

**Notes:**

- Using certain types of paper may require more frequent replacement of the maintenance kit.
- The maintenance kit includes a fuser, MPF pick roller and separator pad, pick tires, separator roller assembly, and transfer roller. These parts may be individually ordered and replaced if necessary.

Item	Part number
<b>MS521</b>	
200K maintenance kit, 100 V	41X1230
200K maintenance kit, 110 V	41X1228
200K maintenance kit, 220 V	41X1229
<b>MS621</b>	
200K maintenance kit, 100 V	41X1227
200K maintenance kit, 110 V	41X1225
200K maintenance kit, 220 V	41X1226
<b>Note:</b> Only an authorized service technician can replace the maintenance kit. Contact your service provider.	

## Configuring supply notifications

1 Open a web browser, and then type the printer IP address in the address field.

**Notes:**

- View the printer IP address on the printer home screen. The IP address appears as four sets of numbers separated by periods, such as 123.123.123.123.
- If you are using a proxy server, then temporarily disable it to load the web page correctly.

2 Click **Settings > Device > Notifications**.

3 From the Supplies menu, click **Custom Supply Notifications**.

4 Select a notification for each supply item.

5 Apply the changes.

## Replacing parts and supplies

### Replacing the toner cartridge

- 1 Open door A.

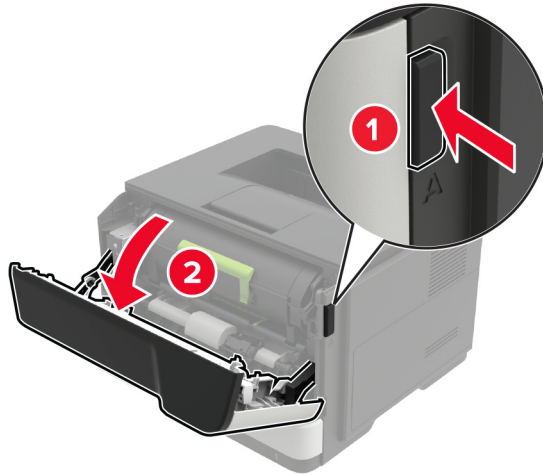

- 2 Remove the used toner cartridge.

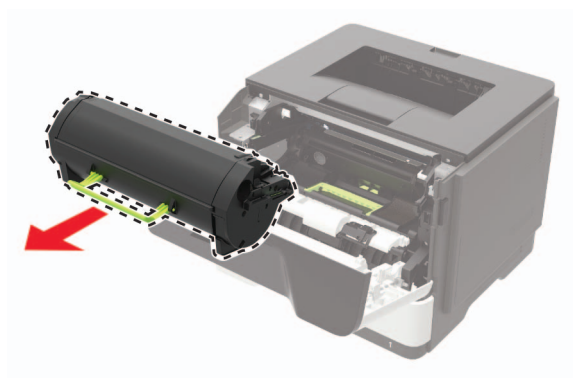

- 3 Unpack the new toner cartridge, and then shake it three times to redistribute the toner.

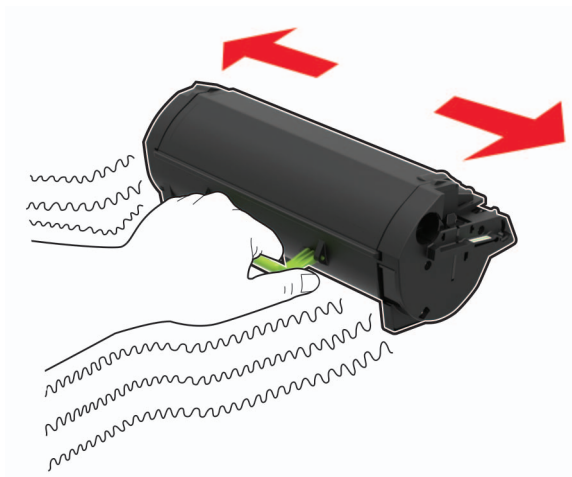

- 4 Insert the new toner cartridge.

**Note:** Use the arrows inside the printer as guides.

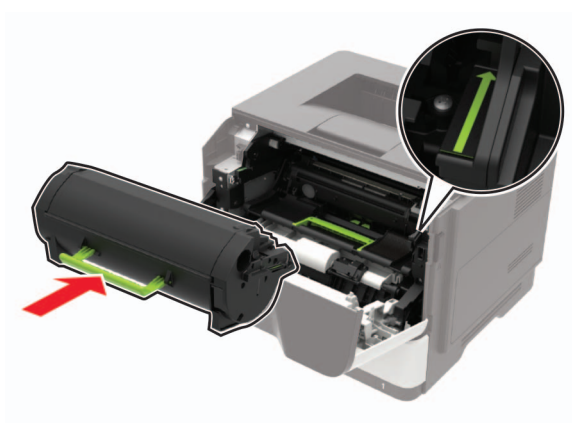

- 5 Close door A.



## Replacing the imaging unit

1 Open door A.

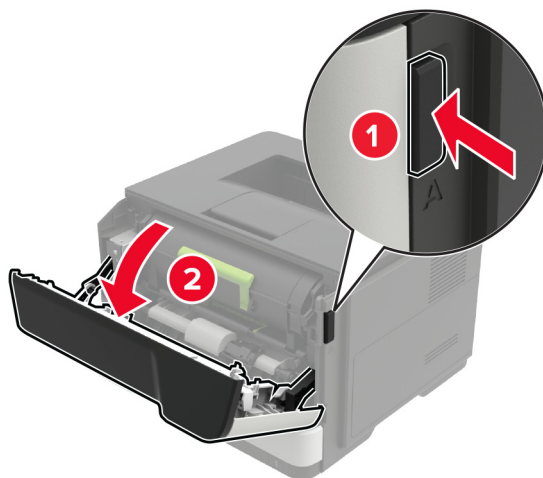

2 Remove the toner cartridge.

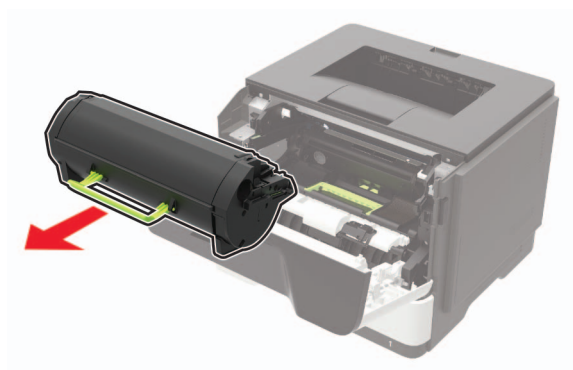

3 Remove the used imaging unit.

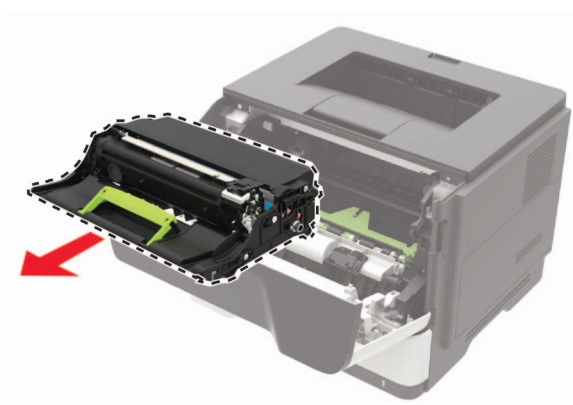

- 4 Unpack the new imaging unit, and then shake it three times to redistribute the toner.

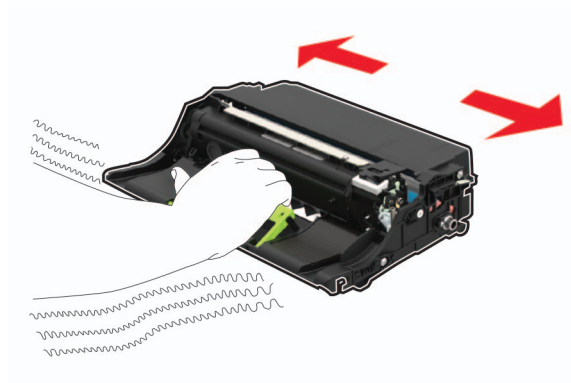

**Warning—Potential Damage:** Do not expose the imaging unit to direct light for more than 10 minutes. Extended exposure to light may cause print quality problems.

**Warning—Potential Damage:** Do not touch the photoconductor drum. Doing so may affect the quality of future print jobs.



- 5 Insert the new imaging unit.

**Note:** Use the arrows inside the printer as guides.

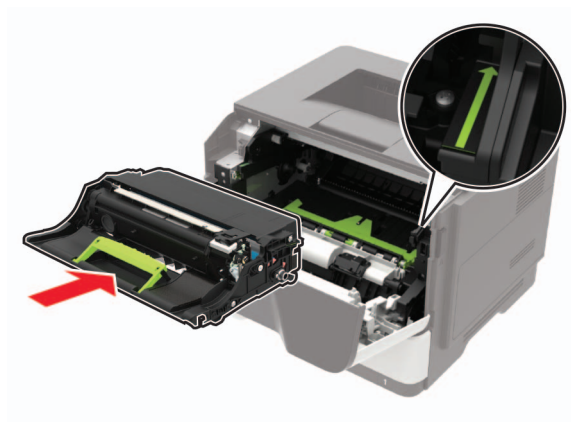

- 6 Insert the toner cartridge.

**Note:** Use the arrows inside the printer as guides.

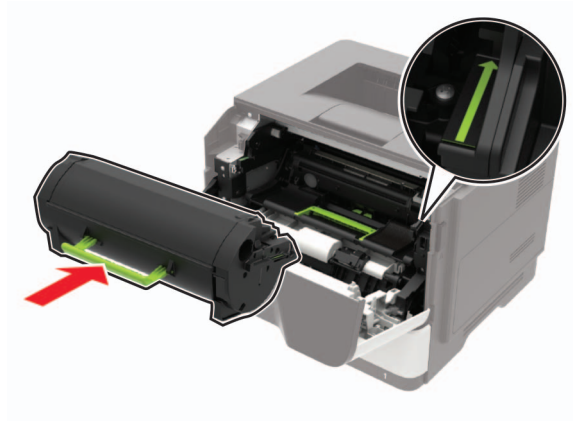

**7** Close door A.

## Replacing the pick tires

- 1** Turn off the printer.
- 2** Unplug the power cord from the electrical outlet, and then from the printer.
- 3** Remove the tray.

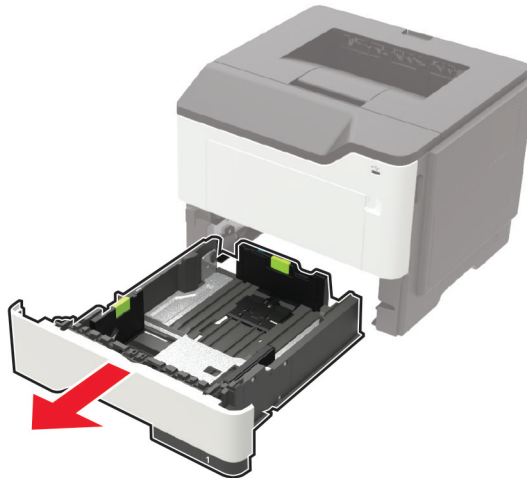

4 Remove the used pick tires one after the other.

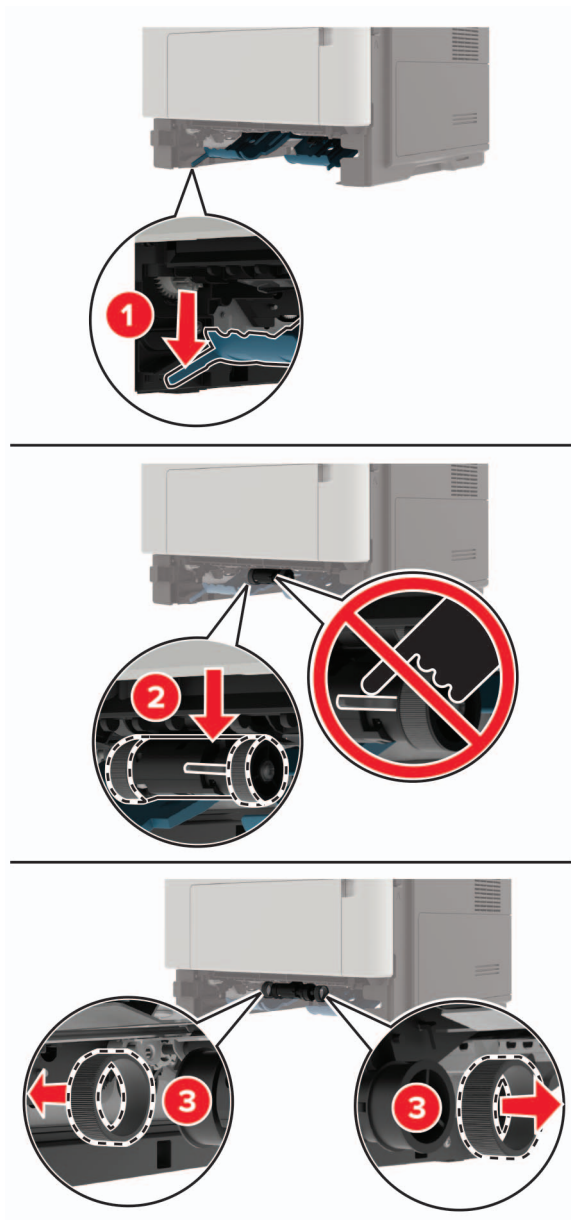

5 Unpack the new pick tires.

- 6 Insert the new pick tires.

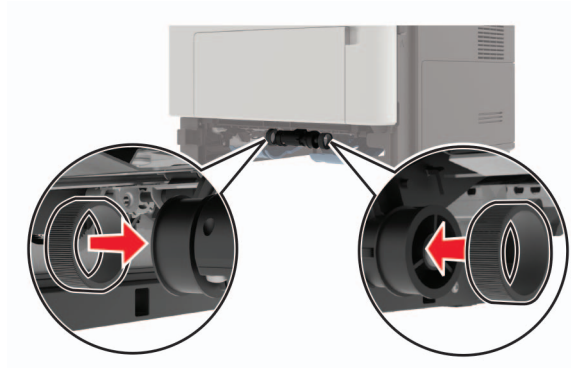

- 7 Insert the tray.
- 8 Connect the power cord to the printer, and then to the electrical outlet.

**⚠ CAUTION—POTENTIAL INJURY:** To avoid the risk of fire or electrical shock, connect the power cord to an appropriately rated and properly grounded electrical outlet that is near the product and easily accessible.

- 9 Turn on the printer.

## Replacing the pick roller assembly

- 1 Turn off the printer.
- 2 Unplug the power cord from the electrical outlet, and then from the printer.
- 3 Remove the optional tray.

**⚠ CAUTION—POTENTIAL INJURY:** If the printer weight is greater than 18 kg (40 lb), then it requires two or more trained personnel to lift it safely.

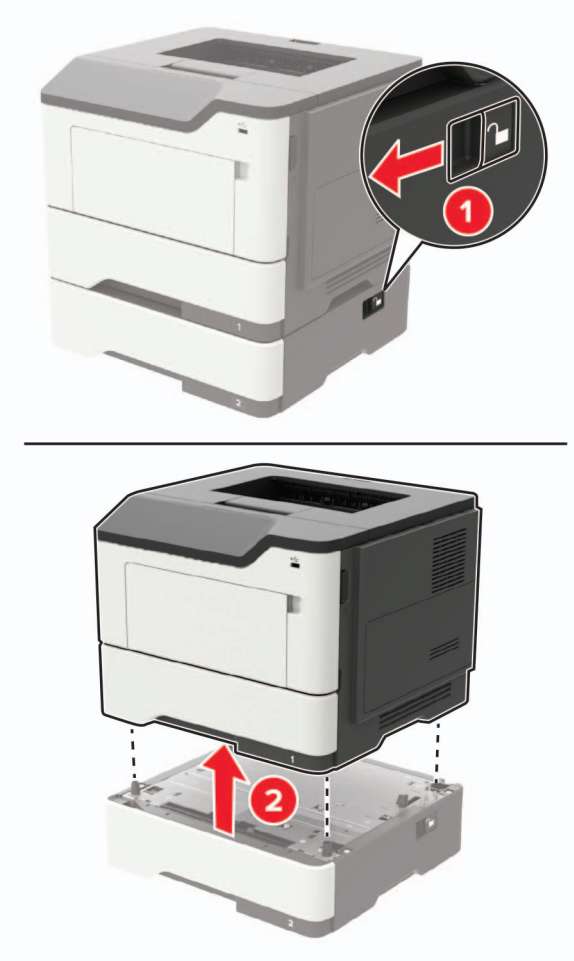

4 Remove the tray insert, and then flip the tray base.

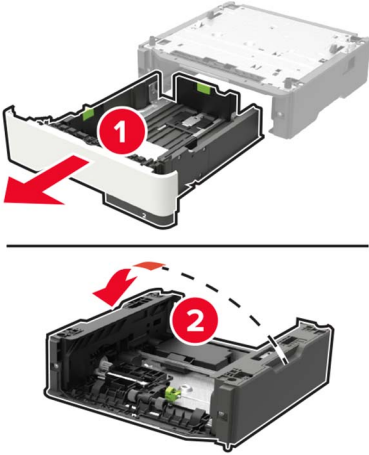

**5** Remove the used pick roller assembly.

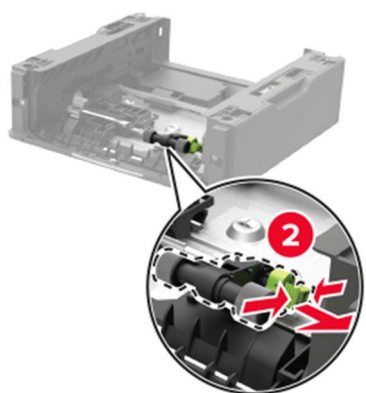
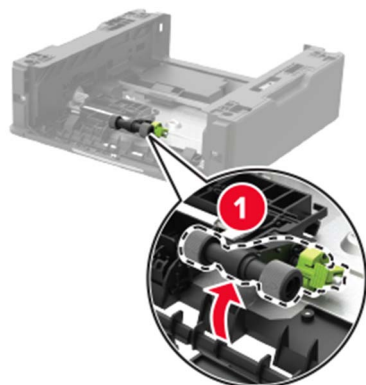

**6** Unpack the new pick roller assembly.

**7** Insert the new pick roller assembly.

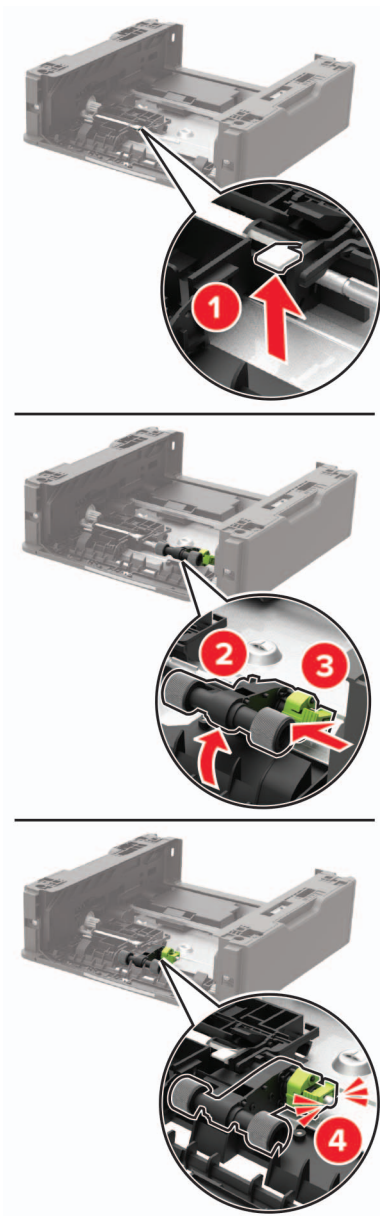

**8** Flip the tray base, and then insert the tray insert.



- 9 Align the printer with the optional tray, and then lower the printer until it *clicks* into place.

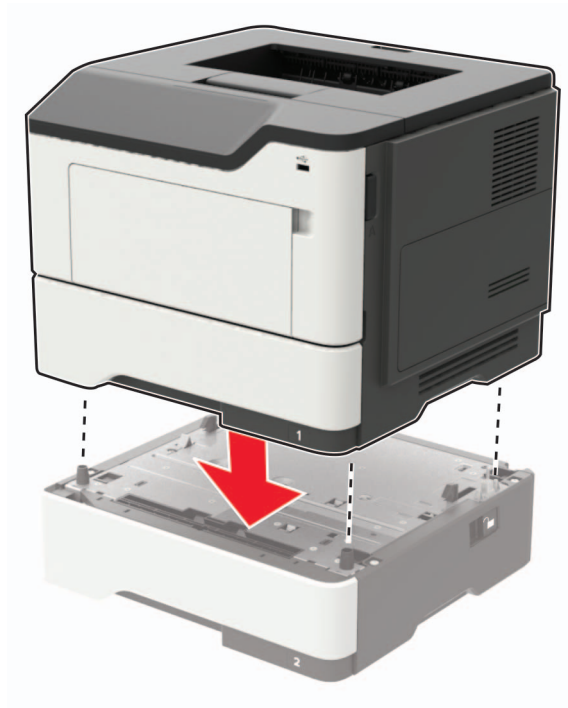

- 10 Connect the power cord to the printer, and then to the electrical outlet.

**⚠ CAUTION—POTENTIAL INJURY:** To avoid the risk of fire or electrical shock, connect the power cord to an appropriately rated and properly grounded electrical outlet that is near the product and easily accessible.

- 11 Turn on the printer.

## Moving the printer

### Moving the printer to another location

**⚠ CAUTION—POTENTIAL INJURY:** If the printer weight is greater than 18 kg (40 lb), then it requires two or more trained personnel to lift it safely.

**⚠ CAUTION—POTENTIAL INJURY:** To avoid the risk of fire or electrical shock, use only the power cord provided with this product or the manufacturer's authorized replacement.

**⚠ CAUTION—POTENTIAL INJURY:** When moving the printer, follow these guidelines to avoid personal injury or printer damage:

- Make sure that all doors and trays are closed.
- Turn off the printer, and then unplug the power cord from the electrical outlet.
- Disconnect all cords and cables from the printer.
- If the printer has separate floor-standing optional trays or output options attached to it, then disconnect them before moving the printer.

- If the printer has a caster base, then carefully roll it to the new location. Use caution when passing over thresholds and breaks in flooring.
- If the printer does not have a caster base but is configured with optional trays or output options, then remove the output options and lift the printer off the trays. Do not try to lift the printer and any options at the same time.
- Always use the handholds on the printer to lift it.
- Any cart used to move the printer must have a surface able to support the full footprint of the printer.
- Any cart used to move the hardware options must have a surface able to support the dimensions of the options.
- Keep the printer in an upright position.
- Avoid severe jarring movements.
- Make sure that your fingers are not under the printer when you set it down.
- Make sure that there is adequate clearance around the printer.

**Note:** Damage to the printer caused by improper moving is not covered by the printer warranty.

## Shipping the printer

For shipping instructions, go to <http://support.lexmark.com> or contact customer support.

## Saving energy and paper

### Configuring power save mode settings

#### Eco-Mode

- 1 From the control panel, navigate to:

 > Settings >  > Device >  > Power Management >  > Eco-Mode > 

- 2 Select a setting.

#### Sleep mode

- 1 From the control panel, navigate to:

 > Settings >  > Device >  > Power Management >  > Timeouts >  > Sleep Mode > 

- 2 Enter the amount of time that the printer stays idle before it enters Sleep mode.

## Hibernate mode

1 From the control panel, navigate to:

 > **Settings** >  > **Device** >  > **Power Management** >  > **Timeouts** >  > **Hibernate Timeout** > 

2 Select the amount of time before the printer enters Hibernate mode.

### Notes:

- Make sure to wake the printer from Hibernate mode before sending a print job.
- The Embedded Web Server is disabled when the printer is in Hibernate mode.

## Conserving supplies

- Print on both sides of the paper.

**Note:** Two-sided printing is the default setting in the print driver.

- Print multiple pages on a single sheet of paper.
- Use the preview feature to see how the document looks like before printing it.
- Print one copy of the document to check its content and format for accuracy.

## Recycling

### Recycling Lexmark products

To return Lexmark products for recycling:

- 1 Go to [www.lexmark.com/recycle](http://www.lexmark.com/recycle).
- 2 Select the product you want to recycle.

**Note:** Printer supplies and hardware not listed in the Lexmark Collection and Recycling Program may be recycled through your local recycling center.

### Recycling Lexmark packaging

Lexmark continually strives to minimize packaging. Less packaging helps to ensure that Lexmark printers are transported in the most efficient and environmentally sensitive manner and that there is less packaging to dispose of. These efficiencies result in fewer greenhouse emissions, energy savings, and natural resource savings. Lexmark also offers recycling of packaging components in some countries or regions. For more information, go to [www.lexmark.com/recycle](http://www.lexmark.com/recycle), and then choose your country or region. Information on available packaging recycling programs is included with the information on product recycling.

Lexmark cartons are 100% recyclable where corrugated recycling facilities exist. Facilities may not exist in your area.

The foam used in Lexmark packaging is recyclable where foam recycling facilities exist. Facilities may not exist in your area.

When you return a cartridge to Lexmark, you can reuse the box that the cartridge came in. Lexmark recycles the box.

## Returning Lexmark cartridges for reuse or recycling

The Lexmark Cartridge Collection Program allows you to return used cartridges for free to Lexmark for reuse or recycling. One hundred percent of the empty cartridges returned to Lexmark are either reused or demanufactured for recycling. The boxes used to return the cartridges are also recycled.

To return Lexmark cartridges for reuse or recycling, do the following:

- 1 Go to [www.lexmark.com/recycle](http://www.lexmark.com/recycle).
- 2 Select the product that you want to recycle.

# Clearing jams

## Avoiding jams

### Load paper properly

- Make sure that the paper lies flat in the tray.

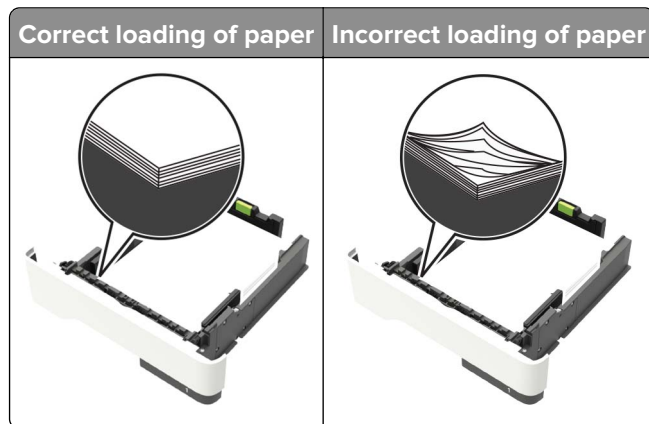

- Do not load or remove a tray while the printer is printing.
- Do not load too much paper. Make sure that the stack height is below the maximum paper fill indicator.
- Do not slide paper into the tray. Load paper as shown in the illustration.

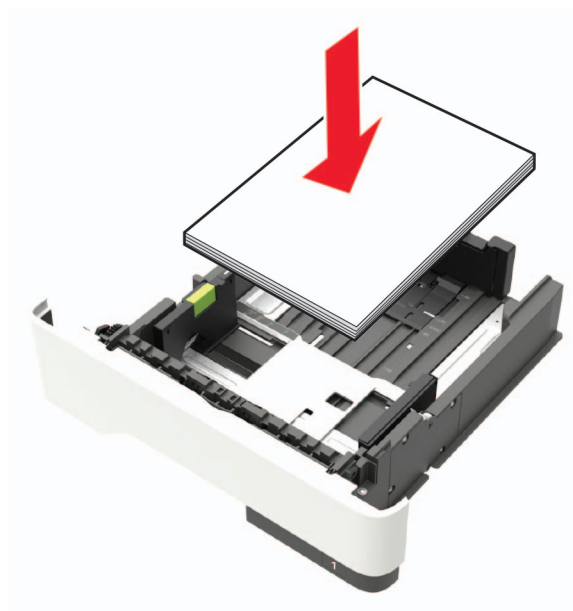

- Make sure that the paper guides are positioned correctly and are not pressing tightly against the paper or envelopes.
- Push the tray firmly into the printer after loading paper.

### Use recommended paper

- Use only recommended paper or specialty media.
- Do not load paper that is wrinkled, creased, damp, bent, or curled.
- Flex, fan, and align the paper edges before loading.

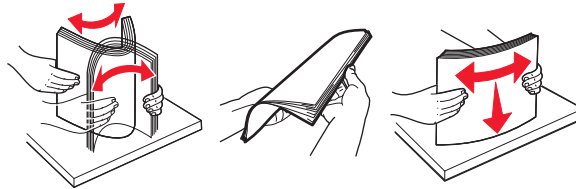

- Do not use paper that has been cut or trimmed by hand.
- Do not mix paper sizes, weights, or types in the same tray.
- Make sure that the paper size and type are set correctly on the computer or printer control panel.
- Store paper according to manufacturer recommendations.

## Identifying jam locations

### Notes:

- When Jam Assist is set to On, the printer automatically flushes blank pages or partially printed pages after a jammed page has been cleared. Check your printed output for blank pages.
- When Jam Recovery is set to On or Auto, the printer reprints jammed pages.

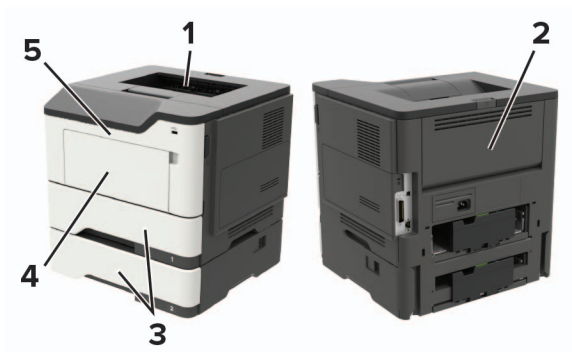

	Jam location
1	Standard bin
2	Rear door
3	Tray [x]
4	Multipurpose feeder
5	Door A

## Paper jam in door A

1 Remove the tray.

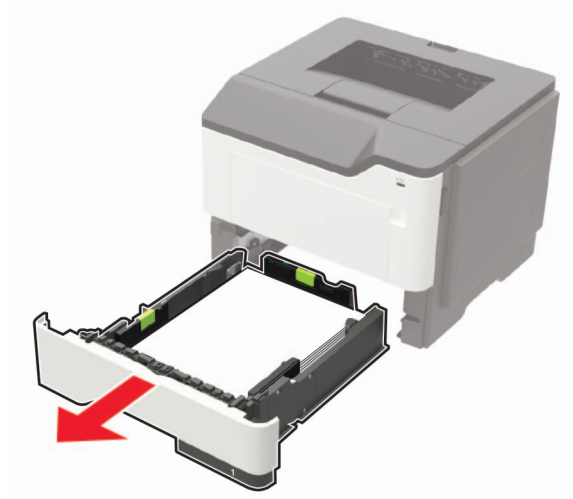

2 Open door A.

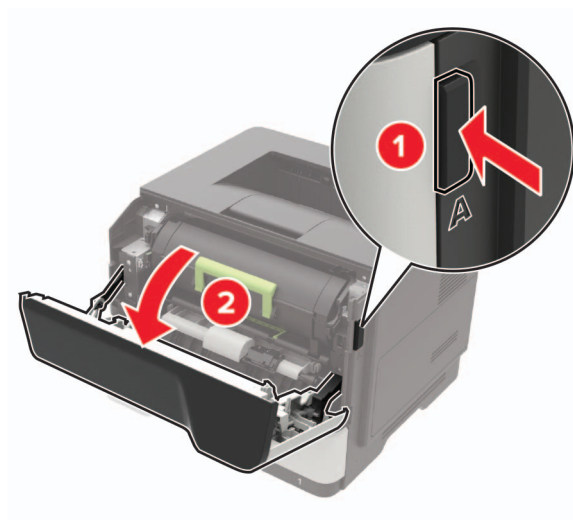

3 Remove the toner cartridge.

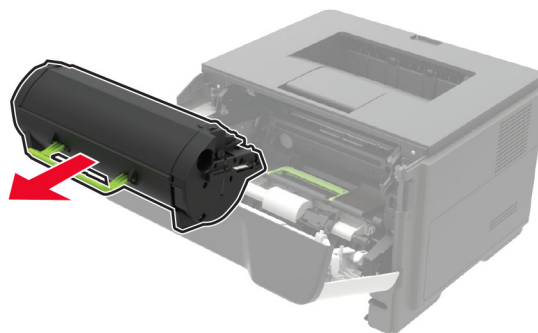

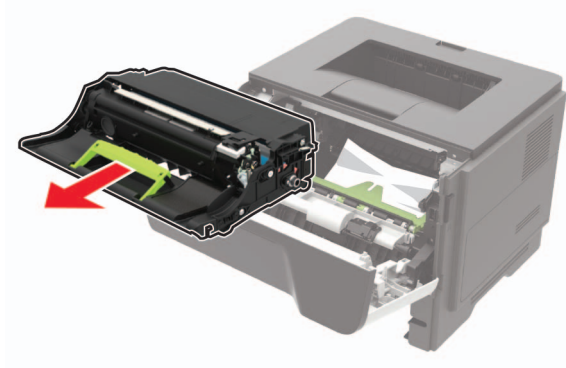
**4** Remove the imaging unit.

**Warning—Potential Damage:** Do not expose the imaging unit to direct light for more than 10 minutes. Extended exposure to light may cause print quality problems.

**Warning—Potential Damage:** Do not touch the photoconductor drum. Doing so may affect the quality of future print jobs.

**5** Remove the jammed paper.

**CAUTION—HOT SURFACE:** The inside of the printer might be hot. To reduce the risk of injury from a hot component, allow the surface to cool before touching it.

**Note:** Make sure that all paper fragments are removed.



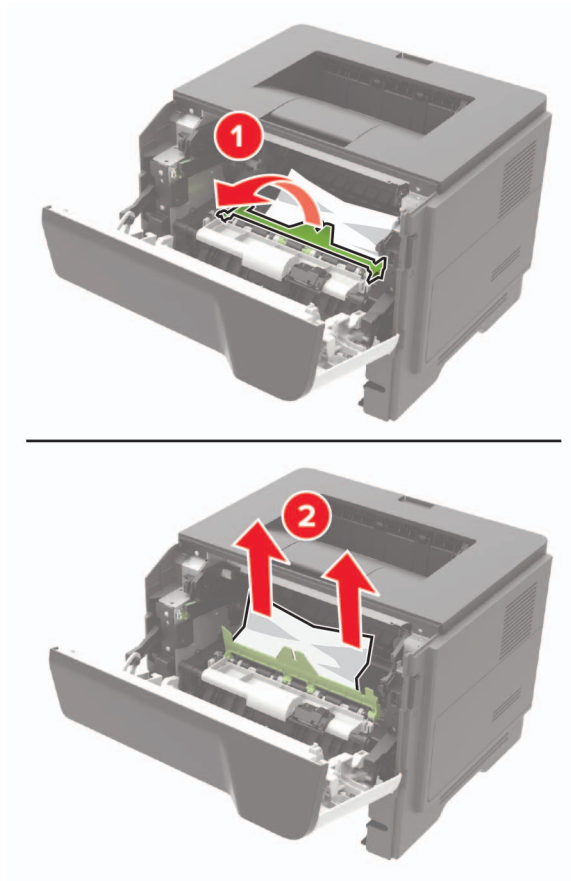

**6** Insert the imaging unit.

**Note:** Use the arrows inside the printer as guides.

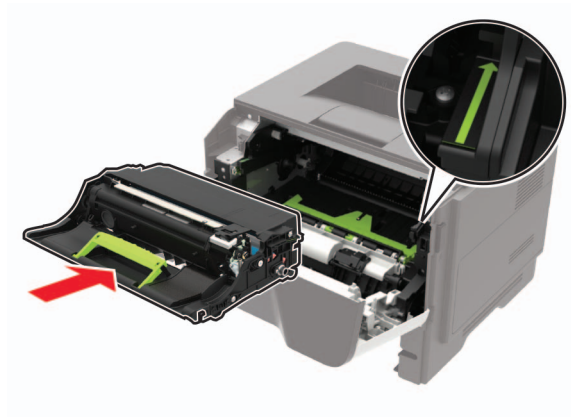

**7** Insert the toner cartridge.

**Note:** Use the arrows inside the printer as guides.

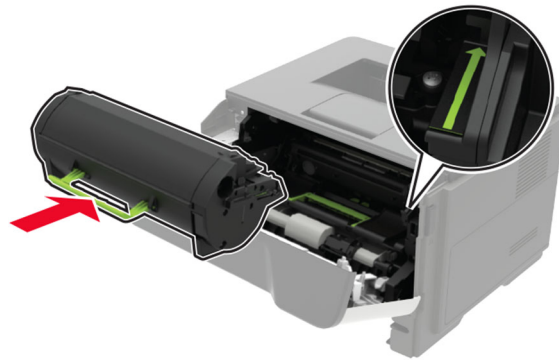

- 8 Close door A.
- 9 Insert the tray.

## Paper jam in the rear door

- 1 Open the rear door.

 **CAUTION—HOT SURFACE:** The inside of the printer might be hot. To reduce the risk of injury from a hot component, allow the surface to cool before touching it.

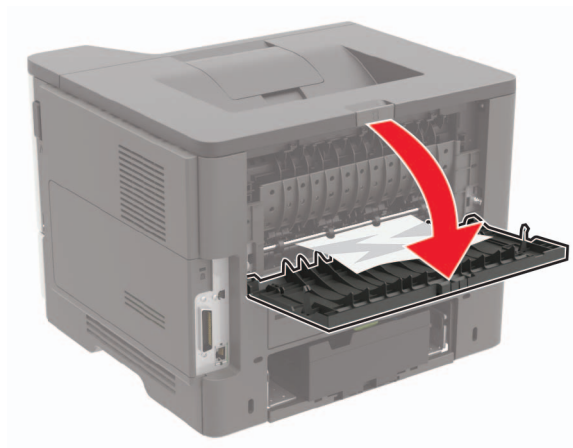

- 2 Remove the jammed paper.

**Note:** Make sure that all paper fragments are removed.

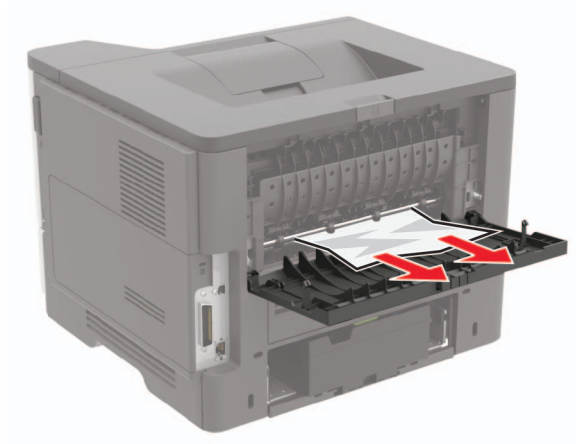

**3** Close the rear door.

## Paper jam in the standard bin

Remove the jammed paper.

**Note:** Make sure that all paper fragments are removed.

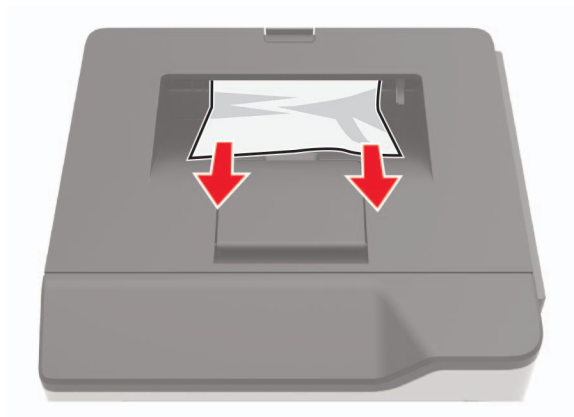

## Paper jam in the duplex unit

- 1 Remove the tray.

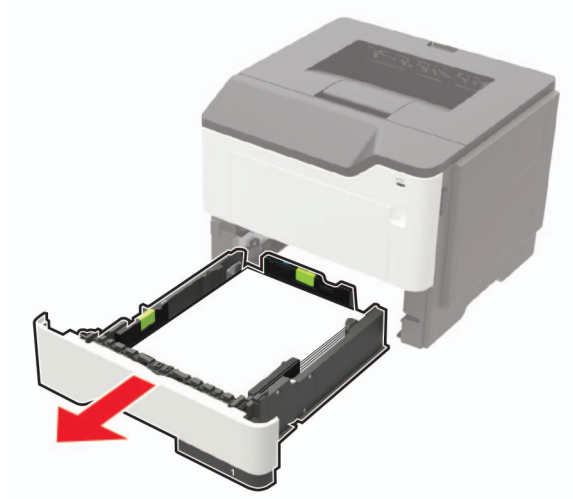

- 2 Remove the jammed paper.

**Note:** Make sure that all paper fragments are removed.

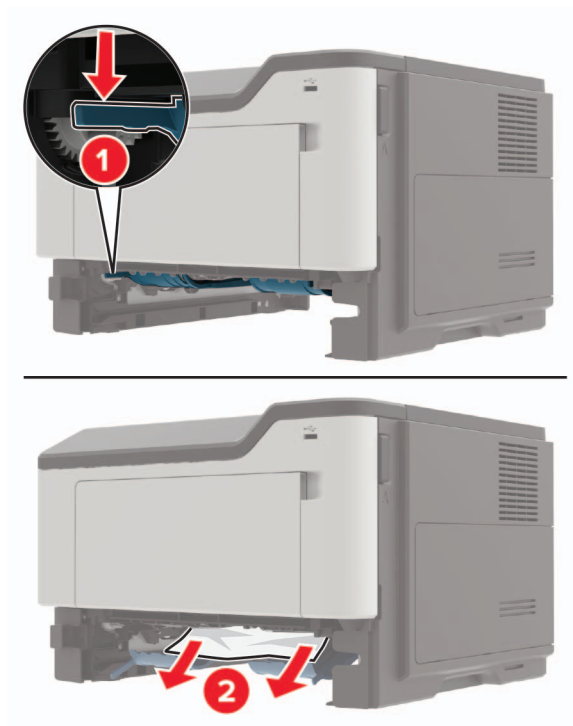

- 3 Insert the tray.

## Paper jam in trays

- 1 Remove the tray.

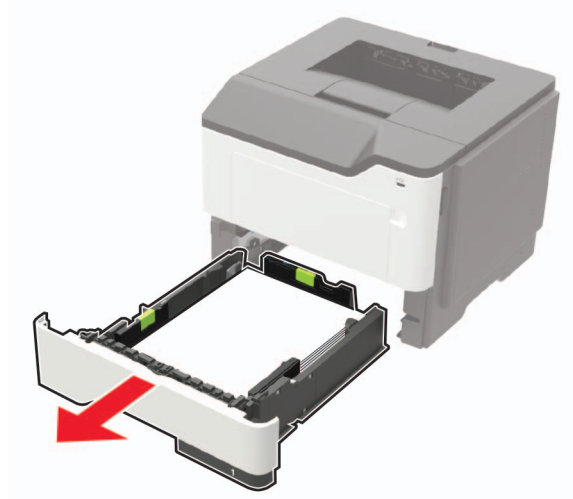

- 2 Remove the jammed paper.

**Note:** Make sure that all paper fragments are removed.

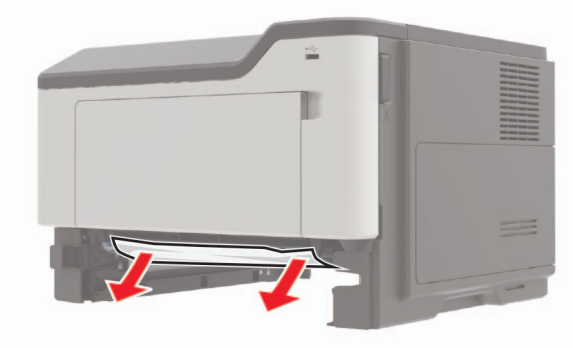

- 3 Insert the tray.

## Paper jam in the multipurpose feeder

- 1 Remove paper from the multipurpose feeder.
- 2 Remove the jammed paper.

**Note:** Make sure that all paper fragments are removed.



3 Flex, fan, and align the paper edges before loading.

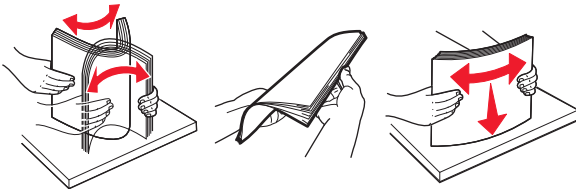

4 Reload paper, and then adjust the paper guide.



# Troubleshooting

## Network connection problems

### Cannot open Embedded Web Server

Action	Yes	No
<p><b>Step 1</b> Check if the printer is on.</p> <p>Is the printer on?</p>	Go to step 2.	Turn on the printer.
<p><b>Step 2</b> Make sure that the printer IP address is correct.</p> <p>View the printer IP address:</p> <ul style="list-style-type: none"> <li>• From the home screen</li> <li>• From the TCP/IP section in the Network/Ports menu</li> <li>• By printing a network setup page or menu settings page, and then finding the TCP/IP section</li> </ul> <p><b>Note:</b> An IP address appears as four sets of numbers separated by periods, such as 123.123.123.123.</p> <p>Is the printer IP address correct?</p>	Go to step 3.	Type the correct printer IP address in the address field.
<p><b>Step 3</b> Check if you are using a supported browser:</p> <ul style="list-style-type: none"> <li>• Internet Explorer® version 11 or later</li> <li>• Microsoft Edge™</li> <li>• Safari version 6 or later</li> <li>• Google Chrome™ version 32 or later</li> <li>• Mozilla Firefox version 24 or later</li> </ul> <p>Is your browser supported?</p>	Go to step 4.	Install a supported browser.
<p><b>Step 4</b> Check if the network connection is working.</p> <p>Is the network connection working?</p>	Go to step 5.	Contact your administrator.
<p><b>Step 5</b> Make sure that the cable connections to the printer and print server are secure. For more information, see the documentation that came with the printer.</p> <p>Are the cable connections secure?</p>	Go to step 6.	Secure the cable connections.

Action	Yes	No
<p><b>Step 6</b> Check if the web proxy servers are disabled.</p> <p>Are the web proxy servers disabled?</p>	Go to step 7.	Contact your administrator.
<p><b>Step 7</b> Access the Embedded Web Server.</p> <p>Did the Embedded Web Server open?</p>	The problem is solved.	Contact <a href="#">customer support</a> .

### Unable to read flash drive

Action	Yes	No
<p><b>Step 1</b> Check if the printer is not busy processing another print, copy, scan, or fax job.</p> <p>Is the printer ready?</p>	Go to step 2.	Wait for the printer to finish processing the other job.
<p><b>Step 2</b> Check if the flash drive is inserted into the front USB port.</p> <p><b>Note:</b> The flash drive does not work when it is inserted into the rear USB port.</p> <p>Is the flash drive inserted into the correct port?</p>	Go to step 3.	Insert the flash drive into the correct port.
<p><b>Step 3</b> Check if the flash drive is supported. For more information, see <a href="#">“Supported flash drives and file types” on page 23</a>.</p> <p>Is the flash drive supported?</p>	Go to step 4.	Insert a supported flash drive.
<p><b>Step 4</b></p> <p><b>a</b> Check if the USB port is enabled. For more information, see <a href="#">“Enabling the USB port” on page 96</a>.</p> <p><b>b</b> Remove, and then insert the flash drive.</p> <p>Does the printer recognize the flash drive?</p>	The problem is solved.	Contact <a href="#">customer support</a> .

### Enabling the USB port

1 From the control panel, navigate to:



2 Select **Enable USB Port**, and then press **OK**.



## Checking the printer connectivity

1 From the control panel, navigate to:



2 Select **Network Setup Page**, and then press **[OK]**.

3 Check the first section of the network setup page, and confirm that the status is connected.

If the status is not connected, then the LAN drop may be inactive, or the network cable may be unplugged or malfunctioning. Contact your administrator for assistance.

## Issues with supplies

### Replace cartridge, printer region mismatch

To correct this problem, purchase a cartridge with the correct region that matches the printer region, or purchase a worldwide cartridge.

- The first number in the message after 42 indicates the region of the printer.
- The second number in the message after 42 indicates the region of the cartridge.

#### Printer and toner cartridge regions

Region	Numeric code
Worldwide or Undefined region	0
North America (United States, Canada)	1
European Economic Area, Western Europe, Nordic countries, Switzerland	2
Asia Pacific	3
Latin America	4
Rest of Europe, Middle East, Africa	5
Australia, New Zealand	6
Invalid region	9

**Note:** To find the region settings of the printer and toner cartridge, print the print quality test pages. From the control panel, navigate to: **Settings > Troubleshooting > Print Quality Test Pages.**

### Non-Lexmark supply

The printer has detected a non-Lexmark supply or part installed in the printer.

Your Lexmark printer is designed to function best with genuine Lexmark supplies and parts. Use of third-party supplies or parts may affect the performance, reliability, or life of the printer and its imaging components.

All life indicators are designed to function with Lexmark supplies and parts and may deliver unpredictable results if third-party supplies or parts are used. Imaging component usage beyond the intended life may damage your Lexmark printer or associated components.

**Warning—Potential Damage:** Use of third-party supplies or parts can affect warranty coverage. Damage caused by the use of third-party supplies or parts may not be covered by the warranty.

To accept any and all of these risks and to proceed with the use of non-genuine supplies or parts in your printer, from the control panel, press and hold **X** and **OK** simultaneously for 15 seconds.

If you do not want to accept these risks, then remove the third-party supply or part from your printer and install a genuine Lexmark supply or part. For more information, see [“Using genuine Lexmark parts and supplies” on page 67.](#)

If the printer does not print after pressing and holding **X** and **OK** simultaneously for 15 seconds, then reset the supply usage counter.

1 From the control panel, navigate to:

**Settings** > **OK** > **Device** > **OK** > **Maintenance** > **OK** > **Config Menu** > **OK** > **Supply Usage And Counters** > **OK**

2 Select the part or supply that you want to reset, and then select **Start**.

3 Read the warning message, and then select **Continue**.

4 Press and hold **X** and **OK** simultaneously for 15 seconds to clear the message.







**Note:** If you are unable to reset the supply usage counters, then return the item to the place of purchase.

## Paper feed problems

### Envelope seals when printing

Action	Yes	No
<p>1 Use envelopes that have been stored in a dry environment.  <b>Note:</b> Printing on envelopes with high moisture content can seal the flaps.</p> <p>2 Resend the print job.</p> <p>Does the envelope seal when printing?</p>	Contact <a href="#">customer support</a> .	The problem is solved.

## Collated printing does not work

Action	Yes	No
<p><b>Step 1</b></p> <p><b>a</b> From the control panel, navigate to:</p> <p> &gt; <b>Settings</b> &gt;  &gt; <b>Print</b> &gt;  &gt; <b>Layout</b> &gt; </p> <p><b>b</b> Select <b>Collate</b>, and then press .</p> <p><b>c</b> Set Collate to On, and then press .</p> <p><b>d</b> Print the document.</p> <p>Is the document collated correctly?</p>	<p>The problem is solved.</p>	<p>Go to step 2.</p>
<p><b>Step 2</b></p> <p><b>a</b> From the document that you are trying to print, open the Print dialog, and then select Collate.</p> <p><b>b</b> Print the document.</p> <p>Is the document collated correctly?</p>	<p>The problem is solved.</p>	<p>Go to step 3.</p>
<p><b>Step 3</b></p> <p><b>a</b> Reduce the number of pages to print.</p> <p><b>b</b> Print the document.</p> <p>Is the document collated correctly?</p>	<p>The problem is solved.</p>	<p>Contact <a href="#">customer support</a>.</p>

## Tray linking does not work





Action	Yes	No
<p><b>Step 1</b></p> <p><b>a</b> Check if the trays contain the same paper size and paper type.</p> <p><b>b</b> Check if the paper guides are positioned correctly.</p> <p><b>c</b> Print the document.</p> <p>Do the trays link correctly?</p>	<p>The problem is solved.</p>	<p>Go to step 2.</p>
<p><b>Step 2</b></p> <p><b>a</b> From the control panel, navigate to:</p> <p><b>Settings &gt; Paper &gt; Tray Configuration &gt; Paper Size/Type</b></p> <p>For non-touch-screen printer models, press  to navigate through the settings.</p> <p><b>b</b> Set the paper size and paper type to match the paper loaded in the linked trays.</p> <p><b>c</b> Print the document.</p> <p>Do the trays link correctly?</p>	<p>The problem is solved.</p>	<p>Go to step 3.</p>

Action	Yes	No
<p><b>Step 3</b></p> <p><b>a</b> Make sure that Tray Linking is set to Automatic. For more information, see <a href="#">“Linking trays” on page 17</a>.</p> <p><b>b</b> Print the document.</p> <p>Do the trays link correctly?</p>	<p>The problem is solved.</p>	<p>Contact <a href="#">customer support</a>.</p>

## Paper frequently jams

Action	Yes	No
<p><b>Step 1</b></p> <p><b>a</b> Remove the tray.</p> <p><b>b</b> Check if paper is loaded correctly.</p> <p><b>Notes:</b></p> <ul style="list-style-type: none"> <li>• Make sure that the paper guides are positioned correctly.</li> <li>• Make sure that the stack height is below the maximum paper fill indicator.</li> <li>• Make sure to print on recommended paper size and type.</li> </ul> <p><b>c</b> Insert the tray.</p> <p><b>d</b> Print the document.</p> <p>Do paper jams occur frequently?</p>	<p>Go to step 2.</p>	<p>The problem is solved.</p>
<p><b>Step 2</b></p> <p><b>a</b> From the control panel, navigate to:  <b>Settings &gt; Paper &gt; Tray Configuration &gt; Paper Size/Type</b></p> <p>For non-touch-screen printer models, press  to navigate through the settings.</p> <p><b>b</b> Set the correct paper size and type.</p> <p><b>c</b> Print the document.</p> <p>Do paper jams occur frequently?</p>	<p>Go to step 3.</p>	<p>The problem is solved.</p>
<p><b>Step 3</b></p> <p><b>a</b> Load paper from a fresh package.</p> <p><b>Note:</b> Paper absorbs moisture due to high humidity. Store paper in its original wrapper until you are ready to use it.</p> <p><b>b</b> Print the document.</p> <p>Do paper jams occur frequently?</p>	<p>Contact <a href="#">customer support</a>.</p>	<p>The problem is solved.</p>

## Jammed pages are not reprinted

Action	Yes	No
<p><b>1</b> From the control panel, navigate to:</p> <p> &gt; <b>Settings</b> &gt;  &gt; <b>Device</b> &gt;  &gt; <b>Notifications</b> &gt; </p> <p><b>2</b> From the Jam Content Recovery menu, set Jam Recovery to <b>On</b> or <b>Auto</b>, and then press .</p> <p>Are the jammed pages reprinted?</p>	The problem is solved.	Contact <a href="#">customer support</a> .

## Printing problems

### Print quality is poor

### Blank or white pages



**Note:** Before solving the problem, print the Print Quality Test Pages. From the control panel, navigate to **Settings > Troubleshooting > Print Quality Test Pages**. For non-touch-screen printer models, press  to navigate through the settings.

Action	Yes	No
<p><b>Step 1</b></p> <p><b>a</b> Check if the printer is using a genuine and supported Lexmark toner cartridge.</p> <p><b>Note:</b> If the cartridge is not supported, then install a supported one.</p> <p><b>b</b> Print the document.</p> <p>Is the printer printing blank or white pages?</p>	Go to step 2.	The problem is solved.

Action	Yes	No
<p><b>Step 2</b></p> <p><b>a</b> Remove any packing material that is left on the imaging unit.</p> <p><b>1</b> Remove the toner cartridge, and then remove the imaging unit.</p> <p><b>Warning—Potential Damage:</b> Do not expose the imaging unit to direct light for more than 10 minutes. Extended exposure to light may cause print quality problems.</p> <p><b>Warning—Potential Damage:</b> Do not touch the photoconductor drum under the imaging unit. Doing so may affect the quality of future print jobs.</p> <p><b>2</b> Check the imaging unit for signs of damage, and replace if necessary.</p> <p><b>Note:</b> Make sure that the photoconductor drum contact is not bent or out of place.</p> <p><b>3</b> Firmly shake the imaging unit to redistribute the toner.</p> <p><b>4</b> Insert the imaging unit, and then insert the toner cartridge.</p> <p><b>b</b> Print the document.</p> <p>Is the printer printing blank or white pages?</p>	<p>Go to step 3.</p>	<p>The problem is solved.</p>
<p><b>Step 3</b></p> <p>Check the status of the toner cartridge, and replace if necessary.</p> <p><b>a</b> From the control panel, navigate to:</p> <p><b>Status/Supplies &gt; Supplies</b></p> <p><b>b</b> Print the document.</p> <p>Is the printer printing blank or white pages?</p>	<p>Contact <a href="#">customer support</a>.</p>	<p>The problem is solved.</p>

**Dark print**



**Note:** Before solving the problem, print the Print Quality Test Pages. From the control panel, navigate to **Settings > Troubleshooting > Print Quality Test Pages**. For non-touch-screen printer models, press  to navigate through the settings.

Action	Yes	No
<p><b>Step 1</b></p> <p><b>a</b> Check if the printer is using a genuine and supported Lexmark toner cartridge.</p> <p><b>Note:</b> If the cartridge is not supported, then install a supported one.</p> <p><b>b</b> Print the document.</p> <p>Is the print dark?</p>	Go to step 2.	The problem is solved.
<p><b>Step 2</b></p> <p><b>a</b> Turn off the printer, wait for about 10 seconds, and then turn on the printer.</p> <p><b>b</b> Reduce toner darkness. From the control panel, navigate to: <b>Settings &gt; Print &gt; Quality</b></p> <p><b>c</b> Print the document.</p> <p>Is the print dark?</p>	Go to step 3.	The problem is solved.
<p><b>Step 3</b></p> <p><b>a</b> Depending on your operating system, specify the paper type from the Printing Preferences or Print dialog.</p> <p><b>Notes:</b></p> <ul style="list-style-type: none"> <li>• Make sure that the setting matches the paper loaded.</li> <li>• You can also change the setting on the printer control panel.</li> </ul> <p><b>b</b> Print the document.</p> <p>Is the print dark?</p>	Go to step 4.	The problem is solved.
<p><b>Step 4</b></p> <p>Check if the paper has texture or rough finishes.</p> <p>Are you printing on textured or rough paper?</p>	Go to step 5.	Go to step 6.
<p><b>Step 5</b></p> <p><b>a</b> Replace textured paper with plain paper.</p> <p><b>b</b> Print the document.</p> <p>Is the print dark?</p>	Go to step 6.	The problem is solved.
<p><b>Step 6</b></p> <p><b>a</b> Load paper from a fresh package.</p> <p><b>Note:</b> Paper absorbs moisture due to high humidity. Store paper in its original wrapper until you are ready to use it.</p> <p><b>b</b> Print the document.</p> <p>Is the print dark?</p>	Go to step 7.	The problem is solved.

Action	Yes	No
<p><b>Step 7</b></p> <p><b>a</b> Remove, and then insert the imaging unit.</p> <p><b>Warning—Potential Damage:</b> Do not expose the imaging unit to direct light for more than 10 minutes. Extended exposure to light may cause print quality problems.</p> <p><b>Warning—Potential Damage:</b> Do not touch the photoconductor drum under the imaging unit. Doing so may affect the quality of future print jobs.</p> <p><b>b</b> Print the document.</p> <p>Is the print dark?</p>	Go to step 8.	The problem is solved.
<p><b>Step 8</b></p> <p><b>a</b> Replace the imaging unit.</p> <p><b>b</b> Print the document.</p> <p>Is the print dark?</p>	Contact <a href="#">customer support</a> .	The problem is solved.

**Fine lines are not printed correctly**

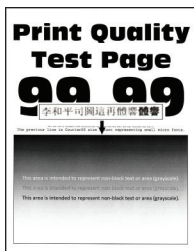

**Note:** Before solving the problem, print the Print Quality Test Pages. From the control panel, navigate to **Settings > Troubleshooting > Print Quality Test Pages**. For non-touch-screen printer models, press **OK** to navigate through the settings.

Action	Yes	No
<p><b>Step 1</b></p> <p><b>a</b> Check if the printer is using a genuine and supported Lexmark toner cartridge.</p> <p><b>Note:</b> If the cartridge is not supported, then install a supported one.</p> <p><b>b</b> Print the document.</p> <p>Are fine lines not printed correctly?</p>	Go to step 2.	The problem is solved.



Action	Yes	No
<p><b>Step 2</b></p> <p><b>a</b> Adjust the print quality settings.</p> <ol style="list-style-type: none"> <li>From the control panel, navigate to: <b>Settings &gt; Print &gt; Quality &gt; Pixel Boost &gt; Fonts</b></li> <li>Adjust Toner Darkness to 7. From the control panel, navigate to: <b>Settings &gt; Print &gt; Quality</b></li> </ol> <p><b>b</b> Print the document.</p> <p>Are fine lines not printed correctly?</p>	<p>Contact <a href="#">customer support</a>.</p>	<p>The problem is solved.</p>

**Folded or wrinkled paper**



**Note:** Before solving the problem, print the Print Quality Test Pages. From the control panel, navigate to **Settings > Troubleshooting > Print Quality Test Pages**. For non-touch-screen printer models, press  to navigate through the settings.

Action	Yes	No
<p><b>Step 1</b></p> <p><b>a</b> Check if the printer is using a genuine and supported Lexmark toner cartridge.</p> <p><b>Note:</b> If the cartridge is not supported, then install a supported one.</p> <p><b>b</b> Print the document.</p> <p>Is the paper folded or wrinkled?</p>	<p>Go to step 2.</p>	<p>The problem is solved.</p>
<p><b>Step 2</b></p> <p><b>a</b> Load paper from a fresh package.</p> <p><b>Note:</b> Paper absorbs moisture due to high humidity. Store paper in its original wrapper until you are ready to use it.</p> <p><b>b</b> Print the document.</p> <p>Is the paper folded or wrinkled?</p>	<p>Go to step 3.</p>	<p>The problem is solved.</p>

Action	Yes	No
<p><b>Step 3</b></p> <p><b>a</b> Depending on your operating system, specify the paper type from the Printing Preferences or Print dialog.</p> <p><b>Notes:</b></p> <ul style="list-style-type: none"> <li>• Make sure that the setting matches the paper loaded.</li> <li>• You can also change the setting from the printer control panel.</li> </ul> <p><b>b</b> Print the document.</p> <p>Is the paper folded or wrinkled?</p>	<p>Contact <a href="#">customer support</a>.</p>	<p>The problem is solved.</p>

### Gray background

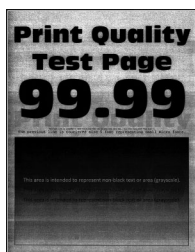

**Note:** Before solving the problem, print the Print Quality Test Pages. From the control panel, navigate to **Settings > Troubleshooting > Print Quality Test Pages**. For non-touch-screen printer models, press **OK** to navigate through the settings.

Action	Yes	No
<p><b>Step 1</b></p> <p><b>a</b> Turn off the printer, wait for 10 seconds, and then turn on the printer.</p> <p><b>b</b> Increase toner darkness. From the control panel, navigate to: <b>Settings &gt; Print &gt; Quality</b></p> <p><b>c</b> Print the document.</p> <p>Does gray background appear on prints?</p>	<p>Go to step 2.</p>	<p>The problem is solved.</p>
<p><b>Step 2</b></p> <p><b>a</b> Check if the printer is using a genuine and supported Lexmark toner cartridge. <b>Note:</b> If the toner cartridge is not supported, then install a supported one.</p> <p><b>b</b> Print the document.</p> <p>Does gray background appear on prints?</p>	<p>Go to step 3.</p>	<p>The problem is solved.</p>

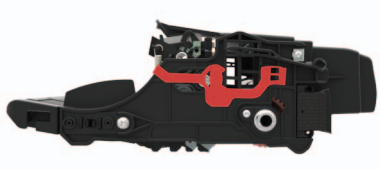
Action	Yes	No
<p><b>Step 3</b></p> <p><b>a</b> Depending on your operating system, specify the paper type from the Printing Preferences or Print dialog.</p> <p><b>Notes:</b></p> <ul style="list-style-type: none"> <li>• Make sure that the setting matches the paper loaded.</li> <li>• You can also change the setting from the printer control panel.</li> </ul> <p><b>b</b> Print the document.</p> <p>Does gray background appear on prints?</p>	<p>Go to step 4.</p>	<p>The problem is solved.</p>
<p><b>Step 4</b></p> <p>Check the status of the toner cartridge, and replace if necessary.</p> <p><b>a</b> From the control panel, navigate to:  <b>Status/Supplies &gt; Supplies</b></p> <p><b>b</b> Print the document.</p> <p>Does gray background appear on prints?</p>	<p>Go to step 5.</p>	<p>The problem is solved.</p>
<p><b>Step 5</b></p> <p><b>a</b> Remove the imaging unit.</p> <p><b>Warning—Potential Damage:</b> Do not expose the imaging unit to direct light for more than 10 minutes. Extended exposure to light may cause print quality problems.</p> <p><b>Warning—Potential Damage:</b> Do not touch the photoconductor drum under the imaging unit. Doing so may affect the quality of future print jobs.</p> <p><b>b</b> Remove any packing material that is stuck on the imaging unit.</p> <div style="text-align: center;">  </div> <p><b>Note:</b> Make sure to remove any obstruction between the charge roller and photoconductor drum.</p> <p><b>c</b> Insert the imaging unit.</p> <p><b>d</b> Print the document.</p> <p>Does gray background appear on prints?</p>	<p>Go to step 6.</p>	<p>The problem is solved.</p>
<p><b>Step 6</b></p> <p><b>a</b> Replace the imaging unit.</p> <p><b>b</b> Print the document.</p> <p>Does gray background appear on prints?</p>	<p>Contact <a href="#">customer support</a>.</p>	<p>The problem is solved.</p>

### Horizontal light bands



**Note:** Before solving the problem, print the Print Quality Test Pages. From the control panel, navigate to **Settings > Troubleshooting > Print Quality Test Pages**. For non-touch-screen printer models, press **OK** to navigate through the settings.

Action	Yes	No
<p><b>a</b> Check if the printer is using a genuine and supported Lexmark toner cartridge.</p> <p><b>Note:</b> If the cartridge is not supported, then install a supported one.</p> <p><b>b</b> Print the document.</p> <p>Do horizontal light bands appear on prints?</p>	<p>Contact <a href="#">customer support</a>.</p>	<p>The problem is solved.</p>

### Incorrect margins



Action	Yes	No
<p><b>Step 1</b></p> <p><b>a</b> Adjust the paper guides to the correct position for the paper loaded.</p> <p><b>b</b> Print the document.</p> <p>Are the margins correct?</p>	<p>The problem is solved.</p>	<p>Go to step 2.</p>

Action	Yes	No
<p><b>Step 2</b></p> <p><b>a</b> Depending on your operating system, specify the paper size from the Printing Preferences or Print dialog.</p> <p><b>Notes:</b></p> <ul style="list-style-type: none"> <li>• Make sure that the setting matches the paper loaded.</li> <li>• You can also change the setting from the printer control panel.</li> </ul> <p><b>b</b> Print the document.</p> <p>Are the margins correct?</p>	<p>The problem is solved.</p>	<p>Contact <a href="#">customer support</a>.</p>

### Light print

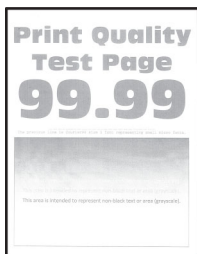

**Note:** Before solving the problem, print the Print Quality Test Pages. From the control panel, navigate to **Settings > Troubleshooting > Print Quality Test Pages**. For non-touch-screen printer models, press  to navigate through the settings.

Action	Yes	No
<p><b>Step 1</b></p> <p><b>a</b> Check if the printer is using a genuine and supported Lexmark toner cartridge.</p> <p><b>Note:</b> If the cartridge is not supported, then install a supported one.</p> <p><b>b</b> Print the document.</p> <p>Is the print light?</p>	<p>Go to step 2.</p>	<p>The problem is solved.</p>
<p><b>Step 2</b></p> <p><b>a</b> Turn off the printer, wait for about 10 seconds, and then turn on the printer.</p> <p><b>b</b> Increase toner darkness. From the control panel, navigate to: <b>Settings &gt; Print &gt; Quality</b></p> <p><b>c</b> Print the document.</p> <p>Is the print light?</p>	<p>Go to step 3.</p>	<p>The problem is solved.</p>

Action	Yes	No
<p><b>Step 3</b></p> <p><b>a</b> Depending on your operating system, specify the paper type from the Printing Preferences or Print dialog.</p> <p><b>Notes:</b></p> <ul style="list-style-type: none"> <li>• Make sure that the setting matches the paper loaded.</li> <li>• You can also change the setting on the printer control panel.</li> </ul> <p><b>b</b> Print the document.</p> <p>Is the print light?</p>	<p>Go to step 4.</p>	<p>The problem is solved.</p>
<p><b>Step 4</b></p> <p>Check the status of the toner cartridge, and replace if necessary.</p> <p><b>a</b> From the control panel, navigate to:  <b>Status/Supplies &gt; Supplies</b></p> <p><b>b</b> Print the document.</p> <p>Is the print light?</p>	<p>Go to step 5.</p>	<p>The problem is solved.</p>
<p><b>Step 5</b></p> <p><b>a</b> Remove the toner cartridge, and then remove the imaging unit.</p> <p><b>Warning—Potential Damage:</b> Do not expose the imaging unit to direct light for more than 10 minutes. Extended exposure to light can cause print quality problems.</p> <p><b>Warning—Potential Damage:</b> Do not touch the photoconductor drum under the imaging unit. Doing so may affect the quality of future print jobs.</p> <p><b>b</b> Push either side of the transfer roller, located below the imaging unit, to check if it depresses and bounces back into place.</p> <p> <b>CAUTION—HOT SURFACE:</b> The inside of the printer might be hot. To reduce the risk of injury from a hot component, allow the surface to cool before touching it.</p> <p><b>c</b> If the transfer roller does not depress and bounce back into place, then remove and insert it.</p> <ol style="list-style-type: none"> <li><b>1</b> Pull up one end of the transfer roller and push it down until it <i>clicks</i> into place.</li> <li><b>2</b> If necessary, repeat the step on the other end.</li> </ol> <p><b>d</b> Firmly shake the imaging unit to redistribute the toner, and then insert it.</p> <p><b>e</b> Insert the toner cartridge.</p> <p><b>f</b> Turn off the printer, wait for 10 seconds, and then turn on the printer.</p> <p><b>g</b> Print the document.</p> <p>Is the print light?</p>	<p>Go to step 6.</p>	<p>The problem is solved.</p>

Action	Yes	No
<p><b>Step 6</b></p> <p><b>a</b> If the issue happens after installing a new maintenance kit, then check whether the transfer roller included with the kit is installed.</p> <p><b>Note:</b> If necessary, replace the transfer roller.</p> <p><b>b</b> Print the document.</p> <p>Is the print light?</p>	Go to step 7.	The problem is solved.
<p><b>Step 7</b></p> <p>Check the status of the imaging unit. From the control panel, navigate to:</p> <p><b>Status/Supplies &gt; Supplies</b></p> <p>Is the imaging unit near End of Life?</p>	Go to step 8.	Contact <a href="#">customer support</a> .
<p><b>Step 8</b></p> <p><b>a</b> Replace the imaging unit.</p> <p><b>b</b> Print the document.</p> <p>Is the print light?</p>	Contact <a href="#">customer support</a> .	The problem is solved.

### Mottled print and dots



**Note:** Before solving the problem, print the Print Quality Test Pages. From the control panel, navigate to **Settings > Troubleshooting > Print Quality Test Pages**. For non-touch-screen printer models, press  to navigate through the settings.

Action	Yes	No
<p><b>Step 1</b></p> <p><b>a</b> Check if the printer is using a genuine and supported Lexmark toner cartridge.</p> <p><b>Note:</b> If the toner cartridge is not supported, then install a supported one.</p> <p><b>b</b> Print the document.</p> <p>Is the print mottled?</p>	Go to step 2.	The problem is solved.

Action	Yes	No
<p><b>Step 2</b> Check the printer for leaked toner contamination.</p> <p>Is the printer free of leaked toner?</p>	Go to step 4.	Go to step 3.
<p><b>Step 3</b>  <b>a</b> Replace the toner cartridge.  <b>b</b> Print the document.</p> <p>Is the print mottled?</p>	Go to step 4.	The problem is solved.
<p><b>Step 4</b> Check the status of the imaging unit. From the control panel, navigate to:  <b>Status/Supplies &gt; Supplies</b></p> <p>Is the imaging unit near end of life?</p>	Go to step 5.	Contact <a href="#">customer support</a> .
<p><b>Step 5</b>  <b>a</b> Replace the imaging unit.  <b>b</b> Print the document.</p> <p>Is the print mottled?</p>	Contact <a href="#">customer support</a> .	The problem is solved.

**Paper curl**



**Note:** Before solving the problem, print the Print Quality Test Pages. From the control panel, navigate to **Settings > Troubleshooting > Print Quality Test Pages**. For non-touch-screen printer models, press  to navigate through the settings.

Action	Yes	No
<p><b>Step 1</b>  <b>a</b> Check if the printer is using a genuine and supported Lexmark toner cartridge.  <b>Note:</b> If the cartridge is not supported, then install a supported one.  <b>b</b> Print the document.</p> <p>Is the paper curled?</p>	Go to step 2.	The problem is solved.



Action	Yes	No
<p><b>Step 2</b></p> <p><b>a</b> Adjust the guides in the tray to the correct position for the paper loaded.</p> <p><b>b</b> Print the document.</p> <p>Is the paper curled?</p>	Go to step 3.	The problem is solved.
<p><b>Step 3</b></p> <p><b>a</b> Depending on your operating system, specify the paper size and paper type from the Printing Preferences or Print dialog.</p> <p><b>Notes:</b></p> <ul style="list-style-type: none"> <li>• Make sure that the settings match the paper loaded.</li> <li>• You can also change the settings from the printer control panel.</li> </ul> <p><b>b</b> Print the document.</p> <p>Is the paper curled?</p>	Go to step 4.	The problem is solved.
<p><b>Step 4</b></p> <p><b>a</b> Remove paper from the tray, and then turn over the paper.</p> <p><b>b</b> Print the document.</p> <p>Is the paper curled?</p>	Go to step 5.	The problem is solved.
<p><b>Step 5</b></p> <p><b>a</b> Load paper from a fresh package.</p> <p><b>Note:</b> Paper absorbs moisture due to high humidity. Store paper in its original wrapper until you are ready to use it.</p> <p><b>b</b> Print the document.</p> <p>Is the paper curled?</p>	Go to step 6.	The problem is solved.
<p><b>Step 6</b></p> <p><b>a</b> Check if the paper loaded is supported.</p> <p><b>Note:</b> If paper is not supported, then load a supported paper.</p> <p><b>b</b> Print the document.</p> <p>Is the paper curled?</p>	Contact <a href="#">customer support</a> .	The problem is solved.

### Print crooked or skewed



**Note:** Before solving the problem, print the Print Quality Test Pages. From the control panel, navigate to **Settings > Troubleshooting > Print Quality Test Pages**. For non-touch-screen printer models, press **OK** to navigate through the settings.

Action	Yes	No
<p><b>Step 1</b></p> <p><b>a</b> Adjust the guides in the tray to the correct position for the paper loaded.</p> <p><b>b</b> Print the document.</p> <p>Is the print crooked or skewed?</p>	Go to step 2.	The problem is solved.
<p><b>Step 2</b></p> <p><b>a</b> Check if the paper loaded is supported.</p> <p><b>Note:</b> If paper is not supported, then load a supported paper.</p> <p><b>b</b> Print the document.</p> <p>Is the print crooked or skewed?</p>	Go to step 3.	The problem is solved.
<p><b>Step 3</b></p> <p><b>a</b> Check the pick tire in the tray for signs of damage and contamination, and replace if necessary.</p> <p><b>b</b> Print the document.</p> <p>Is the print crooked or skewed?</p>	Contact <a href="#">customer support</a> .	The problem is solved.

### Repeating defects



**Note:** Before solving the problem, print the Print Quality Test Pages. From the control panel, navigate to **Settings > Troubleshooting > Print Quality Test Pages**. For non-touch-screen printer models, press **OK** to navigate through the settings.

Action	Yes	No
<p><b>Step 1</b></p> <p>Using the Print Quality Test Pages, check if the distance between the repeating defects is equal to any of the following:</p> <ul style="list-style-type: none"> <li>• 97 mm (3.82 in.)</li> <li>• 47 mm (1.85 in.)</li> <li>• 38 mm (1.5 in.)</li> </ul> <p>Does the distance between the repeating defects match any of the measurements?</p>	Go to step 2.	Take note of the distance, and then contact <a href="#">customer support</a> .
<p><b>Step 2</b></p> <p><b>a</b> Replace the imaging unit.</p> <p><b>b</b> Print the document.</p> <p>Do the repeating defects appear?</p>	Contact <a href="#">customer support</a> .	The problem is solved.

### Solid black pages



**Note:** Before solving the problem, print the Print Quality Test Pages. From the control panel, navigate to **Settings > Troubleshooting > Print Quality Test Pages**. For non-touch-screen printer models, press **OK** to navigate through the settings.

Action	Yes	No
<p><b>Step 1</b></p> <p><b>a</b> Check if the printer is using a genuine and supported Lexmark toner cartridge.</p> <p><b>Note:</b> If the toner cartridge is not supported, then install a supported one.</p> <p><b>b</b> Print the document.</p> <p>Is the printer printing solid black pages?</p>	Go to step 2.	The problem is solved.

Action	Yes	No
<p><b>Step 2</b></p> <p><b>a</b> Remove, and then insert the imaging unit.</p> <p><b>Warning—Potential Damage:</b> Do not expose the imaging unit to direct light for more than 10 minutes. Extended exposure to light may cause print quality problems.</p> <p><b>Warning—Potential Damage:</b> Do not touch the photoconductor drum under the imaging unit. Doing so may affect the quality of future print jobs.</p> <p><b>b</b> Print the document.</p> <p>Is the printer printing solid black pages?</p>	<p>Go to step 3.</p>	<p>The problem is solved.</p>
<p><b>Step 3</b></p> <p><b>a</b> Remove the imaging unit.</p> <p><b>Warning—Potential Damage:</b> Do not expose the imaging unit to direct light for more than 10 minutes. Extended exposure to light may cause print quality problems.</p> <p><b>Warning—Potential Damage:</b> Do not touch the photoconductor drum under the imaging unit. Doing so may affect the quality of future print jobs.</p> <p><b>b</b> Remove any packing material that is stuck on the imaging unit.</p> <div data-bbox="402 1056 776 1192" data-label="Image"> </div> <p><b>Note:</b> Make sure to remove any obstruction between the charge roller and photoconductor drum.</p> <p><b>c</b> Insert the imaging unit.</p> <p><b>d</b> Print the document.</p> <p>Is the printer printing solid black pages?</p>	<p>Go to step 4.</p>	<p>The problem is solved.</p>
<p><b>Step 4</b></p> <p>Check the imaging unit for signs of damage.</p> <p>Is the imaging unit free from damage?</p>	<p>Contact <a href="#">customer support</a>.</p>	<p>Go to step 5.</p>
<p><b>Step 5</b></p> <p><b>a</b> Replace the imaging unit.</p> <p><b>b</b> Print the document.</p> <p>Is the printer printing solid black pages?</p>	<p>Contact <a href="#">customer support</a>.</p>	<p>The problem is solved.</p>

### Text or images cut off





**Note:** Before solving the problem, print the Print Quality Test Pages. From the control panel, navigate to **Settings > Troubleshooting > Print Quality Test Pages**. For non-touch-screen printer models, press **OK** to navigate through the settings.

Action	Yes	No
<p><b>Step 1</b></p> <p><b>a</b> Check if the printer is using a genuine and supported Lexmark toner cartridge.</p> <p><b>Note:</b> If the toner cartridge is not supported, then install a supported one.</p> <p><b>b</b> Print the document.</p> <p>Are text or images cut off?</p>	Go to step 2.	The problem is solved.
<p><b>Step 2</b></p> <p><b>a</b> Remove, and then insert the imaging unit.</p> <p><b>Warning—Potential Damage:</b> Do not expose the imaging unit to direct light for more than 10 minutes. Extended exposure to light may cause print quality problems.</p> <p><b>Warning—Potential Damage:</b> Do not touch the photoconductor drum under the imaging unit. Doing so may affect the quality of future print jobs.</p> <p><b>b</b> Print the document.</p> <p>Are text or images cut off?</p>	Go to step 3.	The problem is solved.

Action	Yes	No
<p><b>Step 3</b></p> <p><b>a</b> Remove the imaging unit.</p> <p><b>Warning—Potential Damage:</b> Do not expose the imaging unit to direct light for more than 10 minutes. Extended exposure to light may cause print quality problems.</p> <p><b>Warning—Potential Damage:</b> Do not touch the photoconductor drum under the imaging unit. Doing so may affect the quality of future print jobs.</p> <p><b>b</b> Remove any packing material that is stuck on the imaging unit.</p> <div data-bbox="402 638 776 779" style="text-align: center;">  </div> <p><b>Note:</b> Make sure to remove any obstruction between the charge roller and photoconductor drum.</p> <p><b>c</b> Insert the imaging unit.</p> <p><b>d</b> Print the document.</p> <p>Are text or images cut off?</p>	<p>Go to step 4.</p>	<p>The problem is solved.</p>
<p><b>Step 4</b></p> <p><b>a</b> Replace the imaging unit.</p> <p><b>b</b> Print the document.</p> <p>Are text or images cut off?</p>	<p>Contact <a href="#">customer support</a>.</p>	<p>The problem is solved.</p>

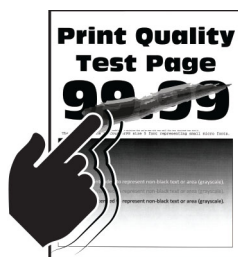
**Toner easily rubs off**



**Note:** Before solving the problem, print the Print Quality Test Pages. From the control panel, navigate to **Settings > Troubleshooting > Print Quality Test Pages**. For non-touch-screen printer models, press  to navigate through the settings.

Action	Yes	No
<p><b>Step 1</b></p> <p><b>a</b> Check if the printer is using a genuine and supported Lexmark toner cartridge.</p> <p><b>Note:</b> If the toner cartridge is not supported, then install a supported one.</p> <p><b>b</b> Print the document.</p> <p>Does the toner easily rub off?</p>	Go to step 2.	The problem is solved.
<p><b>Step 2</b></p> <p><b>a</b> Depending on your operating system, specify the paper type from the Printing Preferences or Print dialog.</p> <p><b>Notes:</b></p> <ul style="list-style-type: none"> <li>• Make sure that the setting matches the paper loaded.</li> <li>• You can also change the setting on the printer control panel.</li> </ul> <p><b>b</b> Print the document.</p> <p>Does the toner easily rub off?</p>	Contact <a href="#">customer support</a> .	The problem is solved.

**Vertical dark bands**

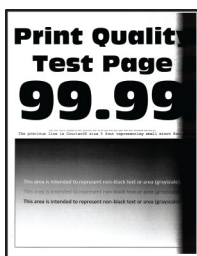

**Note:** Before solving the problem, print the Print Quality Test Pages. From the control panel, navigate to **Settings > Troubleshooting > Print Quality Test Pages**. For non-touch-screen printer models, press  to navigate through the settings.

Action	Yes	No
<p><b>Step 1</b></p> <p><b>a</b> Check if the printer is using a genuine and supported Lexmark toner cartridge.</p> <p><b>Note:</b> If the toner cartridge is not supported, then install a supported one.</p> <p><b>b</b> Print the document.</p> <p>Do vertical dark bands appear on prints?</p>	Go to step 2.	The problem is solved.

Action	Yes	No
<p><b>Step 2</b></p> <p><b>a</b> Remove the toner cartridge, and then remove the imaging unit.</p> <p><b>Warning—Potential Damage:</b> Do not expose the imaging unit to direct light for more than 10 minutes. Extended exposure to light may cause print quality problems.</p> <p><b>Warning—Potential Damage:</b> Do not touch the photoconductor drum under the imaging unit. Doing so may affect the quality of future print jobs.</p> <p><b>b</b> Insert the imaging unit, and then insert the cartridge.</p> <p><b>c</b> Print the document.</p> <p>Do vertical dark bands appear on prints?</p>	<p>Go to step 3.</p>	<p>The problem is solved.</p>
<p><b>Step 3</b></p> <p><b>a</b> Remove the imaging unit.</p> <p><b>Warning—Potential Damage:</b> Do not expose the imaging unit to direct light for more than 10 minutes. Extended exposure to light may cause print quality problems.</p> <p><b>Warning—Potential Damage:</b> Do not touch the photoconductor drum under the imaging unit. Doing so may affect the quality of future print jobs.</p> <p><b>b</b> Remove any packing material that is stuck on the imaging unit.</p> <div data-bbox="404 1094 776 1230" style="text-align: center;">  </div> <p><b>Note:</b> Make sure to remove any obstruction between the charge roller and photoconductor drum.</p> <p><b>c</b> Insert the imaging unit.</p> <p><b>d</b> Print the document.</p> <p>Do vertical dark bands appear on prints?</p>	<p>Go to step 4.</p>	<p>The problem is solved.</p>
<p><b>Step 4</b></p> <p><b>a</b> Check if a bright light enters the right side of the printer, and move the printer if necessary.</p> <p><b>b</b> Print the document.</p> <p>Do vertical dark bands appear on prints?</p>	<p>Contact <a href="#">customer support</a>.</p>	<p>The problem is solved.</p>



### Vertical dark lines or streaks



**Note:** Before solving the problem, print the Print Quality Test Pages. From the control panel, navigate to **Settings > Troubleshooting > Print Quality Test Pages**. For non-touch-screen printer models, press **OK** to navigate through the settings.

Action	Yes	No
<p><b>Step 1</b></p> <p><b>a</b> Check if the printer is using a genuine and supported Lexmark toner cartridge.</p> <p><b>Note:</b> If the toner cartridge is not supported, then install a supported one.</p> <p><b>b</b> Print the document.</p> <p>Do vertical dark lines or streaks appear on prints?</p>	Go to step 2.	The problem is solved.
<p><b>Step 2</b></p> <p><b>a</b> Remove, and then reinstall the imaging unit.</p> <p><b>Warning—Potential Damage:</b> Do not expose the imaging unit to direct light for more than 10 minutes. Extended exposure to light can cause print quality problems.</p> <p><b>Warning—Potential Damage:</b> Do not touch the photoconductor drum under the imaging unit. Doing so may affect the quality of future print jobs.</p> <p><b>b</b> Print the document.</p> <p>Do vertical dark lines or streaks appear on prints?</p>	Go to step 3.	The problem is solved.
<p><b>Step 3</b></p> <p><b>a</b> Replace the imaging unit.</p> <p><b>b</b> Print the document.</p> <p>Do vertical dark lines or streaks appear on prints?</p>	Contact <a href="#">customer support</a> .	The problem is solved.

### Vertical dark streaks with print missing

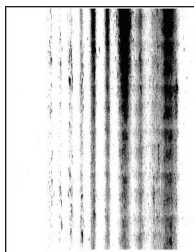

**Note:** Before solving the problem, print the Print Quality Test Pages. From the control panel, navigate to **Settings > Troubleshooting > Print Quality Test Pages**. For non-touch-screen printer models, press **OK** to navigate through the settings.

Action	Yes	No
<p><b>Step 1</b></p> <p><b>a</b> Remove the imaging unit.</p> <p><b>Warning—Potential Damage:</b> Do not expose the imaging unit to direct light for more than 10 minutes. Extended exposure to light may cause print quality problems.</p> <p><b>Warning—Potential Damage:</b> Do not touch the photoconductor drum under the imaging unit. Doing so may affect the quality of future print jobs.</p> <p><b>b</b> Remove any packing material that is stuck on the imaging unit.</p> <div style="text-align: center;">  </div> <p><b>Note:</b> Make sure to remove any obstruction between the charge roller and photoconductor drum.</p> <p><b>c</b> Insert the imaging unit.</p> <p><b>d</b> Print the document.</p> <p>Do vertical dark streaks with missing images appear on prints?</p>	<p>Go to step 2.</p>	<p>The problem is solved.</p>
<p><b>Step 2</b></p> <p><b>a</b> Check if the printer is using a genuine and supported Lexmark toner cartridge.</p> <p><b>Note:</b> If the toner cartridge is not supported, then install a supported one.</p> <p><b>b</b> Print the document.</p> <p>Do vertical dark streaks with missing images appear on prints?</p>	<p>Contact <a href="#">customer support</a>.</p>	<p>The problem is solved.</p>

### Vertical light bands



**Note:** Before solving the problem, print the Print Quality Test Pages. From the control panel, navigate to **Settings > Troubleshooting > Print Quality Test Pages**. For non-touch-screen printer models, press **OK** to navigate through the settings.

Action	Yes	No
<p><b>a</b> Check if the printer is using a genuine and supported Lexmark toner cartridge.</p> <p><b>Note:</b> If the cartridge is not supported, then install a supported one.</p> <p><b>b</b> Print the document.</p> <p>Do vertical light bands appear on prints?</p>	<p>Contact <a href="#">customer support</a>.</p>	<p>The problem is solved.</p>

### Vertical white lines



**Note:** Before solving the problem, print the Print Quality Test Pages. From the control panel, navigate to **Settings > Troubleshooting > Print Quality Test Pages**. For non-touch-screen printer models, press **OK** to navigate through the settings.

Action	Yes	No
<p><b>Step 1</b></p> <p><b>a</b> Check if the printer is using a genuine and supported Lexmark toner cartridge.</p> <p><b>Note:</b> If the cartridge is not supported, then install a supported one.</p> <p><b>b</b> Print the document.</p> <p>Do vertical white lines appear on prints?</p>	<p>Go to step 2.</p>	<p>The problem is solved.</p>

Action	Yes	No
<p><b>Step 2</b></p> <p><b>a</b> Depending on your operating system, specify the paper type from the Printing Preferences or Print dialog.</p> <p><b>Notes:</b></p> <ul style="list-style-type: none"> <li>• Make sure that the setting matches the paper loaded.</li> <li>• You can also change the setting on the printer control panel.</li> </ul> <p><b>b</b> Print the document.</p> <p>Do vertical white lines appear on prints?</p>	<p>Contact <a href="#">customer support</a>.</p>	<p>The problem is solved.</p>

## Slow printing

Action	Yes	No
<p><b>Step 1</b></p> <p><b>a</b> Make sure that the printer is not in Eco-Mode and Quiet Mode.</p> <p><b>b</b> Print the document.</p> <p>Is the printer still printing slow?</p>	<p>Go to step 2.</p>	<p>The problem is solved.</p>
<p><b>Step 2</b></p> <p><b>a</b> Depending on your operating system, specify the paper type from the Printing Preferences or Print dialog.</p> <p><b>Notes:</b></p> <ul style="list-style-type: none"> <li>• Make sure that the setting matches the paper loaded in the tray.</li> <li>• You can also change the setting from the Paper menu on the printer control panel.</li> </ul> <p><b>b</b> Print the document.</p> <p>Is the printer still printing slow?</p>	<p>Go to step 3.</p>	<p>The problem is solved.</p>
<p><b>Step 3</b></p> <p><b>a</b> Reduce the number of pages to print.</p> <p><b>b</b> Print the document.</p> <p>Is the printer still printing slow?</p>	<p>Go to step 4.</p>	<p>The problem is solved.</p>
<p><b>Step 4</b></p> <p><b>a</b> Connect the printer cable securely to the printer and the computer, print server, option, or other network device.</p> <p><b>b</b> Print the document.</p> <p>Is the printer still printing slow?</p>	<p>Go to step 5.</p>	<p>The problem is solved.</p>

Action	Yes	No
<p><b>Step 5</b></p> <p><b>a</b> From the Quality menu on the control panel, set Print Resolution to 600 dpi.</p> <p><b>b</b> Print the document.</p> <p>Is the printer still printing slow?</p>	Go to step 6.	The problem is solved.
<p><b>Step 6</b></p> <p><b>a</b> Make sure that the printer is not overheating.</p> <p><b>Notes:</b></p> <ul style="list-style-type: none"> <li>• Allow the printer to cool down after a very long print job.</li> <li>• Observe the recommended ambient temperature for the printer. For more information, see <a href="#">“Selecting a location for the printer” on page 9.</a></li> </ul> <p><b>b</b> Print the document.</p> <p>Is the printer still printing slow?</p>	Go to step 7.	The problem is solved.
<p><b>Step 7</b></p> <p><b>a</b> Add more printer memory.</p> <p><b>b</b> Print the document.</p> <p>Is the printer still printing slow?</p>	Contact <a href="#">customer support</a> .	The problem is solved.

### Print jobs do not print

Action	Yes	No
<p><b>Step 1</b></p> <p><b>a</b> From the document you are trying to print, open the Print dialog, and then check if you have selected the correct printer.</p> <p><b>b</b> Print the document.</p> <p>Is the document printed?</p>	The problem is solved.	Go to step 2.
<p><b>Step 2</b></p> <p><b>a</b> Check if the printer is on.</p> <p><b>b</b> Resolve any error messages that appear on the display.</p> <p><b>c</b> Print the document.</p> <p>Is the document printed?</p>	The problem is solved.	Go to step 3.

Action	Yes	No
<p><b>Step 3</b></p> <p><b>a</b> Check if the ports are working and if the cables are securely connected to the computer and the printer. For more information, see the setup documentation that came with the printer.</p> <p><b>b</b> Print the document.</p> <p>Is the document printed?</p>	The problem is solved.	Go to step 4.
<p><b>Step 4</b></p> <p><b>a</b> Turn off the printer, wait for about 10 seconds, and then turn on the printer.</p> <p><b>b</b> Print the document.</p> <p>Is the document printed?</p>	The problem is solved.	Go to step 5.
<p><b>Step 5</b></p> <p><b>a</b> Remove, and then reinstall the print driver.</p> <p><b>b</b> Print the document.</p> <p>Is the document printed?</p>	The problem is solved.	Contact <a href="#">customer support</a> .

## The printer is not responding

Action	Yes	No
<p><b>Step 1</b></p> <p>Connect the power cord to the electrical outlet.</p> <p> <b>CAUTION—POTENTIAL INJURY:</b> To avoid the risk of fire or electrical shock, connect the power cord to an appropriately rated and properly grounded electrical outlet that is near the product and easily accessible.</p> <p>Is the printer responding?</p>	The problem is solved.	Go to step 2.
<p><b>Step 2</b></p> <p>Check if the electrical outlet is turned off by a switch or breaker.</p> <p>Is the electrical outlet turned off by a switch or breaker?</p>	Turn on the switch or reset the breaker.	Go to step 3.
<p><b>Step 3</b></p> <p>Check if the printer is on.</p> <p>Is the printer on?</p>	Go to step 4.	Turn on the printer.
<p><b>Step 4</b></p> <p>Check if the printer is in sleep or hibernate mode.</p> <p>Is the printer in sleep or hibernate mode?</p>	Press the power button to wake the printer.	Go to step 5.

Action	Yes	No
<p><b>Step 5</b></p> <p>Check if the cables connecting the printer and the computer are inserted in the correct ports.</p> <p>Are the cables inserted in the correct ports?</p>	Go to step 6.	<p>Make sure to match the following:</p> <ul style="list-style-type: none"> <li>• The USB cable with the USB port on the printer</li> <li>• The Ethernet cable with the Ethernet port on the printer</li> </ul>
<p><b>Step 6</b></p> <p>Turn off the printer, reinstall the hardware options, and then turn it back on.</p> <p>For more information, see the documentation that came with the option.</p> <p>Is the printer responding?</p>	The problem is solved	Go to step 7.
<p><b>Step 7</b></p> <p>Install the correct print driver.</p> <p>Is the printer responding?</p>	The problem is solved	Go to step 8.
<p><b>Step 8</b></p> <p>Turn off the printer, wait for about 10 seconds, and then turn it back on.</p> <p>Is the printer responding?</p>	The problem is solved.	Contact <a href="#">customer support</a> .

## Adjusting toner darkness

1 From the control panel, navigate to:

**Settings > Print > Quality > Toner Darkness**

For non-touch-screen printer models, press  to navigate through the settings.

2 Adjust the setting.

3 Apply the changes.

## Job prints from the wrong tray or on the wrong paper

Action	Yes	No
<p><b>Step 1</b></p> <p><b>a</b> Check if you are printing on the correct paper.</p> <p><b>b</b> Print the document.</p> <p>Is the document printed on the correct paper?</p>	Go to step 2.	Load the correct paper size and paper type.

Action	Yes	No
<p><b>Step 2</b></p> <p><b>a</b> Depending on your operating system, specify the paper size and paper type from the Printing Preferences or Print dialog.</p> <p><b>Notes:</b></p> <ul style="list-style-type: none"> <li>• Make sure that the settings match the paper loaded in the tray.</li> <li>• You can also change the settings on the printer control panel.</li> </ul> <p><b>b</b> Print the document.</p> <p>Is the document printed from the correct tray or on the correct paper?</p>	<p>The problem is solved.</p>	<p>Go to step 3.</p>
<p><b>Step 3</b></p> <p><b>a</b> Check if the trays are not linked. For more information, see <a href="#">“Linking trays” on page 17.</a></p> <p><b>b</b> Print the document.</p> <p>Is the document printed from the correct tray?</p>	<p>The problem is solved.</p>	<p>Contact <a href="#">customer support</a>.</p>

## Contacting customer support

Before contacting customer support, make sure to have the following information:

- Printer problem
- Error message
- Printer model type and serial number

Go to <http://support.lexmark.com> to receive e-mail or chat support, or browse through the library of manuals, support documentation, drivers, and other downloads.

Technical support via telephone is also available. In the U.S. or Canada, call 1-800-539-6275. For other countries or regions, go to <http://support.lexmark.com>.



# Upgrading and migrating

## Hardware

### Available internal options

- Flash memory
- Font cards
- Firmware cards
  - Forms and Bar Code
  - IPDS
  - PRESCRIBE
- Internal solutions port
  - Thin Parallel

### Accessing the controller board



**CAUTION—SHOCK HAZARD:** To avoid the risk of electrical shock, if you are accessing the controller board or installing optional hardware or memory devices sometime after setting up the printer, then turn the printer off, and unplug the power cord from the electrical outlet before continuing. If you have any other devices attached to the printer, then turn them off as well, and unplug any cables going into the printer.

- 1** Turn off the printer.
- 2** Unplug the power cord from the electrical outlet, and then from the printer.
- 3** Using a flat-head screwdriver, open the controller board access cover.

**Warning—Potential Damage:** Controller board electronic components are easily damaged by static electricity. Touch a metal surface on the printer before touching any controller board components or connectors.

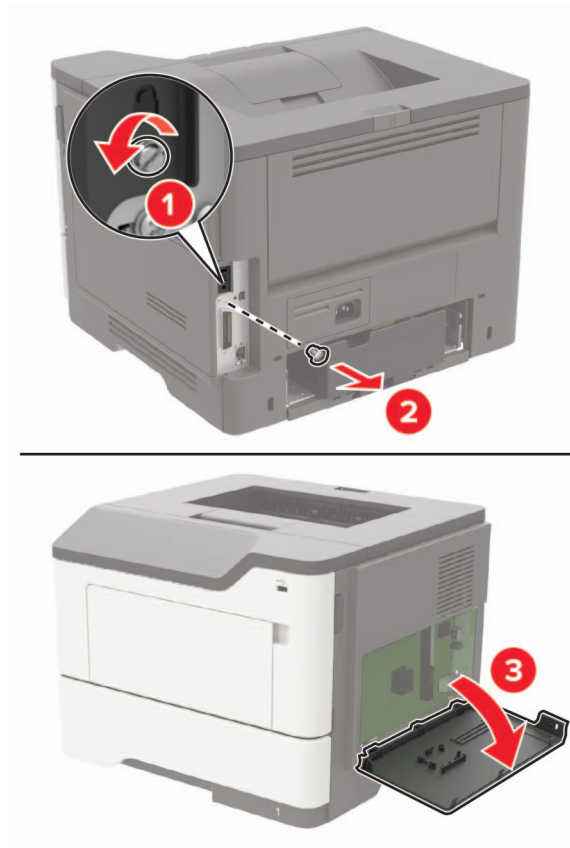

- 4 Close the access cover.
- 5 Connect the power cord to the printer, and then to the electrical outlet.
- 6 Turn on the printer.

## Installing a memory card

**⚠ CAUTION—SHOCK HAZARD:** To avoid the risk of electrical shock, if you are accessing the controller board or installing optional hardware or memory devices sometime after setting up the printer, then turn the printer off, and unplug the power cord from the electrical outlet before continuing. If you have any other devices attached to the printer, then turn them off as well, and unplug any cables going into the printer.

- 1 Turn off the printer.
- 2 Unplug the power cord from the electrical outlet, and then from the printer.
- 3 Open the controller board access cover.

**Warning—Potential Damage:** Controller board electronic components are easily damaged by static electricity. Touch a metal surface on the printer before touching any controller board components or connectors.

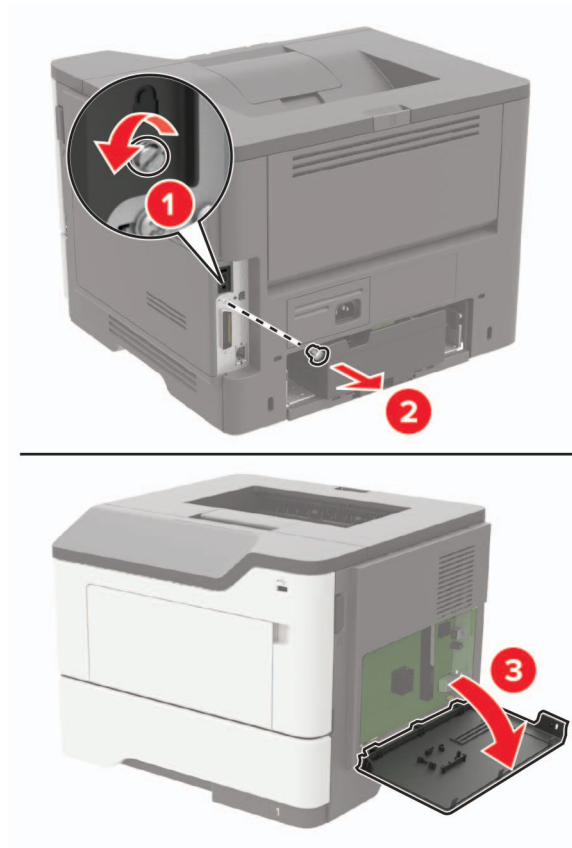

4 Unpack the memory card.

**Warning—Potential Damage:** Do not touch the connection points along the edge of the card.

5 Insert the memory card until it *clicks* into place.

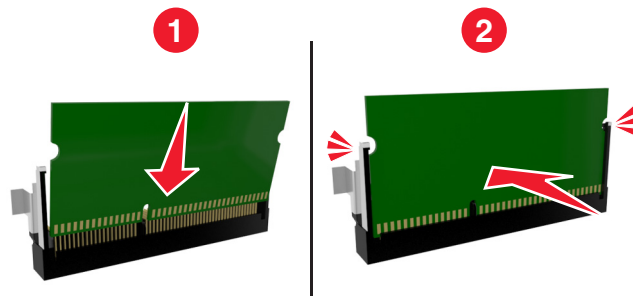

6 Close the controller board access cover.

7 Connect the power cord to the printer, and then to the electrical outlet.

**⚠ CAUTION—POTENTIAL INJURY:** To avoid the risk of fire or electrical shock, connect the power cord to an appropriately rated and properly grounded electrical outlet that is near the product and easily accessible.

8 Turn on the printer.

## Installing an optional card

**⚠ CAUTION—SHOCK HAZARD:** To avoid the risk of electrical shock, if you are accessing the controller board or installing optional hardware or memory devices sometime after setting up the printer, then turn the printer off, and unplug the power cord from the electrical outlet before continuing. If you have any other devices attached to the printer, then turn them off as well, and unplug any cables going into the printer.

- 1 Turn off the printer.
- 2 Unplug the power cord from the electrical outlet, and then from the printer.
- 3 Open the controller board access cover.

**Warning—Potential Damage:** Controller board electronic components are easily damaged by static electricity. Touch a metal surface on the printer before touching any components or connectors.

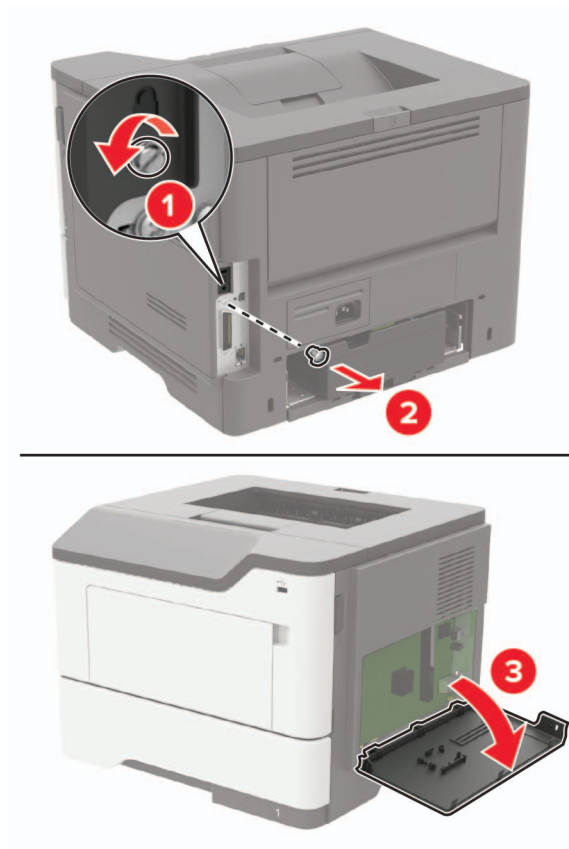

- 4 Unpack the optional card.

**Warning—Potential Damage:** Do not touch the connection points along the edge of the card.

- 5 Push the card firmly into place.

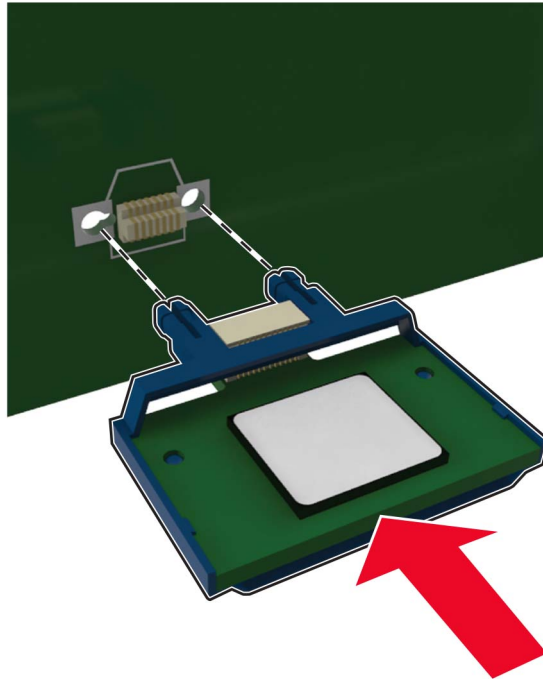

**Note:** The entire length of the connector on the card must touch and be flush against the controller board.

**Warning—Potential Damage:** Improper installation of the card may cause damage to the card and the controller board.

- 6 Close the access cover.
- 7 Connect the power cord to the printer, and then to the electrical outlet.

**CAUTION—POTENTIAL INJURY:** To avoid the risk of fire or electrical shock, connect the power cord to an appropriately rated and properly grounded electrical outlet that is near the product and easily accessible.

- 8 Turn on the printer.

## Installing optional trays

**CAUTION—SHOCK HAZARD:** To avoid the risk of electrical shock, if you are accessing the controller board or installing optional hardware or memory devices sometime after setting up the printer, then turn the printer off, and unplug the power cord from the electrical outlet before continuing. If you have any other devices attached to the printer, then turn them off as well, and unplug any cables going into the printer.

- 1 Turn off the printer.
- 2 Unplug the power cord from the electrical outlet, and then from the printer.

**3** Unpack the optional tray, and then remove all packing material.

**Note:** If optional trays are already installed, then unlock them from the printer before lifting the printer. Do not try to lift the printer and trays at the same time.

**4** Align the printer with the optional tray, and then lower the printer until it *clicks* into place.

**⚠ CAUTION—POTENTIAL INJURY:** If the printer weight is greater than 18 kg (40 lb), then it requires two or more trained personnel to lift it safely.

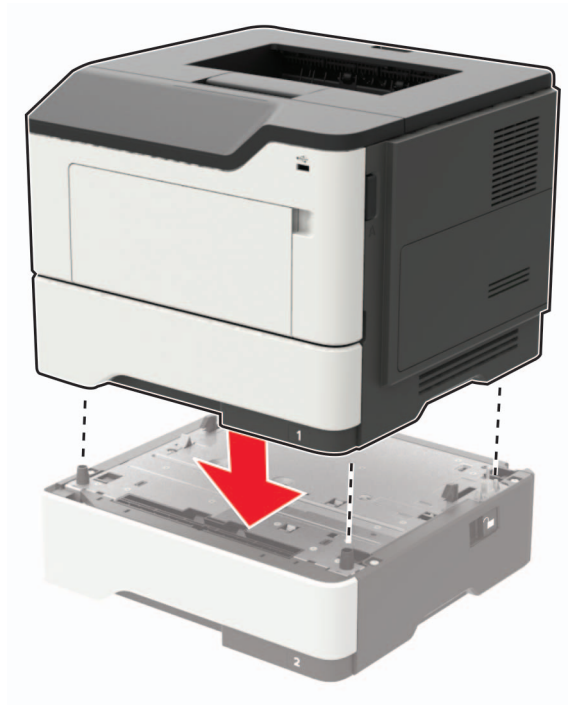

**5** Connect the power cord to the printer, and then to the electrical outlet.

**⚠ CAUTION—POTENTIAL INJURY:** To avoid the risk of fire or electrical shock, connect the power cord to an appropriately rated and properly grounded electrical outlet that is near the product and easily accessible.

**6** Turn on the printer.

Add the tray in the print driver to make it available for print jobs. For more information, see [“Adding available options in the print driver” on page 135](#).

## Software

### Supported operating systems

Using the software CD, you can install the printer software on the following operating systems:

- Windows 10
- Windows 8.1
- Windows Server 2012 R2
- Windows Server 2012

- Windows 7 SP1
- Windows Server 2008 R2 SP1
- Windows Server 2008 SP2
- Windows Vista SP2
- Mac OS X version 10.7 or later
- Red Hat Enterprise Linux WS
- openSUSE Linux
- SUSE Linux Enterprise Server
- Debian GNU/Linux
- Ubuntu
- Fedora
- IBM AIX
- Oracle Solaris SPARC
- Oracle Solaris x86

**Notes:**

- For Windows operating systems, the print drivers and utilities are supported in both 32- and 64-bit versions.
- For drivers and utilities that are compatible with Mac OS X version 10.6 or earlier and for specific supported Linux or UNIX operating system versions, go to <http://support.lexmark.com>.
- For more information on software compatibility with all other operating systems, contact customer support.

## Installing the printer software

- 1 Obtain a copy of the software installer package.
  - From the software CD that came with your printer.
  - Go to <http://support.lexmark.com>, and then select your printer and operating system.
- 2 Run the installer, and then follow the instructions on the computer screen.
- 3 For Macintosh users, add the printer.

**Note:** Obtain the printer IP address from the TCP/IP section in the Network/Ports menu.

## Adding available options in the print driver

### For Windows users

- 1 Open the printers folder.
- 2 Select the printer you want to update, and then do either of the following:
  - For Windows 7 or later, select **Printer properties**.
  - For earlier versions, select **Properties**.
- 3 Navigate to the Configuration tab, and then select **Update Now - Ask Printer**.
- 4 Apply the changes.

## For Macintosh users

- 1 From System Preferences in the Apple menu, navigate to your printer, and then select **Options & Supplies**.
- 2 Navigate to the list of hardware options, and then add any installed options.
- 3 Apply the changes.

## Firmware

### Exporting or importing a configuration file

You can export the configuration settings of your printer into a text file, and then import the file to apply the settings to other printers.

- 1 Open a web browser, and then type the printer IP address in the address field.

#### Notes:

- View the printer IP address on the printer home screen. The IP address appears as four sets of numbers separated by periods, such as 123.123.123.123.
- If you are using a proxy server, then temporarily disable it to load the web page correctly.

- 2 Export or import a configuration file for one or multiple applications.

#### For one application

- a From the Embedded Web Server, click **Apps** > the application that you want > **Configure**.
- b Click **Export** or **Import**.

#### For multiple applications

- a From the Embedded Web Server, click **Export Configuration** or **Import Configuration**.
- b Follow the instructions on the screen.

## Updating firmware

Some applications require a minimum device firmware level to operate correctly.

For more information on updating the device firmware, contact your Lexmark representative.

- 1 From the Embedded Web Server, click **Settings** > **Device** > **Update Firmware**.
- 2 Browse to locate the required flash file.
- 3 Apply the changes.



# Notices

## Product information

Product name:

Lexmark B2546dn; Lexmark B2650dn; Lexmark M1246; Lexmark MS521dn; Lexmark MS621dn

Machine type:

4600

Model(s):

630, 690, 830

## Edition notice

April 2018

**The following paragraph does not apply to any country where such provisions are inconsistent with local law:** LEXMARK INTERNATIONAL, INC., PROVIDES THIS PUBLICATION "AS IS" WITHOUT WARRANTY OF ANY KIND, EITHER EXPRESS OR IMPLIED, INCLUDING, BUT NOT LIMITED TO, THE IMPLIED WARRANTIES OF MERCHANTABILITY OR FITNESS FOR A PARTICULAR PURPOSE. Some states do not allow disclaimer of express or implied warranties in certain transactions; therefore, this statement may not apply to you.

This publication could include technical inaccuracies or typographical errors. Changes are periodically made to the information herein; these changes will be incorporated in later editions. Improvements or changes in the products or the programs described may be made at any time.

References in this publication to products, programs, or services do not imply that the manufacturer intends to make these available in all countries in which it operates. Any reference to a product, program, or service is not intended to state or imply that only that product, program, or service may be used. Any functionally equivalent product, program, or service that does not infringe any existing intellectual property right may be used instead. Evaluation and verification of operation in conjunction with other products, programs, or services, except those expressly designated by the manufacturer, are the user's responsibility.

For Lexmark technical support, visit <http://support.lexmark.com>.

For information on supplies and downloads, visit [www.lexmark.com](http://www.lexmark.com).

© 2018 Lexmark International, Inc.

All rights reserved.

## GOVERNMENT END USERS

The Software Program and any related documentation are "Commercial Items," as that term is defined in 48 C.F.R. 2.101, "Computer Software" and "Commercial Computer Software Documentation," as such terms are used in 48 C.F.R. 12.212 or 48 C.F.R. 227.7202, as applicable. Consistent with 48 C.F.R. 12.212 or 48 C.F.R. 227.7202-1 through 227.7207-4, as applicable, the Commercial Computer Software and Commercial Software Documentation are licensed to the U.S. Government end users (a) only as Commercial Items and (b) with only those rights as are granted to all other end users pursuant to the terms and conditions herein.

## Trademarks

Lexmark, the Lexmark logo, and MarkNet are trademarks or registered trademarks of Lexmark International, Inc. in the United States and/or other countries.

Google Cloud Print and Google Chrome are trademarks of Google Inc.

Macintosh, the Mac logo, and Safari are trademarks of Apple Inc.

Microsoft, Windows, and Internet Explorer are either registered trademarks or trademarks of the Microsoft group of companies in the United States and other countries.

Mopria®, the Mopria® logo, and the Mopria® Alliance logo are registered trademarks and service marks of Mopria Alliance, Inc. in the United States and other countries. Unauthorized use is strictly prohibited.

PCL® is a registered trademark of the Hewlett-Packard Company. PCL is Hewlett-Packard Company's designation of a set of printer commands (language) and functions included in its printer products. This printer is intended to be compatible with the PCL language. This means the printer recognizes PCL commands used in various application programs, and that the printer emulates the functions corresponding to the commands.

PostScript is a registered trademark of Adobe Systems Incorporated in the United States and/or other countries.

All other trademarks are the property of their respective owners.

AirPrint and the AirPrint logo are trademarks of Apple, Inc.

## Licensing notices

All licensing notices associated with this product can be viewed from the CD:\NOTICES directory of the installation software CD.

## Noise emission levels

The following measurements were made in accordance with ISO 7779 and reported in conformance with ISO 9296.

**Note:** Some modes may not apply to your product.

1-meter average sound pressure, dBA	
Printing	One-sided: 56 (All models; Two-sided: 55 (B2546, M1246, MS521), 56 (B2650, MS621)
Scanning	N/A
Copying	N/A
Ready	14

Values are subject to change. See [www.lexmark.com](http://www.lexmark.com) for current values.

## Waste from Electrical and Electronic Equipment (WEEE) directive



The WEEE logo signifies specific recycling programs and procedures for electronic products in countries of the European Union. We encourage the recycling of our products.

If you have further questions about recycling options, visit the Lexmark Web site at [www.lexmark.com](http://www.lexmark.com) for your local sales office phone number.

## India E-Waste notice

This product complies with the India E-Waste (Management and Handling) Rules, 2011, which prohibit use of lead, mercury, hexavalent chromium, polybrominated biphenyls, or polybrominated diphenyl ethers in concentrations exceeding 0.1% by weight and 0.01% by weight for cadmium, except for the exemption set in Schedule II of the Rules.

## Product disposal

Do not dispose of the printer or supplies in the same manner as normal household waste. Consult your local authorities for disposal and recycling options.

## Static sensitivity notice



This symbol identifies static-sensitive parts. Do not touch the areas near these symbols without first touching a metal surface in an area away from the symbol.

## ENERGY STAR

Any Lexmark product bearing the ENERGY STAR emblem on the product or on a start-up screen is certified to comply with Environmental Protection Agency (EPA) ENERGY STAR requirements as configured when shipped by Lexmark.



## Temperature information

Ambient operating temperature	10 to 32°C (50 to 90°F)
Shipping temperature	-40 to 43.3°C (-40 to 110°F)
Storage temperature and relative humidity	0 to 40°C (32 to 104°F) 8 to 80% RH

## Laser notice

The printer is certified in the U.S. to conform to the requirements of DHHS 21 CFR, Chapter I, Subchapter J for Class I (1) laser products, and elsewhere is certified as a Class I laser product conforming to the requirements of IEC 60825-1: 2014.

Class I laser products are not considered to be hazardous. The printer contains internally a Class IIIb (3b) AlGaInP laser that is nominally 15 milliwatts operating in the wavelength region of 650–670 nanometers and enclosed in a non-serviceable printhead assembly. The laser system and printer are designed so there is never any human access to laser radiation above a Class I level during normal operation, user maintenance, or prescribed service conditions.

## Laser advisory label

A laser notice label may be affixed to this printer as shown:

<p>DANGER - Invisible laser radiation when cartridges are removed and interlock defeated. Avoid exposure to laser beam.</p> <p>PERIGO - Radiação a laser invisível será liberada se os cartuchos forem removidos e o lacre rompido. Evite a exposição aos feixes de laser.</p> <p>Opasnost - Nevidljivo lasersko zračenje kada su kasete uklonjene i poništena sigurnosna veza. Izbjegavati izlaganje zracima.</p> <p>NEBEZPEČÍ - Když jsou vyjmuty kazety a je odblokována pojistka, ze zařízení je vysíláno neviditelné laserové záření. Nevystavujte se působení laserového paprsku.</p> <p>FARE - Usynlig laserstråling, når patroner fjernes, og spærreanordningen er slået fra. Undgå at blive udsat for laserstrålen.</p> <p>GEVAAR - Onzichtbare laserstraling wanneer cartridges worden verwijderd en een vergrendeling wordt genegeerd. Voorkom blootstelling aan de laser.</p>
---

DANGER - Rayonnements laser invisibles lors du retrait des cartouches et du déverrouillage des loquets. Eviter toute exposition au rayon laser.

VAARA - Näkymätöntä lasersäteilyä on varottava, kun värikasetit on poistettu ja lukitus on auki. Vältä lasersäteelle altistumista.

GEFAHR - Unsichtbare Laserstrahlung beim Herausnehmen von Druckkassetten und offener Sicherheitssperre. Laserstrahl meiden.

KΙΝΔΥΝΟΣ - Έκλυση αόρατης ακτινοβολίας laser κατά την αφαίρεση των κασετών και την απασφάλιση της μανδάλωσης. Αποφεύγετε την έκθεση στην ακτινοβολία laser.

VESZÉLY – Nem látható lézersugárzás fordulhat elő a patronok eltávolításakor és a zárószerkezet felbontásakor. Kerülje a lézersugárnak való kitettséget.

PERICOLO - Emissione di radiazioni laser invisibili durante la rimozione delle cartucce e del blocco. Evitare l'esposizione al raggio laser.

FARE – Usynlig laserstråling når kassettene tas ut og sperren er satt ut av spill. Unngå eksponering for laserstrålen.

NIEBEZPIECZENSTWO - niewidzialne promieniowanie laserowe podczas usuwania kaset i blokady. Należy unikać naświetlenia promieniem lasera.

ОПАСНО! Невидимое лазерное излучение при извлеченных картриджах и снятии блокировки. Избегайте воздействия лазерных лучей.

Pozor – Nebezpečnostvo neviditeľného laserového žiarenia pri odobratých kazetách a odblokovanej poistke. Nevystavujte sa lúčom.

PELIGRO: Se producen radiaciones láser invisibles al extraer los cartuchos con el interbloqueo desactivado. Evite la exposición al haz de láser.

FARA – Osynlig laserstrålning när patroner tas ur och spärrmekanismen är upphävd. Undvik exponering för laserstrålen.

危険 - 当移除碳粉盒及互锁失效时会产生看不见的激光辐射，请避免暴露在激光光束下。

危険 - 移除碳粉匣與安全連鎖開關失效時會產生看不見的雷射輻射。請避免曝露在雷射光束下。

危険 - カートリッジが取り外され、内部ロックが無効になると、見えないレーザー光が放射されます。このレーザー光に当たらないようにしてください。

## Power consumption

### Product power consumption

The following table documents the power consumption characteristics of the product.

**Note:** Some modes may not apply to your product.

Mode	Description	Power consumption (Watts)
Printing	The product is generating hard-copy output from electronic inputs.	One-sided: 620 (B2546, M1246, MS521), 670 (B2650, MS621); Two-sided: 370 (All models)
Copy	The product is generating hard-copy output from hard-copy original documents.	N/A
Scan	The product is scanning hard-copy documents.	N/A
Ready	The product is waiting for a print job.	8 (B2546, M1246, MS521), 9.5 (B2650, MS621)

Mode	Description	Power consumption (Watts)
Sleep Mode	The product is in a high-level energy-saving mode.	2 (B2546, M1246, MS521), 2.2 (B2650, MS621)
Hibernate	The product is in a low-level energy-saving mode.	0.1 W
Off	The product is plugged into an electrical outlet, but the power switch is turned off.	0.1 W

The power consumption levels listed in the previous table represent time-averaged measurements. Instantaneous power draws may be substantially higher than the average.

Values are subject to change. See [www.lexmark.com](http://www.lexmark.com) for current values.

### Sleep Mode

This product is designed with an energy-saving mode called *Sleep Mode*. The Sleep Mode saves energy by lowering power consumption during extended periods of inactivity. The Sleep Mode is automatically engaged after this product is not used for a specified period of time, called the *Sleep Mode Timeout*.

Factory default Sleep Mode Timeout for this product (in minutes):	15
---	----

By using the configuration menus, the Sleep Mode Timeout can be modified between 1 minute and 120 minutes. Setting the Sleep Mode Timeout to a low value reduces energy consumption, but may increase the response time of the product. Setting the Sleep Mode Timeout to a high value maintains a fast response, but uses more energy.

### Hibernate Mode

This product is designed with an ultra-low power operating mode called *Hibernate mode*. When operating in Hibernate Mode, all other systems and devices are powered down safely.

The Hibernate mode can be entered in any of the following methods:

- Using the Hibernate Timeout
- Using the Schedule Power modes

Factory default Hibernate Timeout for this product in all countries or regions	3 days
--	--------

The amount of time the printer waits after a job is printed before it enters Hibernate mode can be modified between one hour and one month.

### Off mode

If this product has an off mode which still consumes a small amount of power, then to completely stop product power consumption, disconnect the power supply cord from the electrical outlet.

### Total energy usage

It is sometimes helpful to calculate the total product energy usage. Since power consumption claims are provided in power units of Watts, the power consumption should be multiplied by the time the product spends in each mode in order to calculate energy usage. The total product energy usage is the sum of each mode's energy usage.

## Regulatory notices for wireless products

This section contains regulatory information that applies only to wireless models.

If in doubt as to whether your model is a wireless model, go to <http://support.lexmark.com>.

## Modular component notice

This product may contain the following modular component(s):

Lexmark Regulatory Type/LEX-M01-005; FCC ID: IYLLEXM01005; Industry Canada IC: 2376A-M01005

## Exposure to radio frequency radiation

The radiated output power of this device is far below the radio frequency exposure limits of the FCC and other regulatory agencies. A minimum separation of 20 cm (8 inches) must be maintained between the antenna and any persons for this device to satisfy the RF exposure requirements of the FCC and other regulatory agencies.

## Industry Canada (Canada)

Under Industry Canada regulations, this radio transmitter may only operate using an antenna of a type and maximum (or lesser) gain approved for the transmitter by Industry Canada. To reduce potential radio interference to other users, the antenna type and its gain should be so chosen that the equivalent isotropically radiated power (EIRP) is not more than that necessary for successful communication.

This device complies with Industry Canada license-exempt RSS standards. Operation is subject to the following two conditions: (1) this device may not cause interference, and (2) this device must accept any interference, including interference that may cause undesired operation of the device.

To prevent radio interference to the licensed service and to reduce the potential for harmful interference to co-channel mobile satellite systems, this device is intended to be operated indoors and away from windows to provide maximum shielding.

High-power radars are allocated as primary users (i.e., priority users) of the bands 5250–5350MHz and 5650–5850MHz. These radars could cause interference and/or damage to LE-LAN devices.

## Industrie Canada (Canada)

Selon la réglementation d'Industrie Canada, l'émetteur radio ne fonctionne qu'avec une antenne dont le type et le gain maximal (ou inférieur) ont été approuvés par Industrie Canada. Pour réduire les interférences radio potentielles auprès d'autres utilisateurs, le type d'antenne et son gain doivent être choisis de telle sorte que la puissance isotrope rayonnée équivalente (PIRE) ne soit pas supérieure à ce qui est nécessaire pour assurer la réussite de la communication.

Cet appareil est conforme aux normes RSS exemptes de licence d'Industrie Canada. Son fonctionnement est soumis aux deux conditions suivantes : (1) cet appareil ne doit pas causer d'interférences et (2) il doit accepter toutes les interférences, y compris les celles qui peuvent entraîner un fonctionnement indésirable.

Afin de prévenir les interférences radio des services sous licence et pour réduire le risque d'interférences nuisibles aux systèmes de satellites mobiles utilisant les mêmes canaux, cet appareil est destiné à être utilisé à l'intérieur et loin des fenêtres afin de fournir une protection maximale.

Les radars à haute puissance sont définis comme les utilisateurs principaux (p. ex., utilisateurs prioritaires) dans les bandes de 5250-5350 MHz et 5650-5850 MHz. Ces radars peuvent causer des interférences ou des dommages aux appareils RELOC-EL.

## **Federal Communications Commission (FCC) compliance information statement**

This product has been tested and found to comply with the limits for a Class B digital device, pursuant to Part 15 of the FCC Rules. Operation is subject to the following two conditions: (1) this device may not cause harmful interference, and (2) this device must accept any interference received, including interference that may cause undesired operation.

The FCC Class B limits are designed to provide reasonable protection against harmful interference when the equipment is operated in a residential installation. This equipment generates, uses, and can radiate radio frequency energy and, if not installed and used in accordance with the instructions, may cause harmful interference to radio communications. However, there is no guarantee that interference will not occur in a particular installation. If this equipment does cause harmful interference to radio or television reception, which can be determined by turning the equipment off and on, the user is encouraged to try to correct the interference by one or more of the following measures:

- Reorient or relocate the receiving antenna.
- Increase the separation between the equipment and receiver.
- Connect the equipment into an outlet on a circuit different from that to which the receiver is connected.
- Consult your point of purchase or service representative for additional suggestions.

The manufacturer is not responsible for radio or television interference caused by using other than recommended cables or by unauthorized changes or modifications to this equipment. Unauthorized changes or modifications could void the user's authority to operate this equipment.

**Note:** To assure compliance with FCC regulations on electromagnetic interference for a Class B computing device, use a properly shielded and grounded cable such as Lexmark part number 1021231 for parallel attach or 1021294 for USB attach. Use of a substitute cable not properly shielded and grounded may result in a violation of FCC regulations.

Any questions regarding this compliance information statement should be directed to:

Director of Lexmark Technology & Services  
Lexmark International, Inc.  
740 West New Circle Road  
Lexington, KY 40550  
Telephone: (859) 232-3000  
E-mail: [regulatory@lexmark.com](mailto:regulatory@lexmark.com)

## **Industry Canada compliance statement**

This Class B digital apparatus meets all requirements of the Canadian Interference-Causing Equipment Standard ICES-003.

## **Avis de conformité aux normes de l'industrie du Canada**

Cet appareil numérique de classe B est conforme aux exigences de la norme canadienne relative aux équipements pouvant causer des interférences NMB-003.



## 日本の VCCI 規定

製品にこのマークが表示されている場合、次の要件を満たしています。



この装置は、クラス B 情報技術装置です。この装置は、家庭環境で使用することを目的としていますが、この装置がラジオやテレビジョン受信機に近接して使用されると、受信障害を引き起こすことがあります。

取扱説明書に従って正しい取り扱いをしてください。

VCCI-B

## European Community (EC) directives conformity

This product is in conformity with the protection requirements of EC Council directives 2014/30/EU, 2014/35/EU, 2009/125/EC, and 2011/65/EU on the approximation and harmonization of the laws of the Member States relating to electromagnetic compatibility, safety of electrical equipment designed for use within certain voltage limits, the ecodesign of energy-related products, and on the restrictions of use of certain hazardous substances in electrical and electronic equipment.

The manufacturer of this product is: Lexmark International, Inc., 740 West New Circle Road, Lexington, KY, 40550 USA. The authorized representative is: Lexmark International Technology Hungária Kft., 8 Lechner Ödön fasor, Millennium Tower III, 1095 Budapest HUNGARY. A declaration of conformity to the requirements of the Directives is available upon request from the Authorized Representative or may be obtained at [www.lexmark.com/en\\_us/about/regulatory-compliance/european-union-declaration-of-conformity.html](http://www.lexmark.com/en_us/about/regulatory-compliance/european-union-declaration-of-conformity.html).

This product satisfies the Class B limits of EN 55022 and EN55032 and safety requirements of EN 60950-1 or EN 62368-1.

## European Community (EC) directives conformity

This product is in conformity with the protection requirements of EC Council directive 2014/53/EU on the approximation and harmonization of the laws of the Member States relating to radio equipment.

The manufacturer of this product is: Lexmark International, Inc., 740 West New Circle Road, Lexington, KY, 40550 USA. The authorized representative is: Lexmark International Technology Hungária Kft., 8 Lechner Ödön fasor, Millennium Tower III, 1095 Budapest HUNGARY. A declaration of conformity to the requirements of the Directives is available upon request from the Authorized Representative or may be obtained at [www.lexmark.com/en\\_us/about/regulatory-compliance/european-union-declaration-of-conformity.html](http://www.lexmark.com/en_us/about/regulatory-compliance/european-union-declaration-of-conformity.html).

Compliance is indicated by the CE marking:



**Restrictions**

This radio equipment is restricted to indoor use only. Outdoor use is prohibited. This restriction applies to all the countries listed in the table below:

								
AT	BE	BG	CH	CY	CZ	DE	DK	EE
EL	ES	FI	FR	HR	HU	IE	IS	IT
LI	LT	LU	LV	MT	NL	NO	PL	PT
RO	SE	SI	SK	TR	UK			

**EU statement of radio transmitter operational frequency bands and maximum RF power**

This radio product transmits in either the 2.4GHz (2.412–2.472 GHz in the EU) or 5GHz (5.15–5.35, 5.47–5.725 in the EU) bands. The maximum transmitter EIRP power output, including antenna gain, is ≤ 20dBm for both bands.

**STATEMENT OF LIMITED WARRANTY FOR LEXMARK LASER PRINTERS, LEXMARK LED PRINTERS, AND LEXMARK MULTIFUNCTION LASER PRINTERS**

**Lexmark International, Inc., Lexington, KY**

This limited warranty applies to the United States and Canada. For customers outside the U.S., refer to the country-specific warranty information that came with your product.

This limited warranty applies to this product only if it was originally purchased for your use, and not for resale, from Lexmark or a Lexmark Remarketer, referred to in this statement as “Remarketer.”

**Limited warranty**

Lexmark warrants that this product:

- Is manufactured from new parts, or new and serviceable used parts, which perform like new parts
- Is, during normal use, free from defects in material and workmanship

If this product does not function as warranted during the warranty period, contact a Remarketer or Lexmark for repair or replacement (at Lexmark's option).

If this product is a feature or option, this statement applies only when that feature or option is used with the product for which it was intended. To obtain warranty service, you may be required to present the feature or option with the product.

If you transfer this product to another user, warranty service under the terms of this statement is available to that user for the remainder of the warranty period. You should transfer proof of original purchase and this statement to that user.

### **Limited warranty service**

The warranty period starts on the date of original purchase as shown on the purchase receipt and ends 12 months later provided that the warranty period for any supplies and for any maintenance items included with the printer shall end earlier if it, or its original contents, are substantially used up, depleted, or consumed. Fuser Units, Transfer/Transport Units, Paper Feed items, if any, and any other items for which a Maintenance Kit is available are substantially consumed when the printer displays a "Life Warning" or "Scheduled Maintenance" message for such item.

To obtain warranty service you may be required to present proof of original purchase. You may be required to deliver your product to the Remarketer or Lexmark, or ship it prepaid and suitably packaged to a Lexmark designated location. You are responsible for loss of, or damage to, a product in transit to the Remarketer or the Lexmark designated location.

When warranty service involves the exchange of a product or part, the item replaced becomes the property of the Remarketer or Lexmark. The replacement may be a new or repaired item.

The replacement item assumes the remaining warranty period of the original product.

Replacement is not available to you if the product you present for exchange is defaced, altered, in need of a repair not included in warranty service, damaged beyond repair, or if the product is not free of all legal obligations, restrictions, liens, and encumbrances.

As part of your warranty service and/or replacement, Lexmark may update the firmware in your printer to the latest version. Firmware updates may modify printer settings and cause counterfeit and/or unauthorized products, supplies, parts, materials (such as toners and inks), software, or interfaces to stop working. Authorized use of genuine Lexmark products will not be impacted.

Before you present this product for warranty service, remove all print cartridges, programs, data, and removable storage media (unless directed otherwise by Lexmark).

For further explanation of your warranty alternatives and the nearest Lexmark authorized servicer in your area contact Lexmark on the World Wide Web.

Remote technical support is provided for this product throughout its warranty period. For products no longer covered by a Lexmark warranty, technical support may not be available or only be available for a fee.

### **Extent of limited warranty**

Lexmark does not warrant uninterrupted or error-free operation of any product or the durability or longevity of prints produced by any product.

Warranty service does not include repair of failures caused by:

- Modification or unauthorized attachments
- Accidents, misuse, abuse or use inconsistent with Lexmark user's guides, manuals, instructions or guidance
- Unsuitable physical or operating environment
- Maintenance by anyone other than Lexmark or a Lexmark authorized servicer
- Operation of a product beyond the limit of its duty cycle
- Use of printing media outside of Lexmark specifications

- Refurbishment, repair, refilling or remanufacture by a third party of products, supplies or parts
- Products, supplies, parts, materials (such as toners and inks), software, or interfaces not furnished by Lexmark

**TO THE EXTENT PERMITTED BY APPLICABLE LAW, NEITHER LEXMARK NOR ITS THIRD PARTY SUPPLIERS OR REMARKETERS MAKE ANY OTHER WARRANTY OR CONDITION OF ANY KIND, WHETHER EXPRESS OR IMPLIED, WITH RESPECT TO THIS PRODUCT, AND SPECIFICALLY DISCLAIM THE IMPLIED WARRANTIES OR CONDITIONS OF MERCHANTABILITY, FITNESS FOR A PARTICULAR PURPOSE, AND SATISFACTORY QUALITY. ANY WARRANTIES THAT MAY NOT BE DISCLAIMED UNDER APPLICABLE LAW ARE LIMITED IN DURATION TO THE WARRANTY PERIOD. NO WARRANTIES, EXPRESS OR IMPLIED, WILL APPLY AFTER THIS PERIOD. ALL INFORMATION, SPECIFICATIONS, PRICES, AND SERVICES ARE SUBJECT TO CHANGE AT ANY TIME WITHOUT NOTICE.**

### **Limitation of liability**

Your sole remedy under this limited warranty is set forth in this document. For any claim concerning performance or nonperformance of Lexmark or a Remarketer for this product under this limited warranty, you may recover actual damages up to the limit set forth in the following paragraph.

Lexmark's liability for actual damages from any cause whatsoever will be limited to the amount you paid for the product that caused the damages. This limitation of liability will not apply to claims by you for bodily injury or damage to real property or tangible personal property for which Lexmark is legally liable. **IN NO EVENT WILL LEXMARK BE LIABLE FOR ANY LOST PROFITS, LOST SAVINGS, INCIDENTAL DAMAGE, OR OTHER ECONOMIC OR CONSEQUENTIAL DAMAGES.** This is true even if you advise Lexmark or a Remarketer of the possibility of such damages. Lexmark is not liable for any claim by you based on a third party claim.

This limitation of remedies also applies to claims against any Suppliers and Remarketers of Lexmark. Lexmark's and its Suppliers' and Remarketers' limitations of remedies are not cumulative. Such Suppliers and Remarketers are intended beneficiaries of this limitation.

### **Additional rights**

Some states do not allow limitations on how long an implied warranty lasts, or do not allow the exclusion or limitation of incidental or consequential damages, so the limitations or exclusions contained above may not apply to you.

This limited warranty gives you specific legal rights. You may also have other rights that vary from state to state.

# Index

## A

- About this Printer menu 33
- accessing the controller board 129
- adding hardware options
  - print driver 135
- adding internal options
  - print driver 135
- adjusting toner darkness 127
- AirPrint
  - using 22
- attaching cables 11
- avoiding paper jams 85

## B

- blank pages 101

## C

- cannot open Embedded Web Server 95
- checking the printer connectivity 97
- checking the status of parts and supplies 67
- cleaning
  - exterior of the printer 66
  - interior of the printer 66
- cleaning the printer 66
- clearing jam
  - in door A 87
- configuring supply notifications 70
- configuring Universal paper settings 14
- connecting the printer
  - to a wireless network 65
- connecting to a wireless network
  - using PIN method 65
  - using Push Button method 65
- conserving supplies 83
- contacting customer support 128
- control panel
  - buttons 12
  - indicator light 12
  - using 12
- controller board
  - accessing 129

- crooked print 114
- customer support
  - contacting 128

## D

- deactivating the Wi-Fi network 66
- directory list
  - printing 24
- documents, printing
  - from a computer 21
  - from a mobile device 21
- dots on print 111

## E

- Eco-Mode
  - configuring 82
- emission
- notices 138, 143, 144, 145
- enabling the USB port 96
- environmental settings 82
- erasing printer memory 63, 64
- Ethernet menu 46
- Ethernet port 11
- exporting a configuration file
  - using the Embedded Web Server 136
- exporting compressed logs 33
- exporting configuration file 33

## F

- FCC notices 143
- finding more information about the printer 8
- firmware
  - update 136
- flash drive
  - printing from 22
- folder paper 105
- font sample list
  - printing 24

## G

- Google Cloud Print
  - using 21

## H

- hardware options
  - trays 133
- hardware options, adding
  - print driver 135
- Hibernate mode
  - configuring 82
- HTTP/FTP Settings menu 52

## I

- identifying jam locations 86
- imaging unit
  - ordering 69
  - replacing 73
- importing a configuration file
  - using the Embedded Web Server 136
- indicator light
  - understanding the status 13
- installing a memory card 130
- installing an optional card 132
- installing the printer software 135
- internal options
  - firmware cards 129
  - flash memory 129
  - font cards 129
  - installing 132
  - internal solutions port 129
  - memory card 130
- internal options, adding
  - print driver 135
- IPSec menu 51

## J

- jams
  - avoiding 85
- jams, clearing
  - in the duplex unit 92
  - in the multipurpose feeder 93
  - in the standard bin 91
  - trays 93

## L

- Lexmark Mobile Print
  - using 21
- linking trays 17

- loading
  - multipurpose feeder 16
- loading envelopes
  - in the multipurpose feeder 16
- loading trays 14
- locating paper jams 86
- locating the security slot 63

## M

- maintenance kit
  - ordering 69
- Media Types menu 43
- memory card
  - installing 130
- menu
  - 802.1x 50
  - Confidential Print Setup 58
  - Config Menu 30
  - Device 60
  - Ethernet 46
  - Flash Drive Print 55
  - Google Cloud Print 54
  - Help 61
  - HTML 40
  - HTTP/FTP Settings 52
  - Image 40
  - Information Sent to Lexmark 30
  - IPSec 51
  - Job Accounting 36
  - Layout 33
  - Login Restrictions 58
  - LPD Configuration 52
  - Media Types 43
  - Menu Settings Page 60
  - Miscellaneous 60
  - Mobile Services
    - Management 60
  - Network 61
  - Network Overview 43
  - Notifications 27
  - Out of Service Erase 32
  - PCL 38
  - PDF 37
  - PostScript 37
  - Power Management 28
  - Preferences 26
  - Print 61
  - Quality 35
  - Remote Operator Panel 27
  - Restore Factory Defaults 29
  - Security Audit Log 57
  - Setup 34

- SNMP 49
- Solutions LDAP Settings 59
- TCP/IP 48
- ThinPrint 53
- Tray Configuration 41
- Troubleshooting 62
- Universal Setup 42
- USB 54
- Visible Home Screen Icons 32
- Wi-Fi Direct 55
- XPS 37

- menu map 25
- Menu Settings Page
  - printing 62
- menus
  - About this Printer 33
  - Wireless 44
- Miscellaneous 60
- mobile device
  - printing from 21, 22
- Mopria Print Service
  - using 21
- mottled print 111
- moving the printer 9, 81
- multipurpose feeder
  - loading 16

## N

- noise emission levels 138
- Non-Lexmark supply 97
- non-volatile memory 64
  - erasing 63
- notices 138, 139, 140, 141, 142, 143, 144, 145

## O

- operating systems
  - supported 134
- optional card
  - installing 132
- ordering
  - imaging unit 69
  - toner cartridge 67
- ordering supplies
  - maintenance kit 69
- Out of Service Erase menu 32

## P

- paper jam in door A 87
- paper jam in the duplex unit 92

- paper jam in the multipurpose feeder 93
- paper jam in the rear door 90
- paper jam in trays 93
- paper jam, clearing
  - in the duplex unit 92
  - in the multipurpose feeder 93
  - in the rear door 90
  - trays 93
- paper jams
  - avoiding 85
- paper jams, clearing
  - in the standard bin 91
- parallel port 11
- personal identification number method 65
- pick roller assembly
  - replacing 77
- pick tires
  - replacing 75
- power button light
  - understanding the status 13
- power cord socket 11
- power save modes
  - configuring 82
- Preferences menu 26
- print driver
  - hardware options, adding 135
- print jobs not printed 125
- Print Quality Test Pages 62
- print quality troubleshooting
  - blank or white pages 101
  - crooked or skewed print 114
  - dark print 102
  - fine lines are not printed
    - correctly 104
  - folded or wrinkled paper 105
  - gray background on prints 106
  - horizontal light bands 108
  - light print 109
  - mottled print and dots 111
  - paper curl 112
  - repeating defects 114
  - solid black pages 115
  - text or images cut off 117
  - toner easily rubs off 118
  - vertical dark bands 119
  - vertical dark lines or streaks 121
  - vertical dark streaks with print
    - missing 122
  - vertical light bands 123
  - vertical white lines 123

- print troubleshooting
  - collated printing does not work 99
  - envelope seals when printing 98
  - incorrect margins 108
  - jammed pages are not reprinted 101
  - job prints from the wrong tray 127
  - job prints on the wrong paper 127
  - paper frequently jams 100
  - print jobs do not print 125
  - slow printing 124
  - tray linking does not work 99
  - unable to read flash drive 96
- printer
  - minimum clearances 9
  - selecting a location 9
  - shipping 82
- printer configurations 11
- printer hard disk memory 64
- printer information
  - finding 8
- printer is not responding 126
- printer menus 25, 33
- printer messages
  - Non-Lexmark supply 97
  - Replace cartridge, printer region mismatch 97
- printer parts
  - checking the status 67
- printer ports 11
- printer settings
  - restoring to factory defaults 64
- printer software, installing 135
- printer status 13
- printing
  - directory list 24
  - font sample list 24
  - from a computer 21
  - from a flash drive 22
  - from a mobile device 22
  - Menu Settings Page 62
  - printing a directory list 24
  - printing a font sample list 24
  - printing a network setup page 97
  - printing from a computer 21
  - printing from a flash drive 22
  - Push Button method 65
- R**
  - recycling
    - Lexmark packaging 83
    - Lexmark products 83
    - toner cartridges 84
  - removing paper jam
    - in door A 87
  - Replace cartridge, printer region mismatch 97
  - replacing supplies
    - imaging unit 73
    - toner cartridge 71
  - replacing the pick roller assembly 77
  - replacing the pick tires 75
  - reprinting jammed pages 101
  - resetting
    - supply usage counters 97
  - resetting the supply usage counters 97
  - Restore Factory Defaults menu 29
  - restoring factory default settings 64
  - restoring printer settings to factory defaults 64
- S**
  - safety information 5, 6, 7
  - securing printer memory 64
  - security slot
    - locating 63
  - selecting a location for the printer 9
  - setting the card stock size 14
  - setting the envelope size 14
  - setting the label size 14
  - shipping the printer 82
  - skewed print 114
  - Sleep mode
    - configuring 82
  - specialty media
    - setting the paper size 14
    - setting the paper type 14
  - statement of volatility 64
  - supplies
    - checking the status 67
    - conserving 83
  - supplies, ordering
    - toner cartridge 67
  - supply notifications
    - configuring 70
  - supply usage counters
    - resetting 97
  - supported file types 23
  - supported flash drives 23
  - supported operating systems 134
  - supported paper sizes 18
  - supported paper types 19
  - supported paper weights 20
- T**
  - toner cartridge
    - ordering 67
    - replacing 71
  - toner cartridges
    - recycling 84
  - toner darkness
    - adjusting 127
  - trays
    - installing 133
    - loading 14
  - troubleshooting
    - cannot open Embedded Web Server 95
    - printer is not responding 126
  - troubleshooting, print
    - collated printing does not work 99
    - envelope seals when printing 98
    - incorrect margins 108
    - jammed pages are not reprinted 101
    - job prints from the wrong tray 127
    - job prints on the wrong paper 127
    - paper frequently jams 100
    - print jobs do not print 125
    - slow printing 124
    - tray linking does not work 99
  - troubleshooting, print quality
    - blank or white pages 101
    - crooked or skewed print 114
    - dark print 102
    - fine lines are not printed correctly 104
    - folded or wrinkled paper 105
    - gray background on prints 106
    - horizontal light bands 108

- light print 109
- mottled print and dots 111
- paper curl 112
- repeating defects 114
- solid black pages 115
- text or images cut off 117
- toner easily rubs off 118
- vertical dark bands 119
- vertical dark lines or streaks 121
- vertical dark streaks with print
  - missing 122
- vertical light bands 123
- vertical white lines 123

## U

- unable to read flash drive
  - troubleshooting, print 96
- Universal paper settings
  - configuring 14
- unlinking trays 17
- updating firmware
  - flash file 136
- USB port
  - enabling 96
- USB printer port 11
- using
  - genuine Lexmark parts 67
  - genuine Lexmark supplies 67

## V

- vertical dark lines on prints 121
- vertical streaks on prints 121
- volatile memory 64
  - erasing 63

## W

- white lines 123
- white pages 101
- Wireless menu 44
- wireless network
  - connecting the printer to 65
  - Wi-Fi Protected Setup 65
- wireless networking 65
- Wi-Fi network
  - deactivating 66
- Wi-Fi Protected Setup
  - wireless network 65
- wrinkled paper 105