

# Veritas NetBackup™ 5240 Appliance Product Description

# Veritas NetBackup™ 5240 Appliance Product Description

Last updated: 2018-08-02

## Legal Notice

Copyright © 2018 Veritas Technologies LLC. All rights reserved.

Veritas, the Veritas Logo, and NetBackup are trademarks or registered trademarks of Veritas Technologies LLC or its affiliates in the U.S. and other countries. Other names may be trademarks of their respective owners.

This product may contain third-party software for which Veritas is required to provide attribution to the third party ("Third-party Programs"). Some of the Third-party Programs are available under open source or free software licenses. The License Agreement accompanying the Software does not alter any rights or obligations you may have under those open source or free software licenses. Refer to the Third-party Legal Notices document accompanying this Veritas product or available at:

<https://www.veritas.com/about/legal/license-agreements>

The product described in this document is distributed under licenses restricting its use, copying, distribution, and decompilation/reverse engineering. No part of this document may be reproduced in any form by any means without prior written authorization of Veritas Technologies LLC and its licensors, if any.

THE DOCUMENTATION IS PROVIDED "AS IS" AND ALL EXPRESS OR IMPLIED CONDITIONS, REPRESENTATIONS AND WARRANTIES, INCLUDING ANY IMPLIED WARRANTY OF MERCHANTABILITY, FITNESS FOR A PARTICULAR PURPOSE OR NON-INFRINGEMENT, ARE DISCLAIMED, EXCEPT TO THE EXTENT THAT SUCH DISCLAIMERS ARE HELD TO BE LEGALLY INVALID. VERITAS TECHNOLOGIES LLC SHALL NOT BE LIABLE FOR INCIDENTAL OR CONSEQUENTIAL DAMAGES IN CONNECTION WITH THE FURNISHING, PERFORMANCE, OR USE OF THIS DOCUMENTATION. THE INFORMATION CONTAINED IN THIS DOCUMENTATION IS SUBJECT TO CHANGE WITHOUT NOTICE.

The Licensed Software and Documentation are deemed to be commercial computer software as defined in FAR 12.212 and subject to restricted rights as defined in FAR Section 52.227-19 "Commercial Computer Software - Restricted Rights" and DFARS 227.7202, et seq. "Commercial Computer Software and Commercial Computer Software Documentation," as applicable, and any successor regulations, whether delivered by Veritas as on premises or hosted services. Any use, modification, reproduction release, performance, display or disclosure of the Licensed Software and Documentation by the U.S. Government shall be solely in accordance with the terms of this Agreement.

Veritas Technologies LLC  
500 E Middlefield Road  
Mountain View, CA 94043

<http://www.veritas.com>

## Technical Support

Technical Support maintains support centers globally. All support services will be delivered in accordance with your support agreement and the then-current enterprise technical support policies. For information about our support offerings and how to contact Technical Support, visit our website:

<https://www.veritas.com/support>

You can manage your Veritas account information at the following URL:

<https://my.veritas.com>

If you have questions regarding an existing support agreement, please email the support agreement administration team for your region as follows:

Worldwide (except Japan)

[CustomerCare@veritas.com](mailto:CustomerCare@veritas.com)

Japan

[CustomerCare\\_Japan@veritas.com](mailto:CustomerCare_Japan@veritas.com)

## Documentation

The latest documentation is available on the Veritas website:

<https://sort.veritas.com/documents>

## Documentation feedback

Your feedback is important to us. Suggest improvements or report errors or omissions to the documentation. Include the document title, document version, chapter title, and section title of the text on which you are reporting. Send feedback to:

[APPL.docs@veritas.com](mailto:APPL.docs@veritas.com)

You can also see documentation information or ask a question on the Veritas community site:

<http://www.veritas.com/community/>

## Veritas Services and Operations Readiness Tools (SORT)

Veritas Services and Operations Readiness Tools (SORT) is a website that provides information and tools to automate and simplify certain time-consuming administrative tasks. Depending on the product, SORT helps you prepare for installations and upgrades, identify risks in your datacenters, and improve operational efficiency. To see what services and tools SORT provides for your product, see the data sheet:

[https://sort.veritas.com/data/support/SORT\\_Data\\_Sheet.pdf](https://sort.veritas.com/data/support/SORT_Data_Sheet.pdf)

# Contents

<b>Chapter 1</b>	<b>About the NetBackup 5240 Appliance</b> .....	<b>6</b>
	NetBackup 5240 Appliance overview .....	7
	About the NetBackup 5240 CloudCatalyst Appliance .....	8
	Features and components of the NetBackup 5240 Appliance .....	8
	NetBackup 5240 Appliance front panel disk drive configurations .....	10
	NetBackup 5240 Appliance disk drive LEDs .....	11
	NetBackup 5240 Appliance front panel USB port .....	12
	NetBackup 5240 Appliance control panel .....	13
	System Status LED states .....	14
	Power button LED states .....	17
	NetBackup 5240 Appliance rear panel .....	18
	NetBackup 5240 Appliance I/O configuration options .....	21
	NetBackup 5240 Appliance Network Interface Port locations and speeds .....	35
<b>Chapter 2</b>	<b>About the Veritas 2U12 49TB Storage Shelf</b> .....	<b>37</b>
	Veritas 2U12 49TB Storage Shelf overview .....	37
	Usable appliance storage capacities .....	38
	Veritas 2U12 49TB Storage Shelf front panel components .....	39
	Veritas 2U12 49TB Storage Shelf control panel .....	40
	Veritas 2U12 49TB Storage Shelf rear components .....	43
	Veritas 2U12 49TB Storage Shelf I/O modules .....	44
	Veritas 2U12 49TB Storage Shelf Power Cooling Modules .....	48
	NetBackup 5240 Appliance and Veritas 2U12 49TB Storage Shelf connections .....	51
<b>Chapter 3</b>	<b>NetBackup 5240 Appliance and Veritas 2U12 49TB Storage Shelf cables</b> .....	<b>52</b>
	Power cables .....	52
	Network cable .....	53
	Multi-Mode fiber optic cable .....	54
	Twinaxial copper cables .....	55
	SAS-3 cable .....	56

Appendix A	<b>Technical specifications and compliance standards</b> .....	58
	NetBackup 5240 Appliance and Veritas 2U12 49TB Storage Shelf	
	technical specifications .....	58
	Environmental specifications .....	63
	Protocol standards .....	64
	Regulatory, compliance, and certification information .....	65
	Product regulatory compliance .....	65
	Product safety compliance .....	66
	Product EMC Compliance - Class A Compliance .....	66
	Product ecology compliance .....	67
	Certifications / Registrations / Declarations .....	67
	Electromagnetic compatibility notices .....	68
Index .....		70

# About the NetBackup 5240 Appliance

This chapter includes the following topics:

- [NetBackup 5240 Appliance overview](#)
- [About the NetBackup 5240 CloudCatalyst Appliance](#)
- [Features and components of the NetBackup 5240 Appliance](#)
- [NetBackup 5240 Appliance front panel disk drive configurations](#)
- [NetBackup 5240 Appliance front panel USB port](#)
- [NetBackup 5240 Appliance control panel](#)
- [NetBackup 5240 Appliance rear panel](#)

## NetBackup 5240 Appliance overview

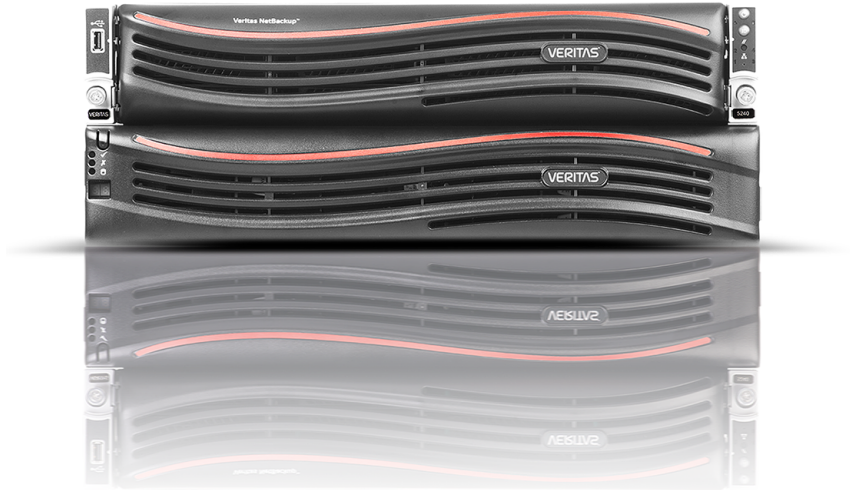

The NetBackup 5240 Appliance is a hardware and software storage system that can scale to 300TB of available backup capacity. It consists of a NetBackup 5240 Appliance and up to six optional Veritas 2U12 49TB Storage Shelves. By itself, the 2U NetBackup 5240 Appliance offers internal storage from 4TB to 27TB, depending on the appliance configuration purchased.

A Veritas 2U12 49TB Storage Shelf offers 49TBs of storage. Attaching six storage shelves offers 300TBs of storage. As with previous generations of the NetBackup 52xx appliances, the NetBackup 5240 Appliance can be configured as a Master Server or a Media Server. It can also be configured as both.

See [“Usable appliance storage capacities”](#) on page 38.

SAS-3 cables connect the NetBackup 5240 Appliance to the storage shelves. SAS-3 cables also connect the storage shelves to each other.

### **About NetBackup 5240 Appliance configurations**

To determine the right NetBackup 5240 Appliance system for your environment, you should consider the environment’s future storage requirements over the lifetime of the system.

Veritas offers four NetBackup 5240 Appliance configurations from which to choose. One of these configurations offers the ability to add additional storage capacity to the system by attaching up to six Veritas 2U12 49TB Storage Shelves.

These configurations include the following:

- One NetBackup 5240 Appliance with 4TBs of internal storage only
- One NetBackup 5240 Appliance with 14TBs of internal storage only
- One NetBackup 5240 Appliance with 27TBs of internal storage only
- One NetBackup 5240 Appliance with 4TBs of internal storage and up to six external 49TB storage shelves for a total of 300TBs of storage

If your environment requires at least 4TBs of storage but less than 27TBs of storage, you should consider the 14TB and 27TB configurations.

If your environment requires more than 27TBs of storage, consider the NetBackup 5240 Appliance with 4TBs of internal storage and one 49TB Veritas 2U12 49TB Storage Shelf. If more storage is required, you can add up to five additional 49TB storage shelves to this configuration.

## About the NetBackup 5240 CloudCatalyst Appliance

The NetBackup 5240 CloudCatalyst Appliance is a customized configuration of the NetBackup 5240 that specifically supports NetBackup CloudCatalyst deduplication. The NetBackup 5240 CloudCatalyst Appliance is a standard model with I/O configuration option 'G' that contains 14 TB of internal storage and 192 GB of memory.

See [“NetBackup 5240 Appliance I/O configuration options”](#) on page 21.

NetBackup CloudCatalyst uses MSDP deduplication technology to upload deduplicated data to the cloud. The data is uploaded by the CloudCatalyst-enabled MSDP cloud storage server, which first stores data in a local cache before uploading it to cloud storage. When configured for CloudCatalyst, all of the appliance's available internal storage is allocated as MSDP cache space. A single NetBackup 5240 CloudCatalyst Appliance supports a cloud storage bucket of up to 1 Petabyte in size.

---

**Note:** When configured for CloudCatalyst, the NetBackup 5240 does not support attached storage shelves. Only the internal storage is used.

---

## Features and components of the NetBackup 5240 Appliance

This section describes the features and components of the NetBackup 5240 Appliance.



Not all of the information in this section applies to the NetBackup 5240 CloudCatalyst Appliance. For more information:

See “About the NetBackup 5240 CloudCatalyst Appliance” on page 8.

**Table 1-1** NetBackup 5240 Appliance features

Feature	Description
Processor	Two (2) Intel® Xenon® E5-2630 v3 2.40GHz processors.
Appliance software version	<p><b>Note:</b> For the latest NetBackup Appliance compatibility information, refer to the NetBackup Hardware Compatibility List posted on the following site:</p> <p><a href="http://www.veritas.com/docs/000033647">http://www.veritas.com/docs/000033647</a></p>
Performance and capacity	<ul style="list-style-type: none"> <li>■ Supports high-performance processors with low-power consumption.</li> <li>■ Provides high-capacity intra-appliance switching bandwidth, along with high I/O throughput.</li> <li>■ Available internal storage capacities of 4TBs, 14TBs, or 27 TBs without optional external storage shelves. The available capacity can be allocated either in part or in whole to a deduplication pool or to an AdvancedDisk pool (non-deduplicated storage).</li> </ul>
System memory configuration (DDR4, RDIMM)	<p>64GB, up to a maximum of 192GBs</p> <p><b>Note:</b> When you purchase the first expansion storage shelf, the Storage Expansion kit that comes with the storage shelf includes an additional 64 GBs of memory.</p> <p>After adding the first storage shelf and the memory, you can increase the appliance memory to 192 GBs by purchasing an additional 64-GB memory kit.</p>
Space reduction	The deduplication engine provides up to 100 times reduction in storage. The client-side plug-in provides similar levels of bandwidth reduction.
Scalable architecture	Due to fingerprinting and RAID redundancy, the overall storage capabilities are not a simple multiplication of the disk size and the total number of disks.
High availability	Supports the redundant hot-swappable disks and power modules.

**Table 1-1** NetBackup 5240 Appliance features (*continued*)

Feature	Description
RAID levels	<p>RAID 1 (standard mirroring) and RAID 6 (block level striping with double distributed parity) are implemented as follows:</p> <ul style="list-style-type: none"> <li>■ Appliance system disks: RAID 1</li> <li>■ Appliance storage disks: RAID 6</li> <li>■ Storage shelf data storage disks: RAID 6</li> </ul> <p><b>Note:</b> The disk drives in the appliance are pre-formatted before the appliance is shipped. These drives should not be moved into different slots or otherwise rearranged.</p>
Fibre Channel support	<p>The NetBackup 5240 Appliance can be ordered with one to five PCIe 8 Gb Fibre Channel host bus adapter cards preinstalled. PCIe 10 Gb Ethernet cards with Fibre Channel ports are also available.</p> <p>See <a href="#">“NetBackup 5240 Appliance I/O configuration options”</a> on page 21.</p>
Rear panel ports	<p>See <a href="#">“NetBackup 5240 Appliance rear panel”</a> on page 18.</p>
Additional storage	<p>Yes</p> <p>You can attach up to six optional storage shelves to the NetBackup 5240 Appliance. Depending on the appliance configuration you purchase, a total of 321 TBs of usable storage capacity is available.</p> <p>See <a href="#">“Usable appliance storage capacities”</a> on page 38.</p>

## NetBackup 5240 Appliance front panel disk drive configurations

The NetBackup 5240 Appliance contains 12 SAS hard disk drives, which can be accessed from the appliance's front panel. An embedded RAID controller on the appliance's mainboard is used to configure four of the 12 disks into two RAID1 mirrored volumes. These volumes are labeled Volume0 and Volume1. The disk drives that are located in slot 0 and slot 1 are configured as the RAID1, VOLUME0 device. These disk drives contain the appliance operating system and the NetBackup application. You can hot-swap one of these disk drives at a time; however, you cannot operate the appliance if both disk drives are removed. The disk drives in slot 2 and slot 3 are configured as the RAID1, VOLUME1 device. These disk drives store all of the log files.

The disk drives in slots 4 through 10 store user data. They are configured as a RAID 6 array, which uses block-level striping with two parity blocks across each of the disk drives in the volume.

The appliance uses the disk drive that is located in slot 11 as a hot-spare disk. If one of the disk drives fails in slots 4 through 10, the appliance automatically initiates a RAID 6 rebuild operation. It rebuilds the RAID 6 array by using the hot-spare disk drive in slot 11. After you replace the failed disk drive, the appliance then copies the information from the disk drive in slot 11 to the new replacement disk. When the copy operation finishes, the disk drive in slot 11 again becomes the hot-spare disk.

---

**Warning:** The disk drives are pre-formatted before the appliance is shipped. Do not rearrange the disks from their original locations.

---

**Figure 1-1** NetBackup 5240 Appliance front panel disk slot assignments



**Table 1-2** NetBackup 5240 Appliance front panel disk drive configurations

Slot	RAID Configuration	Disk drive size				Disk drive role
0, 1	RAID 1	1TB				Boot / swap
2, 3	RAID 1	1TB				Log files
4 - 10	RAID 6	Disk drive size	1TB	3TB	6TB	User data
		Available internal storage space	4TB	14TB	27TB	
11	RAID 6					Hot spare

## NetBackup 5240 Appliance disk drive LEDs

Each disk drive module contains two LEDs on the left-hand side of each module. The LEDs appear as follows:

**Figure 1-2** NetBackup 5240 Appliance disk drive module LEDs



**Table 1-3** NetBackup 5240 Appliance disk drive LEDs

Number	Description	Color	Indication
1	Status LED	Not lit	No faults
		Solid amber	Disk fault
		Blinking amber	RAID rebuild is in progress
2	Activity LED	Not lit	This disk has spun down.
		Solid green	There is no disk activity.
		Blinking green	The disk spins up.
		Blinking green occasionally	Commands are processed.

Note that the disk drive modules that do not contain disk drives also have LEDs. Although there is no drive activity going on, some colored lights may still be seen through the disk modules.

## NetBackup 5240 Appliance front panel USB port

The NetBackup 5240 Appliance front panel includes a USB 2.0-compliant port that supports a data transfer rate of up to 480 Mb/second.

**Figure 1-3** NetBackup 5240 Appliance front USB port



# NetBackup 5240 Appliance control panel

The front panel of the NetBackup 5240 Appliance includes a small panel that is attached to the right side of the device. System information is shown on this panel.

**Figure 1-4** NetBackup 5240 Appliance control panel

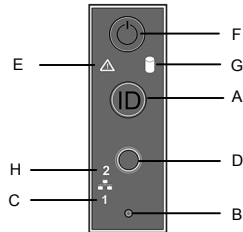

**Table 1-4** NetBackup 5240 Appliance control panel LED descriptions

Label	Component	Description
A	System ID button with integrated LED	<p>The System ID button toggles the integrated ID LED and the blue server board LED on and off.</p> <p>The system ID LED identifies the system for maintenance when the it is racked with similar server systems.</p> <p>See <a href="#">“System Status LED states”</a> on page 14.</p>
B	NMI button (recessed, tool required for use)	<p>When it is depressed, the NMI button puts the appliance in a halt state, issues a non-maskable interrupt (NMI), and then triggers the non-maskable interrupt. All server data can be lost.</p> <p>Veritas recommends that you do not enable NMI by pressing the NMI button.</p>
C H	NIC-5 Activity LED NIC-6 Activity LED	<p>The front control panel includes two activity LED indicators for each on-board network interface controller (NIC). NIC-5 represents network interface controller 5, while NIC-6 represents network interface controller 6.</p> <p>When network links are detected on the controllers, the LEDs are activated and remain on. The LEDs blink when network activity occurs, and the rate at which they blink is determined by the amount of network activity that occurs.</p>

**Table 1-4** NetBackup 5240 Appliance control panel LED descriptions  
*(continued)*

Label	Component	Description
D	System Cold Reset Button (recessed, tool required for use on non-storage models)	When depressed, the System Cold Reset button re-boots and re-initializes the appliance.
E	System Status LED	The System Status LED is bi-color indicator that uses the colors green and amber to display the current health of the appliance.  Two locations are provided for you to monitor the health of the system. You can find the first location on the front control panel, while the second location is located on the back edge of the server board. It is viewable from the rear of the appliance. Both LEDs show the same state of health.  See <a href="#">"System Status LED states"</a> on page 14.
F	Power/Sleep button with integrated LED	The Power/Sleep button toggles the system on and off.  See <a href="#">"Power button LED states"</a> on page 17.
G	Hard Drive Activity LED	The drive activity LED on the front panel indicates drive activity from the on-board hard disk controllers.

## System Status LED states

The System Status LED is a bi-color (Green/Amber) indicator that shows the current health of the system. The appliance provides two locations for this feature. The first location is on the Front Control Panel, while the second location is on the back edge of the server board.

**Figure 1-5** System Status LED control panel location

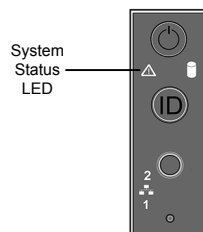

The following table provides a description of each LED state.

**Table 1-5** System Status LED states

Color	State	Criticality	Description
No color	Off - The system is not operating	Not ready	<ul style="list-style-type: none"> <li>■ System is power off (AC and/or DC)</li> <li>■ System is in EuP Lot6 Off Mode</li> <li>■ System is in S5 Soft-Off State</li> <li>■ System is in S4 Hibernate Sleep State</li> </ul>
Green	Solid on (S0)	Healthy	Indicates that the system is running (in S0 State) and its status is "Healthy". The system is not exhibiting any errors. AC power is present and BMC has booted and manageability functionality is up and running.
Green	~1 Hz blink	<p>Degraded</p> <p>The system is operating in a degraded state although still functional.</p> <p>or</p> <p>The system is operating in a redundant state but with an impending failure warning.</p>	<p>System degraded:</p> <ul style="list-style-type: none"> <li>■ Redundant loss, such as power supply or fan. Applies only if the associated platform sub-system has redundancy capabilities.</li> <li>■ Fan warning or failure when the number of fully operational fans is more than minimum number needed to cool the system.</li> <li>■ Non-critical threshold crossed: Temperature (including HSBP temp), voltage, input power to power supply, output current for main power rail from power supply and Processor Thermal Control (Therm Ctrl) sensors.</li> <li>■ Power supply predictive failure occurred while redundant power supply configuration was present.</li> <li>■ Unable to use all of the installed memory (one or more DIMMs failed/disabled but functional memory remains available).</li> <li>■ Battery failure.</li> <li>■ BMC executing in uBoot. (Indicated by Chassis ID blinking at 3Hz). System in degraded state (no manageability). BMC uBoot is running but has not transferred control to the BMC Linux. Server will be in this state 6-8 seconds after BMC reset while it pulls the Linux image into flash.</li> </ul>

**Table 1-5** System Status LED states (*continued*)

Color	State	Criticality	Description
Green	~1 Hz blink	Degraded (continued)	<p>System degraded (continued):</p> <ul style="list-style-type: none"> <li>■ BMC booting Linux. (Indicated by Chassis ID solid ON). System in degraded state (no manageability). Control has been passed from BMC uBoot to BMC Linux itself. It will be in this state for 10-20 seconds.</li> <li>■ BMC Watchdog has reset the BMC.</li> <li>■ Power unit sensor offset for configuration error is asserted.</li> <li>■ Hard disk drive HSC is off-line or degraded.</li> </ul>
Amber	~1 Hz blink	<p>Non-critical</p> <p>The system is operating in a degraded state with an impending failure warning. However, the system is still functioning.</p>	<p>Non-fatal - However, the system is likely to fail:</p> <ul style="list-style-type: none"> <li>■ Critical threshold crossed – Voltage, temperature (including HSBP temp), input power to power supply, output current for main power rail from power supply and PROCHOT (Therm Ctrl) sensors.</li> <li>■ VRD Hot asserted</li> <li>■ Minimum number of fans to cool the system not present or failed</li> <li>■ Hard drive fault</li> <li>■ Power Unit Redundancy sensor – Insufficient resources offset (indicates not enough power supplies present)</li> <li>■ Correctable memory error threshold has been reached for a failing DIMM when the system is operating in a non-redundant mode.</li> </ul>
Amber	Solid on	<p>Critical, non-recoverable – System is halted</p>	<p>Fatal alarm – system has failed or shutdown:</p> <ul style="list-style-type: none"> <li>■ CPU CATERR signal asserted</li> <li>■ MSID mismatch detected (CATERR also asserts for this case)</li> <li>■ CPU1 is missing</li> <li>■ CPU Thermal Trip</li> <li>■ No power – power fault</li> <li>■ DIMM failure when there is only one DIMM present; no other good DIMM memory present</li> </ul>



**Table 1-5** System Status LED states (*continued*)

Color	State	Criticality	Description
Amber	Solid on	Critical, non-recoverable – System is halted	<ul style="list-style-type: none"> <li>■ Uncorrectable Runtime memory error in non-redundant mode</li> <li>■ DIMM Thermal Trip or equivalent</li> <li>■ CPU ERR2 signal is asserted</li> <li>■ BMC/Video memory test failed (Chassis ID shows blue/solid-on for this condition)</li> <li>■ Both uBoot BMC FW images are bad (Chassis ID shows blue/solid-on for this condition)</li> <li>■ Fatal Error in processor initialization:                             <ul style="list-style-type: none"> <li>■ Processor family not identical</li> <li>■ Processor model not identical</li> <li>■ Processor core/thread counts not identical</li> <li>■ Processor cache size not identical</li> <li>■ Unable to synchronize processor frequency</li> </ul> </li> <li>■ Unable to synchronize QPI link frequency</li> </ul>

## Power button LED states

The Power button is located on the NetBackup 5240 Appliance control panel. It is used to turn the appliance on or off.

**Figure 1-6** Power button control panel location

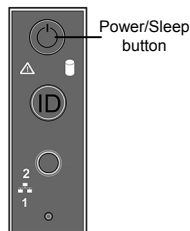

The following table provides a description of each power state.

**Table 1-6** Power button LED states

State	Power Mode	LED	Description
Power - off	Non-ACPI	Off	The system power is off, and the BIOS has not initialized the chipset.
Power - on	Non-ACPI	On	The system power is on and the green Power button LED is active.
S0	ACPI (Advanced Configuration and Power Interface)	Steady on	The system and the operating system are up and running.

## NetBackup 5240 Appliance rear panel

The rear panel of the appliance has several access ports and other features, which are displayed in the following figures.

**Figure 1-7** NetBackup 5240 Appliance rear panel overview

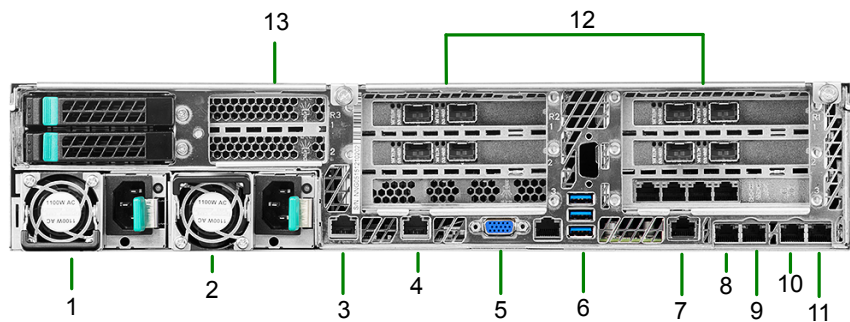

**Table 1-7** NetBackup 5240 Appliance rear panel features and connectors

Number	Function
1,2	Power Supply 1 and Power Supply 2 - Dual, redundant, and hot-swappable power supply modules
3	eth4/NIC 5 A 1-GbE/10-GbE copper connectors for general use
4	eth5/NIC 6 A 1-GbE/10-GbE copper connectors for general use

**Table 1-7** NetBackup 5240 Appliance rear panel features and connectors  
*(continued)*

Number	Function
5	DB-15 VGA monitor connector
6	Three stacked USB 2.0/3.0 Type A serial ports for general use
7	IPMI port - An external RJ45 port used for appliance remote management purposes
8	<p>eth0/NIC 1</p> <p>A 1-GbE port copper connector that is reserved for use during the initial configuration of the appliance. After completing the initial configuration, you can connect NIC1 (eth0) to an administrative network that does not provide any backup data transfer</p> <p>For more information, see the <i>Veritas NetBackup™ 52xx Appliance Initial Configuration Guide - Release 3.1.1</i>.</p> <p><b>Note:</b> Veritas does not support forming a NIC bond using eth0/NIC1 with other eth/NIC ports.</p>
9	<p>eth1/NIC 2</p> <p>A 1-GbE port copper connector for general use</p>
10	<p>eth2/NIC 3</p> <p>A 1-GbE port copper connector for general use</p>
11	<p>eth3/NIC 4</p> <p>A 1-GbE port copper connector for general use</p>

**Table 1-7** NetBackup 5240 Appliance rear panel features and connectors  
*(continued)*

Number	Function
12, 13	<p>The NetBackup 5240 Appliance add-in cards are available in multiple configurations. Several configurations include at least one Fibre Channel host bus adapter card for VMware, optimized deduplication over Fibre Channel, or tape library connectivity.</p> <p>In some configurations the Fibre Channel host bus adapter cards are installed into some of the PCIe slots. If the cards are installed in slots 5 and 6, the configuration supports Fibre Transport Media Server (FTMS) mode. Port 1 of each card is configured by default as Target, while port 2 is configured by default as Initiator. If you want, you can configure port 2 on both cards as Target, and you can configure port 1 on both cards as Initiator.</p> <p><b>Note:</b> Only configurations D and E support FTMS.</p> <p>See <a href="#">"NetBackup 5240 Appliance I/O configuration options"</a> on page 21.</p> <p><b>Note:</b> You cannot bond copper 1 Gb/10 Gb Ethernet ports that are installed in the appliance chassis with PCIe-based 10 Gb Ethernet Fibre Channel ports.</p>

NetBackup 5240 Appliances may include grounding studs in case your lab environment has such a requirement. The studs are located on the rear panel of the appliance. You can use standard grounding practices to connect grounding wires to the studs.

The serial number is located on a vertical bar on the rear panel of the appliance.

**Figure 1-8** Serial number location

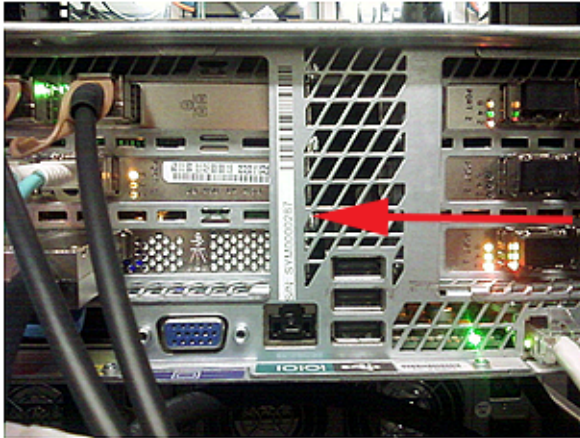

The ports on the rear panel are color-coded for easy identification.

**Figure 1-9** NetBackup 5240 Appliance rear port color codes



## NetBackup 5240 Appliance I/O configuration options

The rear panel of the NetBackup 5240 Appliance contains three PCIe riser card assemblies. PCIe riser card assemblies 1 and 2 each support three standard PCIe cards, while PCIe riser card assembly 3 supports two low profile PCIe cards. The slots are labeled 1 to 8. Slots 1, 2, and 3 are located in PCIe riser card assembly 2. Slots 4, 5, and 6 are located in PCIe riser card assembly 1, while slots 7 and 8 are located in PCIe riser card assembly 3.

**Figure 1-10** Rear panel riser assembly locations and PCIe slot assignments (example: Configuration F)

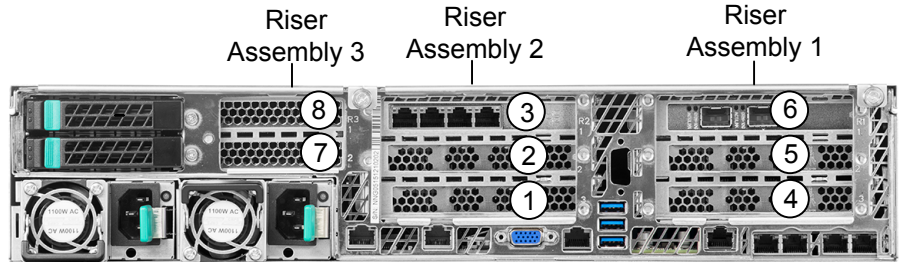

The NetBackup 5240 Appliance supports multiple PCIe-based I/O configuration options. The following table shows the different I/O configuration options that are available.

**Table 1-8** Available NetBackup 5240 Appliance PCIe-based I/O configuration options

I/O configuration option	Slot 1 *	Slot 2	Slot 3	Slot 4	Slot 5	Slot 6	Slot 7 **	Slot 8 ***
A	-	-	-	-	-	-	-	-
B	-	-	-	-	-	8Gb FC HBA <sub>3</sub>	-	-
C	-	-	10GbE NIC <sub>1,3</sub>	-	-	8Gb FC HBA <sub>3</sub>	-	-
D ****	-	8Gb FC HBA <sub>3</sub>	10GbE NIC <sub>1,3</sub>	8Gb FC HBA <sub>3</sub>	8Gb FC HBA <sub>3</sub>	8Gb FC HBA <sub>3</sub>	-	-
E ****	-	8Gb FC HBA <sub>3</sub>	8Gb FC HBA <sub>3</sub>	8Gb FC HBA <sub>3</sub>	8Gb FC HBA <sub>3</sub>	8Gb FC HBA <sub>3</sub>	-	-
F	-	-	1GbE NIC <sup>2</sup> (4 port - RJ45)	-	-	8Gb FC HBA <sub>3</sub>	-	-
G †	-	10GbE NIC <sub>1,3</sub>	10GbE NIC <sub>1,3</sub>	-	10GbE NIC <sub>1,3</sub>	8Gb FC HBA <sub>3</sub>	-	-

**Table 1-8** Available NetBackup 5240 Appliance PCIe-based I/O configuration options (*continued*)

I/O configuration option	Slot 1 *	Slot 2	Slot 3	Slot 4	Slot 5	Slot 6	Slot 7 **	Slot 8 ***
H ****	-	10GbE NIC <sup>1, 3</sup> , (iSCSI capable)	10GbE NIC <sup>1, 3</sup>	-	8Gb FC HBA <sup>3</sup>	8Gb FC HBA <sup>3</sup>	-	-
J	-	-	10GbE NIC <sup>1, 3</sup>	-	-	-	-	-
K ****	-	10GbE NIC <sup>1, 3</sup>	10GbE NIC <sup>1, 3</sup>	8Gb FC HBA <sup>3</sup>	8Gb FC HBA <sup>3</sup>	8Gb FC HBA <sup>3</sup>	-	-
L	-	10GbE NIC <sup>1, 3</sup>	1GbE NIC <sup>2</sup> (4 port - RJ45)	-	-	8Gb FC HBA <sup>3</sup>	-	-

† Includes the Veritas NetBackup™ 5240 CloudCatalyst Appliance

\* Slot 1 contains a factory installed PCIe RAID 6 controller when at least one Veritas 2U12 49TB Storage Shelf is purchased with the NetBackup 5240 Appliance. Otherwise, slot 1 is not populated and is reserved for future use.

\*\* Slot 7 contains the NetBackup 5240 Appliance's internal PCIe raid controller. This RAID controller is used to create the RAID 1 Array for the disk drives on which the appliance operating system is installed. The operating system disk drives are located in slots 0 and 1 of the front panel.

\*\*\* Slot 8 is reserved for the optional SAS tape-out adapter, which is used to connect external SAS devices to the NetBackup 5240 Appliance.

**PCIe card cable connection types:**

<sup>1</sup> Direct-Attach copper cable (also called a Twinaxial cable or Twinax)

<sup>2</sup> Standard copper cable

<sup>3</sup> Fiber optic cable

**Table 1-8** Available NetBackup 5240 Appliance PCIe-based I/O configuration options (*continued*)

I/O configuration option	Slot 1 *	Slot 2	Slot 3	Slot 4	Slot 5	Slot 6	Slot 7 **	Slot 8 ***
--------------------------	----------	--------	--------	--------	--------	--------	-----------	------------

\*\*\*\* I/O configuration option notes:

- A NetBackup 5240 Appliance using configuration H does not support Fibre Channel Replication (FCR) as a Target.
- A NetBackup 5240 Appliance using configurations D, E, H, K, P, R, V, and W can be configured as a dual port or as a quad port Fibre Transport Media Server (FTMS) server.

You can use the Initiator ports for tape-out operations and VMware Datastores in the following scenarios:

- If you do not configure the appliance as an FTMS server.
- If you configure the appliance as a dual port FTMS server.

You can also use the ports as a Fibre Channel Replication Initiator, or in combination with the previously mentioned uses.

## NetBackup 5240 Appliance total I/O on-board and PCIe ports

**Table 1-9** Total number of NetBackup 5240 Appliance on-board and PCIe I/O ports for each I/O configuration

I/O Configuration option	10Gb Ethernet PCIe ports (copper)	10Gb Ethernet PCIe ports (optical)	10Gb iSCSI PCIe ports (optical)	1Gb Ethernet ports (copper)	8Gb Fibre Channel PCIe ports (optical)
A	2	0	0	4 on-board	0
B	2	0	0	4 on-board	2
C	2	2	0	4 on-board	2
D	2	2	0	4 on-board	8
E	2	0	0	4 on-board	10
F	2	0	0	8 (4 on-board, 4 PCIe)	2
G	2	6	0	4 on-board	2
H	2	2	2	4 on-board	4



**Table 1-9** Total number of NetBackup 5240 Appliance on-board and PCIe I/O ports for each I/O configuration (*continued*)

I/O Configuration option	10Gb Ethernet PCIe ports (copper)	10Gb Ethernet PCIe ports (optical)	10Gb iSCSI PCIe ports (optical)	1Gb Ethernet ports (copper)	8Gb Fibre Channel PCIe ports (optical)
J	2	2	0	4 on-board	0
K	2	4	0	4 on-board	6
L	2	2	0	8 (4 on-board, 4 PCIe)	2

**Cable connection types:**

copper = Standard copper cable

optical = fiber optic cable

## Customizable I/O configurations by slot for existing NetBackup 5240 Appliance installations

You can modify and customize the I/O configurations for your particular environment in existing NetBackup 5240 Appliances.

The following table provides information on the make and model of each the PCIe cards that are available for use in each appliance I/O slot.

**Table 1-10** Acceptable PCIe-based I/O cards for each appliance I/O slot

Slot	Acceptable PCIe I/O card	Comment
1	INTEL RS3SC008 12Gb/s 8 port PCI-Express 3.0 X8 SAS RAID controller	External RAID controller to which you connect a Veritas 2U12 49TB Storage Shelf
2	Intel X710-DA2 dual-port 10Gb Ethernet card QLogic QLE8442 dual-port 10Gb Ethernet/iSCSI capable card with SFP+ modules QLogic QLE2562 dual-port 8Gb Fibre Channel host bus adapter with SFP+ modules Intel I350 Quad-port 1Gb Ethernet card with RJ45 connectors	

**Table 1-10** Acceptable PCIe-based I/O cards for each appliance I/O slot  
*(continued)*

Slot	Acceptable PCIe I/O card	Comment
3	Intel X710 10Gb Ethernet network interface card QLogic QLE8442 10Gb Ethernet network interface card QLogic QLE2562 dual-port 8Gb Fibre Channel host bus adapter with SFP+ modules Intel I350 Quad-port 1Gb Ethernet card with RJ45 connectors	
4	Intel X710 10Gb Ethernet network interface card QLogic QLE8442 10Gb Ethernet network interface card QLogic QLE2562 dual-port 8Gb Fibre Channel host bus adapter with SFP+ modules Intel I350 Quad-port 1Gb Ethernet card with RJ45 connectors	
5	Intel X710 10Gb Ethernet network interface card QLogic QLE8442 10Gb Ethernet network interface card QLogic QLE2562 dual-port 8Gb Fibre Channel host bus adapter with SFP+ modules Intel I350 Quad-port 1Gb Ethernet card with RJ45 connectors	
6	Intel X710 10Gb Ethernet network interface card QLogic QLE8442 10Gb Ethernet network interface card QLogic QLE2562 dual-port 8Gb Fibre Channel host bus adapter with SFP+ modules Intel I350 Quad-port 1Gb Ethernet card with RJ45 connectors	
7	Intel RS3UC080 12Gb/s PCI-Express 3.0 x8 Low Profile Ready SATA / SAS RAID Controller	Reserved for the Intel RS3UC080 internal RAID controller, which creates the RAID1 Array for the disks on which the appliance operating system is installed
8	SAS3 SFF-8644 TO SAS3 SFF-8644 SAS tape-out adapter assembly	Used to connect external SAS devices to the NetBackup 5240 Appliance

## Intel X710-DA2 dual-port 10Gb Ethernet card

The Intel X710-DA2 dual-port 10Gb Ethernet card is available with the appliance. The card can be installed in the PCI Riser Assembly in addition to Fibre Channel cards.

---

**Note:** SFP+ modules are not included and must be purchased separately.

---



**Table 1-11** Intel X710-DA2 dual-port 10Gb Ethernet card specifications

Item	Specification
Bracket height	Low profile
Power consumption	Typical: 7.4 watts at 0°C to 55°C (32°F to 131°F)
Operating temperature	0°C to 55°C
Storage temperature	-40°C to +70°C (-40°F to +158°F)
Storage humidity	10% RH to 90% RH (operating, non-condensing) and 5% RH to 93% RH (non-operating, non-condensing)
System Interface Type	PCIe v3.0

**Table 1-11** Intel X710-DA2 dual-port 10Gb Ethernet card specifications  
*(continued)*

Item	Specification
Speed and slot width	8.0 GT/s (gigatransfers per second), 8-Lane
Storage over Ethernet	iSCSI, Fibre Channel over Ethernet (FCoE), Network File System (NFS)
Data rate supported per port	Optical: 1GbE/10GbE Direct attach: 10GbE
LED indicators	LINK (solid) and ACTIVITY (blinking) LINK SPEED (green=10Gbps; yellow=1Gbps)
Certifications	FCC B, UL, CE, VCCI, BSMI, CTICK, KCC
Air Flow (minimum)	50 LFM (linear feet per minute)
Operating temperature	0 to 55 C (32 to 131 F)
Storage temperature	-40 to 70 C (-40 to 158 F)
Storage humidity	90% non-condensing relative at 35 C

To purchase an Intel X710-DA2 dual-port 10Gb Ethernet card and SFP+ modules for your appliance, contact your Veritas sales representative, or your Veritas Partner representative.

**Intel X710-DA2 dual-port 10Gb Ethernet card**

SKU Number	Description
18040	NETBACKUP APPLIANCE 5240 ETH NIC 10 GBIT DUAL PORT OPTICAL CONNECT X710-DA2 PCIE CRU (SFP not included)

**SFP+ Module**

SKU Number	Description
21265784	XX20/XX30/XX40 APPLIANCE 10GB SFP SHORT RANGE 300M OPTICAL MODULE

See [“NetBackup 5240 Appliance I/O configuration options”](#) on page 21.

## Dual-port 10 Gb Ethernet card with SFP+ transceiver ports

The 10Gb Ethernet card with SFP+ transceivers is available with the appliance. The card can be installed in the PCI Riser Assembly in addition to Fibre Channel cards.

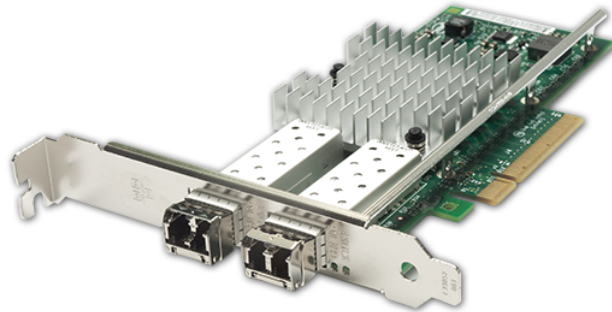

**Table 1-12** Dual-port 10Gb Ethernet card specifications

Item	Specification
Dimensions	2.54 in x 6.6 in (6.4516 cm to 16.764 cm) (low-profile)
Power consumption	Typical: 7.4 watts at 0°C to 55°C (32°F to 131°F)
Operating temperature	0°C to 55°C
Storage temperature	-40°C to +70°C (-40°F to +158°F)
Storage humidity	10% RH to 90% RH (operating, non-condensing) and 5% RH to 93% RH (non-operating, non-condensing)
System interface type	PCIe v3.0
Speed and slot width	8.0 GT/s (gigatransfers per second)
Storage over Ethernet	Fibre Channel over Ethernet (FCoE), Network File System (NFS)
Data rate supported per port	Optical: 1GbE/10GbE Direct attach: 10GbE

**Table 1-12** Dual-port 10Gb Ethernet card specifications (*continued*)

Item	Specification
LED indicators	LINK (solid) and ACTIVITY (blinking) LINK SPEED (green=10Gbps; yellow=1Gbps)
Certifications	FCC B, UL, CE, VCCI, BSMI, CTICK, KCC
Air flow (minimum)	50 LFM (linear feet per minute)
Operating temperature	0 to 55 C (32 to 131 F)
Storage temperature	-40 to 70 C (-40 to 158 F)
Storage humidity	90% non-condensing relative at 35 C

### **QLE8442 dual-port 10Gb Ethernet/iSCSI capable card with SFP+ modules**

The QLE8442 is a dual-port 10GbE network interface card. It supports simultaneous LAN (TCP/IP) and SAN (Fibre Channel over Ethernet [FCoE] and iSCSI) traffic at 10Gbps Ethernet (GbE) line rate speeds.

The card also provides very low host CPU usage by enabling full hardware offloads. It is available with configuration H of the NetBackup 5240 Appliance.

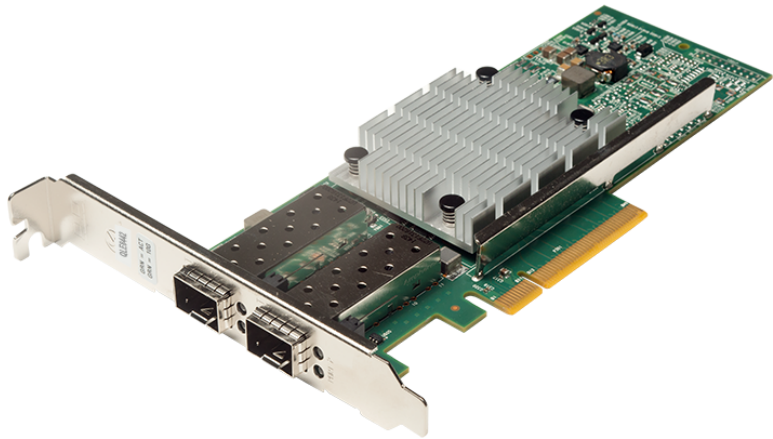

**Table 1-13** QLE8442 dual-port 10Gb Ethernet card specifications

Item	Specification
Bracket height	Full height
Power consumption	9.65 watts (nominal)
System interface type	PCIe v3.0
Speed and slot width	8.0 GT/s, 8-lane
Storage over Ethernet	iSCSI
LED indicators	LINK/ACTIVITY Off = No link (cable disconnected) Continuously illuminated = Line on Blinking = Network activity
Certifications	FCC A, ICES A, UL, CE, VCCI, CISPR, KCC
Operating temperature	0 to 55 C (32 TO 131 f)
Storage temperature	-40 to 65 C (-40 to 149 F)
Operational humidity	7% to 93% at 55 C
Storage humidity	93% maximum at 65 C
Air flow	100 LFM at 55 C

To purchase a QLE8442 dual-port 10Gb Ethernet card with SFP+ modules for your appliance, contact your Veritas sales representative, or your Veritas Partner representative.

**QLE8442 dual-port 10Gb Ethernet card with SFP+ modules**

SKU Number	Description
18293	XX40 QLOGIC QLE8442 10GBPS DUAL PORT ETHERNET/ISCSI CRU with SFP modules included

See [“NetBackup 5240 Appliance I/O configuration options”](#) on page 21.

## QLE2562 dual-port 8Gb Fibre Channel host bus adapter with SFP+ modules

The QLE2562 dual-port 8Gb Fibre Channel (FC) host bus adapter with SFP+ modules connects the appliance to clients or other devices for fiber transport data transfer.

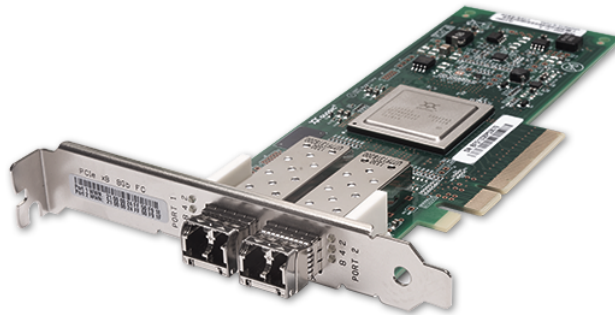

**Table 1-14** QLE2562 dual-port 8Gb Fibre Channel host bus adapter port specifications

Item	Description
Bracket height	Full Height
Power consumption (watts)	6.2 watts (typical)
Operating temperature	0°C to 55°C (32°F to 131°F)
Storage temperature	-40°C to 70°C (-40°F to 158°F)
Operating humidity	5% RH to 93% RH (non-operating, non-condensing) and 5% RH to 93% RH (operating, non-condensing)
System interface type	PCIe v3.0
Certifications	FCC B, UL, CE, VCCI, CISPR, KN, CNS



**Table 1-14** QLE2562 dual-port 8Gb Fibre Channel host bus adapter port specifications (*continued*)

Item	Description			
	Rate	OM1	OM2	OM3
External connections	2Gbps	150m	300m	500m
	4Gbps	70m	150m	380m
	8Gbps	21m	50m	150m

The following table describes the Fibre Channel host bus adapter LED indicator status activity.

**Table 1-15** QLE2562 dual-port 8Gb Fibre Channel host bus adapter LED indicator status activity

LED 1	LED 2	Activity
Off	Off	Power off
Green on	Yellow on	Power on (pre-firmware initialization)
Green on	Yellow on	Power on (post-firmware initialization )
Green and yellow LEDs flash alternately		Firmware error
Off	Yellow, flashing on activity	2Gbps link / input-output (I/O) activity
Green, flashing on activity	Off	4Gbps link / input-output (I/O) activity
Green, flashing on activity	Off	8Gbps link / input-output (I/O) activity

To purchase a QLE2562 dual-port 8Gb Fibre Channel host bus adapter for your appliance, contact your Veritas sales representative, or your Veritas Partner representative.

**QLE2562 dual-port 8Gb Fibre Channel host bus adapter with SFP+ modules**

SKU Number	Description
21265747	5X00 FIBRE CHANNEL HBA 8GB DUAL PORT CRU CORPORATE (SFP modules included)

## Quad-port 1Gb Ethernet card with RJ45 connectors

The quad-port 1Gb Ethernet card with RJ45 connectors is available with the NetBackup 5240 Appliance. The card resides in slot 3 of PCIe riser assembly 2.

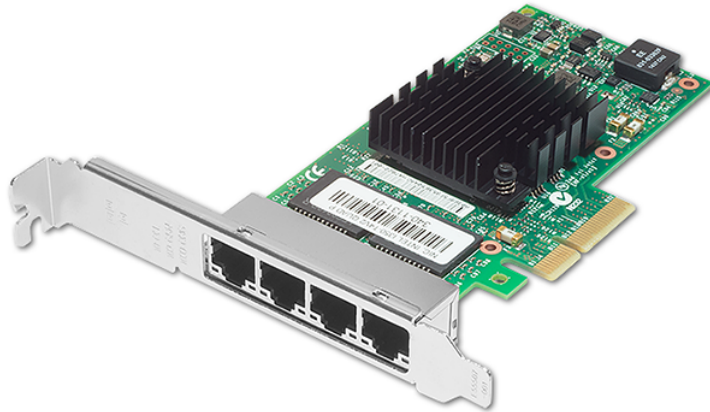

**Table 1-16** Quad-port 1Gb Ethernet card with RJ45 connectors specifications

Item	Description
Bracket height	Full height
System Interface Type	PCIe v2.1
Speed and Slot Width	5.0 GT/s, 4-Lane
Cabling Distances	1GBase-T: Cat 5e or higher 100Base-T: Cat 5 or higher 10Base-T: Cat 3 or higher
LED Indicators	LINK GREEN (solid) and ACTIVITY (blinking) LINK SPEED (yellow = 1Gbps; green=100Mbps; off=10Mbps)
Certifications	FCC B, UL, CE, VCCI, BSMI, CTICK, KCC
Air Flow (minimum)	0 LFM

**Table 1-16** Quad-port 1Gb Ethernet card with RJ45 connectors specifications  
*(continued)*

Item	Description	
Operating Temperature	0 to 55 C (32 to 131 F)	
Storage Temperature	-40 to 70 C (-40 to 158 F)	
Storage Humidity	90% non-condensing relative at 35 C	
Power consumption	Typical	Maximum
Speed = 1Gbps	5 watts	6 watts

## NetBackup 5240 Appliance Network Interface Port locations and speeds

Six Ethernet ports are available for general use with each NetBackup 5240 Appliance.

Refer to the following table for Ethernet port locations and throughput speeds.

**Figure 1-11** NetBackup 5240 Appliance Network Interface Port locations

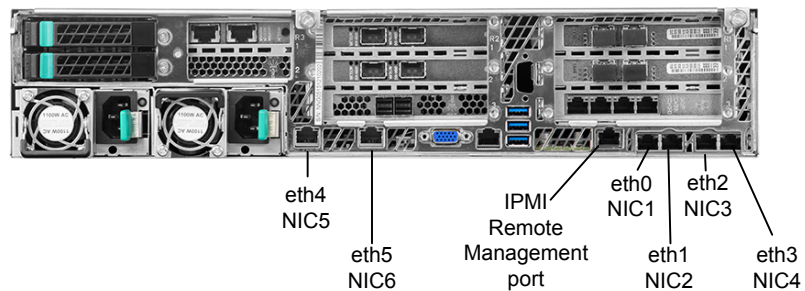

**Table 1-17** NetBackup 5240 Appliance Network Interface Port speeds

1Gb Ethernet /10Gb Ethernet (copper)	1Gb Ethernet (copper)
eth4/NIC5	<p>eth0/NIC1</p> <p>Used for the initial configuration of the appliance. After completing the initial configuration, you can connect NIC1 (eth0) to an administrative network that does not provide any backup data transfer.</p> <p>For more information, see the <i>Veritas NetBackup™ 52xx Appliance Initial Configuration Guide - Release 3.0</i>.</p> <p><b>Note:</b> Veritas does not support forming a NIC bond using eth0/NIC1 with other eth/NIC ports.</p>
eth5/NIC6	<p>eth1/NIC2</p> <p>eth2/NIC3</p>
-	<p>eth3/NIC4</p> <p>IPMI port</p>

# About the Veritas 2U12 49TB Storage Shelf

This chapter includes the following topics:

- [Veritas 2U12 49TB Storage Shelf overview](#)
- [Veritas 2U12 49TB Storage Shelf front panel components](#)
- [Veritas 2U12 49TB Storage Shelf control panel](#)
- [Veritas 2U12 49TB Storage Shelf rear components](#)
- [NetBackup 5240 Appliance and Veritas 2U12 49TB Storage Shelf connections](#)

## Veritas 2U12 49TB Storage Shelf overview

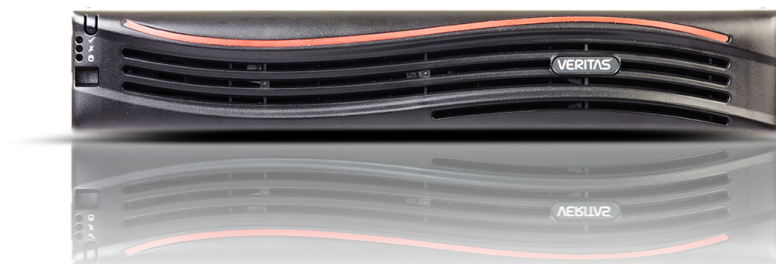

The optional Veritas 2U12 49TB Storage Shelf is a 2U12 drive enclosure that contains twelve 6TB 7200 rpm SAS hard disk drives. Available storage capacity of the storage shelf is 49TBs. Each disk drive can be accessed from the storage shelf's front panel. An embedded RAID controller is used to configure the disk drives into a RAID 6 configuration. One of the disk drives is reserved as a hot spare.

The Veritas 2U12 49TB Storage Shelf also contains two Storage Bay Bridge 2.1 compliant (SBB) Input/Output (I/O) modules. Each I/O module has three SAS-3 ports, which are labeled A, B, and C. As such, each storage shelf contains a total of six SAS-3 I/O ports. However, only ports A and B of each I/O module are used to connect the storage shelf to the appliance or other storage shelves.

Each I/O module also includes one Ethernet port and a 3.5mm RS232 Interface-to-Enclosure Services Processor jack. The Ethernet port and the RS232 jack are only used during on-site debugging operations. They are not used during normal appliance operations.

Along with the I/O modules and the disk drives, the Veritas 2U12 49TB Storage Shelf also includes a front control panel. The control panel provides LED indications of the health of the storage shelf. It uses a dual seven segment display for enclosure identification and a switch that is used for storage shelf configuration purposes.

The Veritas 2U12 49TB Storage Shelf serial number appears on a plastic panel on the left side of Power Cooling Module 0 (PCM 0). The storage shelf serial number begins with the letters SH.

See [“Veritas 2U12 49TB Storage Shelf front panel components”](#) on page 39.

See [“Veritas 2U12 49TB Storage Shelf rear components”](#) on page 43.

See [“Veritas 2U12 49TB Storage Shelf control panel”](#) on page 40.

## Usable appliance storage capacities

**Table 2-1** Usable storage capacities - NetBackup 5240 Appliance and Veritas 2U12 49TB Storage Shelves

Appliance only	Storage shelf capacity	Appliance and one storage shelf	Appliance and two storage shelves	Appliance and three storage shelves	Appliance and four storage shelves	Appliance and five storage shelves	Appliance and six storage shelves
4TiB (5TB)	49TiB (54TB)	53TiB (59TB)	102TiB (113TB)	151TiB (167TB)	200TiB (221TB)	249TiB (275TB)	298TiB (329TB)
14TiB* (15TB)	49TiB (54TB)	63TiB (69TB)	112TiB (123TB)	161TiB (177TB)	210TiB (231TB)	259TiB (285TB)	308TiB (339TB)
27TiB* (30TB)	49TiB (54TB)	76TiB (84TB)	125TiB (138TB)	174TiB (192TB)	223TiB (246TB)	272TiB (300TB)	321TiB (354TB)

**Table 2-1** Usable storage capacities - NetBackup 5240 Appliance and Veritas 2U12 49TB Storage Shelves (*continued*)

Appliance only	Storage shelf capacity	Appliance and one storage shelf	Appliance and two storage shelves	Appliance and three storage shelves	Appliance and four storage shelves	Appliance and five storage shelves	Appliance and six storage shelves
----------------	------------------------	---------------------------------	-----------------------------------	-------------------------------------	------------------------------------	------------------------------------	-----------------------------------

**Note:** Usable storage capacities are rounded values. Veritas calculates these values from the raw storage capacities of the various NetBackup 5240 Appliance-only configurations, which are **4.55** tebibyte, **13.65** tebibyte, and **27.3** tebibyte. The raw capacity of the Veritas 2U12 49TB Storage Shelf is **49.14** tebibyte.

To determine the exact usable capacities of each configuration, use the following formulas:

- <appliance-only capacity> + 49.14 = exact usable capacity
- <appliance-only capacity> + (2 x 49.14) = exact usable capacity
- <appliance-only capacity> + (3 x 49.14) = exact usable capacity
- <appliance-only capacity> + (4 x 49.14) = exact usable capacity
- <appliance-only capacity> + (5 x 49.14) = exact usable capacity
- <appliance-only capacity> + (6 x 49.14) = exact usable capacity

\* You can add up to six Veritas 2U12 49TB Storage Shelves to an existing NetBackup 5240 Appliance with internal storage capacities of 14TiB or 27TiB. However, before you place the system into a production environment, you must migrate all MSDP data from the appliance to the first external storage shelf. After you migrate the MSDP data, the system's usable storage space may fluctuate, depending on how much actual storage space the MSDP data pool uses.

**Note:** Spanning MSDP data across both NetBackup 5240 Appliance internal storage and a storage shelf is not recommended as it may result in degraded performance.

**Warning:** Failure to migrate MSDP data after you connect a storage shelf may result in degraded appliance throughput performance.

For more information about migrating MSDP data, see the following document: [Moving the MSDP partition from a base disk to an expansion disk for optimum performance.](#)

## Veritas 2U12 49TB Storage Shelf front panel components

### Hard disk drive capacities and drive bay slot assignments

The Veritas 2U12 49TB Storage Shelf contains 12 disk drive storage bays that are populated with 6TB 7200 rpm SAS hard disk drives. The available backup storage capacity of the storage shelf equals 49TBs. One of the disk drives is reserved as a hot spare. All disk drives are accessible from the front panel of the storage shelf after you remove the storage shelf bezel.

The following figure shows the front panel disk drive slot assignments within the Veritas 2U12 49TB Storage Shelf.

**Figure 2-1** Veritas 2U12 49TB Storage Shelf disk drive slot layout



---

**Note:** For security purposes, each drive tray is locked by default when the storage shelf is shipped from the factory. To access a hard disk drive, each storage bay must be unlocked using a T10 screw driver.



---

## Veritas 2U12 49TB Storage Shelf control panel

The Veritas 2U12 49TB Storage Shelf control panel is installed on the front left side of the storage shelf.



**Figure 2-2** Veritas 2U12 49TB Storage Shelf control panel



**Table 2-2** Veritas 2U12 49TB Storage Shelf control panel functions

Number	Item	Description
1	Input switch	The Input switch enables you to set the Unit Identification display.
2	Power On / Standby LED (Green or Amber)	The Power On/Standby LED shows Amber when only standby power is available. Otherwise, the LED shows Green when system power is available.
3	Module Fault LED (Power Cooling Module, Cooling, I/O module status) (Amber)	The Module Fault LED illuminates when there is a system hardware fault. The system hardware fault may be associated with a fault LED on a Power Cooling Module (PCM) or on an I/O module.
4	Logical status LED (amber)	The Logical Status LED shows a change of status or a fault. Typically these changes of status or faults are associated with the shelf's disk drives. However, the Logical Status LED can also indicate an issue with an internal RAID controller or external RAID controller, or with a host bus adapter.

**Table 2-2** Veritas 2U12 49TB Storage Shelf control panel functions  
*(continued)*

Number	Item	Description
5	Unit Identification Display	The Unit Identification Display is a dual digit display that provides information about the storage shelf. Its primary function is to assist in the configuration of multiple storage shelves.

**Table 2-3** Control panel LED conditions and statuses

System Power (Green or Amber)	Module Fault (Amber)	Logical Fault (Amber)	Associated LEDs/Alarms	Status
On (Amber)	Off	Off	None	Standby power present, Overall Power failed or switched off
On (Green)	On (Amber)	N/A	Single beep, then double beep	Control Panel Power on - test state (Test state = 5 seconds)
On (Green)	Off	Off	None	Power On - All functions good
On (Green)	On (Amber)	N/A	Power Cooling Module Fault LEDs Fan Fault LEDs	Any Power Cooling Module Fault, Fan Fault, or an over or under temperature issue
On (Green)	On (Amber)	N/A	I/O module LEDs	Any I/O module fault
On (Green)	On (Amber)	N/A	None	Enclosure Logical Fault
On (Green)	Flashing	N/A	Module Fault LED on an I/O module	Unknown I/O module type installed (Invalid or Mixed)
On (Green)	Flashing	N/A	Power Cooling Module Fault LEDs Fan Fault LEDs	Unknown Power Cooling Module installed. (Invalid or Mixed)

**Table 2-3** Control panel LED conditions and statuses *(continued)*

System Power (Green or Amber)	Module Fault (Amber)	Logical Fault (Amber)	Associated LEDs/Alarms	Status
On (Green)	N/A	On	Array in a failed or degraded state	Drive failure has occurred causing loss of availability or redundancy
On (Green)	N/A	Flashing	Arrays in an impacted state	Array operating background function
On	Flashing	N/A	SES state S1	Enclosure ID setting different from "start of day" setting

N/A - Not Applicable

For more information, see the *NetBackup Appliance Hardware Installation Guide - Release 3.0 - NetBackup 5240*.

## Veritas 2U12 49TB Storage Shelf rear components

This section describes the rear panel features of the Veritas 2U12 49TB Storage Shelf.

The following figure provides an overview of the components that comprise the Veritas 2U12 49TB Storage Shelf rear panel.

**Figure 2-3** Veritas 2U12 49TB Storage Shelf rear components

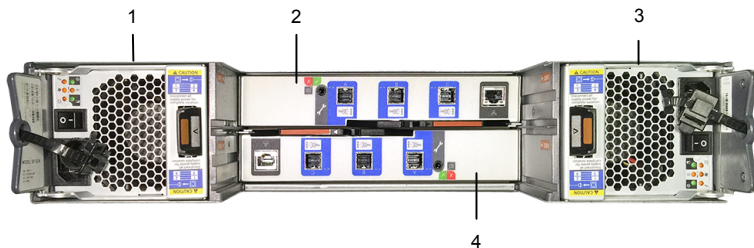

**Table 2-4** Veritas 2U12 49TB Storage Shelf rear components

Number	Component
1	Power Cooling Module 0 (PCM0)
2	I/O module 0
3	Power Cooling Module 1 (PCM1)
4	I/O module 1

See [“Veritas 2U12 49TB Storage Shelf I/O modules”](#) on page 44.

See [“Veritas 2U12 49TB Storage Shelf Power Cooling Modules”](#) on page 48.

See [“Power Cooling Module LEDs”](#) on page 49.

## Veritas 2U12 49TB Storage Shelf I/O modules

This section discusses the Veritas 2U12 49TB Storage Shelf I/O modules.

**Figure 2-4** Veritas 2U12 49TB Storage Shelf I/O module



The following figure and table provides details of the two Veritas 2U12 49TB Storage Shelf I/O module canisters.

**Figure 2-5** Veritas 2U12 49TB Storage Shelf I/O modules

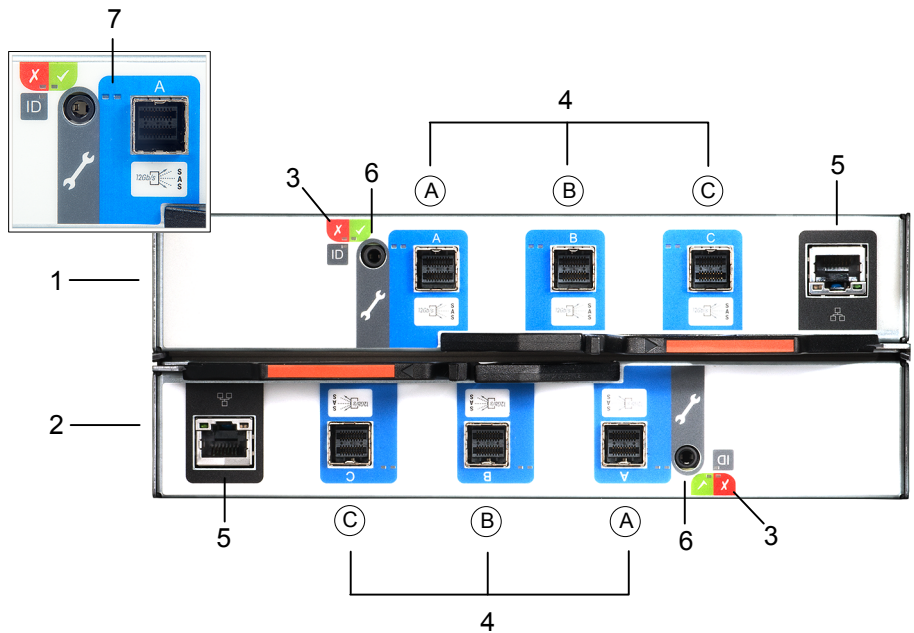

**Table 2-5** Veritas 2U12 49TB Storage Shelf I/O module components

Number	Description
1	I/O module 0
2	I/O module 1
3	I/O module Status LEDs See <a href="#">“I/O module Status LED location and conditions”</a> on page 46.
4	SAS-3 ports - A, B, and C
5	Ethernet port (debugging purposes only)
6	RS232 jack (debugging purposes only)
7	SAS Activity LEDs See <a href="#">“I/O module SAS Activity LED location and conditions”</a> on page 46.

## I/O module Status LED location and conditions

This section discusses the location of the Status LEDs on the I/O module and the Status LED conditions.

**Figure 2-6** I/O module Status indicator LED location

I/O module Status LED location

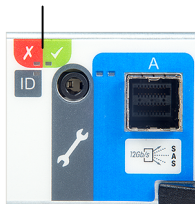

**Table 2-6** I/O module Status LED conditions

Condition	Activity LED (green)	Fault LED (amber)
Module Fault (amber)	On	The I/O module has encountered a fault condition.
	Off	The I/O module is operating normally.
Power (green)	On	The I/O module is on.
	Off	The I/O module is off.
ID (blue)	On	The I/O module controller is being identified.

See [“I/O module SAS Activity LED location and conditions”](#) on page 46.

See [“Veritas 2U12 49TB Storage Shelf I/O modules”](#) on page 44.

## I/O module SAS Activity LED location and conditions

This section discusses the location of the SAS Activity LEDs on the I/O module and the SAS Activity LED conditions.

**Figure 2-7** I/O module SAS Activity LED location

SAS Activity LED location

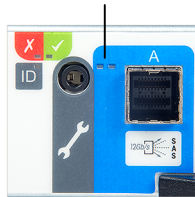

**Table 2-7** I/O module SAS Activity LED conditions

Condition	Activity LED (green)	Fault LED (amber)
No Cable Present	Off	Off
Cable Present All links up, no activity.	On	Off
Cable Present All links up.	Flash with aggregate port activity	Off
Critical Fault Any fault which causes operation of the cable to cease or fail to start. For example, an OVERCURRENT trip.	Off	On
Non-Critical Fault Any fault which does not cause the connection to cease operation. For example, not all links established; OVERTEMPERATURE condition detected.	Flash with aggregate port activity	Flashing - One second on; one second off

See [“Veritas 2U12 49TB Storage Shelf I/O modules”](#) on page 44.

See [“I/O module Status LED location and conditions”](#) on page 46.

## Veritas 2U12 49TB Storage Shelf Power Cooling Modules

The Veritas 2U12 49TB Storage Shelf includes two Power Cooling Modules (PCM). The dual PCMs provide redundant power to the storage shelf. If one PCM fails, the storage shelf continues to operate as the second PCM continues to supply the storage shelf with power.

**Figure 2-8** Power Cooling Module

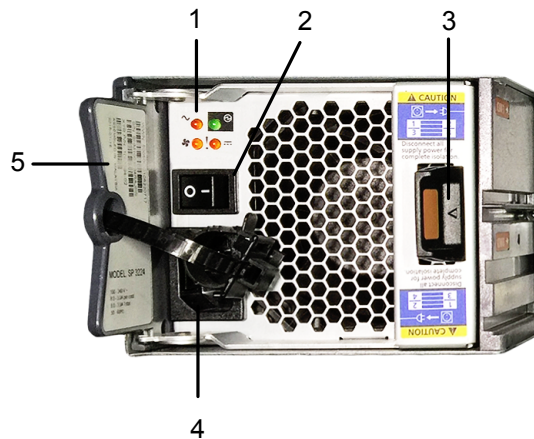

**Table 2-8** Power Cooling Module components

Number	Component
1	Power Cooling Module LEDs See <a href="#">“Power Cooling Module LEDs”</a> on page 49.
2	On/Off switch
3	Release tab
4	AC power socket



**Table 2-8** Power Cooling Module components (*continued*)

Number	Component
5	<p>Serial number - located on the Power Cooling Module 0 tab</p> <p><b>Note:</b> The storage shelf serial number begins with the letters <b>SH</b>.</p> 

### Power Cooling Module LEDs

Power Cooling Modules (PCM) use four LEDs to indicate the status of the PCM.

**Figure 2-9** Power Cooling Module LEDs

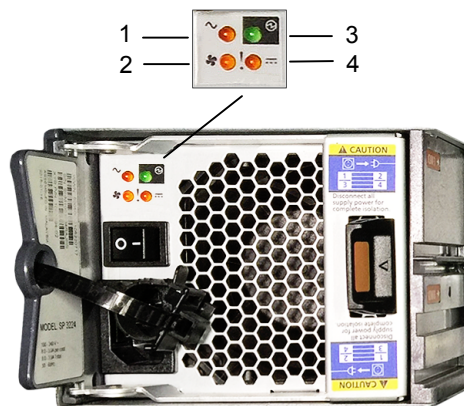

**Table 2-9** Power Cooling Module LED legend

Number	LED condition
1	AC fail
2	Fan fail
3	Power Cooling Module OK
4	DC fail

**Table 2-10** Power Cooling Module LED conditions

Status	Power Cooling Module OK (Green)	Fan Fail (Amber)	AC Fail (Amber)	DC Fail (Amber)
No AC Power (any Power Cooling Module)	Off	Off	Off	Off
No AC Power (this Power Cooling Module only)	Off	Off	On	On
AC Present (Power Cooling Module On OK)	On	Off	Off	Off
Power Cooling Module fan out of tolerance	On	Off	Off	On
Power Cooling Module fan fail	Off	On	Off	Off
Power Cooling Module Fault (Over temp, over volts, over current)	Off	On	On	On
Standby Mode	Flashing	Off	Off	Off
Power Cooling Module firmware download	Off	Flashing	Flashing	Flashing

See [“Veritas 2U12 49TB Storage Shelf Power Cooling Modules”](#) on page 48.

# NetBackup 5240 Appliance and Veritas 2U12 49TB Storage Shelf connections

SAS3 cables are used to connect the NetBackup 5240 Appliance to Veritas 2U12 49TB Storage Shelves. You can connect up to six storage shelves to the appliance.

Figure 2-10 shows the SAS3 cable connections between the NetBackup 5240 Appliance and six Veritas 2U12 49TB Storage Shelves.

You can find detailed information about connecting the NetBackup 5240 Appliance to Veritas 2U12 49TB Storage Shelves in the *NetBackup™ 5240 Appliance Hardware Installation Guide*.

**Figure 2-10** NetBackup 5240 Appliance and Veritas 2U12 49TB Storage Shelf cabling connections

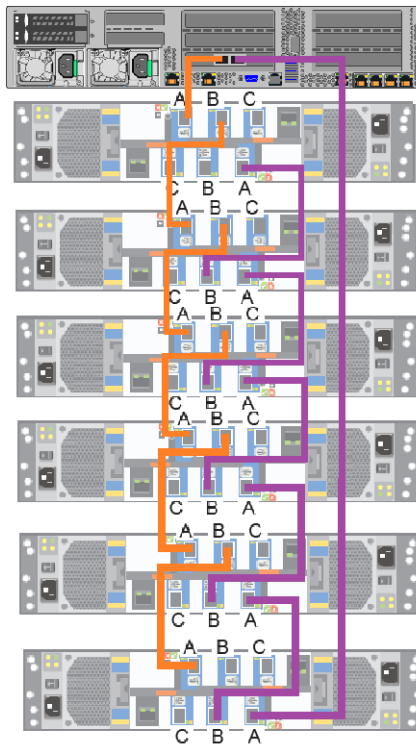

---

**Note:** A 3-meter SAS-3 cable may be required to connect the sixth storage shelf to the appliance if your rack alignment differs from the diagram in [Figure 2-10](#).

---

# NetBackup 5240 Appliance and Veritas 2U12 49TB Storage Shelf cables

This chapter includes the following topics:

- [Power cables](#)
- [Network cable](#)
- [Multi-Mode fiber optic cable](#)
- [Twinaxial copper cables](#)
- [SAS-3 cable](#)

## Power cables

Each of the AC power modules in the NetBackup 5240 Appliance and in the optional Veritas 2U12 49TB Storage Shelf accept one AC power cable. One end of the AC power cable is connected to the power supply on the appliance or the storage device. The other end of the cable is connected to an external Power Distribution Unit (PDU) on the rack.

Power cables include a live line, a neutral line, and a grounding line.

**Figure 3-1** AC power cable



- A AC power connector (IEC-60320-C14) to an external power supply Power Distribution Unit (PDU) on a rack.
- B AC power connector (IEC-60320-C13) to an appliance or a storage device.

---

**Note:** If your power distribution unit is not compatible with the IEC-60320-C14 plug, then Veritas recommends that you purchase your power cable locally. Make sure the power cable meets or exceeds the indicated power rating.

See [“NetBackup 5240 Appliance and Veritas 2U12 49TB Storage Shelf technical specifications”](#) on page 58.

---

## Network cable

The NetBackup appliance communicates with the Ethernet networks through an Ethernet network cable. One end of the network cable connects to the management network port or service network port of the appliance. The other end of the cable connects to the network switch or an external gateway. Both ends of the cable are RJ45 connectors.

**Figure 3-2** Network cable

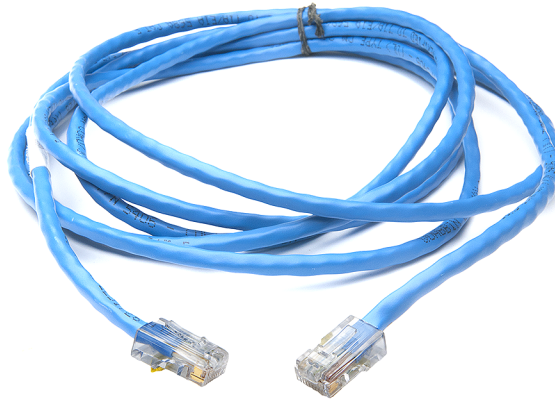

See “[Multi-Mode fiber optic cable](#)” on page 54.

## Multi-Mode fiber optic cable

The NetBackup appliance communicates with the Fibre Channel switch through a multi-mode fiber optic cable. One end of the multi-mode fiber optic cable connects to the 10GbE service network port or the Fibre Channel port. The other end of the cable connects to the Fibre Channel switch or other devices. The two ends of the multi-mode fiber optic cable are LC connectors.

**Figure 3-3** Multi-Mode fiber cable

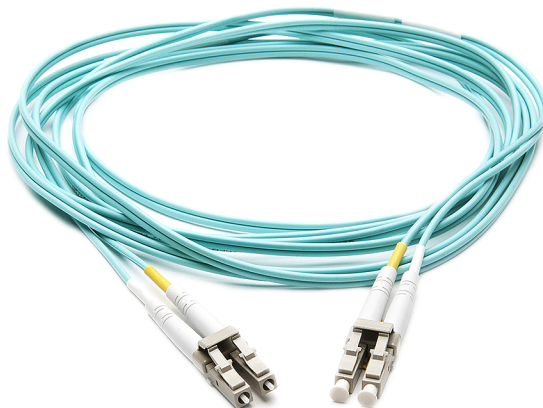

Fiber optic cables require Small Form-factor Pluggable (SFP+) transceivers, which are provided with each device having Fibre Channel ports. The diagram shows the SFP, labeled 1, and the fiber optic cable which is attached to it, labeled 2.

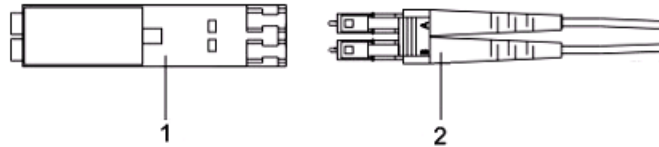

Supported SFPs are listed:

- Finisar
- JDSU

See [“Network cable”](#) on page 53.

## Twinaxial copper cables

The NetBackup 5240 Appliance communicates with Ethernet networks that run the iSCSI protocol through high speed Twinaxial copper cables. If you configure the appliance to communicate with 10 Gb Ethernet iSCSI networks, these cables connect to the iSCSI card in the appliance.

These cables are also known as Direct-Access copper cables, and are available in 1-meter, 3-meter, or 5-meter lengths.



## SAS-3 cable

SAS-3 data cables are used to connect the optional Veritas 2U12 49TB Storage Shelf to the NetBackup 5240 Appliance. SAS-3 cables have a SAS-3 connector on both ends. Two SAS-3 cables ship with each Veritas 2U12 49TB Storage Shelf.



**Figure 3-4** SAS-3 cable



# Technical specifications and compliance standards

This appendix includes the following topics:

- [NetBackup 5240 Appliance and Veritas 2U12 49TB Storage Shelf technical specifications](#)
- [Environmental specifications](#)
- [Protocol standards](#)
- [Regulatory, compliance, and certification information](#)

## NetBackup 5240 Appliance and Veritas 2U12 49TB Storage Shelf technical specifications

### NetBackup 5240 Appliance technical specifications

The following table provides technical specifications for the NetBackup 5240 Appliance.

**Table A-1** NetBackup 5240 Appliance technical specifications

Technical Specification	NetBackup 5240 Appliance
Rack information	19" EIA standard  The rack rails that are provided for the NetBackup 5240 Appliance are extensible to 36" (914mm). This distance is the maximum depth that is allowed between rack posts. If the distance between rack posts is longer than 36" (914mm) the rails and the appliance cannot be properly installed.

**Table A-1** NetBackup 5240 Appliance technical specifications (*continued*)

Technical Specification	NetBackup 5240 Appliance
Processor	Two (2) Intel® Xenon® E5-2630 v3 2.40GHz processors.
CPU speed	2.40GHz
Cores	16 (8 per processor)
System memory (currently supported)	64 GB, 128 GB, or 192 GB  <b>Note:</b> When you purchase the first expansion storage shelf, the Storage Expansion Kit that comes with the storage shelf includes an additional 64 GBs of memory.  After adding the first storage shelf and the memory, you can increase the appliance memory to 192 GBs by purchasing an additional 64-GB memory kit.
Memory type and configuration (DIMMs)	DDR4 RDIMM 8 GB x 8
SAS RAID card installed in a PCIe riser assembly (Y/N)	Mezzanine card: Yes PCIe RAID card: Yes, for storage capacities over 27 TB
RAID cache	1 GB for the internal mezzanine RAID controller.  1 GB is also included on the external PCIe RAID controller when the first storage shelf is purchased.
Usable MSDP and AdvancedDisk storage capacity (TB)	Appliance: 4 TB, 14 TB, 27 TB Each storage shelf: 49 TB Maximum configuration shipped from the factory: 322TB
Maximum number of storage shelves	6
1 Gb Ethernet ports	Up to 8 maximum
10 Gb Ethernet ports	Up to 8 maximum
8 Gb Fibre Channel ports	Up to 10 maximum

**Table A-1** NetBackup 5240 Appliance technical specifications (*continued*)

Technical Specification	NetBackup 5240 Appliance
Dimensions (IEC rack compliant)	Appliance: <ul style="list-style-type: none"> <li>■ Height: 8.89cm (3.5") (approximately 2U)</li> <li>■ Width: 48.26cm (19")</li> <li>■ Depth: 79.38cm (31.25")</li> </ul> Storage shelf: <ul style="list-style-type: none"> <li>■ Height: 8.89cm (3.5") (approximately 2U)</li> <li>■ Width: 48.26cm (19")</li> <li>■ Depth: 60.20cm (23.7")</li> </ul>
Maximum weight	23.26 kg (51.28 lbs)
Shipping weight	54 kg (118 lbs)
AC power requirements	Appliance: <ul style="list-style-type: none"> <li>■ 110 VAC at 5.05 A</li> <li>■ 220 VAC at 2.53 A</li> </ul> Each storage shelf: <ul style="list-style-type: none"> <li>■ 110 VAC at 5.86 A</li> <li>■ 220 VAC at 2.93 A</li> </ul>
AC power cable	Specification: IEC-60320-C14 to IEC-60320-C13, 10A/250V, Black, 4 ft  The IEC-60320-C14 plugs into a Power Distribution Unit. The IEC-60320-C13 plugs into an appliance or storage shelf power supply.  <b>Note:</b> If your power distribution unit is not compatible with the IEC-60320-C14 plug, then Veritas recommends that you purchase your power cable locally. Make sure the power cable meets or exceeds the indicated power rating.  See <a href="#">"Power cables"</a> on page 52.
AC Frequency range	50/60Hz
Typical power consumption	Appliance: <ul style="list-style-type: none"> <li>■ 240 watts</li> </ul> Each storage shelf: <ul style="list-style-type: none"> <li>■ 225 watts</li> </ul>

**Table A-1** NetBackup 5240 Appliance technical specifications (*continued*)

Technical Specification	NetBackup 5240 Appliance
Typical power consumption with a maximum of six connected external storage shelves	1,590 watts (4.9 watts per TB)
Maximum power consumption	Appliance: <ul style="list-style-type: none"> <li>■ 500 watts</li> </ul> Each storage shelf: <ul style="list-style-type: none"> <li>■ 580 watts</li> </ul>
Maximum power consumption with a maximum of six connected external storage shelves	3,980 watts (12.3 watts per TB)
System cooling requirement (heat dissipation)	240 watts (typical) - 819 BTU/hr 500 watts (maximum) - 1706 BTU/hr
System cooling requirement with maximum external storage (heat dissipation)	10,185 BTU/hr
Operating voltage	100V - 127 VAC 200V - 240 VAC
Power conversion efficiency	Appliance: <ul style="list-style-type: none"> <li>■ 90% +</li> </ul> Storage shelf: <ul style="list-style-type: none"> <li>■ 80% +</li> </ul>
Acoustic noise	Appliance: <ul style="list-style-type: none"> <li>■ 70 dBA</li> </ul> Storage shelf: <ul style="list-style-type: none"> <li>■ 63 dBA</li> </ul>

**Veritas 2U12 49TB Storage Shelf technical specifications**

The following table provides technical specifications for a Veritas 2U12 49TB Storage Shelf.

**Table A-2** Veritas 2U12 49TB Storage Shelf technical specifications

Technical specification	Description
Rack information	<p>The rack installation height is the space occupied by a storage shelf in a rack cabinet. The height for the storage shelf is 3.5 inches, 88.9mm. The shelf fits into a 2U rack space. Install the storage shelf in a rack cabinet that is 19 inches (483mm) wide.</p> <p>The rack rails that are provided for the storage shelf are extensible to 36" (914mm). This distance is the maximum depth that is allowed between rack posts. If the distance between rack posts is longer than 36" (914mm) the rails and the appliance cannot be properly installed.</p>
Hot swappable components	Disk drives, power cooling modules, and I/O modules (Storage Bay Bridge (SBB) 2.1)
Usable storage capacity (TB)	49TB
Maximum weight (fully populated)	28 kg (62 lbs)
Shipping weight	52 kg (115 lbs)
Dimensions	<p>Height: 8.89cm (3.5") (approximately 2U)</p> <p>Width: 48.3cm (19") ICE rack compliant</p> <p>Depth: 60.2cm (23.7")</p>
Device types supported	Dual ported 12Gb/s SAS drives
Maximum drives per enclosure	12
Typical power consumption	<p>225 watts per storage shelf</p> <p>You can connect a maximum of four storage shelves to the NetBackup 5240 Appliance.</p>
Maximum power consumption	<p>580 watts per storage shelf</p> <p>You can connect a maximum of four storage shelves to the NetBackup 5240 Appliance.</p>
System cooling requirement (heat dissipation)	<p>225 watts (typical) - 768 BTU/hr</p> <p>580 watts (maximum) - 1979 BTU/hr</p>
Operating voltage	<p>100V - 127VAC</p> <p>200V - 240VAC</p>

**Table A-2** Veritas 2U12 49TB Storage Shelf technical specifications  
*(continued)*

Technical specification	Description
AC Frequency range	50/60Hz
Power conversion efficiency	>80% @ 100V, >80% @240V (>30% load)
Acoustic noise	63 dBA
Non-operational altitude	-300 to 12,192 m (-1,000 to 40,000 ft)
Operational shock	2g 11mSec half sine
Non-operational shock	25g 10mSec half sine
Operational vibration	0.21g RMS 5-500Hz random
Non-operational vibration	1.04g RMS 2-200Hz random
Relocation vibration (Non-operational)	0.3g 2-200Hz sinusoidal

See [“Environmental specifications”](#) on page 63.

## Environmental specifications

The following table lists the environmental specifications for the NetBackup 5240 Appliance and the Veritas 2U12 49TB Storage Shelf.

**Table A-3** NetBackup 5240 Appliance and Veritas 2U12 49TB Storage Shelf environmental specifications

Specification	NetBackup 5240 Appliance / Veritas 2U12 49TB Storage Shelf
Operating temperature	ASHRAE A2 (10°C to 35°C) (50°F to 95°F)
Non-operating temperature	-25°C to 70°C (-13°F to 158°F)  The non-operating temperature is defined as the temperature of the system when the system is turned off. It is also referred to as the storage temperature.  Veritas recommends that you do not store the system in an environment where the temperatures fall outside of the listed temperature range.

**Table A-3** NetBackup 5240 Appliance and Veritas 2U12 49TB Storage Shelf environmental specifications (*continued*)

Specification	NetBackup 5240 Appliance / Veritas 2U12 49TB Storage Shelf
Operating humidity (Relative Humidity)	20% RH to 80% RH
Non-operating humidity	8% RH to 90% RH
Operating altitude	-30 to 3000 m with ASHRAE A2 class derating (0 to 10,000 ft)
Temperature gradient	10°C/hour (50°F/hour)

See [“NetBackup 5240 Appliance and Veritas 2U12 49TB Storage Shelf technical specifications”](#) on page 58.

See [“Protocol standards”](#) on page 64.

## Protocol standards

The following table provides standards with which the NetBackup 5240 Appliance and the Veritas 2U12 49TB Storage Shelf comply.

**Table A-4** NetBackup 5240 Appliance / Veritas 2U12 49TB Storage Shelf standards compliance

Standard	Version
IPMI 2.0	Intelligent Platform Management Interface Specification Second Generation v2.0, Document Revision 1.0
SMBIOS	System Management BIOS (SMBIOS) Reference Specification, Version 2.5
SAS	SAS - 3.0
ACPI	Advanced Configuration and Power Interface Specification, Revision 3.0, September 2
IP	RFC0791: Internet Protocol
FC	INCITS T11 (X3T9.3)
PCIe Express	PCIe 3.0

See [“NetBackup 5240 Appliance and Veritas 2U12 49TB Storage Shelf technical specifications”](#) on page 58.



See “[Environmental specifications](#)” on page 63.

## Regulatory, compliance, and certification information

The following sections give information about the product regulations and compliance.



### WARNING

To ensure regulatory compliance, you must adhere to the assembly instructions in this guide to ensure and maintain compliance with existing product certifications and approvals. Use only the described, regulated components that are specified in this guide. Use of other products or components voids the UL listing and other regulatory approvals of the product. The result is noncompliance with product regulations in the region(s) in which the product is sold.

Before computer integration make sure that the appliance, power supply, and other modules have passed EMC testing. This process helps to ensure EMC compliance with your local regional rules and regulations. The testing is done using a server board with a microprocessor from the same family (or higher) and operating at the same (or higher) speed as the microprocessor that is used on this server board. The final configuration of your appliance product may require additional EMC compliance testing.

This product is an FCC Class A device. Integration of it into a Class B system does not result in a Class B device.

## Product regulatory compliance

The NetBackup appliance, when correctly integrated per this guide, complies with the following safety and electromagnetic compatibility (EMC) regulations.

**Intended Application** - This product was evaluated as Information Technology Equipment (ITE), which may be installed in offices, schools, computer rooms, and similar commercial type locations. The suitability of this product for other product categories and environments, other than an ITE application, may require further evaluation. Other product categories and environments may include medical,

industrial, telecommunications, NEBS, residential, alarm systems, and test equipment.

## Product safety compliance

The following is a list of product safety compliance norms for different countries:

- UL60950 - CSA 60950 (USA / Canada)
- EN60950 (Europe)
- IEC60950 (International)
- CB Certificate & Report, IEC60950 (report to include all country national deviations)
- GS Certification (Germany)
- GOST R 50377-92 - Certification (Russia)
- Belarus Certification (Belarus)
- Ukraine Certification (Ukraine)
- CE - Low Voltage Directive 73/23/EEE (Europe)
- IRAM Certification (Argentina)
- GB4943- CNCA Certification (China)

## Product EMC Compliance - Class A Compliance

The following is a list of EMC compliance norms for different countries:

- FCC /ICES-003 - Emissions (USA/Canada) Verification
- CISPR 22 - Emissions (International)
- EN55022 - Emissions (Europe)
- EN55024 - Immunity (Europe)
- EN61000-3-2 - Harmonics (Europe)
- EN61000-3-3 - Voltage Flicker (Europe)
- CE - EMC Directive 89/336/EEC (Europe)
- VCCI Emissions (Japan)
- AS/NZS 3548 Emissions (Australia / New Zealand)
- BSMI CNS13438 Emissions (Taiwan)
- GOST R 29216-91 Emissions (Russia)

- GOST R 50628-95 Immunity (Russia)
- Belarus Certification (Belarus)
- Ukraine Certification (Ukraine)
- GB 9254 - CNCA Certification (China)
- GB 17625 - (Harmonics) CNCA Certification (China)

## Product ecology compliance

Use of banned substances are restricted in accordance with world-wide regulatory requirements. A Material Declaration Data Sheet is available.

Restrictions include quantity limitations on the following:

- Quantity limit of 0.1% by mass (1000 PPM) for: Lead, Mercury, Hexavalent Chromium, Polybrominated Biphenyls Diphenyl-Ethers (PBB/PBDE)
- Quantity limit of 0.01% by mass (100 PPM) for: Cadmium
- California Code of Regulations, Title 22, Division 4.5, Chapter 33: Best Management Practices for Perchlorate Materials
- China - Restriction of Hazardous Substances (China RoHS)
- WEEE Directive (Europe)
- Packaging Directive (Europe)

## Certifications / Registrations / Declarations

The following is a list of the required certifications, registrations, and declarations:

- NRTL Certification (US/Canada)
- CE Declaration of Conformity (CENELEC Europe)
- FCC/ICES-003 Class A Attestation (USA/Canada)
- VCCI Certification (Japan)
- C-Tick Declaration of Conformity (Australia)
- MED Declaration of Conformity (New Zealand)
- BSMI Certification (Taiwan)
- GOST R Certification / Certification (Russia)
- Belarus Certification / Certification (Belarus)
- IRAM Certification (Argentina)

- CNCA CCC Certification (China)
- Ecology Declaration (International)
- China RoHS Environmental Friendly Use Period
- Packaging & Product Recycling Marks

## Electromagnetic compatibility notices

The following sections list the compatibility notices for USA, Canada, Europe, Japan, and Taiwan.

### **FCC Verification Statement (USA)**

This device complies with Part 15 of the FCC Rules. Operation is subject to the following two conditions: (1) this device may not cause harmful interference, and (2) this device must accept any interference received, including interference that may cause undesired operation.

This equipment has been tested and found to comply with the limits for a Class A digital device, pursuant to Part 15 of the FCC Rules. These limits are designed to provide reasonable protection against harmful interference in a residential installation. This equipment generates, uses, and can radiate radio frequency energy. If the equipment is not installed and used in accordance with the instructions, it may cause harmful interference to radio communications. However, there is no guarantee that interference will not occur in a particular installation. If this equipment does cause harmful interference to a radio or a television reception (can be determined by turning the equipment off and on), the user is encouraged to try to correct the interference by one or more of the following measures:

- Reorient or relocate the receiving antenna.
- Increase the separation between the equipment and the receiver.
- Connect the equipment to an outlet on a circuit other than the one to which the receiver is connected.
- Consult the dealer or an experienced radio/TV technician for help. Any changes or modifications not expressly approved by the grantee of this device can void the user's authority to operate the equipment. The customer is responsible to ensure compliance of the modified product. Only peripherals (computer input or output devices, terminals, printers, etc.) that comply with FCC Class A or B limits may be attached to this product. Operation with noncompliant peripherals is likely to result in interference to radio and TV reception. All cables that are used to connect to peripherals must be shielded and grounded. Operation with

the cables that are connected to peripherals that are not shielded and grounded may result in interference to radio and TV reception.

### **ICES-003 (Canada)**

Cet appareil numérique respecte les limites bruits radioélectriques applicables aux appareils numériques de Classe A prescrites dans la norme sur le matériel brouilleur: "Appareils Numériques", NMB-003 édictée par le Ministre Canadien des Communications.

English translation of the notice above:

This digital apparatus does not exceed the Class A limits for radio noise emissions from the digital apparatus that is set out in the interference-causing equipment standard entitled: "Digital Apparatus," ICES-003 of the Canadian Department of Communications.

### **CE Declaration of Conformity (Europe)**

This product has been tested in accordance to, and complies with the Low Voltage Directive (73/23/EEC) and EMC Directive (89/336/EEC). The product has been marked with the CE Mark to illustrate its compliance.

### **BSMI (Taiwan)**

The BSMI Certification Marking and EMC warning label is located on the outside rear area of the product.

# Index

## Symbols

- 1Gb Ethernet Card
  - quad-port RJ45 connectors 34
- 8Gb Fibre Channel HBA 32

## A

- appliance
  - features 7
    - rear panel 20
  - front panel USB port 12
  - power button LED 17
  - rear panel
    - color codes 21
    - serial number 20
- Appliance and storage shelf cabling connections 51
- appliance configurations
  - available 21

## C

- cables
  - multi-mode fiber optic
    - description 54
  - network
    - description 53
  - power
    - description 52
  - SAS-3
    - description 56
- CloudCatalyst
  - about 8
- color codes
  - rear panel ports 21
- components
  - front panel components
    - Veritas 2U12 49TB Storage Shelf 39
- control panel
  - NetBackup 5240 Appliance 13
  - Veritas 2U12 49TB Storage Shelf 40
- control panel LED descriptions
  - NetBackup 5240 Appliance 13

- control panel LED descriptions *(continued)*
  - Veritas 2U12 49TB Storage Shelf 40

## D

- DIMM
  - system memory configuration 8
- disk drive configurations
  - NetBackup 5240 Appliance 10
- disk drive LED indicators
  - NetBackup 5240 Appliance 11
- disk drive LEDs
  - NetBackup 5240 Appliance 11
- disk drive slots
  - NetBackup 5240 Appliance 10
- drive bay slot assignments
  - Veritas 2U12 49TB Storage Shelf 39

## E

- environmental specifications
  - NetBackup 5240 Appliance / Veritas 2U12 49TB Storage Shelf 63
- eth port color codes 21
- eth ports 20
- Ethernet card
  - dual-port 10GB card specifications 29
  - Intel X710 dual-port 10Gb Ethernet card specifications 27

## F

- FC HBA LED status lights 32
- Fibre Channel card 32

## H

- hard disk drive capacities
  - Veritas 2U12 49TB Storage Shelf 39
- hardware configurations
  - available 21

- I**
- I/O modules
  - Veritas 2U12 49TB Storage Shelf 44
  - LED location and conditions 46
- L**
- LED descriptions
  - NetBackup 5240 Appliance
    - system status 14
- LED indicator status
  - Fibre Channel HBA 33
- LED location and conditions
  - I/O modules
    - Veritas 2U12 49TB Storage Shelf 46
- N**
- NetBackup 5240 Appliance
  - control panel 13
    - LED descriptions 13
    - system status LED location 14
  - disk drive configurations 10
  - disk drive LED indicators 11
  - disk drive LEDs 11
  - features
    - processor 8
    - RAID levels 8
    - system memory configuration (DIMMS) 8
  - front panel drive slots 10
  - RAID configuration 10
- Network Interface Port locations and speeds 35
- NIC locations and speeds 35
- NIC port color codes 21
- NIC ports 20
- O**
- overview
  - Veritas 2U12 49TB Storage Shelf 37
- P**
- PCIe add-in cards
  - 8Gb Fibre Channel HBA 32
  - specifications
    - QLE2562 dual-port 8Gb FC HBA 32
- PCIe slot configurations 21
- power button LED
  - appliance 17
    - descriptions 17
- Power Cooling Modules (PCM)
  - status LEDs
    - Veritas 2U12 49TB Storage Shelf 49
  - Veritas 2U12 49TB Storage Shelf 48
- processor type 8
- protocol standards
  - NetBackup 5240 Appliance / Veritas 2U12 49TB Storage Shelf 64
- Q**
- QLE8442 dual-port 10Gb Ethernet card
  - dual-port 30
- R**
- RAID configuration
  - NetBackup 5240 Appliance 10
- RAID levels 8
- rear components
  - Veritas 2U12 49TB Storage Shelf 43
- rear panel
  - color codes 21
  - connectors 20
    - eth ports 20
    - NIC ports 20
- S**
- SAS Activity LED location and conditions
  - I/O modules
    - Veritas 2U12 49TB Storage Shelf 46
- serial number location
  - Veritas 2U12 49TB Storage Shelf 48
- system features 7
- system status
  - NetBackup 5240 Appliance
    - LED descriptions 14
  - system status LED location
    - NetBackup 5240 Appliance
      - control panel 14
- T**
- technical specifications
  - NetBackup 5240 Appliance 58
  - Veritas 2U12 49TB Storage Shelf 61
- U**
- USB port
  - appliance front panel 12

**V**

## Veritas 2U12 49TB Storage Shelf

- control panel 40

- drive bay slot assignments 39

- front panel components 39

- hard disk drive capacities 39

- I/O modules 44

  - LED location and conditions 46

  - SAS Activity LED location and conditions 46

- overview 37

- Power Cooling Modules (PCM) 48

- rear components 43