



# Upgradable PDU Instruction Manual

[geistglobal.com](http://geistglobal.com)



# Table of Contents

<b>Introduction</b>	<b>4</b>
Welcome.....	4
<b>About this Manual</b>	<b>7</b>
Revision History.....	7
Organization of the Manual.....	7
Audience Profile.....	7
On-line Documentation.....	8
Reporting Document Errors.....	8
Conventions.....	8
Software .....	8
Hardware .....	8
Safety .....	10
Figures .....	11
Tables .....	11
<b>Chapter 1 - Product Specifications</b>	<b>12</b>
<b>Product Specifications</b> .....	<b>12</b>
<b>Overview</b> .....	<b>12</b>
<b>Environmental</b> .....	<b>12</b>
Temperature.....	12
Humidity .....	12
Elevation .....	12
<b>Electrical</b> .....	<b>13</b>
Receptacle Ratings.....	13
<b>Networking</b> .....	<b>13</b>
Ethernet .....	13
Protocols .....	13
User Interfaces.....	13
<b>Regulatory Compliance</b> .....	<b>14</b>
Underwriters Laboratories (UL).....	14
Federal Communications Commission (FCC).....	14
RoHS/WEEE.....	14
<b>Chapter 2 - Installation</b>	<b>16</b>
<b>Pre-Installation</b> .....	<b>16</b>
<b>Installation</b> .....	<b>17</b>
<b>Mounting</b> .....	<b>18</b>
Full Length Brackets.....	18
Mini "L" Brackets (SLB-4).....	19
Vertical Extension Brackets (VCB-1).....	19
Toolless Mounting Hardware (11621).....	20
Toolless Full Length Brackets (TLFL).....	20

Single Side Mount 2 Unit Brackets (TSMX2).....	21
Offset/Side Mount Brackets (EZB-1).....	21
7" Extension Brackets (XB-7).....	22
Flush Mount Brackets (FM).....	22
Adjustable Mount Brackets (AM).....	23
Panel Mount Brackets (PM).....	23
23" Conversion Mounting Brackets (23-RM).....	24
Cable Mount Brackets (CMB-1).....	24
19" Horizontal/Panel Mount Brackets (7938).....	25
<b>Network Setup</b> .....	<b>26</b>
<b>Chapter 3 - Setup</b> .....	<b>31</b>
<b>Interchangeable Monitoring Device</b> .....	<b>31</b>
<b>Web Interface</b> .....	<b>50</b>
<b>Sensors Page</b> .....	<b>50</b>
Overview .....	50
Configuration and Operation.....	51
Alarms & Warnings.....	53
Add/Modify Alarms & Warnings.....	55
<b>System</b> .....	<b>58</b>
<b>Users</b> .....	<b>58</b>
<b>Network</b> .....	<b>61</b>
<b>Web Server</b> .....	<b>62</b>
<b>Display</b> .....	<b>62</b>
<b>Email</b> .....	<b>63</b>
<b>SNMP</b> .....	<b>65</b>
<b>Syslog</b> .....	<b>66</b>
<b>Admin</b> .....	<b>67</b>
<b>Locale</b> .....	<b>67</b>
<b>Utilities</b> .....	<b>68</b>
<b>Help</b> .....	<b>70</b>
<b>Info</b> .....	<b>70</b>
<b>Support Site</b> .....	<b>70</b>
<b>Chapter 4 - Final Checkout</b> .....	<b>71</b>
<b>Final Checkout</b> .....	<b>71</b>
<b>Technical Support</b> .....	<b>71</b>
Resetting PDU.....	71
Service and Maintenance.....	71
More Technical Support.....	71
Using Microsoft Exchange as an SMTP server.....	72
<b>Product-Specific Safety Notices</b> .....	<b>73</b>
<b>General Safety</b> .....	<b>73</b>
<b>Live Circuits Safety</b> .....	<b>73</b>
<b>Equipment Grounding</b> .....	<b>73</b>
<b>Electrostatic Discharge</b> .....	<b>74</b>
<b>Explosive Environment</b> .....	<b>74</b>
<b>Servicing and Adjustments</b> .....	<b>74</b>
<b>Repairs and Modifications</b> .....	<b>74</b>

# Introduction

## Welcome

### Notice to Users

Geist, a division of PCE, Inc., reserves the right to make changes to this document without notice to any user or reseller of this product. Geist, a division of PCE, Inc., also reserves the right to substitute or terminate distribution of this document, with no obligation to notify any person or party of such substitutions or terminations.

### Copyrights

© 2017 - Geist, a division of  
PCE, Inc. All Rights Reserved

### Patents

U.S. Patent 9,276,357 - Geist, a division of PCE, Inc. All Rights Reserved  
U.S. Patent 9,692,178 - Geist, a division of PCE, Inc. All Rights Reserved

### Trademarks

All Trademarks contained herein are registered to Geist, a division of PCE, Inc.

### Use and Disclosure Restrictions

The software and documentation contained in this publication are copyrighted materials.

### Recovery Act Buy American

Geist products adhere to the Buy American provisions of the American Recovery and Reinvestment Act of 2009 (Recovery Act). All Geist goods manufactured in our Lincoln, Nebraska, plant have undergone substantial transformation during production.

### Trade Agreements Act (TAA)

Geist goods manufactured in our Lincoln, Nebraska, plant have undergone substantial transformation during production. These Geist products adhere to U.S. Trade Agreements Act and can be supplied for GSA Schedules and other government contracts.

## Geist Policy on Conflict Minerals

This document details Geist's corporate policy regarding the use of conflict minerals. The policy expressed in this document should be considered to cover the Geist and Geist Europe divisions of PCE Inc.

Section 1502 of the Dodd-Frank Act which was passed by the US Congress in 2010 requires certain companies to annually disclose their use of conflict minerals. Conflict minerals covered under this act include tantalum, tin, tungsten, and gold.

Although Geist is not directly subjected to the requirements of the Dodd-Frank Act, Geist recognizes that all companies within the electronics manufacturing industry supply chain are impacted by this legislation. Geist supports the intent of the law, which is the reduction of violence within the Democratic Republic of the Congo and will take several actions to both advance the goals of the Dodd-Frank Act and to provide exceptional support to our customers.

- Geist will work with our direct suppliers to identify purchased components and materials that contain tin, tantalum, tungsten or gold.
- Geist will work with our direct suppliers to trace sources of any tin, tantalum, tungsten or gold used in our products back to the smelter.
- Geist will document our efforts to trace tin, tantalum, tungsten, and gold minerals back to the smelter and will accurately report the results to our customers.
- Geist will continue to monitor industry progress in identifying conflict-free smelters and will adjust corporate policy as the electronics supply chain becomes more fully documented.

Geist will not require that our direct suppliers source only conflict-free minerals until an adequate number of smelters has been reliably identified and audited by The Electronic Industry Citizenship Coalition (EICC) and the Global e-Sustainability Initiative (GeSI) to service the electronic industry supply chain. Mandating a conflict-free supply chain before an adequate number of smelters has been identified will prohibit the use of all tin, tantalum, tungsten, and gold originating in the Democratic Republic of the Congo and surrounding countries. This prohibition would cut off the sole income source for many artisanal miners within the region and may result in increased violence within the Democratic Republic of the Congo in direct opposition to the goals of the Dodd-Frank Act. Geist will work continuously with our direct suppliers in order to annually increase the percentage of documented conflict-free minerals that are used in our products until all products can be certified as conflict-free.

## WEEE Declaration

Geist Europe is obligated to finance the cost of the collection, treatment, recovery and environmentally sound disposal of all products sold by Geist Europe into the UK market this includes:

- New WEEE (displaying 'the crossed out wheeled bin symbol') that Geist Europe has placed onto the market after the 13th August 2005; and
- Historic WEEE (not displaying 'the crossed out wheeled bin symbol'), when Geist Europe is supplying new WEEE that is intended to replace the historic WEEE and is of equivalent type or fulfills the same function even if the historic WEEE was manufactured by a third party.

Please contact Geist Europe on 01823 275100 for further details or to arrange collection.  
(UK Only)

### **Document Usage**

All reasonable efforts have been made to assure the accuracy of this document from any technical or typographical errors or omissions. Geist, a division of PCE, Inc., and its affiliates disclaim responsibility for any labor, materials, or costs incurred as a result of usage of this document. Nor shall Geist, a division of PCE, Inc., and its affiliates be liable for any damages, inclusive of loss of profits or data, arising from the use of or in connection with this document.

Geist, a division of PCE, Inc., reserves the right to make changes to this document without notice to any user or reseller of this product. Geist, a division of PCE, Inc., also reserves the right to substitute or terminate distribution of this document, with no obligation to notify any person or party of such substitutions or terminations.

© 2017 - Geist, a division of  
PCE, Inc. All Rights Reserved  
Rev 03/3/2017

## About this Manual

This document provides an overview of Geist product(s), the major topics covered include:

- Copyright, Trademarks, and Disclosure Restrictions.
- Instructions for installing, powering and using the equipment.
- Information that will aid in managing and maintaining the equipment.

## Revision History

Revision	Date	Notes	Approved By
1.0	3/2/2017	Original Published Version	JB
1.1	6/27/2017	Updated Utilities section regarding firmware updates via HTTP. Updated VLC section compatibility note.	SC
1.2	6/30/2017	Updated Patent information	JB

## Organization of the Manual

This Geist document contains the following product information:

- Product Specifications - This chapter describes the major product characteristics and its functional role within the system. Where appropriate, reference to cabling among product components and to other Geist product(s) is provided.
- Installation - This chapter provides installation information for the preparation and use of Geist products as well as procedures required to adequately mechanically and electrically attach Geist product into supporting systems.
- Setup - This chapter provides instructions on power-up procedures after product installation and configuration of the software and features.
- Final Checkout - Technical Support guidelines and safety information are provided in this chapter.

## Audience Profile

This document is intended for use by authorized technicians experienced with some of similar product types and for personnel requiring guidance for equipment installation, operation, maintenance, and support.

## On-line Documentation

This document is available on-line and within the corresponding [Geist Product Manuals](#). Additional Geist product supporting [Videos](#), [Product Literature](#) and [Case Studies](#) can be found on the [Geist Resource](#) page.

Product firmware updates can be found and downloaded from the [Geist Support](#) site, under [Firmware Updates](#).

Should this product fail within its warranty period and be in need of repair or replacement, a Return Material Authorization may be obtained on-line from the [RMA Form](#) link located within the [Geist Support](#) site.

## Reporting Document Errors

Should you discover any error or identify a deficiency in this document, please take time to contact us at the following email address:

**Geist-Documents@geistglobal.com**

Please be sure to provide us with the document name, part number, and page number(s). Also, please provide us with description of the error or the deficiency for the document. If you would like for us to contact you, please provide us with your name and contact information.

Thank you for your time. We appreciate any comments and feedback you can provide.

## Conventions

The information contained within this document is established around the framework of various conventions, which are defined as follows:

### Software

- Release Management: Product name, Version control ; (GU V 3.0.0)
  - Product Name: Name of Hardware Platform
  - Version control: V(ersion) Platform #, Major #, Minor #

### Hardware

Product Classification

- Power Distribution Unit
  - Basic
  - Monitored only
  - Switched only
  - Monitored + Switched
- Environmental Monitoring
- Cooling
- Data Center Infrastructure Management (DCIM)



Figure 1 Overlay Symbology Guide











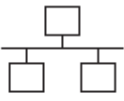

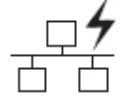

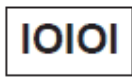



	Ethernet		Activity / Idle
	Power over Ethernet		Power
	Serial		Amps
	Remote Display		Reboot
	Remote Sensors		Silence
	Uplink		Scroll
	Temp		GU Right
	Sensor Configuration		GU Left
		GU Center	

Figure 1 The chart above depicts the symbols used on Geist overlays.

## Safety

This document contains varying levels of alerts pertaining to product and user safety. The alerts are visually presented with graphics and text per Geist equipment guidelines.

The representations are:



### DANGER

INDICATES AN **IMMINENT** HAZARDOUS SITUATION WHICH, IF NOT AVOIDED, WILL RESULT IN **DEATH OR SERIOUS INJURY**.



### WARNING

INDICATES A **POTENTIAL** HAZARDOUS SITUATION WHICH, IF NOT AVOIDED, COULD RESULT IN **DEATH OR SERIOUS INJURY**.



### CAUTION

INDICATES A **POTENTIAL** HAZARDOUS SITUATION WHICH, IF NOT AVOIDED, COULD RESULT IN **PRODUCT DAMAGE AND MINOR TO MODERATE INJURY**.



### NOTE

Provides useful information that is beneficial for operation and usage of this product.

# Figures

Figures presented in this document are identified and designated as follows:

'Figure:', Chapter # - Image #

Example:

Figure 1-1 Name and/or Title goes here

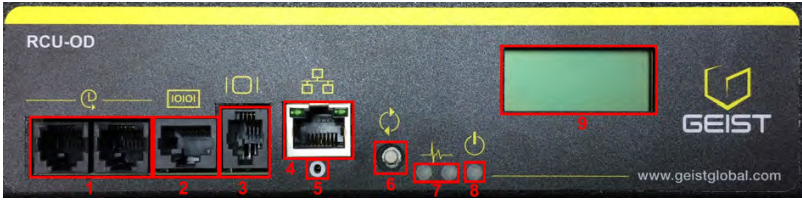

# Tables

Tables presented in this document are identified and designated as follows:

'Table:', Chapter # - Image #

Example:

Table 1-1 Name and/or Title goes here

Column 1	Column 2	Column 3	Column 4	Column 5
Text	Text	Text	Text	Text
Text	Text	Text	Text	Text
Text	Text	Text	Text	Text
Text	Text	Text	Text	Text

# Chapter 1 - Product Specifications

## Product Specifications

### Overview

The Geist Upgradeable (GU) PDU gives data center managers the flexibility to install the intelligence required today, with the option to upgrade technology as needs evolve. From basic power to power monitoring, the Geist Upgradeable product line adapts to a business' needs now and in the future.

To establish this upgrade path, Geist engineers took the robust PDU design and incorporated an Interchangeable Monitoring Device (IMD). Geist PDUs last for many years, and with the IMD design, businesses will be able to upgrade their PDUs to newer monitoring technologies in the future without having to replace the entire PDU. The hot-swappable IMD can be changed out in a few simple steps, without interrupting power to critical servers.

### Environmental

The operational environmental limits pertaining to Temperature, Humidity and Elevation are as defined below.

#### Temperature

Table 1-1 Temperature Limits

	Minimum	Maximum
Operating	10°C (50°F)	45°C (113°F) (standard models) 60°C (140°F) (high temperature models)
Storage	-25°C (13°F)	65°C (149°F)

#### Humidity

Table 1-2 Humidity Limits

	Minimum	Maximum
Operating	5%	95% (non-condensing)
Storage	5%	95% (non-condensing)

#### Elevation

Table 1-3 Elevation Limits

	Minimum	Maximum
Operating	0 m (0 ft)	3,050 m (10,000 ft)
Storage	0 m (0 ft)	15,240 m (50,000 ft)

## Electrical

Electrical product characteristics and performance are defined below. Also, please see the product nameplate for additional rating limits.

## Receptacle Ratings

Table 1-4 Receptacle Ratings

Type	Ratings
NEMA 5-15R or L5-15R	125Vac, 15A
NEMA 5-20R or L5-20R	125Vac, 20A
NEMA 6-20R or L6-20R	250Vac, 20A
NEMA L5-30R	125Vac, 30A
NEMA L6-30R	250Vac, 30A
IEC-60320 C13	250Vac, 10A (UL & CSA 15A, 250Vac)
IEC-60320 C19	250Vac, 16A (UL & CSA 20A, 250Vac)

## Networking

The product communications requirements are identified below.

### Ethernet

The Ethernet link speed for this product is: 10/100 Mb; full duplex.

### Protocols

The communications protocols supported by this product include:  
 ARP, IPv4, IPv6, ICMP, ICMPv6, NDP, TCP, UDP, DNS, HTTP, HTTPS, SMTP, SMTPS, DHCP,  
 SNMP (v1/v2c/v3), and Syslog.

### User Interfaces

This product supports the following user interfaces:  
 SNMP, Web GUI, and JSON API.

## Regulatory Compliance

Geist products are regulated for Safety, Emissions, and Environment Impact per the below agencies and policies.

### Underwriters Laboratories (UL)

UL Standards are used to assess products; test components, materials, systems and performance; and evaluate environmentally sustainable products, renewable energies, food and water products, recycling systems and other innovative technologies.

The UL standards specific to this equipment are as noted on the device nameplate.

### Federal Communications Commission (FCC)

The Federal Communications Commission (FCC) regulates interstate and international communications by radio, television, wire, satellite, and cable in all 50 states, the District of Columbia and U.S. territories. An independent U.S. government agency overseen by Congress, the commission is the United States' primary authority for communications laws, regulation and technological innovation.

The FCC standards specific to this equipment are:

This Class A device complies with part 15 of the FCC Rules. Operation is subject to the following two conditions: (1) This device may not cause harmful interference, and (2) this device must accept any interference received, including interference that may cause undesired operation.

This Class A digital apparatus complies with Canadian ICES-003.

Cet appareil numérique de la classe A est conforme à la norme NMB-003 du Canada.



## WARNING

Changes or modifications to this unit not expressly approved by the party responsible for compliance could void the user's authority to operate this equipment.

### RoHS/WEEE

WEEE stands for Waste from Electrical and Electronic Equipment. WEEE Directive 2002/96/EC mandates the treatment, recovery and recycling of electric and electronic equipment (90% ends up in landfills). All applicable products in the EU market must pass WEEE compliance and carry the "Wheelie Bin" sticker.

RoHS, also known as Lead-Free, stands for Restriction of Hazardous Substances. RoHS, also known as Directive 2002/95/EC, originated in the European Union and restricts the use of six hazardous materials found in electrical and electronic products. All applicable products in the EU market after July 1, 2006 must pass RoHS compliance. RoHS impacts the entire electronics industry and many electrical products as well.

RoHS specifies maximum levels for the following six restricted materials:

- Lead (Pb): < 1000 ppm
- Mercury (Hg): < 100 ppm
- Cadmium (Cd): < 100 ppm
- Hexavalent Chromium: (Cr VI) < 1000 ppm
- Polybrominated Biphenyls (PBB): < 1000 ppm
- Polybrominated Diphenyl Ethers (PBDE): < 1000 ppm
- Bis(2-Ethylhexyl) phthalate (DEHP): < 1000 ppm
- Benzyl butyl phthalate (BBP): < 1000 ppm
- Dibutyl phthalate (DBP): < 1000 ppm
- Diisobutyl phthalate (DIBP): < 1000 ppm

See product label for RoHS/WEEE compliance marks.

## Chapter 2 - Installation

### Pre-Installation

- For standard temperature models, the ambient temperature of the installation location, such as an IT rack, should be no greater than 45°C if the PDU is loaded to its full nameplate current rating. The ambient temperature of the installation location should be not greater than 60°C if the PDU normal current load is a maximum 50% of the nameplate and individual receptacle ratings. (Note: load up to full nameplate rating are permitted during short term abnormal operating conditions).
- Install the PDU such that the amount of airflow required for safe operation of equipment is not compromised.
- Mount the PDU so that a hazardous condition is not achieved due to uneven mechanical loading.
- Follow nameplate ratings when connecting equipment to the branch circuit. Take into consideration the effect that overloading of the circuits might have on overcurrent protection and supplied wiring.
- The PDU relies on the building installation for protection from overcurrent. A certified overcurrent protection device is required in the building installation. The overcurrent protection device should be sized according to the PDU's nameplate ratings and local/national electrical code.
- Reliable earthing of rack-mount equipment should be maintained. Particular attention should be given to supply connections other than direct connections to the branch circuit. The PDU must be connected to an earthed socket outlet.
- PDU is intended for restricted-access locations. Only qualified service personnel should install and access the PDU.
- For pluggable equipment, install the PDU so the input plug or appliance coupler may be disconnected for service.
- The PDU is intended for indoor use only. Do not install the unit in wet or outdoor environments, and do not install it next to water tanks or plumbing.
- The PDU is intended for use with TN, TT, or IT power supply systems.



## Installation

1. Using appropriate hardware, mount unit to rack. See next section for examples.
2. Plug PDU into an appropriately-rated and protected branch-circuit receptacle.
3. Plug in the devices to be powered by the PDU.
4. Turn on each device connected to the PDU. Sequential power-up is recommended to avoid high inrush current.

## Mounting

Optional brackets sold separately.

### Full Length Brackets

Figure 2-1 Full Length Bracket

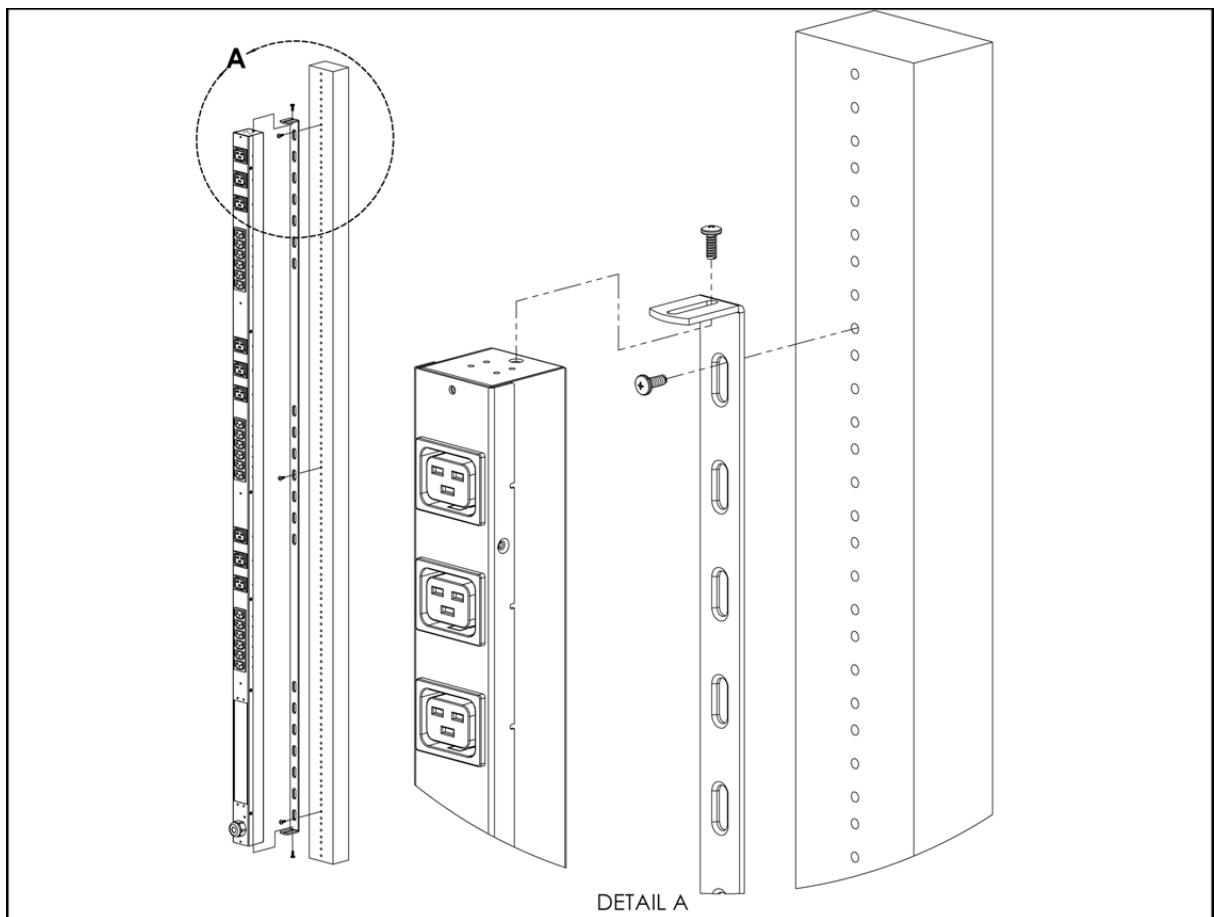

### Mini "L" Brackets (SLB-4)

Figure 2-2 Mini L Brackets

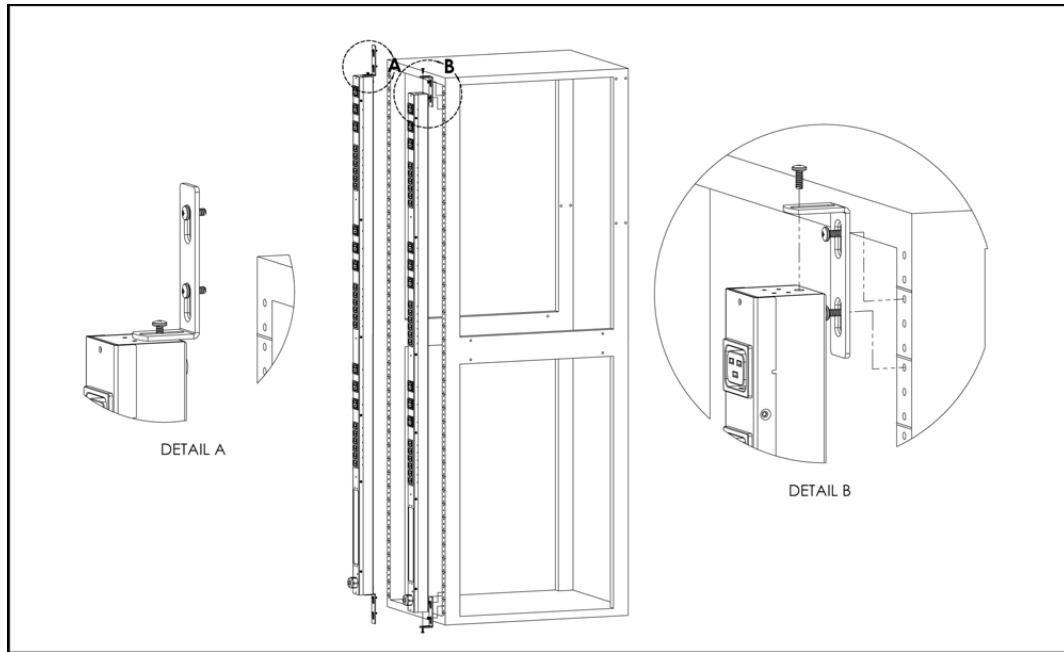

### Vertical Extension Brackets (VCB-1)

Figure 2-3 Vertical Extension Brackets

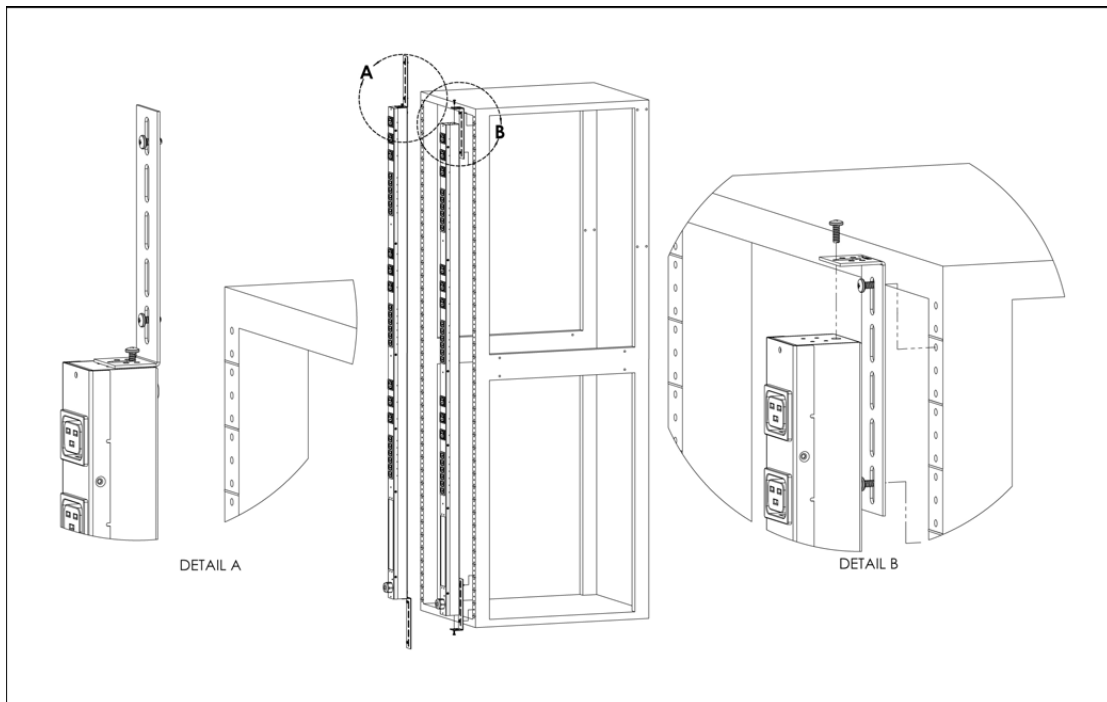

### Toolless Mounting Hardware (11621)

Figure 2-4 Toolless Mounting Hardware

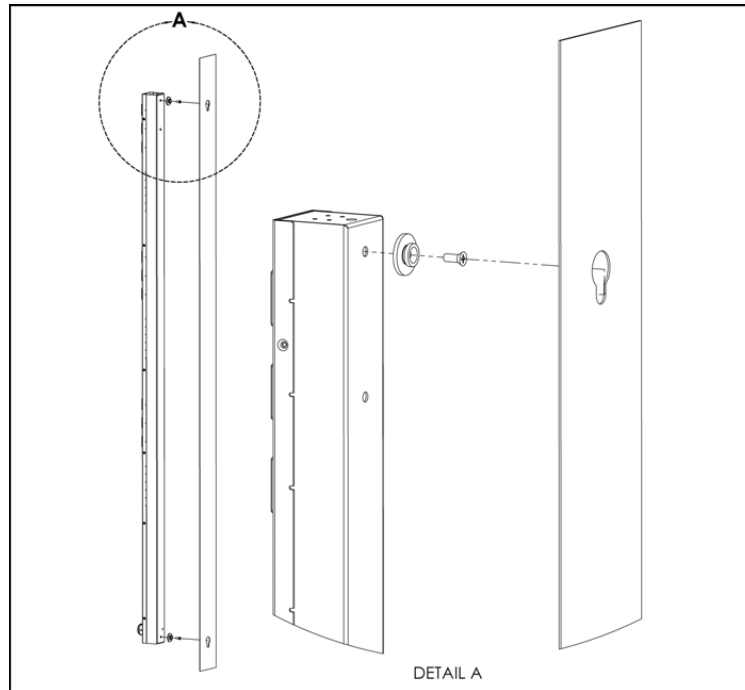

### Toolless Full Length Brackets (TLFL)

Figure 2-5 Toolless Full Length Brackets

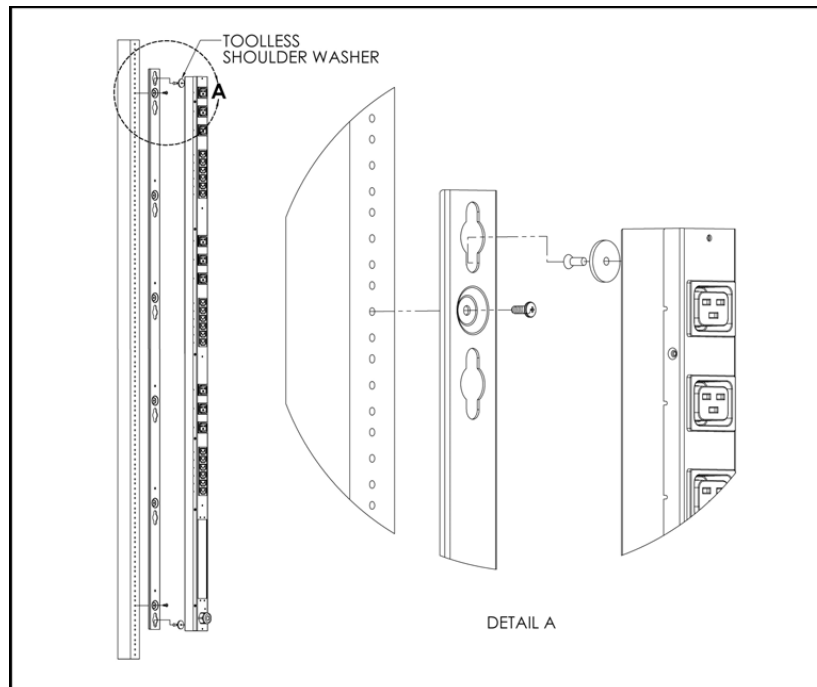

## Single Side Mount 2 Unit Brackets (TSMX2)

Figure 2-6 Single Side Mount 2 Units Brackets

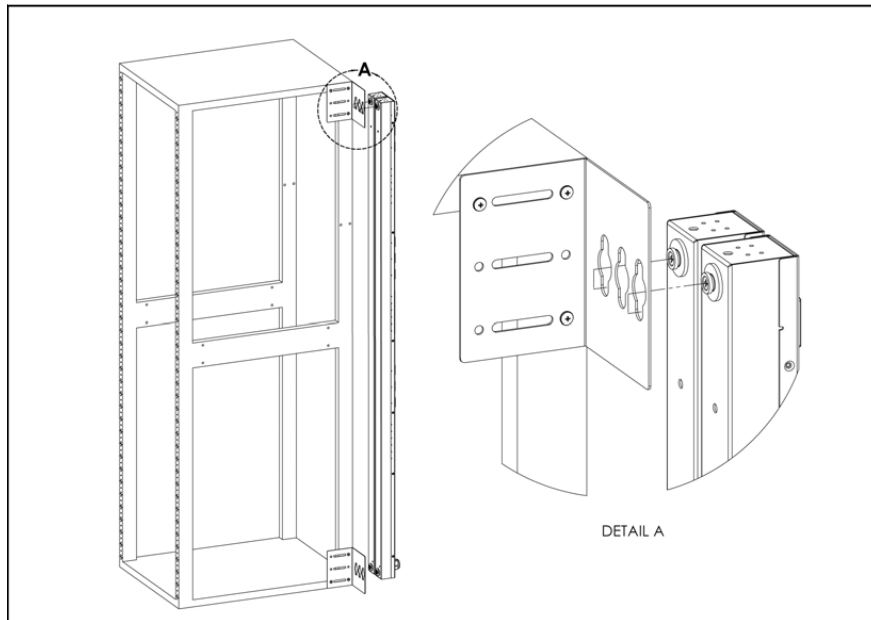

## Offset/Side Mount Brackets (EZB-1)

Figure 2-7 Offset/Side Mount Brackets

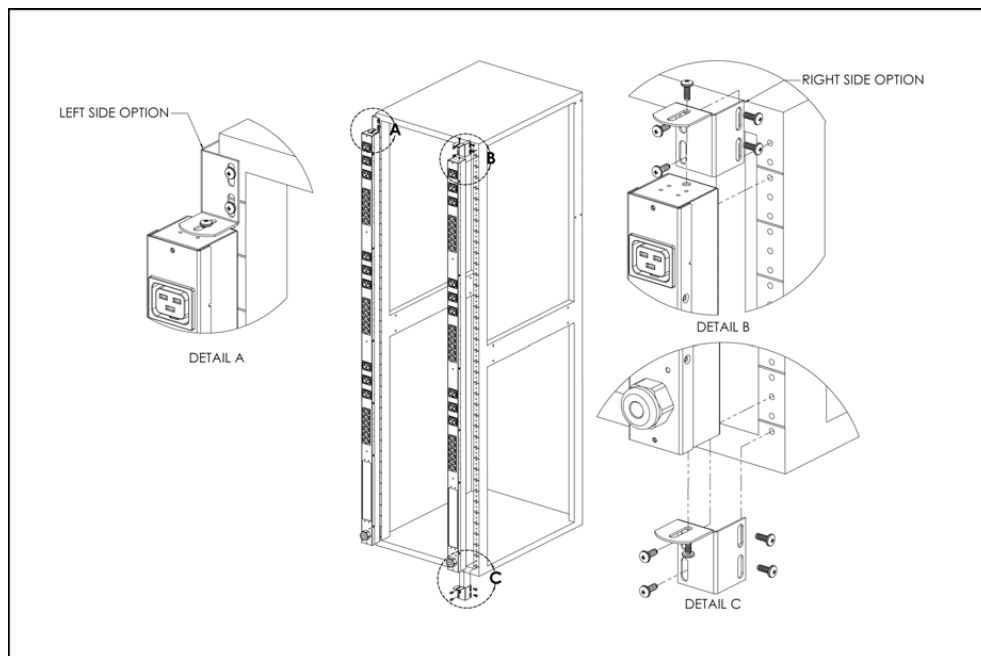

## 7" Extension Brackets (XB-7)

Figure 2-8 7" Extension Brackets

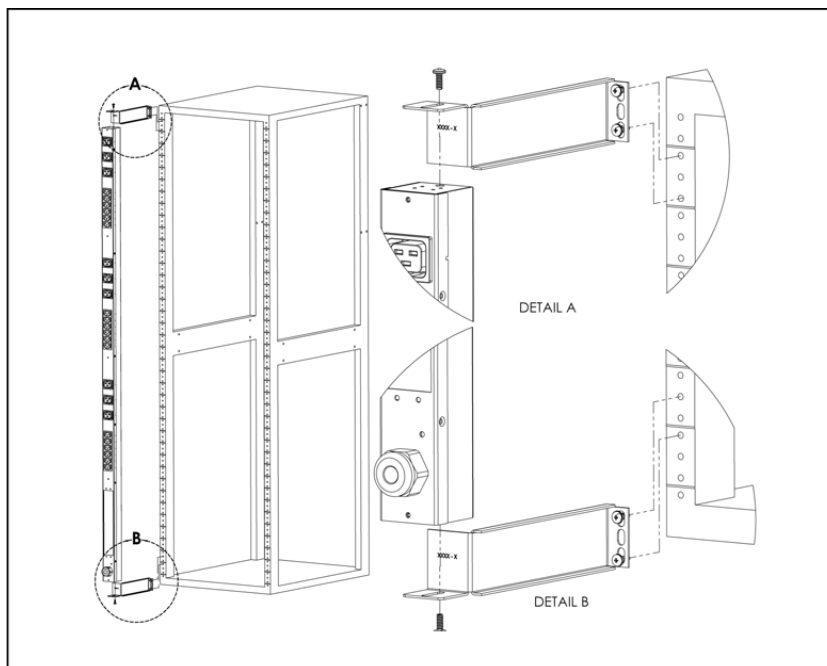

## Flush Mount Brackets (FM)

Figure 2-9 Flush Mount Brackets

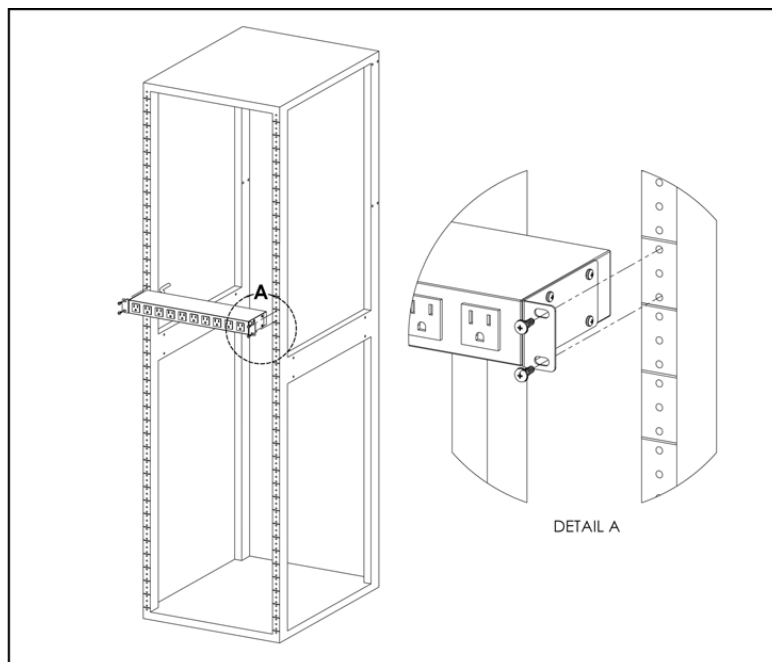

### Adjustable Mount Brackets (AM)

Figure 2-10 Adjustable Mount Brackets

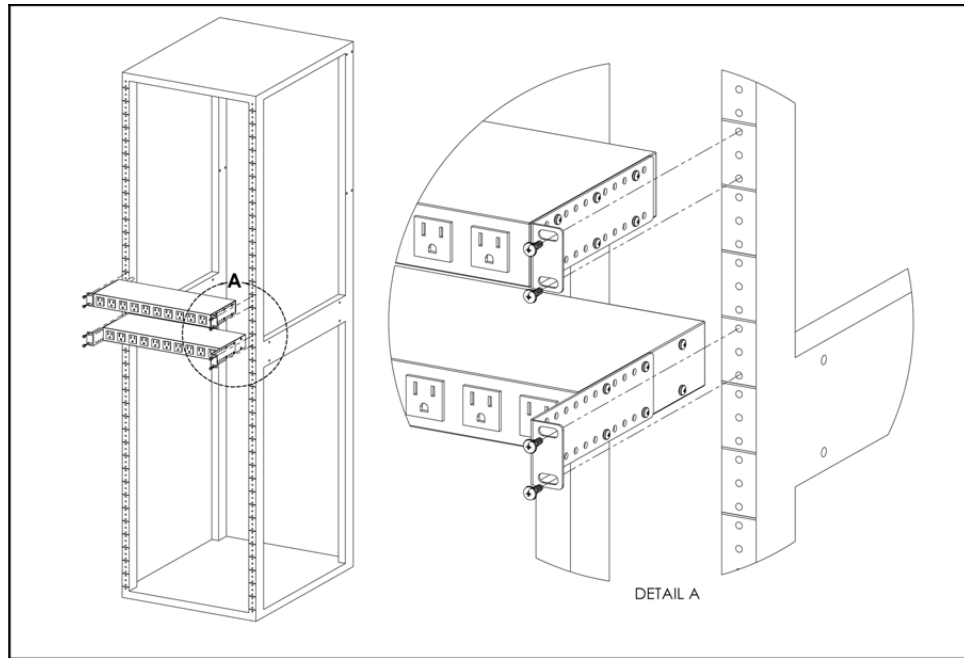

### Panel Mount Brackets (PM)

Figure 2-11 Panel Mount Brackets

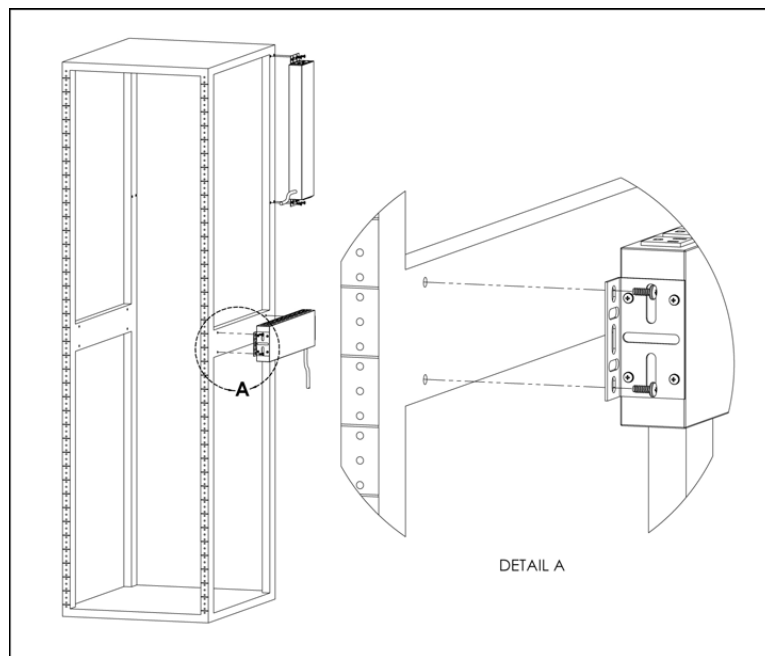

### 23" Conversion Mounting Brackets (23-RM)

Figure 2-12 23" Conversion Mounting Brackets

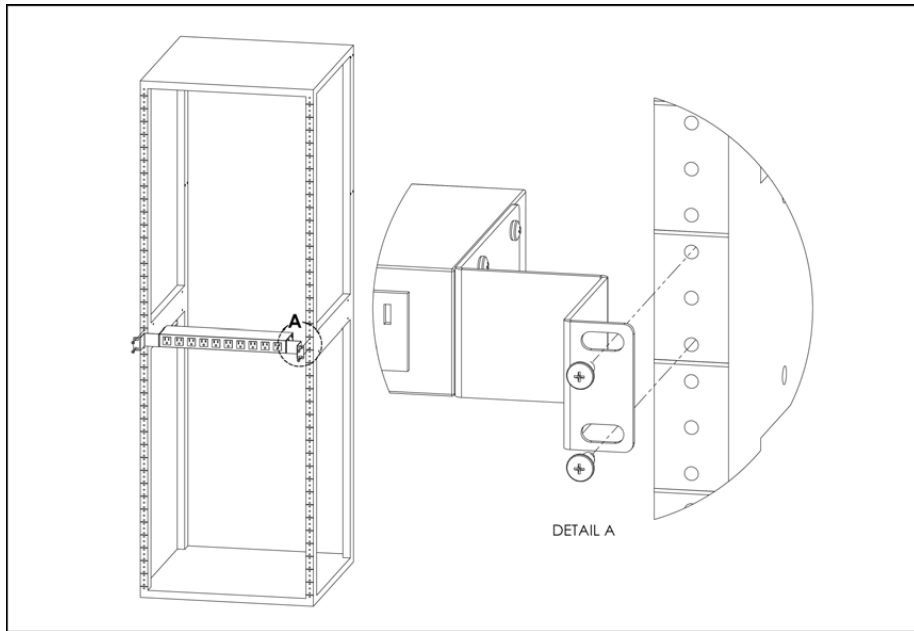

### Cable Mount Brackets (CMB-1)

Figure 2-13 Cable Mount Brackets

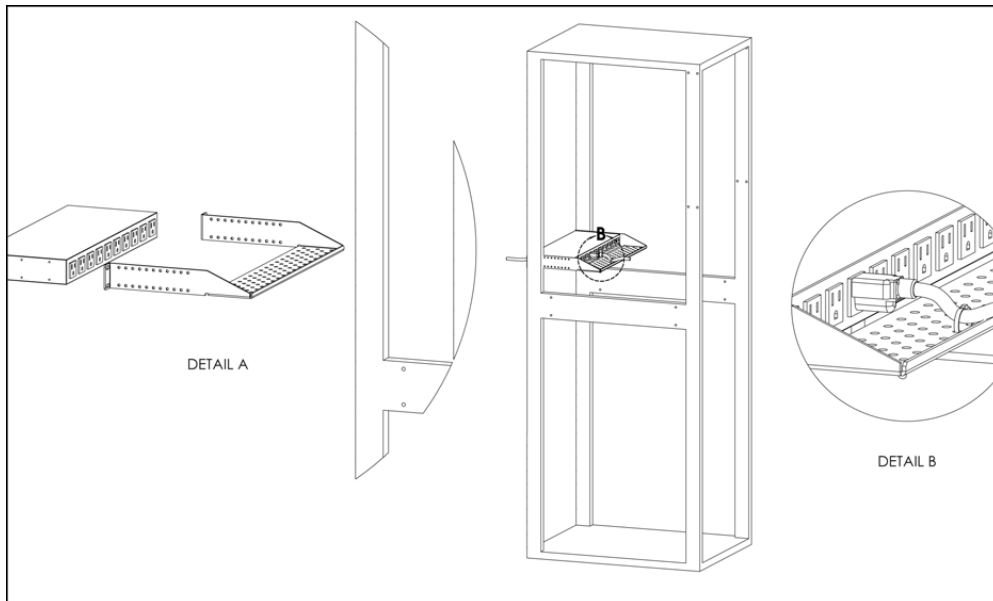



### 19" Horizontal/Panel Mount Brackets (7938)

Figure 2-14 19" Horizontal/Panel Mount Brackets

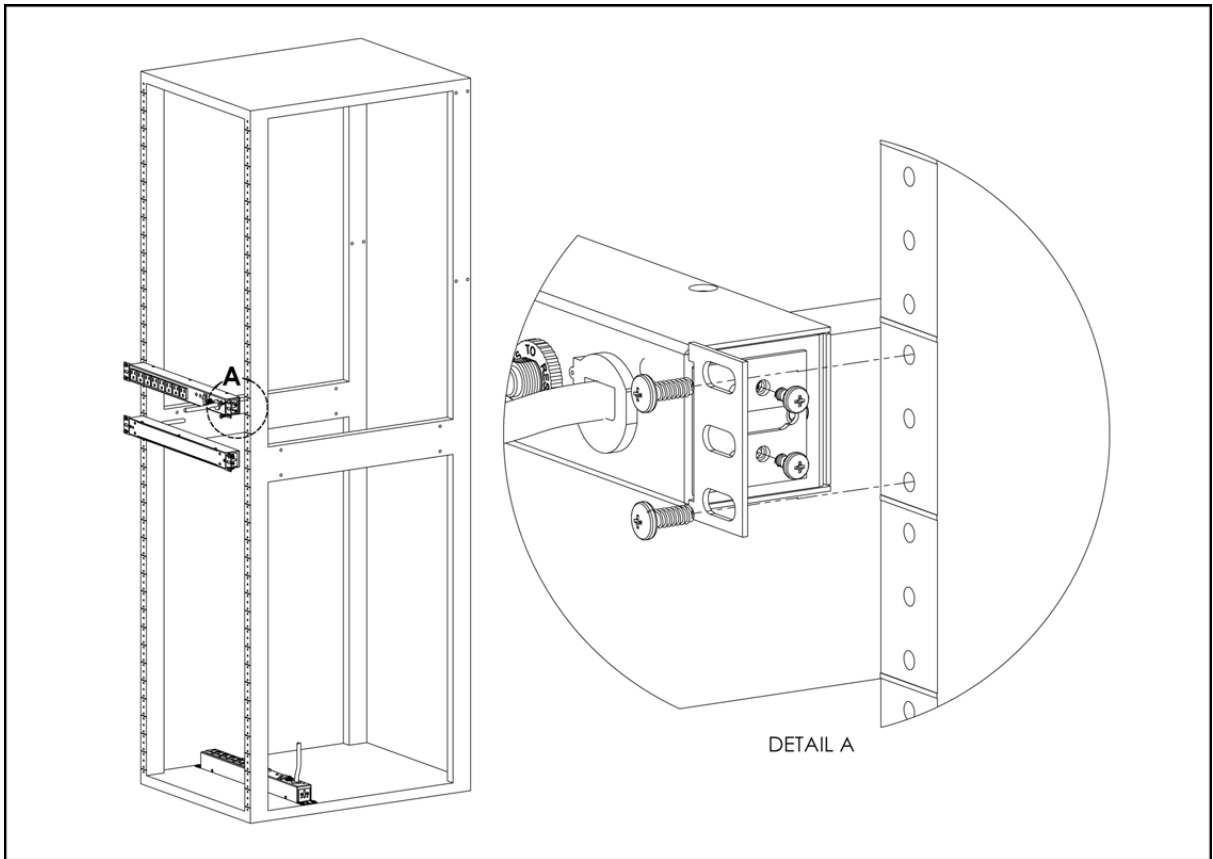

## Network Setup

The Monitored Geist Upgradeable PDU has a default IP address for initial setup and access. Once you have assigned an IP address, the default IP address will no longer be active. To restore the default IP address and reset all user-account information, if the user-assigned address or passwords are lost or forgotten, press and hold the network-reset button located below the Ethernet port for 15 seconds. Holding the center button of the LED display for 10 seconds will also reset the network and user account information.

To completely erase ALL of the user settings and restore the unit back to its factory-default state, disconnect power from the PDU, then press and hold the network-reset button while powering up the PDU.

The Network page (located under the System Tab) allows you to assign the network properties manually, or use DHCP to connect to your network. Access to the unit requires the IP address to be known. Use of a static IP or a reserved DHCP is recommended. The default address is shown on the front of the unit:

Table 2-15 Default IP Address

IP Address:	192.168.123.123
Subnet Mask:	255.255.255.0
Gateway:	192.168.123.1

To access the unit for the first time, you will need to temporarily change your computer's network settings to match the 192.168.123. xxx subnet. To set up the unit, connect it to your computer's Ethernet port, then follow the appropriate instructions for your computer's operating system.

### Windows

- **Windows 2000 / XP / Server 2003:**

Click the **Start** button, choose **Settings**, then **Network Connections**.

- **Windows 7 / Server 2008:**

Click the **Start** button, then choose **Control Panel >> Adjust Your Computer's Settings >> View Network Status and Tasks >> Change Adapter Settings**.

(Alternatively, on some Windows 7 machines, this may be **Start**, then **Settings >> Control Panel >> Network and Sharing Center >> Change Adapter Settings**.)

- **Windows 8 / Server 2012:**

Move the mouse cursor to the bottom or top right corner of the screen, click the **Settings** icon, then select **Control Panel**. Change the view type from **Category** to **Large** or **Small Icons** if necessary, then select **Network and Sharing Center**, then **Change Adapter Settings**.

- **Windows 10:**

Click the **Start** button, then choose **Network & Internet**, then click **Change adapter options**.

Locate the entry under **LAN or High-Speed Internet** or **Local Area Connection** which corresponds to the network card (NIC).



## NOTE

Most computers will have a single Ethernet NIC installed, but a WiFi or 3G adapter will also show as a NIC in this list, so be sure to choose the correct entry.

Double-click on the network adapter's entry in the **Network Connections** list to open its status dialog box, then click the **Properties** button to open the **Local Properties** window.

Figure 2-16 Local Area Connection Properties

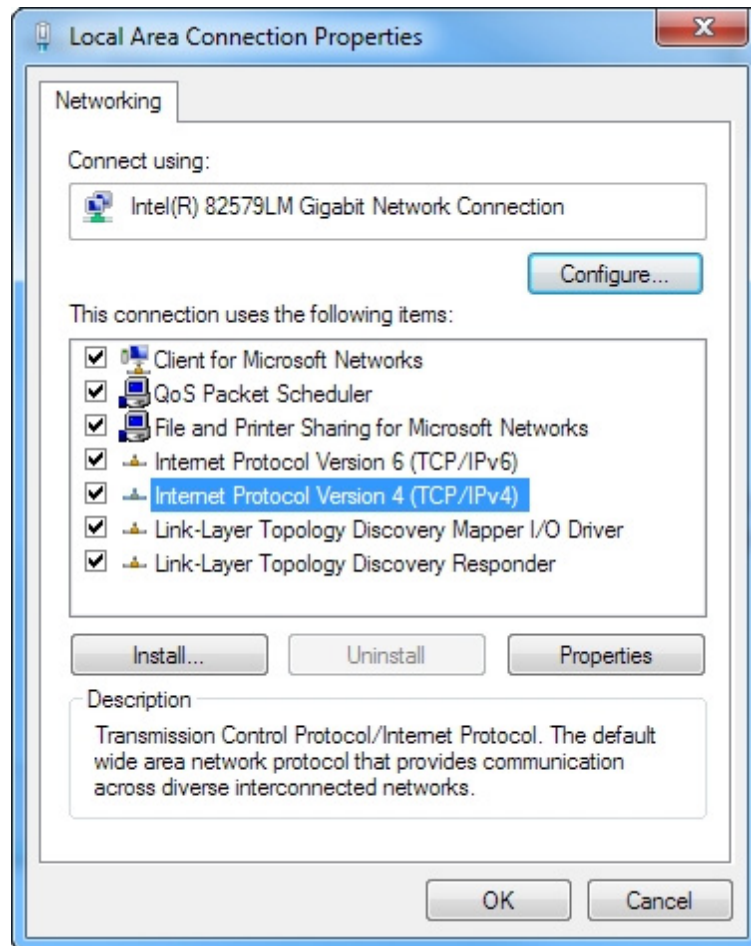

Find the entry titled "**Internet Protocol Version 4 (TCP/IPv4)**" in the list, then click the **Properties** button to open the **Internet Protocol Properties** window. If you see more than one TCP/IP entry, as in the example above, the computer may be configured for IPv6 support as well as IPv4; make sure to select the entry for the IPv4 protocol. Write down the current NIC card settings so you can restore them to normal after you have completed the setup procedure.

Figure 2-17 Internet Protocol Version 4

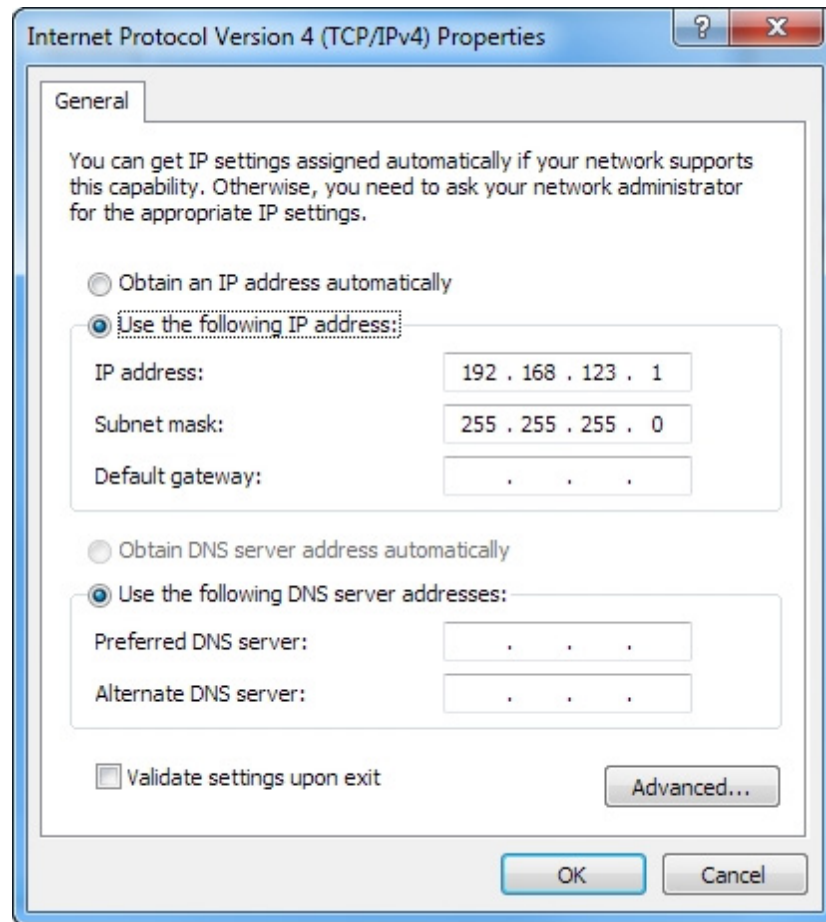

Choose the **Use the following IP address** option, then set **IP address** to 192.168.123.1 and **Subnet Mask** to 255.255.255.0. For this initial setup, **Default Gateway** and the **DNS Server** entries can be left blank. Select **OK**, then **OK** again to close both the **Internet Protocol Properties** and **Local Properties** windows.

Once the NIC settings are configured properly, you should be able to access the unit by typing `http://192.168.123.123` into the address bar of your web browser. If you are setting up the unit for the first time, or if the unit has been reset back to factory defaults via the network-reset button, the unit will require you to create an Admin account and password before you can proceed.

Once you have created an Admin account and have logged into it, the unit's default **Sensors** page should come up by default. Navigate to the **System** tab, then the **Network** page to configure the device's network properties. The unit's IP Address, Subnet Mask, Gateway, and DNS settings can either be assigned manually, or acquired via DHCP.

Note that the new settings will take effect when the **Save** button is clicked. The browser will no longer be able to reload the web page from the 192.168.123.123 address and will probably display a "page not found" or "host unavailable" message. This behavior is normal. Once you have finished configuring the unit's IP address, simply repeat the steps above, and change the computer's Ethernet NIC card settings back to the ones you wrote down prior to changing them, to restore its normal network and internet settings.

## Mac

Click the **System Preferences** icon on the Dock, and choose **Network**.

Figure 2-18 Mac System Preferences

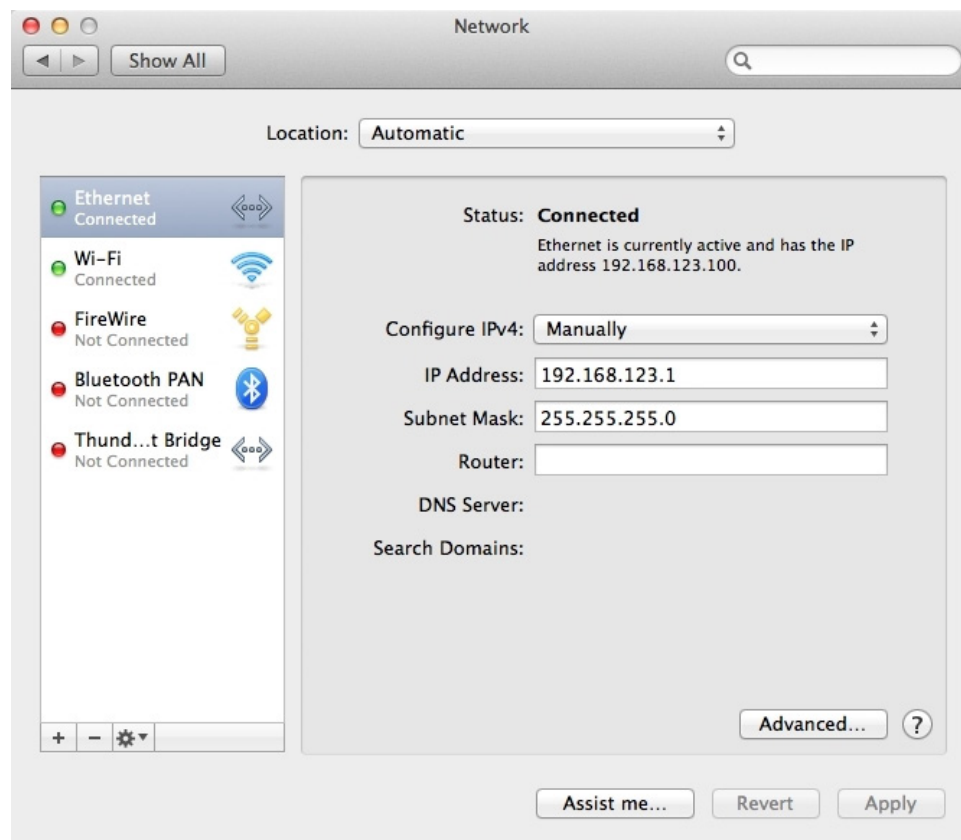

Be sure **Ethernet** is highlighted on the left side of the NIC window. In most cases, there will be one Ethernet entry on a Mac. Write down the current settings so you can restore them to normal after you have completed the setup procedure.

Select **Manually** from the **Configure IPv4** drop-down list, then set **IP Address** to 192.168.123.1 and **Subnet Mask** to 255.255.255.0. (The **Router** and **DNS Server** settings can be left blank for this initial setup.) Click **Apply** when finished.

Once the NIC settings are configured properly, you should be able to access the unit by typing `http://192.168.123.123` into the address bar of your web browser. If you are setting up the unit for the first time, or if the unit has been reset back to factory defaults via the network-reset button, the unit will require you to create an Admin account and password before you can proceed.

Once you have created the Admin account and logged into it, the unit's default **Sensors** page should come up by default. Navigate to the **System** tab, then the **Network** page to configure the device's

network properties. The unit's IP Address, Subnet Mask, Gateway, and DNS settings can either be assigned manually, or acquired via DHCP.

The new settings will take effect when the **Save** button is clicked, so the browser will no longer be able to reload the web page from the 192.168.123.123 address and will probably display a "page not found" or "host unavailable" message. This behavior is normal. Once you have finished configuring the unit's IP address, simply repeat the steps above, and change the computer's Ethernet NIC card settings back to the ones you wrote down prior to changing them, to restore its normal network and internet settings.

## Chapter 3 - Setup

### Interchangeable Monitoring Device

The Interchangeable Monitoring Device (IMD) is the core behind the Geist Upgradable line of power products. The IMD can be replaced and upgraded to allow data-centers to future-proof their locations.

#### **Basic**

The Basic Geist Upgradable PDU is the baseline for the GU line of products. It is built with the IMD-01X module, and provides low cost power distribution with the option to upgrade to add local metering and/or remote monitoring and other features in the future.







#### **Metered**

The Metered Geist Upgradable PDU is a locally metered option for the GU line of products. It is built with the IMD-01D module, and provides a local display for viewing current draw (Amps) and power (Kilowatts), with the option to upgrade to add monitoring and other features in the future.

Figure 3-1 IMD-01D Module



1. **Local Display:** The local display will display the phase, line, and circuit current values (in Amperes).
2. **Display Buttons:** There are three buttons near the IMD display; a back button, a forward button, and a center button. The functions of these buttons are as follows:

<u>Back Button</u>		Decrement to the previous channel.
<u>Forward Button</u>		Increment to the next channel.
<u>Center Button</u>		Toggle between scrolling and static display modes. Holding this button for 10 seconds will perform a network reset, restoring the default IP address and resetting user account information.
 and 		Flip the display 180 degrees. Both buttons must be pressed at the same time.
 x 3		Enable VLC* mode by pressing the center button three times within 2 seconds. Pressing the button while VLC mode is active will return the unit to the standard Current display.

\*See VLC section of manual for more information on this feature.

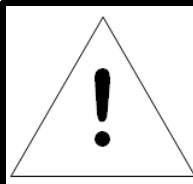

## NOTE

Display Button functionality may vary based on unit configuration.

### Monitored

The Monitored Geist Upgradable PDU is an advanced option for data centers that need full remote monitoring and alarms. It is built with the IMD-02E module, which provides dual Ethernet ports and a local display. **Highlighted in Red below:**

Figure 3-2 IMD-02E Module

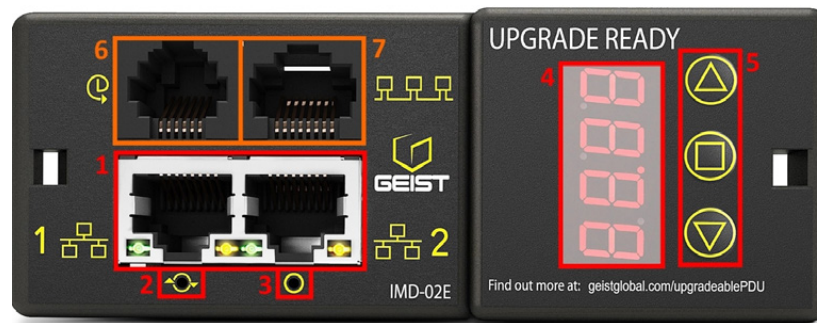

- Dual Ethernet Ports:** The Dual Ethernet ports act as a 2-port Ethernet switch, allowing for multiple devices to be daisy-chained.
- Hard-Reboot Button:** Pressing the hard-reboot button reboots the IMD. This acts as a power-cycle for the IMD, and does not change or remove any user information.
- Network-Reset Button:** Holding the network-reset button for 15 seconds during normal operation will restore the default IP address and reset the user accounts. Holding the network-reset button during power-up will reset all of the unit's settings back to factory-default values.
- Local Display:** The local display will display the phase, line, and circuit current values (in Amperes).
- Display Buttons:** There are three buttons near the IMD display; a back button, a forward button, and a center button. The functions of these buttons are as follows:

Back Button



Decrement to the previous channel.

Forward Button



Increment to the next channel.

Center Button



Toggle between scrolling and static display modes. Holding this button for 10 seconds will perform a network reset, restoring the default IP address and resetting user account information.



Flip the display 180 degrees. Both buttons must be pressed at the same time.



Display the unit's primary IPv4 address. Both buttons must be pressed at the same time.





Enable VLC\* mode by pressing the center button three times within 2 seconds. Pressing the button while VLC mode is active will return the unit to the standard Current display.

\*See VLC section of manual for more information on this feature.



## NOTE

Display Button functionality may vary based on unit configuration.

### Enhanced Monitored

The Enhanced Monitored Geist Upgradable PDU is a more advanced option for data centers that need full remote monitoring, alarms and remote sensors. It is built with the IMD-02E module, which provides dual Ethernet ports, a local display and a RJ12 port for remote sensors. **Highlighted in Red above.**

6. **Remote Sensor Port** : RJ12 port for connecting a Geist plug-and-play remote digital sensor (sold separately). Each digital sensor has a unique serial number and is automatically discovered. GU Enhanced Monitored PDUs support one sensor at a time. The optional Geist A2D Converter can be added to support analog sensing.



## NOTE

When changing sensors the old sensor must be deleted before the new sensor will be discovered.

7. **Proprietary Connectivity** : RJ12 port for future expansion.

### Rapid Spanning Tree Protocol (RSTP)

Geist Upgradable monitored devices, built with the IMD-02E include two Ethernet ports which work together as an internal Ethernet bridge. One of these ports can be used to connect the IMD to an existing network, or both ports can be used at the same time to connect one IMD to another in a daisy-chain configuration.

When both network interfaces are connected, the IMD implements a network bridging protocol called the Rapid Spanning Tree Protocol (RSTP). RSTP is an IEEE standard that is implemented by all managed bridges. Using RSTP, bridges in the network exchange information to find redundant paths, or loops.

When a loop is detected, the bridges in the network work together to temporarily disable the redundant paths. This allows the network to avoid broadcast storms caused by the loops. In addition, RSTP

regularly checks for changes in the network topology. When a connection is lost, RSTP allows the bridges to quickly switch to a redundant path.



## NOTE

RSTP protocol imposes a limit of 40 links between bridges, including IMDs.

### Visible Light Communication (VLC)

The VLC feature on Geist Upgradeable PDUs allows the user to unobtrusively upload product information into a database management system via the embedded LED display. This product feature provides new opportunities to monitor and enable larger amounts of PDU power data to be obtained via the unit's display, and all without physically connecting to the PDU.

Using a smart device, such as a smart phone or tablet with the Geist Mobile app installed, it is possible to capture data from the LED display when running in VLC mode, which can be enabled/disabled easily by using the display buttons on the device, or using the GUI on monitored units.

By default, the Geist Upgradeable LED display will provide the Current (Amps) per input and circuit/breaker. By enabling the VLC feature, the LED Display will scroll through a set of alpha-numeric characters. Utilizing the Geist Mobile app the user can scan the LED display and retrieve additional power metrics which include Volts, Amps, Watts, Volt-Amps and Kilowatt Hours. Before VLC, the power data was only available on network connected PDUs by viewing the GUI, or using external software to collect and display the data. The VLC feature provides this data on local metered only devices, as well as on monitored units without the need to connect them to the network.



## NOTE

To Enable VLC – Press the center square  **button** three times in under 2 seconds as shown in the IMD section - Please see the Interchangeable Monitoring Device and/or Display section for additional information regarding how to enable/disable VLC mode.



## NOTE

With the release of firmware version 3.3.0, Geist has added support for the VLC feature to all standard Metered and Monitored Geist Upgradeable products, as well as a significant majority of its engineered-to-order range. Certain custom models of Geist Upgradeable PDUs may not have VLC support within the Geist Mobile application. If your custom product is not supported by the Geist Mobile app it will be noted in the product specification sheet. Please contact your sales representative if you would like assistance with this.

Latest firmware updates can be found at  
<http://www.geistglobal.com/support/firmware>.



## NOTE

Geist Mobile app currently available via the App Store for iOS devices. Android version is under development and will be available in the Play Store at a later date.

## **Geist Mobile App**

The Home screen allows the user to initiate a device scan or export data via .csv file.

---

Figure 3-3 Mobile App Home Screen

---

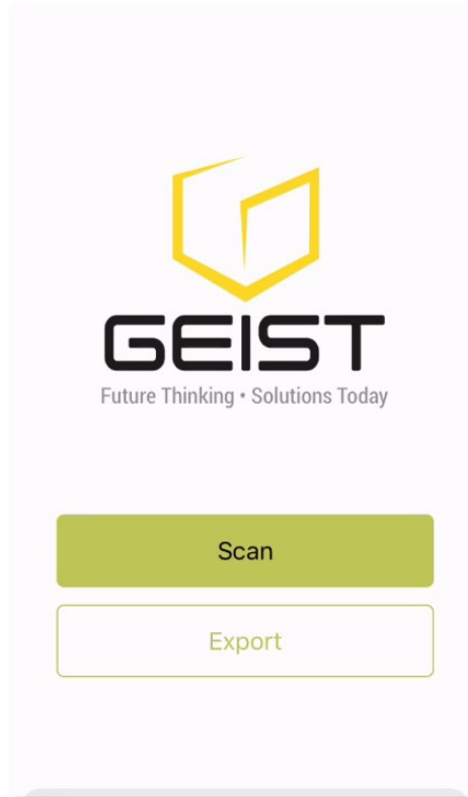

- **Scan:** Turns on scan mode to allow the app to capture VLC data from Geist Upgradeable PDU.
- **Export:** Pressing the export button will launch the smart device's email app and attach the Database .csv file to be emailed to desired recipients.

## Scanning a PDU

Pressing the **Scan** button on the **Home** screen will load the Geist Mobile app scanning engine.

Figure 3-4 Mobile App Scanning Screen

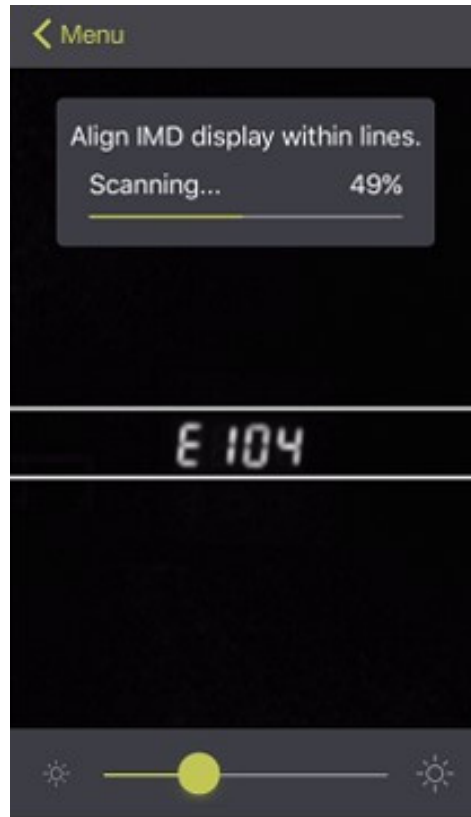

To scan the PDU, position the smart device so that the characters on the LED display are between the lines on the screen.

- The LED characters should be clear and in-focus. If the characters appear too bright or too dark, the exposure setting can be adjusted by using the sliding bar at the bottom of the screen.
- The app will begin to capture data as soon as it can see the LED characters inside the horizontal lines. Scan progress is displayed as a percentage. If the scan percentage is increasing slowly, or resetting, the device is having trouble reading the data properly. In this case, try repositioning the device to improve results.
- After the scan reaches 100% the app will load the **Readings** page.



### NOTE

When a device is scanned for the first time, the Geist Mobile app will recognize the serial number as being new and ask if it should be added to the database as shown below. If added to the database, all future scanned data will be added to the device serial number record.

Figure 3-5 Mobile App New Device Screen

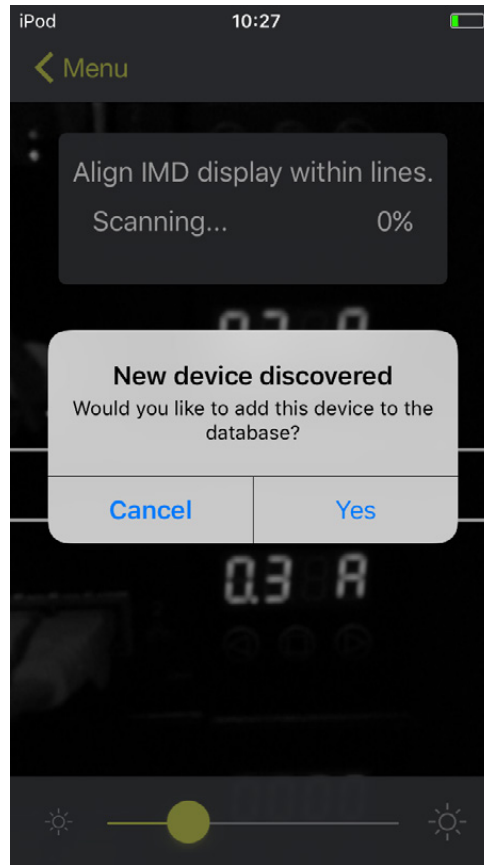

### Scanning tips:

The VLC feature relies upon light for its communication. If the lighting around the display or the lighting going through the lens of the smart device is not optimal then the OCR (Optical Character Recognition) will struggle to capture the data. When looking at the smart device screen during capture, you can see if the characters of the LED display are in focus and bright, if they are blurred, with a surrounding glow or are faint then the VLC capture will fail to work quickly and may be unable to scan at all.

## Proper capture methods:

Figure 3-6 Mobile App Capture Screen

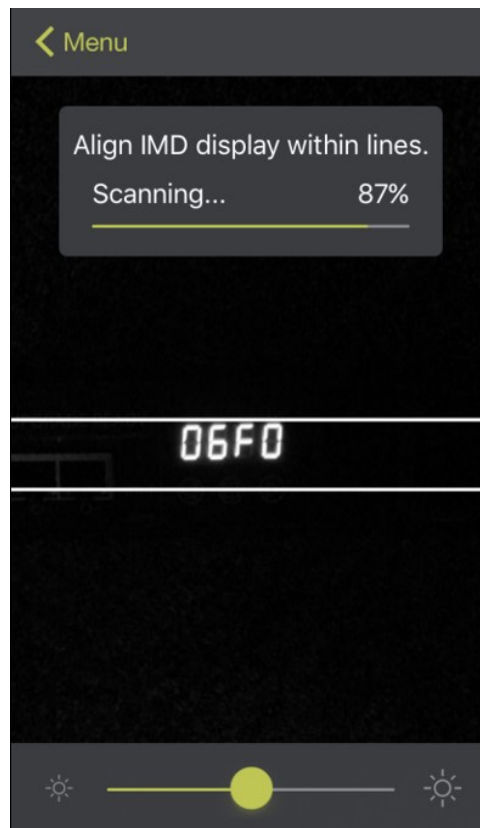

- High Contrast between LED display and background
- No glow around LED display characters
- LED display characters between horizontal guidelines

## Improper capture methods:

Figure 3-7 Mobile App Capture Misalignment

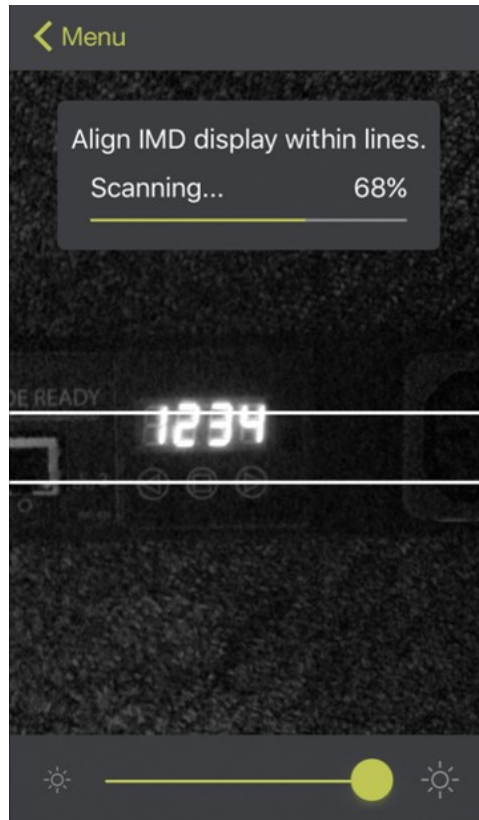

- Blurry image
- Over-exposed image
- Glow around LED display characters
- LED display characters not between horizontal guidelines



**Failure modes & Error messages:**

The Geist Mobile App will retry a scan 2 times if the scan cannot be completed. The scan can fail due to the smart device being unable to correctly capture all the VLC data correctly. If the app cannot properly capture the data, it will retry twice, or display one of the following messages:

Figure 3-8 Mobile App Scan Fail

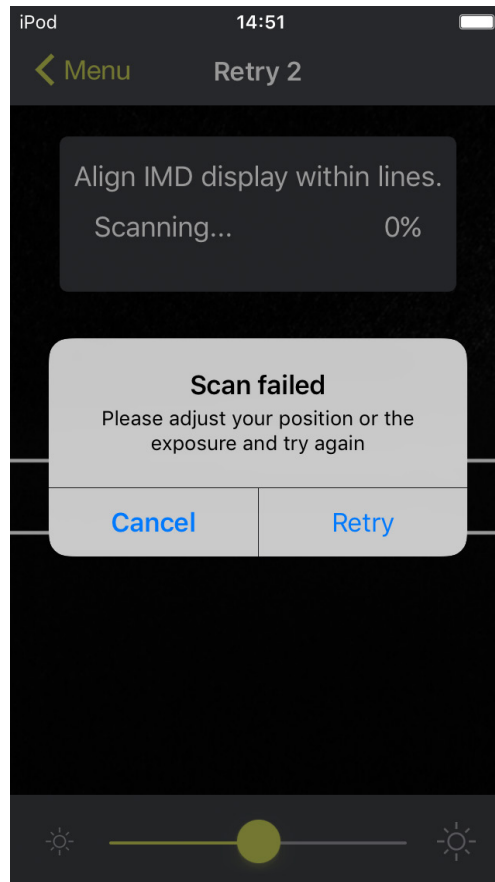

- Scan failed: Incorrect set configuration
- Scan failed: Incorrect data sequence
- Scan failed: Please adjust your position or the exposure and try again

Press cancel to return to the **Home** screen, or retry to return to the **Scan** page

## Readings

The **Readings** page displays scan results for each PDU scanned using VLC.

Figure 3-9 Mobile App Readings Screen

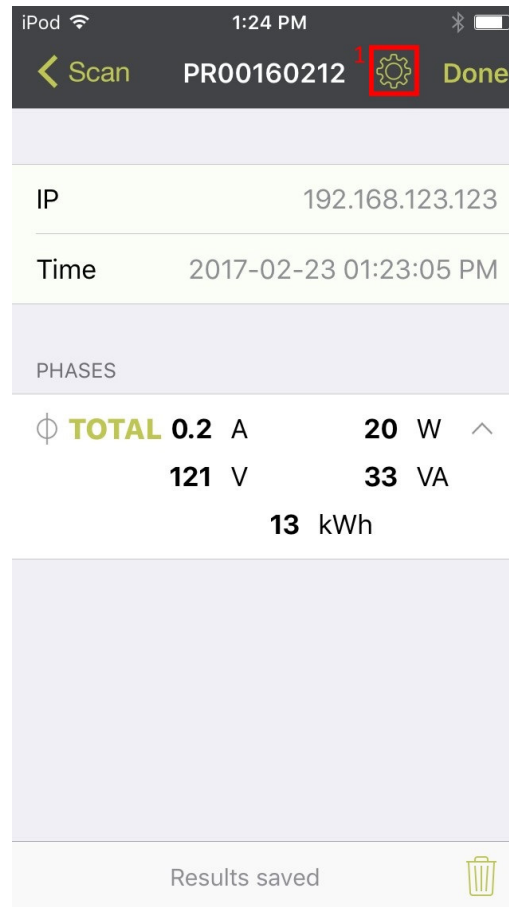

1. Pressing the Settings  button will enable the user to customized the data that is displayed in the scan results.



### NOTE

The unit serial number is displayed in the title bar of the **Readings** page. This serial number will match the serial number located on the surface of the PDU.

Figure 3-10 Mobile App Settings Screen

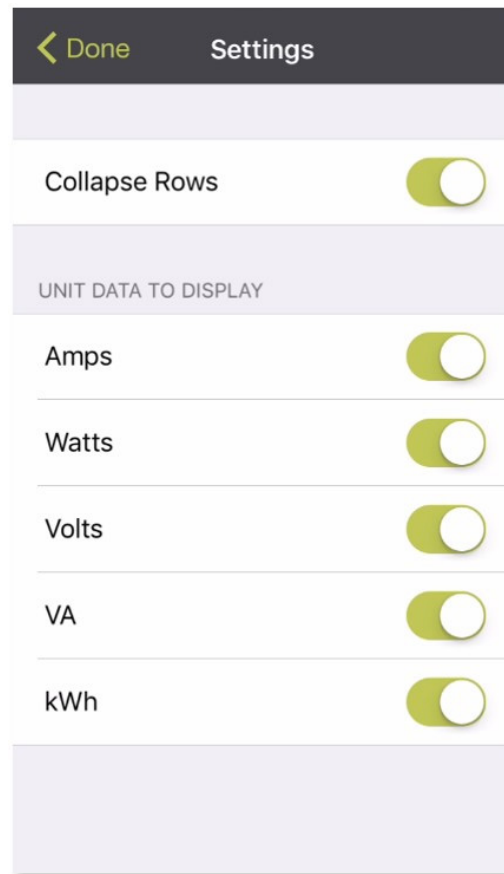

- **Collapse Rows:** Allows user to collapse or expand the **Readings** page to help properly display data on smart devices with smaller screens.
- **Unit Data to Display:** Selects which data is shown on the **Readings** page. All data is stored within the database regardless of settings here. These settings are global and will apply to any scanned unit.

## Export

The **Export** button on the **Home** screen will open the smart device's default email app to send the database of scanned devices in .csv format to the desired recipients.

Figure 3-11 Mobile App Export Screen

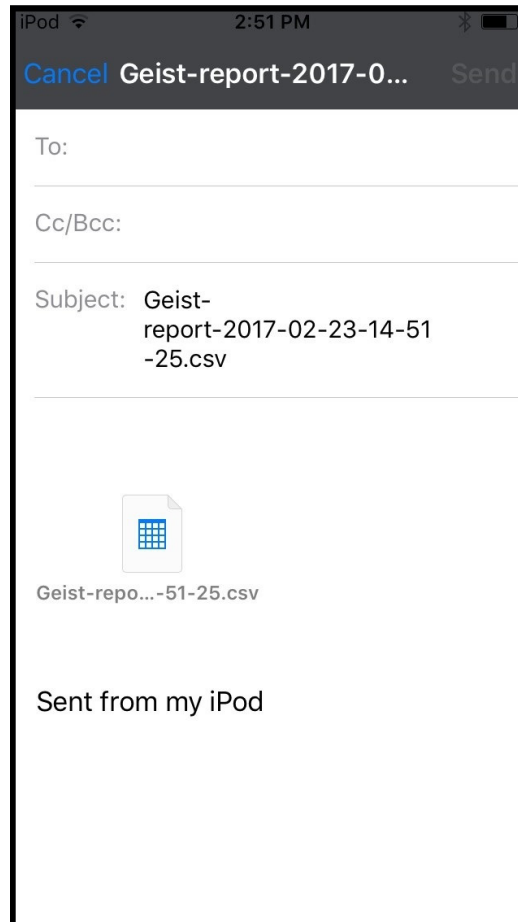

### NOTE

An email app must be properly configured on the smart device to utilize the Export function. The Geist Mobile app does not directly support email functionality. Geist cannot troubleshoot email errors as this would be an issue with either the device, or email service being used.

Each PDU you scan adds a new entry to the database, there is no limit to the number of individual PDU's that can be added but the database has a limit of 10 scans per PDU. Additional scans of the unit will over-write the oldest data for that unit.

The **.csv** data output organizes data first by serial number and then by date & time. You can further organize the data by using the 'Filter' option in Excel.

The data structure is split into two sections:

1. PDU configuration data includes:

- Serial Number
- Frame Definition
- Date/Time stamp
- IPv4 address

2. Power Data includes:

- Power Readings
- Totals

Table 3-1 CSV Data

<b>PDU Configuration Data</b>			
<b>Serial#</b>	<b>FrameDef</b>	<b>YYYY-MM-DD-HH-MM-S</b>	<b>IP Add</b>
Products unique serial number. This is the same serial number present on the units label.	Part of the VLC configuration data and used for debugging.	Timestamp of when the scan occurred.	The IPv4 address of the unit. Locally Metered units will show Null IP address.

<b>Power Data</b>				
<b>1 Volts</b>	<b>1 Amps</b>	<b>1 Watts</b>	<b>1 VA</b>	<b>1 kWh</b>
Input Phase for Single Phase units. Phase A or Phase AB if 3 Phase	Phase Amperes	Phase Real Power	Phase Apparent Power	Phase Kilowatt-Hours
<b>2 Volts</b>	<b>2 Amps</b>	<b>2 Watts</b>	<b>2 VA</b>	<b>2 kWh</b>
Phase B or Phase BC if 3 Phase	Phase Amperes	Phase Real Power	Phase Apparent Power	Phase Kilowatt-Hours
<b>3 Volts</b>	<b>3 Amps</b>	<b>3 Watts</b>	<b>3 VA</b>	<b>3 kWh</b>
Phase C or Phase AC if 3 Phase	Phase Amperes	Phase Real Power	Phase Apparent Power	Phase Kilowatt-Hours

**Some GU models have Dual Inputs with Monitoring or Dual Inline Monitoring, these units can have up to three additional Power readings**

4 Volts	4 Amps	4 Watts	4 VA	4 kWh
Secondary Input Phase for Single Phase units. Phase A or Phase AB if 3 Phase	Phase Amperes	Phase Real Power	Phase Apparent Power	Phase Kilowatt-Hours
5 Volts	5 Amps	5 Watts	5 VA	5 kWh
Secondary Phase B or Phase BC if 3 Phase	Phase Amperes	Phase Real Power	Phase Apparent Power	Phase Kilowatt-Hours
6 Volts	6 Amps	6 Watts	6 VA	6 kWh
Secondary Phase C or Phase AC if 3 Phase	Phase Amperes	Phase Real Power	Phase Apparent Power	Phase Kilowatt-Hours

**Breakers / Circuits**

Breaker 1	Breaker 2	Breaker 3	Breaker 4	Breaker 5	Breaker 6
Breaker / Circuit 1 Amps	Breaker / Circuit 2 Amps	Breaker / Circuit 3 Amps	Breaker / Circuit 4 Amps	Breaker / Circuit 5 Amps	Breaker / Circuit 6 Amps

**Total(s)**

Total Watts (Real Power)	Total VA (Apparent Power)	Total kWh
The total of Watts shown in sections 1-6	The total of VA shown in sections 1-6	The total kWh shown in sections 1-6



**NOTE**

The above table is an outline of data that is present in the database .csv file as is not representative of the actual format of the .csv file. Data stored will vary based on product configuration.

## Removal

The IMD is designed to be field replaceable by **qualified service personnel only**. The IMD module is hot-swappable, meaning it is designed to be replaceable while the PDU is still connected to AC power. If the Geist Upgradable PDU is going to be upgraded by replacing the IMD module, follow the procedure described in this section.

	<p style="text-align: center;"><b>NOTE</b></p> <p style="text-align: center;">Be sure to have the new IMD module ready for installation immediately after removal of the old IMD.</p>
---	---

1. Remove disposable ESD wrist strap from package, remove adhesive backing and attach to PDU, put wrist strap on arm.
2. Insert Geist IMD Removal Tool as shown. Be sure to press tool in level and press in until tool is flush with face of IMD. Some older versions may require overlays to be removed prior to inserting tool.
3. Carefully pull tool and IMD straight out about 2 inches. Remove tool from IMD.

	<p style="text-align: center;"><b>CAUTION</b></p> <p style="text-align: center;"><b>IMD is still connected internally. DO NOT pull IMD more than 2 inches from chassis.</b></p>
---	---

4. Gently unplug the connector from the IMD.

Figure 3-12 IMD Removal Steps

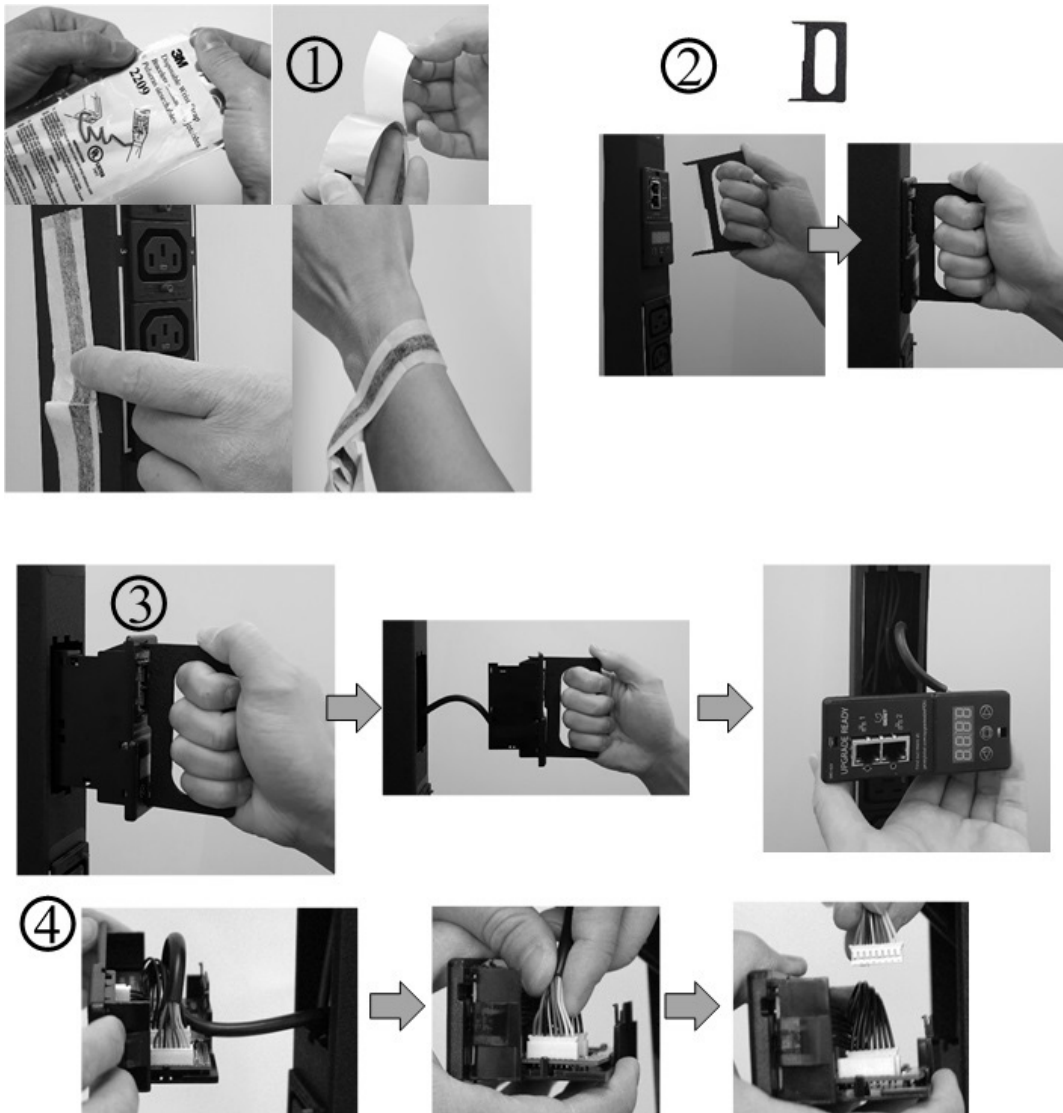



## Installation

1. Connect the cable to the replacement IMD module.
2. Place cable into the strain-relief slot in the IMD's housing as shown.
3. Tuck the excess cable back into the PDU, and slide the IMD straight in.
4. Press with both thumbs until the IMD snaps into place.

Figure 3-13 IMD Installation Steps

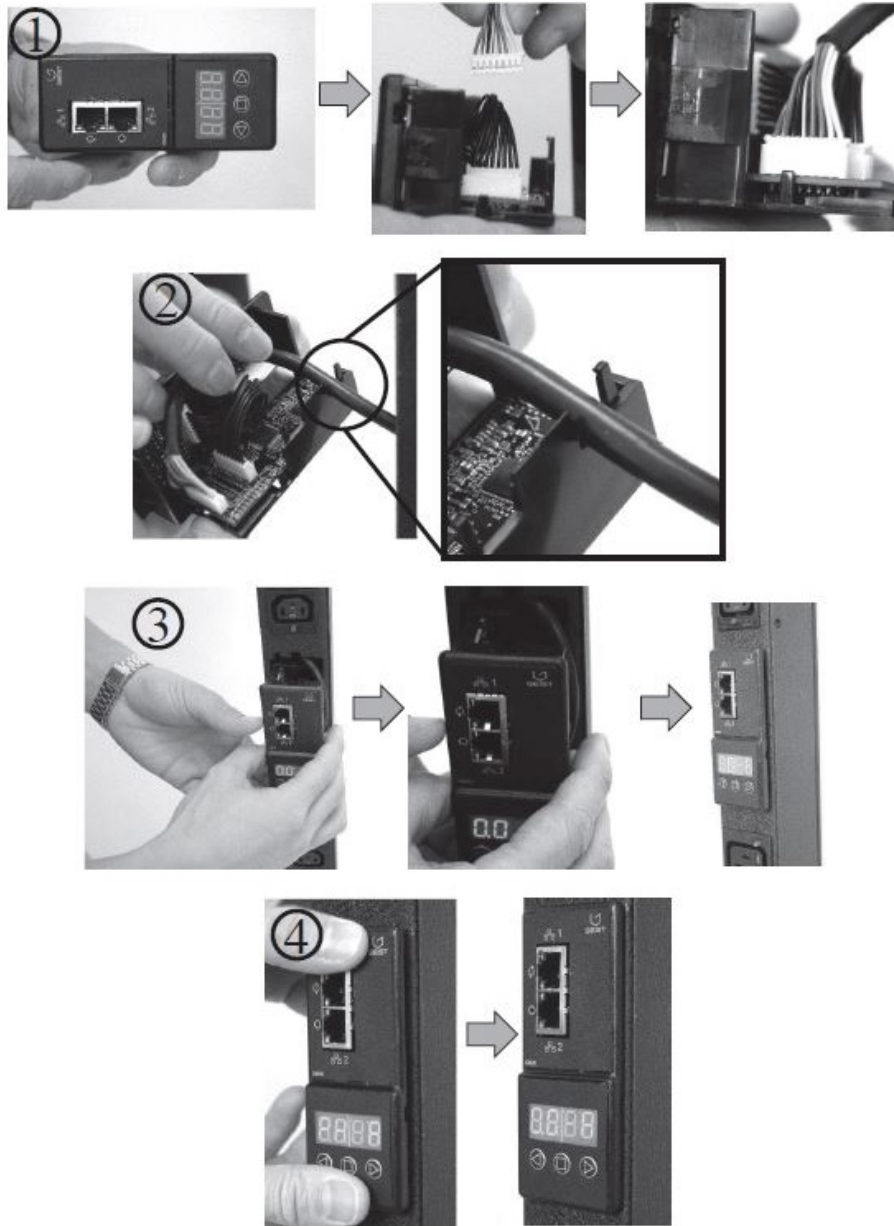

## Web Interface

The unit is accessible via a standard, unencrypted HTTP connection as well as an encrypted HTTPS (SSL) connection. The following web pages are available:

### Sensors Page

#### Overview

The front page, Sensors Overview, gives both current and historical views of the unit's data. Real-time readings are provided for all PDU data and individual circuits' data.

Figure 3-14 Sensors Page

State	Label	Energy (kWh)	Real Power (W)	Apparent Power (VA)	Power Factor (%)	Voltage (VRMS)	Voltage Min (VRMS)	Voltage Max (VRMS)	Peak Voltage (V)	Current (ARMS)	Current Min (ARMS)	Current Max (ARMS)	Peak Current (A)
	Total	0.000	0	6	0								
✓	Phase A	0.000	0	6	0	120.8	117.1	121.7	177.3	0.05	0.04	0.07	0.42
	Phase B	0.000	0	0	0	120.8	117.1	121.8	177.6	0.00	0.00	0.02	0.01
	Phase C	0.000	0	0	1	120.8	117.1	121.8	177.4	0.00	0.00	0.03	0.01

State	Label	Current (ARMS)	Current Min (ARMS)	Current Max (ARMS)	Peak Current (A)
	Circuit 1	0.03	0.02	0.04	0.19
	Circuit 2	0.02	0.02	0.04	0.19
	Circuit 3	0.03	0.02	0.04	0.19
	Circuit 4	0.03	0.02	0.05	0.17
	Circuit 5	0.02	0.02	0.04	0.19
	Circuit 6	0.02	0.02	0.04	0.19

#### 1. Geist Logo

- Clicking on this logo from any page will reload the Sensors Overview page.

#### 2. Sensors, System, and Help Tab

- Mouse over to show sub-menus:
  - Sensors: available options are "Overview" (this page) and "Alarms & Warnings" (see next section)
  - System: available options are "Users", "Network", "Email", "SNMP", "Syslog", "Admin", "Locale", "Restore Defaults", and "Firmware Update." Refer to the appropriate section under "System".
  - Help: available options are "Info" and "Support Site" Refer to the appropriate section under "Help".

#### 3. Log In / Log Out

- Click to log in or log out of the unit. Note that both username and password are case sensitive and no spaces are allow. Prohibited characters for username only are: \$&':<>[ ] { } " + % @ / ; = ? \ ^ | ~ ' ,

#### 4. Alarms and Warnings

- Indicates the number of Alarms and Warnings currently occurring, if any.
5. Device Label
    - Displays the user-assigned label of this unit (see "Configuration and Operation", "Device Labeling").
  6. Device ID
    - Unique product identification and cannot be changed. May be required for technical support.
  7. Total and Individual Phase Monitor
    - Displays AC current, voltage, and power statistics for each individual phase, and for the total of all phases combined.
  8. Current Monitor
    - Displays AC current draw statistics for each individual circuit on the PDU.

---

Figure 3-15 Icons

---



Configuration Icon



Operation Icon



## NOTE

You must log in before making any changes. Only users with Control-level authorizations have access to these settings..

### Device Labeling

1. Click the desired Configuration icon, and change the device's **Label**. (**Name** is the PDU's factory name or model, and cannot be changed.)
2. Once done, click **Save**.

Figure 3-16 Device Labeling

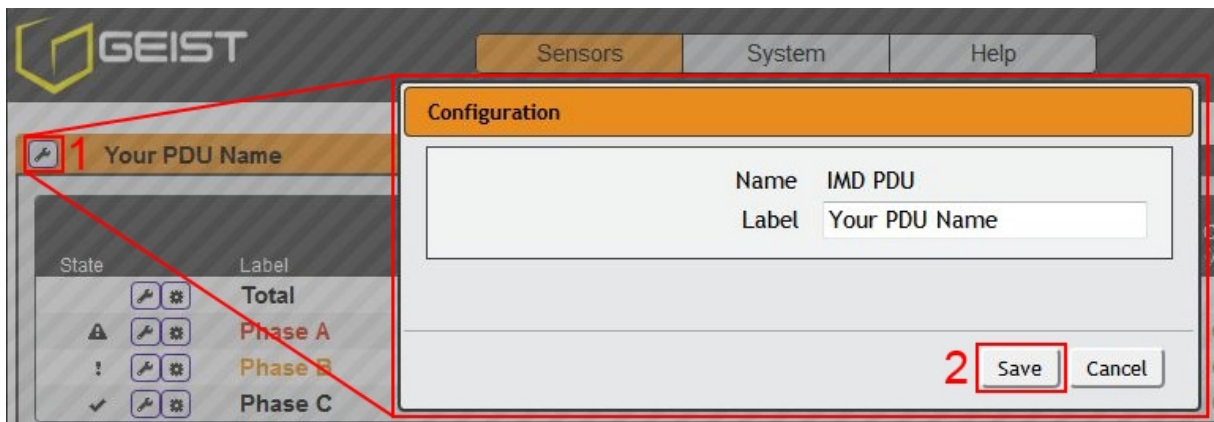

### Phase and Circuit Labels Naming

1. Click the desired Configuration icon, and change the phase or circuit's **Label**. **Name** is the physical phase or circuit, and cannot be changed.
2. Once done, click Save.

Figure 3-17 Phase and Circuit Labeling

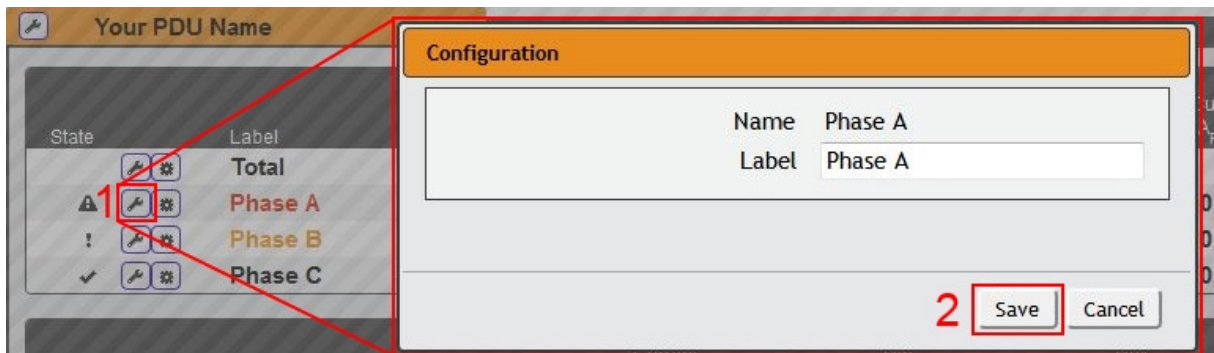

### Resetting Energy (kWh) and Current (Minimum and Maximum) Values

1. Click the Operation icon.
2. Select the operation you wish to perform.
3. Click Submit to execute operation.

Figure 3-18 Resetting Energy and Current Values

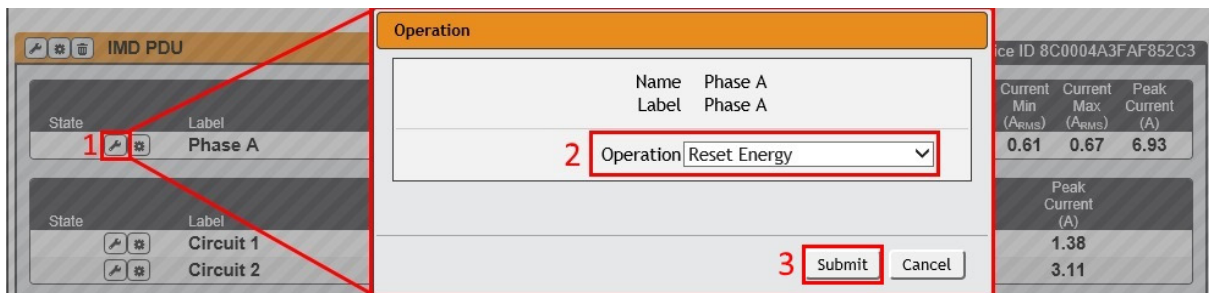





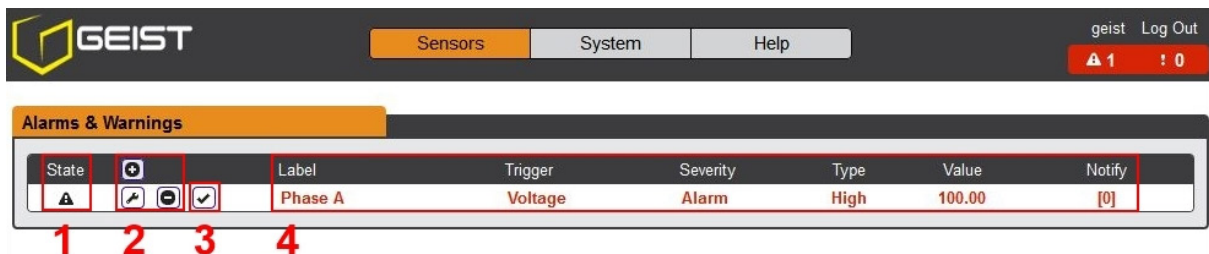

### Alarms & Warnings

The Alarms & Warnings Page allows the user to establish alarm or warning conditions (hereafter referred to as "Events") for each power and circuit reading. Events are triggered when a measurement exceeds a user-defined threshold, either going above the threshold ("high-trip") or below it ("low-trip"). Events are displayed in different sections, based on the device or measurement the Event is associated with. Each Event can have one or more Actions to be taken when the Event occurs.

Figure 3-19 Alarms and Warnings Page



1. State: Shows the status of each Event.
  - Empty: No alert condition.
  -  : This symbol indicates that this particular "Warning" Event has been tripped. A tripped Warning Event displays in orange.
  -  : This symbol indicates that this particular "Alarm" Event has been tripped. A tripped Alarm Event displays in red.
  -  : This symbol indicates that this Event has been acknowledged by user after being tripped. It will remain this way until the condition being measured by this Event returns to normal (i.e. ceases to exceed the trigger threshold for this Event).
2. Configuration: Add/Delete/Modify Alarms & Warnings.
  -  : Add new Alarms & Warnings.
  -  : Modify existing Alarms & Warnings.

-  : Delete Existing Alarms & Warnings.
3. Notification: Notify user of tripped Events, and request acknowledgment.
- Empty: No alert condition.
  -  : Acknowledge button. When a Warning or Alarm Event has occurred; the user can click on this symbol to acknowledge the Event and stop the unit from sending any more notifications about it. Note: Clicking this symbol does not clear the Warning or Alarm Event, it just stops the notifications from repeating.
4. The actual conditions for the various Alarms & Warnings settings are shown here.

### To add a new Alarm or Warning Event:

1. Click the Add/Modify Alarms & Warnings button:

Figure 3-20 Adding Alarms and Warnings

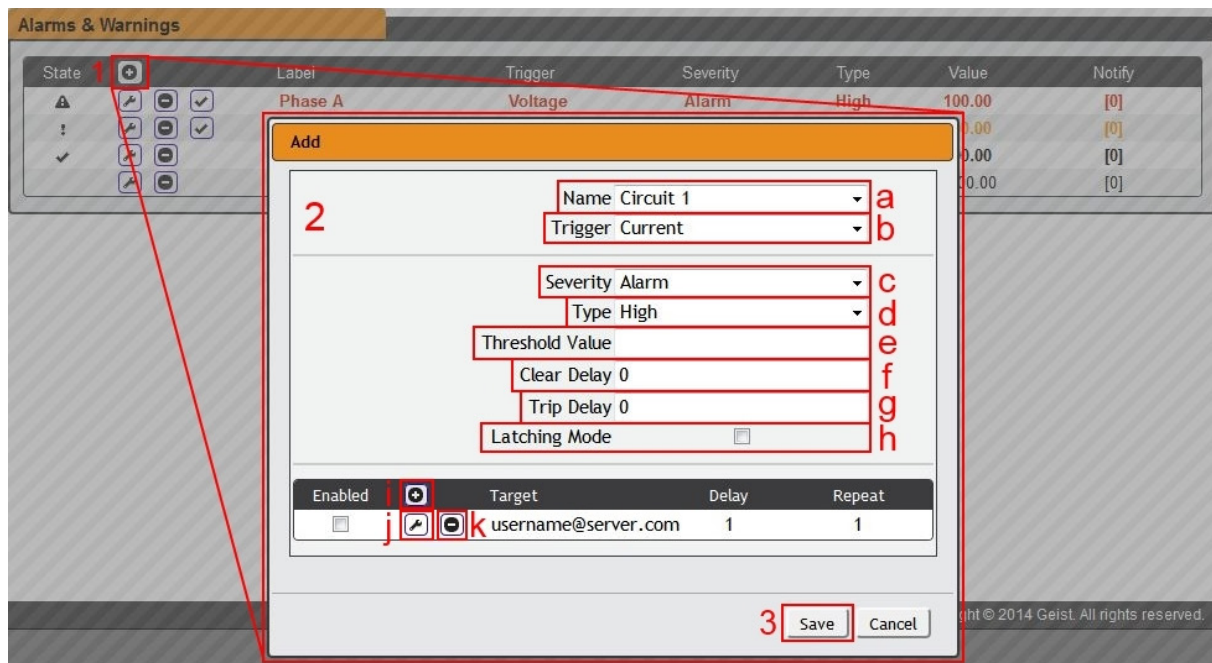

2. Set the desired conditions for this Event as follows:
  - a. Select the **Name** of the phase or circuit you wish to set an Event on.
  - b. Select the measurement (current, voltage, etc.) you want to **Trigger** the Event.
  - c. Set the **Severity** level ("Warning", or "Alarm") for this Event.
  - d. Select the threshold **Type**, "high" (trips if the measurement goes above the threshold) or "low" (trips if the measurement goes below the threshold).
  - e. Type in the desired **Threshold Value** (any number between -999.0 ~ 999.0 is valid).
  - f. Type in the desired **Clear Delay** time in seconds. Any value other than "0" means once this Event is tripped, the measurement must return to normal for this many seconds before the Event will clear and reset. Clear Delay can be up to 14400 seconds (4 hours).
  - g. Type in the desired **Trip Delay** time in seconds. Any value other than "0" means that the measurement must exceed the threshold for this many seconds before the Event will be tripped. Trip Delay can be up to 14400 seconds (4 hours).
  - h. **Latching Mode:** If enabled, this Event and its associated Actions (see below) remain active until the Event is acknowledged, even if the measurement subsequently returns to normal.

- i. To determine where the alert notifications will be sent to when this particular Alarm or Warning Event occurs, click the Add icon to create a new Action, then select the desired options from the drop-down menu:

Figure 3-21 Add Page

- **Target** is the email address or SNMP manager to which notifications should be sent when the Event is tripped.

## NOTE

Note: Target Delays and Repeats are shared across all alarms. If multiple Delay and/or Repeat values are needed for specific Targets, each one must be added to the Target list and then the appropriate 'Enabled' box checked on each alarm. See screen-shot below for example.

Figure 3-22 Target Page

Enabled		Target	Delay	Repeat
<input type="checkbox"/>		target@email.com	90	0
<input checked="" type="checkbox"/>		target@email.com	60	0

- **Delay** determines how long this Event must remain tripped for before this Action's first notification is sent. This is different from the Trip Delay above. Trip Delay determines how long the threshold value has to be exceeded before the Event itself is tripped. This delay determines how long the Event must remain tripped before this Action occurs. Delay can be up to 14400 seconds (4 hours). A Delay of 0 will send the notification immediately.
- **Repeat** determines whether multiple notifications will be sent for this Event Action. Repeat notifications are sent at the specified intervals until the Event is acknowledged, or until the Event is



cleared and reset. The Repeat interval can be up to 14400 seconds (4 hours). A Repeat of 0 disables this feature, and only one notification will be sent.

Then, click **Save** to save this notification Action.

More than one Action can be set for an Alarm or Warning; to add multiple Actions, just click the Add icon again and set each one as desired. Each alert can have up to 32 Actions associated with it.

**To change an existing Alarm or Warning Event:**

Click the Modify icon next to the Alarm or Warning Event you wish to change, then modify its settings as above.

Figure 3-23 Modify Action Page

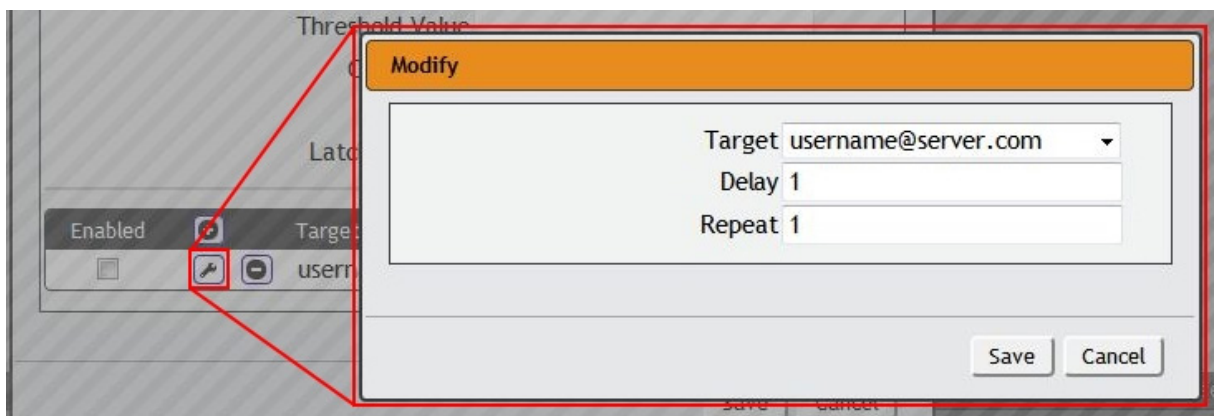

Once an Action has been added, each Action has its own checkbox in the "enabled" column at the far left. The default is unchecked (disabled) when you first add each Action; set the checkbox to enable it. This allows you to selectively turn different Actions on and off for testing.

**To delete an existing Alarm or Warning Event:**

Click the Delete icon next to the Alarm or Warning Event you wish to change, then click **Delete** to confirm.

Figure 3-24 Delete Action Page

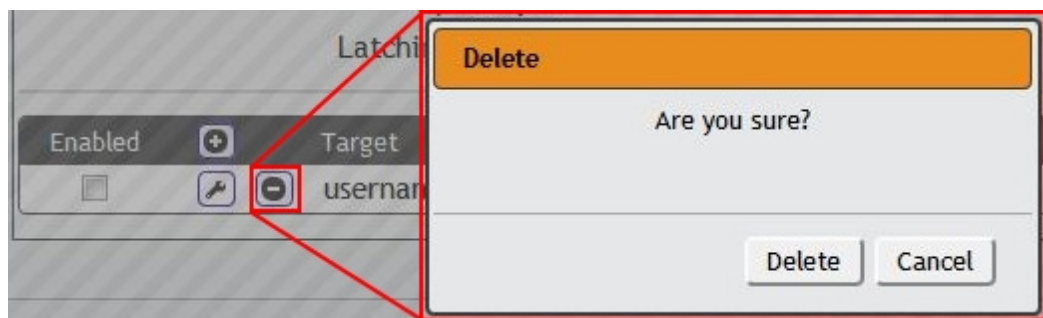

3. When finished, click **Save** to save this Alarm or Warning event.

## System

### Users

The Users page in the System menu allows you to manage or restrict access to the unit's features by creating accounts for different users.

Figure 3-25 User Account Page

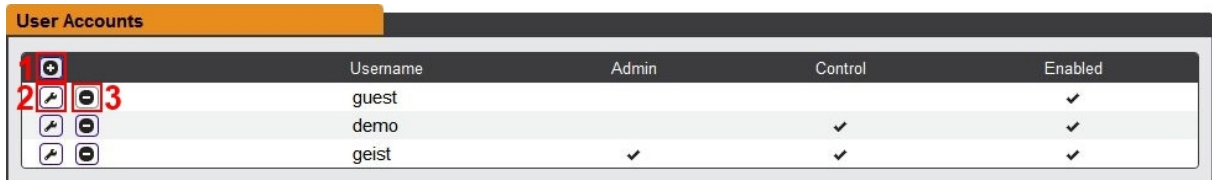

	Username	Admin	Control	Enabled
1	guest			✓
2	demo		✓	✓
3	geist	✓	✓	✓

There are three buttons available on the User Accounts page:

1. Add New User Account
2. Modify User's Account
3. Delete User's Account



### NOTE

Only an Administrator-level account can Add, Modify, or Delete users. Control-level and View-Only accounts can change their own passwords via the Modify button, but cannot Add or Delete accounts, or Modify other accounts. The Guest account cannot Add, Delete, or Modify any account, not even itself.

To Add or Modify a user Account:

1. Click the Add or Modify User icon.

Figure 3-26 Add or Modify User Account Page

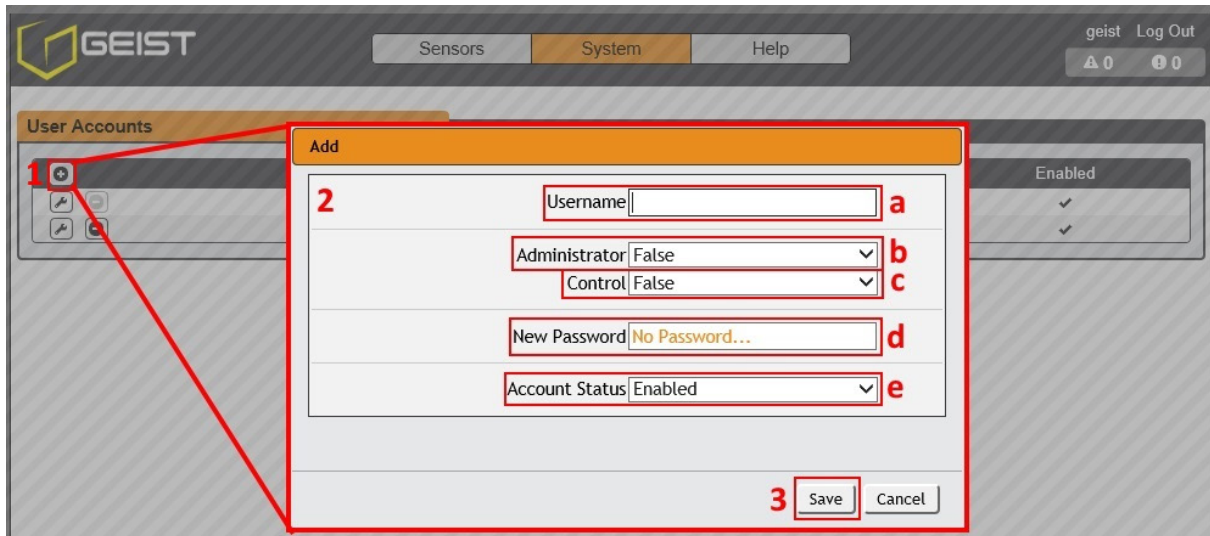

2. Create or modify the account information as follows:
  - Username:** the name of this account. User names may be up to 24 characters long, are case-sensitive, and may not contain spaces or any of these prohibited characters: \$&':<>[ ] { } "+%@/ ; =?\^|~', Note that an account's username cannot be changed after the account is created.
  - Administrator:** if set to True, this account has Administrator-level access to the unit, and can change any setting.
  - Control:** if set to True, this account has Control-level access. Setting Administrator to True will automatically set Control to True as well. Setting this to False makes the account a View-Only account.
  - New Password:** account passwords may be up to 24 characters long, are case-sensitive, and may not contain spaces.
  - Account Status:** set the account to Enabled or Disabled. Disabling an account prevents it from being used to log in, but does not delete it from the account list.
3. Click the **Save** button when finished.

#### Account Types:

- **Administrator:** Administrator accounts (accounts with both Administrator and Control authority set to True, as above) have full control over all available functions and settings on the device, including the ability to modify System settings and add, modify, or delete other users' accounts.
- **Control:** Control accounts (accounts with only Control set to True) have control over all settings pertaining to the device's sensors. They can add, modify, or delete Alarms & Warning Events and notification Actions, and can change the names or labels of the device and its sensors. Control accounts cannot, however, modify System settings or make changes to other users' accounts.

- **View:** If both Administrator and Control are set to False, the account is a View-Only account. The only changes a View-Only account is permitted to make are changing their own account's password, and changing the preferred language for their own account. View-Only accounts cannot change any device or system settings.
- **Guest:** Anyone who brings up the unit's web page without logging in will automatically be viewing the unit as Guest. By default, the Guest account is a View-Only account, and cannot make changes to any settings, although the Administrator can elevate the Guest account to Control-level access if desired, allowing anyone to make changes to names, labels, alarm events, and notifications without logging in. The Guest account cannot be deleted but can be disabled to require login for viewing system status.

Figure 3-27 Change User Password Page

The screenshot shows the GEIST web interface. At the top left is the GEIST logo. To its right are navigation tabs for 'Sensors', 'System', and 'Help'. In the top right corner, there is a 'Log Out' link and a user profile icon. Below the header, there are two main sections. The first section is titled 'Language' and contains a 'Language Preference' dropdown menu set to 'English' and a 'Save' button. The second section is titled 'Change Password' and contains a 'New Password' input field with the text 'Password Set..' and a 'Save' button.

- **Edit User:** Once a user has logged in to their account, they can change their password or language preference by clicking their username, shown next to the Log Out hyperlink at the top right-hand corner of the web page, as shown here.

## Network

The unit's network configuration is set on the Network tab of the System menu. Settings pertaining to the unit's network connection are:

Figure 3-28 Network Configuration Page

The screenshot shows the GEIST Network Configuration page. At the top, there is a navigation bar with 'Sensors', 'System', and 'Help' tabs. The 'System' tab is selected. Below the navigation bar, there are two main sections: 'Hostname' and 'Network'. The 'Hostname' section has a text input field containing 'BB0004A3FAF852' and a 'Save' button. The 'Network' section has several fields: 'Name' (ethernet), 'MAC Address' (00:04:A3:FA:F8:52), 'DHCP' (a dropdown menu set to 'Disabled'), and 'Gateway (IPv4)' (192.168.117.254). Below these fields is a 'Save' button. There are two tables below the 'Network' section. The first table has columns for 'IP Address' and 'Prefix/Netmask'. It contains two rows: one for IPv4 (192.168.117.176 / 24 (255.255.255.0)) and one for IPv6 (FE80::204:A3FF:FEFA:F852 / 64). The second table has columns for 'DNS Server Address' and contains two rows: 8.8.8.8 and 8.8.4.4. Each row in the IP and DNS tables has a 'Modify' icon (a square with a pencil) and a 'Remove' icon (a square with an 'X').

- **DHCP:** Allows the unit to request a dynamic IP address from a server on the network when Enabled. The default is Disabled, or static IP addressing.
- **Gateway (IPv4):** The IP address of the network gateway bridging your private network (LAN) to the public internet network. This is required if the unit needs to reach any services on the internet, such as a public email or NTP server. If DHCP is Enabled, this field will automatically be filled in when the DHCP service assigns the unit an IP address.
- **IP Address:** Displays the IPv4 and IPv6 addresses currently being used by the unit. Clicking on the Modify icon will allow you to change the unit's IPv4 address and Netmask. Note: If DHCP is enabled, then there will be no Modify icon, indicating that this address can't be changed by the user. The IPv6 address is a "Link Local" address inherent to the unit, and cannot be changed.
- **DNS:** Allows the unit to resolve host names for email, NTP, and SNMP servers as well as cameras.



## NOTE

Any changes you make to the Network settings will take effect once the Save button is clicked! If you have changed the IP address or HTTP/HTTPS ports, it will appear as if the unit is no longer responding because the browser will not be able to reload the web page. Just stop or close the browser window, then type in the new IP address into the browser's address bar, and the unit will be accessible.

## Web Server

The unit's Web Server configuration can be updated on the Web Server tab of the System menu.

Figure 3-29 HTTP Configuration Page

HTTP

HTTPS is always enabled.

HTTP Interface: Enabled

HTTP Port: 80

HTTPS Port: 443

Save

- **HTTP Interface:** Enables/disables access via HTTP. HTTPS interface will always be enabled. Available options are: Enabled or Disabled. It is not possible to disable the web interface completely.
- **HTTP/HTTPS Server Port:** Allows you to change the TCP ports which the HTTP and HTTPS services listen to for incoming connections. The defaults are port 80 for HTTP and 443 for HTTPS.

## Display

The unit's display configuration can be changed via the Display tab of the System menu. Settings pertaining to the unit's display are:

Figure 3-30 Display Mode/VLC Configuration Page

The screenshot shows the GEIST System configuration page. At the top, there is a navigation bar with 'Sensors', 'System' (highlighted), and 'Help'. The user is logged in as 'geist' and can 'Log Out'. There are also status indicators for '0' alarms and '0' notifications. The main content area is divided into two sections: 'Display Mode' and 'VLC'. In the 'Display Mode' section, the 'Display Mode' dropdown is set to 'Current' and there is a 'Save' button. In the 'VLC' section, the 'VLC Mode' dropdown is set to 'Disabled' and there is a 'Save' button.

- **Display Mode:** Sets the unit to display Current or Total Power (displayed as kW) on the local LED display.
- **VLC:** Allows user to enable or disable VLC mode from GUI (default is disabled).

## Email

The unit is capable of sending email notifications to up to five email addresses when an Alarm or Warning Event occurs.

Figure 3-31 Email Configuration Page

The screenshot shows the GEIST Email configuration page. At the top, there is a navigation bar with 'Sensors', 'System' (highlighted), and 'Help'. The user is logged in as 'geist' and can 'Log Out'. There are also status indicators for '0' alarms and '0' notifications. The main content area is titled 'Email' and contains a yellow warning box: 'Leave Username and Password blank for relay-only (no authentication)'. Below this, there are several configuration fields: 'SMTP Server' (text input), 'Port' (text input with '25' entered), 'Enable SSL' (dropdown menu set to 'Disabled'), '"From" Email Address' (text input), 'Username' (text input), and 'Password' (text input with 'No Password...' entered). A 'Save' button is located below these fields. Below the 'Save' button, the text 'Success!' is displayed in green. At the bottom of the page, there is a 'Target Email Address' field with the value 'username@server.com' and icons for social media or sharing.

Target email addresses can be configured as follows:



Legend of icons/buttons:

1. Add new target email address.
2. Modify existing target email address.
3. Delete existing target email address.
4. Send test email.

To send emails, the unit must be configured to access the mail server, as follows:

- **SMTP Server:** The name or IP address of a suitable SMTP or ESMTP server.
- **Port:** The TCP port which the SMTP Server uses to provide mail services. Typical values would be port 25 for an unencrypted connection, or 465 and 587 for a TLS/SSL-encrypted connection, but these may vary depending on the mail server's configuration.
- **Enable SSL:** If Enabled, the unit will attempt to connect to the server using a fully-encrypted TLS/SSL connection. Note that when this setting is enabled only fully-encrypted sessions are supported; the "StartTLS" method, where the session starts out as unencrypted and then switches to encrypted partway through the session, is not supported. If using a service that utilizes StartTLS, such as Office365, please leave this option Disabled.
- **"From" Email Address:** The address which the unit's emails should appear to come from. Note that many hosted email services, such as Gmail, will require this to be the email account of a valid user.
- **Username and Password:** The login credentials for the email server. If your server does not require authentication (open relay), these can be left blank.

Microsoft Exchange servers will have to be set to allow SMTP relay from the IP address of the unit. In addition, the Exchange server will need to be set to allow "Basic Authentication", so that the unit will be able to log in with the AUTH LOGIN method of sending its login credentials. Other methods, such as AUTH PLAIN, AUTH MD5, etc. are not supported.

Figure 3-32 Email Target Configuration Page

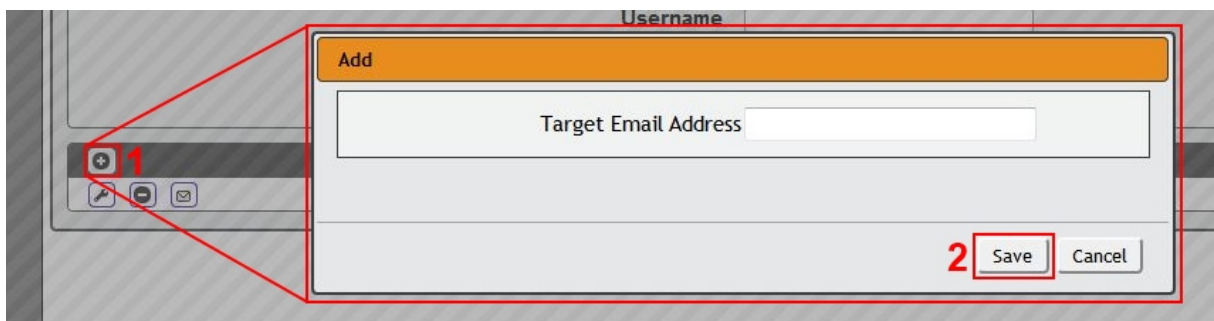

**To Add or Modify a Target Email address:**

1. Click on the Add or Modify icon.
2. Type email address and then click **Save**.

**To Delete a Target Email address:**

1. Click on the Delete icon next to the address you wish to delete.



2. Click the **Delete** button on the pop-up window to confirm.

#### To send a test email:

1. Click on the Test Email icon next to the address you wish to test.
2. A pop-up window will indicate that the test email is being sent. Click **OK** to dismiss the pop-up.

## SNMP

Simple Network Management Protocol (SNMP) can be used to monitor the unit's measurements and status, if desired. SNMP v1, v2c and v3 are supported. In addition, alarm traps can be sent to up to two IP addresses.

Figure 3-33 SNMP Configuration Page

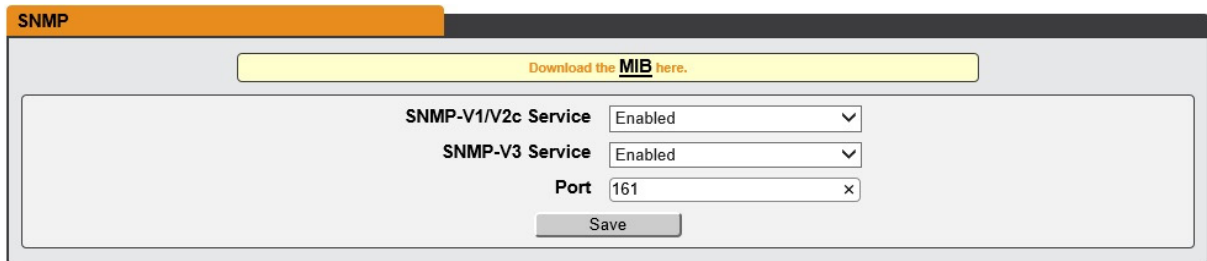

The screenshot shows the SNMP configuration page. At the top, there is a yellow banner that says "Download the MIB here." Below this, there are three dropdown menus: "SNMP-V1/V2c Service" set to "Enabled", "SNMP-V3 Service" set to "Enabled", and "Port" set to "161". A "Save" button is located at the bottom of the configuration area.





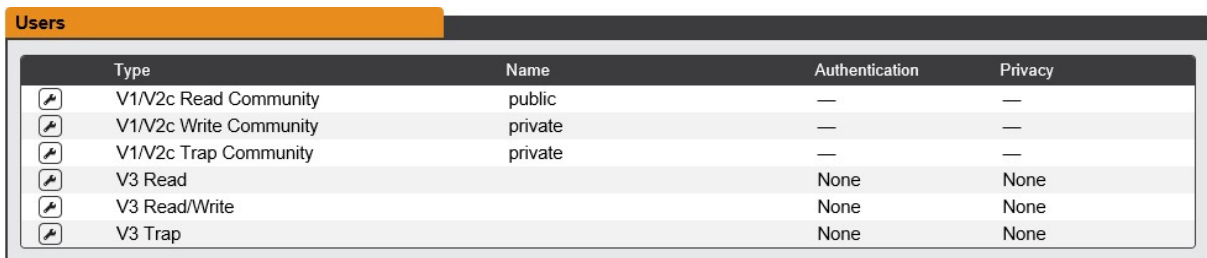

The **SNMP-V1/V2c** and **SNMP-V3 Service** can be enabled or disabled independently as desired. The service will normally listen for data-read requests (a.k.a. "GET requests") on **Port 161**, which is the usual default for SNMP services; this can also be changed if desired.

The Management Information Base (MIB) can be downloaded from the unit, if needed, via the MIB link at the top of the web page. Clicking this link will download a .ZIP archive containing both the MIB file itself, and a CSV-formatted spreadsheet describing the available OIDs in a human-readable form to assist you in setting up your SNMP manager to read data from the unit.

Figure 3-34 SNMP Users Configuration Page



The screenshot shows the SNMP Users configuration page. It features a table with columns for Type, Name, Authentication, and Privacy. Each row has a modify icon (a pencil) to its left.

Type	Name	Authentication	Privacy
 V1/V2c Read Community	public	—	—
 V1/V2c Write Community	private	—	—
 V1/V2c Trap Community	private	—	—
 V3 Read		None	None
 V3 Read/Write		None	None
 V3 Trap		None	None

The **Users** section allows you to configure the various Read, Write, and Trap communities for SNMP services. You can also configure the authentication types and encryption methods used for the SNMP v3 if desired. Click the Modify icon to change settings.

Figure 3-35 SNMP Traps Configuration Page



Traps allows you to define the IP addresses and SNMP types that you wish the traps to be sent to.

Figure 3-36 SNMP Traps/Types IP Configuration Page

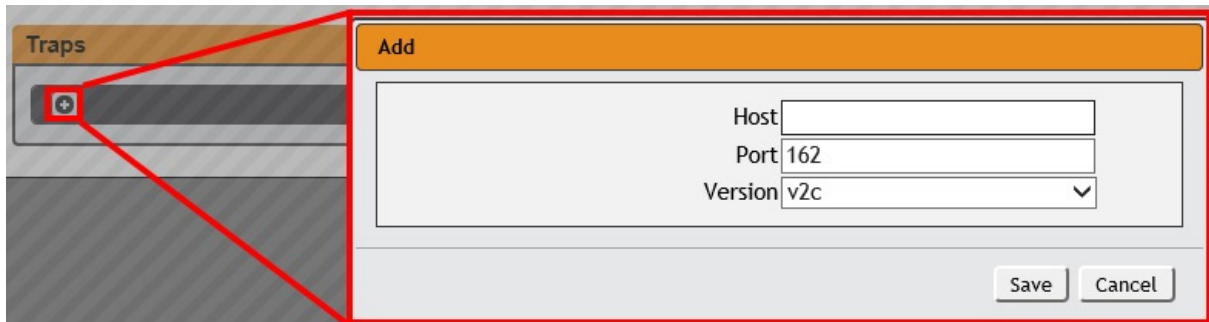

To configure a trap destination:

1. Locate the **Traps** section of the SNMP page, and click on the Add icon.
2. Enter the IP Address which the trap should be sent to in the **Host** field, change the **Port** number if required, select the trap **Version** to be used (v1, v2c, or v3), and click **Save**.

A test trap may be sent by clicking on the Test icon next to the Host IP address. Trap settings can also be updated/changed by clicking the Modify icon next to the Host IP address.

## Syslog

Syslog data can be captured remotely but must first be setup and enabled via the Syslog page.



### NOTE

This function is primarily only useful for diagnostic purposes, and should normally be left Disabled unless advised to enable it by Geist technical support for troubleshooting a specific issue

Figure 3-37 Syslog Configuration Page

## Admin

The Admin page allows the administrator of the device to save their contact information along with the device description and location. Once the info is saved by an administrator, other (non-administrator) users can view the information. Also, the System Label can be modified on this page. This label is typically shown in the title bar of the web browser's window, and/or on the browser tab(s) currently viewing the device.



**NOTE**

This information is strictly for the users' and administrator's convenience. The unit will not attempt to send emails to the "Administrator Email" address and this address cannot be chosen as the Target of an Event Action when configuring an Alarm or Warning Event.

Figure 3-38 Admin Configuration Page

## Locale

The Locale page sets the default Language and Temperature Units for the device. These settings will become the default viewing options for the device, although individual users can change these options for their own accounts. The Guest account will only be able to view the device with the options set here.

Figure 3-39 Locale Configuration Page



Locale

Default Language English ▾

Temperature Units Fahrenheit ▾

Save

## Utilities

The Utilities page in the System menu provides the ability to restore defaults, reboot the communication system and perform firmware updates.

The Restore Defaults section allows the user to restore the unit's settings to the factory defaults. There are two options:

**All Settings:** erases all of the unit's settings, including all Network and User Accounts settings, effectively reverting the entire unit back to its original out-of-the-box state.

**All Non-Network Settings:** erases all settings except the Network and User Accounts.

Figure 3-40 Restore Default Page

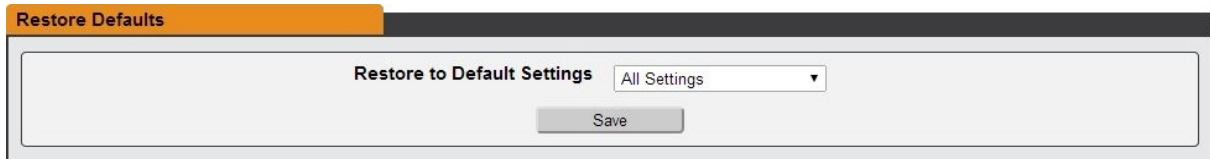

Restore Defaults

Restore to Default Settings All Settings ▾

Save

The Reboot section allows the user to perform a system reboot. This function will not affect power delivery to connected equipment.

Figure 3-41 Reboot Page



Reboot

Reboot

Use the Firmware Update section to load firmware updates into the unit. Firmware updates, when available, can be found on the Geist website: <http://www.geistglobal.com/support/firmware>.

You can also subscribe to a mailing list, to be notified of when firmware updates become available.

Figure 3-42 Firmware Update Page

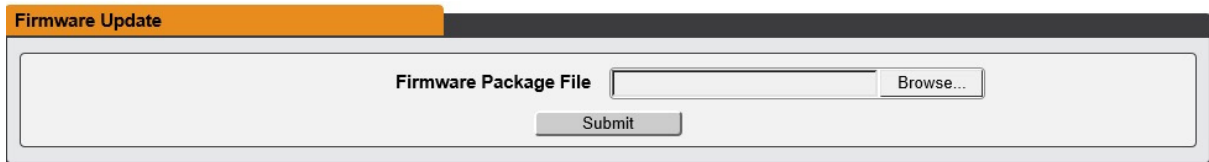

The screenshot shows a web interface for a firmware update. At the top left, there is a tab labeled "Firmware Update" with an orange background. Below this, there is a form area with a light gray background. Inside the form, the text "Firmware Package File" is followed by a text input field and a "Browse..." button. Below the input field and button is a "Submit" button.

Firmware updates will typically come in a .ZIP archive file containing several files including the firmware package itself, a copy of the SNMP MIB, a "readme" text file explaining how to install the firmware, and various other support files as needed. Be sure to un-ZIP the archive and follow the included instructions.



## NOTE

Firmware updates can be performed via HTTP interface only. Updates over the HTTPS interface are not currently supported.

## Help

### Info

The Info Page displays the unit's current configuration information, including the device name and ID, the type of IMD installed, the unit's current firmware versions, and network information. Manufacturer support information is also here.

Figure 3-43 Info Page

Info	
<b>Device Name</b>	Geist IMD PDU
<b>Serial Number</b>	KA14121472
<b>Model Number</b>	MN02X4B1-24D203-3TL5A0A10-S
<b>Part Number</b>	I20002
<b>Device Type</b>	I-02
<b>Version</b>	3.3.1
<b>GUI Version</b>	1.3.0
<b>MAC Address</b>	00:04:A3:FA:F8:52
<b>Hostname</b>	BB0004A3FAF852
<b>Manufacturer</b>	Geist
<b>Manufacturer Site</b>	<a href="http://www.geistglobal.com">www.geistglobal.com</a>
<b>Support Site</b>	<a href="http://www.geistglobal.com/support">www.geistglobal.com/support</a>
<b>Support Email</b>	<a href="mailto:support@geistglobal.com">support@geistglobal.com</a>
<b>Support Telephone</b>	1-800-432-3219   +1 402 474 3400

## Support Site

Technical support can be found at <http://www.geistglobal.com/support>

### Americas

- 1 888 630 4445

### Europe and Middle East

- From within the UK 0845 026 3853
- From abroad +44 845 026 3853

### Asia

- English +1 888 630 4445 (US number)
- Chinese +[86 755 8663 9505](tel:+8675586639505)

## Chapter 4 - Final Checkout

### Final Checkout

#### Technical Support

##### Resetting PDU

Should the PDU lose communication, the processor may be manually rebooted without affecting power to the outlets. Pressing the reboot button on the face of the IMD will cause the processor to reboot. The web interface will remain off-line during boot up. For more information, see the Interchangeable Monitoring Device section of this manual.

##### Service and Maintenance

No service or maintenance is required. Do not attempt to open the PDU or you may void the warranty. There are no serviceable parts inside the PDU other than the field replaceable Interchangeable Monitoring Device (IMD). It is recommended that power be removed from the unit before installing or removing any equipment.

The Interchangeable Monitoring Device is designed to be field replaceable by **qualified service personnel only**. The IMD is designed to be replaced while the PDU is still connected to AC Mains power. Please refer to the IMD section of this document for removal and installation instructions.

##### More Technical Support

<http://geistglobal.com>

###### Americas

- 1 888 630 4445

###### Europe and Middle East

- From within the UK 0845 026 3853
- From abroad +44 845 026 3853

###### Asia

- English +1 888 630 4445 (US number)
- Chinese +[86 755 8663 9505](tel:+8675586639505)

Email: [support@geistglobal.com](mailto:support@geistglobal.com) or contact your distributor  
Technical Support Form: <http://www.geistglobal.com/Tech-Support>

## Using Microsoft Exchange as an SMTP server

If your facility uses a Microsoft Exchange email server, it can be used by the IMD PDU to send Alarm and Warning notification emails if desired. However, the Exchange server may need to be configured to allow SMTP connections from the unit first, as later version of Exchange often have SMTP services or basic authentication disabled by default. If you encounter difficulties in getting your IMD PDU to send emails through your Exchange server, the following notes may be helpful in resolving the problem.



### NOTE

These suggestions only apply if you are using your own, physical Exchange server! Microsoft's hosted "Office365" service is not compatible with the IMD PDU using firmware versions prior to v3.0.0, as Office365 requires a StartTLS connection. Firmware versions 3.0.0 and beyond have support for StartTLS and are compatible with Office365.

First, since the IMD PDU cannot use IMAP or Microsoft's proprietary MAPI/RPC Exchange/Outlook protocols to send messages, you will need to enable SMTP by setting up an "SMTP Send Connector" in the Exchange server. More information on setting up an SMTP Send Connector in Exchange can be found at this Microsoft TechNet article: <http://technet.microsoft.com/en-us/library/aa997285.aspx>

Next: Your Exchange server may also need to be configured to allow messages to be "relayed" from the monitoring unit. Typically, this will involve turning on the "**Reroute incoming SMTP mail**" option in the Exchange server's **Routing** properties, then adding the IMD PDU's IP address as a domain which is permitted to relay mail through the Exchange server. More information about enabling and configuring SMTP relaying in Exchange can be found at this Microsoft TechNet article: <http://technet.microsoft.com/en-us/library/dd277329.aspx>

The SMTP "AUTH PLAIN" and "AUTH LOGIN" authentication methods (also known as "Basic Authentication") for logging in to the server are often no longer enabled by default in Exchange; only Microsoft's proprietary NTLM authentication method is enabled. The AUTH LOGIN method which the IMD PDU requires can be re-enabled as follows:

1. In the Exchange console under **server configuration**, select **hub transport**.
2. Right-click the client server, and select **properties**.
3. Select the **authentication** tab.
4. Check the **Basic Authentication** checkbox.
5. Uncheck the **Offer Basic only after TLS** checkbox
6. Apply or save these changes, and exit. Note that you may need to restart the Exchange service after making these changes.

Finally, once you have enabled SMTP, relaying, and the AUTH LOGIN Basic Authentication method, you may also need to create a user account specifically for the IMD PDU to log into. If you have already created an account prior to enabling the SMTP Send Connector, or you are trying to use an already-existing account created for another user, and the IMD PDU still cannot seem to connect to the Exchange server, the account probably did not properly inherit the new permissions when you enabled them as above. This tends to happen more often on Exchange servers that have been upgraded since the account(s) you are trying to use were first created, but can sometimes happen with accounts when new connectors and plug-ins are added regardless of the Exchange version. Delete the user account, then create a new one for the monitoring unit to use, and the new account should inherit the SMTP authentication and mail-relaying permissions correctly.

If none of the above suggestions succeed in allowing your Geist IMD PDU to send mail through your Exchange server, then you may need to contact Microsoft's technical support for further assistance in



configuring your Exchange server to allow SMTP emails to be sent from a 3rd-party, non-Windows device through your network.

## Product-Specific Safety Notices

The specific procedural safety precautions relating to this product are stated below.

### General Safety

Safety is a serious matter and all precautions should be taken to guarantee a safe work and operational environment. General safety precautions must be observed during all aspects of operation, service, and repair of equipment described in this document. Failure to comply with the safety warnings, procedures and guidelines as presented in this document is in violation of the safety standards of design, manufacture, and intended use of this equipment.

You are responsible for following the safety guidelines and warnings presented in this document for this equipment. Individuals using or maintaining Geist product(s) are expected to follow all the noted warnings and safety precautions necessary for safe operation of the equipment in your environment. Geist assumes no liability for failure to comply with these requirements.

### Live Circuits Safety



**DANGER**  
HAZARDOUS VOLTAGE, CURRENT, AND ENERGY LEVELS ARE PRESENT IN THIS PRODUCT. POWER SWITCHED CIRCUITS CAN HAVE HAZARDOUS VOLTAGES PRESENT EVEN WHEN THE SWITCH IS IN THE OFF POSITION. DO NOT OPERATE THE PRODUCT WITH ANY COVER PLATE REMOVED. ALWAYS MAKE SURE THAT PRODUCT IS FULLY ENCLOSED PRIOR TO USE.

Operating personnel must:

- Not remove equipment covers. Only Geist Authorized Service Personnel or other qualified maintenance personnel may remove equipment covers for internal sub-assembly, or component replacement, or any internal adjustment.
- Not replace any equipment component with power applied to the line cord. Under certain conditions, dangerous voltages may exist even with the input power cable disconnected. Any exceptions for 'Hot-Swap' modules will be specifically noted in this product document.
- Always disconnect input power and discharge circuits before touching any sub-assembly of circuit component.

### Equipment Grounding

To minimize shock hazard, the equipment chassis and enclosure must be connected to an electrical earth ground. The input power cable must be either plugged into an industry electrical code compatible receptacle or wired directly into an electrical code compatible

interface. The equipment earth ground wire (typically green) must be firmly connected to the facility electrical safety ground. The mating electrical interface to this equipment must comply with International Electromechanical Commission (IEC) standards.

## Electrostatic Discharge

Geist strongly recommends that anti-static precautions be taken when installing, removing, or working on and around static sensitivity equipment. Industry approved anti-static devices such as wrist and heel straps, in conjunction with conductive foam pads, should be available and implemented only after verifying that they are in good working condition.

Electronic components such as memory modules, circuit boards, and LED displays, are sensitive to Electro-Static Discharge (ESD). Handling of such components should be done only after proper anti-static workspace conditions have been established. Any static producing packing materials such as plastic, Styrofoam, and some cardboards, should be removed and discarded in a timely manner.

## Explosive Environment

Do not operate this equipment in the presence of flammable gases or fumes. Operation of any electrical equipment in such an environment constitutes a definite safety hazard.

## Servicing and Adjustments

Do not attempt to service this equipment, there are no field serviceable parts or sub-assemblies. Any adjustments should be made by authorized service personnel only.

## Repairs and Modifications

Because of the danger of electrocution and/or severe health hazard, do not install substitute parts or perform any unauthorized modifications of this equipment. It is best to contact Geist for Warranty and Repair Service to ensure that safety features are maintained.



**Thank You For  
Purchasing Geist**

[geistglobal.com](http://geistglobal.com)

