

AVR UPS SERIES

CP825AVRLCDG / CP685AVRLCDG / CP800AVR / CP685AVRG

USER MANUAL

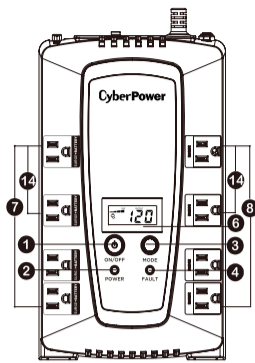

CP825AVRLCDG  
CP685AVRLCDG

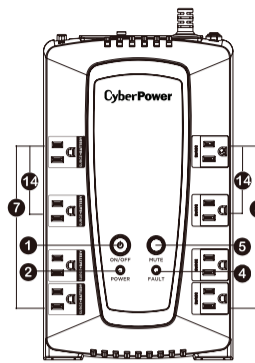

CP800AVR  
CP685AVRG

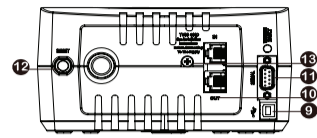

FEATURES

- |  |  |
|--|--|
| 1. Power Switch  | 7. Battery and Surge Protected Outlets                 |
| 2. Power On Indicator                                    | 8. Full-Time Surge Protection Outlets                  |
| 3. Mode Switch<br>For CP825AVRLCDG / CP685AVRLCDG        | 9. USB Port  |
| 4. Fault Indicator                                       | 10. Communication Protection Ports<br>For CP825AVRLCDG |
| 5. Mute Button<br>For CP800AVR / CP685AVRG               | 11. Serial Port  |
| 6. LCD module display<br>For CP825AVRLCDG / CP685AVRLCDG | 12. Circuit Breaker and Reset                          |
|  | 13. Ground Screw                                       |
|  | 14. Outlets Designed for AC Adapters                   |

PRODUCT REGISTRATION

Thank you for purchasing a CyberPower product. This UPS is designed to provide unsurpassed power protection, operation, and performance during the lifetime of the product. Please take a few minutes to register your product at: [www.CyberPowerSystems.com/registration](http://www.CyberPowerSystems.com/registration). Registration certifies your product's warranty, confirms your ownership in the event of a product loss or theft, and entitles you to free technical support. Register your product now to receive the benefits of CyberPower ownership.

Cyber Power Systems (USA), Inc.

4241 12th Avenue East, Suite 400 | Shakopee, MN 55379 | [CyberPowerSystems.com](http://CyberPowerSystems.com)

INSTALLING YOUR UPS SYSTEM - continued

OVERVIEW

The CP825AVRLCDG/CP685AVRLCDG/CP800AVR/CP685AVRG provides complete power protection from utility power that is not always consistent. The CP825AVRLCDG/CP685AVRLCDG/CP800AVR/CP685AVRG features 1030 Joules of surge protection. The unit provides long lasting battery backup during power outages with maintenance free batteries. The CP825AVRLCDG/CP685AVRLCDG/CP800AVR/CP685AVRG ensures consistent power to your computer system and includes software that will automatically save your open files and shutdown your computer system during a utility power loss.

HOW TO DETERMINE THE POWER REQUIREMENTS OF YOUR EQUIPMENT

1. Ensure that the equipment plugged into the UPS does not exceed the UPS unit's rated capacity (825VA/450W for CP825AVRLCDG, 800VA/450W for CP800AVR, 685VA/390W for CP685AVRLCDG, CP685AVRG). If the rated capacities of the unit are exceeded, an overload condition may occur and cause the UPS unit to shut down or the circuit breaker to trip.
2. There are many factors that can affect the amount of power that your electronic equipment will require. For optimal system performance keep the load below 80% of the unit's rated capacity.

HARDWARE INSTALLATION GUIDE

1. Your new UPS may be used immediately upon receipt. However, after receiving a new UPS, to ensure the battery's maximum charge capacity, it is recommended that you charge the battery for at least 8 hours. Your UPS is equipped with an auto-charge feature. When the UPS is plugged into an AC outlet, the battery will automatically charge whether the UPS is turned on or turned off. Note: This UPS is designed with a safety feature to keep the system from being turned on during shipment. The first time you turn the UPS on, you will need to have it connected to AC power or it will not power up.

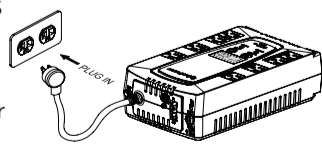

2. With the UPS unit turned off and unplugged, connect your computer, monitor, and any other peripherals requiring battery backup into the battery power supplied outlets. Plug the other peripheral equipment (eg. printer, scanner, speakers, etc.) into the full-time surge protection outlets. **DO NOT plug a laser printer, paper shredder, copier, space heater, vacuum cleaner, sump pump, or other large electrical device into the "Battery and Surge Protected Outlets". The power demands of these devices will overload and possibly damage the unit.**
3. Plug the UPS into a 2-pole, 3-wire grounded receptacle (wall outlet). Make sure the wall branch outlet is protected by a fuse or circuit breaker and does not service equipment with large electrical demands (e.g. air conditioner, refrigerator, copier, etc.). The warranty prohibits the use of extension cords, outlet strips, and surge strips in conjunction with the UPS unit.
4. Press the power switch to turn the unit on. The Power On indicator light will illuminate green and the unit will "beep" once.
5. If an overload is detected, an audible alarm will sound and the unit will emit one long beep. To correct this, turn the UPS off and unplug at least one piece of equipment from the battery power supplied outlets. Make sure the circuit breaker is depressed and then turn the UPS on.
6. To maintain optimal battery charge, leave the UPS plugged into an AC outlet at all times.
7. To store the UPS for an extended period of time, cover it and store with the battery fully charged. While in storage, recharge the battery every three months to ensure optimal battery life.
8. Ensure the wall outlet and UPS are located near the equipment being attached for proper accessibility.

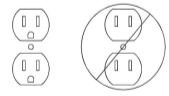

IMPORTANT SAFETY WARNINGS (SAVE THESE INSTRUCTIONS)

This manual contains important safety instructions. Please read and follow all instructions carefully during installation and operation of the unit. Read this manual thoroughly before attempting to unpack, install, or operate your UPS.

**CAUTION!** To prevent the risk of fire or electric shock, install in a temperature and humidity controlled indoor area free of conductive contaminants. (Please see specifications for acceptable temperature and humidity range).

**CAUTION!** Not for use in a computer room as defined in the Standard for the Protection of Electronic Computer / Data Processing Equipment, ANSI/NFPA 75.

**CAUTION!** Do not dispose of batteries in a fire. The batteries may explode.

**CAUTION!** To reduce the risk of electric shock, do not remove the cover except to service the battery. Turn off and unplug the unit before servicing the batteries. There are no user serviceable parts inside except for the battery.

**CAUTION!** Do not open or mutilate batteries. Released electrolyte is harmful to the skin and eyes. It may be toxic.

**CAUTION!** Hazardous live parts inside can be energized by the battery even when the AC input power is disconnected.

**DO NOT USE FOR MEDICAL OR LIFE SUPPORT EQUIPMENT!** CyberPower Systems does not sell products for life support or medical applications. DO NOT use in any circumstance that would affect operation and safety of life support equipment, any medical applications or patient care.

**CAUTION!** The UPS must be connected to an AC power outlet with fuse or circuit breaker protection. Do not plug into an outlet that is not grounded. If you need to de-energize this equipment, turn off and unplug the unit.

**DO NOT USE WITH OR NEAR AQUARIUMS!** To reduce the risk of fire or electric shock, do not use with or near an aquarium. Condensation from the aquarium can cause the unit to short out.

**CAUTION!** To avoid electric shock, turn off the unit and unplug it from the AC power source before connecting equipment to the unit.

**DO NOT USE THE UPS ON ANY TRANSPORTATION!** To reduce the risk of fire or electric shock, do not use the unit on any transportation such as airplanes or ships. The effect of shock or vibration caused during transit and the damp environment can cause the unit to short out.

**CAUTION!** To reduce the risk of fire, connect only to a circuit provided with 20 amperes maximum branch circuit over current protection in accordance with the National Electric Code, ANSI/NFPA 70.

INSTALLING YOUR UPS SYSTEM

UNPACKING

Inspect the UPS upon receipt. The box should contain the following:

- (a) UPS unit
- (b) User's manual
- (c) USB A+B type cable

PowerPanel® Personal software is available on our website. Please visit [www.cyberpowersystems.com](http://www.cyberpowersystems.com) and go to the Software Section for a free download.

AUTOMATIC VOLTAGE REGULATOR

The CP825AVRLCDG/CP685AVRLCDG/CP800AVR/CP685AVRG stabilizes inconsistent utility power to nominal levels that are safe for equipment. Unstable utility power can be damaging to important data and hardware. With Automatic Voltage Regulation (AVR), damaging voltage levels are corrected to safe levels. AVR automatically increases low utility power to a consistent and safe 110/120 volts.

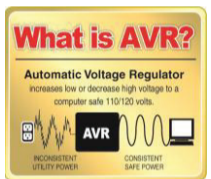

BASIC OPERATION

1. **Power Switch:** Used as the master on/off switch for equipment connected to the battery power supplied outlets. To turn the UPS ON, press the power button for approximately 2 seconds - you will hear a constant tone (1 second) - and release after two short beeps. To turn the UPS OFF, press the power button for approximately 2 seconds - you will hear a constant tone (1 second) - and release after two short beeps. **Alarm setting (For CP825AVRLCDG/CP685AVRLCDG):** The audible alarm can be turned Off or On by double clicking the POWER button. The default setting is for the Alarm On. To turn the Alarm Off, double click the button. You will hear two short beeps when the Alarm is turned off. To turn the Alarm back On, double click the button. You will hear a single short beep when the Alarm is turned on. \*When the Alarm is turned Off, there will be no audible notification when the UPS reaches a low battery state.
2. **Power On Indicator:** This LED is illuminated when the utility power is normal and the UPS outlets are providing power, free of surges and spikes.
3. **Mode Switch (For CP825AVRLCDG/CP685AVRLCDG):** Press the Mode Switch for approximately 3 seconds to enter setup mode to view options: Utility High/low Voltage range, sensitivity setup, LCD sleep ON/OFF, battery test, buzzer ON/OFF, and low battery alarm. When an option is selected, wait for 8 seconds for the setting to be confirmed. After the setting has been confirmed the LCD screen will leave setup mode and go back to status display. If there is no action for 8 seconds during setup, the LCD will also leave setup mode and go back to the status display.
4. **Fault Indicator:** This LED is illuminated if there is a problem with the UPS.
5. **Mute Button (For CP800AVR/CP685AVRG):** Press the button for 2 seconds to enable the audible alarm (beeps once) or disable (beeps twice) the audible alarm.
6. **LCD module display (For CP825AVRLCDG/CP685AVRLCDG):** LCD display shows all the UPS information using icons and messages. For more information please review the "Definitions for Illuminated LCD Indicators" section.
7. **Battery and Surge Protected Outlets:** The unit has four battery powered and surge protected outlets to ensure temporary uninterrupted operation of your equipment during a power failure.
8. **Full-Time Surge Protection Outlets:** The unit has four surge suppression outlets.
9. **USB Port:** The USB port allows connection and communication between the USB port on the computer and the UPS unit.
10. **Communication Protection Ports (For CP825AVRLCDG):** Communication protection ports, bidirectional, will protect a 10/100/1000 Ethernet connection (RJ45).
11. **Serial Port:** Serial Port allow for bi-directional communication among the UPS and the computer. The UPS can control the computer's shutdown in case of an emergency, and at the same time, the computer can monitor the UPS and alter its various programmable parameters.
12. **Circuit Breaker and Reset:** Located on the side of the UPS, the circuit breaker provides overload and fault protection.
13. **Ground Screw:** The ground screw is used for any equipment that needs a chassis ground connection.
14. **Outlets Designed for AC Adapters:** The UPS unit has four widely-spaced outlets. AC power adapters can be plugged into the UPS without overlapping or blocking adjacent outlets.

### REPLACING THE BATTERY

Replacement of batteries located in an **OPERATOR ACCESS AREA**

- When replacing batteries, replace with the same number of the following battery: CyberPower/RB1290 for CP825AVRLCDG, CP800AVR; CyberPower/RB1270B for CP685AVRLCDG, CP685AVRG.
- CAUTION!** Risk of Energy Hazard, 12V, maximum 9 Ampere-hour battery. Before replacing batteries, remove conductive jewelry such as chains, wrist watches, and rings. High energy through conductive materials could cause severe burns.
- CAUTION!** Do not dispose of batteries in a fire. The batteries may explode.

- CAUTION!** Do not open or mutilate batteries. Released material is harmful to the skin and eyes. It may be toxic.
- CAUTION!** A battery can present a risk of electrical shock and high short circuit current. The following precautions should be observed when working on batteries:
  - Remove watches rings, or other metal objects.
  - Use tools with insulated handles.

**CAUTION - RISK OF EXPLOSION IF BATTERY IS REPLACED BY AN INCORRECT TYPE. DISPOSE OF USED BATTERIES ACCORDING TO LOCAL REGULATIONS.**

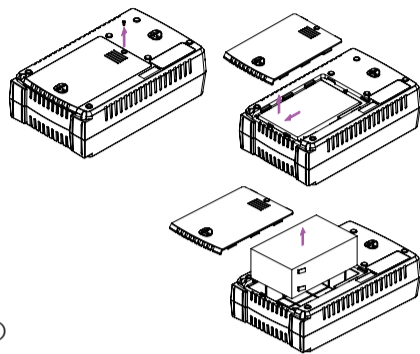

#### TO REPLACE THE BATTERY

- Turn off and unplug all connected equipment.
- Unplug it from the AC power source.
- Turn the UPS upside down.
- Remove the 1 retaining screw.
- Slide the battery compartment cover completely off of the unit.
- Remove the battery from the compartment.
- Disconnect the battery cables from the battery.
- Install the replacement battery by connecting the red wire and black wire to the positive (+) and negative (-) terminal of the battery.
- Put the battery back into the compartment.
- Slide back the battery compartment cover and tighten the retaining screw.
- Charge the unit for 8 hours to fully charge the battery.

**REMINDER:** Batteries are considered **HAZARDOUS WASTE** and must be disposed of properly. Most retailers that sell lead-acid batteries collect used batteries for recycling, as required by local regulations.

### TROUBLESHOOTING

Problem	Possible Cause	Solution
Circuit breaker button is projecting from the back of the unit.	Circuit breaker has been tripped due to an overload.	Turn the UPS off and unplug at least one piece of equipment. Wait 10 seconds, reset the circuit breaker by pressing the button, and then turn the UPS on.
The UPS does not perform expected runtime.	Battery not fully charged.	Recharge the battery by leaving the UPS plugged in.
	Battery is worn out.	Contact CyberPower Systems about replacement batteries at: <a href="http://cyberpowersystems.com/support">cyberpowersystems.com/support</a> .

### TROUBLESHOOTING - continued

Problem	Possible Cause	Solution
The UPS will not turn on.	The on/off switch is designed to prevent damage from rapidly turning it off and on.	Turn the UPS off. Wait 10 seconds and then turn the UPS on.
	The unit is not connected to an AC outlet.	The unit must be connected to a 120V 60Hz outlet.
	The battery is worn out.	Contact CyberPower Systems about replacement batteries at: <a href="http://cyberpowersystems.com/support">cyberpowersystems.com/support</a> .
PowerPanel® Personal is inactive (all icons are gray).	Mechanical problem.	Contact CyberPower Systems at: <a href="http://cyberpowersystems.com/support">cyberpowersystems.com/support</a> .
	The USB cable is not connected.	Connect the USB cable to the UPS unit and an open USB port on the back of the computer.
	The USB cable is connected to a bad USB port.	Check for a different USB port and plug the cable in.
The USB power ports are not providing power to the connected devices.	The unit is not providing battery power.	Shutdown your computer and turn the UPS off. Wait 10 seconds and turn the UPS back on. This should reset the unit.
	The USB power port has Over Current Protection design. When the total current of connected devices is over 2.1A, the USB power ports will stop providing power to the connected devices.	Turn the UPS off and unplug at least one piece of device connected to the USB power port and then turn the UPS on.

Additional troubleshooting information can be found at "Support" at [www.CyberPowerSystems.com](http://www.CyberPowerSystems.com)

### DEFINITIONS FOR ILLUMINATED LED INDICATORS

**INPUT Voltage Meter:** This meter measures the AC voltage that the UPS system is receiving from the utility wall outlet. The UPS is designed to continuously supply connected equipment with stable output voltage. In the event of a complete power loss, severe planned power suppression, or over-voltage, the UPS relies on its internal battery to supply consistent 110/120 output voltage. The INPUT voltage meter can be used as a diagnostic tool to identify poor-quality input power.

**OUTPUT Voltage Meter:** This meter measure, in real time, the AC voltage that the UPS system is providing to the computer during normal AC/Utility Power mode, and battery backup mode.

**ESTIMATED RUNTIME:** This displays the run time estimate of the UPS with the current battery capacity and load.

**NORMAL Icon:** This icon appears when the UPS is working under normal conditions.

**BATTERY Icon:** During a severe planned power suppression or power outage, this icon appears and an alarm sounds (two short beeps followed by a pause) to indicate the UPS is operating from its internal batteries. During

a prolonged planned power suppression or power outage, the alarm will sound continuously to indicate the UPS's batteries are nearly out of power. You should save files and turn off your equipment immediately or allow the software to shut the system down.

**OVER LOAD Icon:** This icon appears and an alarm sounds to indicate the battery-supplied outlets are overloaded. To clear the overload, unplug some of your equipment from the battery-supplied outlets until the icon turns off and the alarm stops.

**BATTERY CAPACITY Meter:** This meter displays the approximate charge level of the UPS's internal battery in 20% increments. During a power outage or severe planned power suppression, the UPS switches to battery power (the BATTERY icon appears) and the battery charge level decreases.

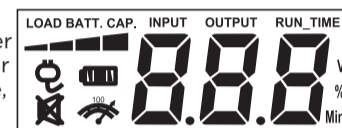

The LCD display indicates a variety of UPS operational conditions. All descriptions apply when the UPS is plugged into an AC outlet and turned on or when the UPS is on battery.

continued

### DEFINITIONS FOR ILLUMINATED LED INDICATORS - continued

**LOAD CAPACITY Meter:** This meter displays the approximate output load level of the UPS battery outlets in 20% increments.

**SENSITIVITY Meter:** This meter displays the sensitivity level of the UPS. It is to control the sensitivity of the UPS to switch to Battery Mode by selecting UPS shutdown voltage

range. When the sensitivity is increased, the UPS will switch to Battery Mode with less input power variation.

**FAULT:** The following number appears if there is a problem with the UPS. Press the POWER button to turn the UPS off.

### DEFINITIONS FOR LED INDICATORS & AUDIBLE ALARMS

POWER	WIRING FAULT	ALARM	CONDITION
On	Off	Off	Normal
On	Off	Beep twice every 30 seconds	<b>Utility Failure - Battery Mode:</b> The UPS is providing power to battery power-supplied outlets from its battery.
On	Off	Rapid beeping every 1/2 second	<b>Utility Failure - Low Battery:</b> The UPS is providing battery power. Rapid beeping indicates the unit will run out of power soon.
On/Off	Flash once every 5 seconds	Constant tone	<b>Battery Mode or AC/Utility Power Mode Overload Fault:</b> Occurs when connected equipment exceeds the rating of battery outlets of the unit. Please unplug at least one piece of equipment from battery outlets..
Off	Flash twice every 5 seconds	Constant tone	<b>Battery Output Short Fault:</b> Please unplug at least one piece of equipment from battery outlets and turn on the UPS again. If the fault still exists, please contact CyberPower Systems for support.
On	Flash 3 times every 5 seconds	Constant tone	<b>Charger Fault:</b> Contact CyberPower Systems for support.

### TECHNICAL SPECIFICATIONS

Series Model	CP825AVRLCDG CP825AVRLCDa	CP685AVRLCDG CP685AVRLCDGa	CP600AVR CP800AVRa	CP685AVR CP685AVRa
Capacity	825 VA/450 W	685 VA/390 W	800 VA/450 W	685 VA/390 W
Nominal Input Voltage	120 V			
Input Frequency	60 Hz ± 3 Hz			
On-Battery Output Voltage	120 VAC ± 5%			
On-Battery Output Frequency	60 Hz ± 3 Hz			
Max. Load for UPS Outlets	825 VA/450 W	685 VA/390 W	800 VA/450 W	685 VA/390 W
Max. Load for Full-time Surge Protection Outlets	12 Amps			
On-Battery Output Wave Form	Simulated Sine Wave			
Surge Protection	1030 J			
Operating Temperature	+ 32°F to 104° F / 0° C to 40° C			
Operating Relative Humidity	0 to 90% non-condensing			

### TECHNICAL SPECIFICATIONS - continued

Series Model	CP825AVRLCDG CP825AVRLCDa	CP685AVRLCDG CP685AVRLCDGa	CP600AVR CP800AVRa	CP685AVR CP685AVRa
Size (W x H x D)	11.02" x 6.81" x 3.47" / (100 x 280 x 355 mm)			
Net Weight	12.74 lbs.	11.62 lbs.	12.74 lbs.	11.62 lbs.
Typical Battery Recharge Time	8 hours typical from total discharge			
Typical Battery Life	3 to 6 years, depending on number of discharge/recharge cycles			
Recommended Battery	Sealed Maintenance Free Lead Acid Battery			
Safety Approvals	UL1778(UPS), cUL107, FCC/DoC Class B			

### SYSTEM FUNCTION BLOCK DIAGRAM

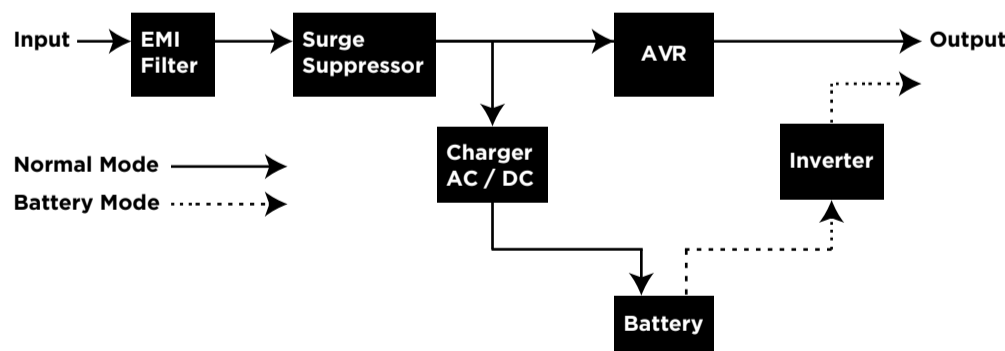

### CYBERPOWER GREENPOWER UPS™ TECHNOLOGY

Advanced Energy-Saving Design

The GreenPower UPS™ has a high-efficiency charger, which makes it the most energy-efficient UPS in its class. The advanced high-frequency charging system significantly improves charging efficiency and conserves energy. As a result of this advanced design, the GreenPower UPS™ uses less energy compared to competitive models. The GreenPower UPS™ is manufactured in accordance with the Restriction on Hazardous Substances (RoHS) directive making it one of the most environmentally-friendly UPS systems on the market today.



### FCC COMPLIANCE STATEMENT

This device complies with part 15 of the FCC rules. Operation is subject to the following two conditions: (1) this device may not cause harmful interference, and (2) this device must accept any interference received, including interference that may cause undesired operation. Note: This equipment has been tested and found to comply with the limits for a Class B digital device, pursuant to part 15 of the FCC Rules. These limits are designed to provide reasonable protection against harmful interference in a residential installation. This equipment generates, uses, and can radiate radio frequency energy and, if not installed and used in accordance with the instructions, may cause harmful interference to radio communications. However, there is no guarantee that interference will not occur in a particular installation. If this equipment does cause harmful interference to radio or television reception, which can be determined by turning the equipment off and on, the user is encouraged to try to correct the interference by one or more of the following measures:



- Reorient or relocate the receiving antenna.  
- Increase the separation between the equipment and receiver.  
- Connect the equipment to an outlet on a circuit different from that to which the receiver is connected.  
- Consult the dealer or an experienced radio/TV technician for help.

**Warning:** Changes or modifications not expressly approved by the party responsible for compliance could void the user's authority to operate the equipment.

Canadian Compliance Statement  
CAN ICES-3 (B)/NMB-3(B)

### LIMITED WARRANTY AND CONNECTED EQUIPMENT GUARANTEE

Please visit [www.CyberPowerSystems.com](http://www.CyberPowerSystems.com) for a copy of the Limited Warranty and Connected Equipment Guarantee.

#### Where Can I Get More Information?

The application of the United Nations Convention of Contracts for the International Sale of Goods is expressly excluded. CyberPower is the warrantor under this Limited Warranty. For further information please feel free to contact CyberPower at: Cyber Power Systems (USA), Inc. 4241 12th Ave E., STE 400, Shakopee, MN 55379; call us at (877) 297-6937, or submit a web ticket online at [cyberpowersystems.com/support](http://cyberpowersystems.com/support).

Cyber Power Systems (USA), Inc. encourages environmentally sound methods for disposal and recycling of its UPS products. Please dispose and/or recycle your UPS and batteries in accordance to the local regulations of your state.

© 2022 CyberPower Systems (USA), Inc. PowerPanel® Personal is a trademark of Cyber Power Systems(USA) Inc. All rights reserved. All other trademarks are the property of their respective owners.