

Bobcat User's Handbook



Table Of Contents

TABLE OF CONTENTS	2
DISCLAIMER.....	4
TRADEMARKS	4
COPYRIGHT	4
PUBLICATION INFORMATION	4
DECLARATION OF CONFORMITY	4
WARRANTY INFORMATION	5
IMPORTANT SAFETY INFORMATION	5
WELCOME	8
ABOUT YOUR COMPUTER	9
PACKAGE CONTENTS	10
CONTACTING XPLORE: SERVICE & QUESTIONS	11
GETTING STARTED	12
FRONT VIEW	12
BACK VIEW	13
RIGHT SIDE VIEW	14
LEFT SIDE VIEW.....	15
BOTTOM VIEW.....	16
LED STATUS INDICATOR.....	17
QUICK START GUIDE.....	18
USING THE TABLET	19
SUSPEND OPERATION.....	19
RESUME OPERATION.....	19
SCREEN INPUT OPERATION	20
MAINTAINING THE TABLET	21
CARING FOR THE TABLET.....	21
TROUBLESHOOTING	23
HARDWARE SPECIFICATIONS	24
AGENCY NOTES	26
FCC NOTICES	26
HEALTH AND SAFETY INFORMATION	28
DOC (INDUSTRY CANADA NOTICES).....	28

UL NOTICE..... 30
SYSTEM DISPOSAL 30

ENVIRONMENT 31

ENVIRONMENTAL POLICY..... 31
TAKE BACK AND RECYCLING PROGRAM 32
ENVIRONMENTAL AND SUSTAINABILITY CORPORATE REPORT 32

Disclaimer

Xplore Technologies® has made every effort to ensure the accuracy and completeness of this document; however, because ongoing development efforts are made to continually improve the capabilities of our products, we cannot guarantee the accuracy of the contents of this document. We disclaim liability for errors, omissions, or future changes herein.

Trademarks

Xplore and the Xplore logo are registered trademarks of Xplore Technologies Corp. of America; iX104, iX104C5, BOBCAT, iX104C5 Lite, and iX104C5 Dual Mode are trademarks of Xplore Technologies Corp. Kensington and MicroSaver are registered trademarks of the Kensington Technology Group. Android is a registered trademark of Google Corporation. MicroSD is registered trademark of the Personal Computer Memory Card International Association. Wi-Fi is a trademark of the Wireless Ethernet Compatibility Alliance (WECA). HDMI is a trademark of "" All other brands, product names, company names, trademarks and service marks used herein are property of their respective companies.

Copyright

Copyright © 2003-2014 Xplore Technologies Corp. All rights reserved. No part of this publication may be copied, reproduced, or translated, without the prior written consent of Xplore Technologies. No part of this publication may be stored or transmitted in any electronic form without the prior consent of Xplore Technologies. Any unauthorized use is a violation of copyright laws.

Publication Information

PN: 95-01211

February 2014

Declaration of Conformity

DECLARATION OF CONFORMITY according to FCC Part 15, IC ICES-003, and RTT&E directives Responsible Party Name: Xplore Technologies Corp.

Address: 14000 Summit Drive, Suite 900, Austin, Texas 78728

Telephone: 512.336.7797

Declares that product: Model Series: BOBCAT complies with Part 15 of the FCC Rules. This device complies with Part 15 of the FCC rules. Operation is subject to the following two conditions: (1) This device may not cause harmful interference, and, (2) This device must accept any interference received, including interference that may cause undesired operation.

WARNING

Changes or modifications to this unit not expressly approved by the party responsible for compliance may void the user's authority to operate this equipment. For more information about FCC, IC, and EU rules and their applicability to the BOBCAT, see, "Agency Notes" on page 24.

Warranty Information

The BOBCAT is backed by a standard 36-month International Limited Warranty. An extended International Limited Warranty is available. Check the service kit included with your computer for warranty terms and conditions.

Important Safety Information

Before you use the BOBCAT (referred to as the tablet), read these safety instructions and the operation instructions in this handbook.

Failure to observe all these instructions voids the Limited Warranty and may lead to suspension or denial of services to the offender, or legal action, or both.

Follow any special regulations governing the use of the tablet and, if radio-enabled, always switch it off in areas where radio devices are forbidden or when the radio device can cause interference or danger.

Always follow any safety laws and regulations pertaining to the use of cell phones and two-way radios, because these laws and regulations typically apply to the use of the wireless-enabled tablet.

Observe all restrictions on the use of radio equipment in fuel depots (fuel storage and distribution areas), chemical plants, and wherever blasting operations are in progress or in any area in which restrictions on radio transmissions are imposed. Switch off the tablet when in an aircraft. The tablet is not FAA-approved for use on aircraft. The effect of the use of the tablet in aircraft is unknown. Using the tablet in an aircraft may affect aircraft instrumentation, communication, and performance; may disrupt the network; and may be illegal.

Operating the wireless-enabled tablet may interfere with the functioning of inadequately protected medical devices such as pacemakers. Consult a physician or the manufacturer of the medical device if you have any questions.

Radio signals from your tablet will not affect the operation of most modern equipment, but certain electronic equipment, including automotive systems, may not be shielded against radio signals from your tablet. Check with the manufacturer of your motor vehicle or the manufacturer's representative to determine whether using the tablet will present any safety issues.

Avoid using the tablet in any environment that requires your full attention, such as when driving a vehicle. If you need to use your tablet while driving, have a passenger use it for you or find a safe location to halt your vehicle.

WARNING BATTERIES

Use only battery types specified in this handbook. Using any other type of battery can be dangerous and can disable the tablet. Do not drop or mishandle the batteries, immerse them in water, or subject them to high heat. Doing so could increase the risk of explosion or leakage, and possibly cause injury. The lithium-ion batteries used in this equipment contain material that is hazardous to your health. If battery contents come in contact with the eyes, IMMEDIATELY flush the affected area with clean water for 15 minutes and have someone else summon medical attention for you. Unaffected persons should assist the affected individual in the vital first flushing of the eyes. RECHARGING THE BATTERY MUST ONLY BE CARRIED OUT IN A NON-HAZERDOUS AREA USING THE SUPPLIED AC ADAPTOR. The definition of hazardous areas can be found in Standard EN 60079-10.

WARNING

When operating the tablet in a known explosive environment do not remove or replace the battery while the circuit is live. Before removing the battery verify that the area is known to be free of ignitable concentrations of flammable substances. EXPLOSION HAZARD – DO NOT DISCONNECT WHILE CIRCUIT IS LIVE UNLESS AREA IS KNOWN TO BE NON-HAZERDOUS.

AVERISSEMENT – RISQUE D'EXPLOSION. NE PAS DÉBRANCHER TANT QUE LE CIRCUIT EST SOUS TENSION, À MOINS QU'IL NE S'AGISSE D'UN EMPLACEMENT NON DANGEREUX.

WARNING

EXPLOSION HAZARD - DO NOT REPLACE THE BATTERY UNLESS POWER HAS BEEN SWITCHED OFF OR THE AREA IS KNOWN TO BE NON-HAZARDOUS;

AVERTISSEMENT - RISQUE D'EXPLOSION - COUPER LE COURANT OU S'ASSURER QUE L'EMPLACEMENT EST DESIGNÉ NON DANGEREUX AVANT DE REPLACER LE BATTERY

WARNING

EXPLOSION HAZARD - SUBSTITUTION OF COMPONENTS MAY IMPAIR SUITABILITY FOR CLASS I, DIVISION 2;

AVERTISSEMENT - RISQUE D'EXPLOSION - LA SUBSTITUTION D'E COMPOSANTS PEUT RENDRE CE MATÉRIEL INACCEPTABLE POUR LES EMPLACEMENTS DE CLASSE I, DIVISION 2;

WARNING

EXPLOSION HAZARD - DO NOT DISCONNECT EQUIPMENT UNLESS POWER HAS BEEN SWITCHED OFF OR THE AREA IS KNOWN TO BE NON-HAZARDOUS

AVERTISSEMENT - RISQUE D'EXPLOSION - AVANT DE DECONNECTER L'EQUIPEMENT, COUPER LE COURANT OU S'ASSURER QUE L'EMPLACEMENT EST DESIGNÉ NON DANGEREUX.

WARNING

Do not use any dock or any other accessory or attachment that is not manufactured or supplied by Xplore or an authorized Xplore accessories supplier. Use of any accessory or attachment that is not supplied or approved for use with the tablet by Xplore is not permitted because it may cause hazards.

Operate the tablet only from the type of power source indicated on the marking label. (See page 54 for more information about the battery and power supply.) Route power supply cords so that they are not likely to be walked on or pinched by items placed upon or against them. Pay particular attention to cords at plugs and convenience receptacles, and at the point where cords exit from the tablet or its dock. Do not overload wall outlets, extension cords, or integral convenience receptacles because this can cause fire or electric shock.

Unplug the tablet and refer the tablet and dock for service to qualified service personnel if any of the following conditions occur:

- The power supply cord or plug is damaged.
- The tablet or dock does not operate normally when you follow the instructions in this book.
- The tablet or dock exhibits a distinct change in performance.

Adjust only controls for which there are instructions in this book. An improper adjustment of other controls can result in damage and may require extensive work by a qualified technician to restore the tablet or dock to normal operation.

CAUTION

Avoid prolonged physical contact with the exposed metal surfaces on the front and back of the tablet. While the tablet may not feel hot to the touch, prolonged physical contact with the tablet surface may cause low-heat injury. In addition, be careful when removing a PC card that has been used for an extended time, as the card may be hot.

Welcome

Welcome to the Xplore Technologies Bobcat tablet, the rugged tablet designed, tested, and manufactured to meet the environmental and physical real-world challenges faced by today's mobile workers. Based on years of experience in rugged mobile applications, the BOBCAT is designed to withstand the abuses of everyday wear and tear. Advanced technology, innovative design, and a rugged case are just a few highlights of your BOBCAT system.



Note: This handbook assumes that you have basic experience using Microsoft Windows 7 or Microsoft Windows 8.1.

About Your Computer

The BOBCAT is a high-performance tablet that runs on Microsoft Windows operating system. The method you use to control the tablet is as follows:

Tablet Model

BOBCAT

Touchscreen

Projected Capacitive Touch (PCT)

Control Method

- Pen (standard with the tablet)
- Multi-finger touch

Note: In this handbook, all information applies to all models unless otherwise noted.

All BOBCAT tablets have been engineered and tested to meet Military Standards for Environmental Extremes (MIL STD 810G). Your tablet includes the following features that make it exceptionally rugged and durable:

- Durable, long-lasting, plastic enclosure
- Interior magnesium alloy frame
- Bumper system and gasket protection mechanisms
- Solid State storage memory
- Integrated, protected wireless LAN and WAN antennas for dual mode operation
- Chemically treated rugged Display Glass

Package Contents

Check to make sure your package includes the following items:

- Quick Start Guide
- AC adapter
- BOBCAT tablet
- Warranty information kit

Optional Accessories

Your package may also include any optional accessories you ordered.

Docking Options

- Vehicle Docking Station

Carrying Cases

- Carrying handle with Stylus and Shoulder Strap
- Tablet backside hand-strap

Memory

- SD memory

Additional Accessories (Optional)

- CAC reader expansion bay
- 1D2D bar code scanner
- Auto adapter (cigarette lighter adapter)

Contacting Xplore: Service & Questions

Note: To troubleshoot problems (including wireless and GPS problems), before you call, read the FAQ page of the Xplore Technologies Web site. Go to <http://www.xploretech.com>; then select Customer Support; then FAQ.

If you purchased your tablet from an authorized Xplore dealer, contact the dealer for service and support.

If you purchased your tablet directly from Xplore, use any of the following methods to contact Xplore for service and support:

Website: <http://www.xploretech.com>

E-mail: customersupport@xploretech.com

Toll free: 1-866-296-8541, extension 222

Fax: 1-512-336-7791

Before you contact Xplore, have the following information ready so that the customer support representative can quickly provide a solution:

Product name: BOBCAT

Product serial number

- The serial number is on the back of the tablet

Conditions under which the problem occurred

Any error messages that were displayed

Type of device connected, if any

This chapter gives you an overview of your tablet and includes a quick-start guide.

Front View

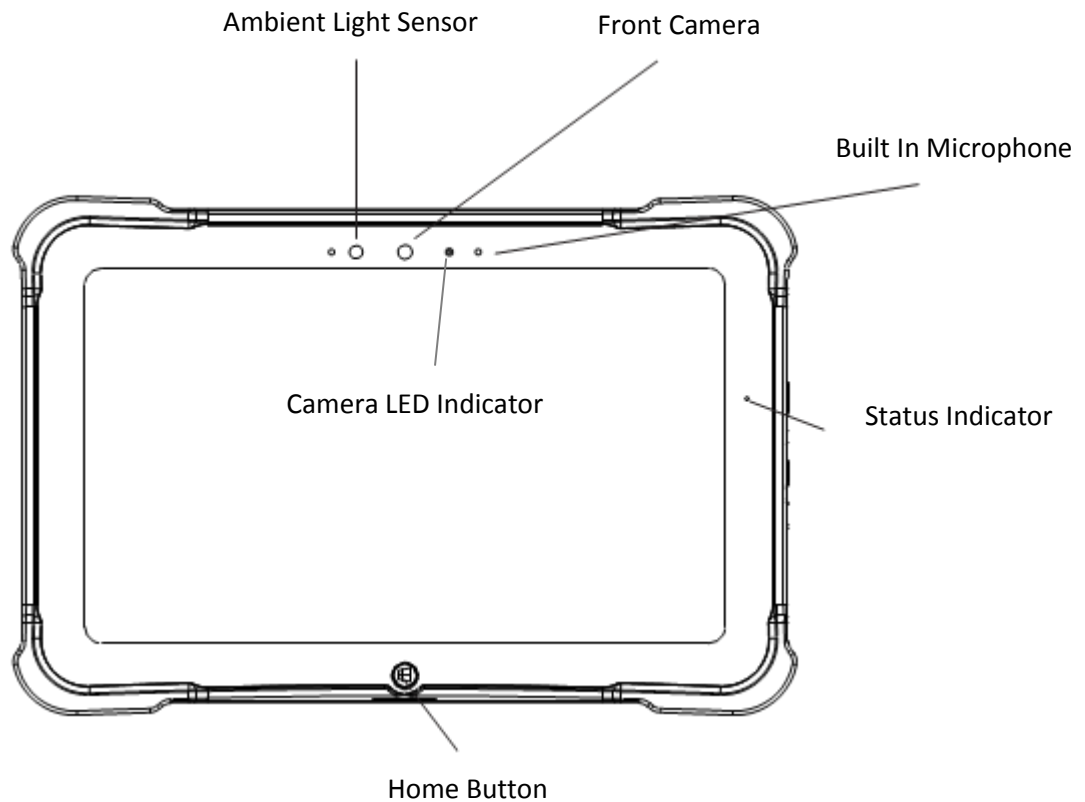

Built-In Microphone	Enables you to input mono audio
Front Camera	HD Video Front Facing Camera for video conferencing, video capture or still picture capture
Status Indicator	Indicates the computer status (on, off, charging)
Home Button	Home Button for easy navigation within the Microsoft Windows environment.
Auto Light Sensor	Detects ambient light conditions

Back View

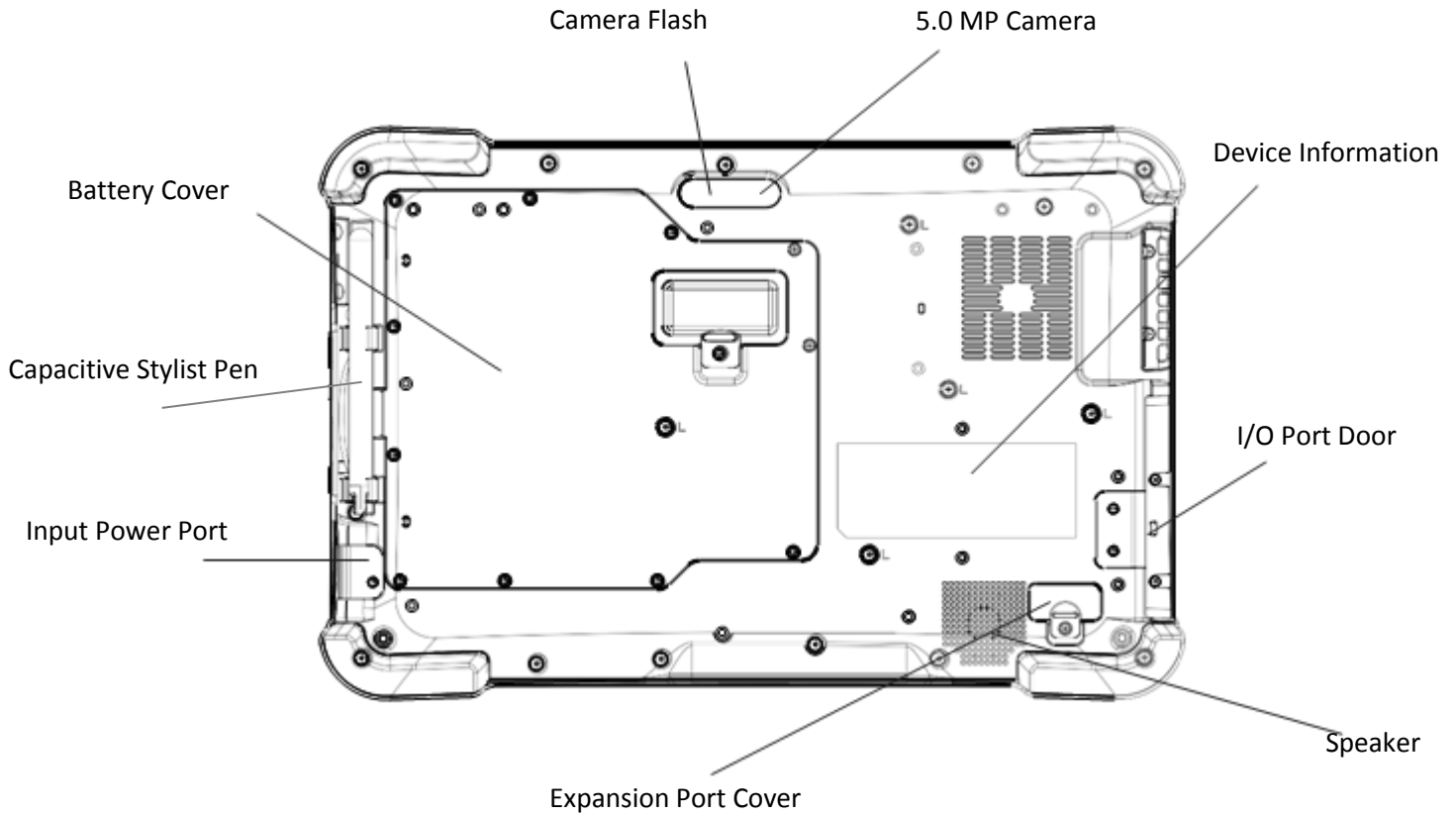

Speaker	Integrated Speaker for Audio Playback
Input Power Port	Powers the commuter when connected to external power supply.
Battery Cover	Provides access to the battery.
Rear 5MP Camera	5 MegaPixel rear facing camera for High Quality still photography or HD Video environment.

Right Side View

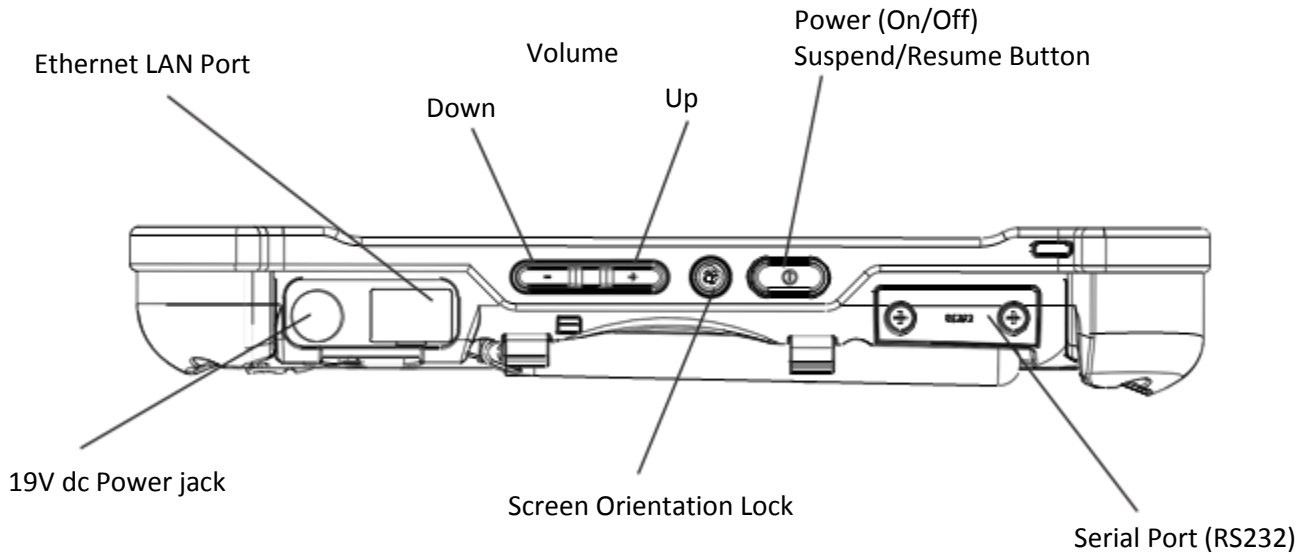

Power (On/Off)	Press to power computer, press and hold for 4 seconds to force power off use
Suspend (On/Off)	Momentarily depress to enter/exit Suspend mode.
Screen Orientation lock	Locks the screen in current position regardless of tablet orientation when pressed. Press again to un-lock screen orientation.
Volume Up/ Down	Press top of rocker button to increase Audio volume Press bottom of rocker button to decrease Audio volume
19V dc Power Input	Pull back cover to expose connector Jack for AC power supply
LAN Connector	RJ45 for Ethernet LAN data connection.
Serial Port	RS232 Serial port expansion area – uses dongle cable for full serial device interface

Left Side View

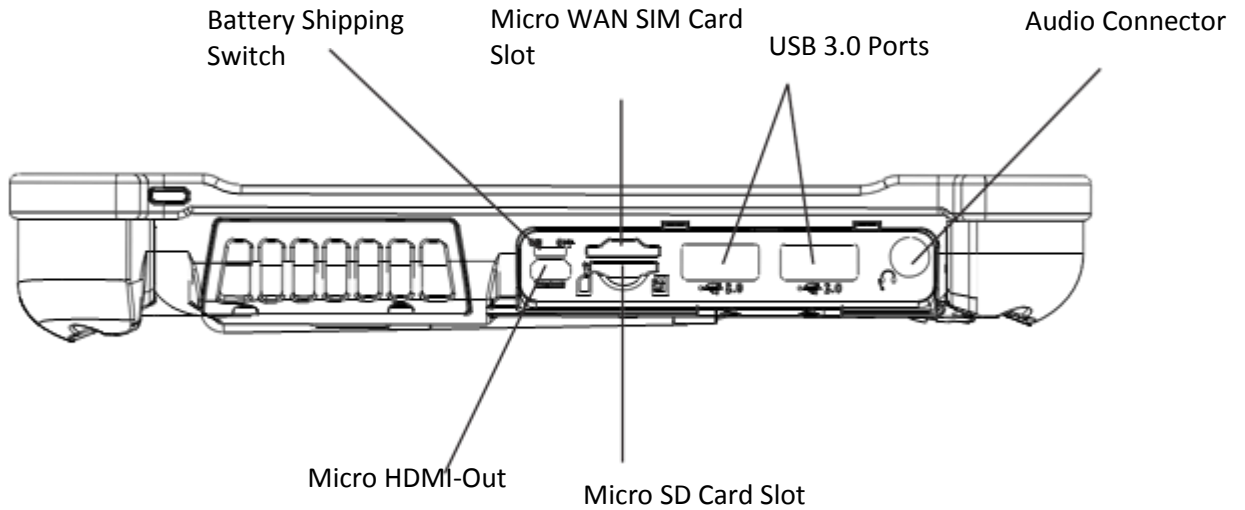

Audio connector	Headset connector for smartphone compatible earphones and microphone
USB Ports	Two full size USB 3.0
HDMI Output	Micro HDMI out connector for connection to External Monitor or HDTV device
Micro WAN SIM Slot	Wireless Data Provider SIM card (insert contacts facing up).
Battery Shipping Switch	Safety Switch to isolate Battery during shipping. It must be turned on (thrown toward tablet top) for the device to operate. See First time operation section.
Micro SD Card Slot	MicroSDXC memory card slot for user memory expansion (insert contacts facing up)

Bottom View

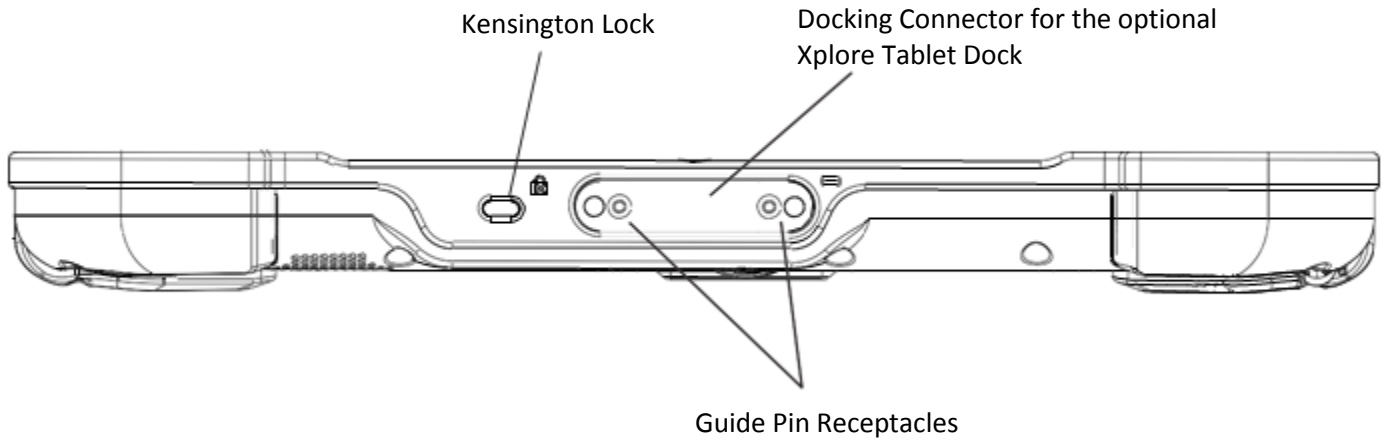

Dock Connector	Enables you to connect the G2 xDock Vehicle Docking Stations.
Guide Pin Receptacles	Help assure a secure connection of the optional xDock. Note: See “Optional accessories” on page 16.
Kensington Lock Slot	Connector for the optional Kensington MicroSaver™ or equivalent compatible Security cable Note: Contact your reseller for information regarding the Kensington security cable.

LED and Camera Status Indicator Table

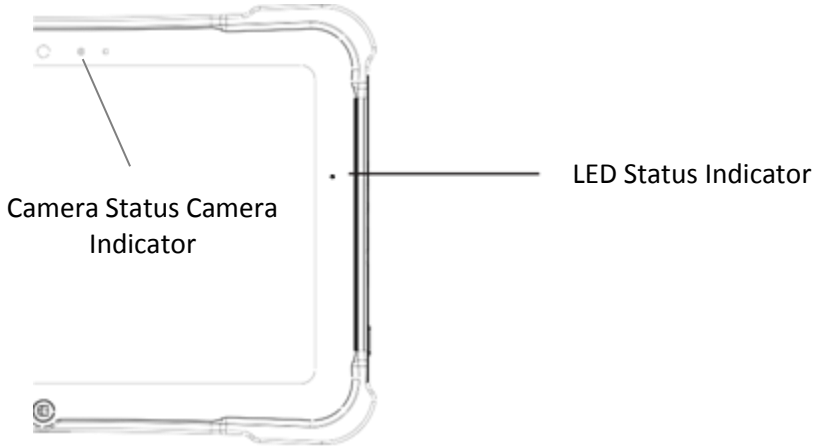

Bobcat LED Profile

LED / Camera Status Indicators System State

Power Source	OFF	ON	Sleep	Error
External	Orange	Green	Green Slow Blink	Red Fast Blink
Battery Charge	Orange Blink	Orange Blink	Orange Blink	Red Fast Blink
Battery Power	OFF	Green	Green Slow Blink	Red Fast Blink
Battery Low <15%	OFF	Red Blink	Red Blink	Red Fast Blink
Battery Critical Low <8%	OFF	Red	Red	Red Fast Blink
System On + Camera On	OFF	Blue	Green Slow Blink	Red Fast Blink
System On + Camera On Battery Low <15%	OFF	Blue	Green Slow Blink	Red Fast Blink
System On + Camera On Battery Critical Low <8%	OFF	Blue	Green Slow Blink	Red Fast Blink

Quick Start Guide

First Time Turning On the Computer

1. Find and Turn the Battery switch ON. A small screwdriver or paperclip may be used for this purpose. For Safety reasons the tablet is shipped with the Battery switch OFF and the tablet will not operate if this step is not taken. It is not necessary to turn the Battery switch of the device ON or OFF during normal device operation so this operation is only needed on initial device operation.

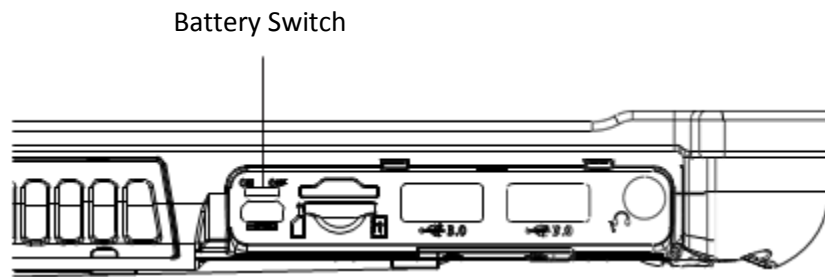

Battery Switch is ON when thrown toward the top side of the tablet.

2. Make sure the battery is charged or that the computer is plugged into an external power source.

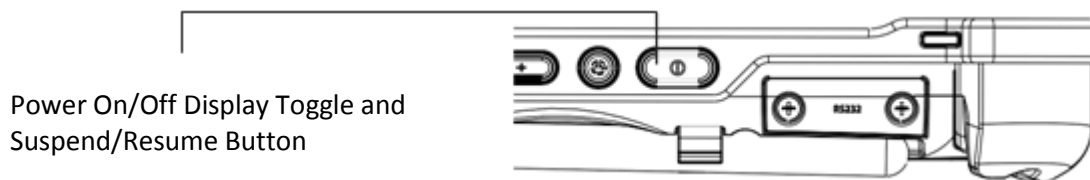

3. Press the Power On/Off/Suspend/Resume button.
4. Xplore Technologies Logo should display. Allow device to finish boot- up and follow configuration instructions on your screen

Suspend Operation

To conserve battery power when you do not want to turn off the computer, put the computer into Suspend mode. (You can suspend operation without closing any apps.) The default configuration at time of purchase is for the system to enter suspend mode automatically after 5 minutes of no activity.

To manually enter suspend mode press the Power switch briefly and release. The display should switch off, without any confirmation menu being presented.

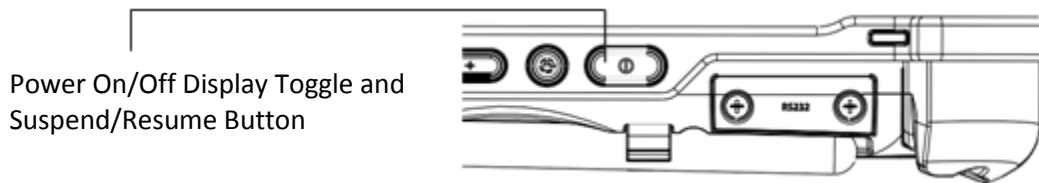

Resume Operation

To resume tablet operation from Suspend mode follow the same procedure as turning the tablet on.

1. Press the Power On/Off/Suspend/Resume button

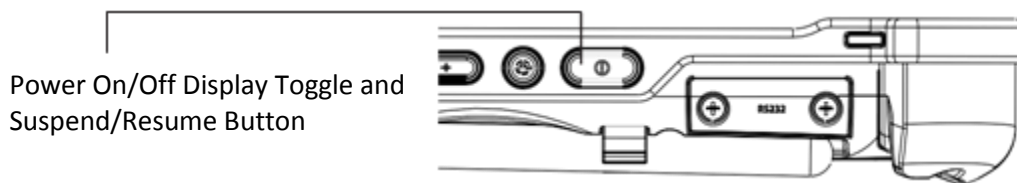

If this is not successful the battery on the tablet may have fully discharged. Plug the tablet into AC power and repeat the procedure

Screen Input Operation



Touch- Select Item or Option
Touch and Hold- Open Special

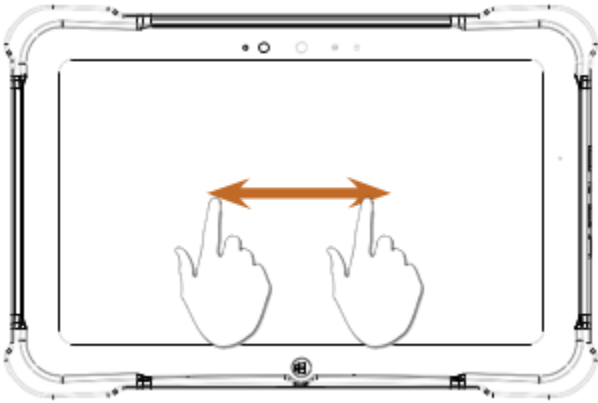

Drag- Scroll the screen
Flick- Scroll the screen quickly
Drag and drop- Move an item

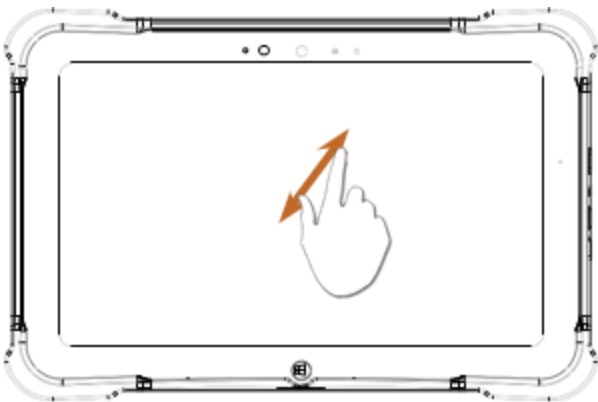

Pinch - Zoom

Maintaining the Tablet

Caring for the Tablet

This section provides information about how to keep your tablet in top working condition.

Checking Power Cords and Connectors

Check AC and DC power cords and power connectors periodically for damage. Replace the power cord immediately if you find any damage.

Protecting the Computer from Damages

- Your computer is designed to sustain a multiple-axis drop to a non-yielding surface. Do not intentionally drop the computer because the cumulative effects of multiple drops may damage the computer.
- Do not place heavy objects on the computer.
- Do not disassemble the computer.
- Keep the computer at least 5 inches (13 centimeters) away from any electrical appliance that generates a strong magnetic field, such as a motor, magnet, TV, refrigerator, or large audio speakers.

Storing the Computer

You can store the computer in the Off state for about 30 days with a fully charged battery installed. After this period, recharge the battery or replace it with a charged battery.

Caring for the Display Screen

To clean the display screen, dampen a soft cotton cloth with water and gently wipe the screen surface.

Note: Do not use isopropyl alcohol to clean the screen. Alcohol may damage the surface of the screen.

Protecting Computer from Damages

The screen protector is a durable, replaceable writing surface that protects the display screen from abrasion.

To obtain screen protectors, check with your reseller, or go to the Xplore Web site at www.xploretech.com for ordering information. Additional information about installation is included with the screen protectors.

Removing the Screen Protector

Slide your fingernail under the edge of the screen protector and pull the protector away from the screen.

Installing a New Screen Protector

Follow the instructions included with your screen protector replacement kit.

Note: If a screen protector is already installed on the display screen, remove it before installing the new screen protector.

Troubleshooting

Table 7 contains solutions to some problems. If you cannot solve the problem by taking the actions described, contact your local help desk or your reseller for further assistance.

Table 7: Troubleshooting

Problem	Possible causes and solution
Computer will not start	<ul style="list-style-type: none"> The battery may be defective or discharged to a critically low level. Connect an external power supply (such as the AC adapter) or install a charged battery. See “Using the battery” on page 54. Internal components may be above or below the acceptable operating range below -20° C or above 60° C). After the temperature returns to safe operating range the computer will start.
The Computer will not resume operation	<ul style="list-style-type: none"> The battery may be defective or discharged to a critically low level. When the battery reaches a critically low level, the computer is forced into Suspend- to-RAM mode to avoid a total system power failure. Connect an external power supply (such as the AC adapter) or install a charged battery. See “Using the battery” on page 54. The computer may be at the critical thermal limit. To avoid damage to heat-sensitive components, the computer enters Suspend-to- RAM mode when the computer operates above 60° C. Operation automatically resumes when the computer cools to below 60° C. Move the computer to a cooler location after being suspended
The Status LED is red, continuous	<ul style="list-style-type: none"> The computer is on, running under battery power, and the charge level in the battery has reached a critical level. Plug the computer into an AC/DC power source or install a charged battery. The system has encountered a fault and is preventing normal operation. Contact your local help desk.
The Status LED is red, blinking	<ul style="list-style-type: none"> The computer is powered on, running under battery power, and the charge level in the battery is at a minimum warning level. Plug the computer into an AC/DC power source or install a charged battery.
Display screen is blank or difficult to read	<ul style="list-style-type: none"> Confirm that the computer is on (the Power icon is continuously displayed in Status area). The brightness may be set too low, causing the screen to appear too dark. To change system brightness, press Settings Icon, Display, Brightness. The video time-out may have expired. Tap the display screen to reactivate the display. Note: This is a normal, power-saving feature.
Headphone or speaker volume is too low	<ul style="list-style-type: none"> The volume may be in Mute mode or set too low. Follow the instruction to adjust headphone or speaker volume. Make sure the volume control in your audio software is set to an audible level.
An external device is not working with the computer	<ul style="list-style-type: none"> The device may need to be enabled in the computer’s configurator program. Contact your local help desk or reseller.

Hardware Specifications

Physical	
Dimensions	11.05" (28.1cm) x 7.07" (18cm) x 0.86" (2.2cm) (W x H x H)
Weight	2.4lbs (1.09 kgs)
Processing	
Dimensions	Intel Bay Trail E3485 Quad Core
Processor Speed	1.9 GHz
Memory/ Storage	
Main RAM	4GB DDR3L 1333
RAM Options	None
Storage	128GB SSD
Storage Expansion	One User accessible micro SDXC
Display	
Display	<ul style="list-style-type: none"> • 10.1" WXGA (1366x768) 16:9 Rugged IPS LCD backlit display • 500 NITS direct bonded screen • 178 degree viewing cone (89 degree off axis) • Contrast ratio 800:1 aspect ratio • Automatic light sensor (ALS) • Multi touch • Glove touch
Graphics	Intel Integrated Mobile Gen 7
Interface	
Integrated Communications	Wireless LAN: 802.11ac Bluetooth 4.0 GPS 2.5 meter accurate LAN: 10/100/1000 Gigabit Ethernet (RJ45)
Integrated Interfaces	<ul style="list-style-type: none"> • DC-in • 2 USB 3.0 • Micro SDXC Micro HDMI-out

	<ul style="list-style-type: none"> • Micro SIM Card Reader RS-232 Serial Ready port • Headphones/Speaker mini-Jack Stereo, smartphone compatible
KeyPad/ User Controls	<p>Application buttons</p> <p>Power On/Off/Suspend/Resume button</p>
Power	
Main Battery	<ul style="list-style-type: none"> • 7.4V Serviceable Lithium Ion • Recharge Time: 3.5 hours (90%) • Life: Up to 8 hours. (Battery life is dependent on operating system, power Management and applications in use.) • Suspend Life: Min. 5 days
AC Adapter	Auto-sensing 100-240V, supplying 19 VDC, with a current of 3.42 A
Environmental	
Temperature	<p>Operating: -4° to 140° F (-20° to 60° C)</p> <p>Storage: -22° to 158° F (-30° to 70° C)</p>
Humidity	95% non-condensing
Shock/ Drop	<p>Operating 5' (1.52 meter) direct to plywood over concrete. 26 drops per Mil Std 810. External</p> <p>battery is not installed.</p>
Vibration	Minimum integrity. Vehicle vibration. US highway truck
IEC Ingress testing	IEC (60529) Ingress tested to an IP65 standard
Agency Approvals	
Emissions and Immunity	<p>Immunity: CISR 22, EN 55024 CB scheme (US, CAN, EU)</p> <p>Emissions: EN 55022, CISPR 22, Cfr 47 Part 15, Subpart B, Ices-003 for Class B (US, CAN, Eu27), CEC, Regulatory bulletin No 110915.02B (BCS), ERP directive</p>
Safety	IEC 60950 CB Scheme (US, CAN, EU)
Operating System	
Operating Systems	<p>Windows 8.1 Pro, 32, 64 bit</p> <p>Windows 7 Pro, 32, 64 bit</p>

FCC Notices

This device complies with Part 15 of the FCC Rules .Operation is subject to the following two conditions: (1) this device may not cause harmful interference, and (2) this device must accept any interference received, including interference that may cause undesired operation. Modifications not expressly approved by Xplore Technologies could void this user's authority to operate the equipment.



Note: This equipment has been tested and found to comply with the limits for a Class B digital device, pursuant to Part 15 of the FCC Rules. These limits are designed to provide reasonable protection against harmful interference in a residential installation. This equipment generates uses and can radiate radio frequency energy and, if not installed and used in accordance with the instructions, may cause harmful interference to radio communications. However, there is no guarantee that interference will not occur in a particular installation. If this equipment does cause harmful interference to radio or television reception, which can be determined by turning the equipment off and on, the user is encouraged to try to correct the interference by one or more of the following measures:

- Reorient or relocate the receiving antenna.
- Increase the separation between the equipment and receiver.
- Connect the equipment into an outlet on a circuit different from that to which the receiver is connected.
- Consult the dealer or an experienced radio/TV technician for help.

WLAN: (Wi-Fi)

Please note that 5150-5250MHz (Ch. 36-48) is restricted to indoor-use only in many countries including the United States.

RF Exposure

Tests for SAR are conducted using standard operating positions specified

By the FCC with the tablet PC transmitting at its highest certified power level in all tested frequency bands. Although the SAR is determined at the highest certified power level, the actual SAR level of the tablet PC while operating can be well below the maximum value. This is because the tablet PC is designed to operate at multiple power levels so as to use only the power required to reach the network. In general, the closer you are to a wireless base station antenna, the lower the power output.

Before a tablet PC model is available for sale to the public, it must be tested and certified to the FCC and IC that it does not exceed the limit established by the government-adopted requirement for safe exposure. The tests are performed in positions and locations (e.g., next to body/lap) as required by the FCC for each model. (Next to body/lap measurements may differ among tablet PC models, depending upon available accessories and FCC and IC requirements). While there may be differences between the SAR levels of various tablet PCs and at various positions, they are all required to meet the government regulations for safe exposure.

This device was evaluated and shown to comply with FCC and IC SAR RF exposure requirements.

Avoid covering or holding antennas when transmitting. Antenna locations are shown in the following figure.

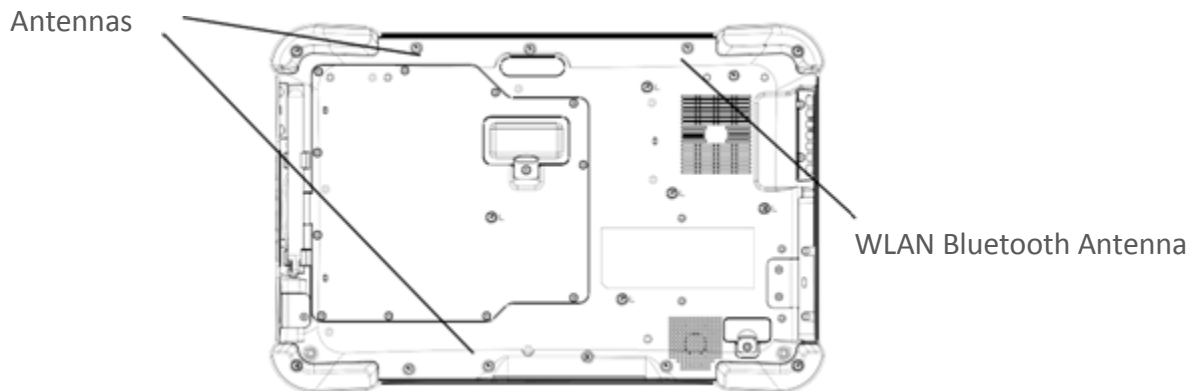

Health and Safety Information

Exposure to Radio Frequency (RF) Signals

Your wireless tablet PC is a radio transmitter and receiver. It is designed and

Manufactured not to exceed the emission limits for exposure to radio frequency (RF) energy set by the Federal Communications Commission of the U.S. Government as well as the RTT&E directive. These limits are part of comprehensive guidelines and establish permitted levels of RF energy for the general population.

The guidelines are based on the safety standards previously set by both U.S. and international standards bodies:

- American National Standards Institute (ANSI) IEEE. C95.1-1992
- National Council on Radiation Protection and Measurement (NCRP). Report 86. 1986
- International Commission on Non-Ionizing Radiation Protection (ICNIRP) 1996
- Ministry of Health (Canada), Safety Code 6. The standards include substantial safety margin designed to assure the safety of all persons, regardless of age and health.
- European Union RTT&E Directive for SAR

The exposure standard for wireless mobile tablet PCs employs a unit of Measurement known as the Specific Absorption Rate, or SAR. The SAR limit set by the FCC is 1.6W/kg. The SAR limit set by the RTT&E is 2.0W/kg.

Note: In the U.S. and Canada, the SAR limit for mobile tablet PCs used by the public is 1.6 watts/kg (W/kg) averaged over one gram of tissue. In Europe the SAR limit for mobile tablet PCs used by the public is 2.0 watts/kg (W/kg) averaged over 10 grams of tissue. The standard incorporates a substantial margin of safety to give additional protection for the public and to account for any variations.

DOC (Industry Canada Notices)

Notice to Users of Radio and Television

This device complies with Industry Canada license-exempt RSS standard(s). Operation is subject to the following two conditions:

- (1) this device may not cause interference, and
- (2) this device must accept any interference, including interference that may cause undesired operation of the device.

Le présent appareil est conforme aux CNR d'Industrie Canada applicables aux appareils radio exempts de licence. L'exploitation est autorisée aux deux conditions suivantes:

- (1) l'appareil ne doit pas produire de brouillage, et

(2) l'utilisateur de l'appareil doit accepter tout brouillage radioélectrique subi, même si le brouillage est susceptible d'en compromettre le fonctionnement."

CAN ICES-3 (B) / NMB-3 (B)

The device could automatically discontinue transmission in case of absence of information to transmit, or operational failure. Note that this is not intended to prohibit transmission of control or signaling information or the use of repetitive codes where required by the technology. The device for the band 5150-5250 MHz is only for indoor usage to reduce potential for harmful interference to co-channel mobile satellite systems; the maximum antenna gain permitted (for devices in the bands 5250-5350 MHz and 5470-5725 MHz) to comply with the e.i.r.p. limit; and The maximum antenna gain permitted (for devices in the band 5725-5850 MHz) to comply with the e.i.r.p. limits specified for point-to-point and non-point-to-point operation as appropriate, as stated in section A9.2(3). In addition, High-power radars are allocated as primary users (meaning they have priority) of the band 5250-5350 MHz and this radar could cause interference and/or damage to LE- LAN devices.

IC radiation exposure statement

This EUT is compliance with SAR for general population/uncontrolled exposure limits in IC RSS-102 and had been tested in accordance with the measurement methods and procedures specified in IEEE 1528

Intel® Dual Band Wireless-AC 7260/AC3160 Country-specific Compliance Statements

Hereby, Xplore Technologies declares that the **Intel® Dual Band Wireless-AC 7260/3160** complies with the essential requirements and other relevant provisions of Directive 1999/5/EC. This equipment is marked with the CE symbol and can be used throughout the European community.

Sierra EM7355/7305 Country-specific Compliance Statements

Hereby, Xplore Technologies declares that the Sierra EM7355/3705 complies with the essential requirements and other relevant provisions of Directive 1999/5/EC. This equipment is marked with the CE symbol and can be used throughout the European community.

UL Notice

This unit requires an AC adapter to operate. Use only UL Listed Class 2 Adapters with an output rating of 19 VDC, with a current of 3.42 A. AC Adapter output polarity:



For authorized repair technicians only

WARNING

For continued protection against risk of fire, replace only with the same type and rating fuse.

WARNING

Danger of explosion if Lithium (clock) battery is incorrectly replaced.

Replace only with the same equivalent type recommended by the manufacturer. Dispose of used batteries according to the manufacturer's instruction.

System Disposal

In the event of system disposal, observe the following information regarding proper procedures in the State of Vermont.

The liquid crystal display (LCD) lamps used in this system contain mercury. In the event of system disposal, be sure to follow local guidelines.



Environmental Policy

Xplore Technologies is committed to managing health, safety and environmental (HS&E) matters as an integral part of our business. In particular, it is our policy to assure the HS&E integrity of our processes and facilities at all times and at all places. We will do so by adhering to the following principles:

Compliance

We will comply with applicable laws and regulations and will implement programs and procedures to assure compliance. Compliance with HS&E standards will be a key ingredient in the training, performance reviews, and incentives of all employees.

Risk Reduction and Prevention Management

We will seek opportunities, beyond compliance requirements, for reducing risk to human health and the environment, and we will establish and meet our own HS&E quality standards where appropriate.

We will employ management systems and procedures specifically designed to prevent activities and/or conditions that pose a threat to human health, safety, or the environment. We will look for ways to minimize risk and protect our employees and the communities in which we operate by employing clean technology, including safe technologies and operating procedures, as well as being prepared for emergencies.

We will strive to minimize releases to the air, land, or water through use of cleaner technologies and the safer use of chemicals. We will minimize the amount and toxicity of waste generated and will ensure the safe treatment and disposal of waste. We will manage scarce resources, such as water, energy, land, and forests in an environmentally sensitive manner.

Communication

We will communicate our commitment to HS&E quality to our employees, vendors, and customers. We will solicit their input in meeting our HS&E goals and in turn will offer assistance to meet their goals.

Continuous Improvement

We will measure our progress as best we can. We will review our progress at least on an annual basis. We will continuously seek opportunities to improve our adherence to these principles, and will periodically report progress to our stakeholders

If you do not have access to the internet please contact our technical support at (866) 296-8541 ext 222.

Take Back and Recycling Program

Send us your unwanted Xplore products and/or batteries, or find a recycling center near you. If you're old Xplore product and/ or batteries have no value or you want to recycle in a socially and environmentally responsible manner, go to <http://www.xploretech.com/contact> and submit a technical support request. Select "Technical support" in the drop down menu under "Reason". Fill in the remaining fields. Under "Message" type in "I want to recycle my product". Click "Submit" and an Xplore Technologies specialist will contact you with shipping instructions.

Alternatively customers can choose to drop their unwanted Xplore products at a local recycling center. For batteries Xplore Technologies has partnered with Call2Recycle® (<http://www.call2recycle.org/>). Call2Recycle® is a program of the Rechargeable Battery Recycling Corporation (RBRC) promoting environmental sustainability by providing free battery and cell phone recycling in North America. RBRC is a 501(c)4 nonprofit public service organization.

For the return of any other Xplore Product (excluding batteries) Xplore Technologies has partnered with R2 Solutions (<http://www.r2solutions.org/>). R2 Solutions (R2S) is a non-profit organization established to house the R2 Practices for proper recycling practices and provide. To find a location near you please go to R2 certified recycler locations (<http://asoft552.acrisoft.com/certified/electronic-recyclers-with-r2-certified-facilities/>). If you prefer to have Xplore Technologies recycle your battery packs please submit a technical support request as described above.

Environmental and Sustainability Corporate Report

As the manufacturer of the world's most advanced ruggedized tablet PC, and peripherals, Xplore Technologies is recognized in the efficient design and manufacturing of its products. In this inaugural Corporate Environmental Responsibility Report we

outline our plans and aspirations to sustain our environment. As you review this report, we welcome your candid feedback. We know that CSER is a journey and your input will help us along the way.

In 2011, Xplore Technologies Corporation of America established the Xplore Technologies Environmental committee to proactively work with stakeholders including customers, nongovernmental organizations (NGOs), and other interested groups on environmental issues. As a result of the committee's work, we have implemented initiatives to improve our performance across the spectrum of corporate environmental responsibility issues. Our progress on implementing these issues is outlined in this report.

While the Xplore Technologies Environmental committee has only been active since 2012 we have always cared for the environment and this has been a core value since Xplore Technologies was founded more than fifteen

years ago. We are proud of our accomplishments to date and, we are committed to continuously improve in the future

Publishing this report is a significant step toward the goal of becoming an environmental sustaining leader of our industry. Going forward, we will persist to perfect our environmental performance and transparency. We will also leverage our role as an industry leader and actively support international organizations and industry associations working to improve environmental conditions.

The Xplore Technologies 2012 Environmental and sustainability corporate report is located at <http://www.xploretech.com//environment>. To obtain the report please click on “Environmental Sustainability Report 2012”. Feel free to save this to your personal files. If you do not have access to the internet please call technical support at (866) 296-8541 ext 222 and request a digital copy be sent to your email.