



Digital Projector

User Manual

LX785 / LU785

VI.00

Copyright and disclaimer

Copyright

Copyright 2019 BenQ Corporation. All rights reserved. No part of this publication may be reproduced, transmitted, transcribed, stored in a retrieval system or translated into any language or computer language, in any form or by any means, electronic, mechanical, magnetic, optical, chemical, manual or otherwise, without the prior written permission of BenQ Corporation. All other logos, products, or company names mentioned in this manual may be the registered trademarks or copyrights of their respective companies, and are used for informational purposes only.

Disclaimer

BenQ Corporation makes no representations or warranties, either expressed or implied, with respect to the contents hereof and specifically disclaims any warranties, merchantability or fitness for any particular purpose. Further, BenQ Corporation reserves the right to revise this publication and to make changes from time to time in the contents hereof without obligation of BenQ Corporation to notify any person of such revision or changes.

This user manual aims to provide the most updated and accurate information to customers, and thus all contents may be modified from time to time without prior notice. Please visit <http://www.benq.com> for the latest version of this manual.

Statement regarding hyperlinks and third-party websites

BenQ is not responsible for the content of the websites or of similar resources, which are maintained and controlled by third parties, that may be linked from this product. Providing links to those websites or to similar resources does not mean that BenQ makes any warranty or representation to their content by expression or by implication.

Any third party content or service preinstalled in this product is provided "as is". BenQ does not, by expression or by implication, make any warrant to the content or to the services provided by third parties. BenQ does not warrant or guarantee that the content or services provided by third parties are accurate, effective, most up-to-date, legal, or complete. Under no circumstances shall BenQ be liable for the content or services provided by third parties including their negligence. Services provided by third parties may be terminated temporarily or permanently. BenQ does not warrant or guarantee that the any content or services provided by third parties are in good condition at any time, and is not liable for the termination of the said content and services. In addition, BenQ is not involved in any transactions you conduct in the websites or similar resources maintained by third parties.

You should contact the content or service providers for any questions, concerns, or disputes.

Table of Contents

Copyright and disclaimer	2
Copyright.....	2
Disclaimer.....	2
Statement regarding hyperlinks and third-party websites	2
Important safety instructions.....	6
General safety instruction	6
Notice on laser.....	7
Laser class.....	7
Laser parameters	7
Label instruction	8
Laser light instruction	9
Prepare for installation	10
Cooling notice	10
Package contents	12
Standard packing items	12
Optional accessories.....	12
Introduction.....	13
Projector exterior view.....	13
Front and upper side view	13
Rear and upper side view.....	13
Controls and functions.....	14
Control panel.....	14
Control terminal	15
Remote control	16
Installation	19
Evaluate for distance by image size	19
Obtaining a preferred projected image size	19
Projection dimensions.....	19
Adjusting by Lens shift	21
Adjusting the vertical image position	21
Adjusting the horizontal image position.....	21
Lens shift range diagram.....	22
Adjusting the Zoom/Focus	23
Installing the side filter.....	23
Connection	24
Before connecting.....	24
Connecting with AV equipment	25
Connecting with computer	26
Connecting with LAN.....	26
Connecting audio	27
Playing sound through the projector.....	27
Connecting smart devices	27

Operations	28
Switch on/off the projector	28
Connecting the power cord.....	28
Power indicator.....	28
Switch on the projector.....	29
Switch off the projector.....	35
Controlling the projector through a Wired LAN environment	36
Configuring the Wired LAN.....	36
Controlling the projector remotely through a web browser.....	38
Using the menu	41
Main menu	41
Display menu	42
Corner Fit menu.....	44
Digital Shrink & Shift menu.....	44
Blanking menu.....	45
3D menu.....	45
Picture menu	46
Color Temperature Fine Tuning menu.....	48
3D Color Management menu.....	49
Source menu	50
System Setup : Basic menu	51
Menu Settings menu.....	52
Operation Settings menu.....	52
System Setup : Advanced menu	53
Audio Settings menu.....	54
Light Settings menu.....	55
Security Settings menu.....	55
Closed Caption menu.....	56
Standby Settings menu.....	56
Network Settings menu.....	56
Information menu	57
Menu structure	58
Maintenance	62
Before maintaining the projector	62
Care of the projector.....	62
Clean the lens front surface	62
Clean the projector case	62
Filter maintenance	63
Cleaning the filter.....	63
Replacing the side filter.....	64
LED indicator	65
System messages.....	65
Burn-In message.....	65

Lamp error message.....	66
Thermal error message.....	66

Troubleshooting 68

Troubleshooting.....	68
The projector does not turn on.....	68
No picture.....	68
Blurred image.....	68
Remote control does not work.....	68
The password is incorrect.....	68

Specifications..... 69

Specifications	69
Dimensions	70
Attaching for ceiling mount.....	70

Appendix..... 71

Timing table	71
Supported timing for PC input	71
Support timing for Component - YPbPr input	72
Support timing for Video input.....	73
Support timing for HDMI-1 / HDMI-2 / HDMI-3 / DVI-D input.....	73
Supporting timing for HDMI-1 / HDMI-2 / HDMI-3 Video input	75
RS232 command control	76
RS232 pin assignment.....	76
RS232 serial port with a crossover cable.....	76
PJLink	82
PJLink protocol.....	82
Control commands.....	82

Important safety instructions

Your projector is designed and tested to meet the latest standards for safety of information technology equipment. However, to ensure safe use of this product, it is important that you follow the instructions mentioned in this manual and marked on the product.

General safety instruction

1. Do not look straight at the projector lens during operation. The intense light beam may damage your eyes.
2. Always open the lens shutter or remove the lens cap when the projector light source is on.
3. In some countries, the line voltage is NOT stable. This projector is designed to operate safely within a mains voltage between 100 to 240 volts AC, but could fail if power cuts or surges of ± 10 volts occur. In areas where the mains voltage may fluctuate or cut out, it is recommended that you connect your projector through a power stabilizer, surge protector or uninterruptible power supply (UPS).
4. Do not block the projection lens with any objects when the projector is under operation as this could cause the objects to become heated and deformed or even cause a fire. To temporarily turn off the light source, press **ECO BLANK** on the remote control.
5. Do not place this product on an unstable cart, stand, or table. The product may fall, sustaining serious damage.
6. Do not attempt to disassemble this projector. There are dangerous high voltages inside which may cause death if you should come into contact with live parts.
Under no circumstances should you ever undo or remove any other covers. Refer servicing only to suitably qualified professional service personnel.
7. Do not place this projector in any of the following environments.
 - Space that is poorly ventilated or confined. Allow at least 50 cm clearance from walls and free flow of air around the projector.
 - Locations where temperatures may become excessively high, such as the inside of a car with all windows rolled up.
 - Locations where excessive humidity, dust, or cigarette smoke may contaminate optical components, shortening the projector's life span and darkening the image.
 - Locations near fire alarms
 - Locations with an ambient temperature above 40°C / 104°F
 - Locations where the altitudes are higher than 3000 m (10000 feet).
8. Do not block the ventilation holes.
 - Do not place this projector on a blanket, bedding or any other soft surface.
 - Do not cover this projector with a cloth or any other item.
 - Do not place inflammables near the projector.

If the ventilation holes are seriously obstructed, overheating inside the projector may result in a fire.

9. Do not step on the projector or place any objects upon it. Besides probable physical damage to the projector, doing so may result in accidents and possible injury.
10. Do not place liquids near or on the projector. Liquids spilled into the projector may cause it to fail. If the projector does become wet, disconnect it from the power supply's wall socket and call BenQ to have the projector serviced.



This equipment has a three-pin grounding-type power plug. Do not remove the grounding pin. As a safety feature, this plug will only fit a grounding-type power outlet. If you are unable to fit the plug into the outlet, contact an electrician.

Notice on laser



This symbol indicates that there is a potential hazard of eye exposure to laser radiation unless the instructions are closely followed.

Laser class



(for USA) This Laser Product is designated as Class 3R during all procedures of operation and complies with IEC/EN 60825-1:2007.

(for WW) This Laser Product is designated as Class I during all procedures of operation and complies with IEC/EN 60825-1:2014.

LASER LIGHT - AVOID DIRECT EYE EXPOSURE.



Do not point laser or allow laser light to be directed or reflected toward other people or reflective objects.

Direct or scattered light can be hazardous to eyes and skin.

There is a potential hazard of eye exposure to laser radiation if the included instructions are not followed.

Caution – use of controls or adjustments or performance of procedures other than those specified herein may result in hazardous radiation exposure.

Laser parameters

Wavelength	450nm - 460nm (Blue)
Mode of operation	Pulsed, due to frame rate
Pulse width	1.34ms
Pulse repetition rate	120Hz
Maximum laser energy	0.698mj
Total internal power	>100w
Apparent source size	>10mm, at lens stop
Divergence	>100 mili Radian

Label instruction

Below drawing show the label's location.

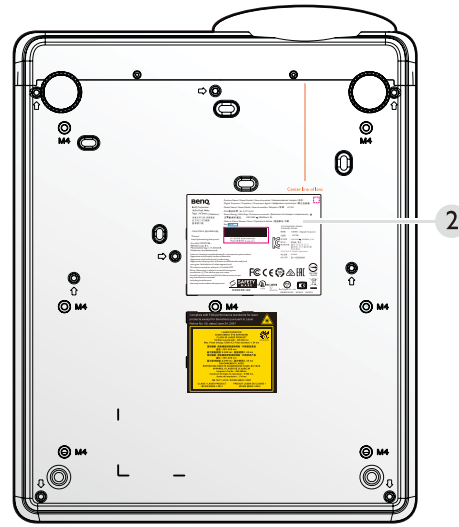
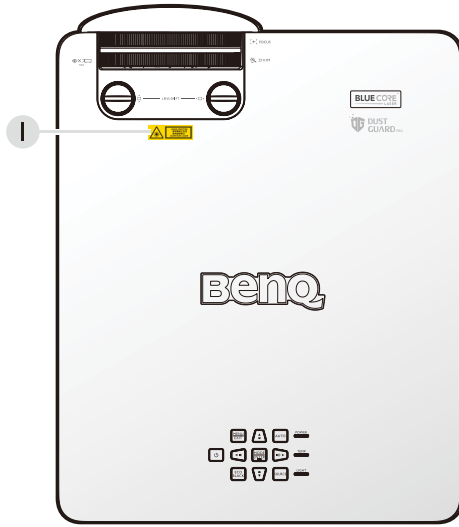

1. Laser warning label



2. Spec label

BENQ BenQ Corporation 16 Jhu Road, Neihu, Taipei 114, Taiwan (Taiwan) 台北市內湖區 基湖路16號 臺灣郵政特准掛號 營業登記證		Product Name / Nama Produk / Nom du produit / Наименование товара / 品名 : Digital Projector / Projektor / Projecteur digital / Цифровые проекторы / 數位投影機 Model Name / Nama Model / Nom du modèle / Модель / 型號 : LX785 P/N / 產品料號 : 9HJL777.XXX Power Rating / Nilai Daya / Puissance nominale / Диапазон питающего напряжения / 額 定電壓/額定電流 : 100-240V ~, 50/60Hz, 5.3A Made in China / Buatan China / Сделано в Китае / 製造產地-中國 Rev: (版本)	
CAN ICES-3 (B)/NMB-3(B) "Patent" http://patmarking.benq.com/ (For EU) IMPORTER: BENQ Europe B.V. Pleinenakkerweg 1-17, 3853 AR, Eindhoven, the Netherlands Laite on liitettävä suojakoekettimillä varustettuun pistokoskaan Apparaten må tilkoples jorden stikkontakt Apparatet skall anslutas till jordets stöck. Apparatens stöckprop skal tilsluttes en stikkontakt med jord, som giver forbindelse til jordingsnettet. This device complies with part 15 of the FCC Rules. Operation is subject to the following two conditions: (1) This device may not cause harmful interference, and (2) this device must accept any interference received, including interference that may cause undesired operation.		KTL 20XXXXXX-XXXXXX 00-000000-XXXXXX 제품명 : 프로젝터 (Digital Projector) 모델명 : LX785 입력전압 : 100-240V~, 50/60Hz, 5.3A 제조사 : BenQ / 研華 제조사명 : 聯華 資訊 工業 (集團) 聯華 資訊 工業 (股 份 有 限 公 司) 리미티드 법인등록번호: BenQ Corporation 제품년월 : 201903 AS 센터 : 82+15883866	
SAFETY MARK E19789 XXXXXX-XX		FCC CE TÜV ENEC RE1000 RoHS UL LISTED PS BENQ Japan Co., Ltd. 32646X-XXXX XXXXX XXXXX	

Laser light instruction

Below drawing is the laser aperture location. Be careful not to let the eye see the light directly.

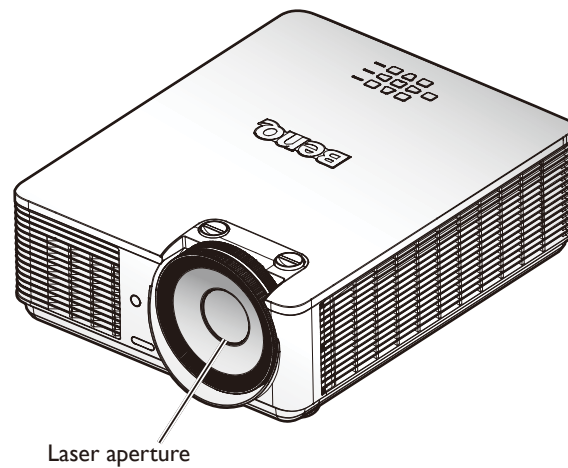

Interlock switches

This machine has 1 (Top cover x 1) Interlock switches to protect the laser light Leakage.

- Will power-off the system individually when the top cover is removed.

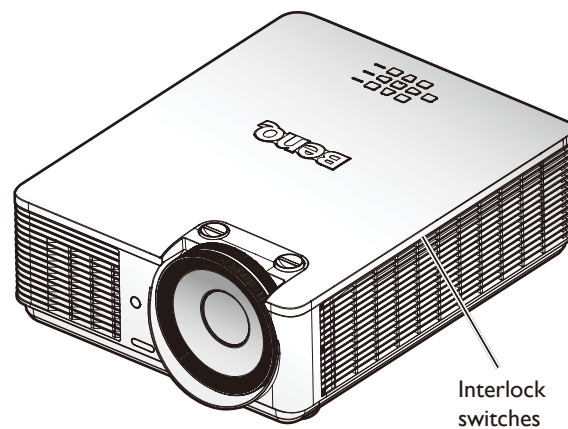

Prepare for installation

Cooling notice

Allow at least 50 cm (19.7 inch) for clearance around the exhaust vent. Make sure no objects block air input within 30 cm (11.8 inch).

Keep the outlet at least 1 m away from the inlets of other projectors.

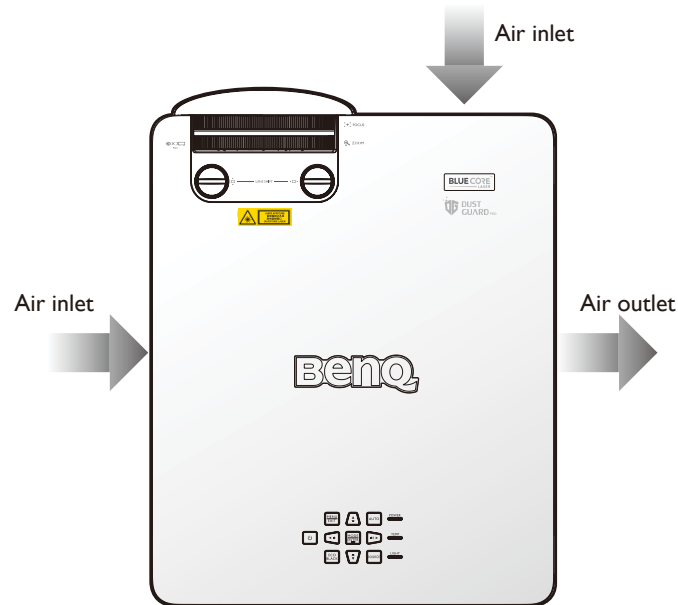

- The projector can be installed at any angle.



- Allow at least 50 cm of clearance around the exhaust vent.

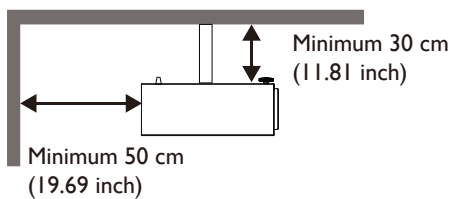
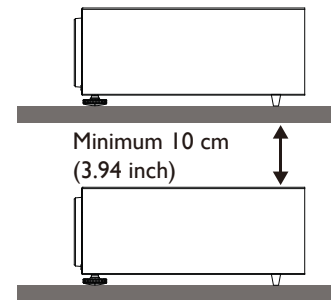
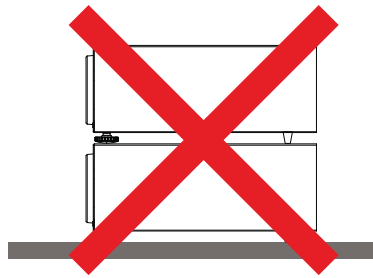
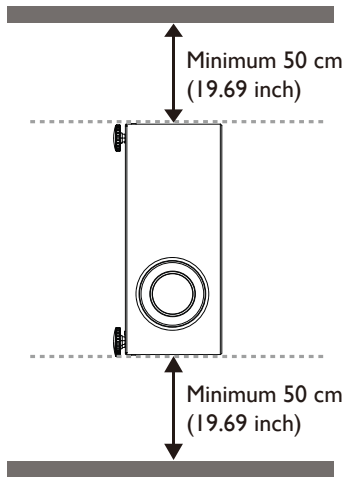
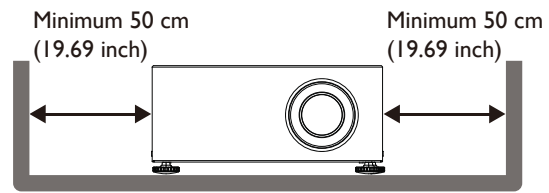
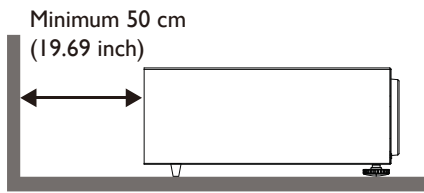

- Ensure that the air intake vents do not recycle hot air from the exhaust vent.
- When operating in an enclosed space, make sure that the surrounding air temperature does not exceed the projector's operating temperature and that the air intake and exhaust vents are unobstructed.
- All enclosures should pass a certified thermal evaluation to ensure that the projector does not recycle exhaust air. Recycling exhaust air may cause the projector to shutdown even if the ambient temperature is within the acceptable operating temperature range.

Caution:

To avoid damaging the DLP chips, never aim a high-power laser beam into the projection lens.

Package contents

Standard packing items

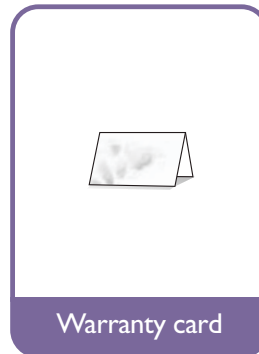
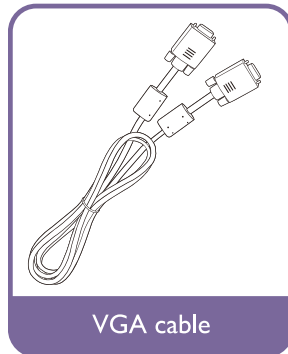
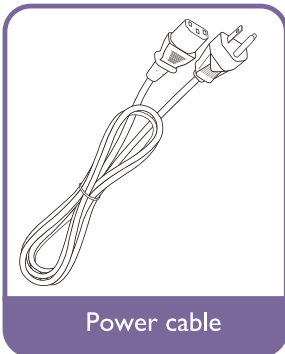
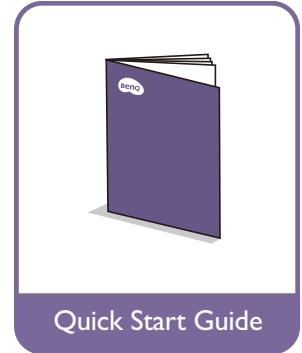
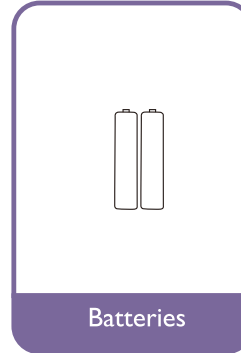
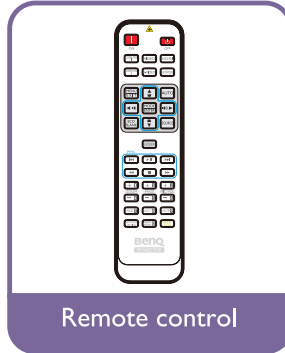
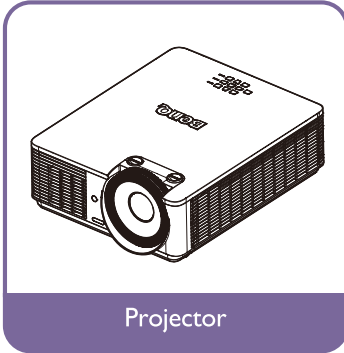

Optional accessories

1. Ceiling mount kit
2. 3D glasses
3. QCast (QP01), InstaShow™ (WDC10)
4. Dust filter

* The warranty card is only supplied in some specific regions. Please consult your dealer for detailed information.

Introduction

Projector exterior view

Front and upper side view

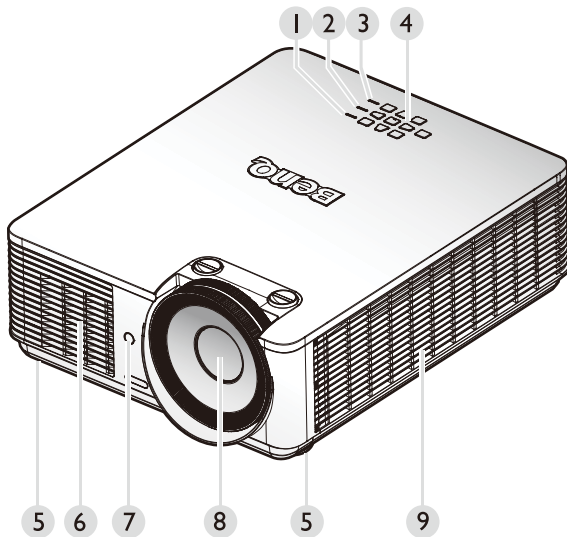

1. POWER indicator light
2. TEMPerature indicator light
3. LIGHT indicator light
4. Control panel
5. Front adjuster foots
6. Front vent (cool air intake)
7. Front IR remote sensor
8. Projection lens
9. Side vent (cool air intake)

Rear and upper side view

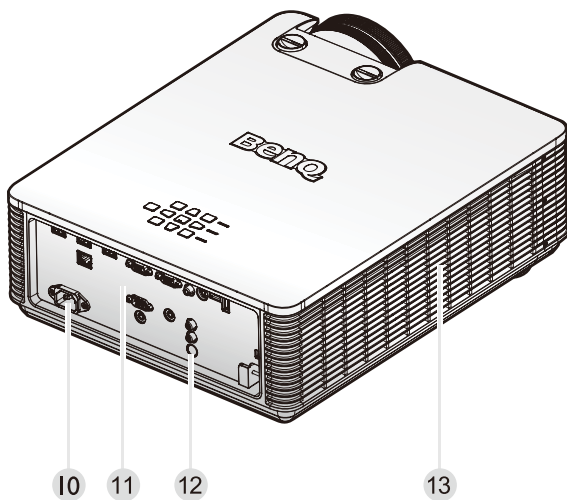







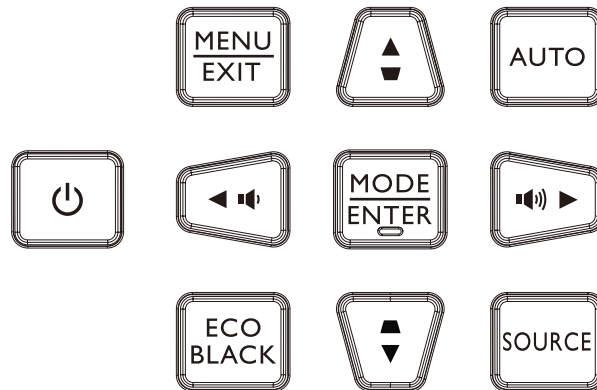





10. AC power cord inlet
11. Control terminals
12. Rear IR remote sensor
13. Vent (cool air outtake)

Controls and functions

Control panel



- **Power**
Toggles the projector between standby mode and on. See ["Switch on the projector" on page 29](#) and ["Switch off the projector" on page 35](#) for details.
- **MENU**
Turns on the On-Screen Display (OSD) menu. Goes back to previous OSD menu, exits and saves menu settings. See ["Using the menu" on page 41](#) for details.
- **Increase Volume/Arrow keys ( /  Left)**
Increase the projector volume.
- **ECO BLACK**
Hide the screen picture.
- **Keystone/Arrow keys ( /  Up)**
When the On-Screen Display (OSD) menu is activated, the , , , and  keys are used as directional arrows to select the desired menu items and to make adjustments. See ["Using the menu" on page 41](#) for details.
- **MODE/ENTER**
Selects an available picture setup mode.
Enacts the selected On-Screen Display (OSD) menu item. See ["Using the menu" on page 41](#) for details.
- **Keystone/Arrow keys ( /  Down)**
Manually corrects distorted images resulting from an angled projection.
- **AUTO**
Automatically determines the best picture timings for the displayed image. See ["Auto adjusting the image" on page 34](#) for details.
- **Decrease Volume/Arrow keys ( /  Right)**
Decreases the projector volume.
- **SOURCE**
Displays the source selection bar.

Control terminal

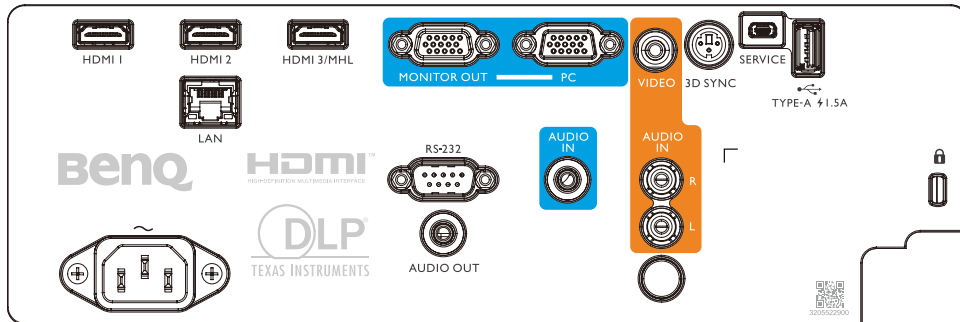

- **HDMI 1**
Connection to HDMI source.
- **HDMI 2**
Connection to HDMI source.
- **HDMI 3/MHL**
Connection to HDMI or MHL source.
- **MONITOR OUT**
Connection to other display equipment for concurrent playback display.
- **PC**
15-pin VGA port for connection to RGB, component HD source, or PC.
- **VIDEO**
Connection to a video source.
- **3D SYNC**
Connection to 3D IR sync signal transmitter.
- **SERVICE**
Maintenance exclusive port for authorized maintenance personnel only.
- **USB 1.5A**
Support 5V/1.5A output.
- **LAN**
For connection to RJ45 Cat5/Cat6 Ethernet cable to control the projector through a network.
- **RS-232**
Standard 9-pin D-sub interface for connection to PC control system and projector maintenance.
- **AUDIO IN**
Connection to an audio input source via an audio cable.
- **AUDIO IN (L/R)**
Connection to an audio input source via an audio or audio L/R cable.
- **AUDIO OUT**
Connection to a speaker or headset.



Note:

For more information about upgrading firmware via LAN, please contact BenQ service.

Remote control

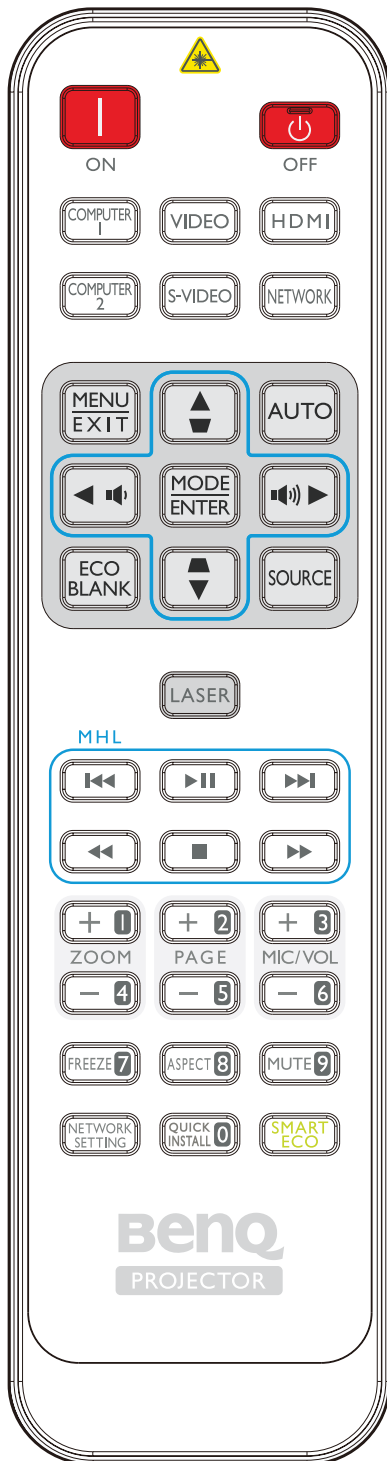

- **ON / OFF**
Toggles the projector between standby mode and on.
- **COMPUTER1/COMPUTER2/VIDEO/S-VIDEO/HDMI/NETWORK**
Selects an input source for display. **HDMI** supports cycle switching between HDMI 1, HDMI 2 and HDMI 3/ MHL input signals. Press **HDMI** repeatedly to switch the HDMI 1, HDMI 2 and HDMI 3/MHL input signals. (**COMPUTER2**, **S-VIDEO** and **NETWORK** are not available for this model)
- **MENU/EXIT**
Turns on the On-Screen Display (OSD) menu. Goes back to previous OSD menu, exits and saves menu settings.
- **Arrow keys (▲ Up, ▼ Down, ◀ Left, ▶ Right)**
When the On-Screen Display (OSD) menu is activated, the arrow keys are used as directional arrows to select the desired menu items and to make adjustments. See "Using the menu" on page 41 for details.
- **VOLUME +/VOLUME -**
Increases/decreases the projector volume.
- **KEystone+/KEystone-**
Manually corrects distorted images resulting from an angled projection.
- **ECO BLANK**
Hide the screen picture.
- **MODE/ENTER**
Selects an available picture setup mode. Activates the selected On-Screen Display (OSD) menu item.
- **AUTO**
Automatically determines the best picture timings for the displayed image.
- **SOURCE**
Displays the source selection bar.
- **LASER**
Emits visible laser pointer light for presentation purposes.

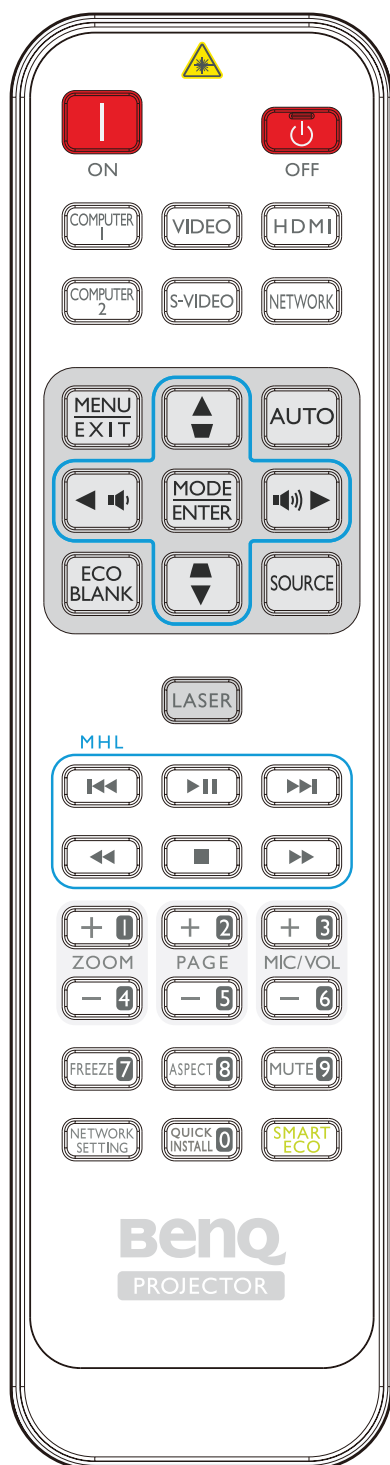

- **MHL control buttons**
Goes to the previous file/Plays/Pauses/Goes to the next file/Rewinds/Stops/Fastforwards during media playback. Only available when controlling your smart device in MHL mode. Key functions supports may vary with different intelligent devices.
- **ZOOM+/ZOOM-**
Magnifies or reduces the projected picture size.
- **PAGE +/PAGE -**
Operate your display software program (on a connected PC) which responds to page up/down commands (like Microsoft PowerPoint).
- **MIC/VOL +/MIC/VOL -**
Microphone input level adjustment. (**MIC/VOL +** and **MIC/VOL -** are not available for this model)
- **FREEZE**
Freezes the projected image.
- **ASPECT**
Selects the display aspect ratio.
- **MUTE**
Toggles projector audio between on and off.
- **NETWORK SETTING**
Displays the Network Settings OSD menu.
- **QUICK INSTALL**
Displays the **Quick Install** OSD menu.
- **SMART ECO**
Switches the light source mode.
- **Numeric buttons**
Enters numbers in network settings. Numeric buttons 1, 2, 3, 4 cannot be pressed when asked to enter password.

Operating the LASER pointer

The Laser Pointer is a presentation aid for professionals. It emits a beam of red light when you press it.

The laser beam is visible. It is necessary to press and hold LASER for continuous output.

Caution:

Do not look into the laser light window or shine the laser light beam on yourself or others. See the warning messages on the back of the remote control prior to using it.

The laser pointer is not a toy. Parents should be mindful of the dangers of laser energy and keep this remote control out of the reach of children.

Avoid Exposure
Laser radiation is emitted from this aperture



Remote control effective range

Infra-Red (IR) remote control sensor is located on the front and rear of the projector. The remote control must be held at an angle within 30 degrees perpendicular to the projector's IR remote control sensor to function correctly. The distance between the remote control and the sensor should not exceed 8 meters (~ 26 feet).

Make sure that there are no obstacles between the remote control and the IR sensor on the projector that might obstruct the infra-red beam.

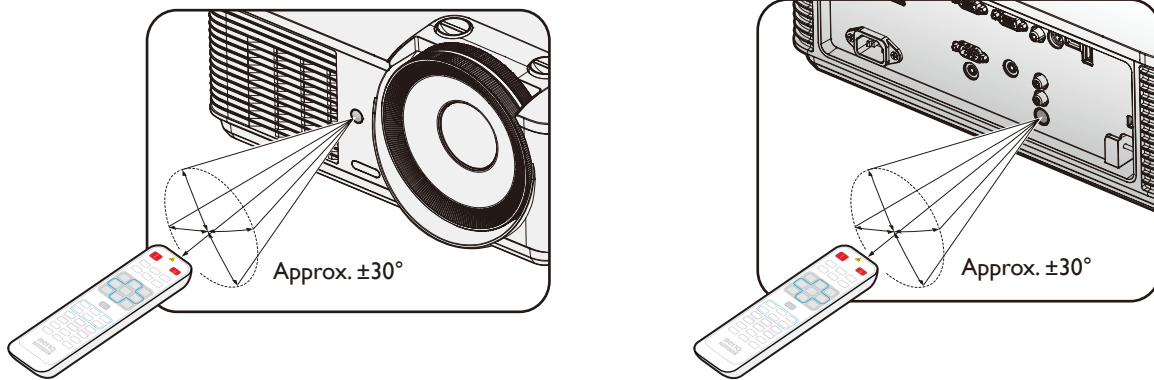

Replacing the remote control battery

1. To open the battery cover, turn the remote control over to view its back, push on the finger grip on the cover and slide it up in the direction of the arrow as illustrated. The cover will slide off.
2. Remove any existing batteries (if necessary) and install two AAA batteries observing the battery polarities as indicated in the base of the battery compartment. Positive (+) goes to positive and negative (-) goes to negative.
3. Refit the cover by aligning it with the base and sliding it back down into position. Stop when it clicks into place.

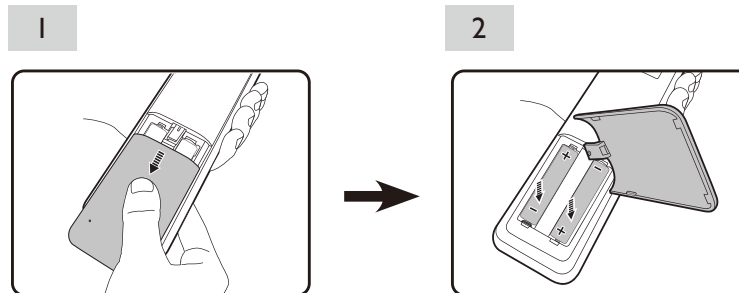

Caution:

- Avoid excessive heat and humidity.
- There may be battery damage if the battery is incorrectly replaced.
- Replace only with the same or equivalent type recommended by the battery manufacturer.
- Dispose of the used battery according to the battery manufacturer's instructions.
- Never throw a battery into a fire. There may be danger of an explosion.
- If the battery is dead or if you will not be using the remote control for a long time, remove the battery to prevent damage to the remote control from possible battery leakage.

Installation

Evaluate for distance by image size

Obtaining a preferred projected image size

The distance from the projector lens to the screen, the zoom setting (if available), and the video format each factors in the projected image size.

Projection dimensions

Refer to "[Dimensions](#)" on [page 70](#) for the center of lens dimensions of this projector before calculating the appropriate position.

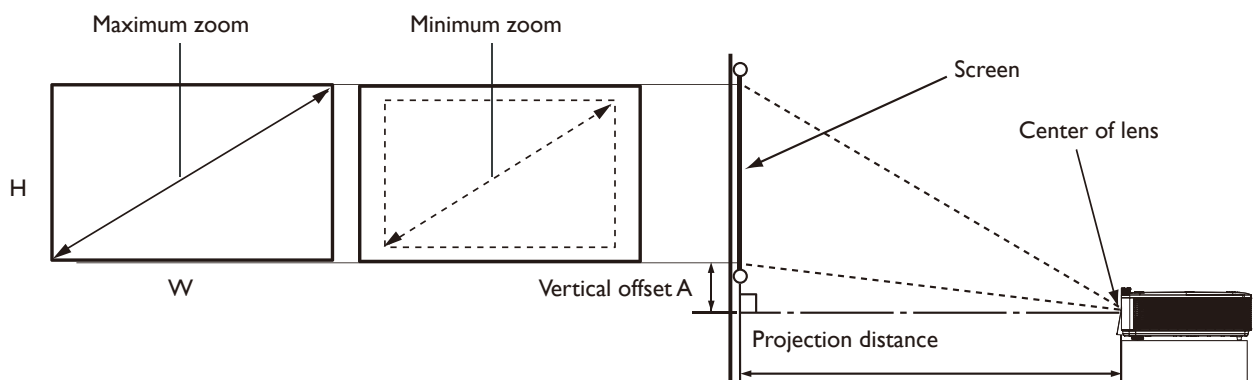

LX785_XGA

TR: 1.51~2.5, offset = 121%

Screen Size				Distance from Screen (mm)			Offset (mm)
Diagonal		Width	Height	Min Distance	Average	Max Distance	A (mm) @ Wide Mode
inch	mm	mm	mm				
30	762	609	457	919	1220	1522	95
40	1016	812	609	1226	1628	2030	127
50	1270	1016	762	1534	2037	2540	160
60	1524	1219	914	1840	2443	3047	191
80	2032	1625	1219	2453	3257	4062	255
90	2286	1828	1371	2760	3665	4570	287
100	2540	2032	1524	3068	4074	5080	320
110	2794	2235	1676	3374	4480	5587	351
120	3048	2438	1828	3681	4888	6095	383
130	3302	2641	1981	3987	5294	6602	416
140	3556	2844	2133	4294	5702	7110	447
150	3810	3048	2286	4602	6111	7620	480
160	4064	3251	2438	4909	6518	8127	511
170	4318	3454	2590	5215	6925	8635	543
180	4572	3657	2743	5522	7332	9142	576
190	4826	3860	2895	5828	7739	9650	607
200	5080	4064	3048	6136	8148	10160	640
250	6350	5080	3810	7670	10185	12700	800
300	7620	6096	4572	9204	12222	15240	960

LU785_WUXGA

TR: 1.15~1.9, offset = 115%

Screen Size				Distance from Screen (mm)			Offset (mm)
Diagonal		Width	Height	Min Distance	Average	Max Distance	A (mm) @ Wide Mode
inch	mm	mm	mm				
30	762	646	403	742	984	1227	60
40	1016	861	538	990	1312	1635	80
50	1270	1076	673	1237	1640	2044	100
60	1524	1292	807	1485	1969	2454	121
80	2032	1723	1076	1981	2627	3273	161
90	2286	1938	1211	2228	2955	3682	181
100	2540	2153	1346	2475	3282	4090	201
110	2794	2369	1480	2724	3612	4501	222
120	3048	2584	1615	2971	3940	4909	242
130	3302	2800	1750	3220	4270	5320	262
140	3556	3015	1884	3467	4597	5728	282
150	3810	3230	2019	3714	4925	6137	302
160	4064	3446	2153	3962	5254	6547	322
170	4318	3661	2288	4210	5582	6955	343
180	4572	3877	2423	4458	5912	7366	363
190	4826	4092	2557	4705	6239	7774	383
200	5080	4307	2692	4953	6568	8183	403
250	6350	5384	3365	6191	8210	10229	504
300	7620	6461	4038	7430	9852	12275	605

 **Note:**

- There is 5% tolerance among these numbers due to optical component variations. BenQ recommends that if you intend to permanently install the projector, you should physically test the projection size and distance using the actual projector before you permanently install it, so as to make allowance for this projector's optical characteristics. This will help you determine the exact mounting position so that it best suits your installation location.
- To optimize the projection quality, we suggest to project images in an area without grayscale.

Adjusting by Lens shift

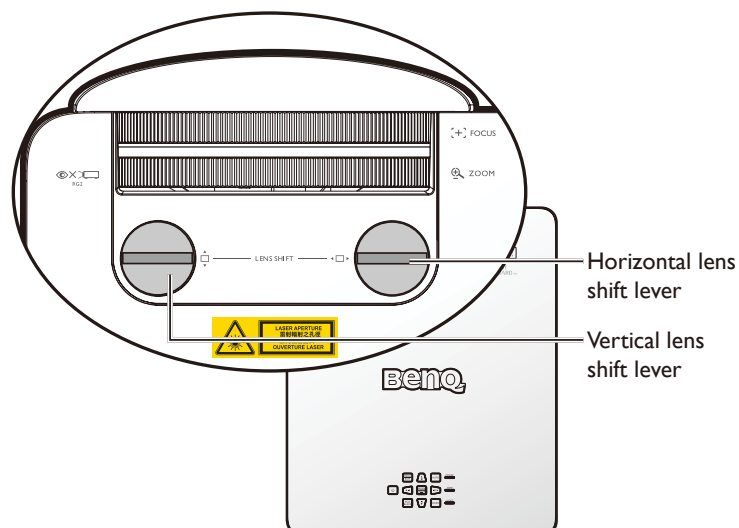

The Lens Shift function can be used to adjust the position of the projected image either horizontally or vertically within the range detailed below.

Adjusting the vertical image position

The vertical image height can be adjusted between 121% +12.3%/-2.2% for LX785 and 115% +10%/-2% for LU785 of offset position. Please consult the Lens Shift Range diagram below for further clarification.

Adjusting the horizontal image position

With the lens in the center position the horizontal image position can be adjusted between +/-3.2% for LX785 and +/-2.5% for LU785. Please consult the Lens Shift Range diagram below for further clarification.

Note:

Image quality is assured only within the listed lens shift range.

Caution:

- If you hear a “clicking sound” during the adjustment, it means that the knob is past its adjustment limit. Please stop adjusting it, in order to avoid any unexpected damage, and turn the knob in the opposite direction, at least to one step before the click.
- If you can't turn it back, please press and turn the knob back at same time.

Lens shift range diagram LX785_XGA

Desk-Front Projection

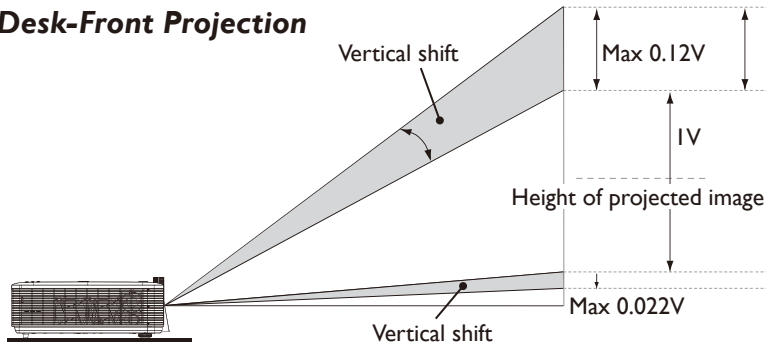

Ceiling Mount-Front Projection

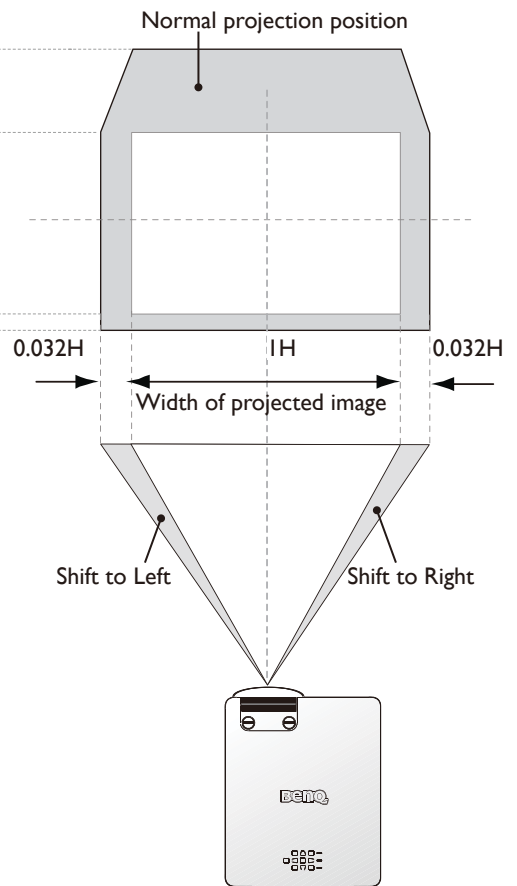
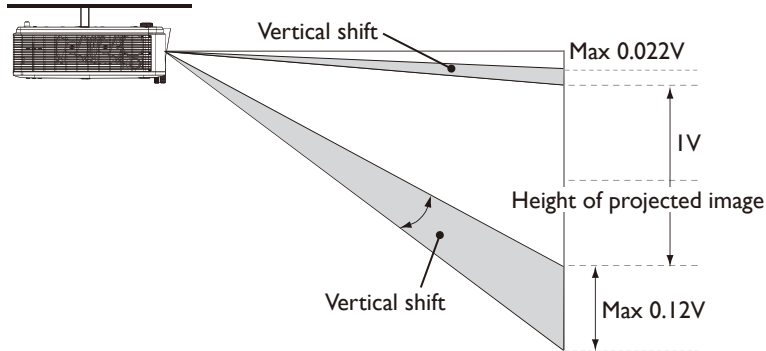

LU785_WUXGA

Desk-Front Projection

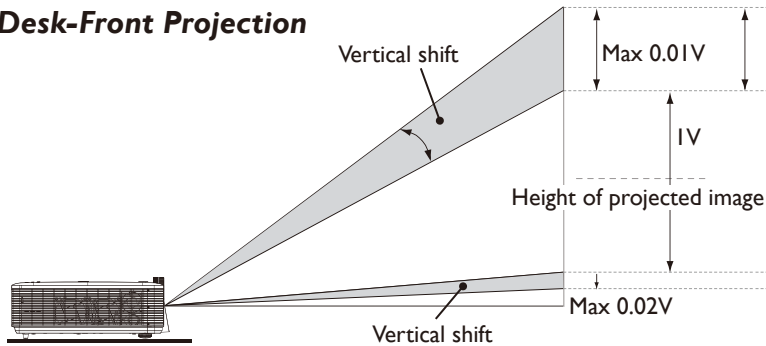

Ceiling Mount-Front Projection

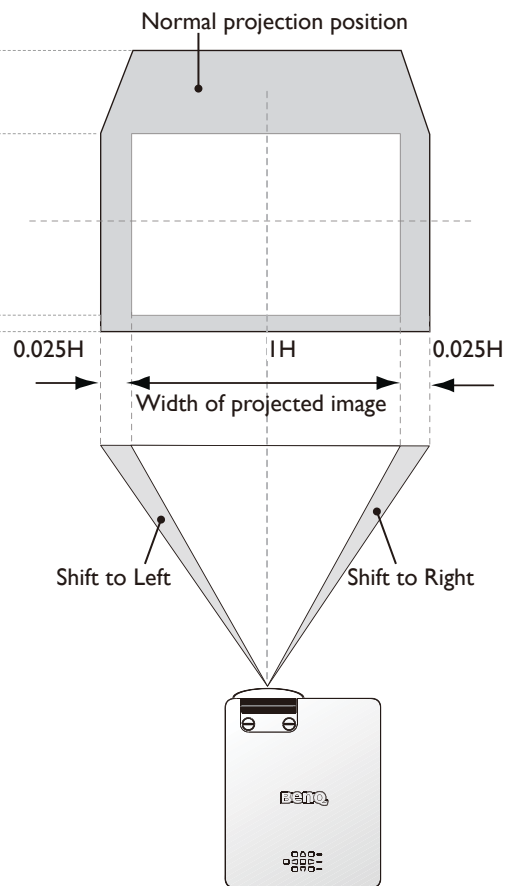
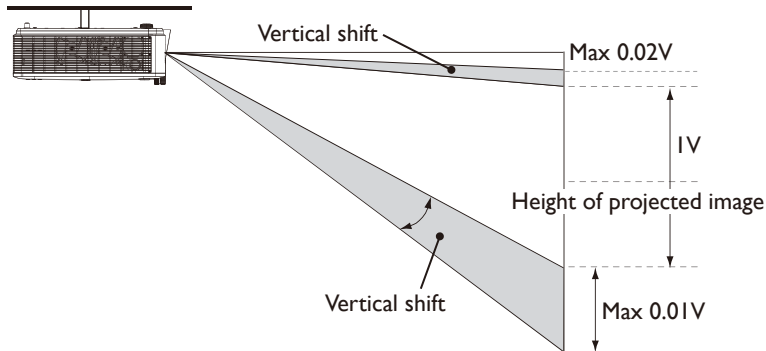

Adjusting the Zoom/Focus

You may turn the zoom ring to zoom in or out. To focus the image, rotate the focus ring until the image is clear. The projector will focus at distances. See page 19.

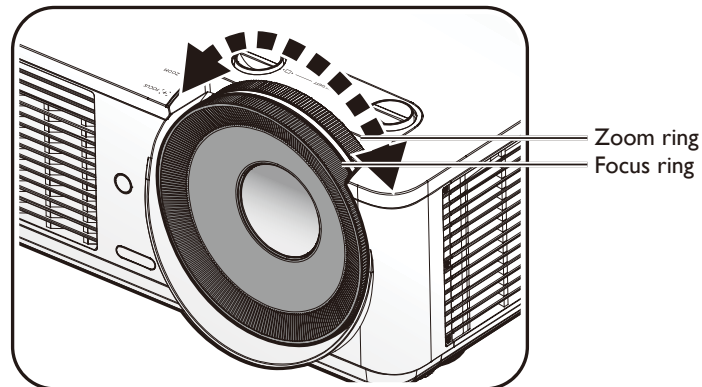

Installing the side filter

Filter is an optional accessory. After you installing the filter, do the following procedures to start filter timing:

After the startup logo, open the On-Screen Display (OSD) menu. Go to the **SYSTEM SETUP: Basic > Operation Settings > Filter Settings** menu. Press **ENTER**. The Filter Settings page displays. Highlight **Filter Timer**. Press **◀/▶** to select **On** and press **ENTER**.

Connection

Before connecting

- Before connecting, carefully read the operating instructions for connecting the external device
- Turn off the power to all devices before connecting cables.
- Take note of the following before connecting cables. Failure to do so may result in malfunctions.
 - Before connecting a cable to the projector or to a device that is connected to the projector, touch any nearby metallic objects to remove any static electricity from your body.
 - Do not use unnecessarily long cables to connect the projector or a device to the projector. Using a longer cable that is wound makes it act like an antenna, making it more susceptible to noise.
 - When connecting cables, connect GND first and then insert the connecting terminal of the connecting device.
- Acquire any connection cables necessary to connect external devices to the system that are not supplied.
- The images on the screen may wobble if the video signal contains too much jitter. In this case, a time base corrector (TBC) must be connected.
- If synchronization signal outputs from computers or video equipment are disrupted due to changes in the video output settings or any other reasons, the colors of projected images may be temporarily disrupted.
- The projector accepts video signals, Y/C signals, YCBCR/YPBPR signals, analog RGB signals (synchronization signals are TTL level), and digital signals.
- Some computer models are not compatible with the projector.
- Use a cable compensator when you connect devices to the projector with long cables. If a cable compensator is not used, the image may not display properly.

PC

No.	Serial
1	R/PR
2	G/Y
3	B/PB
4	-
5	GND
6	GND
7	GND
8	GND

No.	Serial
9	-
10	GND
11	GND
12	DDC data
13	SYNC/HD
14	VD
15	DDC clock

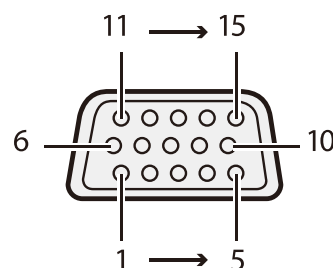

HDMI

No.	Serial
1	TMDS Data2+
2	TMDS Data2 Shield
3	TMDS Data2-
4	TMDS Data1+
5	TMDS Data1 Shield
6	TMDS Data1-
7	TMDS Data0+
8	TMDS Data0 Shield
9	TMDS Data0-
10	TMDS Clock+

No.	Serial
11	TMDS Clock Shield
12	TMDS Clock-
13	CEC
14	Reserved (N.C. on device)
15	SCL
16	SDA
17	DDC/CEC Ground
18	+5 V Power (max 50 mA)
19	Hot Plug Detect

Even-numbered pins of 2 to 18

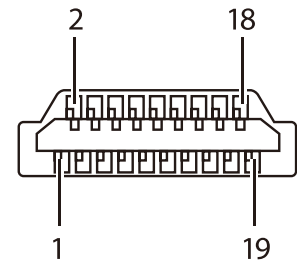

Odd-numbered pins of 1 to 19

Connecting with AV equipment

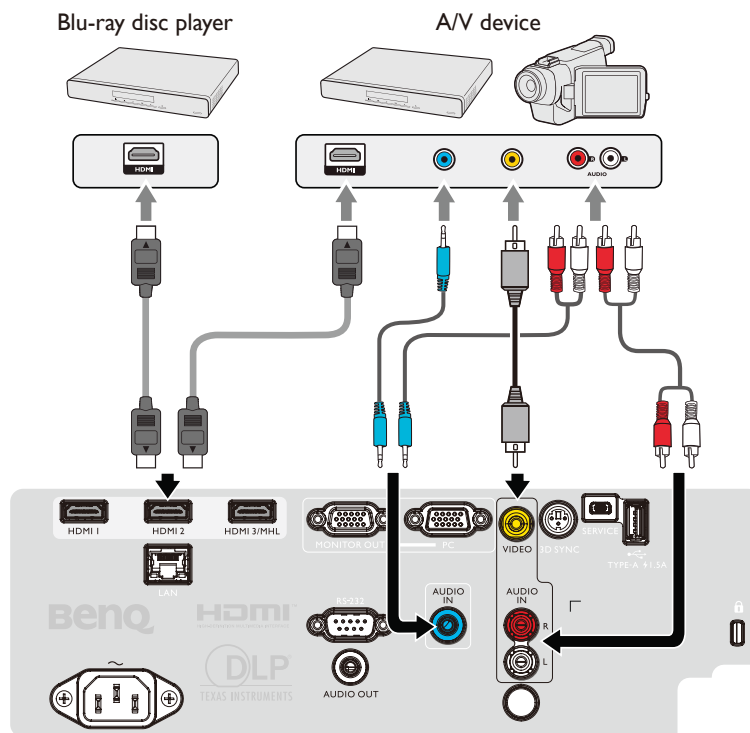

Connecting with computer

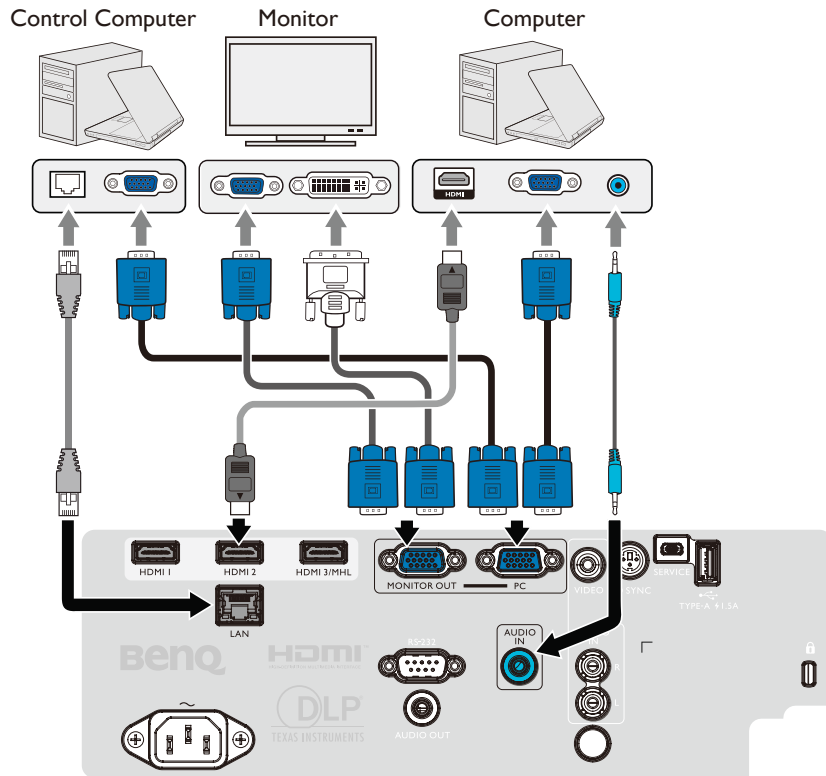

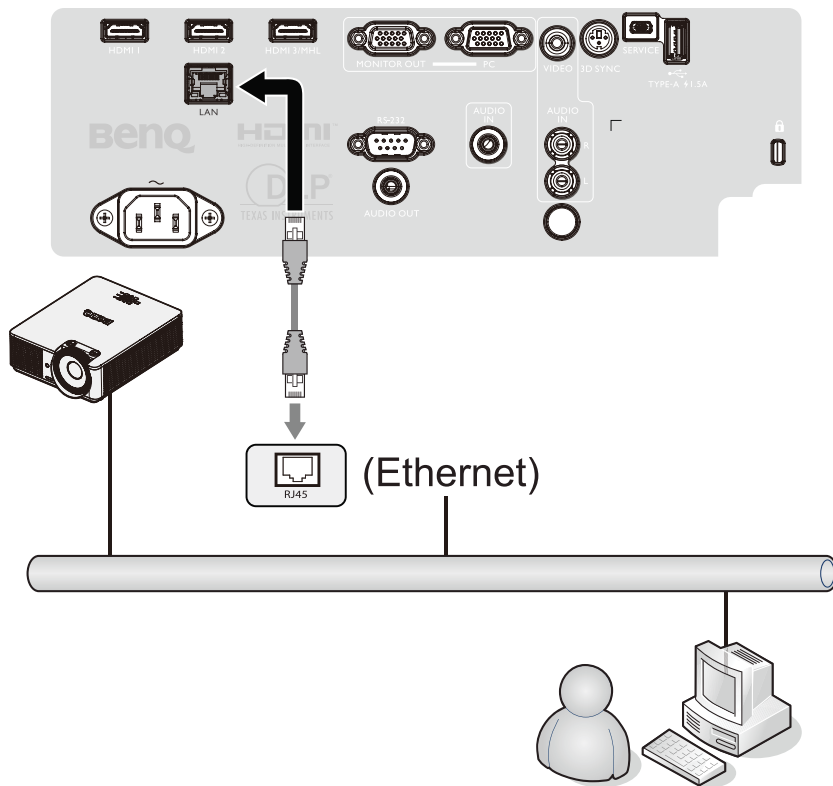

Connecting with LAN



Connecting video source devices

You need only connect the projector to a video source device using just one of the connecting methods, however each provides a different level of video quality. The method you choose will most likely depend upon the availability of matching terminals on both the projector and the video source device as described below:

Terminal Name	Terminal Appearance	Picture Quality
HDMI		Best
Component Video		Better
Video		Normal

Connecting audio

The projector has one built-in mono speaker which are designed to provide basic audio functionality accompanying data presentations for business purposes only. They are not designed for, nor intended for stereo audio reproduction use as might be expected in home theater or home cinema applications. Any stereo audio input (if provided), is mixed into a common mono audio output through the projector speaker.

The built-in speaker will be muted when the **AUDIO OUT** jack is connected.

Note:

- The projector is only capable of playing mixed mono audio, even if a stereo audio input is connected. See "[Connecting audio](#)" on page 27 for details.
- If the selected video image is not displayed after the projector is turned on and the correct video source has been selected, check that the video source device is turned on and operating correctly. Also check that the signal cables have been connected correctly.

Playing sound through the projector

You can make use of the projector (mixed mono) speaker in your presentations, and also connect separate amplified speakers to the AUDIO OUT socket of the projector.

If you have a separate sound system, you will most likely want to connect the audio output of your Video source device to that sound system, instead of to the mono audio projector.

Once connected, the audio can be controlled by the projector On-Screen Display (OSD) menus. The table below describes the connection methods for different devices, and where the sound is from.

Device	PC	Component/Video	HDMI-1/HDMI-2
Audio input port	AUDIO IN (mini jack)	AUDIO (L/R)	HDMI
The projector can play the sound from...	AUDIO IN (mini jack)	AUDIO (L/R)	HDMI
Audio output port	AUDIO OUT	AUDIO OUT	AUDIO OUT

The selected input signal determines which sound will be played by the projector speaker, and which sound will be output from the projector when AUDIO OUT is connected. If you select the PC signal, the projector can play the sound received from AUDIO IN mini jack. If you select the VIDEO signal, the projector can play the sound received from AUDIO (L/R).

Connecting smart devices

The projector can also project the content directly from your personal device(phone, tablet, NB) through optional BenQ wireless solution such as Qcast dongle or InstaShow™.

Please consult to your local agent if you're interested in it.

Operations

Switch on/off the projector

Connecting the power cord

Plug the power cord into the projector and into a wall socket. Turn on the wall socket switch (where fitted). Check that the POWER indicator light on the projector lights orange after power has been applied.

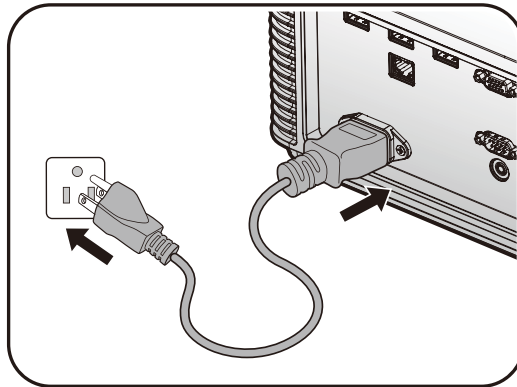

Caution:

Please use the original accessories (e.g. power cable) only with the device to avoid possible dangers such as electric shock and fire.

Power indicator

POWER	TEMP	LIGHT	Status
Orange	-	-	Stand-by
Green Flashing	-	-	Powering up
Green	-	-	Normal operation
Orange Flashing	-	-	Normal power down cooling

Switch on the projector

Press **POWER** on the projector or **ON** on the remote control to start the projector and a start up tone sounds. The **POWER** indicator light flashes green and stays green when the projector is on.

The start up procedure takes about 30 seconds. In the later stage of start up, a startup logo is projected.

(If necessary) Rotate the focus ring to adjust the image clarity.

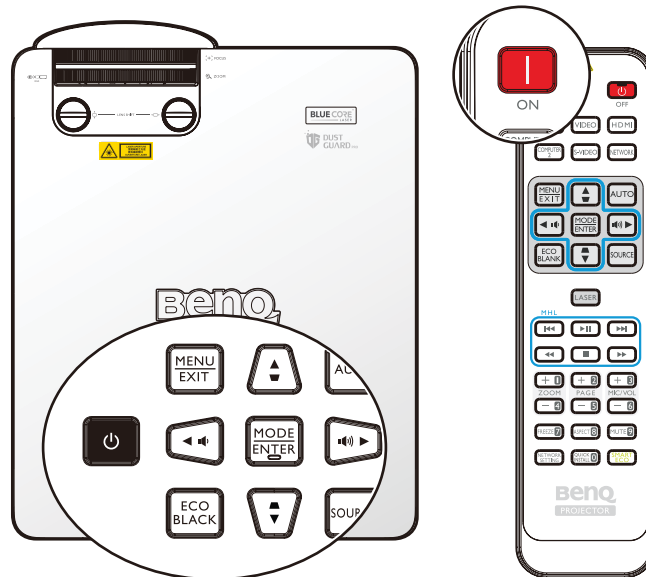

Select language

To use the OSD menus, please set them to your familiar language first.

Please Select Language			
English	한국어	Hrvatski	हिन्दी
Français	Svenska	Română	
Deutsch	Nederlands	Norsk	
Italiano	Türkçe	Dansk	
Español	Čeština	Български	
Русский	Português	suomi	
繁體中文	ไทย	Indonesian	
简体中文	Polski	Ελληνικά	
日本語	Magyar	العربية	
Press Enter to confirm, Exit to leave			

*After this process is done, this menu will not show up again after 1st time adjustment unless user presses **Reset All Settings**.

1. Press **ENTER** on the projector or remote control to turn the OSD menu on.

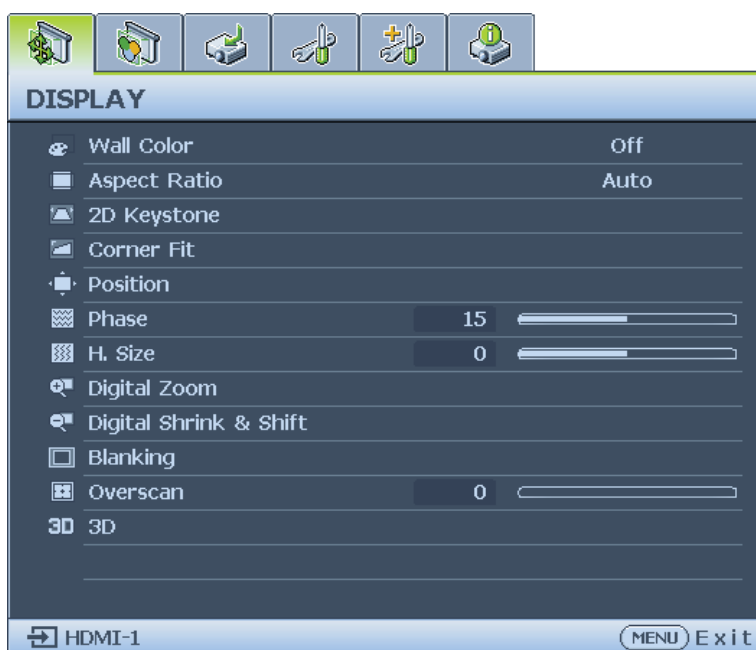

2. Use ◀/▶ to highlight the **System Setup: Basic** menu.

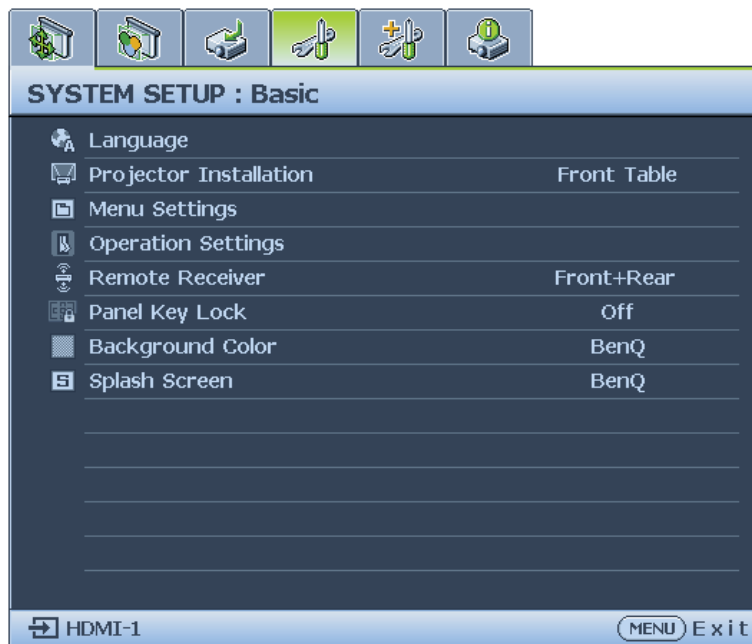

3. Press ▼ to highlight **Language** and press **ENTER** to select a preferred language.



4. Press **ENTER** twice* on the projector or remote control to leave and save the settings.

*The first press leads you back to the main menu and the second press closes the OSD menu.

Using the OSD

Choosing a location

Your projector is designed to be installed in one of four possible installation locations:

1. Front Table

Select this location with the projector placed on a table in front of the screen. This is the most common way to position the projector for quick setup and portability.

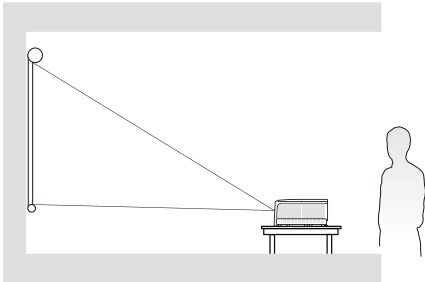

2. Rear Table

Select this location with the projector placed on a table behind the screen. Note that a special rear projection screen is required.

*Set **Rear Table** in the **SYSTEM**

SETUP: Basic > Projector Installation

menu after you turn the projector on.

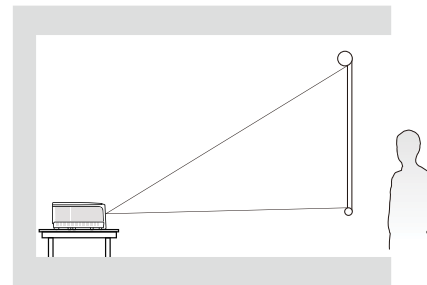

3. Front Ceiling

Select this location with the projector suspended upside-down from the ceiling in front of the screen.

Purchase the BenQ Projector Ceiling Mounting Kit from your dealer to mount your projector on the ceiling.

*Set **Front Ceiling** in the **SYSTEM**

SETUP: Basic > Projector Installation

menu after you turn the projector on.

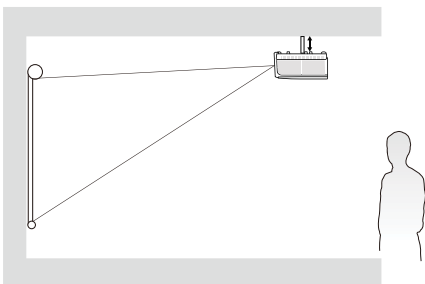

4. Rear Ceiling

Select this location with the projector suspended upside-down from the ceiling behind the screen.

Note that a special rear projection screen and the BenQ Projector Ceiling Mounting Kit are required for this installation location.

*Set **Rear Ceiling** in the **SYSTEM**

SETUP: Basic > Projector Installation

menu after you turn the projector on.

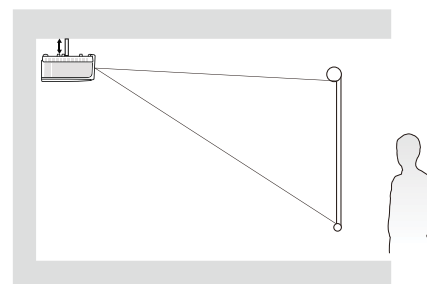

Your room layout or personal preference will dictate which installation location you select. Take into consideration the size and position of your screen, the location of a suitable power outlet, as well as the location and distance between the projector and the rest of your equipment.

Using test pattern

The projector is capable of displaying the grid test pattern. It can be used to assist you with the adjustment of image size and focus, ensuring that the projected image is free from distortion. To display the test pattern, open the OSD menu and go to the **System Setup: Advanced > Test Pattern** and press ◀/▶ to select On.

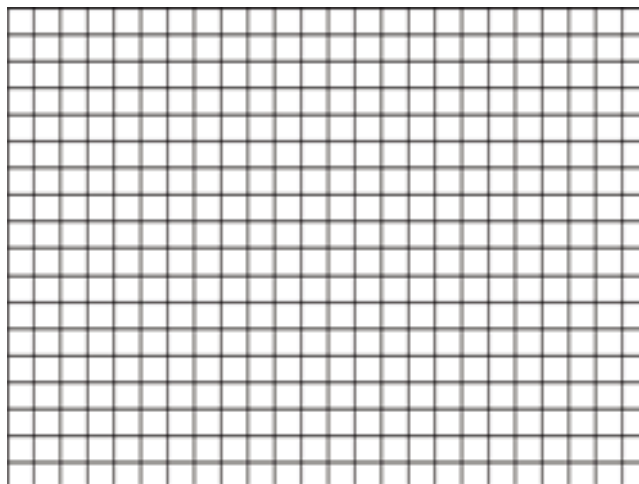

Adjusting by corner fit

Manually adjust four corners of the image by setting the horizontal and vertical values. Using the OSD menu

1. Press **MENU** and then press ◀/▶ until the **Display** menu is highlighted.
2. Press ▼ to highlight **Corner Fit** and press **ENTER**. The **Corner Fit** page displays.

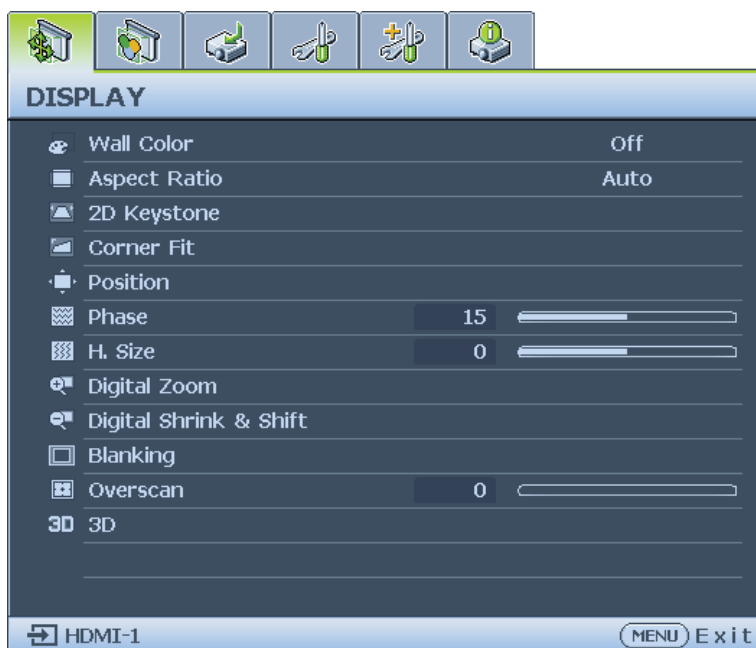

3. Press ▲/▼/◀/▶ to select one of the four corners and press **ENTER**.

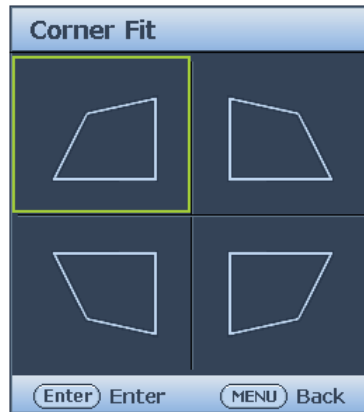

4. Press ▲/▼ to adjust vertical values from 0 to 60.

5. Press ◀/▶ to adjust horizontal values from 0 to 60.

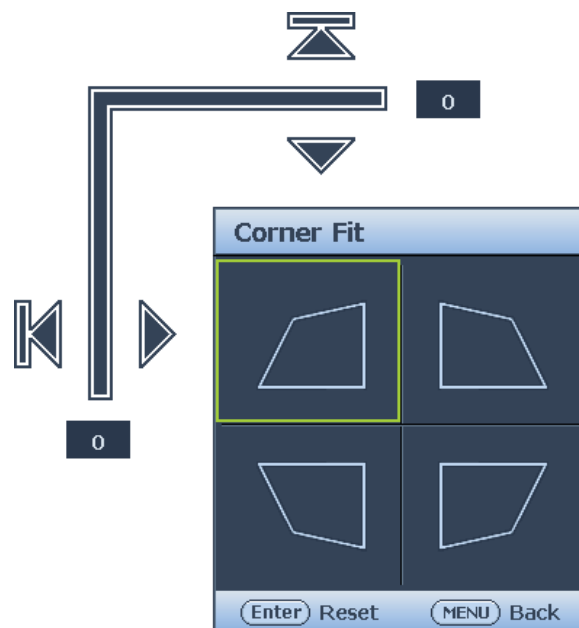

Auto adjusting the image

In some cases, you may need to optimize the picture quality. To do this, press **AUTO** on the projector or remote control. Within 3 seconds, the built-in Intelligent Auto Adjustment function will re-adjust the values of Frequency and Clock to provide the best picture quality.

The current source information will be displayed in the upper left corner of the screen for 3 seconds.

Note:

- The screen will be blank while AUTO is functioning.
- This function is only available when PC signal (analog RGB) is selected.

Fine turning the image size and clarity

1. Adjust the projected image to the size that you need using the ZOOM ring.
2. Sharpen the image by rotating the FOCUS ring.

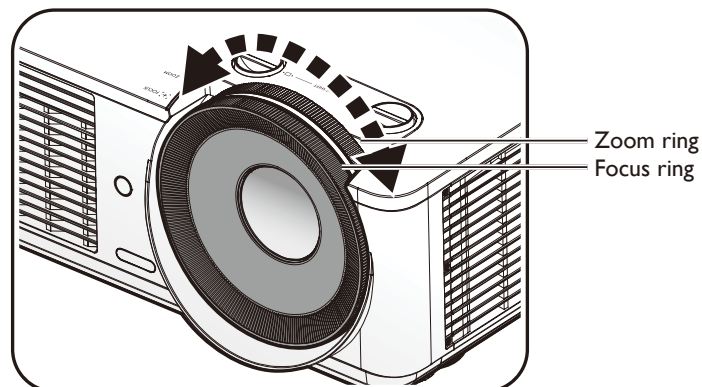

Switch off the projector

1. Press **POWER** or **OFF** and a confirmation message will appear prompting you. If you don't respond in a few seconds, the message will disappear.
2. Press **POWER** or **OFF** a second time. The **POWER** indicator light flashes orange, the projection light source shuts down.

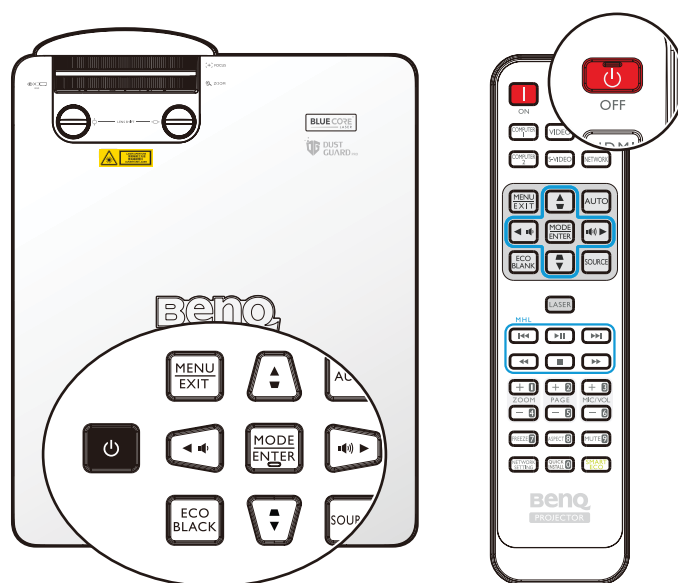

3. Once the cooling process finishes. The **POWER** indicator light is a steady orange and fans stop. Disconnect the power cord from the power outlet.

Caution:

- To protect the light source, the projector will not respond to any commands during the cooling process.
- Press **POWER** or **ON** again to start the projector after the **POWER** indicator light turns orange.

Controlling the projector through a Wired LAN environment

Wired LAN allows you to manage the projector from a computer using a web browser when the computer and the projector are properly connected to the same local area network.

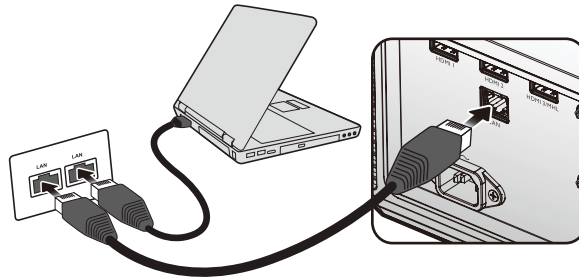

Configuring the Wired LAN

If you are in a DHCP environment:

1. Take a RJ45 cable and connect one end to the RJ45 LAN input jack of the projector and the other end to the RJ45 port.

Note:

When connecting the RJ45 cable, avoid coiling and intertwining the cable as it may cause signal noise or interruption.

2. Press **MENU/EXIT** and then press **◀/▶** until the **System Setup: Advanced** menu is highlighted.
3. Press **▼** to highlight **Network Settings** and press **MODE/ENTER**. The Network Settings page is displayed.
4. Press **▼** to highlight **Wired LAN** and press **MODE/ENTER**. The Wired LAN page is displayed.
5. Press **▼** to highlight **DHCP** and press **◀/▶** to select **On**.
6. Please wait for around 15 - 20 seconds, and then re-enter the Wired LAN page.
7. The **IP Address**, **Subnet Mask**, **Default Gateway**, and **DNS Server** settings will be displayed. Note down the IP address displayed in the **IP Address** row.

WIRED LAN	
Status	Connect
DHCP	◀ On ▶
IP Address	10.82.30.156
Subnet Mask	255.255.255.0
Default Gateway	10.82.159.254
DNS Server	10.82.131.12
Apply	
MENU Back	

Note:

If the IP Address still does not display, contact your ITS administrator.

8. Go back to **System Setup: Advanced > Network Settings** page.
9. Press **▼** to highlight **AMX Device Discovery** and press **◀/▶** to select **On** or **Off**. When **AMX Device Discovery** is **On**, the projector can be detected by AMX controller.

If you are in a non-DHCP environment:

1. Repeat steps 1-4 above.
2. Press ▼ to highlight **DHCP** and press ◀/▶ to select **Off**.
3. Contact your ITS administrator for information on the **IP Address**, **Subnet Mask**, **Default Gateway**, and **DNS Server** settings.
4. Press ▼ to select the item you want to modify and press **MODE/ENTER**.

WIRED LAN	
Status	Connect
DHCP	Off
IP Address	◀ 10.10.10.10 ▶
Subnet Mask	255.255.255.0
Default Gateway	0.0.0.0
DNS Server	0.0.0.0
Apply	
(MENU) Back	

5. Press ◀/▶ to move the cursor and then press ▲/▼ to enter the value.

IP Address	255	.	255	.	10	.	10
------------	-----	---	-----	---	----	---	----

6. To save the setting, press **MODE/ENTER**. If you do not want to save the setting, press **MENU/EXIT**.
7. Press ▼ to highlight **Apply** and press **MODE/ENTER**.
8. Press **MENU/EXIT** to return to Network Settings page, press ▼ to highlight **AMX Device Discovery** and press ◀/▶ to select **On** or **Off**.
9. Press **MENU/EXIT** to exit the menu.

Controlling the projector remotely through a web browser

Once you have the correct IP address for the projector and the projector is on or in standby mode, you can use any computer that is on the same local area network to control the projector.

1. Enter the address of the projector in the address bar of your browser and click Go.

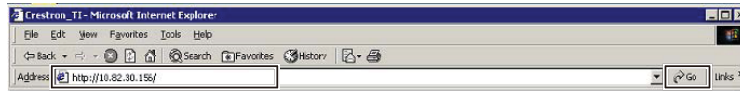

2. The remote network operation page opens. This page (Crestron eControl) allows you to operate the projector as if you were using the remote control or control panel on the projector.



1	To switch input source, click on your desired signal. Note: The source list varies according to the connectors available on the projector. "Video" stands for the Video signal.
2	<p>Menu Auto PC Blank Input ▲ (▼) ▼ (▲) ◀ (▶) ▶ (▶▶▶)</p> <p>OK</p> <p>See "Remote control" on page 16 for details.</p> <p>Activates the selected On-Screen Display (OSD) menu item.</p>

The tools page allows you to manage the projector, configure the LAN control settings and secure access of remote network operation on this projector.

The screenshot shows the BenQ projector's configuration interface. It features a purple header with the BenQ logo and navigation tabs for Tools, Info, and Contact IT Help. The main content area is divided into four sections:

- 1. Crestron Control:** Includes fields for IP Address, Port, and a Send button.
- 2. Projector:** Includes fields for Projector Name, Location, and Assigned To, each with a Send button.
- 3. User Password:** Includes a checkbox for Enabled, a New Password field, and a Confirm field, each with a Send button.
- 4. Admin Password:** Includes a checkbox for Enabled, a New Password field, and a Confirm field, each with a Send button.

At the bottom, there is a large **Exit** button (5) and a small Crestron logo. The text 'Expansion Options' is visible in the bottom right corner.

1. You can name the projector, keep track of its location and the person in charge of it.
2. You can adjust the **LAN Control Settings**.
3. Once set, access to the remote network operation on this projector has been password protected.
4. Once set, access to the tools page has been password-protected.
5. Press **Exit** to go back to the remote network operation page.

 **Note:**

After making the adjustments, press the Send button and the data will be saved in the projector.

Please pay attention to the limitation of input length (including space and other punctuation keys) in the list blow:

Category item	Input length	Maximum number of characters
Crestron Control	IP Address	15
	IP ID	4
	Port	5
Projector	Projector Name	22
	Location	22
	Assigned To	(N/A)
Network Configuration	DHCP (Enabled)	15
	IP Address	15
	Subnet Mask	15
	Default Gateway	15
	DNS Server	(N/A)
User Password	Enabled	(N/A)
	New Password	15
	Confirm	15
Admin Password	Enabled	(N/A)
	New Password	15
	Confirm	15

The info page displays the information and status of this projector. Press **Exit** to go back to the remote network operation page.



Press **Exit** to go back to the remote network operation page.

For more information, visit <http://www.crestron.com> & www.crestron.com/getroomview.

Using the menu

Main menu

The projector is equipped with On-Screen Display (OSD) menus for making various adjustments and settings.

Below is the overview of the OSD menu.

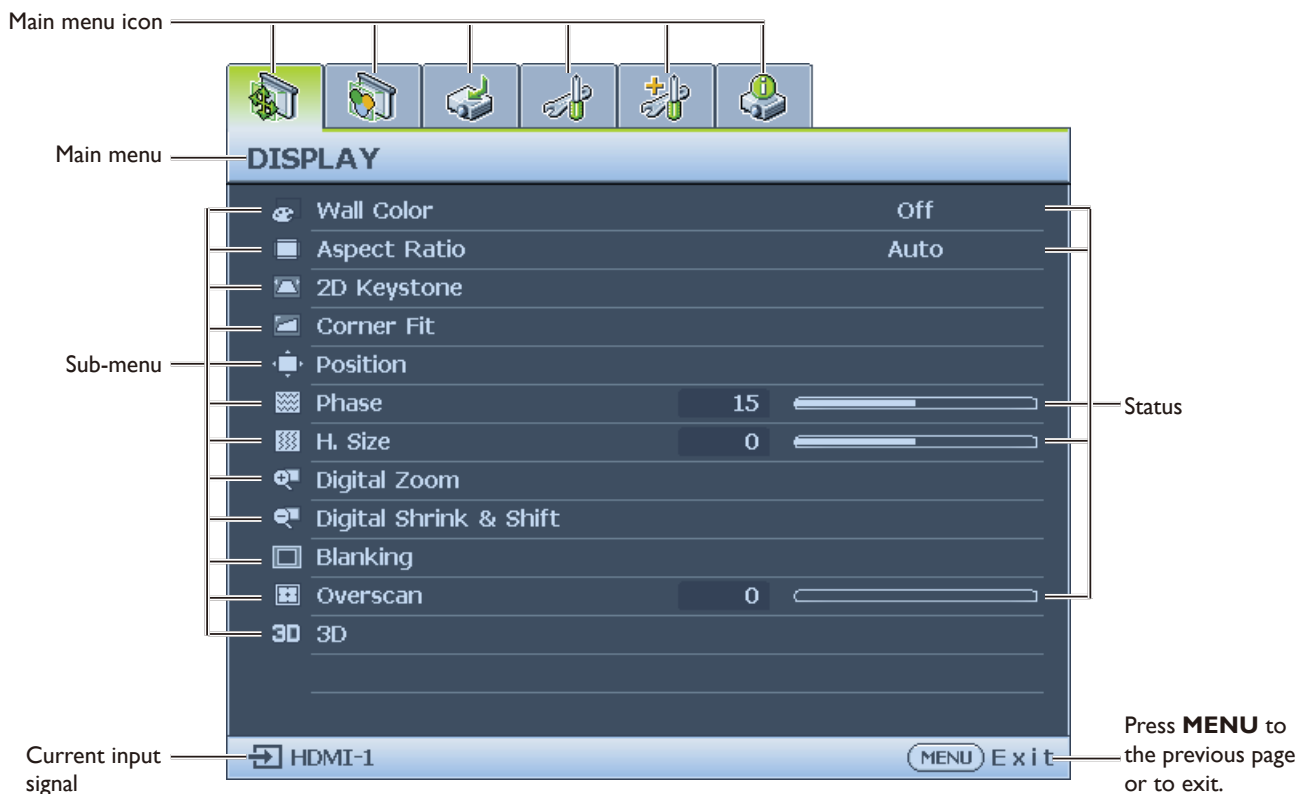

1. Display menu (see "Display menu" on page 42)
2. Picture menu (see "Picture menu" on page 46)
3. Source menu (see "Source menu" on page 50)
4. System Setup : Basic menu (see "System Setup : Basic menu" on page 51)
5. System Setup : Advanced menu (see "System Setup : Advanced menu" on page 53)
6. Information menu (see "Information menu" on page 57)

Available menu items may vary depending on the connected video sources or specified settings. Menu items that are not available will become grayed out.

- Use the arrow keys (▲/▼/◀/▶) on the projector or remote control to move through the menu items.
- Use **ENTER** to confirm the selected menu item.

Display menu

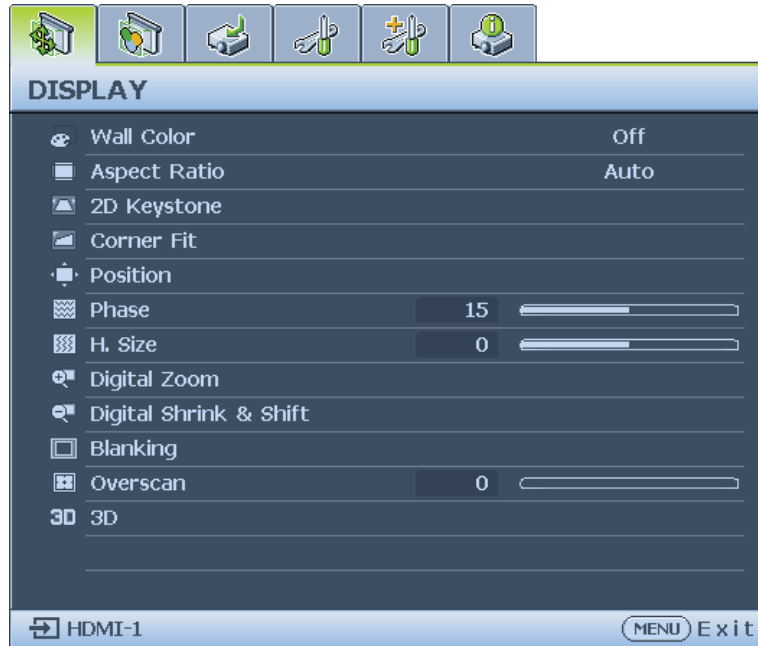

- **Wall Color**

Adjusts the color settings of the image to suit the color of the wall on which the image is projected. The options are Off, Light Yellow, Pink, Light Green, Blue and Blackboard.

- **Aspect Ratio**

Press ◀/▶ to adjust the aspect of the projected image. The options are Auto, Real, 4:3, 16:9 and 16:10.

- Using the remote control

1. Press **ASPECT** to show the current setting.
2. Press **ASPECT** repeatedly to select an aspect ratio to suit the format of the video signal and your display requirements.

1. **Auto:** Scales an image proportionally to fit the projector's native resolution in its horizontal width. This is suitable for the incoming image which is neither in 4:3 nor 16:9 and you want to make most use of the screen without altering the image's aspect ratio.

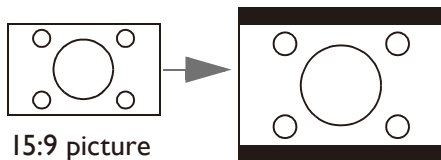

15:9 picture

2. **Real:** The image is projected as its original resolution, and resized to fit within the display area. For input signals with lower resolutions, the projected image will display smaller than if resized to full screen. You could adjust the zoom setting or move the projector away from the screen to increase the image size if necessary. You may also need to refocus the projector after making these adjustments.

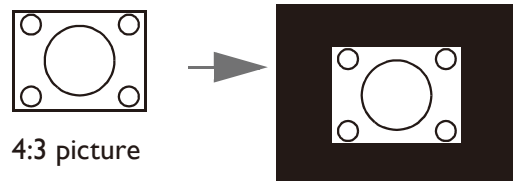

4:3 picture

3. **4:3:** Scales an image so that it is displayed in the center of the screen with a 4:3 aspect ratio. This is most suitable for 4:3 images like computer monitors, standard definition TV and 4:3 images aspect DVD movies, as it displays them without aspect alteration.

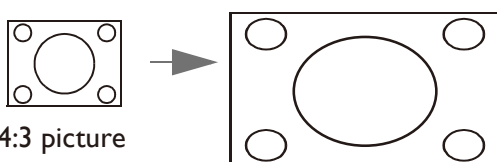

4:3 picture

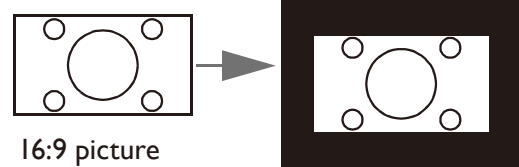

16:9 picture

4. **16:9:** Scales an image so that it is displayed in the center of the screen with a 16:9 aspect ratio. This is most suitable for images which are already in a 16:9 aspect, like high definition TV, as it displays them without aspect alteration.
5. **16:10:** Scales an image so that it is displayed in the center of the screen with a 16:10 aspect ratio. This is most suitable for images which are already in a 16:10 aspect, as it displays them without aspect alteration.

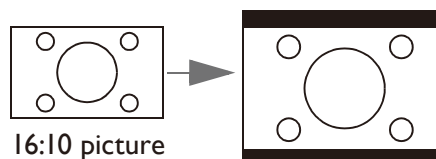
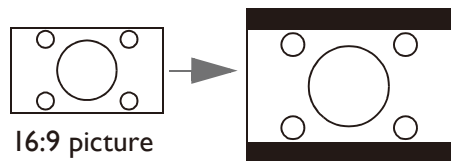

- **2D Keystone**
Press **ENTER** and press **▲/▼/◀/▶** to adjust horizontal or vertical distortion brought by the projection angle.
- **Corner Fit**
Press **ENTER** to enter the **Corner Fit** menu. See "[Corner Fit menu](#)" on page 44 for more details.
- **Position**
Press **ENTER** and press **▲/▼/◀/▶** to adjust the position of the projected picture.
- **Phase**
Press **◀/▶** to adjust Phase for the projected picture.
- **H. Size**
Press **◀/▶** to adjust H. Size for the projected picture.
- **Digital Zoom**
Press **◀/▶** to enlarge the projected image.
- **Digital Shrink & Shift**
Press **ENTER** to enter the **Digital Shrink & Shift** menu. See "[Digital Shrink & Shift menu](#)" on page 44 for more details.
- **Blanking**
Press **ENTER** to enter the **Blanking** menu. See "[Blanking menu](#)" on page 45 for more details.
- **Overscan**
Press **◀/▶** to hide edge of the projected image to damage the noise appear.
- **3D**
Press **ENTER** to enter the **3D** menu. See "[3D menu](#)" on page 45 for more details.

Corner Fit menu

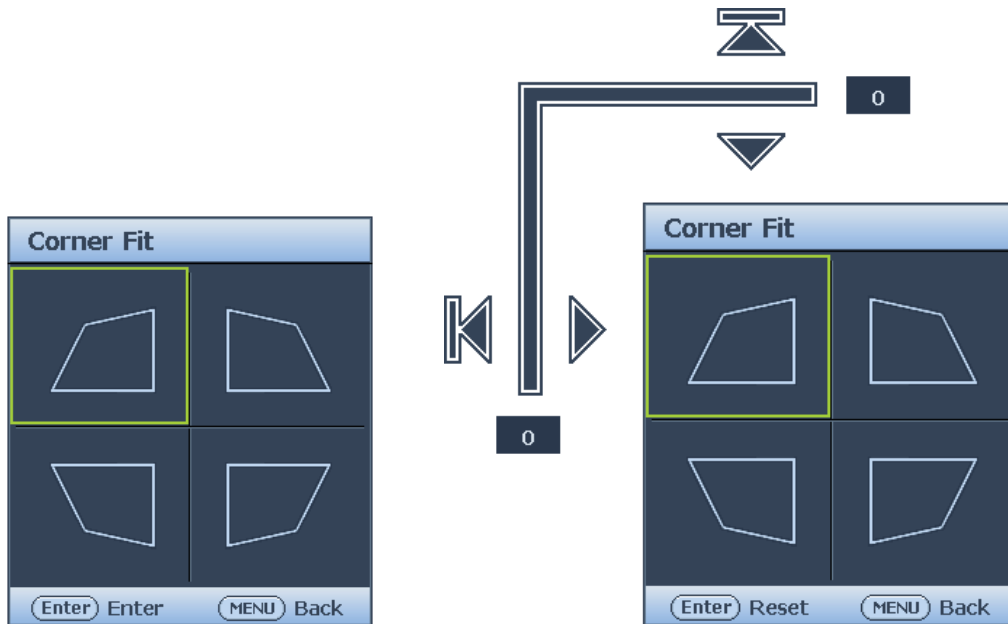

- **Top Left**
Press **ENTER** and press ▲/▼/◀/▶ to correct the top left corner.
- **Top Right**
Press **ENTER** and press ▲/▼/◀/▶ to correct the top right corner.
- **Bottom Left**
Press **ENTER** and press ▲/▼/◀/▶ to correct the bottom left corner.
- **Bottom Right**
Press **ENTER** and press ▲/▼/◀/▶ to correct the bottom right corner.

Digital Shrink & Shift menu

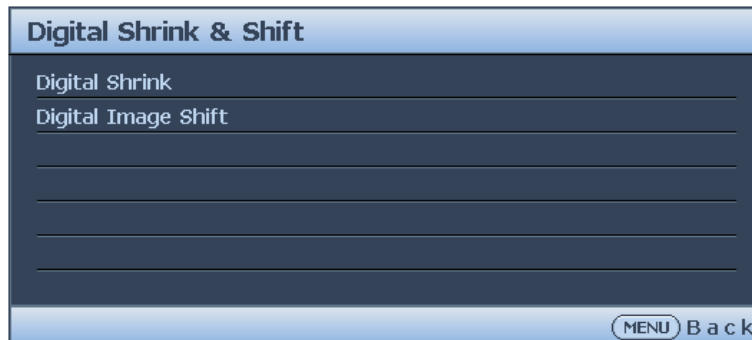

- **Digital Shrink**
Press **ENTER** and press ◀/▶ to reduce the image to a desired size. Press **AUTO SYNC** to restore the picture to its original size.
- **Digital Image Shift**
Press **ENTER** and press ▲/▼/◀/▶ to shift the image. Press **AUTO SYNC** to restore the picture to its original position.

Blanking menu

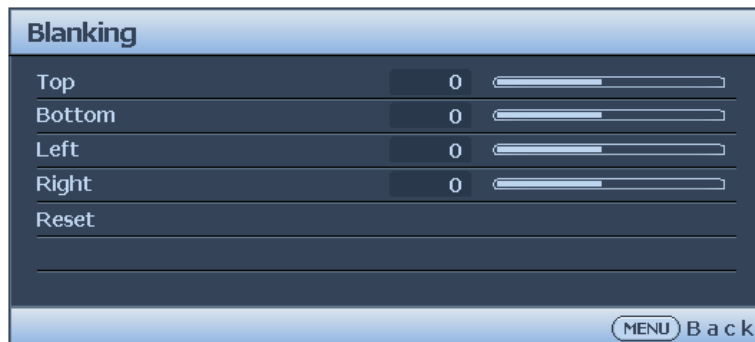

- **Top**
Press ◀/▶ to adjust the top blanking area on the projected picture.
- **Bottom**
Press ◀/▶ to adjust the bottom blanking area on the projected picture.
- **Left**
Press ◀/▶ to adjust the left blanking area on the projected picture.
- **Right**
Press ◀/▶ to adjust the right blanking area on the projected picture.
- **Reset**
Press **ENTER** to set up all Blanking settings to default.

3D menu

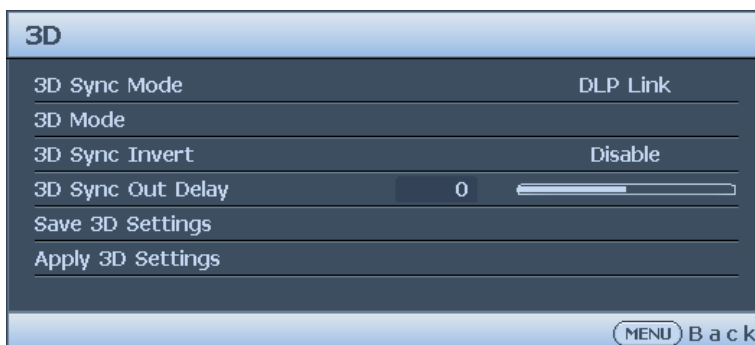

- **3D Sync Mode**
Press ◀/▶ to select the 3D sync mode. The options are DLP Link and VESA 3D.
- **3D Mode**
Press **ENTER** to enter the **3D Mode** menu. Press ▲/▼ to select the 3D format. The options are Auto, Top-Bottom, Frame Sequential, Frame Packing, Side-By-Side and Off.
- **3D Sync Invert**
Press ◀/▶ to enable or disable 3D Sync Invert.
- **3D Sync Out Delay**
Press ◀/▶ to adjust 3D sync out signal delay.
- **Save 3D Settings**
Press **ENTER** to enter the **Save 3D Settings** menu. Press ▲/▼ and **ENTER** to save the current 3D settings.
- **Apply 3D Settings**
Press **ENTER** to enter the **Apply 3D Settings** menu. Press ▲/▼ and **ENTER** to apply the saved 3D settings.

Picture menu



- **Picture Mode**

Press ◀/▶ to select a picture mode. The options are Bright, Presentation, sRGB, Vivid, Cinema, Infographic, 3D, User 1 and User 2.

- **Bright mode:** Maximizes the brightness of the projected image. This mode is suitable for environments where extra-high brightness is required, such as using the projector in well lit rooms.
- **Presentation mode:** Is designed for presentation. The brightness is emphasized in this mode to match PC and notebook coloring.
- **sRGB mode:** Maximizes the purity of RGB colors to provide true-to-life images regardless of brightness setting. It is most suitable for viewing photos taken with an sRGB compatible and properly calibrated camera, and for viewing PC graphic and drawing applications such as AutoCAD.
- **Vivid mode:** Is appropriate for playing colorful movies, video clips from digital cameras or DVs through the PC input for best viewing in a blackened (dimly lit) environment.
- **Cinema mode:** Is appropriate for playing colorful movies, video clips from digital cameras or DVs through the PC input for best viewing in a blackened (dimly lit) environment.
- **Infographic:** Is perfect for presentations with the mixture of text and graphics due to its high color brightness and better color gradation to see the details clearly.
- **3D mode:** Is appropriate for playing 3D images and 3D video clips.
- **User 1/User 2 mode:** Recalls the settings customized based on the current available picture modes.

- **Reference Mode**

Press ◀/▶ to select a reference mode. The options are Bright, Presentation, sRGB, Vivid, Cinema, Infographic and 3D.

- **Brightness**

Press ◀/▶ to adjust the brightness of the projected image.

The higher the value, the brighter the image. And lower the setting, darker the image. Adjust this control so the black areas of the image appear just as black and that detail in the dark areas is visible.

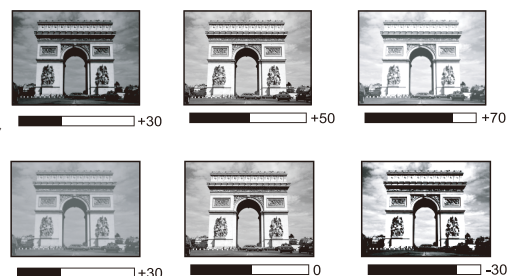

Contrast

Press ◀/▶ to adjust the contrast of the projected image.

The higher the value, the greater the contrast. Use this to set the peak white level after you have previously adjusted the Brightness setting to suit your selected input and viewing environment.

- **Color**

Press ◀/▶ to adjust the color saturation.

Lower setting produces less saturated colors. If the setting is too high, colors on the image will be overpowering, which makes the image unrealistic.

- **Tint**

Press ◀/▶ to adjust the tint of the projected image.

The higher the value, the more reddish the picture becomes. The lower the value, the more greenish the picture becomes.

- **Sharpness**

Press ◀/▶ to adjust the display sharpness of the projected image.

The higher the value, the sharper the picture becomes. The lower the value, the softer the picture becomes.

- **Brilliant Color**

Press ◀/▶ to adjust the brilliant color of the projected image.

This feature utilizes a new color-processing algorithm and system level enhancements to enable higher brightness while providing truer, more vibrant colors in picture. It enables a greater than 50% brightness increase in mid-tone images, which are common in video and natural scenes, so the projector reproduces images in realistic and true colors. If you prefer images with that quality, select **On**. If you don't need it, select **Off**.

When **Off** is selected, the **Color Temperature** function is not available.

- **Gamma Selection**

Press ◀/▶ to select the relationship between input source and picture brightness.

- **Color Temperature**

Press ◀/▶ to adjust the color temperature. The options are Cool, Normal and Warm.

- **Cool:** makes the image appear bluish white.
- **Normal:** Maintains normal colorings for white.
- **Warm:** Makes images appear reddish white.

- **Color Temperature Fine Tuning**

Press **ENTER** to enter the **Color Temperature Fine Tuning** menu. See "[Color Temperature Fine Tuning menu](#)" on page 48 for more details.

- **3D Color Management**

Press **ENTER** to enter the **3D Color Management** menu. See "[3D Color Management menu](#)" on page 49 for more details.

- **Reset Picture Settings**

Press **ENTER** to enter the **Reset Picture Settings** menu. Press **▲/▼** and press **ENTER** to set to the default value.

- **Current:** Returns current picture mode to the factory preset settings.
- **All:** Returns all settings, except User 1/User 2 in the Picture menu to the factory preset settings.

Color Temperature Fine Tuning menu



- **R Gain**

Press **◀/▶** to adjust the Red Gain.

- **G Gain**

Press **◀/▶** to adjust the Green Gain.

- **B Gain**

Press **◀/▶** to adjust the Blue Gain.

- **R Offset**

Press **◀/▶** to adjust the Red Offset.

- **G Offset**

Press **◀/▶** to adjust the Green Offset.

- **B Offset**

Press **◀/▶** to adjust the Blue Offset.

To set a preferred color temperature:

1. Highlight **Color Temperature** and select **Warm**, **Normal** or **Cool** by pressing **◀/▶** on the projector or remote control.
2. Press **▼** to highlight **Color Temperature Fine Tuning** and press **ENTER**. The Color Temperature Fine Tuning page appears.
3. Press **▲/▼** to highlight the item you want to change and adjust the values by pressing **◀/▶**.
 - **R Gain/G Gain/B Gain:** Adjusts the contrast levels of Red, Green, and Blue.
 - **R Offset/G Offset/B Offset:** Adjusts the brightness levels of Red, Green, and Blue.
4. Press **MENU** to exit and save the settings.

3D Color Management menu

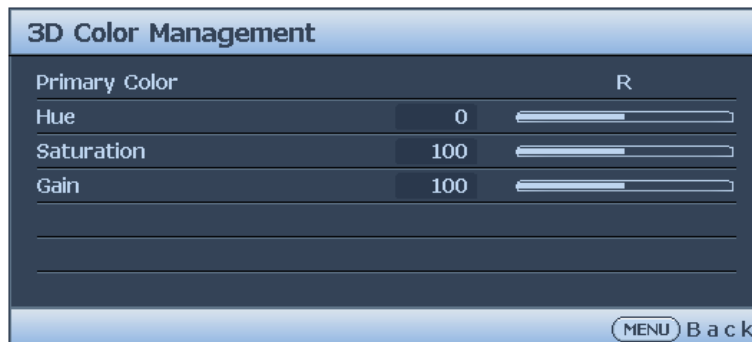

- **Primary Color**
Press **ENTER** to enter the **Primary Color** menu. Press **▲/▼** to select the primary color. The options are R, G, B, C, M and Y.
- **Hue**
Press **ENTER** to enter the **Hue** menu. Press **▲/▼/◀/▶** to adjust settings.
- **Saturation**
Press **ENTER** to enter the **Saturation** menu. Press **▲/▼/◀/▶** to adjust settings.
- **Gain**
Press **ENTER** to enter the **Gain** menu. Press **▲/▼/◀/▶** to adjust settings.

3D Color Management

In most installation situations, color management will not be necessary, such as in classroom, meeting room, or lounge room situations where lights remain on, or where building external windows allow daylight into the room.

Only in permanent installations with controlled lighting levels such as boardrooms, lecture theaters, or home theaters, should color management be considered. Color management provides fine color control adjustment to allow for more accurate color reproduction, should you require it.

Proper color management can only be achieved under controlled and reproducible viewing conditions. You will need to use a colorimeter (color light meter), and provide a set of suitable source images to measure color reproduction. These tools are not provided with the projector; however, your projector supplier should be able to provide you with suitable guidance, or even an experienced professional installer.

The Color Management provides six sets (RGBCMY) of colors to be adjusted. When you select each color, you can independently adjust its range and saturation according to your preference.

If you have purchased a test disc which contains various color test patterns and can be used to test the color presentation on monitors, TVs, projectors, etc. You can project any image from the disc on the screen and enter the 3D Color Management menu to make adjustments.

To adjust the settings:

1. Go to the **Picture** menu and highlight **3D Color Management**.
2. Press **ENTER** and the 3D Color Management page displays.
3. Highlight **Primary color** and press **◀/▶** to select a color from among Red, Green, Blue, Cyan, Magenta and Yellow.

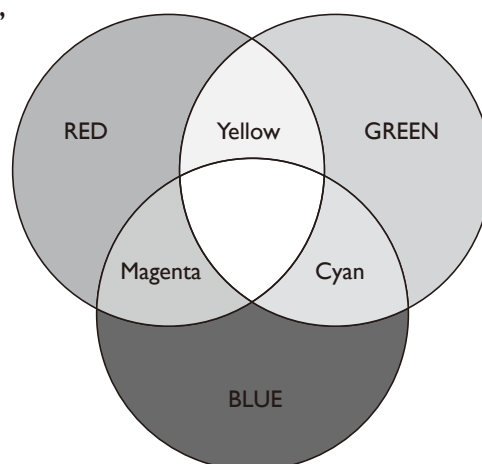

4. Press ▼ to highlight **Hue** and press ◀/▶ to select its range. Increase in the range will include colors consisted of more proportions of its two adjacent colors. Please refer to the illustration to the right for how the colors relate to each other. For example, if you select Red and set its range at 0, only pure red in the projected picture will be selected. Increasing its range will include red close to yellow and red close to magenta.
5. Press ▼ to highlight **Saturation** and adjust its values to your preference by press ◀/▶. Every adjustment made will reflect to the image immediately. For example, if you select Red and set its value at 0, only the saturation of pure red will be affected.

Source menu



- **Quick Auto Search**
Press ◀/▶ to enable or disable search the input source automatically.
- **HDMI Format**
Press ◀/▶ to selects a suitable color format to to optimize display quality. The options are Auto, RGB Limited, RGB Full, YUV Limited and YUV Full.
 - **Auto:** Automatically selects a suitable color space and gray level for the incoming HDMI signal.
 - **RGB Limited:** Utilizes the Limited range RGB 16-235.
 - **RGB Full:** Utilizes the Full range RGB 0-255.
 - **YUV Limited:** Utilizes the Limited range YUV 16-235.
 - **YUV Full:** Utilizes the Full range YUV 0-255.
- **HDMI Equalizer**
Press **ENTER** to enter the **HDMI Equalizer** menu. Press ▲/▼ and press **ENTER** to select the HDMI. Press ◀/▶ to set to the default value.

System Setup : Basic menu

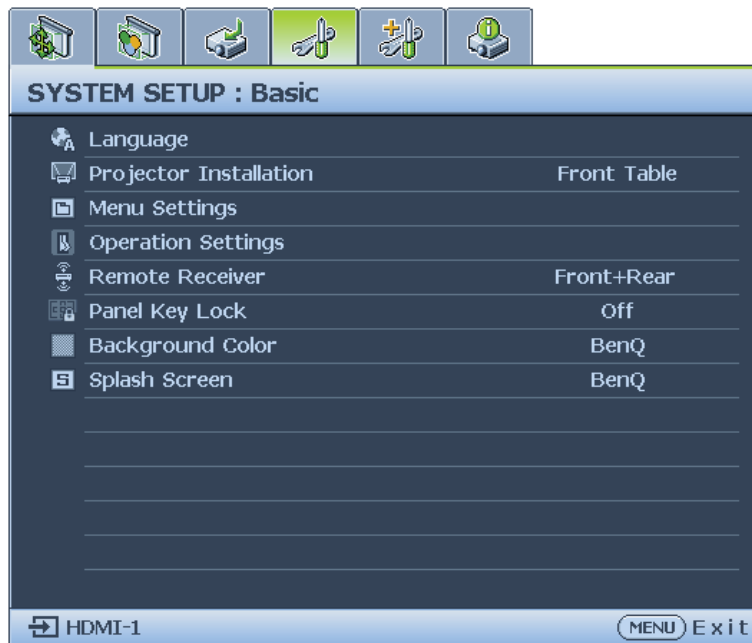

- Language**
 Press **ENTER** to enter the **Language** menu. Press **▲/▼/◀/▶** to select the language of OSD menu.
- Projector Installation**
 Press **◀/▶** to select the projector installation. The options are Front Table, Rear Table, Rear Ceiling and Front Ceiling.
- Menu Settings**
 Press **ENTER** to enter the **Menu Settings** menu. See "[Menu Settings menu](#)" on page 52 for more details.
- Operation Settings**
 Press **ENTER** to enter the **Operation Settings** menu. See "[Operation Settings menu](#)" on page 52 for more details.
- Remote Receiver**
 Press **◀/▶** to select the remote receiver. The options are Front, Rear and Front+Rear.
- Panel Key Lock**
 Press **◀/▶** to enable or disable all panel key functions except **POWER** on the projector.
- Background Color**
 Press **◀/▶** to select the background color when no input signal. The options are BenQ, Black, Blue, Purple and Gray.
- Splash Screen**
 Press **◀/▶** to select the start up pattern when the projector turns on. The options are BenQ, Black and Blue.

Menu Settings menu



- **Menu Display Time**
Press ◀/▶ to select the menu display time period. The options are 5 sec, 10 sec, 20 sec, 30 sec and Always.
- **Menu Position**
Press ◀/▶ to select the menu display position. The options are Center, Top-Left, Top-Right, Bottom-Right and Bottom-Left.
- **Reminder Message**
Press ◀/▶ to enable or disable reminder message displays.

Operation Settings menu



- **Direct Power On**
Press ◀/▶ to enable or disable automatically turning on the projector when the AC power is connected.
- **Signal Power On**
Press ◀/▶ to enable or disable automatically turning on the projector when an input signal is detected.
- **Auto Power Off**
Press ◀/▶ to enable or disable automatically turning off the projector when there is no input signal.
- **Blank Timer**
Press ◀/▶ to set the length of time the image is blanked. The options are Disable, 5 mins, 10 mins, 15 mins, 20 mins, 25 mins and 30 mins.
- **Sleep Timer**
Press ◀/▶ to set the length of time before the projector is turned off. The options are Disable, 30 mins, 1 hr, 2 hr, 3 hr, 4 hr, 8 hr and 12 hr.
- **Filter Settings**
Press **ENTER** to enter the **Filter Settings** menu. See "[Filter Settings menu](#)" on page 53 for more details.

Filter Settings menu

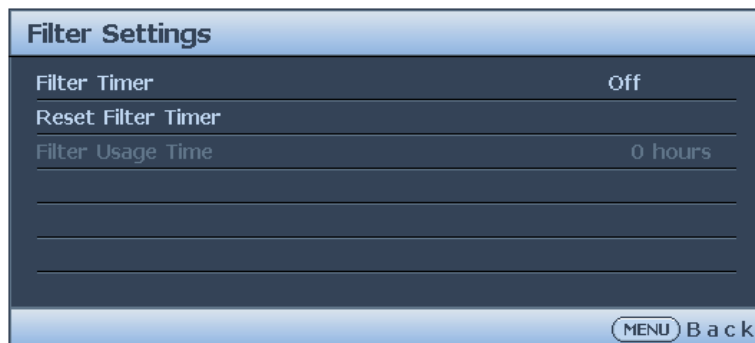

- **Filter Timer**
Press ◀/▶ to enable or disable filter timer.
- **Reset Filter Timer**
Press **ENTER** to reset the filter timer when the filter is replaced.
- **Filter Usage Time**
Displays the current number of hours the filter has been used.

System Setup :Advanced menu

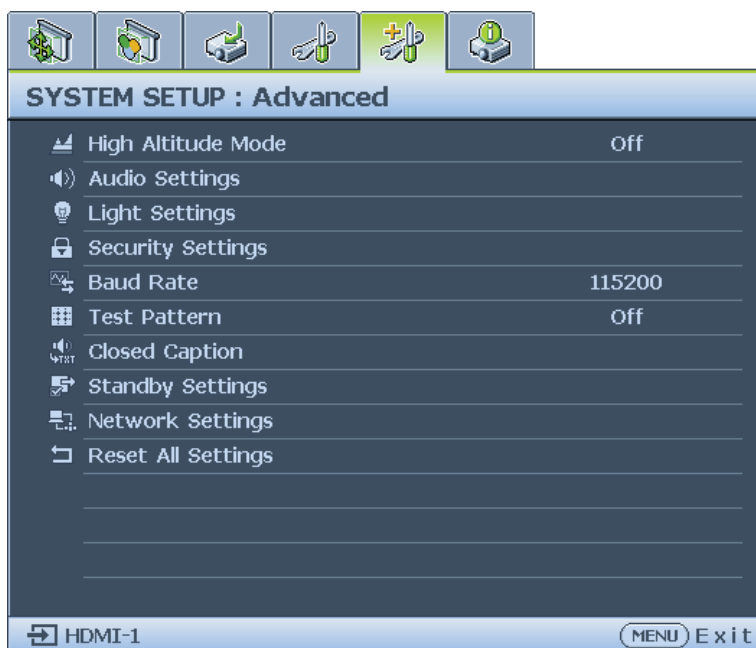

- **High Altitude Mode**
Press ◀/▶ to enable or disable High Altitude Mode. Enable this function when the operating altitude is higher than 1500m or the ambient temperature is over 40°C.
- **Audio Settings**
Press **ENTER** to enter the **Audio Settings** menu. See "Audio Settings menu" on page 54 for more details.
- **Light Settings**
Press **ENTER** to enter the **Light Settings** menu. See "Light Settings menu" on page 55 for more details.
- **Security Settings**
Press **ENTER** to enter the **Security Settings** menu. See "Security Settings menu" on page 55 for more details.

- **Baud Rate**
Press ◀/▶ to select RS-232 baud rate. The options are 2400, 4800, 9600, 14400, 19200, 38400, 57600 and 1152000.
- **Test Pattern**
Press ◀/▶ to select the test pattern. The options are Off, Grid, White, Red, Green, Blue, Black, RGB Ramps, Color Bar, Step Bars, CheckBoard, Horizontal Lines, Vertical Lines, Diagonal Lines, Horizontal Ramp and Vertical Ramps.
- **Closed Caption**
Press **ENTER** to enter the **Closed Caption** menu. See "Closed Caption menu" on page 56 for more details.
- **Standby Settings**
Press **ENTER** to enter the **Standby Settings** menu. See "Standby Settings menu" on page 56 for more details.
- **Network Settings**
Press **ENTER** to enter the **Network Settings** menu. See "Network Settings menu" on page 56 for more details.
- **Reset All Settings**
Press **ENTER** to reset all settings to default value.

Audio Settings menu

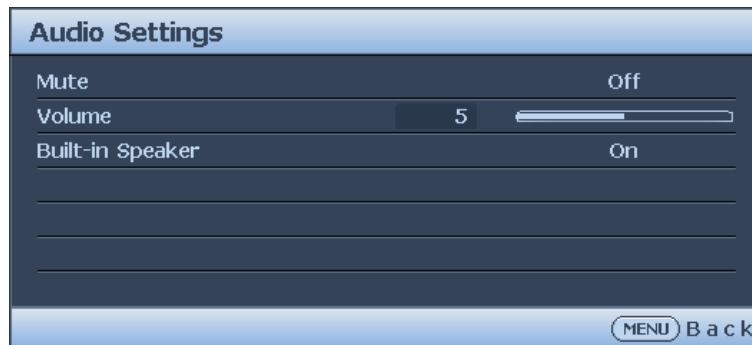

- **Mute**
Press ◀/▶ to enable or disable the mute function.
 - Using the remote control
Press **MUTE** to temporarily turn off the sound. While the sound is off, the screen will display in the upper right corner of the screen.
To restore the sound, press **MUTE** again.
 - Using the OSD menu
 1. Press **MENU** and then press ◀/▶ until the **System Setup: Advanced** menu is highlighted.
 2. Press ▼ to highlight **Audio Settings** and press **ENTER**. The Audio Settings page displays.
 3. Highlight **Mute** and press ◀/▶ to select **On**.
 4. To restore the sound, repeat steps 1-3 and press ◀/▶ to select **Off**.

- **Volume**
Press ◀/▶ to adjust the volume of the projector.
 - Using the remote control
Press **VOLUME+**/**VOLUME-** to select a desired sound level.
 - Using the OSD menu
 1. Press **MENU** and then press ◀/▶ until the **System Setup: Advanced** menu is highlighted.
 2. Press ▼ to highlight **Audio Settings** and press **ENTER**. The Audio Settings page displays.
 3. Press ▼ to highlight **Volume** and press ◀/▶ to select a desired sound level.
- **Built-in speaker**
Press ◀/▶ to enable or disable the built-in speaker.

Light Settings menu

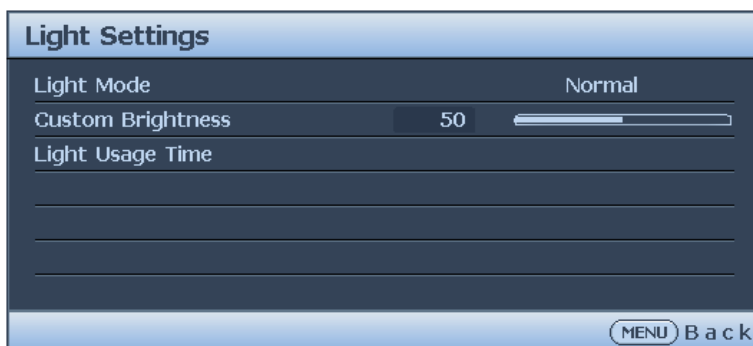

- **Light Mode**
Press ◀/▶ to select the light mode. The options are Normal, Economic, Dimming and Custom.
- **Custom Brightness**
Press ◀/▶ to adjust the brightness of the projector.
- **Light Usage Time**
Press **ENTER** to enter the **Light Source Information** menu.

Security Settings menu



- **Change Password**
Press **ENTER** to change the password.
- **Change Security Settings**
Press **ENTER** to change the security settings.
- **Power On Lock**
Press ◀/▶ to enable or disable the power on lock function. If the function is enabled, you must enter the password every time the projector is turned on.

Closed Caption menu



- **Closed Caption Enable**
Press ◀/▶ to enable or disable the closed caption function.
- **Caption Version**
Press ◀/▶ to select the closed captioning mode. The options are CC1, CC2, CC3 and CC4.

Standby Settings menu



- **Standby Mode**
Press ◀/▶ to select the standby mode. The options are Eco, Network and Normal.
- **Auto Disable Network Standby Mode**
Press ◀/▶ to enable or disable the auto switch from network standby mode to non-network standby mode after a period of time.
- **Audio Pass Through**
Press ◀/▶ to enable the audio line-out function when the projector is in Normal standby mode. The options are Audio In, Audio L/R, HDMI 1, HDMI 2, HDMI 3 and Off.

Network Settings menu



- **Wired LAN**
Press **ENTER** to enter the **Wired LAN** menu to setup the IP address, subnet mask, default gateway, DNS server and DHCP. See "[Controlling the projector through a Wired LAN environment](#)" on page 36 for more details.

- **AMX Device Discovery**
Press ◀/▶ to enable or disable the AMX device discovery function. When the function is enabled, the projector can be detected by an AMX controller.
- **Mac Address**
Displays the current MAC address of the projector.

Information menu



- **Source**
Displays the current signal source.
- **Picture Mode**
Displays the current picture mode.
- **Light Mode**
Displays the current light mode.
- **Resolution**
Displays the native resolution of the input source.
- **3D Format**
Displays the current 3D mode. Only available when 3D Mode is enabled.
- **Color System**
Displays the input system format.
- **Light Usage Time**
Displays the number of hours the light has been used.
- **Firmware Version**
Displays the firmware version of your projector.
- **Service Code**
Displays the service code of your projector.

Menu structure

Main menu	Sub-menu	Options	
Display	Wall Color	Off/ Light Yellow/ Pink/ Light Green/ Blue/ Blackboard	
	Aspect Ratio	Auto/ Real/ 4:3/ 16:9/ 16:10	
	2D Keystone		
	Corner Fit	Top Left/ Top Right/ Bottom Left/ Bottom Right	
	Position		
	Phase		
	H.size		
	Digital zoom	PC: 1.0X~2.0X Video: 1.0X~1.8X	
	Digital Shrink & Shift	Digital Shrink Digital Image Shift	
	Blanking	Top/ Bottom/ Left/ Right/ Reset	
	Overscan	Composite/S-Video: 0- 3 others: 0-3	
	3D	3D Sync Mode	DLP Link/VESA 3D
		3D Mode	Auto/ Frame Sequential/ Frame Packing/ Top-Bottom/ Side-By-Side/ Off
		3D Sync Invert	Disable/ Invert
		3D Sync Out Delay	
		Save 3D Settings	3D Settings 1/ 3D Settings 2/ 3D Settings 3
		Apply 3D Settings	3D Settings 1/ 3D Settings 2/ 3D Settings 3/ Off
Picture	Picture Mode	Bright/ Presentation/ sRGB/ Vivid/ Cinema/ Infographic/ (3D)/ User 1/ User 2	
	Reference Mode	Bright/ Presentation/ sRGB/ Vivid/ Cinema/ Infographic/ (3D)	
	Brightness		
	Contrast		
	Color		
	Tint		
	Sharpness		
	Brilliant Color	On/ Off	
	Gamma Selection	1.8/ 2.0/ 2.1/ 2.2/ 2.3/ 2.4/ 2.6/ BenQ	
	Color Temperature	Cool/ Normal/ Warm	
	Color Temperature	R Gain/ G Gain/ B Gain/	
	Fine Tuning	R Offset/ G Offset/ B Offset	

Main menu	Sub-menu	Options	
Picture	3D Color Management	Primary Color Hue Saturation Gain	
	Reset Picture Settings	Current/ All/ Cancel	
Source	Quick Auto Search	On/ Off	
	HDMI Format	Auto/ RGB Limited/ RGB Full/ YUV Limited/ YUV Full	
	HDMI Equalizer	HDMI-1	Auto/ Lower/ Low/ Middle/ High/ Higher
		HDMI-2	Auto/ Lower/ Low/ Middle/ High/ Higher
HDMI-3		Auto/ Lower/ Low/ Middle/ High/ Higher	
System Setup: Basic	Language	English/ Français/ Deutsch/ Italiano/ Español/ Русский/ 繁體中文/ 简体中文/ 日本語/ 한국어/ Svenska/ Nederlands/ Türkçe/ Čeština/ Português/ हिन्दी/ Polski/ Magyar/ Hrvatski/ Română/ Norsk/ Dansk/ Български/ Suomi/ Indonesian/ Ελληνικά/ العربية/ हिन्दी	
	Projector Installation	Front Table/ Rear Table/ Rear Ceiling/ Front Ceiling	
	Menu Settings	Menu Display Time	5 sec/ 10 sec/ 20 sec/ 30 sec/ Always
		Menu Position	Center/ Top-Left/ Top-Right/ Bottom-Right/ Bottom-Left
		Reminder Message	On/ Off
	Operation Settings	Direct Power On	On/ Off
		Signal Power On	Computer: On/ Off HDMI: On/ Off
		Auto Power Off	Disable/ 3 min/ 10 min/ 15 min/ 20 min/ 25 min/ 30 min
		Blank Timer	Disable/ 5 min/ 10 min/ 15 min/ 20 min/ 25 min/ 30 min
		Sleep Timer	Disable/ 30 min/ 1 hr/ 2 hr/ 3 hr/ 4 hr/ 8 hr/ 12 hr
		Filter Settings	Filter Timer: On/ Off Reset Filter Timer: Reset/ Cancel Filter Usage Time
	Remote Receiver	Front+Rear/ Front/ Rear	
	Panel Key Lock	On/ Off	
Background Color	BenQ/ Black/ Blue/ Purple/ Gray		
Splash Screen	BenQ/ Black/ Blue		

Main menu	Sub-menu	Options
System Setup: Advanced	High Altitude Mode	On/ Off
	Audio Settings	Mute On/ Off
		Volume
		Built-in speaker On/ Off
	Light Settings	Light Mode Normal / Economic/ Dimming/ Custom
		Custom Brightness 25%-100%
		Light Usage Time Light Source Usage Time/ Normal Mode/ Economic Mode/ Dimming Mode/ Custom Mode
	Security Settings	Change Password
		Change Security Settings
		Power On Lock On/ Off
	Baud Rate	2400/ 4800/ 9600/ 14400/ 19200/ 38400/ 57600/ 115200
	Test Pattern	Off/ Grid/ White/ Red/ Green/ Blue/ Black/ RGB Ramps/ Color Bar/ Step Bars/ CheckBoard/ Horizontal Lines/ Vertical Lines/ Diagonal Lines/ Horizontal Ramp/ Vertical Ramps
	Closed Caption	Closed Caption Enable On/ Off
		Caption Version CC1/ CC2/ CC3/ CC4
	Standby Settings	Standby Mode Eco/ Network/ Normal
		Auto Disable Network Standby Mode Never/ 20 min/ 1 hr/ 3 hr/ 6 hr
		Audio Pass Through Audio In/ Audio L/R/ HDMI-1/ HDMI-2/ HDMI-3/ Off
	Network Settings	Wired LAN Status DHCP IP Address Subnet Mask Default Gateway DNS Server Apply
		AMX Device Discovery On/ Off
		Mac Address
	Reset All Settings	Reset/ Cancel

Main menu	Sub-menu	Options
Information	Current System Status	Source Picture Mode Light Mode Resolution 3D Format Color System Light Usage Time Firmware Version Service Code

Maintenance

Before maintaining the projector

- Make sure to turn off the power before maintaining the projector.
- When switching off the projector, make sure to follow the procedures in "[Switch off the projector](#)" on page 35.

Care of the projector

Your projector needs little maintenance. The only thing you need to do on a regular basis is to keep the lens clean.

Never remove any parts of the projector. Contact your dealer if other parts need replacing.

Clean the lens front surface

Clean the lens whenever you notice dirt or dust on the surface.

- Use a canister of compressed air to remove dust.
- If there is dirt or smears, use lens-cleaning paper or moisten a soft cloth with lens cleaner and gently wipe the lens surface.



Caution:

Never use any type of abrasive pad, alkaline/acid cleaner, scouring powder, or volatile solvent, such as alcohol, benzene, thinner or insecticide. Using such materials or maintaining prolonged contact with rubber or vinyl materials may result in damage to the projector surface and cabinet material.

Clean the projector case

Before you clean the case, turn the projector off using the proper shutdown procedure as described in "[Switch off the projector](#)" on page 35 and unplug the power cord.

- To remove dirt or dust, wipe the case with a soft, lint-free cloth.
- To remove stubborn dirt or stains, moisten a soft cloth with water and a neutral pH detergent. Then wipe the case.



Caution:

Never use wax, alcohol, benzene, thinner or other chemical detergents. These can damage the case.

Filter maintenance

Cleaning the filter

The air filter prevents dust from accumulating on the surface of the optical elements inside the projector. If the filter is dirty or clogged, your projector may overheat or degrading the projected image quality.

1. Turn off the projector, and unplug the AC power cord from the AC outlet.
2. Cleaning the filter with a vacuum cleaner.

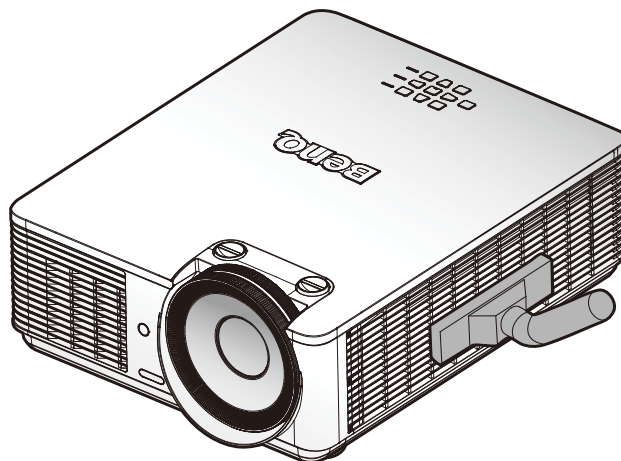

Caution:

Recommend avoiding dusty or smoky environments when you operate the projector; it may cause poor image quality. If the filter is heavily clogged and unable to clean, replace a new filter.

Note:

Using a ladder is recommended to access the filter. Do not remove the projector from the wall mount.

Replacing the side filter

1. Turn off the projector and unplug the power cord from the outlet. Remove any dust on the projector and around the air vents. Remove the filter cover.
3. Align the holes on the new filter with the hooks on the filter cover.

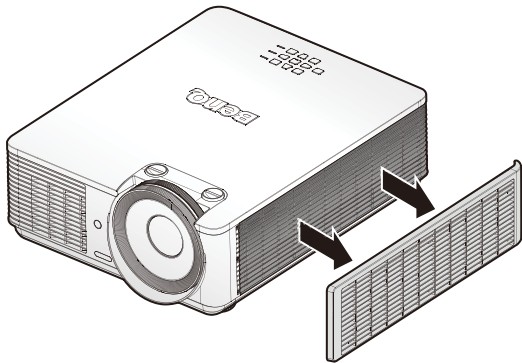

2. Remove the filter from the filter cover.

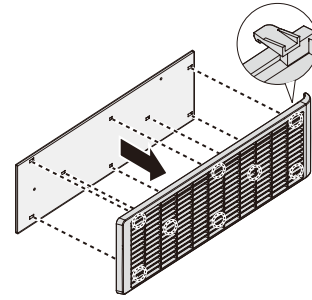
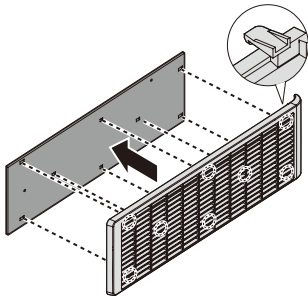

4. Replace the filter cover onto the projector by pushing gently in the direction shown.

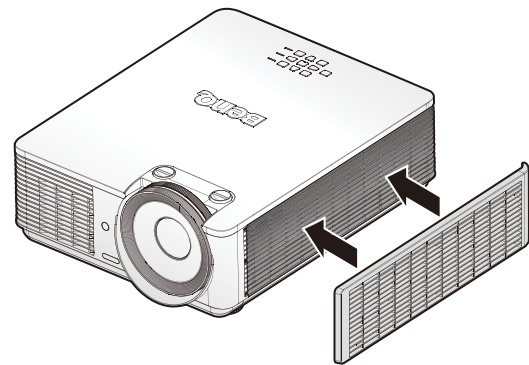

Note:

Do not wash the filter with the water or other liquid matter.

Resetting the filter timer

5. After the startup logo, open the On-Screen Display (OSD) menu. Go to the **SYSTEM SETUP: Basic > Operation Settings > Filter Settings** menu. Press **ENTER**. The Filter Settings page displays. Highlight **Reset Filter Timer**. A warning message displays asking if you want to reset the filter timer. Highlight **Reset** and press **ENTER**. The filter time will be reset to '0'.

LED indicator

POWER



TEMP



LIGHT



System messages

POWER	TEMP	LIGHT	Status
Orange	-	-	Stand-by
Green Flashing	-	-	Powering up
Green	-	-	Normal operation
Orange Flashing	-	-	Normal power down cooling
Red Flashing	Red Flashing	Red Flashing	Downloading
Green	-	Red	Color Wheel start fail
Green	-	Red Flashing	Phosphor Wheel start fail
Red Flashing	-	-	Scaler shutdown fail (data abort)
Red	-	Red	Scaler reset fail (video projector only)
-	Red	-	LAN download fail
-	Green	-	LAN download processing
Orange	-	Green Flashing	Lightsource life exhausted
Orange	-	Green	Lens release
Orange	-	Red	Case open
Orange	-	Red Flashing	Filter replace warning
Orange	Green Flashing	-	Thermal break sensor error

Burn-In message

POWER	TEMP	LIGHT	Status
Green	-	-	Burn-in ON
Green	Green	Green	Burn-in OFF

Lamp error message

POWER	TEMP	LIGHT	Status
-	-	Red	Lamp error in normal operation
-	-	Red Flashing	Lamp is not lit up

Thermal error message

POWER	TEMP	LIGHT	Status
Red	Red	-	Fan 1 error (the actual fan speed is outside the desired speed)
Red	Red Flashing	-	Fan 2 error (the actual fan speed is outside the desired speed)
Red	Green	-	Fan 3 error (the actual fan speed is outside the desired speed)
Red	Green Flashing	-	Fan 4 error (the actual fan speed is outside the desired speed)
Red Flashing	Red	-	Fan 5 error (the actual fan speed is outside the desired speed)
Red Flashing	Red Flashing	-	Fan 6 error (the actual fan speed is outside the desired speed)
Red Flashing	Green	-	Fan 7 error (the actual fan speed is outside the desired speed)
Red Flashing	Green Flashing	-	Fan 8 error (the actual fan speed is outside the desired speed)
Red	Green	Red Flashing	Fan 9 error (the actual fan speed is outside the desired speed)
Red	Green	Red	Fan 10 error (the actual fan speed is outside the desired speed)
Red	Green Flashing	Red Flashing	Fan 11 error (the actual fan speed is outside the desired speed)
Red	Green Flashing	Red	Fan 12 error (the actual fan speed is outside the desired speed)
Green	Red	-	Temperature 1 error (over limited temperature)
Green	Red Flashing	-	Thermal Sensor 1 open error
Green	Green	-	Thermal Sensor 1 short error
Green	Green Flashing	-	Thermal IC #1 I2C Connection error
Green Flashing	Red	-	Temperature 2 error (over limited temperature)
Green Flashing	Red Flashing	-	Thermal Sensor 2 open error
Green Flashing	Green	-	Thermal Sensor 2 short error

POWER	TEMP	LIGHT	Status
Green Flashing	Green Flashing	-	Thermal IC #2 I2C Connection error
Green	Red	Red	Temperature 3 error (over limited temperature)
Green	Red	Red Flashing	Thermal Sensor 3 open error
Green	Red	Green	Thermal Sensor 3 short error
Green	Red	Green Flashing	Thermal IC #3 I2C Connection error
Green	Red Flashing	Red	Temperature 4 error (over limited temperature)
Green	Red Flashing	Red Flashing	Thermal Sensor 4 open error
Green	Red Flashing	Green	Thermal Sensor 4 short error
Green	Red Flashing	Green Flashing	Thermal IC #4 I2C Connection error
Orange	Red	Red	Temperature 5 error (over limited temperature)
Orange	Red	Red Flashing	Thermal Sensor 5 open error
Orange	Red	Green	Thermal Sensor 5 short error
Orange	Red	Green Flashing	Thermal IC #5 I2C Connection error

Troubleshooting

Troubleshooting

The projector does not turn on.

Cause	Remedy
There is no power from the power cable.	Plug the power cord into the AC inlet on the projector, and plug the power cord into the power outlet. If the power outlet has a switch, make sure that it is switched on.
Attempting to turn the projector on again during the cooling process.	Wait until the cooling down process has completed.

No picture.

Cause	Remedy
The video source is not turned on or connected correctly.	Turn the video source on and check that the signal cable is connected correctly.
The projector is not correctly connected to the input signal device.	Check the connection.
The input signal has not been correctly selected.	Select the correct input signal with the SOURCE key on the projector or remote control.

Blurred image.

Cause	Remedy
The projection lens is not correctly focused.	Adjust the focus of the lens using the focus ring.
The projector and the screen are not aligned properly.	Adjust the projection angle and direction as well as the height of the unit if necessary.

Remote control does not work.

Cause	Remedy
The battery is out of power.	Replace the battery with new one.
There is an obstacle between the remote control and the projector.	Remove the obstacle.
You are too far away from the projector.	Stand within 7 meters (23 feet) of the projector.

The password is incorrect.

Cause	Remedy
You do not remember the password.	<ol style="list-style-type: none"> 1. Press and hold AUTO on the projector or remote control for 3 seconds. The projector will display a coded number on the screen. 2. Write down the number and turn off your projector. 3. Seek help from the local BenQ service center to decode the number. You may be required to provide proof of purchase documentation to verify that you are an authorized user of the projector.

Specifications

Specifications

Optical

Resolution

LX785

1024 x 768

LU785

1920 x 1200

Display system

Single-chip DLP™ system

Light source

Normal in 100% brightness

Economic in 80% brightness

Dimming in 50% brightness

Custom from 25% - 100%

Electrical

Power supply

AC100-240V

50/60 Hz

Power consumption

450W (Max); < 0.5W (Standby)

Mechanical

Weight

23.6 lbs (10.7 Kg) (without lens)

Output terminals

Speaker

5 watt x 2 (peak to peak)

Audio signal output

Mini jack x 1

Monitor Out

D-Sub 15-pin (female) x1
(for computer 1 only)

USB

TYPE-A (5V/1.5A)

3D SYNC x 1

Control

USB

Mini type-B x 1

RS-232 serial control

9 pin x 1

IR receiver x 2

LAN control

RJ45 x 1 (10/100 Mbps)

Input terminals

Computer input

RGB input

D-Sub 15-pin (female) x 1

VIDEO

RCA jack x 1

SD/HDTV signal input

Digital - HDMI 1 x 1

HDMI 2 x 1

HDMI 3/MHL x 1

Audio signal input

Audio in

PC audio jack x 1

RCA audio jack (L/R) x 1

Environmental Requirements

Operating temperature

0°C–40°C at sea level

Operating relative humidity

10%–90% (without condensation)

Operating altitude

0–1499 m at 0°C–35°C

1500–3000 m at 0°C–30°C (with High
Altitude Mode on)

Storage temperature

-20°C–60°C

Storage humidity

10%–90% RH (without condensation)

Note:

All specifications are subject to change without notice.

Dimensions

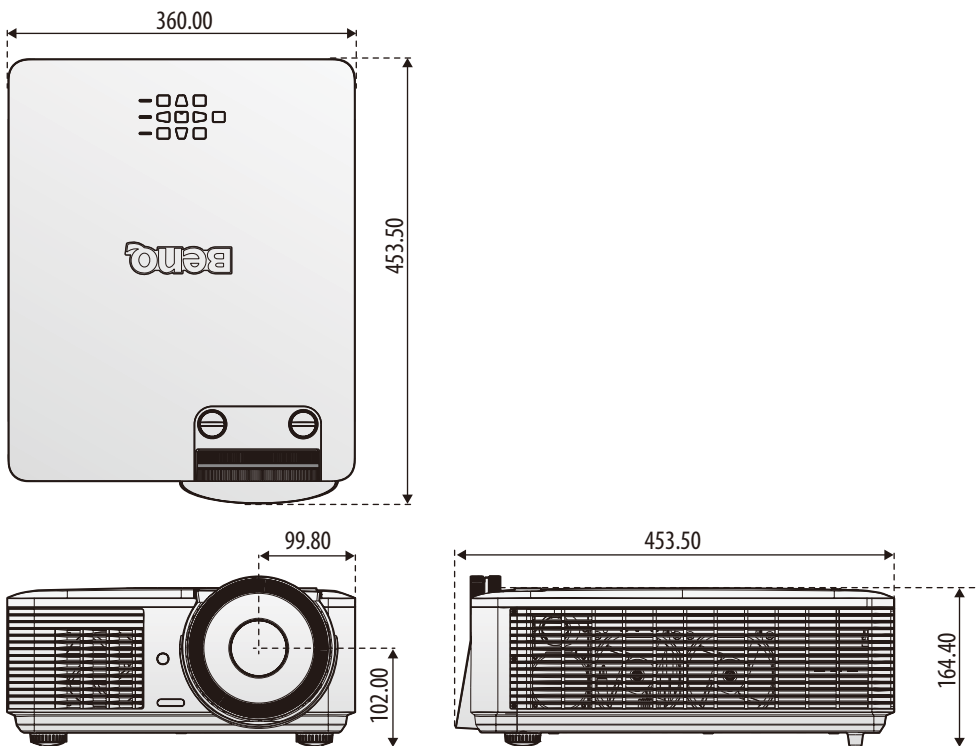

Attaching for ceiling mount

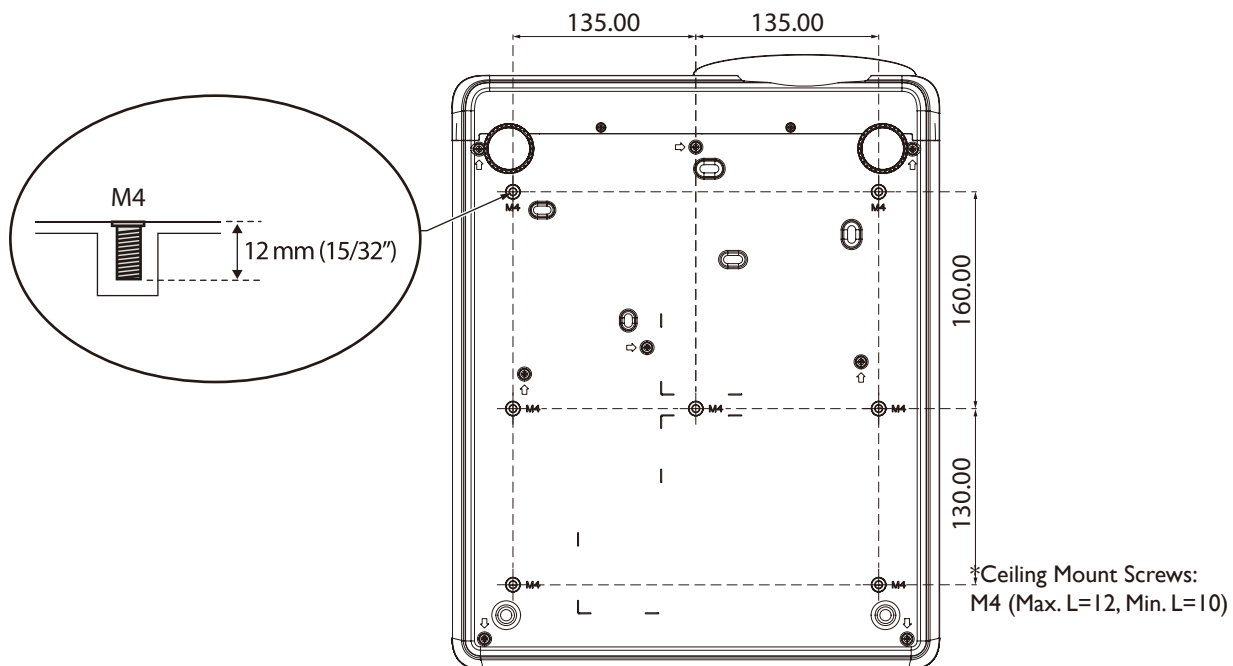

Appendix

Timing table

Supported timing for PC input

Resolution	Mode	Refresh Rate (Hz)	H Frequency (kHz)	Clock (MHz)	3D Frame Sequential	3D Top Bottom	3D side-by-side
720 x 400	720 x 400_70	70.087	31.469	28.3221			
640 x 480	VGA_60	59.940	31.469	25.175	⊙	⊙	⊙
	VGA_72	72.809	37.861	31.500			
	VGA_75	75.000	37.500	31.500			
	VGA_85	85.008	43.269	36.000			
800 x 600	SVGA_60	60.317	37.879	40.000	⊙	⊙	⊙
	SVGA_72	72.188	48.077	50.000			
	SVGA_75	75.000	46.875	49.500			
	SVGA_85	85.061	53.674	56.250			
	SVGA_120 (Reduce Blanking)	119.854	77.425	83.000	⊙		
1024 x 768	XGA_60	60.004	48.363	65.000	⊙	⊙	⊙
	XGA_70	70.069	56.476	75.000			
	XGA_75	75.029	60.023	78.750			
	XGA_85	84.997	68.667	94.500			
	XGA_120 (Reduce Blanking)	119.989	97.551	115.500	⊙		
1152 x 864	1152 x 864_75	75.000	67.500	108.000			
1024 x 576	BenQ NB Timing	60.000	35.820	46.996			
1024 x 600	BenQ NB Timing	64.995	41.467	51.419			
1280 x 720	1280 x 720_60	60.000	45.000	74.250	⊙	⊙	⊙
1280 x 768	1280 x 768_60	59.870	47.776	79.500	⊙	⊙	⊙
1280 x 800	WXGA_60	59.810	49.702	83.500	⊙	⊙	⊙
	WXGA_75	74.934	62.795	106.500			
	WXGA_85	84.880	71.554	122.500			
	WXGA_120 (Reduce Blanking)	119.909	101.563	146.250	⊙		
1280 x 1024	SXGA_60	60.020	63.981	108.000		⊙	⊙
	SXGA_75	75.025	79.976	135.000			
	SXGA_85	85.024	91.146	157.500			
1280 x 960	1280 x 960_60	60.000	60.000	108		⊙	⊙
	1280 x 960_85	85.002	85.938	148.500			
1360 x 768	1360 x 768_60	60.015	47.712	85.500		⊙	⊙

Resolution	Mode	Refresh Rate (Hz)	H Frequency (kHz)	Clock (MHz)	3D Frame Sequential	3D Top Bottom	3D side-by-side
1440 x 900	WXGA+_60	59.887	55.935	106.500		⊙	⊙
1400 x 1050	SXGA+_60	59.978	65.317	121.750		⊙	⊙
1600 x 1200	UXGA	60.000	75.000	162.000		⊙	⊙
1680 x 1050	1680 x 1050_60	59.954	65.290	146.250		⊙	⊙
*1920 x 1080 @60Hz	1920 x 1080_60 (Reduce Blanking)	60.000	67.500	148.500			
*1920 x 1200 @60Hz	1920 x 1200_60 (Reduce Blanking)	59.950	74.038	154.000			
640 x 480 @67Hz	MAC13	66.667	35.000	30.240			
832 x 624 @75Hz	MAC16	74.546	49.722	57.280			
1024 x 768 @75Hz	MAC19	74.930	60.241	80.000			
1152 x 870 @75Hz	MAC21	75.060	68.68	100.000			

 **Note:**

There 3D timing showing depend the EDID file and VGA display card. It is possible that user cannot choose the above 3D timings on VGA display card.

Support timing for Component - YPbPr input

Timing	Resolution	Horizontal Frequency (KHz)	Vertical Frequency (Hz)	Dot Clock Frequency (MHz)	3D Frame Sequential
480i	720 x 480	15.73	59.94	13.50	⊙
480p	720 x 480	31.47	59.94	27.00	⊙
576i	720 x 576	15.63	50.00	13.50	
576p	720 x 576	31.25	50.00	27.00	
720/50p	1280 x 720	37.50	50.00	74.25	
720/60p	1280 x 720	45.00	60.00	74.25	⊙
1080/50i	1920 x 1080	28.13	50.00	74.25	
1080/60i	1920 x 1080	33.75	60.00	74.25	
1080/24p	1920 x 1080	27.00	24.00	74.25	
1080/25p	1920 x 1080	28.13	25.00	74.25	
1080/30p	1920 x 1080	33.75	30.00	74.25	
1080/50p	1920 x 1080	56.25	50.00	148.50	
1080/60p	1920 x 1080	67.50	60.00	148.50	

Support timing for Video input

Video Mode	Horizontal Frequency (KHz)	Vertical Frequency (Hz)	Sub-carrier Frequency (MHz)	3D Frame Sequential
NTSC	15.73	60	3.58	⊙
PAL	15.63	50	4.43	
SECAM	15.63	50	4.25 or 4.41	
PAL-M	15.73	60	3.58	
PAL-N	15.63	50	3.58	
PAL-60	15.73	60	4.43	
NTSC4.43	15.73	60	4.43	

Support timing for HDMI-1 / HDMI-2 / HDMI-3 / DVI-D input

Resolution	Mode	Refresh Rate (Hz)	OH Frequency (kHz)	Clock (MHz)	3D Frame Sequential	3D Top Bottom	3D side-by-side
640 x 480	VGA_60	59.940	31.469	25.175	⊙	⊙	⊙
	VGA_72	72.809	37.861	31.500			
	VGA_75	75.000	37.500	31.500			
	VGA_85	85.008	43.269	36.000			
720 x 400	720 x 400_70	70.087	31.469	28.3221			
800 x 600	SVGA_60	60.317	37.879	40.000	⊙	⊙	⊙
	SVGA_72	72.188	48.077	50.000			
	SVGA_75	75.000	46.875	49.500			
	SVGA_85	85.061	53.674	56.250			
	SVGA_120 (Reduce Blanking)	119.854	77.425	83.000	⊙		
1024 x 768	XGA_60	60.004	48.363	65.000	⊙	⊙	⊙
	XGA_70	70.069	56.476	75.000			
	XGA_75	75.029	60.023	78.750			
	XGA_85	84.997	68.667	94.500			
	XGA_120 (Reduce Blanking)	119.989	97.551	115.500	⊙		
1152 x 864	1152 x 864_75	75.000	67.500	108.000			
1024 x 576	BenQ Notebook Timing	60.000	35.820	46.996			
1024 x 600	BenQ Notebook Timing	64.995	41.467	51.419			
1280 x 720	1280 x 720_60	60.000	45.000	74.250	⊙	⊙	⊙
1280 x 768	1280 x 768_60	59.870	47.776	79.5	⊙	⊙	⊙

Resolution	Mode	Refresh Rate (Hz)	OH Frequency (kHz)	Clock (MHz)	3D Frame Sequential	3D Top Bottom	3D side-by-side
1280 x 800	WXGA_60	59.810	49.702	83.500	⊙	⊙	⊙
	WXGA_75	74.934	62.795	106.500			
	WXGA_85	84.880	71.554	122.500			
	WXGA_120 (Reduce Blanking)	119.909	101.563	146.250	⊙		
1280 x 1024	SXGA_60	60.020	63.981	108.000		⊙	⊙
	SXGA_75	75.025	79.976	135.000			
	SXGA_85	85.024	91.146	157.500			
1280 x 960	1280 x 960_60	60.000	60.000	108.000		⊙	⊙
	1280 x 960_85	85.002	85.938	148.500			
1360 x 768	1360 x 768_60	60.015	47.712	85.500		⊙	⊙
1440 x 900	WXGA+_60	59.887	55.935	106.500		⊙	⊙
1400 x 1050	SXGA+_60	59.978	65.317	121.750		⊙	⊙
1600 x 1200	UXGA	60.000	75.000	162.000		⊙	
1680 x 1050	1680 x 1050_60	59.954	65.290	146.250		⊙	⊙
1920 x 1080 @60Hz	1920 x 1080_60 (Reduce Blanking)	60.000	67.500	148.500		⊙	⊙
1920 x 1200 @60Hz	1920 x 1200_60 (Reduce Blanking)	59.950	74.038	154.000		⊙	⊙
640 x 480 @67Hz	MAC13	66.667	35.000	30.240			
832 x 624 @75Hz	MAC16	74.546	49.722	57.280			
1024 x 768 @75Hz	MAC19	75.020	60.241	80.000			
1152 x 870 @75Hz	MAC21	75.060	68.680	100.000			
1920 x 1080 @120Hz	1920 x 1080_120	120.000	135.000	297.000			
1920 x 1200 @120Hz	1920 x 1080_120 (Reduce Blanking)	119.909	152.404	317.000			

 **Note:**

These timings depend on the EDID file and VGA graphic card limitation. It is possible that a user cannot choose the above timings on a VGA display card.

Supporting timing for HDMI-1 / HDMI-2 / HDMI-3 Video input

Timing	Resolution	Horizontal Frequency (KHz)	Vertical Frequency (Hz)	Dot Clock Frequency (MHz)	3D Frame Sequential	3D Frame Packing	3D Top Bottom	3D side-by-side
480i	720 (1440) x 480	15.73	59.94	27.00	⊙			
480p	720 x 480	31.47	59.94	27.00	⊙			
576i	720 (1440) x 576	15.63	50.00	27.00				
576p	720 x 576	31.25	50.00	27.00				
720/50p	1280 x 720	37.50	50.00	74.25		⊙	⊙	⊙
720/60p	1280 x 720	45.00	60.00	74.25	⊙	⊙	⊙	⊙
1080/24p	1920 x 1080	27.00	24.00	74.25		⊙	⊙	⊙
1080/25p	1920 x 1080	28.13	25.00	74.25				
1080/30p	1920 x 1080	33.75	30.00	74.25				
1080/50i	1920 x 1080	28.13	50.00	74.25				⊙
1080/60i	1920 x 1080	33.75	60.00	74.25				⊙
1080/50p	1920 x 1080	56.25	50.00	148.50			⊙	⊙
1080/60p	1920 x 1080	67.50	60.00	148.50			⊙	⊙

RS232 command control

RS232 pin assignment

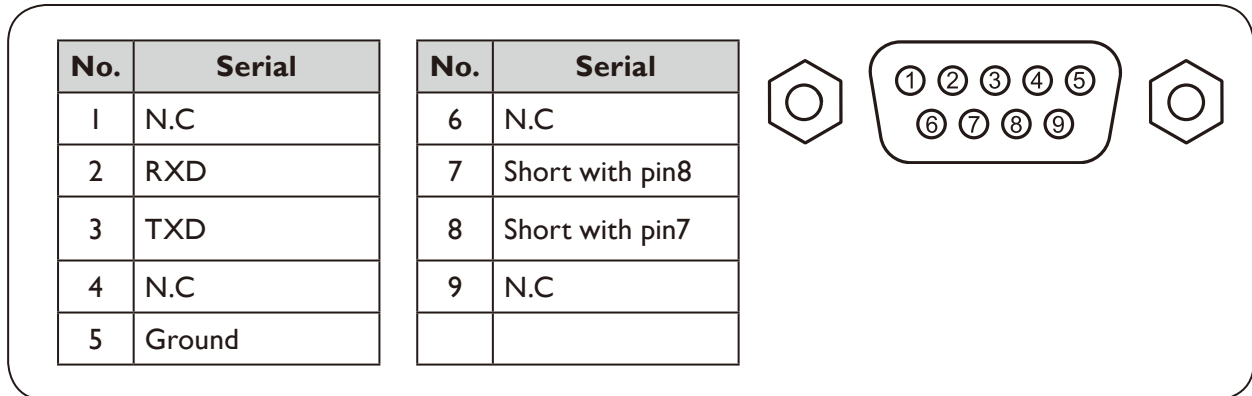

RS232 serial port with a crossover cable

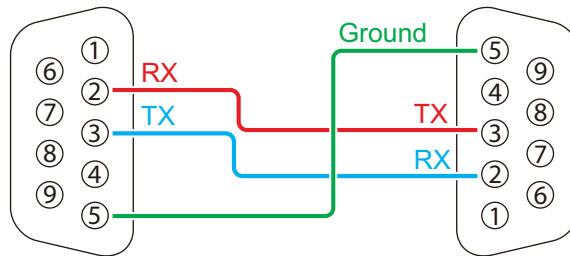

Function	Type	Operation	ASCII
Power	Write	Power On	<CR>*pow=on#<CR>
	Write	Power Off	<CR>*pow=off#<CR>
	Read	Power Status	<CR>*pow=?#<CR>
Source Selection	Write	COMPUTER/YPbPr	<CR>*sour=RGB#<CR>
	Write	HDMI	<CR>*sour=hdmi#<CR>
	Write	HDMI 2	<CR>*sour=hdmi2#<CR>
	Write	HDMI 3 (MHL)	<CR>*sour=hdmi3#<CR>
	Write	Composite	<CR>*sour=vid#<CR>
	Read	Current source	<CR>*sour=?#<CR>
Audio Control	Write	Mute On	<CR>*mute=on#<CR>
	Write	Mute Off	<CR>*mute=off#<CR>
	Read	Mute Status	<CR>*mute=?#<CR>
	Write	Volume +	<CR>*vol=+#<CR>
	Write	Volume -	<CR>*vol=-#<CR>
	Write	Volume level for customer	<CR>*vol=value#<CR>
	Read	Volume Status	<CR>*vol=?#<CR>
Audio Source Select	Write	Audio pass Through off	<CR>*audiosour=off#<CR>
	Write	Audio - Computer1	<CR>*audiosour=RGB#<CR>
	Write	Audio - Video/S-Video	<CR>*audiosour=vid#<CR>
	Write	Audio - HDMI	<CR>*audiosour=hdmi#<CR>
	Write	Audio - HDMI2	<CR>*audiosour=hdmi2#<CR>

Function	Type	Operation	ASCII
Audio Source Select	Write	Audio - HDMI3	<CR>*audiosour=hdmi3#<CR>
	Read	Audio pass Status	<CR>*audiosour=?#<CR>
Picture Mode	Write	Presentation	<CR>*appmod=preset#<CR>
	Write	sRGB	<CR>*appmod=srgb#<CR>
	Write	Bright	<CR>*appmod=bright#<CR>
	Write	Cinema (Rec.709)	<CR>*appmod=cine#<CR>
	Write	Vivid	<CR>*appmod=vivid#<CR>
	Write	Infographic	<CR>*appmod=infographic#<CR>
	Write	User1	<CR>*appmod=user1#<CR>
	Write	User2	<CR>*appmod=user2#<CR>
	Write	3D	<CR>*appmod=threed#<CR>
	Read	Picture Mode	<CR>*appmod=?#<CR>
Picture Setting	Write	Contrast +	<CR>*con=+#<CR>
	Write	Contrast -	<CR>*con=-#<CR>
	Write	Set Contrast value	<CR>*con=5#<CR>
	Read	Contrast value	<CR>*con=?#<CR>
	Write	Brightness +	<CR>*bri=+#<CR>
	Write	Brightness -	<CR>*bri=-#<CR>
	Write	Set Brightness value	<CR>*bri=5#<CR>
	Read	Brightness value	<CR>*bri=?#<CR>
	Write	Color +	<CR>*color=+#<CR>
	Write	Color -	<CR>*color=-#<CR>
	Write	Set Color value	<CR>*color=5#<CR>
	Read	Color value	<CR>*color=?#<CR>
	Write	Sharpness +	<CR>*sharp=+#<CR>
	Write	Sharpness -	<CR>*sharp=-#<CR>
	Write	Set Sharpness value	<CR>*sharp=5#<CR>
	Read	Sharpness value	<CR>*sharp=?#<CR>
	Write	Color Temperature - Warm	<CR>*ct=warm#<CR>
	Write	Color Temperature - Normal	<CR>*ct=normal#<CR>
	Write	Color Temperature - Cool	<CR>*ct=cool#<CR>
	Read	Color Temperature Status	<CR>*ct=?#<CR>
	Write	Aspect 4:3	<CR>*asp=4:3#<CR>
	Write	Aspect 16:9	<CR>*asp=16:9#<CR>
	Write	Aspect 16:10	<CR>*asp=16:10#<CR>
	Write	Aspect Auto	<CR>*asp=AUTO#<CR>
	Write	Aspect Real	<CR>*asp=REAL#<CR>
	Read	Aspect Status	<CR>*asp=?#<CR>
	Write	Vertical Keystone +	<CR>*vkeystone=+#<CR>
	Write	Vertical Keystone -	<CR>*vkeystone=-#<CR>
	Read	Vertical Keystone value	<CR>*vkeystone=?#<CR>
	Write	Horizontal Keystone +	<CR>*hkeystone=+#<CR>
Write	Horizontal Keystone -	<CR>*hkeystone=-#<CR>	

Function	Type	Operation	ASCII
Picture Setting	Read	Horizontal Keystone value	<CR>*hkeystone=?#<CR>
	Write	Overscan Adjustment +	<CR>*overscan=+#<CR>
	Write	Overscan Adjustment -	<CR>*overscan=-#<CR>
	Read	Overscan Adjustment value	<CR>*overscan=?#<CR>
	Write	4 Corners Top-Left - X Decrease	<CR>*cornerfittlx=-#<CR>
	Write	4 Corners Top-Left - X Increase	<CR>*cornerfittlx=+#<CR>
	Read	4 Corners Top-Left - X Status	<CR>*cornerfittlx=?#<CR>
	Write	4 Corners Top-Left - Y Decrease	<CR>*cornerfittly=-#<CR>
	Write	4 Corners Top-Left - Y Increase	<CR>*cornerfittly=+#<CR>
	Read	4 Corners Top-Left - Y Status	<CR>*cornerfittly=?#<CR>
	Write	4 Corners Top-Right - X Decrease	<CR>*cornerfittrx=-#<CR>
	Write	4 Corners Top-Right - X Increase	<CR>*cornerfittrx=+#<CR>
	Read	4 Corners Top-Right - X Status	<CR>*cornerfittrx=?#<CR>
	Write	4 Corners Top-Right - Y Decrease	<CR>*cornerfittry=-#<CR>
	Write	4 Corners Top-Right - Y Increase	<CR>*cornerfittry=+#<CR>
	Read	4 Corners Top-Right - Y Status	<CR>*cornerfittry=?#<CR>
	Write	4 Corners Bottom-Left - X Decrease	<CR>*cornerfitblx=-#<CR>
	Write	4 Corners Bottom-Left - X Increase	<CR>*cornerfitblx=+#<CR>
	Read	4 Corners Bottom-Left - X Status	<CR>*cornerfitblx=?#<CR>
	Write	4 Corners Bottom-Left - Y Decrease	<CR>*cornerfitbly=-#<CR>
	Write	4 Corners Bottom-Left - Y Increase	<CR>*cornerfitbly=+#<CR>
	Read	4 Corners Bottom-Left - Y Status	<CR>*cornerfitbly=?#<CR>
	Write	4 Corners Bottom-Right - X Decrease	<CR>*cornerfitbrx=-#<CR>
	Write	4 Corners Bottom-Right - X Increase	<CR>*cornerfitbrx=+#<CR>
	Read	4 Corners Bottom-Right - X Status	<CR>*cornerfitbrx=?#<CR>
	Write	4 Corners Bottom-Right - Y Decrease	<CR>*cornerfitbry=-#<CR>
	Write	4 Corners Bottom-Right - Y Increase	<CR>*cornerfitbry=+#<CR>
	Read	4 Corners Bottom-Right - Y Status	<CR>*cornerfitbry=?#<CR>
	Write	Digital Zoom in	<CR>*zoomI#<CR>
	Write	Digital Zoom out	<CR>*zoomO#<CR>
	Write	Auto	<CR>*auto#<CR>
	Write	Brilliant color on	<CR>*BC=on#<CR>
	Write	Brilliant color off	<CR>*BC=off#<CR>
Read	Brilliant color status	<CR>*BC=?#<CR>	
Write	Reset current picture settings	<CR>*rstcurpicsetting#<CR>	
Write	Reset all picture settings	<CR>*rstallpicsetting#<CR>	
Operation Settings	Write	Projector Position - Front Table	<CR>*pp=FT#<CR>
	Write	Projector Position - Rear Table	<CR>*pp=RE#<CR>
	Write	Projector Position - Rear Ceiling	<CR>*pp=RC#<CR>
	Write	Projector Position - Front Ceiling	<CR>*pp=FC#<CR>
	Read	Projector Position Status	<CR>*pp=?#<CR>
	Write	Quick auto search	<CR>*QAS=on#<CR>
	Write	Quick auto search	<CR>*QAS=off#<CR>

Function	Type	Operation	ASCII
Operation Settings	Read	Quick auto search status	<CR>*QAS=?#<CR>
	Write	Menu Position - Center	<CR>*menuposition=center#<CR>
	Write	Menu Position - Top-Left	<CR>*menuposition=tl#<CR>
	Write	Menu Position - Top-Right	<CR>*menuposition=tr#<CR>
	Write	Menu Position - Bottom-Right	<CR>*menuposition=br#<CR>
	Write	Menu Position - Bottom-Left	<CR>*menuposition=bl#<CR>
	Read	Menu Position Status	<CR>*menuposition=?#<CR>
	Write	Direct Power On - on	<CR>*directpower=on#<CR>
	Write	Direct Power On - off	<CR>*directpower=off#<CR>
	Read	Direct Power On - Status	<CR>*directpower=?#<CR>
	Write	Signal Power On - on	<CR>*autopower=on#<CR>
	Write	Signal Power On - off	<CR>*autopower=off#<CR>
	Read	Signal Power On - Status	<CR>*autopower=?#<CR>
Baud Rate	Write	2400	<CR>*baud=2400#<CR>
	Write	4800	<CR>*baud=4800#<CR>
	Write	9600	<CR>*baud=9600#<CR>
	Write	14400	<CR>*baud=14400#<CR>
	Write	19200	<CR>*baud=19200#<CR>
	Write	38400	<CR>*baud=38400#<CR>
	Write	57600	<CR>*baud=57600#<CR>
	Write	115200	<CR>*baud=115200#<CR>
	Read	Current Baud Rate	<CR>*baud=?#<CR>
Lamp Control	Read	Lamp Hour	<CR>*ltim=?#<CR>
	Write	Normal mode	<CR>*lampm=lnor#<CR>
	Write	Eco mode	<CR>*lampm=eco#<CR>
	Write	Dimming mode	<CR>*lampm=dimming#<CR>
	Write	Custom mode	<CR>*lampm=custom#<CR>
	Write	Light level for custom mode	<CR>*lampcustom=value#<CR>
	Read	Light level status for custom mode	<CR>*lampcustom=?#<CR>
	Read	Lamp Mode Status	<CR>*lampm=?#<CR>
Miscellaneous	Read	Model Name	<CR>*modelname=?#<CR>
	Read	System F/W Version	<CR>*sysfwversion=?#<CR>
	Read	Scaler F/W Version	<CR>*scalerfwversion=?#<CR>
	Read	Lan F/W Version	<CR>*lanfwversion=?#<CR>
	Read	MCU F/W Version	<CR>*mcfwversion=?#<CR>
	Write	Blank On	<CR>*blank=on#<CR>
	Write	Blank Off	<CR>*blank=off#<CR>
	Read	Blank Status	<CR>*blank=?#<CR>
	Write	Freeze On	<CR>*freeze=on#<CR>
	Write	Freeze Off	<CR>*freeze=off#<CR>
	Read	Freeze Status	<CR>*freeze=?#<CR>
	Write	Menu On	<CR>*menu=on#<CR>
	Write	Menu Off	<CR>*menu=off#<CR>

Function	Type	Operation	ASCII
Miscellaneous	Read	Menu Status	<CR>*menu=?#<CR>
	Write	Source Menu On	<CR>*sourmenu=on#<CR>
	Write	Source Menu Off	<CR>*sourmenu=off#<CR>
	Read	Source Menu Status	<CR>*sourmenu=?#<CR>
	Write	Up	<CR>*up#<CR>
	Write	Down	<CR>*down#<CR>
	Write	Right	<CR>*right#<CR>
	Write	Left	<CR>*left#<CR>
	Write	Enter	<CR>*enter#<CR>
	Write	Back	<CR>*back#<CR>
	Write	Source Menu On	<CR>*sourmenu=on#<CR>
	Write	Source Menu Off	<CR>*sourmenu=off#<CR>
	Read	Source Menu Status	<CR>*sourmenu=?#<CR>
	Write	3D Sync Off	<CR>*3d=off#<CR>
	Write	3D Auto	<CR>*3d=auto#<CR>
	Write	3D Sync Top Bottom	<CR>*3d=tb#<CR>
	Write	3D Sync Frame Sequential	<CR>*3d=fs#<CR>
	Write	3D Frame packing	<CR>*3d=fp#<CR>
	Write	3D Side by side	<CR>*3d=sbs#<CR>
	Write	3D inverter disable	<CR>*3d=da#<CR>
	Write	3D inverter	<CR>*3d=iv#<CR>
	Write	3D nVIDIA	<CR>*3d=nvidia#<CR>
	Read	3D Sync Status	<CR>*3d=?#<CR>
	Write	Remote Receiver - front+rear	<CR>*rr=fr#<CR>
	Write	Remote Receiver - front	<CR>*rr=f#<CR>
	Write	Remote Receiver - rear	<CR>*rr=r#<CR>
	Read	Remote Receiver Status	<CR>*rr=?#<CR>
	Write	AMX Device Discovery - on	<CR>*amxdd=on#<CR>
	Write	AMX Device Discovery - off	<CR>*amxdd=off#<CR>
	Read	AMX Device Discovery Status	<CR>*amxdd=?#<CR>
	Read	Mac Address	<CR>*macaddr=?#<CR>
	Write	High Altitude mode on	<CR>*Highaltitude=on#<CR>
	Write	High Altitude mode off	<CR>*Highaltitude=off#<CR>
Read	High Altitude mode status	<CR>*Highaltitude=?#<CR>	
Color Calibration	Write	Tint +	<CR>*tint=+#<CR>
	Write	Tint -	<CR>*tint=-#<CR>
	Write	Set Tint value	<CR>*tint=value#<CR>
	Read	Get Tint value	<CR>*tint=?#<CR>
	Write	Set gamma value	<CR>*gamma=value#<CR>
	Read	Gamma value status	<CR>*gamma=?#<CR>
	Write	Red Gain +	<CR>*RGain=+#<CR>
	Write	Red Gain -	<CR>*RGain=-#<CR>
Write	Set Red Gain value	<CR>*RGain=value#<CR>	

Function	Type	Operation	ASCII
Color Calibration	Read	Get Red Gain value	<CR>*RGain=?#<CR>
	Write	Green Gain +	<CR>*GGain=+#<CR>
	Write	Green Gain -	<CR>*GGain=-#<CR>
	Write	Set Green Gain value	<CR>*GGain=value#<CR>
	Read	Get Green Gain value	<CR>*GGain=?#<CR>
	Write	Blue Gain +	<CR>*BGain=+#<CR>
	Write	Blue Gain -	<CR>*BGain=-#<CR>
	Write	Set Blue Gain value	<CR>*BGain=value#<CR>
	Read	Get Blue Gain value	<CR>*BGain=?#<CR>
	Write	Red Offset +	<CR>*ROffset=+#<CR>
	Write	Red Offset -	<CR>*ROffset=-#<CR>
	Write	Set Red Offset value	<CR>*ROffset=value#<CR>
	Read	Get Red Offset value	<CR>*ROffset=?#<CR>
	Write	Green Offset +	<CR>*GOffset=+#<CR>
	Write	Green Offset -	<CR>*GOffset=-#<CR>
	Write	Set Green Offset value	<CR>*GOffset=value#<CR>
	Read	Get Green Offset value	<CR>*GOffset=?#<CR>
	Write	Blue Offset +	<CR>*BOffset=+#<CR>
	Write	Blue Offset -	<CR>*BOffset=-#<CR>
	Write	Set Blue Offset value	<CR>*BOffset=value#<CR>
	Read	Get Blue Offset value	<CR>*BOffset=?#<CR>
	Write	Primary Color	<CR>*primcr=value#<CR>
	Read	Primary Color Status	<CR>*primcr=?#<CR>
	Write	Hue +	<CR>*hue=+#<CR>
	Write	Hue -	<CR>*hue=-#<CR>
	Write	Set Hue value	<CR>*hue=value#<CR>
	Read	Get Hue value	<CR>*hue=?#<CR>
	Write	Saturation +	<CR>*saturation=+#<CR>
	Write	Saturation -	<CR>*saturation=-#<CR>
	Write	Set Saturation value	<CR>*saturation=value#<CR>
	Read	Get Saturation value	<CR>*saturation=?#<CR>
	Write	Gain +	<CR>*gain=+#<CR>
Write	Gain -	<CR>*gain=-#<CR>	
Write	Set Gain value	<CR>*gain=value#<CR>	
Read	Get Gain value	<CR>*gain=?#<CR>	
Service	Read	Error Code report	<CR>*error=report#<CR>
	Read	FAN 1 speed	<CR>*fan1=?#<CR>
	Read	FAN 2 speed	<CR>*fan2=?#<CR>
	Read	FAN 3 speed	<CR>*fan3=?#<CR>
	Read	FAN 4 speed	<CR>*fan4=?#<CR>
	Read	Temperature 1	<CR>*tmp1=?#<CR>
	Read	Temperature 2	<CR>*tmp2=?#<CR>
	Read	Temperature 3	<CR>*tmp3=?#<CR>
	Read	LED indicator	<CR>*led=?#<CR>

PJLink

PJLink protocol

The network function of this projector support the PJLink class I, and the PJLink protocol can be used to perform projector setting and projector status query operations from a computer.

Control commands

The following table lists the PJLink protocol commands that can be used to control the projector.

- x characters in table are non-specific characters.

Command	Control Details	Parameter/ Return String	Remark		
POWR	Power supply control	0 1	Standby Power on		
POWR?	Power supply status query	0 1	Standby Power on		
INPT	Input selection	11	PCI / YPbPr1		
INPT?	Input status query	21	VIDEO		
		31	HDMI1		
		32	HDMI2		
		33	HDMI3 / MHL		
AVMT	Mute	11	Video mute On		
AVMT?	Mute query	10	Video mute Off		
		21	Audio mute On		
		20	Audio mute Off		
		31	Video & Audio mute On		
		30	Video & Audio mute Off		
ERST?	Error status query	xxxxxx	1st byte	Indicates fan errors, and returns 0 - 2	0 = No error is detected 1 = Warning 2 = Error
			2nd byte	Indicates light source errors, and returns 0 - 2	
			3rd byte	Indicates temperature errors, and returns 0 - 2	
			4th byte	Return 0	
			5th byte	Return 0	
			6th byte	Indicates other errors, and returns 0 - 2	
LAMP?	Light source status query	xxxxxxxxxxxx	1st number (1-5 digitals): Light source 1 runtime		
INST?	Input selection list query	11 21 31 32 33	LX785/ LU785		

Command	Control Details	Parameter/ Return String	Remark
NAME?	Projector name query	xxxxx	Returns the name set in [PROJECTOR NAME] of [NETWORK SETUP]
INFI?	Manufacturer name query	BenQ	Returns manufacturer name
INF2?	Model name query	LX785/ LU785	Returns moder name
INF0?	Other information queries	xxxxx	Returns information such as version number
CLASS?	Class information query	I	Returns class for PJLink