



Lexmark™

C2240, C2325, C2425, C2535, CS421, CS521, CS622 Printers

User's Guide

September 2022

www.lexmark.com

Machine type(s):

5029

Models:

038, 230, 238, 430, 438, 636, 696

Contents

- Safety information..... 6**
 - Conventions..... 6
 - Product statements..... 6

- Learning about the printer..... 9**
 - Finding information about the printer.....9
 - Selecting a location for the printer..... 11
 - Printer configurations..... 12
 - Attaching cables..... 13

- Using the control panel..... 14**
 - Lexmark C2325 printer..... 14**
 - Lexmark CS421, CS521, C2425, and C2535 printers..... 15**
 - Lexmark CS622 and C2240 printers..... 16**
 - Understanding the status of the power button and indicator light..... 16

- Setting up and using the home screen applications..... 17**
 - Using the home screen..... 17
 - Customizing the home screen..... 18
 - Using Display Customization..... 18
 - Configuring Eco-Settings..... 19
 - Creating a Cloud Connector profile..... 19
 - Setting up Device Quotas..... 19
 - Using QR Code Generator..... 20
 - Using Customer Support..... 20
 - Managing bookmarks..... 20
 - Managing contacts..... 21

- Setting up and using the accessibility features..... 24**
 - Activating Voice Guidance..... 24
 - Navigating the screen using gestures..... 24
 - Enabling Magnification mode..... 25
 - Adjusting the Voice Guidance speech rate..... 25
 - Using the keyboard on the display..... 25
 - Enabling spoken passwords or personal identification numbers..... 25

Loading paper and specialty media..... 26

- Setting the paper size and type..... 26
- Configuring Universal paper settings..... 26
- Loading trays..... 26
- Loading the multipurpose feeder..... 28
- Loading the manual feeder..... 30
- Adjusting the paper stop in the standard bin..... 31
- Linking trays..... 31

Paper support..... 33

- Supported paper sizes..... 33
- Supported paper types..... 35
- Supported paper weights..... 36

Printing..... 38

- Printing from a computer..... 38
- Printing from a mobile device..... 38
- Printing from a flash drive..... 40
- Supported flash drives and file types..... 41
- Configuring confidential jobs..... 41
- Printing confidential and other held jobs..... 42
- Printing from a Cloud Connector profile..... 43
- Printing a font sample list..... 43
- Printing a directory list..... 43

Understanding the printer menus..... 44

- Menu map..... 44
- Device..... 45
- Print..... 57
- Paper..... 66
- USB Drive..... 67
- Network/Ports..... 69
- Security..... 81
- Reports..... 89
- Help..... 89
- Troubleshooting..... 90

Printing the Menu Settings Page..... 90

Securing the printer..... 91

Locating the security slot..... 91
Erasing printer memory..... 91
Erasing printer hard disk memory.....91
Encrypting the printer hard disk..... 92
Restoring factory default settings..... 92
Statement of Volatility..... 92

Maintaining the printer..... 94

Networking..... 94
Cleaning the printer..... 96
Ordering parts and supplies..... 96
Replacing parts and supplies..... 101
Moving the printer.....113
Saving energy and paper..... 114
Recycling..... 115

Clearing jams.....116

Avoiding jams..... 116
Identifying jam locations.....117
Paper jam in trays..... 118
Paper jam in door A.....118
Paper jam in the standard bin.....121
Paper jam in the multipurpose feeder.....122
Paper jam in the manual feeder.....123

Troubleshooting..... 124

Configuring the SMTP server.....124
Network connection problems.....125
Hardware options problems.....127
Issues with supplies..... 128
Paper feed problems..... 130
Printing problems.....133
Color quality problems..... 158
Contacting customer support..... 161

Upgrading and migrating.....162
 Hardware..... 162
 Software..... 168
 Firmware..... 169

Notices.....171

Index..... 184

Safety information

Conventions

Note: A *note* identifies information that could help you.

Warning: A *warning* identifies something that could damage the product hardware or software.

CAUTION: A *caution* indicates a potentially hazardous situation that could injure you.

Different types of caution statements include:



CAUTION—POTENTIAL INJURY: Indicates a risk of injury.



CAUTION—SHOCK HAZARD: Indicates a risk of electrical shock.



CAUTION—HOT SURFACE: Indicates a risk of burn if touched.



CAUTION—TIPPING HAZARD: Indicates a crush hazard.



CAUTION—PINCH HAZARD: Indicates a risk of being caught between moving parts.

Product statements



CAUTION—POTENTIAL INJURY: To avoid the risk of fire or electrical shock, connect the power cord to an appropriately rated and properly grounded electrical outlet that is near the product and easily accessible.



CAUTION—POTENTIAL INJURY: To avoid the risk of fire or electrical shock, use only the power cord provided with this product or the manufacturer's authorized replacement.



CAUTION—POTENTIAL INJURY: Do not use this product with extension cords, multioutlet power strips, multioutlet extenders, or UPS devices. The power capacity of these types of accessories can be easily overloaded by a laser printer and may result in a risk of fire, property damage, or poor printer performance.



CAUTION—POTENTIAL INJURY: Only a Lexmark Inline Surge Protector that is properly connected between the printer and the power cord provided with the printer may be used with this product. The use of non-Lexmark surge protection devices may result in a risk of fire, property damage, or poor printer performance.











CAUTION—SHOCK HAZARD: To avoid the risk of electrical shock, do not place or use this product near water or wet locations.





CAUTION—SHOCK HAZARD: To avoid the risk of electrical shock, do not set up this product or make any electrical or cabling connections, such as the power cord, fax feature, or telephone, during a lightning storm.



CAUTION—POTENTIAL INJURY: Do not cut, twist, bind, crush, or place heavy objects on the power cord. Do not subject the power cord to abrasion or stress. Do not pinch the power cord between objects such as furniture and walls. If any of these things happen, a risk of fire or electrical shock results. Inspect the power cord regularly for signs of such problems. Remove the power cord from the electrical outlet before inspecting it.

-  **CAUTION—SHOCK HAZARD:** To avoid the risk of electrical shock, make sure that all external connections (such as Ethernet and telephone system connections) are properly installed in their marked plug-in ports.
-  **CAUTION—SHOCK HAZARD:** To avoid the risk of electrical shock, if you are accessing the controller board or installing optional hardware or memory devices sometime after setting up the printer, then turn the printer off, and unplug the power cord from the electrical outlet before continuing. If you have any other devices attached to the printer, then turn them off as well, and unplug any cables going into the printer.
-  **CAUTION—SHOCK HAZARD:** To avoid the risk of electrical shock when cleaning the exterior of the printer, unplug the power cord from the electrical outlet and disconnect all cables from the printer before proceeding.
-  **CAUTION—POTENTIAL INJURY:** If the printer weight is greater than 20 kg (44 lb), then it may require two or more people to lift it safely.
-  **CAUTION—POTENTIAL INJURY:** When moving the printer, follow these guidelines to avoid personal injury or printer damage:
- Make sure that all doors and trays are closed.
 - Turn off the printer, and then unplug the power cord from the electrical outlet.
 - Disconnect all cords and cables from the printer.
 - If the printer has separate floor-standing optional trays or output options attached to it, then disconnect them before moving the printer.
 - If the printer has a caster base, then carefully roll it to the new location. Use caution when passing over thresholds and breaks in flooring.
 - If the printer does not have a caster base but is configured with optional trays or output options, then remove the output options and lift the printer off the trays. Do not try to lift the printer and any options at the same time.
 - Always use the handholds on the printer to lift it.
 - Any cart used to move the printer must have a surface able to support the full footprint of the printer.
 - Any cart used to move the hardware options must have a surface able to support the dimensions of the options.
 - Keep the printer in an upright position.
 - Avoid severe jarring movements.
 - Make sure that your fingers are not under the printer when you set it down.
 - Make sure that there is adequate clearance around the printer.
-  **CAUTION—TIPPING HAZARD:** Installing one or more options on your printer or MFP may require a caster base, furniture, or other feature to prevent instability causing possible injury. For more information on supported configurations, see www.lexmark.com/multifunctionprinters.
-  **CAUTION—TIPPING HAZARD:** To reduce the risk of equipment instability, load each tray separately. Keep all other trays closed until needed.
-  **CAUTION—HOT SURFACE:** The inside of the printer might be hot. To reduce the risk of injury from a hot component, allow the surface to cool before touching it.
-  **CAUTION—PINCH HAZARD:** To avoid the risk of a pinch injury, use caution in areas marked with this label. Pinch injuries may occur around moving parts, such as gears, doors, trays, and covers.

 **CAUTION—POTENTIAL INJURY:** This product uses a laser. Use of controls or adjustments or performance of procedures other than those specified in the *User's Guide* may result in hazardous radiation exposure.

 **CAUTION—POTENTIAL INJURY:** The lithium battery in this product is not intended to be replaced. There is a danger of explosion if a lithium battery is incorrectly replaced. Do not recharge, disassemble, or incinerate a lithium battery. Discard used lithium batteries according to the manufacturer's instructions and local regulations.

This product is designed, tested, and approved to meet strict global safety standards with the use of specific manufacturer's components. The safety features of some parts may not always be obvious. The manufacturer is not responsible for the use of other replacement parts.

Refer service or repairs, other than those described in the user documentation, to a service representative.

This product uses a printing process that heats the print media, and the heat may cause the media to release emissions. You must understand the section in your operating instructions that discusses the guidelines for selecting print media to avoid the possibility of harmful emissions.

This product may produce small amounts of ozone during normal operation, and may be equipped with a filter designed to limit ozone concentrations to levels well below the recommended exposure limits. To avoid high ozone concentration levels during extensive usage, install this product in a well-ventilated area and replace the ozone and exhaust filters if instructed to do so in the product maintenance instructions. If there are no references to filters in the product maintenance instructions, then there are no filters requiring replacement for this product.

SAVE THESE INSTRUCTIONS.

Learning about the printer

Finding information about the printer

| What are you looking for? | Find it here |
|---|---|
| Initial setup instructions: <ul style="list-style-type: none"> • Connecting the printer • Installing the printer software | See the setup documentation that came with the printer or go to http://support.lexmark.com . |
| More setup and instructions for using the printer: <ul style="list-style-type: none"> • Selecting and storing paper and specialty media • Loading paper • Configuring printer settings • Viewing and printing documents and photos • Setting up and using the printer software • Configuring the printer on a network • Caring for and maintaining the printer • Troubleshooting and solving problems | <i>Information Center</i> —Go to http://infoserve.lexmark.com . <i>Help Menu Pages</i> —Access the guides on the printer firmware or go to http://support.lexmark.com . <i>Touch Screen Guide</i> —Go to http://support.lexmark.com . Product videos—Go to http://infoserve.lexmark.com/idv/ . |
| Information on setting up and configuring the accessibility features of your printer | <i>Lexmark Accessibility Guide</i> —Go to http://support.lexmark.com . |
| Help using the printer software | Help for Microsoft® Windows® or Macintosh operating systems—Open a printer software program or application, and then click Help . Click  to view context-sensitive information. Notes: <ul style="list-style-type: none"> • Help is automatically installed with the printer software. • Depending on the operating system, the printer software is located in the printer program folder or on the desktop. |

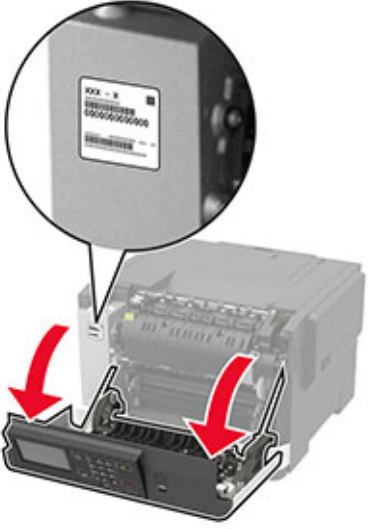
| What are you looking for? | Find it here |
|--|---|
| <p>The latest supplemental information, updates, and customer support:</p> <ul style="list-style-type: none"> • Documentation • Driver downloads • Live chat support • E-mail support • Voice support | <p>Go to http://support.lexmark.com.</p> <p>Note: Select your country or region, and then select your product to view the appropriate support site.</p> <p>Support contact information for your country or region can be found on the website or on the printed warranty that came with the printer.</p> <p>Have the following information ready when you contact customer support:</p> <ul style="list-style-type: none"> • Place and date of purchase • Machine type and serial number  |
| <ul style="list-style-type: none"> • Safety information • Regulatory information • Warranty information • Environmental information | <p>Warranty information varies by country or region:</p> <ul style="list-style-type: none"> • In the U.S.—See the Statement of Limited Warranty included with the printer, or go to http://support.lexmark.com. • In other countries and regions—See the printed warranty that came with the printer. <p><i>Product Information Guide</i>—See the documentation that came with the printer or go to http://support.lexmark.com.</p> |

Selecting a location for the printer

- Leave enough room to open trays, covers, and doors and to install hardware options.
- Set up the printer near an electrical outlet.

⚠ CAUTION—POTENTIAL INJURY: To avoid the risk of fire or electrical shock, connect the power cord to an appropriately rated and properly grounded electrical outlet that is near the product and easily accessible.

⚠ CAUTION—SHOCK HAZARD: To avoid the risk of electrical shock, do not place or use this product near water or wet locations.

- Make sure that airflow in the room meets the latest revision of the ASHRAE 62 standard or the CEN Technical Committee 156 standard.
- Provide a flat, sturdy, and stable surface.
- Keep the printer:
 - Clean, dry, and free of dust
 - Away from stray staples and paper clips
 - Away from the direct airflow of air conditioners, heaters, or ventilators
 - Free from direct sunlight and humidity extremes
- Observe the temperature range.

| | |
|-----------------------|---------------------------|
| Operating temperature | 10 to 32.2°C (50 to 90°F) |
|-----------------------|---------------------------|

- Allow the following recommended amount of space around the printer for proper ventilation:

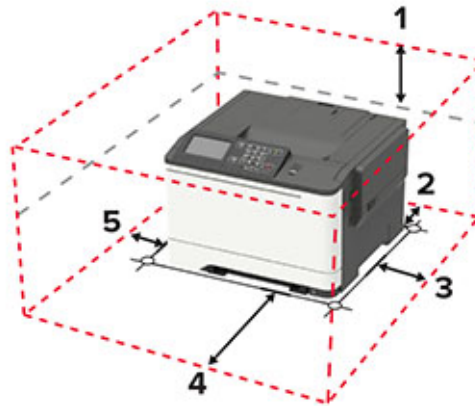

| | | |
|---|------------|---|
| 1 | Top | 254 mm (10 in.) |
| 2 | Rear | 102 mm (4 in.) |
| 3 | Right side | 76 mm (3 in.) |
| 4 | Front | 508 mm (20 in.) Note: The minimum space needed in front of the printer is 75 mm (3 in.) |
| 5 | Left side | 76 mm (3 in.) |

Printer configurations

CAUTION—TIPPING HAZARD: Installing one or more options on your printer or MFP may require a caster base, furniture, or other feature to prevent instability causing possible injury. For more information on supported configurations, see www.lexmark.com/multifunctionprinters.

CAUTION—TIPPING HAZARD: To reduce the risk of equipment instability, load each tray separately. Keep all other trays closed until needed.

Depending on your printer model, you can configure your printer by adding an optional 650-sheet duo tray or both the 650-sheet duo tray and 550-sheet tray. For more information, see [“Installing optional trays” on page 167](#).



| | |
|----------|--|
| 1 | Control panel Note: The appearance may vary depending on your printer model. |
| 2 | Standard bin |
| 3 | Standard 250-sheet tray |
| 4 | Manual feeder |
| 5 | Optional 650-sheet duo tray Note: Available only in some printer models. |
| 6 | Optional 550-sheet tray Note: Available only in some printer models. |

Attaching cables

CAUTION—SHOCK HAZARD: To avoid the risk of electrical shock, do not set up this product or make any electrical or cabling connections, such as the power cord, fax feature, or telephone, during a lightning storm.

CAUTION—POTENTIAL INJURY: To avoid the risk of fire or electrical shock, connect the power cord to an appropriately rated and properly grounded electrical outlet that is near the product and easily accessible.

CAUTION—POTENTIAL INJURY: To avoid the risk of fire or electrical shock, use only the power cord provided with this product or the manufacturer's authorized replacement.

Warning—Potential Damage: To avoid loss of data or printer malfunction, do not touch the USB cable, any wireless network adapter, or the printer in the areas shown while actively printing.



| | Use the | To |
|---|-------------------|---|
| 1 | Ethernet port | Connect the printer to a network. |
| 2 | Power cord socket | Connect the printer to an electrical outlet. |
| 3 | USB port | Attach a keyboard or any compatible option. Note: This port is available only in some printer models. |
| 4 | USB printer port | Connect the printer to a computer. |

Using the control panel

Lexmark C2325 printer

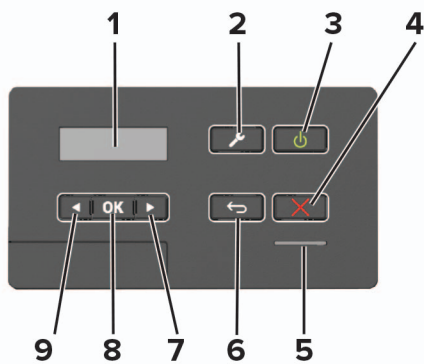

| | Use the | To |
|---|-----------------------|--|
| 1 | Display | <ul style="list-style-type: none"> View printer messages and supply status. Set up and operate the printer. |
| 2 | Menu button | Access the printer menus. |
| 3 | Power button | <ul style="list-style-type: none"> Turn on or turn off the printer. Note: To turn off the printer, press and hold the power button for five seconds. Set the printer to Sleep or Hibernate mode. Wake the printer from Sleep or Hibernate mode. |
| 4 | Stop or Cancel button | Stop the current printer task. |
| 5 | Indicator light | Check the printer status. |
| 6 | Back button | Return to the previous screen. |
| 7 | Right arrow button | <ul style="list-style-type: none"> Scroll through menus or move between screens and menu options. Increase the numeric value of a setting. |
| 8 | Select button | <ul style="list-style-type: none"> Select a menu option. Save the changes in a setting. |
| 9 | Left arrow button | <ul style="list-style-type: none"> Scroll through menus or move between screens and menu options. Decrease the numeric value of a setting. |

Lexmark CS421, CS521, C2425, and C2535 printers

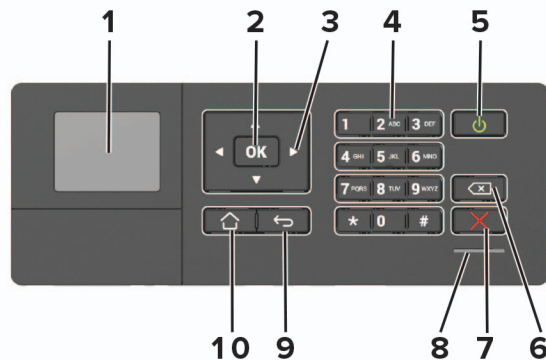

| | Use the | To |
|----|-----------------------|--|
| 1 | Display | <ul style="list-style-type: none"> View printer messages and supply status. Set up and operate the printer. |
| 2 | Select button | <ul style="list-style-type: none"> Select a menu option. Save the changes in a setting. |
| 3 | Arrow buttons | <ul style="list-style-type: none"> Scroll through menus or move between screens and menu options. Adjust the numeric value of a setting. |
| 4 | Numeric keypad | Enter numbers or symbols in an input field. |
| 5 | Power button | <ul style="list-style-type: none"> Turn on or turn off the printer. Note: To turn off the printer, press and hold the power button for five seconds. Set the printer to Sleep or Hibernate mode. Wake the printer from Sleep or Hibernate mode. |
| 6 | Backspace button | Move the cursor backward and delete a character in an input field. |
| 7 | Stop or Cancel button | Stop the current printer task. |
| 8 | Indicator light | Check the printer status. |
| 9 | Back button | Return to the previous screen. |
| 10 | Home button | Go to the home screen. |

Lexmark CS622 and C2240 printers

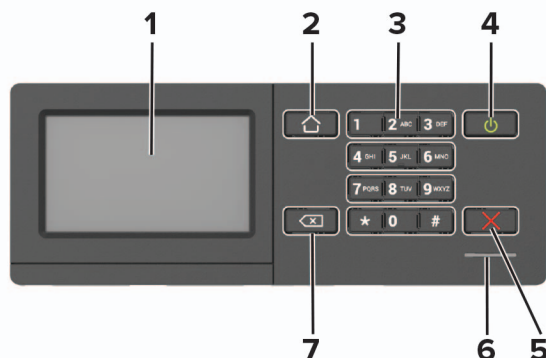

| | Use the | To |
|---|-----------------------|---|
| 1 | Display | <ul style="list-style-type: none"> View printer messages and supply status. Set up and operate the printer. |
| 2 | Home button | Go to the home screen. |
| 3 | Numeric keypad | Enter numbers or symbols in an input field. |
| 4 | Power button | <ul style="list-style-type: none"> Turn on or turn off the printer. <p>Note: To turn off the printer, press and hold the power button for five seconds.</p> <ul style="list-style-type: none"> Set the printer to Sleep or Hibernate mode. Wake the printer from Sleep or Hibernate mode. |
| 5 | Stop or Cancel button | Stop the current printer task. |
| 6 | Indicator light | Check the printer status. |
| 7 | Back button | Return to the previous screen. <ul style="list-style-type: none"> Select a menu option. Save the changes in a setting. |

Understanding the status of the power button and indicator light

| Indicator light | Printer status |
|-----------------|--|
| Off | The printer is off or in Hibernate mode. |
| Blue | The printer is ready or processing data. |
| Red | The printer requires user intervention. |

| Power button light | Printer status |
|--------------------|--|
| Off | The printer is off, ready, or processing data. |
| Solid amber | The printer is in Sleep mode. |
| Blinking amber | The printer is in Hibernate mode. |

Setting up and using the home screen applications

Note: These applications are supported only in some printer models.

Using the home screen

Note: Your home screen may vary depending on your home screen customization settings, administrative setup, and active embedded solutions.



| Touch | To |
|-------|---|
| 1 | Status/Supplies <ul style="list-style-type: none"> Show a warning or error message whenever the printer requires intervention to continue processing. View more information on the printer warning or message, and on how to clear it. <p>Note: You can also access this setting by touching the top section of the home screen.</p> |
| 2 | Job Queue <p>Show all the current print jobs.</p> <p>Note: You can also access this setting by touching the top section of the home screen.</p> |
| 3 | Change Language <p>Change the language on the display.</p> |
| 4 | Settings <p>Access the printer menus.</p> |
| 5 | Eco-Settings <p>Manage energy consumption, noise, toner, and paper usage settings.</p> |
| 6 | Held Jobs <p>Show the print jobs that are held in the printer memory.</p> |
| 7 | USB Drive <p>Print photos and documents from a flash drive.</p> |
| 8 | Address Book <p>Manage a contact list that other applications on the printer can access.</p> |

Customizing the home screen

- 1 Open a web browser, and then type the printer IP address in the address field.

Notes:

- View the printer IP address on the printer home screen. The IP address appears as four sets of numbers separated by periods, such as 123.123.123.123.
- If you are using a proxy server, then temporarily disable it to load the web page correctly.

- 2 Click **Settings > Device > Visible Home Screen Icons**.
- 3 Select the icons that you want to appear on the home screen.
- 4 Apply the changes.

Using Display Customization

Before using the application, make sure to do the following:

- From the Embedded Web Server, click **Apps > Display Customization > Configure**.
- Enable and configure the screen saver, slideshow, and wallpaper settings.

Managing screen saver and slide show images

- 1 From the Screen Saver and Slideshow Images section, add, edit, or delete an image.

Notes:

- You can add up to 10 images.
- When enabled, the status icons appear on the screen saver only when there are errors, warnings, or cloud-based notifications.

- 2 Apply the changes.

Changing the wallpaper image

- 1 From the home screen, touch **Change Wallpaper**.
- 2 Select an image to use.
- 3 Apply the changes.

Running a slide show from a flash drive

- 1 Insert a flash drive into the USB port.
- 2 From the home screen, touch **Slideshow**.
Images appear in alphabetical order.

Note: You can remove the flash drive after the slide show starts, but the images are not stored in the printer. If the slide show stops, then insert the flash drive again to view the images.

Configuring Eco-Settings

- 1 From the home screen, touch **Eco-Settings**.
- 2 Configure Eco-Mode or Schedule Power Modes.
- 3 Apply the changes.

Creating a Cloud Connector profile

We recommend logging in to the printer before you create a profile. To enable a login method, see the *Embedded Web Server - Security Admin Guide*.

- 1 From the home screen, touch **Cloud Connector**.
- 2 Select a cloud service provider.
- 3 Touch **Create a Profile** or .
- 4 Type a unique profile name.
- 5 If necessary, enter a PIN.
Note: When using the printer as guest, protect the profile with a PIN.
- 6 Touch **Create**, and then take note of the authorization code.
Note: The authorization code is valid only for 24 hours.
- 7 Open a web browser, and then go to <https://lexmark.cloud-connect.co>.
- 8 Click **Next**, and then accept the Terms of Use.
- 9 Enter the authorization code, and then click **Connect**.
- 10 Log in to your cloud service provider account.
- 11 Grant permissions.

Note: To complete the authorization process, open the profile within 72 hours.

Setting up Device Quotas

You may need administrative rights to access the application.

- 1 Open a Web browser, and then type the printer IP address in the address field.

Notes:

- View the printer IP address on the printer home screen. The IP address appears as four sets of numbers separated by periods, such as 123.123.123.123.
- If you are using a proxy server, then temporarily disable it to load the Web page correctly.

- 2 Click **Apps > Device Quotas > Configure**.
- 3 From the User Accounts section, add or edit a user, and then set the user quota.
- 4 Apply the changes.

Note: For information on how to configure the application and its security settings, see the *Device Quotas Administrator's Guide*.

Using QR Code Generator

You may need administrative rights to access the application.

- 1 Open a Web browser, and then type the printer IP address in the address field.

Notes:

- View the printer IP address on the printer home screen. The IP address appears as four sets of numbers separated by periods, such as 123.123.123.123.
- If you are using a proxy server, then temporarily disable it to load the Web page correctly.

- 2 Click **Apps > QR Code Generator > Configure**.

- 3 Do either of the following:

- Select a default QR code value.
- Type a QR code value.

- 4 Apply the changes.

Using Customer Support

- 1 From the home screen, touch **Customer Support**.

- 2 Print or e-mail the information.

Note: For information on configuring the application settings, see the *Customer Support Administrator's Guide*.

Managing bookmarks

Creating bookmarks

Use bookmarks to print frequently accessed documents that are stored in servers or on the web.

- 1 Open a web browser, and then type the printer IP address in the address field.

Notes:

- View the printer IP address on the printer home screen. The IP address appears as four sets of numbers separated by periods, such as 123.123.123.123.
- If you are using a proxy server, then temporarily disable it to load the web page correctly.

- 2 Click **Bookmark Setup > Add Bookmark**, and then type a unique name for the bookmark.

3 Select an Address protocol type, and then do one of the following:

- For HTTP and HTTPS, type the URL that you want to bookmark.
- For HTTPS, make sure to use the host name instead of the IP address. For example, type **myWebsite.com/sample.pdf** instead of typing **123.123.123.123/sample.pdf**. Make sure that the host name also matches the Common Name (CN) value in the server certificate. For more information on obtaining the CN value in the server certificate, see the help information for your web browser.
- For FTP, type the FTP address. For example, **myServer/myDirectory**. Enter the FTP port. Port 21 is the default port for sending commands.
- For SMB, type the network folder address. For example, **myServer/myShare/myFile.pdf**. Type the network domain name.
- If necessary, select the Authentication type for FTP and SMB.

To limit access to the bookmark, enter a PIN.

Note: The application supports the following file types: PDF, JPEG, TIFF, and HTML-based web pages. Other file types such as DOCX and XLXS are supported in some printer models.

4 Click **Save**.

Note: To manage bookmarks, click **Bookmark Setup**.

Creating folders

1 Open a web browser, and then type the printer IP address in the address field.

Notes:

- View the printer IP address on the printer home screen. The IP address appears as four sets of numbers separated by periods, such as 123.123.123.123.
- If you are using a proxy server, then temporarily disable it to load the web page correctly.

2 Click **Bookmark Setup > Add Folder**, and then type a unique name for the folder.

Note: To limit access to the folder, enter a PIN.

3 Click **Save**.

Notes:

- You can create folders or bookmarks inside a folder. To create a bookmark, see [“Creating bookmarks” on page 20](#).
- To manage folders, click **Bookmark Setup**.

Managing contacts

Adding contacts

1 Open a web browser, and then type the printer IP address in the address field.

Notes:

- View the printer IP address on the printer home screen. The IP address appears as four sets of numbers separated by periods, such as 123.123.123.123.

- If you are using a proxy server, then temporarily disable it to load the web page correctly.

2 Click **Address Book**.

3 From the Contacts section, add a contact.

Note: You can assign the contact to one or more groups.

4 If necessary, specify a login method to allow application access.

5 Apply the changes.

Adding groups

1 Open a web browser, and then type the printer IP address in the address field.

Notes:

- View the printer IP address on the printer home screen. The IP address appears as four sets of numbers separated by periods, such as 123.123.123.123.
- If you are using a proxy server, then temporarily disable it to load the web page correctly.

2 Click **Address Book**.

3 From the Contact Groups section, add a group name.

Note: You can assign one or more contacts to the group.

4 Apply the changes.

Editing contacts or groups

1 Open a web browser, and then type the printer IP address in the address field.

Notes:

- View the printer IP address on the printer home screen. The IP address appears as four sets of numbers separated by periods, such as 123.123.123.123.
- If you are using a proxy server, then temporarily disable it to load the web page correctly.

2 Click **Address Book**.

3 Do either of the following:

- From the Contacts section, click a contact name, and then edit the information.
- From the Contact Groups section, click a group name, and then edit the information.

4 Apply the changes.

Deleting contacts or groups

1 Open a web browser, and then type the printer IP address in the address field.

Notes:

- View the printer IP address on the printer home screen. The IP address appears as four sets of numbers separated by periods, such as 123.123.123.123.

- If you are using a proxy server, then temporarily disable it to load the web page correctly.

2 Click **Address Book**.

3 Do either of the following:

- From the Contacts section, select a contact that you want to delete.
- From the Contact Groups section, select a group name that you want to delete.

Setting up and using the accessibility features

Notes:

- These features are supported only in some printer models.
- For more information on the accessibility features of your printer model, see the Accessibility Guide at <http://support.lexmark.com>.

Activating Voice Guidance

From the control panel

- 1 Press and hold the **5** key until you hear a voice message.
- 2 Select **OK**.

From the keyboard

- 1 Press and hold the **5** key until you hear a voice message.
- 2 Press **Tab** to navigate the focus cursor to the OK button, and then press **Enter**.

Notes:

- Voice Guidance is also activated when you insert headphones into the headphone jack.
- To adjust the volume, use the volume buttons at the bottom part of the control panel.

Navigating the screen using gestures

Notes:

- The gestures are applicable only when Voice Guidance is activated.
- Enable Magnification to use the zoom and pan gestures.
- Use a physical keyboard to type characters and adjust certain settings.

| Gesture | Function |
|---------------------------|--|
| Double-tap | Select an option or item on the screen. |
| Triple-tap | Zoom in or zoom out text and images. |
| Swipe right or swipe down | Move to the next item on the screen. |
| Swipe left or swipe up | Move to the previous item on the screen. |
| Pan | Access parts of the zoomed image that are beyond the limits of the screen. Note: This gesture requires the use of two fingers to drag across a zoomed image. |
| Swipe up then left | Exit an application and return to the home screen. |

| Gesture | Function |
|----------------------|--|
| Swipe down then left | <ul style="list-style-type: none">• Cancel a job.• Go back to the previous setting.• Exit the screen that appears without changing any setting or value. |
| Swipe up then down | Repeat a spoken prompt. |

Enabling Magnification mode

- 1 From the control panel, press and hold the **5** key until you hear a voice message.
- 2 Select **Magnification mode**.
- 3 Select **OK**.

For more information on navigating a magnified screen, see [“Navigating the screen using gestures” on page 24](#).

Adjusting the Voice Guidance speech rate

- 1 From the home screen, select **Settings > Device > Accessibility > Speech Rate**.
- 2 Select the speech rate.

Using the keyboard on the display

Do one or more of the following:

- Drag a finger over the key to announce the character.
- Lift the finger to enter or type the character in the field.
- Select **Backspace** to delete characters.
- To hear the content in the input field, select **Tab**, and then select **Shift + Tab**.

Enabling spoken passwords or personal identification numbers

- 1 From the home screen, select **Settings > Device > Accessibility > Speak Passwords/PINs**.
- 2 Enable the setting.

Loading paper and specialty media

Setting the paper size and type

- 1 From the control panel, navigate to:

Settings > Paper > Tray Configuration > Paper Size/Type > select a paper source

For non-touch-screen printer models, press  to navigate through the settings.

- 2 Set the paper size and type.

Configuring Universal paper settings

- 1 From the control panel, navigate to:

Settings > Paper > Media Configuration > Universal Setup

For non-touch-screen printer models, press  to navigate through the settings.

- 2 Configure the settings.

Loading trays



CAUTION—TIPPING HAZARD: To reduce the risk of equipment instability, load each tray separately. Keep all other trays closed until needed.

- 1 Remove the tray.

Note: To avoid paper jams, do not remove trays while the printer is busy.



- 2 Adjust the guides to match the size of the paper that you are loading.

Note: Use the indicators on the bottom of the tray to position the guides.

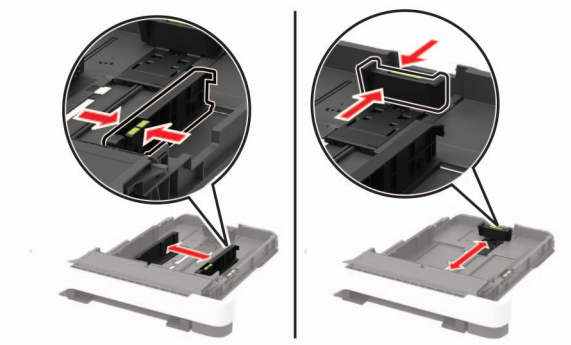

3 Flex, fan, and align the paper edges before loading.

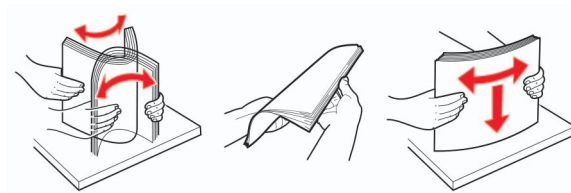

4 Load the paper stack with the printable side faceup, and then make sure that the side guides fit snugly against the paper.



Notes:

- Load letterhead faceup with the header toward the front of the tray for one-sided printing.
- Load letterhead facedown with the header toward the back of the tray for two-sided printing.
- Do not slide paper into the tray.
- To avoid paper jams, make sure that the stack height is below the maximum paper fill indicator.

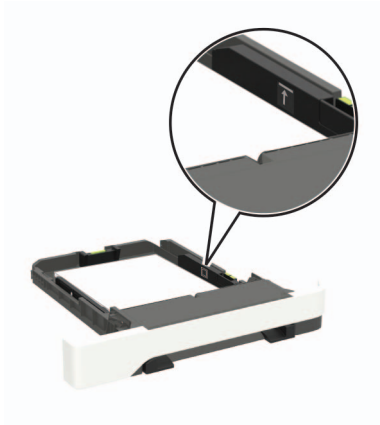

5 Insert the tray.

If necessary, set the paper size and paper type from the control panel to match the paper loaded.

Loading the multipurpose feeder

1 Open the multipurpose feeder.

Note: The multipurpose feeder is available only in some printer models.



2 Adjust the guide to match the size of the paper that you are loading.



3 Flex, fan, and align the paper edges before loading.

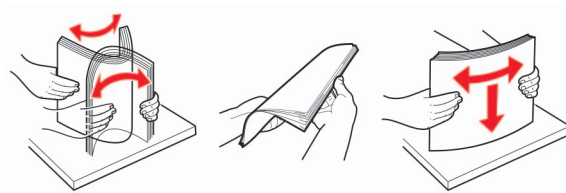

4 Load paper with the printable side facedown.

- Load letterhead with the printable side facedown and the top edge entering the printer first for one-sided printing.



- Load letterhead with the printable side faceup and the top edge entering the printer last for two-sided printing.



- Load envelopes with the flap side up and against the right side of the paper guide.

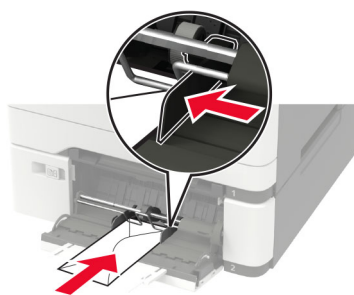

Warning—Potential Damage: Do not use envelopes with stamps, clasps, snaps, windows, coated linings, or self-stick adhesives.

5 From the control panel, set the paper size and paper type to match the paper loaded.

Loading the manual feeder

- 1 Adjust the guide to match the size of the paper that you are loading.

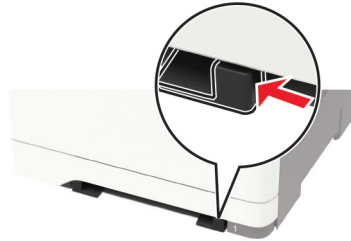

- 2 Load a sheet of paper with the printable side facedown.

- Load letterhead with the printable side facedown and the top edge entering the printer first for one-sided printing.



- Load letterhead with the printable side faceup and the top edge entering the printer last for two-sided printing.



- Load envelope with the flap side up and against the right side of the paper guide.

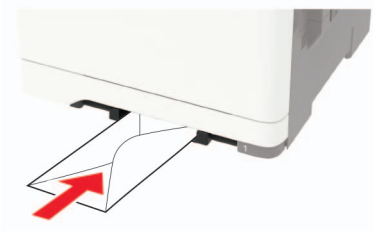

- 3 Feed the paper until its leading edge gets pulled in.

Warning—Potential Damage: To avoid paper jams, do not force paper into the manual feeder.

Adjusting the paper stop in the standard bin

- 1 Raise the paper stop.
- 2 Adjust the paper stop to match the size of the paper that you loaded in the tray.

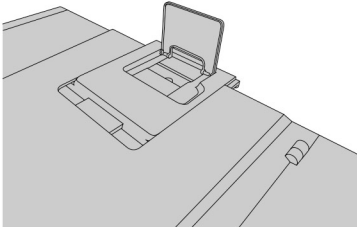
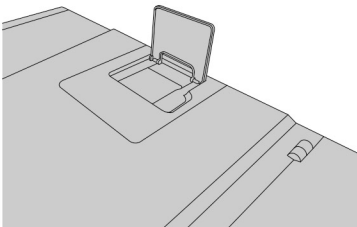
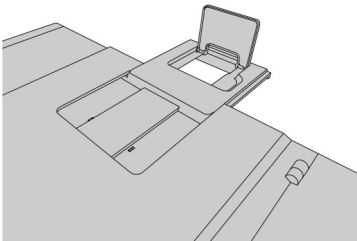
| Paper size and dimension | Paper stop position |
|--|--|
| A4 210 x 297 mm (8.27 x 11.7 in.) |  |
| Letter 215.9 x 279.4 mm (8.5 x 11 in.) |  |
| Legal 215.9 x 355.6 mm (8.5 x 14 in.) |  |

Linking trays

- 1 Open a web browser, and then type the printer IP address in the address field.

Notes:

- View the printer IP address on the printer home screen. The IP address appears as four sets of numbers separated by periods, such as 123.123.123.123.
- If you are using a proxy server, then temporarily disable it to load the web page correctly.

- 2 Click **Settings** > **Paper** > **Tray Configuration**.
- 3 Set the same paper size and paper type for the trays that you are linking.
- 4 Save the settings.
- 5 Click **Settings** > **Device** > **Maintenance** > **Configuration Menu** > **Tray Configuration**.
- 6 Set Tray Linking to **Automatic**.
- 7 Save the settings.

To unlink trays, make sure that no trays have the same paper size and paper type settings.

Warning—Potential Damage: The temperature of the fuser varies according to the specified paper type. To avoid printing issues, match the paper type setting in the printer with the paper loaded in the tray.

Paper support

Supported paper sizes

Note: Your printer model may have a 650-sheet duo tray, which consists of a 550-sheet tray and an integrated 100-sheet multipurpose feeder. The 550-sheet tray of the 650-sheet duo tray supports the same paper sizes as the optional 550-sheet tray. The integrated multipurpose feeder supports different paper sizes, types, and weights.

| Paper size and dimension | Standard 250-sheet tray | Manual feeder | Optional 650-sheet duo tray | | Optional 550-sheet tray | Two-sided printing |
|--|-------------------------|---------------|-----------------------------|---------------------|-------------------------|--------------------|
| | | | 550-sheet tray | Multipurpose feeder | | |
| A4 210 x 297 mm (8.27 x 11.7 in.) | ✓ | ✓ | ✓ | ✓ | ✓ | ✓ |
| A5^{1,2} 148 x 210 mm (5.83 x 8.27 in.) | ✓ | ✓ | ✓ | ✓ | ✓ | ✗ |
| A6 105 x 148 mm (4.13 x 5.83 in.) | ✓ | ✓ | ✗ | ✓ | ✗ | ✗ |
| JIS B5 182 x 257 mm (7.17 x 10.1 in.) | ✓ | ✓ | ✓ | ✓ | ✓ | ✗ |
| Letter 215.9 x 279.4 mm (8.5 x 11 in.) | ✓ | ✓ | ✓ | ✓ | ✓ | ✓ |
| Legal 215.9 x 355.6 mm (8.5 x 14 in.) | ✓ | ✓ | ✓ | ✓ | ✓ | ✓ |
| Executive 184.2 x 266.7 mm (7.25 x 10.5 in.) | ✓ | ✓ | ✓ | ✓ | ✓ | ✗ |
| Oficio (Mexico) 215.9 x 340.4 mm (8.5 x 13.4 in.) | ✓ | ✓ | ✓ | ✓ | ✓ | ✓ |

¹ Load this paper size into tray 1 and the manual feeder with the long edge entering the printer first.

² Load this paper size into tray 2, tray 3, and the multipurpose feeder with the short edge entering the printer first.

³ When Universal is selected, the page is formatted for 215.9 x 355.6 mm (8.5 x 14 in.) unless the size is specified by the software application.

⁴ Load narrow paper with the short edge entering the printer first.

⁵ When Other Envelope is selected, the page is formatted for 215.9 x 355.6 mm (8.5 x 14 in.) unless the size is specified by the software application.

| Paper size and dimension | Standard 250-sheet tray | Manual feeder | Optional 650-sheet duo tray | | Optional 550-sheet tray | Two-sided printing |
|---|-------------------------|---------------|-----------------------------|---------------------|-------------------------|--------------------|
| | | | 550-sheet tray | Multipurpose feeder | | |
| Folio 215.9 x 330.2 mm (8.5 x 13 in.) | ✓ | ✓ | ✓ | ✓ | ✓ | ✓ |
| Statement 139.7 x 215.9 mm (5.5 x 8.5 in.) | ✓ | ✓ | ✗ | ✓ | ✗ | ✗ |
| Hagaki 100 x 148 mm (3.94 x 5.83 in.) | ✓ | ✓ | ✗ | ✓ | ✗ | ✗ |
| Universal ^{3,4} 98.4 x 148 mm to 215.9 x 355.6 mm (3.87 x 5.83 in. to 8.5 x 14 in.) | ✓ | ✓ | ✗ | ✓ | ✗ | ✗ |
| Universal ^{3,4} 76.2 x 127 mm to 215.9 x 355.6 mm (3 x 5 in. to 8.5 x 14 in.) | ✗ | ✓ | ✗ | ✓ | ✗ | ✗ |
| Universal ^{3,4} 148 x 210 mm to 215.9 x 355.6 mm (5.83 x 8.27 in. to 8.5 x 14 in.) | ✓ | ✓ | ✓ | ✓ | ✓ | ✗ |
| Universal ^{3,4} 210 x 250 mm to 215.9 x 355.6 mm (8.27 x 9.84 in. to 8.5 x 14 in.) | ✓ | ✓ | ✓ | ✓ | ✓ | ✓ |
| 7 3/4 Envelope 98.4 x 190.5 mm (3.875 x 7.5 in.) | ✓ | ✓ | ✗ | ✓ | ✗ | ✗ |
| 9 Envelope 98.4 x 225.4 mm (3.875 x 8.9 in.) | ✓ | ✓ | ✗ | ✓ | ✗ | ✗ |

¹ Load this paper size into tray 1 and the manual feeder with the long edge entering the printer first.

² Load this paper size into tray 2, tray 3, and the multipurpose feeder with the short edge entering the printer first.

³ When Universal is selected, the page is formatted for 215.9 x 355.6 mm (8.5 x 14 in.) unless the size is specified by the software application.

⁴ Load narrow paper with the short edge entering the printer first.

⁵ When Other Envelope is selected, the page is formatted for 215.9 x 355.6 mm (8.5 x 14 in.) unless the size is specified by the software application.

| Paper size and dimension | Standard 250-sheet tray | Manual feeder | Optional 650-sheet duo tray | | Optional 550-sheet tray | Two-sided printing |
|--|-------------------------|---------------|-----------------------------|---------------------|-------------------------|--------------------|
| | | | 550-sheet tray | Multipurpose feeder | | |
| 10 Envelope 104.8 x 241.3 mm (4.12 x 9.5 in.) | ✓ | ✓ | X | ✓ | X | X |
| DL Envelope 110 x 220 mm (4.33 x 8.66 in.) | ✓ | ✓ | X | ✓ | X | X |
| C5 Envelope 162 x 229 mm (6.38 x 9.01 in.) | ✓ | ✓ | X | ✓ | X | X |
| B5 Envelope 176 x 250 mm (6.93 x 9.84 in.) | ✓ | ✓ | X | ✓ | X | X |
| Monarch 98.425 x 190.5 mm (3.875 x 7.5 in.) | ✓ | ✓ | X | ✓ | X | X |
| Other Envelope⁵ 98.4 x 162 mm to 176 x 250 mm (3.87 x 6.38 in. to 6.93 x 9.84 in.) | ✓ | ✓ | X | ✓ | X | X |

¹ Load this paper size into tray 1 and the manual feeder with the long edge entering the printer first.

² Load this paper size into tray 2, tray 3, and the multipurpose feeder with the short edge entering the printer first.

³ When Universal is selected, the page is formatted for 215.9 x 355.6 mm (8.5 x 14 in.) unless the size is specified by the software application.

⁴ Load narrow paper with the short edge entering the printer first.

⁵ When Other Envelope is selected, the page is formatted for 215.9 x 355.6 mm (8.5 x 14 in.) unless the size is specified by the software application.

Supported paper types

Notes:

- Your printer model may have a 650-sheet duo tray, which consists of a 550-sheet tray and an integrated 100-sheet multipurpose feeder. The 550-sheet tray of the 650-sheet duo tray supports the same paper types as the 550-sheet tray. The integrated multipurpose feeder supports different paper sizes, types, and weights.
- Labels, envelopes, and card stock always print at 25 pages per minute.

| Paper type | Standard 250-sheet tray | Manual feeder | Optional 650-sheet duo tray | | Optional 550-sheet tray | Two-sided printing |
|--------------|-------------------------|---------------|-----------------------------|---------------------|-------------------------|--------------------|
| | | | 550-sheet tray | Multipurpose feeder | | |
| Plain paper | ✓ | ✓ | ✓ | ✓ | ✓ | ✓ |
| Card stock | ✓ | ✓ | ✓ | ✓ | ✓ | ✗ |
| Envelopes | ✓ | ✓ | ✗ | ✓ | ✗ | ✗ |
| Paper labels | ✓ | ✓ | ✓ | ✓ | ✓ | ✓ |
| Vinyl labels | ✓ | ✓ | ✓ | ✓ | ✓ | ✗ |

Supported paper weights

Notes:

- Your printer model may have a 650-sheet duo tray, which consists of a 550-sheet tray and an integrated 100-sheet multipurpose feeder. The 550-sheet tray of the 650-sheet duo tray supports the same paper types as the 550-sheet tray. The integrated multipurpose feeder supports different paper sizes, types, and weights.
- Labels, envelopes, and card stock always print at 25 pages per minute.

| Paper type and weight | Standard 250-sheet tray | Manual feeder | Optional 650-sheet duo tray | | Optional 550-sheet tray | Two-sided printing |
|--|-------------------------|---------------|-----------------------------|---------------------|-------------------------|--------------------|
| | | | 550-sheet tray | Multipurpose feeder | | |
| Light paper¹ 60–74.9 g/m ² grain long (16– 19.9-lb bond) | ✓ | ✓ | ✓ | ✓ | ✓ | ✓ |
| Plain paper 75–90.3 g/m ² grain long (20– 24-lb bond) | ✓ | ✓ | ✓ | ✓ | ✓ | ✓ |
| Heavy paper 90.3–105 g/m ² grain long (24.1– 28-lb bond) | ✓ | ✓ | ✓ | ✓ | ✓ | ✓ |

¹ Paper less than 75 g/m² (20 lb) must be printed with Paper Type set to Light Paper. Failure to do so may cause excessive curl which can lead to feeding errors, especially in more humid environments.

² Labels and other specialty media are supported for occasional use and must be tested for acceptability.

³ Paper labels up to 105 g/m² (28-lb bond) are supported.

⁴ 100% cotton content maximum weight is 24-lb bond.

⁵ 28-lb bond envelopes are limited to 25% cotton content.

| Paper type and weight | Standard 250-sheet tray | Manual feeder | Optional 650-sheet duo tray | | Optional 550-sheet tray | Two-sided printing |
|---|-------------------------|---------------|-----------------------------|---------------------|-------------------------|--------------------|
| | | | 550-sheet tray | Multipurpose feeder | | |
| Card stock 105.1–162 g/m ² grain long (28.1– 43-lb bond) | ✓ | ✓ | ✓ | ✓ | ✓ | X |
| Card stock 105.1–200 g/m ² grain long (28.1– 53-lb bond) | ✓ | ✓ | X | X | X | X |
| Paper Labels² 131 g/m ² (35-lb bond) | ✓ | ✓ | ✓ | ✓ | ✓ | ✓ ³ |
| Vinyl Labels² 131 g/m ² (35-lb bond) | ✓ | ✓ | ✓ | ✓ | ✓ | X |
| Envelopes^{4,5} 60–105 g/m ² (16– 28-lb bond) | ✓ | ✓ | X | ✓ | X | X |

¹ Paper less than 75 g/m² (20 lb) must be printed with Paper Type set to Light Paper. Failure to do so may cause excessive curl which can lead to feeding errors, especially in more humid environments.

² Labels and other specialty media are supported for occasional use and must be tested for acceptability.

³ Paper labels up to 105 g/m² (28-lb bond) are supported.

⁴ 100% cotton content maximum weight is 24-lb bond.

⁵ 28-lb bond envelopes are limited to 25% cotton content.

Printing

Printing from a computer

Note: For labels, card stock, and envelopes, set the paper size and type in the printer before printing the document.

- 1 From the document that you are trying to print, open the Print dialog.
- 2 If necessary, adjust the settings.
- 3 Print the document.

Printing from a mobile device

Printing from a mobile device using Lexmark Mobile Print

Lexmark™ Mobile Print allows you to send documents and images directly to a supported Lexmark printer.

- 1 Open the document, and then send or share the document to Lexmark Mobile Print.

Note: Some third-party applications may not support the send or share feature. For more information, see the documentation that came with the application.

- 2 Select a printer.
- 3 Print the document.

Printing from a mobile device using Google Cloud Print

Google Cloud Print™ is a mobile printing service that allows enabled applications on mobile devices to print to any Google Cloud Print-ready printer.

- 1 From the home screen of your mobile device, launch an enabled application.
- 2 Tap **Print**, and then select a printer.
- 3 Print the document.

Printing from a mobile device using Mopria Print Service

Mopria® Print Service is a mobile printing solution for mobile devices running on Android™ version 4.4 or later. It allows you to print directly to any Mopria-certified printer.

Note: Before printing, make sure that the Mopria Print Service is enabled.

- 1 From the home screen of your mobile device, launch a compatible application.
- 2 Tap **Print**, and then select the printer.
- 3 Send the print job.

Printing from a mobile device using AirPrint

AirPrint is a mobile printing solution that allows you to print directly from Apple devices to an AirPrint-certified printer.

Notes:



- This application is supported only in some Apple devices.
- This application is supported only in some printer models.

- 1 From the home screen of your mobile device, launch a compatible application.
- 2 Select an item to print, and then tap the share icon.
- 3 Tap **Print**, and then select a printer.
- 4 Print the document.

Printing from a mobile device using Wi-Fi Direct®

Wi-Fi Direct® is a printing service that lets you print to any Wi-Fi Direct-ready printer.

Note: Make sure that the mobile device is connected to the printer wireless network. For more information, see [“Connecting a mobile device to the printer wireless network” on page 95](#).

- 1 From your mobile device, launch a compatible application or select a document from your file manager.
- 2 Depending on your mobile device, do one of the following:
 - Tap  > **Print**.
 - Tap  > **Print**.
 - Tap  > **Print**.
- 3 Select a printer, and then adjust the settings, if necessary.
- 4 Print the document.

Printing from a flash drive

This feature is available only in some printer models.

- 1 Insert the flash drive.



Notes:

- If you insert the flash drive when an error message appears, then the printer ignores the flash drive.
- If you insert the flash drive while the printer is processing other print jobs, then **Busy** appears on the display.

- 2 Select the document that you want to print.

If necessary, configure other print settings.

- 3 Print the document.

To print another document, select **USB Drive**.

Warning—Potential Damage: To avoid loss of data or printer malfunction, do not touch the flash drive or the printer in the area shown while actively printing, reading, or writing from the memory device.



Supported flash drives and file types

Flash drives

- Lexar JumpDrive S70 (16GB and 32GB)
- SanDisk Cruzer (16GB and 32GB)
- PNY Attache (16GB and 32GB)

Notes:

- The printer supports high-speed USB flash drives with full-speed standard.
- USB flash drives must support the File Allocation Table (FAT) system.

File types

Documents

- PDF (version 1.7 or earlier)
- XPS
- Microsoft file formats (.doc, .docx, .xls, .xlsx, .ppt, .pptx) are supported only in some printer models.

Images

- .dcm
- .gif
- .JPEG or .jpg
- .bmp
- .pcx
- .TIFF or .tif
- .png

Configuring confidential jobs

1 From the control panel, navigate to:

Settings > Security > Confidential Print Setup

For non-touch-screen printer models, press  to navigate through the settings.

In some printer models, access the setting from the Embedded Web Server.

2 Configure the settings.

| Use | To |
|-----------------------------|--|
| Max Invalid PIN | Set the number of times an invalid PIN can be entered. Note: When the limit is reached, the print jobs for that user name are deleted. |
| Confidential Job Expiration | Set the expiration time for confidential print jobs. Note: Confidential held jobs are stored in the printer until they are released or deleted manually. |
| Repeat Job Expiration | Set the expiration time for a repeat print job. Note: Repeat held jobs are stored in the printer memory for reprinting. |

| Use | To |
|-----------------------------|--|
| Verify Job Expiration | Set the expiration time that the printer prints a copy before printing the remaining copies. Note: Verify jobs print one copy to check if it is satisfactory before printing the remaining copies. |
| Reserve Job Expiration | Set the expiration time that the printer stores print jobs. Note: Reserve held jobs are automatically deleted after printing. |
| Require All Jobs to be Held | Set the printer to hold all print jobs. |

Printing confidential and other held jobs

For Windows users

- 1 With a document open, click **File > Print**.
- 2 Click **Properties, Preferences, Options,** or **Setup**.
- 3 Click **Print and Hold**.
- 4 Select **Use Print and Hold**, and then assign a user name.
- 5 Select the print job type (Confidential, Repeat, Reserve, or Verify).
If the print job is confidential, then enter a four-digit PIN.
- 6 Click **OK** or **Print**.
- 7 From the printer home screen, release the print job.
 - For confidential print jobs, navigate to:
Held jobs > select your user name > **Confidential** > enter the PIN > select the print job > configure the settings > **Print**
 - For other print jobs, navigate to:
Held jobs > select your user name > select the print job > configure the settings > **Print**

For Macintosh users

- 1 With a document open, choose **File > Print**.
If necessary, click the disclosure triangle to see more options.
- 2 From the print options or Copies & Pages menu, choose **Job Routing**.
- 3 Select the print job type (Confidential, Repeat, Reserve, or Verify).
If the print job is confidential, then assign a user name and a four-digit PIN.
- 4 Click **OK** or **Print**.

- 5 From the printer home screen, release the print job.
 - For confidential print jobs, navigate to:
Held jobs > select your user name > **Confidential** > enter the PIN > select the print job > configure the settings > **Print**
 - For other print jobs, navigate to:
Held jobs > select your user name > select the print job > configure the settings > **Print**

Printing from a Cloud Connector profile

- 1 From the home screen, touch **Cloud Connector**.
- 2 Select a cloud service provider, and then select a profile.
Note: For more information on creating a Cloud Connector profile, see [“Creating a Cloud Connector profile” on page 19](#).
- 3 Select a file.
Note: You cannot select an unsupported file.
- 4 If necessary, change the settings.
- 5 Touch **Print**.

Printing a font sample list

- 1 From the control panel, navigate to:
Settings > **Reports** > **Print** > **Print Fonts**

For non-touch-screen printer models, press  to navigate through the settings.
- 2 Select a font sample.

Printing a directory list

From the control panel, navigate to:

Settings > **Reports** > **Print** > **Print Directory**

For non-touch-screen printer models, press  to navigate through the settings.

Understanding the printer menus

Menu map

| | | |
|-----------------------------------|---|--|
| Device | <ul style="list-style-type: none"> • Preferences • Remote Operator Panel • Notifications • Power Management • Information Sent to Lexmark | <ul style="list-style-type: none"> • Accessibility • Restore Factory Defaults • Maintenance • Visible Home Screen Icons • About This Printer |
| Print | <ul style="list-style-type: none"> • Layout • Setup • Quality • Job Accounting • XPS | <ul style="list-style-type: none"> • PDF • PostScript • PCL • HTML • Image |
| Paper | <ul style="list-style-type: none"> • Tray Configuration | <ul style="list-style-type: none"> • Media Configuration |
| USB Drive | Flash Drive Print | |
| Network/Ports | <ul style="list-style-type: none"> • Network Overview • Wireless • Ethernet • TCP/IP • SNMP • IPSec • 802.1x | <ul style="list-style-type: none"> • LPD Configuration • HTTP/FTP Settings • ThinPrint • USB • Google Cloud Print • Wi-Fi Direct |
| Security ¹ | <ul style="list-style-type: none"> • Login Methods • Schedule USB Devices • Security Audit Log • Login Restrictions • Confidential Print Setup | <ul style="list-style-type: none"> • Disk Encryption • Erase Temporary Data Files • Solutions LDAP Settings • Mobile Services Management • Miscellaneous |
| Reports | <ul style="list-style-type: none"> • Menu Settings Page • Device | <ul style="list-style-type: none"> • Print • Network |
| Help ² | <ul style="list-style-type: none"> • Print All Guides • Color Quality Guide • Connection Guide • Information Guide • Media Guide | <ul style="list-style-type: none"> • Moving Guide • Print Quality Guide • Scan Guide • Supplies Guide |
| Troubleshooting | Print Quality Test Pages | |

¹ In some printer models, this menu can be configured only from the Embedded Web Server.

² This menu is available only in some printer models.

Device

Preferences

| Menu item | Description |
|---|--|
| Display Language [List of languages] | Set the language of the text that appears on the display. |
| Country/Region [List of countries or regions] | Identify the country or region where the printer is configured to operate. |
| Run initial setup Off* On | Run the setup wizard. |
| Keyboard Keyboard Type [List of languages] | Select a language as a keyboard type. Notes: <ul style="list-style-type: none"> All the Keyboard Type values may not appear or may require special hardware to appear. This menu item appears only in some printer models. |
| Displayed information Display Text 1 [IP Address*] Display Text 2 [Date/Time*] Custom Text 1 Custom Text 2 | Specify the information to appear on the home screen. Note: Custom Text 1 and Custom Text 2 appear only in some printer models. |
| Date and Time Configure Current Date and Time Manually Set Date and Time Date Format [MM-DD-YYYY*] Time Format [12 hour A.M./P.M.*] Time Zone [GMT*] | Configure the printer date and time. |
| Date and Time Network Time Protocol Enable NTP [On*] NTP Server Enable Authentication | Configure the settings for Network Time Protocol (NTP). Notes: <ul style="list-style-type: none"> Enable Authentication appears only in some printer models. When Enable Authentication is set to MD5 key, Key ID and Password appear. |
| Paper Sizes U.S.* Metric | Specify the unit of measurement for paper sizes. Note: The country or region selected in the initial setup wizard determines the initial paper size setting. |
| Screen Brightness 20–100% (100*) | Adjust the brightness of the display. Note: This menu item appears only in some printer models. |
| Note: An asterisk (*) next to a value indicates the factory default setting. | |

| Menu item | Description |
|---|---|
| Flash Drive Access Enabled* Disabled | Enable access to the flash drive. Note: This menu item appears only in some printer models. |
| Screen Timeout 5–300 (60*) | Set the idle time in seconds before the display shows the home screen, or before the printer logs off a user account automatically. |
| Note: An asterisk (*) next to a value indicates the factory default setting. | |

Remote Operator Panel

| Menu item | Description |
|---|--|
| External VNC Connection Don't Allow* Allow | Connect an external Virtual Network Computing (VNC) client to the remote control panel. |
| Authentication Type None* Standard Authentication | Set the authentication type when accessing the VNC client server. Note: When set to Standard Authentication, VNC Password appears. |
| Note: An asterisk (*) next to a value indicates the factory default setting. | |

Notifications

| Menu item | Description |
|--|--|
| Error Lighting Off On* | Set the indicator light to come on when a printer error occurs. Note: This menu item appears only in some printer models. |
| Alarm Control Off Single* Continuous | Set the number of times that the alarm sounds when the printer requires user intervention. Note: This menu item appears only in some printer models. |
| Supplies Show Supply Estimates Show estimates* Do not show estimates | Show the estimated status of the supplies. |
| Supplies Cartridge Alarm Off Single* Continuous | Set the number of times that the alarm sounds when the toner cartridge is low. Note: This menu item appears only in some printer models. |
| Note: An asterisk (*) next to a value indicates the factory default setting. | |

| Menu item | Description |
|---|--|
| E-mail Alerts Setup E-mail Setup Primary SMTP Gateway | Type the IP address or host name of the primary SMTP server for sending e-mail. Note: This menu item appears only in some printer models. |
| E-mail Alerts Setup E-mail Setup Primary SMTP Gateway Port 1–65535 (25*) | Enter the port number of the primary SMTP server. Note: This menu item appears only in some printer models. |
| E-mail Alerts Setup E-mail Setup Secondary SMTP Gateway | Type the server IP address or host name of your secondary or backup SMTP server. Note: This menu item appears only in some printer models. |
| E-mail Alerts Setup E-mail Setup Secondary SMTP Gateway Port 1–65535 (25*) | Enter the server port number of your secondary or backup SMTP server. Note: This menu item appears only in some printer models. |
| E-mail Alerts Setup E-mail Setup SMTP Timeout 5-30 seconds (30*) | Specify how long before the printer times out if the SMTP server does not respond. Note: This menu item appears only in some printer models. |
| E-mail Alerts Setup E-mail Setup Reply Address | Specify a reply address in the e-mail. Note: This menu item appears only in some printer models. |
| E-mail Alerts Setup E-mail Setup Always use SMTP default Reply Address Off* On | Use the SMTP default Reply Address. Note: This menu item appears only in some printer models. |
| E-mail Alerts Setup E-mail Setup Use SSL/TLS Disabled* Negotiate Required | Send an e-mail using an encrypted link. Note: This menu item appears only in some printer models. |
| E-mail Alerts Setup E-mail Setup Require Trusted Certificate On* Off | Require a trusted certificate when accessing the SMTP server. Note: This menu item appears only in some printer models. |
| Note: An asterisk (*) next to a value indicates the factory default setting. | |

| Menu item | Description |
|--|--|
| <p>E-mail Alerts Setup E-mail Setup SMTP Server Authentication No authentication required* Login / Plain NTLM CRAM-MD5 Digest-MD5 Kerberos 5</p> | <p>Set the authentication type for the SMTP server. Note: This menu item appears only in some printer models.</p> |
| <p>E-mail Alerts Setup E-mail Setup Device-Initiated E-mail None* Use Device SMTP Credentials</p> | <p>Set whether credentials are required for device-initiated e-mails. Note: This menu item appears only in some printer models.</p> |
| <p>E-mail Alerts Setup E-mail Setup User-Initiated E-mail None Use Device SMTP Credentials Use Session User ID and Password Use Session E-mail address and Password* Prompt user</p> | <p>Set whether credentials are required for user-initiated e-mails. Note: This menu item appears only in some printer models.</p> |
| <p>E-mail Alerts Setup E-mail Setup Use Active Directory Device Credentials Off On*</p> | <p>Enable user credentials and group designations to connect to the SMTP server. Note: This menu item appears only in some printer models.</p> |
| <p>E-mail Alerts Setup E-mail Setup Device Userid</p> | <p>Specify the user ID to connect to the SMTP server. Note: This menu item appears only in some printer models.</p> |
| <p>E-mail Alerts Setup E-mail Setup Device Password</p> | <p>Specify the password to connect to the SMTP server. Note: This menu item appears only in some printer models.</p> |
| <p>E-mail Alerts Setup E-mail Setup Kerberos 5 REALM</p> | <p>Specify the realm for the Kerberos 5 authentication protocol. Note: This menu item appears only in some printer models.</p> |
| <p>E-mail Alerts Setup E-mail Setup NTLM Domain</p> | <p>Specify the domain name for the NTLM security protocol. Note: This menu item appears only in some printer models.</p> |

Note: An asterisk (*) next to a value indicates the factory default setting.

| Menu item | Description |
|--|--|
| <p>E-mail Alerts Setup E-mail Setup Disable “SMTP server not set up” error Off* No</p> | <p>Disable an SMTP setup error message to appear on the display. Note: This menu item appears only in some printer models.</p> |
| <p>Error Prevention Jam Assist Off On*</p> | <p>Set the printer to flush blank pages or pages with partial prints automatically after a jammed page has been cleared.</p> |
| <p>Error Prevention Auto Continue Off On* (5 seconds)</p> | <p>Let the printer continue processing or printing a job automatically after clearing certain printer conditions that require user intervention.</p> |
| <p>Error Prevention Auto Reboot Auto Reboot Reboot when idle Reboot always* Reboot never</p> | <p>Set the printer to restart when an error occurs.</p> |
| <p>Error Prevention Auto Reboot Max Auto Reboots 1–20 (2*)</p> | <p>Set the number of automatic reboots that the printer can perform.</p> |
| <p>Error Prevention Auto Reboot Auto Reboot Window 1–525600 (720*)</p> | <p>Set the number of seconds before the printer performs an automatic reboot.</p> |
| <p>Error Prevention Auto Reboot Auto Reboot Counter</p> | <p>Show a read-only information of the reboot counter. Note: In some printer models, you can reset the counter.</p> |
| <p>Error Prevention Auto Reboot Reset Auto Reboot Counter Cancel Continue</p> | <p>Reset Auto Reboot Counter. Note: This menu item appears only in some printer models.</p> |
| <p>Error Prevention Display Short Paper Error On Auto-clear*</p> | <p>Set the printer to show a message when a short paper error occurs. Note: Short paper refers to the size of the paper loaded.</p> |
| <p>Note: An asterisk (*) next to a value indicates the factory default setting.</p> | |

| Menu item | Description |
|---|--|
| Error Prevention Page Protect Off* On | Set the printer to process the entire page into the memory before printing it. |
| Jam Content Recovery Jam Recovery Off On Auto* | Set the printer to reprint jammed pages. |
| Note: An asterisk (*) next to a value indicates the factory default setting. | |

Power Management

| Menu item | Description |
|---|---|
| Sleep Mode Profile Print With Display Off Display on when printing Allow printing with display off* | Allow printing with the display turned off. |
| Timeouts Sleep Mode 1–120 minutes (15*) | Set the idle time before the printer begins operating in Sleep mode. |
| Timeouts Hibernate Timeout Disabled 1 hour 2 hours 3 hours 6 hours 1 day 2 days 3 days* 1 week 2 weeks 1 month | Set the time before the printer enters Hibernate mode. |
| Timeouts Hibernate Timeout on Connection Hibernate Do Not Hibernate* | Set the printer to Hibernate mode even when an active Ethernet connection exists. |
| Note: An asterisk (*) next to a value indicates the factory default setting. | |

| Menu item | Description |
|---|---|
| Eco-Mode Off* Energy Energy/Paper Paper | Minimize the use of energy, paper, or specialty media. Note: Setting Eco-Mode to Energy or Paper may affect printer performance, but not print quality. |
| Schedule Power Modes Schedules | Schedule the printer when to enter Sleep or Hibernate mode. Note: This menu item appears only in some printer models. |
| Note: An asterisk (*) next to a value indicates the factory default setting. | |

Information Sent to Lexmark

| Menu item | Description |
|---|---|
| Information Sent to Lexmark Supplies and Page Usage (Anonymous) Device Performance (Anonymous) Device Interaction (Anonymous) None of the Above | Send printer usage and performance information to Lexmark. Notes: <ul style="list-style-type: none"> • Device Performance (Anonymous), Device Interaction (Anonymous), and None of the Above appear only in some printer models. • Information Send Time and User Information - Level appear only when you select any of the settings in Information Sent to Lexmark, except None of the Above. |
| Information Send Time Start Time Stop Time | |
| User Information - Level Anonymous Session Information Only* Session Information with Generic User Information Session Information with Actual User IDs | |

Accessibility

Note: This menu appears only in some printer models.

| Menu item | Description |
|---|---|
| Duplicate Key Strike Interval 0–5 (0*) | Set the interval in seconds during which the printer ignores duplicate key presses on an attached keyboard. |
| Key Repeat Initial Delay 0.25–5 (1*) | Set the initial length of delay in seconds before a repeating key starts repeating. Note: This menu item appears only when a keyboard is attached to the printer. |
| Note: An asterisk (*) next to a value indicates the factory default setting. | |

| Menu item | Description |
|---|--|
| Key Repeat Rate 0.5–30 (30*) | Set the number of presses per second for a repeating key. Note: This menu item appears only when a keyboard is attached to the printer. |
| Prolong Screen Timeout Off* On | Let the user remain in the same location and reset the Screen Timeout timer when it expires instead of returning to the home screen. |
| Headphone Volume 1–10 (5*) | Adjust the headphone volume. Note: This menu item appears only when a headphone is attached to the printer. |
| Enable Voice Guidance When Headphone Is Attached Off* On | Enable Voice Guidance when a headphone is attached to the printer. |
| Speak Passwords/PINs Off* On | Set the printer to read out loud passwords or personal identification numbers. Note: This menu item appears only when a headphone or a speaker is attached to the printer. |
| Speech Rate Very Slow Slow Normal* Fast Faster Very Fast Rapid Very Rapid Fastest | Set the Voice Guidance speech rate. Note: This menu item appears only when a headphone or a speaker is attached to the printer. |
| Note: An asterisk (*) next to a value indicates the factory default setting. | |

Restore Factory Defaults

| Menu item | Description |
|---|---|
| Restore Settings Restore all settings Restore printer settings Restore network settings Restore app settings | Restore the printer factory default settings. Note: Restore app settings appears only in some printer models. |

Maintenance

Configuration Menu

| Menu item | Description |
|---|--|
| USB Configuration USB PnP 1* 2 | Change the USB driver mode of the printer to improve its compatibility with a personal computer. Note: This menu item appears only in some printer models. |
| USB Configuration USB Speed Full Auto* | Set the USB port to run at full speed and disable its high-speed capabilities. Note: This menu item appears only in some printer models. |
| Tray Configuration Tray Linking Automatic* Off | Set the printer to link the trays that have the same paper type and paper size settings. |
| Tray Configuration Show Tray Insert Message Off Only for unknown sizes* Always | Show the Tray Insert message. |
| Tray Configuration Paper Prompts Auto* Multipurpose Feeder Manual Paper | Set the paper source that the user fills when a prompt to load paper appears. Note: The multipurpose feeder is available only in some printer models. |
| Tray Configuration Envelope Prompts Auto* Multipurpose Feeder Manual Envelope | Set the paper source that the user fills when a prompt to load envelope appears. Note: The multipurpose feeder is available only in some printer models. |
| Tray Configuration Action for Prompts Prompt user* Continue Use current | Set the printer to resolve paper- or envelope-related change prompts. |
| Reports Menu Settings Page Event Log Event Log Summary HealthCheck Statistics | Print reports about printer menu settings, status, and event logs. |
| Note: An asterisk (*) next to a value indicates the factory default setting. | |

| Menu item | Description |
|---|---|
| Supply Usage And Counters Clear Supply Usage History | Reset the supply usage history, such as number of pages and days remaining, to the factory shipped level. |
| Supply Usage And Counters Reset Color Imaging Kit Counter | Reset the counter after installing a new color imaging kit. Note: This menu item appears only in some printer models. |
| Supply Usage And Counters Reset Maintenance Counter | Reset the counter after installing a new maintenance kit. |
| Supply Usage And Counters Tiered Coverage Ranges | Adjust the range for the amount of color coverage on the printed page. |
| Printer Emulations PPDS Emulation Off* On | Set the printer to recognize and use the PPDS data stream. |
| Print Configuration Black Only Mode Off* On | Print color content in grayscale. |
| Print Configuration Color Trapping Off 1 2* 3 4 5 | Enhance the printed output to compensate for misregistration in the printer. |
| Print Configuration Font Sharpening 0–150 (24*) | Set a text point-size value below which the high-frequency screens are used when printing font data. For example, if the value is 24, then all fonts sized 24 points or less use the high-frequency screens. |
| Device Operations Quiet Mode Off* On | Set the printer to operate in Quiet Mode. Note: Enabling this setting slows down the printer performance. |
| Device Operations Panel Menus Off On* | Enable access to the control panel menus. |
| Device Operations Custom Supply Levels Off* On | Let <i>printservice</i> read and edit values from the Embedded Web Server. |
| Note: An asterisk (*) next to a value indicates the factory default setting. | |

| Menu item | Description |
|---|---|
| Device Operations Safe Mode Off* On | Set the printer to operate in a special mode, in which it attempts to continue offering as much functionality as possible, despite known issues. For example, when set to On and the duplex motor is nonfunctional, the printer performs one-sided printing for a two-sided print job. |
| Device Operations Clear Custom Status | Erase user-defined strings for the Default or Alternate custom messages. |
| Device Operations Clear all remotely-installed messages | Erase messages that were remotely installed. |
| Device Operations Automatically Display Error Screens Off On* | Show existing error messages on the display after the printer remains inactive on the home screen for a length of time equal to the Screen Timeout setting. |
| Device Operations Enable Optional Parallel Port Off* On | Enable an optional parallel port. Note: When set to On, the printer restarts. |
| Toner patch sensor setup Calibration frequency preference Disabled Fewest color adjustment Fewer color adjustment Normal* Better color accuracy Best color accuracy | Set the printer to put down the correct amount of toner to maintain color consistency. |
| Toner patch sensor setup Full calibration | Run the full color calibration. |
| Toner patch sensor setup Print TPS information page | Print a diagnostic page that contains information on toner patch sensor calibration. |
| App Configuration LES Applications Off On* | Enable the Lexmark Embedded Solutions (LES) applications. Notes: <ul style="list-style-type: none"> • This menu item is available only in some printer models. • When set to On, this setting does not affect built-in applications. |
| Note: An asterisk (*) next to a value indicates the factory default setting. | |

Out of Service Erase

| Menu item | Description |
|--|--|
| Out of Service Erase Memory Last Sanitized Hard Disk Last Sanitized | Show information on when the printer memory or hard disk was last sanitized. Note: Hard Disk Last Sanitized appears only in printers with a hard disk installed. |
| Out of Service Erase Sanitize all information on nonvolatile memory Sanitize all information on hard disk Erase all printer and network settings | Clear all settings and applications that are stored in the printer memory or hard disk. Note: Sanitize all information on hard disk appears only in printers with a hard disk installed. |

Visible Home Screen Icons

Note: This menu appears only in some printer models.

| Menu | Description |
|---|---|
| Status/Supplies Job Queue Change Language Address Book Bookmarks Held Jobs USB App Profiles Display Customization Eco-Settings | Specify which icons to show on the home screen. |

About this Printer

| Menu item | Description |
|---|---|
| Asset Tag¹ | Describe the printer. The maximum length is 32 characters. |
| Printer's Location¹ | Identify the printer location. The maximum length is 63 characters. |
| Contact¹ | Personalize the printer name. The maximum length is 63 characters. |
| Export Configuration File to USB² | Export configuration files to a flash drive. |
| Export Compressed Logs to USB² | Export compressed log files to a flash drive. |
| Send Logs Cancel Send | Send diagnostic information to Lexmark. |

¹ In some printer models, this menu item can be configured only from the Embedded Web Server.

² This menu item appears only in some printer models.

Print

Layout

| Menu item | Description |
|---|--|
| Sides 1-sided* 2-sided | Specify whether to print on one side or two sides of the paper. |
| Flip Style Long Edge* Short Edge | Determine which side of the paper (long edge or short edge) is bound when performing two-sided printing. Note: Depending on the option selected, the printer automatically offsets each printed information of the page to bind the job correctly. |
| Blank Pages Print Do Not Print* | Print blank pages that are included in a print job. |
| Collate Off [1,1,1,2,2,2]* On [1,2,1,2,1,2] | Keep the pages of a print job stacked in sequence, particularly when printing multiple copies of the job. |
| Separator Sheets None* Between Copies Between Jobs Between Pages | Insert blank separator sheets when printing. |
| Separator Sheet Source Tray [x] (1*) Multipurpose Feeder | Specify the paper source for the separator sheet. Note: The multipurpose feeder is available only in some printer models. |
| Pages per Side Off* 2 pages per side 3 pages per side 4 pages per side 6 pages per side 9 pages per side 12 pages per side 16 pages per side | Print multiple page images on one side of a sheet of paper. |
| Pages per Side Ordering Horizontal* Reverse Horizontal Vertical Reverse Vertical | Specify the positioning of multiple page images when using Pages per Side. Note: The positioning depends on the number of page images and their page orientation. |
| Note: An asterisk (*) next to a value indicates the factory default setting. | |

| Menu item | Description |
|---|--|
| Pages per Side Orientation Auto* Landscape Portrait | Specify the orientation of a multiple-page document when using Pages per Side. |
| Pages per Side Border None* Solid | Print a border around each page image when using Pages per Side. |
| Copies 1–9999 (1*) | Specify the number of copies for each print job. |
| Print Area Normal* Fit to page Whole Page | Set the printable area on a sheet of paper. |
| Note: An asterisk (*) next to a value indicates the factory default setting. | |

Setup

| Menu item | Description |
|---|---|
| Printer Language PCL Emulation PS Emulation* | Set the printer language. Note: Setting a printer language default does not prevent a software program from sending print jobs that use another printer language. |
| Job Waiting Off* On | Preserve print jobs requiring supplies so that jobs not requiring the missing supplies can print. Note: This menu item appears only when a printer hard disk is installed. |
| Job Hold Timeout 0–255 (30*) | Set the time in seconds that the printer waits for user intervention before it holds jobs that require unavailable resources and continues to print other jobs in the print queue. Note: This menu item appears only when a printer hard disk is installed. |
| Printer Usage Max Speed Max Yield* | Determine how the color imaging kit operates during printing. Notes: <ul style="list-style-type: none"> • When set to Max Yield, the color imaging kit slows or stops while printing groups of black-only pages. • When set to Max Speed, the color imaging kit always runs while printing, whether color or black pages are being printed. |
| Download Target RAM* Disk | Specify where to save all permanent resources, such as fonts and macros, that have been downloaded to the printer. Note: This menu item appears only when a printer hard disk is installed. |
| Note: An asterisk (*) next to a value indicates the factory default setting. | |

| Menu item | Description |
|---|--|
| Resource Save Off* On | Determine what the printer does with downloaded resources, such as fonts and macros, when it receives a job that requires more than the available memory. Notes: <ul style="list-style-type: none"> When set to Off, the printer retains downloaded resources only until memory is needed. Resources associated with the inactive printer language are deleted. When set to On, the printer preserves all the permanent downloaded resources across all language switches. When necessary, the printer shows memory full messages instead of deleting permanent resources. |
| Print All Order Alphabetical* Newest First Oldest First | Specify the order when you choose to print all held and confidential jobs. Note: This menu item appears only when a printer hard disk is installed. |
| Note: An asterisk (*) next to a value indicates the factory default setting. | |

Quality

| Menu item | Description |
|---|--|
| Print Mode Black and White Color* | Set the print mode. |
| Print Resolution 4800 CQ* 1200 dpi | Set the resolution for the printed output. Note: 4800 CQ provides high-quality output at maximum speed. |
| Toner Darkness 1 to 5 (4*) | Determine the lightness or darkness of text images. |
| Halftone Normal* Detail | Enhance the printed output to have smoother lines with sharper edges. |
| Color Saver Off* On | Reduce the amount of toner used to print graphics and images. |
| RGB Brightness -6 to 6 (0*) | Adjust the brightness, contrast, and saturation for color output. Note: This setting does not affect files where CMYK color specifications are used. |
| RGB Contrast 0 to 5 (0*) | |
| RGB Saturation 0 to 5 (0*) | |
| Note: An asterisk (*) next to a value indicates the factory default setting. | |

Advanced Imaging

| Menu item | Description |
|--|--|
| Color Balance Cyan -5 to 5 (0*) Magenta -5 to 5 (0*) Yellow -5 to 5 (0*) Black -5 to 5 (0*) Reset Defaults | Adjust the amount of toner that is used for each color. |
| Color Correction Off Auto* Manual Color Correction Content | Modify the color settings used to print documents. Notes: <ul style="list-style-type: none"> • Off sets the printer to receive the color correction from the software. • Auto sets the printer to apply different color profiles to each object on the printed page. • Manual allows the customization of the RGB or CMYK color conversions applied to each object on the printed page. • Color Correction Content is available only when Color Correction is set to Manual. |
| Color Samples Print Color Samples | Print sample pages for each of the RGB and CMYK color conversion tables used in the printer. |
| Color Adjust | Calibrate the printer to adjust color variations in the printed output. |
| Spot Color Replacement Set Custom CMYK | Assign specific CMYK values to twenty named spot colors. Note: In some printer models, this menu item can be configured only from the Embedded Web Server. |
| RGB Replacement | Match the colors of the output with the original document. Notes: <ul style="list-style-type: none"> • This menu item requires that you select the Display-True-Black color table. • This menu item appears only in the Embedded Web Server. |
| Note: An asterisk (*) next to a value indicates the factory default setting. | |

Job Accounting

Note: This menu appears only when a printer hard disk is installed.

| Menu item | Description |
|---|---|
| Job Accounting Off* On | Set the printer to create a log of the print jobs that it receives. |
| Note: An asterisk (*) next to a value indicates the factory default setting. | |

| Menu item | Description |
|---|--|
| Accounting Log Frequency Daily Weekly Monthly* | Specify how often the printer creates a log file. |
| Log Action at End of Frequency None* E-mail Current Log E-mail & Delete Current Log Post Current Log Post & Delete Current Log | Specify how the printer responds when the frequency threshold expires. Note: The value defined in Accounting Log Frequency determines when this action is triggered. |
| Log Near Full Level Off* On | Specify the maximum size of the log file before the printer executes the Log Action at Near Full. |
| Log Action at Near Full None* E-mail Current Log E-mail & Delete Current Log E-mail & Delete Oldest Log Post Current Log Post & Delete Current Log Post & Delete Oldest Log Delete Current Log Delete Oldest Log Delete All But Current Delete All Logs | Specify how the printer responds when the hard disk is nearly full. Note: The value defined in Log Near Full Level determines when this action is triggered. |
| Log Action at Full None* E-mail & Delete Current Log E-mail & Delete Oldest Log Post & Delete Current Log Post & Delete Oldest Log Delete Current Log Delete Oldest Log Delete All But Current Delete All Logs | Specify how the printer responds when disk usage reaches the maximum limit (100MB). |
| URL to Post Log | Specify where the printer posts job accounting logs. |
| E-mail Address to Send Logs | Specify the e-mail address to which the printer sends job accounting logs. |
| Log File Prefix | Specify the prefix for the log file name. Note: The current host name defined in the TCP/IP menu is used as the default log file prefix. |
| Note: An asterisk (*) next to a value indicates the factory default setting. | |

XPS

| Menu item | Description |
|---|--|
| Print Error Pages Off* On | Print a test page that contains information on errors, including XML markup errors. |
| Minimum Line Width 1–30 (2*) | Set the minimum stroke width. Notes: <ul style="list-style-type: none"> Jobs printed in 1200 dpi use the value directly. Jobs printed in 4800 CQ use half the value. |
| Note: An asterisk (*) next to a value indicates the factory default setting. | |

PDF

| Menu item | Description |
|---|--|
| Scale to Fit Off* On | Scale the page content to fit the selected paper size. |
| Annotations Print Do Not Print* | Specify whether to print annotations in the PDF. |
| Note: An asterisk (*) next to a value indicates the factory default setting. | |

PostScript

| Menu item | Description |
|---|--|
| Print PS Error Off* On | Print a page that describes the PostScript® error. Note: When an error occurs, processing of the job stops, the printer prints an error message, and the rest of the print job is flushed. |
| Minimum Line Width 1–30 (2*) | Set the minimum stroke width. Notes: <ul style="list-style-type: none"> Jobs printed in 1200 dpi use the value directly. Jobs printed in 4800 CQ use half the value. |
| Lock PS Startup Mode Off* On | Disable the SysStart file. |
| Image Smoothing Off* On | Enhance the contrast and sharpness of low-resolution images. Note: This setting has no effect on images with a resolution of 300 dpi or higher. |
| Note: An asterisk (*) next to a value indicates the factory default setting. | |

| Menu item | Description |
|---|--|
| Font Priority Resident* Flash/Disk | Establish the font search order. Notes: <ul style="list-style-type: none"> Resident sets the printer to search its memory for the requested font before searching the flash memory or printer hard disk. Flash/Disk sets the printer to search the flash memory or printer hard disk for the requested font before searching the printer memory. This menu item appears only when a flash memory or printer hard disk is installed. |
| Wait Timeout Off On* (40 seconds) | Set the printer to wait for more data before canceling a print job. |
| Note: An asterisk (*) next to a value indicates the factory default setting. | |

PCL

| Menu item | Description |
|---|---|
| Font Source Resident* Disk Flash All | Choose the source which contains the default font selection. Notes: <ul style="list-style-type: none"> Flash and Disk appear only in some printer models. For Flash and Disk to appear, make sure that they are not read- or write-protected. |
| Font Name [List of available fonts] (Courier*) | Select a font from the specified font source. |
| Symbol Set [List of available symbol set] (10U PC-8*) | Specify the symbol set for each font name. Note: A symbol set is a set of alphabetic and numeric characters, punctuation, and special symbols. Symbol sets support the different languages or specific programs such as math symbols for scientific text. |
| Pitch 0.08–100 (10*) | Specify the pitch for fixed or monospaced fonts. Note: Pitch refers to the number of fixed-space characters in a horizontal inch of type. |
| Orientation Portrait* Landscape | Specify the orientation of text and graphics on the page. |
| Note: An asterisk (*) next to a value indicates the factory default setting. | |

| Menu item | Description |
|--|---|
| Lines per Page 1–255 | Specify the number of lines of text for each page printed through the PCL® datastream. Notes: <ul style="list-style-type: none"> This menu item activates vertical escapement that causes the selected number of requested lines to print between the default margins of the page. 60 is the U.S. factory default setting. 64 is the international factory default setting. |
| PCL5 Minimum Line Width 1–30 (2*) | Set the initial minimum stroke width. Notes: <ul style="list-style-type: none"> Jobs printed in 1200 dpi use the value directly. Jobs printed in 4800CQ use half the value. |
| PCLXL Minimum Line Width 1–30 (2*) | |
| A4 Width 198 mm* 203 mm | Set the width of the logical page on A4-size paper. Note: Logical page is the space on the physical page where data is printed. |
| Auto CR after LF Off* On | Set the printer to perform a carriage return after a line feed control command. Note: Carriage return is a mechanism that commands the printer to move the position of the cursor to the first position on the same line. |
| Auto LF after CR Off* On | Set the printer to perform a line feed after a carriage return control command. |
| Tray Renumber Assign MP Feeder Assign Tray [x] Assign Manual Paper Assign Manual Envelope | Configure the printer to work with a different print driver or custom application that uses a different set of source assignments to request a given paper source. Choose from the following options: Off*—The printer uses the factory default paper source assignments. None—The paper source ignores the Select Paper Feed command. 0–199—Select a numeric value to assign a custom value to a paper source. Note: The multipurpose feeder is available only in some printer models. |
| Tray Renumber View Factory Defaults | Show the factory default value assigned for each paper source. |
| Tray Renumber Restore Defaults | Restore the tray renumber values to their factory defaults. |
| Print Timeout Off On* [90] | Set the printer to end a print job after it has been idle for the specified amount of time in seconds. |
| Note: An asterisk (*) next to a value indicates the factory default setting. | |

HTML

| Menu item | Description |
|---|--|
| Font Name [List of fonts] (Times*) | Set the font to use for HTML documents. |
| Font Size 1–255 (12*) | Set the font size to use for HTML documents. |
| Scale 1–400% (100*) | Scale HTML documents. |
| Orientation Portrait* Landscape | Set the page orientation for HTML documents. |
| Margin Size 8–255 mm (19*) | Set the page margin for HTML documents. |
| Backgrounds Do Not Print Print* | Print background information or graphics for HTML documents. |
| Note: An asterisk (*) next to a value indicates the factory default setting. | |

Image

| Menu item | Description |
|--|---|
| Auto Fit On Off* | Select the best available paper size and orientation setting for an image. Note: When set to On, this menu item overrides the scaling and orientation settings for the image. |
| Invert Off* On | Invert bitonal monochrome images. Note: This menu item does not apply to GIF or JPEG image formats. |
| Scaling Anchor Top Left Best Fit* Anchor Center Fit Height/Width Fit Height Fit Width | Adjust the image to fit the printable area. Note: When Auto Fit is set to On, Scaling is automatically set to Best Fit. |
| Orientation Portrait* Landscape Reverse Portrait Reverse Landscape | Specify the orientation of text and graphics on the page. |
| Note: An asterisk (*) next to a value indicates the factory default setting. | |

Paper

Tray Configuration

| Menu item | Description |
|--|---|
| Default Source Tray [x] (1*) Multipurpose Feeder Manual Paper Manual Envelope | Set the paper source for all print jobs. Note: The multipurpose feeder is available only in some printer models. |
| Paper Size/Type Tray [x] Multipurpose Feeder Manual Paper Manual Envelope | Specify the paper size or paper type loaded in each paper source. Note: The multipurpose feeder is available only in some printer models. |
| Substitute Size Off Statement/A5 Letter/A4 All Listed* | Set the printer to substitute a specified paper size if the requested size is not loaded in any paper source. Notes: <ul style="list-style-type: none"> • Off prompts the user to load the required paper size. • Statement/A5 prints an A5-size document on statement when loading statement, and statement-size jobs on A5 paper size when loading A5. • Letter/A4 prints an A4-size document on letter when loading letter, and letter-size jobs on A4 paper size when loading A4. • All Listed substitutes Letter/A4. |
| Note: An asterisk (*) next to a value indicates the factory default setting. | |

Media Configuration

Universal Setup

| Menu item | Description |
|---|--|
| Units of Measure Inches Millimeters | Specify the unit of measurement for the universal paper. Note: Inches is the U.S. factory default setting. Millimeters is the international factory default setting. |
| Portrait Width 3–14.17 inches (8.50*) 76–359.91 mm (216*) | Set the portrait width of the universal paper. |
| Portrait Height 3–14.17 inches (14*) 76–359.91 mm (356*) | Set the portrait height of the universal paper. |
| Note: An asterisk (*) next to a value indicates the factory default setting. | |

| Menu item | Description |
|---|---|
| Feed Direction Short Edge* Long Edge | Set the printer to pick paper from the short edge or long edge direction. Note: Long Edge appears only when the longest edge is shorter than the maximum width supported. |
| Note: An asterisk (*) next to a value indicates the factory default setting. | |

Media Types

| Menu item | Description |
|---|---|
| Plain Card Stock Recycled Glossy Labels Vinyl Labels Bond Envelope Letterhead Preprinted Colored Paper Light Heavy Rough/Cotton Custom Type [x] | Specify the texture and weight of the paper loaded. |

USB Drive

Note: This menu appears only in some printer models.

Flash Drive Print

| Menu item | Description |
|--|---|
| Number of Copies 1–9999 (1*) | Set the number of copies. |
| Paper Source Tray [x] (1*) Multipurpose Feeder Manual Paper Manual Envelope | Set the paper source for the print job. Note: The multipurpose feeder is available only in some printer models. |
| Note: An asterisk (*) next to a value indicates the factory default setting. | |

| Menu item | Description |
|---|--|
| Color Off On* | Print the output in color. |
| Collate (1,1,1) (2,2,2) (1,2,3) (1,2,3)* | Print multiple copies in sequence. |
| Sides 1-Sided* 2-Sided | Specify whether to print on one side or two sides of the paper. |
| Flip Style Long Edge* Short Edge | Determine which side of the paper (long edge or short edge) is bound when performing two-sided printing. Note: Depending on the option selected, the printer automatically offsets each printed information of the page to bind the job correctly. |
| Pages per Side Off* 2 pages per side 3 pages per side 4 pages per side 6 pages per side 9 pages per side 12 pages per side 16 pages per side | Print multiple page images on one side of a sheet of paper. |
| Pages per Side Ordering Horizontal* Reverse Horizontal Reverse Vertical Vertical | Specify the positioning of multiple page images when using Pages per Side. Note: The positioning depends on the number of page images and their page orientation. |
| Pages per Side Orientation Auto* Landscape Portrait | Specify the orientation of a multiple-page document when using Pages per Side. |
| Pages per Side Border None* Solid | Print a border around each page image when using Pages per Side. |
| Separator Sheets Off* Between Copies Between Jobs Between Pages | Specify whether to insert blank separator sheets when printing. |
| Note: An asterisk (*) next to a value indicates the factory default setting. | |

| Menu item | Description |
|---|---|
| Separator Sheet Source Tray [x] (1*) Multipurpose Feeder | Specify the paper source for the separator sheet. Note: The multipurpose feeder is available only in some printer models. |
| Blank Pages Do Not Print* Print | Specify whether to print blank pages in a print job. |
| Note: An asterisk (*) next to a value indicates the factory default setting. | |

Network/Ports

Network Overview

| Menu item | Description |
|---|---|
| Active Adapter Auto* Standard Network Wireless | Specify how a network is connected. Note: Wireless appears only when a wireless network adapter is installed. |
| Network Status | Show the connection status of the printer network. |
| Display Network Status on Printer On* Off | Show the network status on the display. |
| Speed, Duplex | Show the speed of the currently active network card. |
| IPv4 | Show the IPv4 address. |
| All IPv6 Addresses | Show all IPv6 addresses. |
| Reset Print Server | Reset all active network connections to the printer. Note: This setting removes all network configuration settings. |
| Network Job Timeout Off On* (90 seconds) | Set the time before the printer cancels a network print job. |
| Banner Page Off* On | Print a banner page. |
| Note: An asterisk (*) next to a value indicates the factory default setting. | |

Wireless

Note: This menu is available only in printers connected to a Wi-Fi network or printers that have a wireless network adapter.

| Menu item | Description |
|---|--|
| Setup Using Mobile App | Configure the Wi-Fi connection using Lexmark Mobile Assistant. |
| Setup On Printer Panel Choose Network Add Wi-Fi Network Network Name Network Mode Infrastructure Wireless Security Mode Disabled* WEP WPA2/WPA - Personal WPA2 - Personal 802.1x - RADIUS | Configure the Wi-Fi connection using the control panel. Note: 802.1x - RADIUS can be configured only from the Embedded Web Server. |
| Wi-Fi Protected Setup Start Push Button Method Start PIN Method | Establish a Wi-Fi network and enable network security. Notes: <ul style="list-style-type: none"> • Start Push-Button Method connects the printer to a Wi-Fi network when buttons on both the printer and the access point (wireless router) are pressed within a given time. • Start PIN Method connects the printer to a Wi-Fi network when a PIN on the printer is entered into the wireless settings of the access point. |
| Network Mode BSS Type Infrastructure* | Set the network mode. |
| Enable Wi-Fi Direct On Off* | Enable Wi-Fi Direct-capable devices to connect directly to the printer. |
| Compatibility 802.11b/g/n (2.4GHz)* 802.11a/b/g/n/ac (2.4GHz/5GHz) 802.11a/n/ac (5GHz) | Specify the standard for the Wi-Fi network. Note: 802.11a/b/g/n/ac (2.4GHz/5GHz) and 802.11a/n/ac (5GHz) only appear when a Wi-Fi option is installed. |
| Wireless Security Mode Disabled* WEP WPA2/WPA-Personal WPA2-Personal 802.1x - RADIUS | Set the security mode for connecting the printer to Wi-Fi devices. Note: 802.1x - RADIUS can be configured only from the Embedded Web Server. |
| WEP Authentication Mode Auto* Open Shared | Set the type of Wireless Encryption Protocol (WEP) for the printer. Note: This menu item appears only when the Wireless Security Mode is set to WEP. |
| Set WEP Key | Specify a WEP password for secure Wi-Fi connection. |

| Menu item | Description |
|--|--|
| WPA2/WPA Personal AES | Enable Wi-Fi security through Wi-Fi Protected Access (WPA). Note: This menu item appears only when the Wireless Security Mode is set to WPA2/WPA-Personal. |
| Set Pre-Shared Key | Set the password for secure Wi-Fi connection. |
| WPA2-Personal AES | Enable Wi-Fi security through WPA2. Note: This menu item appears only when the Wireless Security Mode is set to WPA2-Personal. |
| 802.1x Encryption Mode WPA+ WPA2* | Enable Wi-Fi security through 802.1x standard. Notes: <ul style="list-style-type: none"> • This menu item appears only when the Wireless Security Mode is set to 802.1x - RADIUS. • 802.1x - RADIUS can be configured only from the Embedded Web Server. |
| IPv4 Enable DHCP On* Off Set Static IP Address IP Address Netmask Gateway | Enable Dynamic Host Configuration Protocol (DHCP) and configure static IP address. Note: DHCP is a standard protocol that allows a server to distribute IP addressing and configuration information dynamically to clients. |
| IPv6 Enable IPv6 On* Off Enable DHCPv6 On Off* Stateless Address Autoconfiguration On* Off DNS Server Address Manually Assigned IPv6 Address Manually Assigned IPv6 Router Address Prefix All IPv6 Addresses All IPv6 Router Addresses | Enable and configure IPv6 settings in the printer. |
| Network Address UAA LAA | View the network addresses. |

| Menu item | Description |
|--|--|
| PCL SmartSwitch Off On* | Set the printer to switch automatically to PCL emulation when a print job requires it, regardless of the default printer language. Note: If PCL SmartSwitch is off, then the printer does not examine incoming data and uses the default printer language specified in the Setup menu. |
| PS SmartSwitch Off On* | Set the printer to switch automatically to PS emulation when a print job requires it, regardless of the default printer language. Note: If PS SmartSwitch is off, then the printer does not examine incoming data and uses the default printer language specified in the Setup menu. |
| Job Buffering On Off* | Temporarily store print jobs in the printer hard disk before printing. Note: This menu item appears only when a hard disk is installed. |
| Mac Binary PS Auto* On Off | Set the printer to process Macintosh binary PostScript print jobs. Notes: <ul style="list-style-type: none"> • On processes raw binary PostScript print jobs. • Off filters print jobs using the standard protocol. |

Ethernet

| Menu item | Description |
|---|---|
| Network Speed | Show the speed of an active network adapter. |
| IPv4 Enable DHCP On* Off | Enable Dynamic Host Configuration Protocol (DHCP). Note: DHCP is a standard protocol that allows a server to dynamically distribute IP addressing and configuration information to clients. |
| IPv4 Set Static IP Address IP Address Netmask Gateway | Set the static IP address of your printer. |
| IPv6 Enable IPv6 Off On* | Enable IPv6 in the printer. |
| IPv6 Enable DHCPv6 Off* On | Enable DHCPv6 in the printer. |
| Note: An asterisk (*) next to a value indicates the factory default setting. | |

| Menu item | Description |
|---|--|
| IPv6 Stateless Address Autoconfiguration Off On* | Set the network adapter to accept the automatic IPv6 address configuration entries provided by a router. |
| IPv6 DNS Server Address | Specify the DNS server address. |
| IPv6 Manually Assigned IPv6 Address | Assign the IPv6 address. |
| IPv6 Manually Assigned IPv6 Router | Assign the IPv6 address. |
| IPv6 Address Prefix 0–128 (64*) | Specify the address prefix. |
| IPv6 All IPv6 Addresses | Show all IPv6 addresses. |
| IPv6 All IPv6 Router Addresses | Show all IPv6 router addresses. |
| Network Address UAA LAA | Show the printer Media Access Control (MAC) addresses: Locally Administered Address (LAA) and Universally Administered Address (UAA). Note: You can change the printer LAA manually. |
| PCL SmartSwitch Off On* | Set the printer to switch automatically to PCL emulation when a print job requires it, regardless of the default printer language. Note: If PCL SmartSwitch is off, then the printer does not examine incoming data and uses the default printer language specified in the Setup menu. |
| PS SmartSwitch Off On* | Set the printer to switch automatically to PS emulation when a print job requires it, regardless of the default printer language. Note: If PS SmartSwitch is off, then the printer does not examine incoming data and uses the default printer language specified in the Setup menu. |
| Job Buffering Off On* | Temporarily store jobs on the printer hard disk before printing. Notes: <ul style="list-style-type: none"> • This menu item appears only when a hard disk is installed. • This menu item appears only in some printer models. |
| Mac Binary PS Auto* On Off | Set the printer to process Macintosh binary PostScript print jobs. Notes: <ul style="list-style-type: none"> • On processes raw binary PostScript print jobs. • Off filters print jobs using the standard protocol. |
| Note: An asterisk (*) next to a value indicates the factory default setting. | |

| Menu item | Description |
|---|--|
| Energy Efficient Ethernet Off On* | Reduce power consumption when the printer does not receive data from the Ethernet network. |
| Note: An asterisk (*) next to a value indicates the factory default setting. | |

TCP/IP

Note: This menu appears only in network printers or printers attached to print servers.

| Menu item | Description |
|---|---|
| Set Hostname | Set the current TCP/IP host name. |
| Domain Name | Set the domain name. Note: This menu item appears only in some printer models. |
| Allow DHCP/BOOTP to update NTP server Off On* | Allow the DHCP and BOOTP clients to update the NTP settings of the printer. |
| Zero Configuration Name | Specify a service name for the zero configuration network. Note: This menu item appears only in some printer models. |
| Enable Auto IP Off On* | Assign an IP address automatically. |
| DNS Server Address | Specify the current Domain Name System (DNS) server address. |
| Backup DNS Server Address | Specify the backup DNS server addresses. |
| Backup DNS Server Address 2 | |
| Backup DNS Server Address 3 | |
| Domain Search Order | Specify a list of domain names to locate the printer and its resources that reside in different domains on the network. Note: This menu item appears only in some printer models. |
| Enable DDNS Off* On | Update the Dynamic DNS settings. |
| DDNS TTL | Specify the current DDNS settings. |
| Default TTL | |
| DDNS Refresh Time | |
| Enable mDNS Off On* | Update multicast DNS settings. |
| Note: An asterisk (*) next to a value indicates the factory default setting. | |

| Menu item | Description |
|--|--|
| WINS Server Address | Specify a server address for Windows Internet Name Service (WINS). |
| Enable BOOTP Off* On | Allow the BOOTP to assign a printer IP address. |
| Restricted Server List | Specify an IP address for the TCP connections. Notes: <ul style="list-style-type: none"> • Use a comma to separate each IP address. • You can add up to 50 IP addresses. |
| Restricted Server List Options Block All Ports* Block Printing Only Block Printing and HTTP Only | Specify how the IP addresses in the list can access the printer functionality. |
| MTU | Specify a maximum transmission unit (MTU) parameter for the TCP connections. |
| Raw Print Port 1–65535 (9100*) | Specify a raw port number for printers connected on a network. |
| Outbound Traffic Maximum Speed Off* On | Enable the printer maximum transfer rate. |
| Enhanced TLS Security Off* On | Enhance printer privacy and data integrity. |
| Note: An asterisk (*) next to a value indicates the factory default setting. | |

SNMP

Note: This menu appears only in network printers or printers that are attached to print servers.

| Menu item | Description |
|--|--|
| SNMP Versions 1 and 2c Enabled Off On* Allow SNMP Set Off On* Enable PPM MIB Off On* SNMP Community | Configure Simple Network Management Protocol (SNMP) versions 1 and 2c to install print drivers and applications. |
| Note: An asterisk (*) next to a value indicates the factory default setting. | |

| Menu item | Description |
|---|---|
| <p>SNMP Version 3</p> <ul style="list-style-type: none"> Enabled <ul style="list-style-type: none"> Off On* Set Read/Write Credentials <ul style="list-style-type: none"> User Name Password Set Read-only Credentials <ul style="list-style-type: none"> User Name Password Authentication Hash <ul style="list-style-type: none"> MD5 SHA1* Minimum Authentication Level <ul style="list-style-type: none"> No Authentication, No Privacy Authentication, No Privacy Authentication, Privacy* Privacy Algorithm <ul style="list-style-type: none"> DES AES-128* | <p>Configure SNMP version 3 to install and update the printer security.</p> |
| <p>Note: An asterisk (*) next to a value indicates the factory default setting.</p> | |

IPSec

Note: This menu appears only in network printers or printers that are attached to print servers.

| Menu item | Description |
|--|---|
| <p>Enable IPSec</p> <ul style="list-style-type: none"> Off* On | <p>Enable Internet Protocol Security (IPSec).</p> |
| <p>Base Configuration</p> <ul style="list-style-type: none"> Default* Compatibility Secure | <p>Set the IPSec base configuration.</p> <p>Note: This menu item appears only when Enable IPSec is set to On.</p> |
| <p>IPSec Device Certificate</p> | <p>Specify an IPSec certificate.</p> <p>Note: This menu item appears only when Base Configuration is set to Compatibility.</p> |
| <p>Note: An asterisk (*) next to a value indicates the factory default setting.</p> | |

| Menu item | Description |
|---|--|
| Pre-Shared Key Authenticated Connections Host [x] Address Key | Configure the authenticated connections of the printer. Note: These menu items appear only when Enable IPsec is set to On. |
| Certificate Authenticated Connections Host [x] Address[/subnet] Address[/subnet] | |
| Note: An asterisk (*) next to a value indicates the factory default setting. | |

802.1x

Note: This menu appears only in network printers or printers that are attached to print servers.

| Menu item | Description |
|---|--|
| Active Off* On | Let the printer join networks that require authentication before allowing access. Note: To configure the settings of this menu item, access the Embedded Web Server. |
| Note: An asterisk (*) next to a value indicates the factory default setting. | |

LPD Configuration

Note: This menu appears only in network printers or printers that are attached to print servers.

| Menu item | Description |
|---|---|
| LPD Timeout 0–65535 seconds (90*) | Set the time-out value to stop the Line Printer Daemon (LPD) server from waiting indefinitely for hung or invalid print jobs. |
| LPD Banner Page Off* On | Print a banner page for all LPD print jobs. Note: A banner page is the first page of a print job used as a separator of print jobs and to identify the originator of the print job request. |
| LPD Trailer Page Off* On | Print a trailer page for all LPD print jobs. Note: A trailer page is the last page of a print job. |
| LPD Carriage Return Conversion Off* On | Enable carriage return conversion. Note: Carriage return is a mechanism that commands the printer to move the position of the cursor to the first position on the same line. |
| Note: An asterisk (*) next to a value indicates the factory default setting. | |

HTTP/FTP Settings

Note: This menu appears only in network printers or printers attached to print servers.

| Menu item | Description |
|---|--|
| Enable HTTP Server Off On* | Access the Embedded Web Server to monitor and manage the printer. |
| Enable HTTPS Off On* | Configure the Hypertext Transfer Protocol Secure (HTTPS) settings. |
| Enable FTP/TFTP Off On* | Send files using FTP. |
| Local Domains | Specify domain names for HTTP and FTP servers. Note: This menu item appears only in some printer models. |
| HTTP Proxy IP Address | Configure the HTTP and FTP server settings. Note: These menu items appear only in some printer models. |
| FTP Proxy IP Address | |
| HTTP Default IP Port 1–65535 (80*) | |
| HTTPS Device Certificate | |
| FTP Default IP Port 1–65535 (21*) | |
| Timeout for HTTP/FTP Requests 1–299 (30*) | Specify the amount of time before the server connection stops. |
| Retries for HTTP/FTP Requests 1–299 (3*) | Set the number of retries to connect to the HTTP/FTP server. |
| Note: An asterisk (*) next to a value indicates the factory default setting. | |

ThinPrint

| Menu item | Description |
|---|--|
| Enable ThinPrint Off On* | Print using ThinPrint. |
| Port Number 4000–4999 (4000*) | Set the port number for the ThinPrint server. |
| Bandwidth (bits/sec) 100–1000000 (0*) | Set the speed to transmit data in a ThinPrint environment. |
| Note: An asterisk (*) next to a value indicates the factory default setting. | |

| Menu item | Description |
|---|--|
| Packet Size (kbytes) 0–64000 (0*) | Set the packet size for data transmission. |
| Note: An asterisk (*) next to a value indicates the factory default setting. | |

USB

Note: This menu appears only in some printer models.

| Menu item | Description |
|---|---|
| PCL SmartSwitch Off On* | Set the printer to switch to PCL emulation when a print job received through a USB port requires it, regardless of the default printer language. Note: If PCL SmartSwitch is off, then the printer does not examine incoming data and uses the default printer language specified in the Setup menu. |
| PS SmartSwitch Off On* | Set the printer to switch to PS emulation when a print job received through a USB port requires it, regardless of the default printer language. Note: If PS SmartSwitch is off, then the printer does not examine incoming data and uses the default printer language specified in the Setup menu. |
| Job Buffering Off* On | Temporarily store jobs on the printer hard disk before printing. Note: This menu item appears only when a hard disk installed. |
| Mac Binary PS On Auto* Off | Set the printer to process Macintosh binary PostScript print jobs. Notes: <ul style="list-style-type: none"> • When set to On, the printer processes raw binary PostScript print jobs from computers using the Macintosh operating system. • When set to Auto, the printer processes print jobs from computers using either Windows or Macintosh operating systems • When set to Off, the printer filters PostScript print jobs using the standard protocol. |
| Enable USB Port Off On* | Enable the standard USB port. |
| Note: An asterisk (*) next to a value indicates the factory default setting. | |

Google Cloud Print

| Menu item | Description |
|---|--|
| Registration Register | Register the printer to the Google Cloud Print server. |
| Note: An asterisk (*) next to a value indicates the factory default setting. | |

| Menu item | Description |
|---|---|
| Options Enable Google Cloud Print Off On* | Print directly from your Google account. |
| Options Enable Local Discovery Off On* | Allow the registered user and other users on the same subnet to send jobs to the printer locally. |
| Options Enable SSL Peer Verification Off On* | Verify authenticity of the peer certificate to connect to your Google account. |
| Options Always Print As Image Off* On | Set the printer to process PDF files as an image for faster printing. |
| Note: An asterisk (*) next to a value indicates the factory default setting. | |

Wi-Fi Direct

Note: This menu appears only when a direct Wi-Fi network is the active network.

| Menu item | Description |
|---|--|
| SSID | Specify the service set identifier (SSID) of the Wi-Fi network. |
| Set Preshared Key | Set the preshared key (PSK) to authenticate and validate users on a Wi-Fi connection. |
| Show PSK on Setup Page Off On* | Show the PSK on the Network Setup Page. |
| Group Owner IP Address | Specify the IP address of the group owner. |
| Auto-Accept Push Button Requests Off* On | Accept requests to connect to the network automatically. Note: Accepting clients automatically is not secured. |
| Note: An asterisk (*) next to a value indicates the factory default setting. | |

Security

Note: In some printer models, this menu can be configured only from the Embedded Web Server.

Login Methods

Manage Permissions

| Menu item | Description |
|--|---|
| Function Access Modify Address Book Create Profiles Manage Bookmarks Flash Drive Print Flash Drive Color Printing Held Jobs Access User Profiles Cancel Jobs at the Device Change Language Internet Printing Protocol (IPP) B/W Print Color Print | Control access to the printer functions. |
| Administrative Menus Security Menu Network/Ports Menu Paper Menu Reports Menu Function Configuration Menus Supplies Menu Option Card Menu SE Menu Device Menu | Control access to the printer menus. |
| Device Management Remote Management Firmware Updates Apps Configuration Operator Panel Lock Import / Export All Settings Out of Service Erase | Control access to the printer management options. |

| Menu item | Description |
|---|---|
| <p>Apps</p> <ul style="list-style-type: none"> New Apps Slideshow Change Wallpaper Screen Saver Forms and Favorites Eco-Settings | <p>Control access to the printer applications.</p> <p>Note: The list may vary depending on the applications that are enabled from the Embedded Web Server.</p> |

Local Accounts

| Menu item | Description |
|---|--|
| <p>Manage Groups/Permissions</p> <ul style="list-style-type: none"> Add Group <ul style="list-style-type: none"> Import Access Controls Function Access Administrative Menus Device Management Apps All Users <ul style="list-style-type: none"> Import Access Controls Function Access Administrative Menus Device Management Apps Admin | <p>Control group or user access to the printer functions, applications, and security settings.</p> |
| <p>Add User</p> <ul style="list-style-type: none"> User Name/Password User Name Password PIN | <p>Create local accounts to manage access to the printer functions.</p> |
| <p>User Name/Password Accounts</p> <ul style="list-style-type: none"> Add User | |
| <p>User Name Accounts</p> <ul style="list-style-type: none"> Add User | |
| <p>Password Accounts</p> <ul style="list-style-type: none"> Add User | |
| <p>PIN Accounts</p> <ul style="list-style-type: none"> Add User | |

Schedule USB Devices

| Menu item | Description |
|--------------------------------------|-----------------------------------|
| Schedules Add New Schedule | Schedule access to the USB ports. |

Security Audit Log

| Menu item | Description |
|---|---|
| Enable Audit Off* On | Record the events in the secure audit log and remote syslog. |
| Enable Remote Syslog Off* On | Send audit logs to a remote server. |
| Remote Syslog Server | Specify the remote syslog server. |
| Remote Syslog Port 1–65535 (514*) | Specify the remote syslog port. |
| Remote Syslog Method Normal UDP* Stunnel | Specify a syslog method to transmit logged events to a remote server. |
| Note: An asterisk (*) next to a value indicates the factory default setting. | |

| Menu item | Description |
|--|--|
| <p>Remote Syslog Facility</p> <ul style="list-style-type: none"> 0 - Kernel Messages 1 - User-Level Messages 2 - Mail System 3 - System Daemons 4 - Security/Authorization Messages* 5 - Messages Generated Internally by Syslogs 6 - Line Printer Subsystem 7 - Network News Subsystem 8 - UUCP Subsystem 9 - Clock Daemon 10 - Security/Authorization Messages 11 - FTP Daemon 12 - NTP Subsystem 13 - Log Audit 14 - Log Alert 15 - Clock Daemon 16 - Local Use 0 (local0) 17 - Local Use 1 (local1) 18 - Local Use 2 (local2) 19 - Local Use 3 (local3) 20 - Local Use 4 (local4) 21 - Local Use 5 (local5) 22 - Local Use 6 (local6) 23 - Local Use 7 (local7) | <p>Specify a facility code that the printer uses when sending log events to a remote server.</p> |
| <p>Severity of Events to Log</p> <ul style="list-style-type: none"> 0 - Emergency 1 - Alert 2 - Critical 3 - Error 4 - Warning* 5 - Notice 6 - Informational 7 - Debug | <p>Specify the priority level cutoff for logging messages and events.</p> |
| <p>Remote Syslog Non-Logged Events</p> <ul style="list-style-type: none"> Off* On | <p>Send all events, regardless of severity level, to the remote server.</p> |
| <p>Admin's E-mail Address</p> | <p>Send e-mail notification of logged events to the administrator.</p> |
| <p>Note: An asterisk (*) next to a value indicates the factory default setting.</p> | |

| Menu item | Description |
|--|---|
| E-mail Log Cleared Alert Off* On | Send e-mail notification to the administrator when a log entry is deleted. |
| E-mail Log Wrapped Alert Off* On | Send e-mail notification to the administrator when the log becomes full and begins to overwrite the oldest entries. |
| Log Full Behavior Wrap Over Older Entries* E-mail Log Then Delete All Entries | Resolve log storage issues when the log fills its allotted memory. |
| E-mail % Full Alert Off* On | Send e-mail notification to the administrator when the log fills its allotted memory. |
| % Full Alert Level 1–99 (90*) | |
| E-mail Log Exported Alert Off* On | Send e-mail notification to the administrator when a log is exported. |
| E-mail Log Settings Changed Alert Off* On | Send e-mail notification to the administrator when Enable Audit is set. |
| Log Line Endings LF (\n)* CR (\r) CRLF (\r\n) | Specify how the log file terminates the end of each line. |
| Digitally Sign Exports Off* On | Add a digital signature to each exported log file. |
| Clear Log | Delete all audit logs. |
| Export Log Syslog (RFC 5424) Syslog (RFC 3164) CSV | Export a security log to a flash drive. |
| Note: An asterisk (*) next to a value indicates the factory default setting. | |

Login Restrictions

| Menu item | Description |
|---|---|
| Login failures 1–10 (3*) | Specify the number of failed login attempts before the user gets locked out. |
| Failure time frame 1–60 minutes (5*) | Specify the time frame between failed login attempts before the user gets locked out. |
| Lockout time 1–60 minutes (5*) | Specify the lockout duration. |
| Web Login Timeout 1–120 minutes (10*) | Specify the delay for a remote login before the user is logged off automatically. |
| Note: An asterisk (*) next to a value indicates the factory default setting. | |

Confidential Print Setup

| Menu item | Description |
|---|---|
| Max Invalid PIN 2–10 | Set the number of times an invalid PIN can be entered. Notes: <ul style="list-style-type: none"> • A value of zero turns off this setting. • When the limit is reached, the print jobs for that user name and PIN are deleted. |
| Confidential Job Expiration Off* 1 Hour 4 Hours 24 Hours 1 Week | Set the expiration time for confidential print jobs. Notes: <ul style="list-style-type: none"> • If this menu item is changed while confidential print jobs reside in the printer memory or hard disk, then the expiration time for those print jobs does not change to the new default value. • If the printer is turned off, then all confidential jobs held in the printer memory are deleted. |
| Repeat Job Expiration Off* 1 Hour 4 Hours 24 Hours 1 Week | Set the expiration time for a print job that you want to repeat. |
| Verify Job Expiration Off* 1 Hour 4 Hours 24 Hours 1 Week | Set the expiration time that the printer prints a copy for the user to examine its quality, before printing the remaining copies. |
| Note: An asterisk (*) next to a value indicates the factory default setting. | |

| Menu item | Description |
|---|---|
| Reserve Job Expiration Off* 1 Hour 4 Hours 24 Hours 1 Week | Set the expiration time that the printer stores print jobs for printing later. |
| Require All Jobs to be Held Off* On | Set the printer to hold all print jobs. |
| Keep duplicate documents Off* On | Set the printer to print other documents with the same file name without overwriting any of the print jobs. |
| Note: An asterisk (*) next to a value indicates the factory default setting. | |

Disk Encryption

Note: This menu appears only when a printer hard disk is installed.

| Menu item | Description |
|--------------------------------------|---|
| Status Enabled Disabled | Determine whether Disk Encryption is enabled. |
| Start encryption | Prevent the loss of sensitive data in case the printer or its hard disk is stolen. Note: Enabling disk encryption erases all contents in the hard disk. If necessary, back up important data from the printer before starting the encryption. |

Erase Temporary Data Files

| Menu item | Description |
|---|---|
| Stored in onboard memory Off* On | Delete all files stored on the printer memory. |
| Stored on hard disk 1 Pass Erase* 3 Pass Erase 7 Pass Erase | Delete all files stored on the printer hard disk. |
| Note: An asterisk (*) next to a value indicates the factory default setting. | |

Solutions LDAP Settings

| Use | To |
|--|--|
| Follow LDAP Referrals Off* On | Search the different servers in the domain for the logged-in user account. |
| LDAP Certificate Verification No* Yes | Enable verification of LDAP certificates. |

Mobile Services Management

| Use | To |
|--|---------------------------|
| AirPrint Print Off On* | Enable AirPrint printing. |

Miscellaneous

| Menu item | Description |
|---|--|
| Protected Features Show* Hide | Show all the features that Function Access Control (FAC) protects regardless of the security permission that the user has. Note: FAC manages access to specific menus and functions or disables them entirely. |
| Print Permission Off* On | Let the user log in before printing. |
| Default Print Permission Login | Set the default login for Print Permission. |
| Security Reset Jumper Enable "Guest" access* No Effect | Specify the effect of using the security reset jumper. Notes: <ul style="list-style-type: none"> The jumper is located beside a lock icon on the controller board. Enable "Guest" access provides full access control to users who are not logged in. No Effect means that the reset has no effect on the printer security configuration. |
| Minimum Password Length 0–32 (0*) | Specify the minimum characters that are allowed for a password. |
| Note: An asterisk (*) next to a value indicates the factory default setting. | |

Reports

Menu Settings Page

| Menu item | Description |
|---------------------------|---|
| Menu Settings Page | Print a report that contains the printer preferences, settings, and configurations. |

Device

| Menu item | Description |
|---------------------------|--|
| Device Information | Print a report that contains information about the printer. |
| Device Statistics | Print a report about printer usage and supply status. |
| Profile List | Print a list of profiles that are stored in the printer. |
| Asset Report | Print a report that contains the printer serial number and model name. |

Print

| Menu item | Description |
|---|--|
| Print Fonts PCL Fonts PS Fonts | Print samples and information about the fonts that are available in each printer language. |
| Print Directory | Print the resources that are stored in the flash drive or printer hard disk. Note: This menu item appears only when a flash drive or printer hard disk is installed. |

Network

| Menu item | Description |
|---------------------------|--|
| Network Setup Page | Print a page that shows the configured network and wireless settings on the printer. Note: This menu item appears only in network printers or printers connected to print servers. |

Help

Note: This menu appears only in some printer models.

| Menu item | Description |
|---------------------|--|
| Print All Guides | Prints all the guides |
| Media Guide | Provides information about loading paper and specialty media |
| Print Quality Guide | Provides information about solving print quality issues |

| Menu item | Description |
|---------------------|---|
| Color Quality Guide | Provides information about color print quality settings |
| Information Guide | Provides more information sources about the printer |
| Connection Guide | Provides information about connecting the printer locally (USB) or to a network |
| Moving Guide | Provides information about moving, locating, or shipping the printer |
| Supplies Guide | Provides information about ordering supplies |

Troubleshooting

Troubleshooting

| Menu item | Description |
|---------------------------------|---|
| Print Quality Test Pages | Print sample pages to identify and correct print quality defects. |

Printing the Menu Settings Page

1 From the control panel, navigate to:

 > **Settings** >  > **Reports** > 

2 Select **Menu Settings Page**, and then press .

Securing the printer

Note: The hard disk is supported only in some printer models.

Locating the security slot

The printer is equipped with a security lock feature. Attach a security lock compatible with most laptop computers in the location shown to secure the printer in place.



Erasing printer memory

To erase volatile memory or buffered data in your printer, turn off the printer.

To erase non-volatile memory or individual settings, device and network settings, security settings, and embedded solutions, do the following:

- 1 From the control panel, navigate to:

Settings > Device > Maintenance > Out of Service Erase > Sanitize all information on nonvolatile memory

For non-touch-screen printer models, press  to navigate through the settings.

- 2 Depending on your printer model, select **ERASE** or **Continue**.
- 3 Follow the instructions on the display.

Erasing printer hard disk memory

- 1 From the home screen, touch **Settings > Device > Maintenance > Out of Service Erase**.
- 2 Select the **Sanitize all information on hard disk** check box, and then touch **ERASE**.
- 3 Follow the instructions on the display.

Note: This process can take from several minutes to more than an hour, making the printer unavailable for other tasks.

Encrypting the printer hard disk

This process erases all contents in the hard disk. If necessary, back up important data from the printer before starting the encryption.

- 1 From the home screen, touch **Settings > Security > Disk Encryption > Start encryption**.
- 2 Follow the instructions on the display.

Notes:

- To avoid loss of data, do not turn off the printer during the encryption process.
- This process can take from several minutes to more than an hour, making the printer unavailable for other tasks.
- After encryption, the printer automatically restarts.

Restoring factory default settings

- 1 From the control panel, navigate to:
Settings > Device > Restore Factory Defaults

For non-touch-screen printer models, press  to navigate through the settings.

- 2 In the Restore Settings menu, select the settings that you want to restore.
- 3 Select **RESTORE**.
- 4 Follow the instructions on the display.

Statement of Volatility

| Type of memory | Description |
|---------------------|--|
| Volatile memory | The printer uses standard random access memory (RAM) to buffer temporarily user data during simple print and copy jobs. |
| Non-volatile memory | The printer may use two forms of non-volatile memory: EEPROM and NAND (flash memory). Both types are used to store the operating system, printer settings, network information, scanner and bookmark settings, and embedded solutions. |
| Hard disk memory | Some printers may have a hard disk drive installed. The printer hard disk is designed for printer-specific functionality. The hard disk lets the printer retain buffered user data from complex print jobs, form data, and font data. |

Erase the content of any installed printer memory in the following circumstances:

- The printer is decommissioned.
- The printer hard disk is replaced.
- The printer is moved to a different department or location.

- The printer is serviced by someone from outside your organization.
- The printer is removed from your premises for service.
- The printer is sold to another organization.

Disposing of a printer hard disk

- **Degaussing**—Flushes the hard disk with a magnetic field that erases stored data
- **Crushing**—Physically compresses the hard disk to break component parts and render them unreadable
- **Milling**—Physically shreds the hard disk into small metal bits

Note: To guarantee that all data are completely erased, destroy physically each hard disk where data is stored.

Maintaining the printer

Warning—Potential Damage: Failure to maintain optimum printer performance, or to replace parts and supplies, may cause damage to your printer.

Networking

Connecting the printer to a Wi-Fi network

Using the control panel

- 1 From the home screen, navigate to:

Settings > Network/Ports > Wireless

For non-touch-screen printer models, press  to navigate through the settings.

- 2 Select **Setup On Printer Panel**, and then follow the instructions on the display.

Note: For Wi-Fi-network-ready printer models, a prompt for Wi-Fi network setup appears during initial setup.

Using Lexmark Mobile Assistant

- 1 Depending on your mobile device, download the Lexmark Mobile Assistant application from either the Google Play™ store or App Store online store.

- 2 From the control panel, navigate to:

Settings > Network/Ports > Wireless > Setup Using Mobile App > Continue for Printer ID

For non-touch-screen printer models, press  to navigate through the settings.

- 3 From your mobile device, launch the application, and then accept the Terms of Use.
- 4 Grant permissions.
- 5 Tap **Start Wi-Fi Setup**, and then select the printer.
- 6 Select a Wi-Fi network, and then enter your credentials.
- 7 Tap **Finish Wi-Fi Setup**.

Connecting the printer to a wireless network using Wi-Fi Protected Setup (WPS)

Before you begin, make sure that:

- The access point (wireless router) is WPS-certified or WPS-compatible. For more information, see the documentation that came with your access point.
- A wireless network adapter is installed in your printer. For more information, see the instructions that came with the adapter.

Using the Push Button method

- 1 From the control panel, navigate to:

Settings > Network/Ports > Wireless > Wi-Fi Protected Setup > Start Push Button Method

For non-touch-screen printer models, press  to navigate through the settings.

- 2 Follow the instructions on the display.

Using the personal identification number (PIN) method

- 1 From the control panel, navigate to:

Settings > Network/Ports > Wireless > Wi-Fi Protected Setup > Start PIN Method

For non-touch-screen printer models, press  to navigate through the settings.

- 2 Copy the eight-digit WPS PIN.
- 3 Open a Web browser, and then type the IP address of your access point in the address field.

Notes:

- View the printer IP address on the printer home screen. The IP address appears as four sets of numbers separated by periods, such as 123.123.123.123.
 - If you are using a proxy server, then temporarily disable it to load the web page correctly.
- 4 Access the WPS settings. For more information, see the documentation that came with your access point.
 - 5 Enter the eight-digit PIN, and then save the changes.

Connecting a mobile device to the printer wireless network

- 1 Enable Wi-Fi Direct in the printer. From the home screen, navigate to:

Settings > Network/Ports > Wireless > Enable Wi-Fi Direct

For non-touch-screen printer models, press  to navigate through the settings.

Notes:

- The Wi-Fi Direct SSID and password are generated automatically. To view the Wi-Fi Direct SSID and password, go to the Wi-Fi Direct menu.
- You can also change the SSID and password, if necessary.

- 2 Connect your mobile device to the printer wireless network.

Deactivating the Wi-Fi network

- 1 From the printer control panel, navigate to:

Settings > Network/Ports > Network Overview > Active Adapter > Standard Networking

For non-touch-screen printer models, press  to navigate through the settings.

- 2 Follow the instructions on the display.

Cleaning the printer

 **CAUTION—SHOCK HAZARD:** To avoid the risk of electrical shock when cleaning the exterior of the printer, unplug the power cord from the electrical outlet and disconnect all cables from the printer before proceeding.

Notes:

- Perform this task after every few months.
- Damage to the printer caused by improper handling is not covered by the printer warranty.

- 1 Turn off the printer, and then unplug the power cord from the electrical outlet.
- 2 Remove paper from the standard bin and multipurpose feeder.
- 3 Remove any dust, lint, and pieces of paper around the printer using a soft brush or vacuum.
- 4 Wipe the outside of the printer with a damp, soft, lint-free cloth.

Notes:

- Do not use household cleaners or detergents, as they may damage the finish of the printer.
- Make sure that all areas of the printer are dry after cleaning.

- 5 Connect the power cord to the electrical outlet, and then turn on the printer.

 **CAUTION—POTENTIAL INJURY:** To avoid the risk of fire or electrical shock, connect the power cord to an appropriately rated and properly grounded electrical outlet that is near the product and easily accessible.

Ordering parts and supplies

To order parts and supplies in the U.S., contact Lexmark at 1-800-539-6275 for information about Lexmark authorized dealers in your area. In other countries or regions, go to www.lexmark.com or contact the place where you purchased the printer.

Note: All life estimates for printer supplies assume printing on letter- or A4-size plain paper.

Checking the status of parts and supplies

- 1 From the control panel, navigate to:

Settings > Reports > Device > Device Statistics

For non-touch-screen printer models, press  to navigate through the settings.

- 2 From the Supply Information section of the pages printed, check the status of parts and supplies.

Using genuine Lexmark parts and supplies

Your Lexmark printer is designed to function best with genuine Lexmark parts and supplies. Use of third-party supplies or parts may affect the performance, reliability, or life of the printer and its imaging components. It can also affect warranty coverage. Damage caused by the use of third-party parts and supplies is not covered by the warranty. All life indicators are designed to function with Lexmark parts and supplies, and may deliver unpredictable results if third-party parts and supplies are used. Imaging component usage beyond the intended life may damage your Lexmark printer or its associated components.

Ordering a toner cartridge

Notes:

- The estimated cartridge yield is based on the ISO/IEC 19798 standard.
- Extremely low print coverage for extended periods of time may negatively affect actual yield.

Lexmark CS421, CS521, and CS622 Return Program toner cartridges

| Item | United States and Canada | European Economic Area | Rest of Asia Pacific | Latin America | Rest of Europe, Middle East, and Africa | Australia and New Zealand |
|--|--------------------------|------------------------|----------------------|---------------|---|---------------------------|
| Return Program toner cartridges | | | | | | |
| Cyan | 78C10C0 | 78C20C0 | 78C30C0 | 78C40C0 | 78C50C0 | 78C60C0 |
| Magenta | 78C10M0 | 78C20M0 | 78C30M0 | 78C40M0 | 78C50M0 | 78C60M0 |
| Yellow | 78C10Y0 | 78C20Y0 | 78C30Y0 | 78C40Y0 | 78C50Y0 | 78C60Y0 |
| Black | 78C10K0 | 78C20K0 | 78C30K0 | 78C40K0 | 78C50K0 | 78C60K0 |
| Extra high yield Return Program toner cartridges | | | | | | |
| Cyan | 78C1XC0 | 78C2XC0 | 78C3XC0 | 78C4XC0 | 78C5XC0 | 78C6XC0 |
| Magenta | 78C1XM0 | 78C2XM0 | 78C3XM0 | 78C4XM0 | 78C5XM0 | 78C6XM0 |
| Yellow | 78C1XY0 | 78C2XY0 | 78C3XY0 | 78C4XY0 | 78C5XY0 | 78C6XY0 |
| Black | 78C1XK0 | 78C2XK0 | 78C3XK0 | 78C4XK0 | 78C5XK0 | 78C6XK0 |
| Ultra high yield Return Program toner cartridges* | | | | | | |
| Cyan | 78C1UC0 | 78C2UC0 | 78C3UC0 | 78C4UC0 | 78C5UC0 | 78C6UC0 |
| Magenta | 78C1UM0 | 78C2UM0 | 78C3UM0 | 78C4UM0 | 78C5UM0 | 78C6UM0 |
| Yellow | 78C1UY0 | 78C2UY0 | 78C3UY0 | 78C4UY0 | 78C5UY0 | 78C6UY0 |
| Black | 78C1UK0 | 78C2UK0 | 78C3UK0 | 78C4UK0 | 78C5UK0 | 78C6UK0 |
| * Supported only in Lexmark CS521 and CS622 printer models. | | | | | | |
| For more information on countries located in each region, go to www.lexmark.com/regions . | | | | | | |

Lexmark CS421, CS521, and CS622 Regular toner cartridges

| Item | Part number |
|--|-------------|
| Extra high yield toner cartridges¹ | |
| Cyan | 78C0X20 |
| Magenta | 78C0X30 |
| Yellow | 78C0X40 |
| Black | 78C0X10 |
| Ultra high yield toner cartridges² | |
| Cyan | 78C0U20 |
| Magenta | 78C0U30 |
| Yellow | 78C0U40 |
| Black | 78C0U10 |
| ¹ Supported only in the Lexmark CS421 printer model. | |
| ² Supported only in the Lexmark CS521 and CS622 printer models. | |

Lexmark C2325, C2425, and C2535 Return Program toner cartridges

| Item | United States and Canada | European Economic Area | Rest of Asia Pacific | Latin America Distribution | Rest of Europe, Middle East, and Africa | Australia and New Zealand |
|--|--------------------------|------------------------|----------------------|----------------------------|---|---------------------------|
| Return Program toner cartridges | | | | | | |
| Cyan | C2310C0 | C2320C0 | C2330C0 | C2340C0 | C2350C0 | C2360C0 |
| Magenta | C2310M0 | C2320M0 | C2330M0 | C2340M0 | C2350M0 | C2360M0 |
| Yellow | C2310Y0 | C2320Y0 | C2330Y0 | C2340Y0 | C2350Y0 | C2360Y0 |
| Black | C2310K0 | C2320K0 | C2330K0 | C2340K0 | C2350K0 | C2360K0 |
| High yield Return Program toner cartridges | | | | | | |
| Cyan | C231HC0 | C232HC0 | C233HC0 | C234HC0 | C235HC0 | C236HC0 |
| Magenta | C231HM0 | C232HM0 | C233HM0 | C234HM0 | C235HM0 | C236HM0 |
| Yellow | C231HY0 | C232HY0 | C233HY0 | C234HY0 | C235HY0 | C236HY0 |
| Black | C231HK0 | C232HK0 | C233HK0 | C234HK0 | C235HK0 | C236HK0 |
| Extra high yield Return Program toner cartridges¹ | | | | | | |
| Cyan | C241XC0 | C242XC0 | C243XC0 | C244XC0 | C245XC0 | C246XC0 |
| Magenta | C241XM0 | C242XM0 | C243XM0 | C244XM0 | C245XM0 | C246XM0 |
| Yellow | C241XY0 | C242XY0 | C243XY0 | C244XY0 | C245XY0 | C246XY0 |
| ¹ Supported only in Lexmark C2425 and C2535 printer models. | | | | | | |
| ² Supported only in the Lexmark C2535 printer model. | | | | | | |
| For more information on countries located in each region, go to www.lexmark.com/regions . | | | | | | |

| Item | United States and Canada | European Economic Area | Rest of Asia Pacific | Latin America Distribution | Rest of Europe, Middle East, and Africa | Australia and New Zealand |
|---|--------------------------|------------------------|----------------------|----------------------------|---|---------------------------|
| Black | C241XK0 | C242XK0 | C243XK0 | C244XK0 | C245XK0 | C246XK0 |
| Ultra high yield Return Program toner cartridge² | | | | | | |
| Black | C251UK0 | C252UK0 | C253UK0 | C254UK0 | C255UK0 | C256UK0 |
| ¹ Supported only in Lexmark C2425 and C2535 printer models. ² Supported only in the Lexmark C2535 printer model. For more information on countries located in each region, go to www.lexmark.com/regions . | | | | | | |

Lexmark C2325, C2425, and C2535 Regular toner cartridges

| Item | Part number |
|---|-------------|
| High yield toner cartridges¹ | |
| Cyan | C230H20 |
| Magenta | C230H30 |
| Yellow | C230H40 |
| Black | C230H10 |
| Extra high yield toner cartridges | |
| Cyan ² | C240X20 |
| Magenta ² | C240X30 |
| Yellow ² | C240X40 |
| Black ³ | C240X10 |
| Ultra high yield toner cartridge⁴ | |
| Black | C250U10 |
| ¹ Supported only in the Lexmark C2325 printer model. ² Supported only in Lexmark C2425 and C2535 printer models. ³ Supported only in the Lexmark C2425 printer model. ⁴ Supported only in the Lexmark C2535 printer model. | |

C2240 Regular toner cartridges

| Item | United States, Canada, Australia, and New Zealand | Europe, Middle East, and Africa | Rest of Asia Pacific | Latin America Distribution |
|---------|---|---------------------------------|----------------------|----------------------------|
| Cyan | 24B7158 | 24B7182 | 24B7206 | 24B7234 |
| Magenta | 24B7159 | 24B7183 | 24B7207 | 24B7235 |
| Yellow | 24B7160 | 24B7184 | 24B7208 | 24B7236 |
| Black | 24B7161 | 24B7185 | 24B7209 | 24B7237 |

Ordering an imaging kit

| Item | Part number |
|--|-------------|
| Return Program imaging kit | |
| Black Return Program imaging kit | 78C0ZK0 |
| Black and color Return Program imaging kit | 78C0ZV0 |
| Regular imaging kit | |
| Black imaging kit | 78C0Z10 |
| Black and color imaging kit | 78C0Z50 |

Ordering a waste toner bottle

| Item | Part number |
|--------------------|-------------|
| Waste toner bottle | 78C0W00 |

Ordering a maintenance kit

Match the maintenance kit to the printer voltage.

Notes:

- Using certain types of paper may require more frequent replacement of the maintenance kit.
- The maintenance kit includes a fuser and pick tires. These parts may be individually ordered and replaced if necessary.

| Item | Part number |
|--|-------------|
| 100 V fuser maintenance kit | 41X2095 |
| 110 V fuser maintenance kit | 41X2096 |
| 220 V fuser maintenance kit | 41X2097 |
| Note: Only an authorized service technician can replace the maintenance kit. Contact your service provider. | |

Configuring supply notifications

- 1 Open a web browser, and then type the printer IP address in the address field.

Notes:

- View the printer IP address on the printer home screen. The IP address appears as four sets of numbers separated by periods, such as 123.123.123.123.
- If you are using a proxy server, then temporarily disable it to load the web page correctly.

- 2 Click **Settings > Device > Notifications**.
- 3 From the Supplies menu, click **Custom Supply Notifications**.
- 4 Select a notification for each supply item.
- 5 Apply the changes.

Replacing parts and supplies

Replacing a toner cartridge

- 1 Open door B.

Warning—Potential Damage: To prevent damage from electrostatic discharge, touch any exposed metal frame of the printer before accessing or touching interior areas of the printer.



2 Remove the used toner cartridge.

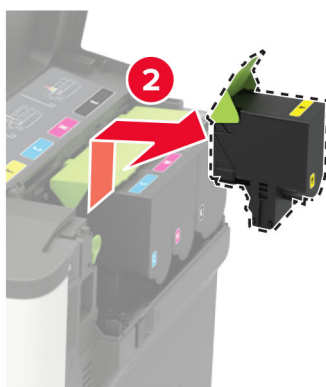

3 Unpack the new toner cartridge.

- 4 Insert the new toner cartridge.



- 5 Close door B.



Replacing the waste toner bottle

- 1 Open door B.

Warning—Potential Damage: To prevent damage from electrostatic discharge, touch any exposed metal frame of the printer before accessing or touching interior areas of the printer.



2 Open door A.

 **CAUTION—HOT SURFACE:** The inside of the printer might be hot. To reduce the risk of injury from a hot component, allow the surface to cool before touching it.

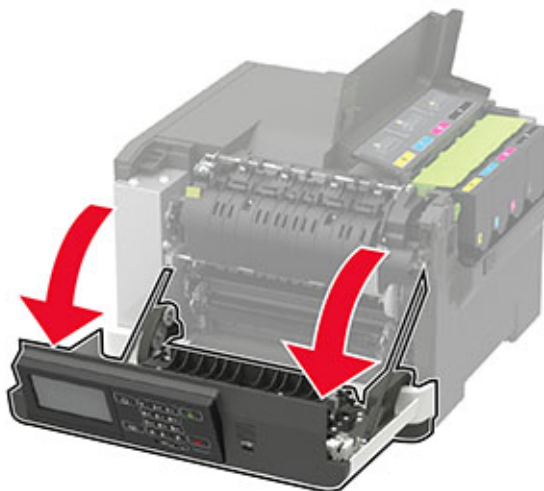

3 Remove the right side cover.

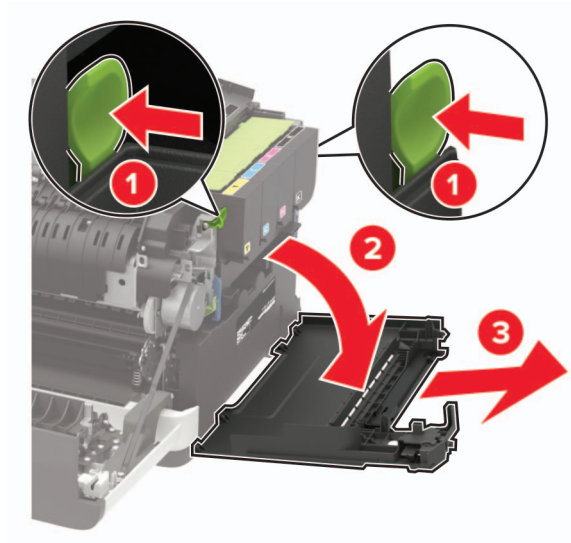

4 Remove the used waste toner bottle.

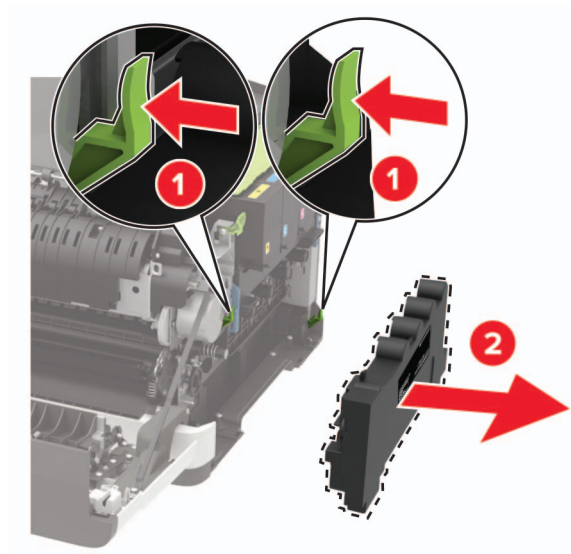

Note: To avoid spilling the toner, place the bottle in an upright position.

5 Unpack the new waste toner bottle.

6 Insert the new waste toner bottle.

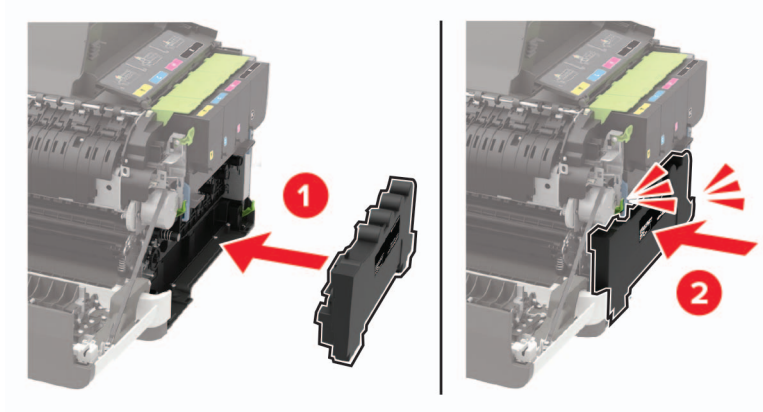

7 Insert the right side cover.

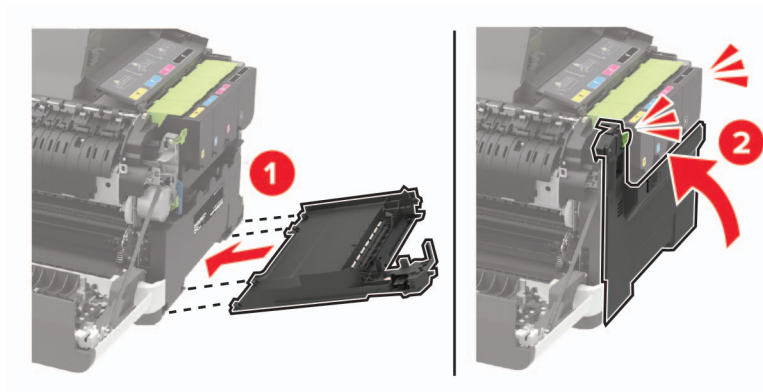

8 Close door B.

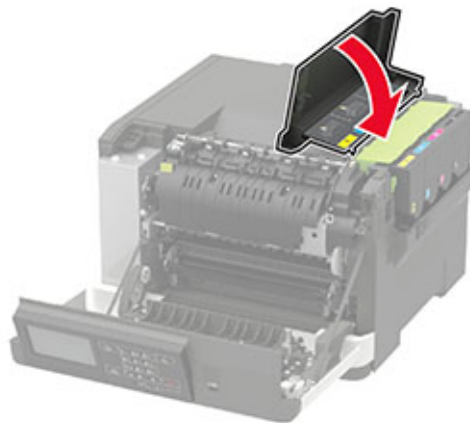

9 Close door A.

Replacing an imaging kit

1 Open door B.

Warning—Potential Damage: To prevent damage from electrostatic discharge, touch any exposed metal frame of the printer before accessing or touching interior areas of the printer.



2 Open door A.

 **CAUTION—HOT SURFACE:** The inside of the printer might be hot. To reduce the risk of injury from a hot component, allow the surface to cool before touching it.

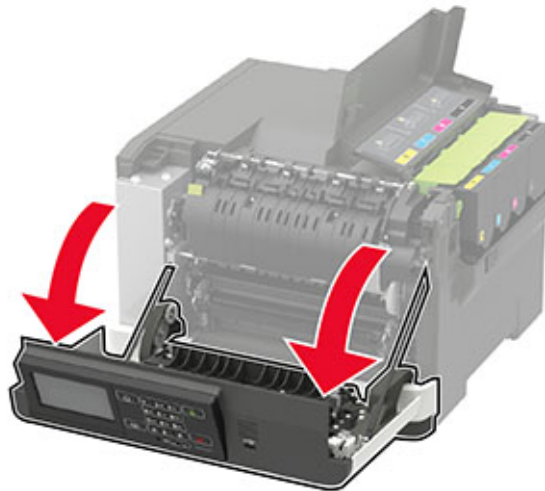

3 Remove the right side cover.

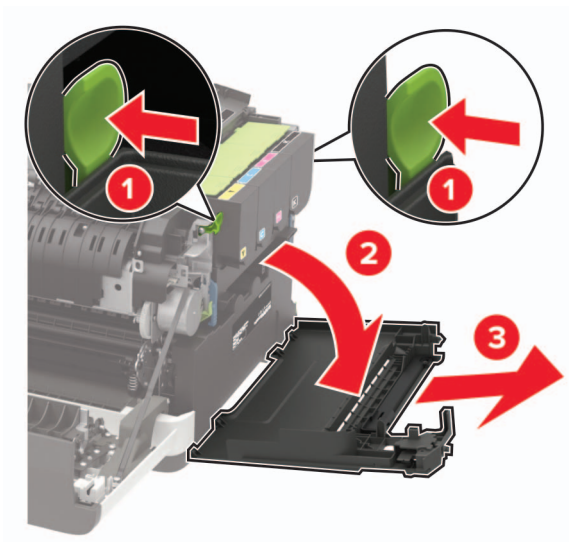

4 Remove the waste toner bottle.

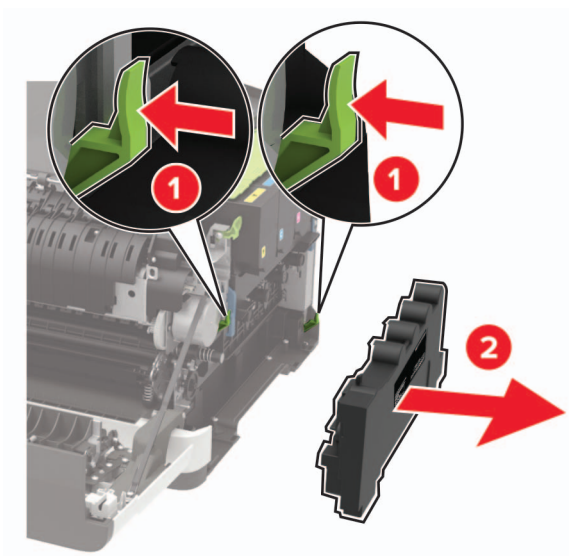

5 Remove the toner cartridges.

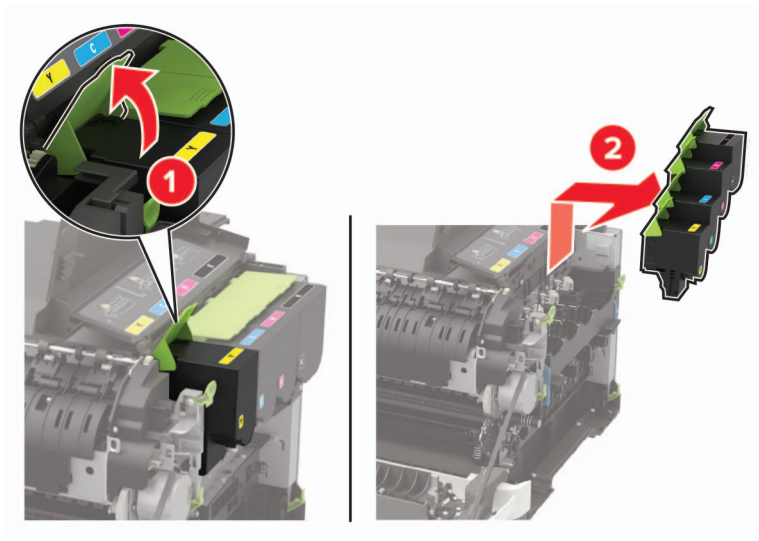

6 Remove the used imaging kit.

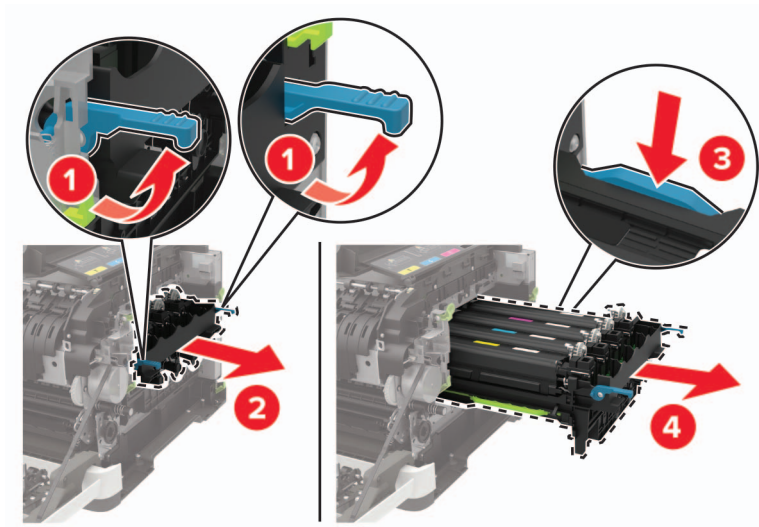

7 Unpack the new imaging kit.

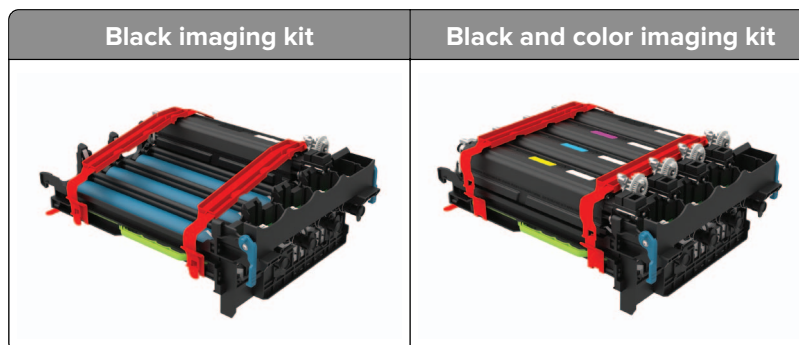

Notes:

- The black imaging kit includes the imaging kit and the black developer unit.

- The black and color imaging kit includes the imaging kit and the black, cyan, magenta, and yellow developer units.
- When replacing the black imaging kit, save the cyan, magenta, and yellow developer units from the used imaging kit.

8 Remove the packing material.

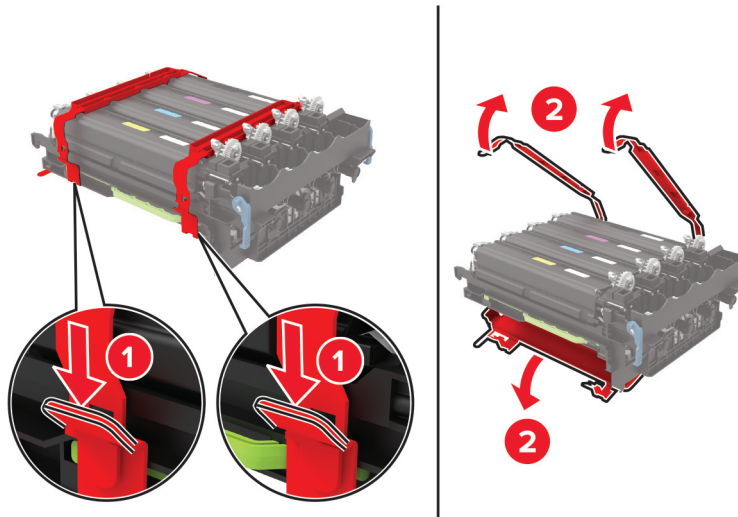

Note: If you are replacing the black imaging kit, then insert the magenta, cyan, and yellow developer units into the new imaging kit.

Warning—Potential Damage: Do not expose the imaging kit to direct light. Extended exposure to light may cause print quality problems.

Warning—Potential Damage: Do not touch the photoconductor drum. Doing so may affect the quality of future print jobs.



9 Insert the imaging kit until it is fully seated.

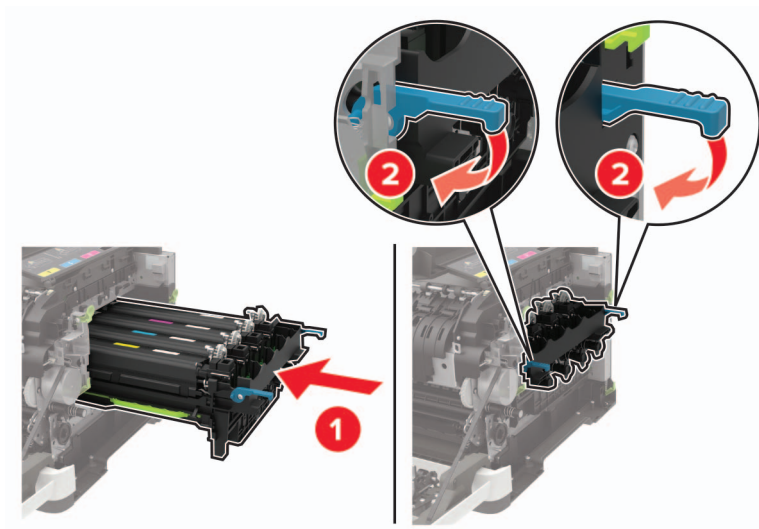

10 Insert the toner cartridges.

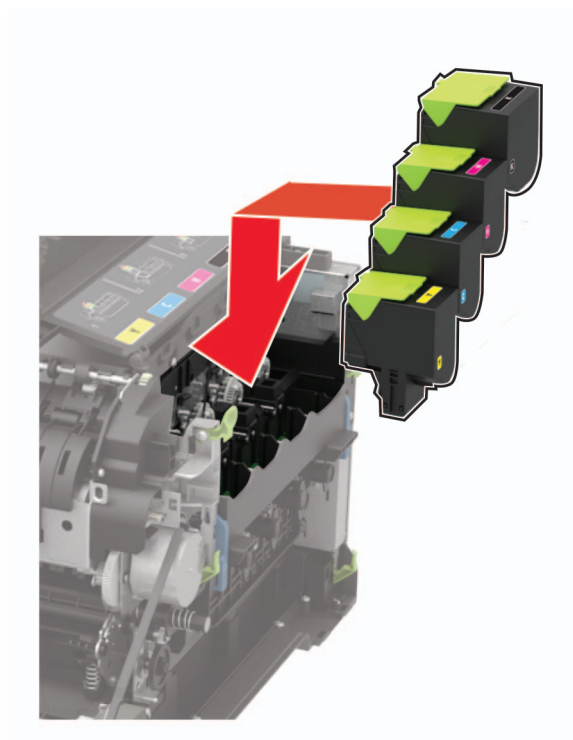

11 Insert the waste toner bottle.

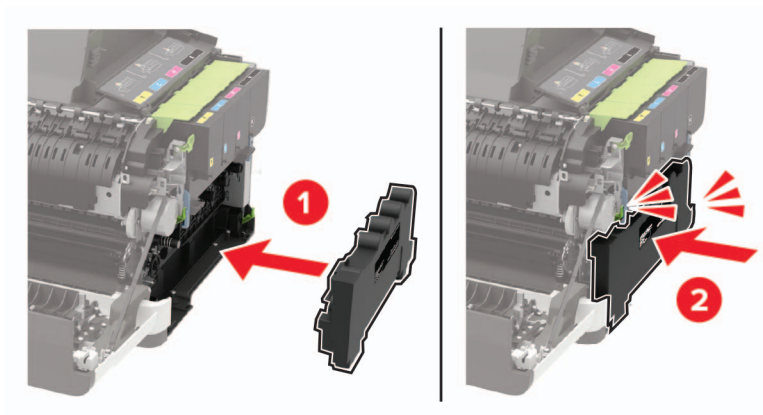

12 Insert the right side cover.

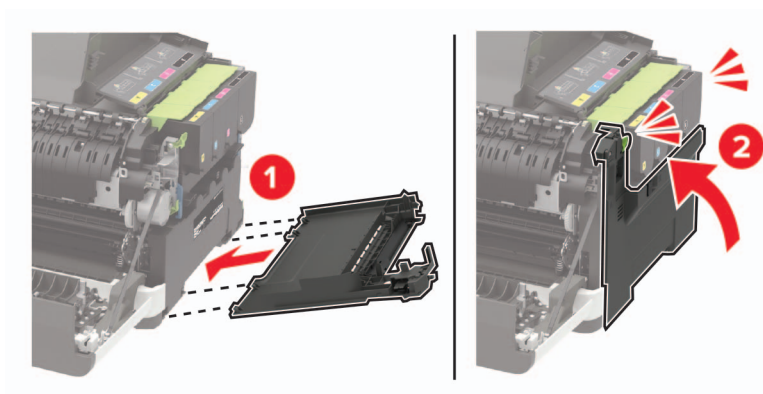

13 Close door B.

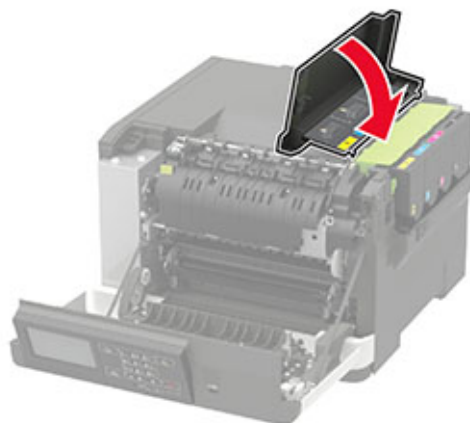



14 Close door A.

Moving the printer

Moving the printer to another location

 **CAUTION—POTENTIAL INJURY:** If the printer weight is greater than 20 kg (44 lb), then it may require two or more people to lift it safely.

 **CAUTION—POTENTIAL INJURY:** To avoid the risk of fire or electrical shock, use only the power cord provided with this product or the manufacturer's authorized replacement.

 **CAUTION—POTENTIAL INJURY:** When moving the printer, follow these guidelines to avoid personal injury or printer damage:

- Make sure that all doors and trays are closed.
- Turn off the printer, and then unplug the power cord from the electrical outlet.
- Disconnect all cords and cables from the printer.
- If the printer has separate floor-standing optional trays or output options attached to it, then disconnect them before moving the printer.
- If the printer has a caster base, then carefully roll it to the new location. Use caution when passing over thresholds and breaks in flooring.
- If the printer does not have a caster base but is configured with optional trays or output options, then remove the output options and lift the printer off the trays. Do not try to lift the printer and any options at the same time.
- Always use the handholds on the printer to lift it.
- Any cart used to move the printer must have a surface able to support the full footprint of the printer.
- Any cart used to move the hardware options must have a surface able to support the dimensions of the options.
- Keep the printer in an upright position.
- Avoid severe jarring movements.
- Make sure that your fingers are not under the printer when you set it down.
- Make sure that there is adequate clearance around the printer.

Note: Damage to the printer caused by improper moving is not covered by the printer warranty.

Shipping the printer

For shipping instructions, go to <http://support.lexmark.com> or contact customer support.

Saving energy and paper

Configuring the power save mode settings

For non-touch-screen printer models, press  to navigate through the settings.

Eco-Mode

- 1 From the control panel, navigate to:
Settings > Device > Power Management > Eco-Mode
- 2 Select a setting.

Sleep mode

- 1 From the control panel, navigate to:
Settings > Device > Power Management > Timeouts > Sleep Mode
- 2 Specify the amount of time that the printer stays idle before it enters Sleep mode.

Hibernate mode

- 1 From the control panel, navigate to:
Settings > Device > Power Management > Timeouts > Hibernate Timeout
- 2 Select the amount of time that the printer stays idle before it enters Hibernate mode.

Notes:

- For Hibernate Timeout to work, set Hibernate Timeout on Connection to Hibernate.
- The Embedded Web Server is disabled when the printer is in Hibernate mode.

Adjusting the brightness of the display

Note: This setting is available only in some printer models.

- 1 From the control panel, navigate to:
Settings > Device > Preferences

For non-touch-screen printer models, press  to navigate through the settings.

- 2 In the Screen Brightness menu, adjust the setting.

Conserving supplies

- Print on both sides of the paper.
Note: Two-sided printing is the default setting in the print driver.
- Print multiple pages on a single sheet of paper.
- Use the preview feature to see how the document looks like before printing it.
- Print one copy of the document to check its content and format for accuracy.

Recycling

Recycling Lexmark products

To return Lexmark products for recycling:

- 1 Go to www.lexmark.com/recycle.
- 2 Select the product you want to recycle.

Note: Printer supplies and hardware not listed in the Lexmark Collection and Recycling Program may be recycled through your local recycling center.

Recycling Lexmark packaging

Lexmark continually strives to minimize packaging. Less packaging helps to ensure that Lexmark printers are transported in the most efficient and environmentally sensitive manner and that there is less packaging to dispose of. These efficiencies result in fewer greenhouse emissions, energy savings, and natural resource savings. Lexmark also offers recycling of packaging components in some countries or regions. For more information, go to www.lexmark.com/recycle, and then choose your country or region. Information on available packaging recycling programs is included with the information on product recycling.

Lexmark cartons are 100% recyclable where corrugated recycling facilities exist. Facilities may not exist in your area.

The foam used in Lexmark packaging is recyclable where foam recycling facilities exist. Facilities may not exist in your area.

When you return a cartridge to Lexmark, you can reuse the box that the cartridge came in. Lexmark recycles the box.

Clearing jams

Avoiding jams

Load paper properly

- Make sure that the paper lies flat in the tray.

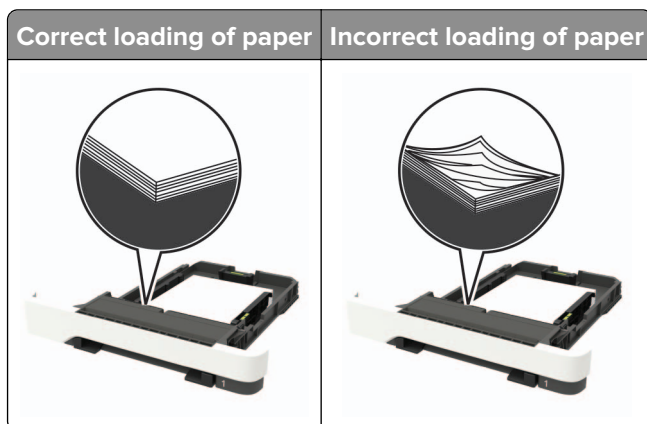

- Do not load or remove a tray while the printer is printing.
- Do not load too much paper. Make sure that the stack height is below the maximum paper fill indicator.
- Do not slide paper into the tray. Load paper as shown in the illustration.

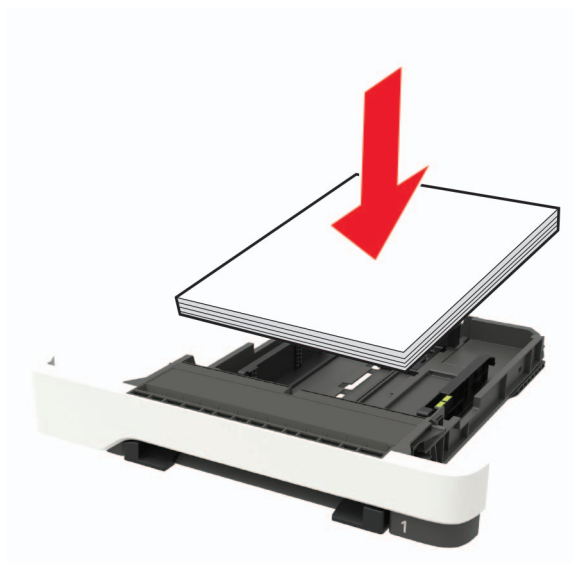

- Make sure that the paper guides are positioned correctly and are not pressing tightly against the paper or envelopes.
- Push the tray firmly into the printer after loading paper.

Use recommended paper

- Use only recommended paper or specialty media.
- Do not load paper that is wrinkled, creased, damp, bent, or curled.

- Flex, fan, and align the paper edges before loading.

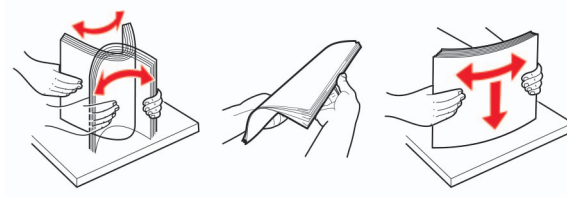

- Do not use paper that has been cut or trimmed by hand.
- Do not mix paper sizes, weights, or types in the same tray.
- Make sure that the paper size and type are set correctly on the computer or printer control panel.
- Store paper according to manufacturer recommendations.

Identifying jam locations

Notes:

- When Jam Assist is set to On, the printer flushes blank pages or pages with partial prints after a jammed page has been cleared. Check your printed output for blank pages.
- When Jam Recovery is set to On or Auto, the printer reprints jammed pages.

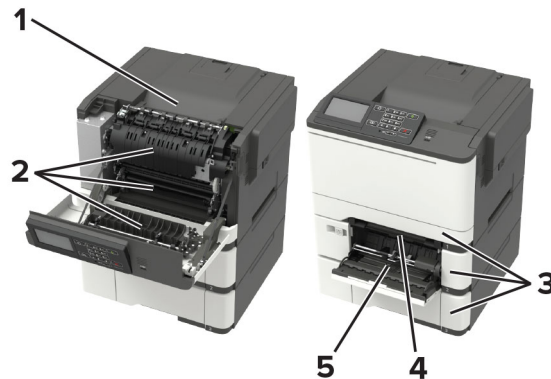

| | Jam location |
|---|--|
| 1 | Standard bin |
| 2 | Door A |
| 3 | Trays |
| 4 | Manual feeder |
| 5 | Multipurpose feeder Note: Available only in some printer models. |

Paper jam in trays

- 1 Remove the tray.



- 2 Remove the jammed paper.

Note: Make sure that all paper fragments are removed.



- 3 Insert the tray.

Paper jam in door A

Paper jam below the fuser

- 1 Open door A.



CAUTION—HOT SURFACE: The inside of the printer might be hot. To reduce the risk of injury from a hot component, allow the surface to cool before touching it.

Warning—Potential Damage: To prevent damage from electrostatic discharge, touch any exposed metal frame of the printer before accessing or touching interior areas of the printer.

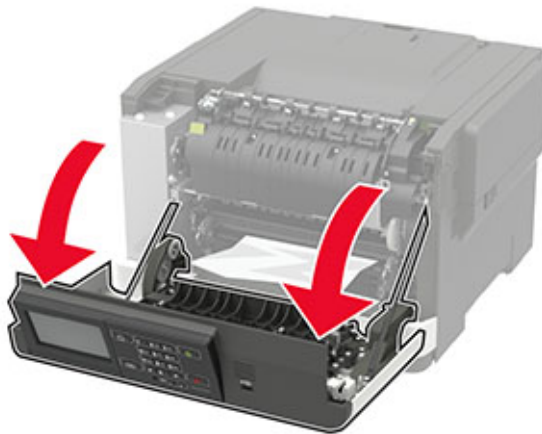

2 Remove the jammed paper.

Note: Make sure that all paper fragments are removed.

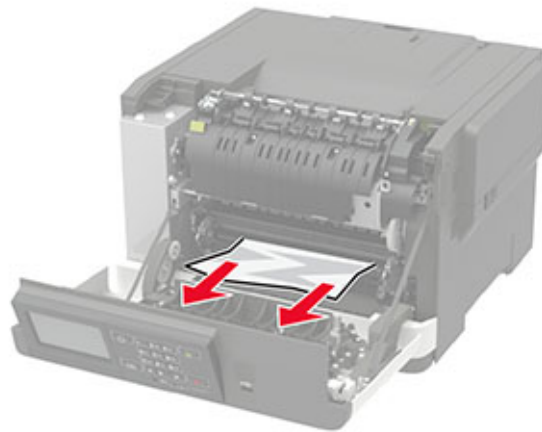

3 Close door A.

Paper jam in the fuser

1 Open door A.



CAUTION—HOT SURFACE: The inside of the printer might be hot. To reduce the risk of injury from a hot component, allow the surface to cool before touching it.

Warning—Potential Damage: To prevent damage from electrostatic discharge, touch any exposed metal frame of the printer before accessing or touching interior areas of the printer.

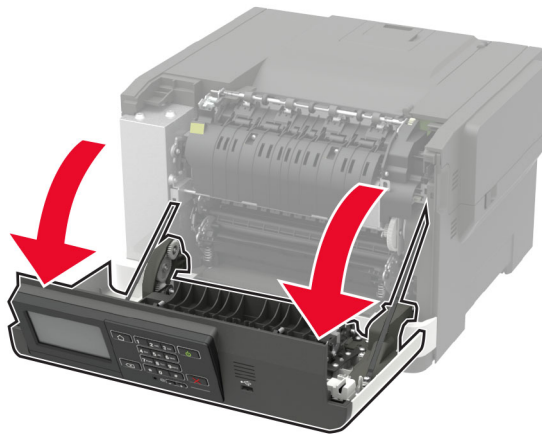

2 Open the fuser access door, and then remove the jammed paper.

Note: Make sure that all paper fragments are removed.

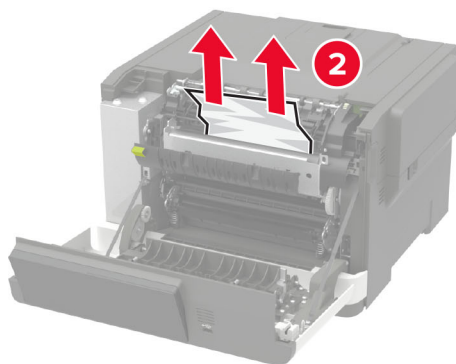
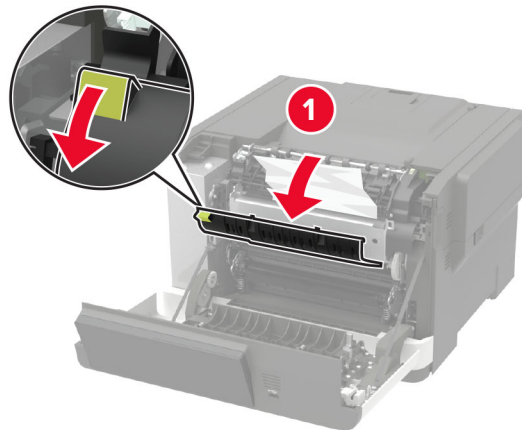

3 Close door A.

Paper jam in the duplex unit

1 Open door A.

 **CAUTION—HOT SURFACE:** The inside of the printer might be hot. To reduce the risk of injury from a hot component, allow the surface to cool before touching it.

Warning—Potential Damage: To prevent damage from electrostatic discharge, touch any exposed metal frame of the printer before accessing or touching interior areas of the printer.



2 Remove the jammed paper.

Note: Make sure that all paper fragments are removed.

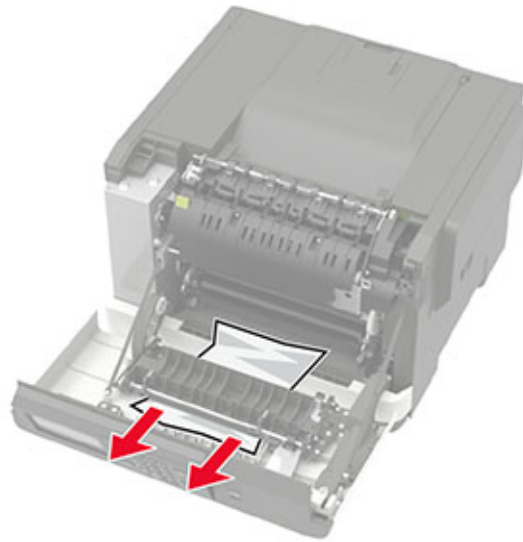

3 Close door A.

Paper jam in the standard bin

Remove the jammed paper.

Warning—Potential Damage: To prevent damage from electrostatic discharge, touch any exposed metal frame of the printer before accessing or touching interior areas of the printer.

Note: Make sure that all paper fragments are removed.



Paper jam in the multipurpose feeder

Note: The multipurpose feeder is available only in some printer models.

- 1 Remove paper from the multipurpose feeder.

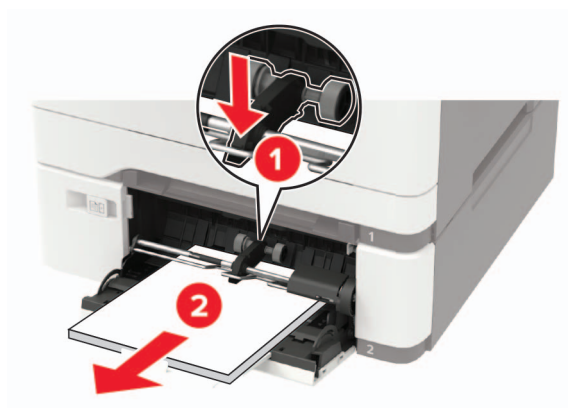

- 2 Remove the jammed paper.

Note: Make sure that all paper fragments are removed.

- 3 Flex, fan, and align the paper edges before loading.

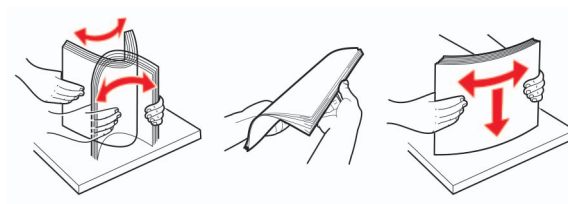

- 4 Reload paper.



Paper jam in the manual feeder

- 1 Remove the tray.



- 2 Remove the jammed paper.

Note: Make sure that all paper fragments are removed.

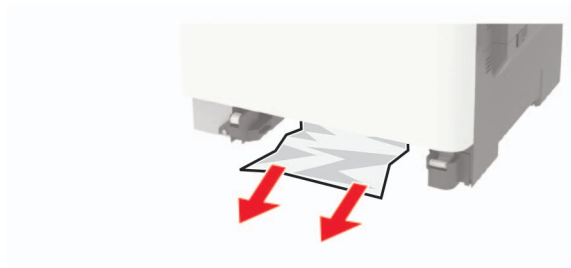

- 3 Insert the tray.

Troubleshooting

Configuring the SMTP server

Note: In some printer models, this setting can be configured only from the Embedded Web Server.

From the control panel

- 1 From the control panel, navigate to:
Settings > Device > Notifications > E-mail Alerts Setup > E-mail Setup
- 2 Configure the settings.

From the Embedded Web Server

- 1 Open a web browser, and then type the printer IP address in the address field.

Notes:

- View the printer IP address on the printer home screen. The IP address appears as four sets of numbers separated by periods, such as 123.123.123.123.
- If you are using a proxy server, then temporarily disable it to load the web page correctly.

- 2 Click **Settings > Device > Notifications > E-mail Alerts Setup**.
- 3 From the E-mail Setup section, configure the settings.
- 4 Click **Save**.

Network connection problems

Cannot open Embedded Web Server

| Action | Yes | No |
|---|---------------|---|
| <p>Step 1 Check if the printer is on.</p> <p>Is the printer on?</p> | Go to step 2. | Turn on the printer. |
| <p>Step 2 Make sure that the printer IP address is correct. View the printer IP address:</p> <ul style="list-style-type: none"> • From the home screen • From the TCP/IP section in the Network/Ports menu • By printing a network setup page or menu settings page, and then finding the TCP/IP section <p>Note: An IP address appears as four sets of numbers separated by periods, such as 123.123.123.123.</p> <p>Is the printer IP address correct?</p> | Go to step 3. | Type the correct printer IP address in the address field. |
| <p>Step 3 Check if you are using a supported browser:</p> <ul style="list-style-type: none"> • Internet Explorer® version 11 or later • Microsoft Edge™ • Safari version 6 or later • Google Chrome™ version 32 or later • Mozilla Firefox version 24 or later <p>Is your browser supported?</p> | Go to step 4. | Install a supported browser. |
| <p>Step 4 Check if the network connection is working.</p> <p>Is the network connection working?</p> | Go to step 5. | Contact your administrator. |
| <p>Step 5 Make sure that the cable connections to the printer and print server are secure. For more information, see the documentation that came with the printer.</p> <p>Are the cable connections secure?</p> | Go to step 6. | Secure the cable connections. |
| <p>Step 6 Check if the web proxy servers are disabled.</p> <p>Are the web proxy servers disabled?</p> | Go to step 7. | Contact your administrator. |

| Action | Yes | No |
|---|------------------------|--|
| <p>Step 7 Access the Embedded Web Server.</p> <p>Did the Embedded Web Server open?</p> | The problem is solved. | Contact customer support . |

Unable to read flash drive

| Action | Yes | No |
|---|------------------------|--|
| <p>Step 1 Check if the printer is not busy processing another print, copy, scan, or fax job.</p> <p>Is the printer ready?</p> | Go to step 2. | Wait for the printer to finish processing the other job. |
| <p>Step 2 Check if the flash drive is inserted into the front USB port.</p> <p>Note: The flash drive does not work when it is inserted into the rear USB port.</p> <p>Is the flash drive inserted into the correct port?</p> | Go to step 3. | Insert the flash drive into the correct port. |
| <p>Step 3 Check if the flash drive is supported. For more information, see “Supported flash drives and file types” on page 41.</p> <p>Is the flash drive supported?</p> | Go to step 4. | Insert a supported flash drive. |
| <p>Step 4</p> <p>a Check if the USB port is enabled. For more information, see “Enabling the USB port” on page 126.</p> <p>b Remove, and then insert the flash drive.</p> <p>Does the printer recognize the flash drive?</p> | The problem is solved. | Contact customer support . |

Enabling the USB port

From the control panel, navigate to:

Settings > Network/Ports > USB > Enable USB Port

For non-touch-screen printer models, press  to navigate through the settings.

Checking the printer connectivity

1 Print the Network Setup Page.

From the control panel, navigate to:

Settings > Reports > Network > Network Setup Page

For non-touch-screen printer models, press  to navigate through the settings.

2 Check the first section of the page and confirm that the status is connected.

If the status is not connected, then the LAN drop may be inactive or the network cable may be unplugged or malfunctioning. Contact your administrator for assistance.

Hardware options problems

Cannot detect internal option

| Action | Yes | No |
|--|------------------------|---------------|
| <p>Step 1 Turn off the printer, wait for about 10 seconds, and then turn on the printer.</p> <p>Does the internal option operate correctly?</p> | The problem is solved. | Go to step 2. |
| <p>Step 2 Print the Menu Settings Page, and then check if the internal option appears in the Installed Features list.</p> <p>Is the internal option listed in the menu settings page?</p> | Go to step 4. | Go to step 3. |
| <p>Step 3 Check if the internal option is installed properly into the controller board.</p> <ul style="list-style-type: none"> a Turn off the printer, and then unplug the power cord from the electrical outlet. b Make sure that the internal option is installed in the appropriate connector in the controller board. c Connect the power cord to the electrical outlet, and then turn on the printer. <p> CAUTION—POTENTIAL INJURY: To avoid the risk of fire or electrical shock, connect the power cord to an appropriately rated and properly grounded electrical outlet that is near the product and easily accessible.</p> <p>Does the internal option operate correctly?</p> | The problem is solved. | Go to step 4. |

| Action | Yes | No |
|--|-------------------------------|--|
| <p>Step 4</p> <p>a Check if the internal option is available in the print driver.</p> <p>Note: If necessary, manually add the internal option in the print driver to make it available for print jobs. For more information, see “Adding available options in the print driver” on page 169.</p> <p>b Resend the print job.</p> <p>Does the internal option operate correctly?</p> | <p>The problem is solved.</p> | <p>Contact customer support.</p> |

Defective flash detected

Try one or more of the following:

- Replace the defective flash memory.
- From the printer control panel, select **Continue** to ignore the message and continue printing.
- Cancel the current print job.

Not enough free space in flash memory for resources

Try one or more of the following:

- From the printer control panel, select **Continue** to clear the message and continue printing.
- Delete fonts, macros, and other data stored in the flash memory.
- Install flash memory with larger capacity.

Note: Downloaded fonts and macros that are not previously stored in the flash memory are deleted.

Unformatted flash detected

Try one or more of the following:

- From the control panel, select **Continue** to stop the defragmentation and continue printing.
- Format the flash memory.

Note: If the error message remains, then the flash memory may be defective and needs to be replaced.

Issues with supplies

Replace cartridge, printer region mismatch

To correct this problem, purchase a cartridge with the correct region that matches the printer region, or purchase a worldwide cartridge.

- The first number in the message after 42 indicates the region of the printer.
- The second number in the message after 42 indicates the region of the cartridge.

Printer and toner cartridge regions

| Region | Numeric code |
|---|--------------|
| Worldwide or Undefined region | 0 |
| North America (United States, Canada) | 1 |
| European Economic Area, Western Europe, Nordic countries, Switzerland | 2 |
| Asia Pacific | 3 |
| Latin America | 4 |
| Rest of Europe, Middle East, Africa | 5 |
| Australia, New Zealand | 6 |
| Invalid region | 9 |

Note: To find the region settings of the printer and toner cartridge, print the print quality test pages. From the control panel, navigate to: **Settings > Troubleshooting > Print Quality Test Pages.**

Non-Lexmark supply

The printer has detected a non-Lexmark supply or part installed in the printer.

Your Lexmark printer is designed to function best with genuine Lexmark supplies and parts. Use of third-party supplies or parts may affect the performance, reliability, or life of the printer and its imaging components.

All life indicators are designed to function with Lexmark supplies and parts and may deliver unpredictable results if third-party supplies or parts are used. Imaging component usage beyond the intended life may damage your Lexmark printer or associated components.

Warning—Potential Damage: Use of third-party supplies or parts can affect warranty coverage. Damage caused by the use of third-party supplies or parts may not be covered by the warranty.

To accept any and all of these risks and to proceed with the use of non-genuine supplies or parts in your printer, depending on your printer model, from the control panel, press and hold **X** and **#**, or **X** and **OK**, simultaneously for 15 seconds.

If you do not want to accept these risks, then remove the third-party supply or part from your printer and install a genuine Lexmark supply or part. For more information, see [“Using genuine Lexmark parts and supplies” on page 97.](#)

If the printer does not print after pressing and holding **X** and **#**, or **X** and **OK**, simultaneously for 15 seconds, then reset the supply usage counter.

- From the control panel, navigate to:
Settings > Device > Maintenance > Configuration Menu > Supply Usage And Counters

For non-touch-screen printer models, press **OK** to navigate through the settings.

- Select the part or supply that you want to reset, and then select **Start**.

- 3 Read the warning message, and then select **Continue**.
- 4 Press and hold **X** and **#**, or **X** and **OK**, simultaneously for 15 seconds to clear the message.

Note: If you are unable to reset the supply usage counters, then return the item to the place of purchase.

Paper feed problems

Envelope seals when printing

| Action | Yes | No |
|--|--|------------------------|
| <p>Step 1</p> <p>a Use an envelope that has been stored in a dry environment. Note: Printing on envelopes with high moisture content can seal the flaps.</p> <p>b Send the print job.</p> <p>Does the envelope seal when printing?</p> | Go to step 2. | The problem is solved. |
| <p>Step 2</p> <p>a Make sure that paper type is set to Envelope. From the control panel, navigate to: Settings > Paper > Tray Configuration > Paper Size/Type</p> <p>For non-touch-screen printer models, press OK to navigate through the settings.</p> <p>b Send the print job.</p> <p>Does the envelope seal when printing?</p> | Contact customer support . | The problem is solved. |

Collated printing does not work

| Action | Yes | No |
|---|------------------------|---------------|
| <p>Step 1</p> <p>a From the printer control panel, navigate to: Settings > Print > Layout > Collate</p> <p>For non-touch-screen printer models, press OK to navigate through the settings.</p> <p>b Set Collate to On.</p> <p>c Print the document.</p> <p>Are the pages collated correctly?</p> | The problem is solved. | Go to step 2. |

| Action | Yes | No |
|--|------------------------|--|
| <p>Step 2</p> <p>a From the document that you are trying to print, open the Print dialog, and then select Collate.</p> <p>b Print the document.</p> <p>Are the pages collated correctly?</p> | The problem is solved. | Go to step 3. |
| <p>Step 3</p> <p>a Reduce the number of pages to print.</p> <p>b Print the document.</p> <p>Are the pages collated correctly?</p> | The problem is solved. | Contact customer support . |

Tray linking does not work

| Action | Yes | No |
|---|------------------------|--|
| <p>Step 1</p> <p>a Check if the trays contain the same paper size and paper type.</p> <p>b Check if the paper guides are positioned correctly.</p> <p>c Print the document.</p> <p>Do the trays link correctly?</p> | The problem is solved. | Go to step 2. |
| <p>Step 2</p> <p>a From the control panel, navigate to: Settings > Paper > Tray Configuration > Paper Size/Type</p> <p>For non-touch-screen printer models, press  to navigate through the settings.</p> <p>b Set the paper size and paper type to match the paper loaded in the linked trays.</p> <p>c Print the document.</p> <p>Do the trays link correctly?</p> | The problem is solved. | Go to step 3. |
| <p>Step 3</p> <p>a Make sure that Tray Linking is set to Automatic. For more information, see “Linking trays” on page 31.</p> <p>b Print the document.</p> <p>Do the trays link correctly?</p> | The problem is solved. | Contact customer support . |

Paper frequently jams

| Action | Yes | No |
|--|--|------------------------|
| <p>Step 1</p> <p>a Remove the tray.</p> <p>b Check if paper is loaded correctly.</p> <p>Notes:</p> <ul style="list-style-type: none"> • Make sure that the paper guides are positioned correctly. • Make sure that the stack height is below the maximum paper fill indicator. • Make sure to print on recommended paper size and type. <p>c Insert the tray.</p> <p>d Print the document.</p> <p>Do paper jams occur frequently?</p> | Go to step 2. | The problem is solved. |
| <p>Step 2</p> <p>a From the control panel, navigate to: Settings > Paper > Tray Configuration > Paper Size/Type</p> <p>For non-touch-screen printer models, press  to navigate through the settings.</p> <p>b Set the correct paper size and type.</p> <p>c Print the document.</p> <p>Do paper jams occur frequently?</p> | Go to step 3. | The problem is solved. |
| <p>Step 3</p> <p>a Load paper from a fresh package.</p> <p>Note: Paper absorbs moisture due to high humidity. Store paper in its original wrapper until you are ready to use it.</p> <p>b Print the document.</p> <p>Do paper jams occur frequently?</p> | Contact customer support . | The problem is solved. |

Jammed pages are not reprinted

| Action | Yes | No |
|--|-------------------------------|--|
| <p>a From the control panel, navigate to: Settings > Device > Notifications > Jam Content Recovery</p> <p>For non-touch-screen printer models, press  to navigate through the settings.</p> <p>b Select On or Auto, and then apply the changes.</p> <p>c Print the document.</p> <p>Are the jammed pages reprinted?</p> | <p>The problem is solved.</p> | <p>Contact customer support.</p> |

Printing problems

Print quality is poor

Blank or white pages



Note: Before solving the problem, print the Print Quality Test Pages. From the control panel, navigate to **Settings > Troubleshooting > Print Quality Test Pages**. For non-touch-screen printer models, press  to navigate through the settings.

| Action | Yes | No |
|---|--|-------------------------------|
| <p>a Remove, and then insert the imaging kit.</p> <p>Warning—Potential Damage: Do not expose the imaging kit to direct light. Extended exposure to light may cause print quality problems.</p> <p>Warning—Potential Damage: Do not touch the photoconductor drum under the imaging kit. Doing so may affect the quality of future print jobs.</p> <p>b Print the document.</p> <p>Is the printer printing blank or white pages?</p> | <p>Contact customer support.</p> | <p>The problem is solved.</p> |

Dark print

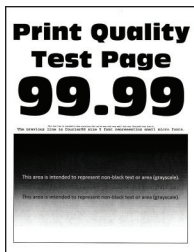



Note: Before solving the problem, print the Print Quality Test Pages. From the control panel, navigate to **Settings > Troubleshooting > Print Quality Test Pages**. For non-touch-screen printer models, press **OK** to navigate through the settings.

| Action | Yes | No |
|---|---------------|------------------------|
| <p>Step 1</p> <p>a Perform Color Adjust. From the control panel, navigate to: Settings > Print > Quality > Advanced Imaging > Color Adjust</p> <p>b Print the document.</p> <p>Is the print too dark?</p> | Go to step 2. | The problem is solved. |
| <p>Step 2</p> <p>a Depending on your operating system, reduce toner darkness from the Printing Preferences or Print dialog. Note: You can also change the setting on the printer control panel. Navigate to: Settings > Print > Quality > Toner Darkness</p> <p>b Print the document.</p> <p>Is the print too dark?</p> | Go to step 3. | The problem is solved. |
| <p>Step 3</p> <p>a Depending on your operating system, specify the paper type from the Printing Preferences or Print dialog. Notes:</p> <ul style="list-style-type: none"> • Make sure that the setting matches the paper loaded. • You can also change the setting on the printer control panel. Navigate to: Settings > Paper > Tray Configuration > Paper Size/Type <p>b Print the document.</p> <p>Is the print too dark?</p> | Go to step 4. | The problem is solved. |

| Action | Yes | No |
|---|--|------------------------|
| <p>Step 4 Check if the paper has texture or rough finishes.</p> <p>Are you printing on textured or rough paper?</p> | Go to step 5. | Go to step 6. |
| <p>Step 5 a Replace textured or rough paper with plain paper. b Print the document.</p> <p>Is the print too dark?</p> | Go to step 6. | The problem is solved. |
| <p>Step 6 a Load paper from a fresh package. Note: Paper absorbs moisture due to high humidity. Store paper in its original wrapper until you are ready to use it. b Print the document.</p> <p>Is the print too dark?</p> | Contact customer support . | The problem is solved. |

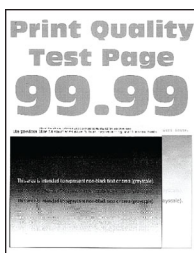
Ghost images



Note: Before solving the problem, print the Print Quality Test Pages. From the control panel, navigate to **Settings > Troubleshooting > Print Quality Test Pages**. For non-touch-screen printer models, press  to navigate through the settings.

| Action | Yes | No |
|--|---------------|------------------------|
| <p>Step 1 a Load the tray with the correct paper type. b Print the document.</p> <p>Do ghost images appear on prints?</p> | Go to step 2. | The problem is solved. |

| Action | Yes | No |
|--|--|------------------------|
| <p>Step 2</p> <p>a Depending on your operating system, specify the paper type from the Printing Preferences or Print dialog.</p> <p>Notes:</p> <ul style="list-style-type: none"> • Make sure that the setting matches the paper loaded. • You can also change the setting on the printer control panel. Navigate to: <p>Settings > Paper > Tray Configuration > Paper Size/Type</p> <p>b Print the document.</p> <p>Do ghost images appear on prints?</p> | Go to step 3. | The problem is solved. |
| <p>Step 3</p> <p>a Perform Color Adjust.</p> <p>From the control panel, navigate to:</p> <p>Settings > Print > Quality > Advanced Imaging > Color Adjust</p> <p>b Print the document.</p> <p>Do ghost images appear on prints?</p> | Go to step 4. | The problem is solved. |
| <p>Step 4</p> <p>a Remove, and then insert the imaging kit.</p> <p>Warning—Potential Damage: Do not expose the imaging kit to direct light. Extended exposure to light may cause print quality problems.</p> <p>Warning—Potential Damage: Do not touch the photoconductor drum under the imaging kit. Doing so may affect the quality of future print jobs.</p> <p>b Print the document.</p> <p>Do ghost images appear on prints?</p> | Contact customer support . | The problem is solved. |

Gray or colored background

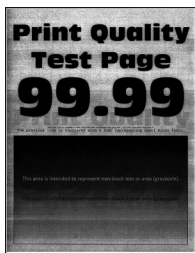

Note: Before solving the problem, print the Print Quality Test Pages. From the control panel, navigate to

Settings > Troubleshooting > Print Quality Test Pages. For non-touch-screen printer models, press  to navigate through the settings.

| Action | Yes | No |
|--|--|------------------------|
| <p>Step 1</p> <p>a Perform Color Adjust. From the control panel, navigate to: Settings > Print > Quality > Advanced Imaging > Color Adjust</p> <p>b Print the document.</p> <p>Does gray or colored background appear on prints?</p> | Go to step 2. | The problem is solved. |
| <p>Step 2</p> <p>a Remove, and then insert the imaging kit. Warning—Potential Damage: Do not expose the imaging kit to direct light. Extended exposure to light may cause print quality problems. Warning—Potential Damage: Do not touch the photoconductor drum under the imaging kit. Doing so may affect the quality of future print jobs.</p> <p>b Print the document.</p> <p>Does gray or colored background appear on prints?</p> | Contact customer support . | The problem is solved. |

Incorrect margins



| Action | Yes | No |
|--|------------------------|---------------|
| <p>Step 1</p> <p>a Adjust the paper guides to the correct position for the paper loaded.</p> <p>b Print the document.</p> <p>Are the margins correct?</p> | The problem is solved. | Go to step 2. |
| <p>Step 2</p> <p>a Set the paper size from the control panel. Navigate to: Settings > Paper > Tray Configuration > Paper Size/Type</p> <p>b Print the document.</p> <p>Are the margins correct?</p> | The problem is solved. | Go to step 3. |

| Action | Yes | No |
|---|-------------------------------|--|
| <p>Step 3</p> <p>a Depending on your operating system, specify the paper size from the Printing Preferences or Print dialog.</p> <p>Note: Make sure that the setting matches the paper loaded.</p> <p>b Print the document.</p> <p>Are the margins correct?</p> | <p>The problem is solved.</p> | <p>Contact customer support.</p> |

Light print

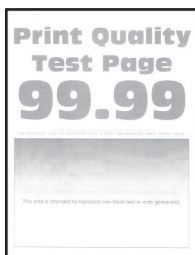

Note: Before solving the problem, print the Print Quality Test Pages. From the control panel, navigate to **Settings > Troubleshooting > Print Quality Test Pages**. For non-touch-screen printer models, press  to navigate through the settings.

| Action | Yes | No |
|--|----------------------|-------------------------------|
| <p>Step 1</p> <p>a Perform Color Adjust.</p> <p>From the control panel, navigate to:</p> <p>Settings > Print > Quality > Advanced Imaging > Color Adjust</p> <p>b Print the document.</p> <p>Is the print light?</p> | <p>Go to step 2.</p> | <p>The problem is solved.</p> |
| <p>Step 2</p> <p>a Depending on your operating system, increase toner darkness from the Printing Preferences or Print dialog.</p> <p>Note: You can also change the setting on the printer control panel. Navigate to:</p> <p>Settings > Print > Quality > Toner Darkness</p> <p>b Print the document.</p> <p>Is the print light?</p> | <p>Go to step 3.</p> | <p>The problem is solved.</p> |

| Action | Yes | No |
|---|---------------|------------------------|
| <p>Step 3</p> <p>a Turn off Color Saver. From the control panel, navigate to: Settings > Print > Quality > Color Saver</p> <p>b Print the document.</p> <p>Is the print light?</p> | Go to step 4. | The problem is solved. |
| <p>Step 4</p> <p>a Depending on your operating system, specify the paper type from the Printing Preferences or Print dialog.</p> <p>Notes:</p> <ul style="list-style-type: none"> • Make sure that the setting matches the paper loaded. • You can also change the setting on the printer control panel. Navigate to: Settings > Paper > Tray Configuration > Paper Size/Type <p>b Print the document.</p> <p>Is the print light?</p> | Go to step 5. | The problem is solved. |
| <p>Step 5</p> <p>Check if paper has texture or rough finishes.</p> <p>Are you printing on textured or rough paper?</p> | Go to step 6. | Go to step 7. |
| <p>Step 6</p> <p>a Replace textured or rough paper with plain paper.</p> <p>b Print the document.</p> <p>Is the print light?</p> | Go to step 7. | The problem is solved. |
| <p>Step 7</p> <p>a Load paper from a fresh package.</p> <p>Note: Paper absorbs moisture due to high humidity. Store paper in its original wrapper until you are ready to use it.</p> <p>b Print the document.</p> <p>Is the print light?</p> | Go to step 8. | The problem is solved. |

| Action | Yes | No |
|--|--|-------------------------------|
| <p>Step 8</p> <p>a Remove, and then insert the imaging kit.</p> <p>Warning—Potential Damage: Do not expose the imaging kit to direct light. Extended exposure to light may cause print quality problems.</p> <p>Warning—Potential Damage: Do not touch the photoconductor drum under the imaging kit. Doing so may affect the quality of future print jobs.</p> <p>b Print the document.</p> <p>Is the print light?</p> | <p>Contact customer support.</p> | <p>The problem is solved.</p> |

Missing colors

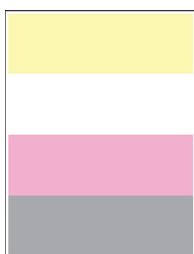

Note: Before solving the problem, print the Print Quality Test Pages. From the control panel, navigate to **Settings > Troubleshooting > Print Quality Test Pages**. For non-touch-screen printer models, press  to navigate through the settings.

| Action | Yes | No |
|---|--|-------------------------------|
| <p>a Remove the toner cartridge of the missing color.</p> <p>b Remove the imaging kit.</p> <p>Warning—Potential Damage: Do not expose the imaging kit to direct light. Extended exposure to light may cause print quality problems.</p> <p>Warning—Potential Damage: Do not touch the photoconductor drum under the imaging kit. Doing so may affect the quality of future print jobs.</p> <p>c Remove, and then insert the developer unit of the missing color.</p> <p>d Insert the imaging kit.</p> <p>e Insert the toner cartridge.</p> <p>f Print the document.</p> <p>Are some colors missing on prints?</p> | <p>Contact customer support.</p> | <p>The problem is solved.</p> |

Mottled print and dots



Note: Before solving the problem, print the Print Quality Test Pages. From the control panel, navigate to **Settings > Troubleshooting > Print Quality Test Pages**. For non-touch-screen printer models, press **OK** to navigate through the settings.

| Action | Yes | No |
|---|---------------|--|
| <p>Step 1 Check the printer for leaked toner contamination.</p> <p>Is the printer free of leaked toner?</p> | Go to step 2. | Contact customer support . |
| <p>Step 2</p> <p>a From the control panel, navigate to: Settings > Paper > Tray Configuration > Paper Size/Type</p> <p>b Check if the paper size and paper type settings match the paper loaded.</p> <p>Note: Make sure that paper does not have texture or rough finishes.</p> <p>Do the settings match?</p> | Go to step 4. | Go to step 3. |
| <p>Step 3</p> <p>a Depending on your operating system, specify the paper size and paper type from the Printing Preferences or Print dialog.</p> <p>Note: Make sure that the settings match the paper loaded.</p> <p>b Print the document.</p> <p>Is the print mottled?</p> | Go to step 4. | The problem is solved. |
| <p>Step 4</p> <p>a Load paper from a fresh package.</p> <p>Note: Paper absorbs moisture due to high humidity. Store paper in its original wrapper until you are ready to use it.</p> <p>b Print the document.</p> <p>Is the print mottled?</p> | Go to step 5. | The problem is solved. |

| Action | Yes | No |
|--|--|-------------------------------|
| <p>Step 5</p> <p>a Remove, and then insert the imaging kit.</p> <p>Warning—Potential Damage: Do not expose the imaging kit to direct light. Extended exposure to light may cause print quality problems.</p> <p>Warning—Potential Damage: Do not touch the photoconductor drum under the imaging kit. Doing so may affect the quality of future print jobs.</p> <p>b Print the document.</p> <p>Is the print mottled?</p> | <p>Contact customer support.</p> | <p>The problem is solved.</p> |

Paper curl



| Action | Yes | No |
|---|----------------------|-------------------------------|
| <p>Step 1</p> <p>a Adjust the guides in the tray to the correct position for the paper loaded.</p> <p>b Print the document.</p> <p>Is the paper curled?</p> | <p>Go to step 2.</p> | <p>The problem is solved.</p> |
| <p>Step 2</p> <p>a Depending on your operating system, specify the paper type from the Printing Preferences or Print dialog.</p> <p>Notes:</p> <ul style="list-style-type: none"> • Make sure that the setting matches the paper loaded. • You can also change the setting on the printer control panel. Navigate to: <p>Settings > Paper > Tray Configuration > Paper Size/Type</p> <p>b Print the document.</p> <p>Is the paper curled?</p> | <p>Go to step 3.</p> | <p>The problem is solved.</p> |

| Action | Yes | No |
|---|--|------------------------|
| <p>Step 3 Print on the other side of the paper. a Remove paper, flip it over, and then reload paper. b Print the document.</p> <p>Is the paper curled?</p> | Go to step 4. | The problem is solved. |
| <p>Step 4 a Load paper from a fresh package. Note: Paper absorbs moisture due to high humidity. Store paper in its original wrapper until you are ready to use it. b Print the document.</p> <p>Is the paper curled?</p> | Contact customer support . | The problem is solved. |

Print crooked or skewed



Note: Before solving the problem, print the Print Quality Test Pages. From the control panel, navigate to **Settings > Troubleshooting > Print Quality Test Pages**. For non-touch-screen printer models, press  to navigate through the settings.

| Action | Yes | No |
|--|---------------|------------------------|
| <p>Step 1 a Adjust the paper guides in the tray to the correct position for the paper loaded. b Print the document.</p> <p>Is the print crooked or skewed?</p> | Go to step 2. | The problem is solved. |
| <p>Step 2 a Load paper from a fresh package. Note: Paper absorbs moisture due to high humidity. Store paper in its original wrapper until you are ready to use it. b Print the document.</p> <p>Is the print crooked or skewed?</p> | Go to step 3. | The problem is solved. |

| Action | Yes | No |
|---|--|-------------------------------|
| <p>Step 3</p> <p>a Check if the paper loaded is supported. Note: If paper is not supported, then load a supported paper.</p> <p>b Print the document.</p> <p>Is the print crooked or skewed?</p> | <p>Contact customer support.</p> | <p>The problem is solved.</p> |

Solid color or black images



Note: Before solving the problem, print the Print Quality Test Pages. From the control panel, navigate to **Settings > Troubleshooting > Print Quality Test Pages**. For non-touch-screen printer models, press **OK** to navigate through the settings.

| Action | Yes | No |
|---|--|-------------------------------|
| <p>a Remove, and then reinstall the imaging kit. Warning—Potential Damage: Do not expose the imaging kit to direct light. Extended exposure to light may cause print quality problems. Warning—Potential Damage: Do not touch the photoconductor drum under the imaging kit. Doing so may affect the quality of future print jobs.</p> <p>b Print the document.</p> <p>Is the printer printing solid color or black images?</p> | <p>Contact customer support.</p> | <p>The problem is solved.</p> |

Text or images cut off



Note: Before solving the problem, print the Print Quality Test Pages. From the control panel, navigate to **Settings > Troubleshooting > Print Quality Test Pages**. For non-touch-screen printer models, press **OK** to navigate through the settings.

| Action | Yes | No |
|--|--|------------------------|
| <p>Step 1</p> <p>a Adjust the paper guides in the tray to the correct position for the paper loaded.</p> <p>b Print the document.</p> <p>Are text or images cut off?</p> | Go to step 2. | The problem is solved. |
| <p>Step 2</p> <p>a Depending on your operating system, specify the paper size from the Printing Preferences or Print dialog.</p> <p>Notes:</p> <ul style="list-style-type: none"> • Make sure that the setting matches the paper loaded. • You can also change the setting on the printer control panel. Navigate to: <p>Settings > Paper > Tray Configuration > Paper Size/Type</p> <p>b Print the document.</p> <p>Are text or images cut off?</p> | Go to step 3. | The problem is solved. |
| <p>Step 3</p> <p>a Remove, and then insert the imaging kit.</p> <p>Warning—Potential Damage: Do not expose the imaging kit to direct light. Extended exposure to light may cause print quality problems.</p> <p>Warning—Potential Damage: Do not touch the photoconductor drum under the imaging kit. Doing so may affect the quality of future print jobs.</p> <p>b Print the document.</p> <p>Are text or images cut off?</p> | Contact customer support . | The problem is solved. |

Toner easily rubs off

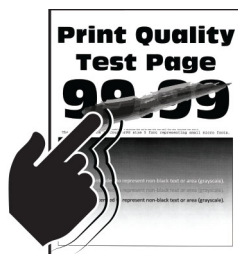

Note: Before solving the problem, print the Print Quality Test Pages. From the control panel, navigate to **Settings > Troubleshooting > Print Quality Test Pages**. For non-touch-screen printer models, press **OK** to navigate through the settings.

| Action | Yes | No |
|---|--|------------------------|
| <p>Step 1</p> <p>a Depending on your operating system, specify the paper type from the Printing Preferences or Print dialog.</p> <p>Notes:</p> <ul style="list-style-type: none"> • Make sure that the setting matches the paper loaded. • You can also change the setting on the printer control panel. Navigate to: <p>Settings > Paper > Tray Configuration > Paper Size/Type</p> <p>b Print the document.</p> <p>Does toner easily rub off?</p> | Go to step 2. | The problem is solved. |
| <p>Step 2</p> <p>a Check if the paper weight is supported.</p> <p>Note: If paper weight is not supported, then load a supported one.</p> <p>b Print the document.</p> <p>Does toner easily rub off?</p> | Go to step 3. | The problem is solved. |
| <p>Step 3</p> <p>a Load paper from a fresh package.</p> <p>Note: Paper absorbs moisture due to high humidity. Store paper in its original wrapper until you are ready to use it.</p> <p>b Print the document.</p> <p>Does toner easily rub off?</p> | Contact customer support . | The problem is solved. |

Uneven print density

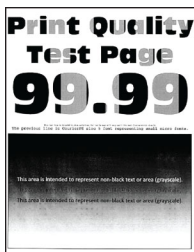

Note: Before solving the problem, print the Print Quality Test Pages. From the control panel, navigate to **Settings > Troubleshooting > Print Quality Test Pages**. For non-touch-screen printer models, press **OK** to navigate through the settings.

| Action | Yes | No |
|--|--|-------------------------------|
| <p>a Remove, and then insert the imaging kit.</p> <p>Warning—Potential Damage: Do not expose the imaging kit to direct light. Extended exposure to light may cause print quality problems.</p> <p>Warning—Potential Damage: Do not touch the photoconductor drum under the imaging kit. Doing so may affect the quality of future print jobs.</p> <p>b Print the document.</p> <p>Is the print density uneven?</p> | <p>Contact customer support.</p> | <p>The problem is solved.</p> |

Horizontal dark lines



Notes:

- Before solving the problem, print the Print Quality Test Pages. From the control panel, navigate to **Settings > Troubleshooting > Print Quality Test Pages**. For non-touch-screen printer models, press  to navigate through the settings.
- If horizontal dark lines keep appearing on the prints, then see the “Repeating defects” topic.

| Action | Yes | No |
|---|----------------------|-------------------------------|
| <p>Step 1</p> <p>a Depending on your operating system, specify the paper type from the Printing Preferences or Print dialog.</p> <p>Notes:</p> <ul style="list-style-type: none"> • Make sure that the setting matches the paper loaded. • You can also change the setting on the printer control panel. Navigate to: Settings > Paper > Tray Configuration > Paper Size/Type <p>b Print the document.</p> <p>Do dark lines appear on prints?</p> | <p>Go to step 2.</p> | <p>The problem is solved.</p> |

| Action | Yes | No |
|--|--|------------------------|
| <p>Step 2</p> <p>a Load paper from a fresh package.</p> <p>Note: Paper absorbs moisture due to high humidity. Store paper in its original wrapper until you use it.</p> <p>b Print the document.</p> <p>Do dark lines appear on prints?</p> | Go to step 3. | The problem is solved. |
| <p>Step 3</p> <p>a Remove, and then insert the imaging kit.</p> <p>Warning—Potential Damage: Do not expose the imaging kit to direct light. Extended exposure to light may cause print quality problems.</p> <p>Warning—Potential Damage: Do not touch the photoconductor drum under the imaging kit. Doing so may affect the quality of future print jobs.</p> <p>b Print the document.</p> <p>Do dark lines appear on prints?</p> | Contact customer support . | The problem is solved. |

Vertical dark lines



Note: Before solving the problem, print the Print Quality Test Pages. From the control panel, navigate to **Settings > Troubleshooting > Print Quality Test Pages**. For non-touch-screen printer models, press  to navigate through the settings.

| Action | Yes | No |
|---|--|------------------------|
| <p>Step 1</p> <p>a Depending on your operating system, specify the paper type from the Printing Preferences or Print dialog.</p> <p>Notes:</p> <ul style="list-style-type: none"> • Make sure that the setting matches the paper loaded. • You can also change the setting on the printer control panel. Navigate to: <p>Settings > Paper > Tray Configuration > Paper Size/Type</p> <p>b Print the document.</p> <p>Do vertical dark lines appear on prints?</p> | Go to step 2. | The problem is solved. |
| <p>Step 2</p> <p>a Load paper from a fresh package.</p> <p>Note: Paper absorbs moisture due to high humidity. Store paper in its original wrapper until you use it.</p> <p>b Print the document.</p> <p>Do vertical dark lines appear on prints?</p> | Go to step 3. | The problem is solved. |
| <p>Step 3</p> <p>a Remove, and then insert the imaging kit.</p> <p>Warning—Potential Damage: Do not expose the imaging kit to direct light. Extended exposure to light can cause print quality problems.</p> <p>Warning—Potential Damage: Do not touch the photoconductor drum under the imaging kit. Doing so may affect the quality of future print jobs.</p> <p>b Print the document.</p> <p>Do vertical dark lines appear on prints?</p> | Contact customer support . | The problem is solved. |

Horizontal white lines



Notes:

- Before solving the problem, print the Print Quality Test Pages. From the control panel, navigate to **Settings > Troubleshooting > Print Quality Test Pages**. For non-touch-screen printer models, press  to navigate through the settings.
- If horizontal white lines keep appearing on your prints, then see the “Repeating defects” topic.

| Action | Yes | No |
|---|--|------------------------|
| <p>Step 1</p> <p>a Depending on your operating system, specify the paper type from the Printing Preferences or Print dialog.</p> <p>Notes:</p> <ul style="list-style-type: none"> • Make sure that the setting matches the paper loaded. • You can also change the setting on the printer control panel. Navigate to: Settings > Paper > Tray Configuration > Paper Size/Type <p>b Print the document.</p> <p>Do horizontal white lines appear on prints?</p> | Go to step 2. | The problem is solved. |
| <p>Step 2</p> <p>a Remove, and then insert the imaging kit.</p> <p>Warning—Potential Damage: Do not expose the imaging kit to direct light. Extended exposure to light can cause print quality problems.</p> <p>Warning—Potential Damage: Do not touch the photoconductor drum under the imaging kit. Doing so may affect the quality of future print jobs.</p> <p>b Print the document.</p> <p>Do horizontal white lines appear on prints?</p> | Contact customer support . | The problem is solved. |

Vertical white lines



Note: Before solving the problem, print the Print Quality Test Pages. From the control panel, navigate to **Settings > Troubleshooting > Print Quality Test Pages**. For non-touch-screen printer models, press  to navigate through the settings.

| Action | Yes | No |
|--|--|------------------------|
| <p>Step 1</p> <p>a Depending on your operating system, specify the paper type from the Printing Preferences or Print dialog.</p> <p>Notes:</p> <ul style="list-style-type: none"> • Make sure that the setting matches the paper loaded. • You can also change the setting on the printer control panel. Navigate to: <p>Settings > Paper > Tray Configuration > Paper Size/Type</p> <p>b Print the document.</p> <p>Do vertical white lines appear on prints?</p> | Go to step 2. | The problem is solved. |
| <p>Step 2</p> <p>Check if you are using the recommended paper type.</p> <p>a Load the paper source with the recommended paper type.</p> <p>b Print the document.</p> <p>Do vertical white lines appear on prints?</p> | Go to step 3. | The problem is solved. |
| <p>Step 3</p> <p>a Remove, and then insert the imaging kit.</p> <p>Warning—Potential Damage: Do not expose the imaging kit to direct light. Extended exposure to light may cause print quality problems.</p> <p>Warning—Potential Damage: Do not touch the photoconductor drum under the imaging kit. Doing so may affect the quality of future print jobs.</p> <p>b Print the document.</p> <p>Do vertical white lines appear on prints?</p> | Contact customer support . | The problem is solved. |

Repeating defects



Note: Before solving the problem, print the Print Quality Test Pages. From the control panel, navigate to **Settings > Troubleshooting > Print Quality Test Pages**. For non-touch-screen printer models, press  to navigate through the settings.



| Action | Yes | No |
|---|--|--|
| <p>a Using the Print Quality Test Pages, measure the distance between the repeating defects on the affected color page.</p> <p>b Check if the repeating defects match any of the following measurements:</p> <p>Imaging kit</p> <ul style="list-style-type: none"> • 94.20 mm (3.71 in.) • 29.80 mm (1.17 in.) • 23.20 mm (0.91 in.) <p>Developer unit</p> <ul style="list-style-type: none"> • 43.90 mm (1.73 in.) • 45.50 mm (1.79 in.) <p>Transfer module</p> <ul style="list-style-type: none"> • 37.70 mm (1.48 in.) • 78.50 mm (3.09 in.) • 55 mm (2.17 in.) <p>Fuser</p> <ul style="list-style-type: none"> • 79.80 mm (3.14 in.) • 94.30 mm (3.71 in.) <p>Do the repeating defects match any of the measurements?</p> | <p>Take note of the distance, and then contact customer support.</p> | <p>Take note of the distance, and then contact customer support.</p> |

Confidential and other held documents do not print

| Action | Yes | No |
|--|-------------------------------|----------------------|
| <p>Step 1</p> <p>a From the control panel, check if the documents appear in the Held Jobs list.</p> <p>Note: If the documents are not listed, then print the documents using the Print and Hold options.</p> <p>b Print the documents.</p> <p>Are the documents printed?</p> | <p>The problem is solved.</p> | <p>Go to step 2.</p> |
| <p>Step 2</p> <p>The print job may contain a formatting error or invalid data.</p> <ul style="list-style-type: none"> • Delete the print job, and then send it again. • For PDF files, generate a new file, and then print the documents. <p>Are the documents printed?</p> | <p>The problem is solved.</p> | <p>Go to step 3.</p> |

| Action | Yes | No |
|--|-------------------------------|--|
| <p>Step 3</p> <p>If you are printing from the Internet, then the printer may be reading the multiple job titles as duplicates.</p> <p>For Windows users</p> <ul style="list-style-type: none"> a Open the Printing Preferences dialog. b From the Print and Hold section, select Keep duplicate documents. c Enter a PIN. d Resend the print job. <p>For Macintosh users</p> <ul style="list-style-type: none"> a Save and name each job differently. b Send the job individually. <p>Are the documents printed?</p> | <p>The problem is solved.</p> | <p>Go to step 4.</p> |
| <p>Step 4</p> <ul style="list-style-type: none"> a Delete some held jobs to free up printer memory. b Resend the print job. <p>Are the documents printed?</p> | <p>The problem is solved.</p> | <p>Go to step 5.</p> |
| <p>Step 5</p> <ul style="list-style-type: none"> a Add printer memory. b Resend the print job. <p>Are the documents printed?</p> | <p>The problem is solved.</p> | <p>Contact customer support.</p> |

Slow printing

| Action | Yes | No |
|---|---------------|------------------------|
| <p>Step 1</p> <p>Make sure that the printer cable is securely connected to the printer and to the computer, print server, option, or other network device.</p> <p>Is the printer printing slow?</p> | Go to step 2. | The problem is solved. |
| <p>Step 2</p> <p>a Make sure that the printer is not in Eco-Mode or Quiet Mode.</p> <ul style="list-style-type: none"> From the control panel, navigate to: Settings > Device > Power Management > Eco-Mode From the control panel, navigate to: Settings > Device > Maintenance > Configuration Menu > Device Operations > Quiet Mode <p>For non-touch-screen printer models, press  to navigate through the settings.</p> <p>b Print the document.</p> <p>Is the printer printing slow?</p> | Go to step 3. | The problem is solved. |
| <p>Step 3</p> <p>a Depending on your operating system, specify the print resolution from the Printing Preferences or Print dialog.</p> <p>b Set the resolution to 4800 CQ.</p> <p>c Print the document.</p> <p>Is the printer printing slow?</p> | Go to step 4. | The problem is solved. |
| <p>Step 4</p> <p>a From the control panel, navigate to: Settings > Print > Quality > Print Resolution</p> <p>For non-touch-screen printer models, press  to navigate through the settings.</p> <p>b Set the resolution to 4800 CQ.</p> <p>c Print the document.</p> <p>Is the printer printing slow?</p> | Go to step 5. | The problem is solved. |

| Action | Yes | No |
|--|--|-------------------------------|
| <p>Step 5</p> <p>a Depending on your operating system, specify the paper type from the Printing Preferences or Print dialog.</p> <p>Notes:</p> <ul style="list-style-type: none"> • Make sure that the setting matches the paper loaded. • Heavier paper prints more slowly. • Paper narrower than letter, A4, and legal may print more slowly. <p>b Print the document.</p> <p>Is the printer printing slow?</p> | <p>Go to step 6.</p> | <p>The problem is solved.</p> |
| <p>Step 6</p> <p>a Make sure that the printer settings for Texture and Weight match the paper being loaded.</p> <p>From the control panel, navigate to:</p> <p>Settings > Paper > Media Configuration > Media Types</p> <p>Note: Rough paper textures and heavy paper weights may print more slowly.</p> <p>b Print the document.</p> <p>Is the printer printing slow?</p> | <p>Go to step 7.</p> | <p>The problem is solved.</p> |
| <p>Step 7</p> <p>Remove held jobs.</p> <p>Is the printer printing slow?</p> | <p>Go to step 8.</p> | <p>The problem is solved.</p> |
| <p>Step 8</p> <p>a Make sure that the printer is not overheating.</p> <p>Notes:</p> <ul style="list-style-type: none"> • Allow the printer to cool down after a long print job. • Observe the recommended ambient temperature for the printer. For more information, see “Selecting a location for the printer” on page 11. <p>b Print the document.</p> <p>Is the printer printing slow?</p> | <p>Go to step 9.</p> | <p>The problem is solved.</p> |
| <p>Step 9</p> <p>a Add more printer memory.</p> <p>b Print the document.</p> <p>Is the printer printing slow?</p> | <p>Contact customer support.</p> | <p>The problem is solved.</p> |

Print jobs do not print

| Action | Yes | No |
|---|------------------------|--|
| <p>Step 1</p> <p>a From the document you are trying to print, open the Print dialog, and then check if you have selected the correct printer.</p> <p>b Print the document.</p> <p>Is the document printed?</p> | The problem is solved. | Go to step 2. |
| <p>Step 2</p> <p>a Check if the printer is on.</p> <p>b Resolve any error messages that appear on the display.</p> <p>c Print the document.</p> <p>Is the document printed?</p> | The problem is solved. | Go to step 3. |
| <p>Step 3</p> <p>a Check if the ports are working and if the cables are securely connected to the computer and the printer. For more information, see the setup documentation that came with the printer.</p> <p>b Print the document.</p> <p>Is the document printed?</p> | The problem is solved. | Go to step 4. |
| <p>Step 4</p> <p>a Turn off the printer, wait for about 10 seconds, and then turn on the printer.</p> <p>b Print the document.</p> <p>Is the document printed?</p> | The problem is solved. | Go to step 5. |
| <p>Step 5</p> <p>a Remove, and then reinstall the print driver.</p> <p>b Print the document.</p> <p>Is the document printed?</p> | The problem is solved. | Contact customer support . |

The printer is not responding

| Action | Yes | No |
|---|---|--|
| <p>Step 1 Check if the power cord is connected to the electrical outlet.</p> <p> CAUTION—POTENTIAL INJURY: To avoid the risk of fire or electrical shock, connect the power cord to an appropriately rated and properly grounded electrical outlet that is near the product and easily accessible.</p> <p>Is the printer responding?</p> | The problem is solved. | Go to step 2. |
| <p>Step 2 Check if the electrical outlet is turned off by a switch or breaker.</p> <p>Is the electrical outlet turned off by a switch or breaker?</p> | Turn on the switch or reset the breaker. | Go to step 3. |
| <p>Step 3 Check if the printer is on.</p> <p>Is the printer on?</p> | Go to step 4. | Turn on the printer. |
| <p>Step 4 Check if the printer is in Sleep or Hibernate mode.</p> <p>Is the printer in Sleep or Hibernate mode?</p> | Press the power button to wake the printer. | Go to step 5. |
| <p>Step 5 Check if the cables connecting the printer and the computer are inserted to the correct ports.</p> <p>Are the cables inserted to the correct ports?</p> | Go to step 6. | Insert the cables to the correct ports. |
| <p>Step 6 Turn off the printer, install the hardware options, and then turn on the printer. For more information, see the documentation that came with the option.</p> <p>Is the printer responding?</p> | The problem is solved. | Go to step 7. |
| <p>Step 7 Install the correct print driver.</p> <p>Is the printer responding?</p> | The problem is solved. | Go to step 8. |
| <p>Step 8 Turn off the printer, wait for about 10 seconds, and then turn on the printer.</p> <p>Is the printer responding?</p> | The problem is solved. | Contact customer support . |

Job prints from the wrong tray or on the wrong paper

| Action | Yes | No |
|---|------------------------|---|
| <p>Step 1</p> <p>a Check if you are printing on the correct paper.</p> <p>b Print the document.</p> <p>Is the document printed on the correct paper?</p> | Go to step 2. | Load the correct paper size and paper type. |
| <p>Step 2</p> <p>a Depending on your operating system, specify the paper size and paper type from the Printing Preferences or Print dialog.</p> <p>Note: You can also change the settings on the printer control panel. Navigate to:</p> <p>Settings > Paper > Tray Configuration > Paper Size/Type</p> <p>For non-touch-screen printer models, press  to navigate through the settings.</p> <p>b Make sure that the settings match the paper loaded.</p> <p>c Print the document.</p> <p>Is the document printed on the correct paper?</p> | The problem is solved. | Go to step 3. |
| <p>Step 3</p> <p>a Check if the trays are linked.</p> <p>For more information, see “Linking trays” on page 31.</p> <p>b Print the document.</p> <p>Is the document printed from the correct tray?</p> | The problem is solved. | Contact customer support . |

Color quality problems

Adjusting toner darkness

1 From the control panel, navigate to:

Settings > Print > Quality > Toner Darkness

For non-touch-screen printer models, press  to navigate through the settings.

2 Adjust the setting.

3 Apply the changes.

Modifying the colors in printed output

For non-touch-screen printer models, press  to navigate through the settings.

- 1 From the control panel, navigate to:
Settings > Print > Quality > Advanced Imaging > Color Correction
- 2 From the Color Correction menu, select **Manual > Color Correction Content**.
- 3 Choose the appropriate color conversion setting.

| Object type | Color conversion tables |
|--|--|
| RGB Image RGB Text RGB Graphics | <ul style="list-style-type: none"> • Vivid—Produces brighter, more saturated colors and may be applied to all incoming color formats. • sRGB Display—Produces an output that approximates the colors displayed on a computer monitor. Black toner usage is optimized for printing photographs. • Display-True Black—Produces an output that approximates the colors displayed on a computer monitor. This setting uses only black toner to create all levels of neutral gray. • sRGB Vivid—Provides an increased color saturation for the sRGB Display color correction. Black toner usage is optimized for printing business graphics. • Off |
| CMYK Image CMYK Text CMYK Graphics | <ul style="list-style-type: none"> • US CMYK—Applies color correction to approximate the Specifications for Web Offset Publishing (SWOP) color output. • Euro CMYK—Applies color correction to approximate Euroscale color output. • Vivid CMYK—Increases the color saturation of the US CMYK color correction setting. • Off |

FAQ about color printing

What is RGB color?

RGB color is a method of describing colors by indicating the amount of red, green, or blue used to produce a certain color. Red, green, and blue light can be added in various amounts to produce a large range of colors observed in nature. Computer screens, scanners, and digital cameras use this method to display colors.

What is CMYK color?

CMYK color is a method of describing colors by indicating the amount of cyan, magenta, yellow, and black used to reproduce a particular color. Cyan, magenta, yellow, and black inks or toners can be printed in various amounts to produce a large range of colors observed in nature. Printing presses, inkjet printers, and color laser printers create colors in this manner.

How is color specified in a document to be printed?

Software programs are used to specify and modify the document color using RGB or CMYK color combinations. For more information, see the software program Help topics.

How does the printer know what color to print?

When printing a document, information describing the type and color of each object is sent to the printer and is passed through color conversion tables. Color is translated into the appropriate amounts of cyan, magenta, yellow, and black toner used to produce the color you want. The object information determines the application of color conversion tables. For example, it is possible to apply one type of color conversion table to text while applying a different color conversion table to photographic images.

What is manual color correction?

When manual color correction is enabled, the printer employs user-selected color conversion tables to process objects. Manual color correction settings are specific to the type of object being printed (text, graphics, or images). It is also specific to how the color of the object is specified in the software program (RGB or CMYK combinations). To apply a different color conversion table manually, see [“Modifying the colors in printed output” on page 159](#).

If the software program does not specify colors with RGB or CMYK combinations, then manual color correction is not useful. It is also not effective if the software program or the computer operating system controls the adjustment of colors. In most situations, setting the Color Correction to Auto generates preferred colors for the documents.

How can I match a particular color (such as a corporate logo)?

From the printer Quality menu, nine types of Color Samples sets are available. These sets are also available from the Color Samples page of the Embedded Web Server. Selecting any sample set generates multiple-page prints consisting of hundreds of colored boxes. Each box contains a CMYK or RGB combination, depending on the table selected. The observed color of each box is obtained by passing the CMYK or RGB combination labeled on the box through the selected color conversion table.



By examining Color Samples sets, you can identify the box with color closest to the color being matched. The color combination labeled on the box can then be used for modifying the color of the object in a software program. For more information, see the software program Help topics. Manual color correction may be necessary to use the selected color conversion table for the particular object.

Selecting which Color Samples set to use for a particular color-matching problem depends on:

- The Color Correction setting being used (Auto, Off, or Manual)
- The type of object being printed (text, graphics, or images)
- How the color of the object is specified in the software program (RGB or CMYK combinations)

If the software program does not specify colors with RGB or CMYK combinations, then the Color Samples pages are not useful. Additionally, some software programs adjust the RGB or CMYK combinations specified in the program through color management. In these situations, the printed color may not be an exact match of the Color Samples pages.

The print appears tinted

| Action | Yes | No |
|--|--|-------------------------------|
| <p>Step 1 Perform Color Adjust.</p> <p>a From the control panel, navigate to: Settings > Print > Quality > Advanced Imaging > Color Adjust</p> <p>For non-touch-screen printer models, press  to navigate through the settings.</p> <p>b Print the document.</p> <p>Does the print appear tinted?</p> | <p>Go to step 2.</p> | <p>The problem is solved.</p> |
| <p>Step 2 From the control panel, navigate to: Settings > Print > Quality > Advanced Imaging > Color Balance</p> <p>For non-touch-screen printer models, press  to navigate through the settings.</p> <p>b Adjust the settings. c Print the document.</p> <p>Does the print appear tinted?</p> | <p>Contact customer support.</p> | <p>The problem is solved.</p> |

Contacting customer support

Before contacting customer support, make sure to have the following information:

- Printer problem
- Error message
- Printer model type and serial number

Go to <http://support.lexmark.com> to receive e-mail or chat support, or browse through the library of manuals, support documentation, drivers, and other downloads.

Technical support via telephone is also available. In the U.S. or Canada, call 1-800-539-6275. For other countries or regions, go to <http://support.lexmark.com>.

Upgrading and migrating

Hardware

Available internal options

- Flash memory
- Font cards
- Firmware cards
 - Forms and Bar Code
 - PRESCRIBE
- Printer hard disk

Note: Some options are available only in some printer models. For more information, contact the place where you purchased the printer.

Accessing the controller board



CAUTION—SHOCK HAZARD: To avoid the risk of electrical shock, if you are accessing the controller board or installing optional hardware or memory devices sometime after setting up the printer, then turn the printer off, and unplug the power cord from the electrical outlet before continuing. If you have any other devices attached to the printer, then turn them off as well, and unplug any cables going into the printer.

- 1 Turn off the printer.
- 2 Unplug the power cord from the electrical outlet, and then from the printer.
- 3 Using a flat-head screwdriver, remove the controller board access cover.

Warning—Potential Damage: Controller board electronic components are easily damaged by static electricity. Touch a metal surface on the printer before touching any controller board electronic components or connectors.

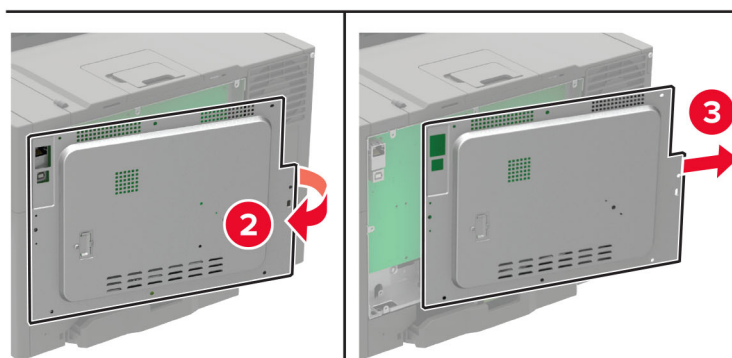
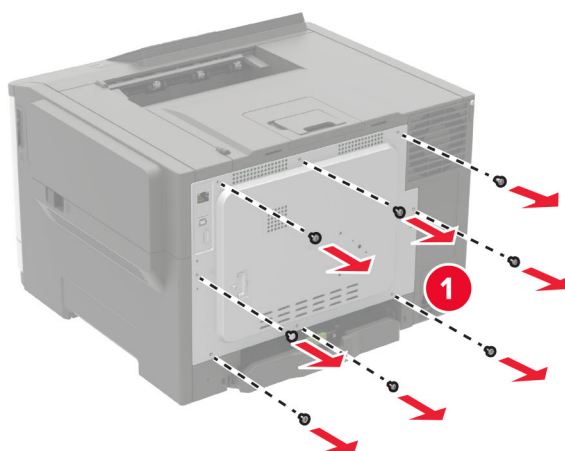

- 4 Attach the access cover.

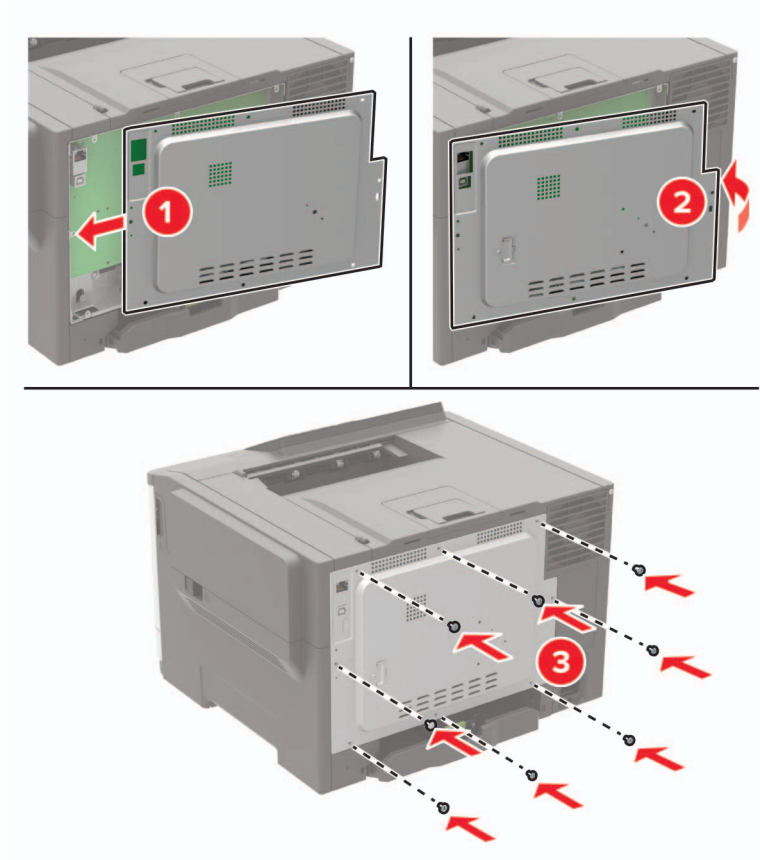

- 5 Connect the power cord to the printer, and then to the electrical outlet.

CAUTION—POTENTIAL INJURY: To avoid the risk of fire or electrical shock, connect the power cord to an appropriately rated and properly grounded electrical outlet that is near and easily accessible.

- 6 Turn on the printer.

Installing a printer hard disk

CAUTION—SHOCK HAZARD: To avoid the risk of electrical shock, if you are accessing the controller board or installing optional hardware or memory devices sometime after setting up the printer, then turn the printer off, and unplug the power cord from the electrical outlet before continuing. If you have any other devices attached to the printer, then turn them off as well, and unplug any cables going into the printer.

- 1 Turn off the printer.
- 2 Unplug the power cord from the electrical outlet, and then from the printer.
- 3 Using a flat-head screwdriver, remove the controller board access cover.

Warning—Potential Damage: Controller board electronic components are easily damaged by static electricity. Touch a metal surface on the printer before touching any controller board components or connectors.

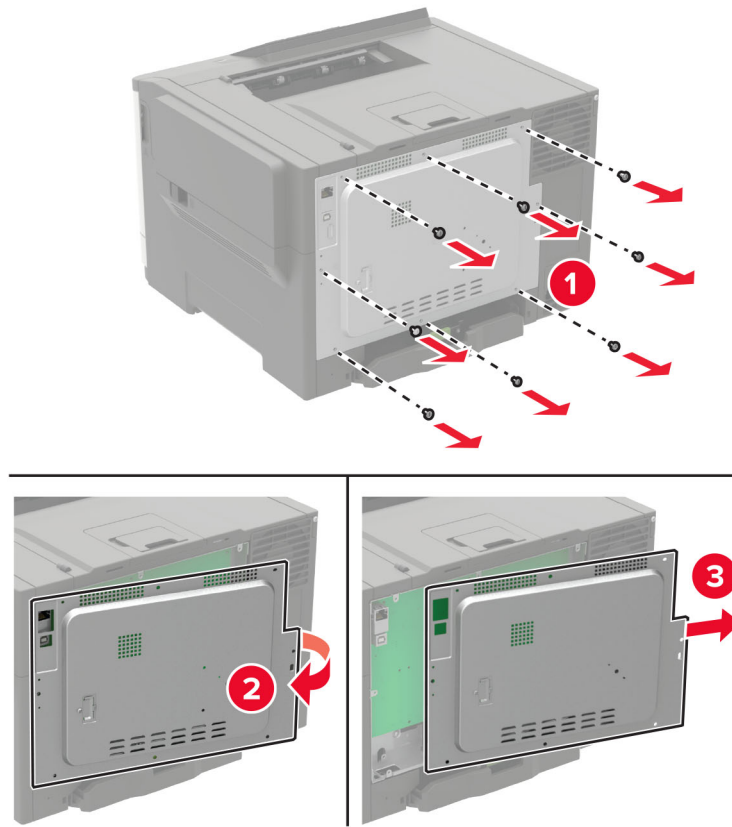

4 Using a flat-head screwdriver, remove the hard disk port cover from the controller board access cover.

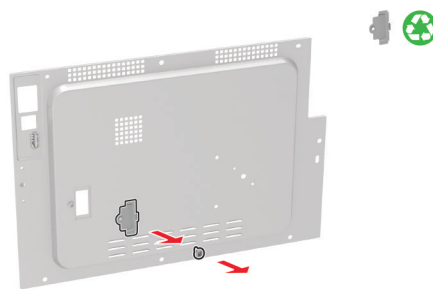

5 Unpack, and then assemble the hard disk.

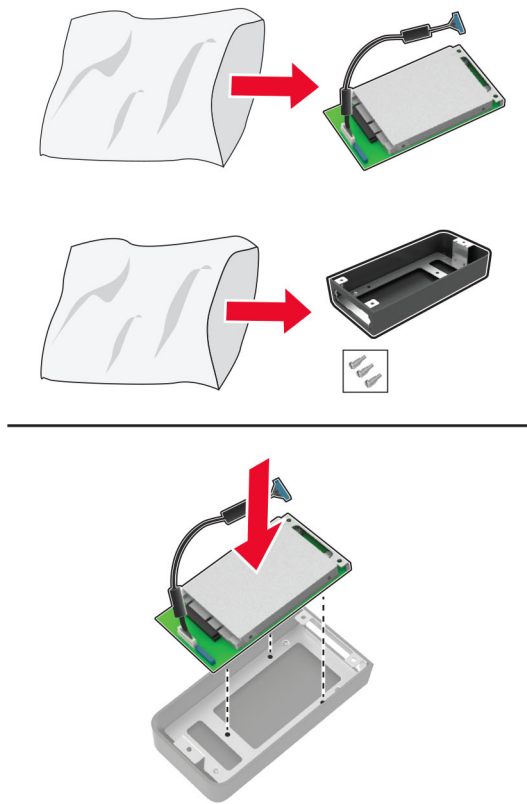

6 Attach the hard disk to the controller board access cover.

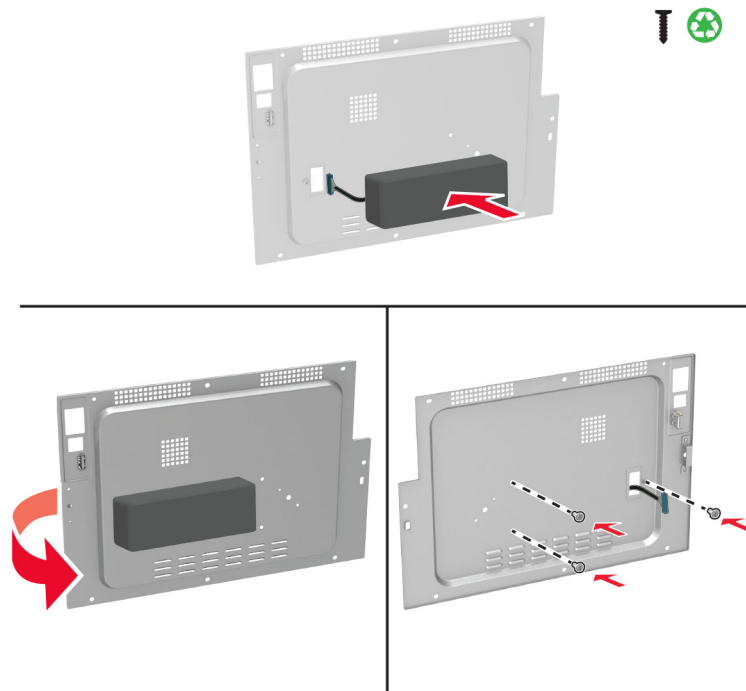

- 7 Connect the hard disk interface cable to the controller board, and then attach the access cover.

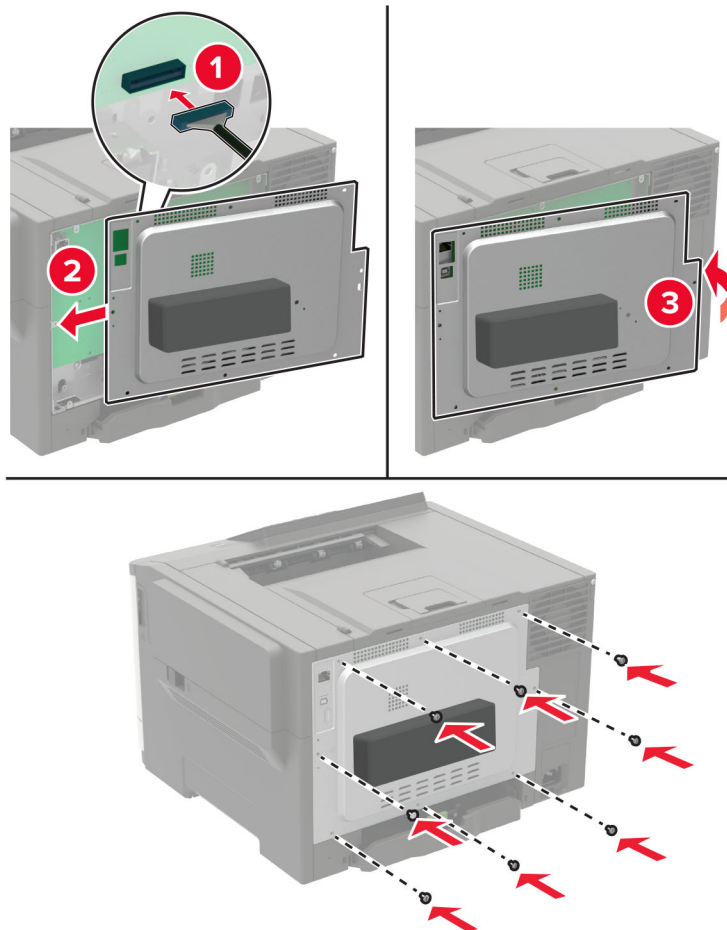

- 8 Connect the power cord to the printer, and then to the electrical outlet.

CAUTION—POTENTIAL INJURY: To avoid the risk of fire or electrical shock, connect the power cord to an appropriately rated and properly grounded electrical outlet that is near the product and easily accessible.

- 9 Turn on the printer.

Installing optional trays

Note: Depending on your printer model, you may install a 650-sheet duo tray or both the 650-sheet duo tray and 550-sheet tray.

CAUTION—SHOCK HAZARD: To avoid the risk of electrical shock, if you are accessing the controller board or installing optional hardware or memory devices sometime after setting up the printer, then turn the printer off, and unplug the power cord from the electrical outlet before continuing. If you have any other devices attached to the printer, then turn them off as well, and unplug any cables going into the printer.

- 1 Turn off the printer.
- 2 Unplug the power cord from the electrical outlet, and then from the printer.

- 3 Unpack the optional tray, and then remove all packing material.
- 4 Align the printer with the optional tray, and then lower the printer into place.

⚠ CAUTION—POTENTIAL INJURY: If the printer weight is greater than 20 kg (44 lb), then it requires two or more trained personnel to lift it safely.



Note: If you are installing both the optional trays, then place the 550-sheet tray below the 650-sheet duo tray.

- 5 Connect the power cord to the printer, and then to the electrical outlet.

⚠ CAUTION—POTENTIAL INJURY: To avoid the risk of fire or electrical shock, connect the power cord to an appropriately rated and properly grounded electrical outlet that is near the product and easily accessible.

- 6 Turn on the printer.

Add the tray in the print driver to make it available for print jobs. For more information, see [“Adding available options in the print driver” on page 169](#).

Software

Installing the printer software

- 1 Obtain a copy of the software installer package.
 - From the software CD that came with your printer.
 - Go to <http://support.lexmark.com>, and then select your printer and operating system.
- 2 Run the installer, and then follow the instructions on the computer screen.

- 3 For Macintosh users, add the printer.

Note: Obtain the printer IP address from the TCP/IP section in the Network/Ports menu.

Adding available options in the print driver

For Windows users

- 1 Open the printers folder.
- 2 Select the printer you want to update, and then do either of the following:
 - For Windows 7 or later, select **Printer properties**.
 - For earlier versions, select **Properties**.
- 3 Navigate to the Configuration tab, and then select **Update Now - Ask Printer**.
- 4 Apply the changes.

For Macintosh users

- 1 From System Preferences in the Apple menu, navigate to your printer, and then select **Options & Supplies**.
- 2 Navigate to the list of hardware options, and then add any installed options.
- 3 Apply the changes.

Firmware

Exporting or importing a configuration file

You can export the configuration settings of your printer into a text file, and then import the file to apply the settings to other printers.

- 1 Open a web browser, and then type the printer IP address in the address field.

Notes:

- View the printer IP address on the printer home screen. The IP address appears as four sets of numbers separated by periods, such as 123.123.123.123.
- If you are using a proxy server, then temporarily disable it to load the web page correctly.

- 2 Export or import a configuration file for one or multiple applications.

For one application

- a From the Embedded Web Server, click **Apps** > the application that you want > **Configure**.
- b Click **Export** or **Import**.

For multiple applications

- a From the Embedded Web Server, click **Export Configuration** or **Import Configuration**.
- b Follow the instructions on the screen.

Updating firmware

Some applications require a minimum device firmware level to operate correctly.

For more information on updating the device firmware, contact your Lexmark representative.

- 1** From the Embedded Web Server, click **Settings > Device > Update Firmware**.
- 2** Browse to locate the required flash file.
- 3** Apply the changes.

Notices

Product information

Product name:

Lexmark C2240, Lexmark C2325dw, Lexmark C2425dw, Lexmark C2535dw, Lexmark CS421dn, Lexmark CS521dn, Lexmark CS622de Printers

Machine type:

5029

Model(s):

038, 230, 238, 430, 438, 636, 696

Edition notice

September 2022

The following paragraph does not apply to any country where such provisions are inconsistent with local law: LEXMARK INTERNATIONAL, INC., PROVIDES THIS PUBLICATION "AS IS" WITHOUT WARRANTY OF ANY KIND, EITHER EXPRESS OR IMPLIED, INCLUDING, BUT NOT LIMITED TO, THE IMPLIED WARRANTIES OF MERCHANTABILITY OR FITNESS FOR A PARTICULAR PURPOSE. Some states do not allow disclaimer of express or implied warranties in certain transactions; therefore, this statement may not apply to you.

This publication could include technical inaccuracies or typographical errors. Changes are periodically made to the information herein; these changes will be incorporated in later editions. Improvements or changes in the products or the programs described may be made at any time.

References in this publication to products, programs, or services do not imply that the manufacturer intends to make these available in all countries in which it operates. Any reference to a product, program, or service is not intended to state or imply that only that product, program, or service may be used. Any functionally equivalent product, program, or service that does not infringe any existing intellectual property right may be used instead. Evaluation and verification of operation in conjunction with other products, programs, or services, except those expressly designated by the manufacturer, are the user's responsibility.

For Lexmark technical support, go to <http://support.lexmark.com>.

For information on Lexmark's privacy policy governing the use of this product, go to www.lexmark.com/privacy.

For information on supplies and downloads, go to www.lexmark.com.

© 2018 Lexmark International, Inc.

All rights reserved.

GOVERNMENT END USERS

The Software Program and any related documentation are "Commercial Items," as that term is defined in 48 C.F.R. 2.101, "Computer Software" and "Commercial Computer Software Documentation," as such terms are used in 48 C.F.R. 12.212 or 48 C.F.R. 227.7202, as applicable. Consistent with 48 C.F.R. 12.212 or 48 C.F.R. 227.7202-1 through 227.7207-4, as applicable, the Commercial Computer Software and Commercial Software

Documentation are licensed to the U.S. Government end users (a) only as Commercial Items and (b) with only those rights as are granted to all other end users pursuant to the terms and conditions herein.

Trademarks

Lexmark and the Lexmark logo are trademarks or registered trademarks of Lexmark International, Inc. in the United States and/or other countries.

Google Cloud Print, Google Chrome, Android, and Google Play are trademarks of Google LLC.

Macintosh, App Store, Safari, and AirPrint are trademarks of Apple Inc., registered in the U.S. and other countries. Use of the Works with Apple badge means that an accessory has been designed to work specifically with the technology identified in the badge and has been certified by the developer to meet Apple performance standards.

Mopria®, the Mopria® logo, and the Mopria® Alliance logo are registered trademarks and service marks of Mopria Alliance, Inc. in the United States and other countries. Unauthorized use is strictly prohibited.

PCL® is a registered trademark of the Hewlett-Packard Company. PCL is Hewlett-Packard Company’s designation of a set of printer commands (language) and functions included in its printer products. This printer is intended to be compatible with the PCL language. This means the printer recognizes PCL commands used in various application programs, and that the printer emulates the functions corresponding to the commands.

PostScript is a registered trademark of Adobe Systems Incorporated in the United States and/or other countries.

Wi-Fi Direct is a registered trademark of Wi-Fi Alliance®.

All other trademarks are the property of their respective owners.

Licensing notices

All licensing notices associated with this product can be viewed from the CD:\NOTICES directory of the installation software CD.

Noise emission levels

The following measurements were made in accordance with ISO 7779 and reported in conformance with ISO 9296.

Note: Some modes may not apply to your product.

| 1-meter average sound pressure, dBA | |
|-------------------------------------|----|
| Printing | 50 |
| Ready | 16 |

Values are subject to change. See www.lexmark.com for current values.

Waste from Electrical and Electronic Equipment (WEEE) directive

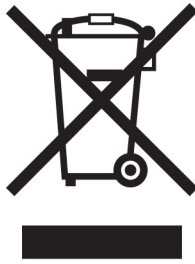

The WEEE logo signifies specific recycling programs and procedures for electronic products in countries of the European Union. We encourage the recycling of our products.

If you have further questions about recycling options, visit the Lexmark Web site at www.lexmark.com for your local sales office phone number.

India E-Waste notice

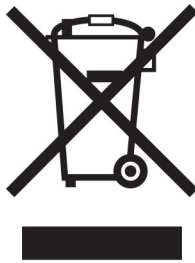

This product complies with the India E-Waste (Management and Handling) Rules, 2011, which prohibit use of lead, mercury, hexavalent chromium, polybrominated biphenyls, or polybrominated diphenyl ethers in concentrations exceeding 0.1% by weight and 0.01% by weight for cadmium, except for the exemption set in Schedule II of the Rules.

Product disposal

Do not dispose of the printer or supplies in the same manner as normal household waste. Consult your local authorities for disposal and recycling options.

Returning Lexmark cartridges for reuse or recycling

The Lexmark Cartridge Collection Program allows you to return used cartridges for free to Lexmark for reuse or recycling. One hundred percent of the empty cartridges returned to Lexmark are either reused or demanufactured for recycling. The boxes used to return the cartridges are also recycled.

To return Lexmark cartridges for reuse or recycling, do the following:

- 1 Go to www.lexmark.com/recycle.
- 2 Select the product that you want to recycle.

Static sensitivity notice

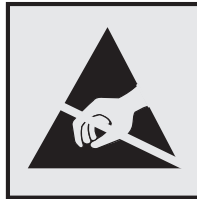

This symbol identifies static-sensitive parts. Do not touch the areas near these symbols without first touching a metal surface in an area away from the symbol.

To prevent damage from electrostatic discharge when performing maintenance tasks such as clearing paper jams or replacing supplies, touch any exposed metal frame of the printer before accessing or touching interior areas of the printer even if the symbol is not present.

ENERGY STAR

Any Lexmark product bearing the ENERGY STAR® emblem on the product or on a start-up screen is certified to comply with Environmental Protection Agency (EPA) ENERGY STAR requirements as configured when shipped by Lexmark.



Temperature information

| | |
|---|--|
| Operating temperature and relative humidity | 10 to 32.2°C (50 to 90°F) and 15 to 80% RH |
| Printer / cartridge / imaging unit long-term storage ¹ | 15.3 to 32.2°C (60 to 90°F) and 8 to 80% RH Maximum wet bulb temperature: 22.8°C (73°F) Non-condensing environment |
| Printer / cartridge / imaging unit short-term shipping | -40 to 43.3°C (-40 to 110°F) |
| <p>¹ Supplies shelf life is approximately 2 years. This is based on storage in a standard office environment at 22°C (72°F) and 45% humidity.</p> <p>² Wet-bulb temperature is determined by the air temperature and the relative humidity.</p> | |

Laser notice

The printer is certified in the U.S. to conform to the requirements of DHHS 21 CFR, Chapter I, Subchapter J for Class I (1) laser products, and elsewhere is certified as a Class I laser product conforming to the requirements of IEC 60825-1: 2014.

Class I laser products are not considered to be hazardous. The printer contains internally a Class IIIb (3b) AlGaInP laser that is nominally 15 milliwatts operating in the wavelength region of 650–670 nanometers and enclosed

in a non-serviceable printhead assembly. The laser system and printer are designed so there is never any human access to laser radiation above a Class I level during normal operation, user maintenance, or prescribed service conditions.

Power consumption

Product power consumption

The following table documents the power consumption characteristics of the product.

Note: Some modes may not apply to your product.

| Mode | Description | Power consumption (Watts) |
|------------|---|--|
| Printing | The product is generating hard-copy output from electronic inputs. | One-sided: 400 (C2325, C2425, CS421); 530 (CS521); 570 (C2240, CS622) Two-sided: 275 (C2325); 280 (C2425, CS421); 360 (CS521); 380 (C2240, CS622) |
| Copy | The product is generating hard-copy output from hard-copy original documents. | N/A |
| Scan | The product is scanning hard-copy documents. | N/A |
| Ready | The product is waiting for a print job. | 20.5 (C2325); 22 (C2425, CS421); 22.5 (C2240, CS622); 22 (C2535, CS521) |
| Sleep Mode | The product is in a high-level energy-saving mode. | 1.3 (CS521); 1.4 (C2325, C2435, CS421); 1.5 (C2240, CS622) |
| Hibernate | The product is in a low-level energy-saving mode. | 0.2 |
| Off | The product is plugged into an electrical outlet, but the power switch is turned off. | 0.2 |

The power consumption levels listed in the previous table represent time-averaged measurements. Instantaneous power draws may be substantially higher than the average.

Values are subject to change. See www.lexmark.com for current values.

Sleep Mode

This product is designed with an energy-saving mode called *Sleep Mode*. The Sleep Mode saves energy by lowering power consumption during extended periods of inactivity. The Sleep Mode is automatically engaged after this product is not used for a specified period of time, called the *Sleep Mode Timeout*.

| | |
|---|----|
| Factory default Sleep Mode Timeout for this product (in minutes): | 15 |
|---|----|

By using the configuration menus, the Sleep Mode Timeout can be modified between 1 minute and 120 minutes. If the print speed is less than or equal to 30 pages per minute, then you can set the timeout only up to 60 minutes. Setting the Sleep Mode Timeout to a low value reduces energy consumption, but may increase the response time of the product. Setting the Sleep Mode Timeout to a high value maintains a fast response, but uses more energy.

Hibernate Mode

This product is designed with an ultra-low power operating mode called *Hibernate mode*. When operating in Hibernate Mode, all other systems and devices are powered down safely.

The Hibernate mode can be entered in any of the following methods:

- Using the Hibernate Timeout
- Using the Schedule Power modes

| | |
|--|--------|
| Factory default Hibernate Timeout for this product in all countries or regions | 3 days |
|--|--------|

The amount of time the printer waits after a job is printed before it enters Hibernate mode can be modified between one hour and one month.

Off mode

If this product has an off mode which still consumes a small amount of power, then to completely stop product power consumption, disconnect the power supply cord from the electrical outlet.

Total energy usage

It is sometimes helpful to estimate the total product energy usage. Since power consumption claims are provided in power units of Watts, the power consumption should be multiplied by the time the product spends in each mode in order to calculate energy usage. The total product energy usage is the sum of each mode's energy usage.

Applicability of Regulation (EU) 2019/2015 and (EU) 2019/2020

Per Commission Regulation (EU) 2019/2015 and (EU) 2019/2020, the light source contained within this product or its component is intended to be used for Image Capture or Image Projection only, and is not intended for use in other applications.

Regulatory notices for wireless products

This section contains regulatory information that applies only to wireless models.

If in doubt as to whether your model is a wireless model, go to <http://support.lexmark.com>.

Modular component notice

Wireless models contain one of the following modular components:

Lexmark Regulatory Type/Model LEX-M07-001; FCC ID:IYLLEXM07001; IC:2376A-LEXM07001

Lexmark Regulatory Type/Model Number LEX-M08-001; FCC ID:IYLLEXM08001; IC:2376A-LEXM08001

To determine which modular components are installed in your particular product, refer to the labeling on your actual product.

Exposure to radio frequency radiation

The radiated output power of this device is far below the radio frequency exposure limits of the FCC and other regulatory agencies. A minimum separation of 20 cm (8 inches) must be maintained between the antenna and any persons for this device to satisfy the RF exposure requirements of the FCC and other regulatory agencies.

Industry Canada (Canada)

This device complies with Industry Canada license-exempt RSS standards. Operation is subject to the following two conditions: (1) this device may not cause interference, and (2) this device must accept any interference, including interference that may cause undesired operation of the device.

Industrie Canada (Canada)

Cet appareil est conforme aux normes RSS exemptes de licence d'Industrie Canada. Son fonctionnement est soumis aux deux conditions suivantes : (1) cet appareil ne doit pas causer d'interférences et (2) il doit accepter toutes les interférences, y compris les celles qui peuvent entraîner un fonctionnement indésirable.

European Community (EC) directives conformity

This product is in conformity with the protection requirements of EC Council directive 2014/53/EU on the approximation and harmonization of the laws of the Member States relating to radio equipment.

The manufacturer of this product is: Lexmark International, Inc., 740 West New Circle Road, Lexington, KY, 40550 USA. The authorized representative is: Lexmark International Technology Hungária Kft., 8 Lechner Ödön fasor, Millennium Tower III, 1095 Budapest HUNGARY. A declaration of conformity to the requirements of the Directives is available upon request from the Authorized Representative or may be obtained at www.lexmark.com/en_us/about/regulatory-compliance/european-union-declaration-of-conformity.html.

Compliance is indicated by the CE marking:



EU statement of radio transmitter operational frequency bands and maximum RF power

This radio product transmits in the 2.4GHz (2.412–2.472GHz) band in the EU. The maximum transmitter EIRP power output, including antenna gain, is ≤ 20 dBm.

Multiple model information

The following information applies to all CS421 (5029-230), CS521 (5029-430), C2325 (5029-038), C2425 (5029-238), and C2535 (5029-438) printer models.

Federal Communications Commission (FCC) compliance information statement

This product has been tested and found to comply with the limits for a Class B digital device, pursuant to Part 15 of the FCC Rules. Operation is subject to the following two conditions: (1) this device may not cause harmful interference, and (2) this device must accept any interference received, including interference that may cause undesired operation.

The FCC Class B limits are designed to provide reasonable protection against harmful interference when the equipment is operated in a residential installation. This equipment generates, uses, and can radiate radio frequency energy and, if not installed and used in accordance with the instructions, may cause harmful interference to radio communications. However, there is no guarantee that interference will not occur in a particular installation. If this equipment does cause harmful interference to radio or television reception, which can be determined by turning the equipment off and on, the user is encouraged to try to correct the interference by one or more of the following measures:

- Reorient or relocate the receiving antenna.
- Increase the separation between the equipment and receiver.
- Connect the equipment into an outlet on a circuit different from that to which the receiver is connected.
- Consult your point of purchase or service representative for additional suggestions.

The manufacturer is not responsible for radio or television interference caused by using other than recommended cables or by unauthorized changes or modifications to this equipment. Unauthorized changes or modifications could void the user's authority to operate this equipment.

Note: To assure compliance with FCC regulations on electromagnetic interference for a Class B computing device, use a properly shielded and grounded cable such as Lexmark part number 1021231 for parallel attach or 1021294 for USB attach. Use of a substitute cable not properly shielded and grounded may result in a violation of FCC regulations.

Any questions regarding this compliance information statement should be directed to:

Director of Lexmark Technology & Services
Lexmark International, Inc.
740 West New Circle Road
Lexington, KY 40550
Telephone: (859) 232-2000
E-mail: regulatory@lexmark.com

Industry Canada compliance statement

This Class B digital apparatus meets all requirements of the Canadian Interference-Causing Equipment Standard ICES-003.

Avis de conformité aux normes de l'industrie du Canada

Cet appareil numérique de classe B est conforme aux exigences de la norme canadienne relative aux équipements pouvant causer des interférences NMB-003.

日本の VCCI 規定

製品にこのマークが表示されている場合、次の要件を満たしています。



この装置は、クラス B 情報技術装置です。この装置は、家庭環境で使用することを目的としていますが、この装置がラジオやテレビジョン受信機に近接して使用されると、受信障害を引き起こすことがあります。

取扱説明書に従って正しい取り扱いをしてください。

VCCI-B

European Community (EC) directives conformity

This product is in conformity with the protection requirements of EC Council directives 2014/30/EU, 2014/35/EU, 2009/125/EC, and 2011/65/EU on the approximation and harmonization of the laws of the Member States relating to electromagnetic compatibility, safety of electrical equipment designed for use within certain voltage limits, the ecodesign of energy-related products, and on the restrictions of use of certain hazardous substances in electrical and electronic equipment.

The manufacturer of this product is: Lexmark International, Inc., 740 West New Circle Road, Lexington, KY, 40550 USA. The authorized representative is: Lexmark International Technology Hungária Kft., 8 Lechner Ödön fasor, Millennium Tower III, 1095 Budapest HUNGARY. A declaration of conformity to the requirements of the Directives is available upon request from the Authorized Representative or may be obtained at www.lexmark.com/en_us/about/regulatory-compliance/european-union-declaration-of-conformity.html.

This product satisfies the Class B limits of EN 55022 and EN55032 and safety requirements of EN 60950-1 or EN 62368-1.

Model-specific information

The following information applies only to the CS622 (5029-636) and C2240 (5029-696) printer models.

Federal Communications Commission (FCC) compliance information statement

This product has been tested and found to comply with the limits for a Class A digital device, pursuant to Part 15 of the FCC Rules. Operation is subject to the following two conditions: (1) this device may not cause harmful interference, and (2) this device must accept any interference received, including interference that may cause undesired operation.

The FCC Class A limits are designed to provide reasonable protection against harmful interference when the equipment is operated in a commercial environment. This equipment generates, uses, and can radiate radio frequency energy and, if not installed and used in accordance with the instruction manual, may cause harmful interference to radio communications. Operation of this equipment in a residential area is likely to cause harmful interference, in which case the user will be required to correct the interference at his own expense.

The manufacturer is not responsible for any radio or television interference caused by using other than recommended cables or by unauthorized changes or modifications to this equipment. Unauthorized changes or modifications could void the user's authority to operate this equipment.

Note: To assure compliance with FCC regulations on electromagnetic interference for a Class A computing device, use a properly shielded and grounded cable such as Lexmark part number 1021231 for parallel attach or 1021294 for USB attach. Use of a substitute cable not properly shielded and grounded may result in a violation of FCC regulations.

Any questions regarding this compliance information statement should be directed to:

Director of Lexmark Technology & Services
Lexmark International, Inc.
740 West New Circle Road
Lexington, KY 40550
Telephone: (859) 232-2000
E-mail: regulatory@lexmark.com

Industry Canada compliance statement

This Class A digital apparatus meets all requirements of the Canadian Interference-Causing Equipment Standard ICES-003.

Avis de conformité aux normes de l'industrie du Canada

Cet appareil numérique de classe A est conforme aux exigences de la norme canadienne relative aux équipements pouvant causer des interférences NMB-003.

Notice to users of Class A products in Brazil

Este produto não é apropriado para uso em ambientes domésticos, pois poderá causar interferências eletromagnéticas que obrigam o usuário a tomar medidas necessárias para minimizar estas interferências.

European Community (EC) directives conformity

This product is in conformity with the protection requirements of EC Council directives 2014/30/EU, 2014/35/EU, and 2011/65/EU on the approximation and harmonization of the laws of the Member States relating to electromagnetic compatibility, safety of electrical equipment designed for use within certain voltage limits, and on the restrictions of use of certain hazardous substances in electrical and electronic equipment.

The manufacturer of this product is: Lexmark International, Inc., 740 West New Circle Road, Lexington, KY, 40550 USA. The authorized representative is: Lexmark International Technology Hungária Kft., 8 Lechner Ödön fasor, Millennium Tower III, 1095 Budapest HUNGARY. A declaration of conformity to the requirements of the Directives is available upon request from the Authorized Representative or may be obtained at www.lexmark.com/en_us/about/regulatory-compliance/european-union-declaration-of-conformity.html.

This product satisfies the Class A limits of EN 55022 and EN55032 and safety requirements of EN 60950-1 or EN 62368-1.

Radio interference notice

Warning

This is a product that complies with the emission requirements of EN55022 and EN55032 Class A limits and immunity requirements of EN55024. This product is not intended to be used in residential/domestic environments.

This is a Class A product. In a domestic environment, this product may cause radio interference, in which case the user may be required to take adequate measures.

STATEMENT OF LIMITED WARRANTY FOR LEXMARK LASER PRINTERS, LEXMARK LED PRINTERS, AND LEXMARK MULTIFUNCTION LASER PRINTERS

Lexmark International, Inc., Lexington, KY

This limited warranty applies to the United States and Canada. For customers outside the U.S., refer to the country-specific warranty information that came with your product.

This limited warranty applies to this product only if it was originally purchased for your use, and not for resale, from Lexmark or a Lexmark Remarketer, referred to in this statement as “Remarketer.”

Limited warranty

Lexmark warrants that this product:

- Is manufactured from new parts, or new and serviceable used parts, which perform like new parts
- Is, during normal use, free from defects in material and workmanship

If this product does not function as warranted during the warranty period, contact a Remarketer or Lexmark for repair or replacement (at Lexmark's option).

If this product is a feature or option, this statement applies only when that feature or option is used with the product for which it was intended. To obtain warranty service, you may be required to present the feature or option with the product.

If you transfer this product to another user, warranty service under the terms of this statement is available to that user for the remainder of the warranty period. You should transfer proof of original purchase and this statement to that user.

Limited warranty service

The warranty period starts on the date of original purchase as shown on the purchase receipt and ends 12 months later provided that the warranty period for any supplies and for any maintenance items included with the printer shall end earlier if it, or its original contents, are substantially used up, depleted, or consumed. Fuser Units, Transfer/Transport Units, Paper Feed items, if any, and any other items for which a Maintenance Kit is available are substantially consumed when the printer displays a “Life Warning” or “Scheduled Maintenance” message for such item.

To obtain warranty service you may be required to present proof of original purchase. You may be required to deliver your product to the Remarketer or Lexmark, or ship it prepaid and suitably packaged to a Lexmark

designated location. You are responsible for loss of, or damage to, a product in transit to the Remarketer or the Lexmark designated location.

When warranty service involves the exchange of a product or part, the item replaced becomes the property of the Remarketer or Lexmark. The replacement may be a new or repaired item.

The replacement item assumes the remaining warranty period of the original product.

Replacement is not available to you if the product you present for exchange is defaced, altered, in need of a repair not included in warranty service, damaged beyond repair, or if the product is not free of all legal obligations, restrictions, liens, and encumbrances.

As part of your warranty service and/or replacement, Lexmark may update the firmware in your printer to the latest version. Firmware updates may modify printer settings and cause counterfeit and/or unauthorized products, supplies, parts, materials (such as toners and inks), software, or interfaces to stop working. Authorized use of genuine Lexmark products will not be impacted.

Before you present this product for warranty service, remove all print cartridges, programs, data, and removable storage media (unless directed otherwise by Lexmark).

For further explanation of your warranty alternatives and the nearest Lexmark authorized servicer in your area contact Lexmark on the World Wide Web.

Remote technical support is provided for this product throughout its warranty period. For products no longer covered by a Lexmark warranty, technical support may not be available or only be available for a fee.

Extent of limited warranty

Lexmark does not warrant uninterrupted or error-free operation of any product or the durability or longevity of prints produced by any product.

Warranty service does not include repair of failures caused by:

- Modification or unauthorized attachments
- Accidents, misuse, abuse or use inconsistent with Lexmark user's guides, manuals, instructions or guidance
- Unsuitable physical or operating environment
- Maintenance by anyone other than Lexmark or a Lexmark authorized servicer
- Operation of a product beyond the limit of its duty cycle
- Use of printing media outside of Lexmark specifications
- Refurbishment, repair, refilling or remanufacture by a third party of products, supplies or parts
- Products, supplies, parts, materials (such as toners and inks), software, or interfaces not furnished by Lexmark

TO THE EXTENT PERMITTED BY APPLICABLE LAW, NEITHER LEXMARK NOR ITS THIRD PARTY SUPPLIERS OR REMARKETERS MAKE ANY OTHER WARRANTY OR CONDITION OF ANY KIND, WHETHER EXPRESS OR IMPLIED, WITH RESPECT TO THIS PRODUCT, AND SPECIFICALLY DISCLAIM THE IMPLIED WARRANTIES OR CONDITIONS OF MERCHANTABILITY, FITNESS FOR A PARTICULAR PURPOSE, AND SATISFACTORY QUALITY. ANY WARRANTIES THAT MAY NOT BE DISCLAIMED UNDER APPLICABLE LAW ARE LIMITED IN DURATION TO THE WARRANTY PERIOD. NO WARRANTIES, EXPRESS OR IMPLIED, WILL APPLY AFTER THIS PERIOD. ALL INFORMATION, SPECIFICATIONS, PRICES, AND SERVICES ARE SUBJECT TO CHANGE AT ANY TIME WITHOUT NOTICE.

Limitation of liability

Your sole remedy under this limited warranty is set forth in this document. For any claim concerning performance or nonperformance of Lexmark or a Remarketer for this product under this limited warranty, you may recover actual damages up to the limit set forth in the following paragraph.

Lexmark's liability for actual damages from any cause whatsoever will be limited to the amount you paid for the product that caused the damages. This limitation of liability will not apply to claims by you for bodily injury or damage to real property or tangible personal property for which Lexmark is legally liable. **IN NO EVENT WILL LEXMARK BE LIABLE FOR ANY LOST PROFITS, LOST SAVINGS, INCIDENTAL DAMAGE, OR OTHER ECONOMIC OR CONSEQUENTIAL DAMAGES.** This is true even if you advise Lexmark or a Remarketer of the possibility of such damages. Lexmark is not liable for any claim by you based on a third party claim.

This limitation of remedies also applies to claims against any Suppliers and Remarketers of Lexmark. Lexmark's and its Suppliers' and Remarketers' limitations of remedies are not cumulative. Such Suppliers and Remarketers are intended beneficiaries of this limitation.

Additional rights

Some states do not allow limitations on how long an implied warranty lasts, or do not allow the exclusion or limitation of incidental or consequential damages, so the limitations or exclusions contained above may not apply to you.

This limited warranty gives you specific legal rights. You may also have other rights that vary from state to state.

Index

A

- accessing the controller board 162
- activating Voice Guidance 24
- adding contacts 21
- adding groups 22
- adding hardware options
 - print driver 169
- adding internal options
 - print driver 169
- adjusting paper stop 31
- adjusting speech rate
 - Voice Guidance 25
- adjusting the brightness
 - display 114
- adjusting toner darkness 158
- AirPrint
 - using 39
- attaching cables 13
- avoiding paper jams 116

B

- bookmarks
 - creating 20
 - creating folders for 21

C

- cannot open Embedded Web Server 125
- card stock
 - loading 28
- changing the wallpaper 18
- checking the printer connectivity 127
- checking the status of parts and supplies 96
- cleaning
 - exterior of the printer 96
 - interior of the printer 96
- cleaning the printer 96
- clearances around the printer 11
- clearing jam
 - below the fuser 118
 - in the duplex unit 118
 - in the fuser 118
 - in the multipurpose feeder 122
 - in trays 118

- clearing jams
 - in the standard bin 121
- Cloud Connector profile
 - creating 19
 - printing from 43
- collated printing does not work 130
- Color Correction
 - manual 159
- Color Correction Content 159
- confidential print jobs 41
 - printing from a Macintosh computer 42
 - printing from Windows 42
- configuring Eco-Mode setting 19
- configuring Eco-Settings 19
- configuring supply notifications 100
- configuring the SMTP server 124
- configuring Universal paper 26
- connecting the mobile device to the printer wireless network 95
- connecting the printer to a wireless network 94
- connecting to a wireless network using PIN method 94
- using Push Button method 94

- conserving supplies 114
- contacting customer support 161
- contacts
 - adding 21
 - deleting 22
 - editing 22
- controller board
 - accessing 162
- creating a Cloud Connector profile 19
- creating bookmarks 20
- creating folders
 - for bookmarks 21
- Customer Support
 - using 20
- customer support
 - contacting 161
- customizing the display 18

D

- deactivating the Wi-Fi network 95
- Defective flash detected 128
- deleting contacts 22
- deleting groups 22
- Device Quotas
 - setting up 19
- directory list
 - printing 43
- display brightness
 - adjusting 114
- Display Customization
 - using 18
- documents, printing
 - from a computer 38
 - from a mobile device 38, 39

E

- Eco-Mode
 - configuring 114
- Eco-Settings
 - configuring 19
- editing contacts 22
- editing groups 22
- emission
 - notices 172, 177, 178, 179, 180
- enabling Magnification mode 25
- enabling personal identification numbers 25
- enabling spoken passwords 25
- enabling the USB port 126
- enabling Wi-Fi Direct 95
- encrypting
 - printer hard disk 92
- envelopes
 - loading 28, 30
- environmental setting
 - Eco-Mode 114
 - Hibernate mode 114
 - sleep mode 114
- erasing non-volatile memory 91
- erasing printer hard disk memory 91
- erasing printer memory 91, 92
- erasing volatile memory 91
- Ethernet port 13

exporting a configuration file
using the Embedded Web
Server 169

e-mail server
setting up 124

F

factory default settings
restoring 92

FAQ about color printing 159

FCC notices 177

finding more information about
the printer 9

firmware
update 170

flash drive
printing from 40

font sample list
printing 43

fuser maintenance kit
ordering 100

G

Google Cloud Print
using 38

groups
adding 22
deleting 22
editing 22

H

hardware options
trays 167

hardware options, adding
print driver 169

held jobs 41
printing from a Macintosh
computer 42
printing from Windows 42

Hibernate mode
configuring 114

home screen
customizing 18
showing icons 18
using 17

home screen icons 17

HTTP/FTP Settings menu 78

humidity around the printer 174

I

icons on the home screen
showing 18

imaging kit
ordering 100
replacing 106

importing a configuration file
using the Embedded Web
Server 169

indicator light
understanding the status 16

installing options
printer hard disk 164

installing the printer software 168

installing trays 167

internal option is not
detected 127

internal options
firmware card 162
memory card 162
printer hard disk 162

internal options, adding
print driver 169

J

jams
avoiding 116
locating jam areas 117
locations 117

jams, clearing
in the manual feeder 123

K

keyboard on the display
using 25

L

letterhead
loading 28, 30

Lexmark Mobile Print
using 38

linking trays 31

loading the manual feeder 30

loading the multipurpose
feeder 28

loading trays 26

locating the security slot 91

M

Magnification mode
enabling 25

managing screen saver 18
manual color correction

applying 159

manual feeder
loading 30

menu
802.1x 77

About this Printer 56

Accessibility 51

Confidential Print Setup 86

Configuration Menu 53

Device 89

Erase Temporary Data Files 87

Ethernet 72

Flash Drive Print 67

Google Cloud Print 79

Help 89

HTML 65

HTTP/FTP Settings 78

Image 65

Information Sent to Lexmark 51

IPSec 76

Job Accounting 60

Layout 57

Local Accounts 82

Login Restrictions 86

LPD Configuration 77

Manage Permissions 81

Media Types 67

Menu Settings Page 89

Miscellaneous 88

Mobile Services
Management 88

Network 89

Network Overview 69

Notifications 46

Out of Service Erase 56

PCL 63

PDF 62

PostScript 62

Power Management 50

Preferences 45

Print 89

Quality 59

Remote Operator Panel 46

Restore Factory Defaults 52

Security Audit Log 83

Setup 58

- SNMP 75
- Solutions LDAP Settings 88
- TCP/IP 74
- ThinPrint 78
- Tray Configuration 66
- Troubleshooting 90
- Universal Setup 66
- USB 79
- Visible Home Screen Icons 56
- Wireless 69
- Wi-Fi Direct 80
- XPS 62
- Menu Settings Page
 - printing 90
- menus
 - Disk Encryption 87
 - Schedule USB Devices 83
- mobile device
 - printing from 38, 39
- Mopria Print Service
 - using 38
- moving the printer 113
- multipurpose feeder
 - loading 28

N

- navigating the screen
 - using gestures 24
- navigating the screen using gestures 24
- noise emission levels 172
- Non-Lexmark supply 129
- non-volatile memory 92
- Not enough free space in flash memory for resources 128
- notices 172, 173, 174, 175, 176, 177, 178, 179, 180

O

- ordering
 - fuser maintenance kit 100
- ordering a black and color imaging kit 100
- ordering a black imaging kit 100
- ordering a waste toner bottle 100
- ordering supplies
 - imaging kit 100
 - toner cartridge 97
 - waste toner bottle 100

P

- paper jam in door A 118
- paper jam in the multipurpose feeder 122
- paper jam in the standard bin 121
- paper jam in trays 118
- paper jam, clearing
 - in the standard bin 121
- paper jams
 - avoiding 116
- paper jams, clearing
 - in the manual feeder 123
- paper stop
 - adjusting 31
- personal identification number method 94
- personal identification numbers
 - enabling 25
- power button light
 - understanding the status 16
- power cord socket 13
- print driver
 - hardware options, adding 169
- print jobs not printed 156
- Print Quality Test Pages 90
- print quality troubleshooting
 - blank pages 133
 - crooked print 143
 - dark print 134
 - ghost images on prints 135
 - gray or colored
 - background 136
 - horizontal dark lines 147
 - horizontal white lines 149
 - light print 138
 - missing colors 140
 - mottled print and dots 141
 - paper curl 142
 - print appears tinted 161
 - repeating defects 151
 - skewed print 143
 - solid color or black images 144
 - text or images cut off 144
 - toner easily rubs off 145
 - uneven print density 146
 - vertical dark lines 148
 - vertical white lines 150
 - white pages 133
- print troubleshooting
 - confidential and other held documents do not print 152
 - envelope seals when printing 130
 - incorrect margins 137
 - jammed pages are not reprinted 133
 - job prints from the wrong tray 158
 - job prints on the wrong paper 158
 - paper frequently jams 132
 - print jobs do not print 156
 - slow printing 154
 - tray linking does not work 131
 - unable to read flash drive 126
- printer
 - shipping 113
- printer configurations 12
- printer connectivity
 - checking 127
- printer hard disk
 - encrypting 92
 - installing 164
- printer hard disk memory 92
 - erasing 91
- printer information
 - finding 9
- printer is not responding 157
- printer location
 - selecting 11
- printer menus 44
- printer messages
 - Defective flash detected 128
 - Non-Lexmark supply 129
 - Not enough free space in flash memory for resources 128
 - Replace cartridge, printer region mismatch 128
 - Unformatted flash detected 128
- printer options troubleshooting
 - cannot detect internal option 127
- printer ports 13
- printer settings
 - restoring factory default 92
- printer software, installing 168
- printer status 16
- printer wireless network
 - connecting the mobile device to 95
- printing
 - AirPrint 88
 - directory list 43

- font sample list 43
- from a Cloud Connector profile 43
- from a computer 38
- from a flash drive 40
- from a mobile device 38, 39
- Menu Settings Page 90
- using Wi-Fi Direct 39
- printing confidential and other held jobs
 - from a Macintosh computer 42
 - from Windows 42
- printing from a computer 38
- printing from a flash drive 40
- Push Button method 94

Q

- QR codes
 - adding 20

R

- recycling
 - Lexmark packaging 115
 - Lexmark products 115
- removing paper jam
 - below the fuser 118
 - in the duplex unit 118
 - in the fuser 118
 - in the multipurpose feeder 122
 - in trays 118
- repeat print jobs 41
 - printing from a Macintosh computer 42
 - printing from Windows 42
- repeating defects 151
- Replace cartridge, printer region mismatch 128
- replacing supplies
 - black and color imaging kit 106
 - black imaging kit 106
 - toner cartridge 101
 - waste toner bottle 103
- reserve print jobs
 - printing from a Macintosh computer 42
 - printing from Windows 42
- resetting
 - supply usage counters 129
- restoring factory default settings 92
- running a slideshow 18

S

- safety information 6, 7, 8
- scheduling power modes 19
- securing printer memory 92
- security slot
 - locating 91
- selecting a location for the printer 11
- setting the paper size 26
- setting the paper type 26
- setting up Device Quotas 19
- setting up e-mail 124
- shipping the printer 113
- showing icons on the home screen 18
- sleep mode
 - configuring 114
- SMTP server
 - configuring 124
- spoken passwords
 - enabling 25
- statement of volatility 92
- status of parts
 - checking 96
- status of supplies
 - checking 96
- storing print jobs 41
- supplies
 - conserving 114
- supply notifications
 - configuring 100
- supply usage counters
 - resetting 129
- supported file types 41
- supported flash drives 41
- supported paper sizes 33
- supported paper types 35
- supported paper weights 36

T

- temperature around the printer 11, 174
- toner cartridge
 - ordering 97
 - replacing 101
- toner darkness
 - adjusting 158
- trays
 - installing 167
 - loading 26

- troubleshooting
 - cannot open Embedded Web Server 125
 - FAQ about color printing 159
 - printer is not responding 157
- troubleshooting, print
 - collated printing does not work 130
 - confidential and other held documents do not print 152
 - envelope seals when printing 130
 - incorrect margins 137
 - jammed pages are not reprinted 133
 - job prints from the wrong tray 158
 - job prints on the wrong paper 158
 - paper frequently jams 132
 - print jobs do not print 156
 - slow printing 154
 - tray linking does not work 131
- troubleshooting, print quality
 - blank pages 133
 - crooked print 143
 - dark print 134
 - ghost images on prints 135
 - gray or colored
 - background 136
 - horizontal dark lines 147
 - horizontal white lines 149
 - light print 138
 - missing colors 140
 - mottled print and dots 141
 - paper curl 142
 - print appears tinted 161
 - repeating defects 151
 - skewed print 143
 - solid color or black images 144
 - text or images cut off 144
 - toner easily rubs off 145
 - uneven print density 146
 - vertical dark lines 148
 - vertical white lines 150
 - white pages 133
- troubleshooting, printer options
 - cannot detect internal option 127

U

- unable to read flash drive
 - troubleshooting, print 126
- Unformatted flash detected 128
- Universal paper
 - configuring 26
- unlinking trays 31
- updating firmware
 - flash file 170
- USB port 13
 - enabling 126
- using
 - genuine Lexmark parts 97
 - genuine Lexmark supplies 97
- using Customer Support 20
- using Display Customization 18
- using QR Code Generator 20
- using the control panel
 - Lexmark C2240 16
 - Lexmark C2325 14
 - Lexmark C2425 15
 - Lexmark C2535 15
 - Lexmark CS421 15
 - Lexmark CS521 15
 - Lexmark CS622 16
- using the home screen 17

V

- verify print jobs 41
 - printing from a Macintosh computer 42
 - printing from Windows 42
- virtual keyboard
 - using 25
- Voice Guidance
 - activating 24
 - speech rate 25
- Voice Guidance speech rate
 - adjusting 25
- volatile memory 92

W

- waste toner bottle
 - replacing 103
- wireless network
 - connecting the printer to 94
 - Wi-Fi Protected Setup 94
- wireless networking 94
- Wi-Fi Direct
 - enabling 95

- printing from a mobile device 39
- Wi-Fi network
 - deactivating 95
- Wi-Fi Protected Setup
 - wireless network 94