



# **MB3442, MX331, MX431 MFPs**

---

## **User's Guide**

**April 2020**

**[www.lexmark.com](http://www.lexmark.com)**

---

Machine type(s):

7019

Models:

235, 4a6, 4b6, 486

# Contents

- Safety information..... 6**
  - Conventions..... 6
  - Product statements..... 6
  
- Learn about the printer..... 9**
  - Finding information about the printer.....9
  - Printer configuration..... 11
  - Using the control panel.....11
  - Customizing the home screen..... 12
  - Changing the language of the keyboard on the display..... 12
  - Understanding the status of the indicator light..... 12
  - Selecting paper..... 13
  
- Set up, install, and configure..... 19**
  - Selecting a location for the printer..... 19
  - Attaching cables.....20
  - Installing optional trays..... 21
  - Setting up the printer to fax.....21
  - Loading paper and specialty media..... 28
  - Installing and updating software, drivers, and firmware..... 31
  - Networking.....33
  - Creating a Cloud Connector profile..... 35
  - Printing the Menu Settings Page.....36
  
- Secure the printer..... 37**
  - Locating the security slot..... 37
  - Erasing printer memory..... 37
  - Restoring factory default settings..... 37
  - Statement of Volatility..... 38
  
- Print..... 39**
  - Printing from a computer.....39
  - Printing from a mobile device..... 39
  - Printing from a flash drive..... 41
  - Supported flash drives and file types..... 42

Configuring confidential jobs..... 42

Printing confidential and other held jobs..... 43

Printing from a Cloud Connector profile..... 43

Printing a font sample list..... 44

Placing separator sheets between copies..... 44

Canceling a print job.....44

Adjusting toner darkness..... 44

**Copy..... 45**

Using the automatic document feeder and scanner glass..... 45

Making copies..... 45

Copying photos.....45

Copying on letterhead..... 46

Copying on both sides of the paper.....46

Reducing or enlarging copies..... 46

Collating copies..... 46

Copying multiple pages onto a single sheet..... 46

Copying cards.....47

Creating a copy shortcut..... 47

**E-mail.....48**

Using the automatic document feeder and scanner glass..... 48

Configuring the SMTP server for e-mail..... 48

Sending an e-mail.....49

Creating an e-mail shortcut..... 49

**Fax..... 50**

Using the automatic document feeder and scanner glass..... 50

Sending a fax.....50

Scheduling a fax..... 51

Creating a fax destination shortcut.....51

Changing the fax resolution..... 51

Adjusting the fax darkness..... 51

Printing a fax log..... 52

Blocking junk faxes..... 52

Forwarding a fax..... 52

**Scan..... 53**

- Using the automatic document feeder and scanner glass..... 53
- Creating an FTP shortcut.....53
- Scanning to an FTP server using a shortcut..... 53
- Creating a network folder shortcut.....54
- Scanning to a network folder using a shortcut.....54
- Scanning to a flash drive..... 54
- Scanning to a Cloud Connector profile..... 55

**Use printer menus..... 56**

- Menu map..... 56
- Device.....57
- Print..... 68
- Paper..... 73
- Copy..... 76
- Fax..... 77
- E-mail..... 84
- FTP..... 88
- USB Drive..... 90
- Network/Ports.....94
- Security.....107
- Cloud Connector..... 111
- Reports.....111
- Troubleshooting..... 112

**Maintain the printer..... 113**

- Checking the status of parts and supplies..... 113
- Configuring supply notifications..... 113
- Setting up e-mail alerts.....113
- Viewing reports..... 113
- Ordering parts and supplies..... 114
- Replacing parts and supplies.....116
- Cleaning printer parts..... 129
- Saving energy and paper..... 131
- Moving the printer to another location.....132
- Shipping the printer..... 133

---

<b>Troubleshoot a problem.....</b>	<b>134</b>
The printer is not responding.....	134
Unable to read flash drive.....	135
Enabling the USB port.....	135
Network connection problems.....	136
Issues with supplies.....	137
Clearing jams.....	138
Paper feed problems.....	153
Printing problems.....	155
Faxing problems.....	183
Scanning problems.....	186
Contacting customer support.....	190
<b>Recycle and dispose.....</b>	<b>191</b>
Recycling Lexmark products.....	191
Recycling Lexmark packaging.....	191
<b>Notices.....</b>	<b>192</b>
<b>Index.....</b>	<b>206</b>

# Safety information





## Conventions

**Note:** A *note* identifies information that could help you.







**Warning:** A *warning* identifies something that could damage the product hardware or software.

**CAUTION:** A *caution* indicates a potentially hazardous situation that could injure you.

Different types of caution statements include:

-  **CAUTION—POTENTIAL INJURY:** Indicates a risk of injury.
-  **CAUTION—SHOCK HAZARD:** Indicates a risk of electrical shock.
-  **CAUTION—HOT SURFACE:** Indicates a risk of burn if touched.
-  **CAUTION—TIPPING HAZARD:** Indicates a crush hazard.
-  **CAUTION—PINCH HAZARD:** Indicates a risk of being caught between moving parts.

## Product statements

-  **CAUTION—POTENTIAL INJURY:** To avoid the risk of fire or electrical shock, connect the power cord to an appropriately rated and properly grounded electrical outlet that is near the product and easily accessible.
-  **CAUTION—POTENTIAL INJURY:** To avoid the risk of fire or electrical shock, use only the power cord provided with this product or the manufacturer's authorized replacement.
-  **CAUTION—POTENTIAL INJURY:** Do not use this product with extension cords, multioutlet power strips, multioutlet extenders, or UPS devices. The power capacity of these types of accessories can be easily overloaded by a laser printer and may result in a risk of fire, property damage, or poor printer performance.
-  **CAUTION—POTENTIAL INJURY:** Only a Lexmark Inline Surge Protector that is properly connected between the printer and the power cord provided with the printer may be used with this product. The use of non-Lexmark surge protection devices may result in a risk of fire, property damage, or poor printer performance.
-  **CAUTION—POTENTIAL INJURY:** To reduce the risk of fire, use only a 26 AWG or larger telecommunications (RJ-11) cord when connecting this product to the public switched telephone network. For users in Australia, the cord must be approved by the Australian Communications and Media Authority.
-  **CAUTION—SHOCK HAZARD:** To avoid the risk of electrical shock, do not place or use this product near water or wet locations.
-  **CAUTION—SHOCK HAZARD:** To avoid the risk of electrical shock, do not set up this product or make any electrical or cabling connections, such as the power cord, fax feature, or telephone, during a lightning storm.

 **CAUTION—POTENTIAL INJURY:** Do not cut, twist, bind, crush, or place heavy objects on the power cord. Do not subject the power cord to abrasion or stress. Do not pinch the power cord between objects such as furniture and walls. If any of these things happen, a risk of fire or electrical shock results. Inspect the power cord regularly for signs of such problems. Remove the power cord from the electrical outlet before inspecting it.

 **CAUTION—SHOCK HAZARD:** To avoid the risk of electrical shock, make sure that all external connections (such as Ethernet and telephone system connections) are properly installed in their marked plug-in ports.

 **CAUTION—SHOCK HAZARD:** To avoid the risk of electrical shock, if you are accessing the controller board or installing optional hardware or memory devices sometime after setting up the printer, then turn the printer off, and unplug the power cord from the electrical outlet before continuing. If you have any other devices attached to the printer, then turn them off as well, and unplug any cables going into the printer.

 **CAUTION—SHOCK HAZARD:** To avoid the risk of electrical shock, do not use the fax feature during a lightning storm.





 **CAUTION—SHOCK HAZARD:** To avoid the risk of electrical shock when cleaning the exterior of the printer, unplug the power cord from the electrical outlet and disconnect all cables from the printer before proceeding.

 **CAUTION—POTENTIAL INJURY:** If the printer weight is greater than 20 kg (44 lb), then it may require two or more people to lift it safely.

 **CAUTION—POTENTIAL INJURY:** When moving the printer, follow these guidelines to avoid personal injury or printer damage:

- Make sure that all doors and trays are closed.
- Turn off the printer, and then unplug the power cord from the electrical outlet.
- Disconnect all cords and cables from the printer.
- If the printer has separate floor-standing optional trays or output options attached to it, then disconnect them before moving the printer.
- If the printer has a caster base, then carefully roll it to the new location. Use caution when passing over thresholds and breaks in flooring.
- If the printer does not have a caster base but is configured with optional trays or output options, then remove the output options and lift the printer off the trays. Do not try to lift the printer and any options at the same time.
- Always use the handholds on the printer to lift it.
- Any cart used to move the printer must have a surface able to support the full footprint of the printer.
- Any cart used to move the hardware options must have a surface able to support the dimensions of the options.
- Keep the printer in an upright position.
- Avoid severe jarring movements.
- Make sure that your fingers are not under the printer when you set it down.
- Make sure that there is adequate clearance around the printer.

 **CAUTION—TIPPING HAZARD:** Installing one or more options on your printer or MFP may require a caster base, furniture, or other feature to prevent instability causing possible injury. For more information on supported configurations, see [www.lexmark.com/multifunctionprinters](http://www.lexmark.com/multifunctionprinters).

-  **CAUTION—TIPPING HAZARD:** To reduce the risk of equipment instability, load each tray separately. Keep all other trays closed until needed.
-  **CAUTION—HOT SURFACE:** The inside of the printer might be hot. To reduce the risk of injury from a hot component, allow the surface to cool before touching it.
-  **CAUTION—PINCH HAZARD:** To avoid the risk of a pinch injury, use caution in areas marked with this label. Pinch injuries may occur around moving parts, such as gears, doors, trays, and covers.
-  **CAUTION—POTENTIAL INJURY:** This product uses a laser. Use of controls or adjustments or performance of procedures other than those specified in the *User's Guide* may result in hazardous radiation exposure.
-  **CAUTION—POTENTIAL INJURY:** The lithium battery in this product is not intended to be replaced. There is a danger of explosion if a lithium battery is incorrectly replaced. Do not recharge, disassemble, or incinerate a lithium battery. Discard used lithium batteries according to the manufacturer's instructions and local regulations.

This product is designed, tested, and approved to meet strict global safety standards with the use of specific manufacturer's components. The safety features of some parts may not always be obvious. The manufacturer is not responsible for the use of other replacement parts.

Refer service or repairs, other than those described in the user documentation, to a service representative.

This product uses a printing process that heats the print media, and the heat may cause the media to release emissions. You must understand the section in your operating instructions that discusses the guidelines for selecting print media to avoid the possibility of harmful emissions.

This product may produce small amounts of ozone during normal operation, and may be equipped with a filter designed to limit ozone concentrations to levels well below the recommended exposure limits. To avoid high ozone concentration levels during extensive usage, install this product in a well-ventilated area and replace the ozone and exhaust filters if instructed to do so in the product maintenance instructions. If there are no references to filters in the product maintenance instructions, then there are no filters requiring replacement for this product.

**SAVE THESE INSTRUCTIONS.**



# Learn about the printer

## Finding information about the printer

What are you looking for?	Find it here
Initial setup instructions: <ul style="list-style-type: none"> <li>• Connecting the printer</li> <li>• Installing the printer software</li> </ul>	See the setup documentation that came with the printer or go to <a href="http://support.lexmark.com">http://support.lexmark.com</a> .
More setup and instructions for using the printer: <ul style="list-style-type: none"> <li>• Selecting and storing paper and specialty media</li> <li>• Loading paper</li> <li>• Configuring printer settings</li> <li>• Viewing and printing documents and photos</li> <li>• Setting up and using the printer software</li> <li>• Configuring the printer on a network</li> <li>• Caring for and maintaining the printer</li> <li>• Troubleshooting and solving problems</li> </ul>	<i>Information Center</i> —Go to <a href="http://infoserve.lexmark.com">http://infoserve.lexmark.com</a> . <i>Product videos</i> —Go to <a href="http://infoserve.lexmark.com/idv/">http://infoserve.lexmark.com/idv/</a> .
Help using the printer software	Help for Microsoft Windows or Macintosh operating systems—Open a printer software program or application, and then click <b>Help</b> .  Click  to view context-sensitive information.  <b>Notes:</b> <ul style="list-style-type: none"> <li>• Help is automatically installed with the printer software.</li> <li>• Depending on the operating system, the printer software is located in the printer program folder or on the desktop.</li> </ul>

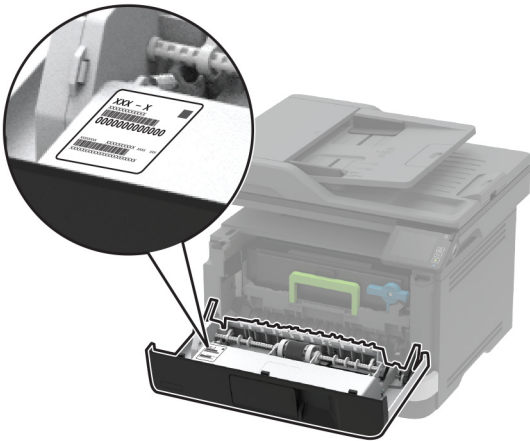
What are you looking for?	Find it here
<p>The latest supplemental information, updates, and customer support:</p> <ul style="list-style-type: none"> <li>• Documentation</li> <li>• Driver downloads</li> <li>• Live chat support</li> <li>• E-mail support</li> <li>• Voice support</li> </ul>	<p>Go to <a href="http://support.lexmark.com">http://support.lexmark.com</a>.</p> <p><b>Note:</b> Select your country or region, and then select your product to view the appropriate support site.</p> <p>Support contact information for your country or region can be found on the website or on the printed warranty that came with the printer.</p> <p>Have the following information ready when you contact customer support:</p> <ul style="list-style-type: none"> <li>• Place and date of purchase</li> <li>• Machine type and serial number</li> </ul> 
<ul style="list-style-type: none"> <li>• Safety information</li> <li>• Regulatory information</li> <li>• Warranty information</li> <li>• Environmental information</li> </ul>	<p>Warranty information varies by country or region:</p> <ul style="list-style-type: none"> <li>• <b>In the U.S.</b>—See the Statement of Limited Warranty included with the printer, or go to <a href="http://support.lexmark.com">http://support.lexmark.com</a>.</li> <li>• <b>In other countries and regions</b>—See the printed warranty that came with the printer.</li> </ul> <p><i>Product Information Guide</i>—See the documentation that came with the printer or go to <a href="http://support.lexmark.com">http://support.lexmark.com</a>.</p>

## Printer configuration

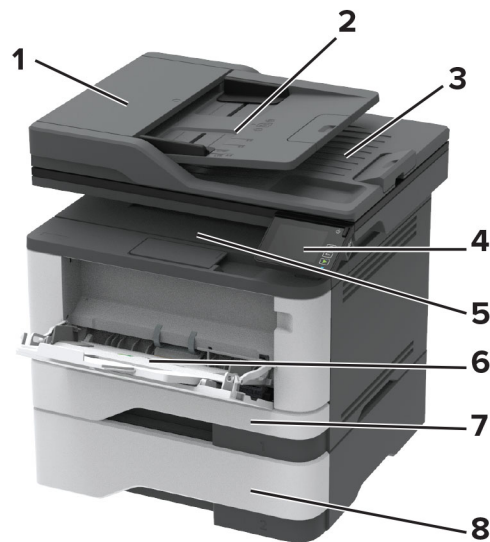

1	Automatic document feeder (ADF)
2	ADF tray
3	ADF bin
4	Control panel
5	Standard bin
6	Multipurpose feeder
7	Standard 250-sheet tray
8	Optional 550-sheet tray

## Using the control panel

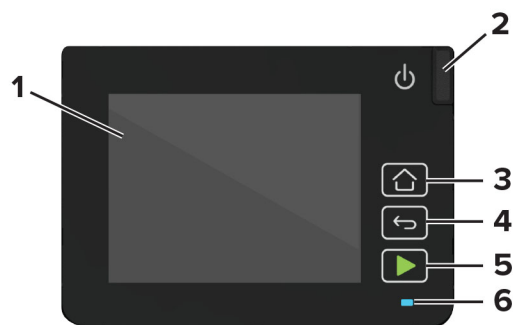

	Control panel part	Function
1	Display	<ul style="list-style-type: none"> <li>View printer messages and supply status.</li> <li>Set up and operate the printer.</li> </ul>
2	Power button	Turn on or turn off the printer. <b>Note:</b> To turn off the printer, press and hold the power button for five seconds.
3	Home button	Go to the home screen.
4	Back button	Return to the previous screen.
5	Start button	Start a job, depending on which mode is selected.
6	Indicator light	Check the status of the printer.

## Customizing the home screen

- From the control panel, touch **Settings > Device > Visible Home Screen Icons**.
- Select the icons that you want to appear on the home screen.
- Apply the changes.

## Changing the language of the keyboard on the display

**Note:** You can only change the language of the keyboard in printer tasks that require alphanumeric input such as e-mail or scan.

- Touch the input field.
- On the keyboard, touch and hold the language key.
- Select a language.

## Understanding the status of the indicator light

Indicator light	Printer status
Off	The printer is off or in Hibernate mode.
Blue	The printer is ready or processing data.
Blinking red	The printer requires user intervention.
Solid amber	The printer is in Sleep mode.

# Selecting paper

## Paper guidelines

Use the appropriate paper to prevent jams and help ensure trouble-free printing.

- Always use new, undamaged paper.
- Before loading paper, know the recommended printable side of the paper. This information is usually indicated on the paper package.
- Do not use paper that has been cut or trimmed by hand.
- Do not mix paper sizes, types, or weights in the same tray; mixing results in jams.
- Do not use coated papers unless they are specifically designed for electrophotographic printing.

## Paper characteristics

The following paper characteristics affect print quality and reliability. Consider these factors before printing on them.

### Weight

The standard tray can feed paper weights from 60 to 120 g/m<sup>2</sup> (16 to 32 lb) grain long paper. Paper lighter than 60 g/m<sup>2</sup> (16 lb) may not be stiff enough to feed properly, and may cause jams.

### Curl

Curl is the tendency for paper to curl at its edges. Excessive curl can cause paper feeding problems. Curl can occur after the paper passes through the printer, where it is exposed to high temperatures. Storing paper unwrapped in hot, humid, cold, or dry conditions can contribute to paper curling before printing and can cause feeding problems.

### Smoothness

Paper smoothness directly affects print quality. If paper is too rough, toner cannot fuse to it properly. If paper is too smooth, it can cause paper feeding or print quality issues. We recommend the use of paper with 50 Sheffield points.

### Moisture content

The amount of moisture in paper affects both print quality and the printer ability to feed the paper correctly. Leave paper in its original wrapper until you use it. Exposure of paper to moisture changes can degrade its performance.

Store paper in its original wrapper in the same environment as the printer for 24 to 48 hours before printing. Extend the time several days if the storage or transportation environment is very different from the printer environment. Thick paper may also require a longer conditioning period.

### Grain direction

Grain refers to the alignment of the paper fibers in a sheet of paper. Grain is either *grain long*, running the length of the paper, or *grain short*, running the width of the paper.

For 60–120 g/m<sup>2</sup> (16–32-lb) paper, grain long paper is recommended.

## Fiber content

Most high-quality xerographic paper is made from 100 percent chemically treated pulped wood. This content provides the paper with a high degree of stability, resulting in fewer paper feeding problems and better print quality. Paper containing fibers such as cotton can negatively affect paper handling.

## Unacceptable paper

The following paper types are not recommended for use with the printer:

- Chemically treated papers used to make copies without carbon paper, also known as carbonless papers, carbonless copy paper (CCP), or no carbon required (NCR) paper
- Preprinted papers with chemicals that may contaminate the printer
- Preprinted papers that can be affected by the temperature in the printer fuser
- Preprinted papers that require a registration (the precise print location on the page) greater than  $\pm 2.3$  mm ( $\pm 0.9$  in.), such as optical character recognition (OCR) forms

In some cases, registration can be adjusted with a software application to successfully print on these forms.

- Coated papers (erasable bond), synthetic papers, thermal papers
- Rough-edged, rough or heavily textured surface papers, or curled papers
- Recycled papers that fail EN12281:2002 (European)
- Paper weighing less than  $60 \text{ g/m}^2$  (16 lb)
- Multiple-part forms or documents

## Selecting preprinted forms and letterhead

- Use grain long paper.
- Use only forms and letterhead printed using an offset lithographic or engraved printing process.
- Avoid paper with rough or heavily textured surfaces.
- Use inks that are not affected by the resin in toner. Inks that are oxidation-set or oil-based generally meet these requirements; latex inks might not.
- Print samples on preprinted forms and letterheads considered for use before buying large quantities. This action determines whether the ink in the preprinted form or letterhead affects print quality.
- When in doubt, contact your paper supplier.
- When printing on letterhead, load the paper in the proper orientation for your printer. For more information, see the *Paper and Specialty Media Guide*.

## Storing paper

Use these paper storage guidelines to help avoid jams and uneven print quality:

- Store paper in its original wrapper in the same environment as the printer for 24 to 48 hours before printing.
- Extend the time several days if the storage or transportation environment is very different from the printer environment. Thick paper may also require a longer conditioning period.
- For best results, store paper where the temperature is  $21^\circ\text{C}$  ( $70^\circ\text{F}$ ) and the relative humidity is 40 percent.
- Most label manufacturers recommend printing in a temperature range of  $18\text{--}24^\circ\text{C}$  ( $65\text{--}75^\circ\text{F}$ ) with relative humidity between 40 and 60 percent.
- Store paper in cartons, on a pallet or shelf, rather than on the floor.

- Store individual packages on a flat surface.
- Do not store anything on top of individual paper packages.
- Take paper out of the carton or wrapper only when you are ready to load it in the printer. The carton and wrapper help keep the paper clean, dry, and flat.

## Supported paper sizes

Paper size	Standard 250-sheet tray	Optional 550-sheet tray	Multipurpose feeder	Two-sided printing	Scanner	ADF
<b>A4</b> 210 x 297 mm (8.27 x 11.7 in.)	✓	✓	✓	✓	✓	✓
<b>A5 Portrait (SEF)</b> 148 x 210 mm (5.83 x 8.27 in.)	✓	✓	✓	x	✓	✓
<b>A5 Landscape (LEF)<sup>1</sup></b> 210 x 148 mm (8.27 x 5.83 in.)	✓	✓	✓	x	✓	✓
<b>A6</b> 105 x 148 mm (4.13 x 5.83 in.)	✓	✓	✓	x	✓	✓
<b>JIS B5</b> 182 x 257 mm (7.17 x 10.1 in.)	✓	✓	✓	x	✓	✓
<b>Oficio (Mexico)</b> 215.9 x 340.4 mm (8.5 x 13.4 in.)	✓	✓	✓	✓	x	✓
<b>Hagaki</b> 100 x 148 mm (3.94 x 5.83 in.)	✓	x	✓	x	✓	x
<b>Statement</b> 139.7 x 215.9 mm (5.5 x 8.5 in.)	✓	✓	✓	x	✓	✓
<b>Executive</b> 184.2 x 266.7 mm (7.25 x 10.5 in.)	✓	✓	✓	x	✓	✓

<sup>1</sup> The default support is long-edge feed.

<sup>2</sup> Paper must at least be 210 mm (8.27 in.) wide and 279.4 mm (11 in.) long for two-sided printing.

<sup>3</sup> When Universal is selected, the page is formatted for 215.90 x 355.60 mm (8.5 x 14 in.) unless specified by the application.

Paper size	Standard 250-sheet tray	Optional 550-sheet tray	Multipurpose feeder	Two-sided printing	Scanner	ADF
<b>Letter</b> 215.9 x 279.4 mm (8.5 x 11 in.)	✓	✓	✓	✓	✓	✓
<b>Legal</b> 215.9 x 355.6 mm (8.5 x 14 in.)	✓	✓	✓	✓	x	✓
<b>Folio</b> 215.9 x 330.2 mm (8.5 x 13 in.)	✓	✓	✓	✓	x	✓
<b>Universal<sup>3</sup></b> 99 x 148 mm to 215.9 x 359.92 mm (3.9 x 5.83 in. to 8.5 x 14.17 in.)	✓	✓	✓	✓ <sup>2</sup>	x	✓
<b>7 3/4 Envelope</b> 98.4 x 190.5 mm (3.875 x 7.5 in.)	x	x	✓	x	✓	x
<b>9 Envelope</b> 98.4 x 225.4 mm (3.875 x 8.9 in.)	x	x	✓	x	✓	x
<b>10 Envelope</b> 104.8 x 241.3 mm (4.12 x 9.5 in.)	x	x	✓	x	✓	x
<b>DL Envelope</b> 110 x 220 mm (4.33 x 8.66 in.)	x	x	✓	x	✓	x
<b>C5 Envelope</b> 162 x 229 mm (6.38 x 9.01 in.)	x	x	✓	x	✓	x
<b>B5 Envelope</b> 176 x 250 mm (6.93 x 9.84 in.)	x	x	✓	x	✓	x

<sup>1</sup> The default support is long-edge feed.

<sup>2</sup> Paper must at least be 210 mm (8.27 in.) wide and 279.4 mm (11 in.) long for two-sided printing.

<sup>3</sup> When Universal is selected, the page is formatted for 215.90 x 355.60 mm (8.5 x 14 in.) unless specified by the application.



Paper size	Standard 250-sheet tray	Optional 550-sheet tray	Multipurpose feeder	Two-sided printing	Scanner	ADF
<b>Other Envelope</b> 98.4 x 162 mm to 176 x 250 mm (3.87 x 6.38 in. to 6.93 x 9.84 in.)	X	X	✓	X	✓	X

<sup>1</sup> The default support is long-edge feed.

<sup>2</sup> Paper must at least be 210 mm (8.27 in.) wide and 279.4 mm (11 in.) long for two-sided printing.

<sup>3</sup> When Universal is selected, the page is formatted for 215.90 x 355.60 mm (8.5 x 14 in.) unless specified by the application.

## Supported paper types

Paper type	Standard 250-sheet tray	Optional 550-sheet tray	Multipurpose feeder	Two-sided printing	Automatic document feeder
<b>Plain paper</b>	✓	✓	✓	✓	✓
<b>Card stock</b>	X	X	✓	X	X
<b>Recycled</b>	✓	✓	✓	✓	X
<b>Paper labels*</b>	✓	✓	✓	X	X
<b>Bond</b>	✓	✓	✓	✓	X
<b>Letterhead</b>	✓	✓	✓	✓	X
<b>Preprinted</b>	✓	✓	✓	✓	X
<b>Colored Paper</b>	✓	✓	✓	✓	X
<b>Light Paper</b>	✓	✓	✓	✓	X
<b>Heavy Paper</b>	✓	✓	✓	✓	X
<b>Rough/Cotton</b>	✓	✓	✓	✓	X
<b>Envelope</b>	X	X	✓	X	X
<b>Rough envelope</b>	X	X	✓	X	X

\* One-sided paper labels are supported for occasional use of less than 20 pages per month. Vinyl, pharmacy, or two-sided labels are not supported.

## Supported paper weights

	Standard 250-sheet tray	Optional 550-sheet tray	Multipurpose feeder	Two-sided printing	Automatic document feeder
Paper weight	60–120 g/m <sup>2</sup> (16–32 lb)	60–120 g/m <sup>2</sup> (16–32 lb)	60–217 g/m <sup>2</sup> (16–58 lb)	60–90 g/m <sup>2</sup> (16–24 lb)	60–90 g/m <sup>2</sup> (16–24 lb)

# Set up, install, and configure

## Selecting a location for the printer

- Leave enough room to open trays, covers, and doors and to install hardware options.
- Set up the printer near an electrical outlet.

**⚠ CAUTION—POTENTIAL INJURY:** To avoid the risk of fire or electrical shock, connect the power cord to an appropriately rated and properly grounded electrical outlet that is near the product and easily accessible.

**⚡ CAUTION—SHOCK HAZARD:** To avoid the risk of electrical shock, do not place or use this product near water or wet locations.

- Make sure that airflow in the room meets the latest revision of the ASHRAE 62 standard or the CEN Technical Committee 156 standard.
- Provide a flat, sturdy, and stable surface.
- Keep the printer:
  - Clean, dry, and free of dust
  - Away from stray staples and paper clips
  - Away from the direct airflow of air conditioners, heaters, or ventilators
  - Free from direct sunlight and humidity extremes
- Observe the recommended temperatures and avoid fluctuations.

Ambient temperature	10 to 32.2°C (50 to 90°F)
Storage temperature	-40 to 40°C (-40 to 104°F)

- Allow the following recommended amount of space around the printer for proper ventilation:

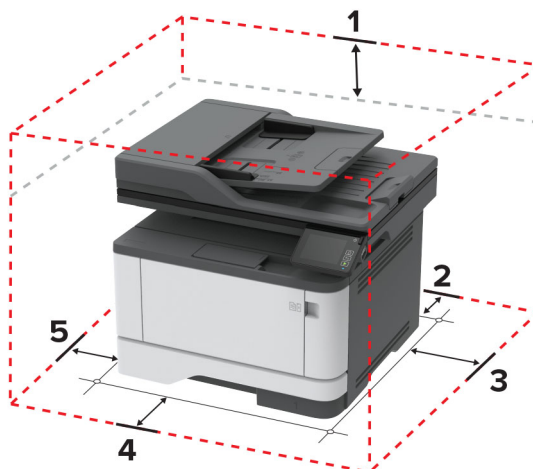

1	Top	305 mm (12 in.)
2	Rear	100 mm (3.94 in.)
3	Right side	76.2 mm (3 in.)

<b>4</b>	Front	305 mm (12 in.) <b>Note:</b> The minimum space needed in front of the printer is 76 mm (3 in.).
<b>5</b>	Left side	110 mm (4.33 in.)

## Attaching cables

- ⚠ CAUTION—SHOCK HAZARD:** To avoid the risk of electrical shock, do not set up this product or make any electrical or cabling connections, such as the power cord, fax feature, or telephone, during a lightning storm.
- ⚠ CAUTION—POTENTIAL INJURY:** To avoid the risk of fire or electrical shock, connect the power cord to an appropriately rated and properly grounded electrical outlet that is near the product and easily accessible.
- ⚠ CAUTION—POTENTIAL INJURY:** To avoid the risk of fire or electrical shock, use only the power cord provided with this product or the manufacturer's authorized replacement.
- ⚠ CAUTION—POTENTIAL INJURY:** To reduce the risk of fire, use only a 26 AWG or larger telecommunications (RJ-11) cord when connecting this product to the public switched telephone network. For users in Australia, the cord must be approved by the Australian Communications and Media Authority.

**Warning—Potential Damage:** To avoid loss of data or printer malfunction, do not touch the USB cable, any wireless network adapter, or the printer in the areas shown while actively printing.

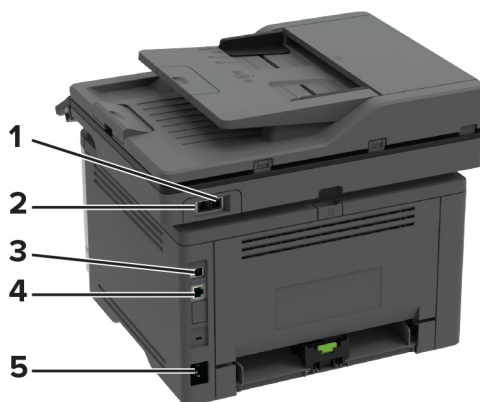

	Printer port	Function
<b>1</b>	EXT port	Connect more devices (telephone or answering machine) to the printer and the telephone line. Use this port if you do not have a dedicated fax line for the printer and if this connection method is supported in your country or region.
<b>2</b>	LINE port	Connect the printer to an active telephone line through a standard wall jack (RJ-11), DSL filter, or VoIP adapter, or any other adapter that allows you to access the telephone line to send and receive faxes.
<b>3</b>	USB printer port	Connect the printer to a computer.
<b>4</b>	Ethernet port	Connect the printer to a network.

	Printer port	Function
5	Power cord socket	Connect the printer to a properly grounded electrical outlet.

## Installing optional trays

**⚠ CAUTION—SHOCK HAZARD:** To avoid the risk of electrical shock, if you are accessing the controller board or installing optional hardware or memory devices sometime after setting up the printer, then turn the printer off, and unplug the power cord from the electrical outlet before continuing. If you have any other devices attached to the printer, then turn them off as well, and unplug any cables going into the printer.

- 1 Turn off the printer.
- 2 Unplug the power cord from the electrical outlet, and then from the printer.
- 3 Unpack the optional tray, and then remove all packing material.
- 4 Align the printer with the optional tray, and then lower the printer into place.

**⚠ CAUTION—POTENTIAL INJURY:** If the printer weight is greater than 20 kg (44 lb), then it may require two or more people to lift it safely.

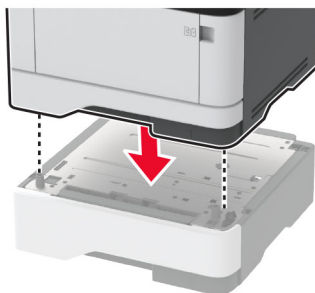

- 5 Connect the power cord to the printer, and then to the electrical outlet.

**⚠ CAUTION—POTENTIAL INJURY:** To avoid the risk of fire or electrical shock, connect the power cord to an appropriately rated and properly grounded electrical outlet that is near the product and easily accessible.

- 6 Turn on the printer.

Add the tray in the print driver to make it available for print jobs. For more information, see [“Adding available options in the print driver” on page 33](#).

## Setting up the printer to fax

### Setting up the fax function

#### Notes:

- Some connection methods are applicable only in some countries or regions.
- If the fax function is enabled and not fully set up, then the indicator light may blink red.

- If you do not have a TCP/IP environment, then use the control panel to set up fax.

**Warning—Potential Damage:** To avoid loss of data or printer malfunction, do not touch cables or the printer in the area shown while actively sending or receiving a fax.

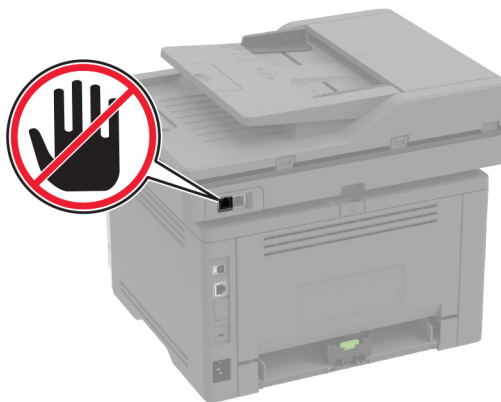

### Using the control panel

- 1 From the home screen, touch:  
**Settings > Device > Preferences > Run Initial Setup**
- 2 Turn off the printer, wait for about 10 seconds, and then turn on the printer.
- 3 On the Fax setup screen, configure the settings.
- 4 Finish the setup.

### Using the Embedded Web Server

- 1 Open a web browser, and then type the printer IP address in the address field.

**Notes:**

- View the printer IP address on the home screen. The IP address appears as four sets of numbers separated by periods, such as 123.123.123.123.
- If you are using a proxy server, then temporarily disable it to load the web page correctly.

- 2 Click **Settings > Fax > Fax Setup > General Fax Settings**.
- 3 Configure the settings.
- 4 Apply the changes.

### Setting up fax using a standard telephone line

 **CAUTION—SHOCK HAZARD:** To avoid the risk of electrical shock, do not set up this product or make any electrical or cabling connections, such as the power cord, fax feature, or telephone, during a lightning storm.

 **CAUTION—SHOCK HAZARD:** To avoid the risk of electrical shock, do not use the fax feature during a lightning storm.

**⚠ CAUTION—POTENTIAL INJURY:** To reduce the risk of fire, use only a 26 AWG or larger telecommunications (RJ-11) cord when connecting this product to the public switched telephone network. For users in Australia, the cord must be approved by the Australian Communications and Media Authority.

### Setup 1: Printer is connected to a dedicated fax line

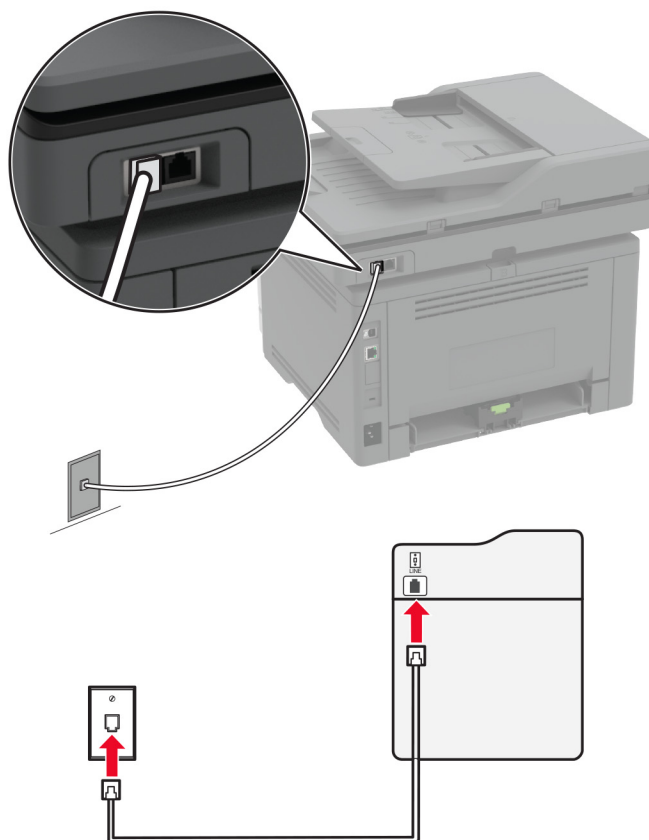

- 1 Connect one end of the telephone cable to the line port of the printer.
- 2 Connect the other end of the cable to an active analog wall jack.

#### Notes:

- You can set the printer to receive faxes automatically (set Auto Answer to **On**) or manually (set Auto Answer to **Off**).
- If you want to receive faxes automatically, then set the printer to pick up on a specified number of rings.

### Setup 2: Printer is sharing the line with an answering machine

**Note:** If you subscribe to a distinctive ring service, then make sure that you set the correct ring pattern for the printer. Otherwise, the printer does not receive faxes even if you have set it to receive faxes automatically.

### Connected to different wall jacks

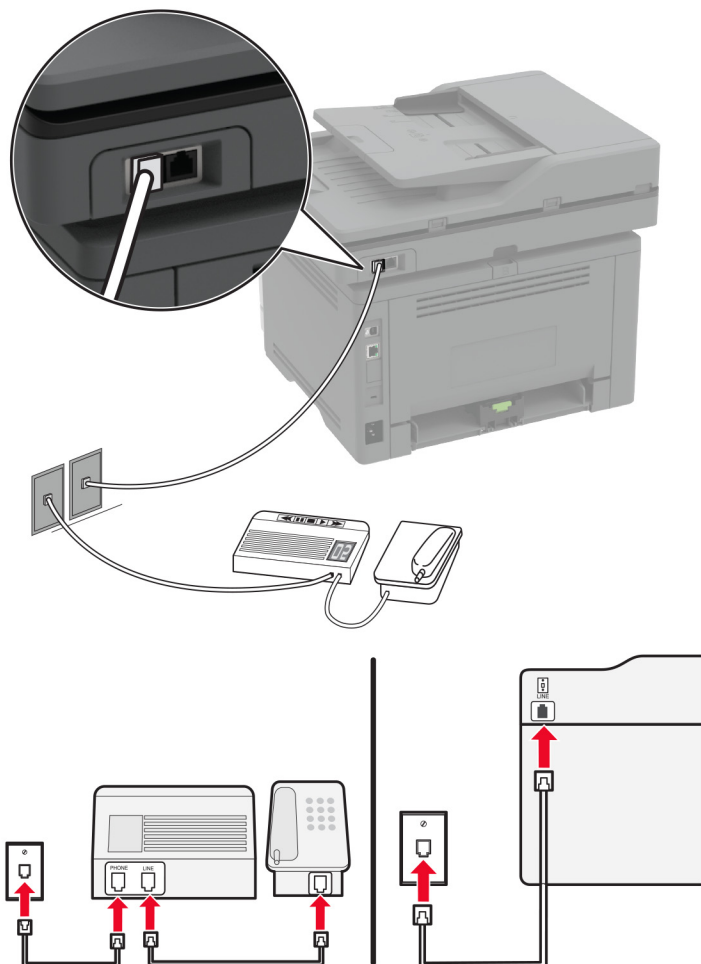

- 1 Connect one end of the telephone cable to the line port of the printer.
- 2 Connect the other end of the cable to an active analog wall jack.

#### Notes:

- If you have only one telephone number on your line, then set the printer to receive faxes automatically.
- Set the printer to pick up calls two rings after the answering machine. For example, if the answering machine picks up calls after four rings, then set the printer Rings to Answer setting to **6**.

### Setting up fax in countries or regions with different telephone wall jacks and plugs

**⚠ CAUTION—SHOCK HAZARD:** To avoid the risk of electrical shock, do not set up this product or make any electrical or cabling connections, such as the power cord, fax feature, or telephone, during a lightning storm.

**⚠ CAUTION—SHOCK HAZARD:** To avoid the risk of electrical shock, do not use the fax feature during a lightning storm.



**⚠ CAUTION—POTENTIAL INJURY:** To reduce the risk of fire, use only a 26 AWG or larger telecommunications (RJ-11) cord when connecting this product to the public switched telephone network. For users in Australia, the cord must be approved by the Australian Communications and Media Authority.

The standard wall jack adopted by most countries or regions is RJ11. If the wall jack or equipment in your facility is not compatible with this type of connection, then use a telephone adapter. An adapter for your country or region may not come with your printer, and you may need to purchase it separately.

There may be an adapter plug installed in the telephone port of the printer. Do not remove the adapter plug from the telephone port of the printer if you are connecting to a serial or cascaded telephone system.

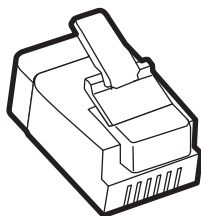

Part name	Part number
Lexmark adapter plug	40X8519

## Connecting the printer to a non-RJ11 wall jack

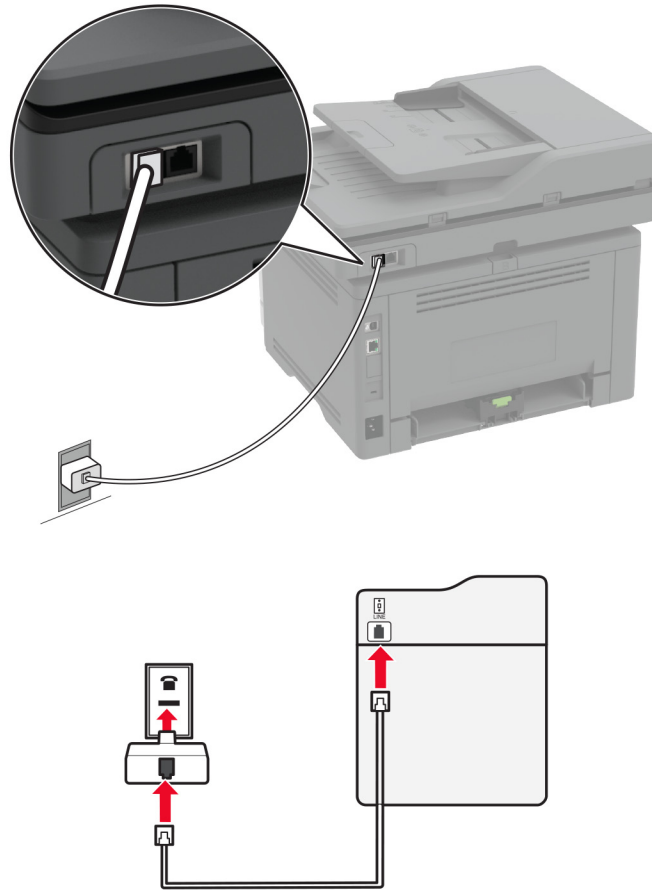

- 1** Connect one end of the telephone cable to the line port of the printer.
- 2** Connect the other end of the cable to the RJ11 adapter, and then connect the adapter to the wall jack.
- 3** If you want to connect another device with a non-RJ11 connector to the same wall jack, then connect it directly to the telephone adapter.

## Connecting the printer to a wall jack in Germany

The German wall jack has two kinds of ports. The N ports are for fax machines, modems, and answering machines. The F port is for telephones. Connect the printer to any of the N ports.

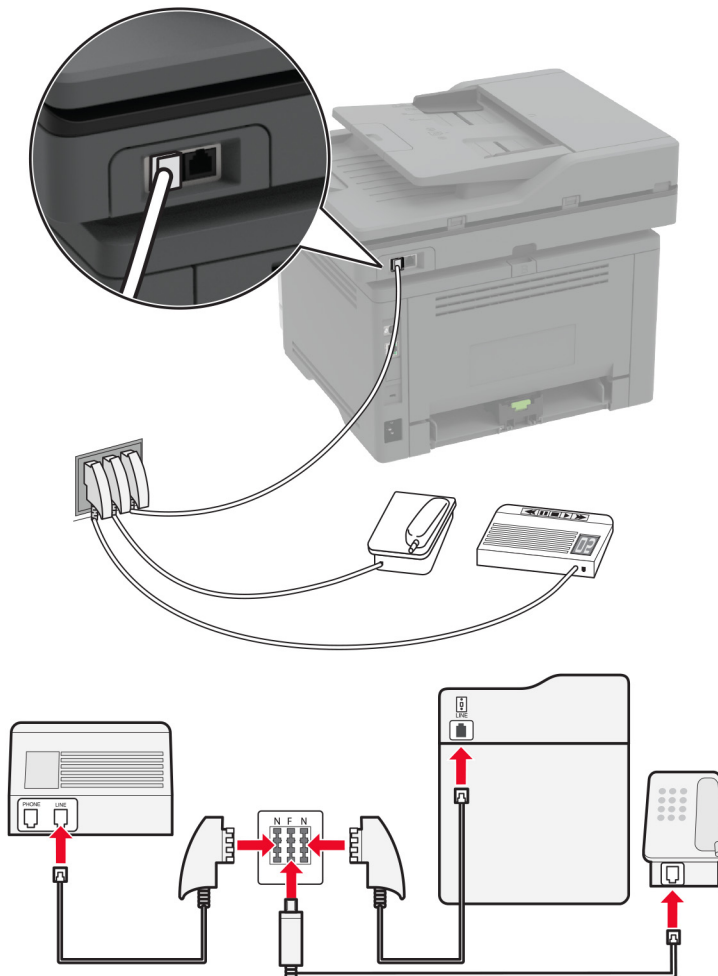

- 1 Connect one end of the telephone cable to the line port of the printer.
- 2 Connect the other end of the cable to the RJ11 adapter, and then connect the adapter to an N port.
- 3 If you want to connect a telephone and answering machine to the same wall jack, then connect the devices as shown.

## Connecting to a distinctive ring service

A distinctive ring service lets you have multiple telephone numbers on one telephone line. Each telephone number is assigned a different ring pattern.

- 1 From the home screen, touch **Settings** > **Fax** > **Fax Setup** > **Fax Receive Settings** > **Admin Controls** > **Answer On**.
- 2 Select a ring pattern.

## Setting the fax date and time

- 1 From the home screen, touch **Settings** > **Device** > **Preferences** > **Date and Time** > **Configure**.
- 2 Configure the settings.

## Configuring daylight saving time

- 1 From the home screen, touch **Settings** > **Device** > **Preferences** > **Date and Time** > **Configure**.
- 2 In the Time Zone menu, touch **(UTC+user) Custom**.
- 3 In the Configure menu, touch **UTC Offset**.
- 4 Configure the settings.

## Configuring the fax speaker settings

- 1 From the home screen, touch **Settings** > **Fax** > **Fax Setup** > **Speaker Settings**.
- 2 Do the following:
  - Set the Speaker Mode to **Always On**.
  - Set the Speaker Volume to **High**.
  - Activate the Ringer Volume.

## Loading paper and specialty media

### Setting the paper size and type

- 1 From the home screen, navigate to:  
**Settings** > **Paper** > **Tray Configuration** > **Paper Size/Type** > select a paper source
- 2 Set the paper size and type.

### Configuring Universal paper settings

- 1 From the home screen, touch **Settings** > **Paper** > **Media Configuration** > **Universal Setup**.
- 2 Configure the settings.

### Loading trays

- 1 Remove the tray.  
**Note:** To avoid paper jams, do not remove the tray while the printer is busy.



**2** Adjust the guides to match the size of the paper that you are loading.

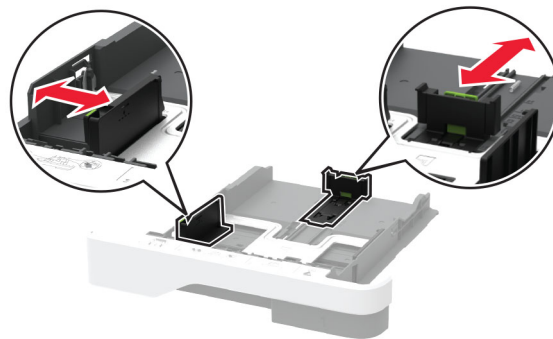

**3** Flex, fan, and align the paper edges before loading.

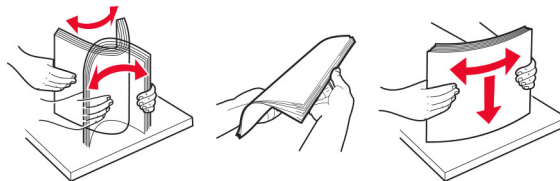

**4** Load the paper stack with the printable side facedown, and then make sure that the guides fit snugly against the paper.

**Notes:**

- Load letterhead facedown with the header toward the front of the tray for one-sided printing.
- Load letterhead faceup with the header toward the back of the tray for two-sided printing.
- Do not slide paper into the tray.
- To avoid paper jams, make sure that the stack height is below the maximum paper fill indicator.



**5** Insert the tray.

If necessary, set the paper size and paper type from the control panel to match the paper loaded.

## Loading the multipurpose feeder

**1** Open the multipurpose feeder.

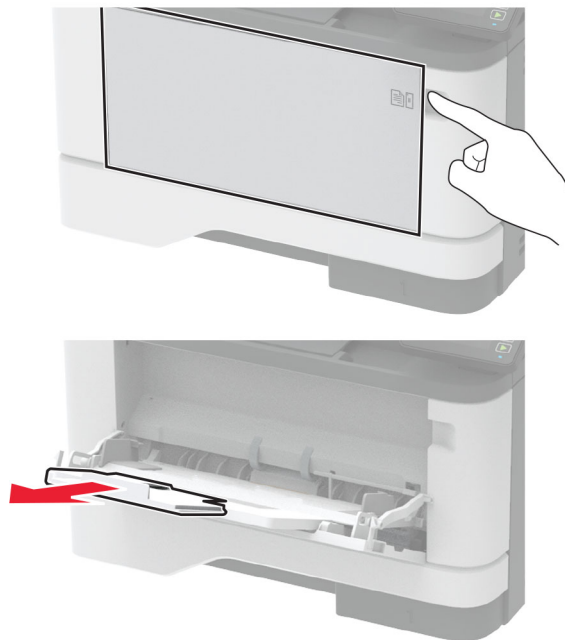

**2** Flex, fan, and align the paper edges before loading.

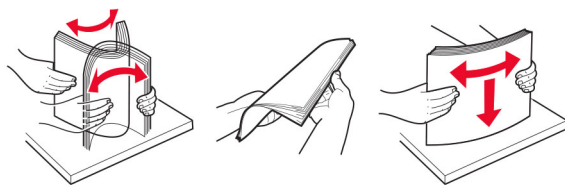

**3** Load paper with the printable side faceup.

**Notes:**

- Load letterhead faceup with the header toward the rear of the printer for one-sided printing.
- Load letterhead facedown with the header toward the front of the printer for two-sided printing.
- Load envelopes with the flap facedown on the left side.

**Warning—Potential Damage:** Do not use envelopes with stamps, clasps, snaps, windows, coated linings, or self-stick adhesives.

- 4 Adjust the guide to match the size of the paper that you are loading.

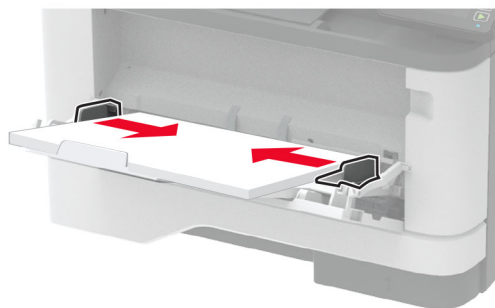

- 5 From the control panel, set the paper size and paper type to match the paper loaded.

## Linking trays

- 1 From the home screen, touch **Settings** > **Paper** > **Tray Configuration** > select a paper source.
- 2 Set the same paper size and paper type for the trays that you are linking.
- 3 From the home screen, touch **Settings** > **Device** > **Maintenance** > **Config Menu** > **Tray Configuration** > **Tray Linking**.
- 4 Touch **Automatic**.

To unlink trays, make sure that no trays have the same paper size and paper type settings.

**Warning—Potential Damage:** The temperature of the fuser varies according to the specified paper type. To avoid printing issues, match the paper type setting in the printer with the paper loaded in the tray.

# Installing and updating software, drivers, and firmware

## Installing the printer software

**Notes:**

- The print driver is included in the software installer package.

- For Macintosh computers with macOS version 10.7 or later, you do not need to install the driver to print on an AirPrint-certified printer.
- 1 Obtain a copy of the software installer package.
    - From the software CD that came with your printer.
    - Go to <http://support.lexmark.com>, and then select your printer and operating system.
  - 2 Run the installer, and then follow the instructions on the computer screen.

## Updating firmware

Some applications require a minimum device firmware level to operate correctly.

For more information on updating the device firmware, contact your Lexmark representative.

- 1 Open a web browser, and then type the printer IP address in the address field.

### Notes:

- View the printer IP address on the printer home screen. The IP address appears as four sets of numbers separated by periods, such as 123.123.123.123.
- If you are using a proxy server, then temporarily disable it to load the web page correctly.

- 2 Click **Settings > Device > Update Firmware**.
- 3 Browse to the flash file.
- 4 Click **Upload**.

## Exporting or importing a configuration file

You can export the configuration settings of your printer into a text file, and then import the file to apply the settings to other printers.

- 1 Open a web browser, and then type the printer IP address in the address field.

### Notes:

- View the printer IP address on the printer home screen. The IP address appears as four sets of numbers separated by periods, such as 123.123.123.123.
- If you are using a proxy server, then temporarily disable it to load the web page correctly.

- 2 From the Embedded Web Server, click **Export Configuration** or **Import Configuration**.
- 3 Follow the instructions on the screen.
- 4 If the printer supports applications, then do the following:
  - a Click **Apps > select the application > Configure**.
  - b Click **Export** or **Import**.



## Adding available options in the print driver

### For Windows users

- 1 Open the printers folder.
- 2 Select the printer you want to update, and then do either of the following:
  - For Windows 7 or later, select **Printer properties**.
  - For earlier versions, select **Properties**.
- 3 Navigate to the Configuration tab, and then select **Update Now - Ask Printer**.
- 4 Apply the changes.

### For Macintosh users

- 1 From System Preferences in the Apple menu, navigate to your printer, and then select **Options & Supplies**.
- 2 Navigate to the list of hardware options, and then add any installed options.
- 3 Apply the changes.

## Networking

### Connecting the printer to a Wi-Fi network

Make sure that Active Adapter is set to Auto. From the home screen, touch **Settings > Network/Ports > Network Overview > Active Adapter**.

#### Using the control panel

- 1 From the home screen, touch **Settings > Network/Ports > Wireless > Setup On Printer Panel > Choose Network**.
- 2 Select a Wi-Fi network, and then type the network password.  
**Note:** For Wi-Fi-network-ready printer models, a prompt for Wi-Fi network setup appears during initial setup.

#### Using Lexmark Mobile Assistant

- 1 Depending on your mobile device, download the Lexmark Mobile Assistant application from either the Google Play™ store or App Store online store.
- 2 From the printer home screen, touch **Settings > Network/Ports > Wireless > Setup Using Mobile App > Printer ID**.
- 3 From your mobile device, launch the application, and then accept the Terms of Use.  
**Note:** If necessary, grant permissions.
- 4 Tap **Connect to Printer > Go to Wi-Fi Settings**.
- 5 Connect your mobile device to the printer wireless network.
- 6 Return to the application, and then tap **Setup Wi-Fi Connection**.

**7** Select a Wi-Fi network, and then type the network password.

**8** Tap **Done**.

## Connecting the printer to a wireless network using Wi-Fi Protected Setup (WPS)

Before you begin, make sure that:

- The access point (wireless router) is WPS-certified or WPS-compatible. For more information, see the documentation that came with your access point.
- A wireless network adapter is installed in your printer. For more information, see the instructions that came with the adapter.
- Active Adapter is set to Auto. From the home screen, touch **Settings** > **Network/Ports** > **Network Overview** > **Active Adapter**.

### Using the Push Button method

- 1** From the home screen, touch **Settings** > **Network/Ports** > **Wireless** > **Wi-Fi Protected Setup** > **Start Push Button Method**.
- 2** Follow the instructions on the display.

### Using the personal identification number (PIN) method

- 1** From the home screen, touch **Settings** > **Network/Ports** > **Wireless** > **Wi-Fi Protected Setup** > **Start PIN Method**.
- 2** Copy the eight-digit WPS PIN.
- 3** Open a web browser, and then type the IP address of your access point in the address field.

#### Notes:

- To know the IP address, see the documentation that came with your access point.
- If you are using a proxy server, then temporarily disable it to load the web page correctly.

- 4** Access the WPS settings. For more information, see the documentation that came with your access point.
- 5** Enter the eight-digit PIN, and then save the changes.

## Connecting a mobile device to the printer

Before connecting your mobile device, make sure to do the following:

- Enable Wi-Fi Direct® in the printer. From the control panel, navigate to: **Settings** > **Network/Ports** > **Wireless** > **Enable Wi-Fi Direct**.
- Show the preshared key (PSK) on the Network Setup Page. From the control panel, navigate to: **Settings** > **Network/Ports** > **Wi-Fi Direct** > **Show PSK on Setup Page**.
- Print the Network Setup Page. From the control panel, navigate to: **Settings** > **Reports** > **Network** > **Network Setup Page**.

## Connecting using Wi-Fi Direct

- 1 From the mobile device, go to the settings menu.
- 2 Enable Wi-Fi, and then tap **Wi-Fi Direct**.
- 3 Select the printer SSID.
- 4 Confirm the connection on the printer control panel.

## Connecting using Wi-Fi

- 1 From the mobile device, go to the settings menu.
- 2 Tap **Wi-Fi**, and then select the printer SSID.

**Note:** The string **DIRECT-xy** (where **x** and **y** are two random characters) is added before the SSID.

- 3 Enter the PSK.

**Note:** The PSK is the password.

### Notes:

- You can change the SSID on the control panel. Navigate to: **Settings > Network/Ports > Wi-Fi Direct > SSID**.
- You can also change the PSK on the control panel. Navigate to: **Settings > Network/Ports > Wi-Fi Direct > Set PSK**.

## Deactivating the Wi-Fi network

- 1 From the home screen, touch **Settings > Network/Ports > Network Overview > Active Adapter > Standard Network**.
- 2 Follow the instructions on the display.

## Checking the printer connectivity

- 1 From the home screen, touch **Settings > Reports > Network > Network Setup Page**.
- 2 Check the first section of the network setup page, and confirm that the status is connected.  
If the status is not connected, then the LAN drop may be inactive, or the network cable may be malfunctioning. Contact your administrator for assistance.

## Creating a Cloud Connector profile

We recommend logging in to the printer before you create a profile. To enable a login method, see the *Embedded Web Server - Security Admin Guide*.

- 1 From the home screen, touch **Cloud Connector**.
- 2 Select a cloud service provider.
- 3 Touch **Create** or .
- 4 Type a unique profile name.

- 5** If necessary, enter a PIN.  
**Note:** When using the printer as guest, protect the profile with a PIN.
- 6** Touch **OK**, and then take note of the authorization code.  
**Note:** The authorization code is valid only for 24 hours.
- 7** Open a web browser, and then go to <https://lexmark.cloud-connect.co>.
- 8** Click **Next**, and then accept the Terms of Use.
- 9** Enter the authorization code, and then click **Connect**.
- 10** Log in to your cloud service provider account.
- 11** Grant permissions.  
**Note:** To complete the authorization process, open the profile within 72 hours.

## Printing the Menu Settings Page

From the home screen, touch **Settings > Reports > Menu Settings Page**.

# Secure the printer

## Locating the security slot

The printer is equipped with a security lock feature. Attach a security lock compatible with most laptop computers in the location shown to secure the printer in place.



## Erasing printer memory

To erase volatile memory or buffered data in your printer, turn off the printer.

To erase non-volatile memory or individual settings, device and network settings, security settings, and embedded solutions, do the following:

- 1 From the home screen, touch **Settings > Device > Maintenance > Out of Service Erase**.
- 2 Select the **Sanitize all information on nonvolatile memory** check box, and then touch **OK**.
- 3 Select either **Start initial setup** or **Leave printer offline**, and then touch **OK**.

## Restoring factory default settings

- 1 From the home screen, touch **Settings > Device > Restore Factory Defaults**.
- 2 In the Restore Settings menu, select the settings that you want to restore.
- 3 Touch **RESTORE**.
- 4 Follow the instructions on the display.

## Statement of Volatility

Your printer contains various types of memory that can store device and network settings, and user data.

Type of memory	Description
Volatile memory	Your printer uses standard <i>random access memory</i> (RAM) to temporarily buffer user data during simple print jobs.
Non-volatile memory	Your printer may use two forms of non-volatile memory: EEPROM and NAND (flash memory). Both types are used to store operating system, device settings, and network information.

Erase the content of any installed printer memory in the following circumstances:

- The printer is being decommissioned.
- The printer is being moved to a different department or location.
- The printer is being serviced by someone from outside your organization.
- The printer is being removed from your premises for service.
- The printer is being sold to another organization.

# Print

## Printing from a computer

**Note:** For labels, card stock, and envelopes, set the paper size and type in the printer before printing the document.

- 1 From the document that you are trying to print, open the Print dialog.
- 2 If necessary, adjust the settings.
- 3 Print the document.

## Printing from a mobile device

### Printing from a mobile device using Lexmark Mobile Print

Lexmark™ Mobile Print allows you to send documents and images directly to a supported Lexmark printer.

- 1 Open the document, and then send or share the document to Lexmark Mobile Print.

**Note:** Some third-party applications may not support the send or share feature. For more information, see the documentation that came with the application.



- 2 Select a printer.
- 3 Print the document.

### Printing from a mobile device using Google Cloud Print

Google Cloud Print™ is a printing service that allows you to print to any Google Cloud Print-ready printer.

Before you begin, make sure that:



- The printer is registered to the Google Cloud Print server.
- The Cloud Print plugin is downloaded from the Google Play store and is enabled in the mobile device.

- 1 From your Android™ mobile device, open a document or select a document from your file manager.
- 2 Tap  > **Print**.
- 3 Select a printer, and then tap .

### Printing from a mobile device using Mopria Print Service

Mopria® Print Service is a mobile printing solution for mobile devices running on Android version 5.0 or later. It allows you to print directly to any Mopria-certified printer.

**Note:** Make sure that you download the Mopria Print Service application from the Google Play store and enable it in the mobile device.

- 1 From your Android mobile device, launch a compatible application or select a document from your file manager.
- 2 Tap  > **Print**.
- 3 Select a printer, and then adjust the settings, if necessary.
- 4 Tap .

## Printing from a mobile device using AirPrint

The AirPrint software feature is a mobile printing solution that allows you to print directly from Apple devices to an AirPrint-certified printer.

### Notes:



- Make sure that the Apple device and the printer are connected to the same network. If the network has multiple wireless hubs, then make sure that both devices are connected to the same subnet.
- This application is supported only in some Apple devices.

- 1 From your mobile device, select a document from your file manager or launch a compatible application.
- 2 Tap  > **Print**.
- 3 Select a printer, and then adjust the settings, if necessary.
- 4 Print the document.

## Printing from a mobile device using Wi-Fi Direct®

Wi-Fi Direct is a printing service that lets you print to any Wi-Fi Direct-ready printer.

**Note:** Make sure that the mobile device is connected to the printer wireless network. For more information, see [“Connecting a mobile device to the printer” on page 34](#).

- 1 From your mobile device, launch a compatible application or select a document from your file manager.
- 2 Depending on your mobile device, do one of the following:
  - Tap  > **Print**.
  - Tap  > **Print**.
  - Tap  > **Print**.
- 3 Select a printer, and then adjust the settings, if necessary.
- 4 Print the document.



## Printing from a flash drive

- 1 Insert the flash drive.

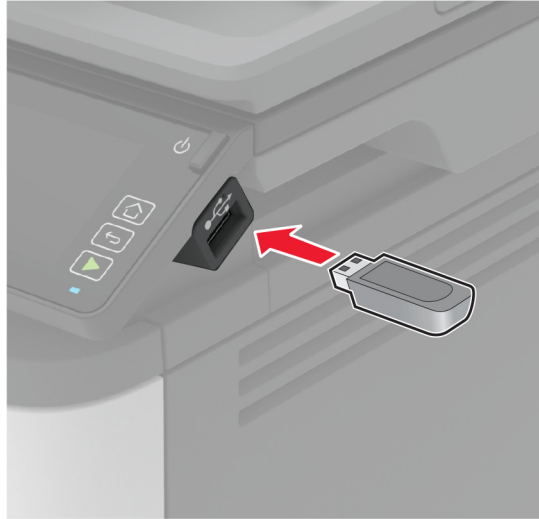

### Notes:

- If you insert the flash drive when an error message appears, then the printer ignores the flash drive.
- If you insert the flash drive while the printer is processing other print jobs, then **Busy** appears on the display.

- 2 From the display, touch the document that you want to print.

If necessary, configure other print settings.

- 3 Send the print job.

To print another document, touch **USB Drive**.

**Warning—Potential Damage:** To avoid loss of data or printer malfunction, do not touch the flash drive or the printer in the area shown while actively printing, reading, or writing from the memory device.



## Supported flash drives and file types

### Flash drives

- Lexar JumpDrive S70 (16GB and 32GB)
- SanDisk Cruzer (16GB and 32GB)
- PNY Attache (16GB and 32GB)

### Notes:

- The printer supports high-speed USB flash drives with full-speed standard.
- USB flash drives must support the File Allocation Table (FAT) system.

### File types

Documents

PDF (version 1.7 or earlier)

Images

.JPEG or .jpg

## Configuring confidential jobs

- 1 From the control panel, navigate to:  
**Settings > Security > Confidential Print Setup**
- 2 Configure the settings.

Use	To
Max Invalid PIN	Set the number of times an invalid PIN can be entered. <b>Note:</b> When the limit is reached, the print jobs for that user name are deleted.
Confidential Job Expiration	Set the expiration time for confidential print jobs. <b>Note:</b> Confidential held jobs are stored in the printer until they are released or deleted manually.
Repeat Job Expiration	Set the expiration time for a repeat print job. <b>Note:</b> Repeat held jobs are stored in the printer memory for reprinting.
Verify Job Expiration	Set the expiration time that the printer prints a copy before printing the remaining copies. <b>Note:</b> Verify jobs print one copy to check if it is satisfactory before printing the remaining copies.
Reserve Job Expiration	Set the expiration time that the printer stores print jobs. <b>Note:</b> Reserve held jobs are automatically deleted after printing.
Require All Jobs to be Held	Set the printer to hold all print jobs.
Keep duplicate documents	Set the printer to print all documents with the same file name.

## Printing confidential and other held jobs

### For Windows users

- 1 With a document open, click **File > Print**.
- 2 Click **Properties, Preferences, Options, or Setup**.
- 3 Click **Print and Hold**.
- 4 Select **Use Print and Hold**, and then assign a user name.
- 5 Select the print job type (Confidential, Repeat, Reserve, or Verify).  
If the print job is confidential, then enter a four-digit PIN.
- 6 Click **OK** or **Print**.
- 7 From the printer home screen, release the print job.
  - For confidential print jobs, navigate to:  
**Held jobs** > select your user name > **Confidential** > enter the PIN > select the print job > configure the settings > **Print**
  - For other print jobs, navigate to:  
**Held jobs** > select your user name > select the print job > configure the settings > **Print**

### For Macintosh users

- 1 With a document open, choose **File > Print**.  
If necessary, click the disclosure triangle to see more options.
- 2 From the print options or Copies & Pages menu, choose **Job Routing**.
- 3 Select the print job type (Confidential, Repeat, Reserve, or Verify).  
If the print job is confidential, then assign a user name and a four-digit PIN.
- 4 Click **OK** or **Print**.
- 5 From the printer home screen, release the print job.
  - For confidential print jobs, navigate to:  
**Held jobs** > select your user name > **Confidential** > enter the PIN > select the print job > configure the settings > **Print**
  - For other print jobs, navigate to:  
**Held jobs** > select your user name > select the print job > configure the settings > **Print**

## Printing from a Cloud Connector profile

- 1 From the home screen, touch **Cloud Connector**.
- 2 Select a cloud service provider, and then select a profile.

**Note:** For more information on creating a Cloud Connector profile, see [“Creating a Cloud Connector profile” on page 35](#).

- 3 Touch **Print**, and then select a file.  
If necessary, change the settings.

**Note:** Make sure to select a supported file.

- 4 Print the document.

## Printing a font sample list

- 1 From the home screen, touch **Settings** > **Reports** > **Print** > **Print Fonts**.
- 2 Touch **PCL Fonts** or **PostScript Fonts**.

## Placing separator sheets between copies

- 1 From the home screen, touch **Settings** > **Print** > **Layout** > **Separator Sheets** > **Between Copies**.
- 2 Print the document.

## Canceling a print job

### From the printer control panel

- 1 From the home screen, touch **Cancel a job**.
- 2 Select a job to cancel.

### From the computer

- 1 Depending on the operating system, do either of the following:
  - Open the printers folder, and then select your printer.
  - From the System Preferences in the Apple menu, navigate to your printer.
- 2 Select a job to cancel.

## Adjusting toner darkness

- 1 From the home screen, touch **Settings** > **Print** > **Quality** > **Toner Darkness**.
- 2 Select a setting.

# Copy

## Using the automatic document feeder and scanner glass

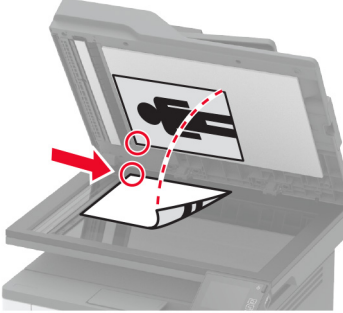
Automatic document feeder (ADF)	Scanner glass
 <ul style="list-style-type: none"> <li>• Use the ADF for multiple-page or two-sided documents.</li> <li>• Load an original document faceup. For multiple-page documents, make sure to align the leading edge before loading.</li> <li>• Make sure to adjust the ADF guides to match the width of the paper that you are loading.</li> </ul>	 <ul style="list-style-type: none"> <li>• Use the scanner glass for single-page documents, book pages, small items (such as postcards or photos), transparencies, photo paper, or thin media (such as magazine clippings).</li> <li>• Place the document facedown in the corner with the arrow.</li> </ul>

## Making copies

- 1 Load an original document into the ADF tray or on the scanner glass.

**Note:** To avoid a cropped image, make sure that the original document and output have the same paper size.

- 2 From the home screen, touch **Copy**, and then specify the number of copies.  
If necessary, adjust the copy settings.

- 3 Copy the document.

**Note:** To make a quick copy, from the control panel, press .

## Copying photos

- 1 Place a photo on the scanner glass.
- 2 From the home screen, touch **Copy** > **Content Type** > **Photo**.
- 3 Copy the document.

## Copying on letterhead

- 1 Load an original document into the ADF tray or on the scanner glass.
- 2 From the home screen, touch **Copy** > **Copy From** > select the size of the original document.
- 3 Touch **Copy To**, and then select the paper source that contains the letterhead.  
If you loaded the letterhead into the multipurpose feeder, then navigate to:  
**Copy To** > **Multipurpose Feeder** > select a paper size > **Letterhead**
- 4 Copy the document.

## Copying on both sides of the paper

- 1 Load an original document into the ADF tray or on the scanner glass.
- 2 From the home screen, touch **Copy** > **Sides**.
- 3 Adjust the settings.
- 4 Copy the document.

## Reducing or enlarging copies

- 1 Load an original document into the ADF tray or on the scanner glass.
- 2 From the home screen, navigate to:  
**Copy** > **Scale** > specify a scale value  
**Note:** Changing the size of the original document or output after setting Scale restores the scale value to Auto.
- 3 Copy the document.

## Collating copies

- 1 Load an original document into the ADF tray or on the scanner glass.
- 2 From the home screen, touch **Copy** > **Collate** > **On** [1,2,1,2,1,2].
- 3 Copy the document.

## Copying multiple pages onto a single sheet

- 1 Load an original document into the ADF tray or on the scanner glass.
- 2 From the home screen, touch **Copy** > **Pages per Side**.
- 3 Adjust the settings.
- 4 Copy the document.

## Copying cards

- 1 Load a card on the scanner glass.
- 2 From the control panel, navigate to:  
**Copy > ID Copy**
- 3 If necessary, adjust the settings.
- 4 Copy the document.

## Creating a copy shortcut

- 1 From the home screen, touch **Copy**.
- 2 Configure the settings, and then touch  .
- 3 Create a shortcut.

## E-mail

### Using the automatic document feeder and scanner glass

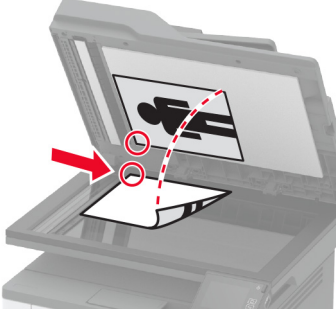
Automatic document feeder (ADF)	Scanner glass
 <ul style="list-style-type: none"> <li>• Use the ADF for multiple-page or two-sided documents.</li> <li>• Load an original document faceup. For multiple-page documents, make sure to align the leading edge before loading.</li> <li>• Make sure to adjust the ADF guides to match the width of the paper that you are loading.</li> </ul>	 <ul style="list-style-type: none"> <li>• Use the scanner glass for single-page documents, book pages, small items (such as postcards or photos), transparencies, photo paper, or thin media (such as magazine clippings).</li> <li>• Place the document facedown in the corner with the arrow.</li> </ul>

## Configuring the SMTP server for e-mail

### From the control panel

- 1 From the control panel, touch **Settings** > **E-mail** > **E-mail Setup**.
- 2 Configure the settings.

### From the Embedded Web Server

- 1 Open a web browser, and then type the printer IP address in the address field.

#### Notes:

- View the printer IP address on the printer home screen. The IP address appears as four sets of numbers separated by periods, such as 123.123.123.123.
- If you are using a proxy server, then temporarily disable it to load the web page correctly.

- 2 Click **Settings** > **E-mail**.
- 3 From the E-mail Setup section, configure the settings.
- 4 Click **Save**.



## Sending an e-mail

- 1 Load an original document into the ADF tray or on the scanner glass.
- 2 From the home screen, touch **E-mail**, and then enter the needed information.
- 3 If necessary, configure the output file type settings.
- 4 Send the e-mail.

## Creating an e-mail shortcut

- 1 From the home screen, touch **E-mail**.
- 2 Configure the settings, and then touch .
- 3 Create a shortcut.

# Fax

## Using the automatic document feeder and scanner glass

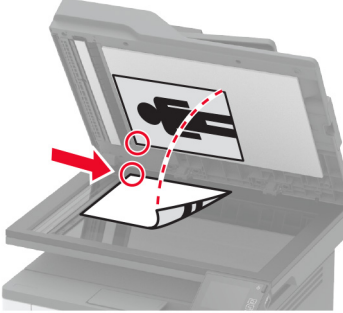
Automatic document feeder (ADF)	Scanner glass
 <ul style="list-style-type: none"> <li>• Use the ADF for multiple-page or two-sided documents.</li> <li>• Load an original document faceup. For multiple-page documents, make sure to align the leading edge before loading.</li> <li>• Make sure to adjust the ADF guides to match the width of the paper that you are loading.</li> </ul>	 <ul style="list-style-type: none"> <li>• Use the scanner glass for single-page documents, book pages, small items (such as postcards or photos), transparencies, photo paper, or thin media (such as magazine clippings).</li> <li>• Place the document facedown in the corner with the arrow.</li> </ul>

## Sending a fax

### Using the control panel

- 1 Load the original document into the ADF tray or on the scanner glass.
- 2 From the home screen, touch **Fax**, and then enter the needed information.
- 3 If necessary, configure other fax settings.
- 4 Send the fax job.

### Using the computer

**Note:** Make sure that the Universal Fax driver is installed.

#### For Windows users

- 1 With a document open, click **File > Print**.
- 2 Select the printer, and then click **Properties, Preferences, Options, or Setup**.
- 3 Click **Fax > Enable fax**, and then enter the recipient number.
- 4 If necessary, configure other fax settings.
- 5 Send the fax job.

### For Macintosh users

- 1 With a document open, choose **File > Print**.
- 2 Select the printer and enter the recipient number.
- 3 If necessary, configure other fax settings.
- 4 Send the fax job.

## Scheduling a fax

- 1 Load the original document into the ADF tray or on the scanner glass.
- 2 From the home screen, navigate to:  
**Fax > To > enter the fax number > Done**
- 3 Touch **Send Time**, configure the date and time, and then touch **OK**.
- 4 Send the fax.

## Creating a fax destination shortcut

- 1 From the home screen, touch **Fax > To**.
- 2 Enter the recipient number, and then touch **Done**.
- 3 Touch .
- 4 Create a shortcut.

## Changing the fax resolution

- 1 Load an original document into the ADF tray or on the scanner glass.
- 2 From the home screen, touch **Fax**, and then enter the needed information.
- 3 Touch **Resolution**, and then adjust the setting.
- 4 Send the fax.

## Adjusting the fax darkness

- 1 Load an original document into the ADF tray or on the scanner glass.
- 2 From the home screen, touch **Fax**, and then enter the needed information.
- 3 Touch **Darkness**, and then adjust the setting.
- 4 Send the fax.

## Printing a fax log

- 1 From the home screen, touch **Settings** > **Reports** > **Fax**.
- 2 Touch **Fax Job Log** or **Fax Call Log**.

## Blocking junk faxes

- 1 From the home screen, touch **Settings** > **Fax** > **Fax Setup** > **Fax Receive Settings** > **Admin Controls**.
- 2 Set Block No Name Fax to **On**.

## Forwarding a fax

- 1 From the home screen, touch **Settings** > **Fax** > **Fax Setup** > **Fax Receive Settings** > **Admin Controls**.
- 2 Touch **Fax Forwarding** > **Forward**.
- 3 Configure the Forward to and Confirmation E-mail settings.

## Scan

### Using the automatic document feeder and scanner glass

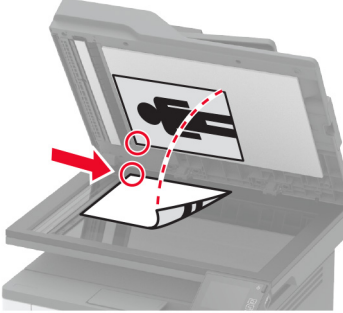
Automatic document feeder (ADF)	Scanner glass
 <ul style="list-style-type: none"> <li>• Use the ADF for multiple-page or two-sided documents.</li> <li>• Load an original document faceup. For multiple-page documents, make sure to align the leading edge before loading.</li> <li>• Make sure to adjust the ADF guides to match the width of the paper that you are loading.</li> </ul>	 <ul style="list-style-type: none"> <li>• Use the scanner glass for single-page documents, book pages, small items (such as postcards or photos), transparencies, photo paper, or thin media (such as magazine clippings).</li> <li>• Place the document facedown in the corner with the arrow.</li> </ul>

## Creating an FTP shortcut

**Note:** You may need administrative rights to create a shortcut.

- 1 Open a web browser, and then type the printer IP address in the address field.

**Notes:**

- View the printer IP address on the printer home screen. The IP address appears as four sets of numbers separated by periods, such as 123.123.123.123.
- If you are using a proxy server, then temporarily disable it to load the web page correctly.

- 2 Click **Shortcuts > Add Shortcut**.
- 3 From the Shortcut Type menu, select **FTP**, and then configure the settings.
- 4 Apply the changes.

## Scanning to an FTP server using a shortcut

- 1 Load an original document into the ADF tray or on the scanner glass.
- 2 From the home screen, touch **Shortcuts > FTP**
- 3 Select the shortcut.

## Creating a network folder shortcut

- 1 Open a web browser, and then type the printer IP address in the address field.

### Notes:

- View the printer IP address on the printer home screen. The IP address appears as four sets of numbers separated by periods, such as 123.123.123.123.
- If you are using a proxy server, then temporarily disable it to load the web page correctly.

- 2 Click **Shortcuts > Add Shortcut**.
- 3 From the Shortcut Type menu, select **Network Folder**, and then configure the settings.
- 4 Apply the changes.

## Scanning to a network folder using a shortcut

- 1 Load an original document into the ADF tray or on the scanner glass.
- 2 From the home screen, touch **Shortcuts > Scan to Network**
- 3 Select the shortcut.

## Scanning to a flash drive

- 1 Load an original document into the ADF tray or on the scanner glass.
- 2 Insert the flash drive.



- 3 Touch **Scan to USB** and adjust the settings if necessary.

**Note:** If the USB Drive screen does not appear, then touch **USB Drive** on the home screen.

- 4 Scan the document.

**Warning—Potential Damage:** To avoid loss of data or printer malfunction, do not touch the flash drive or the printer in the area shown while actively printing, reading, or writing from the memory device.



## Scanning to a Cloud Connector profile

- 1 Load an original document into the ADF tray or on the scanner glass.
- 2 From the home screen, touch **Cloud Connector**.
- 3 Select a cloud service provider, and then select a profile.

**Note:** For more information on creating a Cloud Connector profile, see [“Creating a Cloud Connector profile” on page 35](#).

- 4 Touch **Scan**, and then assign a filename and destination folder.
- 5 Touch **Scan Here**.  
If necessary, change the scan settings.
- 6 Scan the document.

# Use printer menus

## Menu map

Device	<ul style="list-style-type: none"> <li>• <a href="#">Preferences</a></li> <li>• <a href="#">Eco-Mode</a></li> <li>• <a href="#">Remote Operator Panel</a></li> <li>• <a href="#">Notifications</a></li> <li>• <a href="#">Power Management</a></li> </ul>	<ul style="list-style-type: none"> <li>• <a href="#">Information Sent to Lexmark</a></li> <li>• <a href="#">Restore Factory Defaults</a></li> <li>• <a href="#">Maintenance</a></li> <li>• <a href="#">Visible Home Screen Icons</a></li> <li>• <a href="#">About this Printer</a></li> </ul>
Print	<ul style="list-style-type: none"> <li>• <a href="#">Layout</a></li> <li>• <a href="#">Setup</a></li> <li>• <a href="#">Quality</a></li> <li>• <a href="#">PDF</a></li> </ul>	<ul style="list-style-type: none"> <li>• <a href="#">PostScript</a></li> <li>• <a href="#">PCL</a></li> <li>• <a href="#">Image</a></li> </ul>
Paper	<ul style="list-style-type: none"> <li>• <a href="#">Tray Configuration</a></li> </ul>	<ul style="list-style-type: none"> <li>• <a href="#">Media Configuration</a></li> </ul>
Copy	<a href="#">Copy Defaults</a>	
Fax	<ul style="list-style-type: none"> <li>• <a href="#">Fax Defaults</a></li> </ul>	
E-mail	<ul style="list-style-type: none"> <li>• <a href="#">E-mail Setup</a></li> </ul>	<ul style="list-style-type: none"> <li>• <a href="#">E-mail Defaults</a></li> </ul>
FTP	<a href="#">FTP Defaults</a>	
USB Drive	<ul style="list-style-type: none"> <li>• <a href="#">Flash Drive Scan</a></li> </ul>	<ul style="list-style-type: none"> <li>• <a href="#">Flash Drive Print</a></li> </ul>
Network/Ports	<ul style="list-style-type: none"> <li>• <a href="#">Network Overview</a></li> <li>• <a href="#">Wireless</a></li> <li>• <a href="#">Ethernet</a></li> <li>• <a href="#">TCP/IP</a></li> <li>• <a href="#">SNMP</a></li> <li>• <a href="#">IPSec</a></li> <li>• <a href="#">802.1x</a></li> </ul>	<ul style="list-style-type: none"> <li>• <a href="#">LPD Configuration</a></li> <li>• <a href="#">HTTP/FTP Settings</a></li> <li>• <a href="#">USB</a></li> <li>• <a href="#">Restrict external network access</a></li> <li>• <a href="#">Google Cloud Print</a></li> <li>• <a href="#">Wi-Fi Direct</a></li> </ul>
Security	<ul style="list-style-type: none"> <li>• <a href="#">Login methods*</a></li> <li>• <a href="#">Certificate Management*</a></li> <li>• <a href="#">Schedule USB Devices</a></li> <li>• <a href="#">Login Restrictions</a></li> </ul>	<ul style="list-style-type: none"> <li>• <a href="#">Confidential Print Setup</a></li> <li>• <a href="#">Erase Temporary Data Files</a></li> <li>• <a href="#">Miscellaneous</a></li> </ul>
<a href="#">Cloud Connector</a>	<ul style="list-style-type: none"> <li>• Enable/Disable Connectors</li> </ul>	
Reports	<ul style="list-style-type: none"> <li>• <a href="#">Menu Settings Page</a></li> <li>• <a href="#">Device</a></li> <li>• <a href="#">Print</a></li> </ul>	<ul style="list-style-type: none"> <li>• <a href="#">Shortcuts</a></li> <li>• <a href="#">Fax</a></li> <li>• <a href="#">Network</a></li> </ul>
<a href="#">Troubleshooting</a>	Print Quality Test Pages	Cleaning the scanner

\* These menu settings appear only in the Embedded Web Server.



# Device

## Preferences

Menu item	Description
<b>Display Language</b> [List of languages]	Set the language of the text that appears on the display.
<b>Country/Region</b> [List of countries or regions]	Identify the country or region where the printer is configured to operate.
<b>Run initial setup</b> On Off*	Run the setup wizard.
<b>Keyboard</b> Keyboard Type [List of languages]	Select a language as a keyboard type. <b>Note:</b> All the Keyboard Type values may not appear or may require special hardware to appear.
<b>Displayed information</b> Display Text 1 [IP Address*] Display Text 2 [Date/Time*] Custom Text 1 Custom Text 2	Specify the information to appear on the home screen.
<b>Date and Time</b> Configure Current Date and Time Manually Set Date and Time Date Format [MM-DD-YYYY*] Time Format [12 hour A.M./P.M.*] Time Zone [GMT*] UTC (GMT) Offset DST Start DST End DST Offset	Configure the printer date and time. <b>Note:</b> UTC (GMT) Offset, DST Start, DST End, and DST Offset appear only when Time Zone is set to Custom.
<b>Date and Time</b> Network Time Protocol Enable NTP [On*] NTP Server Enable Authentication	Configure the settings for Network Time Protocol (NTP). <b>Note:</b> When Enable Authentication is set to MD5 key, Key ID and Password appear.
<b>Paper Sizes</b> U.S.* Metric	Specify the unit of measurement for paper sizes. <b>Note:</b> The country or region selected in the initial setup wizard determines the initial paper size setting.
<b>Screen Brightness</b> 20–100% (100*)	Adjust the brightness of the display.
<b>Note:</b> An asterisk (*) next to a value indicates the factory default setting.	

Menu item	Description
<b>Flash Drive Access</b> Enabled* Disabled	Enable access to the flash drive.
<b>One Page Flatbed Scanning</b> On Off*	Set copies from the scanner glass to only one page at a time.
<b>Screen Timeout</b> 5–300 (60*)	Set the idle time in seconds before the display shows the home screen, or before the printer logs off a user account automatically.
<b>Note:</b> An asterisk (*) next to a value indicates the factory default setting.	

## Eco-Mode

Menu item	Description
<b>Print</b> Sides 1-Sided* 2-Sided	Specify whether to print on one side or two sides of the paper.
<b>Print</b> Pages per Side Off* 2 pages per side 3 pages per side 4 pages per side 6 pages per side 9 pages per side 12 pages per side 16 pages per side	Print multiple page images on one side of a sheet of paper.
<b>Print</b> Toner Darkness Light Normal* Dark	Determine the lightness or darkness of text or images.
<b>Copy</b> Pages per Side Off* 2 Portrait pages 4 Portrait pages 2 Landscape pages 4 Landscape pages	Specify the number of page images to print on one side of a sheet of paper.
<b>Note:</b> An asterisk (*) next to a value indicates the factory default setting.	

Menu item	Description
<b>Copy</b> Darkness 1-9 (5*)	Adjust the darkness of the scanned image.
<b>Note:</b> An asterisk (*) next to a value indicates the factory default setting.	

## Remote Operator Panel

Menu item	Description
<b>External VNC Connection</b> Don't Allow* Allow	Connect an external Virtual Network Computing (VNC) client to the remote control panel.
<b>Authentication Type</b> None* Standard Authentication	Set the authentication type when accessing the VNC client server.
<b>VNC Password</b>	Specify the password to connect to the VNC client server.  <b>Note:</b> This menu item appears only if Authentication Type is set to Standard Authentication.
<b>Note:</b> An asterisk (*) next to a value indicates the factory default setting.	

## Notifications

Menu item	Description
<b>ADF Loaded Beep</b> Off On*	Enable a sound when loading paper into the ADF.
<b>Alarm Control</b> Off Single* Continuous	Set the number of times that the alarm sounds when the printer requires user intervention.
<b>Supplies</b> Show Supply Estimates Show estimates* Do not show estimates	Show the estimated status of the supplies.
<b>Supplies</b> Cartridge Alarm Off* Single Continuous	Set the number of times that the alarm sounds when the cartridge is low.
<b>Note:</b> An asterisk (*) next to a value indicates the factory default setting.	

Menu item	Description
<b>Supplies</b> Custom Supply Notifications	Configure notification settings when the printer requires user intervention.  <b>Note:</b> This menu item appears only in the Embedded Web Server.
<b>E-mail Alerts Setup</b> E-mail Setup Primary SMTP Gateway Primary SMTP Gateway Port (25*) Secondary SMTP Gateway Secondary SMTP Gateway Port (25*) SMTP Timeout (30 seconds*) Reply Address Always use SMTP default Reply Address(Off*) Use SSL/TLS(Disabled*) Require Trusted Certificate(On*) SMTP Server Authentication (No authentication required*) Device-Initiated E-mail(None*) Device Userid Device Password NTLM Domain Disable "SMTP server not set up" error(Off*)	Configure the e-mail settings of the printer.
<b>Error Prevention</b> Jam Assist Off On*	Set the printer to check for jammed paper automatically.
<b>Error Prevention</b> Auto Continue Disabled Enabled* (5 seconds) Auto Continue Time	Let the printer continue processing or printing a job automatically after clearing certain attendance conditions.
<b>Error Prevention</b> Auto Reboot Auto Reboot Reboot when idle Reboot always* Reboot never	Set the printer to restart when an error occurs.
<b>Error Prevention</b> Auto Reboot Max Auto Reboots (2*)	Set the number of automatic reboots that the printer can perform.
<b>Note:</b> An asterisk (*) next to a value indicates the factory default setting.	

Menu item	Description
<b>Error Prevention</b> Auto Reboot Auto Reboot Window (720*)	Set the number of seconds before the printer performs an automatic reboot.
<b>Error Prevention</b> Auto Reboot Auto Reboot Counter	Show a read-only information of the reboot counter.
<b>Error Prevention</b> Display Short Paper Error On Auto-clear*	Set the printer to show a message when a short paper error occurs.  <b>Note:</b> Short paper refers to the size of the paper loaded.
<b>Error Prevention</b> Page Protect Off* On	Set the printer to process the entire page into the memory before printing it.
<b>Jam Content Recovery</b> Jam Recovery Off On Auto*	Set the printer to reprint jammed pages.
<b>Jam Content Recovery</b> Scanner Jam Recovery Job level Page level*	Specify how to restart a scan job after resolving a paper jam.
<b>Note:</b> An asterisk (*) next to a value indicates the factory default setting.	

## Power Management

Menu item	Description
<b>Sleep Mode Profile</b> Print from Sleep Mode Stay awake after printing Enter Sleep Mode after printing*	Set the printer to stay in Ready mode or return to Sleep mode after printing.
<b>Timeouts</b> Sleep Mode 1–120 minutes (15*)	Set the idle time before the printer begins operating in Sleep mode.
<b>Note:</b> An asterisk (*) next to a value indicates the factory default setting.	

Menu item	Description
<b>Timeouts</b> Hibernate Timeout Disabled 1 hour 2 hours 3 hours 6 hours 1 day 2 days 3 days* 1 week 2 weeks 1 month	Set the time before the printer turns off.
<b>Timeouts</b> Hibernate Timeout on Connection Hibernate Do Not Hibernate*	Set Hibernate Timeout to turn off the printer while an active Ethernet connection exists.
<b>Note:</b> An asterisk (*) next to a value indicates the factory default setting.	

### Information Sent to Lexmark

Menu item	Description
<b>Information Sent to Lexmark</b> Supplies and Page Usage Device Performance None*	Send printer usage and performance information to Lexmark. <b>Note:</b> Information Send Time appears only when you select any of the settings in Information Sent to Lexmark, except None.
<b>Information Send Time</b> Start Time Stop Time	
<b>Note:</b> An asterisk (*) next to a value indicates the factory default setting.	

### Restore Factory Defaults

Menu item	Description
<b>Restore Settings</b> Restore all settings Restore printer settings Restore network settings Restore fax settings	Restore the printer factory default settings.

## Maintenance

### Config Menu

Menu item	Description
<b>USB Configuration</b> USB PnP 1* 2	Change the USB driver mode of the printer to improve its compatibility with a personal computer.
<b>USB Configuration</b> USB Scan to Local On* Off	Set whether the USB device driver enumerates as a USB Simple device (single interface) or as a USB Composite device (multiple interfaces).
<b>USB Configuration</b> USB Speed Full Auto*	Set the USB port to run at full speed and disable its high-speed capabilities.
<b>Tray Configuration</b> Tray Linking Automatic* Off	Set the printer to link the trays that have the same paper type and paper size settings.
<b>Tray Configuration</b> Show Tray Insert Message Off Only for unknown sizes* Always	Show the <b>Tray Insert</b> message.
<b>Tray Configuration</b> A5 Loading Short Edge Long Edge*	Specify the page orientation when loading A5 paper size.
<b>Tray Configuration</b> Paper Prompts Auto* MP Feeder Manual Paper	Set the paper source that the user fills when a prompt to load paper appears.
<b>Tray Configuration</b> Envelope Prompts Auto* MP Feeder Manual Envelope	Set the paper source that the user fills when a prompt to load envelope appears.

**Note:** An asterisk (\*) next to a value indicates the factory default setting.

Menu item	Description
<b>Tray Configuration</b> Action for Prompts Prompt user* Continue Use current	Set the printer to resolve paper- or envelope-related change prompts.
<b>Reports</b> Menu Settings Page Event Log Event Log Summary	Print reports about printer menu settings, status, and event logs.
<b>Supply Usage And Counters</b> Clear Supply Usage History Reset Black Imaging Unit Counter Reset Maintenance Counter	Reset the supply page counter or view the total printed pages.
<b>Printer Emulations</b> PS Emulation Off On*	Set the printer to recognize and use the PS data stream.
<b>Printer Emulations</b> Emulator Security Page Timeout 0–60 (60*)	Set the page timeout during emulation.
<b>Printer Emulations</b> Emulator Security Reset Emulator After Job Off* On	Reset the emulator after a print job.
<b>Printer Emulations</b> Emulator Security Disable Printer Message Access On* Off	Disable access to the printer message during emulation.
<b>Print Configuration</b> Font Sharpening 0–150 (24*)	Set a text point-size value below which the high-frequency screens are used when printing font data.
<b>Fax Configuration</b> Fax Low Power Support Disable Sleep Permit Sleep Auto*	Set fax to enter Sleep mode whenever the printer determines that it should.
<b>Note:</b> An asterisk (*) next to a value indicates the factory default setting.	



Menu item	Description
<b>Print Configuration</b> Print Density Disabled* 1–5 Copy Density Disabled* 1–5	Adjust the toner density when printing or copying documents.
<b>Device Operations</b> Quiet Mode Off* On	Set the printer to reduce the amount of noise that it makes when printing.  <b>Note:</b> Enabling this setting slows down the overall performance of the printer.
<b>Device Operations</b> Panel Menus Enable* Disable	Set the printer to show the control panel menus.  <b>Note:</b> This menu item appears only in the Embedded Web Server.
<b>Device Operations</b> Safe Mode Off* On	Set the printer to operate in a special mode, in which it attempts to continue offering as much functionality as possible, despite known issues.  For example, when set to On, and the duplex motor is nonfunctional, the printer performs one-sided printing of the documents even if the job is two-sided printing.  <b>Note:</b> This setting cannot be used when the tray is not fully inserted or the tray sensor is damaged.
<b>Device Operations</b> Clear Custom Status	Erase all custom messages.
<b>Device Operations</b> Clear all remotely-installed messages	Erase all remotely-installed messages.
<b>Device Operations</b> Automatically Display Error Screens On* Off	Show existing error messages on the display after the printer remains inactive on the home screen for a length of time equal to the Screen Timeout setting.
<b>Scanner Configuration</b> Scanner Manual Registration Print Quick Test	Print a Quick Test target page.  <b>Note:</b> Make sure that the margin spacing on the target page is uniform all the way around the target. If it is not, then the printer margins may need to be reset.
<b>Scanner Configuration</b> Scanner Manual Registration Front ADF Registration Rear ADF Registration Flatbed Registration	Manually register the flatbed and ADF after replacing the ADF, scanner glass, or controller board.
<b>Note:</b> An asterisk (*) next to a value indicates the factory default setting.	

Menu item	Description
<b>Scanner Configuration</b> Edge Erase Flatbed Edge Erase 0–6 (3*) ADF Edge Erase 0–6 (3*)	Set the size, in millimeters, of the no-print area around an ADF or flatbed scan job.
<b>Scanner Configuration</b> Disable Scanner Enabled* Disabled ADF Disabled	Disable the scanner if it is not working properly.
<b>Scanner Configuration</b> Tiff Byte Order CPU Endianness* Little Endian Big Endian	Set the byte order of a TIFF-formatted scan output.
<b>Scanner Configuration</b> Exact Tiff Rows Per Strip On* Off	Set the RowsPerStrip tag value of a TIFF-formatted scan output.
<b>Note:</b> An asterisk (*) next to a value indicates the factory default setting.	

## Out of Service Erase

Menu item	Description
<b>Sanitize all information on nonvolatile memory</b> Erase all printer and network settings Erase all shortcuts and shortcut settings	Clear all settings and applications that are stored in the printer.

## Visible Home Screen Icons

Menu	Description	
<b>Copy</b> Do not display Display*	Specify which icons to show on the home screen.	
<b>E-mail</b> Do not display Display*		
<b>Fax</b> Do not display Display*		
<b>Status/Supplies</b> Do not display Display*		
<b>Job Queue</b> Do not display Display*		
<b>Change Language</b> Do not display* Display		
<b>Held Jobs</b> Do not display Display*		
<b>USB</b> Do not display Display*		
<b>Note:</b> An asterisk (*) next to a value indicates the factory default settings.		

## About this Printer

Menu item	Description
<b>Asset Tag</b>	Describe the printer. The maximum length is 32 characters.
<b>Printer's Location</b>	Identify the printer location. The maximum length is 63 characters.
<b>Contact</b>	Personalize the printer name. The maximum length is 63 characters.
<b>Export Configuration File to USB*</b>	Export configuration files to a flash drive.
<b>Export Compressed Logs to USB*</b>	Export compressed log files to a flash drive.
<b>Send Logs</b> Cancel Send	Send diagnostic information to Lexmark.
* This menu item appears only in some printer models.	

# Print

## Layout

Menu item	Description
<b>Sides</b> 1-Sided* 2-Sided	Specify whether to print on one side or both sides of the paper.
<b>Flip Style</b> Long Edge* Short Edge	Determine which side of the paper is bound when performing two-sided printing.  <b>Note:</b> Depending on the option selected, the printer automatically offsets each printed information of the page to bind the job correctly.
<b>Blank Pages</b> Print Do Not Print*	Print blank pages that are included in a print job.
<b>Collate</b> Off [1,1,1,2,2,2] On [1,2,1,2,1,2]*	Keep the pages of a print job stacked in sequence, particularly when printing multiple copies of the job.
<b>Separator Sheets</b> None* Between Copies Between Jobs Between Pages	Insert blank separator sheets when printing.
<b>Separator Sheet Source</b> Tray [x] (1*) MP Feeder	Specify the paper source for the separator sheet.
<b>Pages per Side</b> Off* 2 pages per side 3 pages per side 4 pages per side 6 pages per side 9 pages per side 12 pages per side 16 pages per side	Print multiple page images on one side of a sheet of paper.
<b>Pages per Side Ordering</b> Horizontal* Reverse Horizontal Vertical Reverse Vertical	Specify the positioning of multiple page images when using Pages per Side.  <b>Note:</b> The positioning depends on the number of page images and their page orientation.
<b>Note:</b> An asterisk (*) next to a value indicates the factory default setting.	

Menu item	Description
<b>Pages per Side Orientation</b> Auto* Landscape Portrait	Specify the orientation of a multiple-page document when using Pages per Side.
<b>Pages per Side Border</b> None* Solid	Print a border around each page image when using Pages per Side.
<b>Copies</b> 1–9999 (1*)	Specify the number of copies for each print job.
<b>Print Area</b> Normal* Whole Page	Set the printable area on a sheet of paper.
<b>Note:</b> An asterisk (*) next to a value indicates the factory default setting.	

## Setup

Menu item	Description
<b>Printer Language</b> PCL Emulation* PS Emulation	Set the printer language.  <b>Note:</b> Setting a printer language default does not prevent a software program from sending print jobs that use another printer language.
<b>Resource Save</b> Off* On	Determine what the printer does with downloaded resources, such as fonts and macros, when it receives a job that requires more than the available memory.  <b>Notes:</b> <ul style="list-style-type: none"> <li>• When set to Off, the printer retains downloaded resources only until memory is needed. Resources associated with the inactive printer language are deleted.</li> <li>• When set to On, the printer preserves all the permanent downloaded resources across all language switches. When necessary, the printer shows memory full messages instead of deleting permanent resources.</li> </ul>
<b>Print All Order</b> Alphabetical* Newest First Oldest First	Specify the order when you choose to print all held and confidential jobs.
<b>Note:</b> An asterisk (*) next to a value indicates the factory default setting.	

## Quality

Menu item	Description
<b>Print Resolution</b> 300 dpi 600 dpi* 1200 Image Q 2400 Image Q	Set the resolution for the text and images on the printed output. <b>Note:</b> Resolution is determined in dots per inch or image quality.
<b>Toner Darkness</b> Light Normal* Dark	Determine the lightness or darkness of text images.
<b>Halftone</b> Normal* Detail	Enhance the printed output to have smoother lines with sharper edges.
<b>Note:</b> An asterisk (*) next to a value indicates the factory default setting.	

## PDF

Menu item	Description
<b>Scale To Fit</b> Yes No*	Scale the page content to fit the selected paper size.
<b>Annotations</b> Print Do Not Print*	Specify whether to print annotations in the PDF.
<b>Print PDF Error</b> Off On*	Enable the printing of PDF error.
<b>Note:</b> An asterisk (*) next to a value indicates the factory default setting.	

## PostScript

Menu item	Description
<b>Print PS Error</b> Off* On	Print a page that describes the PostScript® error. <b>Note:</b> When an error occurs, processing of the job stops, the printer prints an error message, and the rest of the print job is flushed.
<b>Minimum Line Width</b> 1–30 (2*)	Set the minimum stroke width. <b>Note:</b> Jobs printed in 1200 dpi use the value directly.
<b>Note:</b> An asterisk (*) next to a value indicates the factory default setting.	

Menu item	Description
<b>Lock PS Startup Mode</b> Off On*	Disable the SysStart file.
<b>Wait Timeout</b> Disabled Enabled*	Set the printer to wait for more data before canceling a print job. <b>Note:</b> Wait Timeout Time appears only when Wait Timeout is enabled.
<b>Wait Timeout Time</b> 15–65535 (40 seconds*)	
<b>Note:</b> An asterisk (*) next to a value indicates the factory default setting.	

## PCL

Menu item	Description
<b>Font Name</b> [List of available fonts] (Courier*)	Select a font from the specified font source.
<b>Symbol Set</b> [List of available symbol set] (10U PC-8*)	Specify the symbol set for each font name. <b>Note:</b> A symbol set is a set of alphabetic and numeric characters, punctuation, and special symbols. Symbol sets support the different languages or specific programs such as math symbols for scientific text.
<b>Pitch</b> 0.08–100.00 (10.00*)	Specify the pitch for fixed or monospaced fonts. <b>Note:</b> Pitch refers to the number of fixed-space characters in a horizontal inch of type.
<b>Orientation</b> Portrait* Landscape	Specify the orientation of text and graphics on the page.
<b>Lines per Page</b> 1–255	Specify the number of lines of text for each page printed through the PCL® data stream. <b>Notes:</b> <ul style="list-style-type: none"> <li>This menu item activates vertical escapement that causes the selected number of requested lines to print between the default margins of the page.</li> <li>60 is the U.S. factory default setting. 64 is the international factory default setting.</li> </ul>
<b>PCL5 Minimum Line Width</b> 1–30 (2*)	Set the initial minimum stroke width. <b>Note:</b> Jobs printed in 1200 dpi use the value directly.
<b>PCLXL Minimum Line Width</b> 1–30 (2*)	
<b>A4 Width</b> 198 mm* 203 mm	Set the width of the logical page on A4-size paper. <b>Note:</b> Logical page is the space on the physical page where data is printed.
<b>Note:</b> An asterisk (*) next to a value indicates the factory default setting.	

Menu item	Description
<b>Auto CR after LF</b> Off* On	Set the printer to perform a carriage return after a line feed control command.  <b>Note:</b> Carriage return is a mechanism that commands the printer to move the position of the cursor to the first position on the same line.
<b>Auto LF after CR</b> Off* On	Set the printer to perform a line feed after a carriage return control command.
<b>Tray Renumber</b> Assign MP Feeder Assign Tray [x] Assign Manual Paper Assign Manual Envelope	Configure the printer to work with a different print driver or custom application that uses a different set of source assignments to request a given paper source.  Choose from the following options: Off*—The printer uses the factory default paper source assignments. None—The paper source ignores the Select Paper Feed command. 0–199—Select a numeric value to assign a custom value to a paper source.
<b>Tray Renumber</b> View Factory Defaults	Show the factory default value assigned for each paper source.
<b>Tray Renumber</b> Restore Defaults	Restore the tray renumber values to their factory defaults.
<b>Print Timeout</b> Disabled Enabled*	Set the printer to end a print job after it has been idle for the specified amount of time in seconds.  <b>Note:</b> Print Timeout Time appears only when Print Timeout is enabled.
<b>Print Timeout Time</b> 1–255 (90*)	
<b>Note:</b> An asterisk (*) next to a value indicates the factory default setting.	

## Image

Menu item	Description
<b>Auto Fit</b> On Off*	Select the best available paper size and orientation setting for an image.  <b>Note:</b> When set to On, this menu item overrides the scaling and orientation settings for the image.
<b>Invert</b> Off* On	Invert bitonal monochrome images.  <b>Note:</b> This menu item does not apply to GIF or JPEG image formats.
<b>Note:</b> An asterisk (*) next to a value indicates the factory default setting.	



Menu item	Description
<b>Scaling</b> Anchor Top Left Best Fit* Anchor Center Fit Height/Width Fit Height Fit Width	Adjust the image to fit the printable area. <b>Note:</b> When Auto Fit is set to On, Scaling is automatically set to Best Fit.
<b>Orientation</b> Portrait* Landscape Reverse Portrait Reverse Landscape	Specify the orientation of text and graphics on the page.
<b>Note:</b> An asterisk (*) next to a value indicates the factory default setting.	

## Paper

### Tray Configuration

Menu item	Description
<b>Default Source</b> Tray [x] (1*) MP Feeder Manual Paper Manual Envelope	Set the paper source for all print jobs. <b>Note:</b> MP Feeder appears only when Configure MP is set to Cassette.
<b>Paper Size/Type</b> Tray [x] MP Feeder Manual Paper Manual Envelope	Specify the paper size or paper type loaded in each paper source.
<b>Substitute Size</b> Off Statement/A5 Letter/A4 All Listed*	Set the printer to substitute a specified paper size if the requested size is not loaded in any paper source. <b>Notes:</b> <ul style="list-style-type: none"> <li>• Off prompts the user to load the required paper size.</li> <li>• Statement/A5 prints A5-size document on statement when loading statement, and statement-size jobs on A5 paper size when loading A5.</li> <li>• Letter/A4 prints A4-size document on letter when loading letter, and letter-size jobs on A4 paper size when loading A4.</li> <li>• All Listed substitutes Letter/A4.</li> </ul>
<b>Note:</b> An asterisk (*) next to a value indicates the factory default setting.	

Menu item	Description
<b>Configure MP</b> Cassette* Manual First	Set the printer when to pick paper loaded in the multipurpose feeder. <b>Notes:</b> <ul style="list-style-type: none"> <li>• When set to Cassette, the printer treats the multipurpose feeder like a tray.</li> <li>• When set to Manual, the printer treats the multipurpose feeder like a manual feeder.</li> <li>• When set to First, the printer picks paper from the multipurpose feeder until it is empty, regardless of the required paper source or paper size.</li> </ul>
<b>Note:</b> An asterisk (*) next to a value indicates the factory default setting.	

## Media Configuration

### Universal Setup

Menu item	Description
<b>Units of Measure</b> Inches Millimeters	Specify the unit of measurement for the universal paper. <b>Note:</b> Inches is the U.S. factory default setting. Millimeters is the international factory default setting.
<b>Portrait Width</b> 3.90–14.17 inches (8.50*) 99–360 mm (216*)	Set the portrait width of the universal paper.
<b>Portrait Height</b> 3.90–14.17 inches (14*) 99–360 mm (356*)	Set the portrait height of the universal paper.
<b>Feed Direction</b> Short Edge* Long Edge	Set the printer to pick paper from the short edge or long edge direction. <b>Note:</b> Long Edge appears only when the longest edge is shorter than the maximum width supported.
<b>Note:</b> An asterisk (*) next to a value indicates the factory default setting.	

## Custom Scan Sizes

Menu item	Description
<b>Custom Scan Size [x]</b> Scan Size Name Width 1–8.50 inches (8.50*) 25–216 mm (216*) Height 1–14 inches (14*) 25–356 mm (297*) Orientation Portrait* Landscape 2 scans per side Off* On	Assign a scan size name and configure the scan settings.
<b>Note:</b> An asterisk (*) next to a value indicates the factory default setting.	

## Media Types

Menu item	Description
Plain Paper Card Stock Recycled Labels Bond Envelope Rough Envelope Letterhead Preprinted Colored Paper Light Heavy Rough/Cotton Custom Type [X]	Specify the texture, weight, and orientation of the paper loaded.

# Copy

## Copy Defaults

Menu item	Description
<b>Content Type</b> Text Text/Photo* Photo Graphics	Improve the output result based on the content of the original document.
<b>Sides</b> 1 sided to 1 sided* 1 sided to 2 sided 2 sided to 1 sided 2 sided to 2 sided	Specify the scanning behavior based on the original document.
<b>Pages per Side</b> Off* 2 Portrait pages 4 Portrait pages 2 Landscape pages 4 Landscape pages	Specify the number of page images to print on one side of a sheet of paper.
<b>Print Page Borders</b> On Off*	Place a border around each image when printing multiple pages on a single page.
<b>Collate</b> Off [1,1,1,2,2,2] On [1,2,1,2,1,2]*	Print multiple copies in sequence.
<b>“Copy from” Size</b> [List of paper sizes]	Set the paper size of the original document. <b>Note:</b> Letter is the U.S. factory default setting. A4 is the international factory default setting.
<b>“Copy to” Source</b> Tray [x] (1*) MP Feeder Auto Size Match	Specify the paper source for the copy job.
<b>Darkness</b> 1 to 9 (5*)	Adjust the darkness of the scanned image.
<b>Number of Copies</b> 1–9999 (1*)	Specify the number of copies.
<b>Note:</b> An asterisk (*) next to a value indicates the factory default setting.	

## Advanced Imaging

Menu item	Description
<b>Contrast</b> Best for Content* 0 1 2 3 4 5	Specify the contrast of the output.
<b>Background Removal</b> Level -4 to 4 (0*)	Adjust the amount of background visible on a scanned image.
<b>Scan Edge to Edge</b> On Off*	Allow edge-to-edge scanning of the original document.
<b>Note:</b> An asterisk (*) next to a value indicates the factory default setting.	

## Admin Controls

Menu item	Description
<b>Allow Save as Shortcut</b> On* Off	Save custom copy settings as shortcuts.
<b>Note:</b> An asterisk (*) next to a value indicates the factory default setting.	

# Fax

## Fax Defaults

### Fax Mode

Menu item	Description
<b>Fax Mode</b> Fax* Disabled	Select a fax mode.
<b>Note:</b> An asterisk (*) next to a value indicates the factory default setting.	

## Fax Setup

### General Fax settings

Menu item	Description
<b>Fax Name</b>	Identify your fax machine.
<b>Fax Number</b>	Identify your fax number.
<b>Fax ID</b> Fax Name Fax Number*	Notify fax recipients of your fax name or fax number.
<b>Enable Manual Fax</b> On Off*	Set the printer to fax manually. <b>Note:</b> Use a regular telephone line to answer an incoming fax job and to dial a fax number.
<b>Memory Use</b> All receive Mostly receive Equal* Mostly send All send	Set the amount of internal printer memory allocated for faxing. <b>Note:</b> This menu item prevents memory buffer conditions and failed faxes.
<b>Cancel Faxes</b> Allow* Don't Allow	Cancel outgoing faxes before they are transmitted, or cancel incoming faxes before they finish printing.
<b>Fax Number Masking</b> Off* From Left From Right	Specify the format for masking an outgoing fax number.
<b>Digits to Mask</b> 0–58 (0*)	Specify the number of digits to mask in an outgoing fax number.
<b>Enable Line Connected Detection</b> On* Off	Determine whether a telephone line is connected to the printer. <b>Note:</b> Detection takes place when turning on the printer and before each call.
<b>Enable Line In Wrong Jack Detection</b> On* Off	Determine whether a telephone line is connected to the correct port on the printer. <b>Note:</b> Detection takes place when turning on the printer and before each call.
<b>Enable Extension in Use Support</b> On* Off	Determine whether a telephone line is used by another device such as another phone on the same line. <b>Note:</b> This menu item is monitored continuously after turning on the printer.
<b>Optimize Fax Compatibility</b>	Configure the printer fax functionality for optimal compatibility with other fax machines.
<b>Note:</b> An asterisk (*) next to a value indicates the factory default setting.	

Menu item	Description
<b>Fax Transport</b> Analog etherFAX None	Set the fax transport method.
<b>Note:</b> An asterisk (*) next to a value indicates the factory default setting.	

### Fax Send Settings

Menu item	Description
<b>Resolution</b> Standard* Fine Super Fine Ultra Fine	Set the resolution of the scanned image.  <b>Note:</b> A higher resolution increases fax transmission time and requires higher memory.
<b>Original Size</b> [List of paper sizes]	Specify the size of the original document.  <b>Note:</b> Letter is the U.S. factory default setting. A4 is the international factory default setting.
<b>Orientation</b> Portrait* Landscape	Specify the orientation of the original document.
<b>Sides</b> Off* Short Edge Long Edge	Specify the page orientation of text and graphics when scanning a two-sided document.
<b>Content Type</b> Text* Text/Photo Photo Graphics	Improve the output result based on the content of the original document.
<b>Darkness</b> 1–9 (5*)	Adjust the darkness of the scanned image.
<b>Behind a PABX</b> On* Off	Set the printer to dial a fax number without waiting to recognize the dial tone.  <b>Note:</b> Private Automated Branch Exchange (PABX) is a telephone network that allows a single access number to offer multiple lines to outside callers.
<b>Dial Mode</b> Tone* Pulse	Specify the dial mode for incoming or outgoing faxes.
<b>Note:</b> An asterisk (*) next to a value indicates the factory default setting.	

## Advanced Imaging

Menu item	Description
<b>Color Balance</b> Cyan - Red -4 to 4 (0*) Magenta - Green -4 to 4 (0*) Yellow - Blue -4 to 4 (0*)	Adjust the amount of toner used for each color.
<b>Contrast</b> Best for Content* 0 1 2 3 4 5	Set the contrast of the output.
<b>Background Removal</b> Level -4 to 4 (0*)	Adjust the amount of background visible on a scanned image.
<b>Scan Edge to Edge</b> On Off*	Allow edge-to-edge scanning of the original document.
<b>Note:</b> An asterisk (*) next to a value indicates the factory default setting.	

## Admin Controls

Menu item	Description
<b>Automatic Redial</b> 0–9 (5*)	Adjust the number of redial attempts based on the activity levels of recipient fax machines.
<b>Redial Frequency</b> 1–200 minutes (3*)	Increase the time between redial attempts to increase the chance of sending fax successfully.
<b>Enable ECM</b> On* Off	Activate Error Correction Mode (ECM) for fax jobs. <b>Note:</b> ECM detects and corrects errors in the fax transmission process that are caused by telephone line noise and poor signal strength.
<b>Enable Fax Scans</b> On* Off	Fax documents that are scanned at the printer.
<b>Driver to Fax</b> On* Off	Allow the print driver to send fax.
<b>Note:</b> An asterisk (*) next to a value indicates the factory default setting.	



Menu item	Description
<b>Allow Save as Shortcut</b> On* Off	Save fax numbers as shortcuts on the printer.
<b>Max Speed</b> 33600 14400 9600* 4800 2400	Set the maximum speed for sending fax.
<b>Enable Color Fax Scans</b> Off by Default* On by Default Never Use Always Use	Enable color scans for fax.
<b>Auto Convert Color Faxes to Mono Faxes</b> On* Off	Convert all outgoing color faxes to black and white.
<b>Confirm Fax Number</b> Off* On	Ask the user to confirm the fax number.
<b>Dial Prefix</b>	Set a dialing prefix.
<b>Note:</b> An asterisk (*) next to a value indicates the factory default setting.	

### Fax Receive Settings

Menu item	Description
<b>Rings to Answer</b> 1–25 (3*)	Set the number of rings for incoming fax.
<b>Auto Reduction</b> On* Off	Scale incoming fax to fit on the page.
<b>Paper Source</b> Tray [X] MP Feeder Auto*	Set the paper source for printing incoming fax.
<b>Sides</b> On Off*	Print on both sides of the paper.
<b>Note:</b> An asterisk (*) next to a value indicates the factory default setting.	

Menu item	Description
<b>Separator Sheets</b> None* Before Job After Job	Specify whether to insert blank separator sheets when printing.
<b>Separator Sheet Source</b> Tray [X] (1*) MP Feeder	Specify the paper source for the separator sheet.
<b>Fax Footer</b> On Off*	Print the transmission information at the bottom of each page from a received fax.
<b>Fax Footer Time Stamp</b> Receive* Print	Print the time stamp at the bottom of each page from a received fax.
<b>Note:</b> An asterisk (*) next to a value indicates the factory default setting.	

**Admin Controls**

Menu item	Description
<b>Enable Fax Receive</b> On* Off	Set the printer to receive fax.
<b>Enable Color Fax Receive</b> On* Off	Set the printer to receive fax in color.
<b>Enable Caller ID</b> On Off*	Show the number that is sending the incoming fax.
<b>Block No Name Fax</b> On Off*	Block incoming faxes sent from devices with no station ID or fax ID specified.
<b>Answer On</b> All Rings* Single Ring Only Double Ring Only Triple Ring Only Single or Double Rings Only Single or Triple Rings Only Double or Triple Rings Only	Set a distinctive ring pattern for incoming fax.
<b>Auto Answer</b> On* Off	Set the printer to receive fax automatically.
<b>Note:</b> An asterisk (*) next to a value indicates the factory default setting.	

Menu item	Description
<b>Manual Answer Code</b> 0–9 (9*)	Manually enter a code on the telephone number pad to begin receiving fax.  <b>Notes:</b> <ul style="list-style-type: none"> <li>This menu item appears only when the printer shares a line with a telephone.</li> <li>This menu item appears only when you set the printer to receive fax manually.</li> </ul>
<b>Fax Forwarding</b> Print* Print and Forward Forward	Specify whether to forward received fax.
<b>Forward To</b> Destination 1 Destination 2	Specify where to forward received fax.  <b>Note:</b> This menu item appears only when Fax Forwarding is set to Print and Forward or Forward.
<b>Max Speed</b> 33600* 14400 9600 4800 2400	Set the maximum speed for transmitting fax.
<b>Note:</b> An asterisk (*) next to a value indicates the factory default setting.	

### Fax Log settings

Menu item	Description
<b>Transmission Log Frequency</b> Always* Never Only for Error	Specify how often the printer creates a transmission log.
<b>Transmission Log Action</b> Print Off On* E-mail Off* On	Print or e-mail a log for successful fax transmission or transmission error.
<b>Receive Error Log</b> Print Never* Print on Error	Print a log for fax-receive failures.
<b>Auto Print Logs</b> On* Off	Print all fax activity.
<b>Note:</b> An asterisk (*) next to a value indicates the factory default setting.	

Menu item	Description
<b>Log Paper Source</b> Tray [x] (1*) MP Feeder	Specify the paper source for printing logs.
<b>Logs Display</b> Remote Fax Name* Dialed Number	Identify the sender by remote fax name or fax number.
<b>Enable Job Log</b> On* Off	View a summary of all fax jobs.
<b>Enable Call Log</b> On* Off	View a summary of fax dialing history.
<b>Note:</b> An asterisk (*) next to a value indicates the factory default setting.	

### Speaker settings

Menu item	Description
<b>Speaker Mode</b> Always Off* Always On On until Connected	Set the fax speaker mode.
<b>Speaker Volume</b> Low* Medium High	Adjust the fax speaker volume.
<b>Ringer Volume</b> Off* On	Enable the ringer volume.
<b>Note:</b> An asterisk (*) next to a value indicates the factory default setting.	

## E-mail

### E-mail Setup

Menu item	Description
<b>Primary SMTP Gateway</b>	Type the IP address or host name of the primary SMTP server for sending e-mail.
<b>Primary SMTP Gateway Port</b> 1–65535 (25*)	Enter the port number of the primary SMTP server.
<b>Note:</b> An asterisk (*) next to a value indicates the factory default setting.	

Menu item	Description
<b>Secondary SMTP Gateway</b>	Type the server IP address or host name of your secondary or backup SMTP server.
<b>Secondary SMTP Gateway Port</b> 1–65535 (25*)	Enter the server port number of your secondary or backup SMTP server.
<b>SMTP Timeout</b> 5–30 seconds (30*)	Set the time before the printer times out if the SMTP server does not respond.
<b>Reply Address</b>	Specify a reply address in the e-mail.
<b>Always use SMTP default Reply Address</b> On Off*	Always use the default reply address in the SMTP server.
<b>Use SSL/TLS</b> Disabled* Negotiate Required	Specify whether to send e-mail using an encrypted link.
<b>Require Trusted Certificate</b> Off On*	Require a trusted certificate when accessing the SMTP server.
<b>SMTP Server Authentication</b> No authentication required* Login / Plain NTLM CRAM-MD5 Digest-MD5	Set the authentication type for the SMTP server.
<b>Device-Initiated E-mail</b> None* Use Device SMTP Credentials	Specify whether credentials are required for device-initiated e-mail.
<b>Device Userid</b>	Specify the user ID and password to connect to the SMTP server.
<b>Device Password</b>	
<b>NTLM Domain</b>	Specify the domain name for the NTLM security protocol.
<b>Disable "SMTP server not set up" error</b> Off* On	Hide the <b>SMTP server not set up</b> error message.
<b>Note:</b> An asterisk (*) next to a value indicates the factory default setting.	

## E-mail Defaults

Menu item	Description
<b>Subject</b>	Specify the e-mail subject and message.
<b>Message</b>	
<b>File Name</b>	Specify the filename for the scanned document.
<b>Format</b> PDF (.pdf)* TIFF (.tif) JPEG (.jpg) XPS (.xps)	Specify the file format of the scanned document.
<b>PDF Settings</b> PDF Version (1.5*) Archival Version (A-1a*) Secure (Off*) Archival (PDF/A) (Off*)	Configure the PDF settings of the scanned document. <b>Note:</b> Archival Version and Archival (PDF/A) are supported only when PDF Version is set to 1.4.
<b>Content Type</b> Text Text/Photo* Photo Graphics	Improve the output result based on the content type of the original document.
<b>Color</b> Black and White Gray Color*	Set the printer to capture file content in color or in mono.
<b>Resolution</b> 75 dpi 150 dpi* 200 dpi 300 dpi 400 dpi 600 dpi	Set the resolution of the scanned image.
<b>Darkness</b> 1–9 (5*)	Adjust the darkness of the scanned image.
<b>Orientation</b> Portrait* Landscape	Specify the orientation of the original document.
<b>Original Size</b> Mixed Sizes*	Set the paper size of the original document.
<b>Note:</b> An asterisk (*) next to a value indicates the factory default setting.	

Menu item	Description
<b>Sides</b> Off* Short Edge Long Edge	Specify the orientation of the original document when scanning on both sides of the document.
<b>Note:</b> An asterisk (*) next to a value indicates the factory default setting.	

### Advanced Imaging

Menu item	Description
<b>Color Balance</b> Cyan - Red (0*) Magenta - Green (0*) Yellow - Blue (0*)	Adjust the color intensity for cyan, magenta, and yellow.
<b>Contrast</b> Best for content* 0–5	Specify the contrast for the scanned image.
<b>Background Removal</b> Level (0*)	Remove the background color or image noise from the original document.
<b>Scan Edge to Edge</b> On Off*	Scan the original document from edge to edge.
<b>Note:</b> An asterisk (*) next to a value indicates the factory default setting.	

### Admin Controls

Menu item	Description
<b>Max E-mail Size</b> 0–65535 (0*)	Set the allowable file size for each e-mail.
<b>Size Error Message</b>	Specify an error message that the printer sends when an e-mail exceeds its allowable file size. <b>Note:</b> You can type up to 1024 characters.
<b>Send Me a Copy</b> Never appears* On by Default Off by Default Always On	Send a copy of the e-mail to yourself.
<b>Text Default</b> 5–95 (75*)	Set the text quality in the content being scanned.
<b>Text/Photo Default</b> 5–95 (75*)	Set the text and photo quality in the content being scanned.
<b>Note:</b> An asterisk (*) next to a value indicates the factory default setting.	

Menu item	Description
<b>Photo Default</b> 5–95 (50*)	Set the photo quality of the content being scanned.
<b>Transmission Log</b> Print log* Do Not Print Log Print Only For Error	Print a transmission log for e-mail scans.
<b>Log Paper Source</b> Tray [x] (1*) Multipurpose Feeder	Specify the paper source for printing e-mail logs.
<b>Allow Save as Shortcut</b> On* Off	Save an e-mail address as a shortcut.
<b>Reset E-mail Information After Sending</b> On* Off	Reset the To, Subject, Message, and Filename fields to their default values after sending an e-mail.
<b>Note:</b> An asterisk (*) next to a value indicates the factory default setting.	

## FTP

### FTP Defaults

Menu item	Description
<b>Format</b> PDF (.pdf)* TIFF (.tif) JPEG (.jpg) XPS (.xps)	Specify the file format for the scanned image.
<b>PDF Settings</b> PDF Version (1.5*) Archival Version (A-1as*) Secure (Off*) Archival (PDF/A) (Off*)	Configure the PDF settings for the scanned image. <b>Note:</b> Archival Version and Archival (PDF/A) are supported only when PDF Version is set to 1.4.
<b>Content Type</b> Text Text/Photo* Graphics Photo	Improve the output result based on the content type of the original document.
<b>Note:</b> An asterisk (*) next to a value indicates the factory default setting.	



Menu item	Description
<b>Color</b> Black and White Gray Color*	Set the printer to capture file content in color or in mono.
<b>Resolution</b> 75 dpi 150 dpi* 200 dpi 300 dpi 400 dpi 600 dpi	Set the resolution of the scanned image.
<b>Darkness</b> 1–9 (5*)	Adjust the darkness of the scanned image.
<b>Orientation</b> Portrait* Landscape	Specify the orientation of the original document.
<b>Original Size</b> Mixed Sizes*	Set the paper size of the original document.
<b>Sides</b> Off* Long Edge Short Edge	Specify the orientation when scanning on both sides of the document.
<b>File Name</b>	Specify the file name of the scanned image.
<b>Note:</b> An asterisk (*) next to a value indicates the factory default setting.	

### Advanced Imaging

Menu item	Description
<b>Color Balance</b> Cyan - Red (0*) Magenta - Green (0*) Yellow - Blue (0*)	Adjust the color intensity for cyan, magenta, and yellow.
<b>Contrast</b> Best for content* 0 1 2 3 4 5	Specify the contrast for the scanned image.
<b>Note:</b> An asterisk (*) next to a value indicates the factory default setting.	

Menu item	Description
<b>Background Removal</b> Level (0*)	Remove the background color or image noise from the original document. s
<b>Scan Edge to Edge</b> Off* On	Allow edge-to-edge scanning of the original document.
<b>Note:</b> An asterisk (*) next to a value indicates the factory default setting.	

### Admin Controls

Menu item	Description
<b>Text Default</b> 5–95 (75*)	Set the quality of text on the scanned image.
<b>Text/Photo Default</b> 5–95 (75*)	Set the quality of text and photo on the scanned image.
<b>Photo Default</b> 5–95 (50*)	Set the quality of photo on the scanned image.
<b>Transmission Log</b> Print Log* Do Not Print Log Print Only For Error	Print a transmission log for FTP scans.
<b>Log Paper Source</b> Tray [x] (1*) Multipurpose Feeder	Specify the paper source for printing FTP logs.
<b>Note:</b> An asterisk (*) next to a value indicates the factory default setting.	

## USB Drive

### Flash Drive Scan

Menu item	Description
<b>Format</b> PDF (.pdf)* TIFF (.tif) JPEG (.jpg) XPS (.xps)	Specify the file format for the scanned image.
<b>Note:</b> An asterisk (*) next to a value indicates the factory default setting.	

Menu item	Description
<b>PDF Settings</b> PDF Version (1.5*) Archival Version (A-1a*) Secure (Off*) Archival (PDF/A) (Off*)	Configure the PDF settings of the scanned image. <b>Note:</b> Archival Version and Archival (PDF/A) are supported only when PDF Version is set to 1.4.
<b>Content Type</b> Text Text/Photo* Graphics Photo	Improve the output result based on the content type of the original document.
<b>Color</b> Black and White Gray Color*	Set the printer to capture file content in color or in mono.
<b>Resolution</b> 75 dpi 150 dpi* 200 dpi 300 dpi 400 dpi 600 dpi	Set the resolution of the scanned image.
<b>Darkness</b> 1–9 (5*)	Adjust the darkness of the scanned image.
<b>Orientation</b> Portrait* Landscape	Specify the orientation of the original document.
<b>Original Size</b> Mixed Sizes*	Set the paper size of the original document.
<b>Sides</b> Off* Long edge Short edge	Specify the orientation of the original document when scanning on both sides of the document.
<b>File Name</b>	Specify the file name of the scanned image.
<b>Note:</b> An asterisk (*) next to a value indicates the factory default setting.	

## Advanced Imaging

Menu item	Description
<b>Color Balance</b> Cyan - Red (0*) Magenta - Green (0*) Yellow - Blue(0*)	Adjust the color intensity for cyan, magenta, and yellow.
<b>Contrast</b> Best for content* 0–5	Specify the contrast for the scanned image.
<b>Background Removal</b> Level (0*)	Remove the background color or image noise from the original document.
<b>Scan Edge to Edge</b> Off* On	Scan the original document from edge to edge.
<b>Note:</b> An asterisk (*) next to a value indicates the factory default setting.	

## Admin Controls

Menu item	Description
<b>Text Default</b> 5–95 (75*)	Set the quality of text on the scanned image.
<b>Text/Photo Default</b> 5–95 (75*)	Set the quality of text and photo on the scanned image.
<b>Photo Default</b> 5–95 (50*)	Set the quality of a photo on the scanned image.
<b>Note:</b> An asterisk (*) next to a value indicates the factory default setting.	

## Flash Drive Print

Menu item	Description
<b>Number of Copies</b> 1–9999 (1*)	Set the number of copies.
<b>Paper Source</b> Tray [x] (1*) MP Feeder Manual Paper Manual Envelope	Set the paper source for the print job.
<b>Collate</b> 1,1,1 - 2,2,2 1,2,3 - 1,2,3	Keep the pages of a print job stacked in sequence, particularly when printing multiple copies of the job.
<b>Note:</b> An asterisk (*) next to a value indicates the factory default setting.	

Menu item	Description
<b>Sides</b> 1-Sided* 2-Sided	Specify whether to print on one side or both sides of the paper.
<b>Flip Style</b> Long Edge* Short Edge	Determine which side of the paper is bound when performing two-sided printing.
<b>Pages per Side</b> Off* 2 pages per side 3 pages per side 4 pages per side 6 pages per side 9 pages per side 12 pages per side 16 pages per side	Print multiple page images on one side of a sheet of paper.
<b>Pages per Side Ordering</b> Horizontal* Reverse Horizontal Reverse Vertical Vertical	Specify the positioning of multiple page images when using Pages per Side menu.
<b>Pages per Side Orientation</b> Auto* Landscape Portrait	Specify the orientation of multiple page images when using Pages per Side menu.
<b>Pages per Side Border</b> None* Solid	Print a border around each page image when using Pages per Side menu.
<b>Separator Sheets</b> Off* Between Copies Between Jobs Between Pages	Insert blank separator sheets when printing.
<b>Separator Sheet Source</b> Tray [x] (1*) MP Feeder	Specify the paper source for the separator sheet.
<b>Blank Pages</b> Do Not Print* Print	Print blank pages in a print job.
<b>Note:</b> An asterisk (*) next to a value indicates the factory default setting.	

## Network/Ports

### Network Overview

Menu item	Description
<b>Active Adapter</b> Auto* Standard Network Wireless	Specify the type of the network connection.
<b>Network Status</b>	Show the connectivity status of the printer network.
<b>Display Network Status on Printer</b> Off On*	Show the network status on the display.
<b>Speed, Duplex</b>	Show the speed of the currently active network card.
<b>IPv4</b>	Show the IPv4 address.
<b>All IPv6 Addresses</b>	Show all IPv6 addresses.
<b>Reset Print Server</b> Start	Reset all active network connections to the printer. <b>Note:</b> This setting removes all network configuration settings.
<b>Network Job Timeout</b> Off On* (90 seconds)	Set the time before the printer cancels a network print job.
<b>Banner Page</b> Off* On	Print a banner page.
<b>Scan to PC Port Range</b>	Specify a valid port range for printers that are behind a port blocking firewall.
<b>Enable Network Connections</b> Enable* Disable	Enable or disable all network connections.
<b>Enable LLDP</b> Off* On	Enable Link Layer Discovery Protocol (LLDP) in the printer.
<b>Note:</b> An asterisk (*) next to a value indicates the factory default setting.	

## Wireless

Menu item	Description
<b>Setup Using Mobile App</b>	Configure the wireless connection using the Lexmark Mobile Assistant app.
<b>Setup On Printer Panel</b> Choose Network Add Wi-Fi Network <ul style="list-style-type: none"> <li>• Network Name</li> <li>• Network Mode               <ul style="list-style-type: none"> <li>Infrastructure</li> </ul> </li> <li>• Wireless Security Mode               <ul style="list-style-type: none"> <li>Disabled*</li> <li>WEP</li> <li>WPA2/WPA - Personal</li> <li>WPA2 - Personal</li> </ul> </li> </ul>	Determine the wireless network that the printer connects to. <b>Note:</b> This menu item appears as <i>Wireless Connection Setup</i> in the Embedded Web Server.
<b>Wi-Fi Protected Setup</b> Start Push Button Method Start PIN Method	Establish a wireless network and enable network security. <b>Notes:</b> <ul style="list-style-type: none"> <li>• Start Push Button Method connects the printer to a wireless network when buttons on both the printer and the access point (wireless router) are pressed within a given time.</li> <li>• Start PIN Method connects the printer to a wireless network when a PIN on the printer is entered into the wireless settings of the access point.</li> </ul>
<b>Enable Wi-Fi Direct</b> On Off*	Set the printer to connect directly to Wi-Fi devices.
<b>Compatibility</b> 802.11b/g/n (2.4GHz)*	Specify the wireless standard for the wireless network.
<b>Wireless Security Mode</b> Disabled* WEP WPA2/WPA-Personal WPA2-Personal 802.1x - RADIUS	Set the type of security for connecting the printer to wireless devices.
<b>WEP Authentication Mode</b> Auto* Open Shared	Set the type of Wireless Encryption Protocol (WEP) used by the printer. <b>Note:</b> This menu item appears only if Wireless Security Mode is set to WEP.
<b>Set WEP Key</b>	Specify a WEP password for secure wireless connection. <b>Note:</b> This menu item appears only if Wireless Security Mode is set to WEP.

Menu item	Description
<b>WPA2-Personal</b> AES*	Enable wireless security through WPA2. <b>Note:</b> This menu item appears only if Wireless Security Mode is set to WPA2-Personal.
<b>Set PSK</b>	Set the password for secure wireless connection. <b>Note:</b> This menu item appears only if Wireless Security Mode is set to WPA2/WPA-Personal or WPA2-Personal.
<b>WPA2/WPA-Personal</b> AES*	Enable wireless security through WPA2/WPA. <b>Note:</b> This menu item appears only if Wireless Security Mode is set to WPA2/WPA-Personal.
<b>802.1x Encryption Mode</b> WPA+ WPA2*	Enable wireless security through 802.1x standard. <b>Note:</b> This menu item appears only if Wireless Security Mode is set to 802.1x - Radius.
<b>IPv4</b> Enable DHCP On* Off	Enable Dynamic Host Configuration Protocol (DHCP). <b>Note:</b> DHCP is a standard protocol that allows a server to distribute IP addressing and configuration information dynamically to clients.
<b>IPv4</b> Set Static IP Address IP Address Netmask Gateway	Set the static IP address of your printer.
<b>IPv6</b> Enable IPv6 On* Off	Enable IPv6 in the printer.
<b>IPv6</b> Enable DHCPv6 Off* On	Enable DHCPv6 in the printer.
<b>IPv6</b> Stateless Address Autoconfiguration Off On*	Set the network adapter to accept the automatic IPv6 address configuration entries provided by a router.
<b>IPv6</b> DNS Address	Specify the DNS server address.
<b>IPv6</b> Address Prefix 0–128 (64*)	Specify the address prefix.
<b>IPv6</b> All IPv6 Addresses	Show all IPv6 addresses.



Menu item	Description
<b>IPv6</b> All IPv6 Router Addresses	Show all IPv6 router addresses.
<b>Network Address</b> UAA LAA	View the network addresses.
<b>PCL SmartSwitch</b> On* Off	Set the printer to switch automatically to PCL emulation when a print job requires it, regardless of the default printer language. <b>Note:</b> If PCL SmartSwitch is off, then the printer does not examine incoming data and uses the default printer language specified in the Setup menu.
<b>PS SmartSwitch</b> On* Off	Set the printer to switch automatically to PS emulation when a print job requires it, regardless of the default printer language. <b>Note:</b> If PS SmartSwitch is off, then the printer does not examine incoming data and uses the default printer language specified in the Setup menu.
<b>Mac Binary PS</b> Auto* On Off	Set the printer to process Macintosh binary PostScript print jobs. <b>Notes:</b> <ul style="list-style-type: none"> <li>• On processes raw binary PostScript print jobs.</li> <li>• Off filters print jobs using the standard protocol.</li> </ul>

## Ethernet

Menu item	Description
<b>Network Speed</b>	Show the speed of an active network adapter.
<b>IPv4</b> Enable DHCP On* Off	Enable Dynamic Host Configuration Protocol (DHCP). <b>Note:</b> DHCP is a standard protocol that allows a server to distribute IP addressing and configuration information to clients in a dynamic manner.
<b>IPv4</b> Set Static IP Address IP Address Netmask Gateway	Set the static IP address of your printer.
<b>IPv6</b> Enable IPv6 On* Off	Enable IPv6 in the printer.
<b>Note:</b> An asterisk (*) next to a value indicates the factory default setting.	

Menu item	Description
<b>IPv6</b> Enable DHCPv6 Off* On	Enable DHCPv6 in the printer.
<b>IPv6</b> Stateless Address Autoconfiguration On* Off	Set the network adapter to accept the automatic IPv6 address configuration entries provided by a router.
<b>IPv6</b> DNS Address	Specify the DNS server address.
<b>IPv6</b> Address Prefix 0–128 (64*)	Specify the address prefix.
<b>IPv6</b> All IPv6 Addresses	Show all IPv6 addresses.
<b>IPv6</b> All IPv6 Router Addresses	Show all IPv6 router addresses.
<b>Network Address</b> UAA LAA	Show the printer Media Access Control (MAC) addresses: Locally Administered Address (LAA) and Universally Administered Address (UAA). <b>Note:</b> You can change the printer LAA manually.
<b>PCL SmartSwitch</b> On* Off	Set the printer to switch automatically to PCL emulation when a print job requires it, regardless of the default printer language. <b>Note:</b> If PCL SmartSwitch is off, then the printer does not examine incoming data and uses the default printer language specified in the Setup menu.
<b>PS SmartSwitch</b> On* Off	Set the printer to switch automatically to PS emulation when a print job requires it, regardless of the default printer language. <b>Note:</b> If PS SmartSwitch is off, then the printer does not examine incoming data and uses the default printer language specified in the Setup menu.
<b>Mac Binary PS</b> Auto* On Off	Set the printer to process Macintosh binary PostScript print jobs. <b>Notes:</b> <ul style="list-style-type: none"> <li>• On processes raw binary PostScript print jobs.</li> <li>• Off filters print jobs using the standard protocol.</li> </ul>
<b>Energy Efficient Ethernet</b> Auto* On Off	Reduce power consumption when the printer does not receive data from the Ethernet network.
<b>Note:</b> An asterisk (*) next to a value indicates the factory default setting.	

## TCP/IP

**Note:** This menu appears only in network printers or printers attached to print servers.

Menu item	Description
<b>Set Hostname</b>	Set the current TCP/IP host name.
<b>Domain Name</b>	Set the domain name.
<b>Allow DHCP/BOOTP to update NTP server</b> On* Off	Allow the DHCP and BOOTP clients to update the NTP settings of the printer.
<b>Zero Configuration Name</b>	Specify a service name for the zero configuration network.
<b>Enable Auto IP</b> On* Off	Assign an IP address automatically.
<b>DNS Address</b>	Specify the current Domain Name System (DNS) server address.
<b>Backup DNS</b>	Specify the backup DNS server addresses.
<b>Backup DNS 2</b>	
<b>Backup DNS 3</b>	
<b>Domain Search Order</b>	Specify a list of domain names to locate the printer and its resources that reside in different domains on the network.
<b>Enable DDNS</b> Off* On	Update the Dynamic DNS settings.
<b>DDNS TTL</b>	Specify the current DDNS settings.
<b>Default TTL</b>	
<b>DDNS Refresh Time</b>	
<b>Enable mDNS</b> On* Off	Update multicast DNS settings.
<b>WINS Address</b>	Specify a server address for Windows Internet Name Service (WINS).
<b>Enable BOOTP</b> Off* On	Allow the BOOTP to assign a printer IP address.
<b>Restricted Server List</b>	Specify an IP address for the TCP connections.  <b>Notes:</b> <ul style="list-style-type: none"> <li>• This menu item appears only in the Embedded Web Server.</li> <li>• Use a comma to separate each IP address.</li> <li>• You can add up to 50 IP addresses.</li> </ul>
<b>Note:</b> An asterisk (*) next to a value indicates the factory default setting.	

Menu item	Description
<b>Restricted Server List Options</b> Block All Ports* Block Printing Only Block Printing and HTTP Only	Specify how the IP addresses in the list can access the printer functionality. <b>Note:</b> This menu item appears only in the Embedded Web Server.
<b>MTU</b>	Specify a maximum transmission unit (MTU) parameter for the TCP connections.
<b>Raw Print Port</b> 1–65535 (9100*)	Specify a raw port number for printers connected on a network.
<b>Outbound Traffic Maximum Speed</b> Disabled* Enabled	Enable the printer maximum transfer rate.
<b>Enable TLSv1.0</b> On* Off	Enable the TLSv1.0 protocol.
<b>Enable TLSv1.1</b> On* Off	Enable the TLSv1.1 protocol.
<b>SSL Cipher List</b>	Specify the cipher algorithms to use for the SSL or the TLS connections.
<b>Note:</b> An asterisk (*) next to a value indicates the factory default setting.	

## SNMP

**Note:** This menu appears only in network printers or printers that are attached to print servers.

Menu item	Description
<b>SNMP Versions 1 and 2c</b> Enabled Off On* Allow SNMP Set Off On* Enable PPM MIB Off On* SNMP Community	Configure Simple Network Management Protocol (SNMP) versions 1 and 2c to install print drivers and applications.
<b>Note:</b> An asterisk (*) next to a value indicates the factory default setting.	

Menu item	Description
<p><b>SNMP Version 3</b></p> <ul style="list-style-type: none"> <li>Enabled                             <ul style="list-style-type: none"> <li>Off</li> <li>On*</li> </ul> </li> <li>Set Read/Write Credentials                             <ul style="list-style-type: none"> <li>User Name</li> <li>Password</li> </ul> </li> <li>Set Read-only Credentials                             <ul style="list-style-type: none"> <li>User Name</li> <li>Password</li> </ul> </li> <li>Authentication Hash                             <ul style="list-style-type: none"> <li>MD5</li> <li>SHA1*</li> </ul> </li> <li>Minimum Authentication Level                             <ul style="list-style-type: none"> <li>No Authentication, No Privacy</li> <li>Authentication, No Privacy</li> <li>Authentication, Privacy*</li> </ul> </li> <li>Privacy Algorithm                             <ul style="list-style-type: none"> <li>DES</li> <li>AES-128*</li> </ul> </li> </ul>	<p>Configure SNMP version 3 to install and update the printer security.</p>
<p><b>Note:</b> An asterisk (*) next to a value indicates the factory default setting.</p>	

## IPSec

**Note:** This menu appears only in network printers or printers that are attached to print servers.

Menu item	Description
<p><b>Enable IPSec</b></p> <ul style="list-style-type: none"> <li>Off*</li> <li>On</li> </ul>	<p>Enable Internet Protocol Security (IPSec).</p>
<p><b>Base Configuration</b></p> <ul style="list-style-type: none"> <li>Default*</li> <li>Compatibility</li> <li>Secure</li> </ul>	<p>Set the IPSec base configuration.</p> <p><b>Note:</b> This menu item appears only when Enable IPSec is set to On.</p>
<p><b>Note:</b> An asterisk (*) next to a value indicates the factory default setting.</p>	

Menu item	Description
<b>DH (Diffie-Hellman) Group Proposal</b> modp2048 (14)* modp3072 (15) modp4069 (16) modp6144 (17)	Set the IPSec encryption.  <b>Notes:</b> <ul style="list-style-type: none"> <li>DH (Diffie-Hellman) Group Proposal appears only when Base Configuration is set to Compatibility.</li> <li>IKE SA Lifetime (Hours) and IPSec SA Lifetime (Hours) appear only when Base Configuration is set to Secure.</li> </ul>
<b>IKE SA Lifetime (Hours)</b> 1 2 4 8 24*	
<b>IPSec SA Lifetime (Hours)</b> 1 2 4 8* 24	
<b>Proposed Encryption Method</b> 3DES AES*	Specify the encryption and authentication methods to connect to a network securely.  <b>Note:</b> These menu items appear only when Base Configuration is set to Compatibility.
<b>Proposed Authentication Method</b> SHA1 SHA256* SHA512	
<b>IPSec Device Certificate</b>	Specify an IPSec certificate.  <b>Note:</b> This menu item appears only when Enable IPSec is set to On.
<b>Pre-Shared Key Authenticated Connections</b> Host [x] Address Key	Configure the authenticated connections of the printer.  <b>Note:</b> These menu items appear only when Enable IPSec is set to On.
<b>Certificate Authenticated Connections</b> Host [x] Address[/subnet] Address[/subnet]	
<b>Note:</b> An asterisk (*) next to a value indicates the factory default setting.	

## 802.1x

**Note:** This menu appears only in network printers or printers that are attached to print servers.

Menu item	Description
<b>Active</b> Off* On	Let the printer join networks that require authentication before allowing access.
<b>Note:</b> An asterisk (*) next to a value indicates the factory default setting.	

## LPD Configuration

**Note:** This menu appears only in network printers or printers that are attached to print servers.

Menu item	Description
<b>LPD Timeout</b> 0–65535 seconds (90*)	Set the time-out value to stop the Line Printer Daemon (LPD) server from waiting indefinitely for hung or invalid print jobs.
<b>LPD Banner Page</b> Off* On	Print a banner page for all LPD print jobs. <b>Note:</b> A banner page is the first page of a print job used as a separator of print jobs and to identify the originator of the print job request.
<b>LPD Trailer Page</b> Off* On	Print a trailer page for all LPD print jobs. <b>Note:</b> A trailer page is the last page of a print job.
<b>LPD Carriage Return Conversion</b> Off* On	Enable carriage return conversion. <b>Note:</b> Carriage return is a mechanism that commands the printer to move the position of the cursor to the first position on the same line.
<b>Note:</b> An asterisk (*) next to a value indicates the factory default setting.	

## HTTP/FTP Settings

Menu item	Description
<b>Enable HTTP Server</b> Off On*	Access the Embedded Web Server to monitor and manage the printer.
<b>Enable HTTPS</b> Off On*	Configure the Hypertext Transfer Protocol Secure (HTTPS) settings.
<b>Force HTTPS Connections</b> On Off*	Force the printer to use the HTTPS connections.
<b>Enable FTP/TFTP</b> Off On*	Send files using FTP.
<b>Note:</b> An asterisk (*) next to a value indicates the factory default setting.	

Menu item	Description
<b>Local Domains</b>	Specify domain names for HTTP and FTP servers. <b>Note:</b> This menu item appears only in the Embedded Web Server.
<b>HTTP Proxy IP Address</b>	Configure the HTTP and FTP server settings. <b>Note:</b> HTTP Proxy IP Address and FTP Proxy IP Address appear only in the Embedded Web Server.
<b>FTP Proxy IP Address</b>	
<b>HTTP Default IP Port</b> 1–65535 (80*)	
<b>HTTPS Device Certificate</b>	
<b>FTP Default IP Port</b> 1–65535 (21*)	
<b>Timeout for HTTP/FTP Requests</b> 1–299 (30*)	Specify the amount of time before the server connection stops.
<b>Retries for HTTP/FTP Requests</b> 1–299 (3*)	Set the number of retries to connect to the HTTP/FTP server.
<b>Note:</b> An asterisk (*) next to a value indicates the factory default setting.	

## USB

Menu item	Description
<b>PCL SmartSwitch</b> Off On*	Set the printer to switch to PCL emulation when a print job received through a USB port requires it, regardless of the default printer language. <b>Note:</b> If PCL SmartSwitch is off, then the printer does not examine incoming data and uses the default printer language specified in the Setup menu.
<b>PS SmartSwitch</b> Off On*	Set the printer to switch to PS emulation when a print job received through a USB port requires it, regardless of the default printer language. <b>Note:</b> If PS SmartSwitch is off, then the printer does not examine incoming data and uses the default printer language specified in the Setup menu.
<b>Mac Binary PS</b> On Auto* Off	Set the printer to process Macintosh binary PostScript print jobs. <b>Notes:</b> <ul style="list-style-type: none"> <li>• When set to On, the printer processes raw binary PostScript print jobs from computers using the Macintosh operating system.</li> <li>• When set to Auto, the printer processes print jobs from computers using either Windows or Macintosh operating systems</li> <li>• When set to Off, the printer filters PostScript print jobs using the standard protocol.</li> </ul>
<b>Enable USB Port</b> Disable Enable*	Enable the standard USB port.
<b>Note:</b> An asterisk (*) next to a value indicates the factory default setting.	



## Restrict external network access

Menu item	Description
<b>Restrict external network access</b> Off* On	Restrict access to network sites.
<b>External network address</b>	Specify the network addresses with restricted access.
<b>E-mail address for notification</b>	Specify an e-mail address to send a notification of logged events.
<b>Ping frequency</b> 1–300 (10*)	Specify the network query interval in seconds.
<b>Subject</b>	Specify the subject and message of the notification e-mail.
<b>Message</b>	
<b>Note:</b> An asterisk (*) next to a value indicates the factory default setting.	

## Google Cloud Print

Menu item	Description
<b>Registration</b> Register	Register the printer to the Google Cloud Print server.
<b>Options</b> Enable Google Cloud Print Off On*	Print directly from your Google account.
<b>Options</b> Enable Local Discovery Off On*	Allow the registered user and other users on the same subnet to send jobs to the printer locally.
<b>Options</b> Enable SSL Peer Verification Off On*	Verify authenticity of the peer certificate to connect to your Google account.
<b>Options</b> Always Print As Image Off* On	Set the printer to process files as images for faster printing.
<b>Note:</b> An asterisk (*) next to a value indicates the factory default setting.	

## Wi-Fi Direct

**Note:** This menu appears only when a direct Wi-Fi network is the active network.

Menu item	Description
<b>SSID</b>	Specify the service set identifier (SSID) of the Wi-Fi network.
<b>Preferred Channel Number</b> 1–11 (6*) Auto	Set the preferred channel of the Wi-Fi network.
<b>Set PSK</b>	Set the preshared key (PSK) to authenticate and validate users on a Wi-Fi connection.
<b>Show PSK on Setup Page</b> Off On*	Show the PSK on the Network Setup Page.
<b>Group Owner IP Address</b>	Specify the IP address of the group owner.
<b>Auto-Accept Push Button Requests</b> Off* On	Accept requests to connect to the network automatically. <b>Note:</b> Accepting clients automatically is not secured.
<b>Note:</b> An asterisk (*) next to a value indicates the factory default setting.	

# Security

## Login Methods

### Public

Menu item	Description
<p><b>Manage Permissions</b></p> <ul style="list-style-type: none"> <li>Function Access</li> <li>Manage Shortcuts</li> <li>Create Profiles</li> <li>Flash Drive Print</li> <li>Flash Drive Scan</li> <li>Copy Function</li> <li>E-mail Function</li> <li>Fax Function</li> <li>FTP Function</li> <li>Release Held Faxes</li> <li>Held Jobs Access</li> <li>User Profiles</li> <li>Cancel Jobs at the Device</li> <li>Change Language</li> <li>Internet Printing Protocol (IPP)</li> <li>Initiate Scans Remotely</li> <li>B/W Print</li> <li>Network Folder - Scan</li> </ul>	<p>Control access to the printer functions.</p>
<p><b>Manage Permissions</b></p> <ul style="list-style-type: none"> <li>Administrative Menus</li> <li>Security Menu</li> <li>Network/Ports Menu</li> <li>Paper Menu</li> <li>Reports Menu</li> <li>Function Configuration Menus</li> <li>Supplies Menu</li> <li>SE Menu</li> <li>Device Menu</li> </ul>	<p>Control access to the printer menus.</p>
<p><b>Manage Permissions</b></p> <ul style="list-style-type: none"> <li>Device Management</li> <li>Remote Management</li> <li>Firmware Updates</li> <li>Embedded Web Server Access</li> <li>Import / Export All Settings</li> <li>Out of Service Erase</li> </ul>	<p>Control access to the printer management options.</p>

### Local Accounts

Menu item	Description
<b>Add User</b> User Name/Password User Name Password PIN	Create local accounts to manage access to the printer functions.
<b>Manage Groups/Permissions</b> Add Group Import Access Controls Function Access Administrative Menus Device Management All Users Import Access Controls Function Access Administrative Menus Device Management Admin Function Access Administrative Menus Device Management	Control group or user access to the printer functions, applications, and security settings.

### Certificate Management

Menu item	Menu item
<b>Configure Certificate Defaults</b> Common Name Organization Name Unit Name Country/Region Province Name City Name Subject Alternate Name	Set the default values for generated certificates.
Device Certificates	Generate, delete, or view device certificates.
Manage CA Certificates	Load, delete, or view Certificate Authority (CA) certificates.

### Schedule USB Devices

Menu item	Description
<b>Schedules</b> Add New Schedule	Schedule access to the front USB port.

## Login Restrictions

Menu item	Description
<b>Login failures</b> 1–10 (3*)	Specify the number of failed login attempts before the user gets locked out.
<b>Failure time frame</b> 1–60 minutes (5*)	Specify the time frame between failed login attempts before the user gets locked out.
<b>Lockout time</b> 1–60 minutes (5*)	Specify the lockout duration.
<b>Web Login Timeout</b> 1–120 minutes (10*)	Specify the delay for a remote login before the user is logged off automatically.
<b>Note:</b> An asterisk (*) next to a value indicates the factory default setting.	

## Confidential Print Setup

Menu item	Description
<b>Max Invalid PIN</b> 2–10 (0*)	Set the number of times an invalid PIN can be entered.  <b>Notes:</b> <ul style="list-style-type: none"> <li>• A value of zero turns off this setting.</li> <li>• When the limit is reached, the print jobs for that user name and PIN are deleted.</li> </ul>
<b>Confidential Job Expiration</b> Off* 1 Hour 4 Hours 24 Hours 1 Week	Set the expiration time for confidential print jobs.  <b>Notes:</b> <ul style="list-style-type: none"> <li>• If this menu item is changed while confidential print jobs reside in the printer memory, then the expiration time for those print jobs does not change to the new default value.</li> <li>• If the printer is turned off, then all confidential jobs held in the printer memory are deleted.</li> </ul>
<b>Repeat Job Expiration</b> Off* 1 Hour 4 Hours 24 Hours 1 Week	Set the expiration time for a print job that you want to repeat.
<b>Verify Job Expiration</b> Off* 1 Hour 4 Hours 24 Hours 1 Week	Set the expiration time that the printer prints a copy for the user to examine its quality, before printing the remaining copies.
<b>Note:</b> An asterisk (*) next to a value indicates the factory default setting.	

Menu item	Description
<b>Reserve Job Expiration</b> Off* 1 Hour 4 Hours 24 Hours 1 Week	Set the expiration time that the printer stores print jobs for printing later.
<b>Require All Jobs to be Held</b> Off* On	Set the printer to hold all print jobs.
<b>Keep duplicate documents</b> Off* On	Allow the storage of documents with the same file name.
<b>Note:</b> An asterisk (*) next to a value indicates the factory default setting.	

## Erase Temporary Data Files

Menu item	Description
<b>Stored in onboard memory</b> Off* On	Delete all files stored on the printer memory.
<b>Note:</b> An asterisk (*) next to a value indicates the factory default setting.	

## Miscellaneous

Menu item	Description
<b>Print Permission</b> Off* On	Allow the user to print.
<b>Security Reset Jumper</b> Enable "Guest" access* No Effect	Specify user access to the printer. <b>Notes:</b> <ul style="list-style-type: none"> <li>• The jumper is located beside a lock icon on the controller board.</li> <li>• Enable "Guest" access gives anyone access to all aspects of the printer.</li> <li>• No Effect may make access to the printer impossible when the required security information is unavailable.</li> </ul>
<b>Minimum Password Length</b> 0–32	Specify the password length.
<b>Note:</b> An asterisk (*) next to a value indicates the factory default setting.	

## Cloud Connector

Menu item	Description
<b>Enable/Disable Connectors</b>	Enable a cloud service provider.

## Reports

### Menu Settings Page

Menu item	Description
<b>Menu Settings Page</b>	Print a report that contains the printer menus.

### Device

Menu item	Description
<b>Device Information</b>	Print a report that contains information about the printer.
<b>Device Statistics</b>	Print a report about printer usage and supply status.
<b>Profiles List</b>	Print a list of profiles that are stored in the printer.
<b>Asset Report</b>	Print a report that contains the printer serial number and model name.

### Print

Menu item	Description
<b>Print Fonts</b> PCL Fonts PostScript Fonts	Print samples and information about the fonts that are available in each printer language.

### Shortcuts

Menu item	Description
<b>All Shortcuts</b>	Print a report that lists the shortcuts that are stored in the printer.
<b>Fax Shortcuts</b>	
<b>Copy Shortcuts</b>	
<b>E-mail Shortcuts</b>	
<b>FTP Shortcuts</b>	
<b>Network Folder Shortcuts</b>	

## Fax

Menu item	Description
<b>Fax Job Log</b>	Print a report about the last 200 completed fax jobs. <b>Note:</b> This menu item appears only when Enable Job Log is set to On.
<b>Fax Call Log</b>	Print a report about the last 100 attempted, received, and blocked calls. <b>Note:</b> This menu item appears only when Enable Job Log is set to On.

## Network

Menu item	Description
<b>Network Setup Page</b>	Print a page that shows the configured network and wireless settings on the printer. <b>Note:</b> This menu item appears only in network printers or printers connected to print servers.
<b>Wi-Fi Direct Connected Clients</b>	Print a page that shows the list of devices that are connected to the printer using Wi-Fi Direct. <b>Note:</b> This menu item appears only when Enable Wi-Fi Direct is set to On.

## Troubleshooting

Menu item	Description
<b>Print Quality Test Pages</b>	Print sample pages to identify and correct print quality defects.
<b>Cleaning the Scanner</b>	Print instructions on how to clean the scanner.



# Maintain the printer

## Checking the status of parts and supplies

- 1 From the home screen, touch **Status/Supplies**.
- 2 Select the parts or supplies that you want to check.

**Note:** You can also access this setting by touching the top section of the home screen.

## Configuring supply notifications

- 1 Open a web browser, and then type the printer IP address in the address field.

**Notes:**

- View the printer IP address on the printer home screen. The IP address appears as four sets of numbers separated by periods, such as 123.123.123.123.
- If you are using a proxy server, then temporarily disable it to load the web page correctly.

- 2 Click **Settings > Device > Notifications**.
- 3 From the Supplies menu, click **Custom Supply Notifications**.
- 4 Select a notification for each supply item.
- 5 Apply the changes.

## Setting up e-mail alerts

Configure the printer to send e-mail alerts when supplies are low, when paper must be changed or added, or when there is a paper jam.

- 1 Open a web browser, and then type the printer IP address in the address field.

**Notes:**

- View the printer IP address on the printer home screen. The IP address appears as four sets of numbers separated by periods, such as 123.123.123.123.
- If you are using a proxy server, then temporarily disable it to load the web page correctly.

- 2 Click **Settings > Device > Notifications > E-mail Alert Setup**, and then configure the settings.
- 3 Click **Setup E-mail Lists and Alerts**, and then configure the settings.
- 4 Apply the changes.

## Viewing reports

- 1 From the home screen, touch **Settings > Reports**.
- 2 Select the report that you want to view.

## Ordering parts and supplies

To order supplies in the U.S., contact Lexmark at 1-800-539-6275 for information about Lexmark authorized supplies dealers in your area. In other countries or regions, go to [www.lexmark.com](http://www.lexmark.com) or contact the place where you purchased the printer.

**Note:** All life estimates for printer supplies assume printing on letter- or A4-size plain paper.

**Warning—Potential Damage:** Failure to maintain optimum printer performance, or to replace parts and supplies, may cause damage to your printer.

## Using genuine Lexmark parts and supplies

Your Lexmark printer is designed to function best with genuine Lexmark parts and supplies. Use of third-party supplies or parts may affect the performance, reliability, or life of the printer and its imaging components. It can also affect warranty coverage. Damage caused by the use of third-party parts and supplies is not covered by the warranty. All life indicators are designed to function with Lexmark parts and supplies, and may deliver unpredictable results if third-party parts and supplies are used. Imaging component usage beyond the intended life may damage your Lexmark printer or its associated components.

**Warning—Potential Damage:** Supplies and parts without Return Program agreement terms may be reset and remanufactured. However, the manufacturer’s warranty does not cover any damage caused by non-genuine supplies or parts. Resetting counters on the supply or part without proper remanufacturing can cause damage to your printer. After resetting the supply or part counter, your printer may display an error indicating the presence of the reset item.

## Ordering a toner cartridge

**Notes:**

- The estimated cartridge yield is based on the ISO/IEC 19752 standard.
- Extremely low print coverage for extended periods of time may negatively affect actual yield.

### Lexmark MX331 and MX431 Return Program toner cartridges

Item	United States and Canada	European Economic Area	Rest of Asia Pacific	Latin America	Rest of Europe, Middle East, and Africa	Australia and New Zealand
Return Program toner cartridge	55B1000	55B2000	55B3000	55B4000	55B5000	55B6000
High yield Return Program toner cartridge	55B1H00	55B2H00	55B3H00	55B4H00	55B5H00	55B6H00

<sup>1</sup> Supported only in the Lexmark MX431 printer model.  
<sup>2</sup> Available only for contract-managed printers. For more information, contact your Lexmark representative or system administrator.

Item	United States and Canada	European Economic Area	Rest of Asia Pacific	Latin America	Rest of Europe, Middle East, and Africa	Australia and New Zealand
Extra high yield Return Program toner cartridge <sup>1</sup>	55B1X00	55B2X00	55B3X00	55B4X00	55B5X00	55B6X00
Corporate Return Program toner cartridge <sup>2</sup>	55B100E	55B200E	55B300E	55B400E	55B500E	55B600E
High yield Corporate Return Program toner cartridge <sup>2</sup>	55B1H0E	55B2H0E	55B3H0E	55B4H0E	55B5H0E	55B6H0E
Extra high yield Corporate Return Program toner cartridge <sup>1,2</sup>	55B1X0E	55B2X0E	55B3X0E	55B4X0E	55B5X0E	55B6X0E

<sup>1</sup> Supported only in the Lexmark MX431 printer model.

<sup>2</sup> Available only for contract-managed printers. For more information, contact your Lexmark representative or system administrator.

### Lexmark MX331 and MX431 Regular toner cartridges

Item	Worldwide
High yield regular toner cartridge <sup>1</sup>	55B0HA0
Extra high yield regular toner cartridge <sup>2</sup>	55B0XA0

<sup>1</sup> Supported only in the Lexmark MX331 printer model.

<sup>2</sup> Supported only in the Lexmark MX431 printer model.

### Lexmark MB3442 Return Program toner cartridges

Item	United States and Canada	European Economic Area	Rest of Asia Pacific	Latin America	Rest of Europe, Middle East, and Africa	Australia and New Zealand
Return Program toner cartridge	B341000	B342000	B343000	B344000	B345000	B346000
High yield Return Program toner cartridge	B341H00	B342H00	B343H00	B344H00	B345H00	B346H00

Item	United States and Canada	European Economic Area	Rest of Asia Pacific	Latin America	Rest of Europe, Middle East, and Africa	Australia and New Zealand
Extra high yield Return Program toner cartridge	B341X00	B342X00	B343X00	B344X00	B345X00	B346X00

### Lexmark MB3442 Regular toner cartridges

Item	Worldwide
Extra high yield regular toner cartridge	B340XA0

## Ordering an imaging unit

Extremely low print coverage for extended periods of time may cause imaging unit parts to fail before the toner is exhausted.

Item	Part Number
Regular imaging unit	55B0ZA0

## Replacing parts and supplies

### Replacing the toner cartridge

- 1 Open the front door.

**Warning—Potential Damage:** To prevent damage from electrostatic discharge, touch any exposed metal frame of the printer before accessing or touching interior areas of the printer.

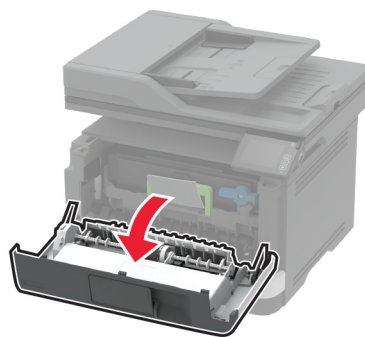
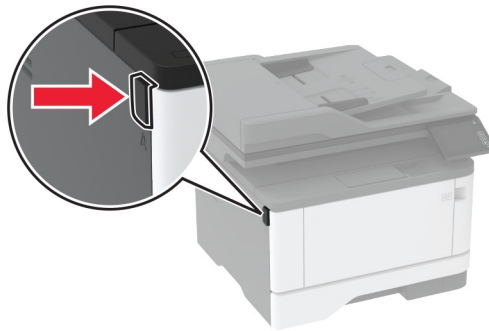

**2** Remove the imaging unit.

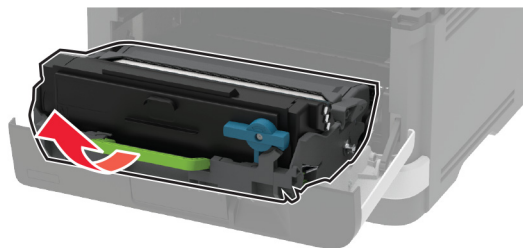

**3** Twist the blue latch, and then remove the used toner cartridge from the imaging unit.

**Warning—Potential Damage:** Do not expose the imaging unit to direct light for more than 10 minutes. Extended exposure to light may cause print quality problems.

**Warning—Potential Damage:** Do not touch the photoconductor drum. Doing so may affect the quality of future print jobs.

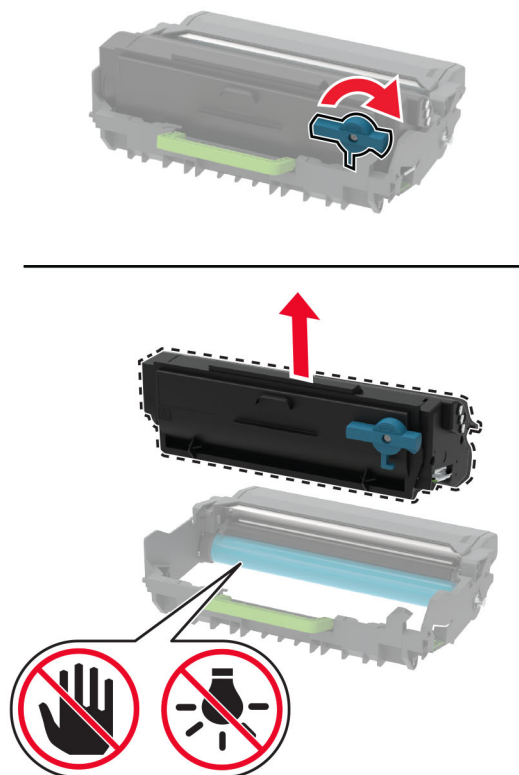

- 4 Unpack the new toner cartridge.
- 5 Shake the toner cartridge to redistribute the toner.

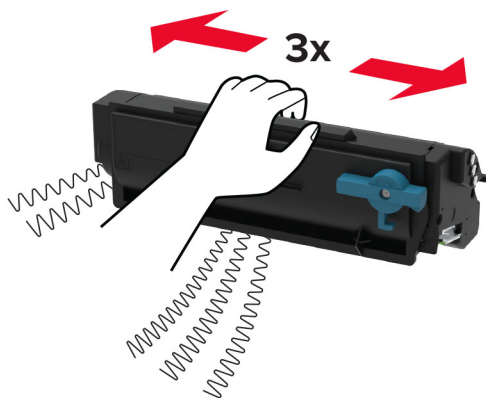

- 6 Insert the new toner cartridge into the imaging unit until it *clicks* into place.

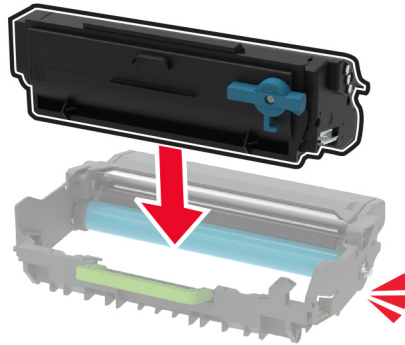

- 7 Insert the imaging unit.

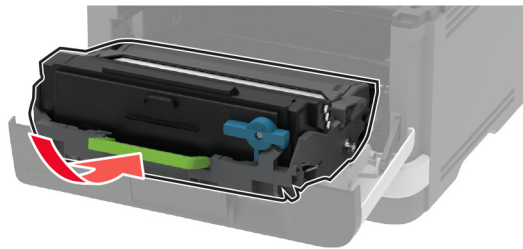

- 8 Close the door.

## Replacing the imaging unit

- 1 Open the front door.

**Warning—Potential Damage:** To prevent damage from electrostatic discharge, touch any exposed metal frame of the printer before accessing or touching interior areas of the printer.

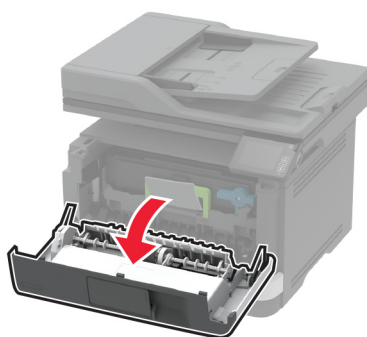
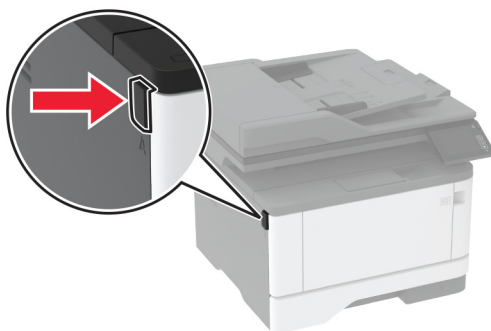

**2** Remove the used imaging unit.

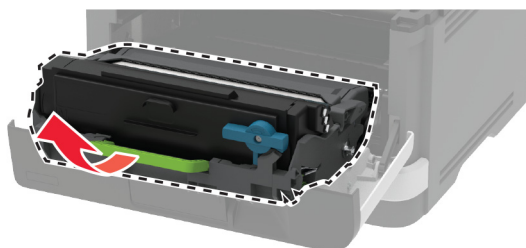



- 3 Twist the blue latch, and then remove the toner cartridge from the used imaging unit.

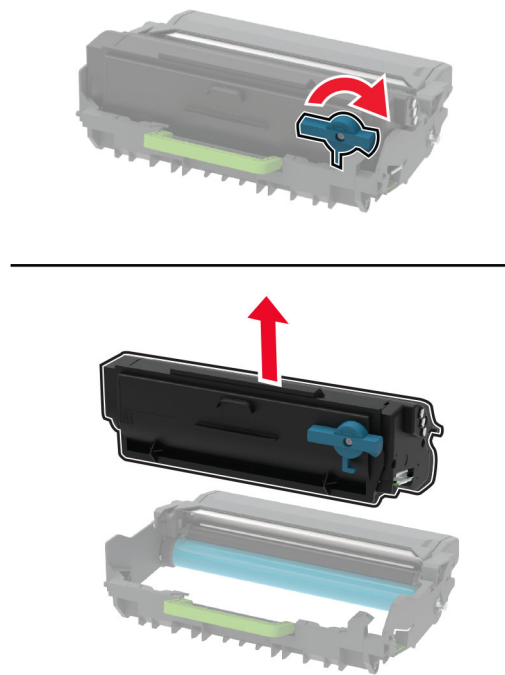

- 4 Unpack the new imaging unit, and then insert the toner cartridge until it *clicks* into place.

**Warning—Potential Damage:** Do not expose the imaging unit to direct light for more than 10 minutes. Extended exposure to light may cause print quality problems.

**Warning—Potential Damage:** Do not touch the photoconductor drum. Doing so may affect the quality of future print jobs.

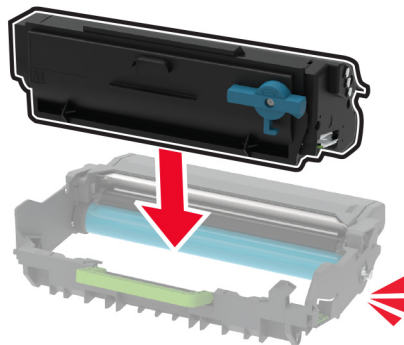

- 5 Insert the new imaging unit.

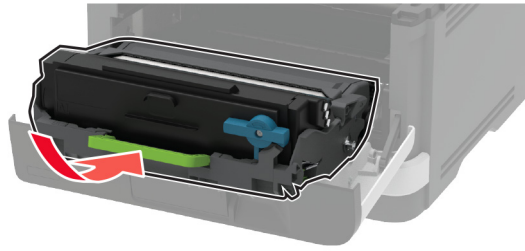

- 6 Close the door.

## Replacing the tray

- 1 Remove the used tray.

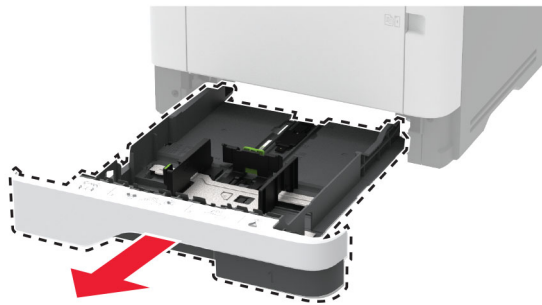

- 2 Unpack the new tray.

- 3 Insert the new tray.

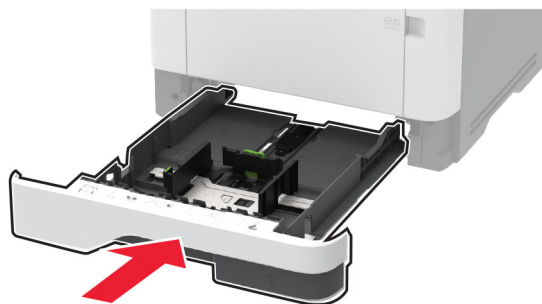

## Replacing the pick roller assembly

- 1 Turn off the printer.
- 2 Unplug the power cord from the electrical outlet, and then from the printer.

**3** Open the front door.

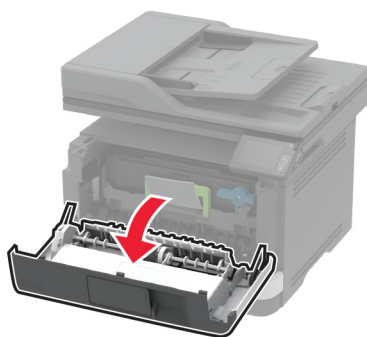
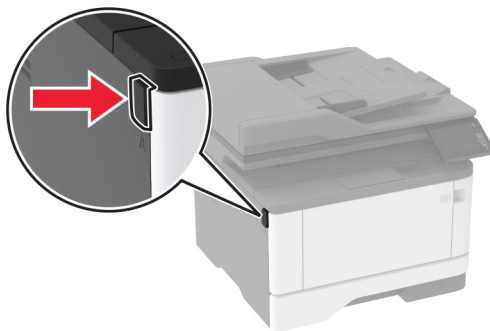

**4** Remove the imaging unit.

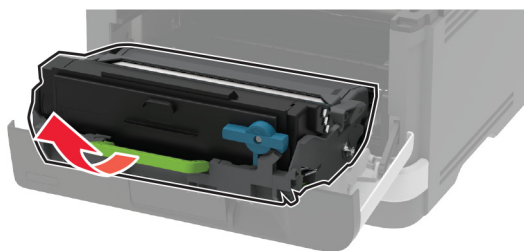

**5** Close the front door.

**6** Remove the tray.



7 Position the printer on its side.

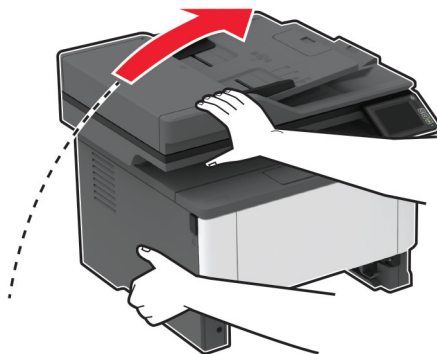

8 Remove the used pick roller assembly.

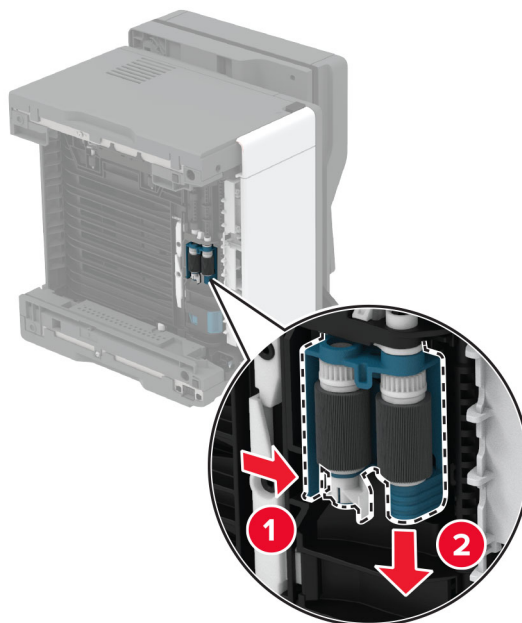

9 Unpack the new pick roller assembly.

**Note:** To avoid contamination, make sure that your hands are clean.

- 10** Insert the new pick roller assembly.

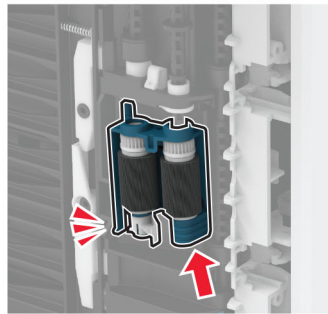
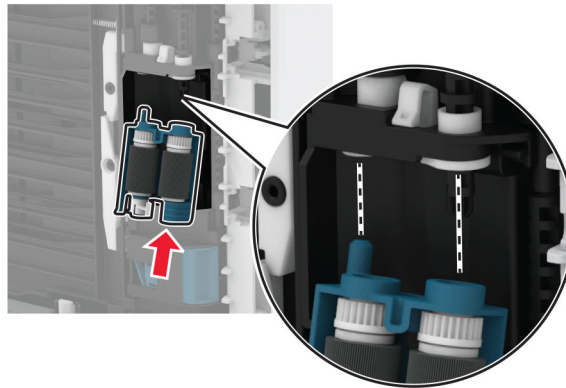

- 11** Place the printer in its original position, and then insert the tray.
- 12** Open the front door.
- 13** Insert the imaging unit.
- 14** Close the front door.
- 15** Connect the power cord to the printer, and then to the electrical outlet.
- ⚠ CAUTION—POTENTIAL INJURY:** To avoid the risk of fire or electrical shock, connect the power cord to an appropriately rated and properly grounded electrical outlet that is near the product and easily accessible.
- 16** Turn on the printer.

## Replacing the tray separator roller

- 1 Remove the tray, and then remove the used separator roller.

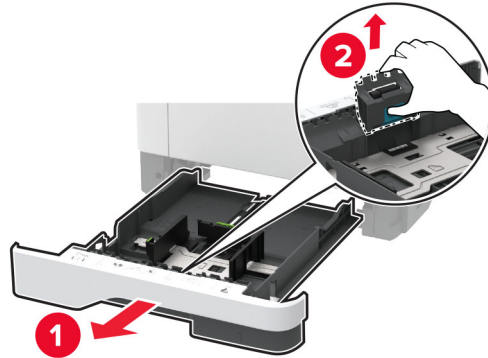

- 2 Unpack the new separator roller.

**Note:** To avoid contamination, make sure that your hands are clean.

- 3 Insert the new separator roller.

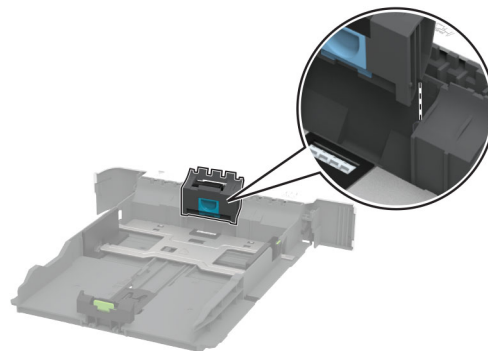

- 4 Insert the tray.

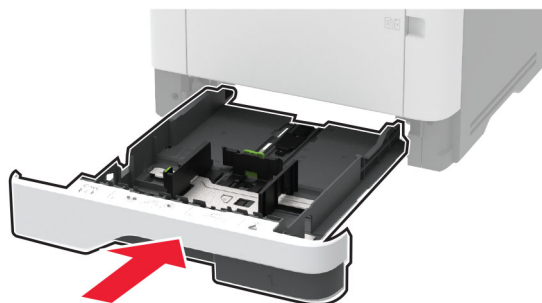

## Replacing the ADF separator pad

1 Open the ADF cover.

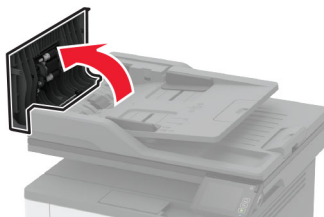

2 Remove the used ADF separator pad.

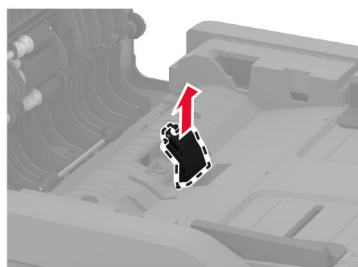
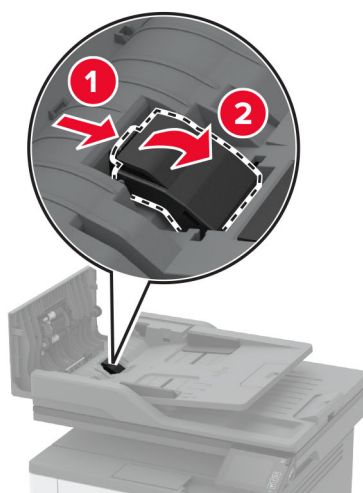

3 Unpack the new ADF separator pad.

**4** Insert the new separator pad until it *clicks* into place.

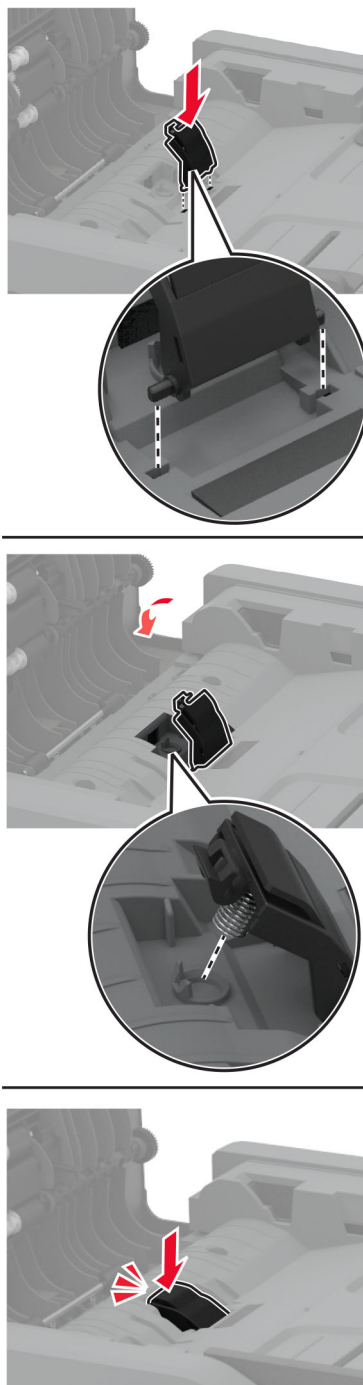

**5** Close the ADF cover.



## Resetting the supply usage counters

- 1 From the home screen, touch **Settings > Device > Maintenance > Config Menu > Supply Usage And Counters**.
- 2 Select the counter that you want to reset.

**Warning—Potential Damage:** Supplies and parts without Return Program agreement terms may be reset and remanufactured. However, the manufacturer's warranty does not cover any damage caused by non-genuine supplies or parts. Resetting counters on the supply or part without proper remanufacturing can cause damage to your printer. After resetting the supply or part counter, your printer may display an error indicating the presence of the reset item.

## Cleaning printer parts

### Cleaning the printer

 **CAUTION—SHOCK HAZARD:** To avoid the risk of electrical shock when cleaning the exterior of the printer, unplug the power cord from the electrical outlet and disconnect all cables from the printer before proceeding.

#### Notes:

- Perform this task after every few months.
- Damage to the printer caused by improper handling is not covered by the printer warranty.

- 1 Turn off the printer, and then unplug the power cord from the electrical outlet.
- 2 Remove paper from the standard bin and multipurpose feeder.
- 3 Remove any dust, lint, and pieces of paper around the printer using a soft brush or vacuum.
- 4 Wipe the outside of the printer with a damp, soft, lint-free cloth.

#### Notes:

- Do not use household cleaners or detergents, as they may damage the finish of the printer.
- Make sure that all areas of the printer are dry after cleaning.

- 5 Connect the power cord to the electrical outlet, and then turn on the printer.

 **CAUTION—POTENTIAL INJURY:** To avoid the risk of fire or electrical shock, connect the power cord to an appropriately rated and properly grounded electrical outlet that is near the product and easily accessible.

## Cleaning the scanner

- 1 Open the scanner cover.

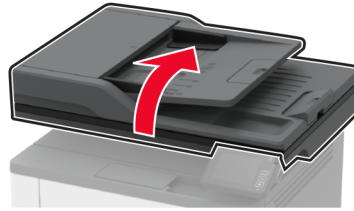

- 2 Using a damp, soft, lint-free cloth, wipe the following areas:

- ADF glass pad

**Note:** In some printer models, this location has an ADF glass instead of a pad.

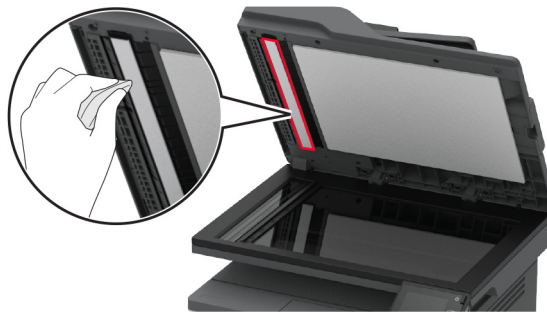

- Scanner glass pad



- ADF glass



- Scanner glass



**3** Close the scanner cover.

## Saving energy and paper

### Configuring the power save mode settings

#### Sleep mode

- 1** From the home screen, touch **Settings > Device > Power Management > Timeouts > Sleep Mode**.
- 2** Specify the amount of time that the printer stays idle before it enters Sleep Mode.

#### Hibernate mode

- 1** From the home screen, touch **Settings > Device > Power Management > Timeouts > Hibernate Timeout**.
- 2** Select the amount of time that the printer stays idle before it enters Hibernate mode.

#### Notes:

- For Hibernate Timeout to work, set Hibernate Timeout on Connection to Hibernate.
- The Embedded Web Server is disabled when the printer is in Hibernate mode.

## Adjusting the brightness of the printer display

- 1 From the home screen, touch **Settings > Device > Preferences > Screen Brightness**.
- 2 Adjust the setting.

## Conserving supplies

- Print on both sides of the paper.

**Note:** Two-sided printing is the default setting in the print driver.

- Print multiple pages on a single sheet of paper.
- Use the preview feature to see how the document looks like before printing it.
- Print one copy of the document to check its content and format for accuracy.

## Moving the printer to another location

 **CAUTION—POTENTIAL INJURY:** If the printer weight is greater than 20 kg (44 lb), then it may require two or more people to lift it safely.

 **CAUTION—POTENTIAL INJURY:** To avoid the risk of fire or electrical shock, use only the power cord provided with this product or the manufacturer's authorized replacement.

 **CAUTION—POTENTIAL INJURY:** When moving the printer, follow these guidelines to avoid personal injury or printer damage:

- Make sure that all doors and trays are closed.
- Turn off the printer, and then unplug the power cord from the electrical outlet.
- Disconnect all cords and cables from the printer.
- If the printer has separate floor-standing optional trays or output options attached to it, then disconnect them before moving the printer.
- If the printer has a caster base, then carefully roll it to the new location. Use caution when passing over thresholds and breaks in flooring.
- If the printer does not have a caster base but is configured with optional trays or output options, then remove the output options and lift the printer off the trays. Do not try to lift the printer and any options at the same time.
- Always use the handholds on the printer to lift it.
- Any cart used to move the printer must have a surface able to support the full footprint of the printer.
- Any cart used to move the hardware options must have a surface able to support the dimensions of the options.
- Keep the printer in an upright position.
- Avoid severe jarring movements.
- Make sure that your fingers are not under the printer when you set it down.
- Make sure that there is adequate clearance around the printer.

**Note:** Damage to the printer caused by improper moving is not covered by the printer warranty.

## Shipping the printer

For shipping instructions, go to <http://support.lexmark.com> or contact customer support.

# Troubleshoot a problem

## The printer is not responding

Action	Yes	No
<p><b>Step 1</b> Check if the power cord is connected to the electrical outlet.</p> <p> <b>CAUTION—POTENTIAL INJURY:</b> To avoid the risk of fire or electrical shock, connect the power cord to an appropriately rated and properly grounded electrical outlet that is near the product and easily accessible.</p> <p>Is the printer responding?</p>	The problem is solved.	Go to step 2.
<p><b>Step 2</b> Check if the electrical outlet is turned off by a switch or breaker.</p> <p>Is the electrical outlet turned off by a switch or breaker?</p>	Turn on the switch or reset the breaker.	Go to step 3.
<p><b>Step 3</b> Check if the printer is on.</p> <p>Is the printer on?</p>	Go to step 4.	Turn on the printer.
<p><b>Step 4</b> Check if the printer is in Sleep or Hibernate mode.</p> <p>Is the printer in Sleep or Hibernate mode?</p>	Press the power button to wake the printer.	Go to step 5.
<p><b>Step 5</b> Check if the cables connecting the printer and the computer are inserted to the correct ports.</p> <p>Are the cables inserted to the correct ports?</p>	Go to step 6.	Insert the cables to the correct ports.
<p><b>Step 6</b> Turn off the printer, install the hardware options, and then turn on the printer. For more information, see the documentation that came with the option.</p> <p>Is the printer responding?</p>	The problem is solved.	Go to step 7.
<p><b>Step 7</b> Install the correct print driver.</p> <p>Is the printer responding?</p>	The problem is solved.	Go to step 8.

Action	Yes	No
<p><b>Step 8</b> Turn off the printer, wait for about 10 seconds, and then turn on the printer.</p> <p>Is the printer responding?</p>	The problem is solved.	Contact <a href="#">customer support</a> .

## Unable to read flash drive

Action	Yes	No
<p><b>Step 1</b> Check if the printer is not busy processing another print, copy, scan, or fax job.</p> <p>Is the printer ready?</p>	Go to step 2.	Wait for the printer to finish processing the other job.
<p><b>Step 2</b> Check if the flash drive is supported. For more information, see <a href="#">“Supported flash drives and file types” on page 42</a>.</p> <p>Is the flash drive supported?</p>	Go to step 3.	Insert a supported flash drive.
<p><b>Step 3</b> Remove, and then insert the flash drive.</p> <p>Does the printer recognize the flash drive?</p>	The problem is solved.	Contact <a href="#">customer support</a> .

## Enabling the USB port

From the home screen, touch **Settings > Network/Ports > USB > Enable USB Port**.

# Network connection problems

## Cannot open Embedded Web Server

Action	Yes	No
<p><b>Step 1</b> Check if the printer is on.</p> <p>Is the printer on?</p>	Go to step 2.	Turn on the printer.
<p><b>Step 2</b> Make sure that the printer IP address is correct.</p> <p><b>Notes:</b></p> <ul style="list-style-type: none"> <li>• View the IP address on the home screen.</li> <li>• An IP address appears as four sets of numbers separated by periods, such as 123.123.123.123.</li> </ul> <p>Is the printer IP address correct?</p>	Go to step 3.	Type the correct printer IP address in the address field.
<p><b>Step 3</b> Check if you are using a supported browser:</p> <ul style="list-style-type: none"> <li>• Internet Explorer version 11 or later</li> <li>• Microsoft Edge</li> <li>• Safari version 6 or later</li> <li>• Google Chrome™ version 32 or later</li> <li>• Mozilla Firefox version 24 or later</li> </ul> <p>Is your browser supported?</p>	Go to step 4.	Install a supported browser.
<p><b>Step 4</b> Check if the network connection is working.</p> <p>Is the network connection working?</p>	Go to step 5.	Contact your administrator.
<p><b>Step 5</b> Make sure that the cable connections to the printer and print server are secure. For more information, see the documentation that came with the printer.</p> <p>Are the cable connections secure?</p>	Go to step 6.	Secure the cable connections.
<p><b>Step 6</b> Check if the web proxy servers are disabled.</p> <p>Are the web proxy servers disabled?</p>	Go to step 7.	Contact your administrator.



Action	Yes	No
<p><b>Step 7</b></p> <p>Access the Embedded Web Server.</p> <p>Did the Embedded Web Server open?</p>	<p>The problem is solved.</p>	<p>Contact <a href="#">customer support</a>.</p>

## Issues with supplies

### Replace cartridge, printer region mismatch

To correct this problem, purchase a cartridge with the correct region that matches the printer region, or purchase a worldwide cartridge.

- The first number in the message after 42 indicates the region of the printer.
- The second number in the message after 42 indicates the region of the cartridge.

#### Printer and toner cartridge regions

Region	Numeric code
Worldwide or Undefined region	0
North America (United States, Canada)	1
European Economic Area, Western Europe, Nordic countries, Switzerland	2
Asia Pacific	3
Latin America	4
Rest of Europe, Middle East, Africa	5
Australia, New Zealand	6
Invalid region	9

**Note:** To find the region settings of the printer and toner cartridge, print the print quality test pages. From the control panel, navigate to: **Settings > Troubleshooting > Print Quality Test Pages**.

### Non-Lexmark supply

The printer has detected a non-Lexmark supply or part installed in the printer.

Your Lexmark printer is designed to function best with genuine Lexmark supplies and parts. Use of third-party supplies or parts may affect the performance, reliability, or life of the printer and its imaging components.

All life indicators are designed to function with Lexmark supplies and parts and may deliver unpredictable results if third-party supplies or parts are used. Imaging component usage beyond the intended life may damage your Lexmark printer or associated components.



**Warning—Potential Damage:** Use of third-party supplies or parts can affect warranty coverage. Damage caused by the use of third-party supplies or parts may not be covered by the warranty.

To accept any and all of these risks and to proceed with the use of non-genuine supplies or parts in your printer, do either of the following:

For touch-screen printer models, press  twice, and then press  twice.

For non-touch-screen printer models, press and hold **X** and **OK** simultaneously for 15 seconds.

If you do not want to accept these risks, then remove the third-party supply or part from your printer and install a genuine Lexmark supply or part. For more information, see [“Using genuine Lexmark parts and supplies” on page 114](#).

For touch-screen printer models, if the printer does not print after pressing  twice, and then pressing , then reset the supply usage counter.

For non-touch-screen printer models, if the printer does not print after pressing and holding **X** and **OK** simultaneously for 15 seconds, then reset the supply usage counter.



**1** From the control panel, navigate to:

**Settings > Device > Maintenance > Config Menu > Supply Usage And Counters**

For non-touch-screen printer models, press **OK** to navigate through the settings.

**2** Select the part or supply that you want to reset.

**3** To clear the message, do either of the following:

- For touch-screen printer models, press  twice, and then press  twice.
- For non-touch-screen printer models, press and hold **X** and **OK** simultaneously for 15 seconds.

**Note:** If you are unable to reset the supply usage counters, then return the item to the place of purchase.

## Clearing jams

### Avoiding jams

#### Load paper properly

- Make sure that the paper lies flat in the tray.

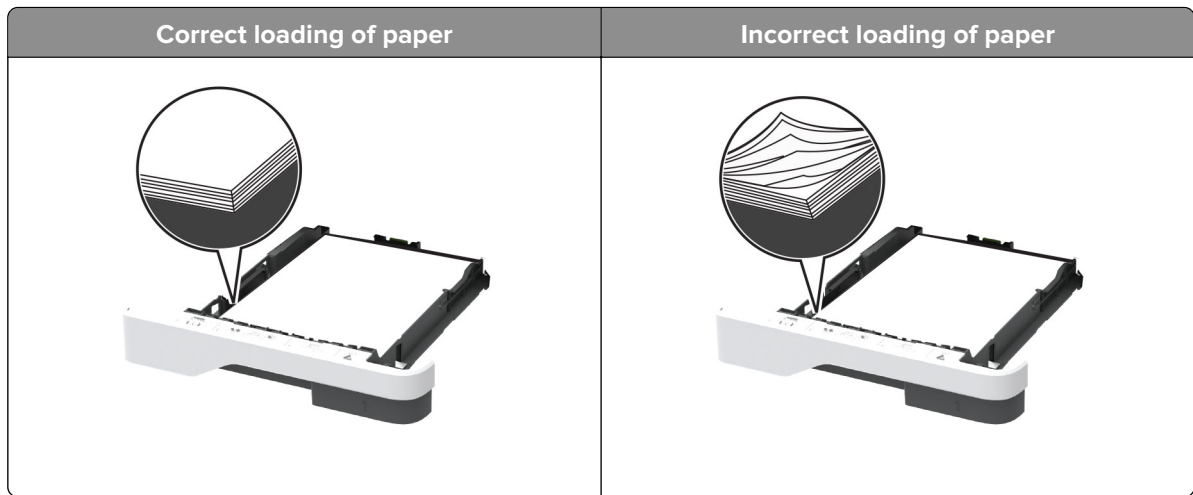

- Do not load or remove a tray while the printer is printing.
- Do not load too much paper. Make sure that the stack height is below the maximum paper fill indicator.
- Do not slide paper into the tray. Load paper as shown in the illustration.

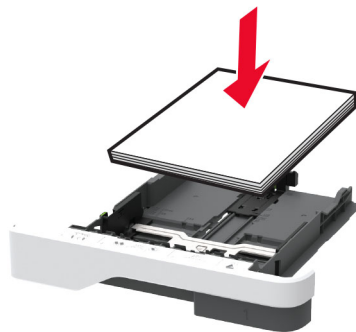

- Make sure that the paper guides are positioned correctly and are not pressing tightly against the paper or envelopes.
- Push the tray firmly into the printer after loading paper.

**Use recommended paper**

- Use only recommended paper or specialty media.
- Do not load paper that is wrinkled, creased, damp, bent, or curled.
- Flex, fan, and align the paper edges before loading.

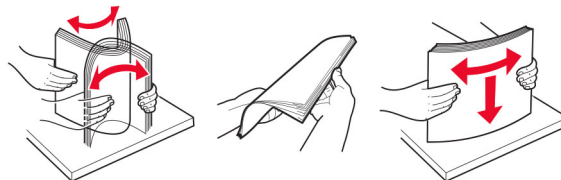

- Do not use paper that has been cut or trimmed by hand.
- Do not mix paper sizes, weights, or types in the same tray.
- Make sure that the paper size and type are set correctly on the computer or printer control panel.
- Store paper according to manufacturer recommendations.

## Identifying jam locations

**Notes:**

- When Jam Assist is set to On, the printer flushes blank pages or pages with partial prints after a jammed page has been cleared. Check your printed output for blank pages.
- When Jam Recovery is set to On or Auto, the printer reprints jammed pages.



	Jam locations
1	Automatic document feeder
2	Standard bin
3	Multipurpose feeder
4	Trays
5	Duplex unit
6	Rear door

## Paper jam in the automatic document feeder

- 1 Remove all original documents from the ADF tray.
- 2 Open the ADF cover.

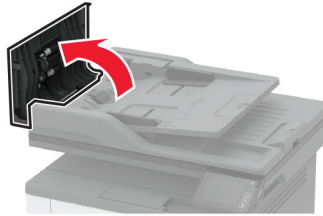

- 3 Remove the jammed paper.

**Note:** Make sure that all paper fragments are removed.

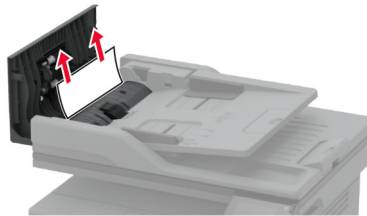

- 4 Close the ADF cover.

## Paper jam in the standard bin

- 1 Raise the scanner, and then remove the jammed paper.
- Note:** Make sure that all paper fragments are removed.

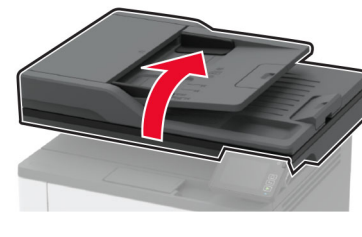

- 2 Lower the scanner.

## Paper jam in the multipurpose feeder

- 1 Remove paper from the multipurpose feeder.



- 2 Remove the jammed paper.

**Note:** Make sure that all paper fragments are removed.

- 3 Close the multipurpose feeder.

- 4 Open the front door.

**Warning—Potential Damage:** To prevent damage from electrostatic discharge, touch any exposed metal frame of the printer before accessing or touching interior areas of the printer.

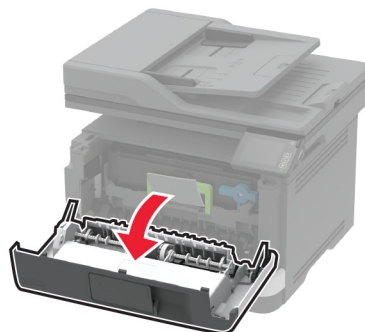
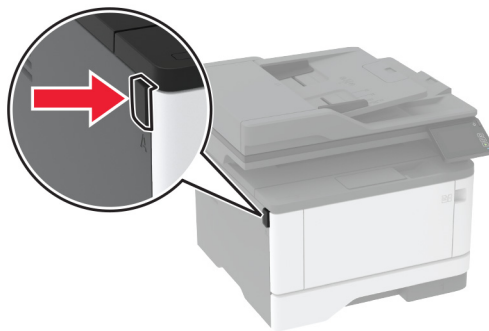

**5** Remove the imaging unit.

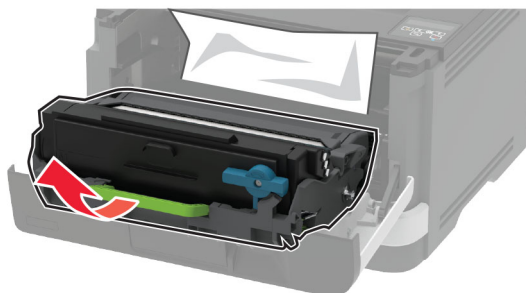

**Warning—Potential Damage:** Do not expose the imaging unit to direct light for more than 10 minutes. Extended exposure to light may cause print quality problems.

**Warning—Potential Damage:** Do not touch the photoconductor drum. Doing so may affect the quality of future print jobs.



**6** Remove the jammed paper.

 **CAUTION—HOT SURFACE:** The inside of the printer might be hot. To reduce the risk of injury from a hot component, allow the surface to cool before touching it.

**Note:** Make sure that all paper fragments are removed.



**7** Insert the imaging unit.

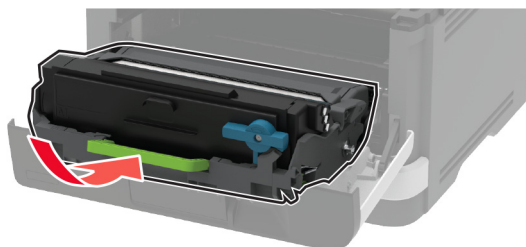

**8** Close the door.

**9** Open the multipurpose feeder.

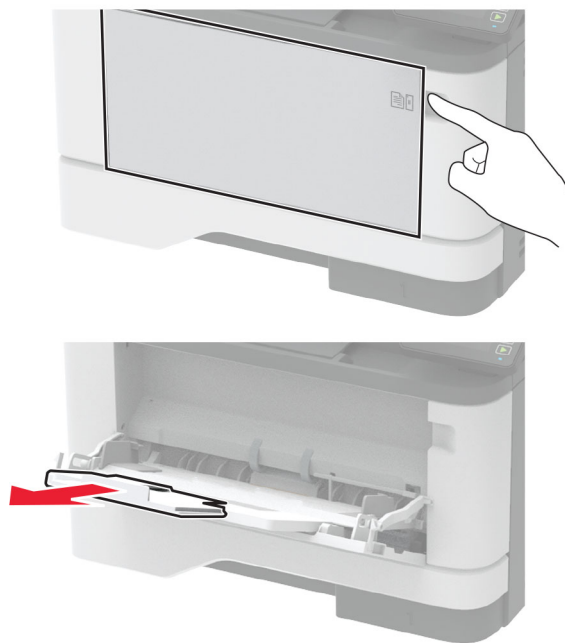

**10** Flex, fan, and align the paper edges before loading.

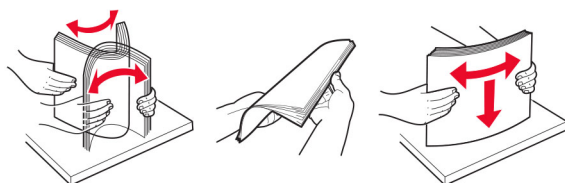

**11** Reload paper.





## Paper jam in trays

- 1 Remove the tray.



- 2 Open the front door.

**Warning—Potential Damage:** To prevent damage from electrostatic discharge, touch any exposed metal frame of the printer before accessing or touching interior areas of the printer.

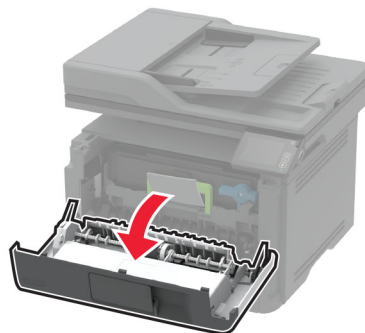
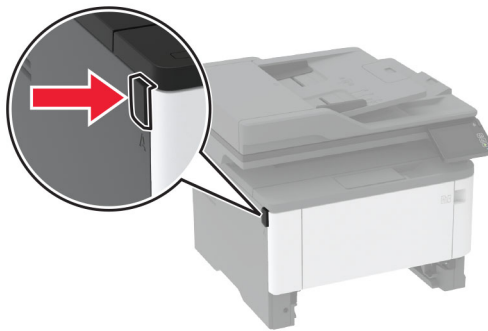

**3** Remove the imaging unit.

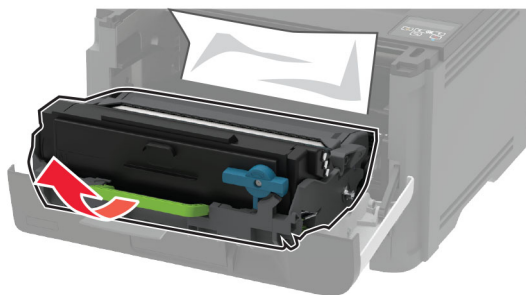

**Warning—Potential Damage:** Do not expose the imaging unit to direct light for more than 10 minutes. Extended exposure to light may cause print quality problems.

**Warning—Potential Damage:** Do not touch the photoconductor drum. Doing so may affect the quality of future print jobs.



**4** Remove the jammed paper.

 **CAUTION—HOT SURFACE:** The inside of the printer might be hot. To reduce the risk of injury from a hot component, allow the surface to cool before touching it.

**Note:** Make sure that all paper fragments are removed.



**5** Insert the imaging unit.

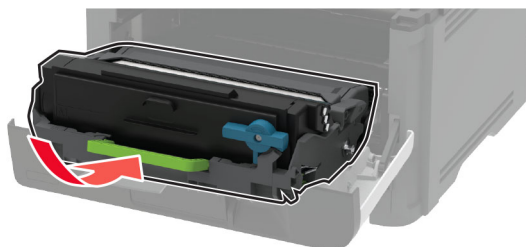

**6** Close the front door, and then insert the tray.

**7** Open the rear door.

 **CAUTION—HOT SURFACE:** The inside of the printer might be hot. To reduce the risk of injury from a hot component, allow the surface to cool before touching it.

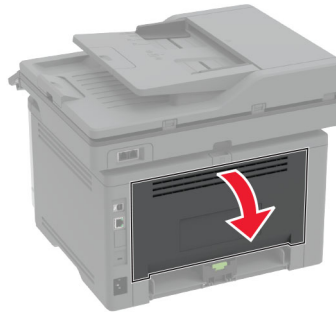

**8** Remove the jammed paper.

**Note:** Make sure that all paper fragments are removed.

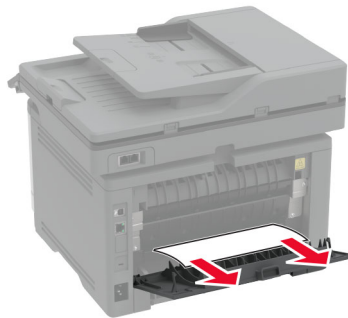

**9** Close the rear door.

**10** Remove the optional tray.



**11** Remove the jammed paper.

**Note:** Make sure that all paper fragments are removed.

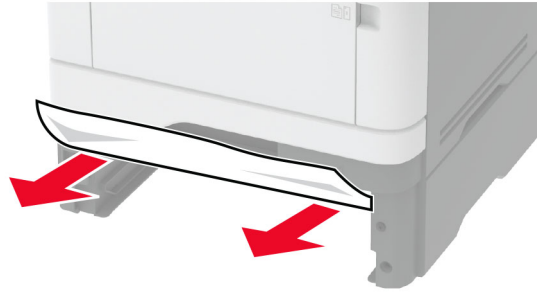

12 Insert the tray.

## Paper jam in the duplex unit

1 Open the front door.

**Warning—Potential Damage:** To prevent damage from electrostatic discharge, touch any exposed metal frame of the printer before accessing or touching interior areas of the printer.

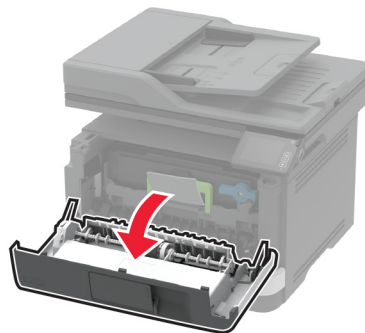
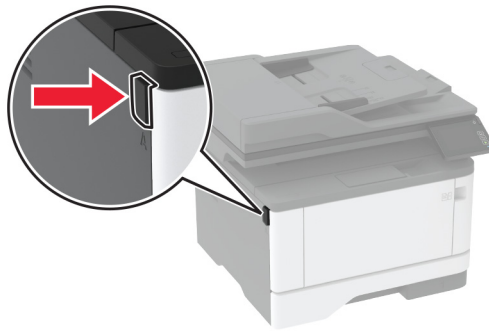

**2** Remove the imaging unit.



**Warning—Potential Damage:** Do not expose the imaging unit to direct light for more than 10 minutes. Extended exposure to light may cause print quality problems.

**Warning—Potential Damage:** Do not touch the photoconductor drum. Doing so may affect the quality of future print jobs.



**3** Remove the jammed paper.

 **CAUTION—HOT SURFACE:** The inside of the printer might be hot. To reduce the risk of injury from a hot component, allow the surface to cool before touching it.

**Note:** Make sure that all paper fragments are removed.



**4** Insert the imaging unit.

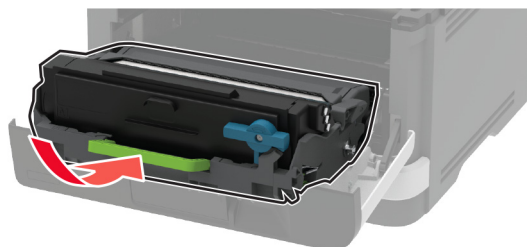

- 5 Close the door.
- 6 Remove the tray.

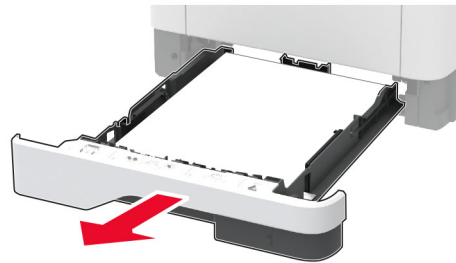

- 7 Push the duplex unit latch to open the duplex unit.

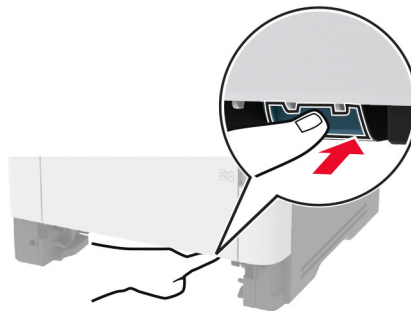

- 8 Remove the jammed paper.

**Note:** Make sure that all paper fragments are removed.

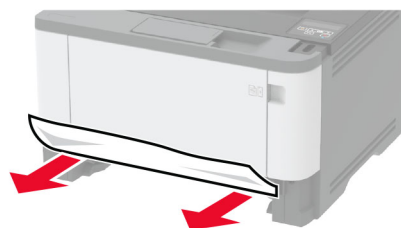

- 9 Close the duplex unit.
- 10 Insert the tray.

## Paper jam in the rear door

- 1 Open the front door.

**Warning—Potential Damage:** To prevent damage from electrostatic discharge, touch any exposed metal frame of the printer before accessing or touching interior areas of the printer.

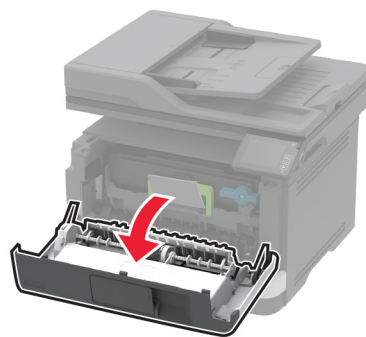
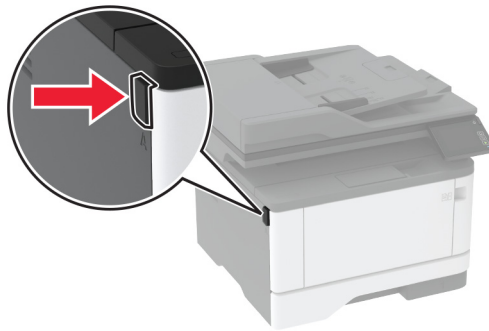

**2** Remove the imaging unit.

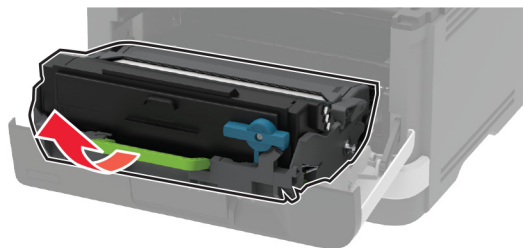

**Warning—Potential Damage:** Do not expose the imaging unit to direct light for more than 10 minutes. Extended exposure to light may cause print quality problems.

**Warning—Potential Damage:** Do not touch the photoconductor drum. Doing so may affect the quality of future print jobs.



**3** Open the rear door.

 **CAUTION—HOT SURFACE:** The inside of the printer might be hot. To reduce the risk of injury from a hot component, allow the surface to cool before touching it.



**4** Remove the jammed paper.

**Note:** Make sure that all paper fragments are removed.

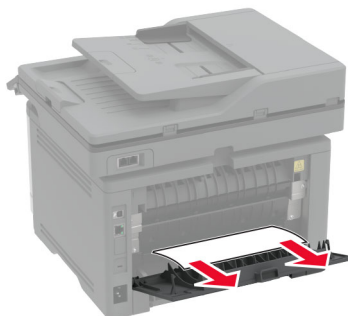

**5** Close the rear door.

**6** Insert the imaging unit.

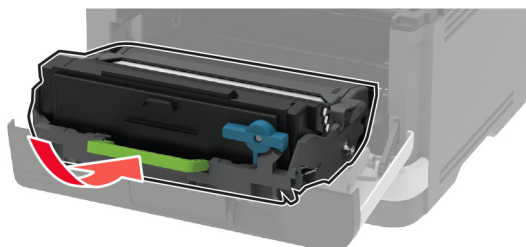

**7** Close the front door.



## Paper feed problems

### Envelope seals when printing

Action	Yes	No
<p><b>Step 1</b></p> <p><b>a</b> Use an envelope that has been stored in a dry environment.  <b>Note:</b> Printing on envelopes with high moisture content can seal the flaps.</p> <p><b>b</b> Send the print job.</p> <p>Does the envelope seal when printing?</p>	Go to step 2.	The problem is solved.
<p><b>Step 2</b></p> <p><b>a</b> Make sure that paper type is set to Envelope.            From the control panel, navigate to:  <b>Settings &gt; Paper &gt; Tray Configuration &gt; Paper Size/Type</b></p> <p><b>b</b> Send the print job.</p> <p>Does the envelope seal when printing?</p>	Contact <a href="#">customer support</a> .	The problem is solved.

### Collated printing does not work

Action	Yes	No
<p><b>Step 1</b></p> <p><b>a</b> From the control panel, navigate to:  <b>Settings &gt; Print &gt; Layout &gt; Collate</b></p> <p><b>b</b> Touch <b>On [1,2,1,2,1,2]</b>.</p> <p><b>c</b> Print the document.</p> <p>Is the document collated correctly?</p>	The problem is solved.	Go to step 2.
<p><b>Step 2</b></p> <p><b>a</b> From the document that you are trying to print, open the Print dialog, and then select <b>Collate</b>.</p> <p><b>b</b> Print the document.</p> <p>Is the document collated correctly?</p>	The problem is solved.	Go to step 3.
<p><b>Step 3</b></p> <p><b>a</b> Reduce the number of pages to print.</p> <p><b>b</b> Print the document.</p> <p>Are the pages collated correctly?</p>	The problem is solved.	Contact <a href="#">customer support</a> .

### Tray linking does not work

Action	Yes	No
<p><b>Step 1</b></p> <p><b>a</b> Check if the trays contain the same paper size and paper type.</p> <p><b>b</b> Check if the paper guides are positioned correctly.</p> <p><b>c</b> Print the document.</p> <p>Do the trays link correctly?</p>	The problem is solved.	Go to step 2.
<p><b>Step 2</b></p> <p><b>a</b> From the home screen, touch <b>Settings &gt; Paper &gt; Tray Configuration &gt; Paper Size/Type</b>.</p> <p><b>b</b> Set the paper size and paper type to match the paper loaded in the linked trays.</p> <p><b>c</b> Print the document.</p> <p>Do the trays link correctly?</p>	The problem is solved.	Go to step 3.
<p><b>Step 3</b></p> <p><b>a</b> Make sure that Tray Linking is set to Automatic. For more information, see <a href="#">“Linking trays” on page 31</a>.</p> <p><b>b</b> Print the document.</p> <p>Do the trays link correctly?</p>	The problem is solved.	Contact <a href="#">customer support</a> .

### Paper frequently jams

Action	Yes	No
<p><b>Step 1</b></p> <p><b>a</b> Remove the tray.</p> <p><b>b</b> Check if paper is loaded correctly.</p> <p><b>Notes:</b></p> <ul style="list-style-type: none"> <li>• Make sure that the paper guides are positioned correctly.</li> <li>• Make sure that the stack height is below the maximum paper fill indicator.</li> <li>• Make sure to print on recommended paper size and type.</li> </ul> <p><b>c</b> Insert the tray.</p> <p><b>d</b> Print the document.</p> <p>Do paper jams occur frequently?</p>	Go to step 2.	The problem is solved.

Action	Yes	No
<p><b>Step 2</b></p> <p><b>a</b> From the control panel, navigate to:  <b>Settings &gt; Paper &gt; Tray Configuration &gt; Paper Size/Type</b></p> <p><b>b</b> Set the correct paper size and type.</p> <p><b>c</b> Print the document.</p> <p>Do paper jams occur frequently?</p>	Go to step 3.	The problem is solved.
<p><b>Step 3</b></p> <p><b>a</b> Load paper from a fresh package.</p> <p><b>Note:</b> Paper absorbs moisture due to high humidity. Store paper in its original wrapper until you are ready to use it.</p> <p><b>b</b> Print the document.</p> <p>Do paper jams occur frequently?</p>	Contact <a href="#">customer support</a> .	The problem is solved.

### Jammed pages are not reprinted

Action	Yes	No
<p><b>a</b> From the control panel, navigate to:  <b>Settings &gt; Device &gt; Notifications &gt; Jam Content Recovery</b></p> <p><b>b</b> In the Jam Recovery menu, select <b>On</b> or <b>Auto</b>.</p> <p><b>c</b> Print the document.</p> <p>Are the jammed pages reprinted?</p>	The problem is solved.	Contact <a href="#">customer support</a> .

## Printing problems

### Print jobs do not print

Action	Yes	No
<p><b>Step 1</b></p> <p><b>a</b> From the document you are trying to print, open the Print dialog, and then check if you have selected the correct printer.</p> <p><b>b</b> Print the document.</p> <p>Is the document printed?</p>	The problem is solved.	Go to step 2.

Action	Yes	No
<p><b>Step 2</b></p> <p><b>a</b> Check if the printer is on.</p> <p><b>b</b> Resolve any error messages that appear on the display.</p> <p><b>c</b> Print the document.</p> <p>Is the document printed?</p>	The problem is solved.	Go to step 3.
<p><b>Step 3</b></p> <p><b>a</b> Check if the ports are working and if the cables are securely connected to the computer and the printer.</p> <p>For more information, see the setup documentation that came with the printer.</p> <p><b>b</b> Print the document.</p> <p>Is the document printed?</p>	The problem is solved.	Go to step 4.
<p><b>Step 4</b></p> <p><b>a</b> Turn off the printer, wait for about 10 seconds, and then turn on the printer.</p> <p><b>b</b> Print the document.</p> <p>Is the document printed?</p>	The problem is solved.	Go to step 5.
<p><b>Step 5</b></p> <p><b>a</b> Remove, and then reinstall the print driver.</p> <p><b>b</b> Print the document.</p> <p>Is the document printed?</p>	The problem is solved.	Contact <a href="#">customer support</a> .

### Confidential and other held documents do not print

Action	Yes	No
<p><b>Step 1</b></p> <p><b>a</b> From the control panel, check if the documents appear in the Held Jobs list.</p> <p><b>Note:</b> If the documents are not listed, then print the documents using the Print and Hold options.</p> <p><b>b</b> Print the documents.</p> <p>Are the documents printed?</p>	The problem is solved.	Go to step 2.

Action	Yes	No
<p><b>Step 2</b></p> <p>The print job may contain a formatting error or invalid data.</p> <ul style="list-style-type: none"> <li>• Delete the print job, and then send it again.</li> <li>• For PDF files, generate a new file, and then print the documents.</li> </ul> <p>Are the documents printed?</p>	The problem is solved.	Go to step 3.
<p><b>Step 3</b></p> <p>If you are printing from the Internet, then the printer may be reading the multiple job titles as duplicates.</p> <p><b>For Windows users</b></p> <ol style="list-style-type: none"> <li>Open the Printing Preferences dialog.</li> <li>From the Print and Hold tab, click <b>Use Print and Hold</b>, and then click <b>Keep duplicate documents</b>.</li> <li>From the Confidential Print section, enter a PIN.</li> <li>Print the documents.</li> </ol> <p><b>For Macintosh users</b></p> <ol style="list-style-type: none"> <li>Save and name each job differently.</li> <li>Send the job individually.</li> </ol> <p>Are the documents printed?</p>	The problem is solved.	Go to step 4.
<p><b>Step 4</b></p> <ol style="list-style-type: none"> <li>Delete some held jobs to free up printer memory.</li> <li>Print the documents.</li> </ol> <p>Are the documents printed?</p>	The problem is solved.	Contact <a href="#">customer support</a> .

### Job prints from the wrong tray or on the wrong paper

Action	Yes	No
<p><b>Step 1</b></p> <ol style="list-style-type: none"> <li>Check if you are printing on the correct paper.</li> <li>Print the document.</li> </ol> <p>Is the document printed on the correct paper?</p>	Go to step 2.	Load the correct paper size and paper type.

Action	Yes	No
<p><b>Step 2</b></p> <p><b>a</b> Depending on your operating system, specify the paper size and paper type from the Printing Preferences or Print dialog.</p> <p><b>Note:</b> You can also change the settings on the printer control panel. Navigate to:</p> <p><b>Settings &gt; Paper &gt; Tray Configuration &gt; Paper Size/Type</b></p> <p><b>b</b> Make sure that the settings match the paper loaded.</p> <p><b>c</b> Print the document.</p> <p>Is the document printed on the correct paper?</p>	<p>The problem is solved.</p>	<p>Go to step 3.</p>
<p><b>Step 3</b></p> <p><b>a</b> Check if the trays are linked.</p> <p>For more information, see <a href="#">“Linking trays” on page 31</a>.</p> <p><b>b</b> Print the document.</p> <p>Is the document printed from the correct tray?</p>	<p>The problem is solved.</p>	<p>Contact <a href="#">customer support</a>.</p>

## Slow printing

Action	Yes	No
<p><b>Step 1</b></p> <p>Make sure that the printer cable is securely connected to the printer and to the computer, print server, option, or other network device.</p> <p>Is the printer printing slow?</p>	<p>Go to step 2.</p>	<p>The problem is solved.</p>
<p><b>Step 2</b></p> <p><b>a</b> Make sure that the printer is not in Quiet Mode.</p> <p>From the home screen, touch <b>Settings &gt; Device &gt; Maintenance &gt; Config Menu &gt; Device Operations &gt; Quiet Mode</b>.</p> <p><b>b</b> Print the document.</p> <p>Is the printer printing slow?</p>	<p>Go to step 3.</p>	<p>The problem is solved.</p>
<p><b>Step 3</b></p> <p><b>a</b> Depending on your operating system, specify the print resolution from the Printing Preferences or Print dialog.</p> <p><b>b</b> Set the resolution to <b>600 dpi</b>.</p> <p><b>c</b> Print the document.</p> <p>Is the printer printing slow?</p>	<p>Go to step 4.</p>	<p>The problem is solved.</p>

Action	Yes	No
<p><b>Step 4</b></p> <p><b>a</b> From the home screen, touch <b>Settings &gt; Print &gt; Quality &gt; Print Resolution</b>.</p> <p><b>b</b> Set the resolution to <b>600 dpi</b>.</p> <p><b>c</b> Print the document.</p> <p>Is the printer printing slow?</p>	<p>Go to step 5.</p>	<p>The problem is solved.</p>
<p><b>Step 5</b></p> <p><b>a</b> Depending on your operating system, specify the paper type from the Printing Preferences or Print dialog.</p> <p><b>Notes:</b></p> <ul style="list-style-type: none"> <li>• Make sure that the setting matches the paper loaded.</li> <li>• You can also change the setting on the printer control panel.</li> <li>• Heavier paper prints more slowly.</li> <li>• Paper narrower than letter, A4, and legal may print more slowly.</li> </ul> <p><b>b</b> Print the document.</p> <p>Is the printer printing slow?</p>	<p>Go to step 6.</p>	<p>The problem is solved.</p>
<p><b>Step 6</b></p> <p><b>a</b> Make sure that the printer settings for texture and weight match the paper being loaded.</p> <p>From the home screen, touch <b>Settings &gt; Paper &gt; Media Configuration &gt; Media Types</b>.</p> <p><b>Note:</b> Rough paper textures and heavy paper weights may print more slowly.</p> <p><b>b</b> Print the document.</p> <p>Is the printer printing slow?</p>	<p>Go to step 7.</p>	<p>The problem is solved.</p>
<p><b>Step 7</b></p> <p>Remove held jobs.</p> <p>Is the printer printing slow?</p>	<p>Go to step 8.</p>	<p>The problem is solved.</p>

Action	Yes	No
<p><b>Step 8</b></p> <p><b>a</b> Make sure that the printer is not overheating.</p> <p><b>Notes:</b></p> <ul style="list-style-type: none"> <li>• Allow the printer to cool down after a long print job.</li> <li>• Observe the recommended ambient temperature for the printer. For more information, see <a href="#">“Selecting a location for the printer” on page 19.</a></li> </ul> <p><b>b</b> Print the document.</p> <p>Is the printer printing slow?</p>	<p>Contact <a href="#">customer support</a>.</p>	<p>The problem is solved.</p>

## Print quality problems

### Print quality is poor

Find the image that resembles the print quality problem you are having, and then click the link below it to read problem-solving steps.

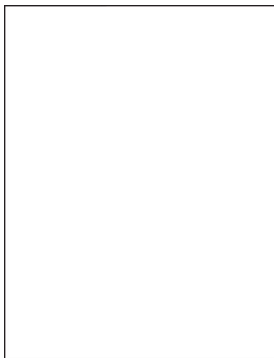

[“Blank or white pages” on page 161](#)

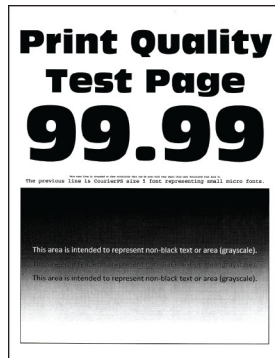

[“Dark print” on page 163](#)

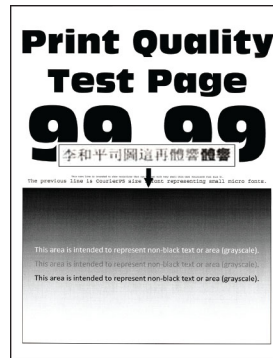

[“Fine lines are not printed correctly” on page 164](#)



[“Folded or wrinkled paper” on page 165](#)

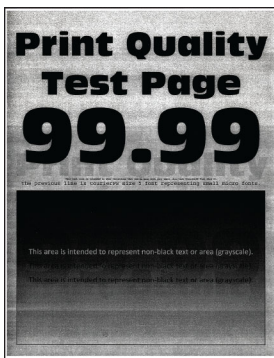

[“Gray background” on page 166](#)



[“Horizontal light bands” on page 176](#)



[“Incorrect margins” on page 168](#)

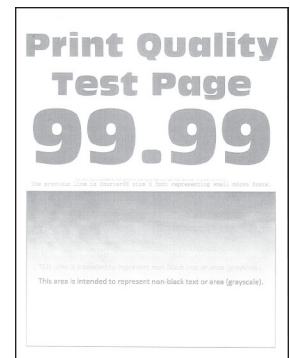

[“Light print” on page 168](#)





["Mottled print and dots" on page 170](#)



["Paper curl" on page 171](#)



["Print crooked or skewed" on page 173](#)



["Repeating defects" on page 182](#)



["Solid black pages" on page 174](#)



["Text or images cut off" on page 175](#)

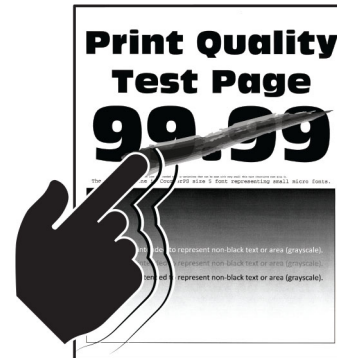

["Toner easily rubs off" on page 176](#)

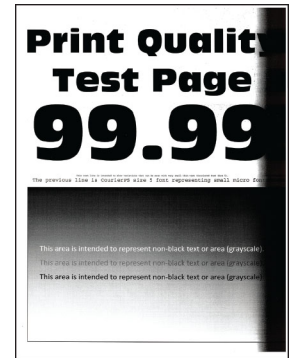

["Vertical dark bands" on page 179](#)



["Vertical dark lines or streaks" on page 180](#)

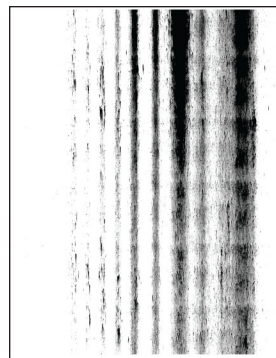

["Vertical dark streaks with print missing" on page 181](#)



["Vertical light bands" on page 177](#)

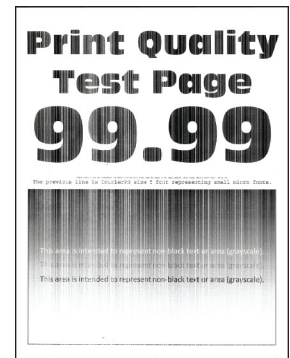

["Vertical white lines" on page 178](#)

**Blank or white pages**

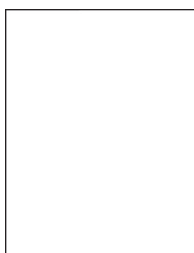

**Note:** Before solving the problem, print the Print Quality Test Pages. From the control panel, navigate to **Settings > Troubleshooting > Print Quality Test Pages**. For non-touch-screen printer models, press **OK** to navigate through the settings.

Action	Yes	No
<p><b>Step 1</b></p> <p><b>a</b> Check if the printer is using a genuine and supported Lexmark toner cartridge.</p> <p><b>Note:</b> If the cartridge is not supported, then install a supported one.</p> <p><b>b</b> Print the document.</p> <p>Is the printer printing blank or white pages?</p>	Go to step 2.	The problem is solved.
<p><b>Step 2</b></p> <p><b>a</b> Remove the imaging unit.</p> <p><b>Warning—Potential Damage:</b> Do not expose the imaging unit to direct light for more than 10 minutes. Extended exposure to light may cause print quality problems.</p> <p><b>Warning—Potential Damage:</b> Do not touch the photoconductor drum under the imaging unit. Doing so may affect the quality of future print jobs.</p> <p><b>b</b> Check the imaging unit for signs of damage.</p> <p><b>Note:</b> Make sure that the photoconductor drum contact is not bent or out of place.</p> <p><b>c</b> Firmly shake the imaging unit to redistribute the toner.</p> <p><b>d</b> Insert the imaging unit.</p> <p><b>e</b> Print the document.</p> <p>Is the printer printing blank or white pages?</p>	Go to step 3.	The problem is solved.
<p><b>Step 3</b></p> <p>Replace the toner cartridge.</p> <p>Is the printer printing blank or white pages?</p>	Go to step 4.	The problem is solved.
<p><b>Step 4</b></p> <p>Replace the imaging unit.</p> <p>Is the printer printing blank or white pages?</p>	Contact <a href="#">customer support</a> .	The problem is solved.

## Dark print

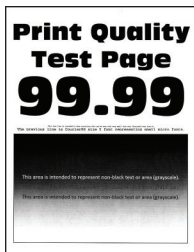

**Note:** Before solving the problem, print the Print Quality Test Pages. From the control panel, navigate to **Settings > Troubleshooting > Print Quality Test Pages**. For non-touch-screen printer models, press **OK** to navigate through the settings.

Action	Yes	No
<p><b>Step 1</b></p> <p><b>a</b> Check if the printer is using a genuine and supported Lexmark toner cartridge.</p> <p><b>Note:</b> If the cartridge is not supported, then install a supported one.</p> <p><b>b</b> Print the document.</p> <p>Is the print dark?</p>	Go to step 2.	The problem is solved.
<p><b>Step 2</b></p> <p><b>a</b> Turn off the printer, wait for about 10 seconds, and then turn on the printer.</p> <p><b>b</b> Reduce toner darkness.</p> <p>From the control panel, navigate to:</p> <p><b>Settings &gt; Print &gt; Quality &gt; Toner Darkness</b></p> <p><b>c</b> Print the document.</p> <p>Is the print dark?</p>	Go to step 3.	The problem is solved.
<p><b>Step 3</b></p> <p><b>a</b> Depending on your operating system, specify the paper type from the Printing Preferences or Print dialog.</p> <p><b>Notes:</b></p> <ul style="list-style-type: none"> <li>• Make sure that the setting matches the paper loaded.</li> <li>• You can also change the setting on the printer control panel. Navigate to <b>Settings &gt; Paper &gt; Tray Configuration &gt; Paper Size/Type</b>.</li> </ul> <p><b>b</b> Print the document.</p> <p>Is the print dark?</p>	Go to step 4.	The problem is solved.

Action	Yes	No
<p><b>Step 4</b></p> <p>Check if the paper has texture or rough finishes.</p> <p>Are you printing on textured or rough paper?</p>	Go to step 5.	Go to step 6.
<p><b>Step 5</b></p> <p><b>a</b> Replace textured paper with plain paper.</p> <p><b>b</b> Print the document.</p> <p>Is the print dark?</p>	Go to step 6.	The problem is solved.
<p><b>Step 6</b></p> <p><b>a</b> Load paper from a fresh package.</p> <p><b>Note:</b> Paper absorbs moisture due to high humidity. Store paper in its original wrapper until you are ready to use it.</p> <p><b>b</b> Print the document.</p> <p>Is the print dark?</p>	Go to step 7.	The problem is solved.
<p><b>Step 7</b></p> <p><b>a</b> Remove, and then insert the imaging unit.</p> <p><b>Warning—Potential Damage:</b> Do not expose the imaging unit to direct light for more than 10 minutes. Extended exposure to light may cause print quality problems.</p> <p><b>Warning—Potential Damage:</b> Do not touch the photoconductor drum under the imaging unit. Doing so may affect the quality of future print jobs.</p> <p><b>b</b> Print the document.</p> <p>Is the print dark?</p>	Go to step 8.	The problem is solved.
<p><b>Step 8</b></p> <p><b>a</b> Replace the imaging unit.</p> <p><b>b</b> Print the document.</p> <p>Is the print dark?</p>	Contact <a href="#">customer support</a> .	The problem is solved.

**Fine lines are not printed correctly**



**Note:** Before solving the problem, print the Print Quality Test Pages. From the control panel, navigate to **Settings > Troubleshooting > Print Quality Test Pages**. For non-touch-screen printer models, press **OK** to navigate through the settings.

Action	Yes	No
<p><b>Step 1</b></p> <p><b>a</b> Check if the printer is using a genuine and supported Lexmark toner cartridge.</p> <p><b>Note:</b> If the cartridge is not supported, then install a supported one.</p> <p><b>b</b> Print the document.</p> <p>Are fine lines not printed correctly?</p>	Go to step 2.	The problem is solved.
<p><b>Step 2</b></p> <p><b>a</b> Increase toner darkness.</p> <p>From the control panel, navigate to: <b>Settings &gt; Print &gt; Quality &gt; Toner Darkness</b></p> <p><b>b</b> Print the document.</p> <p>Are fine lines not printed correctly?</p>	Contact <a href="#">customer support</a> .	The problem is solved.

**Folded or wrinkled paper**



**Note:** Before solving the problem, print the Print Quality Test Pages. From the control panel, navigate to **Settings > Troubleshooting > Print Quality Test Pages**. For non-touch-screen printer models, press **OK** to navigate through the settings.

Action	Yes	No
<p><b>Step 1</b></p> <p><b>a</b> Check if the printer is using a genuine and supported Lexmark toner cartridge.</p> <p><b>Note:</b> If the cartridge is not supported, then install a supported one.</p> <p><b>b</b> Print the document.</p> <p>Is the paper folded or wrinkled?</p>	Go to step 2.	The problem is solved.

Action	Yes	No
<p><b>Step 2</b></p> <p><b>a</b> Load paper from a fresh package.</p> <p><b>Note:</b> Paper absorbs moisture due to high humidity. Store paper in its original wrapper until you are ready to use it.</p> <p><b>b</b> Print the document.</p> <p>Is the paper folded or wrinkled?</p>	Go to step 3.	The problem is solved.
<p><b>Step 3</b></p> <p><b>a</b> Depending on your operating system, specify the paper type from the Printing Preferences or Print dialog.</p> <p><b>Notes:</b></p> <ul style="list-style-type: none"> <li>• Make sure that the setting matches the paper loaded.</li> <li>• You can also change the setting from the printer control panel. Navigate to <b>Settings &gt; Paper &gt; Tray Configuration &gt; Paper Size/Type.</b></li> </ul> <p><b>b</b> Print the document.</p> <p>Is the paper folded or wrinkled?</p>	Contact <a href="#">customer support</a> .	The problem is solved.

**Gray background**

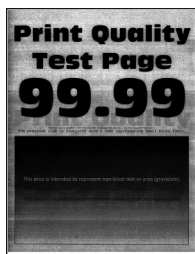

**Note:** Before solving the problem, print the Print Quality Test Pages. From the control panel, navigate to **Settings > Troubleshooting > Print Quality Test Pages**. For non-touch-screen printer models, press **OK** to navigate through the settings.

Action	Yes	No
<p><b>Step 1</b></p> <p><b>a</b> Turn off the printer, wait for 10 seconds, and then turn on the printer.</p> <p><b>b</b> Decrease toner darkness.</p> <p>From the control panel, navigate to:</p> <p><b>Settings &gt; Print &gt; Quality &gt; Toner Darkness</b></p> <p><b>c</b> Print the document.</p> <p>Does gray background appear on prints?</p>	Go to step 2.	The problem is solved.

Action	Yes	No
<p><b>Step 2</b></p> <p><b>a</b> Check if the printer is using a genuine and supported Lexmark toner cartridge.</p> <p><b>Note:</b> If the toner cartridge is not supported, then install a supported one.</p> <p><b>b</b> Print the document.</p> <p>Does gray background appear on prints?</p>	Go to step 3.	The problem is solved.
<p><b>Step 3</b></p> <p><b>a</b> Depending on your operating system, specify the paper type from the Printing Preferences or Print dialog.</p> <p><b>Notes:</b></p> <ul style="list-style-type: none"> <li>• Make sure that the setting matches the paper loaded.</li> <li>• You can also change the setting from the printer control panel. Navigate to <b>Settings &gt; Paper &gt; Tray Configuration &gt; Paper Size/Type</b>.</li> </ul> <p><b>b</b> Print the document.</p> <p>Does gray background appear on prints?</p>	Go to step 4.	The problem is solved.
<p><b>Step 4</b></p> <p><b>a</b> Remove, and then insert the imaging unit.</p> <p><b>Warning—Potential Damage:</b> Do not expose the imaging unit to direct light for more than 10 minutes. Extended exposure to light may cause print quality problems.</p> <p><b>Warning—Potential Damage:</b> Do not touch the photoconductor drum under the imaging unit. Doing so may affect the quality of future print jobs.</p> <p><b>b</b> Print the document.</p> <p>Does gray background appear on prints?</p>	Go to step 5.	The problem is solved.
<p><b>Step 5</b></p> <p><b>a</b> Update the printer firmware. For more information, see <a href="#">“Updating firmware” on page 32</a>.</p> <p><b>b</b> Print the document.</p> <p>Does gray background appear on prints?</p>	Go to step 6.	The problem is solved.
<p><b>Step 6</b></p> <p><b>a</b> Replace the imaging unit.</p> <p><b>b</b> Print the document.</p> <p>Does gray background appear on prints?</p>	Contact <a href="#">customer support</a> .	The problem is solved.

### Incorrect margins



Action	Yes	No
<p><b>Step 1</b></p> <p><b>a</b> Adjust the paper guides to the correct position for the paper loaded.</p> <p><b>b</b> Print the document.</p> <p>Are the margins correct?</p>	The problem is solved.	Go to step 2.
<p><b>Step 2</b></p> <p><b>a</b> Set the paper size. From the control panel, navigate to: <b>Settings &gt; Paper &gt; Tray Configuration &gt; Paper Size/Type</b></p> <p><b>b</b> Print the document.</p> <p>Are the margins correct?</p>	The problem is solved.	Go to step 3.
<p><b>Step 3</b></p> <p><b>a</b> Depending on your operating system, specify the paper size from the Printing Preferences or Print dialog. <b>Note:</b> Make sure that the setting matches the paper loaded.</p> <p><b>b</b> Print the document.</p> <p>Are the margins correct?</p>	The problem is solved.	Contact <a href="#">customer support</a> .

### Light print

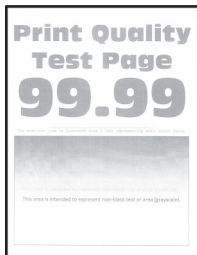

**Note:** Before solving the problem, print the Print Quality Test Pages. From the control panel, navigate to **Settings > Troubleshooting > Print Quality Test Pages**. For non-touch-screen printer models, press **OK** to navigate through the settings.



Action	Yes	No
<p><b>Step 1</b></p> <p><b>a</b> Check if the printer is using a genuine and supported Lexmark toner cartridge.</p> <p><b>Note:</b> If the cartridge is not supported, then install a supported one.</p> <p><b>b</b> Print the document.</p> <p>Is the print light?</p>	Go to step 2.	The problem is solved.
<p><b>Step 2</b></p> <p><b>a</b> Turn off the printer, wait for about 10 seconds, and then turn on the printer.</p> <p><b>b</b> Increase toner darkness. From the control panel, navigate to: <b>Settings &gt; Print &gt; Quality &gt; Toner Darkness</b></p> <p><b>c</b> Print the document.</p> <p>Is the print light?</p>	Go to step 3.	The problem is solved.
<p><b>Step 3</b></p> <p><b>a</b> Depending on your operating system, specify the paper type from the Printing Preferences or Print dialog.</p> <p><b>Notes:</b></p> <ul style="list-style-type: none"> <li>• Make sure that the setting matches the paper loaded.</li> <li>• You can also change the setting on the printer control panel. Navigate to <b>Settings &gt; Paper &gt; Tray Configuration &gt; Paper Size/Type</b>.</li> </ul> <p><b>b</b> Print the document.</p> <p>Is the print light?</p>	Go to step 4.	The problem is solved.
<p><b>Step 4</b></p> <p><b>a</b> Depending on your operating system, specify the print resolution from the Printing Preferences or Print dialog.</p> <p><b>b</b> Set the resolution to <b>600 dpi</b>.</p> <p><b>c</b> Print the document.</p> <p>Is the print light?</p>	Go to step 5.	The problem is solved.

Action	Yes	No
<p><b>Step 5</b></p> <p><b>a</b> Remove the imaging unit.</p> <p><b>Warning—Potential Damage:</b> Do not expose the imaging unit to direct light for more than 10 minutes. Extended exposure to light can cause print quality problems.</p> <p><b>Warning—Potential Damage:</b> Do not touch the photoconductor drum under the imaging unit. Doing so may affect the quality of future print jobs.</p> <p><b>b</b> Firmly shake the imaging unit to redistribute the toner.</p> <p><b>c</b> Insert the imaging unit.</p> <p><b>d</b> Turn off the printer, wait for 10 seconds, and then turn on the printer.</p> <p><b>e</b> Print the document.</p> <p>Is the print light?</p>	Go to step 6.	The problem is solved.
<p><b>Step 6</b></p> <p><b>a</b> Check the status of the toner cartridge.</p> <p>From the control panel, navigate to:</p> <p><b>Settings &gt; Reports &gt; Device &gt; Device Statistics</b></p> <p><b>b</b> From the Supply Information section of the pages printed, check the status of the toner cartridge.</p> <p>Is the toner cartridge near end of life?</p>	Go to step 7.	Contact <a href="#">customer support</a> .
<p><b>Step 7</b></p> <p><b>a</b> Replace the toner cartridge.</p> <p><b>b</b> Print the document.</p> <p>Is the print light?</p>	Contact <a href="#">customer support</a> .	The problem is solved.

### Mottled print and dots



**Note:** Before solving the problem, print the Print Quality Test Pages. From the control panel, navigate to **Settings > Troubleshooting > Print Quality Test Pages**. For non-touch-screen printer models, press **OK** to navigate through the settings.

Action	Yes	No
<p><b>Step 1</b></p> <p><b>a</b> Check if the printer is using a genuine and supported Lexmark toner cartridge.</p> <p><b>Note:</b> If the cartridge is not supported, then install a supported one.</p> <p><b>b</b> Print the document.</p> <p>Is the print mottled?</p>	Go to step 2.	The problem is solved.
<p><b>Step 2</b></p> <p>Check the printer for leaked toner contamination.</p> <p>Is the printer free of leaked toner?</p>	Go to step 3.	Contact <a href="#">customer support</a> .
<p><b>Step 3</b></p> <p><b>a</b> Check the status of the imaging unit. From the control panel, navigate to: <b>Settings &gt; Reports &gt; Device &gt; Device Statistics</b></p> <p><b>b</b> From the Supply Information section of the pages printed, check the status of the imaging unit.</p> <p>Is the imaging unit near end of life?</p>	Go to step 4.	Contact <a href="#">customer support</a> .
<p><b>Step 4</b></p> <p><b>a</b> Replace the imaging unit.</p> <p><b>b</b> Print the document.</p> <p>Is the print mottled?</p>	Contact <a href="#">customer support</a> .	The problem is solved.

### Paper curl



**Note:** Before solving the problem, print the Print Quality Test Pages. From the control panel, navigate to **Settings > Troubleshooting > Print Quality Test Pages**. For non-touch-screen printer models, press **OK** to navigate through the settings.

Action	Yes	No
<p><b>Step 1</b></p> <p><b>a</b> Check if the paper loaded is supported.  <b>Note:</b> If paper is not supported, then load a supported paper.</p> <p><b>b</b> Print the document.</p> <p>Is the paper curled?</p>	Go to step 2.	The problem is solved.
<p><b>Step 2</b></p> <p><b>a</b> Check if the printer is using a genuine and supported Lexmark toner cartridge.  <b>Note:</b> If the cartridge is not supported, then install a supported one.</p> <p><b>b</b> Print the document.</p> <p>Is the paper curled?</p>	Go to step 3.	The problem is solved.
<p><b>Step 3</b></p> <p><b>a</b> Adjust the guides in the tray to the correct position for the paper loaded.</p> <p><b>b</b> Print the document.</p> <p>Is the paper curled?</p>	Go to step 4.	The problem is solved.
<p><b>Step 4</b></p> <p><b>a</b> Depending on your operating system, specify the paper size and paper type from the Printing Preferences or Print dialog.  <b>Notes:</b></p> <ul style="list-style-type: none"> <li>• Make sure that the settings match the paper loaded.</li> <li>• You can also change the setting on the printer control panel. Navigate to <b>Settings &gt; Paper &gt; Tray Configuration &gt; Paper Size/Type.</b></li> </ul> <p><b>b</b> Print the document.</p> <p>Is the paper curled?</p>	Go to step 5.	The problem is solved.
<p><b>Step 5</b></p> <p><b>a</b> Remove paper, flip it over, and then reload paper.</p> <p><b>b</b> Print the document.</p> <p>Is the paper curled?</p>	Go to step 6.	The problem is solved.
<p><b>Step 6</b></p> <p><b>a</b> Load paper from a fresh package.  <b>Note:</b> Paper absorbs moisture due to high humidity. Store paper in its original wrapper until you are ready to use it.</p> <p><b>b</b> Print the document.</p> <p>Is the paper curled?</p>	Contact <a href="#">customer support</a> .	The problem is solved.

## Print crooked or skewed



**Note:** Before solving the problem, print the Print Quality Test Pages. From the control panel, navigate to **Settings > Troubleshooting > Print Quality Test Pages**. For non-touch-screen printer models, press **OK** to navigate through the settings.

Action	Yes	No
<p><b>Step 1</b></p> <p><b>a</b> Adjust the guides in the tray to the correct position for the paper loaded.</p> <p><b>b</b> Print the document.</p> <p>Is the print crooked or skewed?</p>	Go to step 2.	The problem is solved.
<p><b>Step 2</b></p> <p><b>a</b> Load paper from a fresh package.</p> <p><b>Note:</b> Paper absorbs moisture due to high humidity. Store paper in its original wrapper until you are ready to use it.</p> <p><b>b</b> Print the document.</p> <p>Is the print crooked or skewed?</p>	Go to step 3.	The problem is solved.
<p><b>Step 3</b></p> <p><b>a</b> Check if the paper loaded is supported.</p> <p><b>Note:</b> If paper is not supported, then load a supported paper.</p> <p><b>b</b> Print the document.</p> <p>Is the print crooked or skewed?</p>	Contact <a href="#">customer support</a> .	The problem is solved.
<p><b>Step 4</b></p> <p><b>a</b> For two-sided printing, check if the paper size setting in the duplex unit is set correctly.</p> <p><b>Note:</b> Letter, legal, Oficio, or folio must be set to Letter.</p> <p><b>b</b> Print the document.</p> <p>Is the print crooked or skewed?</p>	Contact <a href="#">customer support</a> .	The problem is solved.

### Solid black pages

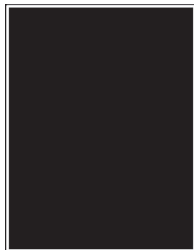

**Note:** Before solving the problem, print the Print Quality Test Pages. From the control panel, navigate to **Settings > Troubleshooting > Print Quality Test Pages**. For non-touch-screen printer models, press **OK** to navigate through the settings.

Action	Yes	No
<p><b>Step 1</b></p> <p><b>a</b> Check if the printer is using a genuine and supported Lexmark toner cartridge.</p> <p><b>Note:</b> If the toner cartridge is not supported, then install a supported one.</p> <p><b>b</b> Print the document.</p> <p>Is the printer printing solid black pages?</p>	Go to step 2.	The problem is solved.
<p><b>Step 2</b></p> <p><b>a</b> Remove, and then insert the imaging unit.</p> <p><b>Warning—Potential Damage:</b> Do not expose the imaging unit to direct light for more than 10 minutes. Extended exposure to light may cause print quality problems.</p> <p><b>Warning—Potential Damage:</b> Do not touch the photoconductor drum under the imaging unit. Doing so may affect the quality of future print jobs.</p> <p><b>b</b> Print the document.</p> <p>Is the printer printing solid black pages?</p>	Go to step 3.	The problem is solved.
<p><b>Step 3</b></p> <p>Check the imaging unit for signs of damage.</p> <p><b>Note:</b> Make sure that the photoconductor drum contact is not bent or out of place.</p> <p>Is the imaging unit free from damage?</p>	Contact <a href="#">customer support</a> .	Go to step 4.
<p><b>Step 4</b></p> <p><b>a</b> Replace the imaging unit.</p> <p><b>b</b> Print the document.</p> <p>Is the printer printing solid black pages?</p>	Contact <a href="#">customer support</a> .	The problem is solved.

### Text or images cut off



**Note:** Before solving the problem, print the Print Quality Test Pages. From the control panel, navigate to **Settings > Troubleshooting > Print Quality Test Pages**. For non-touch-screen printer models, press **OK** to navigate through the settings.

Action	Yes	No
<p><b>Step 1</b></p> <p><b>a</b> Check if the printer is using a genuine and supported Lexmark toner cartridge.</p> <p><b>Note:</b> If the toner cartridge is not supported, then install a supported one.</p> <p><b>b</b> Print the document.</p> <p>Are text or images cut off?</p>	Go to step 2.	The problem is solved.
<p><b>Step 2</b></p> <p><b>a</b> Remove, and then insert the imaging unit.</p> <p><b>Warning—Potential Damage:</b> Do not expose the imaging unit to direct light for more than 10 minutes. Extended exposure to light may cause print quality problems.</p> <p><b>Warning—Potential Damage:</b> Do not touch the photoconductor drum under the imaging unit. Doing so may affect the quality of future print jobs.</p> <p><b>b</b> Print the document.</p> <p>Are text or images cut off?</p>	Go to step 3.	The problem is solved.
<p><b>Step 3</b></p> <p><b>a</b> Replace the imaging unit.</p> <p><b>b</b> Print the document.</p> <p>Are text or images cut off?</p>	Contact <a href="#">customer support</a> .	The problem is solved.

### Toner easily rubs off



**Note:** Before solving the problem, print the Print Quality Test Pages. From the control panel, navigate to **Settings > Troubleshooting > Print Quality Test Pages**. For non-touch-screen printer models, press **OK** to navigate through the settings.

Action	Yes	No
<p><b>Step 1</b></p> <p><b>a</b> Check if the printer is using a genuine and supported Lexmark toner cartridge.</p> <p><b>Note:</b> If the toner cartridge is not supported, then install a supported one.</p> <p><b>b</b> Print the document.</p> <p>Does toner easily rub off?</p>	<p>Go to step 2.</p>	<p>The problem is solved.</p>
<p><b>Step 2</b></p> <p><b>a</b> Depending on your operating system, specify the paper type from the Printing Preferences or Print dialog.</p> <p><b>Notes:</b></p> <ul style="list-style-type: none"> <li>• Make sure that the setting matches the paper loaded.</li> <li>• You can also change the setting on the printer control panel. Navigate to <b>Settings &gt; Paper &gt; Tray Configuration &gt; Paper Size/Type</b>.</li> </ul> <p><b>b</b> Print the document.</p> <p>Does toner easily rub off?</p>	<p>Contact <a href="#">customer support</a>.</p>	<p>The problem is solved.</p>

### Horizontal light bands





**Note:** Before solving the problem, print the Print Quality Test Pages. From the control panel, navigate to **Settings > Troubleshooting > Print Quality Test Pages**. For non-touch-screen printer models, press **OK** to navigate through the settings.

Action	Yes	No
<p><b>Step 1</b></p> <p><b>a</b> Check if the printer is using a genuine and supported Lexmark toner cartridge.</p> <p><b>Note:</b> If the cartridge is not supported, then install a supported one.</p> <p><b>b</b> Print the document.</p> <p>Do horizontal light bands appear on prints?</p>	Go to step 2.	The problem is solved.
<p><b>Step 2</b></p> <p><b>a</b> Remove, and then insert the imaging unit.</p> <p><b>Warning—Potential Damage:</b> Do not expose the imaging unit to direct light for more than 10 minutes. Extended exposure to light may cause print quality problems.</p> <p><b>Warning—Potential Damage:</b> Do not touch the photoconductor drum under the imaging unit. Doing so may affect the quality of future print jobs.</p> <p><b>b</b> Print the document.</p> <p>Do horizontal light bands appear on prints?</p>	Go to step 3.	The problem is solved.
<p><b>Step 3</b></p> <p><b>a</b> Replace the imaging unit.</p> <p><b>b</b> Print the document.</p> <p>Do horizontal light bands appear on prints?</p>	Contact <a href="#">customer support</a> .	The problem is solved.

## Vertical light bands



**Note:** Before solving the problem, print the Print Quality Test Pages. From the control panel, navigate to **Settings > Troubleshooting > Print Quality Test Pages**. For non-touch-screen printer models, press **OK** to navigate through the settings.

Action	Yes	No
<p><b>Step 1</b></p> <p><b>a</b> Check if the printer is using a genuine and supported Lexmark toner cartridge.</p> <p><b>Note:</b> If the cartridge is not supported, then install a supported one.</p> <p><b>b</b> Print the document.</p> <p>Do vertical light bands appear on prints?</p>	Go to step 2.	The problem is solved.
<p><b>Step 2</b></p> <p><b>a</b> Check the status of the toner cartridge. From the control panel, navigate to: <b>Settings &gt; Reports &gt; Device &gt; Device Statistics</b></p> <p><b>b</b> From the Supply Information section of the pages printed, check the status of the toner cartridge.</p> <p>Do vertical light bands appear on prints?</p>	Go to step 3.	The problem is solved.
<p><b>Step 3</b></p> <p><b>a</b> Replace the toner cartridge.</p> <p><b>b</b> Print the document.</p> <p>Do vertical light bands appear on prints?</p>	Contact <a href="#">customer support</a> .	The problem is solved.

### Vertical white lines



**Note:** Before solving the problem, print the Print Quality Test Pages. From the control panel, navigate to **Settings > Troubleshooting > Print Quality Test Pages**. For non-touch-screen printer models, press **OK** to navigate through the settings.

Action	Yes	No
<p><b>Step 1</b></p> <p><b>a</b> Check if the printer is using a genuine and supported Lexmark toner cartridge.</p> <p><b>Note:</b> If the cartridge is not supported, then install a supported one.</p> <p><b>b</b> Print the document.</p> <p>Do vertical white lines appear on prints?</p>	Go to step 2.	The problem is solved.
<p><b>Step 2</b></p> <p><b>a</b> Depending on your operating system, specify the paper type from the Printing Preferences or Print dialog.</p> <p><b>Notes:</b></p> <ul style="list-style-type: none"> <li>• Make sure that the setting matches the paper loaded.</li> <li>• You can also change the setting on the printer control panel. Navigate to <b>Settings &gt; Paper &gt; Tray Configuration &gt; Paper Size/Type.</b></li> </ul> <p><b>b</b> Print the document.</p> <p>Do vertical white lines appear on prints?</p>	Contact <a href="#">customer support</a> .	The problem is solved.

### Vertical dark bands

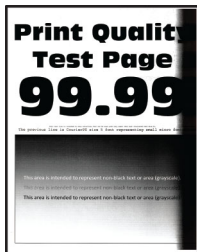

**Note:** Before solving the problem, print the Print Quality Test Pages. From the control panel, navigate to **Settings > Troubleshooting > Print Quality Test Pages**. For non-touch-screen printer models, press **OK** to navigate through the settings.

Action	Yes	No
<p><b>Step 1</b></p> <p><b>a</b> Check if the printer is using a genuine and supported Lexmark toner cartridge.</p> <p><b>Note:</b> If the toner cartridge is not supported, then install a supported one.</p> <p><b>b</b> Print the document.</p> <p>Do vertical dark bands appear on prints?</p>	Go to step 2.	The problem is solved.

Action	Yes	No
<p><b>Step 2</b></p> <p><b>a</b> Remove, and then insert the imaging unit.</p> <p><b>Warning—Potential Damage:</b> Do not expose the imaging unit to direct light for more than 10 minutes. Extended exposure to light may cause print quality problems.</p> <p><b>Warning—Potential Damage:</b> Do not touch the photoconductor drum under the imaging unit. Doing so may affect the quality of future print jobs.</p> <p><b>b</b> Print the document.</p> <p>Do vertical dark bands appear on prints?</p>	Go to step 3.	The problem is solved.
<p><b>Step 3</b></p> <p><b>a</b> Check if a bright light enters the right side of the printer, and move the printer if necessary.</p> <p><b>b</b> Print the document.</p> <p>Do vertical dark bands appear on prints?</p>	Contact <a href="#">customer support</a> .	The problem is solved.

### Vertical dark lines or streaks



**Note:** Before solving the problem, print the Print Quality Test Pages. From the control panel, navigate to **Settings > Troubleshooting > Print Quality Test Pages**. For non-touch-screen printer models, press **OK** to navigate through the settings.

Action	Yes	No
<p><b>Step 1</b></p> <p><b>a</b> Check if the printer is using a genuine and supported Lexmark toner cartridge.</p> <p><b>Note:</b> If the toner cartridge is not supported, then install a supported one.</p> <p><b>b</b> Print the document.</p> <p>Do vertical dark lines or streaks appear on prints?</p>	Go to step 2.	The problem is solved.

Action	Yes	No
<p><b>Step 2</b></p> <p><b>a</b> Remove, and then reinstall the imaging unit.</p> <p><b>Warning—Potential Damage:</b> Do not expose the imaging unit to direct light for more than 10 minutes. Extended exposure to light can cause print quality problems.</p> <p><b>Warning—Potential Damage:</b> Do not touch the photoconductor drum under the imaging unit. Doing so may affect the quality of future print jobs.</p> <p><b>b</b> Print the document.</p> <p>Do vertical dark lines or streaks appear on prints?</p>	Go to step 3.	The problem is solved.
<p><b>Step 3</b></p> <p><b>a</b> Replace the imaging unit.</p> <p><b>b</b> Print the document.</p> <p>Do vertical dark lines or streaks appear on prints?</p>	Contact <a href="#">customer support</a> .	The problem is solved.

### Vertical dark streaks with print missing

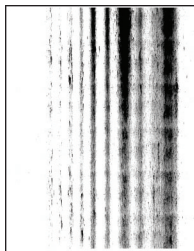

**Note:** Before solving the problem, print the Print Quality Test Pages. From the control panel, navigate to **Settings > Troubleshooting > Print Quality Test Pages**. For non-touch-screen printer models, press **OK** to navigate through the settings.

Action	Yes	No
<p><b>Step 1</b></p> <p><b>a</b> Remove, and then insert the imaging unit.</p> <p><b>Warning—Potential Damage:</b> Do not expose the imaging unit to direct light for more than 10 minutes. Extended exposure to light may cause print quality problems.</p> <p><b>Warning—Potential Damage:</b> Do not touch the photoconductor drum under the imaging unit. Doing so may affect the quality of future print jobs.</p> <p><b>b</b> Print the document.</p> <p>Do vertical dark streaks with missing images appear on prints?</p>	Go to step 2.	The problem is solved.

Action	Yes	No
<p><b>Step 2</b></p> <p><b>a</b> Check if the printer is using a genuine and supported Lexmark toner cartridge.</p> <p><b>Note:</b> If the toner cartridge is not supported, then install a supported one.</p> <p><b>b</b> Print the document.</p> <p>Do vertical dark streaks with missing images appear on prints?</p>	<p>Contact <a href="#">customer support</a>.</p>	<p>The problem is solved.</p>

### Repeating defects



**Note:** Before solving the problem, print the Print Quality Test Pages. From the control panel, navigate to **Settings > Troubleshooting > Print Quality Test Pages**. For non-touch-screen printer models, press **OK** to navigate through the settings.

Action	Yes	No
<p><b>Step 1</b></p> <p>Using the Print Quality Test Pages, check if the distance between the repeating defects is equal to any of the following:</p> <p><b>Imaging unit</b></p> <ul style="list-style-type: none"> <li>• 96 mm (3.78 in.)</li> <li>• 37.7 mm (1.48 in.)</li> </ul> <p><b>Toner cartridge</b></p> <ul style="list-style-type: none"> <li>• 43.5 mm (1.71 in.)</li> <li>• 37.5 mm (1.48 in.)</li> </ul> <p><b>Transfer roller</b></p> <ul style="list-style-type: none"> <li>• 52 mm (2.05 in.)</li> </ul> <p><b>Fuser</b></p> <ul style="list-style-type: none"> <li>• 79.8 mm (3.14 in.)</li> <li>• 62.5 mm (2.46 in.)</li> </ul> <p>Does the distance between the repeating defects match the toner cartridge or imaging unit measurements?</p>	<p>Go to step 2.</p> <p><b>Note:</b> If the repeating defects match the transfer roller or fuser measurements, then contact <a href="#">customer support</a>.</p>	<p>Take note of the distance, and then contact <a href="#">customer support</a>.</p>

Action	Yes	No
<p><b>Step 2</b></p> <p><b>a</b> Replace the affected supply item.</p> <p><b>b</b> Print the document.</p> <p>Do the repeating defects appear?</p>	Contact <a href="#">customer support</a> .	The problem is solved.

## Faxing problems

### Caller ID is not shown

Action	Yes	No
<p>Enable caller ID.</p> <p>From the home screen, touch <b>Settings &gt; Fax &gt; Fax Setup &gt; Fax Receive Settings &gt; Admin Controls &gt; Enable Caller ID</b>.</p> <p>Does the caller ID appear?</p>	The problem is solved.	Contact <a href="#">customer support</a> .

### Cannot send or receive faxes

Action	Yes	No
<p><b>Step 1</b></p> <p>Resolve any error messages that appear on the display.</p> <p>Can you send or receive a fax?</p>	The problem is solved.	Go to step 2.
<p><b>Step 2</b></p> <p>Make sure that the cable connections for the following equipment are secure:</p> <ul style="list-style-type: none"> <li>• Telephone</li> <li>• Handset</li> <li>• Answering machine</li> </ul> <p>Can you send or receive a fax?</p>	The problem is solved.	Go to step 3.
<p><b>Step 3</b></p> <p>Check for a dial tone.</p> <ul style="list-style-type: none"> <li>• Call the fax number to check if it is working properly.</li> <li>• If you are using the On Hook Dial feature, then turn up the volume to check if you hear a dial tone.</li> </ul> <p>Can you hear a dial tone?</p>	Go to step 5.	Go to step 4.

Action	Yes	No
<p><b>Step 4</b>                      Check the telephone wall jack.</p> <ul style="list-style-type: none"> <li><b>a</b> Connect the analog telephone directly to the wall jack.</li> <li><b>b</b> Listen for a dial tone.</li> <li><b>c</b> If you do not hear a dial tone, then use a different telephone cable.</li> <li><b>d</b> If you still do not hear a dial tone, then connect the analog telephone to a different wall jack.</li> <li><b>e</b> If you hear a dial tone, then connect the printer to that wall jack.</li> </ul> <p>Can you send or receive a fax?</p>	<p>The problem is solved.</p>	<p>Go to step 5.</p>
<p><b>Step 5</b>                      Check if the printer is connected to an analog phone service or to the correct digital connector.</p> <ul style="list-style-type: none"> <li>• If you are using an Integrated Services for Digital Network (ISDN) telephone service, then connect to an analog telephone port of an ISDN terminal adapter. For more information, contact your ISDN provider.</li> <li>• If you are using DSL, then connect to a DSL filter or router that supports analog use. For more information, contact your DSL provider.</li> <li>• If you are using a private branch exchange (PBX) telephone service, then make sure that you are connecting to an analog connection on the PBX. If none exists, then consider installing an analog telephone line for the fax machine.</li> </ul> <p>Can you send or receive a fax?</p>	<p>The problem is solved.</p>	<p>Go to step 6.</p>
<p><b>Step 6</b>                      Temporarily disconnect other equipment and disable other telephone services.</p> <ul style="list-style-type: none"> <li><b>a</b> Disconnect other equipment (such as answering machines, computers, modems, or telephone line splitters) between the printer and the telephone line.</li> <li><b>b</b> Disable call waiting and voice mail. For more information, contact your telephone company.</li> </ul> <p>Can you send or receive a fax?</p>	<p>The problem is solved.</p>	<p>Go to step 7.</p>
<p><b>Step 7</b>                      Scan the original document one page at a time.</p> <ul style="list-style-type: none"> <li><b>a</b> Dial the fax number.</li> <li><b>b</b> Scan the document.</li> </ul> <p>Can you send or receive a fax?</p>	<p>The problem is solved.</p>	<p>Contact <a href="#">customer support</a>.</p>



### Can receive but not send faxes

Action	Yes	No
<p><b>Step 1</b> Load the original document properly into the ADF tray or on the scanner glass.</p> <p>Can you send faxes?</p>	The problem is solved.	Go to step 2.
<p><b>Step 2</b> Set up the shortcut number properly.</p> <ul style="list-style-type: none"> <li>• Check if the shortcut number is set for the telephone number that you want to dial.</li> <li>• Dial the telephone number manually.</li> </ul> <p>Can you send faxes?</p>	The problem is solved.	Contact <a href="#">customer support</a> .

### Can send but not receive faxes

Action	Yes	No
<p><b>Step 1</b> Make sure that the paper source is not empty.</p> <p>Can you receive faxes?</p>	The problem is solved.	Go to step 2.
<p><b>Step 2</b> Check the ring count delay settings. From the control panel, touch <b>Settings &gt; Fax &gt; Fax Setup &gt; Fax Receive Settings &gt; Rings to Answer</b>.</p> <p>Can you receive faxes?</p>	The problem is solved.	Go to step 3.
<p><b>Step 3</b> If the printer is printing blank pages, then see <a href="#">“Blank or white pages” on page 161</a>.</p> <p>Can you receive faxes?</p>	The problem is solved.	Contact <a href="#">customer support</a> .

## Poor fax print quality

Action	Yes	No
<p><b>Step 1</b>                      Make sure that there are no print quality defects.</p> <p><b>a</b> From the control panel, touch <b>Settings &gt; Troubleshooting &gt; Print Quality Test Pages</b>.</p> <p><b>b</b> Correct any print quality defects. For more information, see <a href="#">“Print quality problems” on page 160</a>.</p> <p>Is the fax print quality satisfactory?</p>	<p>The problem is solved.</p>	<p>Go to step 2.</p>
<p><b>Step 2</b>                      Decrease the incoming fax transmission speed.</p> <p><b>a</b> From the control panel, touch <b>Settings &gt; Fax &gt; Fax Setup &gt; Fax Receive Settings &gt; Admin Controls</b>.</p> <p><b>b</b> In the Max Speed menu, select a lower transmission speed.</p> <p>Is the fax print quality satisfactory?</p>	<p>The problem is solved.</p>	<p>Contact <a href="#">customer support</a>.</p>

## Scanning problems

### Cannot scan from a computer

Action	Yes	No
<p><b>Step 1</b></p> <p><b>a</b> Turn off the printer, wait for about 10 seconds, and then turn it back on.</p> <p><b>b</b> Resend the scan job.</p> <p>Can you send the scan job?</p>	<p>The problem is solved.</p>	<p>Go to step 2.</p>
<p><b>Step 2</b></p> <p><b>a</b> Make sure that the cables between the printer and the print server are secure.                      For more information, see the setup documentation that came with the printer.</p> <p><b>b</b> Resend the scan job.</p> <p>Can you send the scan job?</p>	<p>The problem is solved.</p>	<p>Contact <a href="#">customer support</a>.</p>

### Partial copies of document or photo

Action	Yes	No
<p><b>Step 1</b></p> <p><b>a</b> Make sure that the document or photo is loaded facedown on the upper left corner of the scanner glass.</p> <p><b>b</b> Copy the document or photo.</p> <p>Is the document or photo copied correctly?</p>	The problem is solved.	Go to step 2.
<p><b>Step 2</b></p> <p><b>a</b> Match the paper size setting and the paper loaded in the tray.</p> <p><b>b</b> Copy the document or photo.</p> <p>Is the document or photo copied correctly?</p>	The problem is solved.	Contact <a href="#">customer support</a> .

### Scan job was not successful

Action	Yes	No
<p><b>Step 1</b></p> <p>Check the cable connections.</p> <p><b>a</b> Make sure that the Ethernet or USB cable is securely connected to the computer and the printer.</p> <p><b>b</b> Resend the scan job.</p> <p>Is the scan job successful?</p>	The problem is solved.	Go to step 2.
<p><b>Step 2</b></p> <p>Check the file you want to scan.</p> <p><b>a</b> Make sure that the file name is not already used in the destination folder.</p> <p><b>b</b> Make sure that the document or photo you want to scan is not open in another application.</p> <p><b>c</b> Resend the scan job.</p> <p>Is the scan job successful?</p>	The problem is solved.	Go to step 3.
<p><b>Step 3</b></p> <p><b>a</b> Make sure that the <b>Append time stamp</b> or the <b>Overwrite existing file</b> check box is selected in the destination configuration settings.</p> <p><b>b</b> Resend the scan job.</p> <p>Is the scan job successful?</p>	The problem is solved.	Contact <a href="#">customer support</a> .

### Poor copy quality

Action	Yes	No
<p><b>Step 1</b></p> <p><b>a</b> Clean the scanner glass and the ADF glass with a damp, soft, lint-free cloth. If your printer has a second ADF glass inside the ADF, then also clean that glass.</p> <p>For more information, see <a href="#">“Cleaning the scanner” on page 130.</a></p> <p><b>b</b> Make sure that the document or photo is loaded facedown on the upper left corner of the scanner glass.</p> <p><b>c</b> Copy the document or photo.</p> <p>Is the copy quality satisfactory?</p>	<p>The problem is solved.</p>	<p>Go to step 2.</p>
<p><b>Step 2</b></p> <p><b>a</b> Check the quality of the original document or photo.</p> <p><b>b</b> Adjust the scan quality settings.</p> <p><b>c</b> Copy the document or photo.</p> <p>Is the copy quality satisfactory?</p>	<p>The problem is solved.</p>	<p>Contact <a href="#">customer support.</a></p>

### Vertical dark streaks on output when scanning from the ADF

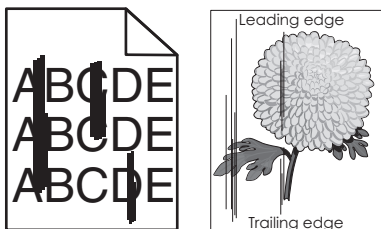

Action	Yes	No
<p><b>a</b> Open the scanner cover.</p> <p><b>b</b> Using a damp, soft, lint-free cloth, wipe the ADF glass and the ADF glass pad.</p> <p><b>c</b> Close the scanner cover.</p> <p><b>d</b> Scan the document.</p> <p>Do vertical streaks appear on scanned documents?</p>	<p>Contact <a href="#">customer support.</a></p>	<p>The problem is solved.</p>

### Scanner does not close

Action	Yes	No
<p>Remove obstructions that keep the scanner cover open.</p> <p>Did the scanner cover close correctly?</p>	<p>The problem is solved.</p>	<p>Contact <a href="#">customer support.</a></p>

### Scanning takes too long or freezes the computer

Action	Yes	No
Close all applications that are interfering with the scan.  Does scanning take too long or freeze the computer?	Contact <a href="#">customer support</a> .	The problem is solved.

### Scanner does not respond

Action	Yes	No
<p><b>Step 1</b></p> <p><b>a</b> Check if the power cord is connected properly to the printer and the electrical outlet.</p> <p> <b>CAUTION—POTENTIAL INJURY:</b> To avoid the risk of fire or electrical shock, connect the power cord to an appropriately rated and properly grounded electrical outlet that is near the product and easily accessible.</p> <p><b>b</b> Copy or scan the document.</p> <p>Is the scanner responding?</p>	The problem is solved.	Go to step 2.
<p><b>Step 2</b></p> <p><b>a</b> Check if the printer is turned on.</p> <p><b>b</b> Resolve any error messages that appear on the display.</p> <p><b>c</b> Copy or scan the document.</p> <p>Is the scanner responding?</p>	The problem is solved.	Go to step 3.
<p><b>Step 3</b></p> <p><b>a</b> Turn off the printer, wait for about 10 seconds, and then turn the printer on.</p> <p><b>b</b> Copy or scan the document.</p> <p>Is the scanner responding?</p>	The problem is solved.	Contact <a href="#">customer support</a> .

### Adjusting scanner registration

- 1 From the control panel, navigate to:  
**Settings > Device > Maintenance > Config Menu > Scanner Configuration > Scanner Manual Registration**
- 2 Touch **Print Quick Test**.
- 3 Place the Print Quick Test page on the scanner glass, and then touch **Flatbed Registration**.
- 4 Touch **Copy Quick Test**.

**5** Compare the Copy Quick Test page with the original document.

**Note:** If the margins of the test page are different from the original document, then adjust Left Margin and Top Margin.

**6** Repeat [step 4](#) and [step 5](#) until the margins of the Copy Quick Test page closely match the original document.

## Adjusting ADF registration

**1** From the control panel, navigate to:

**Settings > Device > Maintenance > Config Menu > Scanner Configuration > Scanner Manual Registration**

**2** Touch **Print Quick Test**.

**3** Place the Print Quick Test page on the ADF tray.

**4** Touch **Front ADF Registration** or **Rear ADF Registration**.

**Notes:**

- To align Front ADF Registration, place the test page faceup, short edge first into the ADF.
- To align Rear ADF Registration, place the test page facedown, short edge first into the ADF.

**5** Touch **Copy Quick Test**.

**6** Compare the Copy Quick Test page with the original document.

**Note:** If the margins of the test page are different from the original document, then adjust Horizontal Adjust and Top Margin.

**7** Repeat [step 5](#) and [step 6](#) until the margins of the Copy Quick Test page closely match the original document.

## Contacting customer support

Before contacting customer support, make sure to have the following information:

- Printer problem
- Error message
- Printer model type and serial number

Go to <http://support.lexmark.com> to receive e-mail or chat support, or browse through the library of manuals, support documentation, drivers, and other downloads.

Technical support via telephone is also available. In the U.S. or Canada, call 1-800-539-6275. For other countries or regions, go to <http://support.lexmark.com>.

# Recycle and dispose

## Recycling Lexmark products

To return Lexmark products for recycling:

- 1 Go to [www.lexmark.com/recycle](http://www.lexmark.com/recycle).
- 2 Select the product you want to recycle.

**Note:** Printer supplies and hardware not listed in the Lexmark Collection and Recycling Program may be recycled through your local recycling center.

## Recycling Lexmark packaging

Lexmark continually strives to minimize packaging. Less packaging helps to ensure that Lexmark printers are transported in the most efficient and environmentally sensitive manner and that there is less packaging to dispose of. These efficiencies result in fewer greenhouse emissions, energy savings, and natural resource savings. Lexmark also offers recycling of packaging components in some countries or regions. For more information, go to [www.lexmark.com/recycle](http://www.lexmark.com/recycle), and then choose your country or region. Information on available packaging recycling programs is included with the information on product recycling.

Lexmark cartons are 100% recyclable where corrugated recycling facilities exist. Facilities may not exist in your area.

The foam used in Lexmark packaging is recyclable where foam recycling facilities exist. Facilities may not exist in your area.

When you return a cartridge to Lexmark, you can reuse the box that the cartridge came in. Lexmark recycles the box.

# Notices

## Product information

Product name:

Lexmark MB3442dw; Lexmark MX331adn; Lexmark MX431adn, Lexmark MX431adw MFPs

Machine type:

7019

Model(s):

235, 4a6, 4b6, 486

## Edition notice

April 2020

**The following paragraph does not apply to any country where such provisions are inconsistent with local law:** LEXMARK INTERNATIONAL, INC., PROVIDES THIS PUBLICATION "AS IS" WITHOUT WARRANTY OF ANY KIND, EITHER EXPRESS OR IMPLIED, INCLUDING, BUT NOT LIMITED TO, THE IMPLIED WARRANTIES OF MERCHANTABILITY OR FITNESS FOR A PARTICULAR PURPOSE. Some states do not allow disclaimer of express or implied warranties in certain transactions; therefore, this statement may not apply to you.

This publication could include technical inaccuracies or typographical errors. Changes are periodically made to the information herein; these changes will be incorporated in later editions. Improvements or changes in the products or the programs described may be made at any time.

References in this publication to products, programs, or services do not imply that the manufacturer intends to make these available in all countries in which it operates. Any reference to a product, program, or service is not intended to state or imply that only that product, program, or service may be used. Any functionally equivalent product, program, or service that does not infringe any existing intellectual property right may be used instead. Evaluation and verification of operation in conjunction with other products, programs, or services, except those expressly designated by the manufacturer, are the user's responsibility.

For Lexmark technical support, go to <http://support.lexmark.com>.

For information on Lexmark's privacy policy governing the use of this product, go to [www.lexmark.com/privacy](http://www.lexmark.com/privacy).

For information on supplies and downloads, go to [www.lexmark.com](http://www.lexmark.com).

© 2020 Lexmark International, Inc.

All rights reserved.

## GOVERNMENT END USERS

The Software Program and any related documentation are "Commercial Items," as that term is defined in 48 C.F.R. 2.101, "Computer Software" and "Commercial Computer Software Documentation," as such terms are used in 48 C.F.R. 12.212 or 48 C.F.R. 227.7202, as applicable. Consistent with 48 C.F.R. 12.212 or 48 C.F.R. 227.7202-1 through 227.7207-4, as applicable, the Commercial Computer Software and Commercial Software



Documentation are licensed to the U.S. Government end users (a) only as Commercial Items and (b) with only those rights as are granted to all other end users pursuant to the terms and conditions herein.

## Trademarks

Lexmark and the Lexmark logo are trademarks or registered trademarks of Lexmark International, Inc. in the United States and/or other countries.

Google Cloud Print, Google Chrome, Android, and Google Play are trademarks of Google LLC.

Macintosh, App Store, Safari, and AirPrint are trademarks of Apple Inc., registered in the U.S. and other countries. Use of the Works with Apple badge means that an accessory has been designed to work specifically with the technology identified in the badge and has been certified by the developer to meet Apple performance standards.

Mopria®, the Mopria® logo, and the Mopria® Alliance logo are registered trademarks and service marks of Mopria Alliance, Inc. in the United States and other countries. Unauthorized use is strictly prohibited.

PCL® is a registered trademark of the Hewlett-Packard Company. PCL is Hewlett-Packard Company’s designation of a set of printer commands (language) and functions included in its printer products. This printer is intended to be compatible with the PCL language. This means the printer recognizes PCL commands used in various application programs, and that the printer emulates the functions corresponding to the commands.

PostScript is a registered trademark of Adobe Systems Incorporated in the United States and/or other countries.

Wi-Fi Direct is a registered trademark of Wi-Fi Alliance®.

All other trademarks are the property of their respective owners.

## Licensing notices

All licensing notices associated with this product can be viewed from the CD:\NOTICES directory of the installation software CD.

## Noise emission levels

The following measurements were made in accordance with ISO 7779 and reported in conformance with ISO 9296.

**Note:** Some modes may not apply to your product.

1-meter average sound pressure, dBA	
Printing	One-sided: 53; Two-sided: 50
Scanning	58
Copying	59
Ready	14

Values are subject to change. See [www.lexmark.com](http://www.lexmark.com) for current values.

## Waste from Electrical and Electronic Equipment (WEEE) directive



The WEEE logo signifies specific recycling programs and procedures for electronic products in countries of the European Union. We encourage the recycling of our products.

If you have further questions about recycling options, visit the Lexmark Web site at [www.lexmark.com](http://www.lexmark.com) for your local sales office phone number.

## India E-Waste notice



This product complies with the India E-Waste (Management and Handling) Rules, 2011, which prohibit use of lead, mercury, hexavalent chromium, polybrominated biphenyls, or polybrominated diphenyl ethers in concentrations exceeding 0.1% by weight and 0.01% by weight for cadmium, except for the exemption set in Schedule II of the Rules.

## Product disposal

Do not dispose of the printer or supplies in the same manner as normal household waste. Consult your local authorities for disposal and recycling options.

## Returning Lexmark cartridges for reuse or recycling

The Lexmark Cartridge Collection Program allows you to return used cartridges for free to Lexmark for reuse or recycling. One hundred percent of the empty cartridges returned to Lexmark are either reused or demanufactured for recycling. The boxes used to return the cartridges are also recycled.

To return Lexmark cartridges for reuse or recycling, do the following:

- 1 Go to [www.lexmark.com/recycle](http://www.lexmark.com/recycle).
- 2 Select the product that you want to recycle.

## Static sensitivity notice

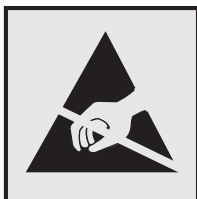

This symbol identifies static-sensitive parts. Do not touch the areas near these symbols without first touching a metal surface in an area away from the symbol.

To prevent damage from electrostatic discharge when performing maintenance tasks such as clearing paper jams or replacing supplies, touch any exposed metal frame of the printer before accessing or touching interior areas of the printer even if the symbol is not present.

## ENERGY STAR

Any Lexmark product bearing the ENERGY STAR® emblem on the product or on a start-up screen is certified to comply with Environmental Protection Agency (EPA) ENERGY STAR requirements as of the date of manufacture.



## Temperature information

Ambient operating temperature	10 to 32.2°C (50 to 90°F)
Shipping temperature	-40 to 40°C (-40 to 104°F)
Storage temperature and relative humidity	-40 to 40°C (-40 to 104°F) 8 to 80% RH

## Laser notice

The printer is certified in the U.S. to conform to the requirements of DHHS 21 CFR, Chapter I, Subchapter J for Class I (1) laser products, and elsewhere is certified as a Class I laser product conforming to the requirements of IEC 60825-1: 2014.

Class I laser products are not considered to be hazardous. The laser system and printer are designed so there is never any human access to laser radiation above a Class I level during normal operation, user maintenance, or prescribed service conditions. The printer has a non-serviceable printhead assembly that contains a laser with the following specifications:

Class: IIIb (3b) AlGaInP

Nominal output power (milliwatts): 25

Wavelength (nanometers): 775–800

## Power consumption

### Product power consumption

The following table documents the power consumption characteristics of the product.

**Note:** Some modes may not apply to your product.

Mode	Description	Power consumption (Watts)
Printing	The product is generating hard-copy output from electronic inputs.	One-sided: 530 (MX331), 580 (MX431, MB3442); Two-sided: 315 (MX331), 330 (MX431, MB3442)
Copy	The product is generating hard-copy output from hard-copy original documents.	550 (MX331); 600 (MX431, MB3442)
Scan	The product is scanning hard-copy documents.	13 (MX331); 14 (MX431, MB3442)
Ready	The product is waiting for a print job.	6.5 (MX331); 7 (MX431adn); 7.5 (MX431adw, MB3442)
Sleep Mode	The product is in a high-level energy-saving mode.	0.8 (MX331); 0.9 (MX431adn); 1.1 (MX431adw, MB3442)
Hibernate	The product is in a low-level energy-saving mode.	0.1
Off	The product is plugged into an electrical outlet, but the power switch is turned off.	0.1

The power consumption levels listed in the previous table represent time-averaged measurements. Instantaneous power draws may be substantially higher than the average.

Values are subject to change. See [www.lexmark.com](http://www.lexmark.com) for current values.

### Sleep Mode

This product is designed with an energy-saving mode called *Sleep Mode*. The Sleep Mode saves energy by lowering power consumption during extended periods of inactivity. The Sleep Mode is automatically engaged after this product is not used for a specified period of time, called the *Sleep Mode Timeout*.

Factory default Sleep Mode Timeout for this product (in minutes):	15
---	----

By using the configuration menus, the Sleep Mode Timeout can be modified between 1 minute and 120 minutes. If the print speed is less than or equal to 30 pages per minute, then you can set the timeout only up to 60 minutes. Setting the Sleep Mode Timeout to a low value reduces energy consumption, but may increase the response time of the product. Setting the Sleep Mode Timeout to a high value maintains a fast response, but uses more energy.

## Hibernate Mode

This product is designed with an ultra-low power operating mode called *Hibernate mode*. When operating in Hibernate Mode, all other systems and devices are powered down safely.

The Hibernate mode can be entered in any of the following methods:

- Using the Hibernate Timeout
- Using the Schedule Power modes

Factory default Hibernate Timeout for this product in all countries or regions	3 days
--	--------

The amount of time the printer waits after a job is printed before it enters Hibernate mode can be modified between one hour and one month.

## Off mode

If this product has an off mode which still consumes a small amount of power, then to completely stop product power consumption, disconnect the power supply cord from the electrical outlet.

## Total energy usage

It is sometimes helpful to estimate the total product energy usage. Since power consumption claims are provided in power units of Watts, the power consumption should be multiplied by the time the product spends in each mode in order to calculate energy usage. The total product energy usage is the sum of each mode's energy usage.

## Regulatory notices for telecommunication terminal equipment

This section contains regulatory information pertaining to products that contain the analog facsimile card:

Lexmark Regulatory Type/Model Number:

LEX-M14-002

## Notice to users of the US telephone network: FCC requirements

This equipment complies with Part 68 of the FCC rules and the requirements adopted by the Administrative Council for Terminal Attachments (ACTA). On the back of this equipment is a label that contains, among other information, a product identifier in the format US:AAAEQ##TXXXX. If requested, this number must be provided to your telephone company.

This equipment uses the RJ-11C Universal Service Order Code (USOC) jack.

A plug and jack used to connect this equipment to the premises' wiring and telephone network must comply with the applicable FCC Part 68 rules and requirements adopted by the ACTA. Use a compliant telephone cord (RJ-11) that is 26 AWG or larger when connecting this product to the public switched telephone network. See your setup documentation for more information.

The Ringer Equivalence Number (REN) is used to determine the number of devices that may be connected to a telephone line. Excessive RENs on a telephone line may result in the devices not ringing in response to an incoming call. In most but not all areas, the sum of RENs should not exceed five (5.0). To be certain of the number of devices that may be connected to a line, as determined by the total RENs, contact your local telephone

company. For products approved after July 23, 2001, the REN for this product is part of the product identifier that has the format US:AAAEQ##TXXXX. The digits represented by ## are the REN without a decimal point (for example, 03 is a REN of 0.3). For earlier products, the REN is shown separately on the label.

If this equipment causes harm to the telephone network, the telephone company will notify you in advance that temporary discontinuance of service may be required. If advance notice is not practical, the telephone company will notify the customer as soon as possible. You will also be advised of your right to file a complaint with the FCC.

The telephone company may make changes in its facilities, equipment, operations or procedures that could affect the operation of this equipment. If this happens, the telephone company will provide advance notice in order for you to make necessary modifications to maintain uninterrupted service.

If you experience trouble with this equipment, for repair or warranty information, contact Lexmark International, Inc. at [www.lexmark.com](http://www.lexmark.com) or your Lexmark representative. If the equipment is causing harm to the telephone network, the telephone company may request that you disconnect the equipment until the problem is resolved.

This equipment contains no user serviceable parts. For repair and warranty information, contact Lexmark International, Inc. See the previous paragraph for contact information.

Connection to party line service is subject to state tariffs. Contact the state public utility commission, public service commission, or corporation commission for information.

If your home has specially wired alarm equipment connected to the telephone line, ensure the installation of this equipment does not disable your alarm equipment. If you have questions about what will disable alarm equipment, consult your telephone company or a qualified installer.

The Telephone Consumer Protection Act of 1991 makes it unlawful for any person to use a computer or other electronic device, including fax machines, to send any message unless said message clearly contains in a margin at the top or bottom of each transmitted page or on the first page of the transmission, the date and time it is sent and an identification of the business or other entity, or other individual sending the message, and the telephone number of the sending machine or such business, other entity, or individual. (The telephone number provided may not be a 900 number or any other number for which charges exceed local or long-distance transmission charges.)

See your user documentation in order to program this information into your fax machine.

## **Notice to users of the Canadian telephone network**

This product meets the applicable Industry Canada technical specifications.

The Ringer Equivalence Number (REN) indicates the maximum number of devices allowed to be connected to a telephone interface. The termination of an interface may consist of any combination of devices subject only to the requirement that the sum of the RENs of all the devices not exceed five. The REN is located on the product label.

This equipment uses CA11A telephone jacks.

### **Avis réservé aux utilisateurs du réseau téléphonique du Canada**

Ce produit est conforme aux spécifications techniques d'Industrie Canada.

Le numéro REN (ringer equivalence number : numéro d'équivalence de sonnerie) indique le nombre maximum d'appareils pouvant être connectés à l'interface téléphonique. En bout de ligne, le nombre d'appareils qui peuvent être connectés n'est pas directement limité, mais la somme des REN de ces appareils ne doit pas dépasser cinq. Le numéro REN est indiqué sur l'étiquette produit.

Cet équipement utilise des prises de téléphone CA11A.

## **Notice to users of the New Zealand telephone network**

The following are special conditions for the Facsimile User Instructions. The grant of a telepermit for any item of terminal equipment indicates only that Telecom has accepted that the item complies with minimum conditions for connection to its network. It indicates no endorsement of the product by Telecom, nor does it provide any sort of warranty. Above all, it provides no assurance that any item will work correctly in all respects with another item of telepermitted equipment of a different make or model, nor does it imply that any product is compatible with all of Telecom's network services.

This equipment shall not be set up to make automatic calls to the Telecom "111" Emergency Service.

This equipment may not provide for the effective hand-over of a call to another device connected to the same line.

This equipment should not be used under any circumstances that may constitute a nuisance to other Telecom customers.

This equipment is not capable, under all operating conditions, of correct operation at the higher speeds for which it is designed. Telecom will accept no responsibility should difficulties arise in such circumstances.

The decadic (or pulse) dialing on this device is unsuitable for use on the Telecom network in New Zealand.

For correct operation, the total of all the Ringer Equivalence Numbers (RENs) of all parallel devices connected to the same telephone line may not exceed 5. The REN of this device is located on the label.

This device uses an RJ-11C modular connector. Contact your point of purchase if a BT adapter is required. The Lexmark part number is 80D1873.

Some parameters required for compliance with Telecom's telepermit requirements are dependent on the equipment associated with this device. The associated equipment shall be set to operate within the following limits for compliance to Telecom's specifications:

- There shall be no more than 10 call attempts to the same number within any 30 minute period for any single manual call initiation, and
- The equipment shall go on-hook for a period of not less than 30 seconds between the end of one attempt and the beginning of the next call attempt.
- The equipment shall be set to ensure that automatic calls to different numbers are spaced such that there is not less than 5 seconds between the end of one call attempt and the beginning of another.

## **Japanese telecom notice**

The installed optional modem is in compliance with Japanese Telecommunication Law and has been Certified by JATE, with the following Certification Number:

A18-0046001

	Lexmark International, Inc.
	LEX-M14-002
	A18-0046001

## Using this product in Switzerland

This product requires a Swiss billing tone filter (Lexmark part number 80D1877) to be installed on any line which receives metering pulses in Switzerland.

## Utilisation de ce produit en Suisse

Cet appareil nécessite l'utilisation d'un filtre de tonalité de facturation suisse (n° de référence Lexmark : 80D1877) devant être installé sur toute ligne recevant des impulsions de comptage en Suisse.

## Verwendung dieses Produkts in der Schweiz

Für dieses Produkt muss ein schweizerischer Billing Tone Filter zur Zählzeichenübertragung (Lexmark Teilenummer 80D1877) für jede Leitung installiert werden, über die in der Schweiz Zeitsteuertakte übertragen werden.

## Uso del prodotto in Svizzera

Questo prodotto richiede un filtro toni Billing svizzero, (codice Lexmark 80D1877) da installare su tutte le linee che ricevono impulsi remoti in Svizzera.

## Regulatory notices for wireless products

This section contains regulatory information that applies only to wireless models.

If in doubt as to whether your model is a wireless model, go to <http://support.lexmark.com>.

## Modular component notice

Wireless models contain the following modular component:

Regulatory Type/Model Number LEX-M08-001; FCC ID:IYLLEXM08001; IC:2376A-LEXM08001

To determine which modular components are installed in your particular product, refer to the labeling on your actual product.



## Exposure to radio frequency radiation

The radiated output power of this device is far below the radio frequency exposure limits of the FCC and other regulatory agencies. A minimum separation of 20 cm (8 inches) must be maintained between the antenna and any persons for this device to satisfy the RF exposure requirements of the FCC and other regulatory agencies.

## Industry Canada (Canada)

This device complies with Industry Canada license-exempt RSS standards. Operation is subject to the following two conditions: (1) this device may not cause interference, and (2) this device must accept any interference, including interference that may cause undesired operation of the device.

## Industrie Canada (Canada)

Cet appareil est conforme aux normes RSS exemptes de licence d'Industrie Canada. Son fonctionnement est soumis aux deux conditions suivantes : (1) cet appareil ne doit pas causer d'interférences et (2) il doit accepter toutes les interférences, y compris les celles qui peuvent entraîner un fonctionnement indésirable.

## Federal Communications Commission (FCC) compliance information statement

This product has been tested and found to comply with the limits for a Class B digital device, pursuant to Part 15 of the FCC Rules. Operation is subject to the following two conditions: (1) this device may not cause harmful interference, and (2) this device must accept any interference received, including interference that may cause undesired operation.

The FCC Class B limits are designed to provide reasonable protection against harmful interference when the equipment is operated in a residential installation. This equipment generates, uses, and can radiate radio frequency energy and, if not installed and used in accordance with the instructions, may cause harmful interference to radio communications. However, there is no guarantee that interference will not occur in a particular installation. If this equipment does cause harmful interference to radio or television reception, which can be determined by turning the equipment off and on, the user is encouraged to try to correct the interference by one or more of the following measures:

- Reorient or relocate the receiving antenna.
- Increase the separation between the equipment and receiver.
- Connect the equipment into an outlet on a circuit different from that to which the receiver is connected.
- Consult your point of purchase or service representative for additional suggestions.

The manufacturer is not responsible for radio or television interference caused by using other than recommended cables or by unauthorized changes or modifications to this equipment. Unauthorized changes or modifications could void the user's authority to operate this equipment.

**Note:** To assure compliance with FCC regulations on electromagnetic interference for a Class B computing device, use a properly shielded and grounded cable such as Lexmark part number 1021231 for parallel attach or 1021294 for USB attach. Use of a substitute cable not properly shielded and grounded may result in a violation of FCC regulations.

Any questions regarding this compliance information statement should be directed to:

Director of Lexmark Technology & Services  
Lexmark International, Inc.  
740 West New Circle Road  
Lexington, KY 40550  
Telephone: (859) 232-2000  
E-mail: regulatory@lexmark.com

## Industry Canada compliance statement

This Class B digital apparatus meets all requirements of the Canadian Interference-Causing Equipment Standard ICES-003.

## Avis de conformité aux normes de l'industrie du Canada

Cet appareil numérique de classe B est conforme aux exigences de la norme canadienne relative aux équipements pouvant causer des interférences NMB-003.

## 日本の VCCI 規定

製品にこのマークが表示されている場合、次の要件を満たしています。



この装置は、クラス B 情報技術装置です。この装置は、家庭環境で使用することを目的としていますが、この装置がラジオやテレビジョン受信機に近接して使用されると、受信障害を引き起こすことがあります。取扱説明書に従って正しい取り扱いをしてください。

VCCI-B

## European Community (EC) directives conformity

This product is in conformity with the protection requirements of EC Council directive 2014/53/EU on the approximation and harmonization of the laws of the Member States relating to radio equipment.

The manufacturer of this product is: Lexmark International, Inc., 740 West New Circle Road, Lexington, KY, 40550 USA. The authorized representative is: Lexmark International Technology Hungária Kft., 8 Lechner Ödön fasor, Millennium Tower III, 1095 Budapest HUNGARY. A declaration of conformity to the requirements of the Directives is available upon request from the Authorized Representative or may be obtained at [www.lexmark.com/en\\_us/about/regulatory-compliance/european-union-declaration-of-conformity.html](http://www.lexmark.com/en_us/about/regulatory-compliance/european-union-declaration-of-conformity.html).

Compliance is indicated by the CE marking:



## **EU and other countries statement of radio transmitter operational frequency bands and maximum RF power**

This radio product transmits in the 2.4GHz (2.412–2.472GHz) band in the EU. The maximum transmitter EIRP power output, including antenna gain, is  $\leq 20\text{dBm}$ .

## **European Community (EC) directives conformity**

This product is in conformity with the protection requirements of EC Council directives 2014/30/EU, 2014/35/EU, 2009/125/EC, and 2011/65/EU on the approximation and harmonization of the laws of the Member States relating to electromagnetic compatibility, safety of electrical equipment designed for use within certain voltage limits, the ecodesign of energy-related products, and on the restrictions of use of certain hazardous substances in electrical and electronic equipment.

The manufacturer of this product is: Lexmark International, Inc., 740 West New Circle Road, Lexington, KY, 40550 USA. The authorized representative is: Lexmark International Technology Hungária Kft., 8 Lechner Ödön fasor, Millennium Tower III, 1095 Budapest HUNGARY. A declaration of conformity to the requirements of the Directives is available upon request from the Authorized Representative or may be obtained at [www.lexmark.com/en\\_us/about/regulatory-compliance/european-union-declaration-of-conformity.html](http://www.lexmark.com/en_us/about/regulatory-compliance/european-union-declaration-of-conformity.html).

This product satisfies the Class B limits of EN 55022 and EN55032 and safety requirements of EN 60950-1 or EN 62368-1.

## **STATEMENT OF LIMITED WARRANTY FOR LEXMARK LASER PRINTERS, LEXMARK LED PRINTERS, AND LEXMARK MULTIFUNCTION LASER PRINTERS**

### **Lexmark International, Inc., Lexington, KY**

This limited warranty applies to the United States and Canada. For customers outside the U.S., refer to the country-specific warranty information that came with your product.

This limited warranty applies to this product only if it was originally purchased for your use, and not for resale, from Lexmark or a Lexmark Remarketer, referred to in this statement as “Remarketer.”

### **Limited warranty**

Lexmark warrants that this product:

- Is manufactured from new parts, or new and serviceable used parts, which perform like new parts
- Is, during normal use, free from defects in material and workmanship

If this product does not function as warranted during the warranty period, contact a Remarketer or Lexmark for repair or replacement (at Lexmark's option).

If this product is a feature or option, this statement applies only when that feature or option is used with the product for which it was intended. To obtain warranty service, you may be required to present the feature or option with the product.

If you transfer this product to another user, warranty service under the terms of this statement is available to that user for the remainder of the warranty period. You should transfer proof of original purchase and this statement to that user.

### **Limited warranty service**

The warranty period starts on the date of original purchase as shown on the purchase receipt and ends 12 months later provided that the warranty period for any supplies and for any maintenance items included with the printer shall end earlier if it, or its original contents, are substantially used up, depleted, or consumed. Fuser Units, Transfer/Transport Units, Paper Feed items, if any, and any other items for which a Maintenance Kit is available are substantially consumed when the printer displays a “Life Warning” or “Scheduled Maintenance” message for such item.

To obtain warranty service you may be required to present proof of original purchase. You may be required to deliver your product to the Remarketer or Lexmark, or ship it prepaid and suitably packaged to a Lexmark designated location. You are responsible for loss of, or damage to, a product in transit to the Remarketer or the Lexmark designated location.

When warranty service involves the exchange of a product or part, the item replaced becomes the property of the Remarketer or Lexmark. The replacement may be a new or repaired item.

The replacement item assumes the remaining warranty period of the original product.

Replacement is not available to you if the product you present for exchange is defaced, altered, in need of a repair not included in warranty service, damaged beyond repair, or if the product is not free of all legal obligations, restrictions, liens, and encumbrances.

As part of your warranty service and/or replacement, Lexmark may update the firmware in your printer to the latest version. Firmware updates may modify printer settings and cause counterfeit and/or unauthorized products, supplies, parts, materials (such as toners and inks), software, or interfaces to stop working. Authorized use of genuine Lexmark products will not be impacted.

Before you present this product for warranty service, remove all print cartridges, programs, data, and removable storage media (unless directed otherwise by Lexmark).

For further explanation of your warranty alternatives and the nearest Lexmark authorized servicer in your area contact Lexmark on the World Wide Web.

Remote technical support is provided for this product throughout its warranty period. For products no longer covered by a Lexmark warranty, technical support may not be available or only be available for a fee.

### **Extent of limited warranty**

Lexmark does not warrant uninterrupted or error-free operation of any product or the durability or longevity of prints produced by any product.

Warranty service does not include repair of failures caused by:

- Modification or unauthorized attachments
- Accidents, misuse, abuse or use inconsistent with Lexmark user’s guides, manuals, instructions or guidance
- Unsuitable physical or operating environment
- Maintenance by anyone other than Lexmark or a Lexmark authorized servicer
- Operation of a product beyond the limit of its duty cycle
- Use of printing media outside of Lexmark specifications

- Refurbishment, repair, refilling or remanufacture by a third party of products, supplies or parts
- Products, supplies, parts, materials (such as toners and inks), software, or interfaces not furnished by Lexmark

**TO THE EXTENT PERMITTED BY APPLICABLE LAW, NEITHER LEXMARK NOR ITS THIRD PARTY SUPPLIERS OR REMARKETERS MAKE ANY OTHER WARRANTY OR CONDITION OF ANY KIND, WHETHER EXPRESS OR IMPLIED, WITH RESPECT TO THIS PRODUCT, AND SPECIFICALLY DISCLAIM THE IMPLIED WARRANTIES OR CONDITIONS OF MERCHANTABILITY, FITNESS FOR A PARTICULAR PURPOSE, AND SATISFACTORY QUALITY. ANY WARRANTIES THAT MAY NOT BE DISCLAIMED UNDER APPLICABLE LAW ARE LIMITED IN DURATION TO THE WARRANTY PERIOD. NO WARRANTIES, EXPRESS OR IMPLIED, WILL APPLY AFTER THIS PERIOD. ALL INFORMATION, SPECIFICATIONS, PRICES, AND SERVICES ARE SUBJECT TO CHANGE AT ANY TIME WITHOUT NOTICE.**

### **Limitation of liability**

Your sole remedy under this limited warranty is set forth in this document. For any claim concerning performance or nonperformance of Lexmark or a Remarketer for this product under this limited warranty, you may recover actual damages up to the limit set forth in the following paragraph.

Lexmark's liability for actual damages from any cause whatsoever will be limited to the amount you paid for the product that caused the damages. This limitation of liability will not apply to claims by you for bodily injury or damage to real property or tangible personal property for which Lexmark is legally liable. **IN NO EVENT WILL LEXMARK BE LIABLE FOR ANY LOST PROFITS, LOST SAVINGS, INCIDENTAL DAMAGE, OR OTHER ECONOMIC OR CONSEQUENTIAL DAMAGES.** This is true even if you advise Lexmark or a Remarketer of the possibility of such damages. Lexmark is not liable for any claim by you based on a third party claim.

This limitation of remedies also applies to claims against any Suppliers and Remarketers of Lexmark. Lexmark's and its Suppliers' and Remarketers' limitations of remedies are not cumulative. Such Suppliers and Remarketers are intended beneficiaries of this limitation.

### **Additional rights**

Some states do not allow limitations on how long an implied warranty lasts, or do not allow the exclusion or limitation of incidental or consequential damages, so the limitations or exclusions contained above may not apply to you.

This limited warranty gives you specific legal rights. You may also have other rights that vary from state to state.

# Index

## A

- adapter plug 24
- adding a shortcut
  - copy 47
- adding hardware options
  - print driver 33
- adding internal options
  - print driver 33
- adding shortcut
  - e-mail 49
  - fax destination 51
- ADF registration
  - adjusting 190
- ADF separator pad
  - replacing 127
- adjusting ADF registration 190
- adjusting darkness
  - fax 51
- adjusting scanner registration 189
- adjusting the brightness
  - printer display 132
- adjusting the brightness of the printer display 132
- adjusting toner darkness 44
- AirPrint
  - using 40
- Android device
  - printing from 39
- answering machine
  - setting up 22
- assigning printer to a ring pattern 27
- attaching cables 20
- automatic document feeder (ADF)
  - using 45, 48, 50, 53
- avoiding paper jams 138

## B

- blank pages 161
- blocking junk faxes 52

## C

- can send but not receive faxes 185

- canceling a print job
  - from the computer 44
  - from the printer control panel 44
- cannot open Embedded Web Server 136
- cannot receive faxes 185
- cards
  - copying 47
- changing resolution
  - fax 51
- checking the status of parts and supplies 113
- cleaning
  - exterior of the printer 129
  - interior of the printer 129
- cleaning the printer 129
- Cleaning the Scanner 112
- cleaning the scanner 130
- clearing jam
  - in the duplex unit 148
  - in the multipurpose feeder 142
  - in the rear door 150
  - in trays 145
- clearing jams
  - in the standard bin 141
- Cloud Connector profile
  - creating 35
  - printing from 43
  - scanning to 55
- collated printing does not work 153
- collating copies 46
- confidential print jobs 42
  - printing from a Macintosh computer 43
  - printing from Windows 43
- confidential print jobs do not print 156
- configuring daylight saving time 28
- configuring supply notifications 113
- configuring the settings
  - fax speaker 28
- configuring the SMTP server 48
- connecting printer to distinctive ring service 27

- connecting the printer
  - to a wireless network 33
- connecting to a wireless network
  - using PIN method 34
  - using Push Button method 34
- conserving supplies 132
- contacting customer support 190
- control panel
  - using 11
- copy troubleshooting
  - partial copies of documents or photos 187
  - poor copy quality 188
  - scanner does not respond 189
- copying
  - cards 47
  - on both sides of the paper 46
  - on letterhead 46
  - photos 45
  - using the automatic document feeder (ADF) 45
  - using the scanner glass 45
- copying different paper sizes 45
- copying from
  - selected tray 45
- copying multiple pages
  - onto a single sheet 46
- creating a Cloud Connector profile 35
- creating a shortcut
  - copy 47
  - FTP address 53
  - network folder 54
- creating an FTP shortcut 53
- creating shortcut
  - e-mail 49
  - fax destination 51
- crooked print 173
- customer support
  - contacting 190
- cut off images 175
- cut off text 175

## D

- dark print 163
- date and time
  - fax settings 28

- daylight saving time
  - configuring 28
- deactivating the Wi-Fi network 35
- different paper sizes, copying 45
- distinctive ring service, fax
  - enabling 27
- documents, printing
  - from a computer 39
  - from a mobile device 39
- dots on print 170

## E

- emission notices 193, 201, 202
- enabling the USB port 135
- enlarging copies 46
- environmental settings 131
- erasing printer memory 37
- Ethernet port 20
- exporting a configuration file
  - using the Embedded Web Server 32
- EXT port 20
- e-mail
  - sending 49
- e-mail alerts
  - setting up 113
- e-mail server
  - setting up 48
- e-mail shortcut
  - creating 49
- e-mailing
  - using the automatic document feeder (ADF) 48
  - using the scanner glass 48

## F

- factory default settings
  - restoring 37
- fax
  - forwarding 52
  - scheduling send time and date 51
  - setting up 21
- fax darkness
  - adjusting 51
- fax destination shortcut
  - creating 51
- fax log
  - viewing 52

- fax resolution
  - changing 51
- fax setup
  - country- or region-specific 24
  - standard telephone line connection 22
- fax speaker
  - configuring the settings 28
- fax troubleshooting
  - caller ID is not shown 183
  - cannot receive faxes 185
  - cannot send faxes 185
  - cannot send or receive faxes 183
  - poor print quality 186
- faxing
  - from the printer 21
  - setting the date and time 28
  - using the automatic document feeder (ADF) 50
  - using the scanner glass 50
- FCC notices 201
- finding more information about the printer 9
- fine lines are not printed correctly 164
- firmware, updating 32
- flash drive
  - printing from 41
  - scanning to 54
- folder paper 165
- font sample list
  - printing 44
- FTP address
  - creating a shortcut 53
- FTP server
  - scanning to 53

## G

- genuine Lexmark parts and supplies 114
- genuine parts and supplies 114
- Google Cloud Print
  - using 39
- gray background on prints 166

## H

- hardware options
  - trays 21
- hardware options, adding print driver 33

- held jobs 42
  - printing from a Macintosh computer 43
  - printing from Windows 43
- held jobs do not print 156
- Hibernate mode
  - configuring 131
- home screen
  - customizing 12
- home screen icons
  - displaying 12
- horizontal light bands 176

## I

- icons on the home screen
  - showing 12
- images cut off 175
- imaging unit
  - ordering 116
  - replacing 119
- importing a configuration file
  - using the Embedded Web Server 32
- incorrect margins 168
- indicator light
  - understanding the status 12
- installing the print driver 31
- installing the printer software 31
- installing trays 21
- internal options, adding print driver 33

## J

- jam locations
  - identifying 140
- jams
  - avoiding 138
- jams, clearing
  - in the automatic document feeder 141
- junk faxes
  - blocking 52

## K

- keyboard on the display
  - changing the language 12

## L

- language, changing the keyboard on the display 12

- letterhead
  - copying on 46
  - selecting 14
- Lexmark Mobile Print
  - using 39
- light print 168
- LINE port 20
- linking trays 31
- loading envelopes
  - in the multipurpose feeder 30
- loading letterhead
  - in the multipurpose feeder 30
- loading trays 28
- locating jam areas 140
- locating the security slot 37

## M

- making copies 45
- memory
  - types installed on printer 38
- menu
  - 802.1x 102
  - About this Printer 67
  - Certificate Management 108
  - Cloud Connector 111
  - Confidential Print Setup 109
  - Config Menu 63
  - Copy Defaults 76
  - Custom Scan Sizes 75
  - Device 111
  - Eco-Mode 58
  - Erase Temporary Data Files 110
  - Ethernet 97
  - E-mail Defaults 86
  - E-mail Setup 84
  - Fax 112
  - Fax Mode 77
  - Fax Setup 78
  - Flash Drive Print 92
  - Flash Drive Scan 90
  - FTP Defaults 88
  - Google Cloud Print 105
  - HTTP/FTP Settings 103
  - Image 72
  - Information Sent to Lexmark 62
  - IPSec 101
  - Layout 68
  - Local Accounts 108
  - Login Restrictions 109
  - LPD Configuration 103
  - Media Types 75
  - Menu Settings Page 111

- Miscellaneous 110
- Network 112
- Network Overview 94
- Notifications 59
- Out of Service Erase 66
- PCL 71
- PDF 70
- PostScript 70
- Power Management 61
- Preferences 57
- Print 111
- Public 107
- Quality 70
- Remote Operator Panel 59
- Restore Factory Defaults 62
- Restrict external network
  - access 105
- Schedule USB Devices 108
- Setup 69
- Shortcuts 111
- SNMP 100
- TCP/IP 99
- Tray Configuration 73
- Troubleshooting 112
- Universal Setup 74
- USB 104
- Visible Home Screen Icons 67
- Wireless 95
- Wi-Fi Direct 105
- Menu Settings Page
  - printing 36
- missing print 181
- mobile device
  - printing from 39, 40
- Mopria Print Service 39
- mottled print 170
- moving the printer 19, 132
- multipurpose feeder
  - loading 30

## N

- network folder
  - creating a shortcut 54
  - scanning to 54
- network setup page
  - printing 35
- noise emission levels 193
- Non-Lexmark supply 137
- non-volatile memory 38
  - erasing 37
- notices 193, 194, 195, 196, 197, 201, 202

## O

- ordering
  - toner cartridge 114
- ordering supplies
  - imaging unit 116

## P

- paper
  - letterhead 14
  - preprinted forms 14
  - selecting 13
  - unacceptable 14
  - Universal size setting 28
- paper characteristics 13
- paper curl 171
- paper guidelines 13
- paper jam
  - in the rear door 150
  - in trays 145
- paper jam in the automatic document feeder 141
- paper jam in the duplex unit 148
- paper jam in the multipurpose feeder 142
- paper jam in the standard bin 141
- paper jam, clearing
  - in the automatic document feeder 141
  - in the standard bin 141
- paper jams
  - avoiding 138
  - location 140
- paper sizes, supported 15
- paper types, supported 17
- paper weights, supported 18
- parts of the printer 11
- parts status
  - checking 113
- personal identification number method 34
- photos
  - copying 45
- pick roller assembly
  - replacing 122
- placing separator sheets 44
- poor fax print quality 186
- power cord socket 20
- power save modes
  - configuring 131
- preprinted forms
  - selecting 14



- print driver
    - hardware options, adding 33
    - installing 31
  - print job
    - canceling from the computer 44
    - canceling from the printer control panel 44
  - print jobs not printed 155
  - print quality is poor 160
  - Print Quality Test Pages 112
  - print quality troubleshooting
    - blank or white pages 161
    - crooked print 173
    - dark print 163
    - fine lines are not printed correctly 164
    - folded or wrinkled paper 165
    - gray background on prints 166
    - horizontal light bands 176
    - light print 168
    - mottled print and dots 170
    - paper curl 171
    - repeating defects 182
    - skewed print 173
    - solid black pages 174
    - text or images cut off 175
    - toner easily rubs off 176
    - vertical dark bands 179
    - vertical dark lines or streaks 180
    - vertical dark streaks with print missing 181
    - vertical light bands 177
    - vertical white lines 178
  - print troubleshooting
    - collated printing does not work 153
    - confidential and other held documents do not print 156
    - envelope seals when printing 153
    - incorrect margins 168
    - jammed pages are not reprinted 155
    - job prints from the wrong tray 157
    - job prints on the wrong paper 157
    - paper frequently jams 154
    - print jobs do not print 155
    - print quality is poor 160
    - slow printing 158
    - tray linking does not work 154
    - unable to read flash drive 135
  - printer
    - minimum clearances 19
    - selecting a location 19
    - shipping 133
  - printer configuration 11
  - printer display
    - adjusting the brightness 132
  - printer information
    - finding 9
  - printer is not responding 134
  - printer memory
    - erasing 37
  - printer menus 56
  - printer messages
    - Non-Lexmark supply 137
    - Replace cartridge, printer region mismatch 137
  - printer ports 20
  - printer settings
    - restoring factory default 37
  - printer software
    - installing 31
  - printer status 12
- printing
- font sample list 44
  - from a Cloud Connector profile 43
  - from a computer 39
  - from a flash drive 41
  - from a mobile device 39, 40
  - from an Android device 39
  - Menu Settings Page 36
  - network setup page 35
  - using Google Cloud Print 39
  - using Mopria Print Service 39
  - using Wi-Fi Direct 40
- printing a font sample list 44
- printing a network setup page 35
- printing confidential and other held jobs
- from a Macintosh computer 43
  - from Windows 43
- printing from a computer 39
- printing from a flash drive 41
- Push Button method 34

**R**

- received fax
  - forwarding 52
- recycling
  - Lexmark packaging 191
  - Lexmark products 191
- reducing copies 46
- removing paper jam
  - in the duplex unit 148
  - in the multipurpose feeder 142
  - in the rear door 150
  - in trays 145
- repeat print jobs 42
  - printing from a Macintosh computer 43
  - printing from Windows 43
- repeating defects on print 182
- Replace cartridge, printer region mismatch 137
- replacing parts
  - ADF separator pad 127
  - pick roller assembly 122
  - tray 122
  - tray separator roller 126
- replacing supplies
  - imaging unit 119
  - toner cartridge 116
- reports
  - printer status 113
  - printer usage 113
- reserve print jobs
  - printing from a Macintosh computer 43
  - printing from Windows 43
- resetting
  - supply usage counters 137
- resetting supply usage counters 129
- restoring factory default settings 37
- RJ11 adapter 24

**S**

- safety information 7, 8
- saving paper 46
- saving toner 46
- scan troubleshooting
  - cannot scan from a computer 186
  - partial copies of documents or photos 187

- poor copy quality 188
  - scan job was not successful 187
  - scanner does not respond 189
  - scanning freezes the
    - computer 189
  - scanning takes too long 189
  - vertical dark streaks on output
    - when scanning from the ADF 188
  - scanner
    - cleaning 130
  - scanner does not close 188
  - scanner glass
    - using 45, 48, 50, 53
  - scanner registration
    - adjusting 189
  - scanning
    - to a Cloud Connector profile 55
    - to a network folder 54
    - to an FTP server 53
    - using the automatic document feeder (ADF) 53
    - using the scanner glass 53
  - scanning quality problem 188
  - scanning to a flash drive 54
  - scheduling a fax 51
  - security slot
    - locating 37
  - selecting a location for the printer 19
  - sending a fax
    - using the computer 50
    - using the control panel 50
  - sending an e-mail 49
  - separator sheets
    - placing 44
  - setting the paper size 28
  - setting the paper type 28
  - setting the Universal paper size 28
  - setting up e-mail alerts 113
  - setting up fax
    - country- or region-specific 24
    - standard telephone line connection 22
  - shipping the printer 133
  - shortcut, creating
    - e-mail 49
    - fax destination 51
  - shortcut, creating a copy 47
  - skewed print 173
  - Sleep mode
    - configuring 131
  - slow printing 158
  - SMTP server for e-mail
    - configuring 48
  - solid black pages 174
  - sorting multiple copies 46
  - statement of volatility 38
  - storing paper 14
  - storing print jobs 42
  - supplies
    - conserving 132
  - supplies status
    - checking 113
  - supplies, ordering
    - toner cartridge 114
  - supply notifications
    - configuring 113
  - supply usage counters
    - resetting 129, 137
  - supported file types 42
  - supported flash drives 42
  - supported paper sizes 15
  - supported paper types 17
  - supported paper weights 18
- T**
- text cut off 175
  - toner cartridge
    - ordering 114
    - replacing 116
  - toner darkness
    - adjusting 44
  - toner easily rubs off 176
  - tray separator roller
    - replacing 126
  - trays
    - installing 21
    - linking 31
    - loading 28
    - replacing 122
    - unlinking 31
  - troubleshooting
    - cannot open Embedded Web Server 136
    - print quality is poor 160
    - printer is not responding 134
  - troubleshooting, copy
    - partial copies of documents or photos 187
    - poor copy quality 188
    - scanner does not close 188
    - scanner does not respond 189
  - troubleshooting, fax
    - caller ID is not shown 183
    - cannot send faxes 185
    - cannot send or receive faxes 183
    - poor print quality 186
  - troubleshooting, print
    - collated printing does not work 153
    - confidential and other held documents do not print 156
    - envelope seals when printing 153
    - incorrect margins 168
    - jammed pages are not reprinted 155
    - job prints from the wrong tray 157
    - job prints on the wrong paper 157
    - paper frequently jams 154
    - print jobs do not print 155
    - slow printing 158
    - tray linking does not work 154
  - troubleshooting, print quality
    - blank or white pages 161
    - crooked print 173
    - dark print 163
    - fine lines are not printed correctly 164
    - folded or wrinkled paper 165
    - gray background on prints 166
    - horizontal light bands 176
    - light print 168
    - mottled print and dots 170
    - paper curl 171
    - repeating defects 182
    - skewed print 173
    - solid black pages 174
    - text or images cut off 175
    - toner easily rubs off 176
    - vertical dark bands 179
    - vertical dark lines or streaks 180
    - vertical dark streaks with print missing 181
    - vertical light bands 177
    - vertical white lines 178
  - troubleshooting, scan
    - cannot scan from a computer 186

- partial copies of documents or photos 187
- poor copy quality 188
- scan job was not successful 187
- scanner does not close 188
- scanner does not respond 189
- vertical dark streaks on output
  - when scanning from the ADF 188
- two-sided copying 46

## U

- unable to read flash drive
  - troubleshooting, print 135
- Universal paper size
  - setting 28
- unlinking trays 31
- updating firmware 32
- USB port
  - enabling 135
- USB printer port 20
- using genuine Lexmark parts and supplies 114
- using the ADF
  - copying 45
- using the automatic document feeder (ADF) 45, 48, 50, 53
- using the control panel 11
- using the scanner
  - glass 45, 48, 50, 53
  - copying 45

## V

- verify print jobs 42
  - printing from a Macintosh computer 43
  - printing from Windows 43
- vertical dark bands 179
- vertical dark lines on prints 180
- vertical dark streaks 181
- vertical dark streaks on output
  - when scanning from the ADF 188
- vertical light bands 177
- vertical streaks on prints 180
- vertical white lines 178
- viewing a fax log 52
- viewing reports 113
- volatile memory 38
  - erasing 37
- volatility
  - statement of 38

## W

- white lines 178
- white pages 161
- wireless network
  - connecting the printer to 33
  - Wi-Fi Protected Setup 34
- wireless networking 33
- Wi-Fi Direct
  - printing from a mobile device 40
- Wi-Fi network
  - deactivating 35
- Wi-Fi Protected Setup
  - wireless network 34
- wrinkled paper 165