



HP Color LaserJet Pro MFP M282-M285

User Guide



www.hp.com/videos/LaserJet
www.hp.com/support/ljM282MFP



HP Color LaserJet Pro MFP M282-M285

User Guide

Copyright and License

© Copyright 2019 HP Development Company, L.P.

Reproduction, adaptation, or translation without prior written permission is prohibited, except as allowed under the copyright laws.

The information contained herein is subject to change without notice.

The only warranties for HP products and services are set forth in the express warranty statements accompanying such products and services. Nothing herein should be construed as constituting an additional warranty. HP shall not be liable for technical or editorial errors or omissions contained herein.

Edition 3, 08/2019

Trademark Credits

Adobe®, Adobe Photoshop®, Acrobat®, and PostScript® are trademarks of Adobe Systems Incorporated.

Apple and the Apple logo are trademarks of Apple Inc., registered in the U.S. and other countries.

macOS is a trademark of Apple Inc., registered in the U.S. and other countries.

AirPrint is a trademark of Apple Inc., registered in the U.S. and other countries.

iPad is a trademark of Apple Inc., registered in the U.S. and other countries.

iPod is a trademark of Apple Inc., registered in the U.S. and other countries.

iPhone is a trademark of Apple Inc., registered in the U.S. and other countries.

Microsoft®, Windows®, Windows® XP, and Windows Vista® are U.S. registered trademarks of Microsoft Corporation.

UNIX® is a registered trademark of The Open Group.

Table of contents

1 Printer overview	1
Warning icons	2
Printer views	3
Printer front view	3
Printer back view	4
Control-panel view	5
Home screen layout	6
How to use the touchscreen control panel	7
Printer specifications	8
Technical specifications	8
Supported operating systems	8
Mobile printing solutions	10
Printer dimensions	11
Power consumption, electrical specifications, and acoustic emissions	12
Operating environmental range	12
Printer hardware setup and software installation	13
2 Paper trays	15
Introduction	16
Load paper to the single-sheet slot (Tray 1)	16
Introduction	16
Tray 1 paper orientation	18
Load paper to Tray 2	19
Introduction	19
Tray 2 paper orientation	21
Load and print envelopes	23
Introduction	23
Print envelopes	23
Envelope orientation	24
Load and print labels	25
Introduction	25
Manually feed labels	25

Label orientation	26
3 Supplies, accessories, and parts	27
Order supplies, accessories, and parts	28
Ordering	28
Supplies and accessories	28
Customer self-repair parts	29
Replace the toner cartridges	30
Introduction	30
Remove and replace the toner cartridges	32
4 Print	35
Print tasks (Windows)	36
How to print (Windows)	36
Automatically print on both sides (Windows)	36
Manually print on both sides (Windows)	37
Print multiple pages per sheet (Windows)	37
Select the paper type (Windows)	38
Print tasks (macOS)	39
How to print (macOS)	39
Automatically print on both sides (macOS)	39
Manually print on both sides (macOS)	39
Print multiple pages per sheet (macOS)	40
Select the paper type (macOS)	40
Additional print tasks	40
Mobile printing	41
Introduction	41
Wi-Fi Direct (wireless models only)	41
Enable or disable Wi-Fi Direct	42
Change the printer Wi-Fi Direct name	42
HP ePrint via email	43
HP ePrint software	44
AirPrint	44
Android embedded printing	45
Use walk-up USB printing	46
Introduction	46
Step one: Access USB files on the printer	46
Step two: Print USB documents	46
Option one: Print documents	46
Option two: Print photos	47

5 Copy	49
Make a copy	50
Copy on both sides (duplex)	51
Copy on both sides automatically	51
Copy on both sides manually	51
6 Scan	53
Scan by using the HP Scan software (Windows)	54
Scan by using the HP Smart Software (macOS)	55
Set up the Scan to E-mail feature	56
Introduction	56
Before you begin	56
Method one: Use the Scan to Email Wizard (Windows)	56
Method two: Set up the Scan to Email feature via the HP Embedded Web Server	58
Step one: Access the HP Embedded Web Server (EWS)	58
Step two: Configure the Scan to E-mail feature	58
Step three: Add contacts to the E-mail Address Book	60
Step four: Configure the default E-mail Options	60
Set up the Scan to Network Folder feature	61
Introduction	61
Before you begin	61
Method one: Use the Scan to Network Folder Wizard (Windows)	61
Method two: Set up the Scan to Network Folder feature via the HP Embedded Web Server	63
Step one: Access the HP Embedded Web Server (EWS)	63
Step two: Configure the Scan to Network Folder feature	63
Scan to a USB flash drive	65
Scan to email	66
Scan to a network folder	67
Additional scan tasks	68
7 Fax	69
Set up to send and receive faxes	70
Before starting	70
Step 1: Identify the phone connection type	70
Step 2: Set up the fax	71
Dedicated phone line	71
Shared voice/fax line	72
Shared voice/fax line with an answering machine	73
Step 3: Configure the fax time, date, and header	74
HP Fax Setup Wizard	74

Printer control panel	75
HP Embedded Web Server (EWS) and HP Device Toolbox (Windows)	75
Step 4: Run a fax test	76
Send a fax	77
Fax from the flatbed scanner	77
Fax from the document feeder	78
Use speed dials and group-dial entries	78
Send a fax from the software	79
Send a fax from a third-party software program, such as Microsoft Word	79
8 Manage the printer	81
Use HP Web Services applications (touchscreen models only)	82
Change the printer connection type (Windows)	83
Advanced configuration with HP Embedded Web Server (EWS) and HP Device Toolbox (Windows)	84
Configure IP network settings	87
Introduction	87
Printer sharing disclaimer	87
View or change network settings	87
Rename the printer on a network	87
Manually configure IPv4 TCP/IP parameters from the control panel	88
Printer security features	89
Introduction	89
Assign or change the system password using the Embedded Web Server	89
Energy-conservation settings	90
Introduction	90
Print with EconoMode	90
Set the Sleep/Auto Off After Inactivity setting	90
Set the Shut Down After Inactivity delay and configure the printer to use 1 watt or less of power	90
Set the Delay Shut Down setting	91
HP Web Jetadmin	92
Update the firmware	93
Method one: Update the firmware using the control panel	93
Method two: Update the firmware using the Firmware Update Utility	93
9 Solve problems	95
Customer support	96
Control panel help system	97
Restore the factory-set defaults	98
A “Cartridge is low” or “Cartridge is very low” message displays on the printer control panel	99
Change the “Very Low” settings	99
For printers with fax capability	100

Order supplies	100
Printer does not pick up paper or misfeeds	101
Introduction	101
The product does not pick up paper	101
The product picks up multiple sheets of paper	101
The document feeder jams, skews, or picks up multiple sheets of paper	101
Clear paper jams	103
Introduction	103
Paper jam locations	103
Experiencing frequent or recurring paper jams?	104
Clear paper jams in the document feeder	105
Clear paper jams in the single-sheet slot (Tray 1)	108
Clear paper jams in Tray 2	110
Clear paper jams in the rear door and the fuser area	112
Clear paper jams in the duplexer (duplex models only)	114
Clear paper jams in the output bin	116
Improve print quality	118
Introduction	118
Update the printer firmware	119
Print from a different software program	119
Check the paper-type setting for the print job	119
Check the paper type setting on the printer	119
Check the paper type setting (Windows)	119
Check the paper type setting (macOS)	119
Check toner-cartridge status	120
Print a cleaning page	120
Visually inspect the toner cartridge or cartridges	121
Check paper and the printing environment	121
Step one: Use paper that meets HP specifications	121
Step two: Check the environment	121
Step three: Set the individual tray alignment	122
Try a different print driver	122
Check the EconoMode settings	123
Adjust Print Density	123
Calibrate the printer to align the colors	124
Adjust color settings (Windows)	124
Print and interpret the print quality page	124
Resolving print quality problems	126
Introduction	126
Troubleshoot print quality problems	126
Improve copy and scan image quality	134

Introduction	134
Check the scanner glass for dirt and smudges	134
Eliminate lines or streaks when using the document feeder	135
Check the paper settings	135
Check the image adjustment settings	135
Optimize for text or pictures	136
Check the scanner resolution and color settings on the computer	136
Resolution and color guidelines	136
Color	137
Edge-to-edge copying	137
Clean the pickup rollers and separation pad in the document feeder	138
Improve fax image quality	139
Introduction	139
Check the scanner glass for dirt and smudges	139
Check the send-fax resolution settings	140
Check the error-correction settings	140
Check the fit-to-page setting	140
Clean the pickup rollers and separation pad in the document feeder	141
Send to a different fax machine	142
Check the sender's fax machine	142
Solve wired network problems	143
Introduction	143
Poor physical connection	143
The computer is using the incorrect IP address for the printer	143
The computer is unable to communicate with the printer	144
The printer is using incorrect link and duplex settings for the network	144
New software programs might be causing compatibility problems	144
The computer or workstation might be set up incorrectly	144
The printer is disabled, or other network settings are incorrect	144
Solve wireless network problems	145
Introduction	145
Wireless connectivity checklist	145
The printer does not print after the wireless configuration completes	146
The printer does not print, and the computer has a third-party firewall installed	146
The wireless connection does not work after moving the wireless router or printer	146
Cannot connect more computers to the wireless printer	146
The wireless printer loses communication when connected to a VPN	147
The network does not appear in the wireless networks list	147
The wireless network is not functioning	147
Perform a wireless network diagnostic test	147
Reduce interference on a wireless network	147

Solve fax problems	149
Introduction	149
Fax troubleshooting checklist	149
Solve general fax problems	150
Faxes are sending slowly	150
Fax quality is poor	151
Fax cuts off or prints on two pages	152

Index	153
--------------------	------------

1 Printer overview

- [Warning icons](#)
- [Printer views](#)
- [Printer specifications](#)
- [Printer hardware setup and software installation](#)

For more information:

The following information is correct at the time of publication. For current information, see www.hp.com/support/ljM282MFP.

HP's all-inclusive help for the printer includes the following information:

- Install and configure
- Learn and use
- Solve problems
- Download software and firmware updates
- Join support forums
- Find warranty and regulatory information

Warning icons

Warning icon definitions: The following warning icons may appear on HP products. Apply appropriate caution where applicable.

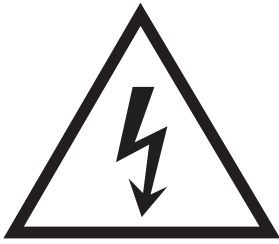

• Caution: Electric shock



• Caution: Hot surface

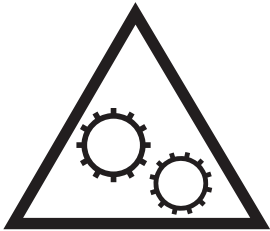

• Caution: Keep body parts away from moving parts



• Caution: Sharp edge in close proximity

Printer views

- [Printer front view](#)
- [Printer back view](#)
- [Control-panel view](#)

Printer front view

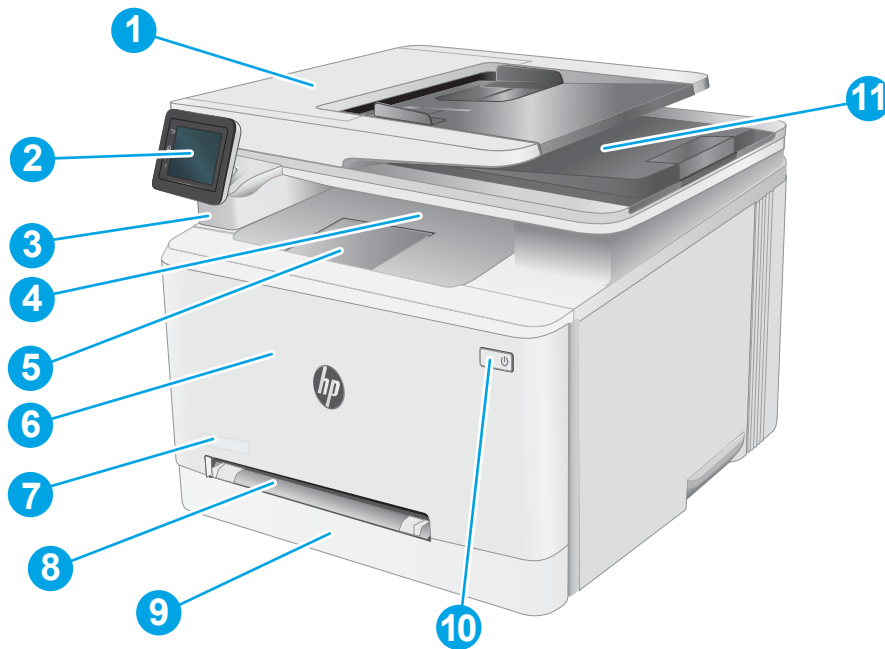

Table 1-1 Printer front view legend

Number	Description
1	Document feeder
2	Control panel with color touchscreen display
3	Walk-up USB port for printing and scanning without a computer
4	Output bin
5	Output bin extension
6	Front door (access to the toner cartridges)
7	Model name
8	Single-sheet priority feed slot (Tray 1)
9	Main input tray (Tray 2)
10	Power button
11	Scanner

Printer back view

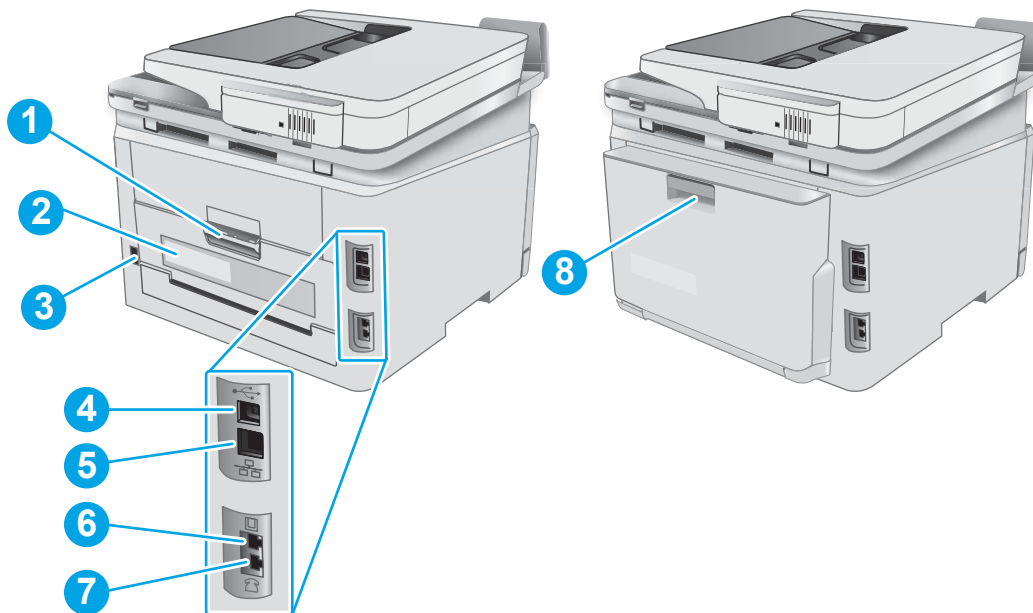

Table 1-2 Printer back view legend

Number	Description
1	Rear door (access for clearing jams)
2	Serial number and product number label
3	Power connection
4	USB interface port
5	Ethernet port
6	Fax "line in" port for attaching the fax phone line to the printer (fax models only)
7	Telephone "line out" port for attaching an extension phone, answering machine, or other device (fax models only)
8	Duplexer (duplex models only)

Control-panel view

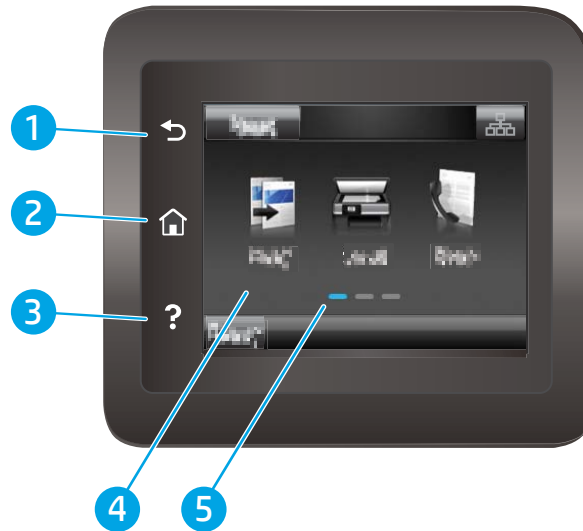



Table 1-3 Control panel legend

Number	Control panel component	Function
1	Back button ↶	Returns to the previous screen
2	Home button 🏠	Provides access to the Home screen
3	Help button ❓	Provides access to the control-panel help system
4	Color touchscreen	Provides access to menus, help animations, and printer information.
5	Home page screen indicator	The display indicates which Home screen the control panel is currently displaying.

 **NOTE:** While the control panel does not have a standard **Cancel** button, during many printer processes a **Cancel** button appears on the touchscreen. This permits users to cancel a process before the printer completes it.

Home screen layout

The Home screen provides access to the printer features and indicates the current status of the printer. Return to the Home screen at any time by touching the Home button on the printer control panel.

 **NOTE:** The features that appear on the Home screen can vary, depending on the printer configuration.

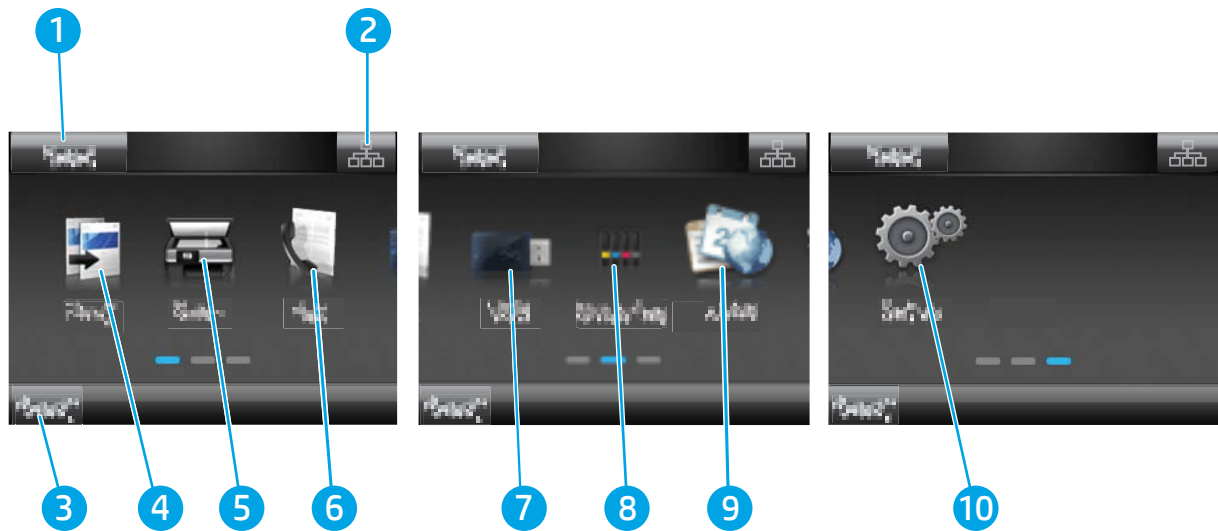











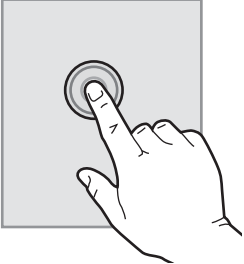

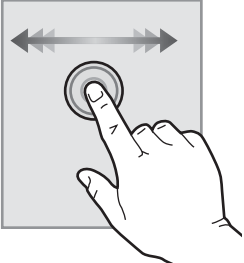

Table 1-4 Home screen legend

Number	Home screen component	Function
1	Reset button	Touch this button to reset any temporary job settings to the default printer settings.
2	Connection Information button	Touch this button to open the Connection Information menu, which provides network information. The button appears as either a wired network icon  or a wireless network icon  , depending on the type of network to which the printer is connected.
3	Printer status	This screen area provides information about the overall printer status.
4	Copy button 	Touch this button to open the copy feature.
5	Scan button 	Touch this button to open the scan features: <ul style="list-style-type: none"> • Scan to USB Drive • Scan to Network Folder • Scan to E-mail
6	Fax button 	Touch this button to open the fax features.
7	USB button 	Touch this button to open the USB Flash Drive menu.
8	Supplies button 	Touch this button to view information about supplies status.
9	Apps button 	Touch this button to open the Apps menu to print directly from select Web applications.
10	Setup button 	Touch this button to open the Setup menu.

How to use the touchscreen control panel

Use the following actions to use the printer touchscreen control panel.

Table 1-5 Touchscreen control panel actions

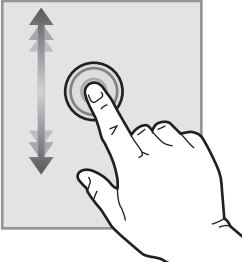
Action	Description	Example
Touch 	Touch an item on the screen to select that item or open that menu. Also, when scrolling through menus, briefly touch the screen to stop the scrolling.	Touch the Setup button  to open the Setup menu.
Swipe 	Touch the screen and then move the finger horizontally to move the screen sideways.	Swipe the Home screen to access the Setup button  .
Scroll 	Touch the screen, and then, without lifting the finger, move the finger vertically to move the screen.	Scroll through the Setup menu.

Printer specifications

 **IMPORTANT:** The following specifications are correct at the time of publication, but they are subject to change. For current information, see www.hp.com/support/ljM282MFP.

- [Technical specifications](#)
- [Supported operating systems](#)
- [Mobile printing solutions](#)
- [Printer dimensions](#)
- [Power consumption, electrical specifications, and acoustic emissions](#)
- [Operating environmental range](#)

Technical specifications

See www.hp.com/support/ljM282MFP for current information.

Supported operating systems

The following information applies to the printer-specific Windows PCL 6 and HP print drivers for macOS and to the software installer.

Windows: The HP Software Installer installs the “HP PCL.6” version 3 print driver, the “HP PCL 6” version 3 print driver, or the “HP PCL-6” version 4 print driver, depending on the Windows operating system, along with optional software when using the software installer. Download the “HP PCL.6” version 3 print driver, the “HP PCL 6” version 3 print driver, and the “HP PCL-6” version 4 print driver from the printer-support website for this printer: www.hp.com/support/ljM282MFP.

macOS: Mac computers are supported with this printer. Download HP Smart either from 123.hp.com or from the Printer Support page, and then use HP Smart to install the HP print driver. HP Smart is not included in the HP Software Installer.

1. Go to 123.hp.com.
2. Follow the steps provided to download the printer software.

Linux: For information and print drivers for Linux, go to www.hp.com/go/linuxprinting.

UNIX: For information and print drivers for UNIX®, go to www.hp.com/go/unixmodelscripts.

Table 1-6 Supported operating systems and print drivers

Operating system	Print driver installed (from the software on the web)	Notes
Windows® XP SP3, 32-bit	The “HP PCL.6” printer-specific print driver is installed for this operating system as part of the software installation.	Microsoft retired mainstream support for Windows XP in April 2009. HP will continue to provide best effort support for the discontinued XP operating system. Some features of the print driver are not supported.

Table 1-6 Supported operating systems and print drivers (continued)

Operating system	Print driver installed (from the software on the web)	Notes
Windows Vista®, 32-bit	The “HP PCL-6” printer-specific print driver is installed for this operating system as part of the software installation.	Microsoft retired mainstream support for Windows Vista in April 2012. HP will continue to provide best effort support for the discontinued Vista operating system. Some features of the print driver are not supported.
Windows 7, 32-bit and 64-bit	The “HP PCL-6” printer-specific print driver is installed for this operating system as part of the software installation.	This operating system is fully supported.
Windows 8, 32-bit and 64-bit	The “HP PCL-6” printer-specific print driver is installed for this operating system as part of the software installation.	Windows 8 RT support is provided through Microsoft IN OS Version 4, 32-bit driver.
Windows 8.1, 32-bit and 64-bit	The “HP PCL-6” V4 printer-specific print driver is installed for this operating system as part of the software installation.	Windows 8.1 RT support is provided through Microsoft IN OS Version 4, 32-bit driver.
Windows 10, 32-bit and 64-bit	The “HP PCL-6” V4 printer-specific print driver is installed for this operating system as part of the software installation.	This operating system is fully supported.
Windows Server 2008 SP2, 32-bit	The “HP PCL-6” printer-specific print driver is available for download from the printer-support website. Download the driver, and then use the Microsoft Add Printer tool to install it.	Microsoft retired mainstream support for Windows Server 2008 in January 2015. HP will continue to provide best effort support for the discontinued Server 2008 operating system. Some features of the print driver are not supported.
Windows Server 2008 SP2, 64-bit	The “HP PCL-6” printer-specific print driver is available for download from the printer-support website. Download the driver, and then use the Microsoft Add Printer tool to install it.	Microsoft retired mainstream support for Windows Server 2008 in January 2015. HP will continue to provide best effort support for the discontinued Server 2008 operating system.
Windows Server 2008 R2, SP 1, 64-bit	The “HP PCL-6” printer-specific print driver is installed for this operating system as part of the software installation.	This operating system is fully supported.
Windows Server 2012, 64-bit	The “HP PCL-6” printer-specific print driver is installed for this operating system as part of the software installation.	This operating system is fully supported.
Windows Server 2012 R2, 64-bit	The “HP PCL-6” printer-specific print driver is installed for this operating system as part of the software installation.	This operating system is fully supported.
Windows 10 server (Server 2016), 32-bit and 64-bit	The “HP PCL-6” printer-specific print driver is installed for this operating system as part of the software installation.	This operating system is fully supported.
macOS v10.15 Catalina, macOS v10.14 Mojave, macOS v10.13 High Sierra, macOS v10.12 Sierra	To install the print driver, download HP Smart from 123.hp.com . Follow the steps provided to install the printer software and print driver.	This operating system is fully supported.

 **NOTE:** For a current list of supported operating systems, go to www.hp.com/support/ljM282MFP for HP’s all-inclusive help for the printer.

 **NOTE:** For HP UPD driver support for this printer, go to www.hp.com/go/upd. Under **Additional information**, click the links.

Table 1-7 Minimum system requirements

Windows	macOS
<ul style="list-style-type: none">• Internet connection	<ul style="list-style-type: none">• Internet connection
<ul style="list-style-type: none">• Dedicated USB 1.1 or 2.0 connection or a network connection	<ul style="list-style-type: none">• 1 GB of available hard-disk space
<ul style="list-style-type: none">• 400 MB of available hard-disk space	
<ul style="list-style-type: none">• 1 GB RAM (32-bit) or 2 GB RAM (64-bit)	

Mobile printing solutions

HP offers multiple mobile and ePrint solutions to enable easy printing to an HP printer from a laptop, tablet, smartphone, or other mobile device. To see the full list and to determine the best choice, go to www.hp.com/go/LaserJetMobilePrinting.

 **NOTE:** Update the printer firmware to ensure all mobile printing and ePrint capabilities are supported.

- Wi-Fi Direct (wireless models only)
- HP ePrint via email (Requires HP Web Services to be enabled and the printer to be registered with HP Connected)
- HP ePrint app (Available for Android, iOS, and Blackberry)
- HP Smart app for iOS and Android devices
- HP ePrint software
- Google Cloud Print
- AirPrint
- Android Printing

Printer dimensions

Figure 1-1 Dimensions for the nw models

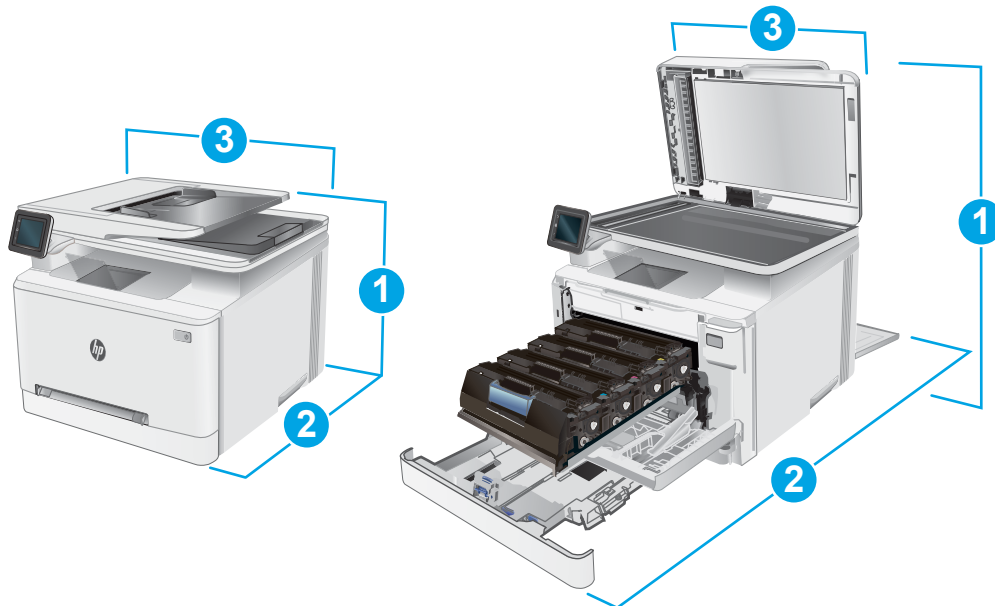

Table 1-8 Dimensions for the nw models

Dimension	Printer fully closed	Printer fully open
1. Height	334.1 mm (13.2 in)	590 mm (23.2 in)
2. Depth	388.6 mm (15.3 in)	855 mm (33.7 in)
3. Width	420 mm (16.5 in)	453 mm (17.8 in)
Weight (with cartridges)	18 kg (39.7 lb)	18 kg (39.7 lb)

Figure 1-2 Dimensions for the cdw, fdn and fdw models

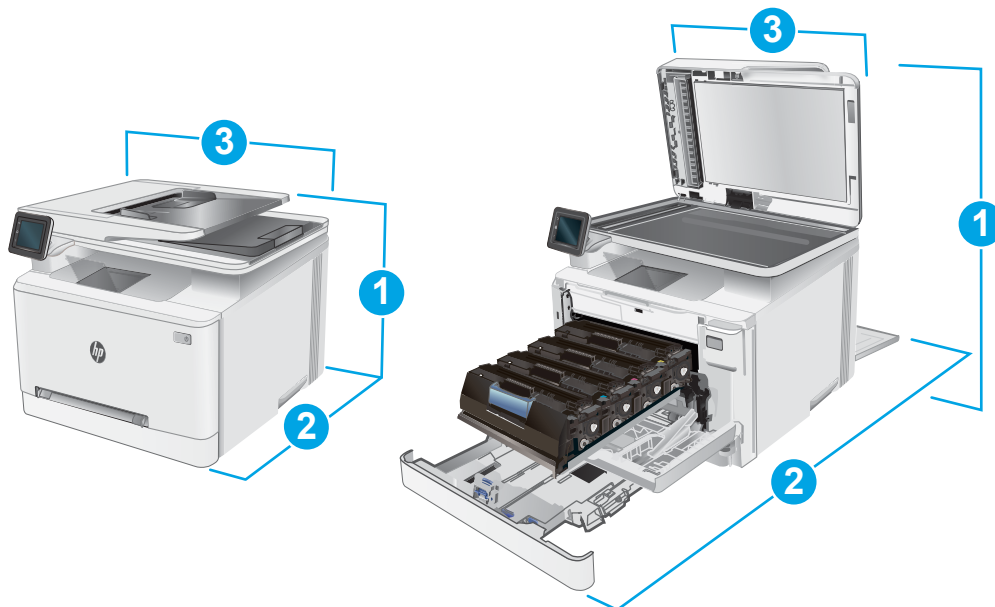

Table 1-9 Dimensions for the cdw, fdn and fdw models

Dimension	Printer fully closed	Printer fully open
1. Height	334.1 mm (13.2 in)	590 mm (23.2 in)
2. Depth	421.7 mm (16.6 in)	1008 mm (39.7 in)
3. Width	420 mm (16.5 in)	453 mm (17.8 in)
Weight (with cartridges)	18.7 kg (41.2 lb)	18.7 kg (41.2 lb)

Power consumption, electrical specifications, and acoustic emissions

See www.hp.com/support/ljM282MFP for current information.

⚠ CAUTION: Power requirements are based on the country/region where the printer is sold. Do not convert operating voltages. This will damage the printer and void the printer warranty.

Operating environmental range

Table 1-10 Operating environmental range

Environment	Recommended	Allowed
Temperature	15° to 27°C (59° to 80.6°F)	10° to 32.5°C (50° to 90.5°F)
Relative humidity	30% to 70% relative humidity (RH)	10% to 80% (RH)

Printer hardware setup and software installation

For basic setup instructions, see the Setup Poster and Getting Started Guide that came with the printer. For additional instructions, go to HP support on the Web.

Go to www.hp.com/support/ljM282MFP for HP's all-inclusive help for the printer. Find the following support:

- Install and configure
- Learn and use
- Solve problems
- Download software and firmware updates
- Join support forums
- Find warranty and regulatory information

2 Paper trays

- [Introduction](#)
- [Load paper to the single-sheet slot \(Tray 1\)](#)
- [Load paper to Tray 2](#)
- [Load and print envelopes](#)
- [Load and print labels](#)

For more information:

The following information is correct at the time of publication. For current information, see www.hp.com/support/ljM282MFP.

HP's all-inclusive help for the printer includes the following information:

- Install and configure
- Learn and use
- Solve problems
- Download software and firmware updates
- Join support forums
- Find warranty and regulatory information

Introduction

⚠ CAUTION: Do not extend more than one paper tray at a time.

Do not use paper tray as a step.

Keep hands out of paper trays when closing.

All trays must be closed when moving the printer.

Load paper to the single-sheet slot (Tray 1)

Introduction

The following information describes how to load paper in Tray 1. This tray holds 1 sheet of paper, use it to print single-page documents, documents that require multiple paper types, or envelopes.

📝 NOTE: To avoid paper jams:

- Never add or remove paper from the tray during printing.
 - Use paper that is not wrinkled, folded, or damaged.
-

1. Move the paper width guides in the single-sheet priority feed slot outward.

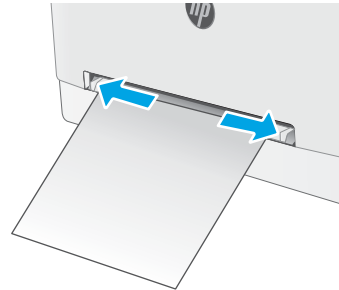

2. Place the top edge of the sheet at the opening, and then adjust the side guides so that they lightly touch the sheet, but do not bend it.

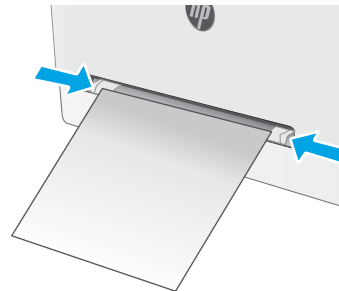

3. Insert the single sheet into the slot and hold it. The printer will pull the sheet partially into the paper path. For information about how to orient the paper, see [Tray 1 paper orientation on page 18](#).

NOTE: Depending on the size of the paper, you might need to support the sheet with two hands until the sheet advances into the printer.

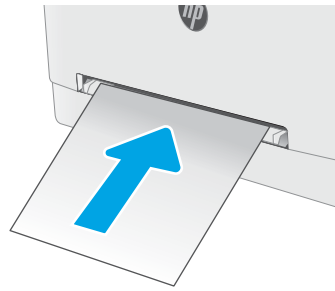



4. At the computer, begin the printing process from the software application. Make sure that the driver is set to the correct paper type and size for the paper being printed from the single-sheet priority feed slot.

Tray 1 paper orientation

When using paper that requires a specific orientation, load it according to the information in the following table.

Table 2-1 Tray 1 paper orientation

Paper type	Image orientation	Output	Paper size	How to load paper
Letterhead or Preprinted	Portrait NOTE: In Tray 1, A5 paper can be oriented for both Landscape and Portrait printing.	1-sided printing	Letter, Legal, Executive, Oficio (8.5 x 13), A4, A5, A6, B5 (JIS), B5 (ISO), Postcard #10, Japanese Postcard (Postcard (JIS)), Double Japan Postcard Rotated (Double Postcard (JIS))	Face-up Top edge leading into the printer 
Letterhead or Preprinted	Portrait	2-sided printing	Letter, Legal, Executive, Oficio (8.5 x 13), A4, A5, A6, B5 (JIS), B5 (ISO), Postcard #10, Japanese Postcard (Postcard (JIS)), Double Japan Postcard Rotated (Double Postcard (JIS))	Face-down Top edge leading into the printer 
Prepunched	Portrait NOTE: In Tray 1, A5 paper can be oriented for both Landscape and Portrait printing.	1-sided printing or 2-sided printing	Letter, Legal, Executive, Oficio (8.5 x 13), A4, A5, A6, B5 (JIS), B5 (ISO), Postcard #10, Japanese Postcard (Postcard (JIS)), Double Japan Postcard Rotated (Double Postcard (JIS))	Face-up Holes toward the left side of the printer 

Load paper to Tray 2

Introduction

The following information describes how to load paper in Tray 2. This tray holds up to 250 sheets of 75 g/m² (20 lb) paper.

 **NOTE:** To avoid paper jams:

- Never add or remove paper from the tray during printing.
- Before loading the tray, remove all of the paper from the input tray and straighten the stack.
- When loading the tray, do not fan the paper.
- Use paper that is not wrinkled, folded, or damaged.

1. Open the tray.

NOTE: Do not open this tray while it is in use.

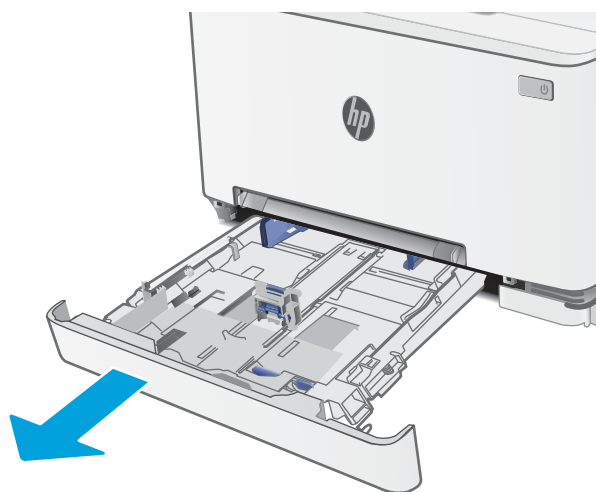

2. Adjust the paper guides by squeezing the adjustment latches and sliding the guides to the size of the paper being used.

NOTE: To load legal-size paper, extend the tray front by pressing the blue latch and pulling the front of the tray. When loaded with legal-size paper, Tray 2 extends from the front of the printer approximately 57.5 mm (2.2 in).

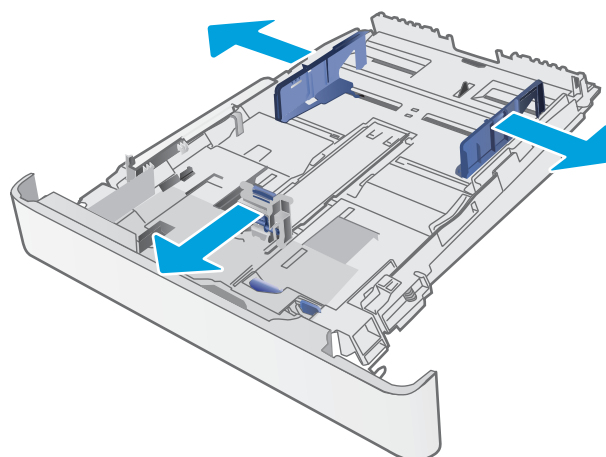

3. Load the paper into the tray. For information about how to orient the paper, see [Tray 2 paper orientation on page 21](#).

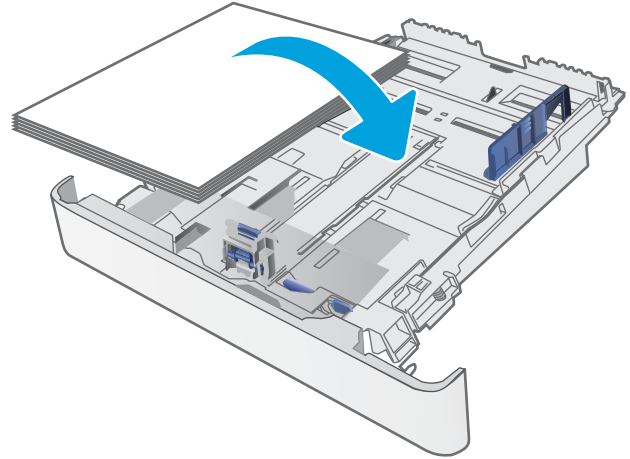

4. Adjust the guides so that they lightly touch the paper stack, but do not bend it.

NOTE: Do not adjust the paper guides tightly against the paper stack.

NOTE: To prevent jams, adjust the paper guides to the correct size and do not overfill the tray.

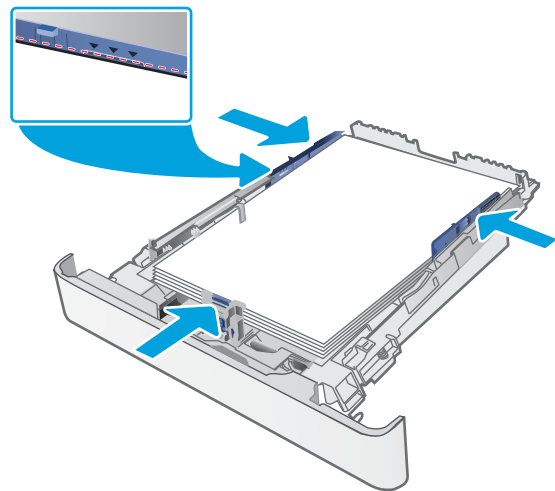

5. Close the tray.



Tray 2 paper orientation

When using paper that requires a specific orientation, load it according to the information in the following table.

Table 2-2 Tray 2 paper orientation

Paper type	Image orientation	Output	Paper size	How to load paper
Letterhead or preprinted	Portrait	1-sided printing	Letter, Legal, Executive, Oficio (8.5 x 13), A4, A6, B5 (JIS), B5 (ISO), Postcard #10, Japanese Postcard (Postcard (JIS)), Double Japan Postcard Rotated (Double Postcard (JIS))	Face-up Top edge toward the back of the tray
Letterhead or preprinted	Portrait	2-sided printing	Letter, Legal, Executive, Oficio (8.5 x 13), A4, A6, B5 (JIS), B5 (ISO), Postcard #10, Japanese Postcard (Postcard (JIS)), Double Japan Postcard Rotated (Double Postcard (JIS))	Face-down Top edge toward the back of the tray
Letterhead or preprinted	Landscape	1-sided printing	A5	Face-up Top edge toward the back of the tray

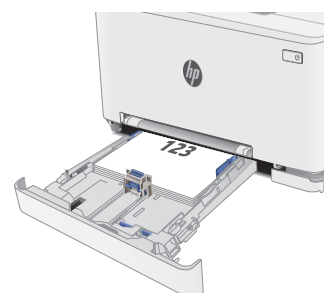
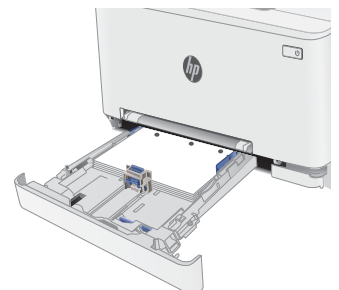
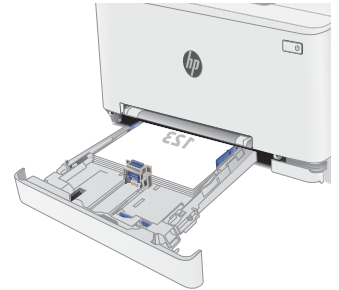

Table 2-2 Tray 2 paper orientation (continued)

Paper type	Image orientation	Output	Paper size	How to load paper
Letterhead or preprinted	Landscape	2-sided printing	A5	Face-down Top edge toward the back of the tray
Prepunched	Portrait	1-sided printing or 2-sided printing	Letter, Legal, Executive, Oficio (8.5 x 13), A4, A6, B5 (JIS), B5 (ISO), Postcard #10, Japanese Postcard (Postcard (JIS)), Double Japan Postcard Rotated (Double Postcard (JIS))	Face-up Holes toward the left side of the tray
Prepunched	Landscape	1-sided printing or 2-sided printing	A5	Face-up Holes toward the front of the tray



Load and print envelopes

Introduction

The following information describes how to print and load envelopes. Tray 1 holds 1 envelope. Tray 2 holds up to 5 envelopes.

To print envelopes using the manual feed option, follow these steps to select the correct settings in the print driver, and then load the envelopes into the tray after sending the print job to the printer.

Print envelopes

1. From the software program, select the **Print** option.
2. Select the printer from the list of printers, and then click or tap the **Properties** or **Preferences** button to open the print driver.

 **NOTE:** The name of the button varies for different software programs.

 **NOTE:** To access these features from a Windows 8 or 8.1 Start screen, select **Devices**, select **Print**, and then select the printer.

3. Click or tap the **Paper/Quality** tab.
4. In the **Paper size** drop-down list, select the correct size for the envelopes.
5. In the **Paper type** drop-down list, select **Envelope**.
6. In the **Paper source** drop-down list, select **Manual feed**.
7. Click the **OK** button to close the **Document Properties** dialog box.
8. In the **Print** dialog box, click the **OK** button to print the job.

Envelope orientation

Table 2-3 Envelope orientation

Tray	Envelope size	How to load envelopes
Tray 1	Envelope #10, Envelope Monarch, Envelope B5, Envelope C5, Envelope DL	Face up Short, postage end leading into the printer
Tray 2	Envelope #10, Envelope Monarch, Envelope B5, Envelope C5, Envelope DL	Face up Short, postage end leading into the printer

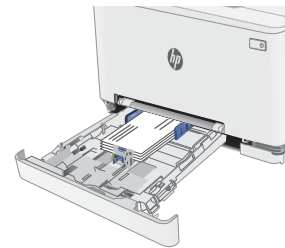

Load and print labels

Introduction

The following information describes how to print and load labels. Tray 1 holds 1 sheet of labels. Tray 2 holds up to 50 sheets of labels.

To print labels using the manual feed option, follow these steps to select the correct settings in the print driver, and then load the labels into the tray after sending the print job to the printer. When using manual feed, the printer waits to print the job until it detects that the tray has been opened.

Manually feed labels

1. From the software program, select the **Print** option.
2. Select the printer from the list of printers, and then click or tap the **Properties** or **Preferences** button to open the print driver.



NOTE: The name of the button varies for different software programs.



NOTE: To access these features from a Windows 8 or 8.1 Start screen, select **Devices**, select **Print**, and then select the printer.

3. Click the **Paper/Quality** tab.
4. In the **Paper size** drop-down list, select the correct size for the sheets of labels.
5. In the **Paper type** drop-down list, select **Labels**.
6. In the **Paper source** drop-down list, select **Manual feed**.
7. Click the **OK** button to close the **Document Properties** dialog box.
8. In the **Print** dialog box, click the **OK** button to print the job.

Label orientation

Table 2-4 Label orientation

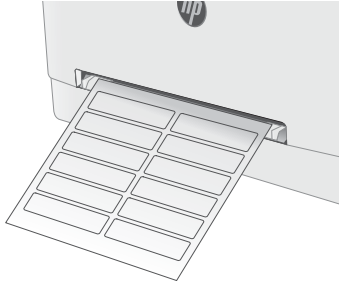
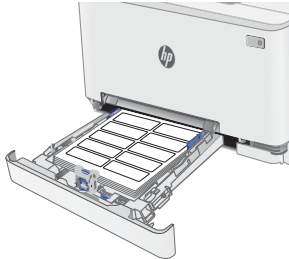
Tray	How to load labels
Tray 1	Face-up Top edge leading into the printer
	
Tray 2	Face-up Top edge leading into the printer
	

3 Supplies, accessories, and parts

- [Order supplies, accessories, and parts](#)
- [Replace the toner cartridges](#)

For more information:

The following information is correct at the time of publication. For current information, see www.hp.com/support/ljM282MFP.

HP's all-inclusive help for the printer includes the following information:

- Install and configure
- Learn and use
- Solve problems
- Download software and firmware updates
- Join support forums
- Find warranty and regulatory information

Order supplies, accessories, and parts

Ordering

Table 3-1 Ordering options

Ordering option	Ordering information
Order supplies and paper	www.hp.com/go/suresupply
Order genuine HP parts or accessories	www.hp.com/buy/parts
Order through service or support providers	Contact an HP-authorized service or support provider.
Order using the HP Embedded Web Server (EWS)	To access, in a supported Web browser on the computer, enter the printer IP address or host name in the address/URL field. The EWS contains a link to the HP SureSupply Web site, which provides options for purchasing Original HP supplies.

Supplies and accessories

Table 3-2 North America, Latin America, Asia Pacific Countries/Regions, and Japan

Item	Description	Cartridge number	Part number
HP 206A Black Original LaserJet Toner Cartridge	Standard-capacity replacement black toner cartridge	206A	W2110A
HP 206X High Yield Black Original LaserJet Toner Cartridge	High-capacity replacement black toner cartridge	206X	W2110X
HP 206A Cyan Original LaserJet Toner Cartridge	Standard-capacity replacement cyan toner cartridge	206A	W2111A
HP 206X High Yield Cyan Original LaserJet Toner Cartridge	High-capacity replacement cyan toner cartridge	206X	W2111X
HP 206A Yellow Original LaserJet Toner Cartridge	Standard-capacity replacement yellow toner cartridge	206A	W2112A
HP 206X High Yield Yellow Original LaserJet Toner Cartridge	High-capacity replacement yellow toner cartridge	206X	W2112X
HP 206A Magenta Original LaserJet Toner Cartridge	Standard-capacity replacement magenta toner cartridge	206A	W2113A
HP 206X High Yield Magenta Original LaserJet Toner Cartridge	High-capacity replacement magenta toner cartridge	206X	W2113X

Table 3-3 Europe, Russia, CIS, Middle East, and Africa

Item	Description	Cartridge number	Part number
HP 207A Black Original LaserJet Toner Cartridge	Standard-capacity replacement black toner cartridge	207A	W2210A
HP 207X High Yield Black Original LaserJet Toner Cartridge	High-capacity replacement black toner cartridge	207X	W2210X
HP 207A Cyan Original LaserJet Toner Cartridge	Standard-capacity replacement cyan toner cartridge	207A	W2211A

Table 3-3 Europe, Russia, CIS, Middle East, and Africa (continued)

Item	Description	Cartridge number	Part number
HP 207X High Yield Cyan Original LaserJet Toner Cartridge	High-capacity replacement cyan toner cartridge	207X	W2211X
HP 207A Yellow Original LaserJet Toner Cartridge	Standard-capacity replacement yellow toner cartridge	207A	W2212A
HP 207X High Yield Yellow Original LaserJet Toner Cartridge	High-capacity replacement yellow toner cartridge	207X	W2212X
HP 207A Magenta Original LaserJet Toner Cartridge	Standard-capacity replacement magenta toner cartridge	207A	W2213A
HP 207X High Yield Magenta Original LaserJet Toner Cartridge	High-capacity replacement magenta toner cartridge	207X	W2213X

Customer self-repair parts

Customer Self-Repair (CSR) parts are available for many HP LaserJet printers to reduce repair time. More information about the CSR program and benefits can be found at www.hp.com/go/csr-support and www.hp.com/go/csr-faq.

Genuine HP replacement parts can be ordered at www.hp.com/buy/parts or by contacting an HP-authorized service or support provider. When ordering, one of the following will be needed: part number, serial number (found on back of printer), product number, or printer name.

- Parts listed as **Mandatory** self-replacement are to be installed by customers, unless you are willing to pay HP service personnel to perform the repair. For these parts, on-site or return-to-depot support is not provided under the HP printer warranty.
- Parts listed as **Optional** self-replacement can be installed by HP service personnel at your request for no additional charge during the printer warranty period.

Table 3-4 Customer self-repair parts

Item	Description	Self-replacement options	Part number
Single-sheet priority feed slot tray	Replacement tray for single-sheet priority feed slot (Tray 1)	Mandatory	RM2-1693-000
250-sheet paper input tray	Replacement cassette for Tray 2	Mandatory	RM2-1683-000

Replace the toner cartridges

Introduction

This printer indicates when the toner cartridge level is low. The actual toner cartridge life remaining can vary. Consider having a replacement cartridge available to install when print quality is no longer acceptable.

To purchase cartridges or check cartridge compatibility for the printer, go to HP SureSupply at www.hp.com/go/suresupply. Scroll to the bottom of the page and verify that the country/region is correct.

The printer uses four colors and has a different toner cartridge for each color: yellow (Y), magenta (M), cyan (C), and black (K). The toner cartridges are inside the front door.

Table 3-5 Toner cartridges for North America, Latin America, Asia Pacific Countries/Regions, and Japan

Item	Description	Cartridge number	Part number
HP 206A Black Original LaserJet Toner Cartridge	Standard-capacity replacement black toner cartridge	206A	W2110A
HP 206X High Yield Black Original LaserJet Toner Cartridge	High-capacity replacement black toner cartridge	206X	W2110X
HP 206A Cyan Original LaserJet Toner Cartridge	Standard-capacity replacement cyan toner cartridge	206A	W2111A
HP 206X High Yield Cyan Original LaserJet Toner Cartridge	High-capacity replacement cyan toner cartridge	206X	W2111X
HP 206A Yellow Original LaserJet Toner Cartridge	Standard-capacity replacement yellow toner cartridge	206A	W2112A
HP 206X High Yield Yellow Original LaserJet Toner Cartridge	High-capacity replacement yellow toner cartridge	206X	W2112X
HP 206A Magenta Original LaserJet Toner Cartridge	Standard-capacity replacement magenta toner cartridge	206A	W2113A
HP 206X High Yield Magenta Original LaserJet Toner Cartridge	High-capacity replacement magenta toner cartridge	206X	W2113X

Table 3-6 Toner cartridges for Europe, Russia, CIS, Middle East, and Africa

Item	Description	Cartridge number	Part number
HP 207A Black Original LaserJet Toner Cartridge	Standard-capacity replacement black toner cartridge	207A	W2210A
HP 207X High Yield Black Original LaserJet Toner Cartridge	High-capacity replacement black toner cartridge	207X	W2210X
HP 207A Cyan Original LaserJet Toner Cartridge	Standard-capacity replacement cyan toner cartridge	207A	W2211A
HP 207X High Yield Cyan Original LaserJet Toner Cartridge	High-capacity replacement cyan toner cartridge	207X	W2211X
HP 207A Yellow Original LaserJet Toner Cartridge	Standard-capacity replacement yellow toner cartridge	207A	W2212A
HP 207X High Yield Yellow Original LaserJet Toner Cartridge	High-capacity replacement yellow toner cartridge	207X	W2212X

Table 3-6 Toner cartridges for Europe, Russia, CIS, Middle East, and Africa (continued)

Item	Description	Cartridge number	Part number
HP 207A Magenta Original LaserJet Toner Cartridge	Standard-capacity replacement magenta toner cartridge	207A	W2213A
HP 207X High Yield Magenta Original LaserJet Toner Cartridge	High-capacity replacement magenta toner cartridge	207X	W2213X

 **NOTE:** High-yield toner cartridges contain more toner than standard cartridges for increased page yield. For more information, go to www.hp.com/go/learnaboutesupplies.

Do not remove the toner cartridge from its package until it is time to install it.

 **CAUTION:** To prevent damage to the toner cartridge, do not expose it to light for more than a few minutes. Cover the green imaging drum if the toner cartridge must be removed from the printer for an extended period of time.

The following illustration shows the toner-cartridge components.

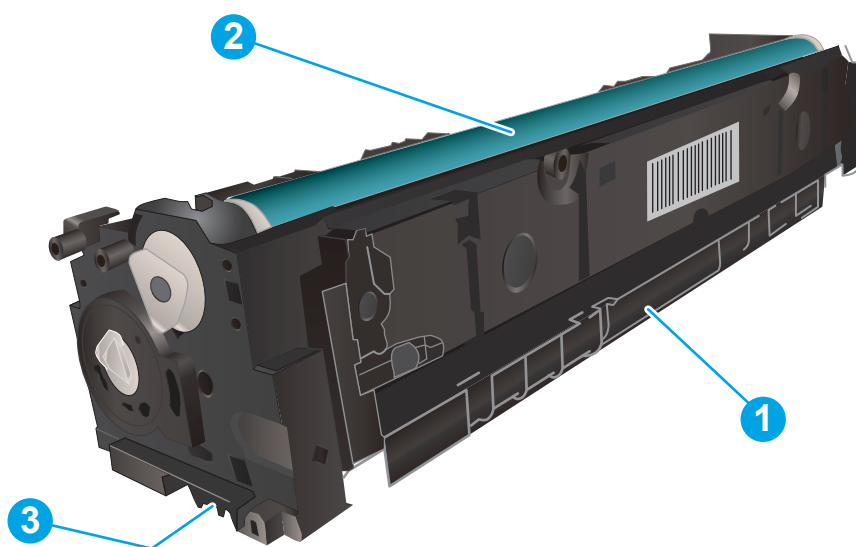



Table 3-7 Toner cartridge legend

Number	Description
1	Handle
2	Imaging drum
3	Memory chip

 **CAUTION:** If toner gets on clothing, wipe it off by using a dry cloth and wash the clothes in cold water. Hot water sets toner into fabric.

 **NOTE:** Information about recycling used toner cartridges is in the toner cartridge box.

Remove and replace the toner cartridges

1. Open the front door.



2. Grasp the blue handle on the toner cartridge drawer, and then pull out the drawer.



3. Grasp the handle on the toner cartridge, and then pull the toner cartridge straight up to remove it.



4. Remove the new toner cartridge package from the box, and then pull the release tab on the packaging.

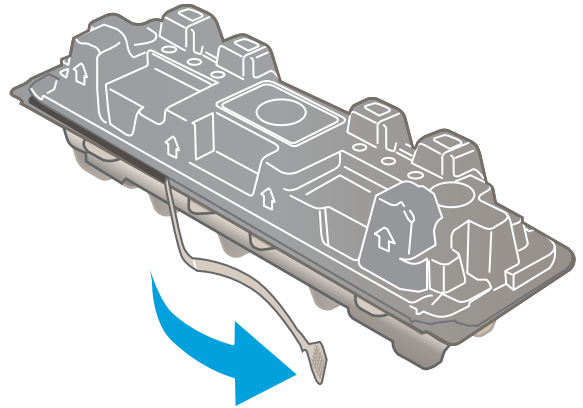

5. Remove the toner cartridge from the opened packaging shell. Save all packaging for recycling the used toner cartridge.

NOTE: Avoid touching the green imaging drum. Fingerprints on the imaging drum can cause print defects.

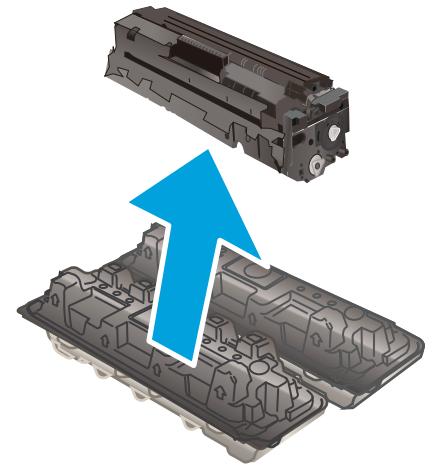

6. Holding the toner on both ends, gently rock the toner cartridge end to end to distribute the toner evenly inside the cartridge.

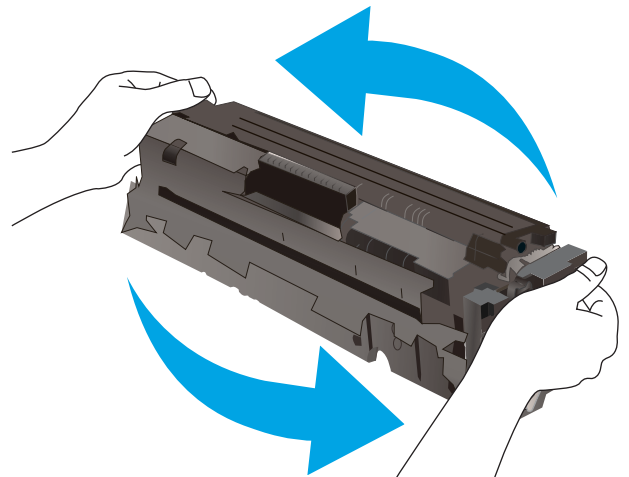

7. Install the new toner cartridge. Make sure that the color chip on the cartridge matches the color chip on the drawer.

NOTE: Avoid touching the green imaging drum. Fingerprints on the imaging drum can cause print defects.



8. Close the toner cartridge drawer.



9. Close the front door.



4 Print

- [Print tasks \(Windows\)](#)
- [Print tasks \(macOS\)](#)
- [Mobile printing](#)
- [Use walk-up USB printing](#)

For more information:

The following information is correct at the time of publication. For current information, see www.hp.com/support/ljM282MFP.

HP's all-inclusive help for the printer includes the following information:

- Install and configure
- Learn and use
- Solve problems
- Download software and firmware updates
- Join support forums
- Find warranty and regulatory information

Print tasks (Windows)

How to print (Windows)

The following procedure describes the basic printing process for Windows.

1. From the software program, select the **Print** option.
2. Select the printer from the list of printers. To change settings, click the **Properties** or **Preferences** button to open the print driver.

 **NOTE:** The name of the button varies for different software programs.

 **NOTE:** In Windows 10, 8.1, and 8, these applications will have a different layout with different features from what is described below for desktop applications. To access the print feature from a Start screen app, complete the following steps:

- **Windows 10:** Select **Print**, and then select the printer.
- **Windows 8.1 or 8:** Select **Devices**, select **Print**, and then select the printer.

For the HP PCL-6 V4 driver, the HP Smart application downloads additional driver features when **More settings** is selected.

 **NOTE:** For more information, click the Help (?) button in the print driver.

3. Click the tabs in the print driver to configure the available options. For example, set the paper orientation on the **Finishing** tab, and set the paper source, paper type, paper size, and quality settings on the **Paper/Quality** tab.
4. Click the **OK** button to return to the **Print** dialog box. Select the number of copies to print from this screen.
5. Click the **Print** button to print the job.

Automatically print on both sides (Windows)

Use this procedure for printers that have an automatic duplexer installed. If the printer does not have an automatic duplexer installed, or to print on paper types that the duplexer does not support, print on both sides manually.

1. From the software program, select the **Print** option.
2. Select the printer from the list of printers, and then click the **Properties** or **Preferences** button to open the print driver.

 **NOTE:** The name of the button varies for different software programs.

 **NOTE:** In Windows 10, 8.1, and 8, these applications will have a different layout with different features from what is described below for desktop applications. To access the print feature from a Start screen app, complete the following steps:

- **Windows 10:** Select **Print**, and then select the printer.
- **Windows 8.1 or 8:** Select **Devices**, select **Print**, and then select the printer.

For the HP PCL-6 V4 driver, the HP Smart application downloads additional driver features when **More settings** is selected.

3. Click the **Finishing** tab.
4. Select **Print on both sides**. Click **OK** to close the **Document Properties** dialog.
5. In the **Print** dialog, click **Print** to print the job.

Manually print on both sides (Windows)

Use this procedure for printers that do not have an automatic duplexer installed or to print on paper that the duplexer does not support.

1. From the software program, select the **Print** option.
2. Select the printer from the list of printers, and then click the **Properties** or **Preferences** button to open the print driver.

 **NOTE:** The name of the button varies for different software programs.

 **NOTE:** In Windows 10, 8.1, and 8, these applications will have a different layout with different features from what is described below for desktop applications. To access the print feature from a Start screen app, complete the following steps:

- **Windows 10:** Select **Print**, and then select the printer.
- **Windows 8.1 or 8:** Select **Devices**, select **Print**, and then select the printer.

For the HP PCL-6 V4 driver, the HP Smart application downloads additional driver features when **More settings** is selected.

3. Click the **Finishing** tab.
4. Select **Print on both sides (manually)**, and then click **OK** to close the **Document Properties** dialog.
5. In the **Print** dialog, click **Print** to print the first side of the job.
6. Retrieve the printed stack from the output bin, and place it in Tray 1.
7. If prompted, select the appropriate control panel button to continue.

Print multiple pages per sheet (Windows)

1. From the software program, select the **Print** option.
2. Select the printer from the list of printers, and then click the **Properties** or **Preferences** button to open the print driver.

 **NOTE:** The name of the button varies for different software programs.

 **NOTE:** In Windows 10, 8.1, and 8, these applications will have a different layout with different features from what is described below for desktop applications. To access the print feature from a Start screen app, complete the following steps:

- **Windows 10:** Select **Print**, and then select the printer.
- **Windows 8.1 or 8:** Select **Devices**, select **Print**, and then select the printer.

For the HP PCL-6 V4 driver, the HP Smart application downloads additional driver features when **More settings** is selected.

3. Click the **Finishing** tab.
4. Select the number of pages per sheet from the **Pages per sheet** drop-down list.
5. Select the correct **Print page borders**, **Page order**, and **Orientation** options. Click **OK** to close the **Document Properties** dialog.
6. In the **Print** dialog, click **Print** to print the job.

Select the paper type (Windows)

1. From the software program, select the **Print** option.
2. Select the printer from the list of printers, and then click or tap the **Properties** or **Preferences** button to open the print driver.

 **NOTE:** The name of the button varies for different software programs.

 **NOTE:** In Windows 10, 8.1, and 8, these applications will have a different layout with different features from what is described below for desktop applications. To access the print feature from a Start screen app, complete the following steps:

- **Windows 10:** Select **Print**, and then select the printer.
- **Windows 8.1 or 8:** Select **Devices**, select **Print**, and then select the printer.

For the HP PCL-6 V4 driver, the HP Smart application downloads additional driver features when **More settings** is selected.

3. Click the **Paper/Quality** tab.
4. Select the option for the type of paper you are using, and then click **OK**.
5. Click **OK** to close the **Document Properties** dialog.
6. In the **Print** dialog, click **Print** to print the job.

Print tasks (macOS)

How to print (macOS)

The following procedure describes the basic printing process for macOS.

1. Click the **File** menu, and then click the **Print** option.
2. Select the printer.
3. Click **Show Details** or **Copies & Pages**, and then select other menus to adjust the print settings.

 **NOTE:** The name of the item varies for different software programs.

4. Click the **Print** button.

Automatically print on both sides (macOS)

 **NOTE:** This information applies to printers that include an automatic duplexer.

 **NOTE:** This feature is available if you install the HP print driver. It might not be available if you are using AirPrint.

1. Click the **File** menu, and then click the **Print** option.
2. Select the printer.
3. Click **Show Details** or **Copies & Pages**, and then click the **Layout** menu.

 **NOTE:** The name of the item varies for different software programs.

4. Select a binding option from the **Two-Sided** drop-down list.
5. Click the **Print** button.

Manually print on both sides (macOS)

 **NOTE:** This feature is available if you install the HP print driver. It might not be available if you are using AirPrint.

1. Click the **File** menu, and then click the **Print** option.
2. Select the printer.
3. Click **Show Details** or **Copies & Pages**, and then click the **Manual Duplex** menu.

 **NOTE:** The name of the item varies for different software programs.

4. Click the **Manual Duplex** box, and select a binding option.
5. Click the **Print** button.
6. Go to the printer, and remove any blank paper that is in Tray 1.
7. Retrieve the printed stack from the output bin and place it with the printed-side facing down in the input tray.
8. If prompted, touch the appropriate control panel button to continue.

Print multiple pages per sheet (macOS)

1. Click the **File** menu, and then click the **Print** option.
2. Select the printer.
3. Click **Show Details** or **Copies & Pages**, and then click the **Layout** menu.



NOTE: The name of the item varies for different software programs.

4. From the **Pages per Sheet** drop-down list, select the number of pages that you want to print on each sheet.
5. In the **Layout Direction** area, select the order and placement of the pages on the sheet.
6. From the **Borders** menu, select the type of border to print around each page on the sheet.
7. Click the **Print** button.

Select the paper type (macOS)

1. Click the **File** menu, and then click the **Print** option.
2. Select the printer.
3. Click **Show Details** or **Copies & Pages**, and then click the **Media & Quality** menu or the **Paper/Quality** menu.



NOTE: The name of the item varies for different software programs.

4. Select from the **Media & Quality** or **Paper/Quality** options.



NOTE: This list contains the master set of options available. Some options are not available on all printers.

- **Media Type:** Select the option for the type of paper for the print job.
 - **Print Quality:** Select the resolution level for the print job.
 - **Edge-To-Edge Printing:** Select this option to print close to the paper edges.
5. Click the **Print** button.

Additional print tasks

Go to www.hp.com/support/ljM282MFP.

Instructions are available for performing specific print tasks, such as the following:

- Create and use printing shortcuts or presets
- Select the paper size, or use a custom paper size
- Select the page orientation
- Create a booklet
- Scale a document to fit a specific paper size
- Print the first or last pages of the document on different paper
- Print watermarks on a document

Mobile printing

Introduction

HP offers multiple mobile and ePrint solutions to enable easy printing to an HP printer from a laptop, tablet, smartphone, or other mobile device. To see the full list and to determine the best choice, go to www.hp.com/go/LaserJetMobilePrinting.

 **NOTE:** Update the printer firmware to ensure all mobile printing and ePrint capabilities are supported.

- [Wi-Fi Direct \(wireless models only\)](#)
- [HP ePrint via email](#)
- [HP ePrint software](#)
- [AirPrint](#)
- [Android embedded printing](#)

Wi-Fi Direct (wireless models only)

Wi-Fi Direct enables printing from a wireless mobile device without requiring a connection to a network or the Internet.

Not all mobile operating systems are currently supported by Wi-Fi Direct. If the mobile device does not support Wi-Fi Direct, you must change the wireless network connection of the device to the Wi-Fi Direct connection of the printer before printing.

 **NOTE:** For non-Wi-Fi Direct capable mobile devices, the Wi-Fi Direct connection only enables printing. After using Wi-Fi Direct to print, you must reconnect to a local network in order to access the Internet.



To access to the printer Wi-Fi Direct connection, complete the following steps:

1. From the Home screen on the printer control panel, touch the Connection Information button .
2. Open the following menus:
 - a. [Wi-Fi Direct](#)
 - b. [Settings](#)
 - c. [Connection Method](#)
3. Choose one of the following connection methods:
 - [Automatic](#): Choosing this option sets the password to 12345678.
 - [Manual](#): Choosing this option generates a secure, randomly generated password.
4. On the mobile device, open the **Wi-Fi** or the **Wi-Fi Direct** menu.
5. From the list of available networks, select the printer name.

 **NOTE:** If the printer name does not display, you might be out of range of the Wi-Fi Direct signal. Move the device closer to the printer.

6. If prompted, enter the Wi-Fi Direct password.

 **NOTE:** For Android devices that support Wi-Fi Direct, if the connection method is set to **Automatic**, the connection will occur automatically, without a password prompt. If the connection method is set to **Manual**, you will need to either press the **OK** button, or provide a personal identification number (PIN) — displayed on the printer control panel — as a password on the mobile device.

 **NOTE:** To access the Wi-Fi Direct password, from Home screen on the printer control panel, touch the Connection Information button .

7. Open the document, and then select the **Print** option.

 **NOTE:** If the mobile device does not support printing, install the HP ePrint mobile app.

8. Select the printer from the list of available printers, and then select **Print**.

9. After the print job is complete, some mobile devices need to be reconnected to the local network.

- Android 4.0 and later tablets and phones with the HP Print Service or Mopria mobile printing plugin installed
- Most Windows 8.1 computers, tablets, and laptops that have the HP print driver installed

The following devices and computer operating systems do not support **Wi-Fi Direct**, but can print to a printer that does:



- Apple iPhone and iPad
- Mac computers running macOS

For more information on Wi-Fi Direct printing, go to www.hp.com/go/wirelessprinting.

Wi-Fi Direct capabilities can be enabled or disabled from the printer control panel.

Enable or disable Wi-Fi Direct



1. From the Home screen on the printer control panel, select the Connection Information button .
2. Open the following menus:
 - a. [Wi-Fi Direct](#)
 - b. [Settings](#)
 - c. [On/Off](#)
3. Touch the [On](#) menu item. Touching the [Off](#) button disables Wi-Fi Direct printing.

 **NOTE:** In environments where more than one model of the same printer is installed, it might be helpful to provide each printer a unique Wi-Fi Direct name for easier printer identification for Wi-Fi Direct printing. The Wi-Fi Direct Name is also available by touching the Connection Information icon  from the Home screen on the printer control panel, and then touching the Wi-Fi Direct icon.

Change the printer Wi-Fi Direct name

Follow this procedure to change the printer Wi-Fi Direct name using the HP Embedded Web Server (EWS):

Step one: Open the HP Embedded Web Server

1. From the Home screen on the printer control panel, touch the Connection Information button  and then touch the **Network Connected** button  or the **Network Wi-Fi ON** button  to display the IP address or host name.
2. Open a web browser, and in the address line, type the IP address or host name exactly as it displays on the printer control panel. Press the **Enter** key on the computer keyboard. The EWS opens.

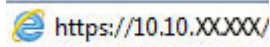

 **NOTE:** If the web browser displays a message indicating that accessing the website might not be safe, select the option to continue to the website. Accessing this website will not harm the computer.

Step two: Change the Wi-Fi Direct name

1. Click the **Networking** tab.
2. On the left navigation pane, click the **Wi-Fi Direct Setup** link.
3. In the **Wi-Fi Direct Name** field, enter the new name.
4. Click **Apply**.

HP ePrint via email

Use HP ePrint to print documents by sending them as an email attachment to the printer's email address from any email-enabled device.

To use HP ePrint, the printer must meet these requirements:

- The printer must be connected to a wired or wireless network and have Internet access.
- HP Web Services must be enabled on the printer, and the printer must be registered with HP Connected.

Follow this procedure to enable HP Web Services and register with HP Connected:

1. From the Home screen on the printer control panel, touch the Connection Information button .
2. Open the following menus:
 - a. **HP ePrint**
 - b. **Settings**
 - c. **Enable Web Services**
3. Touch the **Print** button to read the terms of use agreement. Touch the **OK** button to accept the terms of use and enable HP Web Services

The printer enables Web Services, and then prints an information page. The information page contains the printer code necessary to register the HP printer at HP Connected.

4. Go to www.hpconnected.com to create an HP ePrint account and complete the setup process.

HP ePrint software

The HP ePrint software makes it easy to print from a Windows or Mac desktop or laptop computer to any HP ePrint-capable printer. This software makes it easy to find HP ePrint-enabled printers that are registered to your HP Connected account. The target HP printer can be located in the office or at locations across the globe.

- **Windows:** After installing the software, open the **Print** option from within your application, and then select **HP ePrint** from the installed printers list. Click the **Properties** button to configure print options.
- **macOS:** After installing the software, select **File, Print**, and then select the arrow next to **PDF** (in the bottom left of the driver screen). Select **HP ePrint**.

For Windows, the HP ePrint software supports TCP/IP printing to local network printers on the network (LAN or WAN) to products that support UPD PostScript®.

Windows and macOS both support IPP printing to LAN or WAN network-connected products that support ePCL.

Windows and macOS also both support printing PDF documents to public print locations and printing using HP ePrint via email through the cloud.

Go to www.hp.com/go/eprintssoftware for drivers and information.

 **NOTE:** For Windows, the name of the HP ePrint Software print driver is HP ePrint + JetAdvantage.

 **NOTE:** The HP ePrint software is a PDF workflow utility for macOS, and is not technically a print driver.

 **NOTE:** HP ePrint Software does not support USB printing.

AirPrint

Direct printing using Apple's AirPrint is supported for iOS and from Mac computers running macOS 10.7 Lion and newer. Use AirPrint to print directly to the printer from an iPad, iPhone (3GS or later), or iPod touch (third generation or later) in the following mobile applications:

- Mail
- Photos
- Safari
- iBooks
- Select third-party applications

To use AirPrint, the printer must be connected to the same network (sub-net) as the Apple device. For more information about using AirPrint and about which HP printers are compatible with AirPrint, go to www.hp.com/go/MobilePrinting.

 **NOTE:** Before using AirPrint with a USB connection, verify the version number. AirPrint versions 1.3 and earlier do not support USB connections.

Android embedded printing

HP's built-in print solution for Android and Kindle enables mobile devices to automatically find and print to HP printers that are either on a network or within wireless range for Wi-Fi Direct printing.

The print solution is built into the many versions of the operating system.



NOTE: If printing is not available on your device, go to the [Google Play > Android apps](#) and install the HP Print Service Plugin.

For more information on how to use Android embedded printing and which Android devices are supported, go to www.hp.com/go/LaserJetMobilePrinting.

Use walk-up USB printing

Introduction

This printer features walk-up USB printing, for quickly printing files without sending them from a computer. The printer accepts standard USB flash drives in the USB port. It supports the following types of files:

- .pdf
- .jpg
- .prn and .PRN
- .cht and .CHT
- .pxl
- .pcl and .PCL
- .ps and .PS
- .doc and .docx
- .ppt and .pptx

Step one: Access USB files on the printer

1. Insert the USB flash drive into the walk-up USB port on the printer.
2. The [USB Flash Drive](#) menu opens with the following options:
 - [Print Documents](#)
 - [View and Print Photos](#)
 - [Scan to USB Drive](#)

Step two: Print USB documents

Option one: Print documents

1. To print a document, select [Print Documents](#).
2. Select the name of the document to print. If the document is stored in a folder, select the folder first, and then select the document to print.
3. When the summary screen opens, the following settings can be adjusted:
 - [Number of Copies](#)
 - [Paper Size](#)
 - [Paper Type](#)
 - [Fit to Page](#)

- Collation
 - Output Color (color models only)
4. Select [Print](#) to print the document.
 5. Retrieve the printed job from the output bin, and remove the USB flash drive.

Option two: Print photos

1. To print photos, select [View and Print Photos](#).
2. Select the preview image of each photo to be printed, and then select [Done](#).
3. When the summary screen opens, the following settings can be adjusted:
 - [Image Size](#)
 - [Paper Size](#)
 - [Paper Type](#)
 - [Number of Copies](#)
 - [Output Color](#) (color printers only)
 - [Lighter/Darker](#)
4. Select [Print](#) to print the photos.
5. Retrieve the printed job from the output bin, and remove the USB flash drive.

5 Copy

- [Make a copy](#)
- [Copy on both sides \(duplex\)](#)

For more information:

The following information is correct at the time of publication. For current information, see www.hp.com/support/ljM282MFP.

HP's all-inclusive help for the printer includes the following information:

- Install and configure
- Learn and use
- Solve problems
- Download software and firmware updates
- Join support forums
- Find warranty and regulatory information

Make a copy

1. Load the document on the scanner glass according to the indicators on the product.
2. From the Home screen on the product control panel, touch the **Copy** button .
3. To optimize copy quality for different types of documents, touch the **Settings** button, and then scroll to and touch the **Optimize** button. Swipe the control panel screen to scroll through the options, and then touch an option to select it. The following copy-quality settings are available:
 - **Auto Select**: Use this setting when you are not concerned about the quality of the copy. This is the default setting.
 - **Mixed**: Use this setting for documents that contain a mixture of text and graphics.
 - **Text**: Use this setting for documents that contain mostly text.
 - **Picture**: Use this setting for documents that contain mostly graphics.
4. Touch **Number of Copies**, and then use the touchscreen keypad to adjust the number of copies.
5. Touch the **Black** or **Color** button to start copying.

Copy on both sides (duplex)

- [Copy on both sides automatically](#)
- [Copy on both sides manually](#)

Copy on both sides automatically

1. Load the original documents into the document feeder with the first page facing up, and with the top of the page leading.
2. Adjust the paper guides to fit the size of the document.
3. From the Home screen on the product control panel, touch the **Copy** button .
4. Touch the **Settings** button.
5. Scroll to and touch the **Two-Sided** button.
6. Swipe through the options, and then touch an option to select it.
7. Touch the **Black** or **Color** button to start copying.

Copy on both sides manually

1. Place the document face-down on the scanner glass with the upper-left corner of the page in the upper-left corner of the glass. Close the scanner.
2. From the Home screen on the product control panel, touch the **Copy** button .
3. Touch the **Settings** button.
4. Scroll to and touch the **Two-Sided** button.
5. Swipe through the options, and then touch an option to select it.
6. Touch the **Black** or **Color** button to start copying.
7. The product prompts you to load the next original document. Place it on the glass, and then touch the **OK** button.
8. Repeat this process until you have scanned the last page. Touch the **Done** button to finish printing the copies.

6 Scan

- [Scan by using the HP Scan software \(Windows\)](#)
- [Scan by using the HP Smart Software \(macOS\)](#)
- [Set up the Scan to E-mail feature](#)
- [Set up the Scan to Network Folder feature](#)
- [Scan to a USB flash drive](#)
- [Scan to email](#)
- [Scan to a network folder](#)
- [Additional scan tasks](#)

For more information:

The following information is correct at the time of publication. For current information, see www.hp.com/support/ljM282MFP.

HP's all-inclusive help for the printer includes the following information:

- Install and configure
- Learn and use
- Solve problems
- Download software and firmware updates
- Join support forums
- Find warranty and regulatory information

Scan by using the HP Scan software (Windows)

Use the HP Scan software to initiate scanning from software on your computer. You can save the scanned image as a file or send it to another software application.

1. Open the HP Printer Assistant.
 - **Windows 10:** From the **Start** menu, click **All Apps**, click **HP**, and then select the printer name.
 - **Windows 8.1:** Click the down arrow in lower left corner of the **Start** screen, and then select the printer name.
 - **Windows 8:** Right-click an empty area on the **Start** screen, click **All Apps** on the app bar, and then select the printer name.
 - **Windows 7:** From the computer desktop, click **Start**, select **All Programs**, click **HP**, click the folder for the printer, and then select the printer name.
2. In the HP Printer Assistant, select **Scan**, and then select **Scan a Document or Photo**.
3. Adjust the settings if necessary.
4. Click **Scan**.

Scan by using the HP Smart Software (macOS)

Use the HP Smart software to initiate scanning from software on your computer.

1. Load the document in the document feeder or on the scanner glass according to the indicators on the printer.
2. From the computer, open **HP Smart**, which is located in the **Applications** folder.
3. Follow the on-screen instructions to scan the document.
4. When you have scanned all the pages, click **File** and then **Save** to save them to a file.

Set up the Scan to E-mail feature

- [Introduction](#)
- [Before you begin](#)
- [Method one: Use the Scan to Email Wizard \(Windows\)](#)
- [Method two: Set up the Scan to Email feature via the HP Embedded Web Server](#)

Introduction

The printer has a feature that enables it to scan a document and send it to one or more email addresses. To use this scan feature, the printer must be connected to a network; however, the feature is not available until it has been configured. There are two methods for configuring Scan to Email, the Scan to Email Setup Wizard (Windows), which is installed in the HP program group for the printer as part of the full software installation, and the Scan to Email Setup through the HP Embedded Web Server (EWS). Use the following information to set up the Scan to Email feature.

Before you begin

To set up the Scan to Email feature, the printer must have an active network connection to the same network as the computer that will run the setup process.

Administrators need the following information before beginning the configuration process.

- Administrative access to the printer
- SMTP server (e.g., smtp.mycompany.com)



NOTE: If you do not know the SMTP server name, SMTP port number, or authentication information, contact the email/Internet service provider or system administrator for the information. SMTP server names and port names are typically easy to find by doing an Internet search. For example, use terms like "gmail smtp server name" or "yahoo smtp server name" to search.

- SMTP port number
- SMTP server authentication requirements for outgoing email messages, including the user name and password used for authentication, if applicable.



NOTE: Consult your email service provider's documentation for information on digital sending limits for your email account. Some providers may temporarily lock your account if you exceed your sending limit.

Method one: Use the Scan to Email Wizard (Windows)

Use the Scan to Email Wizard, available from the HP Printer Assistant application (Windows), to set up the Scan to Email feature. The setup wizards include the options for basic configuration.



NOTE: Some operating systems do not support the Scan to Email Wizard.

1. Open the HP Printer Assistant.
 - **Windows 10:** From the **Start** menu, click **All Apps**, click **HP**, and then select the printer name.
 - **Windows 8.1:** Click the down arrow in lower left corner of the **Start** screen, and then select the printer name.

- **Windows 8:** Right-click an empty area on the **Start** screen, click **All Apps** on the app bar, and then select the printer name.
 - **Windows 7:** From the computer desktop, click **Start**, select **All Programs**, click **HP**, click the folder for the printer, and then select the printer name.
2. In the HP Printer Assistant, select **Scan**, and then select **Scan to E-mail Wizard**.



NOTE: If the **Scan to E-mail Wizard** option is not available, use [Method two: Set up the Scan to Email feature via the HP Embedded Web Server on page 58](#)

3. In the **Outgoing Email Profiles** dialog, click the **New** button. The **Scan to Email Setup** dialog opens.
4. On the **1. Start** page, enter the sender's email address in the **Email Address** field.
5. In the **Display Name** field, enter the sender's name. This is the name that will display on the printer control panel.
6. To require a PIN to be entered on the printer control panel before the printer can send an email, enter a 4-digit PIN in the **Security PIN** field, and then re-enter the PIN in the **Confirm Security PIN** field, and then click **Next**.



NOTE: HP recommends creating a PIN to secure the email profile.



NOTE: When a PIN is created, it must be entered on the printer control panel each time the profile is used to send a scan to email.

7. On the **2. Authenticate** page, enter the **SMTP Server** name and **SMTP Port** number.



NOTE: In most cases, the default port number does not need to be changed.



NOTE: If you are using a hosted SMTP service such as Gmail, verify the SMTP address, port number, and SSL settings from the service provider's website or other sources. Typically, for Gmail, the SMTP address is smtp.gmail.com, port number 465, and the SSL should be enabled.

Please refer to online sources to confirm these server settings are current and valid at the time of configuration.

8. If you are using Google™ Gmail for email service, select the **Always use secure connection (SSL/TLS)** check box.
9. Select the **Maximum Size of Email** from the drop-down menu.



NOTE: HP recommends using the default file size of **Automatic** for the maximum size.



10. If the SMTP server requires authentication to send an email, select the **Email Log-in Authentication** check box, enter the **User ID** and **Password**, and then click **Next**.
11. On the **3. Configure** page, to automatically copy the sender on email messages sent from the profile, select **Include sender in all email messages sent out successfully from the printer**, and then click **Next**.
12. On the **4. Finish** page, review the information and verify all the settings are correct. If there is an error, click the **Back** button to correct the error. If the settings are correct, click the **Save and Test** button to test the configuration.

13. When the **Congratulations** message displays, click **Finish** to complete the configuration.
14. The **Outgoing Email Profiles** dialog now shows the newly added sender email profile. Click **Close** to exit the wizard.

Method two: Set up the Scan to Email feature via the HP Embedded Web Server

- [Step one: Access the HP Embedded Web Server \(EWS\)](#)
- [Step two: Configure the Scan to E-mail feature](#)
- [Step three: Add contacts to the E-mail Address Book](#)
- [Step four: Configure the default E-mail Options](#)

Step one: Access the HP Embedded Web Server (EWS)





1. From the Home screen on the printer control panel, touch the Network button  or the Wireless button  to display the IP address or host name.
2. Open a web browser, and in the address line, type the IP address or host name exactly as it displays on the printer control panel. Press the **Enter** key on the computer keyboard. The EWS opens.

 <https://10.10.XX.XXX/>

 **NOTE:** If the web browser displays a message indicating that accessing the website might not be safe, select the option to continue to the website. Accessing this website will not harm the computer.

Step two: Configure the Scan to E-mail feature

1. In the HP EWS, click the **System** tab.
2. On the left navigation pane, click the **Administration** link.
3. In the Enabled Features area, set the **Scan to Email** option to **On**.
4. Click the **Scan** tab.
5. On the left navigation pane, click the **Outgoing E-mail Profiles** link.
6. On the **Outgoing E-mail Profiles** page, click the **New** button.
7. In the **E-mail Address** area, complete the following fields:
 - a. In the **Your E-mail Address** field, enter the sender's email address for the new outgoing email profile.
 - b. In the **Display Name** field, enter the sender's name. This is the name that will display on the printer control panel.
8. In the **SMTP Server Settings** area, complete the following fields:

- a. In the **SMTP Server** field, enter the address of the SMTP server.
 - b. In the **SMTP Port** field, enter the SMTP port number.
-
-  **NOTE:** In most cases, the default port number does not need to be changed.
-  **NOTE:** If you are using a hosted SMTP service such as Gmail, verify the SMTP address, port number, and SSL settings from the service provider's website or other sources. Typically, for Gmail, the SMTP address is smtp.gmail.com, port number 465, and the SSL should be enabled.
- Please refer to online sources to confirm these server settings are current and valid at the time of configuration.
-
- c. If you are using Google™ Gmail for email service, select the **Always use secure connection (SSL/TLS)** check box.
9. If the SMTP server requires authentication to send an email, complete the following fields in the **SMTP Authentication** area:
 - a. Select the **SMTP server requires authentication for outgoing e-mail messages** check box.
 - b. In the **SMTP User ID** field, enter the user ID for the SMTP server.
 - c. In the **SMTP Password** field, enter the password for the SMTP server.
 10. To require a PIN to be entered on the printer control panel before an email is sent using the email address, complete the following fields in the **Optional PIN** area:
 - a. In the **PIN (Optional)** field, enter a four digit PIN.
 - b. In the **Confirm PIN** field, re-enter the four digit PIN.
-
-  **NOTE:** HP recommends creating a PIN to secure the email profile.
-  **NOTE:** When a PIN is created, it must be entered on the printer control panel each time the profile is used to send a scan to email.
-
11. To configure optional email preferences, complete the following fields in the **E-mail Message Preferences** area:
 - a. From the **Maximum Size for E-mail Message Attachments** drop-down list, select the maximum size for email message attachments.
-
-  **NOTE:** HP recommends using the default file size of **Automatic** for the maximum size.
-
- b. To automatically copy the sender on email messages sent from the profile, select the **Auto CC** check box.
12. Review all the information, and then click one of the following options:
 - **Save and Test:** Select this option to save the information and test the connection.
 - **Save Only:** Select this option to save the information without testing the connection.
 - **Cancel:** Select this option to quit the configuration without saving.

Step three: Add contacts to the E-mail Address Book

- ▲ In the left navigation pane, click **E-mail Address Book** to add email addresses to the address book accessible from the printer.

To enter an individual email address complete the following task:

- In the **Contact Name** field, enter the name of the new email contact.
- In the **Contact E-mail Address**, enter the email address of the new email contact.
- Click **Add/Edit**.

To create an email group, complete the following task:

- Click **New Group**.
- In the **Enter the group name** field, enter a name for the new group.
- Click a name in the **All Individuals** area, and then click the arrow button to move it to the **Individuals in Group** area.



NOTE: Select multiple names at one time by pressing **Ctrl** and then clicking a name.

- Click **Save**.

Step four: Configure the default E-mail Options

- ▲ In the left navigation pane, click **E-mail options** to configure the default email options.

- In the **E-mail Subject and Body Text** area, complete the following fields:
 - In the **E-mail Subject** field, enter a default subject line for the email messages.
 - In the **Body Text** field, enter a custom default message for the email messages.
 - Select **Show body text** to enable the default body text to display in emails.
 - Select **Hide body text** to suppress the default body text for an email.
- In the **Scan Settings** area, complete the following fields:
 - From the **Scan File Type** drop-down list, select the default file format for scanned files.
 - From the **Scan Paper Size** drop-down list, select the default paper size for scanned files.
 - From the **Scan Resolution** drop-down list, select the default resolution for scanned files.



NOTE: Higher resolution images have more dots per inch (dpi), so they show more detail. Lower resolution images have fewer dots per inch and show less detail, but the file size is smaller.

- From the **Output Color** drop-down list, select **Black & White** or **Color**.
 - In the **File Name Prefix** field, enter a file name prefix (e.g., MyScan).
- Click **Apply**.

Set up the Scan to Network Folder feature

- [Introduction](#)
- [Before you begin](#)
- [Method one: Use the Scan to Network Folder Wizard \(Windows\)](#)
- [Method two: Set up the Scan to Network Folder feature via the HP Embedded Web Server](#)

Introduction

The printer has a feature that enables it to scan a document and save it to a network folder. To use this scan feature, the printer must be connected to a network; however, the feature is not available until it has been configured. There are two methods for configuring Scan to network folder, the Scan to Network Folder Wizard (Windows), which is installed in the HP program group for the printer as part of the full software installation, and the Network Folder Setup through the HP Embedded Web Server (EWS). Use the following information to set up the Scan to Network Folder feature.

Before you begin

To set up the Scan to Network Folder feature, the printer must have an active network connection to the same network as the computer that will run the setup process.

Administrators need the following information before beginning the configuration process.

- Administrative access to the printer
- The network path of the destination folder (e.g., \\servername.us.companyname.net\scans)



NOTE: The network folder must be set up as a shared folder for the Scan to Network Folder feature to work.

Method one: Use the Scan to Network Folder Wizard (Windows)

Use the Scan to Network Folder Wizard, available from the HP Printer Assistant application (Windows), to set up the Scan to Network Folder feature.



NOTE: Some operating systems do not support the Scan to Network Folder Wizard.

1. Open the HP Printer Assistant.
 - **Windows 10:** From the **Start** menu, click **All Apps**, click **HP**, and then select the printer name.
 - **Windows 8.1:** Click the down arrow in lower left corner of the **Start** screen, and then select the printer name.
 - **Windows 8:** Right-click an empty area on the **Start** screen, click **All Apps** on the app bar, and then select the printer name.
 - **Windows 7:** From the computer desktop, click **Start**, select **All Programs**, click **HP**, click the folder for the printer, and then select the printer name.
2. In the HP Printer Assistant, select **Scan**, and then select **Scan to Network Folder Wizard**.



NOTE: If the **Scan to Network Folder Wizard** option is not available, use [Method two: Set up the Scan to Network Folder feature via the HP Embedded Web Server on page 63](#)

3. In the **Network Folder Profiles** dialog, click the **New** button. The **Scan to Network Folder Setup** dialog opens.
4. On the **1. Start** page, enter the folder name in the **Display Name** field. This is the name that will display on the printer control panel.
5. Complete the **Destination Folder** field in one of the following ways:
 - a. Enter the file path manually.
 - b. Click the **Browse** button and navigate to the folder location.
 - c. Complete the following task to create a shared folder:
 - i. Click **Share Path**.
 - ii. In the **Manage Network Shares** dialog, click **New**.
 - iii. In the **Share Name** field, enter the name to display for the shared folder.
 - iv. To complete the Folder Path field, click the **Browse** button, and then select one of the following options. Click **OK** when done.
 - Navigate to an existing folder on the computer.
 - Click **Make New Folder** to create a new folder.
 - v. If the shared path needs a description, enter a description in the **Description** field.
 - vi. In the **Share Type** field, select one of the following options, and then click **Apply**.
 - **Public**
 - **Private**
6. To create a shortcut to the network folder on the computer desktop, select the **Create a Desktop shortcut to the network folder** check box
7. To require a PIN to be entered on the printer control panel before the printer can send a scanned document to a network folder, enter a 4-digit PIN in the **Security PIN** field, and then re-enter the PIN in the **Confirm Security PIN** field. Click **Next**.



NOTE: For security considerations, HP recommends selecting **Private** as the share type.

- vii. When a **The share was successfully created** message displays, click **OK**.
- viii. Select the check box for the destination folder, and then click **OK**.



NOTE: HP recommends creating a PIN to secure the destination folder.



NOTE: When a PIN is created, it must be entered on the printer control panel each time a scan is sent to the network folder.



8. On the **2. Authenticate** page, enter the Windows **User Name** and Windows **Password** used to log in to the computer, and then click **Next**.
9. On the **3. Configure** page, select the default scan settings by completing the following task, and then click **Next**.

- a. From the **Document Type** drop-down list, select the default file format for scanned files.
 - b. From the **Color Preference** drop-down list, select Black & White or Color.
 - c. From the **Paper Size** drop-down list, select the default paper size for scanned files.
 - d. From the **Quality Settings** drop-down list, select the default resolution for scanned files.
-
-  **NOTE:** Higher resolution images have more dots per inch (dpi), so they show more detail. Lower resolution images have fewer dots per inch and show less detail, but the file size is smaller.
-
- e. In the **Filename Prefix** field, enter a file name prefix (e.g., MyScan).
10. On the **4. Finish** page, review the information and verify all the settings are correct. If there is an error, click the **Back** button to correct the error. If the settings are correct, click the **Save and Test** button to test the configuration.
 11. When the **Congratulations** message displays, click **Finish** to complete the configuration.
 12. The **Network Folder Profiles** dialog now shows the newly added sender email profile. Click **Close** to exit the wizard.

Method two: Set up the Scan to Network Folder feature via the HP Embedded Web Server

- [Step one: Access the HP Embedded Web Server \(EWS\)](#)
- [Step two: Configure the Scan to Network Folder feature](#)

Step one: Access the HP Embedded Web Server (EWS)

1. From the Home screen on the printer control panel, touch the Network button  or the Wireless button  to display the IP address or host name.
2. Open a web browser, and in the address line, type the IP address or host name exactly as it displays on the printer control panel. Press the **Enter** key on the computer keyboard. The EWS opens.

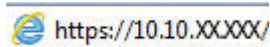
 <https://10.10.XX.XX/>

-  **NOTE:** If the web browser displays a message indicating that accessing the website might not be safe, select the option to continue to the website. Accessing this website will not harm the computer.

Step two: Configure the Scan to Network Folder feature

1. In the HP EWS, click the **System** tab.
2. On the left navigation pane, click the **Administration** link.
3. In the Enabled Features area, set the **Scan to Network Folder** option to **On**.
4. Click the **Scan** tab.
5. On the left navigation pane, make sure that the **Network Folder Setup** link is highlighted. The **Scan to Network Folder** page should be displayed.
6. On the **Network Folder Configuration** page, click the **New** button.

7. In the **Network Folder Information** area, complete the following fields:
 - a. In the **Display Name** field, enter the name to display for the folder.
 - b. In the **Network Path** field, enter the network path to the folder.
 - c. In the **Username** field, enter the user name needed to access the folder on the network.
 - d. In the **Password** field, enter the password needed to access the folder on the network.
8. To require a PIN to be entered on the printer control panel before the printer can send a file to a network folder, complete the following fields in the **Secure the Folder Access with a PIN** area:
 - a. In the **PIN (Optional)** field, enter a four digit PIN.
 - b. In the **Confirm PIN** field, re-enter the four digit PIN.

 **NOTE:** HP recommends creating a PIN to secure the destination folder.

 **NOTE:** When a PIN is created, it must be entered on the printer control panel each time a scan is sent to the network folder.

9. In the **Scan Settings** area, complete the following fields:
 - a. From the **Scan File Type** drop-down list, select the default file format scanned files.
 - b. From the **Scan Paper Size** drop-down list, select the default paper size for scanned files.
 - c. From the **Scan Resolution** drop-down list, select the default scan resolution for scanned files.

 **NOTE:** Higher resolution images have more dots per inch (dpi), so they show more detail. Lower resolution images have fewer dots per inch and show less detail, but the file size is smaller.

- d. In the **Output Color** drop-down list, select whether scanned files will be in black and white or in color.
 - e. In the **File Name Prefix** field, enter a file name prefix (e.g., MyScan).
10. Review all the information, and then click one of the following options:
 - **Save and Test:** Select this option to save the information and test the connection.
 - **Save Only:** Select this option to save the information without testing the connection.
 - **Cancel:** Select this option to quit the configuration without saving.

Scan to a USB flash drive

1. Load the document on the scanner glass or into the document feeder according to the indicators on the printer.
2. Insert a USB flash drive into the walk-up USB port.
3. The **USB Flash Drive** menu opens with the following options:
 - [Print Documents](#)
 - [View and Print Photos](#)
 - [Scan to USB Drive](#)
4. Select [Scan to USB Drive](#).
5. When the summary screen opens, the following settings can be adjusted:
 - [Scan File Type](#)
 - [Scan Resolution](#)
 - [Scan Paper Size](#)
 - [Scan Source](#)
 - [File Name Prefix](#)
 - [Output Color](#)
6. Touch the [Scan](#) button to scan and save the file.

The printer creates a folder named **HPSCANS** on the USB drive, and it saves the file in .PDF or .JPG format using an automatically generated file name.

Scan to email

Use the printer control panel to scan a file directly to an email address. The scanned file is sent to the address as an email message attachment.



NOTE: In order to use this feature, the printer must be connected to a network and the Scan to Email feature must be configured by using the Scan to Email Setup Wizard (Windows) or the HP Embedded Web Server.

1. Load the document on the scanner glass according to the indicators on the printer.
2. From the Home screen on the printer control panel, touch the [Scan](#) icon .
3. Touch [Scan to E-mail](#).
4. Select the [From](#) address that you want to use. This is also known as an “outgoing email profile.”



NOTE: If the printer is configured with only one outgoing email profile, then this option will not be available.



NOTE: If the PIN feature has been set up, enter the PIN and touch the [OK](#) button. However, a PIN is not required to use this feature.

5. Touch the [To](#) button and pick the address or group to which you want to send the file. Touch the [Done](#) button when finished.
 - To send the message to a different address, touch the [New](#) again and enter the email address.
6. Touch the [Subject](#) button if you would like to add a subject line.
7. The control panel screen displays the scan settings.
 - To view the scan settings, touch [Settings](#).
 - To change a scan setting, touch [Edit](#) and then change the setting.
8. Touch the [Scan](#) button to start the scan job.

Scan to a network folder

Use the printer control panel to scan a document and save it to a folder on the network.



NOTE: In order to use this feature, the printer must be connected to a network and the Scan to Network Folder feature must be configured by using the Scan to Network Folder Setup Wizard (Windows) or the HP Embedded Web Server.

1. Load the document on the scanner glass according to the indicators on the printer.
2. From the Home screen on the printer control panel, touch the [Scan](#) icon .
3. Touch the [Scan to Network Folder](#) item.
4. In the list of network folders, select the folder to which you want to save the document.
5. The control panel screen displays the scan settings.
 - If you want to change any of the settings, touch the [Settings](#) button, and then change the settings.
 - If the settings are correct, go to the next step.
6. Touch the [Scan](#) button to start the scan job.

Additional scan tasks

Go to www.hp.com/support/ljM282MFP.

Instructions are available for performing specific scan tasks, such as the following:

- How to scan a general photo or document
- How to scan as editable text (OCR)
- How to scan multiple pages into a single file

7 Fax

- [Set up to send and receive faxes](#)
- [Send a fax](#)

For more information:

The following information is correct at the time of publication. For current information, see www.hp.com/support/ljM282MFP.

HP's all-inclusive help for the printer includes the following information:

- Install and configure
- Learn and use
- Solve problems
- Download software and firmware updates
- Join support forums
- Find warranty and regulatory information

Set up to send and receive faxes

- [Before starting](#)
- [Step 1: Identify the phone connection type](#)
- [Step 2: Set up the fax](#)
- [Step 3: Configure the fax time, date, and header](#)
- [Step 4: Run a fax test](#)

Before starting

Make sure that the printer was fully set up before connecting the fax service.

 **NOTE:** Use the telephone cable and any adapters that shipped with the printer to connect the printer to the telephone jack.

 **NOTE:** In countries/regions that use serial telephone systems, an adapter is shipped with the printer. Use the adapter to connect other telecom devices to the same telephone jack the printer is connected to.

Complete the instructions in each of the following four steps:

[Step 1: Identify the phone connection type on page 70.](#)

[Step 2: Set up the fax on page 71.](#)

[Step 3: Configure the fax time, date, and header on page 74.](#)

[Step 4: Run a fax test on page 76.](#)

Step 1: Identify the phone connection type

Review the following equipment and service types to determine which setup method to use. The method used depends on the equipment and services already installed on the phone system.

 **NOTE:** The printer is an analog device. HP recommends using the printer on a dedicated analog telephone line.

- **Dedicated phone line:** The printer is the only piece of equipment or service connected to the phone line
- **Voice calls:** Voice and fax calls use the same phone line
- **Answering machine:** An answering machine answers voice calls on the same phone line used for fax calls
- **Voice mail:** A voice-mail subscription service uses the same phone line as the fax
- **Distinctive ring service:** A service from the telephone company that allows several phone numbers to be associated with one phone line, and each number has a different ring pattern; the printer detects the ring pattern assigned to it and answers the call
- **Computer dial-up modem:** A computer uses the phone line to connect to the Internet through a dial-up connection
- **DSL line:** A digital subscriber line (DSL) service from the telephone company; this service might be called ADSL in some countries/regions

- **PBX or ISDN phone system:** A private branch exchange (PBX) phone system or an integrated services digital network (ISDN) system
- **VoIP phone system:** Voice over Internet protocol (VoIP) through an Internet provider

Step 2: Set up the fax

Click the link below that best describes the environment in which the printer will be sending and receiving faxes, and follow the setup instructions.

- [Dedicated phone line on page 71](#)
- [Shared voice/fax line on page 72](#)
- [Shared voice/fax line with an answering machine on page 73](#)

Instructions for only three of the connection types are included here. For more information about connecting the printer with other connection types, go to the support website www.hp.com/support/ljM282MFP.

 **NOTE:** This printer is an analog fax device. HP recommends using the printer on a dedicated analog telephone line. For a digital environment, such as DSL, PBX, ISDN, or VoIP, make sure to use the correct filters and configure the digital settings correctly. For more information, contact the digital service provider.

 **NOTE:** Do not connect more than three devices to the telephone line.

 **NOTE:** Voice mail is not supported with this printer.

Dedicated phone line

Follow these steps to set up the printer on a dedicated phone line with no additional services.

1. Connect the telephone cable to the fax port on the printer and to the telephone jack on the wall.

 **NOTE:** Some countries/regions might require an adapter for the telephone cable that came with the printer.

 **NOTE:** On some printers, the fax port might be above the phone port. Refer to the icons on the printer.

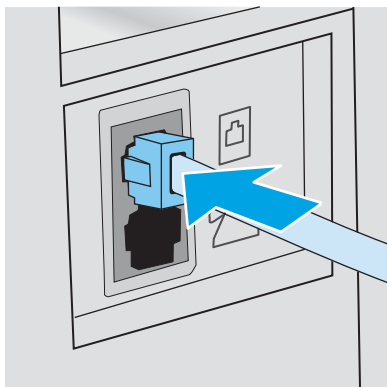

2. Set the printer to answer fax calls automatically.
 - a. Turn the printer on.
 - b. From the control panel, open the [Setup](#) menu.

- c. Select the [Fax Setup](#) menu.
 - d. Select the [Basic Setup](#) menu.
 - e. Select the [Answer Mode](#) setting.
 - f. Select the [Automatic](#) option.
3. Continue to [Step 3: Configure the fax time, date, and header on page 74](#).

Shared voice/fax line

Follow these steps to set up the printer on a shared voice/fax line.

1. Disconnect any devices that are connected to the telephone jack.
2. Connect the telephone cable to the fax port on the printer and to the telephone jack on the wall.

 **NOTE:** Some countries/regions might require an adapter to the telephone cable that came with the printer.

 **NOTE:** On some printers, the fax port might be above the phone port. Refer to the icons on the printer.

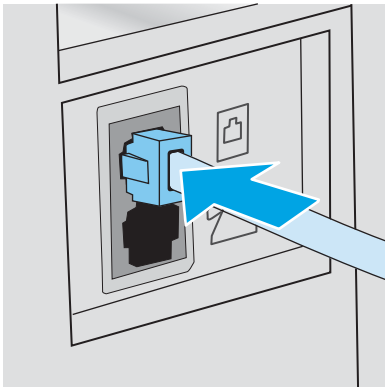

3. Remove the plug from the telephone line out port on the rear of the printer, and then connect a phone to this port.
4. Set the printer to answer fax calls automatically.
 - a. Turn the printer on.
 - b. From the control panel, open the [Setup](#) menu.
 - c. Select the [Fax Setup](#) menu.
 - d. Select the [Basic Setup](#) menu.
 - e. Select the [Answer Mode](#) setting, and then select the [Automatic](#) option.
5. Set the printer to check for a dial tone before sending a fax.

 **NOTE:** This prevents the printer from sending a fax while someone is on the telephone.

- a. From the control panel, open the [Setup](#) menu.
- b. Select the [Fax Setup](#) menu.

- c. Select the [Advanced Setup](#) menu.
 - d. Select the [Detect Dial Tone](#) setting, and then select [On](#).
6. Continue to [Step 3: Configure the fax time, date, and header on page 74](#).

Shared voice/fax line with an answering machine

Follow these steps to set up the printer on a shared voice/fax line with an answering machine.

1. Disconnect any devices that are connected to the telephone jack.
2. Connect the telephone cable to the fax port on the printer and to the telephone jack on the wall.

 **NOTE:** Some countries/regions might require an adapter for the telephone cable that came with the printer.

 **NOTE:** On some printers, the fax port might be above the phone port. Refer to the icons on the printer.

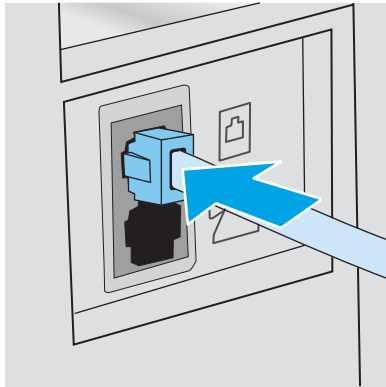

3. Remove the plug from the telephone line out port on the rear of the printer.
4. Connect the answering machine telephone cable to the telephone line out port on the rear of the printer.

 **NOTE:** Connect the answering machine directly to the printer, or the answering machine might record fax tones from a sending fax machine and the printer might not receive faxes.

 **NOTE:** If the answering machine does not have a built-in telephone, connect a telephone to the **OUT** port on the answering machine for convenience.

 **NOTE:** On some printers, the fax port might be above the phone port. Refer to the icons on the printer.

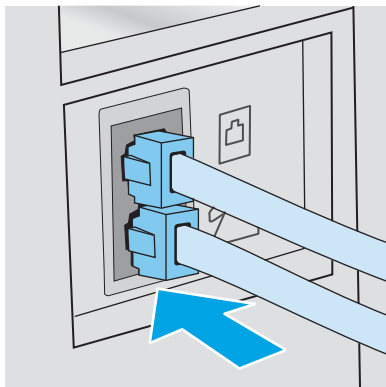

5. Configure the rings to answer setting on the printer.
 - a. Turn the printer on.
 - b. From the control panel, open the [Setup](#) menu.
 - c. Select the [Fax Setup](#) menu.
 - d. Select the [Basic Setup](#) menu.
 - e. Select the [Rings to Answer](#) option.
 - f. Use the numeric keypad on the printer control panel to set the number of rings, and then select [OK](#).
6. Set the printer to answer fax calls automatically.
 - a. From the control panel, open the [Setup](#) menu.
 - b. Select the [Fax Setup](#) menu.
 - c. Select the [Basic Setup](#) menu.
 - d. Select the [Answer Mode](#) setting, and then select the [Automatic](#) option.
7. Set the printer to check for a dial tone before sending a fax.



NOTE: This prevents the printer from sending a fax while someone is on the telephone.

- a. From the control panel, open the [Setup](#) menu.
 - b. Select the [Fax Setup](#) menu.
 - c. Select the [Advanced Setup](#) menu.
 - d. Select the [Detect Dial Tone](#) setting, and then select the **On** button.
8. Continue to [Step 3: Configure the fax time, date, and header on page 74](#).

Step 3: Configure the fax time, date, and header

Configure the printer fax settings using one of the following methods:

- [HP Fax Setup Wizard on page 74](#) (recommended method)
- [Printer control panel on page 75](#)
- [HP Embedded Web Server \(EWS\) and HP Device Toolbox \(Windows\) on page 75](#) (if the software is installed)



NOTE: In the United States and many other countries/regions, setting the time, date, and other fax header information is a legal requirement.

HP Fax Setup Wizard

Access the Fax Setup Wizard after *initial* setup and software installation by following these steps.



NOTE: Some operating systems do not support the Fax Setup Wizard.

1. Open the HP Printer Assistant.

- **Windows 10:** From the **Start** menu, click **All Apps**, click **HP**, and then select the printer name.
 - **Windows 8.1:** Click the down arrow in lower left corner of the **Start** screen, and then select the printer name.
 - **Windows 8:** Right-click an empty area on the **Start** screen, click **All Apps** on the app bar, and then select the printer name.
 - **Windows 7, Windows Vista, and Windows XP:** From the computer desktop, click **Start**, select **All Programs**, click **HP**, click the folder for the printer, and then select the printer name.
2. In the HP Printer Assistant, select **Fax**, and then select **Fax Setup Wizard**.
 3. Follow the on-screen instructions in the HP Fax Setup Wizard to configure the fax settings.
 4. Continue to [Step 4: Run a fax test on page 76](#).

Printer control panel

To use the control panel to set the date, time, and header, complete the following steps.

1. From the control panel, open the [Setup](#) menu.
2. Select the [Fax Setup](#) menu.
3. Select the [Basic Setup](#) menu.
4. Select the [Time/Date](#) option.
5. Select [12-hour clock](#) or [24-hour clock](#).
6. Use the keypad to enter the current time, and then select [OK](#).
7. Select the date format.
8. Use the keypad to enter the current date, and then select [OK](#).
9. Select the [Fax Header](#) menu.
10. Use the keypad to enter the fax number, and then select [OK](#).

 **NOTE:** The maximum number of characters for the fax number is 20.

11. Use the keypad to enter the company name or header, and then select [OK](#).

 **NOTE:** The maximum number of characters for the fax header is 25.

12. Continue to [Step 4: Run a fax test on page 76](#).

HP Embedded Web Server (EWS) and HP Device Toolbox (Windows)

1. Start the HP EWS either from the software or a web browser.

Method one: Open the HP Embedded Web Server (EWS) from the software

- a. Open the HP Printer Assistant.

- **Windows 10:** From the **Start** menu, click **All Apps**, click **HP**, and then select the printer name.
 - **Windows 8.1:** Click the down arrow in lower left corner of the **Start** screen, and then select the printer name.
 - **Windows 8:** Right-click an empty area on the **Start** screen, click **All Apps** on the app bar, and then select the printer name.
 - **Windows 7, Windows Vista, and Windows XP:** From the computer desktop, click **Start**, select **All Programs**, click **HP**, click the folder for the printer, and then select the printer name.
- b. In the HP Printer Assistant, select **Print**, and then select **HP Device Toolbox**.

Method two: Open the HP Embedded Web Server (EWS) from a web browser

- a. On the printer control panel, press the Setup button . Open the **Network Setup** menu, select **Show IP Address**, and then select **Yes**. Return to the Home screen to view the IP address.
- b. Open a web browser, and in the address line, type the IP address or host name exactly as it displays on the printer control panel. Press the **Enter** key on the computer keyboard. The EWS opens.

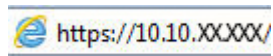

 **NOTE:** If the web browser displays a message indicating that accessing the website might not be safe, select the option to continue to the website. Accessing this website will not harm the computer.

2. Click the **Fax** tab.
3. Follow the on-screen instructions to configure the fax settings.
4. Continue to [Step 4: Run a fax test on page 76](#).

Step 4: Run a fax test

Run a fax test to make sure that the fax is set up correctly.

1. From the control panel, open the **Setup** menu.
2. Select the **Self Diagnostics** menu.
3. Select the **Run Fax Test** option. The printer prints a test report.
4. Review the report.
 - If the report indicates the printer **passed the test**, the printer is ready to send and receive faxes.
 - If the report indicates the printer **failed the test**, review the report for more information about fixing the problem. The fax troubleshooting checklist has more information on resolving fax problems.

Send a fax

- [Fax from the flatbed scanner](#)
- [Fax from the document feeder](#)
- [Use speed dials and group-dial entries](#)
- [Send a fax from the software](#)
- [Send a fax from a third-party software program, such as Microsoft Word](#)

Fax from the flatbed scanner

1. Place the document face-down on the scanner glass.



2. From the Home screen on the printer control panel, touch the **Fax** icon .
3. Use the keypad to enter the fax number.
4. Touch the **Start Fax** button.
5. The printer prompts you to confirm that you are sending from the scanner glass. Touch the **Yes** button.
6. The printer prompts you to load the first page. Touch the **OK** button.
7. The printer scans the first page and then prompts you to load another page. If the document has multiple pages, touch the **Yes** button. Continue this process until you have scanned all the pages.
8. When you have scanned the last page, touch the **No** button at the prompt. The printer sends the fax.

Fax from the document feeder

1. Insert the originals into the document feeder face-up.

CAUTION: To prevent damage to the printer, do not use an original that contains correction tape, correction fluid, paper clips, or staples. Also, do not load photographs, small originals, or fragile originals into the document feeder.

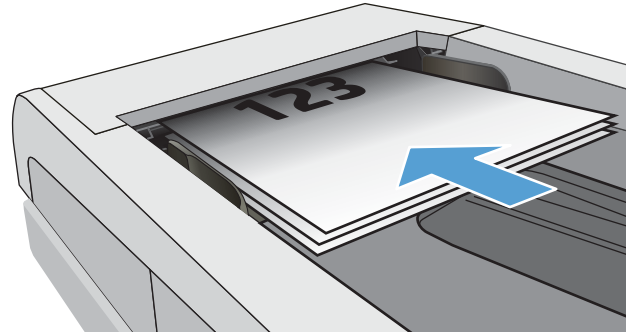

2. Adjust the paper guides until they are snug against the paper.

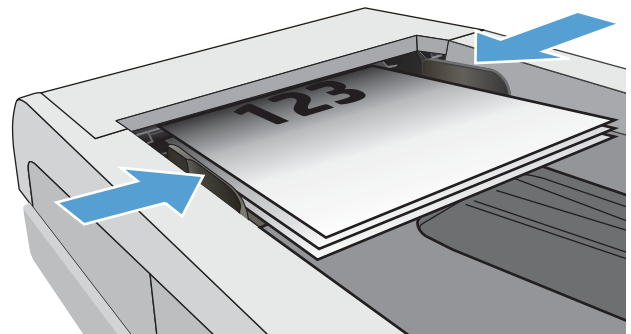



3. From the Home screen on the printer control panel, touch the **Fax** icon .
4. Use the keypad to enter the fax number.
5. Touch the **Start Fax** button.

Use speed dials and group-dial entries

 **NOTE:** Phone book entries must be set up using the **Fax Menu** prior to using the phone book to send faxes.

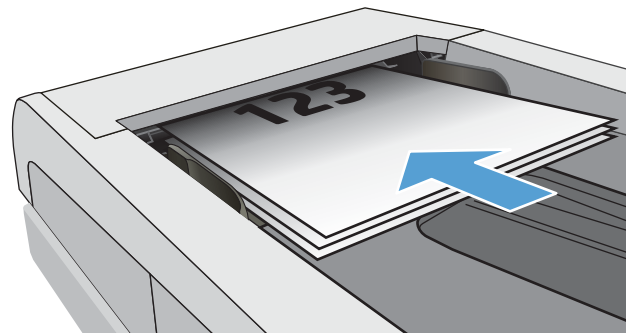
1. Load the document onto the scanner glass or into the document feeder.



2. From the Home screen on the printer control panel, touch the **Fax** icon .
3. On the keypad, touch the fax phone book icon.
4. Touch the name of the individual or group entry that you want to use.
5. Touch the **Start Fax** button.

Send a fax from the software

The procedure to send a fax varies according to your specifications. The most typical steps follow.

1. Open the HP Printer Assistant.
 - **Windows 10:** From the **Start** menu, click **All Apps**, click **HP**, and then select the printer name.
 - **Windows 8.1:** Click the down arrow in lower left corner of the **Start** screen, and then select the printer name.
 - **Windows 8:** Right-click an empty area on the **Start** screen, click **All Apps** on the app bar, and then select the printer name.
 - **Windows 7:** From the computer desktop, click **Start**, select **All Programs**, click **HP**, click the folder for the printer, and then select the printer name..
2. In the HP Printer Assistant, select **Fax**, and then select **Send Fax**.
3. Enter the fax number of one or more recipients.
4. Load the document in the document feeder.
5. Click **Send Now**.

Send a fax from a third-party software program, such as Microsoft Word

1. Open a document in a third-party program.
2. Click the **File** menu, and then click **Print**.
3. Select the fax print driver from the print driver drop-down list. The fax software opens.
4. Enter the fax number of one or more recipients.
5. Include any pages loaded at the printer. This step is optional.
6. Click **Send Now**.

8 Manage the printer

- [Use HP Web Services applications \(touchscreen models only\)](#)
- [Change the printer connection type \(Windows\)](#)
- [Advanced configuration with HP Embedded Web Server \(EWS\) and HP Device Toolbox \(Windows\)](#)
- [Configure IP network settings](#)
- [Printer security features](#)
- [Energy-conservation settings](#)
- [HP Web Jetadmin](#)
- [Update the firmware](#)

For more information:

The following information is correct at the time of publication. For current information, see www.hp.com/support/ljM282MFP.

HP's all-inclusive help for the printer includes the following information:

- Install and configure
- Learn and use
- Solve problems
- Download software and firmware updates
- Join support forums
- Find warranty and regulatory information

Use HP Web Services applications (touchscreen models only)

HP Web Services applications provide useful content that can be automatically downloaded from the Internet to the printer. Choose from a variety of applications including news, calendars, forms, and cloud-based document storage.

To activate these applications and schedule the downloads, go to the HP Connected website at www.hpconnected.com



NOTE: To use this feature, the printer must be connected to a wired or wireless network and have internet access. HP Web Services must be enabled on the printer.

Enable Web Services

This process enables both HP Web Services and the [Apps](#) button .

1. From the Home screen on the printer control panel, swipe until the [Setup](#) menu displays. Touch the [Setup](#) icon  to open the menu.
2. Touch [HP Web Services](#).
3. Touch [Enable Web Services](#).
4. To print the HP Web Services Terms of Use, touch [Print](#).
5. Touch [OK](#) to complete the procedure.

After you download an application from the HP Connected website, it is available in the [Apps](#) menu on the printer control panel.

Change the printer connection type (Windows)

If you are already using the printer and you wish to change the way it is connected, use **Device Setup & Software** to change the connection. For example, connect the new printer to the computer using a USB or network connection, or change the connection from a USB to a wireless connection.

To open **Device Setup & Software**, complete the following procedure:

1. Open the HP Printer Assistant.
 - **Windows 10:** From the **Start** menu, click **All Apps**, click **HP**, and then select the printer name.
 - **Windows 8.1:** Click the down arrow in lower left corner of the **Start** screen, and then select the printer name.
 - **Windows 8:** Right-click an empty area on the **Start** screen, click **All Apps** on the app bar, and then select the printer name.
 - **Windows 7, Windows Vista, and Windows XP:** From the computer desktop, click **Start**, select **All Programs**, click **HP**, click the folder for the printer, and then select the printer name.
2. In the HP Printer Assistant, select **Tools** from the navigation bar, and then select **Device Setup & Software**.

Advanced configuration with HP Embedded Web Server (EWS) and HP Device Toolbox (Windows)

Use the HP Embedded Web Server to manage printing functions from your computer instead of the printer control panel.

- View printer status information
- Determine the remaining life for all supplies and order new ones
- View and change tray configurations (paper types and sizes)
- View and print internal pages
- View and change network configuration

The HP Embedded Web Server works when the printer is connected to an IP-based network. The HP Embedded Web Server does not support IPX-based printer connections. You do not have to have Internet access to open and use the HP Embedded Web Server.

When the printer is connected to the network, the HP Embedded Web Server is automatically available.



 **NOTE:** HP Device Toolbox is software used to connect to the HP Embedded Web Server when the printer is connected to a computer via USB. It is available only if a full installation was performed when the printer was installed on a computer. Depending on how the printer is connected, some features might not be available.

 **NOTE:** The HP Embedded Web Server is not accessible beyond the network firewall.

Method one: Open the HP Embedded Web Server (EWS) from the software

1. Open the HP Printer Assistant.
 - **Windows 10:** From the **Start** menu, click **All Apps**, click **HP**, and then select the printer name.
 - **Windows 8.1:** Click the down arrow in lower left corner of the **Start** screen, and then select the printer name.
 - **Windows 8:** Right-click an empty area on the **Start** screen, click **All Apps** on the app bar, and then select the printer name.
 - **Windows 7:** From the computer desktop, click **Start**, select **All Programs**, click **HP**, click the folder for the printer, and then select the printer name.
2. In the HP Printer Assistant, select **Print**, and then select **HP Device Toolbox**.

Method two: Open the HP Embedded Web Server (EWS) from a web browser

1. From the Home screen on the printer control panel, touch the Connection Information button , and then touch the **Network Connected** button  or the **Network Wi-Fi ON** button  to display the IP address or host name.

- Open a web browser, and in the address line, type the IP address or host name exactly as it displays on the printer control panel. Press the **Enter** key on the computer keyboard. The EWS opens.

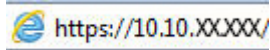

NOTE: If the web browser displays a message indicating that accessing the website might not be safe, select the option to continue to the website. Accessing this website will not harm the computer.

Table 8-1 EWS tabs

Tab or section	Description
<p>Home tab</p> <p>Provides printer, status, and configuration information.</p>	<ul style="list-style-type: none"> • Device Status: Shows the printer status and shows the approximate percent life remaining of HP supplies. • Supplies Status: Shows the approximate percent life remaining of HP supplies. Actual supply life remaining can vary. Consider having a replacement supply available to install when print quality is no longer acceptable. The supply does not need to be replaced unless the print quality is no longer acceptable. • Device Configuration: Shows the information found on the printer configuration page. • Network Summary: Shows the information found on the printer network configuration page. • Reports: Print the configuration and supplies status pages that the printer generates. • Color Usage Log: Shows a summary of color jobs that the printer has produced. (Color models only) • Event Log: Shows a list of all printer events and errors. • Open Source Licenses: Shows a summary of the licenses for open source software programs that can be used with the printer.
<p>System tab</p> <p>Provides the ability to configure the printer from your computer.</p>	<ul style="list-style-type: none"> • Device Information: Provides basic printer and company information. • Paper Setup: Change the default paper-handling settings for the printer. • Print Quality: Change the default print-quality settings for the printer. • Energy Settings: Change the default times for entering Sleep/Auto Off mode or automatic shut down. • Print Density: Change the print density of contrasts, highlights, midtones, and shadows. • Paper Types: Configure print modes that correspond to the paper types that the printer accepts. • System Setup: Change the system defaults for the printer. • Supply Settings: Change the settings for Cartridge is low alerts and other supplies information. • Service: Perform the cleaning procedure on the printer. • Save and Restore: Save the current settings for the printer to a file on the computer. Use this file to load the same settings onto another printer or to restore these settings to this printer at a later time. • Administration: Set or change the printer password. Enable or disable printer features. <p>NOTE: The System tab can be password-protected. If this printer is on a network, always consult with the administrator before changing settings on this tab.</p>

Table 8-1 EWS tabs (continued)

Tab or section	Description
<p>Print tab</p> <p>Provides the ability to change default print settings from your computer.</p>	<ul style="list-style-type: none"> • Printing: Change the default printer print settings, such as number of copies and paper orientation. These are the same options that are available on the control panel. • PCL5: View and change the PCL5 settings. • PostScript: Turn off or on the Print PS Errors feature.
<p>Fax tab</p> <p>(Fax models only)</p>	<ul style="list-style-type: none"> • Receive Options: Configure how the printer handles incoming faxes. • Phone Book: Add or delete entries in the fax phone book. • Junk Fax List: Set fax numbers to block from sending faxes to the printer. • Fax Activity Log: Review recent fax activity for the printer.
<p>Scan tab</p> <p>(MFP models only)</p>	<p>Configure the Scan to Network Folder and Scan to E-mail features.</p> <ul style="list-style-type: none"> • Network Folder Setup: Configure folders on the network to which the printer can save a scanned file. • Scan to E-mail Setup: Begin the process to set up the Scan to E-mail feature. • Outgoing E-mail Profiles: Set an email address that will appear as the “from” address for all emails sent from the printer. Configure the SMTP Server information. • E-mail Address Book: Add or delete entries in the email address book. • E-mail Options: Configure a default subject line and body text. Configure default scan settings for emails.
<p>Copy tab</p> <p>(MFP models only)</p>	<p>Configure the default copy settings.</p>
<p>Networking tab</p> <p>(Network-connected printers only)</p> <p>Provides the ability to change network settings from your computer.</p>	<p>Network administrators can use this tab to control network-related settings for the printer when it is connected to an IP-based network. It also allows the network administrator to set up Wireless Direct functionality. This tab does not appear if the printer is directly connected to a computer.</p>
<p>HP Web Services tab</p>	<p>Use this tab to set up and use various web tools with the printer.</p>

Configure IP network settings

- [Introduction](#)
- [Printer sharing disclaimer](#)
- [View or change network settings](#)
- [Rename the printer on a network](#)
- [Manually configure IPv4 TCP/IP parameters from the control panel](#)

Introduction





Use the following sections to configure the printer network settings.

Printer sharing disclaimer

HP does not support peer-to-peer networking, as the feature is a function of Microsoft operating systems and not of the HP printer drivers. Go to Microsoft at www.microsoft.com.

View or change network settings

Use the HP Embedded Web Server to view or change IP configuration settings.

1. Open the HP Embedded Web Server (EWS):
 - a. From the Home screen on the printer control panel, touch the Connection Information button  / , and then touch the **Network Connected** button  or the **Network Wi-Fi ON** button  to display the IP address or host name.
 - b. Open a web browser, and in the address line, type the IP address or host name exactly as it displays on the printer control panel. Press the **Enter** key on the computer keyboard. The EWS opens.





 <https://10.10.XXXXX/>

 **NOTE:** If the web browser displays a message indicating that accessing the website might not be safe, select the option to continue to the website. Accessing this website will not harm the computer.

2. Click the **Networking** tab to obtain network information. Change settings as needed.

Rename the printer on a network

To rename the printer on a network so that it can be uniquely identified, use the HP Embedded Web Server.

1. Open the HP Embedded Web Server (EWS):
 - a. From the Home screen on the printer control panel, touch the Connection Information button  / , and then touch the **Network Connected** button  or the **Network Wi-Fi ON** button  to display the IP address or host name.

- b. Open a web browser, and in the address line, type the IP address or host name exactly as it displays on the printer control panel. Press the **Enter** key on the computer keyboard. The EWS opens.

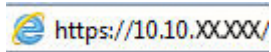

 **NOTE:** If the web browser displays a message indicating that accessing the website might not be safe, select the option to continue to the website. Accessing this website will not harm the computer.

2. Open the **System** tab.
3. On the **Device Information** page, the default printer name is in the **Device Description** field. You can change this name to uniquely identify this printer.

 **NOTE:** Completing the other fields on this page is optional.

4. Click the **Apply** button to save the changes.

Manually configure IPv4 TCP/IP parameters from the control panel

Use the control-panel menus to manually set an IPv4 address, subnet mask, and default gateway.

1. From the Home screen on the printer control panel, touch the **Setup** button .
2. Scroll to and touch the **Network Setup** menu.
3. Touch the **IPv4 Config Method** menu, and then touch the **Manual** button.
4. Use the keypad on the touchscreen to enter the IP address, and touch the **OK** button. Touch the **Yes** button to confirm.
5. Use the keypad on the touchscreen to enter the subnet mask, and touch the **OK** button. Touch the **Yes** button to confirm.
6. Use the keypad on the touchscreen to enter the default gateway, and touch the **OK** button. Touch the **Yes** button to confirm.

Printer security features





Introduction

The printer includes several security features to restrict who has access to configuration settings, to secure data, and to prevent access to valuable hardware components.

- [Assign or change the system password using the Embedded Web Server](#)

Assign or change the system password using the Embedded Web Server

Assign an administrator password for access to the printer and the HP Embedded Web Server so that unauthorized users cannot change the printer settings.

1. Open the HP Embedded Web Server (EWS):
 - a. From the Home screen on the printer control panel, touch the Connection Information button  / , and then touch the **Network Connected** button  or the **Network Wi-Fi ON** button  to display the IP address or host name.
 - b. Open a web browser, and in the address line, type the IP address or host name exactly as it displays on the printer control panel. Press the **Enter** key on the computer keyboard. The EWS opens.

 <https://10.10.XX.XXX/>

 **NOTE:** If the web browser displays a message indicating that accessing the website might not be safe, select the option to continue to the website. Accessing this website will not harm the computer.

2. On the **System** tab, click the **Administration** link in the left navigation pane.
3. In the area labeled **Product Security**, enter the password in the **Password** field.
4. Re-enter the password in the **Confirm Password** field.
5. Click the **Apply** button.

 **NOTE:** Make note of the password and store it in a safe place.

6. Click the **Apply** button.

 **NOTE:** Make note of the password and store it in a safe place.

Energy-conservation settings

- [Introduction](#)
- [Print with EconoMode](#)
- [Set the Sleep/Auto Off After Inactivity setting](#)
- [Set the Shut Down After Inactivity delay and configure the printer to use 1 watt or less of power](#)
- [Set the Delay Shut Down setting](#)

Introduction

The printer includes several economy features to conserve energy and supplies.

Print with EconoMode

This printer has an EconoMode option for printing drafts of documents. Using EconoMode can use less toner. However, using EconoMode can also reduce print quality.

HP does not recommend the full-time use of EconoMode. If EconoMode is used full-time, the toner supply might outlast the mechanical parts in the toner cartridge. If print quality begins to degrade and is no longer acceptable, consider replacing the toner cartridge.



NOTE: If this option is not available in your print driver, you can set it using the HP Embedded Web Server.

1. From the software program, select the **Print** option.
2. Select the printer, and then click the **Properties** or **Preferences** button.
3. Click the **Paper/Quality** tab.
4. Click the **EconoMode** check box.

Set the Sleep/Auto Off After Inactivity setting

Use the control panel menus to set the amount of idle time before the printer enters sleep mode.

Complete the following procedure to change the Sleep/Auto Off After setting:

1. From the Home screen on the printer control panel, swipe until the **Setup** menu displays. Touch the **Setup** icon to open the menu.
2. Open the following menus:
 - a. [System Setup](#)
 - b. [Energy Settings](#)
 - c. [Sleep/Auto Off After](#)
3. Select the time for the Sleep/Auto Off After delay.

Set the Shut Down After Inactivity delay and configure the printer to use 1 watt or less of power

Use the control panel menus to set the amount of time before the printer shuts down.

 **NOTE:** After the printer shuts down, the power consumption is 1 watt or less.

Complete the following procedure to change the Shut Down After Delay setting:

1. From the Home screen on the printer control panel, swipe until the [Setup](#) menu displays. Touch the [Setup](#) icon  to open the menu.
2. Open the following menus:
 - a. [System Setup](#)
 - b. [Energy Settings](#)
 - c. [Shut Down After](#)
3. Select the time for the Shut Down After delay.

 **NOTE:** The default value is [4 hours](#).

Set the Delay Shut Down setting

Use the control panel menus to select whether or not the printer delays shutting down after the power button is pressed.

Complete the following procedure to change the Delay Shut Down setting:

1. From the Home screen on the printer control panel, swipe until the [Setup](#) menu displays. Touch the [Setup](#) icon  to open the menu.
2. Open the following menus:
 - a. [System Setup](#)
 - b. [Energy Settings](#)
 - c. [Delay Shut Down](#)
3. Select one of the delay options:
 - [No Delay](#): The printer shuts down after a period of inactivity determined by the Shut Down After setting.
 - [When Ports Are Active](#): When this option is selected the printer will not shut down unless all ports are inactive. An active network link or fax connection will prevent the printer from shutting down.

HP Web Jetadmin

HP Web Jetadmin is an award-winning, industry-leading tool for efficiently managing a wide variety of networked HP products, including printers, multifunction printers, and digital senders. This single solution allows you to remotely install, monitor, maintain, troubleshoot, and secure your printing and imaging environment — ultimately increasing business productivity by helping you save time, control costs, and protect your investment.

HP Web Jetadmin upgrades are periodically made available to provide support for specific product features. Go to www.hp.com/go/webjetadmin for more information.

Update the firmware

HP offers periodic printer updates, new Web Services apps, and new features to existing Web Services apps. Follow these steps to update the printer firmware for a single printer. When you update the firmware, Web Service apps will update automatically.

There are two supported methods to perform a firmware update on this printer. Use only one of the following methods to update the printer firmware.

Method one: Update the firmware using the control panel

Use these steps to load the firmware from the control panel (for network-connected printers only), and/or set the printer to automatically load future firmware updates. For USB-connected printers, skip to method two.

1. Make sure the printer is connected to a wired (Ethernet) or wireless network with an active Internet connection.

 **NOTE:** The printer must be connected to the internet to update the firmware via a network connection.

2. From the Home screen on the printer control panel, touch the **Setup** button .
3. Scroll to and open the **Service** menu, and then open the **LaserJet Update** menu.

 **NOTE:** If the **LaserJet Update** option is not listed, use method two.

4. Touch **Check for Updates Now** to check for updates.

 **NOTE:** The printer automatically checks for an update, and if a newer version is detected, the update process automatically starts.

5. Set the printer to automatically update the firmware when updates become available.

From the Home screen on the printer control panel, touch the **Setup** button .

Scroll to and open the **Service** menu, open the **LaserJet Update** menu, and then select the **Manage Updates** menu.

Set the **Allow Updates** option to **YES**, and then set the **Check automatically** option to **ON**.

Method two: Update the firmware using the Firmware Update Utility

Use these steps to manually download and install the Firmware Update Utility from HP.com.

 **NOTE:** This method is the only firmware update option available for printers connected to the computer via a USB cable. It also works for printers connected to a network.

 **NOTE:** You must have a print driver installed in order to use this method.

1. Go to www.hp.com/go/support, click the **Drivers & Software** link, type the printer name in the search field, press the **ENTER** button, and then select the printer from the list of search results.
2. Select the operating system.
3. Under the **Firmware** section, locate the **Firmware Update Utility**.
4. Click **Download**, click **Run**, and then click **Run** again.

5. When the utility launches, select the printer from the drop-down list, and then click **Send Firmware**.



NOTE: To print a configuration page to verify the installed firmware version before or after the update process, click **Print Config**.

6. Follow the on-screen instructions to complete the installation, and then click the **Exit** button to close the utility.

9 Solve problems

- [Customer support](#)
- [Control panel help system](#)
- [Restore the factory-set defaults](#)
- [A “Cartridge is low” or “Cartridge is very low” message displays on the printer control panel](#)
- [Printer does not pick up paper or misfeeds](#)
- [Clear paper jams](#)
- [Improve print quality](#)
- [Resolving print quality problems](#)
- [Improve copy and scan image quality](#)
- [Improve fax image quality](#)
- [Solve wired network problems](#)
- [Solve wireless network problems](#)
- [Solve fax problems](#)

For more information:

The following information is correct at the time of publication. For current information, see www.hp.com/support/ljM282MFP.

HP's all-inclusive help for the printer includes the following information:

- Install and configure
- Learn and use
- Solve problems
- Download software and firmware updates
- Join support forums
- Find warranty and regulatory information

Customer support

Table 9-1 Customer support options

Support option	Location
Get telephone support for your country/region	Country/region phone numbers are on the flyer that was in the box with the printer or at support.hp.com .
Have the printer name, serial number, date of purchase, and problem description ready	
Get 24-hour Internet support, and download software utilities and drivers	www.hp.com/support/ljM282MFP
Order additional HP service or maintenance agreements	www.hp.com/go/carepack
Register the printer	www.register.hp.com

Control panel help system

The printer has a built-in Help system that explains how to use each screen. To open the Help system, touch the Help button **?** in the lower-left corner of the screen.



For some screens, the Help opens to a global menu where you can search for specific topics. You can browse through the menu structure by touching the buttons in the menu.

Some Help screens include animations that guide you through procedures, such as clearing jams.

For screens that contain settings for individual jobs, the Help opens to a topic that explains the options for that screen.

If the printer alerts you of an error or warning, touch the Help button **?** to open a message that describes the problem. The message also contains instructions to help solve the problem.

Restore the factory-set defaults

Restoring the factory-set defaults returns all of the printer and network settings to the factory defaults. It will not reset the page count, or tray size. To restore the printer to the factory-default settings, follow these steps.

 **CAUTION:** Restoring the factory-set defaults returns all of the settings to the factory defaults, and it also deletes any pages that are stored in the memory.

1. From the Home screen on the printer control panel, swipe until the **Setup** menu displays. Touch the **Setup** icon  to open the menu.
2. Scroll to and select the **Service** menu.
3. Scroll to and select **Restore Defaults**, and then touch **OK**.

The printer automatically restarts.

A “Cartridge is low” or “Cartridge is very low” message displays on the printer control panel

Cartridge is low: The printer indicates when a toner cartridge level is low. Actual toner cartridge life remaining may vary. Consider having a replacement available to install when print quality is no longer acceptable. The toner cartridge does not need to be replaced now.

Continue printing with the current cartridge until redistributing the toner no longer yields acceptable print quality. To redistribute the toner, remove the toner cartridge from the printer and gently rock the cartridge back and forth end to end. Reinsert the toner cartridge into the printer and close the cover.

Cartridge is very low: The printer indicates when the cartridge level is very low. Actual cartridge life remaining may vary. To extend the life of the toner, gently rock the cartridges back and forth end to end. Consider having a replacement available to install when print quality is no longer acceptable. The cartridge does not need to be replaced now unless the print quality is no longer acceptable.

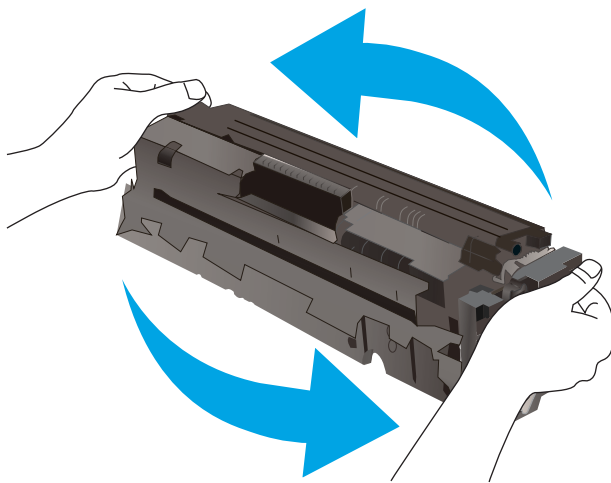

HP's Premium Protection Warranty expires when a message indicating that HP's Premium Protection Warranty on this supply has ended appears on the Supplies Status Page or the EWS.

Change the “Very Low” settings

You can change the way the printer reacts when supplies reach the Very Low state. You do not have to re-establish these settings when you install a new toner cartridge.

1. From the Home screen on the printer control panel, swipe until the [Setup](#) menu displays. Touch the [Setup](#) icon  to open the menu.
2. Open the following menus:
 - a. [System Setup](#)
 - b. [Supply Settings](#)
 - c. [Black Cartridge](#) or [Color Cartridges](#)
 - d. [Very Low Setting](#)
3. Select one of the following options:

- Select the **Continue** option to set the printer to alert you that the toner cartridge is very low, but to continue printing.
- Select the **Stop** option to set the printer to stop printing until you replace the toner cartridge.
- Select the **Prompt** option to set the printer to stop printing and prompt you to replace the toner cartridge. You can acknowledge the prompt and continue printing. A customer configurable option on this printer is "Prompt to Remind Me in 100 pages, 200 pages, 300 pages, 400 pages, or never." This option is provided as a customer convenience and is not an indication these pages will have acceptable print quality.

For printers with fax capability

When the printer is set to the **Stop** or **Prompt** option, there is some risk that faxes will not print when the printer resumes printing. This can occur if the printer has received more faxes than the memory can hold while the printer is waiting.

The printer can print faxes without interruption when it passes the Very Low threshold if you select the **Continue** option for the toner cartridge, but print quality might degrade.

Order supplies

Table 9-2 Ordering options

Ordering option	Ordering information
Order supplies and paper	www.hp.com/go/suresupply
Order through service or support providers	Contact an HP-authorized service or support provider.
Order using the HP Embedded Web Server (EWS)	To access, in a supported web browser on your computer, enter the printer IP address or host name in the address/URL field. The EWS contains a link to the HP SureSupply website, which provides options for purchasing Original HP supplies.

Printer does not pick up paper or misfeeds

Introduction

The following solutions can help solve problems if the printer is not picking up paper from the tray or is picking up multiple sheets of paper at one time. Either of these situations can result in paper jams.

- [The product does not pick up paper](#)
- [The product picks up multiple sheets of paper](#)
- [The document feeder jams, skews, or picks up multiple sheets of paper](#)

The product does not pick up paper

If the product does not pick up paper from the tray, try these solutions.

1. Open the product and remove any jammed sheets of paper.
2. Load the tray with the correct size of paper for your job.
3. Make sure the paper size and type are set correctly on the product control panel.
4. Make sure the paper guides in the tray are adjusted correctly for the size of paper. Adjust the guides to the appropriate indentation in the tray.
5. Check the product control panel to see if the product is waiting for you to acknowledge a prompt to feed the paper manually. Load paper, and continue.
6. The rollers above the tray might be contaminated. Clean the rollers with a lint-free cloth dampened with warm water.

The product picks up multiple sheets of paper

If the product picks up multiple sheets of paper from the tray, try these solutions.

1. Remove the stack of paper from the tray and flex it, rotate it 180 degrees, and flip it over. *Do not fan the paper.* Return the stack of paper to the tray.
2. Use only paper that meets HP specifications for this product.
3. Use paper that is not wrinkled, folded, or damaged. If necessary, use paper from a different package.
4. Make sure the tray is not overfilled. If it is, remove the entire stack of paper from the tray, straighten the stack, and then return some of the paper to the tray.
5. Make sure the paper guides in the tray are adjusted correctly for the size of paper. Adjust the guides to the appropriate indentation in the tray.
6. Make sure the printing environment is within recommended specifications.

The document feeder jams, skews, or picks up multiple sheets of paper

 **NOTE:** This information applies to MFP printers only.

- The original might have something on it, such as staples or self-adhesive notes, that must be removed.
- Check that all rollers are in place and that the roller-access cover inside the document feeder is closed.

- Make sure that the top document-feeder cover is closed.
- The pages might not be placed correctly. Straighten the pages and adjust the paper guides to center the stack.
- The paper guides must be touching the sides of the paper stack to work correctly. Make sure that the paper stack is straight and the guides are against the paper stack.
- The document feeder input tray or output bin might contain more than the maximum number of pages. Make sure the paper stack fits below the guides in the input tray, and remove pages from the output bin.
- Verify that there are no pieces of paper, staples, paper clips, or other debris in the paper path.
- Clean the document-feeder rollers and the separation pad. Use compressed air or a clean, lint-free cloth moistened with warm water. If misfeeds still occur, replace the rollers.
- From the Home screen on the printer control panel, scroll to and touch the [Supplies](#) button. Check the status of the document-feeder kit, and replace it if necessary.

Clear paper jams

Introduction

The following information includes instructions for clearing paper jams from the product.

- [Paper jam locations](#)
- [Experiencing frequent or recurring paper jams?](#)
- [Clear paper jams in the document feeder](#)
- [Clear paper jams in the single-sheet slot \(Tray 1\)](#)
- [Clear paper jams in Tray 2](#)
- [Clear paper jams in the rear door and the fuser area](#)
- [Clear paper jams in the duplexer \(duplex models only\)](#)
- [Clear paper jams in the output bin](#)

Paper jam locations

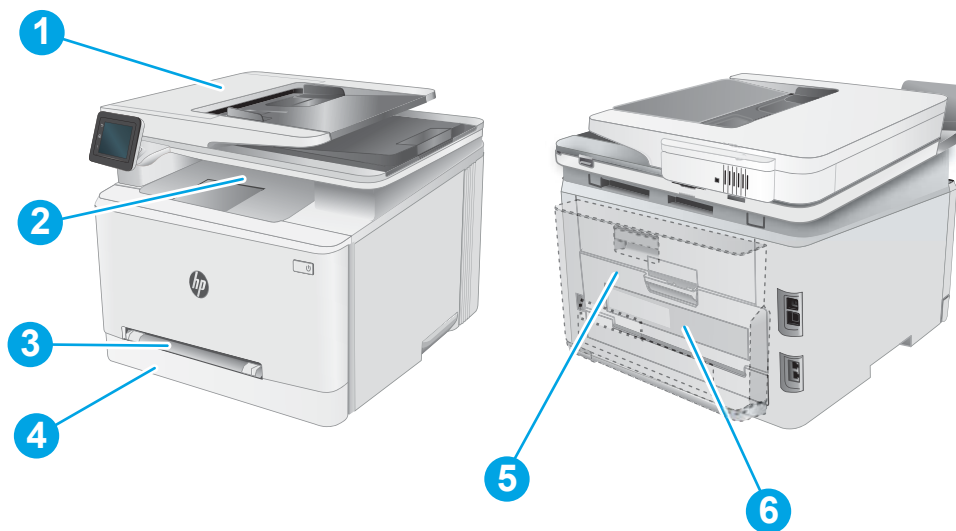

Table 9-3 Jam locations legend



Number	Description
1	Document feeder
2	Output bin
3	Single-sheet priority feed slot (Tray 1)
4	Tray 2

Table 9-3 Jam locations legend (continued)

Number	Description
5	Rear door and fuser area
6	Duplexer (duplex models only)

Experiencing frequent or recurring paper jams?

Follow these steps to solve problems with frequent paper jams. If the first step does not resolve the problem continue with the next step until you have resolved the problem.

1. If paper has jammed in the product, clear the jam and then print a configuration page to test the product.
2. Check that the tray is configured for the correct paper size and type on the product control panel. Adjust paper settings if necessary.
 - a. From the Home screen on the product control panel, swipe until the **Setup** menu displays. Touch the Setup icon  to open the menu.
 - b. Open the following menus:
 - i. **System Setup**
 - ii. **Paper setup**
 - c. Select the tray from the list.
 - d. Select **Default Paper Type** and then select the type of paper that is in the tray.
 - e. Select **Default Paper Size** and then select the size of paper that is in the tray.
3. Turn the product off, wait 30 seconds, and then turn it on again.
4. Print a cleaning page to remove excess toner from inside the product.
 - a. From the Home screen on the product control panel, swipe until the **Setup** menu displays. Touch the Setup icon  to open the menu.
 - b. Touch the **Service** menu.
 - c. Touch the **Cleaning Page** button.
 - d. Load plain letter or A4 paper when you are prompted.
Wait until the process is complete. Discard the page that prints.
5. Print a configuration page to test the product.
 - a. From the Home screen on the product control panel, swipe until the **Setup** menu displays. Touch the Setup icon  to open the menu.
 - b. Open the **Reports** menu.
 - c. Select **Configuration Report**.

If none of these steps resolves the problem, the product might need service. Contact HP customer support.

Clear paper jams in the document feeder

Use the following procedure to check for paper in all possible jam locations related to document feeder. When a jam occurs, the control panel might display a message and an animation that assists in clearing the jam.

1. Open the document-feeder cover.



2. Remove any jammed paper.

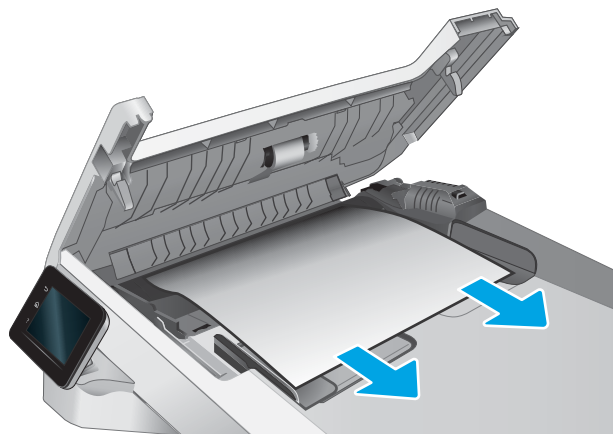

3. Close the document feeder cover.

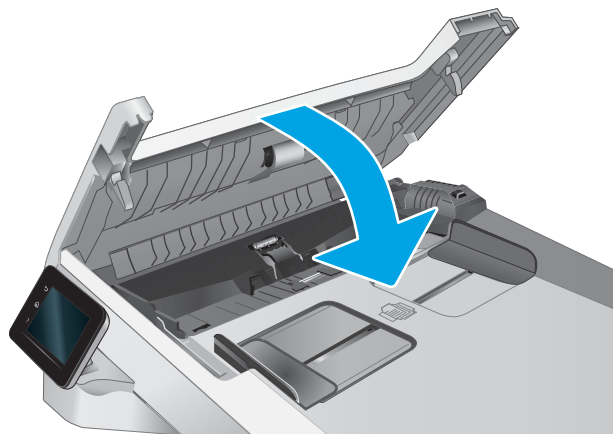

4. Lift the document feeder input tray to provide better access to the document feeder output bin, and then remove any jammed paper from the output area.





5. Open the scanner lid. If paper is jammed behind the white plastic backing, gently pull it out.



6. Lower the scanner lid.



 **NOTE:** To avoid jams, make sure the guides in the document-feeder input tray are adjusted tightly against the document. Remove all staples and paper clips from original documents.

 **NOTE:** Original documents that are printed on heavy, glossy paper can jam more frequently than originals that are printed on plain paper.

Clear paper jams in the single-sheet slot (Tray 1)

Use the following procedure to clear jams in Tray 1. When a jam occurs, the control panel might display a message and an animation that assists in clearing the jam.

1. Pull Tray 2 completely out of the printer.



2. Push down on the single-sheet priority feed slot, and then pull out the feed slot tray.

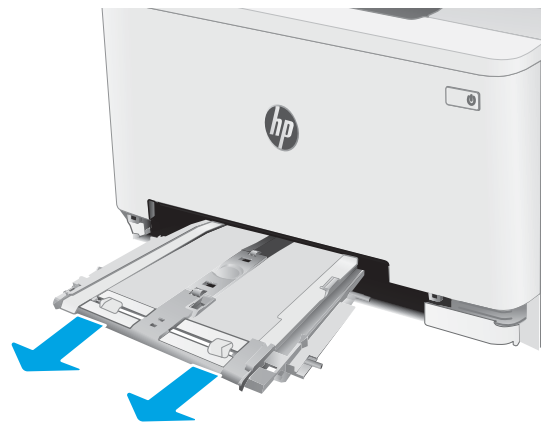

3. Gently pull any jammed paper straight out of the single-sheet priority feed slot.

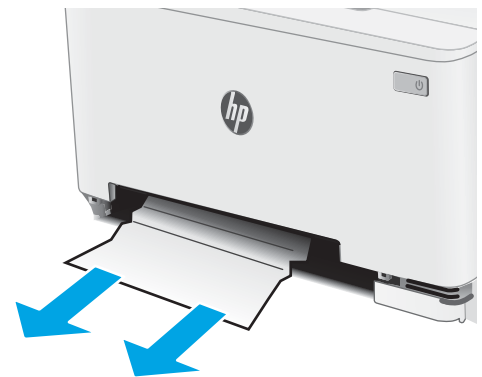

4. Push the single-sheet priority feed slot tray into the printer.



5. Reinsert and close Tray 2.



Clear paper jams in Tray 2

Use the following procedure to check for paper in all possible jam locations related to Tray 2. When a jam occurs, the control panel might display a message and an animation that assists in clearing the jam.

1. Pull the tray completely out of the printer.

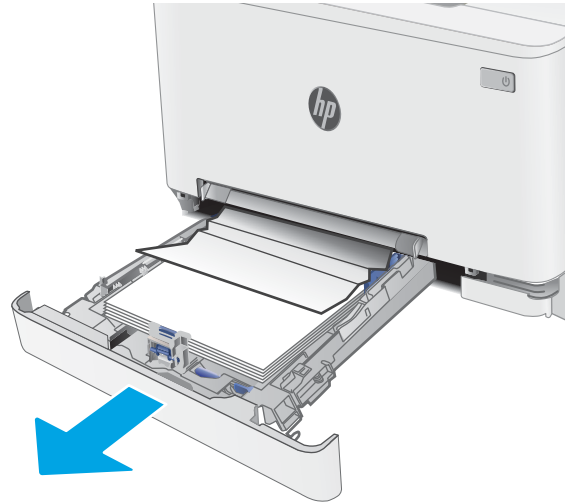

2. Remove any jammed or damaged sheets of paper.

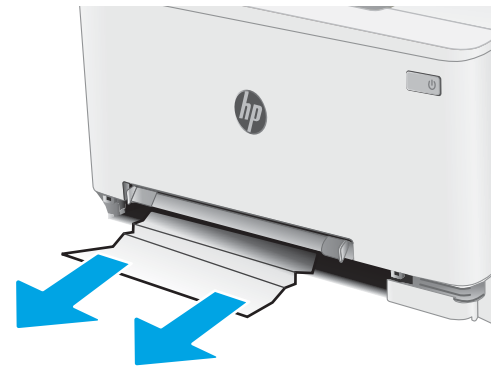

3. If no jammed paper is visible, or if jammed paper is deep enough in the Tray 2 feed area that it is difficult to remove, press down on the single-sheet priority feed slot, and then remove the feed slot tray.

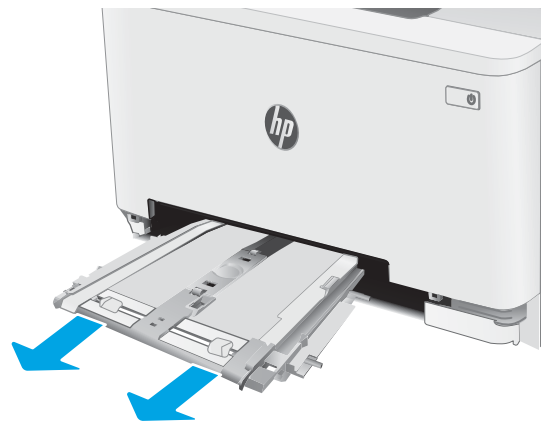

4. Remove any jammed or damaged sheets of paper.

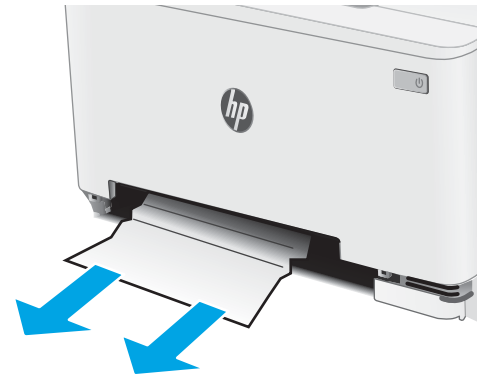

5. Push the single-sheet priority feed slot tray into the printer.

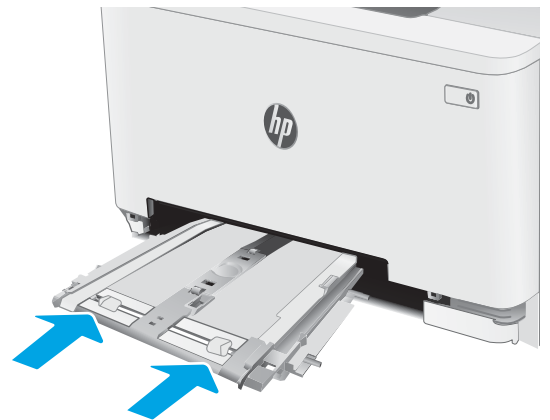

6. Reinsert and close Tray 2.



Clear paper jams in the rear door and the fuser area

Use the following procedure to clear jams in the rear door and fuser area. When a jam occurs, the control panel might display a message and an animation that assists in clearing the jam.

⚠ CAUTION: The fuser can be hot while the printer is in use. Wait for the fuser to cool before handling it.

1. Open the rear door.

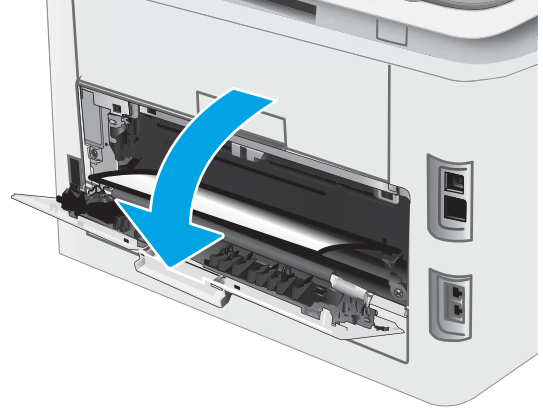

2. Gently pull out any jammed paper from the rollers in the rear door area.

CAUTION: The fuser can be hot while the printer is in use. Wait for the fuser to cool before handling it.

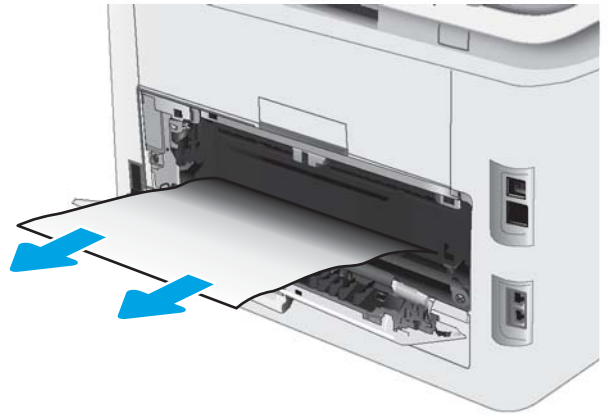

3. Close the rear door.

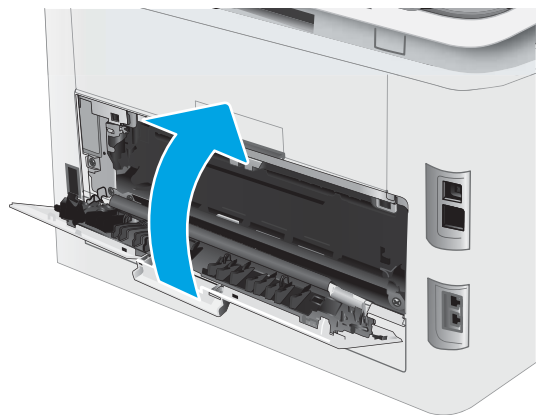

Clear paper jams in the duplexer (duplex models only)

Use the following procedure to clear jams in the duplexer. When a jam occurs, the control panel might display a message and an animation that assists in clearing the jam.

⚠ CAUTION: The fuser can be hot while the printer is in use. Wait for the fuser to cool before handling it.

1. At the rear of the printer, open the duplexer.

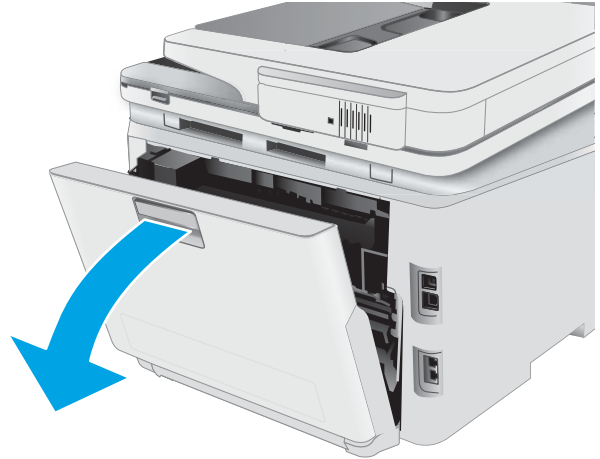

2. Remove any jammed or damaged sheets of paper.

CAUTION: The fuser can be hot while the printer is in use. Wait for the fuser to cool before handling it.



3. Close the duplexer.

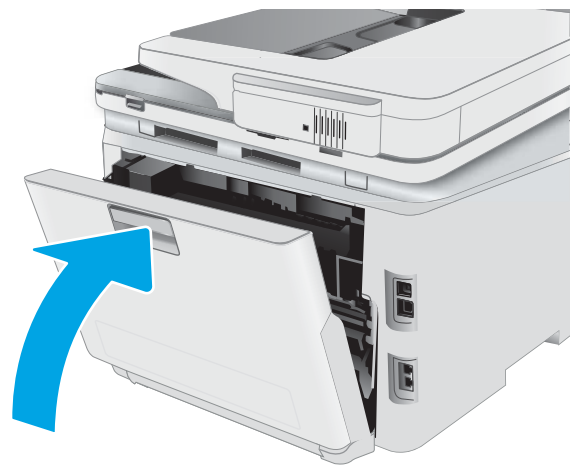

Clear paper jams in the output bin

Use the following procedure to check for paper in all possible jam locations related to the output bin. When a jam occurs, the control panel might display a message and an animation that assists in clearing the jam.

⚠ CAUTION: The fuser can be hot while the printer is in use. Wait for the fuser to cool before handling it.

1. Open the rear door.

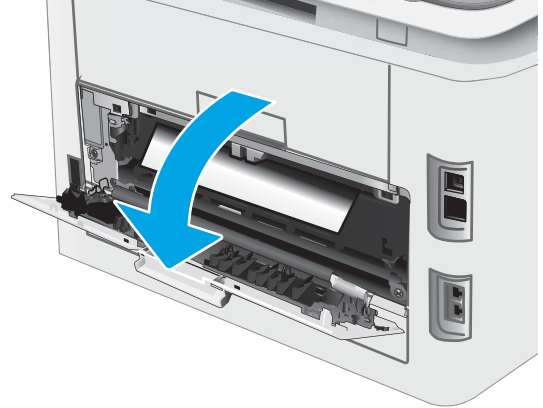

2. If paper is visible in the output bin, grasp the leading edge and remove it. Use both hands to remove jammed paper to avoid tearing the paper.



3. Gently remove any jammed paper from the rollers in the rear door area.

CAUTION: The fuser can be hot while the printer is in use. Wait for the fuser to cool before handling it.

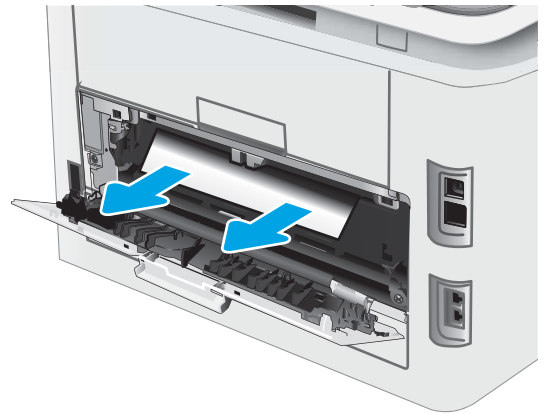

4. Close the rear door.

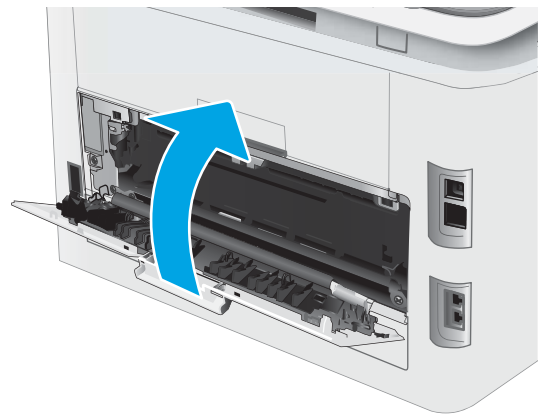

Improve print quality

- [Introduction](#)
- [Update the printer firmware](#)
- [Print from a different software program](#)
- [Check the paper-type setting for the print job](#)
- [Check toner-cartridge status](#)
- [Print a cleaning page](#)
- [Visually inspect the toner cartridge or cartridges](#)
- [Check paper and the printing environment](#)
- [Try a different print driver](#)
- [Check the EconoMode settings](#)
- [Adjust Print Density](#)
- [Calibrate the printer to align the colors](#)
- [Adjust color settings \(Windows\)](#)
- [Print and interpret the print quality page](#)

Introduction

The following information provides troubleshooting steps to resolve print-quality problems, including the following problems:

- Smears
- Fuzzy print
- Dark print
- Light print
- Streaks
- Missing toner
- Scattered dots of toner
- Loose toner
- Skewed images

To resolve these or other print-quality problems, try the following solutions in the order presented.

For information about resolving specific image defects, see the Resolving print quality problems section of this User Guide.

Update the printer firmware

Try upgrading the printer firmware. For more information, see the Update the firmware section of this User Guide.

Print from a different software program

Try printing from a different software program. If the page prints correctly, the problem is with the software program from which you were printing.

Check the paper-type setting for the print job

Check the paper type setting when printing from a software program and the printed pages have smears, fuzzy or dark print, curled paper, scattered dots of toner, loose toner, or small areas of missing toner.

Check the paper type setting on the printer

1. Open the tray.
2. Verify that the tray is loaded with the correct type of paper.
3. Close the tray.
4. Follow the control panel instructions to confirm or modify the paper type settings for the tray.

Check the paper type setting (Windows)

1. From the software program, select the **Print** option.
2. Select the printer, and then click the **Properties** or **Preferences** button.
3. Click the **Paper/Quality** tab.
4. From the **Paper Type** drop-down list, click the **More...** option.
5. Expand the list of **Type is:** options.
6. Expand the category of paper types that best describes your paper.
7. Select the option for the type of paper you are using, and click the **OK** button.
8. Click the **OK** button to close the **Document Properties** dialog box. In the **Print** dialog box, click the **OK** button to print the job.

Check the paper type setting (macOS)

1. Click the **File** menu, and then click the **Print** option.
2. In the **Printer** menu, select the printer.
3. By default, the print driver displays the **Copies & Pages** menu. Open the menus drop-down list, and then click the **Finishing** menu.
4. Select a type from the **Media Type** drop-down list.
5. Click the **Print** button.

Check toner-cartridge status

Follow these steps to check the estimated life remaining in the toner cartridges and if applicable, the status of other replaceable maintenance parts.

Step one: Print the supplies status page

1. From the Home screen on the printer control panel, select the [Setup](#) menu.
2. Select [Reports](#).
3. Select [Supplies Status](#).

Step two: Check supplies status

1. Look at the supplies status report to check the percent of life remaining for the toner cartridges and if applicable, the status of other replaceable maintenance parts.

Print quality problems can occur when using a toner cartridge that is at its estimated end of life. The supplies status page indicates when a supply level is very low.

HP's Premium Protection Warranty expires when a message indicating that HP's Premium Protection Warranty on this supply has ended appears on the Supplies Status Page or the EWS.

The toner cartridge does not need to be replaced now unless the print quality is no longer acceptable. Consider having a replacement available to install when print quality is no longer acceptable.

If you determine that you need to replace a toner cartridge or other replaceable maintenance parts, the supplies status page lists the genuine HP part numbers.

2. Check to see if you are using a genuine HP cartridge.

A genuine HP toner cartridge has "HP" on it, or has the HP logo on it. For more information on identifying HP cartridges go to www.hp.com/go/learnaboutsupplies.

Print a cleaning page

During the printing process paper, toner, and dust particles can accumulate inside the printer and can cause print-quality issues such as toner specks or spatter, smears, streaks, lines, or repeating marks.

Use the following procedure to print a cleaning page.

1. From the Home screen on the printer control panel, select the [Setup](#) menu.
2. Select the following menus:
 - a. [Service](#)
 - b. [Cleaning Page](#)
3. Load plain letter or A4 paper when you are prompted, and then select [OK](#).

A **Cleaning** message displays on the printer control panel. Wait until the process is complete. Discard the page that prints.

Visually inspect the toner cartridge or cartridges

Follow these steps to inspect each toner cartridge.

1. Remove the toner cartridges from the printer, and verify that the sealing tape has been removed.
2. Check the memory chip for damage.
3. Examine the surface of the green imaging drum.

 **CAUTION:** Do not touch the imaging drum. Fingerprints on the imaging drum can cause print-quality problems.

4. If you see any scratches, fingerprints, or other damage on the imaging drum, replace the toner cartridge.
5. Reinstall the toner cartridge, and print a few pages to see if the problem has resolved.

Check paper and the printing environment

Step one: Use paper that meets HP specifications

Some print-quality problems arise from using paper that does not meet HP specifications.

- Always use a paper type and weight that this printer supports.
- Use paper that is of good quality and free of cuts, nicks, tears, spots, loose particles, dust, wrinkles, voids, staples, and curled or bent edges.
- Use paper that has not been previously printed on.
- Use paper that does not contain metallic material, such as glitter.
- Use paper that is designed for use in laser printers. Do not use paper that is designed only for use in Inkjet printers.
- Use paper that is not too rough. Using smoother paper generally results in better print quality.

Step two: Check the environment

The environment can directly affect print quality and is a common cause for print-quality or paper-feeding issues. Try the following solutions:

- Move the printer away from drafty locations, such as open windows or doors, or air-conditioning vents.
- Make sure the printer is not exposed to temperatures or humidity outside of printer specifications.
- Do not place the printer in a confined space, such as a cabinet.
- Place the printer on a sturdy, level surface.
- Remove anything that is blocking the vents on the printer. The printer requires good air flow on all sides, including the top.
- Protect the printer from airborne debris, dust, steam, grease, or other elements that can leave residue inside the printer.

Step three: Set the individual tray alignment

Follow these steps when text or images are not centered or aligned correctly on the printed page when printing from specific trays.

1. From the Home screen on the printer control panel, select the [Setup](#) menu.
2. Select the following menus:
 - a. [System Setup](#)
 - b. [Print Quality](#)
 - c. [Adjust Alignment](#)
 - d. [Print Test Page](#)
3. Select the tray to adjust, and then follow the instructions on the printed pages.
4. Print the test page again to verify the results. Make further adjustments if necessary.
5. Select [OK](#) to save the new settings.

Try a different print driver

Try a different print driver when printing from a software program and the printed pages have unexpected lines in graphics, missing text, missing graphics, incorrect formatting, or substituted fonts.

Download any of the following drivers from the HP Web site: www.hp.com/support/ljM282MFP.

Table 9-4 Print drivers

Driver	Description
HP PCL6 driver	If available, this printer-specific print driver supports older operating systems like Windows® XP and Windows Vista®. For a list of supported operating systems, go to www.hp.com/go/support .
HP PCL 6 driver	This printer-specific print driver supports Windows 7 and newer operating systems that support version 3 drivers. For a list of supported operating systems, go to www.hp.com/go/support .
HP PCL-6 driver	This product-specific print driver supports Windows 8 and newer operating systems that support version 4 drivers. For a list of supported operating systems, go to www.hp.com/go/support .
HP UPD PS driver	<ul style="list-style-type: none">• Recommended for printing with Adobe® software programs or with other highly graphics-intensive software programs• Provides support for printing from postscript emulation needs, or for postscript flash font support
HP UPD PCL 6	<ul style="list-style-type: none">• Recommended for printing in all Windows environments• Provides the overall best speed, print quality, and printer feature support for most users• Developed to align with Windows Graphic Device Interface (GDI) for best speed in Windows environments• Might not be fully compatible with third-party and custom software programs that are based on PCL 5

Check the EconoMode settings

HP does not recommend the full-time use of EconoMode. If EconoMode is used full-time, the toner supply might outlast the mechanical parts in the toner cartridge. If print quality begins to degrade and is no longer acceptable, consider replacing the toner cartridge.

 **NOTE:** This feature is available with the PCL 6 print driver for Windows. If you are not using that driver, you can enable the feature by using the HP Embedded Web Server.

Follow these steps if the entire page is too dark or too light.

1. From the software program, select the **Print** option.
2. Select the printer, and then click the **Properties** or **Preferences** button.
3. Click the **Paper/Quality** tab, and locate the **Print Quality** area.
4. If the entire page is too dark, use these settings:



- Select the **600 dpi** option, if available.
- Select the **EconoMode** check box to enable it.

If the entire page is too light, use these settings:

- Select the **FastRes 1200** option, if available.
 - Clear the **EconoMode** check box to disable it.
5. Click the **OK** button to close the **Document Properties** dialog box. In the **Print** dialog, click the **OK** button to print the job.

Adjust Print Density

Complete the following steps to adjust the print density.

1. Open the HP Embedded Web Server (EWS)::
 - a. From the Home screen on the printer control panel, touch the Network button  or the Wireless button  to display the IP address or host name.
 - b. Open a web browser, and in the address line, type the IP address or host name exactly as it displays on the printer control panel. Press the **Enter** key on the computer keyboard. The EWS opens.

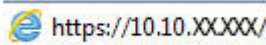

 **NOTE:** If the web browser displays a message indicating that accessing the website might not be safe, select the option to continue to the website. Accessing this website will not harm the computer.

2. Click the **System** tab, and then select the **Print Density** page.
3. Select the correct density settings.
4. Click **Apply** to save the changes.

Calibrate the printer to align the colors

Calibration is a printer function that optimizes print quality.

Follow these steps to resolve print-quality problems such as misaligned color, colored shadows, blurry graphics, or other print-quality issues.

1. From the Home screen on the printer control panel, select the [Setup](#) menu.
2. Select the following menus:
 - a. [System Setup](#)
 - b. [Print Quality](#)
 - c. [Color Calibration](#)
 - d. [Calibrate Now](#)
3. **2-line control panels only:** Select [OK](#) to start the calibration process.
4. A **Calibrating** message will display on the printer control panel. The calibration process takes a few minutes to complete. Do not turn the printer off until the calibration process has finished. Wait while the printer calibrates, and then try printing again.

Adjust color settings (Windows)

When printing from a software program, follow these steps if colors on the printed page do not match colors on the computer screen, or if the colors on the printed page are not satisfactory.

Change the color options

1. From the software program, select the **Print** option.
2. Select the printer, and then click the **Properties** or **Preferences** button.
3. Click the **Color** tab.
4. Click the **Print in Grayscale** option to print a color document in black and shades of gray. Use this option to print color documents for photocopying or faxing. Also use this option to print draft copies or to save color toner.
5. Click the **OK** button to close the **Document Properties** dialog box. In the **Print** dialog box, click the **OK** button to print the job.

Print and interpret the print quality page

1. From the Home screen on the printer control panel, select the [Setup](#) menu.
2. Select the [Reports](#) menu.
3. Select the [Print Quality Page](#) item.

This page contains five bands of color, which are divided into four groups as indicated in the following illustration. By examining each group, you can isolate the problem to a particular toner cartridge.

Figure 9-1 Print quality page

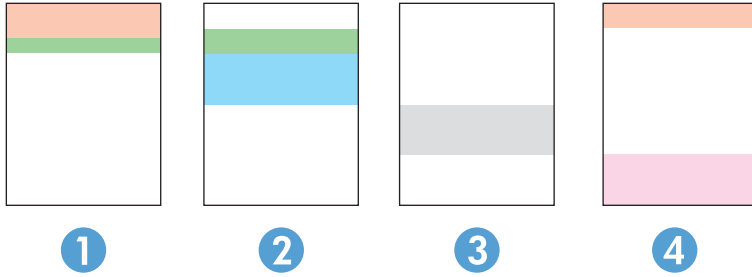

Table 9-5 Print quality page legend

Section	Toner cartridge
1	Yellow
2	Cyan
3	Black
4	Magenta

- If dots or streaks appear in only one of the groups, replace the toner cartridge that correlates with that group.
- If dots appear in more than one group, print a cleaning page. If this does not solve the problem, determine if the dots are always the same color; for example, if magenta dots appear in all five color bands. If the dots are all the same color, replace that toner cartridge.
- If streaks appear in multiple color bands, contact HP. A component other than the toner cartridge is probably causing the problem.

Resolving print quality problems

- [Introduction](#)
- [Troubleshoot print quality problems](#)

Introduction

The following information provides troubleshooting steps for solving image defect issues, including the following defects:

- Light print
- Gray background or dark print
- Blank pages
- Black pages
- Dark or light bands
- Dark or light streaks
- Missing toner
- Skewed images
- Colors that do not align
- Curled paper

Troubleshoot print quality problems

Table 9-6 Image defects table quick reference



Defect	Defect	Defect
Table 9-7 Light print on page 128 	Table 9-8 Gray background or dark print on page 129 	Table 9-9 Blank page — No print on page 129 

Table 9-6 Image defects table quick reference (continued)







Defect	Defect	Defect
<p>Table 9-10 Black page on page 130</p> 	<p>Table 9-11 Banding defects on page 130</p> 	<p>Table 9-12 Streak defects on page 131</p> 
<p>Table 9-13 Fixing/fuser defects on page 132</p> 	<p>Table 9-14 Image placement defects on page 132</p> 	<p>Table 9-15 Color plane registrations defects (color models only) on page 133</p> 
<p>Table 9-16 Output defects on page 133</p> 		

Image defects, no matter the cause, can often be resolved using the same steps. Use the following steps as a starting point for solving image defect issues.

1. Reprint the document. Print quality defects can be intermittent in nature or can go away completely with continued printing.
2. Check the condition of the cartridge or cartridges. If a cartridge is in a **Very Low** state (it has passed the rated life), replace the cartridge.
3. Make sure that the driver and tray print mode settings match the media that is loaded in the tray. Try using a different ream of media or a different tray. Try using a different print mode.
4. Make sure that the printer is within the supported operating temperature/humidity range.
5. Make sure that the paper type, size, and weight are supported by the printer. See the printer support page at support.hp.com for a list of the supported paper sizes and types for the printer.

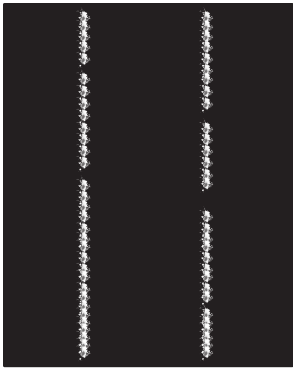
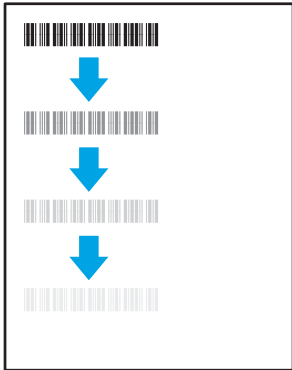
 **NOTE:** The term “fusing” refers to the part of the printing process where toner is affixed to paper.

The following examples depict letter-size paper that has passed through the printer short-edge first.

Table 9-7 Light print

Description	Sample	Possible solutions
<p>Light print:</p> <p>The printed content on the entire page is light or faded.</p>		<ol style="list-style-type: none"> 1. Reprint the document. 2. Remove the cartridge, and then shake it to redistribute the toner. Reinsert the toner cartridges into the printer and close the cover. For a graphical representation of this procedure, see Replace the toner cartridges. 3. Mono models only: Make sure that the Economode setting is disabled both at the printer control panel and in the print driver. 4. Make sure that the cartridge is installed correctly. 5. Print a Supply status page and check for life and usage of the cartridge. 6. Replace the cartridge. 7. If the problem persists, go to support.hp.com.

Table 9-8 Gray background or dark print

Description	Sample	Possible solutions
<p>Gray background or dark print: The image or text is darker than expected.</p>		<ol style="list-style-type: none"> 1. Make sure that the paper in the trays has not already been run through the printer. 2. Use a different paper type. 3. Reprint the document. 4. Mono models only: From the Home screen on the printer control panel, go to the Adjust Toner Density menu, and then adjust the toner density to a lower level. 5. Make sure that the printer is in within the supported operating temperature and humidity range. 6. Replace the cartridge. 7. If the problem persists, go to support.hp.com.

Table 9-9 Blank page — No print

Description	Sample	Possible solutions
<p>Blank page — No print: The page is completely blank and contains no printed content.</p>		<ol style="list-style-type: none"> 1. Make sure that the cartridge is genuine HP cartridges. 2. Make sure that the cartridge is installed correctly. 3. Print with a different cartridge. 4. Check the paper type in the paper tray and adjust the printer settings to match. If necessary, select a lighter paper type. 5. If the problem persists, go to support.hp.com.

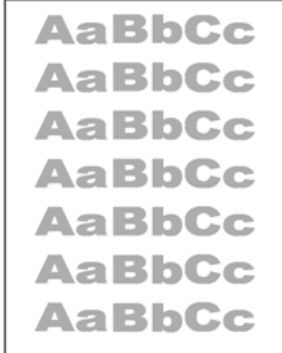
Table 9-10 Black page

Description	Sample	Possible solutions
<p>Black page:</p> <p>The entire printed page is black.</p>		<ol style="list-style-type: none">1. Visually inspect the cartridge to check for damage.2. Make sure that the cartridge is installed correctly.3. Replace the cartridge4. If the problem persists, go to support.hp.com.

Table 9-11 Banding defects

Description	Sample	Possible solutions
<p>Repetitive wide-pitch banding and Impulse bands:</p> <p>Dark or light lines which repeat down the length of the page. They might be sharp or soft in nature. The defect displays only in areas of fill, not in text or sections with no printed content.</p>		<ol style="list-style-type: none">1. Reprint the document.2. Try printing from another tray.3. Replace the cartridge.4. Use a different paper type.5. Enterprise models only: From the Home screen on the printer control panel, go to the Adjust Paper Types menu, and then choose a print mode that is designed for a slightly heavier media than what you are using. This slows the print speed and might improve the print quality.6. If the problem persists, go to support.hp.com.

Table 9-12 Streak defects

Description	Sample	Possible solutions
<p>Light vertical streaks:</p> <p>Light streaks that usually span the length of the page. The defect displays only in areas of fill, not in text or sections with no printed content.</p>		<ol style="list-style-type: none">1. Reprint the document.2. Remove the cartridge, and then shake it to redistribute the toner.3. If the problem persists, go to support.hp.com. <p>NOTE: Both light and dark vertical streaks can occur when the printing environment is outside the specified range for temperature or humidity. Refer to your printer's environmental specifications for allowable temperature and humidity levels.</p>
<p>Dark vertical streaks and ITB cleaning streaks (color models only):</p> <p>Dark lines which occur down the length of the page. The defect might occur anywhere on the page, in areas of fill or in sections with no printed content.</p>		<ol style="list-style-type: none">1. Reprint the document.2. Remove the cartridge, and then shake it to redistribute the toner.3. Print a cleaning page.4. Check the toner level in the cartridge.5. If the problem persists, go to support.hp.com.

Table 9-13 Fixing/fuser defects

Description	Sample	Possible solutions
<p>Hot fuser offset (shadow):</p> <p>Slight shadows, or offsets, of the image repeated down the page. The repeated image might fade with each recurrence.</p>		<ol style="list-style-type: none"> 1. Reprint the document. 2. Check the paper type in the paper tray and adjust the printer settings to match. If necessary, select a lighter paper type. 3. If the problem persists, go to support.hp.com.
<p>Poor fusing:</p> <p>Toner rubs off along either edge of page. This defect is more common at the edges of high-coverage jobs and on light media types but can occur anywhere on the page.</p>		<ol style="list-style-type: none"> 1. Reprint the document. 2. Check the paper type in the paper tray and adjust the printer settings to match. If necessary, select a heavier paper type. 3. Enterprise models only: From the printer control panel, go to the Edge-to-Edge menu and then select Normal. Reprint the document. 4. Enterprise models only: From the printer control panel, select Auto Include Margins and then reprint the document. 5. If the problem persists, go to support.hp.com.

Table 9-14 Image placement defects

Description	Sample	Possible solutions
<p>Margins and skew:</p> <p>The image is not centered, or is skewed on the page. The defect occurs when the paper is not positioned properly as it is pulled from the tray and moves through the paper path.</p>		<ol style="list-style-type: none"> 1. Reprint the document. 2. Remove the paper and then reload the tray. Make sure that all the paper edges are even on all sides. 3. Make sure that the top of the paper stack is below the tray full indicator. Do not overfill the tray. 4. Make sure that the paper guides are adjusted to the correct size for the paper. Do not adjust the paper guides tightly against the paper stack. Adjust them to the indentations or markings in the tray. 5. If the problem persists, go to support.hp.com.

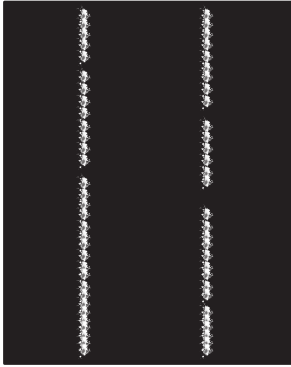
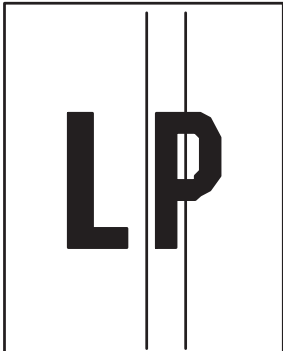
Table 9-15 Color plane registrations defects (color models only)

Description	Sample	Possible solutions
<p>Color plane registrations:</p> <p>One or more color of the planes is not aligned with the other color planes. The primary error will typically occur with yellow.</p>		<ol style="list-style-type: none"> 1. Reprint the document. 2. From the printer control panel, calibrate the printer. 3. If a cartridge has reached a Very Low state or the printed output is severely faded, replace the cartridge. 4. From the printer control panel use the Restore Calibration feature to reset the printer's calibration settings to the factory defaults. 5. If the problem persists, go to support.hp.com.

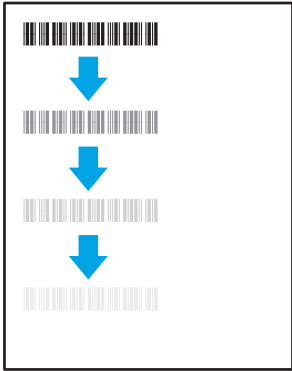
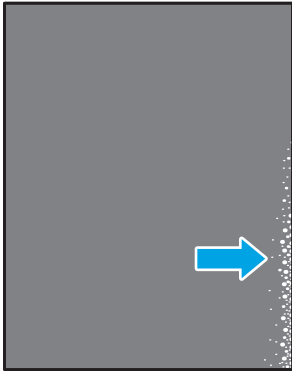
Table 9-16 Output defects

Description	Sample	Possible solutions
<p>Output curl:</p> <p>Printed paper has curled edges. The curled edge can be along the short or long side of the paper. Two types of curl are possible:</p> <ul style="list-style-type: none"> • Positive curl: The paper curls toward the printed side. The defect occurs in dry environments or when printing high coverage pages. • Negative curl: The paper curls away from the printed side. The defect occurs in high-humidity environments or when printing low coverage pages. 		<ol style="list-style-type: none"> 1. Reprint the document. 2. Positive curl: From the printer control panel, select a heavier paper type. The heavier paper type creates a higher temperature for printing. Negative curl: From the printer control panel, select a lighter paper type. The lighter paper type creates a lower temperature for printing. Try storing the paper in a dry environment prior or use freshly opened paper. 3. Print in duplex mode. 4. If the problem persists, go to support.hp.com.
<p>Output stacking:</p> <p>The paper does not stack well in the output tray. The stack might be uneven, skewed, or the pages might be pushed out of the tray and onto the floor. Any of the following conditions can cause this defect:</p> <ul style="list-style-type: none"> • Extreme paper curl • The paper in the tray is wrinkled or deformed • The paper is a non-standard paper type, such as envelopes • The output tray is too full 		<ol style="list-style-type: none"> 1. Reprint the document. 2. Extend the output bin extension. 3. If the defect is caused by extreme paper curl, complete the troubleshooting steps for Output curl. 4. Use a different paper type. 5. Use freshly opened paper. 6. Remove the paper from the output tray before the tray gets too full. 7. If the problem persists, go to support.hp.com.

Improve copy and scan image quality

Introduction

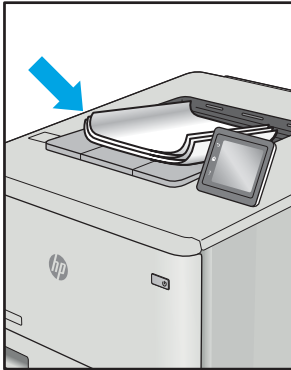
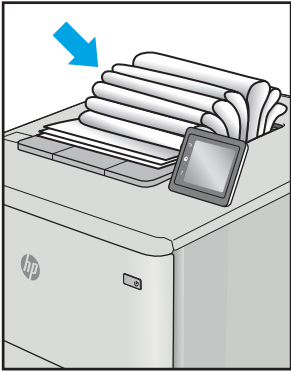
If the printer is having image quality problems, try the following solutions in the order presented to resolve the issue.

- [Check the scanner glass for dirt and smudges](#)
- [Eliminate lines or streaks when using the document feeder](#)
- [Check the paper settings](#)
- [Check the image adjustment settings](#)
- [Optimize for text or pictures](#)
- [Check the scanner resolution and color settings on the computer](#)
- [Edge-to-edge copying](#)
- [Clean the pickup rollers and separation pad in the document feeder](#)

Try these few simple steps first:

- Use the flatbed scanner rather than the document feeder.
- Use high-quality originals.
- When using the document feeder, load the original document into the feeder correctly, using the paper guides, to avoid unclear or skewed images.

If the problem still exists, try these additional solutions. If they do not fix the problem, see “Improve print quality” for further solutions.

Check the scanner glass for dirt and smudges

Over time, specks of debris might collect on the scanner glass and white plastic backing, which can affect performance. Use the following procedure to clean the scanner.

1. Press the power button to turn the printer off, and then disconnect the power cable from the electrical outlet.
2. Open the scanner lid.
3. Clean the scanner glass and the white plastic backing underneath the scanner lid with a soft cloth or sponge that has been moistened with nonabrasive glass cleaner.

 **CAUTION:** Do not use abrasives, acetone, benzene, ammonia, ethyl alcohol, or carbon tetrachloride on any part of the printer; these can damage the printer. Do not place liquids directly on the glass or platen. They might seep and damage the printer.

4. Dry the glass and white plastic parts with a chamois or a cellulose sponge to prevent spotting.
5. Connect the power cable to an outlet, and then press the power button to turn the printer on.

Eliminate lines or streaks when using the document feeder

If lines or streaks appear on copied or scanned documents when using the document feeder, use the procedure below to clean debris from the document feeder glass. Debris can include dust, paper or toner dust, residue from sticky note adhesive, correction fluid or tape, ink, fingerprints, and more.

1. Open the scanner lid.
2. Locate the one-inch strip of glass to the left of the main scanner flatbed glass, and then use a soft, lint-free cloth moistened with water to clean the glass strip.

⚠ CAUTION: Do not use abrasives, acetone, benzene, ammonia, ethyl alcohol, or carbon tetrachloride on any part of the product; these can damage the product. Do not place liquids directly on the glass or platen. They might seep and damage the product.

3. On the underside of the scanner lid above the strip of glass, use a soft, lint-free cloth moistened with water to clean the upper plastic strip.
4. Dry the glass strip and the upper strip with a soft, dry cloth to prevent spotting, and then try again to copy or scan.

Check the paper settings

1. From the Home screen on the printer control panel, touch the **Copy** icon .
2. Touch the **Settings** button, and then scroll to and touch the **Paper** button.
3. From the list of paper sizes, touch the name of the paper size that is in the tray.
4. From the list of paper types, touch the name of the paper type that is in the tray.

Check the image adjustment settings

1. From the Home screen, touch the **Copy** button.
2. Touch the **Settings** button, and then scroll to and touch the **Image Adjustment** button.
3. Touch the name of the setting you want to adjust.
 - **Lightness:** Adjusts the lightness/darkness setting.
 - **Contrast:** Adjusts the contrast between the lightest and darkest areas of the image.
 - **Sharpen:** Adjusts clarity of text characters.
 - **Background Removal:** Adjusts the darkness of the background of the image. This is especially useful for original documents that are printed on colored paper.
 - **Color Balance:** Adjusts the red, green, and blue color hues.
 - **Grayness:** Adjusts the vividness of colors.
4. Touch the **—** or **+** buttons to adjust the value for the setting, and then touch the **OK** button.
5. Adjust another setting, or touch the back arrow to return to the main copy menu.

Optimize for text or pictures

1. From the Home screen on the printer control panel, touch the **Copy** icon .
2. Touch the **Settings** button, and then scroll to and touch the **Optimize** button.
3. Touch the name of the setting you want to adjust.
 - **Auto Select**: Use this setting when you are not concerned about the quality of the copy. This is the default setting.
 - **Mixed**: Use this setting for documents that contain a mixture of text and graphics.
 - **Text**: Use this setting for documents that contain mostly text.
 - **Picture**: Use this setting for documents that contain mostly graphics.

Check the scanner resolution and color settings on the computer

If you are printing a scanned image, and the quality is not what you expected, you might have selected a resolution or color setting in the scanner software that does not match your needs. Resolution and color affect the following features of scanned images:

- Image clarity
- Texture of gradations (smooth or rough)
- Scan time
- File size

Scanning resolution is measured in pixels per inch (ppi).

 **NOTE:** Scanning ppi levels are not interchangeable with printing dpi (dots per inch) levels.

Color, grayscale, and black and white define the number of colors possible. You can adjust the scanner hardware resolution to up to 1200 ppi.

The resolution and color guidelines table lists simple tips that you can follow to meet your scanning needs.

 **NOTE:** Setting the resolution and color to a high value can create large files that take up disk space and slow the scanning process. Before setting the resolution and color, determine how you are going to use the scanned image.

Resolution and color guidelines

The following table describes the recommended resolution and color settings for different types of scan jobs.

 **NOTE:** The default resolution is 200 ppi.

Table 9-17 Recommended resolution and color settings

Intended use	Recommended resolution	Recommended color settings
Fax	150 ppi	<ul style="list-style-type: none">• Black and White

Table 9-17 Recommended resolution and color settings (continued)

Intended use	Recommended resolution	Recommended color settings
Email	150 ppi	<ul style="list-style-type: none"> • Black and White, if the image does not require smooth gradation • Grayscale, if the image requires smooth gradation • Color, if the image is in color
Edit text	300 ppi	<ul style="list-style-type: none"> • Black and White
Print (graphics or text)	600 ppi for complex graphics, or if you want to significantly enlarge the document 300 ppi for normal graphics and text 150 ppi for photos	<ul style="list-style-type: none"> • Black and White for text and line art • Grayscale for shaded or colored graphics and photos • Color, if the image is in color
Display on screen	75 ppi	<ul style="list-style-type: none"> • Black and White for text • Grayscale for graphics and photos • Color, if the image is in color

Color

You can set the color values to the following settings when scanning.

Table 9-18 Color settings

Setting	Recommended use
Color	Use this setting for high-quality color photos or documents in which the color is important.
Black and White	Use this setting for text documents.
Grayscale	Use this setting when file size is an issue or when you want to scan a document or photograph quickly.

Edge-to-edge copying

The printer cannot print fully edge-to-edge. There is a 4 mm (1/6 inch) unprintable border around the page.

Considerations for printing or scanning documents with cropped edges:

- When the original is smaller than the output size, move the original 4 mm (1/6 inch) away from the corner indicated by the icon on the scanner. Recopy or scan in this position.
- When the original is the size of the printed output that you want, use the [Reduce/Enlarge](#) feature to reduce the image so the copy is not cropped.

Clean the pickup rollers and separation pad in the document feeder

If the document feeder experiences paper-handling problems, such as jams or multiple-page feeds, clean the document-feeder rollers and separation pad.

1. Open the document-feeder access cover.

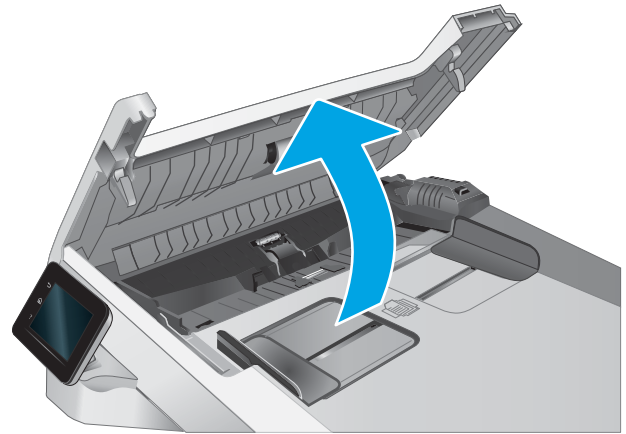

2. Use a moist, lint-free cloth to wipe both pickup rollers and the separation pad to remove dirt.

CAUTION: Do not use abrasives, acetone, benzene, ammonia, ethyl alcohol, or carbon tetrachloride on any part of the printer; these can damage the printer.

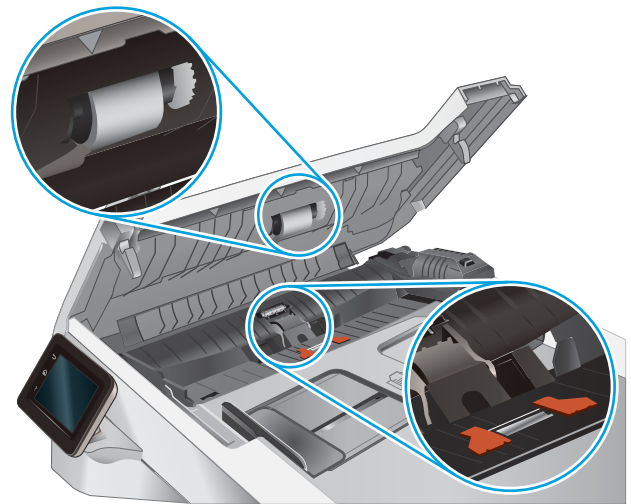

3. Close the document feeder access cover.

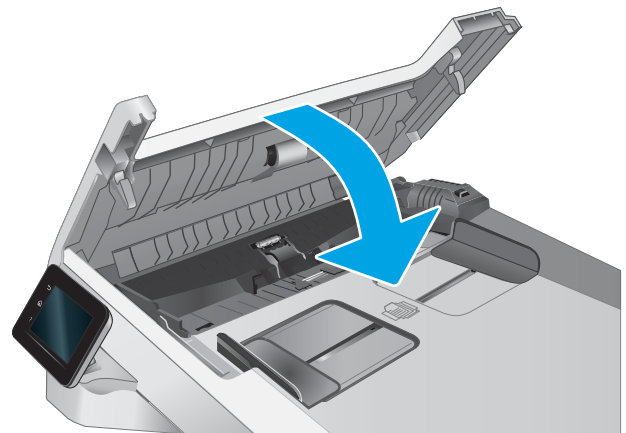

Improve fax image quality

Introduction

If the printer is having image quality problems, try the following solutions in the order presented to resolve the issue.

- [Check the scanner glass for dirt and smudges](#)
- [Check the send-fax resolution settings](#)
- [Check the error-correction settings](#)
- [Check the fit-to-page setting](#)
- [Clean the pickup rollers and separation pad in the document feeder](#)
- [Send to a different fax machine](#)
- [Check the sender's fax machine](#)

Try these few simple steps first:

- Use the flatbed scanner rather than the document feeder.
- Use high-quality originals.
- When using the document feeder, load the original document into the feeder correctly, using the paper guides, to avoid unclear or skewed images.

If the problem still exists, try these additional solutions. If they do not fix the problem, see “Improve print quality” for further solutions.

Check the scanner glass for dirt and smudges

Over time, specks of debris might collect on the scanner glass and white plastic backing, which can affect performance. Use the following procedure to clean the scanner.

1. Press the power button to turn the printer off, and then disconnect the power cable from the electrical outlet.
2. Open the scanner lid.
3. Clean the scanner glass and the white plastic backing underneath the scanner lid with a soft cloth or sponge that has been moistened with nonabrasive glass cleaner.

⚠ CAUTION: Do not use abrasives, acetone, benzene, ammonia, ethyl alcohol, or carbon tetrachloride on any part of the printer; these can damage the printer. Do not place liquids directly on the glass or platen. They might seep and damage the printer.

4. Dry the glass and white plastic parts with a chamois or a cellulose sponge to prevent spotting.
5. Connect the power cable to an outlet, and then press the power button to turn the printer on.

Check the send-fax resolution settings

If the printer was unable to send a fax because the receiving fax machine did not answer or was busy, the printer attempts to redial based on the redial-on-busy, redial-on-no-answer, and redial-on-communication-error options.

1. From the Home screen on the printer control panel, swipe until the [Setup](#) menu displays. Touch the [Setup](#) icon  to open the menu.
2. Touch the [Fax Setup](#) menu.
3. Touch the [Advanced Setup](#) menu.
4. Open the [Fax Resolution](#) menu.

Check the error-correction settings

Usually, the printer monitors the signals on the telephone line while it is sending or receiving a fax. If the printer detects an error during the transmission and the error-correction setting is [On](#), the printer can request that the portion of the fax be resent. The factory-set default for error correction is [On](#).

You should turn off error correction only if you are having trouble sending or receiving a fax, and you are willing to accept the errors in the transmission. Turning off the setting might be useful when you are trying to send a fax overseas or receive one from overseas, or if you are using a satellite telephone connection.

1. From the Home screen on the printer control panel, swipe until the [Setup](#) menu displays. Touch the [Setup](#) icon  to open the menu.
2. Touch the [Service](#) menu.
3. Touch the [Fax Service](#) menu.
4. Touch the [Error Correction](#) button, and then touch the [On](#) button.

Check the fit-to-page setting

If the printer printed a fax job off the page, turn on the fit-to-page feature from the printer control panel.



NOTE: Make sure that the default paper size setting matches the size of the paper in the tray.

1. From the Home screen on the printer control panel, swipe until the [Setup](#) menu displays. Touch the [Setup](#) icon  to open the menu.
2. Touch the [Fax Setup](#) menu.
3. Touch the [Advanced Setup](#) menu.
4. Touch the [Fit to Page](#) button, and then touch the [On](#) button.

Clean the pickup rollers and separation pad in the document feeder

If the document feeder experiences paper-handling problems, such as jams or multiple-page feeds, clean the document-feeder rollers and separation pad.

1. Open the document-feeder access cover.

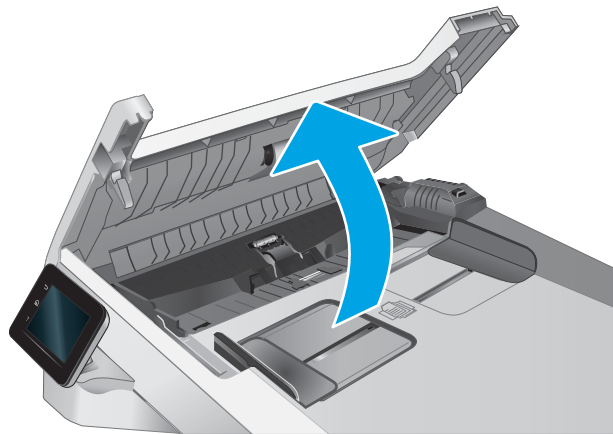

2. Use a moist, lint-free cloth to wipe both pickup rollers and the separation pad to remove dirt.

CAUTION: Do not use abrasives, acetone, benzene, ammonia, ethyl alcohol, or carbon tetrachloride on any part of the printer; these can damage the printer.

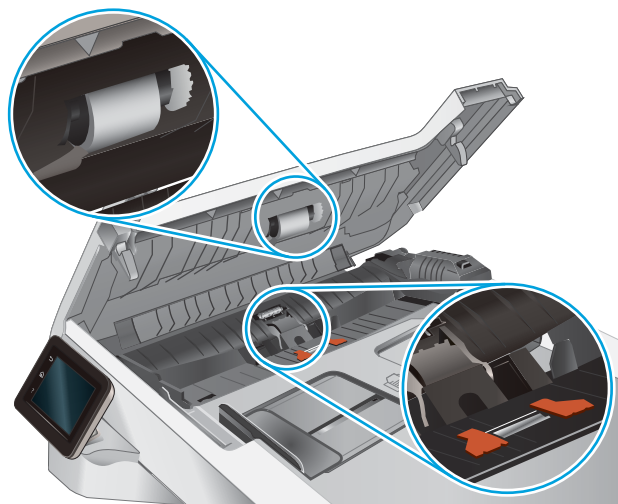

3. Close the document feeder access cover.

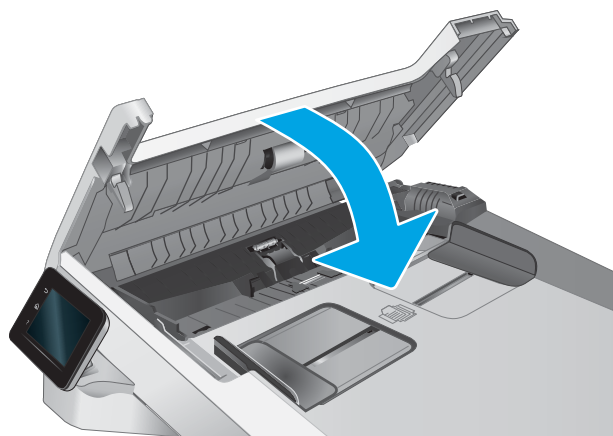

Send to a different fax machine

Try sending the fax to a different fax machine. If the fax quality is better, the problem is related to the initial recipient's fax machine settings or supplies status.

Check the sender's fax machine

Ask the sender to try sending from a different fax machine. If the fax quality is better, the problem is with the sender's fax machine. If a different fax machine is unavailable, ask the sender to consider making the following changes:

- Make sure the original document is on white (not colored) paper.
- Increase the fax resolution, quality level, or contrast settings.
- If possible, send the fax from a computer software program.

Solve wired network problems

Introduction

Certain types of problems can indicate there is a network communication problem. These problems include the following issues:

- The periodic loss of ability to communicate with the printer
- The printer cannot be found during driver installation
- A periodic failure to print



NOTE: If you have been experiencing intermittent loss of network connectivity, first update the printer firmware. For instructions on how to update the printer firmware, go to <http://support.hp.com>, search for your printer, and then search on “update the firmware.”

Check the following items to verify that the printer is communicating with the network. Before beginning, print a configuration page from the printer control panel and locate the printer IP address that is listed on this page.

- [Poor physical connection](#)
- [The computer is using the incorrect IP address for the printer](#)
- [The computer is unable to communicate with the printer](#)
- [The printer is using incorrect link and duplex settings for the network](#)
- [New software programs might be causing compatibility problems](#)
- [The computer or workstation might be set up incorrectly](#)
- [The printer is disabled, or other network settings are incorrect](#)



NOTE: HP does not support peer-to-peer networking, as the feature is a function of Microsoft operating systems and not of the HP print drivers. For more information, go to Microsoft at www.microsoft.com.

Poor physical connection

1. Verify that the printer is attached to the correct network port using a cable of the correct length.
2. Verify that cable connections are secure.
3. Look at the network port connection on the back of the printer, and verify that the amber activity light flashes indicating network traffic, and the green link-status light is continuously lit indicating a network link.
4. If the problem continues, try a different cable or port on the hub.

The computer is using the incorrect IP address for the printer

1. Open the printer properties and click the **Ports** tab. Verify that the current IP address for the printer is selected. The printer IP address is listed on the printer configuration page.
2. If you installed the printer using the HP standard TCP/IP port, select the box labeled **Always print to this printer, even if its IP address changes**.

3. If you installed the printer using a Microsoft standard TCP/IP port, use the hostname instead of the IP address.
4. If the IP address is correct, delete the printer and then add it again.

The computer is unable to communicate with the printer

1. Test network communication by pinging the network.
 - a. Open a command-line prompt on your computer.
 - For Windows, click **Start**, click **Run**, type `cmd`, and then press **Enter**.
 - For macOS, go to **Applications**, then **Utilities**, and open **Terminal**.
 - b. Type `ping` followed by the IP address for your printer.
 - c. If the window displays round-trip times, the network is working.
2. If the ping command failed, verify that the network hubs are on, and then verify that the network settings, the printer, and the computer are all configured for the same network (also known as subnet).
3. Open the printer properties and click the **Ports** tab. Verify that the current IP address for the printer is selected. The printer IP address is listed on the printer configuration page.
4. If you installed the printer using the HP standard TCP/IP port, select the box labeled **Always print to this printer, even if its IP address changes**.
5. If you installed the printer using a Microsoft standard TCP/IP port, use the printer's hostname instead of the IP address.
6. If the IP address is correct, delete the printer and then add it again.

The printer is using incorrect link and duplex settings for the network

HP recommends leaving these settings in automatic mode (the default setting). If you change these settings, you must also change them for your network.

New software programs might be causing compatibility problems

Verify that any new software programs are correctly installed and that they use the correct print driver.

The computer or workstation might be set up incorrectly

1. Check the network drivers, print drivers, and the network redirection settings.
2. Verify that the operating system is configured correctly.

The printer is disabled, or other network settings are incorrect

1. Review the printer's configuration/networking pages to check the status of the network settings and protocols.
2. Reconfigure the network settings if necessary.

Solve wireless network problems

- [Introduction](#)
- [Wireless connectivity checklist](#)
- [The printer does not print after the wireless configuration completes](#)
- [The printer does not print, and the computer has a third-party firewall installed](#)
- [The wireless connection does not work after moving the wireless router or printer](#)
- [Cannot connect more computers to the wireless printer](#)
- [The wireless printer loses communication when connected to a VPN](#)
- [The network does not appear in the wireless networks list](#)
- [The wireless network is not functioning](#)
- [Perform a wireless network diagnostic test](#)
- [Reduce interference on a wireless network](#)

Introduction

Use the troubleshooting information to help resolve issues.



NOTE: To determine whether Wi-Fi Direct printing is enabled on your printer, print a configuration page from the printer control panel

Wireless connectivity checklist

- Verify that the network cable is not connected.
- Verify that the printer and the wireless router are turned on and have power. Also make sure that the wireless radio in the printer is turned on.
- Verify that the service set identifier (SSID) is correct. Print a configuration page to determine the SSID. If you are not sure the SSID is correct, run the wireless setup again.
- With secured networks, verify that the security information is correct. If the security information is incorrect, run the wireless setup again.
- If the wireless network is working correctly, try accessing other computers on the wireless network. If the network has Internet access, try connecting to the Internet over a wireless connection.
- Verify that the encryption method (AES or TKIP) is the same for the printer as it is for the wireless access point (on networks using WPA security).
- Verify that the printer is within the range of the wireless network. For most networks, the printer must be within 30 m (100 ft) of the wireless access point (wireless router).
- Verify that obstacles do not block the wireless signal. Remove any large metal objects between the access point and the printer. Make sure poles, walls, or support columns containing metal or concrete do not separate the printer and wireless access point.

- Verify that the printer is located away from electronic devices that might interfere with the wireless signal. Many devices can interfere with the wireless signal including motors, cordless phones, security system cameras, other wireless networks, and some Bluetooth devices.
- Verify that the print driver is installed on the computer.
- Verify that you have selected the correct printer port.
- Verify that the computer and printer connect to the same wireless network.
- For macOS, verify that the wireless router supports Bonjour.

The printer does not print after the wireless configuration completes

1. Make sure that the printer is turned on and in the ready state.
2. Turn off any third-party firewalls on your computer.
3. Make sure that the wireless network is working correctly.
4. Make sure that your computer is working correctly. If necessary, restart the computer.
5. Verify that you can open the printer HP Embedded Web Server from a computer on the network.

The printer does not print, and the computer has a third-party firewall installed

1. Update the firewall with the most recent update available from the manufacturer.
2. If programs request firewall access when you install the printer or try to print, make sure you allow the programs to run.
3. Temporarily turn off the firewall, and then install the wireless printer on the computer. Enable the firewall when you have completed the wireless installation.

The wireless connection does not work after moving the wireless router or printer

1. Make sure that the router or printer connects to the same network that your computer connects to.
2. Print a configuration page.
3. Compare the service set identifier (SSID) on the configuration page to the SSID in the printer configuration for the computer.
4. If the numbers are not the same, the devices are not connecting to the same network. Reconfigure the wireless setup for the printer.

Cannot connect more computers to the wireless printer

1. Make sure that the other computers are within the wireless range and that no obstacles block the signal. For most networks, the wireless range is within 30 m (100 ft) of the wireless access point.
2. Make sure that the printer is turned on and in the ready state.
3. Make sure there are not more than 5 concurrent Wi-Fi Direct users.
4. Turn off any third-party firewalls on your computer.

5. Make sure that the wireless network is working correctly.
6. Make sure that your computer is working correctly. If necessary, restart the computer.

The wireless printer loses communication when connected to a VPN

- Typically, you cannot connect to a VPN and other networks at the same time.

The network does not appear in the wireless networks list

- Make sure the wireless router is turned on and has power.
- The network might be hidden. However, you can still connect to a hidden network.

The wireless network is not functioning

1. Make sure that the network cable is not connected.
2. To verify if the network has lost communication, try connecting other devices to the network.
3. Test network communication by pinging the network.
 - a. Open a command-line prompt on your computer.
 - For Windows, click **Start**, click **Run**, type `cmd`, and then press [Enter](#).
 - For macOS, go to **Applications**, then **Utilities**, and open **Terminal**.
 - b. Type `ping` followed by the router IP address.
 - c. If the window displays round-trip times, the network is working.
4. Make sure that the router or printer connects to the same network that the computer connects to.
 - a. Print a configuration page.
 - b. Compare the service set identifier (SSID) on the configuration report to the SSID in the printer configuration for the computer.
 - c. If the numbers are not the same, the devices are not connecting to the same network. Reconfigure the wireless setup for the printer.

Perform a wireless network diagnostic test

From the printer control panel, you can run a diagnostic test that provides information about the wireless network settings.

1. From the Home screen on the printer control panel, swipe until the [Setup](#) menu displays. Touch the [Setup](#) icon  to open the menu.
2. Scroll to and select [Self Diagnostics](#).
3. Select [Run Wireless Test](#) to start the test. The printer prints a test page that shows test results.

Reduce interference on a wireless network

The following tips can reduce interference in a wireless network:

- Keep the wireless devices away from large metal objects, such as filing cabinets, and other electromagnetic devices, such as microwaves and cordless telephones. These objects can disrupt radio signals.
- Keep the wireless devices away from large masonry structures and other building structures. These objects can absorb radio waves and lower signal strength.
- Position the wireless router in a central location in line of sight with the wireless printers on the network.

Solve fax problems

Introduction

Use the fax troubleshooting information to help resolve issues.

- [Fax troubleshooting checklist](#)
- [Solve general fax problems](#)

Fax troubleshooting checklist

- Several possible fixes are available. After each recommended action, retry faxing to see if the problem is resolved.
 - For best results during fax problem solving, make sure the line from the printer is connected directly to the wall phone port. Disconnect all other devices that are connected to the printer.
1. Verify that the telephone cord is connected to the correct port on the back of the printer.
 2. Check the phone line by using the fax test:
 - a. From the Home screen on the printer control panel, swipe until the **Setup** menu displays. Touch the **Setup** icon  to open the menu.
 - b. Open the following menus:
 - i. [Service](#)
 - ii. [Fax Service](#)
 - c. Select the [Run Fax Test](#) option. The printer prints a fax test report.

The report contains the following possible results:

 - **Pass:** The report contains all of the current fax settings for review.
 - **Fail:** The report indicates the nature of the error and contains suggestions for how to resolve the issue.
 3. Verify that the printer firmware is current:
 - a. Print a configuration page from the control panel [Reports](#) menu to obtain the current firmware date code.
 - b. Go to www.hp.com/go/support, click the **Drivers & Software** link, type the printer name in the search field, press the **ENTER** button, and then select the printer from the list of search results.
 - c. Select the operating system.
 - d. Under the **Firmware** section, locate the **Firmware Update Utility**.

 **NOTE:** Make sure to use the firmware update utility that is specific to the printer model.

 - e. Click **Download**, click **Run**, and then click **Run** again.
 - f. When the utility launches, select the printer from the drop-down list, and then click **Send Firmware**.

- a. Open the [Setup Menu](#).
- b. Open the [Fax Setup](#) menu.
- c. Open the [Advanced Setup](#) menu.
- d. Open the [Fax Speed](#) menu.
- e. Select the correct setting.
- Divide large fax jobs into smaller sections, and then fax them individually.
- Change the fax settings on the control panel to a lower resolution.
 - a. Open the [Setup Menu](#).
 - b. Open the [Fax Setup](#) menu.
 - c. Open the [Advanced Setup](#) menu.
 - d. Open the [Fax Resolution](#) menu.
 - e. Select the correct setting.

Fax quality is poor

Fax is blurry or light.

- Increase fax resolution when sending faxes. Resolution does not affect received faxes.
 - a. Open the [Setup Menu](#).
 - b. Open the [Fax Setup](#) menu.
 - c. Open the [Advanced Setup](#) menu.
 - d. Open the [Fax Resolution](#) menu.
 - e. Select the correct setting.



NOTE: Increasing resolution slows transmission speed.

- Turn on the [Error Correction](#) setting from the control panel.
 - a. Open the [Setup Menu](#).
 - b. Open the [Service](#) menu.
 - c. Open the [Fax Service](#) menu.
 - d. Open the [Error Correction](#) menu.
 - e. Select the [On](#) setting.
- Check the toner cartridges and replace if necessary.
- Ask the sender to darken the contrast setting on the sending fax machine, and then resend the fax.

Fax cuts off or prints on two pages

- Set the [Default Paper Size](#) setting. Faxes print on a single size of paper based on the [Default Paper Size](#) settings.
 - a. Open the [Setup Menu](#).
 - b. Open the [System Setup](#) menu.
 - c. Open the [Paper Setup](#) menu.
 - d. Open the [Default Paper Size](#) menu.
 - e. Select the correct setting.
- Set the paper type and size for the tray used for faxes.
- Turn on the [Fit to Page](#) setting to print longer length faxes on letter or A4 size paper.
 - a. Open the [Setup Menu](#).
 - b. Open the [Fax Setup](#) menu.
 - c. Open the [Advanced Setup](#) menu.
 - d. Open the [Fit to Page](#) menu.
 - e. Select the [On](#) setting.



NOTE: If the [Fit to Page](#) setting is off and the [Default Paper Size](#) setting is set to letter, a legal size original prints on two pages.

Index

A

- accessories
 - ordering 28
 - part numbers 28
- acoustic specifications 12
- AirPrint 44
- Android devices
 - printing from 45
- applications
 - downloading 82
- Apps menu 82

B

- bins, output
 - locating 3
- browser requirements
 - HP Embedded Web Server 84

C

- calibrate
 - colors 124
- cartridge
 - replacing 30
- checklist
 - fax troubleshooting 149
 - wireless connectivity 145
- cleaning
 - glass 134, 139
 - paper path 120
- color options
 - changing, Windows 124
- color theme
 - changing, Windows 124
- colors
 - calibrate 124
- control panel
 - help 97
 - locating 3

- control panel buttons
 - locating 5
- copying
 - edges of documents 137
 - multiple copies 50
 - optimizing for text or pictures 136
 - setting paper size and type 135
 - single copies 50
 - two-sided documents 51
- covers, locating 3
- customer support
 - online 96

D

- defaults, restoring 98
- dimensions, printer 11
- document feeder 51
 - copying two-sided documents 51
 - faxing from 78
 - jams 105
 - paper-feeding problems 101
- double-sided copying 51
- double-sided printing
 - Mac 39
 - Windows 37
- drivers, supported 8
- duplex 51
- duplex printing
 - Mac 39
- duplex printing (double-sided)
 - settings (Windows) 36
 - Windows 37
- duplexer
 - jams 114
- duplexing
 - manually (Mac) 39
 - manually (Windows) 37

E

- EconoMode setting 90, 123
- economy settings 90
- electrical specifications 12
- electronic faxes
 - sending 79
- Embedded Web Server (EWS)
 - assigning passwords 89
 - features 84
- envelope
 - orientation 23
- envelopes
 - loading in Tray 1 16
 - orientation 18
- envelopes, loading 23
- Explorer, versions supported
 - HP Embedded Web Server 84

F

- factory-set defaults, restoring 98
- fax
 - sending from software 79
 - solve general problems 150
 - speed dials 78
- fax ports
 - locating 4
- fax troubleshooting
 - checklist 149
- faxing
 - from a computer (Windows) 79
 - from the document feeder 78
 - from the flatbed scanner 77
- fuser
 - jams 112

G

- glass, cleaning 134, 139

- H**
 - help, control panel 97
 - HP Customer Care 96
 - HP Device Toolbox, using 84
 - HP Embedded Web Server (EWS)
 - features 84
 - HP ePrint 43
 - HP ePrint software 44
 - HP EWS, using 84
 - HP Scan software (Windows) 54
 - HP Smart Software (macOS) 55
 - HP Web Jetadmin 92
 - HP Web Services
 - applications 82
 - enabling 82
- I**
 - image quality
 - check toner-cartridge status 120
 - image quality issues
 - examples and solutions 126
 - interface ports
 - locating 4
 - Internet Explorer, versions supported
 - HP Embedded Web Server 84
- J**
 - jams
 - document feeder 105
 - duplexer 114
 - fuser 112
 - locations 103
 - output bin 116
 - rear door 112
 - single-sheet priority feed slot
 - 108
 - Tray 1 108
 - Tray 2 110
 - Jetadmin, HP Web 92
- L**
 - label
 - orientation 25
 - labels
 - printing on 25
 - labels, loading 25
 - loading
 - paper in Tray 1 16
 - paper in Tray 2 19
- M**
 - Main input tray
 - loading envelopes 23
 - loading labels 25
 - maintenance kits
 - part numbers 29
 - manual duplex
 - Mac 39
 - Windows 37
 - memory
 - included 8
 - memory chip (toner)
 - locating 30
 - Microsoft Word, faxing from 79
 - mobile printing
 - Android devices 45
 - mobile printing solutions 8
 - mobile printing, software supported
 - 10
 - multiple pages per sheet
 - printing (Mac) 40
 - printing (Windows) 37
- N**
 - Netscape Navigator, versions supported
 - HP Embedded Web Server 84
 - network installation 83
 - network port
 - locating 4
 - networks
 - HP Web Jetadmin 92
 - installing the printer 83
 - supported 8
 - number of copies, changing 50
- O**
 - on/off button, locating 3
 - online help, control panel 97
 - online support 96
 - operating systems (OS)
 - supported 8
 - operating systems, supported 8
 - ordering
 - supplies and accessories 28
 - OS (operating system)
 - supported 8
 - output bin
 - clear jams 116
 - locating 3
- P**
 - pages per minute 8
 - pages per sheet
 - selecting (Mac) 40
 - selecting (Windows) 37
 - paper
 - loading Tray 1 16
 - loading Tray 2 19
 - selecting 121
 - Tray 1 orientation 18
 - Tray 2 orientation 21
 - paper jams
 - document feeder 105
 - duplexer 114
 - fuser 112
 - locations 103
 - output bin 116
 - rear door 112
 - single-sheet priority feed slot
 - 108
 - Tray 1 108
 - Tray 2 110
 - paper pickup problems
 - solving 101
 - paper type
 - selecting (Windows) 38
 - paper types
 - selecting (Mac) 40
 - paper, ordering 28
 - part numbers
 - accessories 28
 - replacement parts 29
 - staple cartridges 29
 - supplies 28, 29
 - toner cartridge 29
 - toner cartridges 28
 - phone book, fax
 - adding entries 78
 - power
 - consumption 12
 - power connection
 - locating 4
 - power switch, locating 3
 - print drivers, supported 8
 - print media
 - loading in Tray 1 16
 - print on both sides
 - Mac 39
 - manually, Windows 37
 - Windows 37

- printing
 - from USB flash drives 46
- printing on both sides
 - settings (Windows) 36
- Priority input tray
 - loading envelopes 23
 - loading labels 25
- product and serial number label
 - locating 4

R

- rear door
 - jams 112
- replacement parts
 - part numbers 29
- replacing
 - toner cartridges 30
- restoring factory-set defaults 98

S

- scanner
 - faxing from 77
 - glass cleaning 134, 139
- scanning
 - from HP Scan software (Windows) 54
 - from HP Smart Software (macOS) 55
- sending faxes
 - from software 79
- serial number label
 - locating 4
- settings
 - factory-set defaults, restoring 98
- shut down after delay
 - setting 90
- single-sheet priority feed slot
 - jams 108
 - loading 16
 - paper orientation 18
- sleep delay
 - setting 90
- software
 - sending faxes 79
- solve problems
 - fax 150
- specifications
 - electrical and acoustic 12
- speed dials
 - programming 78

- staple cartridges
 - part numbers 29
- supplies
 - low threshold settings 99
 - ordering 28
 - part numbers 28, 29
 - replacing toner cartridges 30
 - using when low 99
- support
 - online 96
- system requirements
 - HP Embedded Web Server 84
 - minimum 10

T

- technical support
 - online 96
- toner cartridge
 - low threshold settings 99
 - part numbers 29
 - using when low 99
- toner cartridges
 - components 30
 - part numbers 28
 - replacing 30
- Tray 1
 - jams 108
 - loading 16
 - paper orientation 18
- Tray 2
 - jams 110
 - loading 19
 - paper orientation 21
- trays
 - capacity 8
 - included 8
 - locating 3
- troubleshooting
 - check toner-cartridge status 120
 - faxes 149
 - network problems 143
 - paper feed problems 101
 - wired network 143
 - wireless network 145
- two-sided copying 51
- two-sided printing
 - settings (Windows) 36

U

- USB flash drives
 - printing from 46
- USB port
 - locating 4

W

- walk-up USB port
 - locating 3
- walk-up USB printing 46
- web browser requirements
 - HP Embedded Web Server 84
- Web Services
 - applications 82
 - enabling 82
- Web sites
 - customer support 96
 - HP Web Jetadmin, downloading 92
- weight, printer 11
- Wi-Fi Direct Printing 41
- Wi-Fi Direct printing 10
- Windows
 - faxing from 79
- wireless network
 - troubleshooting 145
- wireless network interference 147
- Word, faxing from 79

