

**Wireless Serial Device Server**  
**SD-330AC**

---

**User's Manual**





---

# Index

<b>1. Introduction .....</b>	<b>1</b>
1-1. Introduction .....	2
About the notation .....	2
Disclaimers.....	2
Trademarks .....	2
1-2. Safety Instructions .....	3
1-3. Product Information and Customer Services.....	6
Product Information .....	6
Customer Support Center .....	6
<b>2. About SD-330AC .....</b>	<b>7</b>
2-1. Package Contents .....	8
2-2. Features .....	9
2-3. Parts and Functions.....	11
Parts and Functions .....	11
Serial Port PIN Assignment and Serial Cable .....	14
2-4. LED Lighting Pattern .....	15
2-5. Hardware Specifications .....	17
Hardware specification list.....	17
Standards compliance .....	20
2-6. Software Specifications.....	24

---

---

Software Specifications.....	24
RFC2217 Command List.....	25
2-7. Wireless Interference Information.....	26
Notes.....	26
2-8. Notes on Security.....	28
<b>3. Software Overview.....</b>	<b>29</b>
3-1. What is Serial Device Server Setup? .....	30
Select Configuration Method.....	30
TCP/IP Settings .....	31
Wireless LAN Settings .....	32
3-2. What is SX Virtual Link for Serial Device Server? .....	33
About SX Virtual Link for Serial Device Server .....	33
Functional Overview .....	33
3-3. Download the Utilities.....	35
<b>4. How to Configure.....</b>	<b>37</b>
4-1. Before Setup.....	38
Check your wireless LAN settings.....	38
About configuration methods.....	39
4-2. Necessary items for Setup.....	40
4-3. Power on .....	41
4-4. Configure Network Settings.....	42

---

---

4-5. Configure SD-330AC Using Smart Wireless Setup .....	49
Confirm that your wireless router supports WPS.....	49
Configure Network Settings .....	49
Push Button Method .....	51
PIN Code Method .....	53

## **5. How to Use ..... 57**

5-1. Link to Serial Device Using the Serial Device Connection Utility ..	58
What is Serial Port Emulation Mode? .....	58
Install Application .....	58
Start SX Virtual Link for Serial Device Server .....	63
Link to a serial device .....	64
Start a serial communication software.....	66
Unlink from a serial device.....	67
5-2. Ecable Mode.....	68
What is Ecable Mode? .....	68
Before You Begin.....	69
Link to Serial Device .....	73
5-3. Raw TCP Connection Mode .....	74
What is Raw TCP Connection Mode?.....	74
Before You Begin.....	74
Link to Serial Device .....	77
5-4. Use Access Point Feature.....	78

---

---

Before You Begin.....	78
Link to Wireless Client Devices .....	80
<b>6. Other Functions .....</b>	<b>85</b>
6-1. Configure Using the SD-330AC Web Page .....	86
Access the SD-330AC Web Page .....	86
Log in to the SD-330AC Web Page .....	91
Log out the SD-330AC Web Page .....	92
Configure Advanced Network Settings.....	93
Configure Serial Port Settings.....	98
Configuration Item List.....	100
6-2. Security Settings.....	114
Change the Password .....	114
Allow Communication Only from a Particular PC.....	115
6-3. Maintenance .....	117
Reboot SD-330AC.....	117
Reset to Factory Default.....	119
Update Firmware .....	122
6-4. About the Print Server Feature.....	125
About the Print Server Feature .....	125
Before Using Standard Windows Printing .....	126
Printing Using the Standard TCP/IP Port on Windows 7 / Server 2008R2 ..	127
Printing Using the LPR Port on Windows 7 / Server 2008R2..	132

---

---

Printing Using the Standard TCP/IP Port on Windows 8.1 / 10	
/ Server 2012 / Server 2012R2 / Server 2016 .....	137
Printing Using the LPR Port on Windows 8.1 / 10	
/ Server 2012 / Server 2012R2 / Server 2016 .....	142
6-5. SX Virtual Link for Serial Device Server .....	147
6-5-1. Main Window and Menu .....	147
Main window and buttons .....	147
Device server icons .....	149
USB device icons .....	150
Status icons .....	151
Right-click menu .....	152
6-5-2. USB Device Operational Settings .....	153
Change the USB device name displayed in	
SX Virtual Link for Serial Device Server's main window .....	153
Automatically connect to a USB device when it is detected ...	153
Automatically reconnect to a USB device when it is	
disconnected abnormally .....	154
Automatically start a designated application	
when a USB device is connected .....	154
About the USB device properties dialog .....	155
6-5-3. How to Use a Printer .....	159
6-5-4. SX Virtual Link for Serial Device Server and the Task Tray ...	161
Controlling SX Virtual Link for Serial Device Server from the task tray ...	161

---

---

6-5-5.How to Request for Disconnect .....	162
6-5-6.SX Virtual Link for Serial Device Server Optional Settings...	164
6-5-7.Uninstall.....	169

## **7. Troubleshooting ..... 171**

7-1. Problems During the Setup.....	172
7-2. Problems While Using SD-330AC .....	176
7-3. Wireless LAN Problems.....	180





# *1.* Introduction

---

Thank you for purchasing the Serial Device Server SD-330AC.  
This manual provides information on how to configure and use SD-330AC.  
Please read the **1-2.Safety Instructions** carefully before using SD-330AC.

# 1-1. Introduction

---

## About the notation

- \* This manual uses the following symbols to indicate specific information for operating SD-330AC.
- \* Be sure to carefully review before using SD-330AC.



: This symbol indicates important information that needs to be observed when operating SD-330AC. Make sure to read this information for safe and proper use.



: This symbol indicates information that is useful when using SD-330AC. If you experience difficulties operating SD-330AC, please refer to this information first.

## Disclaimers

- \* The unauthorized transfer or copying of the content of this manual, in whole or in part, without prior written consent is expressly prohibited by law.
- \* The content of this manual is subject to change without notice.
- \* This manual was prepared to accurately match the content of each OS, but the actual information shown on the computer monitor may differ from the content of this manual due to future OS version upgrades, modifications, and other changes.
- \* Although every effort was made to prepare this manual with the utmost accuracy, Silex Technology will not be held liable for any damages as a result of errors, setting examples, or other content.

## Trademarks



- \* AMC Manager® is a registered trademark of silex technology.
- \* Microsoft and Windows are either registered trademarks or trademarks of Microsoft Corporation in the United States and/or other countries.
- \* Other brand or product names are registered trademarks or trademarks of their respective owners.

## 1-2. Safety Instructions







This page provides the safety instructions for safe use of SD-330AC.

To ensure safe and proper use, please read the following information carefully before using SD-330AC. The safety instructions include important information on safe handling of SD-330AC and on general safety issues.

### < Indication of the warning >

	<b>Warning</b>	"Warning" indicates the existence of a hazard that could result in death or serious injury if the safety instruction is not observed. result in bodily injury if the safety instruction is not observed.
	<b>Caution</b>	"Caution" indicates the existence of a hazard that could result in serious injury or material damage if the safety instruction is not observed.

### < Indication of the symbol >

	This symbol indicates the warning and notice. ( Example:  "Danger of the electric shock" )
	This symbol indicates the prohibited actions. ( Example:  "Disassembly is prohibited" )
	This symbol indicates the necessary actions. ( Example:  "Remove the AC plug from an outlet" )



## Warning

	<ul style="list-style-type: none"> <li>* In the following cases, turn off the connected devices and unplug the AC plug of this product from a power outlet. Failure to follow these instructions may cause fire or an electrical shock.             <ul style="list-style-type: none"> <li>- When this product emits a strange smell, smoke or sound or becomes too hot to touch.</li> <li>- When foreign objects (metal, liquid, etc.) gets into this product.</li> <li>- When this product is dropped or the case is broken or cracked.</li> </ul> </li> </ul>
	<ul style="list-style-type: none"> <li>* Do not disassemble or modify this product. It may cause fire, electrical shock or malfunction.</li> <li>* Do not disassemble or modify the AC adaptor that came with this product. It may cause fire, electrical shock or malfunction.</li> </ul>
	<ul style="list-style-type: none"> <li>* Do not cover up the vents on this product. The temperature inside may rise and cause fire or malfunction.</li> <li>* Do not place any objects on top of this product. It may cause fire, electrical shock or malfunction.</li> <li>* Do not place any objects on top of this product. It may cause fire, electrical shock or malfunction.</li> <li>* Do not roll up or wrap the AC cord. It may cause fire or an electrical shock.</li> <li>* Do not plug or unplug the AC adaptor or any other cables with wet hands. It may cause an electrical shock or malfunction.</li> <li>* Keep the small parts out of reach of young children. If these are swallowed, consult a doctor immediately.</li> </ul>
	<ul style="list-style-type: none"> <li>* For use of the devices connected to this product, please follow all warnings, cautions and notices given by that manufacturer and carefully use them in a proper manner.</li> <li>* Failure to follow these instructions may cause fire, electrical shock or malfunction.</li> <li>* Use the correct power voltage. Improper voltage may cause fire or an electrical shock.</li> <li>* If a ground wire is supplied with your device to use with, connect it to the ground terminal in order to prevent an electrical shock. Do not connect the ground wire to gas pipe, water pipe, lighting rod or telephone ground wire. It may cause malfunction.</li> <li>* Keep the cords and cables away from children. It may cause an electrical shock or serious injury.</li> </ul>



## Caution

	<ul style="list-style-type: none"> <li>* Use the AC adaptor supplied with this product. Other AC adaptors may cause malfunction.</li> <li>* Do not place any objects on the cable or bend, twist, or pull it excessively.</li> <li>* Do not use or store this product under the following conditions.</li> <li>* It may cause malfunction.             <ul style="list-style-type: none"> <li>- Locations subject to vibration or shock</li> <li>- Shaky, uneven or tilted surfaces</li> <li>- Locations exposed to direct sunlight</li> <li>- Humid or dusty places</li> <li>- Wet places (kitchen, bathroom, etc.)</li> <li>- Near a heater or stove</li> <li>- Locations subject to extreme changes in temperature</li> <li>- Near strong electromagnetic sources (magnet, radio, wireless device, etc.)</li> </ul> </li> </ul>
	<ul style="list-style-type: none"> <li>* Do not pull on the cord to disconnect the plug from the power supply. The cord may be broken, which could result in fire or an electrical shock.</li> <li>* Follow the law of each country when you discard this product.</li> <li>* Verify all codes or cables are plugged correctly before using this product.</li> </ul>
	<ul style="list-style-type: none"> <li>* When this product will not be used for a long time, unplug the power cables of this product and the other devices you are using with it.</li> <li>* When removing this product, disconnect the AC plugs of both this product and the other devices you are using with it.</li> </ul>

## 1-3. Product Information and Customer Services

### Product Information

The services below are available from the Silex Technology website. For details, please visit the Silex Technology website.

Silex Technology website  
**URL:<https://www.silextechnology.com/>**

- \* Latest firmware download
- \* Latest software download
- \* Latest manual download
- \* Support information (FAQ)

### Customer Support Center

Customer Support is available for any problems that you may encounter. If you cannot find the relevant problem in this manual or on our website, or if the corrective procedure does not resolve the problem, please contact Silex Technology Customer Support.

Contact Information	
USA	<a href="mailto:support@silexamerica.com">support@silexamerica.com</a>
Europe	<a href="mailto:support@silexeurope.com">support@silexeurope.com</a>



**Note**

- \* Refer to the Silex Technology website ( <https://www.silextechnology.com/> ) for the latest FAQ and product information.

## 2. About SD-330AC

---

## 2-1. Package Contents

---

Following items are bundled:

- \* SD-330AC
- \* AC adaptor
- \* Rubber foot (4pcs)
- \* Warranty Booklet
- \* Setup Guide
- \* GPL License Notice  
(Distribution of source code subject to open source software)



---

## 2-2. Features

---

SD-330AC is a serial device server which allows you to connect to serial devices via wired or wireless LAN.

SD-330AC has the following features:

\* **Share various serial devices**

By using SD-330AC and the serial device connection utility, "SX Virtual Link for Serial Device Server", you can share various serial devices among Windows PCs (for details on the supported OS, refer to **2-6. Software Specifications**). Serial devices can be used as if they were connected directly to your PC.

\* **Support various applications**

In addition to **SX Virtual Link for Serial Device Server**, SD-330AC has 2 communication modes as follows to support a wide variety of network environments and operating systems.

**Ecable Mode**

If two SD-330AC's are used, you can communicate with serial devices or PCs with no network interface over the network. For details, refer to **6-2. Ecable Mode (Link to the Registered Device)**.

**Raw TCP Connection Mode**

Serial port data can be sent or received transparently over TCP/IP. You can communicate with a serial device using an application that runs on the TCP Socket API. For details, refer to **6-3. Raw TCP Connection Mode (Link to Serial Device Using TCP Raw Port)**.

\* **IEEE802.11a/b/g/n/ac Wireless LAN standard**

SD-330AC supports IEEE802.11a/b/g/n/ac which allows sharing of various serial devices over a wireless network.

For authentication method, WEP, WPA and WPA2 can be selected, and 128 bit for WEP, AUTO for WPA and AES for WPA2 can be selected respectively as the encryption method. Also, as IEEE802.1X is supported, LEAP/EAP-TLS/EAP-TTLS/PEAP/EAP-FAST can be used.

\* **Access Point Feature**

Various wireless devices can be used over a wireless network using the Access Point feature of SD-330AC.



\* To connect to a wireless network using the Access Point feature of SD-330AC, the same wireless setting needs to be configured to SD-330AC and your wireless client device.

**Note**

\* **Easy Wireless Configuration**

Wireless configuration using the push button or PIN code is available to configure SD-330AC when your wireless router supports WPS.

\* **AMC Manager (non-free program) / AMC Manager (free program)**

SD-330AC supports the total management software, "AMC Manager". The AMC Manager provides the useful features as follows:

- Remote device control and monitoring
- Bulk configuration and firmware updates



- For details on the "AMC Manager", please visit our website.

**Note**

## 2-3. Parts and Functions

### Parts and Functions

The parts name and functions are as follows:

<<Front>>

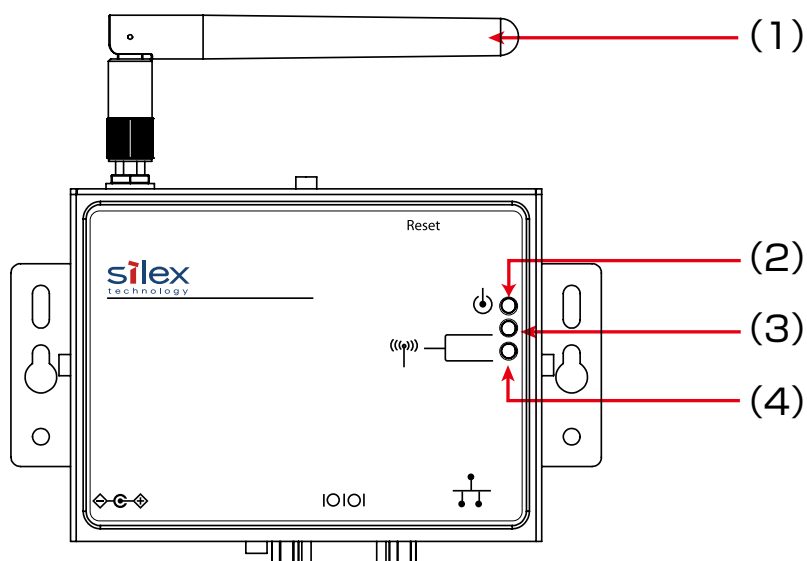

(1)	Wireless LAN antenna	This antenna is used for a wireless communication.
(2)	Orange LED	For details, refer to <b>2-4. LED Lighting Pattern.</b>
(3)	Yellow LED	
(4)	Green LED	

<<Top>>

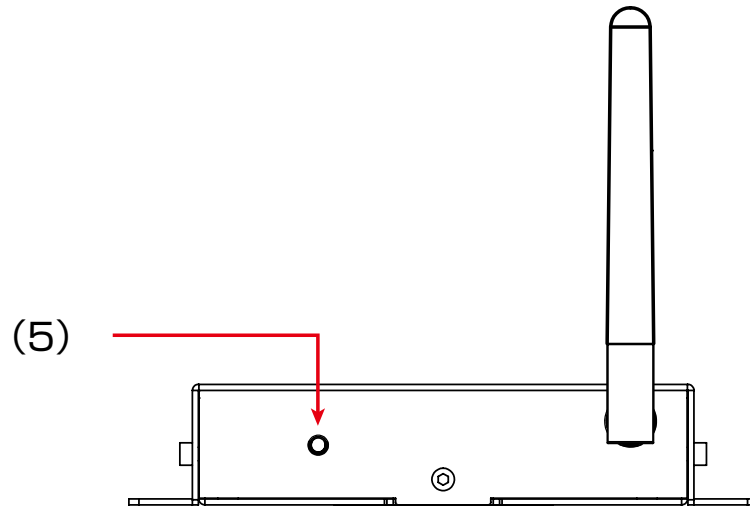

(5)	Push Switch	This push switch is used to reset to the factory defaults. For details on the factory default configuration, refer to <b>Reset to Factory Default</b> .
-----	-------------	---

<<Bottom>>

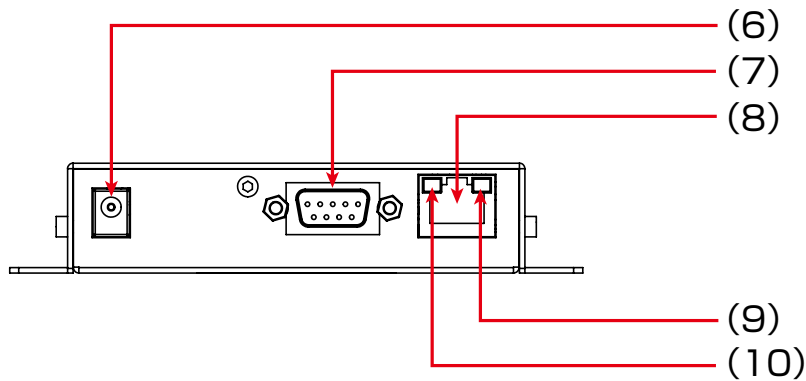

(6)	DC Connector	Connect an AC adaptor.
(7)	Serial Port	Connect a serial cable.
(8)	Network Port	Connect a network cable.
(9)	Yellow LED	Indicates the network connection status. For details, refer to <b>2-4. LED Lighting Pattern</b> .
(10)	Green LED	

<<Back>>

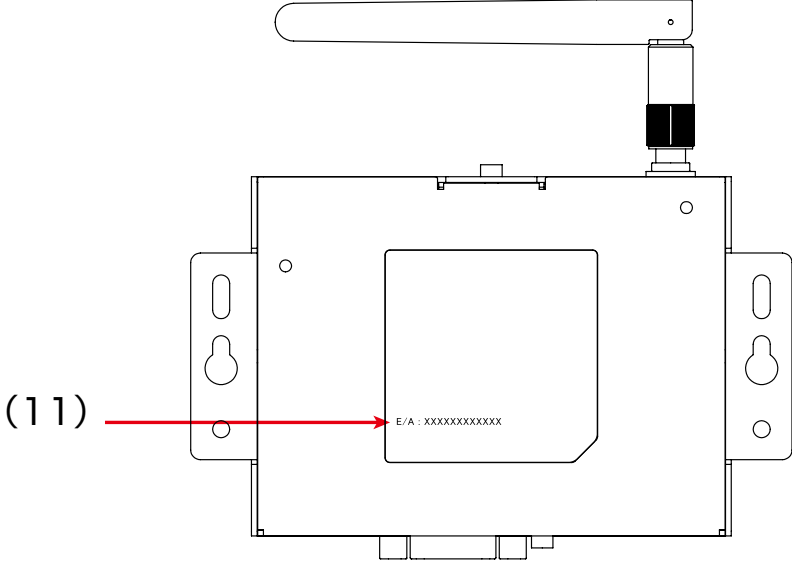

(11)	Ethernet Address	Ethernet Address of SD-330AC
------	------------------	------------------------------

## Serial Port PIN Assignment and Serial Cable

The serial port PIN assignment is as follows:

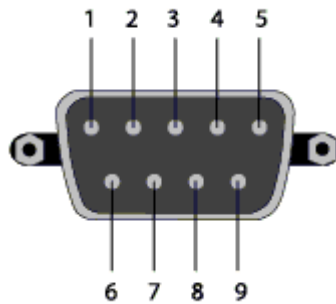

PIN No.	Details	Input / Output
1	DCD(Data Carrier Direct)	Input
2	RxD(Receive Data)	Input
3	TxD(Transmit Data)	Output
4	DTR(Data Terminal Ready)	Output
5	GND(Ground)	Input
6	DSR(Data Set Ready)	Input
7	RTS(Request To Send)	Output
8	CTS(Clear To Send)	Input
9	RI(Ring Indicate)	Input

Use the serial cable that came with your serial device (the one you may have been using to directly connect the PC and serial device) or that is recommended in the operating manual of your serial device.

## 2-4. LED Lighting Pattern

SD-330AC has 3 LEDs (Orange, Yellow, Green) to show the operating status.

<<FRONT>>

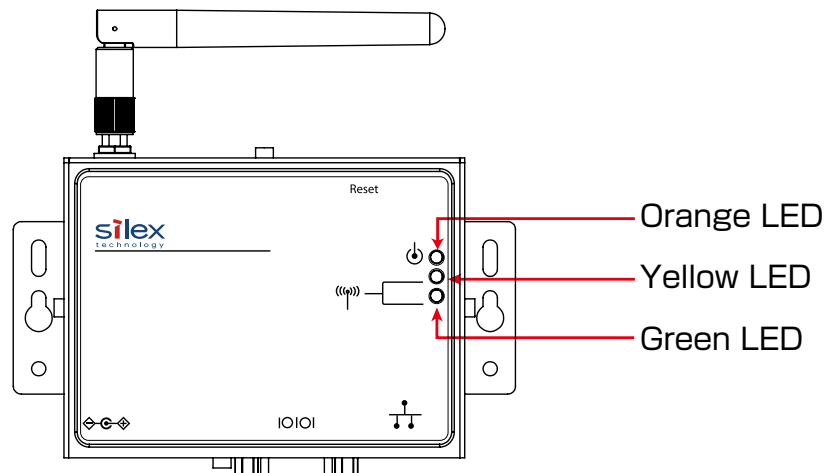

Orange LED	Product Status
ON	SD-330AC is powered on
OFF	SD-330AC is not powered on
Blink	Updating the firmware

Yellow / Green LED		Product Status
Yellow LED	Green LED	
OFF	OFF	Operating in a wired LAN mode
OFF	ON	Connected to Access Point in Infrastructure mode (Authentication is not completed)
Blink	OFF	Connected to Access Point in Infrastructure mode (Trying to obtain an IP address)
ON	OFF	Connected to Access Point in Infrastructure mode (IP address is determined)
ON	ON	Connected in Raw TCP mode
OFF	Blink	Operating in AccessPoint mode

<<BOTTOM>>

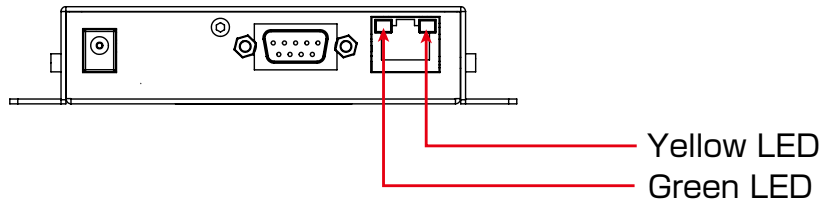

Yellow / Green LED		Product Status
Yellow LED	Green LED	
OFF	OFF	A network cable is not connected
OFF	ON	Connected in 10BASE -T network
ON	ON	Connected in 100BASE -TX network



## 2-5. Hardware Specifications

### Hardware specification list

Memory	RAM : 128MByte	
	FlashROM : 32MByte	
Wired network interface	10BASE-T / 100BASE-TX 1 port (auto-sensing)	
Serial Interface	RS-232C : 1 port	
Power supply	Operating voltage : 5V	
Push Switch	1 button	
LED	Front	3 Orange LED Yellow LED Green LED
	Wired LAN connector	2 Yellow LED Green LED
EMC	VCCI Class-B FCC Part 15 Subpart B Class-B ICES-003 Class-B EN 301 489-1/-17 , EN 55032 Class-B AS/NZS CISPR32 / EN 55032 Class-B	
Radio regulation	MIC FCC Part 15 Subpart C / Subpart E ISED RSS-247 EN 300 328 , EN 301 893	

Operating environment	Temperature : 0°C to +50°C * AC adaptor (that comes with SD-330AC) : 0°C to +40°C	
	Humidity : 20% to 80%RH (Non-condensing)	
Storage environment	Temperature : -20°C to +70°C	
	Humidity : 20% to 90%RH (Non-condensing)	

Wireless network interface	IEEE802.11a	Bandwidth	5GHz
		Transmission system	OFDM
		Transmission speed	6M / 9M / 12M / 18M / 24M / 36M / 48M / 54M (auto-sensing)
		Channel	[US] W52 : 36, 40, 44, 48 W53 : 52, 56, 60, 64 W56 : 100, 104, 108, 112, 116, 132, 136, 140 W58 : 149, 153, 157, 161, 165  [EU/UK] W52 : 36, 40, 44, 48 W53 : 52, 56, 60, 64 W56 : 100, 104, 108, 112, 116, 120, 124, 128, 132, 136, 140  * When the Access Point feature is used, W53 and W56 channels cannot be used.
	IEEE802.11b	Bandwidth	2.4GHz
		Transmission system	DS-SS
		Transmission speed	1M / 2M / 5.5M / 11M (auto-sensing)
		Channel	[US] : 1-11ch [EU/UK] : 1-13ch
	IEEE802.11g	Bandwidth	2.4GHz
		Transmission system	OFDM
		Transmission speed	6M / 9M / 12M / 18M / 24M / 36M / 48M / 54M (auto-sensing)
		Channel	[US] : 1-11ch [EU/UK] : 1-13ch
	IEEE802.11ng HT20	Bandwidth	2.4GHz
		Transmission system	DSSS-OFDM
		Transmission speed	MCS 0 / 1 / 2 / 3 / 4 / 5 / 6 / 7
		Channel	[US] : 1-11ch [EU/UK] : 1-13ch

Wireless network interface	IEEE802.11na HT20 / HT40	Bandwidth	5GHz
		Transmission system	OFDM
		Transmission speed	MCS 0 / 1 / 2 / 3 / 4 / 5 / 6 / 7
		Channel	[US] W52 : 36, 40, 44, 48 W53 : 52, 56, 60, 64 W56 : 100, 104, 108, 112, 116, 132, 136, 140 W58 : 149, 153, 157, 161, 165  [EU/UK] W52 : 36, 40, 44, 48 W53 : 52, 56, 60, 64 W56 : 100, 104, 108, 112, 116, 120, 124, 128, 132, 136, 140  * When the Access Point feature is used, W53 and W56 channels cannot be used.
	IEEE802.11ac VHT20 / VHT40 / VHT80	Bandwidth	5GHz
		Transmission system	OFDM
		Transmission speed	MCS0/1/2/3/4/5/6/7/8/9
		Channel	[US] W52 : 36, 40, 44, 48 W53 : 52, 56, 60, 64 W56 : 100, 104, 108, 112, 116, 132, 136, 140 W58 : 149, 153, 157, 161, 165  [EU/UK] W52 : 36, 40, 44, 48 W53 : 52, 56, 60, 64 W56 : 100, 104, 108, 112, 116, 120, 124, 128, 132, 136, 140  * When the Access Point feature is used, W53 and W56 channels cannot be used.
Antenna (*Wireless model only)		Non-directional antenna	

## Standards compliance

### Notice to US Customers



**Contains FCC ID : N6C-SDMAC**

#### **FCC Rules Part 15**

##### **FCC CAUTION**

Changes or modifications not expressly approved by the party responsible for compliance could void the user's authority to operate the equipment.

#### **FCC Rules Part 15 §15.19(a)(3)**

This device complies with Part 15 of the FCC Rules. Operation is subject to the following two conditions:

- (1) This device may not cause harmful interference, and
- (2) this device must accept any interference received, including interference that may cause undesired operation.

#### **FCC Rules Part 15 Subpart C §15.247 and Subpart E**

This equipment complies with FCC radiation exposure limits set forth for an uncontrolled environment and meets the FCC radio frequency (RF) Exposure Guidelines. This equipment should be installed and operated keeping the radiator at least 20cm or more away from person's body.

#### **FCC Rules Part 15 Subpart E §15.407(c)**

Data transmission is always initiated by software, which is passed down through the MAC, through the digital and analog baseband, and finally to the RF chip. Several special packets are initiated by the MAC. These are the only ways the digital baseband portion will turn on the RF transmitter, which it then turns off at the end of the packet.

Therefore, the transmitter will be on only while one of the aforementioned packets is being transmitted. In other words, this device automatically discontinues transmission in case of either absence of information to transmit or operational failure.

#### **FCC Rules Part 15 Subpart E §15.407(g)**

Frequency Tolerance: +/-20 ppm

#### **FCC Rules Part 15 Subpart C §15.247(g) / Subpart E**

This device and its antenna(s) must not be co-located or operation in conjunction with any other antenna or transmitter.

**FCC Rules Part 15 Subpart B §15.105(b)**

Note: This equipment has been tested and found to comply with the limits for a Class B digital device, pursuant to part 15 of the FCC Rules. These limits are designed to provide reasonable protection against harmful interference in a residential installation. This equipment generates, uses and can radiate radio frequency energy and, if not installed and used in accordance with the instructions, may cause harmful interference to radio communications. However, there is no guarantee that interference will not occur in a particular installation. If this equipment does cause harmful interference to radio or television reception, which can be determined by turning the equipment off and on, the user is encouraged to try to correct the interference by one or more of the following measures:

- Reorient or relocate the receiving antenna.
- Increase the separation between the equipment and receiver.
- Connect the equipment into an outlet on a circuit different from that to which the receiver is connected.
- Consult the dealer or an experienced radio/TV technician for help.

**Notice to Canadian Customers****CAN ICES-3 (B)/NMB-3 (B)****Contains IC: 4908A-SDMAC****RSS-Gen Issue 5 §8.4**

This device contains licence-exempt transmitter(s)/receiver(s) that comply with Innovation, Science and Economic Development Canada's licence-exempt RSS(s). Operation is subject to the following two conditions:

1. This device may not cause interference.
2. This device must accept any interference, including interference that may cause undesired operation of the device.

L'émetteur/récepteur exempt de licence contenu dans le présent appareil est conforme aux CNR d'Innovation, Sciences et Développement économique Canada applicables aux appareils radio exempts de licence. L'exploitation est autorisée aux deux conditions suivantes :

1. L'appareil ne doit pas produire de brouillage;
2. L'appareil doit accepter tout brouillage radioélectrique subi, même si le brouillage est susceptible d'en compromettre le fonctionnement.

**RSS-Gen Issue 5 §6.8**

This radio transmitter 4908A-SDMAC has been approved by Innovation, Science and Economic Development Canada to operate with the antenna types listed below, with the maximum permissible gain indicated. Antenna types not included in this list that have a gain greater than the maximum gain indicated for any type listed are strictly prohibited for use with this device.

Antenna type	Gain	Impedance
Pole antenna(1019-015A)	2.4GHz : 2.14 dBi 5GHz : 4 dBi	50Ω

Le présent émetteur radio 4908A-SDMAC a été approuvé par Innovation, Sciences et Développement économique Canada pour fonctionner avec les types d'antenne énumérés ci-dessous et ayant un gain admissible maximal. Les types d'antenne non inclus dans cette liste, et dont le gain est supérieur au gain maximal indiqué pour tout type figurant sur la liste, sont strictement interdits pour l'exploitation de l'émetteur.

Type d'antenne	Gain	l'impédance
Antenne pôle (1019-015A)	2,4GHz : 2,14 dBi 5GHz : 4 dBi	50Ω

**RSS-247 Issue 2 §6.2.2.2**

for indoor use only (5150-5350 MHz)

Pour usage intérieur seulement (5150-5350 MHz)

**RSS-247 Issue 2 §6.4**

Data transmission is always initiated by software, which is the passed down through the MAC, through the digital and analog baseband, and finally to the RF chip. Several special packets are initiated by the MAC. These are the only ways the digital baseband portion will turn on the RF transmitter, which it then turns off at the end of the packet. Therefore, the transmitter will be on only while one of the aforementioned packets is being transmitted. In other words, this device automatically discontinues transmission in case of either absence of information to transmit or operational failure.

La transmission des données est toujours initiée par le logiciel, puis les données sont transmises par l'intermédiaire du MAC, par la bande de base numérique et analogique et, enfin, à la puce RF. Plusieurs paquets spéciaux sont initiés par le MAC. Ce sont les seuls moyens pour qu'une partie de la bande de base numérique active l'émetteur RF, puis désactive celui-ci à la fin du paquet. En conséquence, l'émetteur reste uniquement activé lors de la transmission d'un des paquets susmentionnés. En d'autres termes, ce dispositif interrompt automatiquement toute transmission en cas d'absence d'information à transmettre ou de défaillance.

**RSS-102 Issue 5 §2.6**

This equipment complies with ISED radiation exposure limits set forth for an uncontrolled environment and meets RSS-102 of the ISED radio frequency (RF) Exposure rules. This equipment should be installed and operated keeping the radiator at least 20cm or more away from person’s body.

Cet équipement est conforme aux limites d’exposition aux rayonnements énoncées pour un environnement non contrôlé et respecte les règles d’exposition aux fréquences radioélectriques (RF) CNR-102 de l’ISDE. Cet équipement doit être installé et utilisé en gardant une distance de 20 cm ou plus entre le radiateur et le corps humain.

**Notice to European Customers**

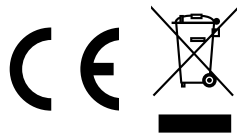

AT	EE	IE	NL	ES	CH
BE	FI	IT	PL	SE	HR
BG	FR	LV	PT	/	MK
CY	DE	LT	RO	IS	TR
CZ	EL	LU	SK	LI	ME
DK	HU	MT	SI	NO	RS

**Notice to UK Customers**



Restrictions or Requirements in the UK

## 2-6. Software Specifications

### Software Specifications

Supported protocols		TCP/IP
Supported OS		* Windows 7 or later * Windows Server 2008R2 or later
Serial port	Baud rate	300, 600, 1200, 2400, 4800, 9600, 19200, 38400, 57600, 115200, 230400, 460800, 921600 (bps)  * When the baud rate is higher than 230400bps, the data integrity is not guaranteed.
	Bits per character	7, 8
	Stop bit	1, 2
	Parity	NONE, ODD, EVEN
	Flow control	NONE, XON/XOFF, RTS/CTS
Wireless LAN	Authentication method	Open System WPA-PSK WPA2-PSK 802.1X WPA-EAP(TLS, TTLS, LEAP, PEAP(v0,v1), FAST) WPA2-EAP(TLS, TTLS, LEAP, PEAP(v0,v1), FAST)
	Encryption mode	WEP(128bit) AES AUTO
Others		RFC2217 support (see below for details)



- For the latest compatibility information for each operating system, visit our website ( <https://www.silextechnology.com/> ).



## RFC2217 Command List

SD-330AC supports RFC2217. When SD-330AC is used in Serial Port Emulation Mode, you can utilize the following RFC2217 commands over the network.

Command	Details	Note
SIGNATURE	Exchanges the device information.	Not supported
SET-BAUDRATE	Changes the baud rate.	Client -> Server (one-way)
SET-DATASIZE	Change the bits per character.	Client -> Server (one-way)
SET-PARITY	Changes the parity.	Client -> Server (one-way)
SET-STOPSIZE	Changes the stop bit.	Client -> Server (one-way)
SET-CONTROL	Enables/Disables the flow control or use for PIN setting.	Client -> Server (one-way)
NOTIFY-LINESTATE	Server notifies the client of line status changes.	* Client -> Server (one-way)
NOTIFY-MODEMSTATE	Server notifies the client of modem status changes.	Client -> Server (one-way)
FLOWCONTROL-SUSPEND	The receiver of this command will be unable to send any data or commands.	Client <-> Server (bidirectional)
FLOWCONTROL-RESUME	The receiver of this command will be able to send data and commands.	Client <-> Server (bidirectional)
SET-LINESTATE-MASK	Set the information to send by NOTIFY-LINESTATE.	Client -> Server (one-way)
SET-MODEMSTATE-MASK	Set the information to send by NOTIFY-MODEMSTATE.	Client -> Server (one-way)
PURGE-DATA	Requests the server to clear the serial buffer.	Client -> Server (one-way)

## 2-7. Wireless Interference Information

### Notes

**Do not use SD-330AC near the following devices or places.**

The following equipment may use the same band. If you use this product near this equipment, the radio waves from SD-330AC and the following devices may interfere with each other.

- \* Industrial, scientific and medical devices such as microwave, pacemaker, etc.
- \* Licensed radio station in a factory
- \* Small power radio station (A non-licensed radio station)

**Do not use SD-330AC near a cellular phone, TV or Radio.**

A cellular phone, TV, and radio use a different radio band than our product. Generally if they are used near SD-330AC, it will not cause a problem. However, when they approximate SD-330AC, sound or image noise can happen.

**If there is reinforced concrete/metal between wireless devices, they may not connect.**

SD-330AC can connect through wood or glass, but may have troubles connecting through reinforced concrete/metal.

#### Wireless Equipment for 2.4GHz band

This band of equipment is used by a microwave, industry, science, medical equipment and licensed in room or low power (non licensed) radio stations.

- \* Before you use this equipment, verify that it will not interfere with other broadcasting.
- \* If interference happens, stop using the equipment or change the band. Contact us to discuss ways of avoiding interference (example: create the wall).

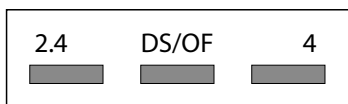

2.4	: Wireless devices using 2.4GHz frequency band
DS/OF	: DS-SS or OFDM is used as modulation.
4	: The range of interference is equal to or lower than 40m.
	: All bands can be used to avoid interference.

### **Notes on using 5GHz band**

Use of 5.2GHz band (W52) and 5.3GHz band (W53) outdoors is prohibited by the radio law. Be sure to use only W56 channel and not to use W52/W53 channels outdoors.

## 2-8. Notes on Security

---

Because a wireless LAN uses electromagnetic signals instead of a network cable to establish communication with network devices, it has the advantage of allowing devices to connect to the network easily. However, a disadvantage of this is that within a certain range, the electromagnetic signals can pass through barriers such as walls, and if security countermeasures are not implemented in some way, problems such as the following may occur:

- \* Communication is intercepted by a third party
- \* Unauthorized access to the network
- \* Leakage of personal information (ID and Card information)
- \* Spoofing and the falsification of intercepted data
- \* System crashes and data corruption

Nowadays, wireless LAN cards or access points are equipped with security measures that address such security problems, so that you can enable security-related settings for wireless LAN products in order to reduce the likelihood of problems occurring.

We recommend that you make yourself fully acquainted with the possible implications of what might happen if you use a wireless product without enabling security features, and that you configure security-related settings and use wireless products at your own responsibility.

# 3. Software Overview

---

## 3-1. What is Serial Device Server Setup?

The Serial Device Server Setup is the configuration utility exclusively designed for serial device servers. TCP/IP settings, wireless LAN settings, etc. can be configured by following the instructions on the screen after SD-330AC is powered on and displayed on this utility.

### Select Configuration Method

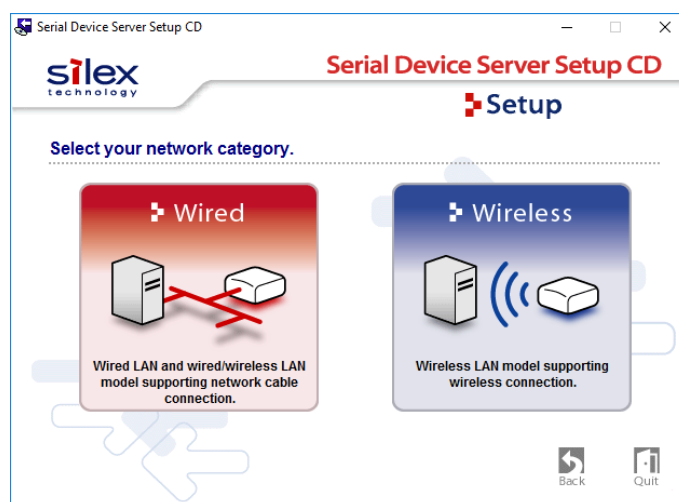

Wired	Connect a network cable to SD-330AC and start the initial configuration from a PC.
Wireless	Start the initial configuration from a PC over the wireless network.



**TIP**

\* SD-330AC does not support the configuration over a wireless LAN by clicking **Wireless**.

## TCP/IP Settings

Configure the IP address appropriate for your environment.

Serial Device Server Setup

Setting TCP/IP  
Setting TCP/IP will proceed.

Get IP Address Automatically

Assign IP Address

IP Address: 169 . 254 . 111 . 111

Subnet Mask: 255 . 255 . 0 . 0

Default Gateway: 0 . 0 . 0 . 0

MEMO  
If you select [Get IP Address Automatically], the DHCP server assigns an IP address to this product. If a DHCP server is not available, please manually assign an IP address.

< Back Next > Cancel

Get IP Address Automatically	Select this to automatically assign an IP Address using the DHCP server.
Assign IP Address	Select this to manually configure IP Address, subnet mask and default gateway.



**TIP**

- \* Enter a Subnet Mask and Default Gateway if necessary.
- \* If there are no DHCP servers on your network and the IP address of your computer is assigned manually, a sample address created with your computer's settings will be displayed in the window below. In such a case, please enter an IP address manually. The IP address used in the screen below is a sample address. Please specify an IP address appropriate for your environment.

Serial Device Server Setup

Setting TCP/IP  
Setting TCP/IP will proceed.

Get IP Address Automatically

Assign IP Address

IP Address: 169 . 254 . 111 . 111

Subnet Mask: 255 . 255 . 0 . 0

Default Gateway: 0 . 0 . 0 . 0

MEMO  
If you select [Get IP Address Automatically], the DHCP server assigns an IP address to this product. If a DHCP server is not available, please manually assign an IP address.

< Back Next > Cancel

## Wireless LAN Settings

Configure the wireless LAN settings appropriate for your environment.

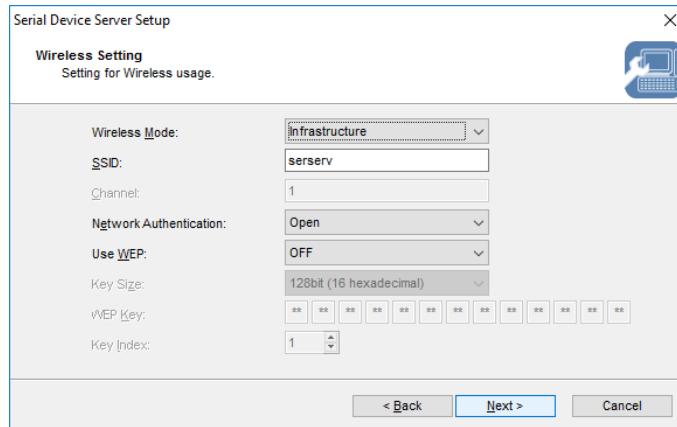

The screenshot shows a dialog box titled "Serial Device Server Setup" with a close button (X) in the top right corner. Below the title bar, the text "Wireless Setting" is displayed, followed by "Setting for Wireless usage." and a small icon of a computer with a hand. The main area contains several configuration fields:

- Wireless Mode:** A dropdown menu set to "Infrastructure".
- SSID:** A text input field containing "serserv".
- Channel:** A text input field containing "1".
- Network Authentication:** A dropdown menu set to "Open".
- Use WEP:** A dropdown menu set to "OFF".
- Key Size:** A dropdown menu set to "128bit (16 hexadecimal)".
- WEP Key:** A series of 16 small input boxes, each containing "xx".
- Key Index:** A spinner box set to "1".

At the bottom of the dialog box, there are three buttons: "< Back", "Next >", and "Cancel".



## 3-2. What is SX Virtual Link for Serial Device Server?

### About SX Virtual Link for Serial Device Server

SX Virtual Link for Serial Device Server allows you to connect your computer to a serial device that is connected to a device server.

Use SX Virtual Link for Serial Device Server when you connect/disconnect to/from the serial device.

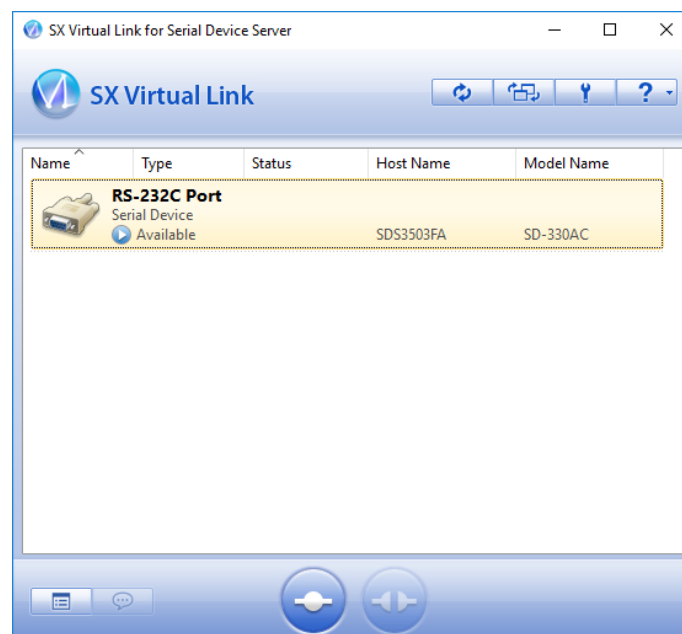

### Functional Overview

#### \* **Easy to Use**

You only have to select the serial device in SX Virtual Link for Serial Device Server and click the **Connect** button.

The serial device can be used from your computer as if it was directly connected to your computer. When finished using the serial device, click the **Disconnect** button in SX Virtual Link for Serial Device Server.

#### \* **Allows Control from the Task tray**

The minimized menu window in the task tray will allow you to connect/disconnect to/from serial devices without displaying SX Virtual Link for Serial Device Server's main window.

\* **Send a Remote Message to Another User to Request for Disconnect**

When you are sharing a serial device with several users and one of them occupies the serial device for a long time, you can request to the user to disconnect the device by sending a remote message. If the user accepts the disconnect request, the right of use is automatically passed down to you, so that you can use the serial device.

\* **Operating Settings for Each serial Device**

The operational settings such as Start designated application when connected or Automatically connect this device when it is available can be configured for each serial device.

## 3-3. Download the Utilities

The utilities to configure and use SD-330AC can be downloaded from our website.

1. Access the URL below on the PC to use to configure SD-330AC.

**URL: <https://www.silextechnology.com/>**

2. Go to the **Support** page and select the product model.

Product Model	SD-330AC
---------------	----------

3. Download the utilities below and extract them on the PC.

Utilities	Serial Device Server Setup
	SX Virtual Link for Serial Device Server



**Note**

\* In order to upgrade the firmware version, the firmware file needs to be downloaded.

The download is completed.

Blank page

# 4. How to Configure

---

## 4-1. Before Setup

This page explains the preparation and configuration method to be noted before starting the setup.

### Check your wireless LAN settings

To use SD-330AC over wireless LAN network, you need to configure the wireless settings appropriate for your network. This setting must be the same as that of destination devices such as Access Point. Please collect the following information first:

SSID	This name is used to identify the wireless devices. It is also known as ESSID.	
Encryption method	No encryption	Communication data is not encrypted.
	WEP	Communication data is encrypted based on the encryption key (WEP key). <b>WEP key size (128bit)</b> and <b>WEP key</b> must be the same as that of destination device.
	WPA/WPA2	Communication data is encrypted based on the encryption key (Pre-Shared Key). <b>Pre-Shared Key</b> and <b>Encryption mode (AES / AUTO)</b> must be the same as that of destination device.



\* When you will use SD-330AC in a wired network, you do not have to collect these information.

#### Note

---

## About configuration methods

---

The following configuration methods are available:

\* **Configure through a wired LAN (Recommended)**

Connect SD-330AC to the network using a network cable and configure from a PC.

\* **Configure using Smart Wireless Setup**

Use the PIN code method or push button method to configure the network settings when the wireless router supports WPS.



Please choose the one appropriate for your environment.



- \* Please be sure to read the operation manual of your serial device before you connect it to SD-330AC. The connecting method and position may vary depending on the serial device to be connected.
- \* Please use the AC adaptor bundled with SD-330AC. Other AC adaptors may cause unexpected damages.
- \* If SD-330AC has been used in another network, reset it to the factory default settings before you start the configuration. (Please refer to **Reset to Factory Default** for details.
- \* If using a firewall function of commercial security software, disable the firewall function while configuring SD-330AC. Refer to FAQ in our website at (<https://www.silextechnology.com/>) for details.

## 4-2. Necessary items for Setup

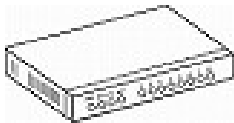
The following items are required in order to connect SD-330AC to a network.

<p>Ethernet Hub</p> 	<p>Use to connect SD-330AC and other network devices such as a PC. When there are available LAN ports on the network in which SD-330AC is to be installed, you do not have to purchase a new Ethernet Hub or broadband router as SD-330AC can be connected to the available LAN port.</p>
<p>Network Cable</p> 	<p>Use to connect SD-330AC and network devices such as an Ethernet Hub, broadband router and PC.</p>
<p>Serial Cable</p> 	<p>Use to connect SD-330AC and serial devices. For details on the supported serial cable, refer to <b>2-3. Parts and Functions - Serial Port PIN Assignment and Serial Cable.</b></p>



**TIP**

\* When you connect SD-330AC to 100BASE-TX network, please use the Ethernet Hub and network cable which support 100BASE-TX (category 5 or above).



## 4-3. Power on

1. Connect a network cable to SD-330AC and the other end to an Ethernet Hub (or broadband router, Access Point, PC).  
Then, connect the AC adaptor to SD-330AC and the plug to the outlet.

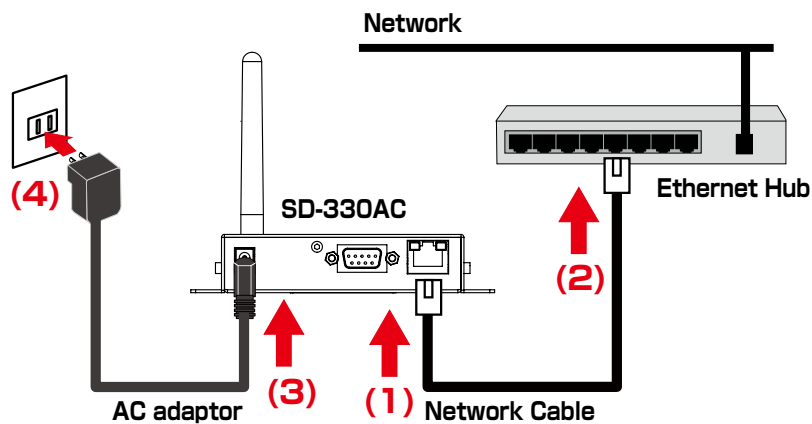

2. Check that the LEDs on SD-330AC light as follows.

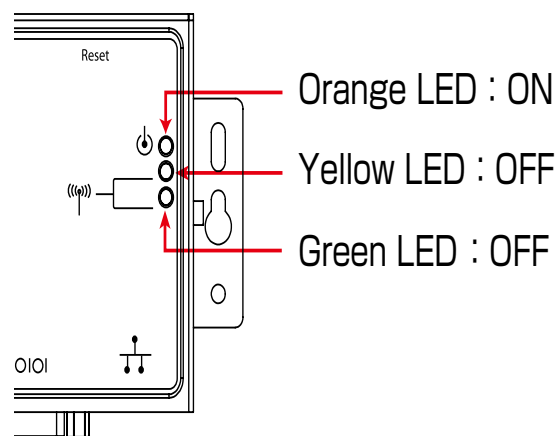

LED	Status
Orange LED	ON
Green / Yellow LEDs	OFF

## 4-4. Configure Network Settings

This page explains how to configure SD-330AC from a PC using a network cable.

1. Extract the compressed file of **Serial Device Server Setup** that you have downloaded. Double-click **Sdsetup.exe** in the extracted folder to start the Serial Device Server Setup utility.
2. The startup menu is displayed. Click **Device Server Setup**.

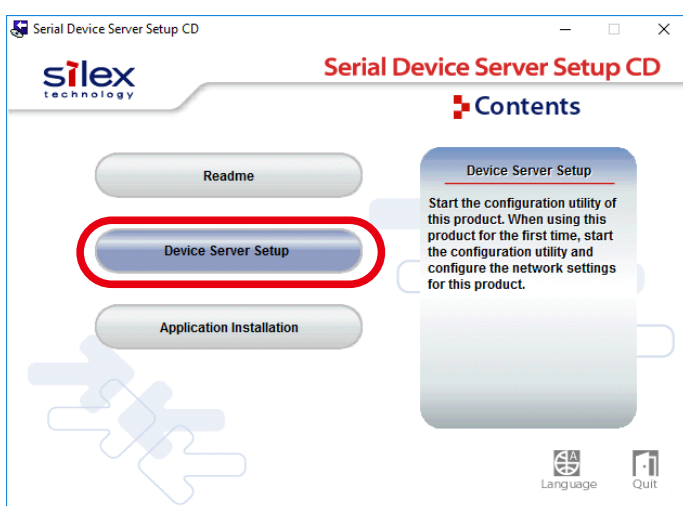

3. Click **Wired**.

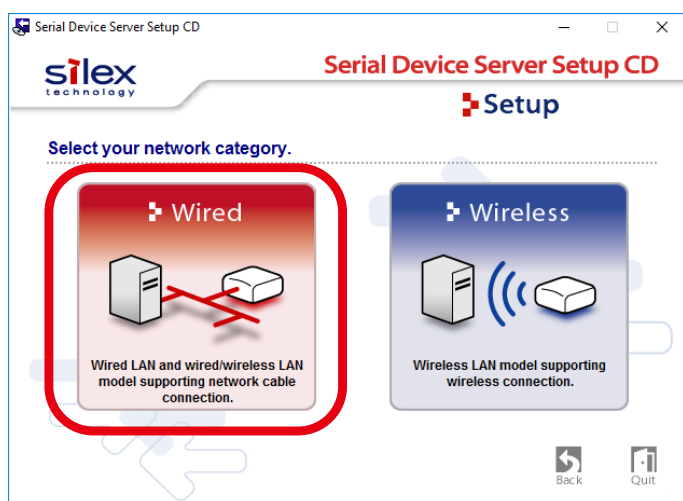

**TIP**

- \* If the User Account Control screen is displayed, click **Continue** or **Yes**.
- \* If the message below is displayed, click **Yes**.

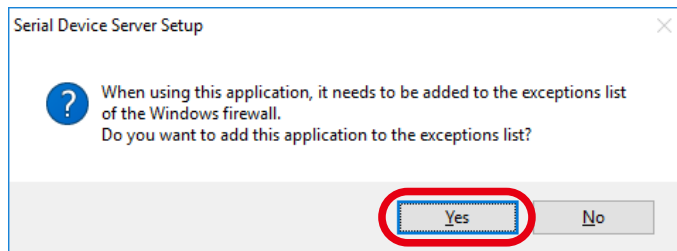

#### 4. The Serial Device Server Setup screen is displayed. Click **Next**.



#### 5. Read the **SOFTWARE LICENSE AGREEMENT** and click **Yes**.

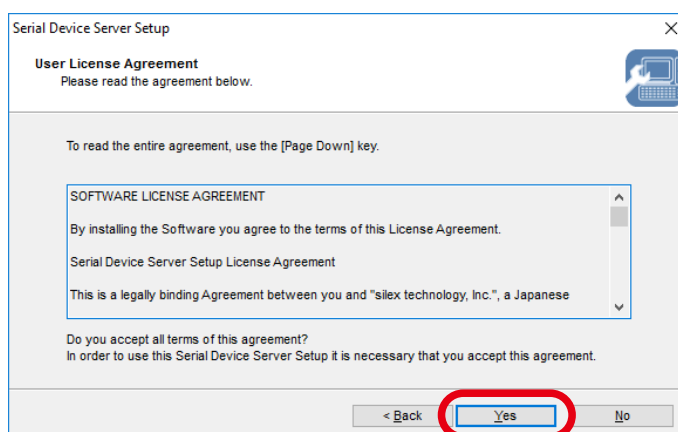

## 6. Select SD-330AC and click **Next**.

Serial Device Server Setup

**Device Server Search**  
Enter the Ethernet Address printed on this product or select it from the list.

Ethernet Address: 84 : 25 : 3F : 35 : 03 : FA

Search result overview:

Ethernet Address	IP Address	Model Name
84:25:3f:35:03:fa	169.254.111.111	SD-330AC

If the Ethernet Address is not detected, refer to the FAQ on our homepage.  
<http://www.silexamerica.com/support/>

< Back **Next >** Cancel



**TIP**

- \* If SD-330AC is using the factory default settings and an IP address other than 0.0.0.0 is displayed in the list, it means the IP address was obtained from a DHCP server.
- \* If SD-330AC is not displayed on the list, click Search. If this does not help, refer to **SD-330AC is not displayed in the search result of Serial Device Server Setup.** in 7-1. **Problems During the Setup.**

## 7. Configure the TCP/IP settings appropriate for your environment.



**Note**

- \* If you are not sure how to determine the IP address to set, refer to **How should I determine the way to assign IP address to SD-330AC?** in 7-1. **Problems During the Setup.**

**<< Obtain an IP address automatically from a DHCP server >>**

Select **Get IP Address Automatically** and click **Next**.

Serial Device Server Setup

**Setting TCP/IP**  
Setting TCP/IP will proceed.

**Get IP Address Automatically**

Design IP Address

IP Address: 169 . 254 . 111 . 111

Subnet Mask: 255 . 255 . 0 . 0

Default Gateway: 0 . 0 . 0 . 0

MEMO  
If you select [Get IP Address Automatically], the DHCP server assigns an IP address to this product. If a DHCP server is not available, please manually assign an IP address.

< Back **Next >** Cancel

## &lt;&lt; Assign an IP address manually &gt;&gt;

Select **Assign IP Address** and enter an IP address. Click **Next**.

Serial Device Server Setup

Setting TCP/IP  
Setting TCP/IP will proceed.

Get IP Address Automatically  
 Assign IP Address

IP Address: 169 . 254 . 111 . 111

Subnet Mask: 255 . 255 . 0 . 0

Default Gateway: 0 . 0 . 0 . 0

MEMO  
If you select [Get IP Address Automatically], the DHCP server assigns an IP address to this product. If a DHCP server is not available, please manually assign an IP address.

< Back   **Next >**   Cancel

**TIP**

- \* The IP address used in the screen above is a sample address. Please enter an IP address appropriate for your environment.
- \* Enter a **Subnet Mask** and **Default Gateway** if necessary.
- \* If there are no DHCP servers on your network and the IP address of your PC is assigned manually, the screen below will be displayed. Please configure an IP address appropriate for your environment.

Serial Device Server Setup

Setting TCP/IP  
Setting TCP/IP will proceed.

IP Address: 0 . 0 . 0 . 0

Subnet Mask: 0 . 0 . 0 . 0

Default Gateway: 0 . 0 . 0 . 0

< Back   **Next >**   Cancel

## 8. Configure the wireless settings and click **Next**.

Serial Device Server Setup

Wireless Setting  
Setting for Wireless usage.

Wireless Mode: infrastructure

SSID: serserv

Channel: 1

Network Authentication: Open

Use WEP: OFF

Key Size: 128bit (16 hexadecimal)

WEP Key: \*\*

Key Index: 1

< Back Next > Cancel



**TIP**

\* The settings used in the screen above are sample values. See the information below for your reference.

Wireless Mode	Fixed to <b>Infrastructure</b> .
SSID	Enter the same SSID as the Access Point.
<b>When encrypting communication using WEP</b>	
Network Authentication	Select <b>Open</b> .
Use WEP	Select <b>ON</b> .
Key Size	Set the same WEP key size as the Access Point (128bit). To enter a WEP key by a string, select <b>128bit (ASCII)</b> . To enter a WEP key by a number, select <b>128bit (hexadecimal)</b> .
WEP Key	Enter the same WEP key as the Access Point.
Key Index	Enter the same key index as the Access Point.
<b>When encrypting communication using WPA</b>	
Network Authentication	Select <b>WPA</b> .
Encryption Mode	Fixed to <b>AUTO</b> .
Pre-Shared Key	Enter the same Pre-Shared key as the Access Point.
<b>When encrypting communication using WPA2</b>	
Network Authentication	Select <b>WPA2</b> .
Encryption Mode	Fixed to <b>AES</b> .
Pre-Shared Key	Enter the same Pre-Shared key as the Access Point.
<b>When using no encryption</b>	
Network Authentication	Select <b>Open</b> .
Use WEP	Select <b>OFF</b> .

## 9. Check the settings and click **Execute**.

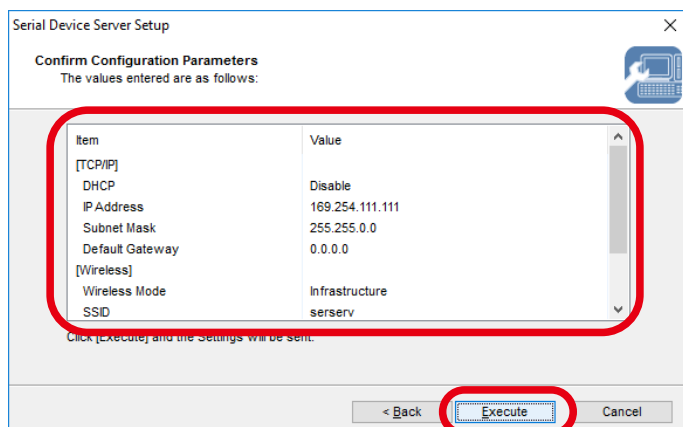

\* The information displayed in this screen will vary depending on the items you have configured.



\* If an error occurs after clicking Execute, please refer to **Communication error occurs when configuring with Serial Device Server Setup.** in **7-1. Problems During the Setup.**

## 10. Select **Yes** and click **Finish**.

Continue to install the SX Virtual Link for Serial Device Server. For details on the installation, refer to **Install Application**.

After the installation is finished, go on to **11**.

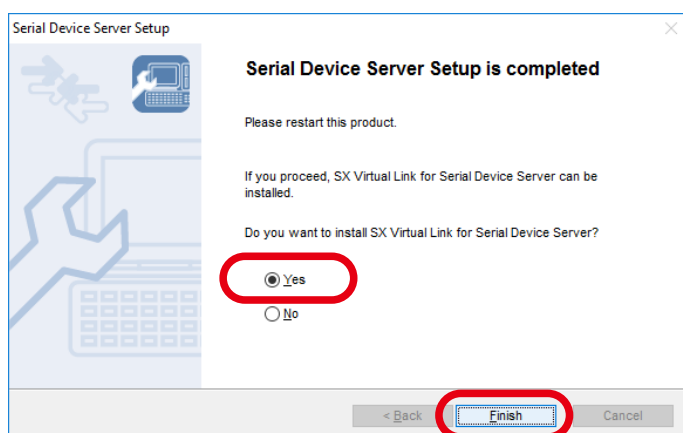

\* When **No** is selected, go on to **11**.

**11.** Remove the power plug from the outlet and the network cable from SD-330AC.

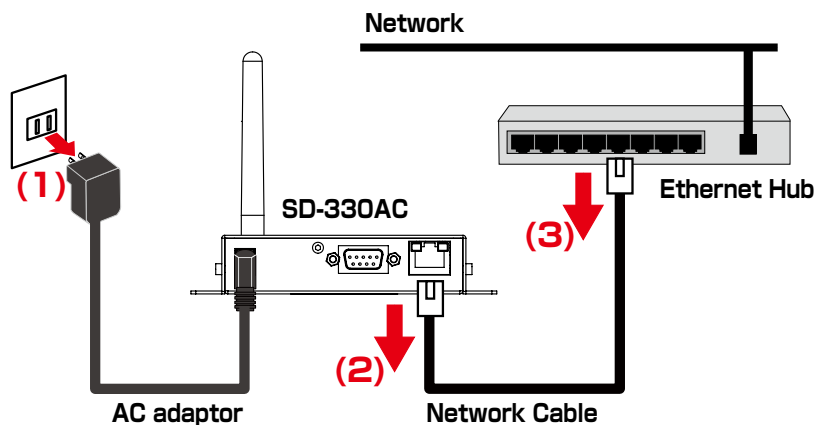

\* If you plan to use SD-330AC in a wired network after completing the configuration, the network cable does not need to be unplugged

**12.** Connect the serial device that you wish to share over the network to SD-330AC using a serial cable and insert the power plug of SD-330AC into the outlet.

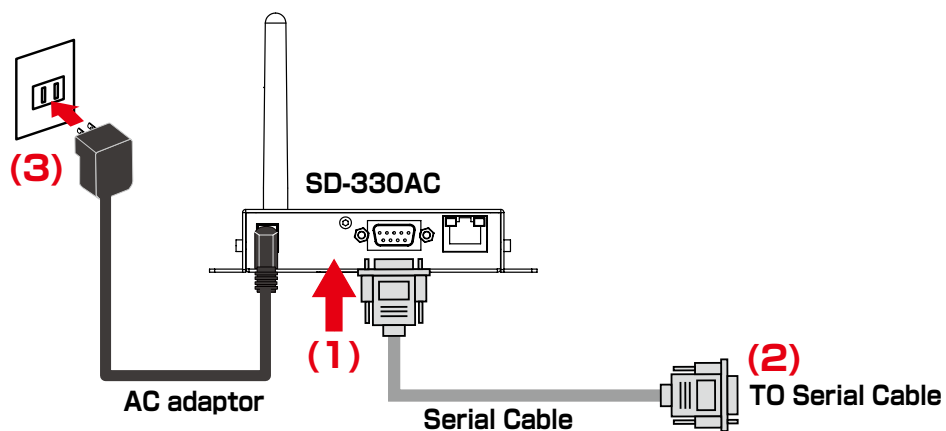

Network configuration is complete.



## 4-5. Configure SD-330AC Using Smart Wireless Setup

This page explains the Smart Wireless Setup which can be used when your wireless router supports WPS (Wi-Fi Protected Setup).

### Confirm that your wireless router supports WPS

To perform the wireless configuration using WPS, your wireless router must support WPS. Please make sure that a wireless router supporting WPS is set up in your environment.

To see if your wireless router supports WPS or not, refer to the operation manual that came with the router or contact the manufacturer.



**TIP**

- \* Depending on your wireless router, WPS may need to be enabled manually. For details, refer to the operation manual that came with your wireless router.
- \* If a security feature such as MAC Address filtering is enabled on your wireless router, disable it temporarily so that SD-330AC can communicate with your wireless router.

### Configure Network Settings

1. Configure the TCP/IP settings and install the necessary application according to the instructions from **1** to **10** at **4-4. Configure Network Settings**.



**TIP**

- \* The wireless configuration at 8 will not be necessary. Click **Next** then.

2. Access the Web page of SD-330AC using the Web browser.



**Note**

- \* For details on how to access the Web page of SD-330AC using the Web browser, refer to **Access the SD-330AC Web Page**.

3. From the left menu on the Web page, click **Wireless LAN**.

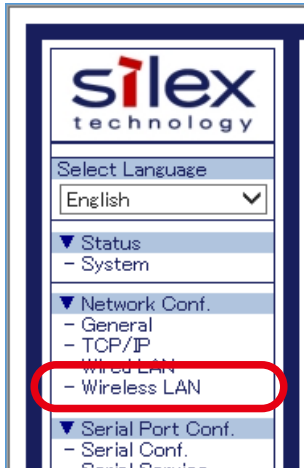

4. Click the **Smart Wireless Setup** tab.

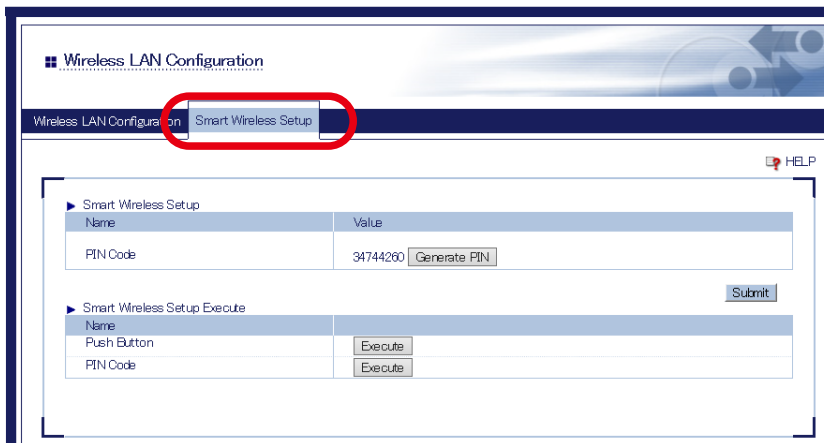

## Push Button Method

1. Press the WPS button on your wireless LAN router.  
Check that your wireless router start to wait for a wireless connection.



### Note

- \* The name, position and shape of the WPS button will differ depending on your wireless router. For details, refer to the operation manual that came with your wireless router.
- \* Please use only one wireless router. If two or more routers are waiting for wireless connections, SD-330AC will not be able to connect properly.

2. In the Web page, click **Execute** at **Push Button**.

Wireless LAN Configuration

Wireless LAN Configuration Smart Wireless Setup

Smart Wireless Setup

Name	Value
PIN Code	34744260 <input type="button" value="Generate PIN"/>

Smart Wireless Setup Execute

Push Button	<input type="button" value="Execute"/>
PIN Code	<input type="button" value="Execute"/>

3. The Smart Wireless Setup will begin.

Wireless LAN Configuration

Wireless LAN Configuration Smart Wireless Setup

Smart Wireless Setup Running

Progress bar: 10 blue dots



### Note

- \* Depending on your environment, it may take up to 2 mins to finish the wireless configuration.

4. When the configuration is completed, SD-330AC will be configured with the same setting as the wireless router.

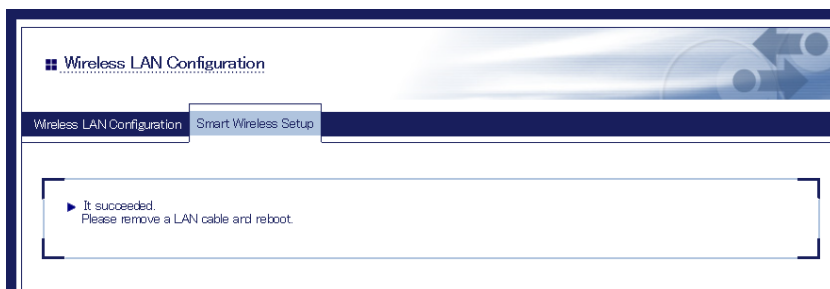

5. Remove the power plug from the outlet and the network cable from SD-330AC.

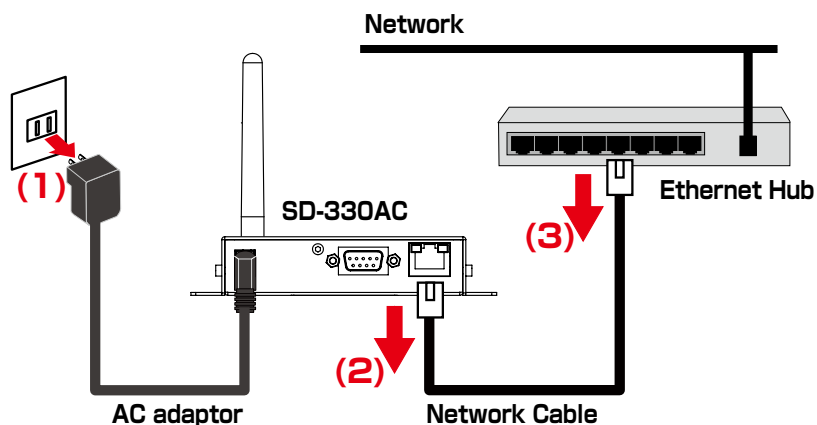

6. Connect the serial device that you wish to share over the network to SD-330AC using a serial cable and insert the power plug of SD-330AC into the outlet.

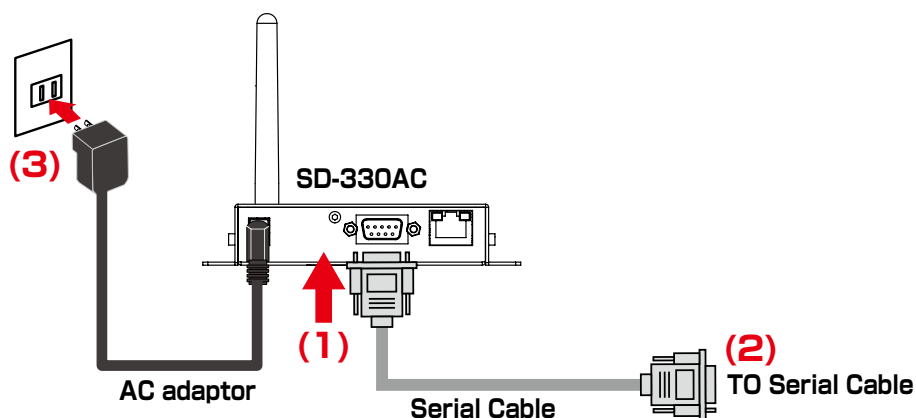

## PIN Code Method

1. Check the PIN code on the Web page.  
Keep displaying the Web page as it will be used again after you enter the PIN code on the Access Point side.

Wireless LAN Configuration

Wireless LAN Configuration Smart Wireless Setup

Smart Wireless Setup

Name	Value
PIN Code	34744260 <input type="button" value="Generate PIN"/>

Smart Wireless Setup Execute

Name	
Push Button	<input type="button" value="Execute"/>
PIN Code	<input type="button" value="Execute"/>



\* To change the PIN code, click **Generate PIN**. A new PIN code will be issued.

### Note

2. Open the Web page of Access Point using the Web browser (Internet Explorer, Edge, etc).  
Enter the PIN code and start the WPS on that page.
3. Go back to the Smart Wireless Setup page of SD-330AC after the WPS is started on the Access Point.  
Click **Execute** at **PIN Code**.

Wireless LAN Configuration

Wireless LAN Configuration Smart Wireless Setup

Smart Wireless Setup

Name	Value
PIN Code	34744260 <input type="button" value="Generate PIN"/>

Smart Wireless Setup Execute

Name	
Push Button	<input type="button" value="Execute"/>
PIN Code	<input type="button" value="Execute"/>

4. The Smart Wireless Setup will begin.

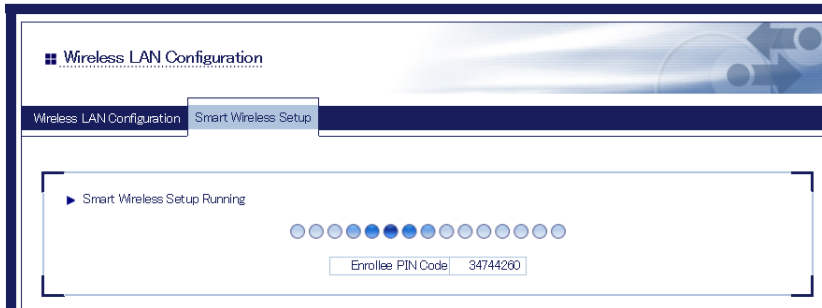

5. When the configuration is completed, SD-330AC will be configured with the same setting as the wireless router.

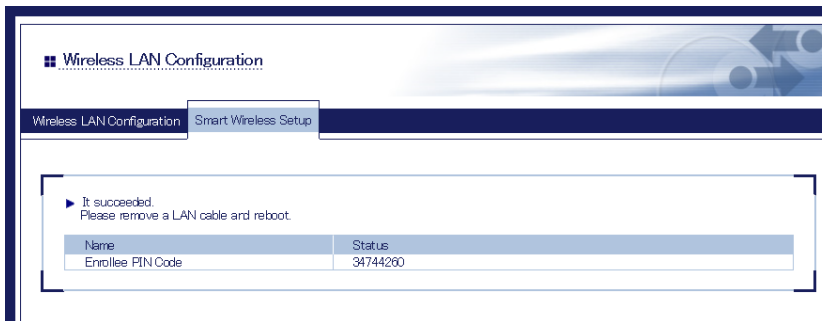

6. Remove the power plug from the outlet and the network cable from SD-330AC.

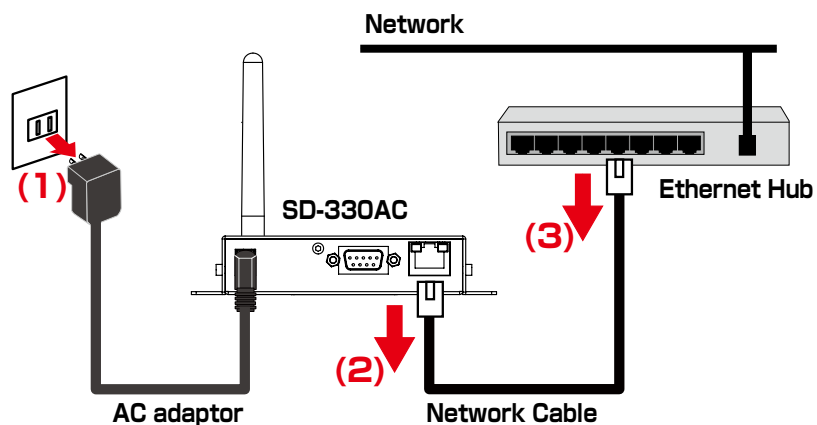

7. Connect the serial device that you wish to share over the network to SD-330AC using a serial cable and insert the power plug of SD-330AC into the outlet.

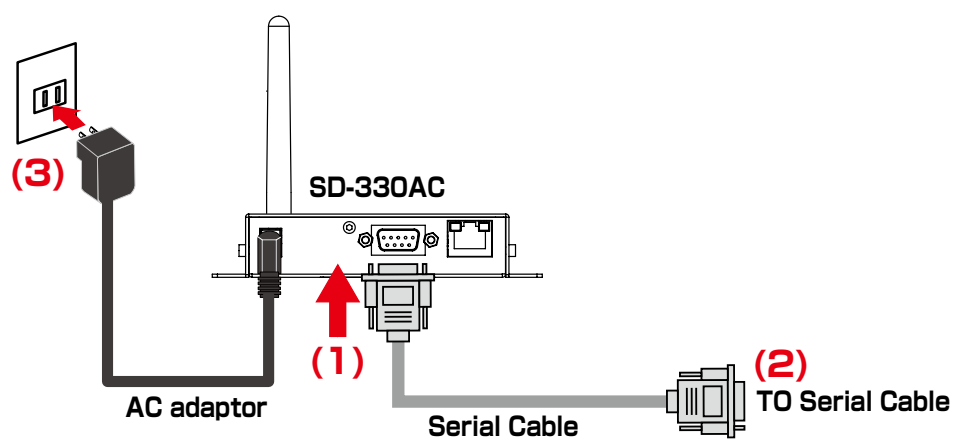

Blank page



# 5. How to Use

---

## 5-1. Link to Serial Device Using the Serial Device Connection Utility

### (Serial Port Emulation Mode)

#### What is Serial Port Emulation Mode?

Serial Port Emulation Mode is a function to emulate the standard Windows COM port on network using the serial device connection utility, "SX Virtual Link for Serial Device Server". If this function is used, users can communicate with serial devices over the network using a serial port communication utility (e.g. terminal software, etc.).

**Note**

- \* If you are using the USB device management utility, "SX Virtual Link", please uninstall it and use "**SX Virtual Link for Serial Device Server**". It can discover, link to and unlink from both USB devices and serial devices. For details on how to install it, see **Install Application**.

#### Install Application

This page explains how to install the serial device connection utility, "SX Virtual Link for Serial Device Server".

- \* If SX Virtual Link for Serial Device Server is not installed yet, install it according to the instructions below.
- \* If you have completed the configuration and continue to install the application, start from 3 in this section.

**TIP**

- \* Administrator privilege is required for installation.

**Note**

- \* If you are using the USB device management utility, "SX Virtual Link", you can use "SX Virtual Link for Serial Device Server" instead of "SX Virtual Link" to discover, link to and unlink from both USB devices and serial devices.

1. Extract the compressed file of **SX Virtual Link for Serial Device Server** that you have downloaded.  
Double-click **Cosetup.exe** in the extracted folder to start the **SX Virtual Link for Serial Device Server** installer.



\* If the User Account Control screen is displayed, click **Yes** or **Continue**.

**TIP**

2. Select **English** and click **Next**.

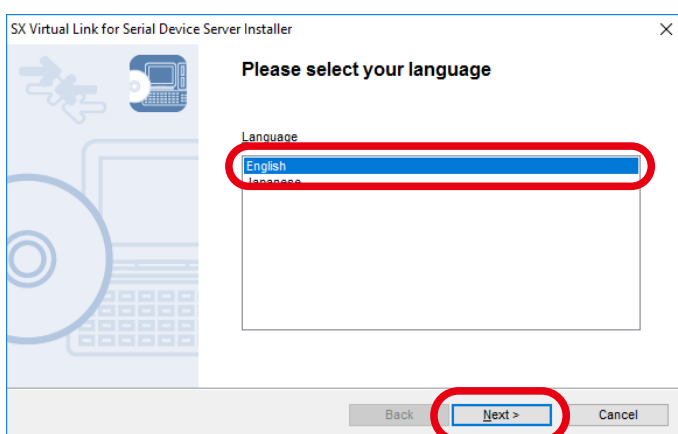

3. SX Virtual Link for Serial Device Server Install wizard is displayed. Click **Next**.

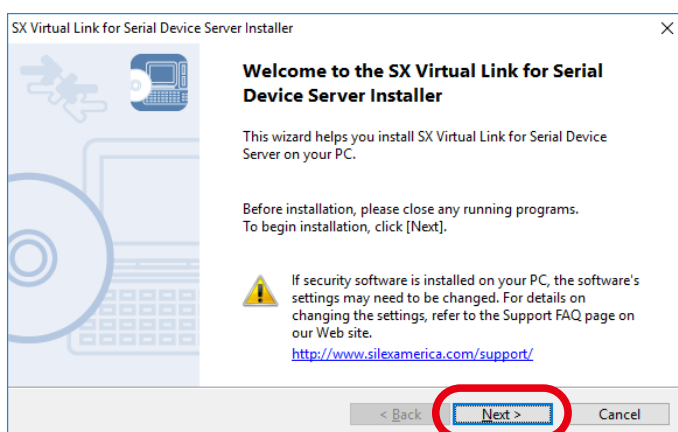

**4.** Read the **SOFTWARE LICENSE AGREEMENT** and click **Yes**.

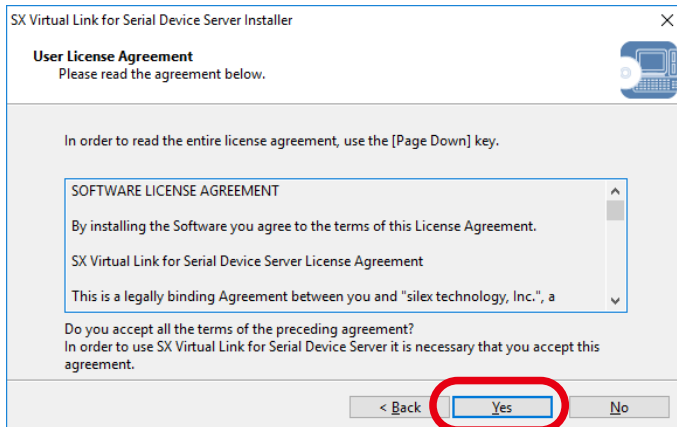

**5.** Select a folder to install SX Virtual Link for Serial Device Server into and click **Next**.

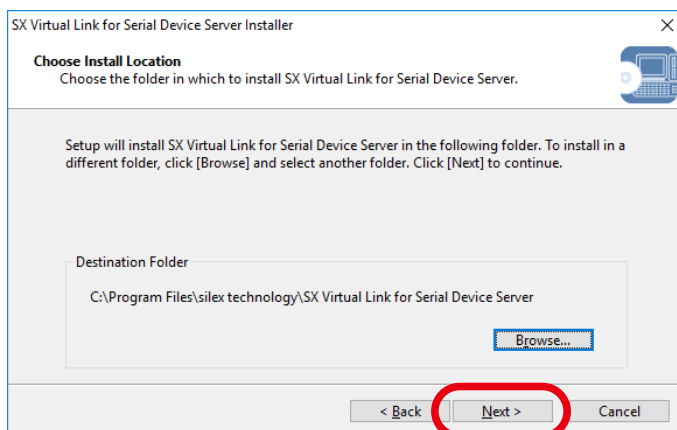

**6.** Enter a Group Name to be displayed in the Start Menu. Click **Next**.

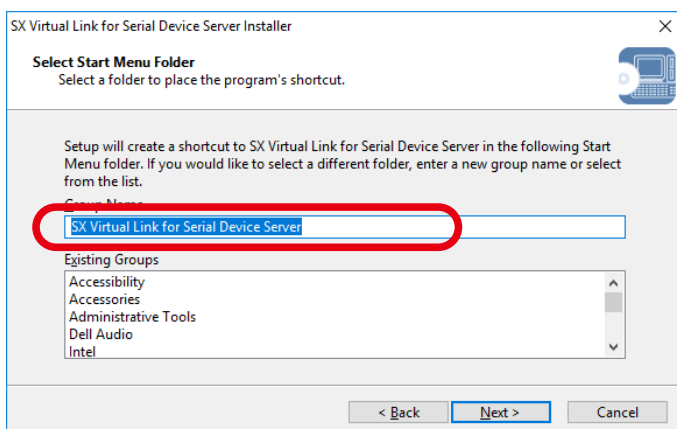

## 7. Click **Start** to begin the installation.

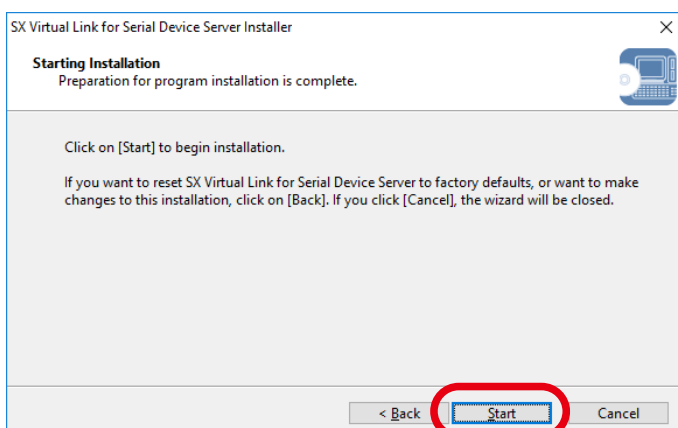

## 8. A confirmation message for software installation is displayed. Click **Install**.

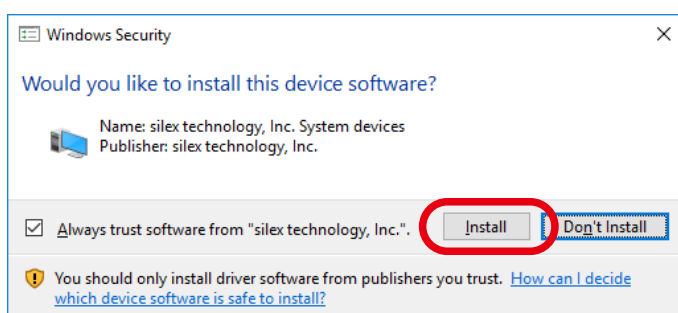

Again, click **Install**.

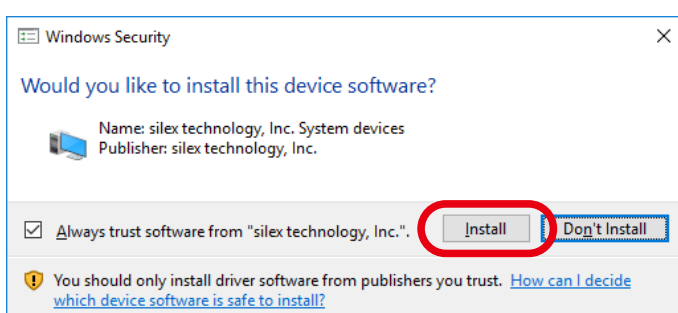

**TIP**

\* If the message below is displayed, click **Yes**.

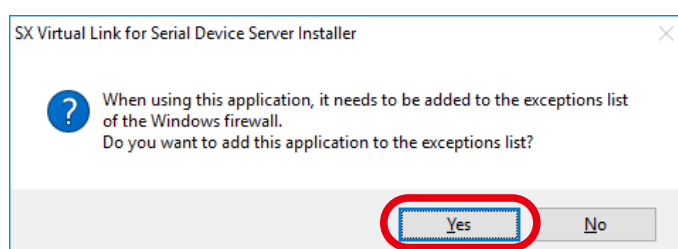

9. SX Virtual Link for Serial Device Server has been installed. Click **Finish**.

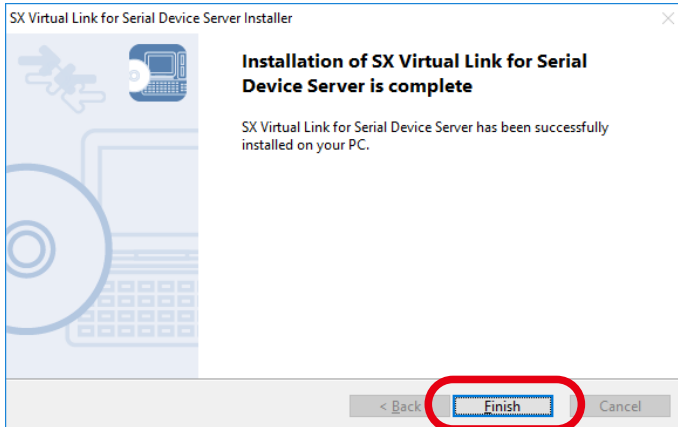

\* If using a firewall function of commercial security software, please add SX Virtual Link for Serial Device Server to the exception list in your security software. Refer to the FAQ on our website ( <https://www.silxtechnology.com/> ) for details on adding an application to the exception list.

Application installation is complete. SX Virtual Link for Serial Device Server will run.

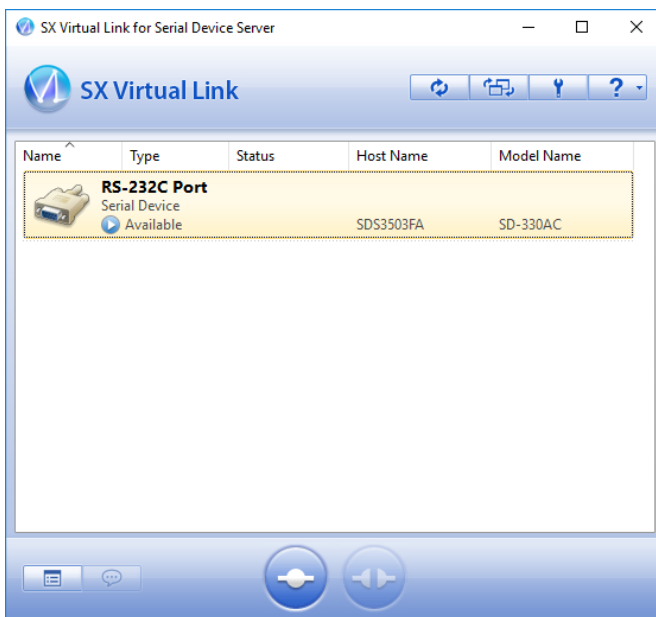

## Start SX Virtual Link for Serial Device Server

How to start SX Virtual Link for Serial Device Server is as follows:

1. Click the icon  in the task tray.



### Note

\* If SX Virtual Link for Serial Device Server is not running, click **Start - All Programs - SX Virtual Link for Serial Device Server - SX Virtual Link for Serial Device Server**.

2. The SX Virtual Link for Serial Device Server's main window appears and the serial devices running on the network are displayed in the device list.

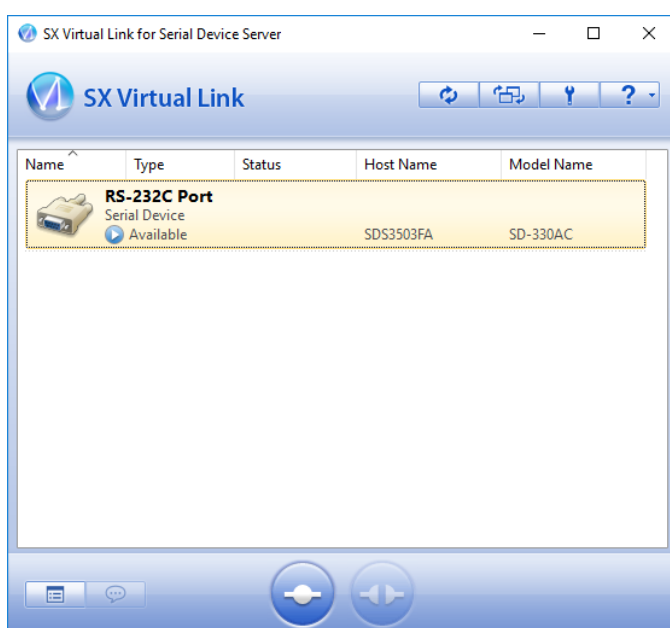

## Link to a serial device

How to link to serial device is as follows:

1. Select the serial device in SX Virtual Link for Serial Device Server's main window and connect to it.

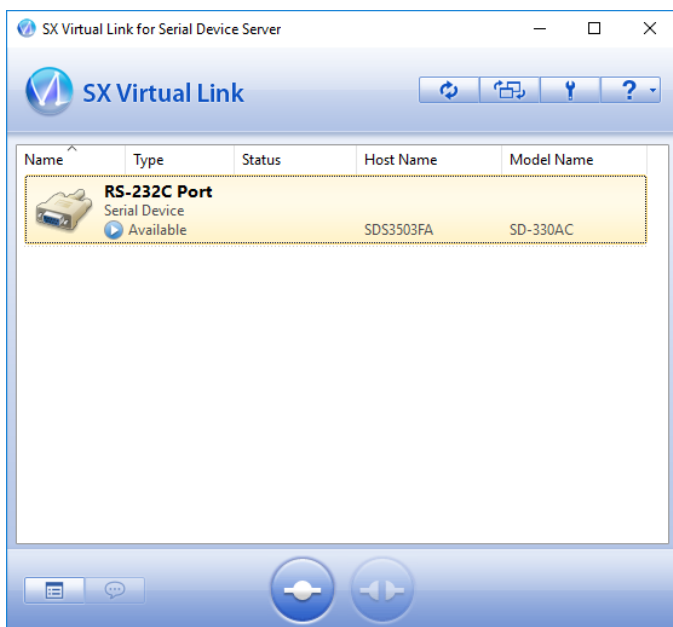

### How to Link:

Double-click	Double-click the serial device in SX Virtual Link for Serial Device Server's main window.
Use a button	Select the serial device and click the Connect button  in SX Virtual Link for Serial Device Server's main window.
Right-click	Right-click on the serial device in SX Virtual Link for Serial Device Server's main window and click <b>Connect</b> in the menu displayed.
Use a keyboard	Select the serial device using the up/down arrow keys and press <b>Alt + C</b> on your keyboard.



**Note**

\* To specify the COM port manually, please complete the following steps before you link to the serial device.

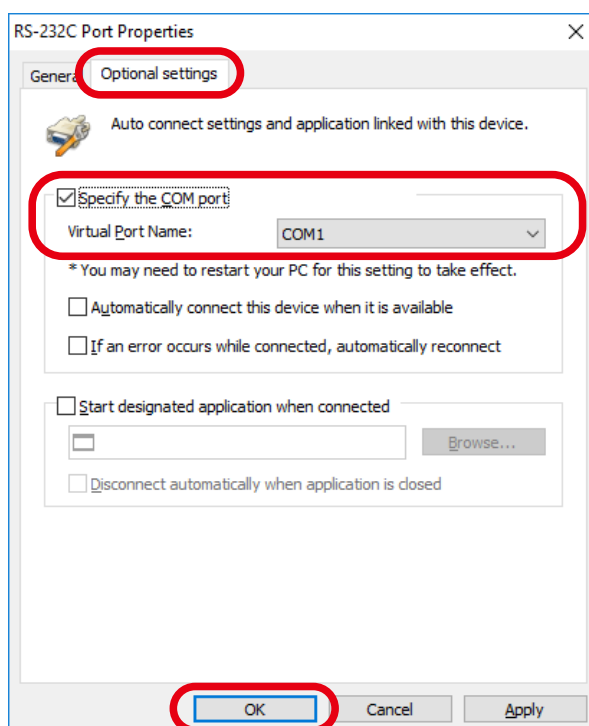

1. Select the serial device that you wish to link and click the Properties button  .
2. In the **Optional settings** tab, check **Specify the COM port** check box and select the COM port that you wish to use from **Virtual Port Name**.

Do not select one that is already used on your system.



3. Click **OK**.

The COM port has been specified.

\* When the Connect button  is clicked, the message below may be displayed. Check the message and click **OK**. Finish the COM port currently used in your system and click the Connect button  again.

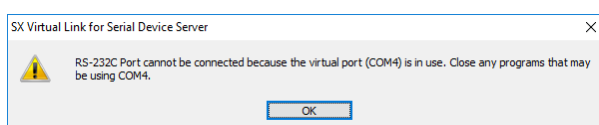

2. Once you successfully link to the serial device, the status icon is changed in SX Virtual Link for Serial Device Server's main window.  
The COM port that you have selected is displayed in the status column.

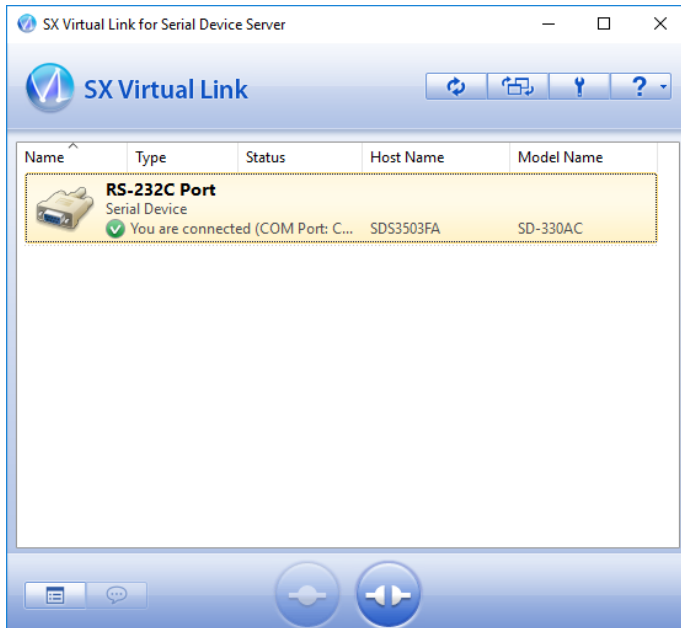

## Start a serial communication software

Start a serial communication software such as a terminal software program.

On the serial communication software, select the COM port that is displayed in the status column of SX Virtual Link for Serial Device Server's main window. Also, configure the serial port settings such as baud rate, stop bit, etc.

Once the communication settings are complete, you can communicate with the serial device connected to SD-330AC.

## Unlink from a serial device

How to unlink from serial device is as follows:

Select the serial device in SX Virtual Link for Serial Device Server's main window and disconnect from it.

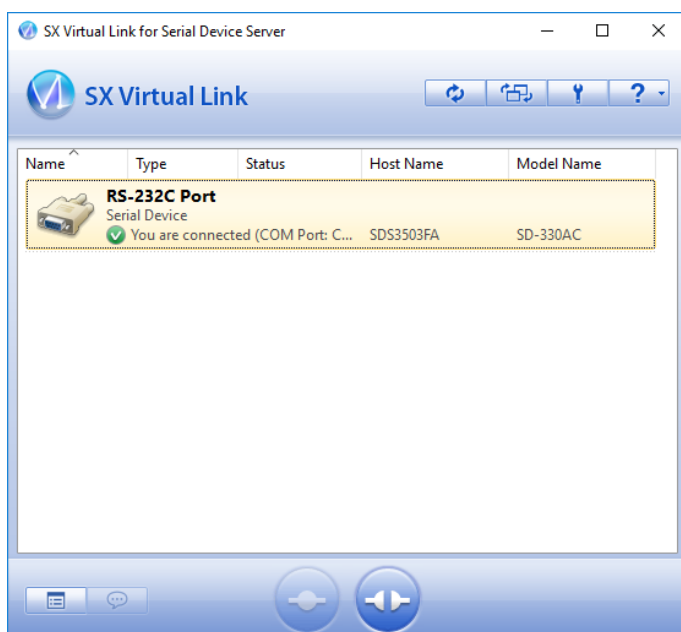

### How to Unlink:

Double-click	Double-click the serial device in SX Virtual Link for Serial Device Server's main window.
Use a button	Select the serial device and click the Disconnect button  in SX Virtual Link for Serial Device Server's main window.
Right-click	Right-click on the serial device in SX Virtual Link for Serial Device Server's main window and click <b>Disconnect</b> in the menu displayed.
Use a keyboard	Select the serial device using the up/down arrow keys and press <b>Alt + D</b> on your keyboard.

## 5-2. Ecable Mode

### (Link to the Registered Device)

#### What is Ecable Mode?

Ecable Mode is a feature that allows serial devices with no network interface to communicate with each other using two SD-330AC's.

One SD-330AC is used as a transmitter and the other one is used as a receiver, and a serial device is connected for each end. To allow communication between them, the IP address of the receiver needs to be registered to the transmitter.

When both SD-330AC's are turned on and the network connection is established, the serial devices can communicate with each other via SD-330AC.

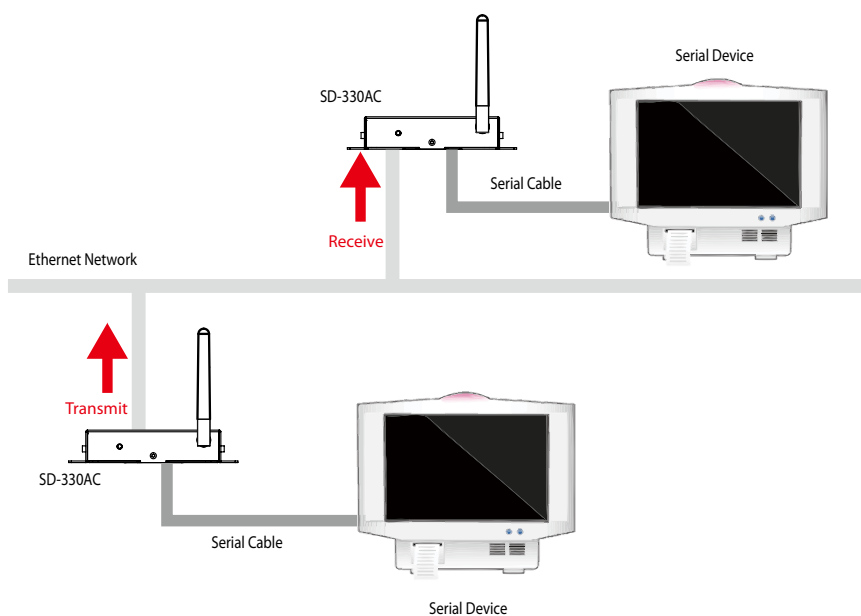

When SD-330AC's are communicating with each other using Ecable Mode, the transmitter end sends the serial port data to the receiver end, and the receiver end sends it to the serial device.

## Before You Begin

Change the settings to use SD-330AC in Ecable Mode.

1. Access the Web page of the SD-330AC that you wish to use as the transmitter end.



\* For details on how to access the Web page, refer to **Access the SD-330AC Web Page**.

### Note

2. In the left pane of the Web page, click **General**.

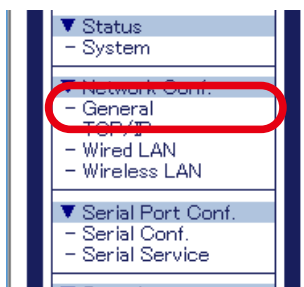

3. Select **OFF** for **SX Virtual Link compatibility**.

General Configuration

General Configuration

HELP

Name	Value
System Name	SDS3503FA
System Description	Silex SD-330AC
System Contact	
System Location	
SNMP Get Community Name	
SNMP Set Community Name	

Name	Value
SX Virtual Link compatibility	OFF

Submit

When completed, click the **Submit** button.

4. In the left pane of the Web page, click **Serial Conf.**

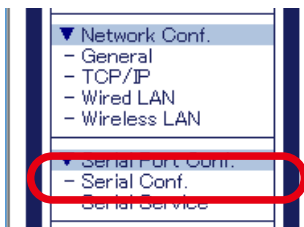

5. In the page displayed, configure the following settings at **General Configuration** as appropriate for your serial device.

- \* Baud Rate
- \* Bits per character
- \* Stop Bits
- \* Parity
- \* Flow Control

Select **Enabled** for **Ecable Mode**.

For **Destination IP Address**, enter the IP address of the receiver end (another SD-330AC).

For **Destination Port**, enter the port number that you wish to use.

For **Connection attempt time**, set the interval for connection retry.

To encrypt the communication, select **Enabled** for **Ecable Encryption**.

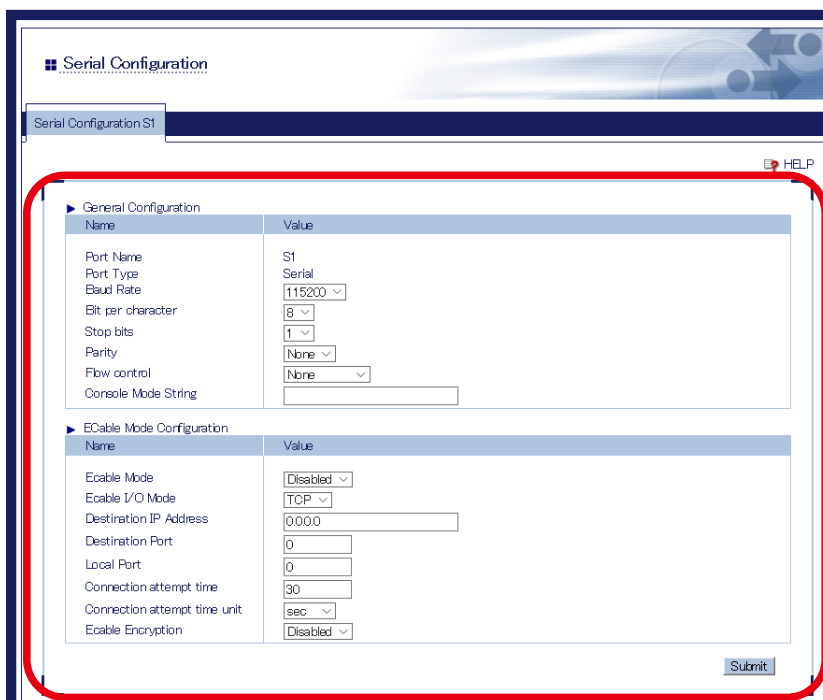
A screenshot of the 'Serial Configuration' web page. The page title is 'Serial Configuration' and the sub-page is 'Serial Configuration S1'. There is a 'HELP' link in the top right. The main content is divided into two sections: 'General Configuration' and 'ECable Mode Configuration'. The 'General Configuration' section has a table with columns 'Name' and 'Value'. The 'ECable Mode Configuration' section also has a table with columns 'Name' and 'Value'. A red rectangle highlights the entire configuration area. At the bottom right, there is a 'Submit' button.

Name	Value
Port Name	S1
Port Type	Serial
Baud Rate	115200
Bit per character	8
Stop bits	1
Parity	None
Flow control	None
Console Mode String	

Name	Value
Ecable Mode	Disabled
Ecable I/O Mode	TCP
Destination IP Address	0.0.0.0
Destination Port	0
Local Port	0
Connection attempt time	30
Connection attempt time unit	sec
Ecable Encryption	Disabled

When completed, click the **Submit** button.

6. Also, access the Web page of the receiver end and click **General**.

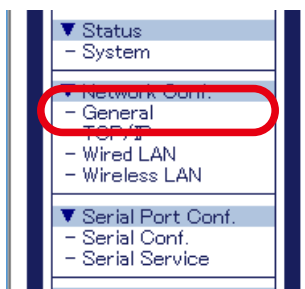

7. Select **OFF** for **SX Virtual Link compatibility**.

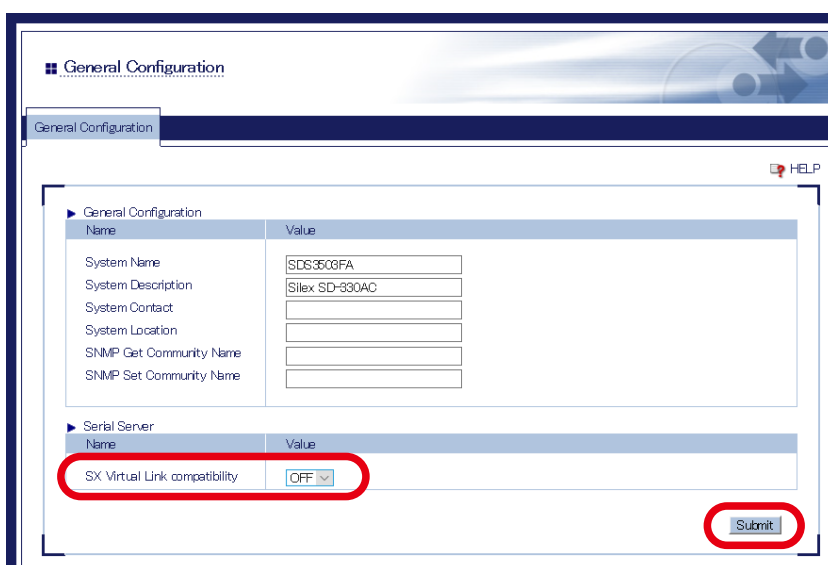

A screenshot of the 'General Configuration' web page. The page title is 'General Configuration'. Below the title is a 'General Configuration' tab. The main content area is divided into two sections: 'General Configuration' and 'Serial Server'. The 'General Configuration' section has a table with columns 'Name' and 'Value'. The 'Serial Server' section has a table with columns 'Name' and 'Value'. The 'SX Virtual Link compatibility' option is highlighted with a red oval, and its value is 'OFF'. A 'Submit' button is also highlighted with a red oval.

Name	Value
System Name	SDS3503FA
System Description	Silex SD-830AC
System Contact	
System Location	
SNMP Get Community Name	
SNMP Set Community Name	

  

Name	Value
SX Virtual Link compatibility	OFF

Submit

When completed, click the **Submit** button.

8. In the left pane of the Web page, click **Serial Conf.** and configure the settings at **General Configuration**.

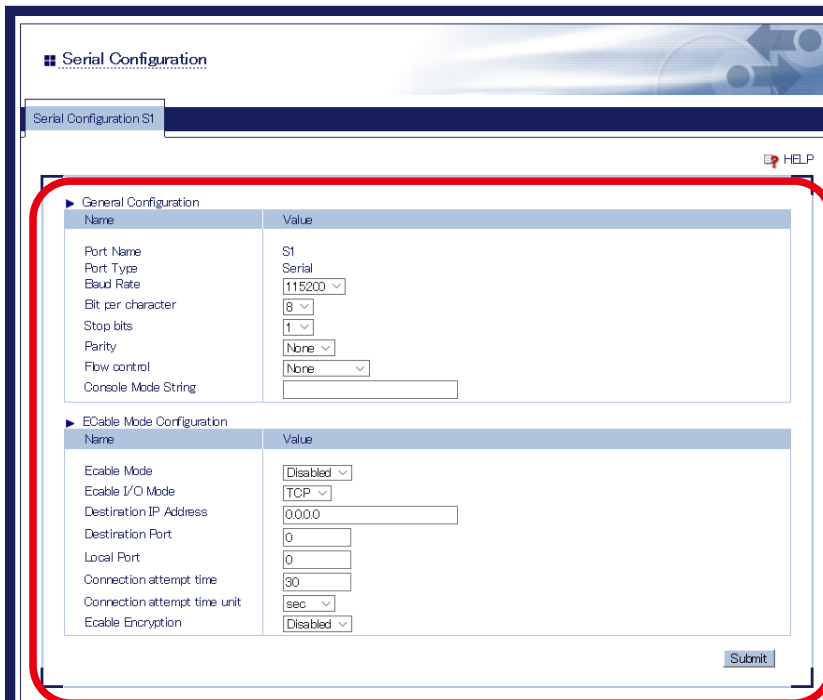

The screenshot shows the 'Serial Configuration' web page for 'Serial Configuration S1'. The 'General Configuration' section is highlighted with a red border. The 'ECable Mode Configuration' section is also visible below it.

Name	Value
Port Name	S1
Port Type	Serial
Baud Rate	115200
Bit per character	8
Stop bits	1
Parity	None
Flow control	None
Console Mode String	

Name	Value
ECable Mode	Disabled
ECable I/O Mode	TCP
Destination IP Address	0.0.0.0
Destination Port	0
Local Port	0
Connection attempt time	30
Connection attempt time unit	sec
ECable Encryption	Disabled

When completed, click the **Submit** button.

9. In the left pane of the Web page, click **Serial Service**.



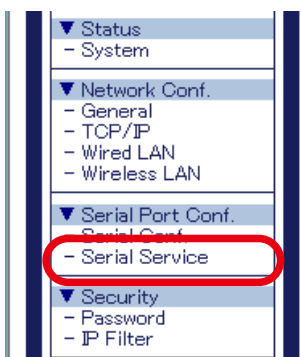

10. For TCP Port, enter the same value for both receiver end and transmitter end.

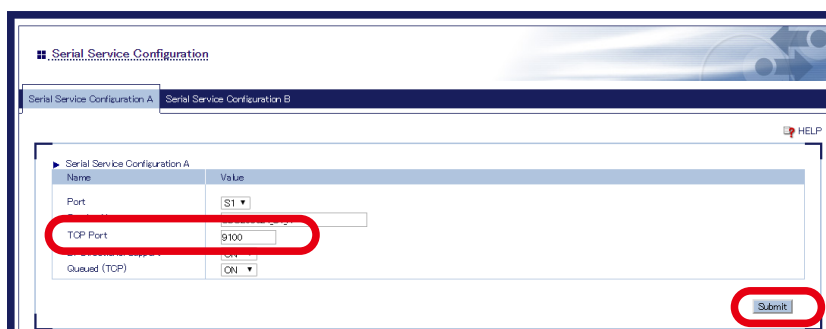

The screenshot shows a web-based configuration interface for 'Serial Service Configuration'. It has two tabs: 'Serial Service Configuration A' and 'Serial Service Configuration B'. The 'Serial Service Configuration A' tab is active. Below the tabs is a table with two columns: 'Name' and 'Value'. The table contains the following entries:

Name	Value
Port	S1
TCP Port	9100
Quasud (TCP)	ON

Red circles highlight the 'TCP Port' field and the 'Submit' button.

When completed, click the **Submit** button.

The configuration has been completed.

## Link to Serial Device

Power on both serial devices and then both SD-330AC's.

After they are powered on, bidirectional communication will be active between the serial devices.

## 5-3. Raw TCP Connection Mode

### (Link to Serial Device Using TCP Raw Port)

#### What is Raw TCP Connection Mode?

Raw TCP Connection Mode is a feature used to send or receive serial port data transparently over TCP/IP.

Using this feature, you can directly communicate with a serial device using an application program that runs on the TCP Socket API.

#### Before You Begin

Change the settings to use SD-330AC in Raw TCP Connection Mode.

1. Access the Web page of SD-330AC.



\* For details on how to access the Web page, refer to **Access the SD-330AC Web Page**.

#### Note

2. In the left pane of the Web page, click **General**.

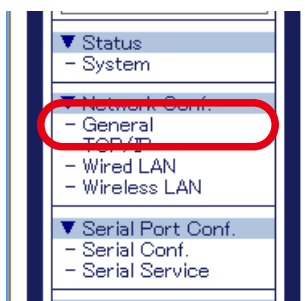

**3.** Select **OFF** for SX Virtual Link compatibility.

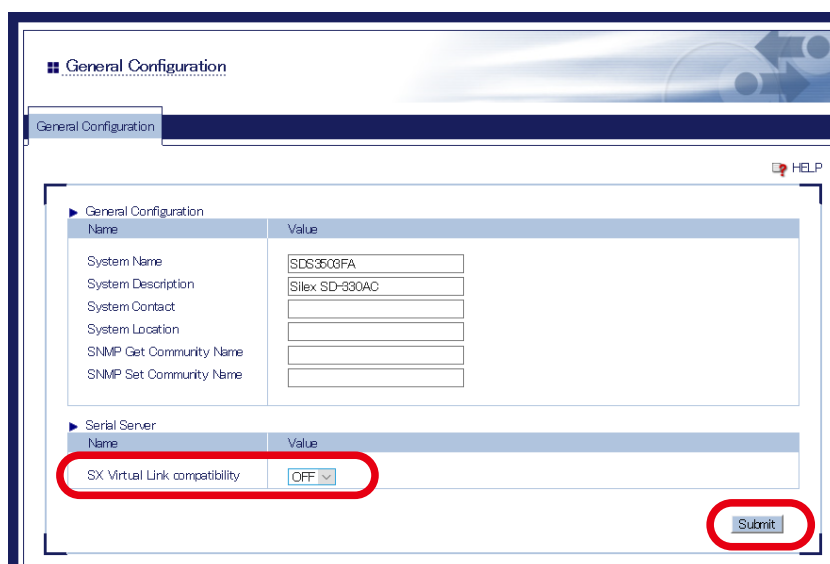

The screenshot shows a web interface for 'General Configuration'. It features a table with two sections: 'General Configuration' and 'Serial Server'. The 'Serial Server' section has a row for 'SX Virtual Link compatibility' with a dropdown menu set to 'OFF'. A 'Submit' button is located at the bottom right of the form area.

Name	Value
System Name	SDS350GFA
System Description	Silex SD-830AC
System Contact	
System Location	
SNMP Get Community Name	
SNMP Set Community Name	

Name	Value
SX Virtual Link compatibility	OFF

Submit

When completed, click the **Submit** button.

**4.** In the left pane of the Web page, click **Serial Conf.**



**5.** In the page displayed, configure the following settings at **General Configuration** as appropriate for your serial device.

- \* Baud Rate
- \* Bits per character
- \* Stop Bits
- \* Parity
- \* Flow Control

**Serial Configuration**

Serial Configuration S1

HELP

**General Configuration**

Name	Value
Port Name	S1
Port Type	Serial
Baud Rate	115200
Bit per character	8
Stop bits	1
Parity	None
Flow control	None
Console Mode String	

**Eable Mode Configuration**

Name	Value
Eable Mode	Disabled
Eable I/O Mode	TCP
Destination IP Address	0.0.0.0
Destination Port	0
Local Port	0
Connection attempt time	30
Connection attempt time unit	sec
Eable Encryption	Disabled

Submit

When completed, click the **Submit** button.

**6.** In the left pane of the Web page, click **Serial Service**.

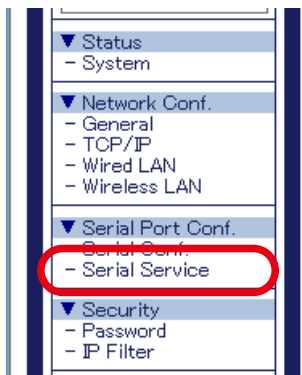

7. For **TCP Port**, enter the TCP port number that you wish to use for your application.

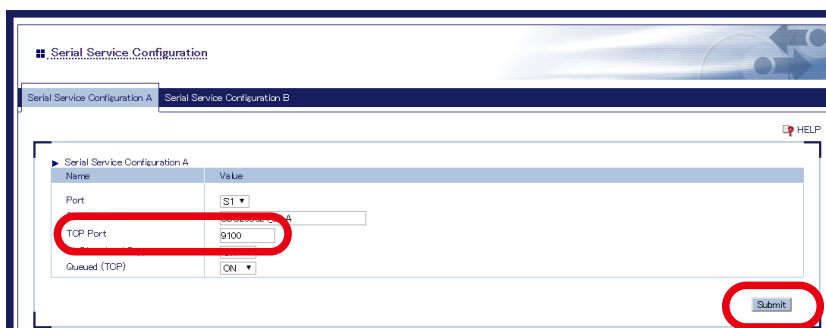

The screenshot shows a web-based configuration interface titled "Serial Service Configuration". It has two tabs: "Serial Service Configuration A" and "Serial Service Configuration B". The "Serial Service Configuration A" tab is active. Below the tabs is a table with two columns: "Name" and "Value". The table contains the following entries:

Name	Value
Port	S1
TCP Port	9100
Quasud (TCP)	ON

Red circles highlight the "TCP Port" field and the "Submit" button at the bottom right of the configuration area.

When completed, click the **Submit** button.

The configuration has been completed.

## Link to Serial Device

Power on the serial devices and then SD-330AC.

Start an application that runs on the TCP Socket API from your PC and bidirectional communication with the serial device will be active when a link is established.

## 5-4. Use Access Point Feature

### Before You Begin

How to turn on the Access Point mode on SD-330AC is explained as follows.

1. Access the Web page of SD-330AC.



\* For details on how to access the Web page, refer to **Access the SD-330AC Web Page**.

#### Note

2. In the left pane of the Web page, click **Wireless LAN**.

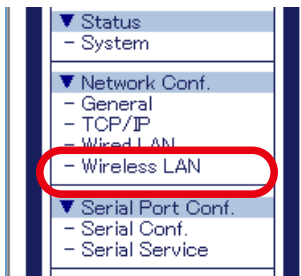

3. Select **AccessPoint** at **Wireless Mode** and configure the following settings at **Wireless LAN Basic Configuration**.

- \* SSID
- \* Channel
- \* Network Authentication

Wireless LAN Basic Configuration	
Name	Value
Wireless Mode	Infra
SSID	sensev
Network Authentication	Open

WEP Configuration	
Name	Value
WEP	OFF

When it is finished, click **Submit**.

- To take effect of the changes, restart SD-330AC by clicking **Restart** from the left pane of the Web page.



**Note**

\* If you are to continue configuration on the other pages, you do not have to restart SD-330AC. Restart it when all configuration is done.

The configuration has been completed.

## Link to Wireless Client Devices

The following explains how to make a link from the wireless client device when SD-330AC is operating in Access Point mode.

Below configuration methods are available:

- \* Configure the Wireless Settings on a Client Device
- \* Make a Link Using the Web Page of SD-330AC
- \* Make a Link Using the PIN Code



\* To make a link using the Web page or PIN code, your wireless client device needs to support WPS.

### <<Configure the Wireless Settings on a Client Device>>

Configure the client device with the same wireless settings as SD-330AC.

For details on how to configure the settings on the client device, refer to the operating manual that came with the client device.

After the configuration is completed, the client device can be used wirelessly via SD-330AC.

### <<Make a Link Using the Web Page of SD-330AC>>



\* Move the wireless client device closer to SD-330AC so that both devices can communicate.

**1.** Check that the client device supports WPS and is powered on.

**2.** Access the Web page of SD-330AC.



\* For details on how to access the Web page, refer to **Access the SD-330AC Web Page**.



3. In the left pane of the Web page, click **Wireless LAN**.

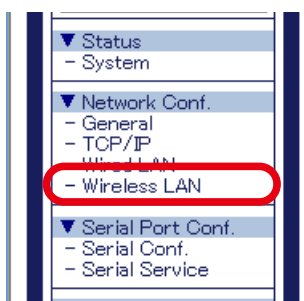

4. Click the **Smart Wireless Setup** tab.

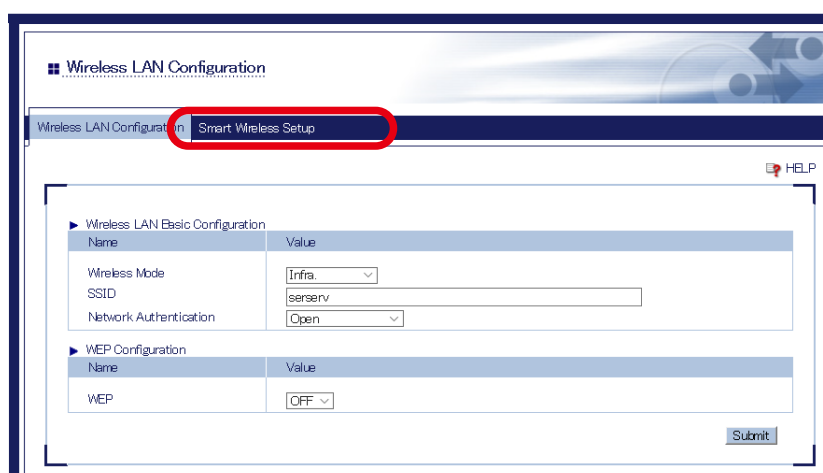

5. Click **Execute** at **Push Button**.

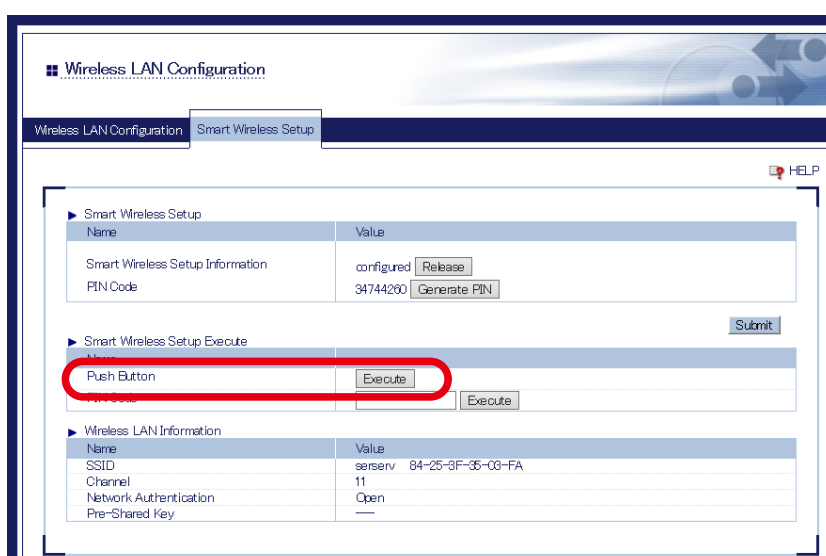

**6.** Press the wireless configuration switch on the client device.



**Note**

- \* The name, position and shape of the wireless configuration switch (WPS button) will differ depending on your wireless device. For details, refer to the operation manual that came with your wireless device.
- \* Please use only one wireless device. Even if two or more devices are waiting for wireless connections, SD-330AC can connect only one device which replied first.

**7.** The Smart Wireless Setup will begin.



**8.** When the configuration is completed, the same setting as SD-330AC is configured to the wireless client device.  
Check that the client device communicates with SD-330AC.

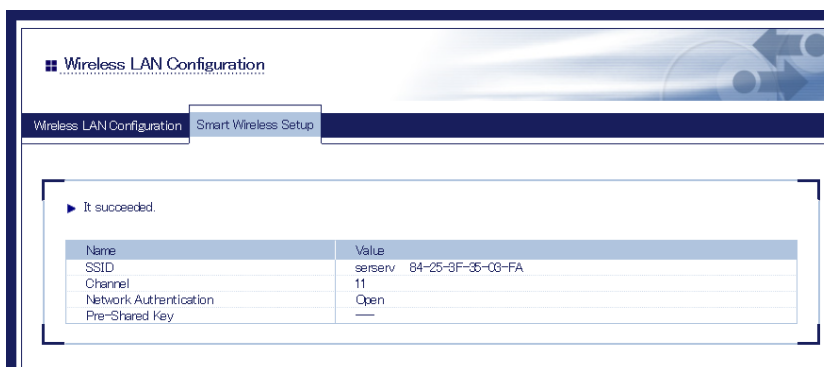

## <<Make a Link Using the PIN Code>>



\* Move the wireless client device closer to SD-330AC so that both devices can communicate.

**TIP**

1. Check that the client device supports WPS and is powered on.

2. Access the Web page of SD-330AC.



\* For details on how to access the Web page, refer to **Access the SD-330AC Web Page**.

**Note**

3. In the left pane of the Web page, click **Wireless LAN**.

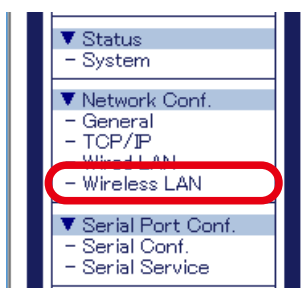

4. Click the **Smart Wireless Setup** tab.

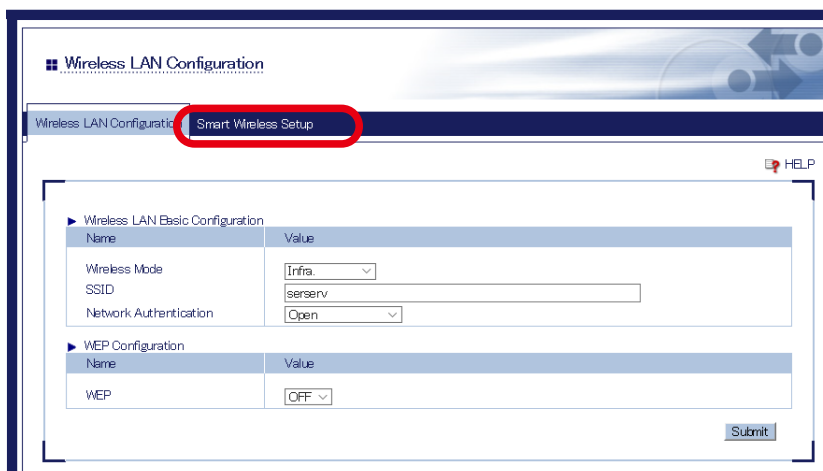

5. Enter the PIN code of the wireless client device at **PIN Code** and click **Execute**.

Wireless LAN Configuration

Smart Wireless Setup

Smart Wireless Setup

Name	Value
Smart Wireless Setup Information	configured <input type="button" value="Release"/>
PIN Code	34744260 <input type="button" value="Generate PIN"/>

Smart Wireless Setup Execute

Name	Value
Push Button	<input type="button" value="Execute"/>
PIN Code	<input type="text"/> <input type="button" value="Execute"/>

Wireless LAN Information

Name	Value
SSID	serv 84-25-3F-35-03-FA
Channel	11
Network Authentication	Open
Pre-Shared Key	—

6. The Smart Wireless Setup will begin.

Wireless LAN Configuration

Smart Wireless Setup

Smart Wireless Setup Running

Progress bar: 10 dots, 4th dot is filled.

Name	Value
Enrollee PIN Code	42464703

7. When the configuration has completed, the same settings as SD-330AC will be configured for the wireless client device.  
Check that the client device communicates with SD-330AC.

Wireless LAN Configuration

Smart Wireless Setup

It succeeded.

Name	Value
Enrollee PIN Code	42464703
SSID	serv 84-25-3F-35-03-FA
Channel	11
Network Authentication	Open
Pre-Shared Key	—

# 6. Other Functions

---

## 6-1. Configure Using the SD-330AC Web Page

Since SD-330AC has the HTTP protocol, advanced settings can be configured or changed via a Web browser. Useful functions such as a remote restart or factory default configuration for SD-330AC are available.



**TIP**

- \* To use a Web browser, the TCP/IP settings need to be enabled, and an IP address needs to be configured.
- \* We recommend the following Web browsers:

Microsoft Internet Explorer 9 or higher
Microsoft Edge 20 or higher
Mozilla Firefox 3.0.0 or higher
Google Chrome Version 51 or higher

### Access the SD-330AC Web Page

<<Use SX Virtual Link for Serial Device Server to display the Web page>>

1. In the SX Virtual Link for Serial Device Server's main window, select the serial device connected to SD-330AC and then click **Properties** button  .



- The properties dialog is displayed. In the **General** tab, click **Device Server Properties**.

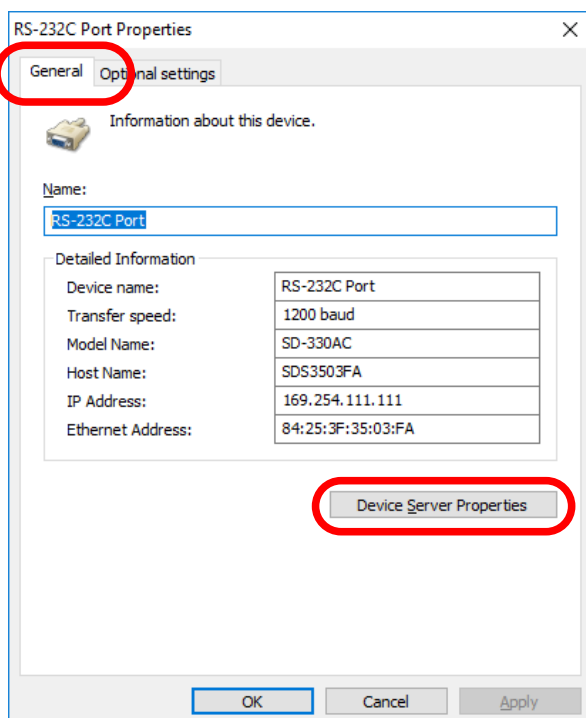

- The Web browser will run and the login password configuration page will be displayed. Enter the password to configure for SD-330AC and click **Submit**.

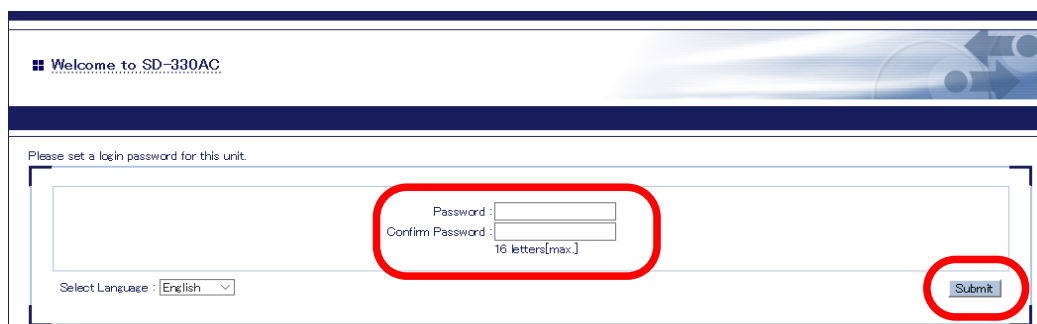
**TIP**

\* The login password configuration page is displayed only when SD-330AC is configured for the first time.

4. The System Status page will be displayed.

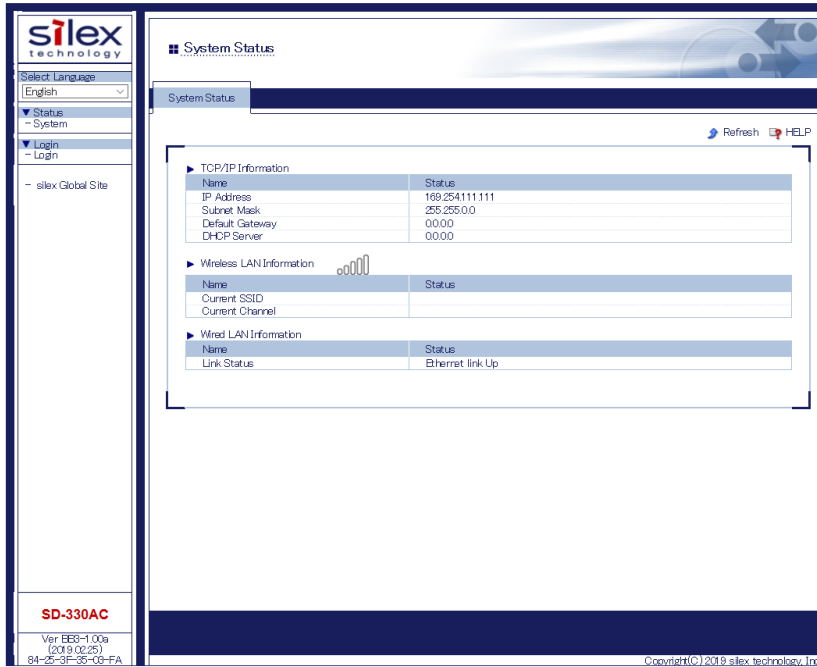



## &lt;&lt;Use a Web browser to display the Web page&gt;&gt;

1. Enter the IP address that is configured on SD-330AC in the address bar of the Web browser. Press the ENTER key.

**Example)** Enter 172.25.72.239 and press the ENTER key.

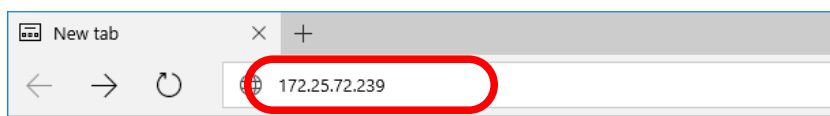

2. The login password configuration page will be displayed. Enter the password to configure for SD-330AC and click **Submit**.

A screenshot of the SD-330AC login password configuration page. The page title is "Welcome to SD-330AC". Below the title, it says "Please set a login password for this unit." There are two input fields: "Password:" and "Confirm Password:". The "Confirm Password:" field has a note "16 letters[max.]". A "Submit" button is located at the bottom right of the form, circled in red. There is also a "Select Language" dropdown menu set to "English".

**TIP**

\* The login password configuration page is displayed only when SD-330AC is configured for the first time.

3. The System Status page will be displayed.

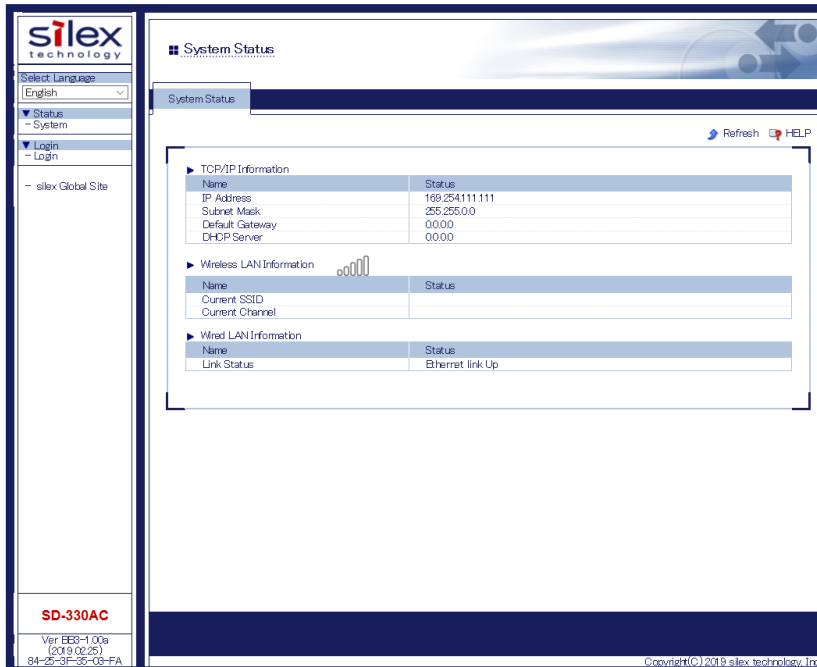

## Log in to the SD-330AC Web Page

Follow the instructions below to log in to the Web page.

1. In the left pane of the Web page, click **Login**.



2. In the login page, enter the password and click **Login**.

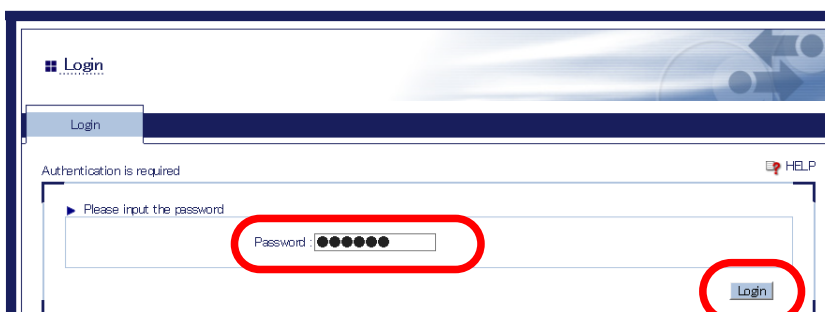

## Log out the SD-330AC Web Page

Follow the instructions below to log out the Web page.

1. In the left pane of the Web page, click **Logout**.

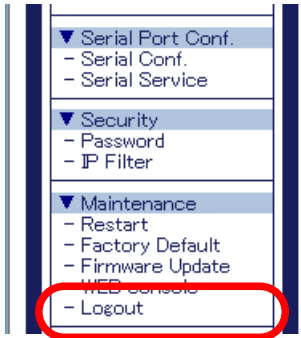

2. Click **Yes** to the confirmation message.

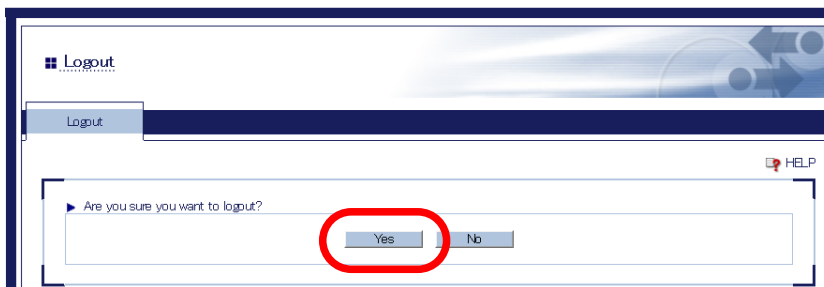

## Configure Advanced Network Settings

### <<General Configuration>>

1. In the left pane of the Web page, click **General**.

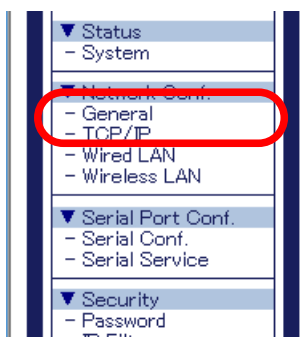

2. Enter or select the setting and click **Submit**.

The image shows the 'General Configuration' web page. The page title is 'General Configuration'. Below the title, there is a 'General Configuration' tab. The main content area contains two sections: 'General Configuration' and 'Serial Server'. The 'General Configuration' section has a table with the following fields:

Name	Value
System Name	SD63503FA
System Description	Silex SD-330AC
System Contact	
System Location	
SNMP Get Community Name	
SNMP Set Community Name	

The 'Serial Server' section has a table with the following field:

Name	Value
SX Virtual Link compatibility	ON

At the bottom right of the page, there is a 'Submit' button.

3. To take effect of the changes, restart SD-330AC by clicking **Restart** from the left pane of the Web page.



#### Note

- \* If you are to continue configuration on other pages, you do not have to restart SD-330AC. Restart it when all configuration is done.
- \* For details on how to restart SD-330AC, refer to **6-3. Maintenance - Reboot SD-330AC - Remote reboot from the Web page**.

## &lt;&lt;TCP/IP Configuration&gt;&gt;

1. In the left pane of the Web page, click **TCP/IP**.

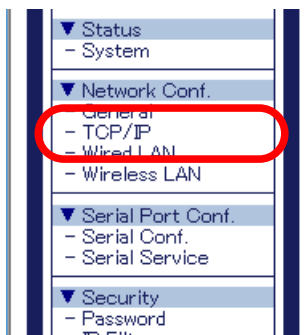

2. Enter or select the setting and click **Submit**.

The screenshot shows the 'TCP/IP Configuration' page. It has a 'TCP/IP Configuration' tab and a 'HELP' button. The main content area is divided into two sections:

TCP/IP Configuration		
Name	Current Value	Value
DHCP		AUTO
IP Address	169.254.111.111	169.254.111.111
Subnet Mask	255.255.0.0	255.255.0.0
Default Gateway	0.0.0.0	0.0.0.0
DNS Server (Primary)	0.0.0.0	0.0.0.0
DNS Server (Secondary)	0.0.0.0	0.0.0.0

IP Protocol Configuration	
Name	Value
Protocols which are checked are enabled.	
<input type="checkbox"/> Telnet(23)	
<input checked="" type="checkbox"/> HTTP(80) NOTE: Disabling HTTP will prevent access to this server via the browser interface.	
<input checked="" type="checkbox"/> HTTPS(443) NOTE: Disabling HTTP will prevent access to this server via the browser interface.	
<input type="checkbox"/> TFTP(69)	
<input checked="" type="checkbox"/> SNMP(161)	
<input checked="" type="checkbox"/> NTP (123)	
<input checked="" type="checkbox"/> TCP Port (9100,3001,9101,3002)	

3. To take effect of the changes, restart SD-330AC by clicking **Restart** from the left pane of the Web page.

**Note**

- \* If you are to continue configuration on other pages, you do not have to restart SD-330AC. Restart it when all configuration is done.
- \* For details on how to restart SD-330AC, refer to **6-3. Maintenance - Reboot SD-330AC - Remote reboot from the Web page**.

## &lt;&lt;Wired LAN Configuration&gt;&gt;

1. In the left pane of the Web page, click **Wired LAN**.

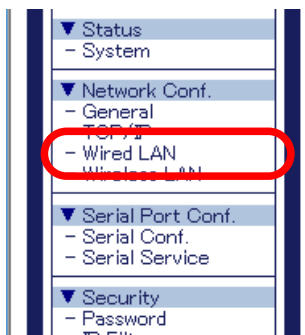

2. Enter or select the setting and click **Submit**.



3. To take effect of the changes, restart SD-330AC by clicking **Restart** from the left pane of the Web page.

**Note**

- \* If you are to continue configuration on other pages, you do not have to restart SD-330AC. Restart it when all configuration is done.
- \* For details on how to restart SD-330AC, refer to **6-3. Maintenance - Reboot SD-330AC - Remote reboot from the Web page**.

## &lt;&lt;Wireless LAN (Wireless LAN Configuration)&gt;&gt;

1. In the left pane of the Web page, click **Wireless LAN**.

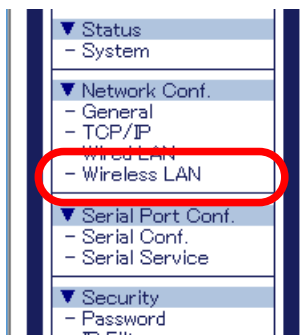

2. Enter or select the setting and click **Submit**.

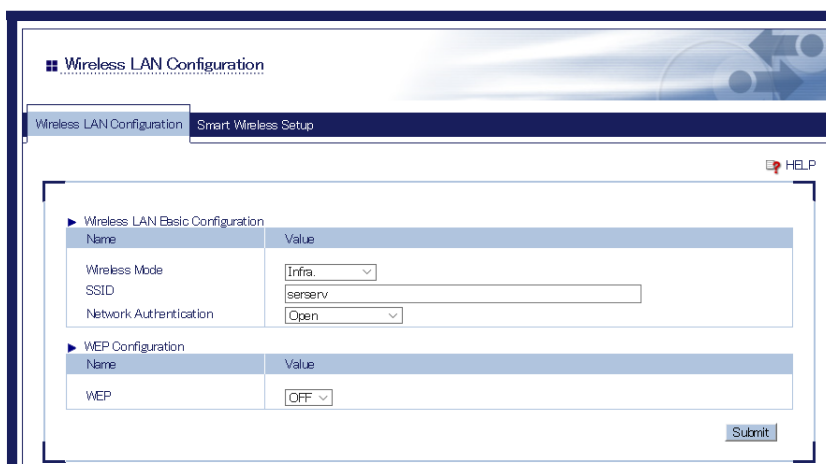

3. To take effect of the changes, restart SD-330AC by clicking **Restart** from the left pane of the Web page.

**Note**

- \* If you are to continue configuration on other pages, you do not have to restart SD-330AC. Restart it when all configuration is done.
- \* For details on how to restart SD-330AC, refer to **6-3. Maintenance - Reboot SD-330AC - Remote reboot from the Web page**.



## &lt;&lt;Wireless LAN (Smart Wireless Setup)&gt;&gt;

1. In the left pane of the Web page, click **Wireless LAN**.

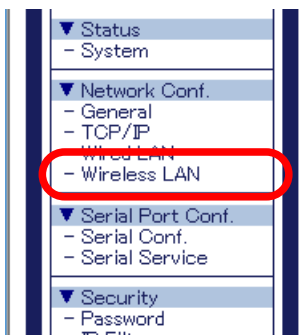

2. Enter or select the setting and click **Submit**.

 A screenshot of the 'Wireless LAN Configuration' web page. The page has a title bar with 'Wireless LAN Configuration' and 'Smart Wireless Setup' tabs. Below the tabs is a 'HELP' icon. The main content area is divided into two sections:
 

- Smart Wireless Setup:** A table with columns 'Name' and 'Value'. The 'PIN Code' row shows the value '34744260' and a 'Generate PIN' button.
- Smart Wireless Setup Execute:** A table with columns 'Name' and 'Execute'. It has two rows: 'Push Button' and 'PIN Code', each with an 'Execute' button.

 A 'Submit' button is located to the right of the 'Smart Wireless Setup' table.

3. To take effect of the changes, restart SD-330AC by clicking **Restart** from the left pane of the Web page.

**Note**

- \* If you are to continue configuration on other pages, you do not have to restart SD-330AC. Restart it when all configuration is done.
- \* For details on how to restart SD-330AC, refer to **6-3. Maintenance - Reboot SD-330AC - Remote reboot from the Web page**.

## Configure Serial Port Settings

### <<Serial Configuration>>

1. In the left pane of the Web page, click **Serial Conf.**

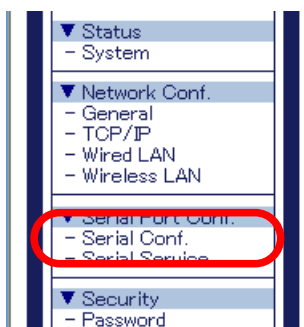

2. Enter or select the setting and click **Submit**.

The screenshot shows the 'Serial Configuration' web page. The 'Serial Configuration S1' tab is active. The page is divided into two main sections: 'General Configuration' and 'E-able Mode Configuration'. Both sections contain a table with 'Name' and 'Value' columns.

Name	Value
Port Name	S1
Port Type	Serial
Baud Rate	115200
Bit per character	8
Stop bits	1
Parity	None
Flow control	None
Console Mode String	

Name	Value
E-able Mode	Disabled
E-able I/O Mode	TCP
Destination IP Address	0.0.0.0
Destination Port	0
Local Port	0
Connection attempt time	30
Connection attempt time unit	sec
E-able Encryption	Disabled

A 'Submit' button is located at the bottom right of the configuration area.

3. To take effect of the changes, restart SD-330AC by clicking **Restart** from the left pane of the Web page.



#### Note

- \* If you are to continue configuration on other pages, you do not have to restart SD-330AC. Restart it when all configuration is done.
- \* For details on how to restart SD-330AC, refer to **6-3. Maintenance - Reboot SD-330AC - Remote reboot from the Web page.**

## &lt;&lt;Serial Service Configuration&gt;&gt;

1. In the left pane of the Web page, click **Serial Service**.

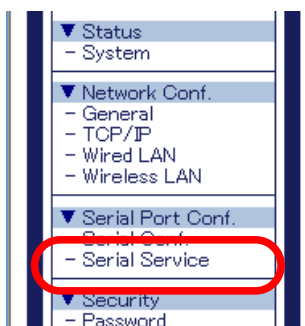

2. Enter or select the setting and click **Submit**.

 A screenshot of the 'Serial Service Configuration' web page. The page title is 'Serial Service Configuration'. Below the title, there are two tabs: 'Serial Service Configuration A' and 'Serial Service Configuration B'. A 'HELP' icon is visible in the top right corner. The main content area shows a table with two columns: 'Name' and 'Value'. The table contains the following entries:
 

Name	Value
Port	ST
Service Name	SDS29824.S1.A
TCP Port	9100
Bi-Directional Support	ON
Queued (TCP)	ON

 A 'Submit' button is located at the bottom right of the configuration area.

3. To take effect of the changes, restart SD-330AC by clicking **Restart** from the left pane of the Web page.

**Note**

- \* If you are to continue configuration on other pages, you do not have to restart SD-330AC. Restart it when all configuration is done.
- \* For details on how to restart SD-330AC, refer to **6-3. Maintenance - Reboot SD-330AC - Remote reboot from the Web page**.

## Configuration Item List

The SD-330AC has the following configuration items:

### <<Network Configuration (General)>>

<b>General Configuration</b>	
Name	System Name
Details	Enter a unique name for the server. This name can be up to 32 ASCII printable characters.
Default	SDSxxxxxx (xxxxxx is a last 6 digits of Ethernet Address)
Name	System Description
Details	Enter a description for the server that may provide helpful information about the server. This description can be up to 64 ASCII printable characters.
Default	Silex xxxxxxxx (xxxxxx is product name)
Name	System Contact
Details	Enter the name of the person to contact for information about the server. This name can be up to 63 ASCII printable characters.
Default	NONE
Name	System Location
Details	Enter the location of the server. This location can be up to 63 ASCII printable characters.
Default	NONE
Name	SNMP Get Community Name
Details	Enter the name of the community to be used for fetching SNMP information from the server.
Default	public
Name	SNMP Set Community Name
Details	Enter the name of the community to be used for setting SNMP items in the server.
Default	public



- \* Notes on SNMP Get Community Name and SNMP Set Community Name
- When these items are displayed in the Web page, the current values will not be displayed in the entry fields.
  - When the configuration is updated without entering any settings, the configuration will not change.

<b>Serial Server</b>	
Name	SX Virtual Link compatibility
Details	Enable or disable the SX Virtual Link compatibility.
Default	ON

## &lt;&lt;Network Configuration (TCP/IP)&gt;&gt;

TCP/IP Configuration	
Name	DHCP
Details	<p>Set IP address configuration method by selecting from AUTO, DHCP and STATIC.</p> <p><b>AUTO</b> : Tries to acquire IP address from DHCP server. A static IP address is used when it fails.</p> <p><b>DHCP</b> : Tries to acquire IP address from DHCP server. Unlike AUTO mode, DHCP request is continuously sent until it is replied.</p> <p><b>STATIC</b> : Uses a static IP address.</p>
Default	AUTO
Name	IP Address
Details	<p>Set the IP address.</p> <p>The value must be 4 numbers separated by dots and expressed in the format [xxx.xxx.xxx.xxx].</p>
Default	169.254.111.111
Name	Subnet Mask
Details	<p>Set the subnet mask.</p> <p>The value must be 4 numbers separated by dots and expressed in the format [xxx.xxx.xxx.xxx].</p> <p>When set to "0.0.0.0", a subnet mask appropriate for the IP address is automatically used.</p>
Default	255.255.0.0
Name	Default Gateway
Details	<p>Set the gateway address.</p> <p>The value must be 4 numbers separated by dots and expressed in the format [xxx.xxx.xxx.xxx]. Also, the gateway needs to be running in the same subnetwork as SD-330AC. If "0.0.0.0" is set, this setting is disabled.</p>
Default	0.0.0.0
Name	DNS Server (Primary)
Details	<p>Set a primary DNS server address.</p> <p>When DHCP is enabled, the DNS address obtained from these servers will be given higher priority.</p>
Default	0.0.0.0
Name	DNS Server (Secondary)
Details	<p>Set a secondary DNS server address.</p> <p>When DHCP is enabled, the DNS address obtained from these servers will be given higher priority.</p>
Default	0.0.0.0

<b>IP Protocol Configuration</b>	
Name	
Details	Each selection controls a TCP/IP based protocol. Set "ON" for a protocol to allow a remote host to access the server using that protocol. Set "OFF" to disallow use of the protocol.
Default	Telnet(23)/TFTP(69) are OFF, and the other protocols are ON.

<b>DHCP Server Configuration</b>	
Name	DHCP Server
Details	Enables/Disables the DHCP Server function (ON/OFF).
Default	OFF
Name	Start IP Address
Details	Set the start IP Address for lease.
Default	0.0.0.0
Name	End IP Address
Details	Set the end IP Address for lease.
Default	0.0.0.0
Name	Subnet Mask
Details	Set the subnet mask for IP address range. If 0.0.0.0 (default value) is set, the subnet mask appropriate for the Start IP Address will automatically be used.
Default	0.0.0.0
Name	Default Gateway
Details	Set the gateway address. This is disabled if 0.0.0.0 (default value) is set.
Default	0.0.0.0
Name	Lease Time
Details	Set the lease time (Days/Hours/Minutes). When the setting is "0Days 0Hours 0Minutes", assigned lease time is 10days.
Default	10Days 0Hours 0Minutes

<b>Application Encryption CA Certificate (*1)</b>	
Name	Current Setting
Details	Shows the CA certificate information. CA certificate is used for an option of the encrypted communication function. When the CA certificate is installed, it is used for verification of the certificate that is sent from the connected device. To delete the certificate, check the checkbox at <b>Delete</b> and click <b>Submit</b> at bottom right of the page.
Default	Not Installed
Name	Certificate File
Details	Upload a certificate file. When the certificate has already been installed, it is overwritten. The file format must be PEM encoded X.509 format.
Default	NONE

<b>Application Encryption Local Certificate (*1)</b>	
Name	Current Setting
Details	Shows the local certificate information. The local certificate is used for the encrypted communication function (HTTPS, SSH, Ecable mode, etc.). To delete the certificate, check the checkbox at <b>Delete</b> and click <b>Submit</b> at the bottom right of the page. By clicking the <b>Download</b> button, the local certificate can be downloaded as a PEM-encoded X.509 file. If no certificate is installed, a self-signed certificate is installed when this product is powered on.
Default	When a certificate is not set when SD-330AC is turned on, the self-signed certificate below is automatically applied.  X509 certificate version : v1 Public key algorithm : RSA Public key size[bits] : 2048 Signature algorithm : SHA256withRSA Common name(CN) : SDSxxxxxxx( System Name ) Organization name(O) : silex technology, Inc. City name(L) : Seika State name(ST) : Kyoto Country name(C) : JP Date and time of issue : May 1 01:00:00 2017 GMT Expiration date : May 1 01:00:00 2117 GMT
Name	Certificate File
Details	Upload a certificate file. When the certificate has already been installed, it is overwritten. The file format must be PEM encoded X.509 format.
Default	NONE

<b>Application Encryption Local Private Key (*1)</b>	
Name	Current Setting
Details	Shows the secret key information. The secret key is the information paired with the local certificate. When the local certificate is uploaded, the corresponding secret key also needs to be uploaded. To delete the secret key, check the checkbox at <b>Delete</b> and click [Submit] at bottom right of the page.
Default	When a local private key is not set when SD-330AC is turned on, the private key corresponding to the local certificate is automatically set.
Name	Private Key File
Details	Upload a secret key file. When the certificate has already been installed, it is overwritten. The file format must be PEM encoded RSA or PKCS#8 format.
Default	NONE
Name	Password
Details	Enter the password for secret key file. This password must be the one you have set for the secret key file when the secret key file is created.
Default	NONE



(\*1) Certificate and privacy key configuration

**TIP**

When the certificate and privacy key configuration contains a problem and it may affect the function of this product, the certificate and privacy key are deleted when this product is restarted, and the self-signed certificate and the corresponding privacy key of this product are used instead.

## <<Network Configuration (Wired LAN)>>

<b>Wired LAN Basic Configuration</b>	
Name	LAN Interface
Details	Select the physical network type. In most cases, AUTO is used. If the LINK lamp on your HUB does not light up when SD-330AC is turned on, configure this setting to match that of the HUB.
Default	AUTO



## &lt;&lt;Network Configuration (Wireless LAN)&gt;&gt;

<b>Wireless LAN Basic Configuration</b>	
Name	Wireless Mode
Details	<p>Select whether SD-330AC will communicate with the wireless network in Infrastructure mode (<b>Infra.</b>) or in AccessPoint mode (<b>AccessPoint</b>).</p> <p><b>When using an Access Point:</b> Select "Infra.". SD-330AC will communicate with a network device via the Access Point which has the same SSID as SD-330AC.</p> <p><b>When using as an Access Point :</b> Select "AccessPoint". SD-330AC operates as an Access Point.</p> <p>* When using SD-330AC in AccessPoint mode, the network authentication mode is limited to "Open" or "WPA-Personal/WPA2-Personal".</p>
Default	Infra
Name	SSID
Details	<p>Set an SSID. Up to 32 alphanumeric characters can be used. The SSID is an ID that logically distinguishes one wireless LAN network from another. When different SSIDs are used among wireless devices, they cannot communicate with each other even if they are running in the same area and channel.</p>
Default	serserv
Name	Channel
Details	<p>Set a channel. A channel needs to be selected only when running in AccessPoint mode. Wireless devices must share the same channel to communicate with each other on a wireless LAN. When a network device running with the same SSID but in a different channel is found, SD-330AC automatically switches the channel to that of the device.</p>
Default	11

Name	Network Authentication
Details	<p>Select the network authentication mode that will be used to connect to the Access Point.</p> <p>To ensure a secure network, it is recommended to use WPA/WPA2. For IEEE 802.11n, only AES can be used.</p> <p><b>Open (Open System)</b> Allows all access without authentication. For encryption mode, WEP can be used.</p> <p><b>WPA-Personal/WPA2-Personal</b> Uses PSK for network authentication. For encryption mode, AUTO is used for WPA-Personal and AES is used for WPA2-Personal. The encryption key will be generated by communicating with the Access Point using a Pre-Shared key. WEP key setting is not used for this mode.</p> <p><b>802.1X</b> Uses EAP for network authentication. For encryption mode, WEP can be used.</p> <p><b>WPA-Enterprise/WPA2-Enterprise</b> Uses EAP for network authentication. For encryption mode, AUTO/TKIP/AES can be selected. WEP key setting is not used for this mode.</p>
Default	Open

<b>WEP Configuration</b>	
Name	WEP
Details	Enable/Disable WEP encryption (ON / OFF).
Default	OFF
Name	Key Index
Details	Set the number of the WEP to be used as the default key (1-4).
Default	1
Name	WEP Key1-4
Details	<p>Set the WEP key for WEP encryption.</p> <p>Up to 4 WEP keys can be set. This setting must be the same as that of your Access Point or other devices you wish to connect to.</p> <p>A WEP key must be 26-digit hexadecimal characters, which consists of numbers (0-9) and English letters (A-F).</p>
Default	000000000000000000000000

<b>WPA/WPA2 Configuration</b>	
Name	Encryption Mode
Details	Select the encryption mode that you wish to use for WPA/WPA2 authentication. This setting must be the same as that of your Access Point or other devices you wish to connect to. Select one of the following: <b>AUTO</b> : Used for WPA. An appropriate encryption mode is automatically selected for the Access Point. <b>AES</b> : Standard encryption mode used for WPA2.
Default	AUTO for WPA AES for WPA2
Name	Pre-Shared Key
Details	Set a Pre-Shared Key for WPA (8-63 character string or 64 hexadecimal characters).
Default	Device Server

<b>IEEE802.1X Authentication Configuration (only when Infra. mode is on)</b>	
Name	802.1X Authentication Type
Details	Select EAP method when 802.1X or WPA/WPA2-Enterprise is selected. Select one from LEAP, EAP-TLS, EAP-TTLS, PEAP or EAP-FAST.
Default	EAP-TTLS
Name	User Name in 802.1X
Details	Configure the user name used for EAP authentication
Default	anonymous
Name	Password in 802.1X
Details	Configure the password for EAP authentication when LEAP, EAP-TTLS,PEAP or EAP-FAST is selected.
Default	anonymous

<b>CA Certificate (only when Infra. mode is on)</b>	
Name	Current Setting
Details	Shows the current CA certificate. CA certificate is necessary for EAP-TLS and optional for EAP-TTLS, PEAP. To delete the certificate, check the check box at <b>Delete</b> and then click <b>Submit</b> at right bottom of the page.
Default	Not Installed

Name	Certificate File
Details	Uploads the certificate. When the certificate is already installed, it will be replaced. Only X.509 (encoded in PEM format) is supported.
Default	NONE

**Client Certificate (only when Infra. mode is on)**

Name	Current Setting
Details	Shows the current client certificate. Client certificate is necessary for EAP-TLS. To delete the certificate, check the check box at <b>Delete</b> and then click <b>Submit</b> at right bottom of the page. Click the <b>Generate Certificate</b> button to create a self-signed client certificate. Click the <b>Download</b> button to download a client certificate as X.509 file (encoded in PEM format).
Default	Not Installed
Name	Certificate File
Details	Uploads the certificate. When the certificate is already installed, it will be replaced. Only X.509 (encoded in PEM format) is supported.
Default	NONE

**Client Certificate Secret Key File (only when Infra. mode is on)**

Name	Current Setting
Details	Shows the current secret key. Secret key is the information paired with client certificate. When client certificate is uploaded, the corresponding secret key also needs to be uploaded. When a self-signed certificate is generated, the corresponding secret key will be generated automatically. To delete the secret key, check the check box at <b>Delete</b> and then click <b>Submit</b> at right bottom of the page.
Default	Not Installed
Name	Certificate File
Details	Uploads the secret key. When the certificate is already installed, it will be replaced. RSA and PKCS8 (encoded in PEM format) are supported.
Default	NONE
Name	Password
Details	Set the password for secret key. This password is set when secret key file is generated. When a self-signed certificate is generated, the corresponding password will automatically be set.
Default	NONE

<b>Generate Self-Signed Certificate</b>	
Name	Generate Self-Signed Certificate
Details	Generate a self-signed certificate. The self-signed certificate is a certificate without signature of the third party certificate authority. As validity of information is not verified in an objective way, this certificate is not used for where higher reliability is required, but used for testing or temporal operation for a particular purpose. Modify the certificate setting and click <b>Submit</b> to generate the certificate and secret key. The wireless configuration page will be displayed again then.
Default	NONE

<b>Smart Wireless Setup</b>	
Name	PIN Code
Details	Displays the PIN Code to be entered to your wireless router (Access Point) during the Smart Wireless Setup. A new PIN Code can be generated randomly by clicking the button.
Default	-
Name	PIN Code
Details	Displays the PIN Code to be entered to your wireless router (Access Point) during the Smart Wireless Setup. A new PIN Code can be generated randomly by clicking the button.
Default	-

**Note**

\* The items displayed in the Wireless LAN Configuration page will differ depending on what option is selected at Network Authentication.

## &lt;&lt;Serial Port Configuration (Serial Configuration)&gt;&gt;

<b>General Configuration</b>	
Name	Port Name
Details	Port Name
Default	S1
Name	Port Type
Details	Port Type
Default	Serial
Name	Baud Rate
Details	Select the speed at which the port should send and receive data. (300, 600, 1200, 2400, 4800, 9600, 19200, 38400, 57600, 115200, 230400, 460800, 921600)
Default	115200
Name	Bit per character
Details	Select the number of bits per character. (7, 8)
Default	8
Name	Stop bits
Details	Select the number of stop bits after each character. (1, 2)
Default	1
Name	Parity
Details	Select the parity scheme for each character. (NONE, ODD, EVEN)
Default	NONE
Name	Flow control
Details	Select the flow control method. (NONE, XON/XOFF, RTS/CTS)
Default	NONE
Name	Console Mode String
Details	If this string is defined, input from serial port will be scanned. When a string is received that matches this string, the serial port will switch to console mode. To specify non-printable string, specify the hexadecimal value starting from '\ x'.
Default	NONE

<b>Ecable Mode Configuration</b>	
Name	Ecable Mode
Details	When Ecable mode is enabled, SD-330AC will try to make a network connection to the remote device defined by following parameters. When the connection is established, data received on serial port will be sent to the remote device and data received on the remote device will be sent to serial port.
Default	Disabled
<hr/>	
Name	Ecable I/O Mode
Details	Select a network protocol for remote host I/O to use when Ecable mode is enabled.
Default	TCP
<hr/>	
Name	Destination IP Address
Details	Enter the IP address of the device to make a connection with when Ecable mode is enabled. It is possible to specify this using a host name when TCP mode is on.
Default	0.0.0.0
<hr/>	
Name	Destination Port
Details	Enter the TCP port number of the device to make a connection with when Ecable mode is enabled.
Default	0
<hr/>	
Name	Local Port
Details	Enter the port of local server that a remote client sends data to when UDP mode is on and Ecable mode is enabled.
Default	0
<hr/>	
Name	Connection attempt time
Details	Specify the Ecable connection attempt interval.
Default	30
<hr/>	
Name	Connection attempt time unit
Details	Specify the unit of Ecable connection attempt interval.
Default	sec
<hr/>	
Name	Ecable Encryption
Details	Enable/Disable TLS when TCP mode is on.
Default	Disabled

## &lt;&lt;Serial Port Configuration (Serial Service)&gt;&gt;

<b>Port Service Configuration</b>	
Name	Port
Details	Specifies the physical port associated with the service.
Default	S1
Name	Service Name
Details	Specify the service name. Usually, this field does not need to be changed.
Default	SDSxxxxxx_S1_A for port service setting A SDSxxxxxx_S1_B for port service setting B (xxxxxx is a last 6 digits of Ethernet Address)
Name	Raw TCP Port
Details	Specify the TCP port to use when this service is connected.
Default	9100 for port service setting A 3001 for port service setting B
Name	Bi-Directional Support
Details	When ON is selected, the service sends data back from the connected device to network. Usually, this setting does not need to be changed.
Default	ON
Name	Queued (TCP)
Details	When ON is selected and raw TCP port is specified, SD-330AC adds the job to queue after it is sent to that port. When OFF is selected, the received job is discarded when SD-330AC is handling other jobs.
Default	OFF
Name	Encryption
Details	If this setting is ON, the communication data will be encrypted using TLS.
Default	OFF

## &lt;&lt;Security (Password)&gt;&gt;

Name	New Password
Details	Set an administrative password as an ASCII string (up to 16 characters). This password is used as authentication for changing the settings from the Web page.
Default	NONE



## &lt;&lt;Security (IP Filter)&gt;&gt;

<b>Add New Range.</b>	
Name	Starting Address Ending Address Add
Details	To add the IP address range for a remote host, enter the start address (lower address) and end address (higher address) and click the <b>Add</b> button. All hosts are allowed to access SD-330AC as long as they have the IP address within the registered range.
Default	0.0.0.0

<b>Manage Configured Ranges.</b>	
Name	Remove
Details	To remove the IP address range from the list, select the address range from the list and click the <b>Remove</b> button. When a PC is currently accessing SD-330AC and the IP address of such PC is removed, access to SD-330AC will become unavailable on that PC. Removing all address ranges means allowing access from all hosts.
Default	NONE

## 6-2. Security Settings

### Change the Password

1. Access the Web page of SD-330AC.



\* For details on how to access the Web page, refer to **Access the SD-330AC Web Page**.

#### Note

2. In the left pane of the Web page, click **Password**.

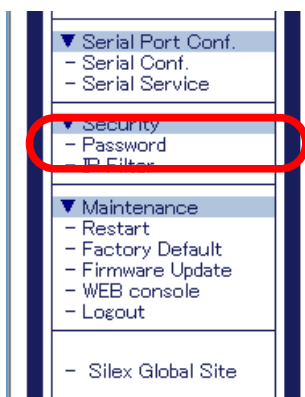

3. The Password Configuration page is displayed.  
Enter the password to **New Password** and click **Submit**.

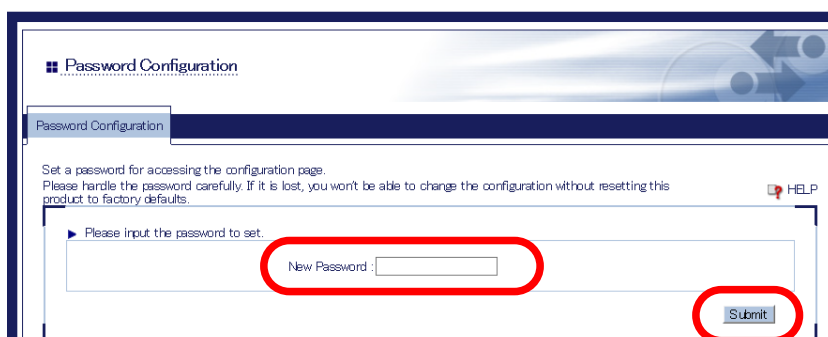

\* Please handle the password carefully. If the password is lost, you will not be able to change the settings again unless SD-330AC is reset to the factory default setting.

- To take effect of the changes, restart SD-330AC by clicking **Restart** from the left pane of the Web page.

**Note**

- \* If you are to continue configuration on other pages, you do not have to restart SD-330AC. Restart it when all configuration is done.
- \* For details on how to restart SD-330AC, refer to **6-3. Maintenance - Reboot SD-330AC - Remote reboot from the Web page**.

## Allow Communication Only from a Particular PC

### <<About IP Filter Feature>>

If this feature is used, SD-330AC allows access only from the registered IP address ranges. Up to 4 IP address ranges can be specified.

### <<IP Filter Settings>>

IP filter settings can be configured from the Web page.

The example below shows how to allow communications only from the IP address range "172.25.72.10" - "172.25.72.20":

- Access the Web page of SD-330AC.

**Note**

- \* For details on how to access the Web page, refer to **Access the SD-330AC Web Page**.

- In the left pane of the Web page, click **IP Filter**.

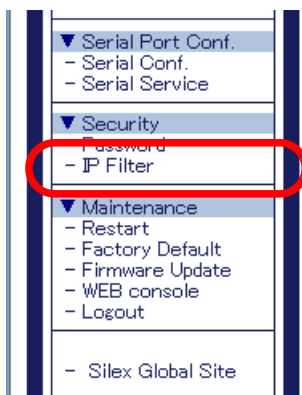

3. Enter the **Starting Address** and **Ending Address** and click Add (up to 4 address ranges can be registered).

In this example, 172.25.72.10 is entered as the start address and 172.25.72.20 is entered as the end address to allow communication from that range.

Add New Range.	
Name	Value
Starting Address	172.25.72.10
Ending Address	172.25.72.20
<input type="button" value="Add"/>	

Manage Configured Ranges.	
Name	Value

**TIP**

- \* If the address range is deleted which includes the IP address of the computer which is currently accessing SD-330AC, the communication for that computer will be lost. It will not recover until the IP filter feature is disabled.

**Note**

- \* By deleting all the registered address ranges from **Manage Configured Ranges**, you can disable the IP filter feature as well as allow accesses from all IP addresses.

4. To take effect of the changes, restart SD-330AC by clicking **Restart** from the left pane of the Web page.

**Note**

- \* If you are to continue configuration on other pages, you do not have to restart SD-330AC. Restart it when all configuration is done.
- \* For details on how to restart SD-330AC, refer to **6-3. Maintenance - Reboot SD-330AC - Remote reboot from the Web page**.

## 6-3. Maintenance

### Reboot SD-330AC



\* Before you start, please make sure that no PCs are currently linked.

**TIP**

#### <<Manual reboot at the unit side>>

1. Unplug the AC plug of SD-330AC from the power outlet.
2. Insert the AC plug back into the power outlet again.
3. The reboot will be complete in 30 seconds.

#### <<Remote reboot from the Web page>>

1. Access the Web page of SD-330AC.



\* For details on how to access the Web page, refer to **Access the SD-330AC Web Page**.

**Note**

2. In the left pane of the Web page, click **Restart**.

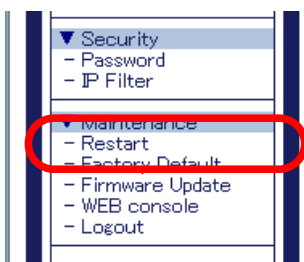

3. The Restart page is displayed.  
Click **Yes**.

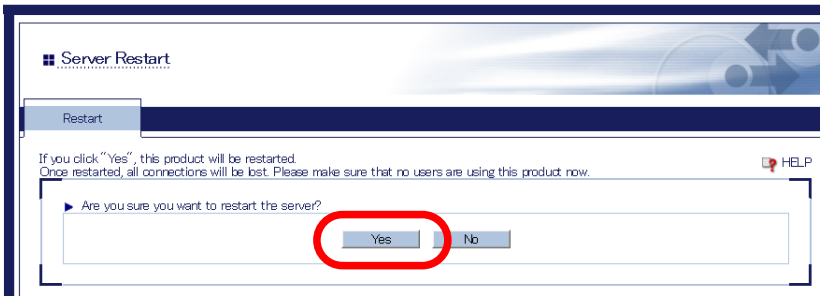

4. The reboot will begin.

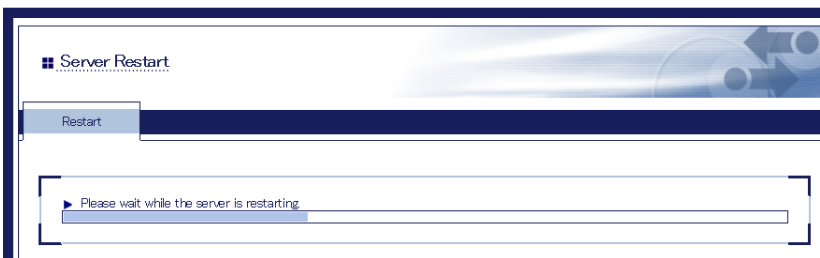

5. When the system status page is displayed, the reboot is completed.  
Finish the Web browser.

## Reset to Factory Default

If SD-330AC has been used in a particular network and you wish to change the settings to use it for another network, please initialize SD-330AC first according to the instructions below:



**TIP**

\* The following settings are not initialized even if SD-330AC is reset to the factory defaults.

Web Page	Item
General - General Configuration	System Description
TCP/IP - CA Certificate	Certificate File
TCP/IP - Application Encryption Local Certificate	Certificate File
TCP/IP - Application Encryption Local Private Key	Private Key File
	Password
Wired LAN - Wired LAN Basic Configuration	LAN Interface
Wireless LAN - CA Certificate	Certificate File
Wireless LAN - Client Certificate	Certificate File
Wireless LAN - Client Certificate Secret Key File	Private Key File
	Password

### <<Reset using the RESET switch on SD-330AC>>



**TIP**

- \* It is recommended to take notes of the current settings. You cannot restore it once the factory default configuration is complete.
- \* Before you start, please make sure that no PCs are currently linked.
- \* Do not turn off SD-330AC while resetting to factory default.
- \* Do not press the push switch on the top when turning on SD-330AC again after it was reset to the factory default settings.
- \* The following settings will remain even after finishing the factory default configuration.
  - Network Conf. - General - System Description
  - Network Conf. - Wired LAN - LAN Interface

1. Press and hold the push switch with a fine tipped object such as a pen or pencil when the SD-330AC is powered on. Keep pressing it for 5 or more seconds.

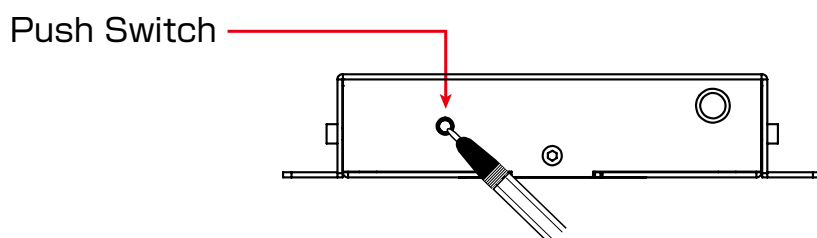

2. The factory default configuration will begin when the push switch is released.
3. When the factory default configuration has completed, the SD-330AC will automatically be restarted **after the orange LED turns off**.

### <<Reset from the Web page>>

1. Access the Web page of SD-330AC.



\* For details on how to access the Web page, refer to **Access the SD-330AC Web Page**.

#### Note

2. In the left pane of the Web page, click **Factory Default**.

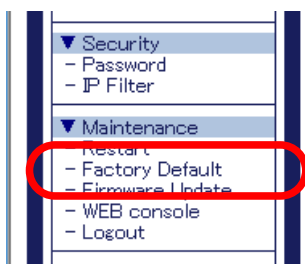

3. The factory default configuration page is displayed.  
Click **Yes**.

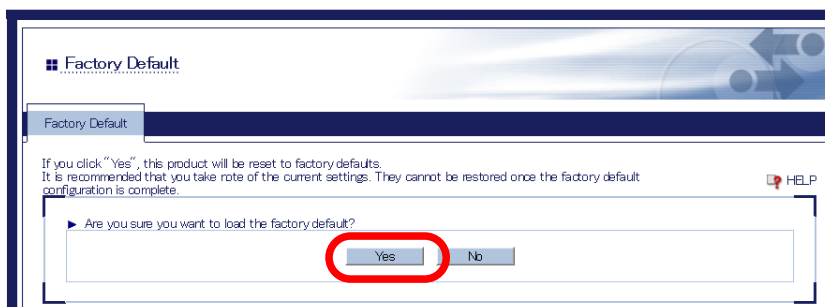



4. A confirmation message is displayed. Click **OK** to start the factory default configuration.

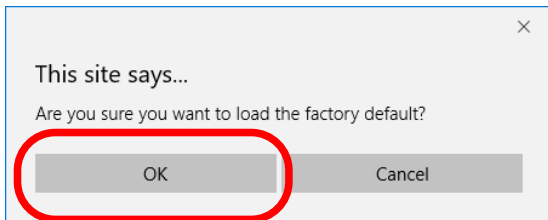

5. The Restart page is displayed.  
Click **Yes**.

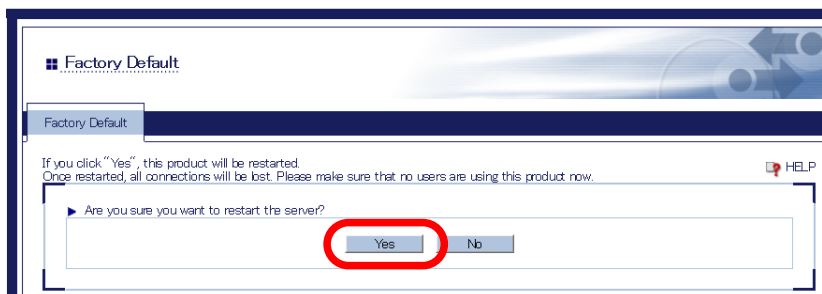

6. The reboot will begin.

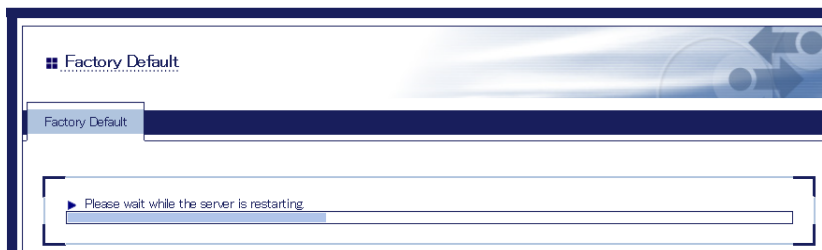

7. When the system status page is displayed, the factory default configuration has completed.  
Close the Web browser.

## Update Firmware

### <<Download the latest firmware file>>

Please download the latest firmware file from our website.  
For how to download the firmware file, refer to Download the Utilities.

### <<Update the firmware>>



- \* Before you start, please make sure that no PCs are currently linked.
- \* Do not turn off SD-330AC while the firmware update is in process.
- \* It is recommended to take notes of the current settings. You cannot restore it once the firmware update is complete.

### 1. Access the Web page of SD-330AC.



#### Note

- \* For details on how to access the Web page, refer to **Access the SD-330AC Web Page**.

### 2. In the left pane of the Web page, click **Firmware Update**.

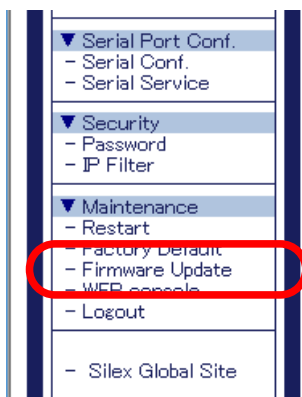

- The Firmware Update page is displayed.  
Click **Browse** to select the firmware file to be loaded to SD-330AC.  
Check that the file name is displayed in the **New firmware** field and click **Update**.

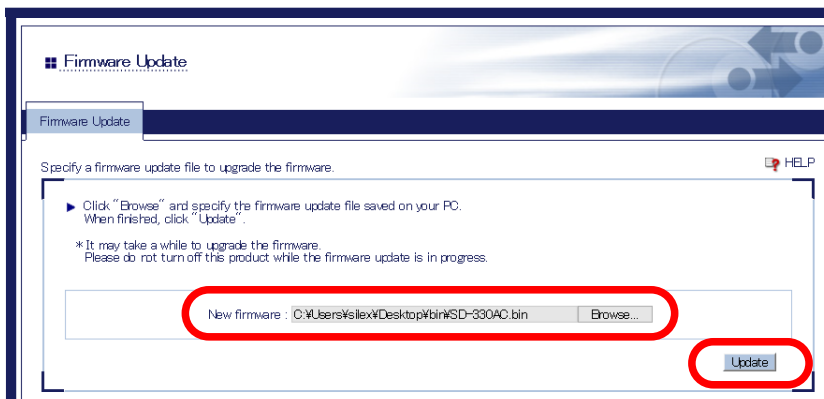

- A confirmation message is displayed. Click **OK**.

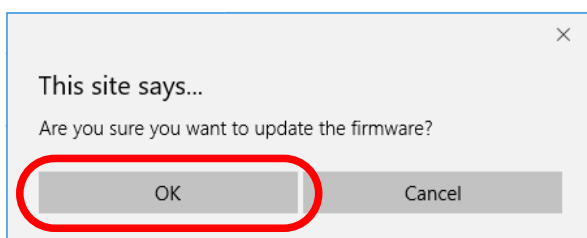

- The firmware update will begin.



6. When the system status page is displayed, the firmware update is completed.  
See the bottom left of the page and check that the version information is changed.



7. Finish the Web browser.

---

## 6-4. About the Print Server Feature

---

### About the Print Server Feature

The print server feature uses network printing protocols to allow you to print over the network.

SD-330AC supports the common network printing protocols, "Raw" and "LPR".  
When a printer is connected to SD-330AC, standard Windows printing can be used.

Please note that you do not have to use SX Virtual Link for Serial Device Server for printing via the print server feature.



**TIP**

- \* When using standard Windows printing, up to 1 printer can be used at a time. To connect 2 or more printers, SX Virtual Link for Serial Device Server must be used.
- \* It is impossible to print to printers connected to other computers via SX Virtual Link for Serial Device Server. Also, when printers are busy with standard Windows printing, they cannot be connected via SX Virtual Link for Serial Device Server.
- \* To use the print server feature, the SX Virtual Link compatibility needs to be set to **OFF**.

## Before Using Standard Windows Printing

Before adding a printer port, access the Web page of SD-330AC and check the destination printer port assigned to the printer connected to SD-330AC.

Serial Service Configuration A	
Name	Value
Port	S1
Service Name	SDS298624,S1_A
TCP Port	9100
Bi-Directional Support	ON
Queued (TCP)	ON

### \* To use the Raw mode printing

Take a note of the TCP port number assigned to the printer and go on to the following sections for detailed configuration.

- \* **Printing Using the Standard TCP/IP Port on Windows 7 / Server 2008R2**
- \* **Printing Using the Standard TCP/IP Port on Windows 8.1 / 10 / Server 2012 / Server 2012R2 / Server 2016**

### \* To use the LPR mode printing

Take a note of the service name assigned to the printer and go on to the following sections for detailed configuration.

- \* **Printing Using the LPR Port on Windows 7 / Server 2008R2**
- \* **Printing Using the LPR Port on Windows 8.1 / 10 / Server 2012 / Server 2012R2 / Server 2016**



#### Note

\* For details on how to access the Web page, refer to **Access the SD-330AC Web Page**.

## Printing Using the Standard TCP/IP Port on Windows 7 / Server 2008R2

This page explains how to configure the settings to print on Windows 7 / Server 2008R2 using the standard TCP/IP port.

1. Click **Start - Control Panel - View devices and printers - Add a printer.**
2. The wizard for adding a printer appears. **Click Add a network, wireless or Bluetooth printer.**

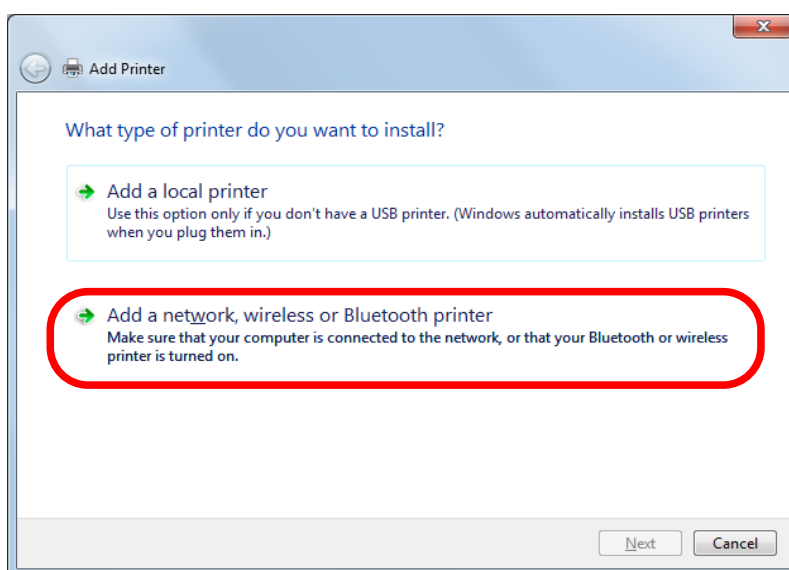

3. Click **The printer that I want isn't listed.**

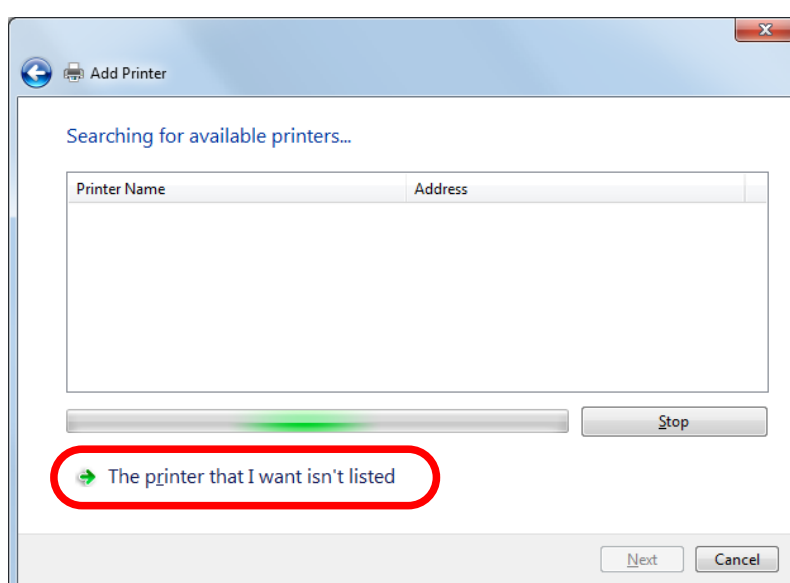

4. Select the method to add a printer.  
Select **Add a printer using a TCP/IP address or hostname** and click **Next**.

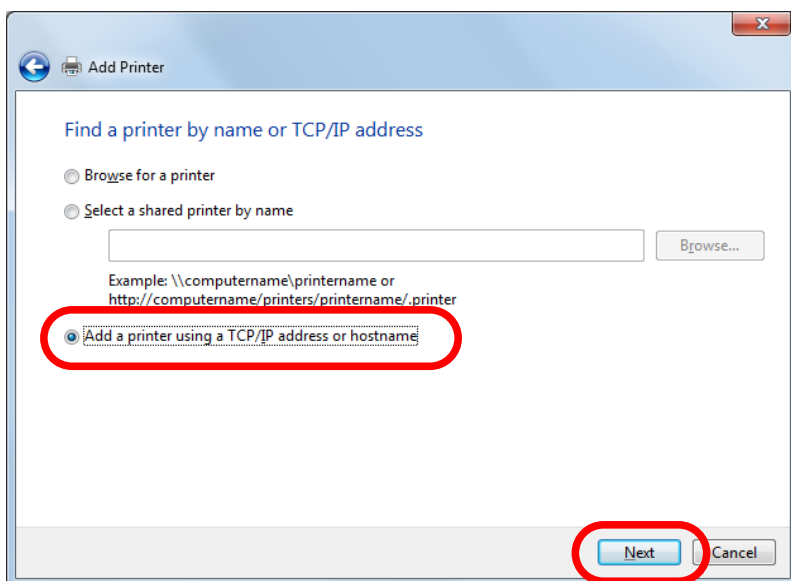

5. Select **TCP/IP Device** for Device type and enter the IP address assigned to SD-330AC for **Hostname or IP address**.  
Clear **Query the printer and automatically select the driver to use** check box and click **Next**.

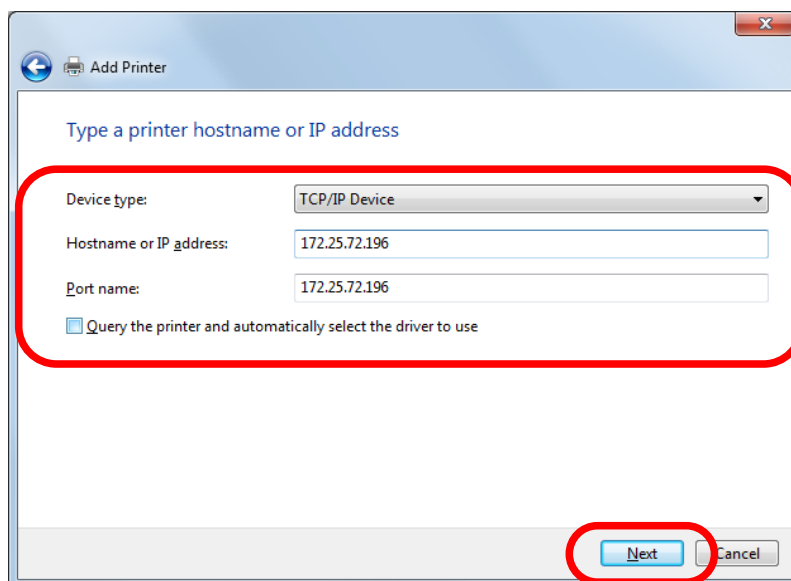
**Note**

\* In most cases, the default port name is used. If you wish to change the port name, enter a unique name that is not used for other ports.

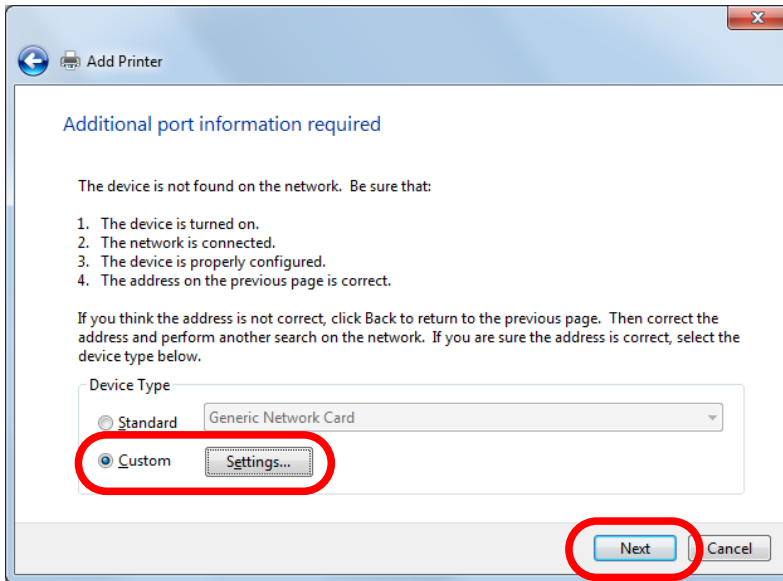

**6. Select Custom and click Settings.****7. Configure the port settings. Select Raw.**

Enter the RAW port number displayed on the Web page for **TCP Port Number**.  
Click **OK**.

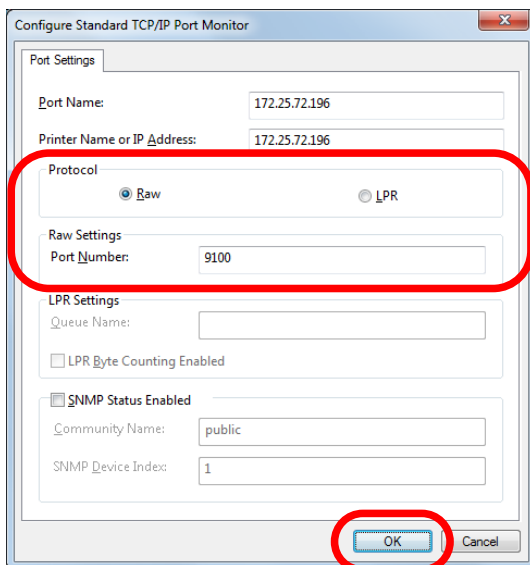

**8.** Click **Next**.

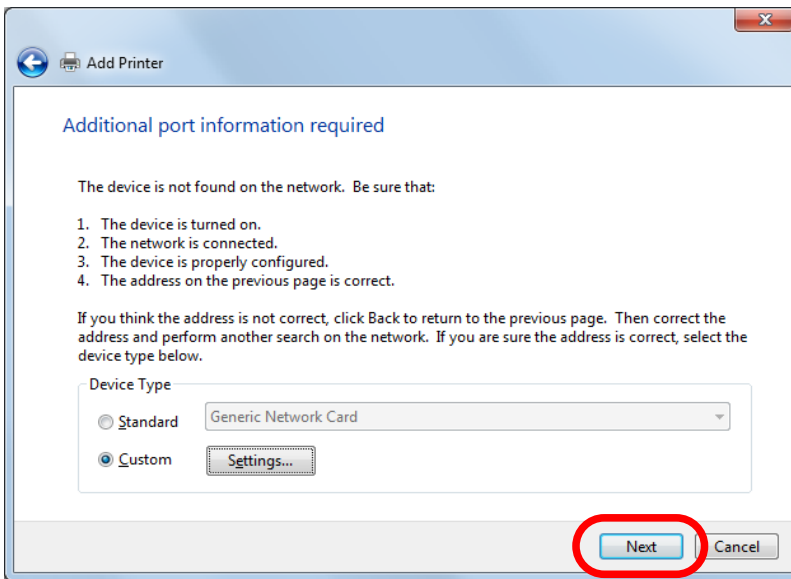

**9.** Select a printer driver.  
Select the printer driver you want to use and click **Next**.

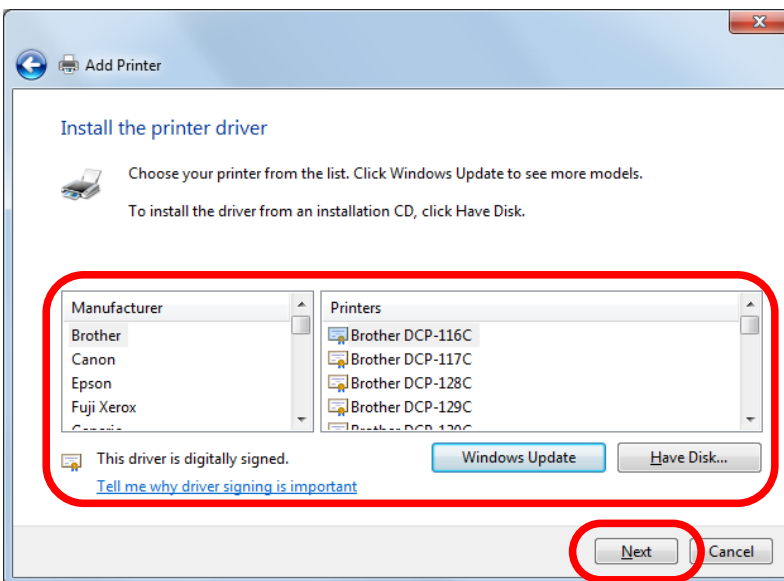

10. Enter a printer name and click **Next**.

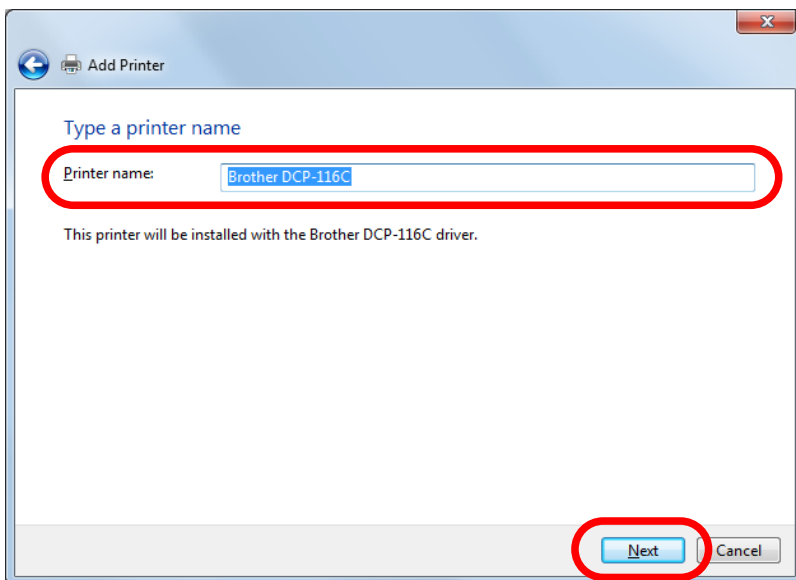

11. Click **Print a test page** and see the result of printing. If the print result is OK, click **Finish**. The print setting has been completed.

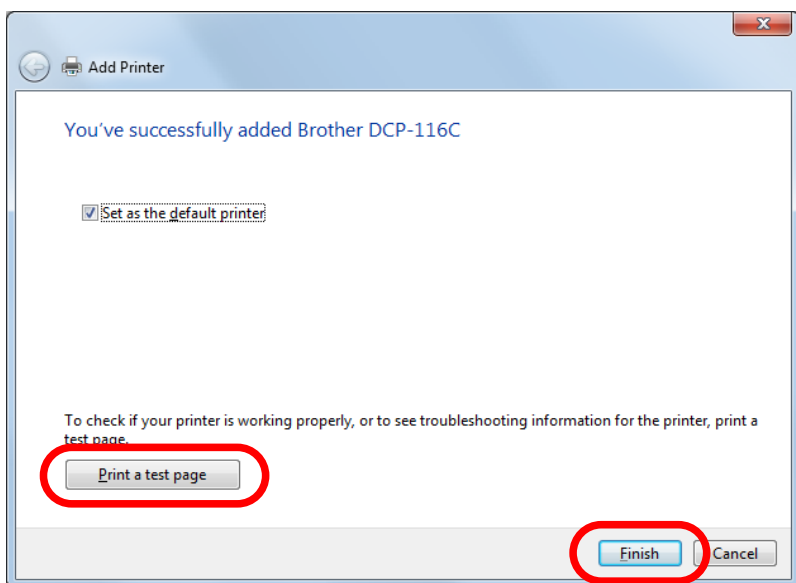

## Printing Using the LPR Port on Windows 7 / Server 2008R2

This page explains how to configure the settings to print on Windows 7 / Server 2008R2 using the standard LPR port.

1. Click **Start - Control Panel - View devices and printers - Add a printer.**
2. The wizard for adding a printer appears. Click **Add a network, wireless or Bluetooth printer.**

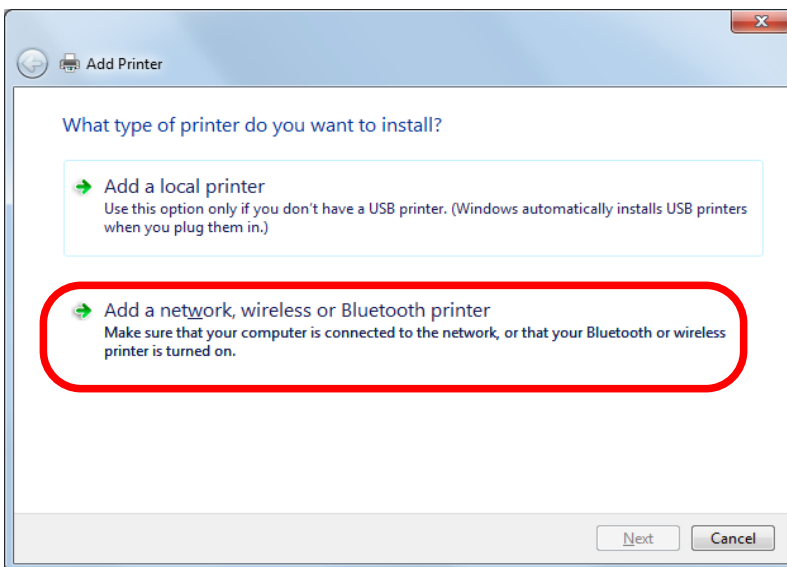

3. Click **The printer that I want isn't listed.**

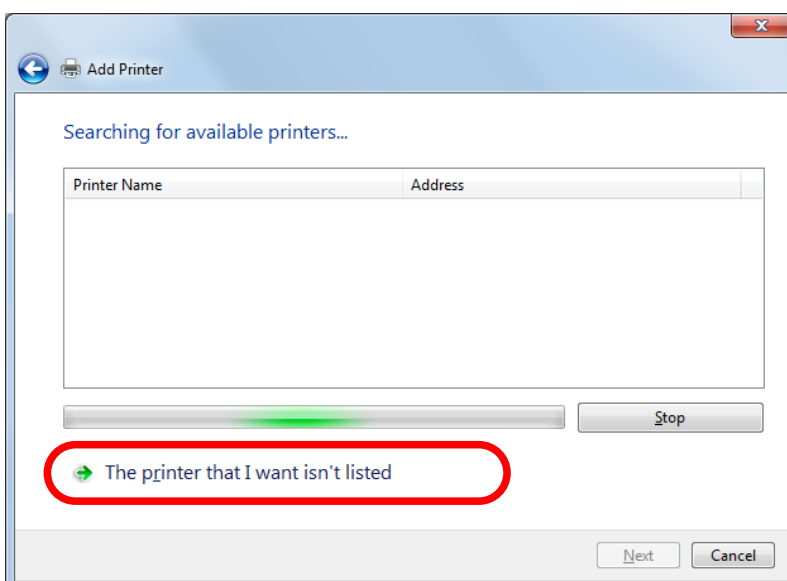

4. Select the method to add a printer.  
Select **Add a printer using a TCP/IP address or hostname** and click **Next**.

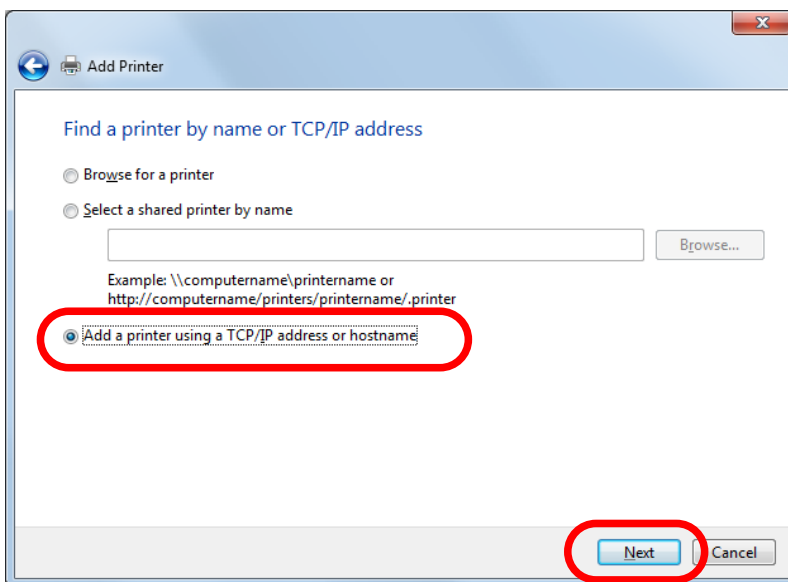

5. Select **TCP/IP Device** for Device type and enter the IP address assigned to SD-330AC for **Hostname or IP address**.  
Clear **Query the printer and automatically select the driver to use** check box and click **Next**.

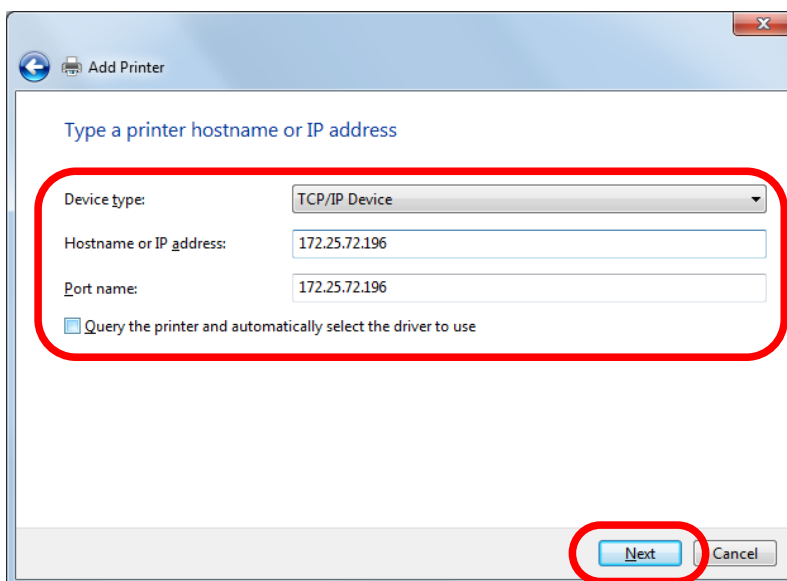
**Note**

\* In most cases, the default port name is used. If you wish to change the port name, enter a unique name that is not used for other ports.

## 6. Select **Custom** and click **Settings**.

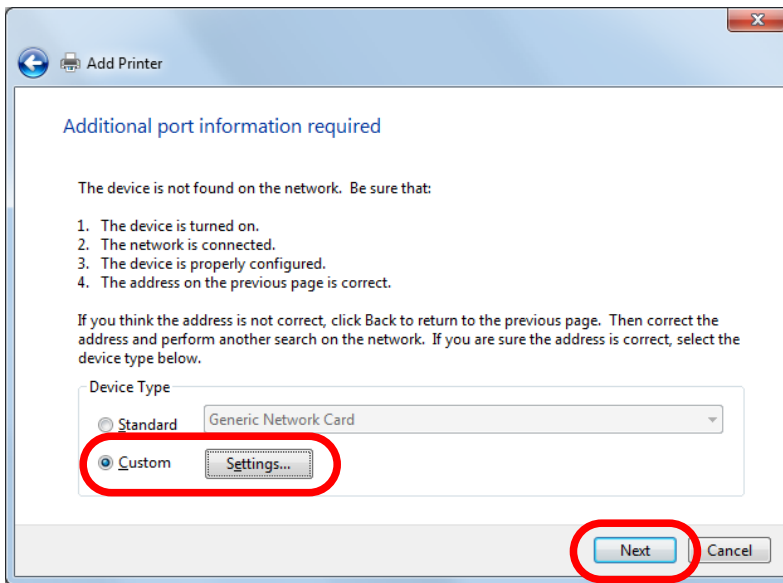

## 7. Configure the port settings. Select **LPR**.

Type the queue name displayed on the Web page for **Service name** and select the **LPR Byte Counting Enabled** check box. Click **OK**.

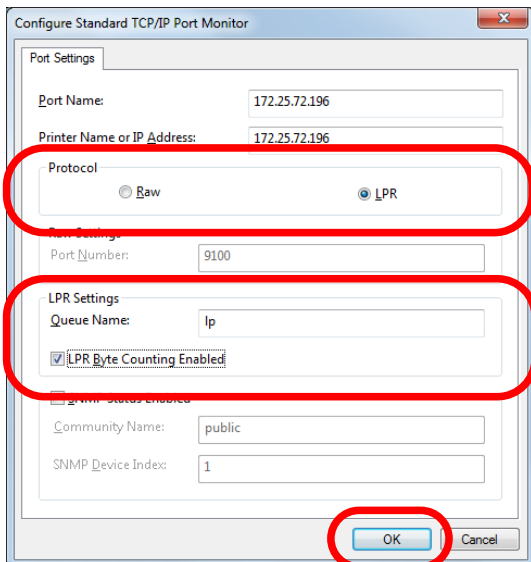

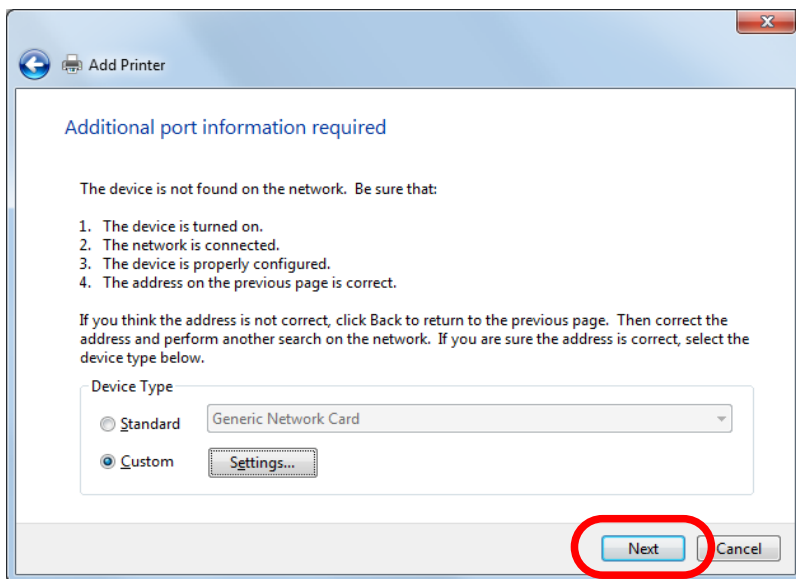
**8. Click Next.****9. Select a printer driver.**

Select the printer driver you want to use and click **Next**.

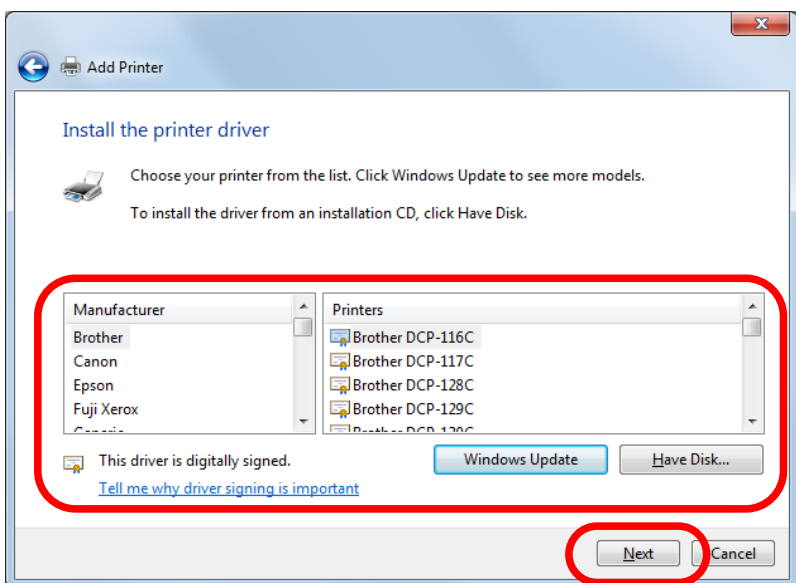

10. Enter a printer name and click **Next**.

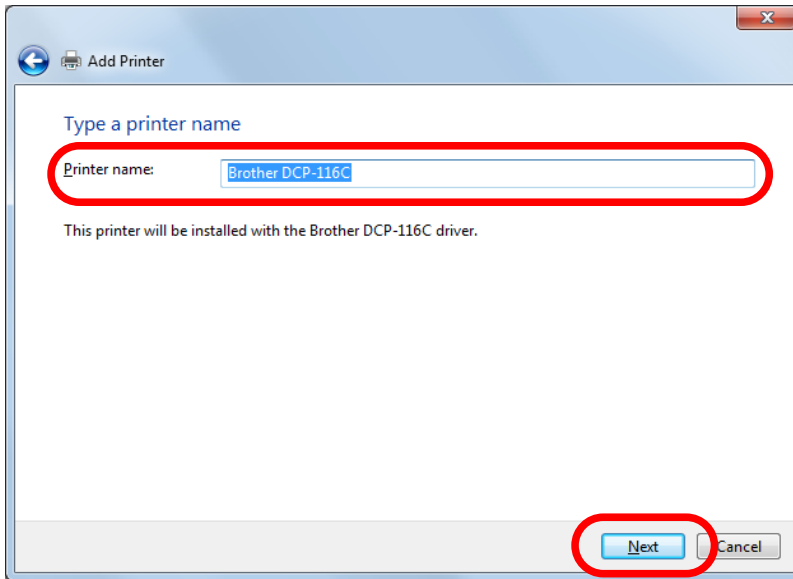

11. Click **Print a test page** and see the result of printing. If the print result is OK, click **Finish**. The print setting has been completed.

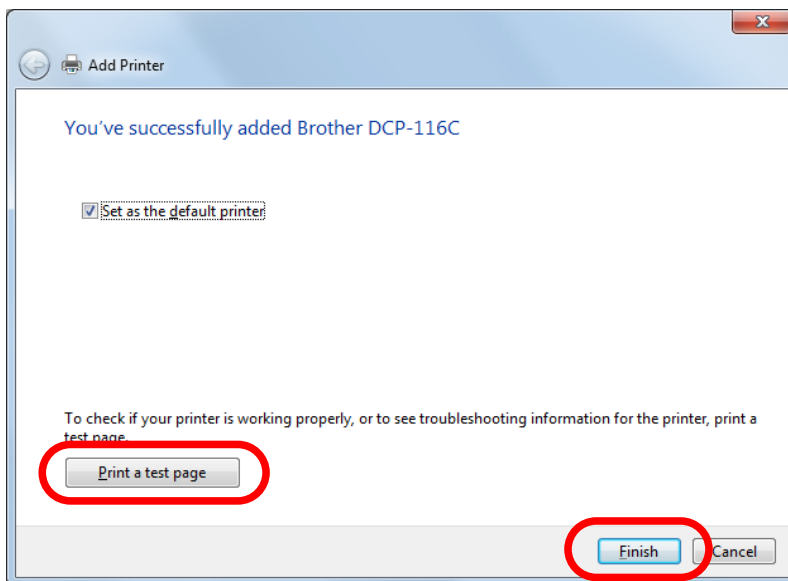



---

## Printing Using the Standard TCP/IP Port on Windows 8.1 / 10 / Server 2012 / Server 2012R2 / Server 2016

This page explains how to configure the settings to print on Windows 8.1 / 10 / Server 2012 / Server 2012R2 / Server 2016 using the standard TCP/IP port.



\* In this page, sample screens captured from Windows 8.1 are used.

1. Click **Start - Control Panel - View devices and printers - Add a printer.**
2. Click **The printer that I want isn't listed.**

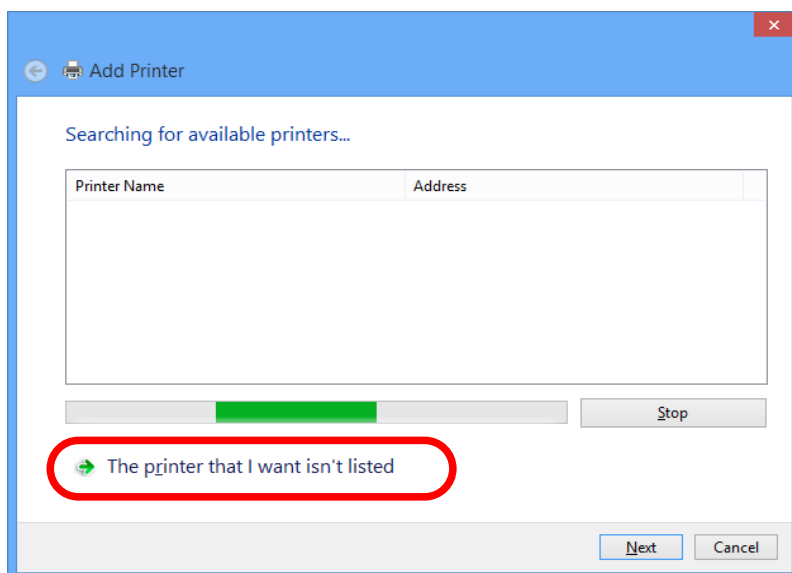

3. Select the method to add a printer.  
Select **Add a printer using a TCP/IP address or hostname** and click **Next**.

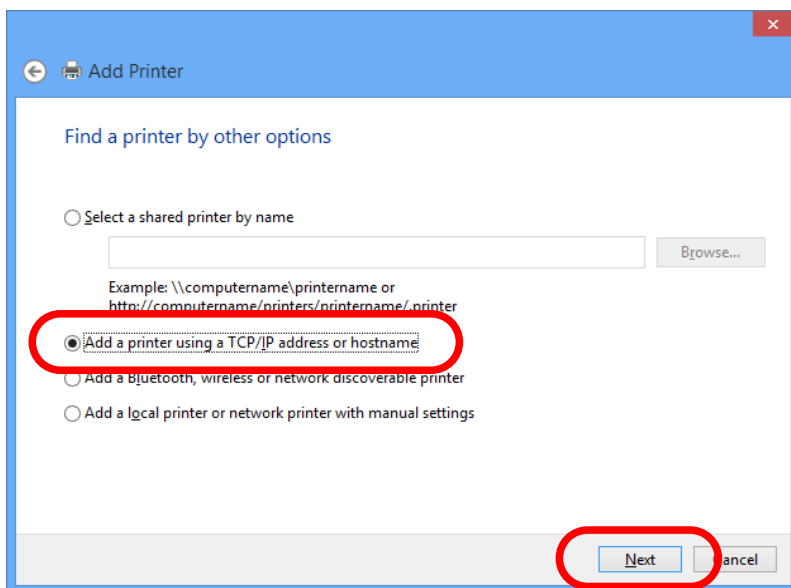

4. Select **TCP/IP Device** for Device type and enter the IP address assigned to SD-330AC for **Hostname or IP address**.  
Clear **Query the printer and automatically select the driver to use** check box and click **Next**.

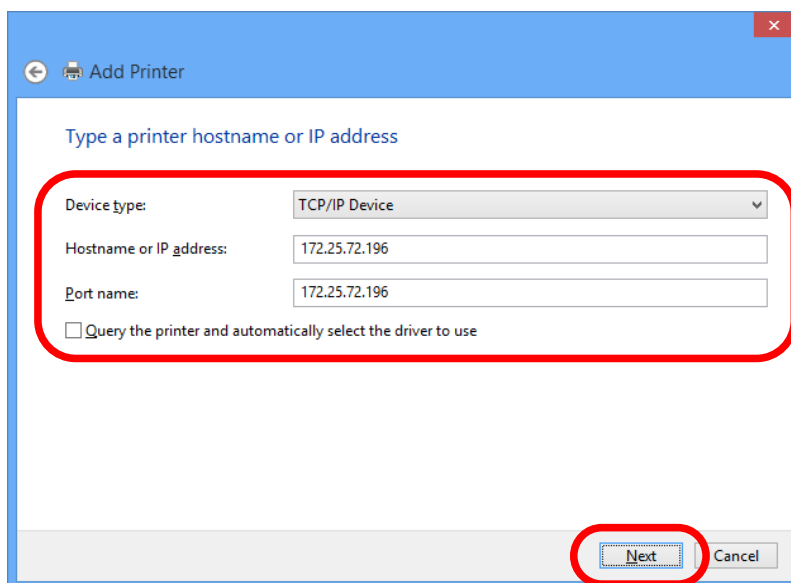
**Note**

\* In most cases, the default port name is used. If you wish to change the port name, enter a unique name that is not used for other ports.

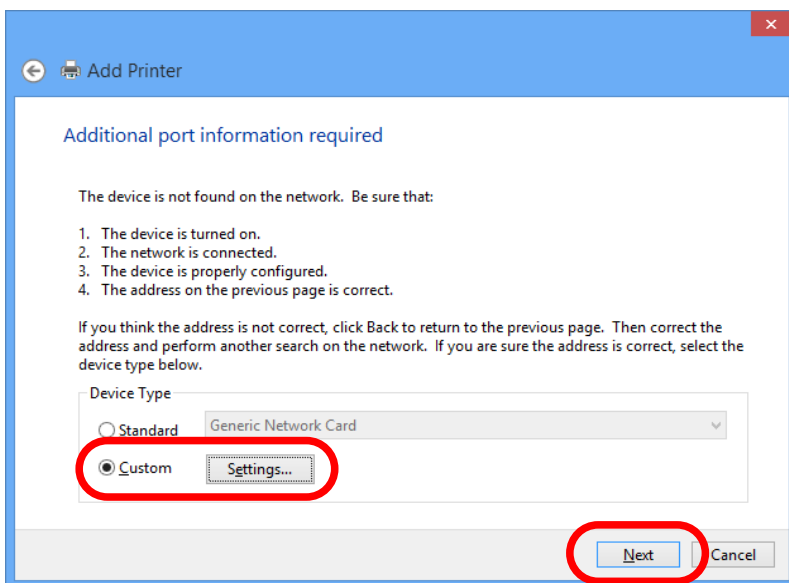
**5. Select Custom and click Settings.****6. Configure the port settings. Select Raw.**

Enter the RAW port number displayed on the Web page for **TCP Port Number**.  
Click **OK**.

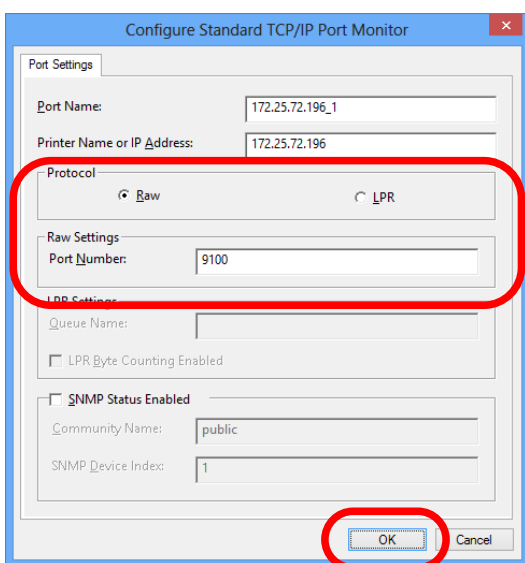

**7. Click Next.**

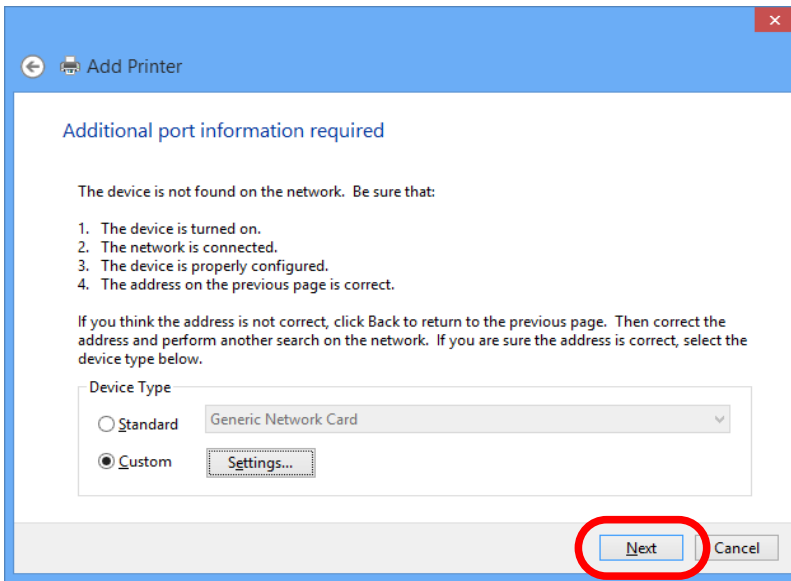

**8. Select a printer driver.**  
Select the printer driver you want to use and click **Next**.

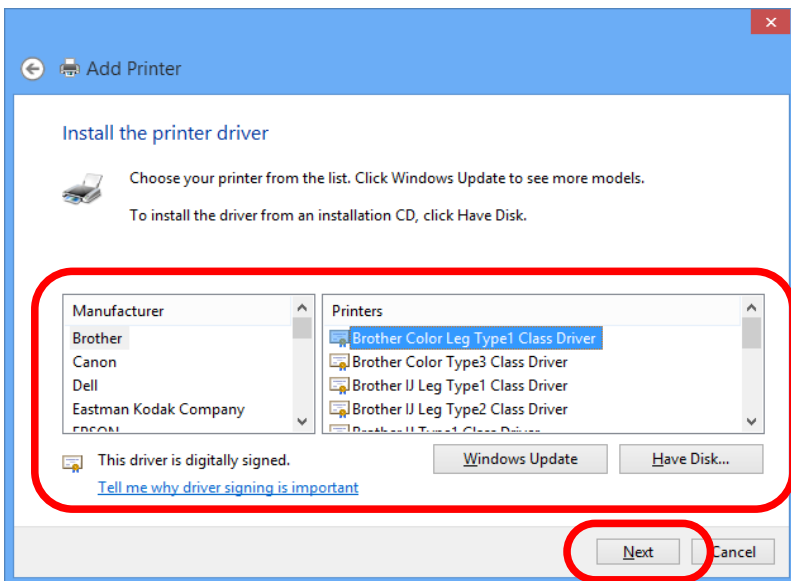

9. Enter a printer name and click **Next**.

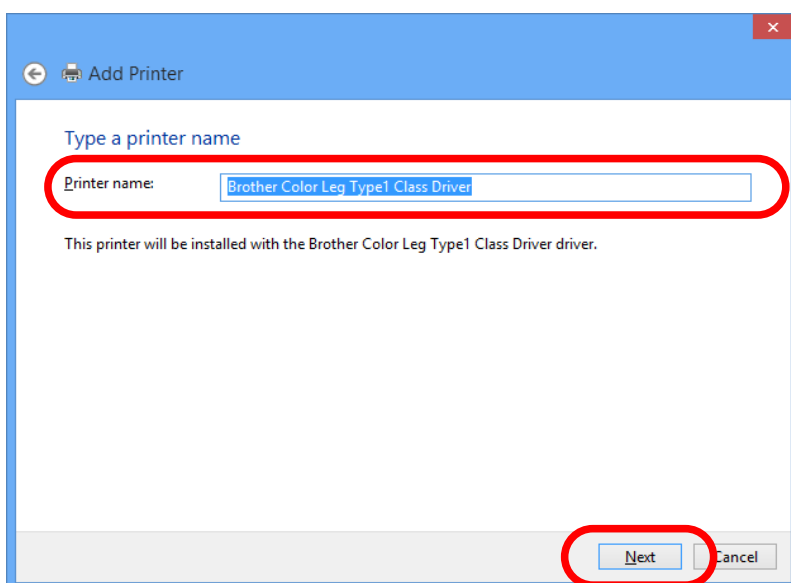

10. Click **Print a test page** and see the result of printing. If the print result is OK, click **Finish**. The print setting has been completed.

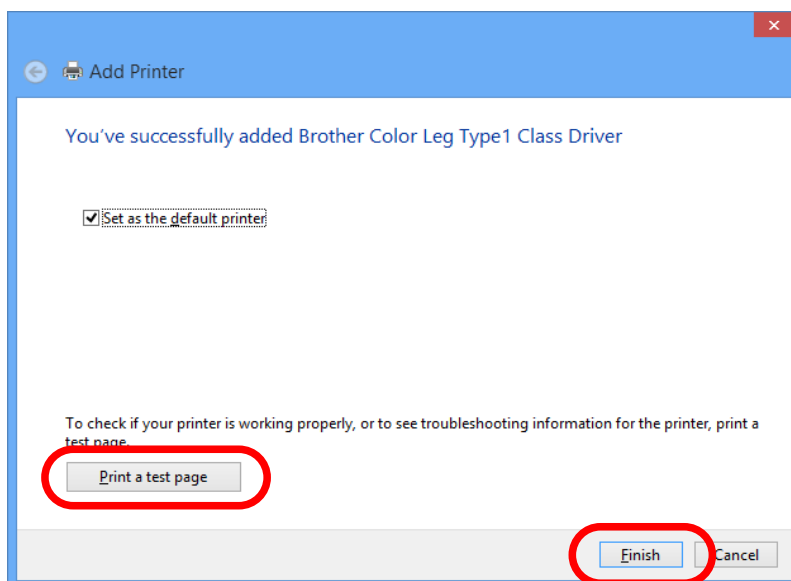

## Printing Using the LPR Port on Windows 8.1 / 10 / Server 2012 / Server 2012R2 / Server 2016

This page explains how to configure the settings to print on Windows 8.1 / 10 / Server 2012 / Server 2012R2 / Server 2016 using the standard LPR port.



\* In this page, sample screens captured from Windows 8.1 are used.

1. Click **Start - Control Panel - View devices and printers - Add a printer.**
2. Click **The printer that I want isn't listed.**

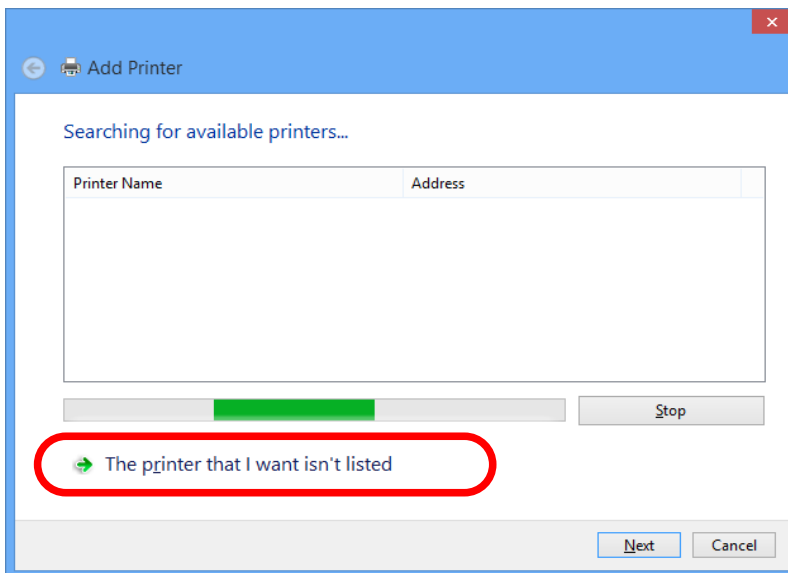

3. Select the method to add a printer.  
Select **Add a printer using a TCP/IP address or hostname** and click **Next**.

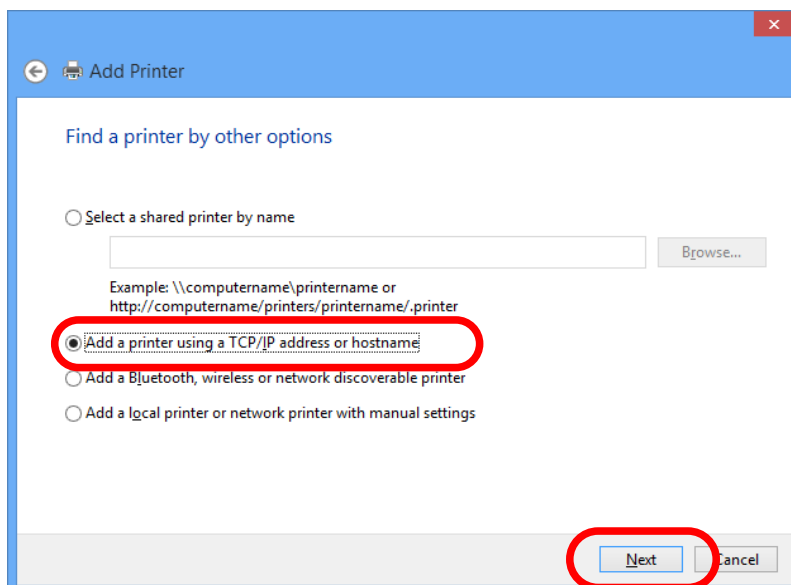

4. Select **TCP/IP Device** for Device type and enter the IP address assigned to SD-330AC for **Hostname or IP address**.  
Clear **Query the printer and automatically select the driver to use** check box and click **Next**.

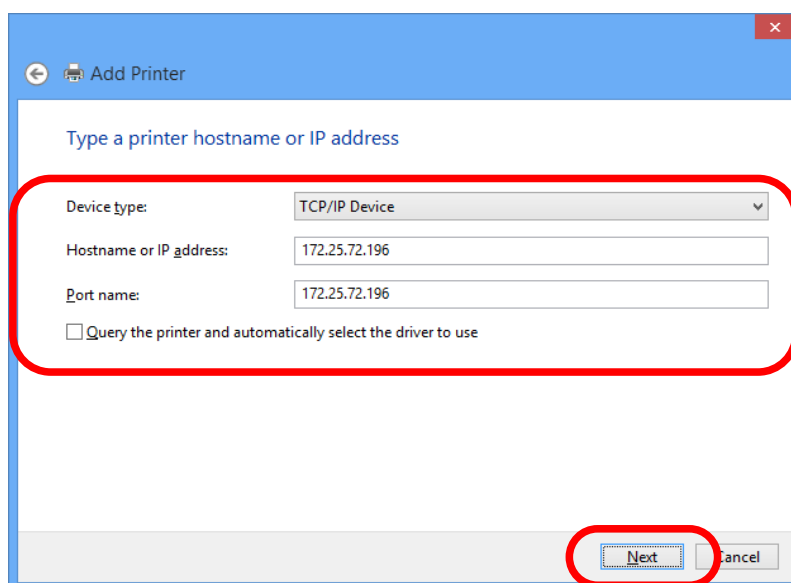
**Note**

\* In most cases, the default port name is used. If you wish to change the port name, enter a unique name that is not used for other ports.

## 5. Select **Custom** and click **Settings**.

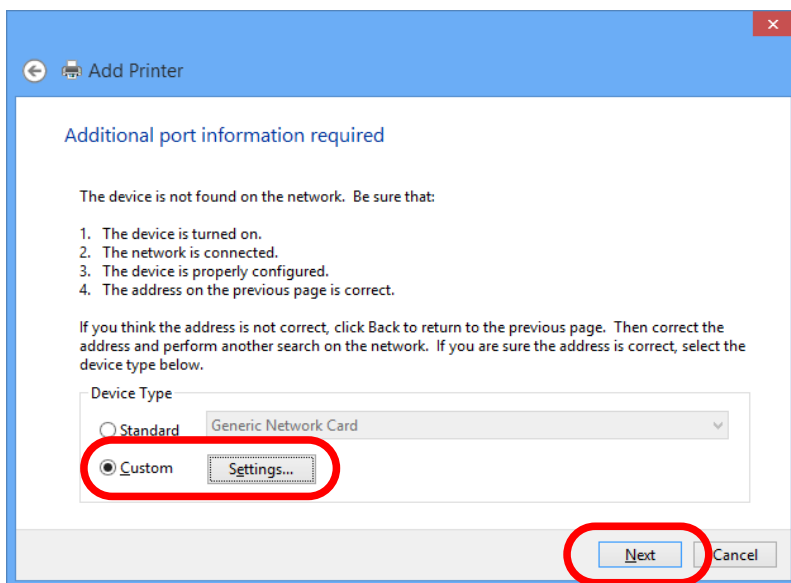

## 6. Configure the port settings. Select **LPR**.

Type the queue name displayed on the Web page for **Service name** and select the **LPR Byte Counting Enabled** check box. Click **OK**.

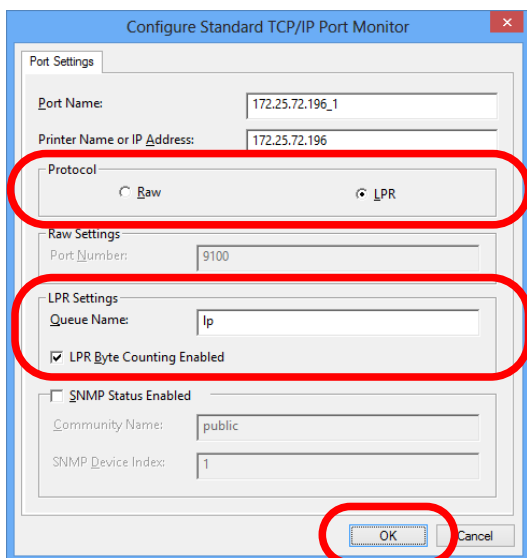



## 7. Click **Next**.

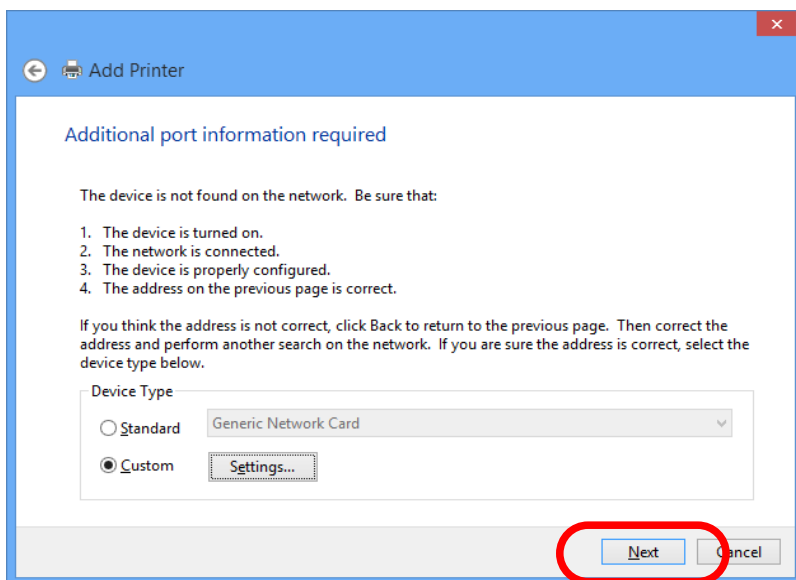

## 8. Select a printer driver.

Select the printer driver you want to use and click **Next**.

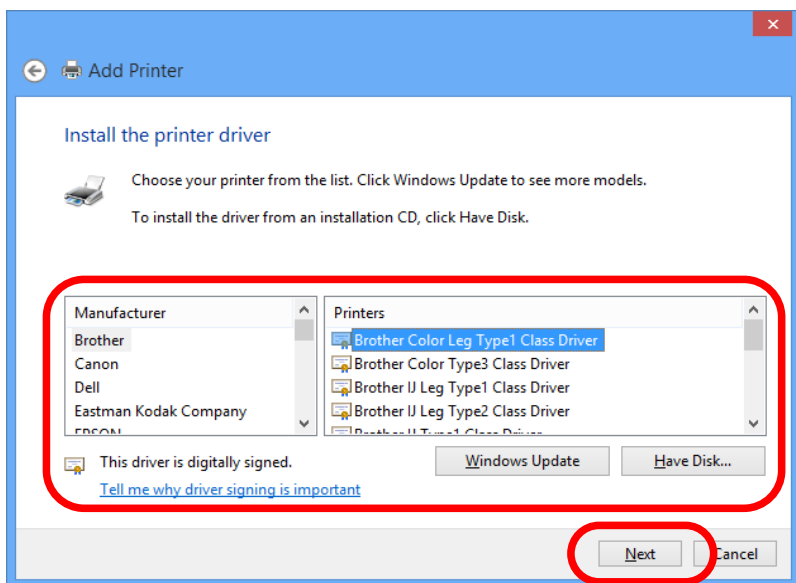

9. Enter a printer name and click **Next**.

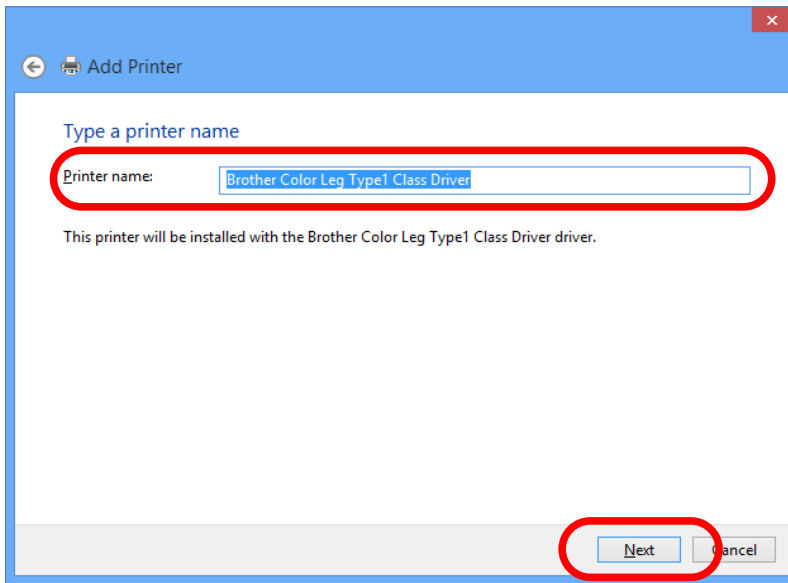

10. Click **Print a test page** and see the result of printing. If the print result is OK, click **Finish**. The print setting has been completed.

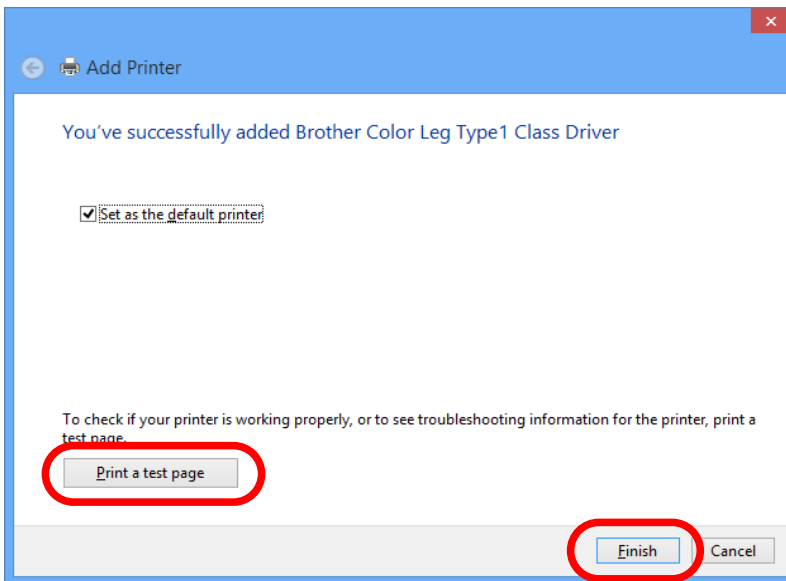

## 6-5. SX Virtual Link for Serial Device Server

### 6-5-1. Main Window and Menu

#### Main window and buttons

SX Virtual Link for Serial Device Server has 2 view modes as follows. To switch the view mode, click the  button on the main window.



\* The current view mode is saved when SX Virtual Link for Serial Device Server exits. The same view mode will be used the next time SX Virtual Link for Serial Device Server starts.

#### Note

#### Device server view (default)

In device server view, the device servers running on the network and USB devices connected to them are displayed in a list.

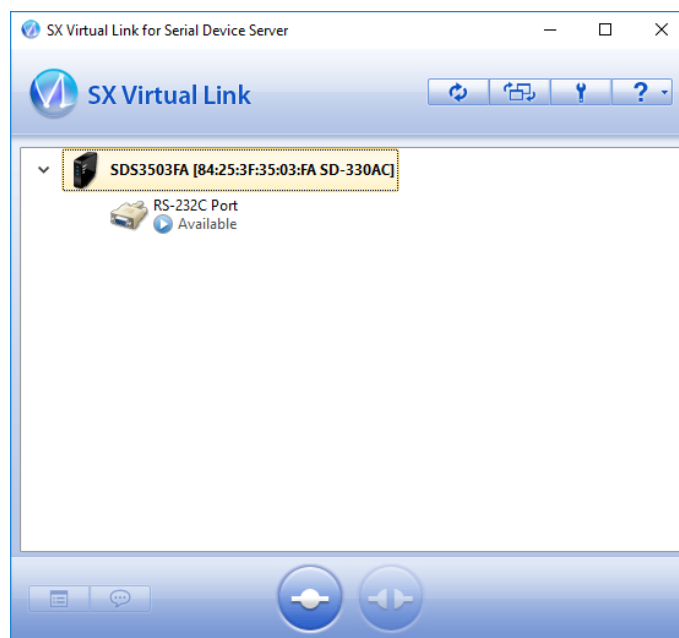



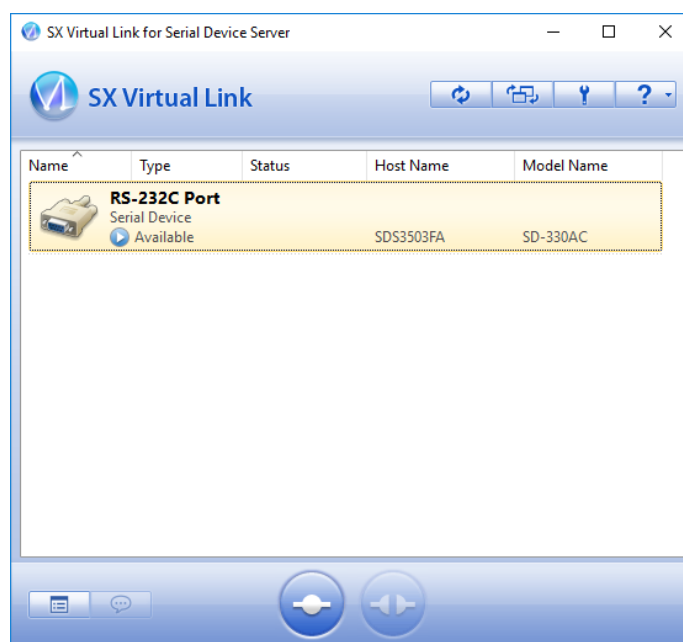

## USB device view

In USB device view, only the USB devices connected to a device server running on the network are displayed in a list.







The following buttons are used to control the USB devices.

Buttons	Name	Details
	Properties button	Shows the properties of the USB device that you have selected in the USB device list. For details on USB device properties, refer to <b>USB Device Operational Settings</b> .
	Request Use button	Requests to the user who is currently using the USB device that you have selected in the USB device list to disconnect from it by sending a remote message. For details on Request Use, refer to <b>How to Request for Disconnect</b> .
	Connect button	Connects your PC to the USB device that you have selected in the USB device list. You can also connect to the USB device by double-clicking the USB device in the list. If the USB device is running as NAS, it can be mapped as a network drive.
	Disconnect button	Disconnects your PC from the USB device that you have selected in the USB device list. You can also disconnect from the USB device by double-clicking the USB device in the list.

In USB device view, the column headings at the top of the list can be changed via optional display settings. For details, refer to SX Virtual Link for Serial Device Server Optional Settings. Also, if you click a column header, the order of USB devices will be sorted by the column you have clicked.

Name ^	Type	Status	Host Name	Model Name
--------	------	--------	-----------	------------

The following buttons are used to display the SX Virtual Link for Serial Device Server optional settings or general information windows.

Buttons	Name	Details
	Refresh button	Refreshes the status of all devices in the USB device list.
	Switch view button	Switches between USB device view and device server view.
	Option button	Displays the SX Virtual Link for Serial Device Server optional settings window. For details on the optional settings window, refer to SX Virtual Link for Serial Device Server Optional Settings.
	Help button	Displays the following windows or websites: SX Virtual Link for Serial Device Server Online Help Customer Support Website Company Website (top page) Version information

## Device server icons

SX Virtual Link for Serial Device Server uses a different icon for each device server (only when in device server view).

## USB device icons





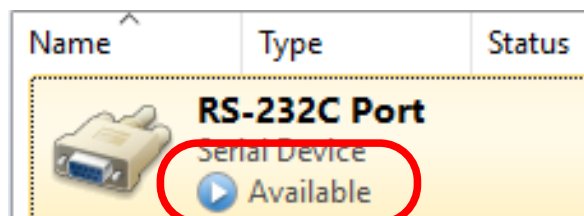

SX Virtual Link for Serial Device Server uses a different icon for each USB device as listed below:

Icons	Details
	Multifunction devices with printing capability
	Single function printers
	Imaging devices (scanners)
	Storage devices (hard disks, USB memory, etc)
	Audio devices
	Interface class devices (mice, keyboards, etc)
	Video devices (isochronous devices, Web cameras, etc)
	Display devices
	Serial Device
	Other devices

## Status icons

SX Virtual Link for Serial Device Server uses the following icons to show the status of USB devices connected to a device server:



icons	Details
	USB device is available.
	USB device is connected to your PC.
	USB device is being used by someone else.
	Updating the USB device status.
	The USB device or USB device server is turned off, or the USB device is not connected to the device server.
	The USB device server is not detected.

## Right-click menu

The right-click menu is explained below:

When a device server in the list is right-clicked, the following menu is displayed:

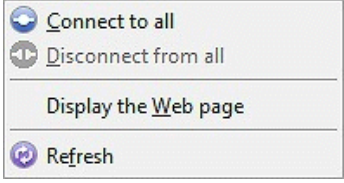
Right-click menu	Item	Details
	Connect to all	Connects to all USB devices plugged into the selected device server.
	Disconnect from all	Disconnects from all USB devices plugged into the selected device server.
	Display the Web page	Opens the Web page of the selected device server.
	Refresh	Refreshes the list of device servers in the main window.

When a USB device in the list is right-clicked, the following menu is displayed:

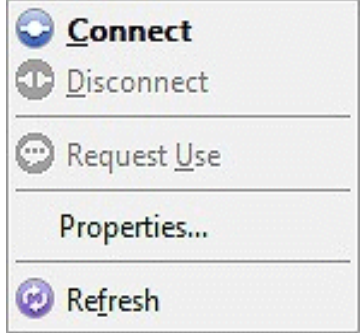
Right-click menu	Item	Details
	Connect	Connects to the selected USB device.
	Disconnect	Disconnects from the selected USB device.
	Request Use	Requests to the user who is currently using the USB device that you have selected in the USB device list to disconnect from it. For details on Request Use, refer to <b>How to Request for Disconnect</b> .
	Properties	Displays the properties window of the selected USB device. For details on USB device properties, refer to <b>USB Device Operational Settings</b> .
	Refresh	Refreshes the list of USB devices in the main window.



## 6-5-2. USB Device Operational Settings

Change the USB device name displayed in SX Virtual Link for Serial Device Server's main window

In SX Virtual Link for Serial Device Server's main window, the default name originally registered to the USB device is shown in the USB device list.

The USB device name can be changed from the General tab in the properties dialog. For details on the properties dialog, refer to 6. About the USB device properties dialog.



\* Even if the device name is changed, the default name originally registered to the device is not changed. Also, this change takes effect only for the PC from which you have changed the device name and not for other PCs.

### Automatically connect to a USB device when it is detected

SX Virtual Link for Serial Device Server can automatically connect to a USB device when it is detected.

If you are the only person that will use a particular USB device, you can utilize the auto-connect function to automatically connect to the USB device without clicking the Connect button on SX Virtual Link for Serial Device Server's main window.

The auto-connect function can be enabled from the Connect tab in the properties dialog. For details on the properties dialog, refer to 6. About the USB device properties dialog.



\* If you wish to connect to all USB devices automatically, check the Automatically connect newly discovered USB devices check box on the SX Virtual Link for Serial Device Server option dialog. For details, refer to SX Virtual Link for Serial Device Server Optional Settings.

## Automatically reconnect to a USB device when it is disconnected abnormally

SX Virtual Link for Serial Device Server can automatically reconnect to a USB device when the connection between the USB device and your PC is lost due to a communication error.

The auto-reconnect option for USB devices that have been abnormally disconnected can be enabled from the Connect tab in the properties dialog.

For details on the properties dialog, refer to 6. About the USB device properties dialog.

The auto-reconnect setting will take effect the next time you connect to the USB device.



- \* The auto-reconnect feature may not work properly depending on the USB device or PC's status during the error. In such a case, reboot the PC, USB device and device server.
- \* This option is only for recovery purposes in case of an error. Please do not unplug the USB device intentionally while it is connected to your PC via SX Virtual Link for Serial Device Server.

## Automatically start a designated application when a USB device is connected

SX Virtual Link for Serial Device Server can automatically start a designated application when a USB device is connected to your PC.

The auto-application startup feature can be enabled by registering the application that you wish to use with a particular USB device (e.g. image reading software for a scanner, music management software for a music player, backup software for storage media, etc) to SX Virtual Link for Serial Device Server. After an application is registered to SX Virtual Link for Serial Device Server, it will automatically start when the USB device is connected to your PC via SX Virtual Link for Serial Device Server. Thus, you will not have to manually start the application.

The auto-application startup feature can be enabled from the Connect tab in the properties dialog.

For details on the properties dialog, refer to 6. About the USB device properties dialog.

The auto-application startup feature will take effect the next time you connect to the USB device.

## About the USB device properties dialog

The above operational settings are available from the properties dialog of each USB device.

How to open and use the properties dialog:

1. Select the USB device in SX Virtual Link for Serial Device Server's main window and click the **Properties** button  .
2. The **General** tab is displayed. In the General tab, you can change the USB device name to be displayed in SX Virtual Link for Serial Device Server's main window.

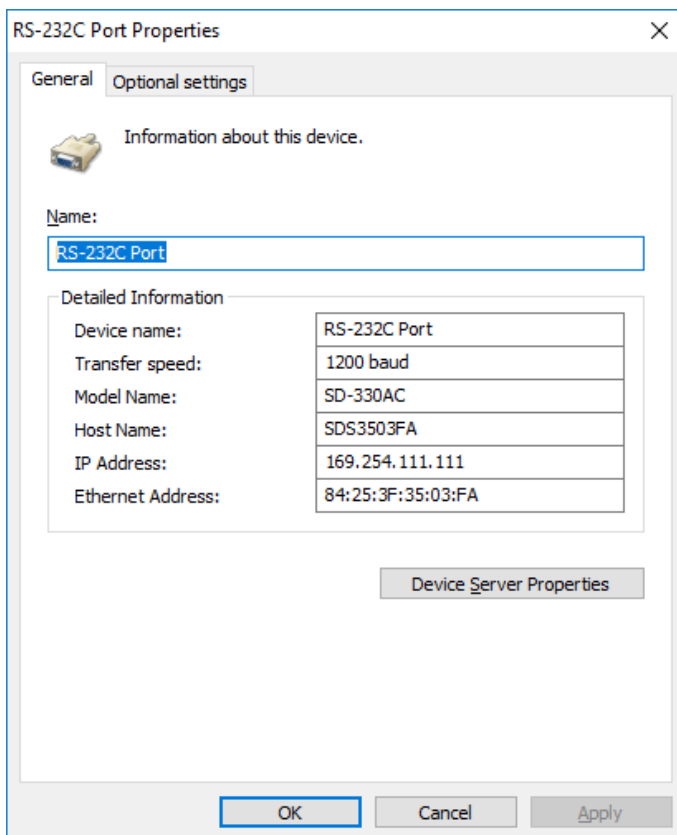

## Configuration Items

Item	Details
Name	Change the USB device name to be displayed in SX Virtual Link for Serial Device Server's main window. For details, refer to 1. Change the USB device name displayed in SX Virtual Link for Serial Device Server's main window.
Device Server Properties	Opens the Web page of the device server. On the Web page, various settings are available. For details, please refer to the users manual.

## Detailed Information

Item	Details
Device name	This is the device name recognized by the device server.
Transfer speed	This is the transfer speed. The transfer speed of serial device is displayed only when the serial device is connected. The transfer speed of USB device is always displayed.
Model Name	Model name of the device server
Host Name	Host name of the device server
IP Address	IP address of the device server
Ethernet Address	Ethernet Address of the device server

3. If you click the **Connect** tab, you can configure the settings shown below.

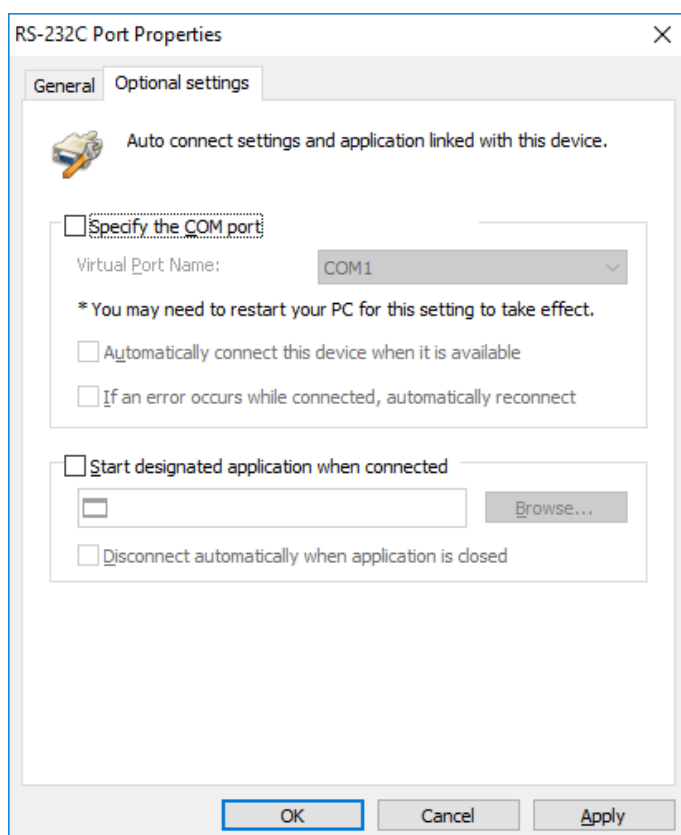

### COM Information

Item	Details
Specify the COM port	<p>When this setting is OFF, the number of unused port is automatically assigned when connected.</p> <p>When this setting is ON, the COM port is automatically created. This COM port is not deleted even after SX Virtual Link for Serial Device Server is closed.</p> <p>* In case of the following, the settings cannot be changed.</p> <ul style="list-style-type: none"> <li>- Serial server is being connected.</li> <li>- The created COM port is used by another application.</li> </ul>
Virtual Port Name	Select the number of COM port to be used when connected. The port number is COM1 to COM255.
Automatically connect this device when it is available	Automatically connects the device when it is detected by SX Virtual Link for Serial Device Server.
If an error occurs while connected, automatically reconnect	Automatically reconnects the device when it is disconnected incorrectly but is detected again.

**Application Setting**

Item	Details
Start designated application when connected	Starts the designated application when the device is connected.
Disconnected automatically when application is closed	Automatically disconnects from the device when the designated application is closed.
Application item	Specify the application. The application can also be specified by drag & drop.
Browse button	Opens a folder to specify the application.

## 6-5-3. How to Use a Printer

SX Virtual Link for Serial Device Server has a feature that detects print jobs and then automatically connects to, prints to and disconnects from the printer (or USB device with printing capability) if it is connected to a device server.

You will not have to click the Connect button  in the SX Virtual Link for Serial Device Server's main window before you print a job.



**TIP**

- \* To use the printer auto-connect function, the printer driver needs to be installed in advance.
- \* The printer auto-connect function may not be available for some USB devices with printing capability. In such cases, please connect/disconnect to/from the USB device manually by clicking the Connect/Disconnect buttons in SX Virtual Link for Serial Device Server.
- \* To use the printer auto-connect function, SX Virtual Link for Serial Device Server must be running. Please be sure to start SX Virtual Link for Serial Device Server before you print a job. For those who print frequently, it is recommended to set SX Virtual Link for Serial Device Server to automatically start at PC startup. For details, refer to **SX Virtual Link for Serial Device Server Optional Settings**.

How to enable the printer auto-connect function:

1. Select a printer in SX Virtual Link for Serial Device Server's main window and click the **Properties** button . When the properties dialog is displayed, click the Connect tab.
2. Check **Enable auto connect**, select **Connect automatically only for printing** and click **OK**.

Item	Details
Automatically connect this device when it is available	Automatically connects the device when it is detected by SX Virtual Link for Serial Device Server.
Connect automatically only for printing	Automatically connects the device when a print job is spooled on the monitored printer object, and disconnects it when the print job is finished.
Configure button	Connects the device and configures the initial settings to enable the auto-printing function.
Confirm button	Shows the printer object monitored by auto-printing function.
If an error occurs while connected, automatically reconnect	Automatically reconnects the device when it is disconnected incorrectly but is detected again.

**Note**

- \* If the USB device driver is not installed on your PC or the USB device has never been connected to your PC via SX Virtual Link for Serial Device Server, the following window is displayed.

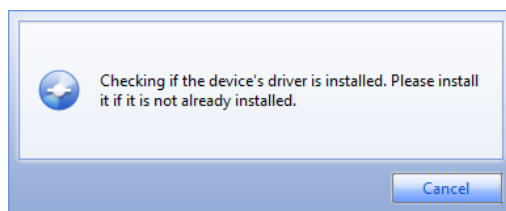

To enable the Connect automatically only for printing setting, a printer driver needs to be associated with your printer. Check Enable auto connect, select Connect automatically only for printing and then click the Configure button to start the printer driver association. After the association is complete, the window will be displayed as in step 2.

If the printer driver association does not finish despite waiting for a while, you can manually associate the driver.

1. From the dialog window displayed, click the Configure button.
2. The Auto Printer Connect window will be displayed.

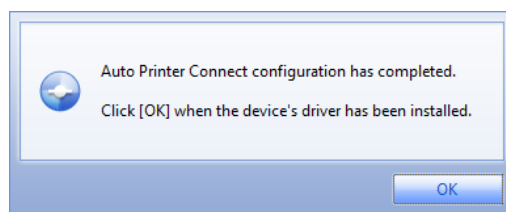

3. Check the Manually configure a printer to automatically connect check box, select the appropriate printer and click OK.

After the association is complete, the window will be displayed as in step 2.

- \* If the last part of a job is not printed completely while the printer auto-connect function is active, click the Confirm button to open the printer monitoring dialog. Extend the time period in Time before disconnecting after print job is sent field.

The printer auto-connect function has been enabled.

All the jobs output to the printer you have selected at step **1** will be printed automatically.

**TIP**

- \* Some printers may show an error message on their printer status monitor after a job is printed. In such cases, close the printer status monitor manually as it has no effect on printing.



## 6-5-4.SX Virtual Link for Serial Device Server and the Task Tray

### Controlling SX Virtual Link for Serial Device Server from the task tray

Right-click  in the task tray to display the SX Virtual Link for Serial Device Server menu as shown below.

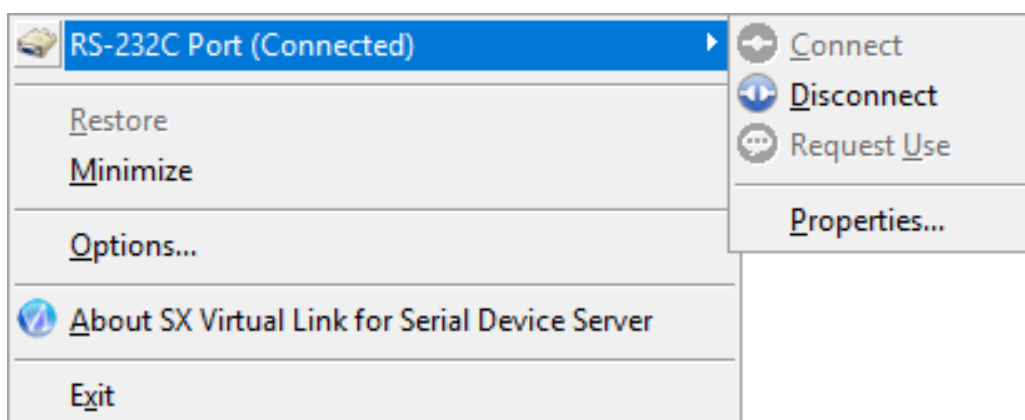

Item	Details
Restore	Restores SX Virtual Link for Serial Device Server to its default size.
Minimize	Minimizes SX Virtual Link for Serial Device Server.
Options	Opens the options dialog. Each optional setting is available.
About SX Virtual Link for Serial Device Server	Displays the SX Virtual Link for Serial Device Server version.
Exit	Closes SX Virtual Link for Serial Device Server.

Item	Details
Connect	Connects to the selected USB device.
Disconnect	Disconnects from the selected USB device.
Request Use	Asks the user who is currently using the USB device that you wish to use to disconnect from it. For details on Request Use, refer to <b>How to Request for Disconnect</b> .
Properties	Shows the properties window of the selected USB device. For details on USB device properties, refer to <b>USB Device Operational Settings</b> .

## 6-5-5.How to Request for Disconnect

SX Virtual Link for Serial Device Server has a feature allowing you to request to a user to disconnect from the USB device that you wish to connect to by sending a remote message so that the right of use is passed down to you. This function is called "Request Use".

Select the USB device that you wish to use on SX Virtual Link for Serial Device Server's main window and click the Request Use button  .

A disconnect request message will be displayed on the PC of the user who is currently using the USB device that you have selected. If the user accepts the disconnect request, your PC will be connected to the USB device.

The Request Use process is as follows:

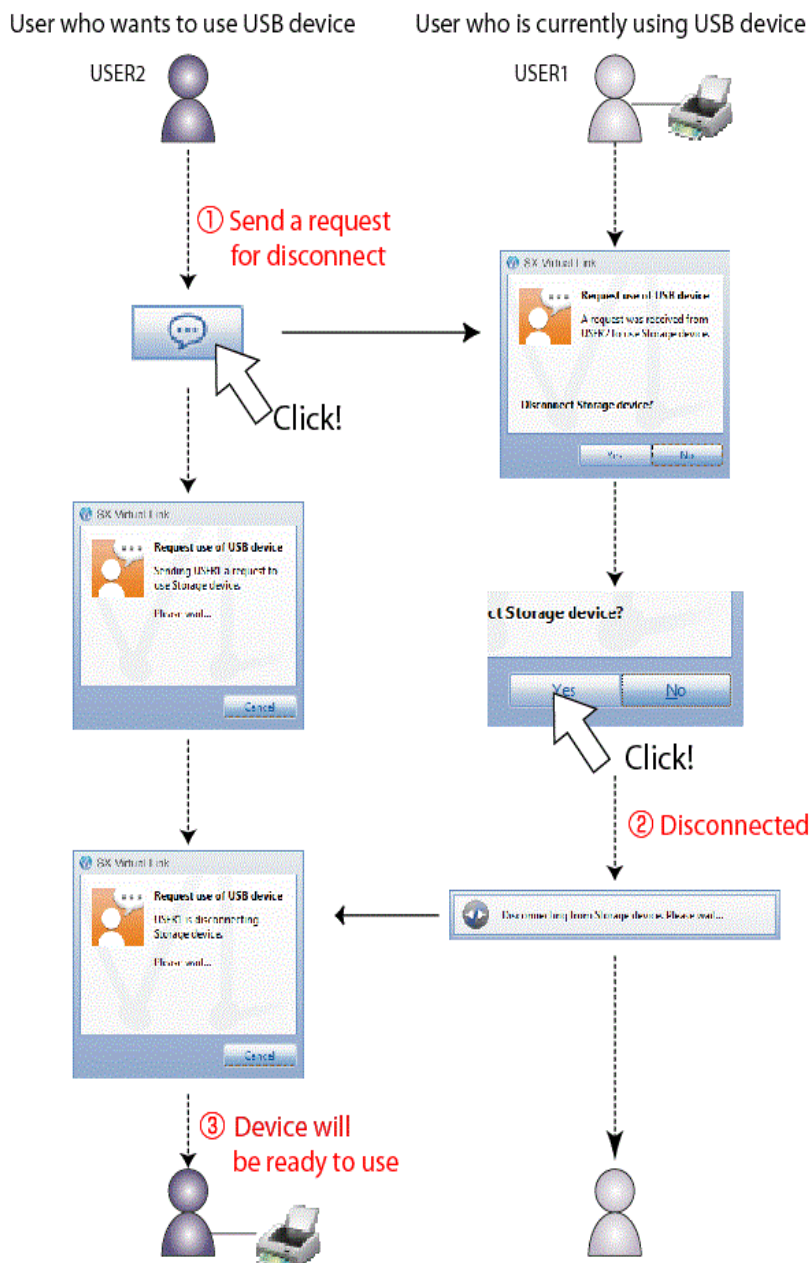

**Note**

- \* The disconnect request could be denied. If the disconnect request is denied, the message on the right will be displayed on the PC from which the disconnect request was sent.



- \* If no response is returned, the message on the right will be displayed.

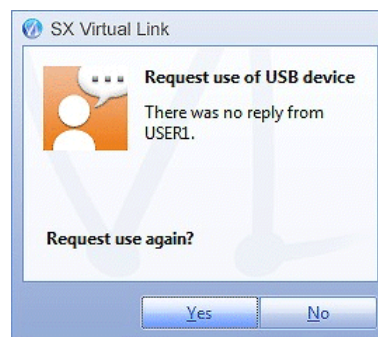

- \* Only one disconnect request can be sent at a time. If several users send disconnect requests, priority is given to the first user. For the other users, the message on the right will be displayed. In such a case, please try again a while later.

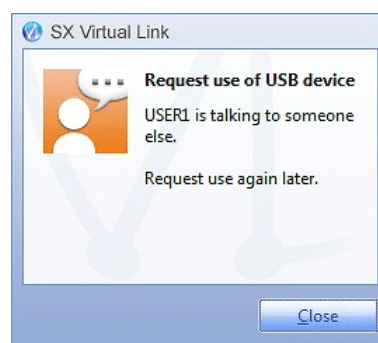

- \* Your PC can be set to automatically disconnect from a USB device when a disconnect request is received. For details on how to use this feature, refer to **USB Device Operational Settings**.

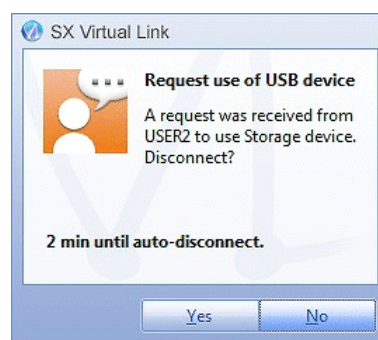

## 6-5-6.SX Virtual Link for Serial Device Server Optional Settings

This page explains the SX Virtual Link for Serial Device Server optional settings.

SX Virtual Link general settings such as startup and communication settings can be configured.

Click the **Option** button (  ) on SX Virtual Link for Serial Device Server's main window. The options dialog will be displayed.

The options dialog provides the following settings. Click OK when you have finished configuring the settings.

### General

Basic operational settings can be configured.

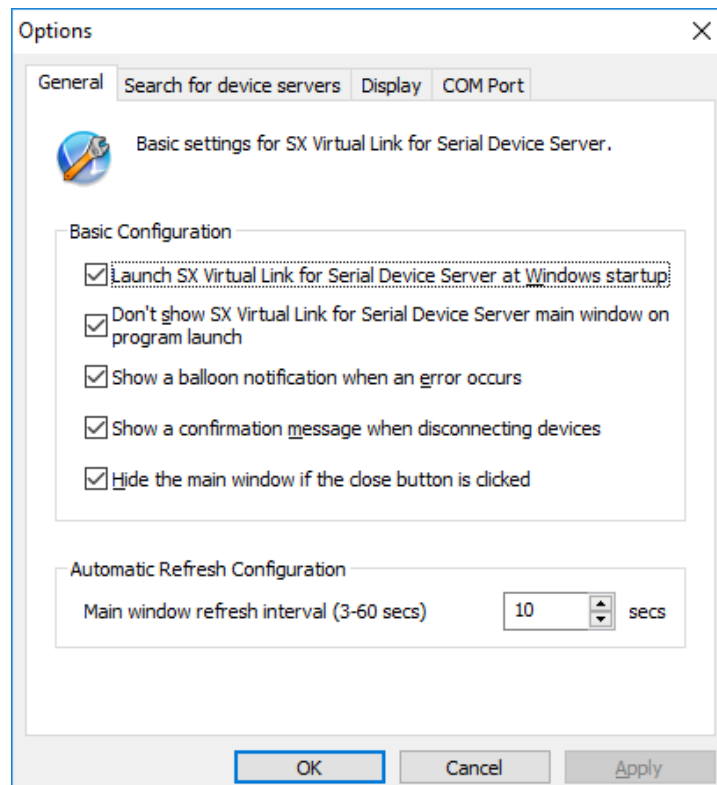

Launch SX Virtual Link for Serial Device Server at Windows startup

Adds SX Virtual Link for Serial Device Server to the Startup folder.  
When added to the Startup folder, SX Virtual Link for Serial Device Server will automatically start at Windows logon.  
(Default: On)

Don't show SX Virtual Link for Serial Device Server main window on program launch	Starts SX Virtual Link for Serial Device Server as a minimized icon. The minimized icon will be displayed in task tray. (Default: On)
Show a balloon notification when an error occurs	Notifies you of a device error by displaying a balloon message in the task tray. (Default: On)
Show a confirmation message when disconnecting devices	Displays a confirmation message before disconnecting a USB device via SX Virtual Link for Serial Device Server. (Default: On)
Hide the main window if the close button is clicked	Minimizes SX Virtual Link for Serial Device Server if the close button is clicked on the main window. (Default: Off)
Main window refresh interval	Sets the refresh interval for the connected device status. (Default: 10 seconds)

## Search for device servers

The broadcast address can be configured.

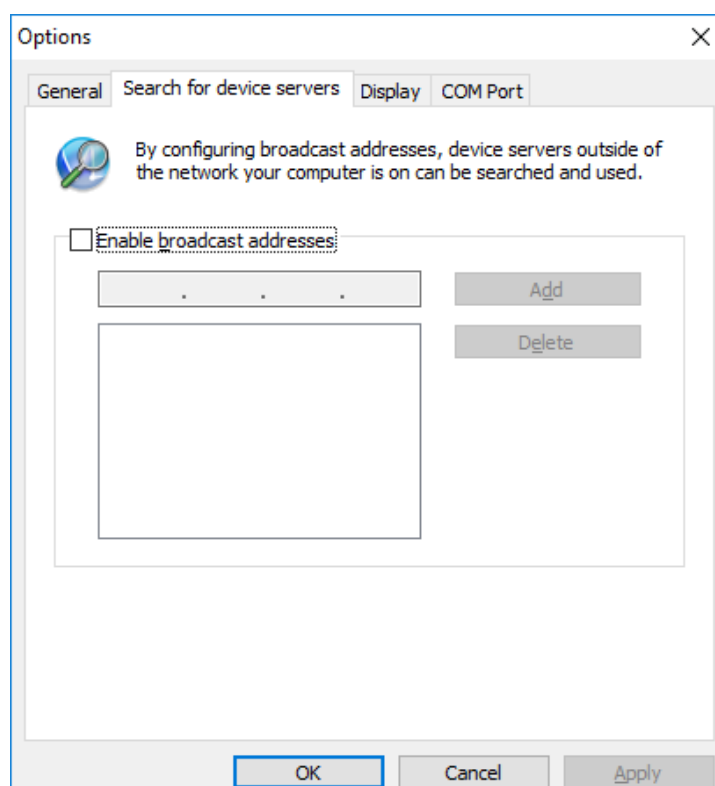

Enable broadcast addresses	<p>Registers the broadcast addresses used to search for device servers over the network router. If no broadcast addresses are specified, only device servers in your local segment will be searched.</p> <p>To register a broadcast address, check <b>Enable broadcast addresses</b>, enter the broadcast address into the address field and click the <b>Add</b> button. (Up to 16 addresses can be registered.)</p> <p>To remove an address from the list, select it and click the <b>Delete</b> button.</p>
----------------------------	--

**Note**

- \* For example, to register "192.168.1.xxx" (Subnet Mask:255.255.255.0), enter "192.168.1.255" into the address field. In the sample screen below, "192.168.1.255" and "192.168.2.255" are registered to include "192.168.1.xxx" and "192.168.2.xxx" (Subnet Mask:255.255.255.0) addresses for the device server search.

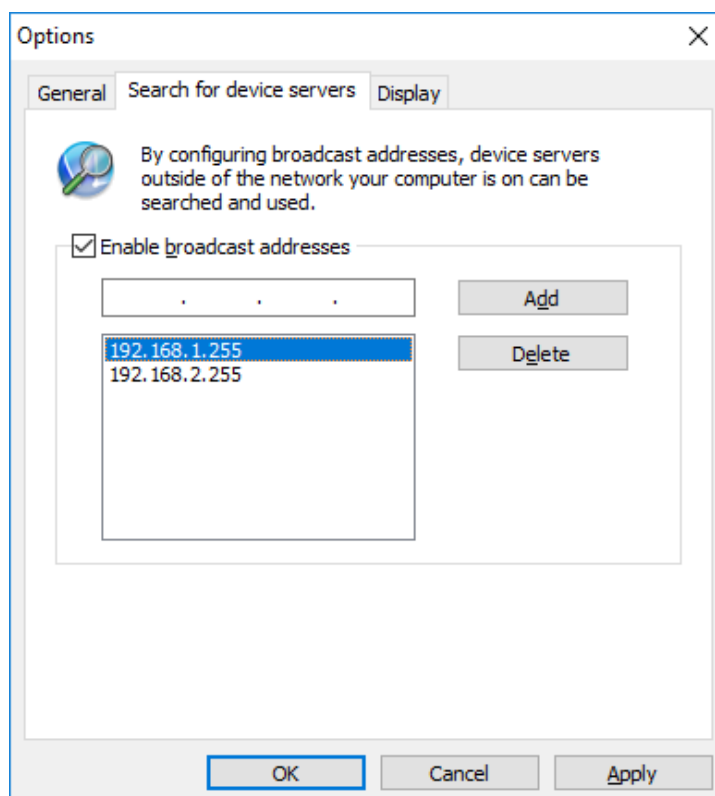

For which broadcast addresses to use for the device server search, please ask your network administrator.

## Display

The SX Virtual Link display settings can be configured.

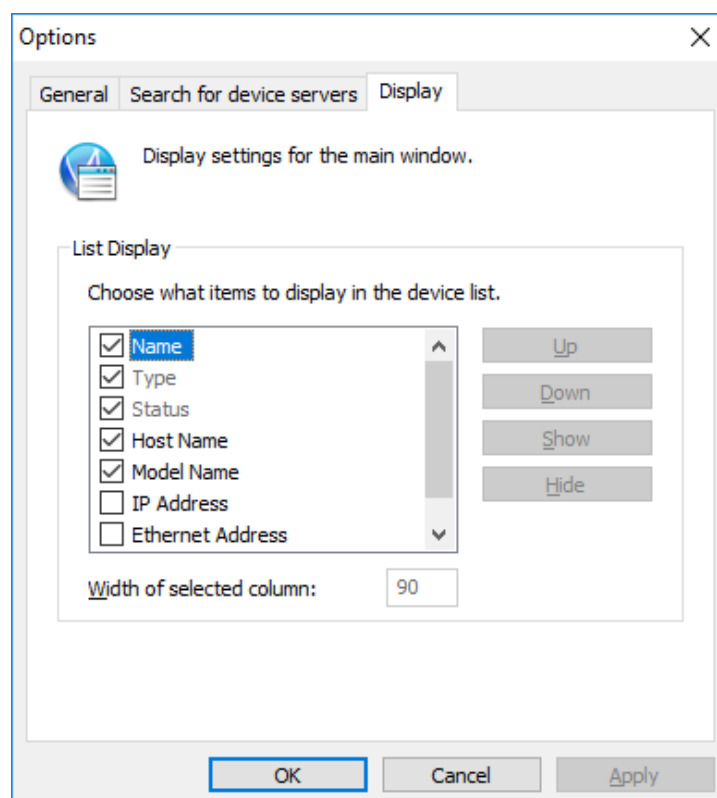

Name	Displays the name of USB devices connected to the device server. The USB device name can be changed. For details, refer to USB Device Operational Settings. (Default: On) * This check box cannot be cleared.
Type	Displays the type of USB devices connected to the device server. (Default: On) * This check box cannot be cleared.
Status	Displays the status of USB devices connected to the device server. (Default: On) * This check box cannot be cleared.
Host Name	Display the host name of the device server. The host name can be changed from the device server settings. For details, refer to the users manual. (Default: On)
Model Name	Displays the model name of the device server. (Default: On)
IP Address	Displays the IP Address of the device server. (Default: Off)

Ethernet Address	Displays the Ethernet Address of the device server. The Ethernet Address is the 12-digit number found on the side or backside of the device server. (Default: Off)
Auto Connect	Displays the current status of the USB device's auto-connect settings. Either "Enabled" or "Disabled" is displayed. (Default: Off)
Width of selected column	Changes the width of each column heading at the top of the USB device list. * The widths of the Name and Type columns cannot be changed.



\* It is impossible to hide or change the display order of Name, Type and Status.

### COM Port

The COM port can be refreshed or deleted after it is added to SX Virtual Link for Serial Device Server.

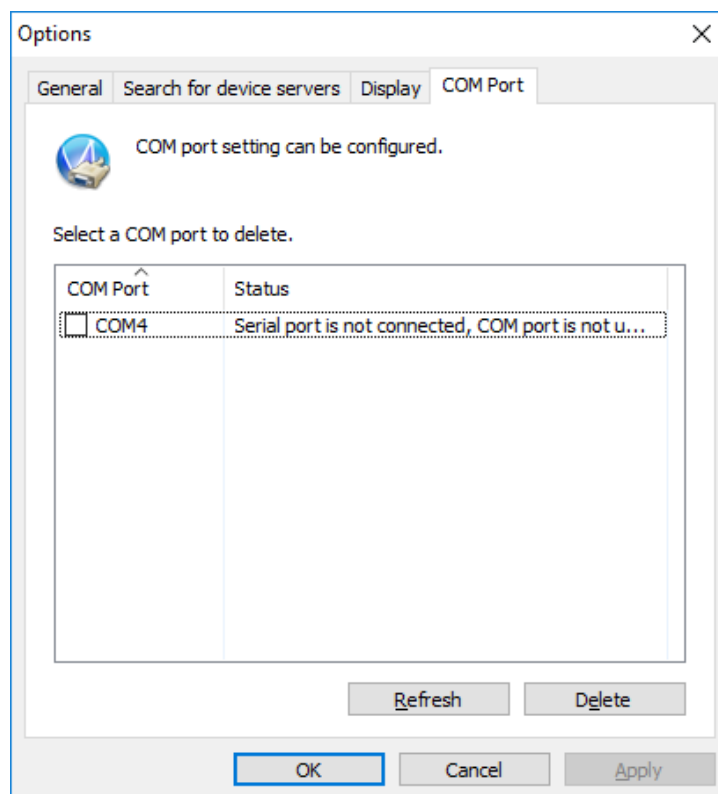

Refresh button	Refreshes the COM port status.
Delete button	Deletes the COM ports whose check boxes are checked.



## 6-5-7.Uninstall

How to uninstall SX Virtual Link for Serial Device Server:



- \* To uninstall SX Virtual Link for Serial Device Server, administrator privilege is required.
- \* In the following procedures, the screen shots captured from Windows Vista are used as examples. Please note that the actual screens or menus may vary depending on your OS.

1. Click Control Panel - Uninstall a program.
2. Select SX Virtual Link for Serial Device Server from the list and click **Uninstall**.

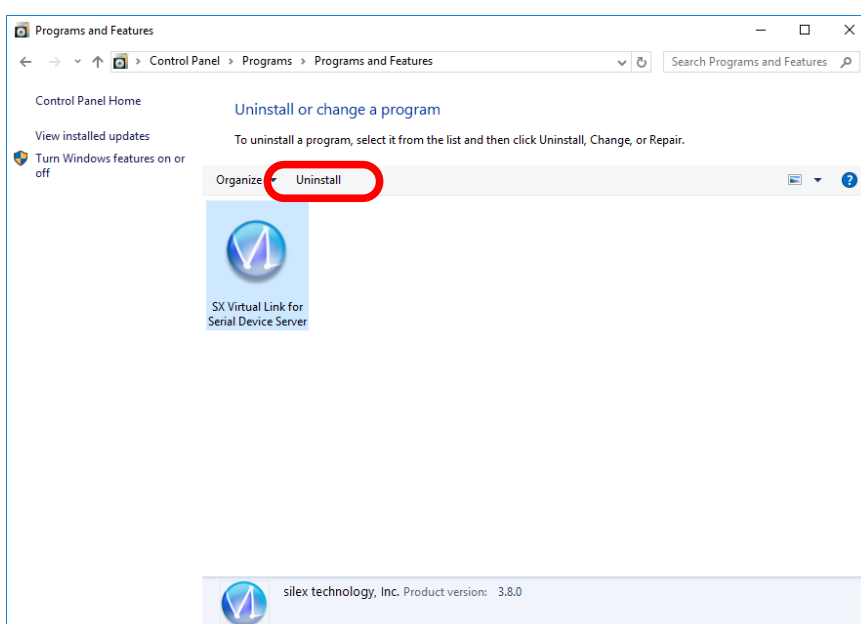

3. The User Account Control message is displayed. Click **Continue**.
4. A confirmation message is displayed. Click **Yes** to start the uninstallation.

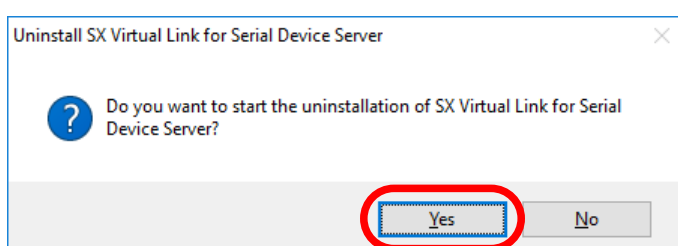

5. When the below window is displayed, click **Finish**.

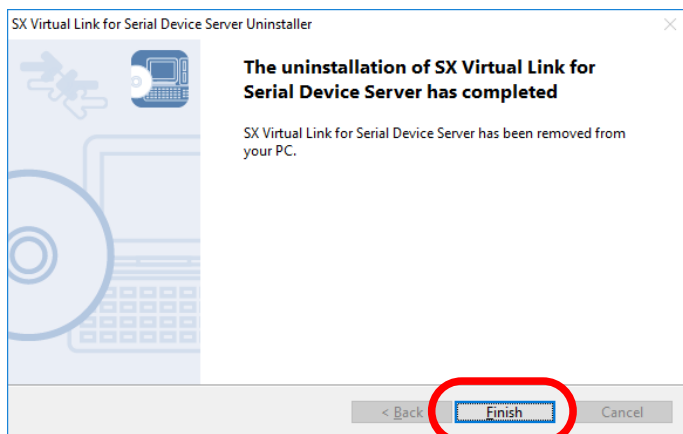

SX Virtual Link for Serial Device Server has been uninstalled.

# 7. Troubleshooting

---

## 7-1. Problems During the Setup

### SD-330AC is not displayed in the search result of Serial Device Server Setup.

When SD-330AC is not displayed in the search result of Serial Device Server Setup, the cause need to be determined from the installation status, network environment, and status of PC used for the configuration of SD-330AC. When using a wireless LAN product, please also refer to the **Wireless LAN Problems** as described later.

SD-330AC or the Ethernet Hub SD-330AC is connected to may have a problem regarding connection, power transmission, or operation.

Solution	Please check the LED status of SD-330AC and the Ethernet Hub SD-330AC is connected to. If the LED indicates improper status, replace the AC plug and other cables, and reboot the connected devices.
----------	--

The startup of SD-330AC may not have been completed.

Solution	It takes up to 30sec for SD-330AC to get ready after it is powered on. Please wait until SD-330AC becomes ready and then click the Search in the Serial Device Server Setup.
----------	--

SD-330AC may not be in the same network segment (environment without a router) as your PC.

Solution	During the initial configuration, place SD-330AC and PC in the same network segment.
----------	--

If SD-330AC has been used in another network, it may have the settings not allowing the communication with your PC.

Solution	Please reset SD-330AC to the factory default setting. Refer to <b>Reset to Factory Default</b> for details.
----------	---

Security software such as firewall may be interrupting the communication with SD-330AC.

Solution	Please abort your security software. Refer to FAQ in our website ( <a href="https://www.silextechnology.com/">https://www.silextechnology.com/</a> ) for details on how to abort security software.
----------	--

---

**Communication error occurs when configuring with Serial Device Server Setup.**

When a communication error occurs during Serial Device Server Setup, the cause needs to be determined from the settings of the PC used for the configuration.

SD-330AC may not be in the same network segment (environment without a router) as your PC.	
--	--

Solution	During the initial configuration, place SD-330AC and PC in the same network segment.
----------	--

In the environment where there is DHCP server, the DHCP server may have configured the IP address of the different segment to a PC.	
---	--

Solution	Please select Obtain an IP address automatically at Internet Protocol (TCP/IP) Properties of the PC. Otherwise connect the PC and SD-330AC to the standalone Ethernet Hub and see how it works.
----------	--

If SD-330AC has been used in another network, it may have the settings not allowing the communication with your PC.	
---	--

Solution	Please reset SD-330AC to the factory default setting. <b>Refer to Reset to Factory Default</b> for details.
----------	---

### How should I determine the way to assign an IP address to SD-330AC?

There are two ways to assign an IP address to SD-330AC; one is to Get IP address automatically from DHCP server and the other is to Assign IP address manually. Choose the way to assign an IP address according to your environment.

When there is a DHCP server in the network environment:

Solution	You can use Get IP address automatically from DHCP server. As SD-330AC is set by default to Get IP address automatically, SD-330AC will obtain an IP address appropriate to your network environment from the DHCP server just by powering up SD-330AC. Refer to <b>Reset to Factory Default</b> for details on how to reset SD-330AC to the factory default settings.
----------	--

When there is no DHCP server in the network environment, or when you do not prefer getting an IP address from DHCP server:

Solution	<p>Please use Assign IP address manually. Keep in mind of the following points regarding the IP address to assign to SD-330AC.</p> <ul style="list-style-type: none"> <li>* Assign an IP address unique in the network.</li> <li>* Assign an IP address that has the same address class as the PC that will use SD-330AC. e.g. When an IP address of the PC is "192.168.0.xx", assign an address such as "192.168.0.100" that is not used by other network devices.</li> </ul> <p>(Tips about the IP address)</p> <ul style="list-style-type: none"> <li>* An IP address is a unique number for identifying network devices. An IP address is indicated with four numbers divided by a period (.), for example "192.168.0.1". The integer from 0-255 is used for each number.</li> <li>* An IP address is, depending on the number assigned, categorized to 3 classes below.</li> <li>* Numbers making up the IP address are either network numbers indicating network, or host numbers indicating each network device; each number indicates the different meaning based on the IP address class. Each class is categorized as the following diagram which is indicating a network number as n, and a host number as u. An IP address with the same network number must be assigned to the network devices in the same network segment.</li> <li>* There is an address range in the IP address called the private address that could be used freely. In the LAN environment not directly connected to the internet, an IP address is assigned within the range of the private address.</li> </ul> <table border="1" style="width: 100%; border-collapse: collapse;"> <thead> <tr> <th style="width: 20%;">First 1 digits in IP address</th> <th style="width: 10%;">Class</th> <th style="width: 20%;">Definition of IP address n: network number u: host number</th> <th style="width: 20%;">Size of the network to be used</th> <th style="width: 30%;">Private address</th> </tr> </thead> <tbody> <tr> <td style="text-align: center;">0 - 127</td> <td style="text-align: center;">A</td> <td style="text-align: center;">n.u.u.u</td> <td style="text-align: center;">Large network</td> <td style="text-align: center;">10.0.0.0 - 10.255.255.255</td> </tr> <tr> <td style="text-align: center;">128 - 191</td> <td style="text-align: center;">B</td> <td style="text-align: center;">n.n.u.u</td> <td style="text-align: center;">Mid-size network</td> <td style="text-align: center;">172.16.0.0 - 172.31.255.255</td> </tr> <tr> <td style="text-align: center;">192 - 223</td> <td style="text-align: center;">C</td> <td style="text-align: center;">n.n.n.u</td> <td style="text-align: center;">Small network</td> <td style="text-align: center;">192.168.0.0 - 192.168.255.255</td> </tr> </tbody> </table>	First 1 digits in IP address	Class	Definition of IP address n: network number u: host number	Size of the network to be used	Private address	0 - 127	A	n.u.u.u	Large network	10.0.0.0 - 10.255.255.255	128 - 191	B	n.n.u.u	Mid-size network	172.16.0.0 - 172.31.255.255	192 - 223	C	n.n.n.u	Small network	192.168.0.0 - 192.168.255.255
First 1 digits in IP address	Class	Definition of IP address n: network number u: host number	Size of the network to be used	Private address																	
0 - 127	A	n.u.u.u	Large network	10.0.0.0 - 10.255.255.255																	
128 - 191	B	n.n.u.u	Mid-size network	172.16.0.0 - 172.31.255.255																	
192 - 223	C	n.n.n.u	Small network	192.168.0.0 - 192.168.255.255																	

---

**An error message is displayed when installing SX Virtual Link for Serial Device Server.**

An older version of SX Virtual Link for Serial Device Server may already be installed on the PC.

Solution	If SX Virtual Link for Serial Device Server Ver.3.3.0 is installed on your PC, you cannot install the newer version of SX Virtual Link for Serial Device Server. Remove the older version first and try installing the newer version again.
----------	---

**Is it possible to install "SX Virtual Link" (USB device management utility) and "SX Virtual Link for Serial Device Server" (serial device management utility) on the same PC?**

It is possible to install "SX Virtual Link" and "SX Virtual Link for Serial Device Server" on the same PC. However, please note that "SX Virtual Link for Serial Device Server" can replace "SX Virtual Link". You can manage both USB devices and serial devices, including discovering, linking to and unlinking from them using "SX Virtual Link for Serial Device Server".

Solution	You can install "SX Virtual Link for Serial Device Server" on a PC which has "SX Virtual Link" already installed. However, if "SX Virtual Link" is installed on a PC which has "SX Virtual Link for Serial Device Server" already installed, you will not be able to link to serial devices. Remember that "SX Virtual Link for Serial Device Server" can be used to discover, link to and unlink from both USB devices and serial devices. If "SX Virtual Link for Serial Device Server" is installed on your PC, do not install "SX Virtual Link".
----------	---

## 7-2. Problems While Using SD-330AC

### Serial devices are not displayed or temporarily displayed in SX Virtual Link for Serial Device Server.

If serial devices are not displayed in SX Virtual Link for Serial Device Server, you need to check the cable connection as well as the network settings between SD-330AC and your PC.

SD-330AC or the Ethernet Hub SD-330AC is connected to may have a problem regarding connection, power transmission or operation.

Solution	Please check the LED status of SD-330AC and the Ethernet Hub SD-330AC is connected to. If the LED indicates improper status, replace the AC plug and other cables, and reboot the connected devices.
----------	--

The startup of SD-330AC may not have been completed.

Solution	It takes up to 30sec for SD-330AC to get ready after it is powered on. Please wait until SD-330AC becomes ready, and then click the Refresh button  in SX Virtual Link for Serial Device Server again.
----------	---

Security software such as firewall may be interrupting the communication with SD-330AC.

Solution	Please add SX Virtual Link for Serial Device Server to the exception list in your security software. Please refer to the FAQ on our website ( <a href="https://www.silextechnology.com/">https://www.silextechnology.com/</a> ) for details on adding an application to the exception list.
----------	---

An IP address unable to communicate with your PC may be assigned to SD-330AC.

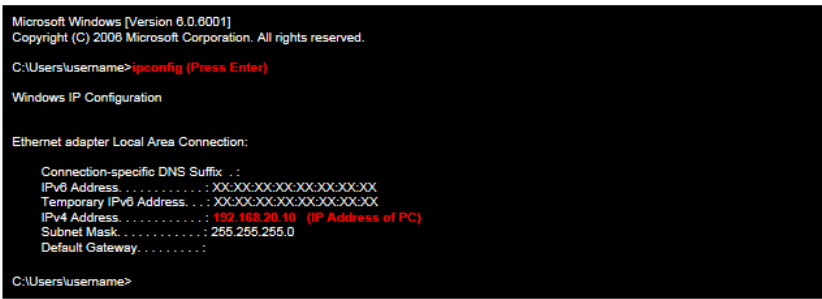
Solution	<p>First, check the IP Address of your PC. To check the IP Address, use the Windows Command Prompt.</p> <ol style="list-style-type: none"> <li>1. Select <b>Start - All Programs - Accessories - Command Prompt</b>.</li> <li>2. When the Command Prompt is started, execute the ipconfig command.</li> </ol> <p>Example of executing the <b>ipconfig</b> command</p>  <pre>Microsoft Windows [Version 6.0.6001] Copyright (C) 2006 Microsoft Corporation. All rights reserved.  C:\Users\username&gt;ipconfig (Press Enter)  Windows IP Configuration  Ethernet adapter Local Area Connection:      Connection-specific DNS Suffix  . :     IPv6 Address . . . . . : ::::     Temporary IPv6 Address . . . . . : ::::     IPv4 Address . . . . . : 192.168.20.10 (IP Address of PC)     Subnet Mask . . . . . : 255.255.255.0     Default Gateway . . . . . :</pre> <p>Check that the IP Address of the PC is a proper address for communicating with the IP Address of SD-330AC. If the PC and SD-330AC are in the same network segment but use a different network number in their addresses, you need to change either the address of the PC or SD-330AC. Also, if there is a router between the PC and SD-330AC, check that the default gateway address is properly configured.</p>
----------	--



The IP address assigned to SD-330AC may be in use by another network device.	
Solution	<p>First, turn off SD-330AC and open the Windows Command Prompt. Ping the IP address of SD-330AC.</p> <ol style="list-style-type: none"> <li>1. Select <b>Start - All Programs - Accessories - Command Prompt</b>.</li> <li>2. When the Command Prompt appears, execute the <b>ping</b> command.</li> </ol> <p>Example of executing the ping command when the IP address of SD-330AC is 192.168.20.20</p>  <pre> Microsoft Windows [Version 6.0.6001] Copyright (C) 2006 Microsoft Corporation. All rights reserved.  C:\Users\username&gt;ping 192.168.20.20 (Press Enter)  Pinging 192.168.20.20 with 32 bytes of data:  (When there is a reply) Reply from 192.168.20.20: bytes=32 time&lt;1ms TTL=128 Reply from 192.168.20.20: bytes=32 time&lt;1ms TTL=128 Reply from 192.168.20.20: bytes=32 time&lt;1ms TTL=128 Reply from 192.168.20.20: bytes=32 time&lt;1ms TTL=128  (When there is no reply) Reply from XXX.XXX.XXX.XXX: Destination host unreachable. Reply from XXX.XXX.XXX.XXX: Destination host unreachable. Reply from XXX.XXX.XXX.XXX: Destination host unreachable. Reply from XXX.XXX.XXX.XXX: Destination host unreachable. </pre> <p>If there is a reply while SD-330AC is turned off, it means there is another network device using the same IP address as SD-330AC. In such a case, change the IP address of either SD-330AC or the other network device.</p>

A serial cable used to connect SD-330AC and a serial device may not be plugged in correctly.	
Solution	Please check that the serial cable is properly plugged into SD-330AC and the serial device. If you have a spare serial cable, replace the cable.

### I cannot communicate with a serial device.

If you cannot communicate with the serial device connected to SD-330AC, you need to check the communication settings on SD-330AC and the serial communication software.

A serial cable used to connect SD-330AC and a serial device may not be plugged in correctly.

Solution	Please check that the serial cable is properly plugged into SD-330AC and the serial device. If you have a spare serial cable, replace the cable.
----------	--

Serial communication settings may differ between the serial device and serial communication software.

Solution	When you are using SX Virtual Link for Serial Device Server to communicate with a serial device, the serial communication settings may differ between the serial device and serial communication software. If the serial communication settings are different between them, you may not be able to communicate with the serial device. Also, output serial data may not be transferred correctly. Check the settings on the serial communication software and match it with those used in the serial device. For details on how to change the settings on your serial communication software, refer to the operation manual that came with it.
----------	---

Serial communication settings may differ between SD-330AC and the serial device.

Solution	If you are using Ecable Mode or Raw TCP Connection Mode to communicate with a serial device, the serial communication settings may differ between SD-330AC and the serial device. If the serial communication settings are different between them, you may not be able to communicate with the serial device. Also, output serial data may not be transferred correctly. You can change the serial communication settings of SD-330AC from the Web page. For details on how to change the settings on the Web page, refer to <b>Configure Serial Port Settings</b> or <b>Configuration Item List - Serial Port Configuration</b> .
----------	---

When using SD-330AC in Ecable Mode, the destination IP address or TCP port number settings may be incorrect.

Solution	In Ecable Mode, two SD-330AC's must be configured with the proper IP addresses to communicate with each other, and the same TCP port number should be used for both. If these settings are different between them, serial communication may fail due to a network connection not being established. For detailed settings to use SD-330AC in <b>Ecable Mode</b> , refer to <b>Ecable Mode (Link to the Registered Device) - 2. Before You Begin</b> .
----------	--

When using SD-330AC in Raw TCP Connection Mode, the TCP port number may be different between SD-330AC and the application program.

Solution	In Raw TCP Connection Mode, SD-330AC and the application program should be configured with the same TCP port number. If this setting is different between them, serial communication may fail due to a network connection not being established. For detailed settings to use SD-330AC in <b>Raw TCP Connection Mode</b> , refer to <b>Raw TCP Connection Mode (Link to Serial Device Using TCP Raw Port) - 2. Before You Begin</b> .
----------	--

**SD-330AC turns on in a wireless LAN mode although it is connected to a wired LAN using a network cable.**

If SD-330AC is powered on while it is connected to a 10BASE-T Ethernet HUB using a network cable, SD-330AC could turn on in a wireless LAN mode.

## Solution

Extend the amount of time to recognize a wired LAN so that SD-330AC can turn on in wired LAN mode.  
The instructions below provide an example of how to set "5 sec" for the amount of time to recognize a wired LAN.

1. Access the SD-330AC Web page and click **WEB console** from the left menu. Enter the **SET NW STARTDELAY 5** to the field and click **Enter**.

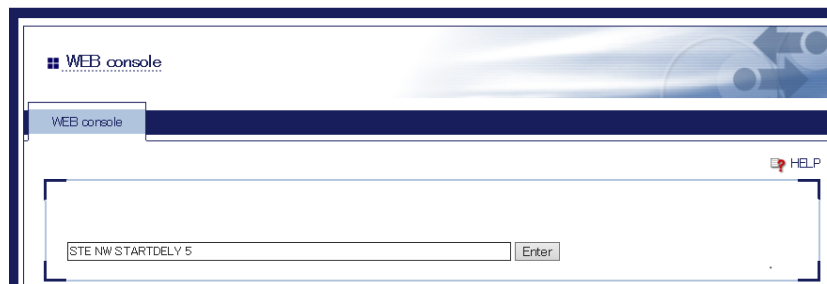

2. Enter **SAVE** to the field and click **Enter**. To check the setting, enter **SHOW NW STARTDELAY** to the field and click **Enter**. The current setting is displayed.
3. When the configuration is completed, click **Restart** under **Maintenance** to restart SD-330AC.

## 7-3. Wireless LAN Problems

### Is there any information I should check before configuring SD-330AC?

To connect SD-330AC in Infrastructure mode, please check the following configuration information of the Access Point.

SSID (ESSID)	ID to identify the Access Point.
Encryption requirements	Whether encrypted communication with the Access Point is required or not.
Encryption mode	Encryption type (WEP, WPA, WPA2 and etc.) in case it is required.
Encryption key	Key necessary for encryption. WEP key, when using WEP encryption. Pre-Shared Key, when using WPA/WPA2 encryption.
Key index	Which key from 1 to 4 is enabled, when using a WEP key.
Other security function	Information for a security function configured to an Access Point. e.g. MAC address filter if a security function is configured to the Access Point, configuration of the Access Point needs to be changed to allow the communication with SD-330AC.

### Does SD-330AC support the auto-connection function of the Access Point?

**\* SD-330AC does not support proprietary auto-connection function of the Access Point implemented by each manufacturer.**

If the environment setting of an Access Point has been set using the auto-connection function of the Access Point, please check the configuration information listed in the previous section. If there is any unclear information, configuration of the Access Point needs to be changed manually.

**SD-330AC can be used and connected via wired LAN, but cannot be communicated via wireless LAN.**

Please check the operation status and configuration of SD-330AC.

SD-330AC may have been started with wired LAN mode.

Solution	When the network cable is connected to SD-330AC, it starts with wired LAN mode. If an Ethernet cable is connected to SD-330AC, unplug the network cable and restart SD-330AC.
----------	---

Wireless LAN configuration of SD-330AC may not be suitable to your environment.

Solution	Connect a network cable to SD-330AC and check the wireless LAN settings.
----------	--

**Connection is interrupted and disconnected.**

If your wireless LAN is interrupted and disconnected, SD-330AC may be installed at a location subject to weaker radio wave signals.

Solution	Please reconsider the location of installation and condition of use.
----------	--

Blank page