



User's Manual

ColorEdge® **PROMINENCE** **CG3146**

HDR Reference Monitor

Thank you for purchasing our HDR reference monitor.

Important

Please read this "User's Manual", and "PRECAUTIONS" (separate volume) carefully to familiarize yourself with safe and effective usage.

-
- Refer to the "Setup Guide" for information on the installation / connection of the monitor.
 - For the latest product information including the "User's Manual", refer to our web site :
www.eizoglobal.com
-

Location of Caution Statement

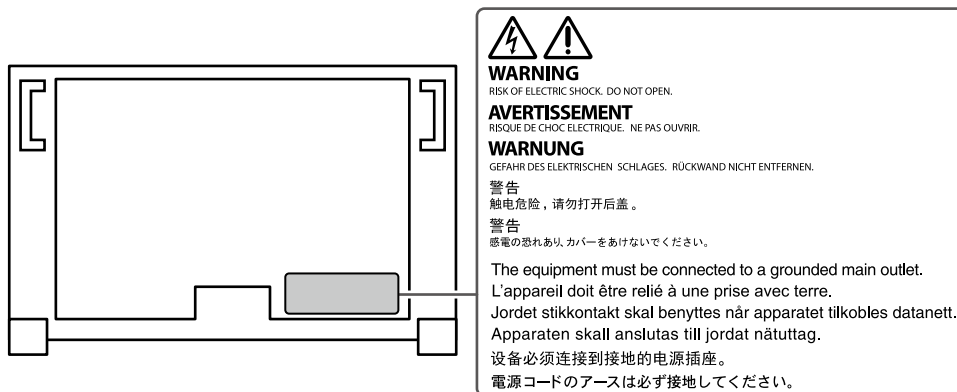

This product has been adjusted specifically for use in the region to which it was originally shipped. If operated outside this region, the product may not perform as stated in the specifications.

No part of this manual may be reproduced, stored in a retrieval system, or transmitted, in any form or by any means, electronic, mechanical, or otherwise, without the prior written permission of EIZO Corporation. EIZO Corporation is under no obligation to hold any submitted material or information confidential unless prior arrangements are made pursuant to EIZO Corporation's receipt of said information. Although every effort has been made to ensure that this manual provides up-to-date information, please note that EIZO monitor specifications are subject to change without notice.

Notice for This Monitor

About the Usage of This Product

This product is suited for producing videos, where accurate color reproduction is a priority.

This product has been adjusted specifically for use in the region to which it was originally shipped. If the product is used outside the region, it may not operate as specified in the specifications.

This product may not be covered by warranty for uses other than those described in this manual.

The specifications noted in this manual are only applicable when the following are used:

- Power cords provided with the product
 - Signal cables specified by us
-

Only use optional products manufactured or specified by us with this product.

About the LCD Panel

The LCD panel is manufactured using high-precision technology. Although, missing pixels or lit pixels may appear on the LCD panel, this is not a malfunction. Percentage of effective dots: 99.9994 % or higher.

It takes about 3 minutes (under our measurement conditions) for the monitor display to stabilize. For highly accurate adjustments, please wait 20 minutes or more after the monitor power has been turned on.

If you switch SDR color modes and HDR color modes, wait 30 minutes or more after switching the color modes, and then adjust the monitor.

Monitors should be set to a lower brightness to reduce changes in luminosity caused by long-term use and maintain a stable display.

When the screen image is changed after displaying the same image for extended periods of time, an afterimage may appear. Use the screen saver or power save function to avoid displaying the same image for extended periods of time. Depending on the image, an afterimage may appear even if it was displayed for a short period of time. To remove such a phenomenon, change the image or keep the power turned off for several hours.

If the monitor displays continuously over a long period of time, smudges or burn-in may appear. To maximize the life of the monitor, we recommend the monitor be turned off periodically. Use the power button on the front of the monitor to turn it off.

The backlight of the LCD panel has a fixed lifetime. Depending on the usage pattern, such as usage for long continuous periods, the lifespan of the backlight may run out sooner, requiring replacement. When the screen becomes dark or begins to flicker, please contact your local EIZO representative.

Do not press on the LCD panel or edge of the frame strongly, as this may result in display malfunctions, such as interference patterns, etc. If pressure is continuously applied to the LCD panel surface, the liquid crystal may deteriorate or the LCD panel may be damaged. (If the pressure marks remain on the panel, leave the monitor with a black or white screen. The symptom may disappear.)

Do not scratch or press on the LCD panel with any sharp objects, as this may result in damage to the LCD panel. Do not attempt to brush with tissues as this may scratch the panel.

About the Installation

When the monitor is cold and brought into a room or the room temperature goes up quickly, dew condensation may occur on the interior and exterior surfaces of the monitor. In that case, do not turn the monitor on. Instead wait until the dew condensation disappears, otherwise it may cause some damage to the monitor.

If you place this product on a lacquer-coated desk, the color may adhere to the bottom of the stand due to the composition of the rubber. Check the desk surface before use.

About the Maintenance

Periodic cleaning is recommended to keep the monitor looking new and to prolong its operation lifetime (refer to “Cleaning” (page 4)).

Update program for the internal software (firmware) of the monitor may be provided to improve the performance of monitor and other purposes. Select “Software and Drivers” in “Support” from our web site (www.eizoglobal.com), enter the product name, and perform search.

Cleaning

The stains on the cabinet and LCD panel surface can be removed by using the provided ScreenCleaner.

Attention

- Chemicals such as alcohol and antiseptic solution may cause gloss variation, tarnishing, and fading of the cabinet or LCD panel, and also quality deterioration of the image.
 - Never use thinner, benzine, wax, or abrasive cleaner as they may damage the cabinet or LCD panel surface.
-

To Use the Monitor Comfortably

- An excessively dark or bright screen may affect your eyes. Adjust the brightness of the monitor according to the environmental conditions.
- Staring at the monitor for a long time tires your eyes. Take a 10-minute rest every hour.

Contents

Notice for This Monitor	3	Chapter 5 Custom Key Settings	40
Cleaning	4	5-1. Basic Operation of the Custom Keys	40
To Use the Monitor Comfortably	4	5-2. Assigning a Function to a Custom Key	40
Contents	5	● Functions that can be Assigned to	
Chapter 1 Introduction	6	Custom Keys	42
1-1. Features	6	Chapter 6 Administrator Settings	43
● Large built-in high resolution 4K LCD		6-1. Basic Operation of the "Administrator	
that is advantageous for video production	6	Settings" Menu.....	43
● Support for HDR (High Dynamic Range)		6-2. "Administrator Settings" Menu	
video	6	Functions	44
● Support for SDI signal input or output		Chapter 7 SDR/HDR Settings	45
for long-distance transmissions	6	7-1. About Each Color Mode	45
● Built-in mode for automatically switching		● Types and Applications of Color Modes	
to the optimal color settings	7	for Image Creation	45
● Various functions that support color		● BT.2020	46
grading work.....	7	● BT.709	47
● Equipped with a USB Hub function.....	7	● DCI-P3	48
1-2. Controls and Functions	8	● PQ_BT.2100.....	49
● Front	8	● PQ_DCI-P3.....	50
● Rear.....	9	● HLG_BT.2100.....	51
Chapter 2 Basic Adjustments/Settings	11	7-2. Setting Procedure.....	52
2-1. Switching Input Signals	11	● List of Setting Items.....	55
2-2. Switching the Display Mode (color mode) ...	11	7-3. Settings with ColorNavigator 7	56
● Display Modes.....	12	● Setting Procedure	56
● Color Mode Setting Values	13	● Target Settings of ColorNavigator 7.....	56
2-3. Using the Quick Check Function	14	Chapter 8 Troubleshooting	58
Chapter 3 Advanced Adjustments/Settings ... 15		8-1. No Picture	58
3-1. Basic Operation of the Setting Menu	15	8-2. Imaging Problems.....	59
3-2. Setting Menu Functions	17	8-3. SelfCalibration Problems.....	60
● Signal	17	8-4. Other Problems	61
● Color.....	19	Chapter 9 Reference	62
● SelfCalibration.....	26	9-1. Attaching the Installation Fixture	62
● Screen.....	27	9-2. Connecting Multiple External Devices	64
● Preferences.....	31	9-3. Making Use of the USB Hub Function	65
● Languages	34	● Connection Procedure	65
● Information	34	9-4. Specifications	66
Chapter 4 SelfCalibration	35	● Accessories.....	67
4-1. SelfCalibration functions.....	36	Appendix	68
4-2. Setting targets.....	38	Trademark	68
4-3. Executing.....	38	License	68
● Executing regardless of a schedule.....	38	Warning for Radio interference.....	69
● Executing by setting a schedule	38		
● Activating SelfCalibration in Standard Mode ...	38		
● Activating SelfCalibration in Advanced Mode ...	39		
4-4. Checking results	39		

Chapter 1 Introduction

This chapter describes the features of the monitor and the name of each control.

1-1. Features

● Large built-in high resolution 4K LCD that is advantageous for video production

- 31.1-inch widescreen monitor with support for DCI 4K resolution (4096 × 2160)
Supports the digital cinema standard for DCI 4K resolution of 4096 × 2160. In addition to 4K videos, which have a high resolution that is more than 4x greater than full HD, multiple full HD videos can be displayed at the same time.
- Faithful reproduction of video colors with a wide color gamut display
99 % of DCI is covered, for a highly accurate color management environment.
- Achieves a contrast ratio of 1,000,000:1*1
A high contrast ratio allows black to be displayed in a firmer tone.
*1 Standard value. Not a guaranteed value.
- Built-in IPS LCD panel with 178° horizontal and vertical wide viewing angles

● Support for HDR (High Dynamic Range) video

- Complies with the international HDR standards for movies and broadcasts
Supports both the HDR "PQ format" for streaming and movie production, and the HDR "Hybrid Log Gamma format" for broadcasts. The "PQ format" complies with the ITU-R BT.2100*2 and SMPTE ST2084*3 international HDR standards, and the "Hybrid Log Gamma format" complies with the ITU-R BT.2100 international HDR standard. This makes it possible to use the monitor for the color grading of a wide range of HDR content, such as movies and broadcasts.
*2 ITU-R is the International Telecommunication Union-Radio communication Sector.
*3 SMPTE is the Society of Motion Picture and Television Engineers.
- High brightness and high contrast ratio
High brightness and a high contrast ratio are achieved by installing a dedicated IPS LCD panel and a dedicated backlight unit with a high level of brightness.
- Built-in color mode function
Reproduces a color temperature, gamma, and color gamut compliant with ITU-R BT.2100 and other standards.
See ["Color Mode" \(page 20\)](#).

● Support for SDI signal input or output for long-distance transmissions

- Built-in SDI input terminals
This monitor is equipped with one SDI input terminal that supports up to 12G-SDI signals, and three SDI input terminals that support up to 3G-SDI signals.
- Built-in SDI output terminals that support through-out (active)

● Built-in mode for automatically switching to the optimal color settings

- Color Mode "SYNC_SIGNAL"

This monitor is equipped with a color mode (SYNC_SIGNAL) so you can automatically set the optimal values for the color settings of the monitor according to the input signal. If you use this mode, the color settings of the monitor automatically switch to the optimal color settings for HDR when the input signal is switched from SDR to HDR, so setting the colors manually is not necessary.

● Various functions that support color grading work

- Dedicated video production functions, such as a Gamut Warning function and a Luminance Warning function

See [“Chapter 3 Advanced Adjustments/Settings” \(page 15\)](#).

- 4K Zoom function

When a 4K2K signal (a signal with a resolution of 4096 × 2160 or 3840 × 2160) is displayed on the monitor, the specified area can be doubled in size. This is convenient for checking details in an image.

See [“Zoom” \(page 28\)](#).

- User-defined custom key function

Work efficiency can be improved by assigning frequently used functions to the buttons on the front of the monitor.

See [“Chapter 5 Custom Key Settings” \(page 40\)](#).

- Quick Check function

Use the Quick Check function to check signals for which you can temporarily change the brightness, gamma, or other settings.

- Displays HDCP (High Bandwidth Digital Protection) protected content

- Monitor hood included as standard

Includes a monitor hood that effectively prevents reflections from external light, such as the reflected glare of a light. The monitor hood uses magnets for easy attachment and removal.

- SelfCalibration function

The built-in calibration sensor enables the monitor to calibrate itself by using SelfCalibration.

See [“Chapter 4 SelfCalibration” \(page 35\)](#).

● Equipped with a USB Hub function

- Supports USB 3.1 Gen 1

Achieves high-speed data transfers of up to 5 Gbps, which enables transfers of large amounts of data to and from USB memory devices in a short amount time.





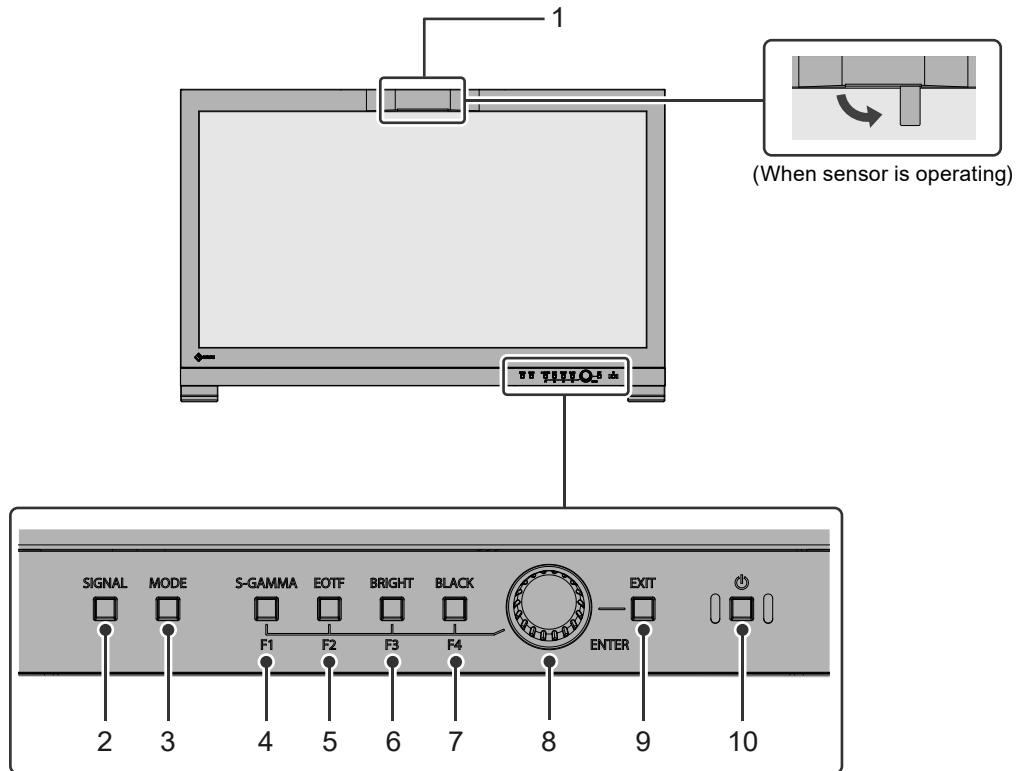

Also, the  USB downstream port supports quick charging, so you can recharge your smartphone or tablet in a short period of time.

See [“9-3. Making Use of the USB Hub Function” \(page 65\)](#) and [“USB CHARGE Port” \(page 31\)](#).

1-2. Controls and Functions

● Front



1. Built-in calibration sensor	Executes calibration for monitors. By executing SelfCalibration, the calibration sensor automatically operates and regularly calibrates the monitor (page 35).
2.  (SIGNAL) button	Switches the input signal.
3.  (MODE) button	Switches the color mode.
4.  (S-GAMMA (F1)) button	The function assigned to the button is executed. The indicator color differs depending on the function settings.
5.  (EOTF (F2)) button	Blue : The Quick Check function is enabled
6.  (BRIGHT (F3)) button	White : The Quick Check function is disabled
7.  (BLACK (F4)) button	OFF : A function other than the Quick Check function is assigned
8. Dial	Turn the dial to the left or right to select items on the Setting menu and adjust the setting values. The Setting menu appears when you press the dial. Press the dial to confirm the settings after you are finished.
9.  (EXIT) button	Returns to the previous screen.
10. Power button	Turns the power on or off. The indicator is lit when you turn the power on. The indicator color differs depending on the monitor's operation status. White : Normal operating mode Orange : Power saving mode OFF : Power off

● Rear

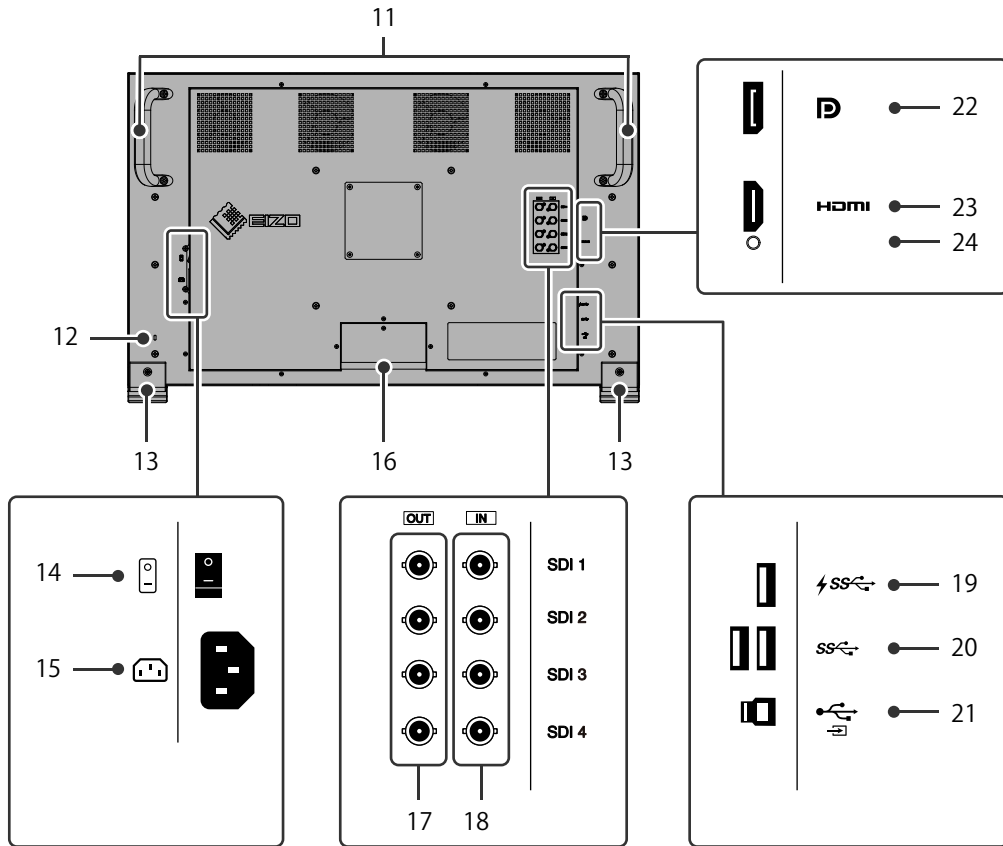

11. Transportation handle	<p>This handle is used for transportation.</p> <p>Attention</p> <ul style="list-style-type: none"> With help from one other person, firmly grasp and hold the monitor by the bottom while grabbing the handle, and carefully convey the monitor so as not to drop it.
12. Security lock slot	<p>Complies with Kensington's MicroSaver security system.</p>
13. Stand	<p>The height and angle cannot be adjusted.</p>
14. Main power switch	<p>Turns the main power on or off.</p> <p>⏻: On ⏻: Off</p>
15. Power connector	<p>Connects the power cord.</p>
16. Cable holder	<p>Covers the monitor cables.</p> <p>Attention</p> <ul style="list-style-type: none"> Do not hold the monitor by the cable holder when transporting the monitor. The cable holder may be damaged, or this may result in other injury or damage.
17. SDI output terminal (BNC)	<p>The signal input to the SDI input terminal is output.</p> <p>SDI 1 supports 12G/6G/3G/HD-SDI.</p> <p>SDI 2, SDI 3, and SDI 4 support 3G/HD-SDI.</p> <p>Attention</p> <ul style="list-style-type: none"> This product supports through-out (active). When outputting the signal, turn the main power of the monitor on.
18. SDI input terminal (BNC)	<p>Connects to a device that has SDI output.</p> <p>SDI 1 supports 12G/6G/3G/HD-SDI.</p> <p>SDI 2, SDI 3, and SDI 4 support 3G/HD-SDI.</p>

19. USB Type-A connector (USB downstream port, supports quick charging)	Connects to a peripheral USB device (page 31).
20. USB Type-A connector (USB downstream port)	Connects to a peripheral USB device.
21. USB Type-B connector (USB upstream port)	Connects to the USB cable when using software that requires a USB connection, or when using the USB Hub function (page 65).
22. DisplayPort connector	Connects to an external device that has DisplayPort output.
23. HDMI connector	Connects to an external device that has HDMI output.
24. Opening for HDMI cable fixing clamp	This is used to fix the HDMI cable clamp in place.

Chapter 2 Basic Adjustments/Settings

This chapter describes the basic functions that can be set by pressing the buttons on the front of the monitor. For advanced adjustment and setting procedures using the Setting menu, see “Chapter 3 Advanced Adjustments/Settings” (page 15).

2-1. Switching Input Signals

When a monitor has multiple signal inputs, the signal to display on-screen can be changed.

Press the ^{SIGNAL} (SIGNAL) button to display the menu for selection of the input signal.

Turn the dial to select the input signal that you want to display, and then press the dial to confirm the settings.

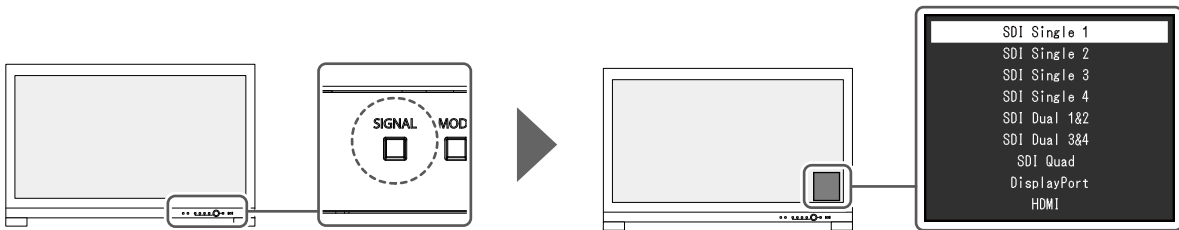

2-2. Switching the Display Mode (color mode)

This function allows easy selection of a display mode according to monitor application.

Press the ^{MODE} (MODE) button to display the menu for selection of the color mode.

Turn the dial to select the color mode that you want to display, and then press the dial to confirm the settings.

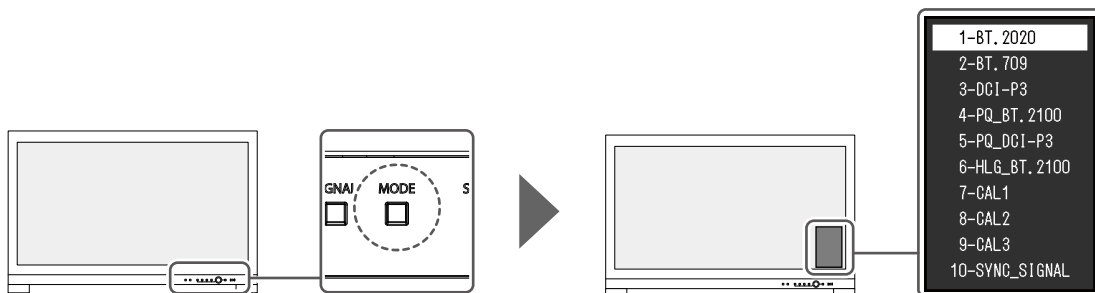

● Display Modes

Color Mode	Purpose
Standard Mode	Adjust color using the monitor's Setting menu.
BT.2020	See "Color Mode Setting Values" (page 13) for detailed setting values for each color mode.
BT.709	
DCI-P3	
PQ_BT.2100	
PQ_DCI-P3	
HLG_BT.2100	
SYNC_SIGNAL	
Advanced Mode	Adjusts the monitor's display using the monitor's SelfCalibration function or color management software "ColorNavigator 7".
CAL1	Displays the screen adjusted by SelfCalibration or ColorNavigator 7.
CAL2	
CAL3	

Note

- If you switch between SDR color modes (BT.2020, BT.709, and DCI-P3) and HDR color modes (PQ_BT.2100, PQ_DCI-P3, and HLG_BT.2100), wait 30 minutes or more after switching the color modes, and then adjust the monitor.

● Color Mode Setting Values

-: Cannot be changed

Item	Color Mode									
	BT.2020	BT.709	DCI-P3	PQ_ BT.2100	PQ_ DCI-P3	HLG_ BT.2100	CAL1 / CAL2 / CAL3	SYNC_ SIGNAL		
Brightness (cd/m ²)	100	100	48	1000	1000	1000	-	100 ^{*1}		
Temperature	D65	D65	D65	D65	D65	D65	-	D65		
Gamma (EOTF)	2.4	2.4	2.6	PQ	PQ	HLG	-	2.4 ^{*1}		
PQ Option	-	-	-	1000 cd/m ² Clipping	1000 cd/m ² Clipping	-	-	-		
HLG System Gamma	-	-	-	-	-	1.2	-	-		
Color Gamut	BT.2020	BT.709	DCI	BT.2020	DCI	BT.2020	-	BT.709 ^{*1}		
Advanced Settings	Hue	0	0	0	0	0	-	0		
	Saturation	0	0	0	0	0	-	0		
	Gamut Clipping	On	On	On	On	On	-	On		
	XYZ Format	-	-	Off	-	Off	-	-		
	Gain	Red	Calculated from color temperature					-	Calculated from color temperature	
		Green						-		
		Blue						-		
	Black Level	All	0	0	0	0	0	-	0	
		Red	0	0	0	0	0	-	0	
		Green	0	0	0	0	0	-	0	
		Blue	0	0	0	0	0	-	0	
	6 Colors	Magenta	Hue	0	0	0	0	0	-	0
			Saturation	0	0	0	0	0	-	0
			Lightness	0	0	0	0	0	-	0
		Red	Hue	0	0	0	0	0	-	0
			Saturation	0	0	0	0	0	-	0
			Lightness	0	0	0	0	0	-	0
Yellow		Hue	0	0	0	0	0	-	0	
		Saturation	0	0	0	0	0	-	0	
		Lightness	0	0	0	0	0	-	0	
Green		Hue	0	0	0	0	0	-	0	
		Saturation	0	0	0	0	0	-	0	
		Lightness	0	0	0	0	0	-	0	
Cyan	Hue	0	0	0	0	0	-	0		
	Saturation	0	0	0	0	0	-	0		
	Lightness	0	0	0	0	0	-	0		
Blue	Hue	0	0	0	0	0	-	0		
	Saturation	0	0	0	0	0	-	0		
	Lightness	0	0	0	0	0	-	0		

*1 This is set automatically according to the input signal. If the value cannot be retrieved from the input signal, the value shown in the table is set.

Note

- Use ColorNavigator 7 to set CAL1 / CAL2 / CAL3. These settings cannot be changed in the Setting menu on the monitor.
 - A color mode can be set for each input signal.
 - See “Color” (page 19) for details about each item.
 - You can disable specific mode selections. For more information, see “Mode Skip” (page 32).
-

2-3. Using the Quick Check Function

This function is for temporarily changing the HLG System Gamma, Gamma (EOTF), Brightness, and Black Level Lift.

1. Executing Quick Check

1. Press the button for an item you want to check (HLG System Gamma: ^{S-GAMMA}, Gamma (EOTF): ^{EOTF}, Brightness: ^{BRIGHT}, Black Level Lift: ^{BLACK}) to change the setting value temporarily.

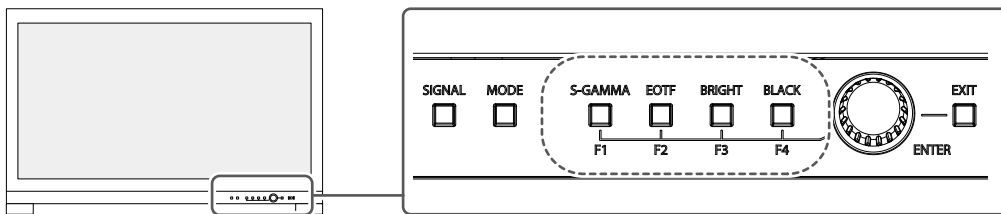

The Quick Check function is executed.

2. Setting

1. Use the buttons to adjust/set the selected item, and then press the dial to confirm the settings. The setting value will be changed temporarily.

Note

- When the button for ^{S-GAMMA} (S-GAMMA), ^{EOTF} (EOTF), ^{BRIGHT} (BRIGHT), or ^{BLACK} (BLACK) is lit up in blue, the Quick Check function is being executed.
-

3. Exiting Quick Check

1. Press the button for ^{S-GAMMA} (S-GAMMA), ^{EOTF} (EOTF), ^{BRIGHT} (BRIGHT), or ^{BLACK} (BLACK) that is lit up in blue.

The setting value returns to the state prior to making changes.

Note

- Quick Check can also be exited using the following operations:
 - Turn the power on or off using the main power switch or power button
 - Switch the input signal or color mode
 - Execute "Reset" in the "Color" menu
 - Execute "Monitor Reset" in the "Preferences" menu
 - Execute SelfCalibration
 - Start ColorNavigator 7
 - Change the assignment of the custom key to a function other than Quick Check (see “5-2. Assigning a Function to a Custom Key” (page 40))
 - Change the HLG System Gamma, Gamma (EOTF), Brightness, or Black Level Lift in the Setting menu
-

Chapter 3 Advanced Adjustments/Settings

This chapter describes the advanced monitor adjustment and setting procedures using the Setting menu. For the basic setting functions using the buttons on the front of the monitor, see “Chapter 2 Basic Adjustments/Settings” (page 11).

3-1. Basic Operation of the Setting Menu

1. Menu display

1. Press the dial.

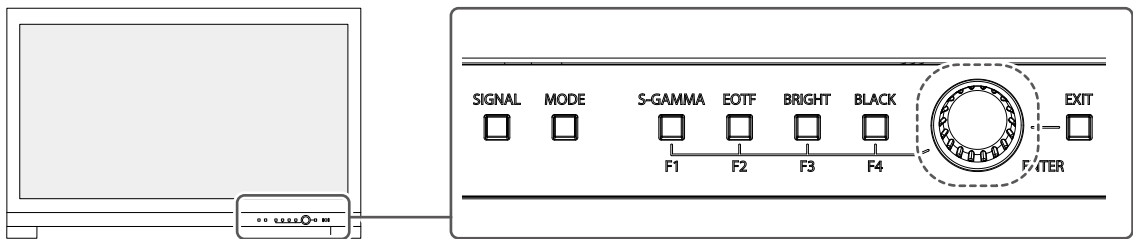

The Setting menu appears.



2. Adjusting/setting

1. Turn the dial to choose a menu to adjust/set, and then press the dial.

The Sub menu appears.

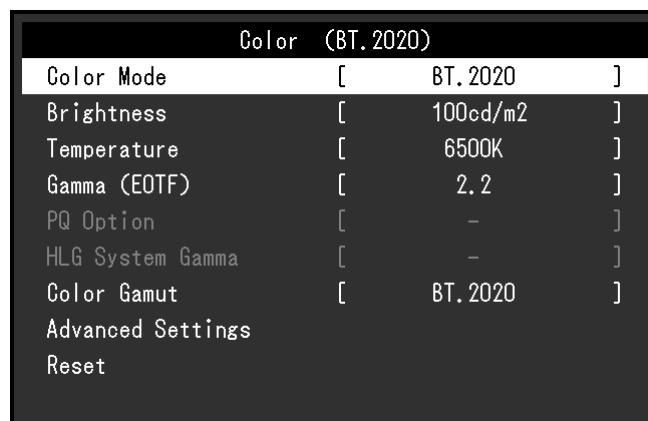

- Turn the dial to choose an item to adjust/set, and then press the dial.
The Adjustment/Setting menu appears.



- Turn the dial to adjust/set the selected item, and then press the dial to confirm the settings.
The Sub menu appears.

Pressing the ^{EXIT} (EXIT) button during adjustment/setting will cancel the adjustment/setting and restore the state prior to making changes.

3. Exiting

- Press the ^{EXIT} (EXIT) button.
The Setting menu appears.
- Press the ^{EXIT} (EXIT) button.
The Setting menu exits.

3-2. Setting Menu Functions

● Signal

The signal settings are used to configure advanced settings for input signals, such as the color format and input range.

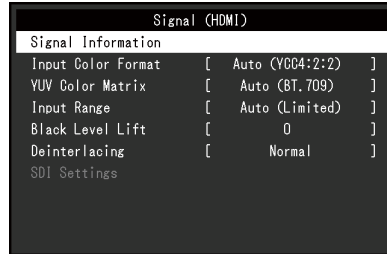

Function	Settings	Description
Signal Information	-	<p>You can check the information for the input signal. The information displayed may differ depending on the input signal.</p> <ul style="list-style-type: none"> • SDI <div data-bbox="842 855 1342 1176" data-label="Image"> </div> • DisplayPort <div data-bbox="842 1272 1342 1592" data-label="Image"> </div> • HDMI <div data-bbox="842 1688 1342 2009" data-label="Image"> </div>

Function	Settings	Description
Input Color Format	Auto YUV 4:2:2*1 YUV 4:4:4*1 YUV*2 RGB*1 *2 YCC4:2:2 10bit*3 YCC4:2:2 12bit*3 YCC4:4:4 10bit*3 YCC4:4:4 12bit*3 RGB4:4:4 10bit*3 RGB4:4:4 12bit*3	The color space of the input signal can be specified. Try changing this setting if colors are not displayed correctly. Normally, select "Auto". When an SDI signal is input, the bit depth is specified using the Input Color Format. If the specified bit depth is invalid, a signal error is displayed.

*1 Only enabled during HDMI input

*2 Only enabled during DisplayPort input

*3 Only enabled during SDI input. To apply the settings to the input signal, you must press the dial to confirm the settings.

Function	Settings	Description
YUV Color Matrix	Auto BT.601 BT.709 BT.2020	Select the YUV format of the input signal. Use this setting for gradation collapse or other occurrences where the screen is displayed incorrectly because of a problem with the input signal.
Input Range	Auto Full Limited (109% White) Limited SDI Full	Depending on the external device, the black and white levels in the video signal output to the monitor may be restricted. If the signal is displayed on the monitor in its restricted form, the blacks will be faint, the whites dull, and contrast will be reduced. The brightness range of such signals can be extended to match the actual contrast ratio of the monitor. <ul style="list-style-type: none"> • "Auto" The monitor automatically recognizes the brightness range of input signals and displays images appropriately. • "Full" The input signal brightness range is not extended. • "Limited (109% White)" The brightness range of the input signal is extended from 16 - 254 (10 bits: 64 - 1019) to 0 - 255 (10 bits: 0 - 1023) for display. • "Limited" The brightness range of the input signal is extended from 16 - 235 (10 bits: 64 - 940) to 0 - 255 (10 bits: 0 - 1023) for display. • "SDI Full" The brightness range of the input signal is extended from 1 - 254 (10 bits: 4 - 1019) to 0 - 255 (10 bits: 0 - 1023) for display.
Black Level Lift	-500 to 500	The black video level is changed without changing the white video level of the input signal.
Deinterlacing	Normal Line Doubler	Select the IP conversion format. Normally, it is not necessary to change this setting from "Normal".

Function		Settings	Description
SDI Settings	Time Code Settings	Time Code Format Position Size	The time code can be set. <ul style="list-style-type: none"> Time Code If this function is set to "On", the time code is displayed. Format You can choose either "VITC" or "LTC" for the format of the time code. Position You can choose either "Top" or "Bottom" for the position to display the time code. Size You can choose either "Small" or "Large" for the size of the time code.
	Interlace / PsF	Auto Interlace PsF	When an SDI signal other than progressive is input, the display format can be set.

● Color

The setting details differ depending on the color mode selected.

When the color mode is Standard Mode (BT.2020 / BT.709 / DCI-P3 / PQ_BT.2100 / PQ_DCI-P3 / HLG_BT.2100 / SYNC_SIGNAL)

Each color mode setting can be adjusted according to personal preference.

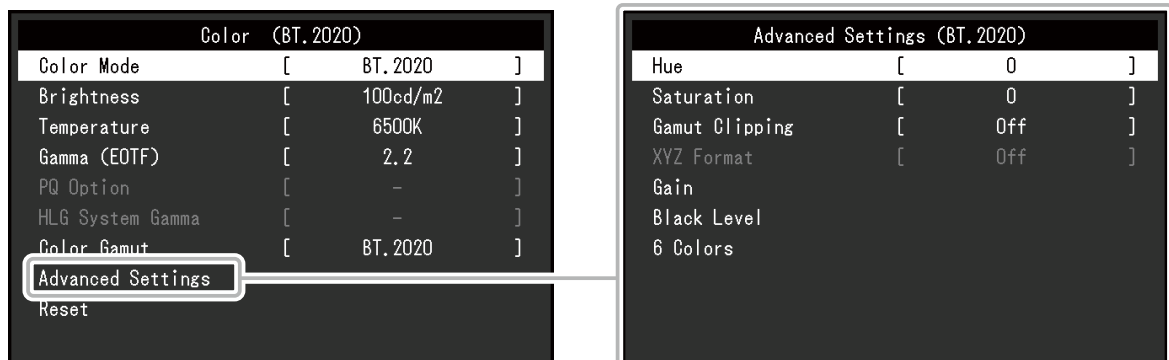

Attention

- The same image may be seen in different colors on multiple monitors due to differences between individual monitors. Make fine color adjustment visually when matching colors on multiple monitors.

Note

- If "Color Mode" is "SYNC_SIGNAL", the "Brightness", "Gamma (EOTF)", and "Color Gamut" are automatically set according to the input signal and cannot be changed.
- Use the values shown in "cd/m²" and "K" as a guide only.

Function	Settings	Description
Color Mode	BT.2020 BT.709 DCI-P3 PQ_BT.2100 PQ_DCI-P3 HLG_BT.2100 CAL1 CAL2 CAL3 SYNC_SIGNAL	Switch to the desired mode according to the monitor application. Note <ul style="list-style-type: none"> For more information on how to switch modes, see “2-2. Switching the Display Mode (color mode)” (page 11). Regarding "CAL1 / CAL2 / CAL3" see page 24.
Brightness	48 cd/m ² to 1000 cd/m ²	The screen brightness is adjusted by changing the brightness of the backlight (light source from the LCD back panel). Note <ul style="list-style-type: none"> If a value that cannot be set is selected, the value will appear in magenta. In such a case, change the value. 48 cd/m² to 300 cd/m² can be set in increments of 1, and 300 cd/m² to 1000 cd/m² can be set in increments of 100.
Temperature	Native 4000 K to 10000 K D50 D65 D65 (CRT) DCI User	The color temperature can be adjusted. The color temperature is used to express the chromaticity of "White". The value is expressed in degrees "K" (Kelvin). The screen becomes reddish at a low color temperature, and bluish at a high color temperature, like the temperature of a flame. Specify a color temperature in units of 100 K, or select a standard name. Note <ul style="list-style-type: none"> Select "Native" to display the original colors of the LCD panel. "Gain" allows you to perform more advanced adjustment. When gain is changed, the color temperature is changed to "User". The gain preset values are set for each color temperature setting value.
Gamma (EOTF)	1.6 to 2.7 sRGB EBU(2.35) PQ HLG	Adjust the gamma. The brightness of the monitor varies depending on the input signal, however, the variation rate is not simply proportional to the input signal. The control performed to keep the balance between the input signal and the brightness of the monitor is called "Gamma correction". Set the gamma, or select a standard name. Note <ul style="list-style-type: none"> If you select "HLG", you must set "HLG System Gamma".

Function	Settings	Description
PQ Option	300cd/m ² Clipping 500cd/m ² Clipping 1000cd/m ² Clipping 4000cd/m ² Emulation 10000cd/m ² Emulation	<p>Areas with brightness equal to or greater than the value set here are displayed as clipping or emulation at this setting value for the PQ signal that is input to the monitor.</p> <ul style="list-style-type: none"> • 300cd/m² Clipping Setting used to check the display of monitor with maximum brightness of 300 cd/m². Input video level of 637 (10 bits) or more is clipped. • 500cd/m² Clipping Setting used to check the display of monitor with maximum brightness of 500 cd/m². Input video level of 693 (10 bits) or more is clipped. • 1000cd/m² Clipping Set the brightness to 1000 cd/m² to display properly. Input video level of 770 (10 bits) or more is clipped. • 4000cd/m² Emulation Setting with which the image is properly displayed when monitor brightness is set to 4000 cd/m². This setting is used for a temporarily check because this monitor cannot display 4000 cd/m². All gradients are emulated. Input video level of 924 (10 bits) or more is clipped. • 10000cd/m² Emulation Setting with which the image is properly displayed when monitor brightness is set to 10000 cd/m². This setting is used for a temporarily check because this monitor cannot display 10000 cd/m². All gradients are emulated. <p>Note</p> <ul style="list-style-type: none"> • This can be set when "PQ" is specified for "Gamma (EOTF)". • You can check the areas where clipping or emulation occurs. For more information, see "Luminance Warning" (page 29). • For relation between input and output for each setting, see "Setting of PQ Option and Display" (page 22).
HLG System Gamma	1.0 to 1.5	<p>Adjust the system gamma value for the HLG signal that is input to the monitor.</p> <p>Note</p> <ul style="list-style-type: none"> • This can be set when "HLG" is specified for "Gamma (EOTF)".
Color Gamut	Native Adobe [®] RGB sRGB EBU BT.709 BT.2020 SMPTE-C DCI-P3	<p>Set the color reproduction area (color gamut). "Color Gamut" is the range of colors that can be represented. Multiple standards are defined.</p> <p>Note</p> <ul style="list-style-type: none"> • Select "Native" to display the original color gamut of the LCD panel. • The method of displaying colors outside the monitor's displayable range within the defined color gamut can be set. For more information, see "Gamut Clipping" (page 23).

Setting of PQ Option and Display

This section describes the setting of PQ Option and the relation between the input signal (10 bits: 0 - 1023) and the brightness displayed on the monitor.

Note

- This relation assumes that the input signal is full range (and that "Input Range" in "Signal" is set to "Full").

● 300 cd/m² Clipping, 500 cd/m² Clipping, and 1000 cd/m² Clipping

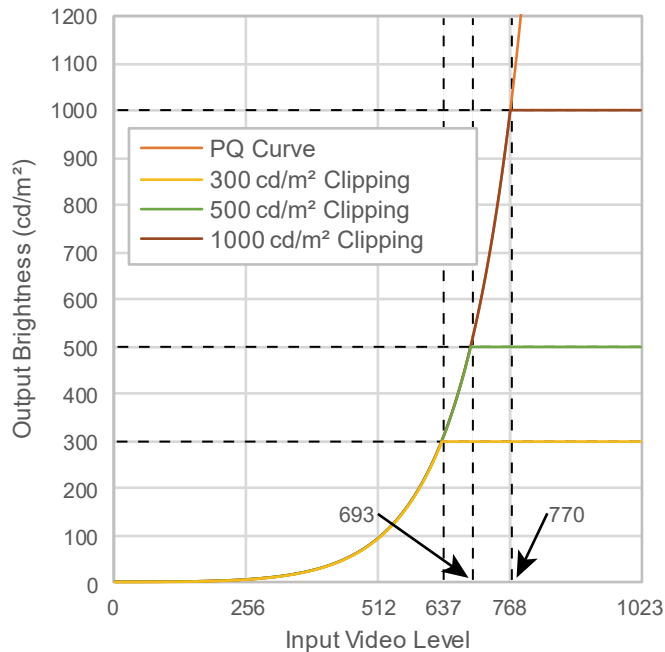

- Set the brightness to the specified value to display properly.
- Example: When PQ Option is set to 300cd/m² Clipping, set the monitor brightness to 300 cd/m².

● 4000 cd/m² Emulation and 10000 cd/m² Emulation (Monitor brightness setting: 1000 cd/m²)

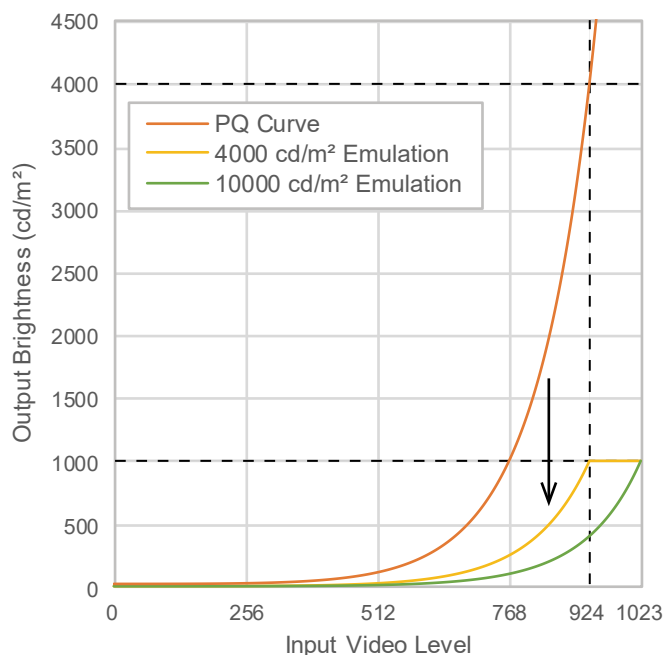

- This setting is used for a temporarily check.
- Example: When PQ Option is set to 4000cd/m² Emulation, the representation of gradation is equivalent to that of the monitor with the maximum brightness of 4000 cd/m². In this case, the representation of gradation is decreased according to the brightness setting of this monitor because it has the maximum brightness of 4000 cd/m² or less.

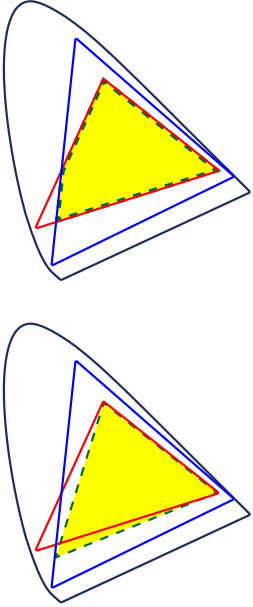
Function		Settings	Description
Advanced Settings	Hue	-100 to 100	<p>The hue can be adjusted.</p> <p>Note</p> <ul style="list-style-type: none"> Using this function may make some color gradations unavailable for display.
	Saturation	-100 to 100	<p>The saturation can be adjusted.</p> <p>Note</p> <ul style="list-style-type: none"> Using this function may make some color gradations unavailable for display. The minimum value (-100) changes the screen to monochrome.
	Gamut Clipping	On Off	<p>The method of displaying colors outside the monitor's displayable range within the color gamut specified in accordance with "Color Gamut" (page 21) can be set.</p> <ul style="list-style-type: none"> "On" <ul style="list-style-type: none"> The range of colors that are displayable on the monitor will be accurately displayed in accordance with the standard. Colors outside the displayable range will be saturated. "Off" <ul style="list-style-type: none"> Displays colors with priority on the color gradation rather than the color accuracy. The vertices of the color gamut defined in the standard move to a range that can be displayed by the monitor. This allows the closest colors displayable by the monitor to be displayed. <div style="text-align: right;">  </div> <div style="text-align: right; margin-top: 10px;"> <p>— Color gamut displayable by the monitor</p> <p>— Color gamut defined by standard</p> <p>- - - Color gamut displayed on screen</p> </div> <p>Note</p> <ul style="list-style-type: none"> The diagrams shown above are conceptual diagrams, and they do not display the actual color gamut of the monitor. This setting will be disabled if "Native" is selected at "Color Gamut" (page 21).
XYZ Format	On Off	<p>If this function is set to "On", the XYZ signal for digital cinema can be displayed on the monitor.</p> <p>Note</p> <ul style="list-style-type: none"> This can be set only when "Color Gamut" (page 21) is set to "DCI-P3". If you select "On", you cannot set "Color Gamut". 	

Function		Settings	Description
Advanced Settings	Gain	0 to 2000	The brightness of each color component red, green, and blue is called Gain. The chromaticity of "white" can be changed by adjusting the gain. Note <ul style="list-style-type: none"> Using this function may make some color gradations unavailable for display. The gain value changes according to the color temperature. When gain is changed, the color temperature is changed to "User".
	Black Level	0 to 1500	You can adjust the brightness and chromaticity for black by adjusting the levels of red, green, and blue, or by adjusting all of the black levels. Display the black test pattern or the background and adjust the black level.
	6 Colors	-100 to 100	The hue, saturation and lightness (brightness) can each be adjusted for the colors Magenta, Red, Yellow, Green, Cyan, and Blue.
Reset		-	Resets any color adjustment values for the currently selected color mode back to the default settings.

When the color mode is Advanced Mode (CAL1 / CAL2 / CAL3)

You can set targets for SelfCalibration and execute calibration.

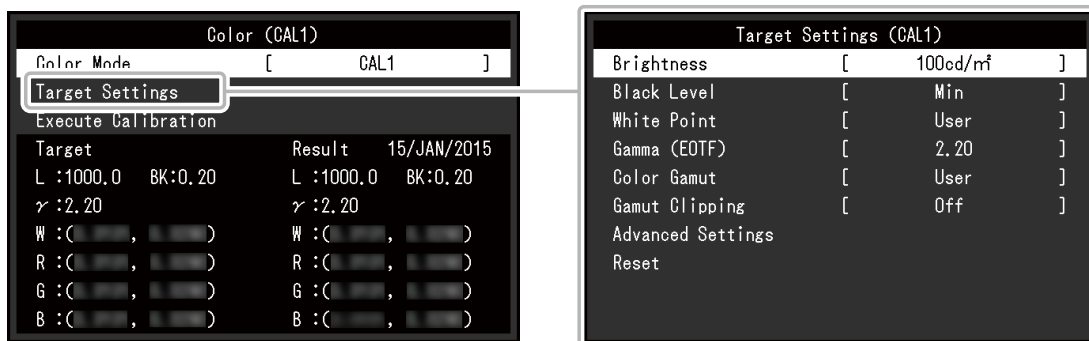

Function		Settings	Description
Color Mode		BT.2020 BT.709 DCI-P3 PQ_BT.2100 PQ_DCI-P3 HLG_BT.2100 CAL1 CAL2 CAL3 SYNC_ SIGNAL	Switch to the desired mode according to the monitor application. Note <ul style="list-style-type: none"> For more information on how to switch modes, see "2-2. Switching the Display Mode (color mode)" (page 11). Regarding "BT.2020 / BT.709 / DCI-P3 / PQ_BT.2100 / PQ_DCI-P3 / HLG_BT.2100", see page 19.
Target Settings	Brightness	Min 48 cd/m ² to 1000 cd/m ² Max	Set the brightness that will be used as a calibration target for SelfCalibration. Note <ul style="list-style-type: none"> 48 cd/m² to 300 cd/m² can be set in increments of 1, and 300 cd/m² to 1000 cd/m² can be set in increments of 100.
	Black Level	Min 0.2 to 3.5	Set the black level that will be used as a calibration target for SelfCalibration.

Function		Settings	Description
Target Settings	White Point	Temperature	4000 K to 10000 K User D50 D65 D65 (CRT) DCI-P3
		White(x) / White(y)	0.2400 to 0.4500
	Gamma (EOTF)	Gamma (EOTF)	1.0 to 2.7 sRGB EBU(2.35) L* PQ HLG Fixed
		Gamma Policy	Standard Gray Balance Fixed Gamma
		PQ Option	300cd/m ² Clipping 500cd/m ² Clipping 1000cd/m ² Clipping 4000cd/m ² Clipping Emulation 10000cd/m ² Emulation
HLG System Gamma	1.0 to 1.5		
			<p>Set the White Point that will be used as a calibration target for SelfCalibration.</p> <p>Set the White Point using the color coordinates (White(x) / White(y)) or color temperature.</p> <p>When specifying color coordinates, set the values for "White(x)" and "White(y)", respectively.</p> <p>When specifying the color temperature, set the color temperature in units of 100 K or select a color temperature according to each standard.</p> <p>Note</p> <ul style="list-style-type: none"> When color coordinates are specified, the color temperature is changed to "User".
			<p>Set the gamma that will be used as a calibration target for SelfCalibration.</p> <p>Set the gamma, or select the gamma curve defined by each standard.</p> <p>Note</p> <ul style="list-style-type: none"> The "Gamma (EOTF)" becomes "Fixed" when adjusting with ColorNavigator 7.
			<p>Select the gamma adjustment method for SelfCalibration.</p> <ul style="list-style-type: none"> "Standard" Adjust the gray balance while retaining the contrast. "Gray Balance" Adjust the monitor so that the chromaticity of the middle tone area equals the white point. "Fixed Gamma" Select to use specific gamma settings. <p>Attention</p> <ul style="list-style-type: none"> If "HLG" is specified for "Gamma (EOTF)", "Fixed Gamma" is selected and this setting cannot be changed. With "Gray Balance", all points of the grayscale are adjusted toward the target white point. Select this to prioritize whiteness when correcting the middle tone area. However, the following restrictions apply when "Gray Balance" is selected: <ul style="list-style-type: none"> The contrast may decrease. The color gamut may be narrower than when adjusting with "Fixed Gamma".
			<p>Set the PQ Option that will be used as a calibration target for SelfCalibration.</p> <p>Note</p> <ul style="list-style-type: none"> This can be set when "PQ" is specified for "Gamma (EOTF)".
			<p>Set the HLG system gamma that will be used as a calibration target for SelfCalibration.</p> <p>Note</p> <ul style="list-style-type: none"> This can be set when "HLG" is specified for "Gamma (EOTF)".

Function		Settings	Description	
Target Settings	Color Gamut	Native Adobe®RGB sRGB EBU BT.709 BT.2020 SMPTE-C DCI-P3 User	Set the color gamut that will be used as a calibration target for SelfCalibration. In "Color Gamut", the color gamut defined by each standard can be selected. To set a color gamut other than those specified by each standard, specify the color coordinates of each RGB color, and the display method ("Gamut Clipping") of colors outside the color gamut of the monitor. Note	
		Red(x) / Red(y) / Green(x) / Green(y) / Blue(x) / Blue(y)	0.0000 to 1.0000 • When you select "Native" in "Color Gamut", the preset color gamut of the LCD panel is displayed. • When color coordinates are specified in the color gamut settings, the color gamut is changed to "User".	
	Gamut Clipping		On Off	
	Advanced Settings	Limited (109% White)	On Off	Set whether the brightness range of the input signal is extended from 16 - 254 (10 bits: 64 - 1019) to 0 - 255 (10 bits: 0 - 1023) for display. Note • This can be set when "1.0 to 2.7" is specified for "Gamma (EOTF)".
Reset		-	Resets any calibration targets for the currently selected color mode back to the default settings.	

● SelfCalibration

Refer to ["4-1. SelfCalibration functions"](#) (page 36).

● Screen

The signal settings are used to configure advanced settings for input signals, such as the screen display size and color format.

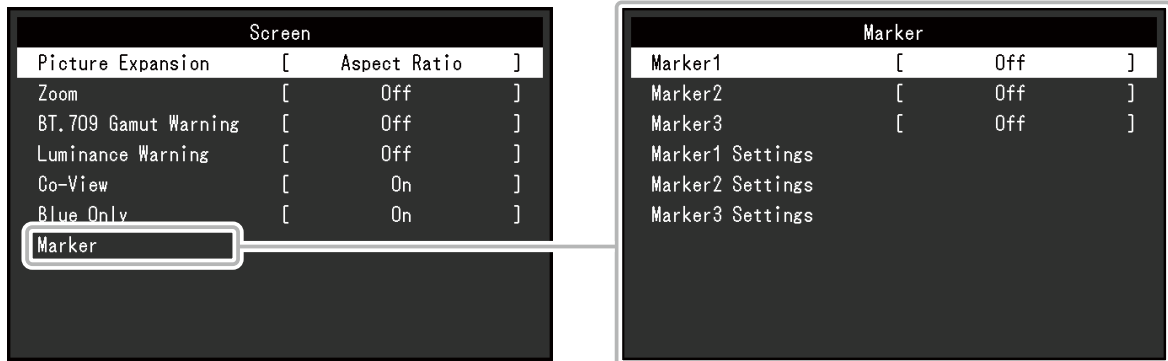

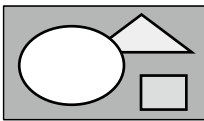
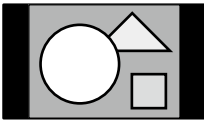
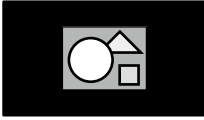
Function	Settings	Description
Picture Expansion	Auto Full Screen Aspect Ratio Dot by Dot	<p>The screen size of the monitor display can be changed.</p> <ul style="list-style-type: none"> • "Auto" The monitor automatically changes the screen size according to the resolution information and aspect ratio information from the input signal (only for HDMI input). • "Full Screen" Displays an image in full screen. Images are distorted in some cases because the vertical rate is not equal to the horizontal rate. • "Aspect Ratio" Displays an image in full screen. However, since aspect ratios are maintained, part of an image may not be visible in horizontal or vertical direction. • "Dot by Dot" Displays the image at the set resolution or at the size specified by the input signal. <p>Note</p> <ul style="list-style-type: none"> • Example settings <ul style="list-style-type: none"> - Full Screen  - Aspect Ratio  - Dot by Dot (Input Signal) 

Function	Settings	Description
Zoom	Off Center Lower Left Upper Left Upper Right Lower Right	<p>When a 4K2K signal (a signal with a resolution of 4096 × 2160 or 3840 × 2160) is displayed on the monitor, the specified area can be doubled in size. This is convenient for checking details in an image.</p> <div data-bbox="742 347 1396 548" style="text-align: center;"> </div> <p>Note</p> <ul style="list-style-type: none"> You cannot use this function with a 4K 60 Hz / 50 Hz HDMI signal.
BT.709 Gamut Warning	Off Clip On	<p>If a signal that complies with the ITU-R BT.2020 standard is input, you can set the display method for colors that exceed the color gamut for the BT.709 standard.</p> <ul style="list-style-type: none"> "Off" Images are displayed according to the color gamut for BT.2020. (The actual color gamut that is displayed on the monitor will depend on the setting for "Gamut Clipping" (page 23).) <div data-bbox="774 985 1356 1164" style="text-align: center;"> </div> <ul style="list-style-type: none"> "Clip" Colors that are outside of the color gamut for BT.709 are expressed within the color gamut for BT.709 (clipping occurs). <div data-bbox="774 1310 1356 1489" style="text-align: center;"> </div> <ul style="list-style-type: none"> "On" Colors that are outside of the color gamut for BT.709 are displayed in gray. <div data-bbox="774 1635 1356 1814" style="text-align: center;"> </div> <p>Note</p> <ul style="list-style-type: none"> This function can be set only when "Color Gamut" (page 21) is set to "BT.2020". This function and "Luminance Warning" cannot be enabled at the same time. If this function is set to "On" or "Clip", the "Luminance Warning" function is automatically set to "Off".

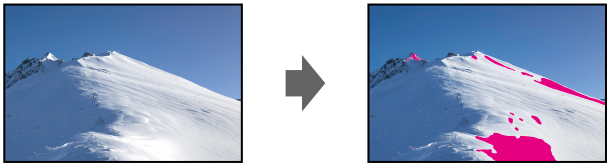
Function	Settings	Description
Luminance Warning	Off On (Yellow) On (Magenta)	<p>You can check areas with a brightness that is higher than the brightness that is set for the PQ Option function for the input signal (areas where clipping occurs).</p> <p style="text-align: right;">Example: Setting On (Magenta)</p>  <p>Note</p> <ul style="list-style-type: none"> This function and "BT.709 Gamut Warning" cannot be enabled at the same time. If this function is set to "On", the "BT.709 Gamut Warning" function is automatically set to "Off".
Co-View	Off On	<p>If this function is set to "On", the monitor can be easily viewed at a wider angle, such as when multiple people are looking at the monitor at the same time.</p> <p>Note</p> <ul style="list-style-type: none"> If small dots or fine lines that should be brighter are displayed a little too darkly, there are cases when this problem can be solved by setting this function to "Off". However, a halo effect might occur when this function is set to "Off".
Blue Only	Off On	Use this function to check the noise.

Function	Settings	Description	
Marker	Marker 1	Off On On (3 division grid)	<p>If this function is set to "On", markers are displayed. If "On (3 division grid)" is set, boundary lines are displayed that divide the image into three equal parts with Marker 1 and Marker 1.</p> <p>Note</p> <ul style="list-style-type: none"> If "On (3 division grid)" is set, "Marker 2" and "Marker 3" are disabled.
	Marker 2 Marker 3	Off On	If this function is set to "On", markers are displayed.
	Marker1 Settings Marker2 Settings Marker3 Settings	Type Aspect Dots (Center) Dots (Free)	You can select the position and size of the marker.
		Aspect 4:3 13:9 14:9 15:9 16:9 21:9 1.85:1 2.35:1 2.39:1 User	You can set the aspect ratio for the displayed marker.
		Aspect (User) 1.00:1 to 3.00:1	You can set the aspect ratio for the displayed marker freely. This can only be set when "User" is selected for "Aspect".





Function		Settings		Description
Marker	Marker1 Settings Marker2 Settings Marker3 Settings	Area Size	50.0 % to 100.0 % User	You can set the size of the area. This can only be set when "Aspect" is selected for "Type".
		Hor. Position	*1	You can set the horizontal position of the marker. This can only be set when "Dots (Free)" is selected for "Type".
		Ver. Position	*1	You can set the vertical position of the marker. This can only be set when "Dots (Free)" is selected for "Type".
		Width	*1	You can set the width of the marker. This can only be set when "Dots (Free)" or "Dots (Center)" is selected for "Type", or when "Aspect" is selected for "Type" and "User" is selected for "Area Size".
		Height	*1	You can set the height of the marker. This can only be set when "Dots (Free)" or "Dots (Center)" is selected for "Type", or when "Aspect" is selected for "Type" and "User" is selected for "Area Size".
		Thickness	1 dot to 6 dots	You can set the thickness of the marker.
		Color	White Red Green Blue Cyan Magenta Yellow Gray	You can set the color of the marker.

*1 The values that can be set may differ depending on the resolution of the input signal.

● Preferences

The monitor's settings can be configured to suit the usage environment or personal preference.

Preferences		
USB CHARGE Port	[Normal]
Power Save	[On]
Off Timer	[15h]
Indicator	[4]
Input Skip		
Mode Skip		
Custom Key		
Monitor Reset		

Function	Settings	Description
USB CHARGE Port	Normal Charging Only	<p>The USB downstream  port of the monitor supports USB 3.1 Gen 1 quick charging. By changing this setting to "Charging Only", devices connected to the  port can be charged more quickly than when using the "Normal" setting.</p> <p>Note</p> <ul style="list-style-type: none"> • Make sure to complete any communication between connected USB devices and the PC before switching this setting. When the setting is switched, all communication will be temporarily interrupted. • Devices that are connected to the  port must support quick charging. • When "Charging Only" is set, data communications between the PC and connected devices via the  port are not possible, and therefore, connected devices will not work. • When "Charging Only" is set, charging is possible even when the monitor and PC are not connected by USB cable.
Power Save	On Off	<p>This function allows you to set the monitor to the power saving mode, depending on the state of an external device connected to it.</p> <p>The monitor changes to power saving mode about 15 seconds after signal input ceases to be detected. When the monitor has shifted to power saving mode, images are not displayed on the screen.</p> <ul style="list-style-type: none"> • Exiting power saving mode <ul style="list-style-type: none"> - If the monitor receives input, it automatically exits power saving mode and returns to the normal display mode. <p>Note</p> <ul style="list-style-type: none"> • At the time of shifting to power saving mode, a message that indicates the transition is displayed 5 seconds in advance. • When you are not using the monitor, turn off the main power switch to cut down on power consumption. • When the monitor is in power saving mode, devices connected to the USB downstream port will still work. Therefore, power consumption of the monitor varies depending on the connected devices, even in the power saving mode.

Function		Settings	Description
Off Timer		Off 6h 9h 12h 15h 18h	You can set the time for the monitor's power to automatically turn off. The monitor will automatically turn off when the time set here elapses after the monitor is turned on, or after the monitor wakes up from Power Save. Note <ul style="list-style-type: none"> • One minute before the Off Timer function is triggered, a message is displayed to notify you that the monitor's power will be turned off. • Only the power button can be operated while this message is displayed.
Indicator		Off 1 to 7	The brightness of the power button and the control buttons when the screen is displayed can be set. (Default setting: 4)
Input Skip		Skip -	This function allows skipping of input signals that will not be used when the input signals are switched. Note <ul style="list-style-type: none"> • Not all input signals can be set to "Skip".
Mode Skip		Skip -	This function allows skipping of modes that will not be used when selecting modes. Please use this function if display modes are limited, or if you want to prevent randomly changing the display status. Note <ul style="list-style-type: none"> • Not all modes can be set to "Skip".
Custom Key	[F1]	S-GAMMA -Quick Check-Off Input Range Zoom BT.709 Gamut Warning Luminance Warning Prev. Color Mode Information Time Code Marker 1 Marker 2 Marker 3 Blue Only Co-View	You can set the function that is assigned to the [F1] key. Note <ul style="list-style-type: none"> • By default, this key is set to the "S-GAMMA -Quick Check-" function. • Regarding the custom keys, see "Chapter 5 Custom Key Settings" (page 40).
	[F2]	EOTF -Quick Check-Off Input Range Zoom BT.709 Gamut Warning Luminance Warning Prev. Color Mode Information Time Code Marker 1 Marker 2 Marker 3 Blue Only Co-View	You can set the function that is assigned to the [F2] key. Note <ul style="list-style-type: none"> • By default, this key is set to the "EOTF -Quick Check-" function. • Regarding the custom keys, see "Chapter 5 Custom Key Settings" (page 40).

Function		Settings	Description
Custom Key	[F3]	BRIGHT -Quick Check-Off Input Range Zoom BT.709 Gamut Warning Luminance Warning Prev. Color Mode Information Time Code Marker 1 Marker 2 Marker 3 Blue Only Co-View	You can set the function that is assigned to the [F3] key. Note <ul style="list-style-type: none"> By default, this key is set to the "BRIGHT -Quick Check-" function. Regarding the custom keys, see "Chapter 5 Custom Key Settings" (page 40).
	[F4]	BLACK -Quick Check-Off Input Range Zoom BT.709 Gamut Warning Luminance Warning Prev. Color Mode Information Time Code Marker 1 Marker 2 Marker 3 Blue Only Co-View	You can set the function that is assigned to the [F4] key. Note <ul style="list-style-type: none"> By default, this key is set to the "BLACK -Quick Check-" function. Regarding the custom keys, see "Chapter 5 Custom Key Settings" (page 40).
Monitor Reset		-	Restores all settings to their default values, except for the settings in the "Administrator Settings" menu.

● Languages

The display language for menus and messages can be selected.

Settings

English, German, French, Spanish, Italian, Swedish, Japanese, Simplified Chinese, Traditional Chinese



● Information

You can check the monitor information (model name, serial number (S/N), firmware version, usage time) and the input signal information.

Example:

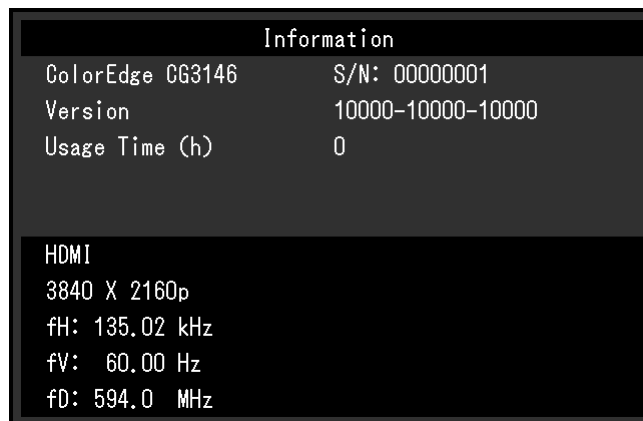

Chapter 4 SelfCalibration

This product is equipped with a built-in calibration sensor. By setting the calibration targets and execution schedule in advance, the calibration sensor automatically operates and regularly calibrates the monitor. This automatic calibration function is called "SelfCalibration".

The adjustment content of SelfCalibration differs depending on the color mode that is executed.

- Standard Mode (color mode excluding "CAL1", "CAL2", and "CAL3"): the monitor's color reproduction gamut is updated and the display mode in each mode is adjusted as follows.
 - The temperature is adjusted so that it is as close as possible to the specified value.
 - The gamut values are adjusted so that they are close to each specified value.
 - Information on brightness is updated.
- Advanced Mode (color mode "CAL1", "CAL2", and "CAL3"):
 - When performing SelfCalibration on the monitor itself, calibrate the monitor to match the set targets.
 - When using ColorNavigator 7, use a measurement device with the software to maintain the calibrated state of the monitor.

Attention

- If multiple color modes are set for the mode for SelfCalibration, the warming up process is executed multiple times (*1), and it may take some time before SelfCalibration finishes for all color modes.
- *1 When SelfCalibration is executed consecutively for color modes with large differences in brightness, such as in cases where SelfCalibration for HDR color mode (PQ_BT.2100, PQ_DCI-P3, or HLG_BT.2100) is executed after SelfCalibration for SDR color mode (BT.2020, BT.709, or DCI-P3), the warming up process is executed each time.

Note

- SelfCalibration can be executed 30 minutes after turning on the monitor.
- SelfCalibration can also be executed when there are no external device signals being input.
- To preserve adjustments that you set by using ColorNavigator 7, it is recommended to execute SelfCalibration.
- Because brightness and chromaticity will change as you use the monitor, it is recommended to calibrate the monitor periodically.
- The measurement results from the built-in calibration sensor can be correlated with the measurement results from the external measurement device that you want to use as a reference. For details, refer to the ColorNavigator 7 User's Manual.

You can set the calibration targets and execution schedule by using ColorNavigator 7 or the monitor's Setting menu.

You can download the ColorNavigator 7 software and User's Manual from our website:

www.eizoglobal.com

Note

- When using the software, you will need to connect a PC to the monitor with the supplied USB cable.
 - For details on the USB cable connection, see "[Connection Procedure](#)" (page 65).
 - While using the software, do not operate the power button or control buttons on the front side of the monitor.
-

4-1. SelfCalibration functions

Set the details for "SelfCalibration".

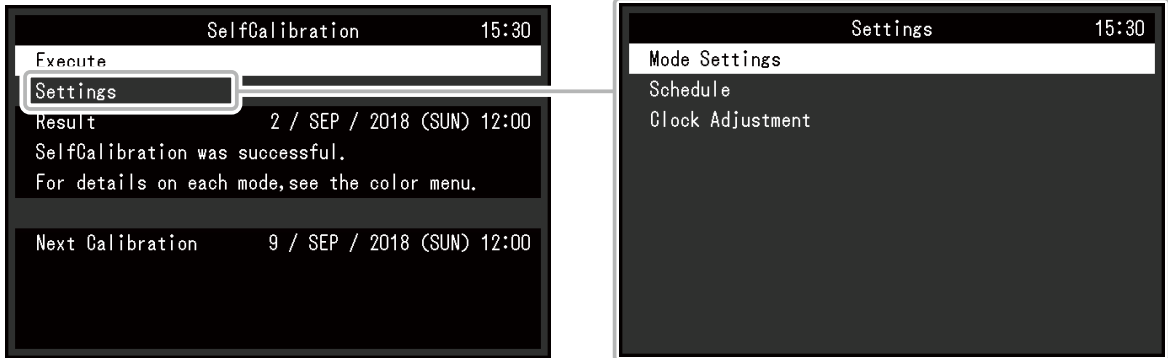

Function		Settings		Description
Execute		-		SelfCalibration can be executed manually regardless of the schedule. Note <ul style="list-style-type: none"> After selecting "Execute", warming up (after the power to the monitor is switched on, leaving the monitor on for a certain period of time until the display becomes stable) may be executed before the built-in calibration sensor comes out.
Settings	Mode Settings	Standard Mode		On Off Switch between enabling/disabling SelfCalibration in Standard Mode.
		Advanced Mode	CAL1 CAL2 CAL3	On Off Switch between enabling/disabling SelfCalibration in Advanced Mode.
	Schedule	Start time	Power Save Immediately Application Off	Select the timing to execute SelfCalibration upon reaching the time set in the schedule. <ul style="list-style-type: none"> "Power Save" <ul style="list-style-type: none"> To be executed under any of the following conditions. <ul style="list-style-type: none"> When the monitor is in "Power Save" mode or power is off at the set time. The monitor shifts to the power saving mode or the power is turned off when the set time in the schedule is exceeded. "Immediately" <ul style="list-style-type: none"> SelfCalibration is executed immediately at the set time. "Application" <ul style="list-style-type: none"> Execute SelfCalibration according to the timing set using ColorNavigator Network. For details on ColorNavigator Network, refer to our web site (www.eizoglobal.com). "Off" <ul style="list-style-type: none"> SelfCalibration is not executed.
	Frequency	Daily Weekly Monthly Quarterly Biannually Annually Usage Time	Select the SelfCalibration execution cycle.	

Function		Settings	Description
Settings	Schedule	Timing	<p>Jan/Apr/Jul/Oct Feb/May/Aug/Nov Mar/Jun/Sep/Dec Jan/Jul Feb/Aug Mar/Sep Apr/Oct May/Nov Jun/Dec Jan to Dec Every 50 hours to Every 500 hours</p> <p>When the execution cycle is "Quarterly", "Biannually", "Annually", or "Usage Time", select the timing for executing SelfCalibration.</p> <p>The settings differ depending on the execution cycle setting.</p> <ul style="list-style-type: none"> "Quarterly": Jan/Apr/Jul/Oct, Feb/May/Aug/Nov, Mar/Jun/Sep/Dec "Biannually": Jan/Jul, Feb/Aug, Mar/Sep, Apr/Oct, May/Nov, Jun/Dec "Annually": Jan to Dec "Usage Time": Every 50 hours to Every 500 hours
		Week	<p>1st week to 5th week</p> <p>When the execution cycle is "Monthly", "Quarterly", "Biannually", or "Annually", select the week for executing SelfCalibration.</p> <p>Note</p> <ul style="list-style-type: none"> When no day has been selected for "Day" in the selected week, the week of execution will be as follows: <ul style="list-style-type: none"> - When the selected week is "1st week": 2nd week - When the selected week is "5th week": 4th week
		Day	<p>Sunday to Saturday</p> <p>When the execution cycle is "Weekly", "Monthly", "Quarterly", "Biannually", or "Annually", select the day for executing SelfCalibration.</p>
		Time	<p>0:00 to 11:55 PM</p> <p>When the execution cycle is "Daily", "Weekly", "Monthly", "Quarterly", "Biannually", or "Annually", select the time for executing SelfCalibration.</p>
	Clock Adjustment	-	<p>Set the monitor date and time.</p> <p>Note</p> <ul style="list-style-type: none"> When the clock has not been set, the schedule will not be applied. If the main power supply is disconnected for an extended period of time, the clock may need resetting. When ColorNavigator 7 is started, the date and time are automatically set.
Result		-	The SelfCalibration execution result is displayed.
Next Calibration		-	The next SelfCalibration scheduled execution date is displayed.

4-2. Setting targets

Set calibration targets for Advanced Mode. You can set targets by using ColorNavigator 7 or on the monitor itself.

When using the monitor itself, set the following functions in the "Color" menu.

- "Color Mode"
Select either "CAL1", "CAL2", or "CAL3".
- "Target Settings"
Set a calibration target for SelfCalibration.

4-3. Executing

SelfCalibration can be executed by setting a schedule or it can be executed regardless of a schedule. You can set a schedule by using ColorNavigator 7 or on the monitor itself.

When executing SelfCalibration by setting a schedule on the monitor itself, the method to enable SelfCalibration differs depending on the type of color mode (Standard Mode or Advanced Mode).

Attention

- If there is a change in the video signal from the external device during SelfCalibration (the signal disappears, a signal is input during a no-signal state, or other), SelfCalibration is automatically canceled.
-

● Executing regardless of a schedule

Manually execute SelfCalibration.

There are two methods for executing SelfCalibration, as follows.

- Execute from the "SelfCalibration" menu
In the "SelfCalibration" menu, select "Execute".
SelfCalibration is executed for all the color modes selected as "On" in "Settings" - "Mode Settings" of the "SelfCalibration" menu.
- Executing from the "Color" menu
In "Color Mode" in the "Color" menu, select either "CAL1", "CAL2", or "CAL3", and then select "Execute Calibration".
Execute SelfCalibration for the displayed color mode.

● Executing by setting a schedule

Set the calibration schedule for SelfCalibration.

In "Settings" in the "SelfCalibration" menu, set the calibration schedule and monitor date and time for SelfCalibration.

Attention

- If a scheduled SelfCalibration is automatically canceled, it is executed again when the monitor transitions to the power saving mode an hour or more after cancellation or when the monitor is turned off using .
-

● Activating SelfCalibration in Standard Mode

Execute SelfCalibration in Standard Mode.

In "Settings" in the "SelfCalibration" menu, set the following functions:

- "Mode Settings"
Set "Standard Mode" to "On".

● Activating SelfCalibration in Advanced Mode

Execute SelfCalibration in Advanced Mode.

In "Settings" in the "SelfCalibration" menu, set the following functions:

- "Mode Settings"
Select "Advanced Mode".
- "Advanced Mode"
Select either "CAL1", "CAL2", or "CAL3", and set "On".

4-4. Checking results

Check the SelfCalibration calibration results by using the monitor.

In the "Color" menu, set the following functions:

- "Color Mode"
Select either "CAL1", "CAL2", or "CAL3".
- "Result"
Check the calibration result of SelfCalibration.

Chapter 5 Custom Key Settings

You can assign functions to the custom keys to easily start specified functions.
This chapter describes how to operate the custom keys and how to assign functions to the custom keys.

5-1. Basic Operation of the Custom Keys

1. Execute

1. Press the (F1) button, (F2) button, (F3) button, or (F4) button.

The function assigned to the (F1) button, (F2) button, (F3) button, or (F4) button is executed.

5-2. Assigning a Function to a Custom Key

1. Menu display

1. Press the dial.

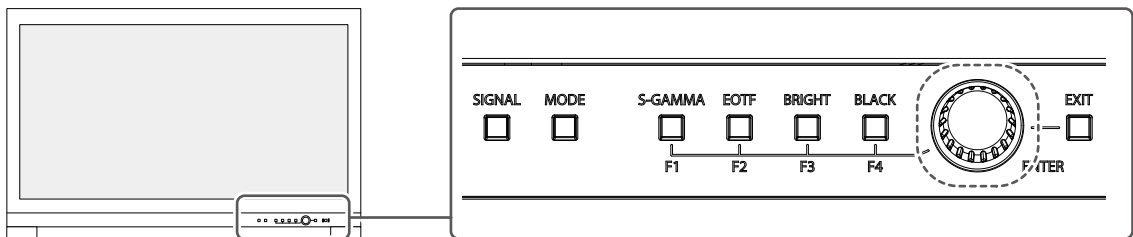

The Setting menu appears.



- Turn the dial to select "Preferences", and then press the dial.

The Preferences menu appears.

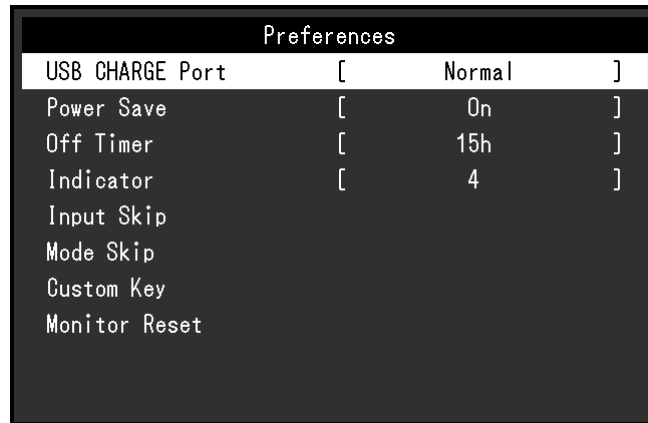

- Turn the dial to select "Custom Key", and then press the dial.

The Custom Key menu appears.

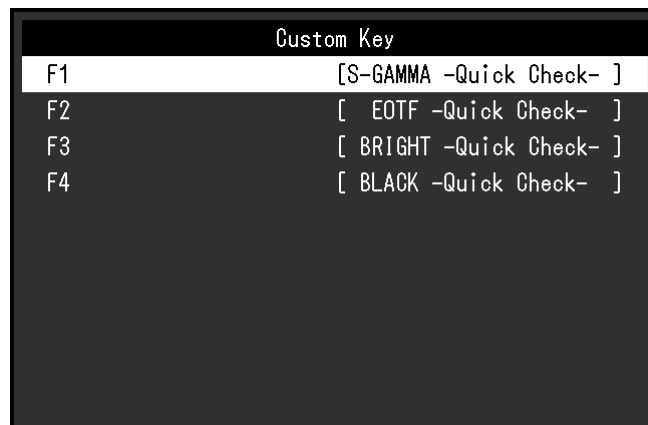

- Turn the dial to select the custom key to which you want to assign a function, and then press the dial.

The menu for assigning a function appears.

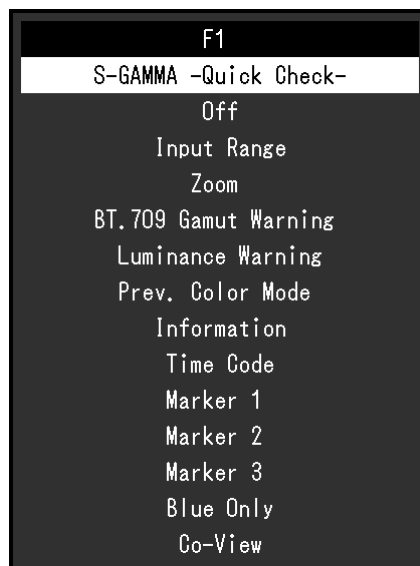

For more information about functions, see ["Functions that can be Assigned to Custom Keys"](#) (page 42).

- Turn the dial to select the function that you want to assign, and then press the dial.
That function is assigned to the custom key.

2. Exiting

- Press the  (EXIT) button several times.

The Setting menu exits.

● Functions that can be Assigned to Custom Keys

Function	Description
S-GAMMA -Quick Check-	Sets the HLG System Gamma of the Quick Check function. For more information, see page 14 .
EOTF -Quick Check-	Sets the Gamma (EOTF) of the Quick Check function. For more information, see page 14 .
BRIGHT -Quick Check-	Sets the Brightness of the Quick Check function. For more information, see page 14 .
BLACK -Quick Check-	Sets the Black Level Lift of the Quick Check function. For more information, see page 14 .
Off	Disables the custom key.
Input Range	Sets the Input Range function. For more information, see page 18 .
Zoom	Sets the Zoom function. For more information, see page 28 .
BT.709 Gamut Warning	Sets the BT.709 Gamut Warning function. For more information, see page 28 .
Luminance Warning	Sets the Luminance Warning function. For more information, see page 29 .
Prev. Color Mode	You can return to the previous color mode. This is convenient for checking the differences between two color modes. Attention <ul style="list-style-type: none"> When using ColorNavigator 7, it is necessary to reselect the color mode after exiting the software.
Information	You can view the input signal information and color information. Example: <div style="display: flex; justify-content: space-around; margin: 10px 0;"> <div style="background-color: #333; color: #eee; padding: 5px; border: 1px solid #555;"> <pre style="margin: 0;"> HDMI (Color Mode:BT, 709) 1/2 Resolution 4096 X 2160P 24.00Hz Bit Depth / Colorimetry 10bit/SMPTE170M or BT.709 Color Format / Range RGB4:4:4/Limited Range EOTF ST2084 White Point x:0.31300 y:0.32900 Primary Red x:0.31300 y:0.32900 Green x:0.31300 y:0.32900 Blue x:0.31300 y:0.32900 Luminance Min / Max 0.0001cd/m² / 65535cd/m² MaxCLL / MaxFALL 65535cd/m² / 65535cd/m² </pre> </div> <div style="background-color: #333; color: #eee; padding: 5px; border: 1px solid #555;"> <pre style="margin: 0;"> Color (Color Mode:BT, 709) 2/2 Brightness 100cd/m² Temperature D65 Gamma (EOTF) 2.4 PQ Option - HLG System Gamma - Color Gamut BT, 709 </pre> </div> </div> Note <ul style="list-style-type: none"> You can check the monitor information under “Information” (page 34) on the Setting menu.
Time Code	Sets the Time Code function. For more information, see page 19 .
Marker 1	Sets the Marker 1 function. For more information, see page 29 .
Marker 2	Sets the Marker 2 function. For more information, see page 29 .
Marker 3	Sets the Marker 3 function. For more information, see page 29 .
Blue Only	Sets the Blue Only function. For more information, see page 29 .
Co-View	Sets the Co-View function. For more information, see page 29 .

Chapter 6 Administrator Settings

This chapter describes how to configure monitor operation using the "Administrator Settings" menu.

6-1. Basic Operation of the "Administrator Settings" Menu

1. Menu display

1. Press \odot to turn off the monitor.
2. While pressing the leftmost button, press \odot for more than 2 seconds to turn on the monitor.

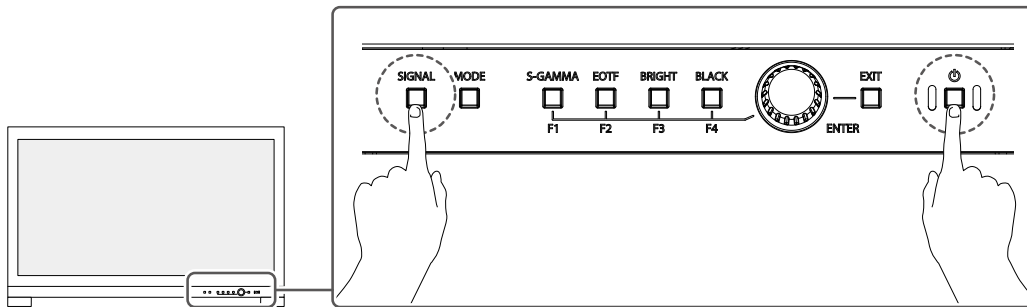

The "Administrator Settings" menu appears.

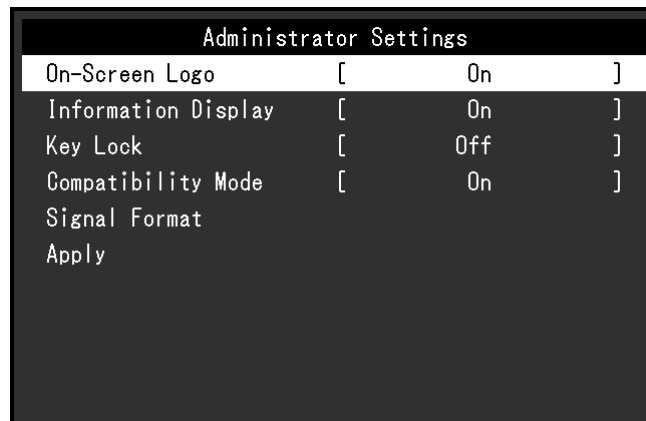

2. Setting

1. Turn the dial to choose an item to set, and then press the dial.
The Adjustment/Setting menu appears.

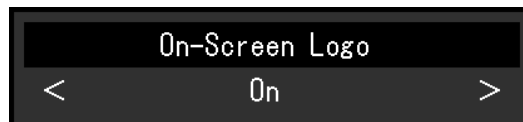

2. Turn the dial to set the selected item, and then press the dial.
The "Administrator Settings" menu appears.

3. Applying and exiting

1. Select "Apply", and then press the dial.
The settings are confirmed and the "Administrator Settings" menu quits.

6-2. "Administrator Settings" Menu Functions

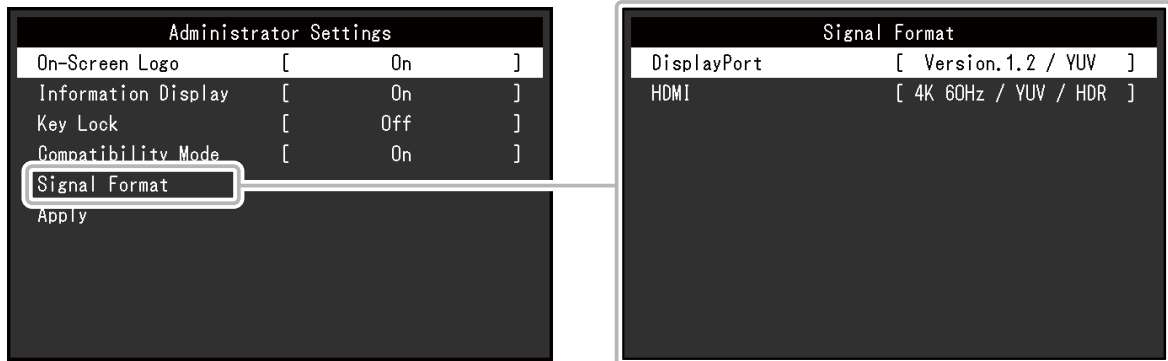

Function		Settings	Description
On-Screen Logo		Off On	When this function is set to "Off", the EIZO logo that is displayed when the monitor is turned on does not appear.
Information Display		Off On	When this function is set to "On", "Signal Information" (page 17) is displayed when the signal or color mode is switched. When set to "Off", "Signal Information" (page 17) is not displayed when the signal or color mode is switched.
Key Lock		Off Menu All	In order to prevent changes to settings, the control buttons on the front of the monitor can be locked. <ul style="list-style-type: none"> "Off" (Default setting) All buttons are enabled. "Menu" The dial is locked. The settings of the Quick Check function can be changed. "All" All buttons except the power button are locked.
Compatibility Mode		Off On	To avoid the following effects, set this function to "On". <ul style="list-style-type: none"> When you switch the monitor's power back on or return from power saving mode, windows or icons may have shifted position. The PC's power save function does not operate correctly.
Signal Format	DisplayPort	Version 1.2 Version 1.2 / YUV	You can switch the signal type that the monitor can display. Try changing this setting if the input signal is not displayed, or if the displayed image does not appear correctly. Note • The default setting for "4K 30Hz" and "4K 60Hz / YUV / HDR" is 1920 × 1080.
	HDMI	4K 30Hz 4K 60Hz / YUV / HDR 4K 60Hz	

Chapter 7 SDR/HDR Settings

This chapter describes how to configure the monitor settings to use this monitor for image creation.

“7-1. About Each Color Mode” (page 45) describes applications and configurations of each color mode.

“7-2. Setting Procedure” (page 52) describes the procedure to configure each color mode settings suitable for the display of each application.

“7-3. Settings with ColorNavigator 7” (page 56) describes the overview of procedure to configure settings using software.

Attention

- See “Information” (page 34) to check the firmware version of your monitor before configuring the settings. Select “Software and Drivers” in “Support” from our web site (www.eizoglobal.com), enter the product name, and perform a search. Download the program and update the firmware if its version is different from the latest version.

Note

- It takes about 3 minutes (under our measurement conditions) for the monitor display to stabilize. For highly accurate adjustments, please wait 20 minutes or more after the monitor power has been turned on.
- If you switch between SDR color modes (BT.2020, BT.709, and DCI-P3) and HDR color modes (PQ_BT.2100, PQ_DCI-P3, and HLG_BT.2100), wait 30 minutes or more after switching the color modes, and then adjust the monitor.

7-1. About Each Color Mode

● Types and Applications of Color Modes for Image Creation

Color Mode	Application	
BT.2020	(SDR)	This color mode is suitable for reproducing ITU-R BT.2020 standard-compliant color gamut and gamma.
BT.709	(SDR)	This color mode is suitable for reproducing ITU-R BT.709 standard-compliant color gamut and gamma.
DCI-P3	(SDR)	This color mode is suitable for reproducing DCI standard-compliant color gamut and gamma.
PQ_BT.2100	(HDR)	This color mode is suitable for reproducing ITU-R BT.2100 standard-compliant color gamut in PQ format gamma (EOTF).
PQ_DCI-P3	(HDR)	This color mode is suitable for reproducing DCI standard-compliant color gamut in PQ format gamma (EOTF).
HLG_BT.2100	(HDR)	This color mode is suitable for reproducing ITU-R BT.2100 standard-compliant color gamut in HLG format gamma (EOTF).

The relation between input signal (10 bits: 0 - 1023) and the brightness displayed on the monitor when each color mode is configured properly is described below. For more information about how to configure the settings, see “7-2. Setting Procedure” (page 52).

● BT.2020

The relation between input signal (0 - 1023) and the brightness displayed on the monitor is described below.

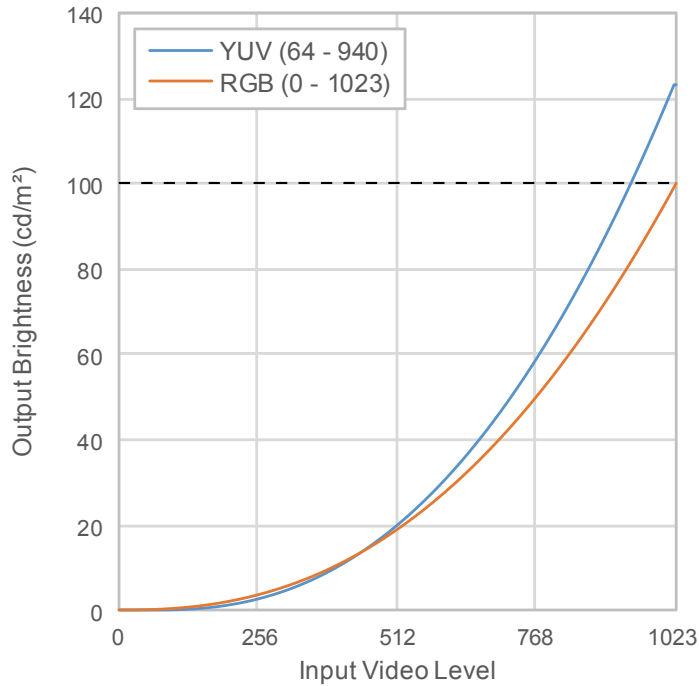

Main Setting Items of Setting Menu

For more information about procedure to configure the settings, see “7-2. Setting Procedure” (page 52).

Item		Input Color Format*1	
		RGB	YUV
Signal	YUV Color Matrix	Auto	BT.2020*2
	Input Range	Full	Limited (109% White)
Color	Brightness (cd/m²)	100	123
	Temperature	D65	D65
	Gamma (EOTF)	2.4	2.4
	Color Gamut	BT.2020	BT.2020

*1 If the image is displayed correctly, you can check the settings in “Signal” - “Signal Information” in the Setting menu. If the text including “YCbCr” or “YCC” is displayed in the blue rectangles in the figures below, the input signal is YUV.
If the text including “RGB” is displayed, the input signal is RGB.

• SDI

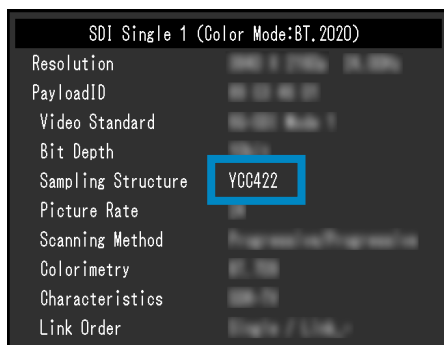

• HDMI

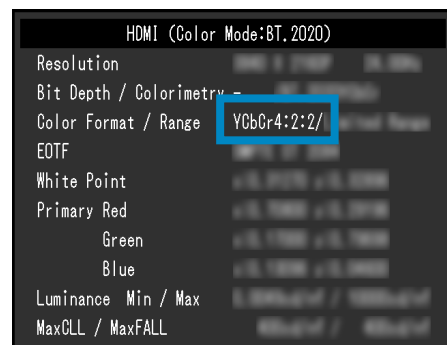

*2 A conversion constant other than BT.2020 may be applied due to restrictions or settings of your equipment and tools.

● BT.709

The relation between input signal (0 - 1023) and the brightness displayed on the monitor is described below.

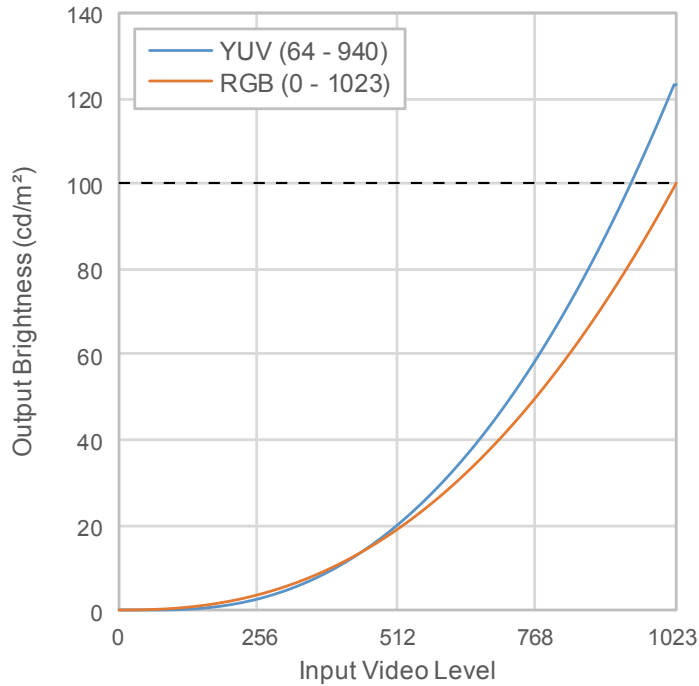

Main Setting Items of Setting Menu

For more information about procedure to configure the settings, see “7-2. Setting Procedure” (page 52).

Item		Input Color Format*1	
		RGB	YUV
Signal	YUV Color Matrix	Auto	BT.709
	Input Range	Full	Limited (109% White)
Color	Brightness (cd/m ²)	100	123
	Temperature	D65	D65
	Gamma (EOTF)	2.4	2.4
	Color Gamut	BT.709	BT.709

*1 If the image is displayed correctly, you can check the settings in “Signal” - “Signal Information” in the Setting menu. If the text including “YCbCr” or “YCC” is displayed in the blue rectangles in the figures below, the input signal is YUV.

If the text including “RGB” is displayed, the input signal is RGB.

- SDI

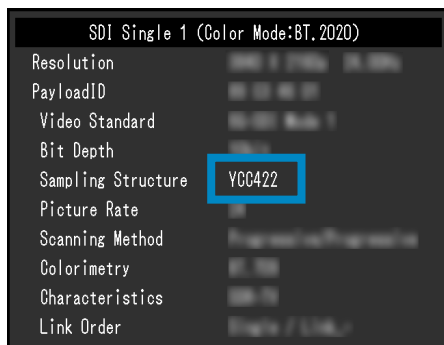

- HDMI

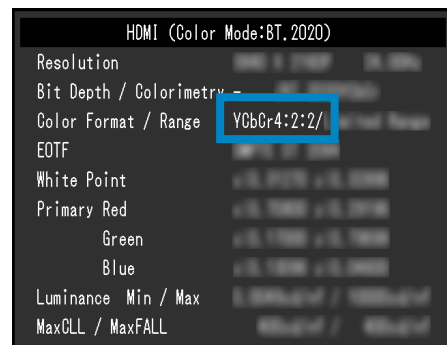

● DCI-P3

The relation between input signal (0 - 1023) and the brightness displayed on the monitor is described below.

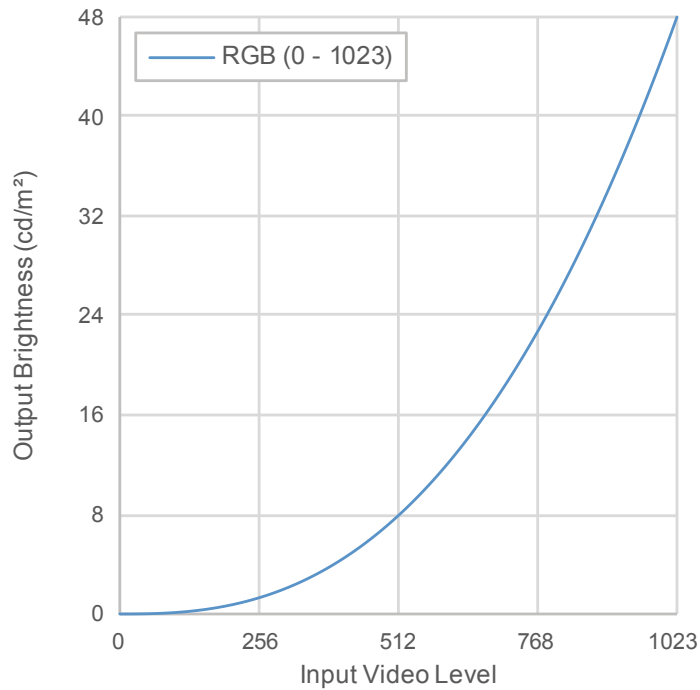

Main Setting Items of Setting Menu

For more information about procedure to configure the settings, see [“7-2. Setting Procedure”](#) (page 52).

Item		Input Color Format
		RGB
Signal	YUV Color Matrix	Auto
	Input Range	Full
Color	Brightness (cd/m ²)	48
	Temperature	D65
	Gamma (EOTF)	2.6
	Color Gamut	DCI-P3

● PQ_BT.2100

The relation between input signal (0 - 1023) and the brightness displayed on the monitor is described below.

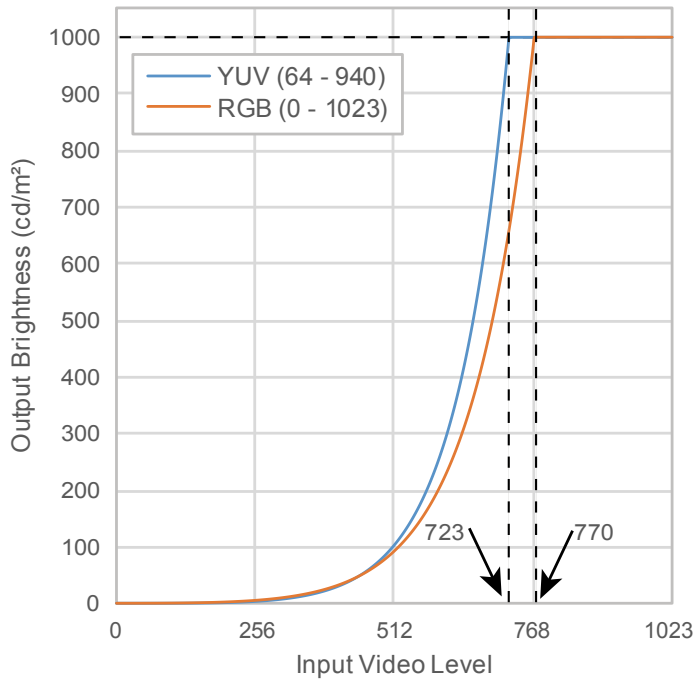

Main Setting Items of Setting Menu

For more information about procedure to configure the settings, see “7-2. Setting Procedure” (page 52).

Item		Input Color Format*1	
		RGB	YUV
Signal	YUV Color Matrix	Auto	BT.2020*2
	Input Range	Full	Limited
Color	Brightness (cd/m²)	1000	1000
	Temperature	D65	D65
	Gamma (EOTF)	PQ	PQ
	PQ Option*3	1000cd/m² Clipping	1000cd/m² Clipping
	Color Gamut	BT.2020	BT.2020

*1 If the image is displayed correctly, you can check the settings in “Signal” - “Signal Information” in the Setting menu. If the text including “YCbCr” or “YCC” is displayed in the blue rectangles in the figures below, the input signal is YUV.

If the text including “RGB” is displayed, the input signal is RGB.

• SDI

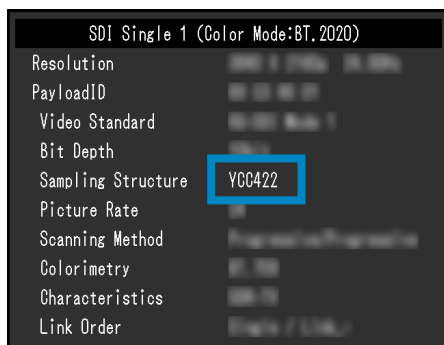

• HDMI

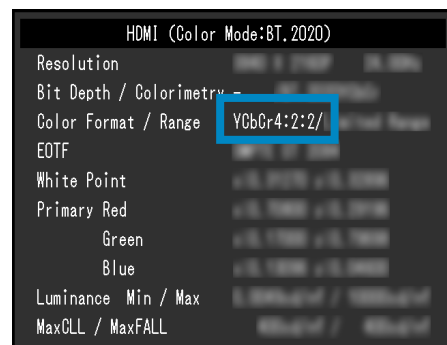

*2 A conversion constant other than BT.2020 may be applied due to restrictions or settings of your equipment and tools.

*3 For more information, see “PQ Option” (page 21) and “Setting of PQ Option and Display” (page 22).

● PQ_DCI-P3

The relation between input signal (0 - 1023) and the brightness displayed on the monitor is described below.

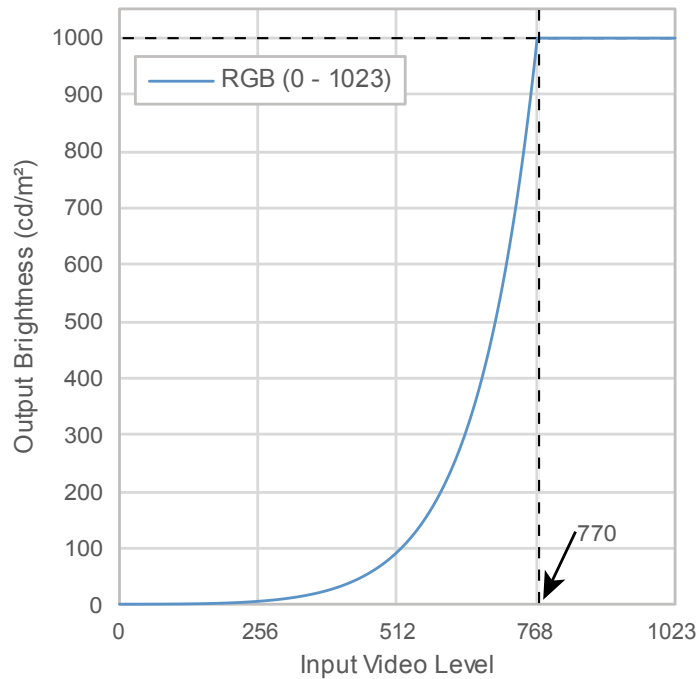

Main Setting Items of Setting Menu

For more information about procedure to configure the settings, see “7-2. Setting Procedure” (page 52).

Item		Input Color format
		RGB
Signal	YUV Color Matrix	Auto
	Input Range	Full
Color	Brightness (cd/m ²)	1000
	Temperature	D65
	Gamma (EOTF)	PQ
	PQ Option ^{*1}	1000cd/m ² Clipping
	Color Gamut	DCI-P3

*1 For more information, see “PQ Option” (page 21) and “Setting of PQ Option and Display” (page 22).

● HLG_BT.2100

The relation between input signal (0 - 1023) and the brightness displayed on the monitor is described below.

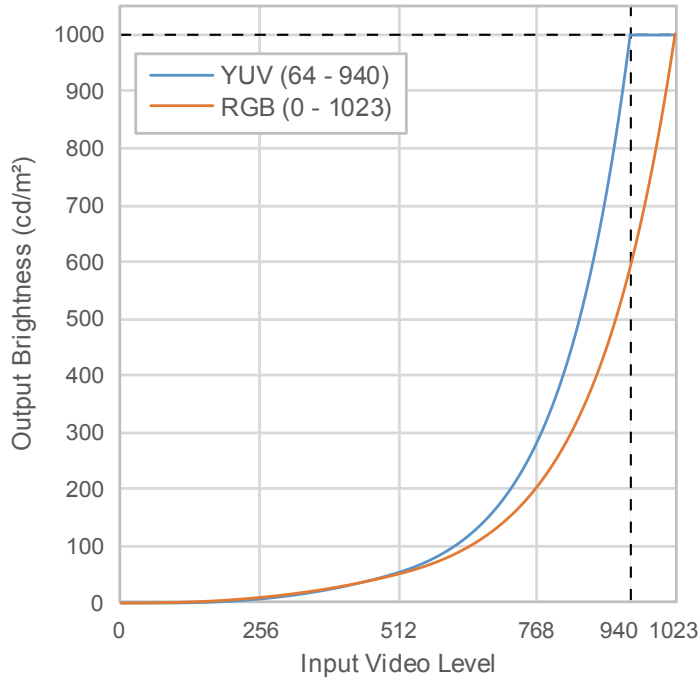

Main Setting Items of Setting Menu

For more information about procedure to configure the settings, see “7-2. Setting Procedure” (page 52).

Item		Input Color Format*1	
		RGB	YUV
Signal	YUV Color Matrix	Auto	BT.2020*2
	Input Range	Full	Limited
Color	Brightness (cd/m²)	1000	1000
	Temperature	D65	D65
	Gamma (EOTF)	HLG	HLG
	HLG System Gamma	1.2	1.2
	Color Gamut	BT.2020	BT.2020

*1 If the image is displayed correctly, you can check the settings in “Signal” - “Signal Information” in the Setting menu. If the text including “YCbCr” or “YCC” is displayed in the blue rectangles in the figures below, the input signal is YUV.

If the text including “RGB” is displayed, the input signal is RGB.

• SDI

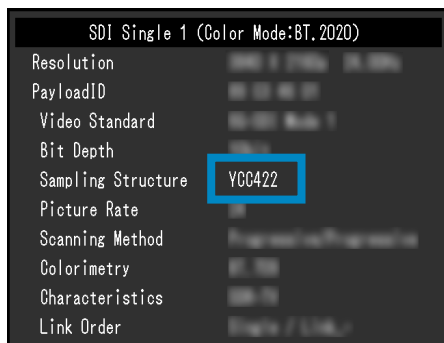

• HDMI

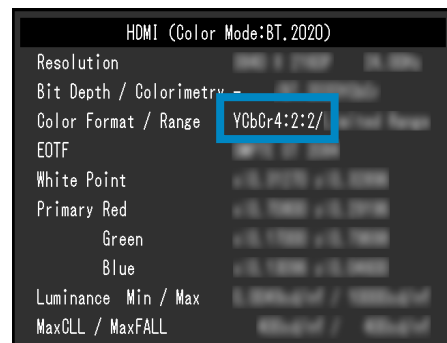

*2 A conversion constant other than BT.2020 may be applied due to restrictions or settings of your equipment and tools.

7-2. Setting Procedure

This section describes the procedure to use the monitor with the settings suitable for displaying SDR or HDR image.

Note

- For more information about SDR/HDR setting procedure with ColorNavigator 7, see “7-3. Settings with ColorNavigator 7” (page 56).

1. Select a color mode.

Select a color mode suitable for the application.

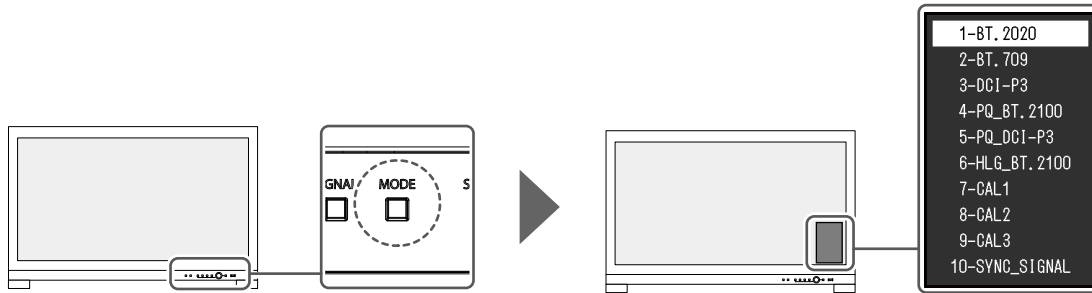

Color Mode	Application	
BT.2020	(SDR)	This color mode is suitable for reproducing ITU-R BT.2020 standard-compliant color gamut and gamma.
BT.709	(SDR)	This color mode is suitable for reproducing ITU-R BT.709 standard-compliant color gamut and gamma.
DCI-P3	(SDR)	This color mode is suitable for reproducing DCI standard-compliant color gamut and gamma.
PQ_BT.2100	(HDR)	This color mode is suitable for reproducing ITU-R BT.2100 standard-compliant color gamut in PQ format gamma (EOTF).
PQ_DCI-P3	(HDR)	This color mode is suitable for reproducing DCI standard-compliant color gamut in PQ format gamma (EOTF).
HLG_BT.2100	(HDR)	This color mode is suitable for reproducing ITU-R BT.2100 standard-compliant color gamut in HLG format gamma (EOTF).

2. Display “Signal” in the Setting menu, and configure the settings required.

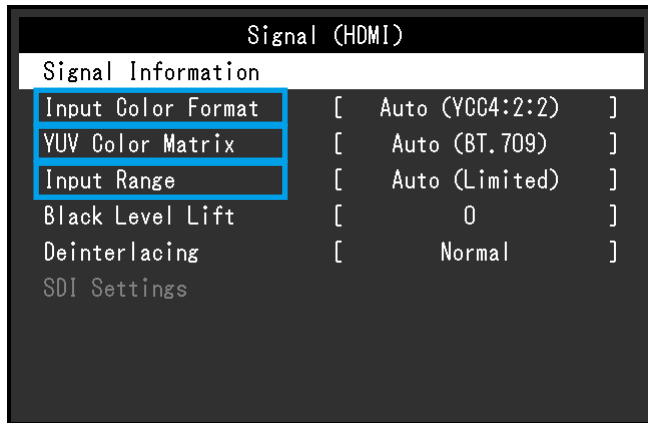

Note

- For more information about basic operation of the Setting menu, see [“3-1. Basic Operation of the Setting Menu” \(page 15\)](#).

- If the image is not properly displayed, set “Input Color Format” in the “Signal” menu.
If the text including “YCbCr” or “YCC” is displayed in “Signal Information” in the “Signal” menu, the input signal is YUV. If the text including “RGB” is displayed, the input signal is RGB.
- If the YUV signal is displayed, “YUV Color Matrix” is set.

Settings for each color mode selected are shown below.

Color Mode	YUV Color Matrix
BT.2020	BT.2020
BT.709	BT.709
PQ_BT.2100	BT.2020
HLG_BT.2100	BT.2020

Note

- If the input signal is RGB, use the default setting.
- A conversion constant other than BT.2020 may be applied due to restrictions or settings of your equipment and tools. If it is the case, configure the settings properly for your equipment and tools.

- Set “Input Range”.

Settings for each color mode and color format selected are shown below.

Color Mode	Input Color Format	Input Range
BT.2020	RGB	Full
	YUV	Limited (109% White)
BT.709	RGB	Full
	YUV	Limited (109% White)
DCI-P3	RGB	Full
PQ_BT.2100	RGB	Full
	YUV	Limited
PQ_DCI-P3	RGB	Full
HLG_BT.2100	RGB	Full
	YUV	Limited

3. Display “Color” in the Setting menu, and configure the settings required.

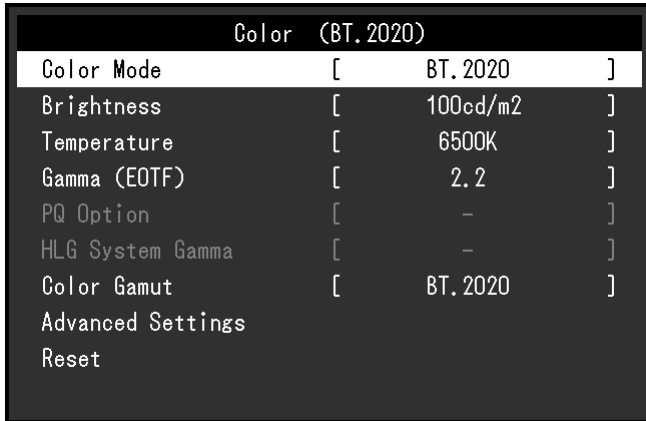

Note



- It is recommended to perform “Reset” in “Color” before configuring the settings. If you perform “Reset”, no additional configuration is required except for the SDR image with YUV signal.

Settings for each color mode and color format selected are shown below.

Color Mode	Input Color Format	Brightness (cd/m ²)	Gamma (EOTF)
BT.2020	RGB	100	2.4
	YUV	100	2.4
BT.709	RGB	100	2.4
	YUV	100	2.4
DCI-P3	RGB	48	2.6
PQ_BT.2100	RGB	1000	PQ
	YUV	1000	PQ
PQ_DCI-P3	RGB	1000	PQ
HLG_BT.2100	RGB	1000	HLG
	YUV	1000	HLG

Settings for Advanced Settings are left default. For more information, see “[Color Mode Setting Values](#)” (page 13).

4. Close the Setting menu to complete settings.

Press the  (EXIT) button to exit “Color” and display the Setting menu. Press the  (EXIT) button again to exit the Setting menu.

● List of Setting Items

Signal

Color Mode	Input Color Format	YUV Color Matrix	Input Range ^{*1}
BT.2020	RGB	Auto	Full
	YUV	BT.2020 ^{*1}	Limited (109% White)
BT.709	RGB	Auto	Full
	YUV	BT.709 ^{*1}	Limited (109% White)
DCI-P3	RGB	Auto	Full
PQ_BT.2100	RGB	Auto	Full
	YUV	BT.2020 ^{*1}	Limited
PQ_DCI-P3	RGB	Auto	Full
HLG_BT.2100	RGB	Auto	Full
	YUV	BT.2020 ^{*1}	Limited

*1 This item is changed from the default setting.

Color

-: Cannot be changed

Color Mode	Color Format	Brightness (cd/m ²)	Temperature	Gamma (EOTF)	PQ Option	HLG System Gamma	Color Gamut
BT.2020	RGB	100	D65	2.4	-	-	BT.2020
	YUV	100					
BT.709	RGB	100	D65	2.4	-	-	BT.709
	YUV	100					
DCI-P3	RGB	48	D65	2.6	-	-	DCI
PQ_BT.2100	RGB	1000	D65	PQ	1000cd/m ² Clipping	-	BT.2020
	YUV						
PQ_DCI-P3	RGB	1000	D65	PQ	1000cd/m ² Clipping	-	DCI
HLG_BT.2100	RGB	1000	D65	HLG	-	1.2	BT.2020
	YUV						

7-3. Settings with ColorNavigator 7

You can use ColorNavigator 7 to configure monitor settings suitable for SDR or HDR display. It is recommended to use ColorNavigator 7 to calibrate the monitor for the following cases.

- To perform regular calibration
ColorNavigator 7 has a function to notify when to perform calibration.
- To verify whether the monitor is properly calibrated
ColorNavigator 7 has a function to verify calibration status.

Note

- For more information about how to perform adjustment by operating only the Setting menu of the monitor, see “7-2. Setting Procedure” (page 52).
- For more information about ColorNavigator 7, refer to our web site.
(www.eizoglobal.com/products/coloredge/cn7)

● Setting Procedure

1. Select a color mode in the Setting menu in the monitor

See step 1 in “7-2. Setting Procedure” (page 52) to configure the setting.

2. Display “Signal” in the Setting menu of the monitor, and configure the settings required

See step 2 in “7-2. Setting Procedure” (page 52) to configure the setting.

Note

- See “List of Setting Items” (page 55) for the list of setting items.

3. Start ColorNavigator 7

4. Point at the color mode selected in the color mode list, right-click, and set the color mode type to “Advanced”

5. Set the adjustment target according to the application

For more information, see “Target Settings of ColorNavigator 7” (page 56).

● Target Settings of ColorNavigator 7

Color Mode Type, Brightness, Black Level, Temperature

Color Mode	Color Format	Color Mode Type	Brightness (cd/m ²)	Black Level	Temperature
BT.2020	RGB	Advanced*1	100	Minimum Value	D65
	YUV		100		
BT.709	RGB	Advanced*1	100	Minimum Value	D65
	YUV		100		
DCI-P3	RGB	Advanced*1	48	Minimum Value	D65
PQ_BT.2100	RGB	Advanced*1	1000	Minimum Value	D65
	YUV				
PQ_DCI-P3	RGB	Advanced*1	1000	Minimum Value	D65
HLG_BT.2100	RGB	Advanced*1	1000	Minimum Value	D65
	YUV				

*1 This item is changed from the default setting.

Gamma (EOTF), PQ Option, HLG System Gamma, Adjustment Method

-: Cannot be changed

Color Mode	Color Format	Gamma (EOTF)	PQ Option	HLG System Gamma	Adjustment Method
BT.2020	RGB	2.4	-	-	Standard
	YUV				
BT.709	RGB	2.4	-	-	Standard
	YUV				
DCI-P3	RGB	2.6	-	-	Standard
PQ_ BT.2100	RGB	PQ	1000cd/m ² Clipping	-	Standard
	YUV				
PQ_DCI-P3	RGB	PQ	1000cd/m ² Clipping	-	Standard
HLG_ BT.2100	RGB	HLG	-	1.2	Standard
	YUV				

Color Gamut, Gamut Clipping, Option

Color Mode	Color Format	Color Gamut (Standard Value)	Gamut Clipping	Option* ¹
BT.2020	RGB	BT.2020	On	-
	YUV			On
BT.709	RGB	BT.709	On	-
	YUV			On
DCI-P3	RGB	DCI-P3	On	-
PQ_ BT.2100	RGB	BT.2020	On	-
	YUV			
PQ_DCI-P3	RGB	DCI-P3	On	-
HLG_ BT.2100	RGB	BT.2020	On	-
	YUV			

*1 Setting for "Optimize to Limited (109% White)"

Chapter 8 Troubleshooting

8-1. No Picture

Problem	Possible cause and remedy
<p>1. No picture</p> <ul style="list-style-type: none"> Power indicator does not light up. <hr/> <ul style="list-style-type: none"> Power indicator is lighting white. <hr/> <ul style="list-style-type: none"> Power indicator is lighting orange. <hr/> <ul style="list-style-type: none"> Power indicator is flashing orange and white. 	<ul style="list-style-type: none"> Check whether the power cord is connected properly. Turn on the main power switch on the rear side of the monitor. Press . Turn off the main power switch on the rear side of the monitor, and then turn it on again a few minutes later. <hr/> <ul style="list-style-type: none"> Increase "Brightness" and/or "Gain" in the Setting menu (see "Color" (page 19)). <hr/> <ul style="list-style-type: none"> Switch the input signal. Move the mouse or press any key on the keyboard. Check whether the external device is turned on. Turn off the main power switch on the rear side of the monitor, and then turn it on again. <hr/> <ul style="list-style-type: none"> This problem may occur when an external device is connected via the DisplayPort connector. Connect via the signal cable specified by EIZO, turn off the monitor, and then turn it on again.
<p>2. The message below appears.</p> <hr/> <ul style="list-style-type: none"> This message appears when no signal is input. <p>Example:</p> <div data-bbox="371 1111 695 1211" style="border: 1px solid black; background-color: black; color: white; padding: 5px; text-align: center;"> HDMI No Signal </div> <hr/> <ul style="list-style-type: none"> The message shows that the input signal is out of the frequency specification range. <p>Example:</p> <div data-bbox="371 1406 695 1525" style="border: 1px solid black; background-color: black; color: white; padding: 5px; text-align: center;"> HDMI Signal Error </div>	<p>This message appears when the signal is not input correctly even though the monitor is functioning properly.</p> <hr/> <ul style="list-style-type: none"> The message shown left may appear, because some external devices do not output the signal immediately after power-on. Check whether the external device is turned on. Check whether the signal cable is connected properly. Switch the input signal. Turn off the main power switch on the rear side of the monitor, and then turn it on again. Try changing "Signal Format" in the Administrator Settings menu (see "Signal Format" (page 44)). <hr/> <ul style="list-style-type: none"> Check whether the external device is configured to meet the resolution and vertical scan frequency requirements of the monitor (see "Compatible Resolutions"). Reboot the external device. Change to the appropriate setting using the graphics board's utility. Refer to the User's Manual of the graphics board for details. For SDI signal input, try changing "Input Color Format" (see "Input Color Format" (page 18)).

8-2. Imaging Problems

Problem	Possible cause and remedy
1. The screen is too bright or too dark.	<ul style="list-style-type: none">• Use "Brightness" in the Setting menu to adjust it (see "Color" (page 19)). The LCD monitor backlight has a limited life span. If the screen becomes dark or begins to flicker, contact your local EIZO representative.
2. Afterimages appear	<ul style="list-style-type: none">• Afterimages are particular to LCD monitors. Avoid displaying the same image for a long time.• Use the screen saver or power saving function to avoid displaying the same image for extended periods of time.
3. Green/red/blue/white dots or defective dots remain on the screen.	<ul style="list-style-type: none">• This is due to LCD panel characteristics and not a malfunction.
4. Interference patterns or pressure marks remain on the LCD panel.	<ul style="list-style-type: none">• Display a white or black image over the entire screen. The symptom may disappear.
5. Noise appears on the screen.	<ul style="list-style-type: none">• When inputting HDCP system signals, normal images may not be displayed immediately.
6. When you switch the power back on or return from power saving mode, windows or icons may have shifted position.	<ul style="list-style-type: none">• In the "Administrator Settings" menu, set "Compatibility Mode" to "On" (see "Compatibility Mode" (page 44)).
7. The screen colors look strange.	<ul style="list-style-type: none">• Try changing "Input Color Format" in the Setting menu (see "Input Color Format" (page 18)).• For HDMI signal input, try changing "Signal Format" in the "Administrator Settings" menu (see "Signal Format" (page 44)).
8. The image does not display on the entire screen.	<ul style="list-style-type: none">• Try changing "Picture Expansion" in the Setting menu (see "Picture Expansion" (page 27)).

8-3. SelfCalibration Problems

Problem	Possible cause and remedy
1. The built-in calibration sensor does not come out/stays out.	<ul style="list-style-type: none"> • Turn off the main power, and then turn it on again a few minutes later.
2. SelfCalibration cannot be executed.	<ul style="list-style-type: none"> • Check whether a color mode for executing SelfCalibration has been set (see "Mode Settings" (page 36)). • Check whether the date and time are set correctly on the monitor (see "Clock Adjustment" (page 37)). • Check whether the execution schedule been set (see "Schedule" (page 36)). • Check whether the calibration targets are set correctly (see "Target Settings" (page 24)). • Try calibrating the monitor by using ColorNavigator 7.
3. SelfCalibration failure	Refer to the error code table. If an error code that does not appear in the error code table is displayed, contact your local EIZO representative.
4. SelfCalibration is canceled while in progress.	<ul style="list-style-type: none"> • If there is a change in the video signal from the external device during SelfCalibration (the signal disappears, a signal is input during a no-signal state, or other), SelfCalibration is canceled. • Prevent any changes in the video signal while executing SelfCalibration. • If a scheduled SelfCalibration is canceled, it is executed again when the monitor transitions to the power saving mode after an hour or more or when the monitor is turned off using . SelfCalibration can also be executed regardless of the schedule (see "4-3. Executing" (page 38)).

Error Code Table

If an error related to any of the following values occurs, the error code and error message are displayed in the "Color" menu.

- Calibration target value
- Adjustable brightness settings
- Adjustable black level settings

Error Code	Error Message
000020	The sensor failed to open.
000021	Check whether there is any foreign object near the sensor.
010141	Invalid target value has been set. Check the target value.
****52	The target black level is too low. Up the target black level or set "Min".

8-4. Other Problems

Problem	Possible cause and remedy
1. The Setting menu/Mode menu cannot be displayed	<ul style="list-style-type: none"> • Check whether the control button lock function works (see “Key Lock” (page 44)). • Control buttons are locked when the main window of ColorNavigator 7 is displayed. Exit the software.
2. The monitor connected with the USB cable is not detected. / The peripheral USB device connected to the monitor does not work.	<ul style="list-style-type: none"> • Check whether the USB cable is connected correctly (see “9-3. Making Use of the USB Hub Function” (page 65)). • If a peripheral device is connected to the  port, try checking the “USB CHARGE Port” setting (see “USB CHARGE Port” (page 31)). If it is set to “Charging Only”, the peripheral device will not work. • Try changing to a different USB port on the external device. • Try changing to a different USB port on the monitor. • Reboot the external device. • If the peripheral devices work correctly when the external device and peripheral devices are connected directly, contact your local EIZO representative. • Check whether the external device and OS are USB compliant. (For USB compliance of the respective devices, consult their manufacturers.) • Depending on the USB 3.1 Gen 1 host controller that you are using, connected USB devices may not be recognized correctly. Update to the latest USB 3.1 Gen 1 driver provided by each manufacturer, or connect the monitor to the USB 2.0 port. • Check the external device’s BIOS setting for USB when using Windows. (Refer to the User’s Manual of the external device for details.)
3. Audio is not output.	<ul style="list-style-type: none"> • This product is not equipped with a speaker.

Chapter 9 Reference

9-1. Attaching the Installation Fixture

This product can be detached from the stand and attached to an installation fixture.

Attention

- When installing, do so by carefully following the information in the User Manual about the arm or stand.
- Ensure the following and select components that comply with the VESA standards.
 - Clearance between screw holes: 200 mm x 200 mm
 - Must be strong enough to support weight of the monitor unit and attachments such as cables.
- Please follow the specifications for the screw tightening torque. If the tightening is not performed correctly, the attached part may be damaged, which may result in injury or equipment damage.
- Do not install the display screen at an angle. Position it vertically.
- Connect the cables after attaching an arm or stand
- Installation should be performed by two or more people.
- The monitor and installation fixture are heavy. Dropping them may result in injury or equipment damage.
- Periodically check the tightness of the screws. If not sufficiently tight, the monitor may detach from the arm, which may result in injury or equipment damage.

1. Being careful not to damage the LCD panel surface, and being careful not to put weight on the parts of the monitor that stick out (the built-in calibration sensor and the dial), place the LCD panel surface face-down on a table or other stable location.

2. Remove the stand.

Remove the fixing screws on the stand, and detach the left and right sides of the stand.

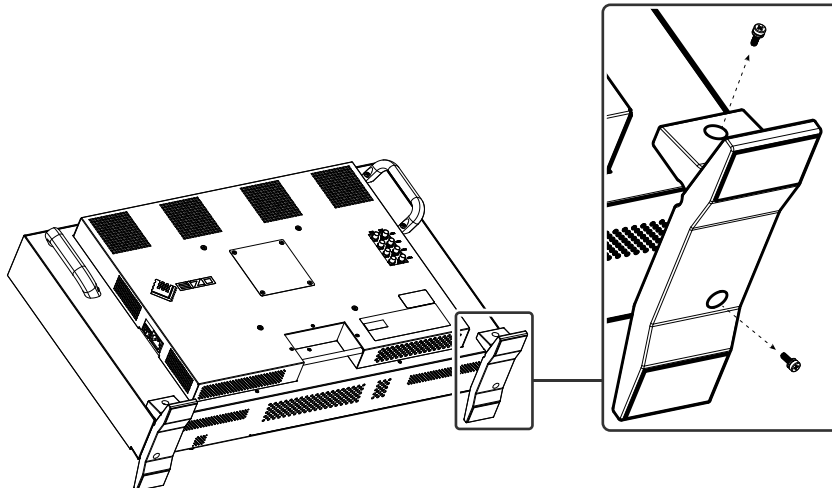

3. Detach the back plate.

Remove the fixing screws on the plate, and detach the plate.

Attention

- The plate and screws must be removed, or the installation fixture may not be able to be positioned correctly.
- The removed plate and screws are not used to attach the installation fixture.

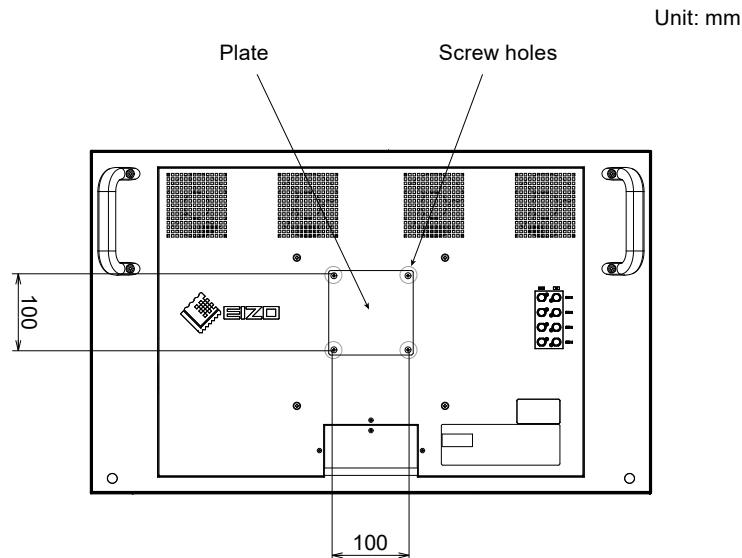

4. Remove the screws from the four screw holes with 200 mm pitch.

Attention

- The screws removed in this step are not used to attach the installation fixture. Use separately sold, commercially available screws.

5. Insert commercially available screws into the four screw holes with 200 mm pitch and fix the installation fixture in place.

Screws: M6 screws

Tightening torque: 2.0 N·m to 2.5 N·m

Attention

- Do not attach the installation fixture to the screw holes with 100 mm pitch. The monitor may be damaged, which may result in injury or equipment damage.

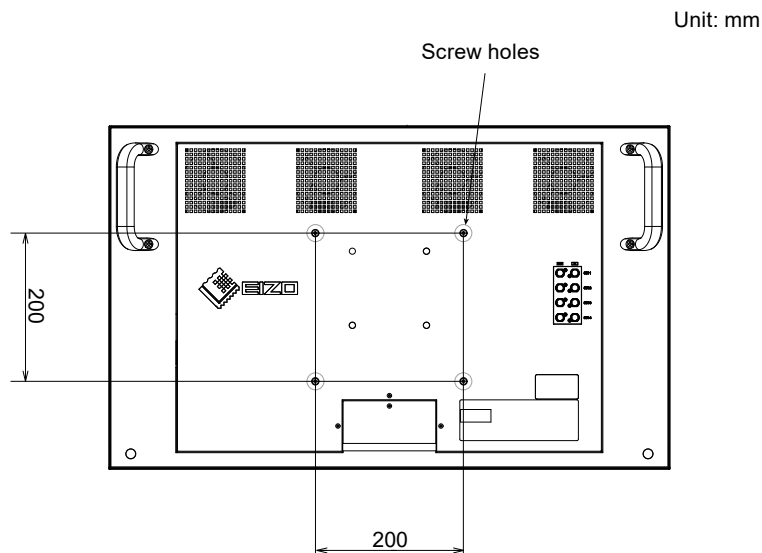

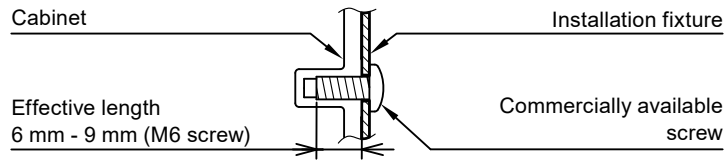



9-2. Connecting Multiple External Devices

The product allows you to connect multiple external devices and switch between them for display.

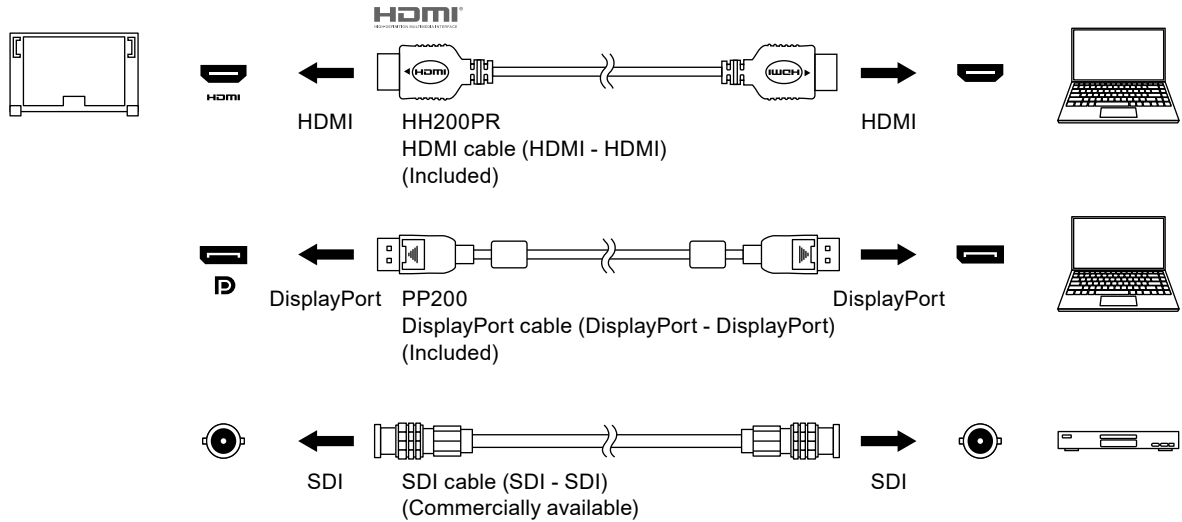
Connection examples



Note

- The input signal changes each time the  (SIGNAL) button on the front of the monitor is pressed. For more information, see [“2-1. Switching Input Signals”](#) (page 11).

9-3. Making Use of the USB Hub Function

This monitor is equipped with a USB hub. It works as a USB hub when connected to a USB-compatible external device, allowing the connection of peripheral USB devices.

● Connection Procedure

1. Connect the USB cable between the USB downstream port of the external device and USB upstream port of the monitor.

For the location of the monitor's USB Type-B connector, see ["Rear"](#) (page 9).

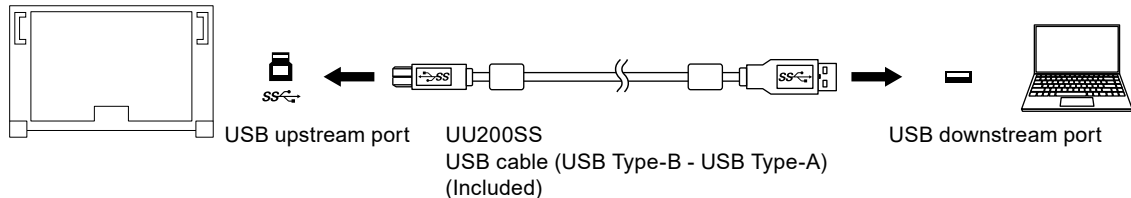

2. Connect the peripheral USB device to the USB downstream port of the monitor.



Attention

- This monitor may not work depending on the used external device, OS or peripheral devices. For USB compatibility of peripheral devices, contact their manufactures.
- When the monitor is in power saving mode, devices connected to the USB downstream port will still work. Therefore, power consumption of the monitor varies depending on the connected devices, even in the power saving mode.
- When the main power switch of the monitor is off, a device connected to the USB downstream port will not operate.
- When the "USB CHARGE Port" setting in "Preferences" is set to "Charging Only", a peripheral device will not work if connected to the port.
- Ensure that communication between all peripheral devices connected to the monitor and the external device is ended before switching the "USB CHARGE Port" setting. When the setting is switched, all communication will be temporarily interrupted.

Note

- This product supports USB 3.1 Gen 1. When connecting peripheral devices using USB cable that supports USB 3.1 Gen 1, high-speed data communication is possible.
- The USB downstream port also supports quick charging. This allows you to recharge your smartphone or tablet in a short period of time. (See ["USB CHARGE Port"](#) (page 31))

9-4. Specifications

LCD Panel	Type	IPS (Anti-Glare)
	Backlight	Wide color gamut LED
	Size	78.9 cm (31.1 inch)
	Resolution	4096 dots × 2160 lines
	Display Size (H × V)	698.0 mm × 368.1 mm
	Pixel Pitch	0.170 mm × 0.170 mm
	Display Colors	Approx. 1073.74 million colors: Supports 10-bit (24-bit LUT)
	Viewing Angle (H × V, typical)	178° / 178°
	Maximum Brightness (typical)	1000 cd/m ²
	Contrast Ratio (typical)	1,000,000:1
	Response Time (typical)	Black → White → Black: 20 ms Gray-to-gray: 10 ms
Color Gamut Display (typical)	DCI coverage: 99 %, NTSC ratio: 109 %	
Video Signals	Input Terminals	HDMI × 1: Supports 8-bit, 10-bit, and 12-bit displays* ¹ (HDCP-compatible) DisplayPort × 1: Supports 8-bit and 10-bit displays (HDCP-compatible) SDI (12G / 6G / 3G / HD-SDI) × 1: Supports 10-bit and 12-bit displays SDI (3G / HD-SDI) × 3: Supports 10-bit and 12-bit displays *1 The maximum number of display bits is 10.
	Output Terminals	SDI (12G / 6G / 3G / HD-SDI) × 1: Supports 10-bit and 12-bit displays SDI (3G / HD-SDI) × 3: Supports 10-bit and 12-bit displays
	Horizontal scan frequency	HDMI: 15 kHz to 136 kHz DisplayPort: 25 kHz to 137 kHz
	Vertical scan frequency	23 Hz to 61 Hz (For 720 x 400: 69 Hz to 71 Hz)
	Frame Synchronization mode	23.75 Hz to 30.25 Hz, 47.5 Hz to 60.5 Hz
	Dot clock (Max.)	HDMI: 600.0 MHz DisplayPort: 598.3 MHz
USB	Port	Upstream port × 1 Downstream port × 3 (The  port supports quick charging.)
	Standard	USB Specification Revision 3.1 Gen 1 USB Battery Charging Specification Rev.1.2
	Communication Speed	5 Gbps (super), 480 Mbps (high), 12 Mbps (full), 1.5 Mbps (low)
	Supply Current	Downstream: Max. 900 mA per 2 ports Downstream ( port): Normal: Max. 1.5 A per port, Charging Only: Max. 2.6 A per port
Power	Input	100–240 VAC ±10 %, 50/60 Hz 4.70 A–2.00 A
	Maximum Power Consumption	463 W or less
	Power Save Mode	1.2 W or less (When "Compatibility Mode" is set to "Off", "USB CHARGE Port" is set to "Normal", and no USB device is connected)
	Standby Mode	1.0 W or less (When "Compatibility Mode" is set to "Off", "USB CHARGE Port" is set to "Normal", and no USB device is connected)

Physical Specifications	Outside Dimensions (Without Monitor Hood)	757 mm × 488 mm × 208 mm (W × H × D)
	Net Weight (Without Monitor Hood)	Approx. 26.5 kg
	Net Weight (Without Stand and Monitor Hood)	Approx. 25.2 kg
Operating Environment Requirements	Temperature	0 °C to 30 °C
	Humidity	20 % to 80 % R.H. (no condensation)
	Air Pressure	540 hPa to 1060 hPa
Transportation/ Storage Environment Requirements	Temperature	-20 °C to 60 °C
	Humidity	10 % to 90 % R.H. (no condensation)
	Air Pressure	200 hPa to 1060 hPa

● Accessories

For the latest information about the accessories, refer to our web site. www.eizoglobal.com

Appendix

Trademark

The terms HDMI and HDMI High-Definition Multimedia Interface, and the HDMI Logo are trademarks or registered trademarks of HDMI Licensing, LLC in the United States and other countries.

The DisplayPort Compliance Logo and VESA are registered trademarks of the Video Electronics Standards Association.

The SuperSpeed USB Trident Logo is a registered trademark of USB Implementers Forum, Inc.



The USB Power Delivery Trident Logos are trademarks of USB Implementers Forum, Inc.



DICOM is the registered trademark of the National Electrical Manufacturers Association for its standards publications relating to digital communications of medical information.

Kensington and Microsaver are registered trademarks of ACCO Brands Corporation.

Thunderbolt is a trademark of Intel Corporation in the United States and/or other countries.

Microsoft and Windows are registered trademarks of Microsoft Corporation in the United States and other countries.

Adobe is a registered trademark of Adobe Systems Incorporated in the United States and other countries.

Apple, macOS, Mac OS, OS X, Macintosh and ColorSync are registered trademarks of Apple Inc.

ENERGY STAR is a registered trademark of the United States Environmental Protection Agency in the United States and other countries.

EIZO, the EIZO Logo, ColorEdge, CuratOR, DuraVision, FlexScan, FORIS, RadiCS, RadiForce, RadiNET, Raptor and ScreenManager are registered trademarks of EIZO Corporation in Japan and other countries.

ColorEdge Tablet Controller, ColorNavigator, EcoView NET, EIZO EasyPIX, EIZO Monitor Configurator, EIZO ScreenSlicer, G-Ignition, i-Sound, Quick Color Match, RadiLight, Re/Vue, SafeGuard, Screen Administrator, Screen InStyle, ScreenCleaner and UniColor Pro are trademarks of EIZO Corporation.

All other company names, product names, and logos are trademarks or registered trademarks of their respective companies.

License

The bitmap font used for this product is designed by Ricoh Industrial Solutions Inc.

Warning for Radio interference

For U.S.A., Canada Only

FCC Supplier's Declaration of Conformity

We, the Responsible Party

EIZO Inc.

5710 Warland Drive, Cypress, CA 90630

Phone: (562) 431-5011

declare that the product

Trade name: EIZO

Model: ColorEdge PROMINENCE CG3146

is in conformity with Part 15 of the FCC Rules. Operation of this product is subject to the following two conditions: (1) this device may not cause harmful interference, and (2) this device must accept any interference received, including interference that may cause undesired operation.

WARNING!

This equipment has been tested and found to comply with the limits for a Class A digital device, pursuant to Part 15 of the FCC Rules. These limits are designed to provide reasonable protection against harmful interference when the equipment is operated in a commercial environment. This equipment generates, uses, and can radiate radio frequency energy and if not installed and used in accordance with the instruction manual, may cause harmful interference to radio communications. Operation of this equipment in a residential area is likely to cause harmful interference in which case the user will be required to correct the interference at his own expense.

Changes or modifications not expressly approved by the party responsible for compliance could void the user's authority to operate the equipment.

Note

Use the attached specified cable below or EIZO signal cable with this monitor so as to keep interference within the limits of a Class A digital device.

- AC Cord
- Shielded Signal Cable (enclosed)

Canadian Notice

This Class A information technology equipment complies with Canadian ICES-003.

Cet équipement informatique de classe A est conforme à la norme NMB-003 du Canada.

For Europe, Australia, New Zealand, etc Only

Warning

Operation of this equipment in a residential environment could cause radio interference.

Warnung

Der Betrieb dieses Geräts in einer Wohnumgebung könnte Funkstörungen verursachen.

Avertissement

L'utilisation de cet équipement dans une zone résidentielle pourrait provoquer des interférences radio.

