

# ACX710 Universal Metro Router Hardware Guide

Published  
2020-09-24

Juniper Networks, Inc.  
1133 Innovation Way  
Sunnyvale, California 94089  
USA  
408-745-2000  
www.juniper.net

Juniper Networks, the Juniper Networks logo, Juniper, and Junos are registered trademarks of Juniper Networks, Inc. in the United States and other countries. All other trademarks, service marks, registered marks, or registered service marks are the property of their respective owners.

Juniper Networks assumes no responsibility for any inaccuracies in this document. Juniper Networks reserves the right to change, modify, transfer, or otherwise revise this publication without notice.

*ACX710 Universal Metro Router Hardware Guide*  
Copyright © 2020 Juniper Networks, Inc. All rights reserved.

The information in this document is current as of the date on the title page.

## YEAR 2000 NOTICE

Juniper Networks hardware and software products are Year 2000 compliant. Junos OS has no known time-related limitations through the year 2038. However, the NTP application is known to have some difficulty in the year 2036.

## END USER LICENSE AGREEMENT

The Juniper Networks product that is the subject of this technical documentation consists of (or is intended for use with) Juniper Networks software. Use of such software is subject to the terms and conditions of the End User License Agreement (“EULA”) posted at <https://support.juniper.net/support/eula/>. By downloading, installing or using such software, you agree to the terms and conditions of that EULA.

# Table of Contents

## About the Documentation | ix

Documentation and Release Notes | ix

Using the Examples in This Manual | ix

Merging a Full Example | x

Merging a Snippet | xi

Documentation Conventions | xi

Documentation Feedback | xiv

Requesting Technical Support | xiv

Self-Help Online Tools and Resources | xv

Creating a Service Request with JTAC | xv

1

## Overview

### ACX710 System Overview | 17

ACX710 Universal Metro Router Description | 17

Benefits of ACX710 Routers | 17

ACX710 System Overview | 18

ACX710 Router Model | 18

Field-Replaceable Units in ACX710 Routers | 19

ACX710 Routers Hardware and CLI Terminology Mapping | 19

ACX710 System Software Overview | 21

### ACX710 Chassis | 21

Management Panel of ACX710 Routers | 21

Port Panel of ACX710 Routers | 22

Chassis Status LEDs on ACX710 Routers | 23

Network Port LED on ACX710 Routers | 25

Safety Labels on ACX710 Routers | 26

### Cooling System and Airflow in ACX710 Routers | 27

### DC Power Specifications for ACX710 Routers | 28

## Site Planning, Preparation, and Specifications

### Site Preparation Checklist for ACX710 Routers | 30

### ACX710 Site Guidelines and Requirements | 31

General Site Guidelines | 32

Site Electrical Wiring Guidelines | 32

Chassis Physical Specifications for ACX710 Routers | 33

Environmental Requirements and Specifications for ACX710 Routers | 33

ACX710 Grounding Cable and Lug Specifications | 34

Clearance Requirements for Airflow and Hardware Maintenance for ACX710 Routers | 35

Cabinet Requirements for ACX710 Routers | 36

Rack Requirements for ACX710 Routers | 37

### ACX710 Network Cable and Transceiver Planning | 38

Determining Transceiver Support for ACX710 | 39

Cable Specifications for QSFP+ and QSFP28 Transceivers | 40

Calculating Power Budget and Power Margin for Fiber-Optic Cables | 42

How to Calculate Power Budget for Fiber-Optic Cable | 42

How to Calculate Power Margin for Fiber-Optic Cable | 42

Fiber-Optic Cable Signal Loss, Attenuation, and Dispersion | 44

Signal Loss in Multimode and Single-Mode Fiber-Optic Cable | 44

Attenuation and Dispersion in Fiber-Optic Cable | 44

### ACX710 Management Cable Specifications and Pinouts | 45

Management Cable Specifications for ACX710 Routers | 46

RJ-45 Management Port Connector Pinout on ACX710 Routers | 46

RJ-45 to DB-9 Serial Port Adapter Pinout Information | 47

Console Port Connector Pinout on ACX710 Routers | 47

SFP, SFP+, SFP28, QSFP+, and QSFP28 Port Connector Pinout Information | 48

USB Port Specifications for an ACX Series Router | 53

Alarm Port Pinouts | 53

TOD Port Connector Pinout Information | 54

## 3

## Initial Installation and Configuration

### ACX710 Installation Overview | 57

### Unpack and Mount an ACX710 Router | 57

Unpack an ACX710 Router | 58

Mount an ACX710 Router in a Rack | 59

Before You Begin Rack Installation | 60

Install an ACX710 Router in a Rack | 61

### Connect ACX710 to Power | 63

Connect Earth Ground to ACX710 Routers | 63

DC Power Cabling | 64

Connect DC Power to an ACX710 Router | 65

### Connect ACX710 to External Devices | 67

Connect an ACX710 Router to a Management Console | 67

Connect an ACX710 Router to a Network for Out-of-Band Management | 69

Connect an ACX710 Router to External Clocking and Timing Devices | 70

Connect a T1 or an E1 External Clocking Device to the ACX710 Router | 70

Connect a Time-of-Day Device to the ACX710 Router | 70

Connect an ACX710 Router to External Alarm Devices | 71

### Perform Initial Software Configuration for the ACX710 Routers | 72

## 4

## Maintaining Components

### Maintain ACX710 Components | 76

Replace an ACX710 Fan Tray | 76

Remove a Fan Tray from an ACX710 Router | 76

Install a Fan Tray in an ACX710 Router | 77

Replace an SFP, SFP+, or QSFP+ Transceiver | 79

Remove a Transceiver | 79

Install a Transceiver | 81

- Replace a QSFP28 Transceiver | 83
  - Remove a QSFP28 Transceiver | 83
  - Install a QSFP28 Transceiver | 85
- How to Handle Fiber-Optic Cables | 87

## **Remove an ACX710 Router | 88**

- Power Off an ACX710 Router | 88
- Remove an ACX710 Router from a Rack or Cabinet | 90

## **5**

## **Troubleshooting Hardware**

### **Troubleshoot an ACX710 Router | 93**

- Alarm Types and Severity Classes on ACX Series Routers | 93
  - Alarm Types | 93
  - Alarm Severity Classes | 94

## **6**

## **Contacting Customer Support and Returning the Chassis or Components**

### **Contacting Customer Support and Returning the Chassis or Components | 96**

- How to Return a Hardware Component to Juniper Networks, Inc. | 96
- How to Locate the Serial Number on an ACX710 Router or Component | 97
  - List the Chassis and Component Details Using the CLI | 97
  - Locate the Chassis Serial Number ID Label on an ACX710 Router | 99
  - Locate the Serial Number ID Label on an ACX710 Fan Tray | 99
- Contact Customer Support to Obtain Return Material Authorization | 100
- Guidelines for Packing Hardware Components for Shipment | 100

## **7**

## **Safety and Compliance Information**

### **General Safety Guidelines and Warnings | 104**

### **Definitions of Safety Warning Levels | 105**

### **Qualified Personnel Warning | 108**

### **Warning Statement for Norway and Sweden | 109**

### **Fire Safety Requirements | 109**

- Fire Suppression | 109
- Fire Suppression Equipment | 109

### **Installation Instructions Warning | 111**

**Restricted Access Warning | 112**

**Ramp Warning | 114**

**Rack-Mounting and Cabinet-Mounting Warnings | 115**

**Grounded Equipment Warning | 121**

**Radiation from Open Port Apertures Warning | 122**

**Laser and LED Safety Guidelines and Warnings | 123**

General Laser Safety Guidelines | 123

Class 1 Laser Product Warning | 124

Class 1 LED Product Warning | 125

Laser Beam Warning | 126

**Maintenance and Operational Safety Guidelines and Warnings | 126**

Battery Handling Warning | 128

Jewelry Removal Warning | 129

Lightning Activity Warning | 131

Operating Temperature Warning | 132

Product Disposal Warning | 134

**General Electrical Safety Guidelines and Warnings | 135**

**Prevention of Electrostatic Discharge Damage | 136**

**Site Electrical Wiring Guidelines | 137**

**DC Power Electrical Safety Guidelines | 138**

**DC Power Copper Conductors Warning | 139**

**DC Power Disconnection Warning | 140**

**DC Power Grounding Requirements and Warning | 142**

**DC Power Wiring Sequence Warning | 144**

**DC Power Wiring Terminations Warning | 147**

**Multiple Power Supplies Disconnection Warning | 150**

**Action to Take After an Electrical Accident | 151**

**Agency Approvals for ACX710 Routers | 151**

**Compliance Statements for NEBS | 152**

**Compliance Statements for EMC Requirements | 152**

Canada | 153

European Community | 153

Israel | 153

Japan | 153

United States | 154

**Compliance Statements for Environmental Requirements | 154**



# About the Documentation

## IN THIS SECTION

- Documentation and Release Notes | ix
- Using the Examples in This Manual | ix
- Documentation Conventions | xi
- Documentation Feedback | xiv
- Requesting Technical Support | xiv

Use this guide to install hardware and perform initial software configuration, routine maintenance, and troubleshooting for the ACX710 Router.

After completing the installation and basic configuration procedures covered in this guide, refer to the Junos OS documentation for information about further software configuration.

## Documentation and Release Notes

To obtain the most current version of all Juniper Networks® technical documentation, see the product documentation page on the Juniper Networks website at <https://www.juniper.net/documentation/>.

If the information in the latest release notes differs from the information in the documentation, follow the product Release Notes.

Juniper Networks Books publishes books by Juniper Networks engineers and subject matter experts. These books go beyond the technical documentation to explore the nuances of network architecture, deployment, and administration. The current list can be viewed at <https://www.juniper.net/books>.

## Using the Examples in This Manual

If you want to use the examples in this manual, you can use the **load merge** or the **load merge relative** command. These commands cause the software to merge the incoming configuration into the current candidate configuration. The example does not become active until you commit the candidate configuration.

If the example configuration contains the top level of the hierarchy (or multiple hierarchies), the example is a *full example*. In this case, use the **load merge** command.

If the example configuration does not start at the top level of the hierarchy, the example is a *snippet*. In this case, use the **load merge relative** command. These procedures are described in the following sections.

## Merging a Full Example

To merge a full example, follow these steps:

1. From the HTML or PDF version of the manual, copy a configuration example into a text file, save the file with a name, and copy the file to a directory on your routing platform.

For example, copy the following configuration to a file and name the file **ex-script.conf**. Copy the **ex-script.conf** file to the **/var/tmp** directory on your routing platform.

```
system {
  scripts {
    commit {
      file ex-script.xsl;
    }
  }
}
interfaces {
  fxp0 {
    disable;
    unit 0 {
      family inet {
        address 10.0.0.1/24;
      }
    }
  }
}
```

2. Merge the contents of the file into your routing platform configuration by issuing the **load merge** configuration mode command:

```
[edit]
user@host# load merge /var/tmp/ex-script.conf
load complete
```

## Merging a Snippet

To merge a snippet, follow these steps:

1. From the HTML or PDF version of the manual, copy a configuration snippet into a text file, save the file with a name, and copy the file to a directory on your routing platform.

For example, copy the following snippet to a file and name the file **ex-script-snippet.conf**. Copy the **ex-script-snippet.conf** file to the **/var/tmp** directory on your routing platform.

```
commit {  
  file ex-script-snippet.xml; }
```

2. Move to the hierarchy level that is relevant for this snippet by issuing the following configuration mode command:

```
[edit]  
user@host# edit system scripts  
[edit system scripts]
```

3. Merge the contents of the file into your routing platform configuration by issuing the **load merge relative** configuration mode command:

```
[edit system scripts]  
user@host# load merge relative /var/tmp/ex-script-snippet.conf  
load complete
```

For more information about the **load** command, see [CLI Explorer](#).

## Documentation Conventions

[Table 1 on page xii](#) defines notice icons used in this guide.

Table 1: Notice Icons







Icon	Meaning	Description
	Informational note	Indicates important features or instructions.
	Caution	Indicates a situation that might result in loss of data or hardware damage.
	Warning	Alerts you to the risk of personal injury or death.
	Laser warning	Alerts you to the risk of personal injury from a laser.
	Tip	Indicates helpful information.
	Best practice	Alerts you to a recommended use or implementation.

Table 2 on page xii defines the text and syntax conventions used in this guide.

Table 2: Text and Syntax Conventions

Convention	Description	Examples
<b>Bold text like this</b>	Represents text that you type.	To enter configuration mode, type the <b>configure</b> command:  user@host> <b>configure</b>
Fixed-width text like this	Represents output that appears on the terminal screen.	user@host> <b>show chassis alarms</b>  No alarms currently active
<i>Italic text like this</i>	<ul style="list-style-type: none"> <li>Introduces or emphasizes important new terms.</li> <li>Identifies guide names.</li> <li>Identifies RFC and Internet draft titles.</li> </ul>	<ul style="list-style-type: none"> <li>A policy <i>term</i> is a named structure that defines match conditions and actions.</li> <li><i>Junos OS CLI User Guide</i></li> <li>RFC 1997, <i>BGP Communities Attribute</i></li> </ul>

Table 2: Text and Syntax Conventions (*continued*)

Convention	Description	Examples
<i>Italic text like this</i>	Represents variables (options for which you substitute a value) in commands or configuration statements.	Configure the machine's domain name:  [edit] root@# <b>set system domain-name</b> <i>domain-name</i>
<b>Text like this</b>	Represents names of configuration statements, commands, files, and directories; configuration hierarchy levels; or labels on routing platform components.	<ul style="list-style-type: none"> <li>To configure a stub area, include the <b>stub</b> statement at the [edit <b>protocols ospf area area-id</b>] hierarchy level.</li> <li>The console port is labeled <b>CONSOLE</b>.</li> </ul>
< > (angle brackets)	Encloses optional keywords or variables.	<b>stub</b> <default-metric <i>metric</i> >;
(pipe symbol)	Indicates a choice between the mutually exclusive keywords or variables on either side of the symbol. The set of choices is often enclosed in parentheses for clarity.	<b>broadcast</b>   <b>multicast</b>  ( <i>string1</i>   <i>string2</i>   <i>string3</i> )
# (pound sign)	Indicates a comment specified on the same line as the configuration statement to which it applies.	<b>rsvp { # Required for dynamic MPLS only</b>
[ ] (square brackets)	Encloses a variable for which you can substitute one or more values.	<b>community name members [ <i>community-ids</i> ]</b>
Indentation and braces ( { } )	Identifies a level in the configuration hierarchy.	[edit] routing-options { static { route default { nexthop <i>address</i> ; retain; } } }
;(semicolon)	Identifies a leaf statement at a configuration hierarchy level.	

---

**GUI Conventions**

---

Table 2: Text and Syntax Conventions (*continued*)

Convention	Description	Examples
<b>Bold text like this</b>	Represents graphical user interface (GUI) items you click or select.	<ul style="list-style-type: none"> <li>In the Logical Interfaces box, select <b>All Interfaces</b>.</li> <li>To cancel the configuration, click <b>Cancel</b>.</li> </ul>
> (bold right angle bracket)	Separates levels in a hierarchy of menu selections.	In the configuration editor hierarchy, select <b>Protocols&gt;Ospf</b> .

## Documentation Feedback

We encourage you to provide feedback so that we can improve our documentation. You can use either of the following methods:

- Online feedback system—Click TechLibrary Feedback, on the lower right of any page on the [Juniper Networks TechLibrary](#) site, and do one of the following:

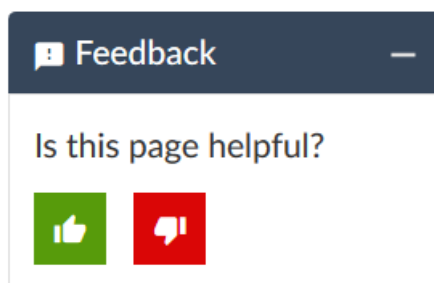

- Click the thumbs-up icon if the information on the page was helpful to you.
- Click the thumbs-down icon if the information on the page was not helpful to you or if you have suggestions for improvement, and use the pop-up form to provide feedback.
- E-mail—Send your comments to [techpubs-comments@juniper.net](mailto:techpubs-comments@juniper.net). Include the document or topic name, URL or page number, and software version (if applicable).

## Requesting Technical Support

Technical product support is available through the Juniper Networks Technical Assistance Center (JTAC). If you are a customer with an active Juniper Care or Partner Support Services support contract, or are

covered under warranty, and need post-sales technical support, you can access our tools and resources online or open a case with JTAC.

- JTAC policies—For a complete understanding of our JTAC procedures and policies, review the *JTAC User Guide* located at <https://www.juniper.net/us/en/local/pdf/resource-guides/7100059-en.pdf>.
- Product warranties—For product warranty information, visit <https://www.juniper.net/support/warranty/>.
- JTAC hours of operation—The JTAC centers have resources available 24 hours a day, 7 days a week, 365 days a year.

## Self-Help Online Tools and Resources

For quick and easy problem resolution, Juniper Networks has designed an online self-service portal called the Customer Support Center (CSC) that provides you with the following features:

- Find CSC offerings: <https://www.juniper.net/customers/support/>
- Search for known bugs: <https://prsearch.juniper.net/>
- Find product documentation: <https://www.juniper.net/documentation/>
- Find solutions and answer questions using our Knowledge Base: <https://kb.juniper.net/>
- Download the latest versions of software and review release notes: <https://www.juniper.net/customers/csc/software/>
- Search technical bulletins for relevant hardware and software notifications: <https://kb.juniper.net/InfoCenter/>
- Join and participate in the Juniper Networks Community Forum: <https://www.juniper.net/company/communities/>
- Create a service request online: <https://myjuniper.juniper.net>

To verify service entitlement by product serial number, use our Serial Number Entitlement (SNE) Tool: <https://entitlementsearch.juniper.net/entitlementsearch/>

## Creating a Service Request with JTAC

You can create a service request with JTAC on the Web or by telephone.

- Visit <https://myjuniper.juniper.net>.
- Call 1-888-314-JTAC (1-888-314-5822 toll-free in the USA, Canada, and Mexico).

For international or direct-dial options in countries without toll-free numbers, see <https://support.juniper.net/support/requesting-support/>.

# 1

CHAPTER

## Overview

---

ACX710 System Overview | **17**

ACX710 Chassis | **21**

Cooling System and Airflow in ACX710 Routers | **27**

DC Power Specifications for ACX710 Routers | **28**

---



# ACX710 System Overview

## IN THIS SECTION

- [ACX710 Universal Metro Router Description | 17](#)
- [ACX710 Router Model | 18](#)
- [Field-Replaceable Units in ACX710 Routers | 19](#)
- [ACX710 Routers Hardware and CLI Terminology Mapping | 19](#)
- [ACX710 System Software Overview | 21](#)

## ACX710 Universal Metro Router Description

The Juniper Networks ACX710 Universal Metro Routers are high-performance routers designed to deliver solutions that address the evolution needs of the mobile backhaul.

The ACX710 router provides an aggregation solution that is cost-effective and compact, and that supports emerging deployments such as segment routing and Ethernet VPN (EVPN). The ACX710 includes support for numerous features such as modern network management using NETCONF and YANG, and precise synchronization that helps address the increasing demands of high-speed networks.

This video provides a brief overview of the ACX710.



Video: [ACX710 Hardware Overview](#)

### Benefits of ACX710 Routers

- **Optimized space**—The ACX710 router has a small footprint and is optimized for space-constrained deployments.
- **High performance**—The ACX710 router offers high-density 1GbE, 10GbE, and 100GbE ports with full-duplex throughput of 320 Gbps and 24-Gbit DRAM packet buffer. The ACX710 is designed to deliver solutions that support emerging deployments.
- **Zero-touch provisioning**—The ACX710 router supports zero-touch provisioning (ZTP), which enables you to automate provisioning and deployment with minimal manual intervention. This helps save time and accelerate deployments.

## ACX710 System Overview

The ACX710 router is a 1-U compact and fixed-configuration model with high-density 1GbE, 10GbE, and 100GbE ports. ACX710 routers provide full-duplex throughput of 320 Gbps and 24-Gbit DRAM packet buffer.

We ship these routers with a DC power supply module that has dual power feeds and a fan tray with five high-performance fans that can effectively cool the chassis.

[Figure 1 on page 18](#) shows the front of the ACX710 router.

Figure 1: Front View of the ACX710 Router

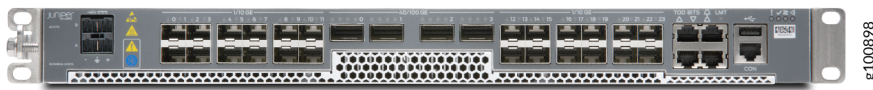

[Figure 2 on page 18](#) shows the rear view of the ACX710 router.

Figure 2: Rear View of the ACX710 Router



SEE ALSO

[Cooling System and Airflow in ACX710 Routers | 27](#)

[DC Power Specifications for ACX710 Routers | 28](#)

## ACX710 Router Model

The ACX710 routers are available with a dual feed DC power supply module and a fan tray with five high-performance fans.

The model number for ACX710 routers is ACX710-DC.

## Field-Replaceable Units in ACX710 Routers

Field-replaceable units (FRUs) are components that you can replace at your site. The following are the ACX710 FRUs:

- Fan tray
- Optical transceivers



**CAUTION:** Replace a failed fan tray with a new fan tray within three minutes of removal to prevent chassis overheating. Do not operate the router with missing FRUs for longer than one minute.

**NOTE:** If you have a Juniper J-Care service contract, register any addition, change, or upgrade of hardware components at <https://www.juniper.net/customers/csc/management/updateinstallbase.jsp>. Failure to do so can result in significant delays if you need replacement parts. This note does not apply if you replace existing components with the same type of component.

**NOTE:** Before removing the optical transceivers, we recommend that you disable the interface using the **set interfaces *interface-name* disable** command.

SEE ALSO

| [Replace an ACX710 Fan Tray | 76](#)

## ACX710 Routers Hardware and CLI Terminology Mapping

[Table 3 on page 20](#) describes the hardware terms used in ACX710 router documentation and the corresponding terms used in the Junos OS CLI.

Table 3: CLI Equivalents of Terms Used in Documentation for ACX710 Routers

Hardware Item (as Displayed in the CLI)	Description (as Displayed in the CLI)	Value (as Displayed in the CLI)	Item in Documentation	Additional Information
<b>Chassis</b>	ACX710	-	Router chassis	<a href="#">“Chassis Physical Specifications for ACX710 Routers” on page 33</a>
<b>Routing Engine</b>	RE-ACX710	-	Built-in Routing Engine	
<b>FPC <i>n</i></b>	Abbreviated name of the Flexible PIC Concentrator (FPC; an FPC is equivalent to a line card)	Value of <i>n</i> is always 0.	The router does not have actual FPCs. In this case, FPC refers to the router itself.	<i>Interface Naming Conventions Used in the Junos OS Operational Commands</i>
<b>PIC <i>n</i></b>	Abbreviated name of the Physical Interface Card (PIC)	Value of <i>n</i> is a value in the range of 0-1.	The router does not have actual PICs  Built-in network ports on the front panel of the router are mapped to logical PICs.	<i>Interface Naming Conventions Used in the Junos OS Operational Commands</i>
<b>xcvr <i>n</i></b>	Abbreviated name of the transceiver	<i>n</i> is a value equivalent to the number of the port in which the transceiver is installed.	Optical transceivers	<i>Port and Interface Specifications</i>
<b>Power Supply 0</b>	Assy, Pwr Sply, DC Feed B, Airflow out	-	DC power supply module	<a href="#">“DC Power Specifications for ACX710 Routers” on page 28</a>
<b>Fan tray 0</b>	Fan module, Airflow Out	-	Fan tray	<a href="#">“Cooling System and Airflow in ACX710 Routers” on page 27</a>

## ACX710 System Software Overview

ACX710 routers use the Junos operating system (OS), which provides Layer 2 and Layer 3 switching, routing, and security services. The same Junos OS code base that runs on an ACX710 router also runs on all Juniper Networks QFX Series and EX Series switches, and on J Series, MX Series, ACX Series, PTX Series, and T Series routers.

# ACX710 Chassis

### IN THIS SECTION

- [Management Panel of ACX710 Routers | 21](#)
- [Port Panel of ACX710 Routers | 22](#)
- [Chassis Status LEDs on ACX710 Routers | 23](#)
- [Network Port LED on ACX710 Routers | 25](#)
- [Safety Labels on ACX710 Routers | 26](#)

## Management Panel of ACX710 Routers

The management panel of ACX710 routers is located on the front of the router along with the interface ports. [Figure 3 on page 22](#) shows the management panel components on an ACX710 router.

Figure 3: Management Panel Components on ACX710 Routers

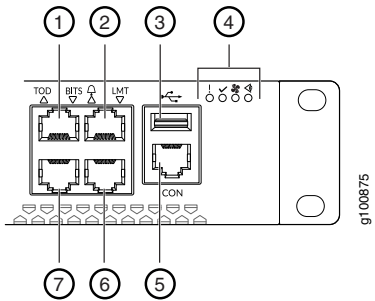

1–TOD port (RJ-45)	5–Console port (RJ-45)
2–I/O port (RJ-45)	6–LMT port (RJ-45)
3–USB port	7–BITS port (RJ-48C)
4–LEDs	

The management panel on an ACX710 router displays the router product number and consists of the following components:

- Status LEDs
- RJ-45 1PPS+TOD (ITU-T G.703 Amd1) port to connect to an external time-of-day (TOD) device. See [“Connect a Time-of-Day Device to the ACX710 Router” on page 70.](#)
- RJ-45 alarm port for three input and one output alarm contacts. See [“Connect an ACX710 Router to External Alarm Devices” on page 71.](#)
- USB port for image updates
- RJ-45 console (**CON**) port to connect the device to a management console or to a console server. See [“Connect an ACX710 Router to a Management Console” on page 67.](#)
- RJ-45 (**LMT**) port to connect the device to a network for out-of-band management. See [“Connect an ACX710 Router to a Network for Out-of-Band Management” on page 69.](#)
- RJ-48C (**BITS**) port for 2.048 MHz, E1/T1 (BITS) input/output. See [“Connect a T1 or an E1 External Clocking Device to the ACX710 Router” on page 70.](#)

## Port Panel of ACX710 Routers

The port panel of an ACX710 router has the following port configurations:

- Twenty-four 10GbE or 1GbE ports (ports **0** through **23**) that operate at 10-Gbps speed when you use small form-factor pluggable plus (SFP+) transceivers or at 1-Gbps speed when you use small form-factor pluggable (SFP) optics. Ports **0** through **15** also support 1000-Mbps speed when you use tri-rate SFP optics. Ports **16** through **23** support 100-Mbps and 1000-Mbps speeds when you use tri-rate SFP optics.
- Four 100GbE ports (ports **0** through **3**) that support quad small form-factor pluggable 28 (QSFP28) transceivers. You can channelize these ports into four 25-Gbps interfaces using breakout cables and channelization configuration. These ports also support 40-Gbps speed when you use quad small form-factor pluggable plus (QSFP+) optics. You can channelize these 40-Gbps ports into four 10-Gbps interfaces using breakout cables and channelization configuration.

Figure 4 on page 23 shows the port panel on an ACX710 router.

Figure 4: ACX710 Router Port Panel

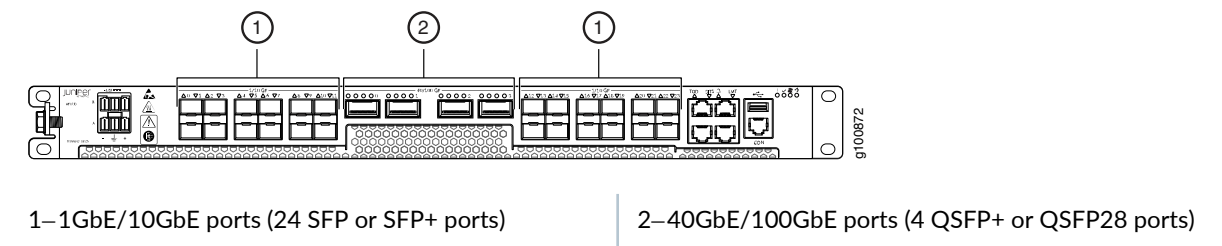

SEE ALSO

| [Interface Naming Convention for ACX710](#)

## Chassis Status LEDs on ACX710 Routers

ACX710 routers have four chassis status LEDs on the front side of the chassis.

Figure 5: Chassis Status LEDs on an ACX710 Router

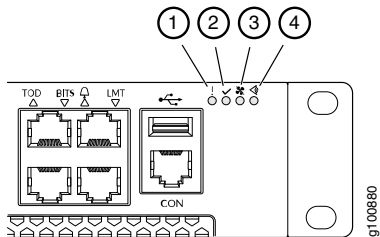

1–Fault LED	3–Fan LED
2–Operational LED	4–Status LED

Table 4 on page 24 describes the chassis status LEDs on ACX710 routers, their colors and states, and the status that they indicate.

Table 4: Chassis Status LEDs on ACX710 Routers

Name	Color	State	Description
Fault	Unlit	Off	The router is halted, or there is no alarm.
	Red	On steadily	A major hardware fault has occurred, such as a temperature alarm or power failure, and the router has halted. Power off the router by setting the power source outlet to the off (O) position and unplugging the power cords. Correct any voltage or site temperature issues, and allow the router to cool down.
Operational	Unlit	Off	The router is powered off or halted.
	Green	On steadily	The router is powered on or in operation.



Table 4: Chassis Status LEDs on ACX710 Routers (*continued*)

Name	Color	State	Description
Fan	Unlit	Off	The fan module is operating normally. The system has verified that the module is engaged, that the airflow is in the correct direction, and that the fan is operating correctly.
	Yellow	On steadily	An error has been detected in the fan module. Replace the fan tray as soon as possible. Either the fan has failed, or it is seated incorrectly. To maintain proper airflow through the chassis, leave the fan tray installed in the chassis until you are ready to replace it.
Status	Unlit	Off	No major or critical alarms in the system.
	Yellow	On steadily	There is a major or critical alarm in the system.

SEE ALSO

[Troubleshoot an ACX710 Router | 93](#)

## Network Port LED on ACX710 Routers

The color and state of the network port LED on an ACX710 router indicates the link activity on and status of network ports.

[Table 5 on page 25](#) describes how to interpret the color and state of the network port LED.

Table 5: Network Port LED on ACX710 Routers

Color	State	Description
Off	Unlit	There is no link on the port.

Table 5: Network Port LED on ACX710 Routers (*continued*)







Color	State	Description
Green	Blinking	A link is established, and there is link activity.
	On steadily	A link is established, but there is no link activity.

## Safety Labels on ACX710 Routers

The front panel of ACX710 routers displays safety labels.

[Table 6 on page 26](#) describes how to interpret the safety labels.

Table 6: Safety Labels on ACX710 Routers

Symbol	Description
	Alerts you that the device emits visible or invisible laser radiation, and that you should avoid any direct exposure to the laser beam.
	Indicates that you must wear an ESD wrist strap to avoid equipment damage from electrostatic discharge.
	Alerts you to the presence of hot surfaces on the device. Exercise caution when handling the device.
	Alerts you to the risk of electric shock.
	Indicates that you must exercise caution when operating the device.
	Alerts you to keep your distance from moving fan blades.
	Indicates that the mains plug must be disconnected in case of malfunction or when left unattended.

# Cooling System and Airflow in ACX710 Routers

The cooling system in an ACX710 router consists of a fan tray that is installed in the rear of the router. The fans in the fan tray draw cool air into the chassis to maintain an acceptable operating temperature for the device and its components. You remove and replace a fan tray from the rear end of the chassis. The router continues to operate for a limited period of time during the replacement of the fan tray without a thermal shutdown.

Figure 6 on page 27 shows the fan tray in an ACX710 router.

Figure 6: Fan Tray in ACX710 Routers

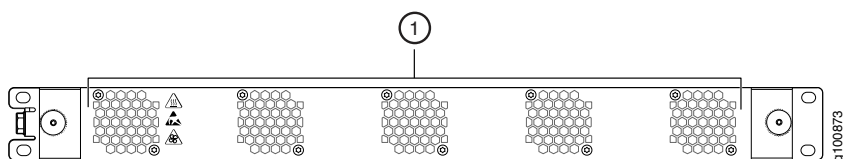

1–Fan tray

In the ACX710 router, cool air is pulled through the front of the chassis towards the fan tray, from where it is exhausted out of the chassis through the rear.

Figure 7 on page 27 shows the front-to-back airflow through the ACX710 chassis.

Figure 7: Airflow Through the ACX710 Chassis

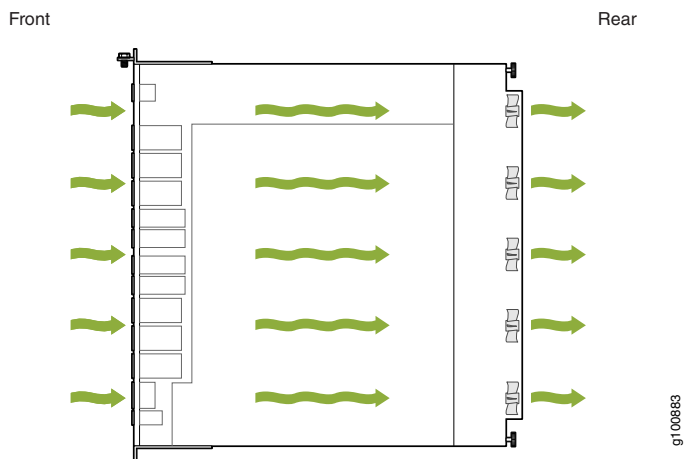

RELATED DOCUMENTATION

## DC Power Specifications for ACX710 Routers

The ACX710 router supports a dual feed DC power supply module. [Table 7 on page 28](#) describes the DC power specifications for ACX710 routers. For the 2-pole DC circuit breaker, the recommended maximum value is 32 A and the minimum value is 8 A.

**Table 7: DC Power Specifications for ACX710 Routers**

Item	Specifications
Nominal input voltage	-48 V DC
Input voltage range	-38 V DC to -60 V DC
Maximum current	6 A
Typical power consumption	150 W
Maximum power consumption	225 W

### RELATED DOCUMENTATION

[Connect DC Power to an ACX710 Router | 65](#)

[DC Power Cabling | 64](#)

# 2

CHAPTER

## Site Planning, Preparation, and Specifications

---

Site Preparation Checklist for ACX710 Routers | **30**

ACX710 Site Guidelines and Requirements | **31**

ACX710 Network Cable and Transceiver Planning | **38**

ACX710 Management Cable Specifications and Pinouts | **45**

---

# Site Preparation Checklist for ACX710 Routers

The checklist in [Table 8 on page 30](#) summarizes the tasks you need to perform when preparing a site for an ACX710 router installation.

**Table 8: Site Preparation Checklist for ACX710 Routers**

Item or Task	For More Information	Performed By	Date
<b>Environment</b>			
Verify that environmental factors such as temperature and humidity do not exceed router tolerances.	<a href="#">“Environmental Requirements and Specifications for ACX710 Routers” on page 33</a>		
<b>Power</b>			
Measure the distance between external power sources and router installation site.			
Calculate the power consumption and requirements.	<a href="#">“DC Power Specifications for ACX710 Routers” on page 28</a>		
<b>Rack or Cabinet</b>			
Verify that your rack or cabinet meets the minimum requirements for the installation of the router.	<a href="#">“Rack Requirements for ACX710 Routers” on page 37</a> <a href="#">“Cabinet Requirements for ACX710 Routers” on page 36</a>		
Plan rack or cabinet location, including required space clearances.	<a href="#">“Clearance Requirements for Airflow and Hardware Maintenance for ACX710 Routers” on page 35</a>		
Secure the rack or cabinet to the floor and building structure.			
<b>Cables</b>			

Table 8: Site Preparation Checklist for ACX710 Routers (continued)

Item or Task	For More Information	Performed By	Date
Acquire cables and connectors: <ul style="list-style-type: none"> <li>• Determine the number of cables needed based on your planned configuration.</li> <li>• Review the maximum distance allowed for each cable. Choose the length of cable based on the distance between the hardware components being connected.</li> </ul>	<a href="#">“Determining Transceiver Support for ACX710” on page 39</a> <a href="#">“Cable Specifications for QSFP+ and QSFP28 Transceivers” on page 40</a>		
Plan cable routing and management.			

#### RELATED DOCUMENTATION

[ACX710 Installation Overview | 57](#)

[Unpack and Mount an ACX710 Router | 57](#)

## ACX710 Site Guidelines and Requirements

#### IN THIS SECTION

- [General Site Guidelines | 32](#)
- [Site Electrical Wiring Guidelines | 32](#)
- [Chassis Physical Specifications for ACX710 Routers | 33](#)
- [Environmental Requirements and Specifications for ACX710 Routers | 33](#)
- [ACX710 Grounding Cable and Lug Specifications | 34](#)
- [Clearance Requirements for Airflow and Hardware Maintenance for ACX710 Routers | 35](#)
- [Cabinet Requirements for ACX710 Routers | 36](#)
- [Rack Requirements for ACX710 Routers | 37](#)

## General Site Guidelines

Efficient device operation requires proper site planning and maintenance and proper layout of the equipment, rack or cabinet (if used), and wiring closet.

To plan and create an acceptable operating environment for your device and prevent environmentally caused equipment failures:

- Keep the area around the chassis free from dust and conductive material, such as metal flakes.
- Follow prescribed airflow guidelines to ensure that the cooling system functions properly and that exhaust from other equipment does not blow into the intake vents of the device.
- Follow the prescribed electrostatic discharge (ESD) prevention procedures to prevent damaging the equipment. Static discharge can cause components to fail completely or intermittently over time.
- Install the device in a secure area, so that only authorized personnel can access the device.

## Site Electrical Wiring Guidelines

Table 9 on page 32 describes the factors you must consider while planning the electrical wiring at your site.

 **WARNING:** You must provide a properly grounded and shielded environment and use electrical surge-suppression devices.

Table 9: Site Electrical Wiring Guidelines

Site Wiring Factor	Guidelines
Signaling limitations	<p>If your site experiences any of the following problems, consult experts in electrical surge suppression and shielding:</p> <ul style="list-style-type: none"> <li>• Improperly installed wires cause radio frequency interference (RFI).</li> <li>• Damage from lightning strikes occurs when wires exceed recommended distances or pass between buildings.</li> <li>• Electromagnetic pulses (EMPs) caused by lightning damage unshielded conductors and electronic devices.</li> </ul>



Table 9: Site Electrical Wiring Guidelines (continued)

Site Wiring Factor	Guidelines
Radio frequency interference	<p>To reduce or eliminate RFI from your site wiring, do the following:</p> <ul style="list-style-type: none"> <li>• Use a twisted-pair cable with a good distribution of grounding conductors.</li> <li>• If you must exceed the recommended distances, use a high-quality twisted-pair cable with one ground conductor for each data signal when applicable.</li> </ul>
Electromagnetic compatibility	<p>If your site is susceptible to problems with electromagnetic compatibility (EMC), particularly from lightning or radio transmitters, seek expert advice.</p> <p>Some of the problems caused by strong sources of electromagnetic interference (EMI) are:</p> <ul style="list-style-type: none"> <li>• Destruction of the signal drivers and receivers in the device</li> <li>• Electrical hazards as a result of power surges conducted over the lines into the equipment</li> </ul>

## Chassis Physical Specifications for ACX710 Routers

The ACX710 router chassis is a rigid sheet-metal structure that houses the hardware components. [Table 10 on page 33](#) summarizes the physical specifications of ACX710 routers and router components.

Table 10: Physical Specifications of an ACX710 Router

Item	Height	Width	Depth	Weight
ACX710	1.71 in. (43.6 mm)	17.43 in. (442.8 mm)	12.40 in.(315. mm)	8 kg
Fan tray	1.73 in. (44 mm)	17.4 in. (442 mm)	2.36 in. (60 mm)	1.2 kg

## Environmental Requirements and Specifications for ACX710 Routers

The router must be installed in a rack or cabinet. It must be housed in a dry, clean, well-ventilated, and temperature-controlled environment.

Follow these environmental guidelines:

- The site must be as dust-free as possible because dust can clog air intake vents and filters, reducing the efficiency of the router cooling system.

- Maintain ambient airflow for normal router operation. If the airflow is blocked or restricted, or if the intake air is too warm, the router might overheat, and the router temperature monitor might shut down the device to protect the hardware components.

Table 11 on page 34 lists the environmental conditions required for normal router operation.

**Table 11: ACX710 Router Environmental Tolerances**

Description	Tolerance
Altitude	-60 m to 4000 m
Relative humidity	5% to 95% (non-condensing)
Nominal operating temperature	-40° C to 65° C (-40° F to 149° F)
Shipping and storage temperature	-40° C to 70° C (-40° F to 158° F)
Cold start temperature	-40° C (-40° F)
Pollution degree	2 (IEC 60950)
Acoustic noise level	< 7.2 Bels (EN 300 753)
Enclosure classification	IP20 (IEC 60529)
Environmental class	GR-3108 Class 1 and Class 2
Seismic	Complies with Zone 4 earthquake requirements per NEBS GR-63-CORE, Issue 4.

**NOTE:** Install ACX Series devices only in restricted areas, such as dedicated equipment rooms and equipment closets, in accordance with Articles 110-16, 110-17, and 110-18 of the National Electrical Code, ANSI/NFPA 70.

## ACX710 Grounding Cable and Lug Specifications

For installations that require a separate grounding conductor to the chassis, the router must be adequately grounded before power is connected to ensure proper operation and to meet safety and electromagnetic

interference (EMI) requirements. To ground an ACX710 router, connect a grounding cable to earth ground, and then attach it to the chassis grounding points.



**WARNING:** The router is pluggable type A equipment installed in a restricted-access location. It has a separate protective earthing terminal provided on the chassis in addition to the grounding pin of the power supply cord. This separate protective earthing terminal must be permanently connected to earth ground for installations that require a separate grounding conductor to the chassis.



**WARNING:** To comply with GR-1089 requirements, all intra-building copper cabling used for SFP+ and QSFP+ ports must be shielded and grounded at both ends.



**CAUTION:** Before router installation begins, a licensed electrician must attach a cable lug to the grounding cables that you supply. A cable with an incorrectly attached lug can damage the router.

**NOTE:** You must ensure that all cables are rated for the environment in which they are deployed.

For an ACX710 router, you need a grounding cable and straight lug with dual holes. You also need a dual-hole straight lug connector. The grounding lug accommodates 6 AWG (10 mm<sup>2</sup>), minimum 90° C wire, or as required by the local code.

SEE ALSO

| [Connect Earth Ground to ACX710 Routers](#) | 63

## Clearance Requirements for Airflow and Hardware Maintenance for ACX710 Routers

When planning the site for installing an ACX710 router, you must allow sufficient clearance around the installed chassis (see [Figure 8 on page 36](#)).

Figure 8: Clearance Requirements for Airflow and Hardware Maintenance for ACX710 Routers

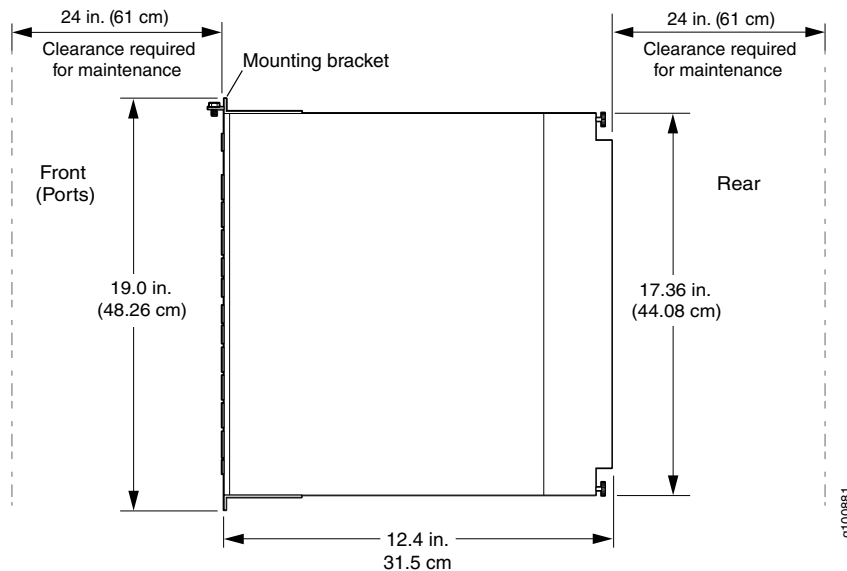

- For the cooling system to function properly, the airflow around the chassis must be unrestricted. See [“Cooling System and Airflow in ACX710 Routers” on page 27](#) for more information about the airflow through the chassis.
- If you are mounting an ACX710 router in a rack or cabinet with other equipment, ensure that the exhaust from other equipment does not blow into the intake vents of the chassis.
- For service personnel to remove and install hardware components, and to accommodate the interface and power cable bend radius, there must be adequate space at the front and rear of the router. Allow at least 24 in. (61 cm) of space both at the front and the rear of the router.

SEE ALSO

[Cooling System and Airflow in ACX710 Routers | 27](#)

## Cabinet Requirements for ACX710 Routers

You can mount an ACX710 router in an enclosure or cabinet that contains a four-post 19-in. open rack as defined in *Cabinets, Racks, Panels, and Associated Equipment* (document number EIA-310-D) published by the Electronics Industry Association.

[Table 12 on page 37](#) provides the cabinet requirements and specifications for an ACX710 router.

Table 12: Cabinet Requirements for ACX710 Routers

Cabinet Requirement	Guidelines
Cabinet size and clearance	The minimum cabinet size for accommodating an ACX710 router is 36 in. (91.4 cm) deep. Large cabinets improve airflow and reduce the chance of overheating.
Cabinet airflow requirements	<p>When you mount the router in a cabinet, ensure that ventilation through the cabinet is sufficient to prevent overheating.</p> <ul style="list-style-type: none"> <li>• Ensure that the cool air supply you provide through the cabinet adequately dissipates the thermal output of the router (or routers).</li> <li>• Ensure that the cabinet allows the chassis hot exhaust air from the chassis to exit the cabinet without recirculating into the router. An open cabinet (without a top or doors) that employs hot air exhaust extraction from the top allows the best airflow through the chassis. If the cabinet contains a top or doors, perforations in these elements assist with removing the hot exhaust air.</li> <li>• In the ACX710 router, air is pulled through the front of the chassis towards the fan tray, from where it is exhausted out of the chassis. Install the router in the cabinet in a way that maximizes the open space on the rear side of the chassis. This maximizes the clearance for critical airflow.</li> <li>• Route and dress all cables to minimize the blockage of airflow to and from the chassis.</li> <li>• Ensure that the spacing of rails and adjacent cabinets allows for proper clearance around the router and cabinet.</li> </ul>

## Rack Requirements for ACX710 Routers

The ACX710 routers are designed to be installed on four-post racks.

[Table 13 on page 37](#) provides the rack requirements and specifications for ACX710 routers.

Table 13: Rack Requirements for ACX710 Routers

Rack Requirement	Guidelines
Rack type	<p>Use a four-post rack that provides bracket holes or hole patterns spaced at 1-U increments (1.75 in. or 4.45 cm), and ensure that the rack meets the size and strength requirements to support the weight of the router.</p> <p>A U is the standard rack unit defined in <i>Cabinets, Racks, Panels, and Associated Equipment</i> (document number EIA-310-D) published by the Electronics Industry Association.</p>

Table 13: Rack Requirements for ACX710 Routers (*continued*)

Rack Requirement	Guidelines
Mounting bracket hole spacing	Ensure that the holes in the mounting brackets are spaced at 1 U (1.75 in. or 4.45 cm) so that the router can be mounted in any rack that provides holes spaced at that distance.
Rack size and strength	<ul style="list-style-type: none"> <li>● Ensure that the rack complies with the standards for a 19-in. rack as defined in <i>Cabinets, Racks, Panels, and Associated Equipment</i> (document number EIA-310-D) published by the Electronics Industry Association.</li> <li>● Use an 800-mm rack as defined in the four-part <i>Equipment Engineering (EE) European telecommunications standard for equipment practice</i> (document numbers ETS 300 119-1 through 119-4) published by the European Telecommunications Standards Institute (<a href="http://www.etsi.org">http://www.etsi.org</a>). The horizontal spacing between the rails in a rack that complies with this standard is usually wider than the device's mounting brackets, which measure 19 in. (48.26 cm) from outer edge to outer edge. Use approved wing devices to narrow the opening between the rails as required.</li> <li>● Ensure that the rack rails are spaced widely enough to accommodate the external dimensions of the router chassis. The outer edges of the front-mounting brackets extend the width to 19 in. (48.26 cm).</li> <li>● Ensure that for four-post installations, the front and rear rack rails are spaced between 23.6 in. (60 cm) and 36 in. (91.4 cm) front-to-back.</li> <li>● Ensure that the rack is strong enough to support the weight of the router. A fully configured ACX710 router weighs about 17.64 lb (8 kg).</li> <li>● Ensure that the spacing of rails and adjacent racks allows for proper clearance around the router and rack.</li> </ul>
Rack connection to building structure	<ul style="list-style-type: none"> <li>● Secure the rack to the building structure.</li> <li>● If earthquakes are a possibility in your geographical area, secure the rack to the floor.</li> <li>● Secure the rack to the ceiling brackets and to the wall or floor brackets for maximum stability.</li> </ul>

## ACX710 Network Cable and Transceiver Planning

### IN THIS SECTION

- [Determining Transceiver Support for ACX710 | 39](#)
- [Cable Specifications for QSFP+ and QSFP28 Transceivers | 40](#)

- Calculating Power Budget and Power Margin for Fiber-Optic Cables | 42
- Fiber-Optic Cable Signal Loss, Attenuation, and Dispersion | 44

## Determining Transceiver Support for ACX710

You can find information about the pluggable transceivers and connector types that are supported on your Juniper Networks device by using the Hardware Compatibility Tool. The tool also documents the optical and cable characteristics, where applicable, for each transceiver. You can search for transceivers by product—the tool displays all the transceivers supported on that device—or by category, interface speed, or type. The list of supported transceivers for the ACX710 is located at <https://apps.juniper.net/hct/product/#prd=ACX710>.



**CAUTION:** If you face a problem running a Juniper Networks device that uses a third-party optic or cable, the Juniper Networks Technical Assistance Center (JTAC) can help you diagnose the source of the problem. Your JTAC engineer might recommend that you check the third-party optic or cable and potentially replace it with an equivalent Juniper Networks optic or cable that is qualified for the device.

For the I-temp and C-temp transceivers that are supported on ACX710, see the following maximum ambient temperature values that are supported:

- Supports I-temp SFP, SFP+, and SFP28 transceivers up to 1.5W in full working temperature range (-40° C to +65° C).
- Supports I-temp SFP, SFP+, and SFP28 transceivers up to 2W, with 10° C degradation in maximum working temperature range (-40° C to +55° C).
- Supports I-temp QSFP+ and QSFP28 transceivers up to 4.5W in full working temperature range (-40° C to +65° C).
- Supports C-temp SFP, SFP+, and SFP28 transceivers up to 1W, with 10° C degradation in maximum working temperature range (0° C to +55° C).
- Supports C-temp SFP, SFP+, and SFP28 transceivers up to 1.5W, with 15° C degradation in maximum working temperature range (0° C to +50° C).

- Supports C-temp SFP, SFP+, and SFP28 transceivers up to 2W, with 20° C degradation in maximum working temperature range (0° C to +45° C).
- Supports C-temp QSFP+ and QSFP28 transceivers up to 4.5W, with 10° C degradation in maximum working temperature range (0° C to +55° C).

## Cable Specifications for QSFP+ and QSFP28 Transceivers

The 40GbE quad small form-factor pluggable plus (QSFP+) and 100GbE quad small form-factor pluggable 28 (QSFP28) transceivers that are used in ACX Series routers use 12-ribbon multimode fiber crossover cables with female MPO connectors (SR4 optics only). The fiber can be either OM3 or OM4. Juniper Networks does not sell these cables.



**CAUTION:** To maintain agency approvals, use only a properly constructed, shielded cable.

**TIP:** Ensure that you order cables with the correct polarity. Vendors refer to these crossover cables as *key up to key up*, *latch up to latch up*, *Type B*, or *Method B*. If you are using patch panels between two QSFP+ transceivers or two QSFP28 transceivers, ensure that the proper polarity is maintained through the cable plant.

[Table 14 on page 40](#) describes the signals on each fiber. [Table 15 on page 41](#) shows the pin-to-pin connections for proper polarity.

**Table 14: QSFP+ MPO Cable Signals**

Fiber	Signal
1	Tx0 (Transmit)
2	Tx1 (Transmit)
3	Tx2 (Transmit)
4	Tx3 (Transmit)
5	Unused
6	Unused



Table 14: QSFP+ MPO Cable Signals (continued)

Fiber	Signal
7	Unused
8	Unused
9	Rx3 (Receive)
10	Rx2 (Receive)
11	Rx1 (Receive)
12	Rx0 (Receive)

Table 15: QSFP+ MPO Fiber-Optic Crossover Cable Pinouts

Pin	Pin
1	12
2	11
3	10
4	9
5	8
6	7
7	6
8	5
9	4
10	3
11	2
12	1

## Calculating Power Budget and Power Margin for Fiber-Optic Cables

Use the information in this topic and the specifications for your optical interface to calculate the power budget and power margin for fiber-optic cables.

**TIP:** You can use the [Hardware Compatibility Tool](#) to find information about the pluggable transceivers supported on your Juniper Networks device.

To calculate the power budget and power margin, perform the following tasks:

1. [How to Calculate Power Budget for Fiber-Optic Cable | 42](#)
2. [How to Calculate Power Margin for Fiber-Optic Cable | 42](#)

### How to Calculate Power Budget for Fiber-Optic Cable

To ensure that fiber-optic connections have sufficient power for correct operation, you need to calculate the link's power budget, which is the maximum amount of power it can transmit. When you calculate the power budget, you use a worst-case analysis to provide a margin of error, even though all the parts of an actual system do not operate at the worst-case levels. To calculate the worst-case estimate of power budget ( $P_B$ ), you assume minimum transmitter power ( $P_T$ ) and minimum receiver sensitivity ( $P_R$ ):

$$P_B = P_T - P_R$$

The following hypothetical power budget equation uses values measured in decibels (dB) and decibels referred to one milliwatt (dBm):

$$P_B = P_T - P_R$$

$$P_B = -15 \text{ dBm} - (-28 \text{ dBm})$$

$$P_B = 13 \text{ dB}$$

### How to Calculate Power Margin for Fiber-Optic Cable

After calculating a link's power budget, you can calculate the power margin ( $P_M$ ), which represents the amount of power available after subtracting attenuation or link loss (LL) from the power budget ( $P_B$ ). A worst-case estimate of  $P_M$  assumes maximum LL:

$$P_M = P_B - LL$$

$P_M$  greater than zero indicates that the power budget is sufficient to operate the receiver.

Factors that can cause link loss include higher-order mode losses, modal and chromatic dispersion, connectors, splices, and fiber attenuation. [Table 16 on page 43](#) lists an estimated amount of loss for the factors used in the following sample calculations. For information about the actual amount of signal loss caused by equipment and other factors, refer to vendor documentation.

**Table 16: Estimated Values for Factors Causing Link Loss**

Link-Loss Factor	Estimated Link-Loss Value
Higher-order mode losses	Single mode—None Multimode—0.5 dB
Modal and chromatic dispersion	Single mode—None Multimode—None, if product of bandwidth and distance is less than 500 MHz-km
Connector	0.5 dB
Splice	0.5 dB
Fiber attenuation	Single mode—0.5 dB/km Multimode—1 dB/km

The following sample calculation for a 2-km-long multimode link with a power budget ( $P_B$ ) of 13 dB uses the estimated values from [Table 16 on page 43](#) to calculate link loss (LL) as the sum of fiber attenuation (2 km @ 1 dB/km, or 2 dB) and loss for five connectors (0.5 dB per connector, or 2.5 dB) and two splices (0.5 dB per splice, or 1 dB) as well as higher-order mode losses (0.5 dB). The power margin ( $P_M$ ) is calculated as follows:

$$P_M = P_B - LL$$

$$P_M = 13 \text{ dB} - 2 \text{ km (1 dB/km)} - 5 (0.5 \text{ dB}) - 2 (0.5 \text{ dB}) - 0.5 \text{ dB}$$

$$P_M = 13 \text{ dB} - 2 \text{ dB} - 2.5 \text{ dB} - 1 \text{ dB} - 0.5 \text{ dB}$$

$$P_M = 7 \text{ dB}$$

The following sample calculation for an 8-km-long single-mode link with a power budget ( $P_B$ ) of 13 dB uses the estimated values from [Table 16 on page 43](#) to calculate link loss (LL) as the sum of fiber attenuation (8 km @ 0.5 dB/km, or 4 dB) and loss for seven connectors (0.5 dB per connector, or 3.5 dB). The power margin ( $P_M$ ) is calculated as follows:

$$P_M = P_B - LL$$

$$P_M = 13 \text{ dB} - 8 \text{ km} (0.5 \text{ dB/km}) - 7(0.5 \text{ dB})$$

$$P_M = 13 \text{ dB} - 4 \text{ dB} - 3.5 \text{ dB}$$

$$P_M = 5.5 \text{ dB}$$

In both examples, the calculated power margin is greater than zero, indicating that the link has sufficient power for transmission and does not exceed the maximum receiver input power.

## Fiber-Optic Cable Signal Loss, Attenuation, and Dispersion

### IN THIS SECTION

- [Signal Loss in Multimode and Single-Mode Fiber-Optic Cable | 44](#)
- [Attenuation and Dispersion in Fiber-Optic Cable | 44](#)

### Signal Loss in Multimode and Single-Mode Fiber-Optic Cable

Multimode fiber is large enough in diameter to allow rays of light to reflect internally (bounce off the walls of the fiber). Interfaces with multimode optics typically use LEDs as light sources. However, LEDs are not coherent sources. They spray varying wavelengths of light into the multimode fiber, which reflects the light at different angles. Light rays travel in jagged lines through a multimode fiber, causing signal dispersion. When light traveling in the fiber core radiates into the fiber cladding, higher-order mode loss results. Together these factors limit the transmission distance of multimode fiber compared with single-mode fiber.

Single-mode fiber is so small in diameter that rays of light can reflect internally through one layer only. Interfaces with single-mode optics use lasers as light sources. Lasers generate a single wavelength of light, which travels in a straight line through the single-mode fiber. Compared with multimode fiber, single-mode fiber has higher bandwidth and can carry signals for longer distances.

Exceeding the maximum transmission distances can result in significant signal loss, which causes unreliable transmission.

### Attenuation and Dispersion in Fiber-Optic Cable

Correct functioning of an optical data link depends on modulated light reaching the receiver with enough power to be demodulated correctly. *Attenuation* is the reduction in power of the light signal as it is transmitted. Attenuation is caused by passive media components, such as cables, cable splices, and

connectors. Although attenuation is significantly lower for optical fiber than for other media, it still occurs in both multimode and single-mode transmission. An efficient optical data link must have enough light available to overcome attenuation.

*Dispersion* is the spreading of the signal over time. The following two types of dispersion can affect an optical data link:

- Chromatic dispersion—Spreading of the signal over time resulting from the different speeds of light rays.
- Modal dispersion—Spreading of the signal over time resulting from the different propagation modes in the fiber.

For multimode transmission, modal dispersion, rather than chromatic dispersion or attenuation, usually limits the maximum bit rate and link length. For single-mode transmission, modal dispersion is not a factor. However, at higher bit rates and over longer distances, chromatic dispersion rather than modal dispersion limits maximum link length.

An efficient optical data link must have enough light to exceed the minimum power that the receiver requires to operate within its specifications. In addition, the total dispersion must be less than the limits specified for the type of link in Telcordia Technologies document GR-253-CORE (Section 4.3) and International Telecommunications Union (ITU) document G.957.

When chromatic dispersion is at the maximum allowed, its effect can be considered as a power penalty in the power budget. The optical power budget must allow for the sum of component attenuation, power penalties (including those from dispersion), and a safety margin for unexpected losses.

## ACX710 Management Cable Specifications and Pinouts

### IN THIS SECTION

- [Management Cable Specifications for ACX710 Routers | 46](#)
- [RJ-45 Management Port Connector Pinout on ACX710 Routers | 46](#)
- [RJ-45 to DB-9 Serial Port Adapter Pinout Information | 47](#)
- [Console Port Connector Pinout on ACX710 Routers | 47](#)
- [SFP, SFP+, SFP28, QSFP+, and QSFP28 Port Connector Pinout Information | 48](#)
- [USB Port Specifications for an ACX Series Router | 53](#)
- [Alarm Port Pinouts | 53](#)
- [TOD Port Connector Pinout Information | 54](#)

## Management Cable Specifications for ACX710 Routers

Table 17 on page 46 lists the specifications for the cables that connect the console and management ports to management devices.

Table 17: Specifications of Cables to Connect to Management Devices

Ports	Cable Specifications	Receptacle	Additional Information
RJ-45 Console port	CAT5e unshielded twisted pair (UTP) cable	RJ-45	<a href="#">“Connect an ACX710 Router to a Management Console” on page 67</a>
Management Ethernet port	Ethernet cable with an RJ-45 connector	RJ-45	<a href="#">“Connect an ACX710 Router to a Network for Out-of-Band Management” on page 69</a>

## RJ-45 Management Port Connector Pinout on ACX710 Routers

Table 18 on page 46 provides the pinout information for the RJ-45 connector for the management port on ACX710 routers.

Table 18: RJ-45 Management Port Connector Pinout Information

Pin	Signal
1	TX_D1+
2	TX_D1-
3	RX_D2+
4	BI_D3+
5	BI_D3-
6	RX_D2-
7	BI_D4+

**Table 18: RJ-45 Management Port Connector Pinout Information** *(continued)*

Pin	Signal
8	BI_D4-

## RJ-45 to DB-9 Serial Port Adapter Pinout Information

The console port is an RS-232 serial interface that uses an RJ-45 connector to connect to a management device such as a PC or a laptop. If your laptop or PC does not have a DB-9 male connector pin and you want to connect your laptop or PC to the device, use a combination of the RJ-45 to DB-9 female adapter along with a USB to DB-9 male adapter.

[Table 19 on page 47](#) provides the pinout information for the RJ-45 to DB-9 serial port adapter.

**Table 19: RJ-45 to DB-9 Serial Port Adapter Pinout Information**

RJ-45 Pin	Signal	DB-9 Pin	Signal
1	RTS	8	CTS
2	DTR	6	DSR
3	TxD	2	RxD
4	GND	5	GND
6	RxD	3	TxD
7	DSR	4	DTR
8	CTS	7	RTS

## Console Port Connector Pinout on ACX710 Routers

The console port on a Juniper Networks device is an RS-232 serial interface that uses an RJ-45 connector to connect to a console management device. The baud rate for the console port must be set to 115200 baud.

Table 20 on page 48 provides the pinout information for the RJ-45 console connector.

**NOTE:** If your laptop or PC does not have a DB-9 male connector pin and you want to connect your laptop or PC directly to a device, use a combination of the RJ-45 to DB-9 female adapter and a USB to DB-9 male adapter. You must provide the USB to DB-9 male adapter.

**Table 20: Console Port Connector Pinout Information**

Pin	Signal	Input/Output
1	RTS	OUT
2	DTS	OUT
3	TxD	OUT
4	GND	GND
5	GND	GND
6	RxD	IN
7	DSR	IN
8	CTS	IN

## SFP, SFP+, SFP28, QSFP+, and QSFP28 Port Connector Pinout Information

The tables in this topic provide the connector pinout information for the SFP, SFP+, SFP28, QSFP+, and QSFP28 ports.

- [Table 21 on page 48](#)—SFP network port connector pinout information
- [Table 22 on page 50](#)—SFP+ and SFP28 network port connector pinout information
- [Table 23 on page 51](#)—QSFP+ and QSFP28 network module port connector pinout information

**Table 21: SFP Network Port Connector Pinout Information**

Pin	Signal	Description
1	VeeT	Module transmitter ground



Table 21: SFP Network Port Connector Pinout Information (continued)

Pin	Signal	Description
2	TX_Fault	Module transmitter fault
3	TX_Disable	Transmitter disabled
4	SDA	2-wire serial interface data line
5	SCL-	2-wire serial interface clock
6	MOD_ABS	Module absent
7	RS	Rate select
8	RX_LOS	Receiver loss of signal indication
9	VeeR	Module receiver ground
10	VeeR	Module receiver ground
11	VeeR	Module receiver ground
12	RD-	Receiver inverted data output
13	RD+	Receiver noninverted data output
14	VeeR	Module receiver ground
15	VccR	Module receiver 3.3 V supply
16	VccT	Module transmitter 3.3 V supply
17	VeeT	Module transmitter ground
18	TD+	Transmitter noninverted data input
19	TD-	Transmitter inverted data input
20	VeeT	Module transmitter ground

Table 22: SFP+ and SFP28 Network Port Connector Pinout Information

Pin	Signal	Description
1	VeeT	Module transmitter ground
2	TX_Fault	Module transmitter fault
3	TX_Disable	Transmitter disabled
4	SDA	2-wire serial interface data line
5	SCL-	2-wire serial interface clock
6	MOD_ABS	Module absent
7	RS0	Rate select 0, optionally controls SFP+ module receiver
8	RX_LOS	Receiver loss of signal indication
9	RS1	Rate select 1, optionally controls SFP+ transmitter
10	VeeR	Module receiver ground
11	VeeR	Module receiver ground
12	RD-	Receiver inverted data output
13	RD+	Receiver noninverted data output
14	VeeR	Module receiver ground
15	VccR	Module receiver 3.3 V supply
16	VccT	Module transmitter 3.3 V supply
17	VeeT	Module transmitter ground
18	TD+	Transmitter noninverted data input
19	TD-	Transmitter inverted data input
20	VeeT	Module transmitter ground

Table 23: QSFP+ and QSFP28 Network Port Connector Pinout Information

Pin	Signal
1	GND
2	TX2n
3	TX2p
4	GND
5	TX4n
6	TX4p
7	GND
8	ModSelL
9	LPMode_Reset
10	VccRx
11	SCL
12	SDA
13	GND
14	RX3p
15	RX3n
16	GND
17	RX1p
18	RX1n
19	GND
20	GND
21	RX2n

Table 23: QSFP+ and QSFP28 Network Port Connector Pinout Information (continued)

Pin	Signal
22	RX2p
23	GND
24	RX4n
25	RX4p
26	GND
27	ModPrsL
28	IntL
29	VccTx
30	Vcc1
31	Reserved
32	GND
33	TX3p
34	TX3n
35	GND
36	TX1p
37	TX1n
38	GND

## USB Port Specifications for an ACX Series Router

The following Juniper Networks USB flash drives have been tested and are officially supported for the USB port on all ACX Series routers:

- RE-USB-1G-S
- RE-USB-2G-S
- RE-USB-4G-S



**CAUTION:** Any USB memory product that is not listed as supported for ACX Series routers has not been tested by Juniper Networks. The use of any unsupported USB memory product could expose your ACX Series router to unpredictable behavior. Juniper Networks Technical Assistance Center (JTAC) can provide only limited support for issues related to unsupported hardware. We strongly recommend that you use only supported USB flash drives.

All USB flash drives used on ACX Series routers must have the following features:

- USB 2.0 or later
- Formatted with a FAT or MS-DOS file system

## Alarm Port Pinouts

[Table 24 on page 53](#) provides the alarm port pinout information on ACX710 routers.

**Table 24: Alarm Port Pinout Information**

Pin	Signal	Input/Output
1	ALARM_IN0_Sig	IN
2	ALARM_IN0_Return	IN
3	ALARM_IN0_Return	IN
4	ALARM_IN2_Sig	IN
5	ALARM_IN1_Return	IN

Table 24: Alarm Port Pinout Information (*continued*)

Pin	Signal	Input/Output
6	ALARM_IN2_Return	IN
7	ALARM_OUT_Sig	OUT
8	ALARM_OUT_Return	OUT

## TOD Port Connector Pinout Information

The time-of-day port labeled **TOD** on the front panel of the router is composed of two electrical interfaces that provide both TOD and 1PPS signals on the same port.

[Table 25 on page 54](#) provides the TOD port pinout information on ACX710 routers.

Table 25: TOD Port Connector Pinout Information

PIN number	Time Input Mode		Time Output Mode	
	Signal Name	Signal Definition	Signal Name	Signal Definition
1	CONTROL- / 1PPS_LOOP_O UT-	GPS receiver control or 1PPS loop out negative	1PPS_LOOP_IN -	1PPS loop in negative
2	CONTROL+ / 1PPS_LOOP_O UT+	GPS receiver control or 1PPS loop out positive	1PPS_LOOP_IN +	1PPS loop in positive
3	1PPS_IN-	RX 1PPS negative	1PPS_OUT-	TX 1PPS negative
4	GND	GND	GND	GND
5	Power supply/ 10Kohm to GND	Power supply or 10Kohm to GND, depends whether remote connection is GPS receiver or node	10Kohm to GND	
6	1PPS_IN+	RX 1PPS positive	1PPS_OUT+	TX 1PPS positive

Table 25: TOD Port Connector Pinout Information (*continued*)

PIN number	Time Input Mode		Time Output Mode	
7	RX-	RX TOD time message negative	TX-	TX TOD time message negative
8	RX+	RX TOD time message positive	TX+	TX TOD time message positive

The TOD output mode is used for monitoring and measuring the accuracy of Precision Time Protocol (PTP) recovered time and phase, and can also be used to provide time and phase information to downstream devices. In the TOD input mode, the telecom boundary clock (T-BC) synchronizes its local clock to the GPS, and distributes time and phase information to downstream PTP devices.

# 3

CHAPTER

## Initial Installation and Configuration

---

ACX710 Installation Overview | 57

Unpack and Mount an ACX710 Router | 57

Connect ACX710 to Power | 63

Connect ACX710 to External Devices | 67

Perform Initial Software Configuration for the ACX710 Routers | 72

---



# ACX710 Installation Overview

You can mount ACX710 routers in one of two ways:

- Flush with the front of a 19-in. four-post rack. Use the standard mounting brackets provided with the router for this configuration.
- Recessed 2 in. (5 cm) from the front of a 19-in. four-post rack. Use the extension bracket provided in the standard mounting kit for this configuration. Recessed mounting is primarily used in enclosed cabinets.

To install and connect an ACX710 router:

1. Follow the instructions in [“Unpack and Mount an ACX710 Router” on page 57.](#)

2. Determine how the device is to be mounted.

For instructions on flush or recessed mounting, see [“Mount an ACX710 Router in a Rack” on page 59.](#)

3. Follow the instructions in:

a. [“Connect Earth Ground to ACX710 Routers” on page 63.](#)

b. [“Connect DC Power to an ACX710 Router” on page 65.](#)

c. *Register Products—Mandatory for Validating SLAs*

4. Follow the instructions in [“Perform Initial Software Configuration for the ACX710 Routers” on page 72.](#)

## RELATED DOCUMENTATION

| [Chassis Physical Specifications for ACX710 Routers | 33](#)

# Unpack and Mount an ACX710 Router

## IN THIS SECTION

- [Unpack an ACX710 Router | 58](#)
- [Mount an ACX710 Router in a Rack | 59](#)

## Unpack an ACX710 Router

The ACX710 router chassis is a rigid sheet-metal structure that houses the hardware components. An ACX710 router is shipped in a cardboard carton, secured with foam packing material. The carton also contains an accessory box and quick start instructions.



**CAUTION:** ACX710 routers are maximally protected inside the shipping carton. Do not unpack the router until you are ready to begin installation.

To unpack an ACX710 router:

1. Move the shipping carton to a staging area as close to the installation site as possible, where you have enough room to remove the system components.
2. Position the carton so that the arrows are pointing up.
3. Open the top flaps on the shipping carton.

Figure 9: Open the Shipping Carton

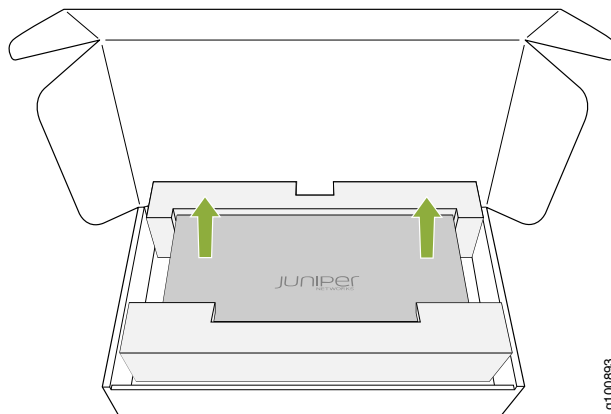

4. Remove the accessory box, and verify the contents against the inventory included in the box.
5. Pull out the packing material that is holding the router in place.
6. Verify the chassis components that you received.
7. Save the shipping carton and packing materials in case you need to move or ship the router later.

Table 26: Inventory of Components Supplied with an ACX710

Component	Quantity
Chassis with one fan tray	1
19-in. four-post rack with fasteners	1
5 m 14 AWG, three-wire DC power cord	2
5 m 6 AWG grounding cable	1
End User License Agreement (EULA)	1
Documentation roadmap card	1

SEE ALSO

[Environmental Requirements and Specifications for ACX710 Routers](#) | 33

## Mount an ACX710 Router in a Rack

### IN THIS SECTION

- [Before You Begin Rack Installation](#) | 60
- [Install an ACX710 Router in a Rack](#) | 61

You can mount an ACX710 router on a rack using the mounting kit provided with the device.

## Before You Begin Rack Installation

Before you begin mounting an ACX710 router in the rack:

1. Ensure that you understand how to prevent electrostatic discharge (ESD) damage. See [“Prevention of Electrostatic Discharge Damage” on page 136](#).
2. Verify that the site meets the requirements described in [“Site Preparation Checklist for ACX710 Routers” on page 30](#).
3. Place the rack in its permanent location, allowing adequate clearance for airflow and maintenance, and secure it to the building structure.
4. Read [“General Site Guidelines” on page 32](#), with particular attention to *Chassis and Component Lifting Guidelines*.
5. Remove the router from the shipping carton. See [“Unpack an ACX710 Router” on page 58](#).
6. Ensure that you have the following parts and tools available to mount the router in a rack:
  - ESD grounding strap (not provided)
  - One pair of front-mounting rails (provided)
  - Screws to secure the mounting rails to the chassis (not provided)
  - Appropriate screwdriver for the mounting screws (not provided)
  - Two power cords with plugs appropriate for your geographical location (provided)
  - RJ-45 cable and RJ-45 to DB-9 serial port adapter (not provided)
  - Management host, such as a PC laptop, with a serial port (not provided)



**CAUTION:** If you are mounting multiple units on a rack, mount the heaviest unit at the bottom of the rack and mount the other units from the bottom of the rack to the top in decreasing order of the weight of the units.

## Install an ACX710 Router in a Rack

To install the router in a four-post rack:

1. Position the router in front of the rack.
2. Wrap and fasten one end of the ESD grounding strap around your bare wrist, and connect the other end of the strap to a site ESD point.
3. Align the holes in the front-mounting rails with the holes on the side of the chassis (see [Figure 10 on page 61](#)).

**Figure 10: Install the Mounting Rails on an ACX710 Router**

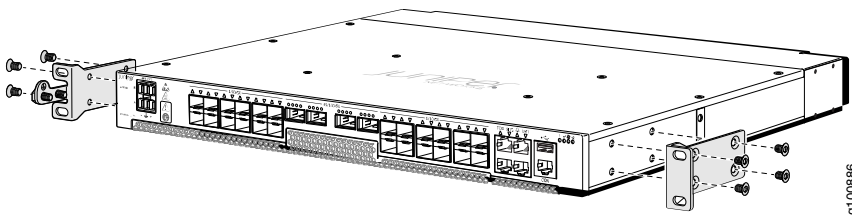

4. Using a Phillips (+) number 2 screwdriver, secure the mounting rails to the chassis using the mounting screws.
5. With one person on each side, hold on to the bottom of the chassis, and carefully lift the chassis so that the mounting rails are aligned with the rack rails.
6. Carefully slide the chassis with the rails attached on to the rack rails (see [Figure 11 on page 61](#)).

**Figure 11: Install the ACX710 Router in a Four-Post Rack**

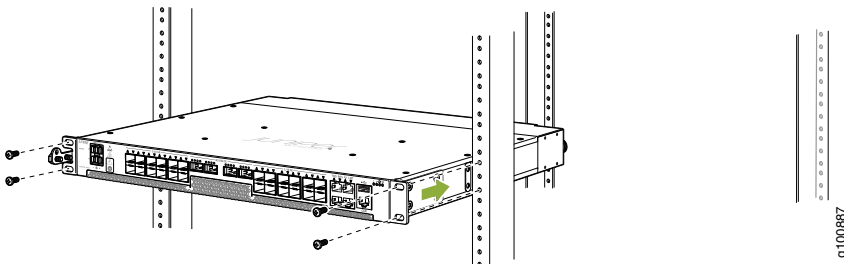

7. Install mounting screws into each of the front-mounting bracket holes aligned with the rack, starting from the bottom, and tighten the screws.

- Align the holes in the cable bar with the holes at the top of the mounting bracket, and tighten the screws to attach the cable bar.

**Figure 12: Install the Cable Bar**

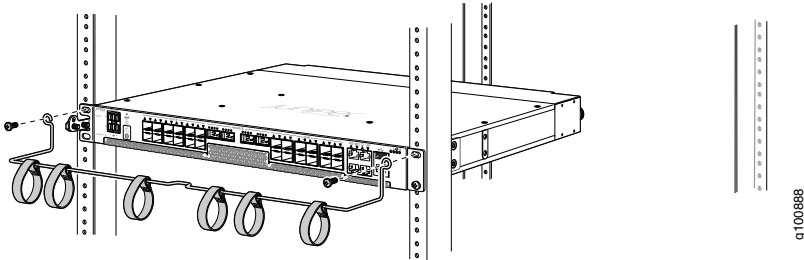

- Visually inspect the alignment of the chassis.

If you've installed the chassis properly in the rack, all the mounting screws on one side of the rack are aligned with the mounting screws on the opposite side, and the router is level. [Figure 13 on page 62](#) shows the router fully secured and installed in a four-post rack.

**Figure 13: ACX710 Router Installed in a Four-Post Rack**

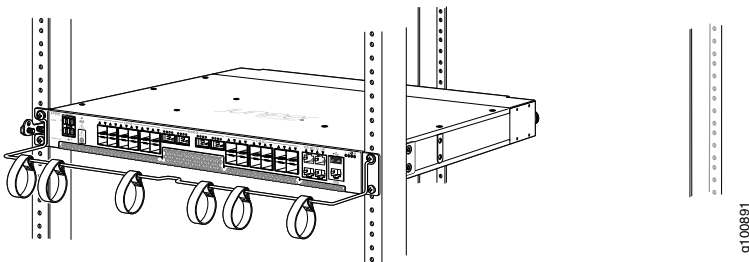

SEE ALSO

[Rack Requirements for ACX710 Routers](#) | 37

# Connect ACX710 to Power

## IN THIS SECTION

- [Connect Earth Ground to ACX710 Routers | 63](#)
- [DC Power Cabling | 64](#)
- [Connect DC Power to an ACX710 Router | 65](#)

## Connect Earth Ground to ACX710 Routers

To meet safety and electromagnetic interference (EMI) requirements and to ensure proper operation, the router must be adequately grounded before power is connected.

You need a protective earthing terminal bracket for connecting the chassis to earth ground. This two-holed bracket is attached on the side of the chassis through the mounting rail, and provides a protective earthing terminal for the router. The grounding points are in the form of studs that are sized for M6 screws. (You need to provide these screws with integrated washers as we do not ship them in the accessory kit).

To ground the ACX710 router:

1. Verify that a licensed electrician has attached the cable lug provided with the router to the grounding cable.
2. Attach an electrostatic discharge (ESD) grounding strap to your bare wrist, and connect the other end of the strap to an approved site ESD grounding point. See the instructions for your site.
3. Ensure that all grounding surfaces are clean and are brought to a bright finish before you make grounding connections.
4. Connect the grounding cable to a proper earth ground.
5. Place the grounding cable lug over the grounding points on the side of the chassis (see [Figure 14 on page 64](#)).

Figure 14: Connect the Grounding Cable to the ACX710 Router

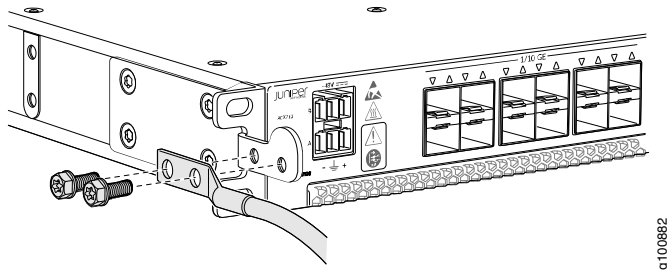

6. Secure the grounding cable lug with the screws.
7. Dress the grounding cable, and verify that it does not touch or block access to router components, and that it does not drape where people could trip on it.

**NOTE:**

- Bare connectors and all grounding surfaces must be brought to a bright finish and coated with an antioxidant before crimp connections are made.
- Non-conductive coatings on equipment that is to be bonded or grounded should be removed from threads and other contact surfaces to assure electrical continuity. To screw the box to its rack, use the thread-forming type unit mounting screws that remove any paint or non-conductive coatings to establish metal-to-metal contact.

## DC Power Cabling

Before you connect the DC power cable, you must ensure that the polarity of the DC power cable installation is correct.

Figure 15 on page 65 shows the DC power cabling styles for an ACX710 router.



Figure 15: DC Power Cabling Options

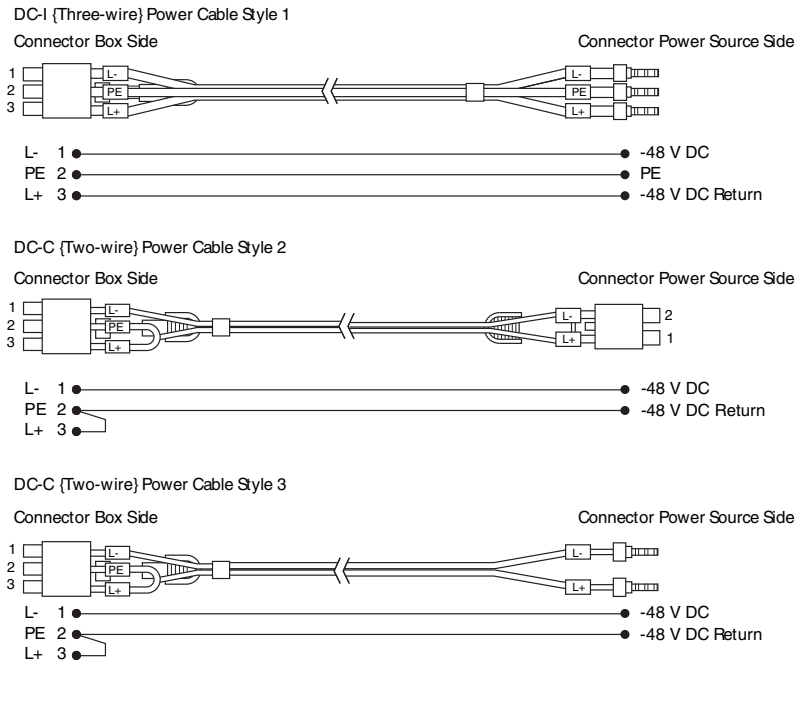

For DC-I (three-wire) power cable style 1, if PE is connected to -48 V DC at DC power sources, it will cause a short circuit and the circuit breaker on the DC power sources will be tripped.

For DC-C (two-wire) power cable style 3, if the -48 V DC return is connected to -48 V DC at DC power sources, it will cause a short circuit and the circuit breaker on the DC power source will be tripped.

## Connect DC Power to an ACX710 Router

Before you begin connecting DC power to the router:

- Ensure that you have taken the necessary precautions to prevent electrostatic discharge (ESD) damage (see [“Prevention of Electrostatic Discharge Damage”](#) on page 136).
- Ensure that you have connected the router chassis to earth ground.



**CAUTION:** Before you connect power to the router, a licensed electrician must attach a cable lug to the grounding and power cables that you supply. A cable with an incorrectly attached lug can damage the router (for example, by causing a short circuit).

To meet safety and electromagnetic interference (EMI) requirements and to ensure proper operation, you must connect the chassis to earth ground before you connect the chassis to power. For installations that require a separate grounding conductor to the chassis, use the protective earthing terminal on the router chassis to connect to the earth ground.

- Ensure that you have the following parts and tools available:
  - DC power source cables
  - Phillips (+) screwdriver, number 2 (not provided)
  - Multimeter (not provided)

To connect DC power to an ACX710 router:

1. Wrap and fasten one end of the ESD grounding strap around your bare wrist, and connect the other end of the strap to the site ESD point.
2. Power off the DC input appliance inlet on the source power supply.
3. Connect the power cord to the power source outlet.
4. Insert the power cord firmly into the inlet.

**Figure 16: Connect a DC Power Cord to an ACX710 Router**

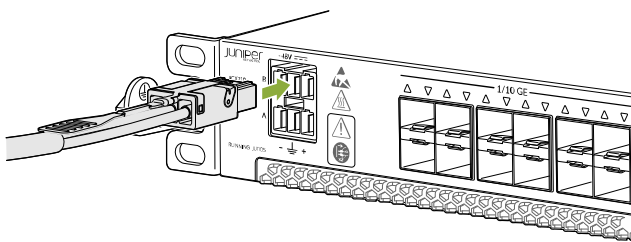

9100878

5. Route the power cord appropriately. Verify that the power cord does not block the air exhaust or access to router components, or drape where people could trip over it.
6. Power on the source power supply.

SEE ALSO

| [DC Power Specifications for ACX710 Routers](#) | 28

## Connect ACX710 to External Devices

### IN THIS SECTION

- [Connect an ACX710 Router to a Management Console](#) | 67
- [Connect an ACX710 Router to a Network for Out-of-Band Management](#) | 69
- [Connect an ACX710 Router to External Clocking and Timing Devices](#) | 70
- [Connect an ACX710 Router to External Alarm Devices](#) | 71

### Connect an ACX710 Router to a Management Console

ACX710 routers have a console (**CON**) port that uses an RJ-45 connector to connect the device to a management console or a console server.

Ensure that you have an RJ-45 to DB-9 rollover cable available.

[Figure 17 on page 67](#) shows the RJ-45 connector of an Ethernet cable.

**Figure 17: RJ-45 Connector on an Ethernet Cable**

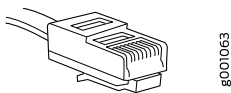

**NOTE:** If your laptop or PC does not have a DB-9 male connector pin and you want to connect your laptop or PC directly to the ACX710 router, use a combination of the RJ-45 cable and RJ-45 to DB-9 adapter and a USB to DB-9 male adapter.

To connect the ACX710 router to a management console (see [Figure 18 on page 68](#) and [Figure 19 on page 68](#)):

1. Connect one end of the Ethernet cable to the console port (labeled **CON**) on the device.
2. Connect the other end of the Ethernet cable into the console server (see [Figure 18 on page 68](#)) or management console (see [Figure 19 on page 68](#)).

**Figure 18: Connect an ACX710 Router to a Management Console Through a Console Server**

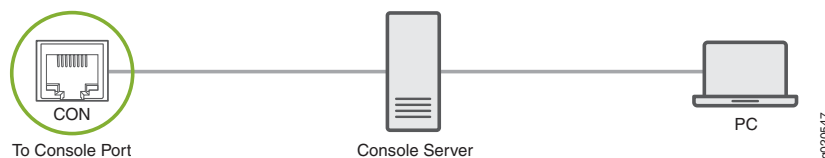

**Figure 19: Connect an ACX710 Router Directly to a Management Console**



#### SEE ALSO

[Management Cable Specifications for ACX710 Routers | 46](#)

[RJ-45 Management Port Connector Pinout on ACX710 Routers | 46](#)

## Connect an ACX710 Router to a Network for Out-of-Band Management

You can monitor and manage an ACX710 router by using a dedicated management channel. Use the management port (LMT) to connect the ACX710 router to a network for out-of-band management.

Ensure that you have an Ethernet cable that has an RJ-45 connector at either end. [Figure 20 on page 69](#) shows the RJ-45 connector of the Ethernet cable.

**Figure 20: RJ-45 Connector on an Ethernet Cable**

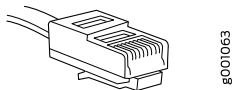

**NOTE:** You cannot use the management ports to perform the initial configuration of an ACX710 router. You must configure the management ports before you can successfully connect to the ACX710 router using these ports. See [“Perform Initial Software Configuration for the ACX710 Routers” on page 72](#).

Ensure that you have an appropriate cable available. See [“ACX710 Network Cable and Transceiver Planning” on page 38](#).

To connect an ACX710 router to a network for out-of-band management (see [Figure 21 on page 69](#)):

1. Connect one end of the Ethernet cable to one of the management ports.
2. Connect the other end of the cable to the management PC (see [Figure 21 on page 69](#)).

**Figure 21: Connect an ACX710 Router to a Network for Out-of-Band Management**

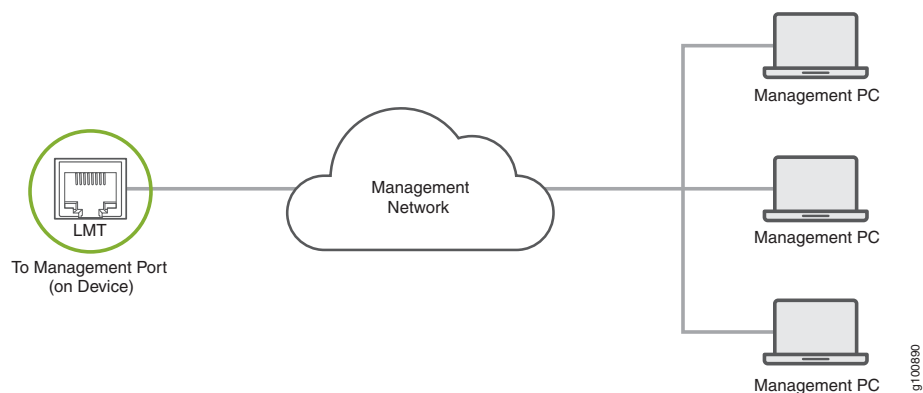

## Connect an ACX710 Router to External Clocking and Timing Devices

### IN THIS SECTION

- [Connect a T1 or an E1 External Clocking Device to the ACX710 Router | 70](#)
- [Connect a Time-of-Day Device to the ACX710 Router | 70](#)

The ACX710 router supports external clock synchronization for T1 or E1 line timing sources and external inputs.

### Connect a T1 or an E1 External Clocking Device to the ACX710 Router

The ACX710 router contains an external building-integrated timing supply (BITS) port labeled **BITS** on the front panel of the router.

To connect the router to a BITS T1 or E1 external clocking device:

1. Attach an electrostatic discharge (ESD) grounding strap on your bare wrist, and connect the strap to one of the ESD points on the chassis.
2. Plug one end of the RJ-45 cable into the internal clock port on the front panel.
3. Plug the other end of the RJ-45 cable into the T1 or E1 external clocking device.
4. Configure the clock source as BITS T1 or E1 interface. See *Configuring External Clock Synchronization for ACX Series Routers*.

### Connect a Time-of-Day Device to the ACX710 Router

A time-of-day (TOD) port labeled **TOD** on the front panel of the router allows you to connect to external GPS Receiver Units (GRUs). For more information about the GRUs supported on ACX710, contact your Juniper sales representative.

The **TOD** port is composed of two electrical interfaces that provide both TOD and 1PPS signal on the same port.

- **1PPS interface**—Supports 1-pulse-per-second (PPS) signal.
- **TOD message interface**—Used for a serial communication channel to transfer time and status messages between the time master and the client.

For information about TOD port pinouts, see [Table 25 on page 54](#).

We do not ship the cable to connect an ACX710 router to an external GPS receiver unit. You can make the cable as required.

To connect the router to a TOD external timing device:

1. Attach an electrostatic discharge (ESD) grounding strap on your bare wrist, and connect the strap to one of the ESD points on the chassis.
2. Plug one end of the RJ-45 cable into the TOD port on the front panel.
3. Plug the other end of the RJ-45 cable into the TOD timing device.
4. Configure the port. See *Configuring External Clock Synchronization for ACX Series Routers*.

SEE ALSO

[TOD Port Connector Pinout Information | 54](#)

## Connect an ACX710 Router to External Alarm Devices

The ACX710 router provides an alarm port for connecting the router to external alarm devices. The alarm port is an RJ45 port that has three input and one output alarm contacts. The router can receive an alarm signal from an external alarm device, or it can activate the alarm relay contacts whenever a system condition triggers an alarm, which in turn activates the external alarm devices. For information about alarm port pinouts, see [Table 24 on page 53](#).

[Figure 22 on page 71](#) shows how to connect the alarm port cable to the router.

**Figure 22: Connect the Alarm Port Cable to the Alarm Port on an ACX710 Router**

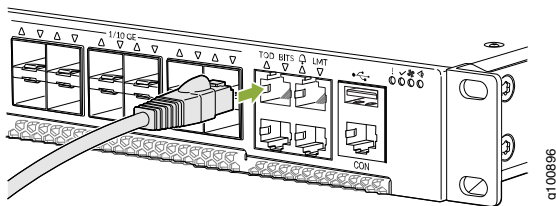

To connect the router to an external alarm device:

1. Attach an electrostatic discharge (ESD) grounding strap on your bare wrist, and connect the strap to one of the ESD points on the chassis.
2. Plug one end of the RJ-45 cable into the alarm port on the front panel.
3. Plug the other end of the RJ-45 cable into the external alarm device.
4. Configure the port. See *Configuring Chassis Alarm Relays*.

SEE ALSO

| [Alarm Port Pinouts | 53](#)

## Perform Initial Software Configuration for the ACX710 Routers

You must perform the initial configuration of an ACX710 router through the console port by using the command-line interface (CLI).

Before you begin connecting and configuring an ACX710 router, set the following parameter values on the console server or PC:

- Baud Rate—115200
- Flow Control—None
- Data—8
- Parity—None
- Stop Bits—1
- DCD State—Disregard

To connect and configure the router from the console:

1. Connect the console (**CON**) port to a laptop or PC using the supplied RJ-45 cable and RJ-45 to DB-9 adapter. The console (**CON**) port is located on the management panel of the router.
2. Log in as **root**.



You do not need a password. If the software booted before you connected to the console port, you might need to press the Enter key for the prompt to appear.

```
login: root
```

3. Start the CLI.

```
root@% cli
```

4. Enter configuration mode.

```
root> configure
```

5. Add a password to the root administration user account.

```
[edit]
```

```
root@# set system root-authentication plain-text-password
```

```
New password: password
```

```
Retype new password: password
```

6. (Optional) Configure the name of the router. If the name includes spaces, enclose the name in quotation marks (" ").

```
[edit]
```

```
root@# set system host-name host-name
```

7. Configure the default gateway.

```
[edit]
```

```
root@# set routing-options static route default next-hop address
```

8. Configure the IP address and prefix length for the router's management interface.

```
[edit]
```

```
root@# set interfaces em0 unit 0 family inet address address/prefix-length
```



**CAUTION:** Although you can use the CLI to configure two management Ethernet interfaces within the same subnet, only one interface is usable and supported.

9. (Optional) Configure the static routes to remote prefixes with access to the management port.

```
[edit]
```

```
root@# set routing-options static route remote-prefix next-hop destination-ip retain no-readvertise
```

10. Enable the Telnet service.

```
[edit]  
root@# set system services telnet
```

**NOTE:** When Telnet is enabled, you cannot log in to a router through Telnet by using root credentials. Root login is allowed only for SSH access.

11. Commit the configuration to activate it on the router.

```
[edit]  
root@# commit
```

# 4

CHAPTER

## Maintaining Components

---

Maintain ACX710 Components | **76**

Remove an ACX710 Router | **88**

---

# Maintain ACX710 Components

## IN THIS SECTION

- [Replace an ACX710 Fan Tray | 76](#)
- [Replace an SFP, SFP+, or QSFP+ Transceiver | 79](#)
- [Replace a QSFP28 Transceiver | 83](#)
- [How to Handle Fiber-Optic Cables | 87](#)

## Replace an ACX710 Fan Tray

### IN THIS SECTION

- [Remove a Fan Tray from an ACX710 Router | 76](#)
- [Install a Fan Tray in an ACX710 Router | 77](#)

### Remove a Fan Tray from an ACX710 Router

The fans in the fan tray of an ACX710 router draw cool air into the chassis to maintain an acceptable operating temperature for the device and its components. Air is pulled through the front of the chassis towards the fan tray, from where it is exhausted out of the chassis through the rear.



**CAUTION:** You must replace a failed fan tray with a new fan tray within three minutes of removal to prevent chassis overheating. Before removing the fan tray, ensure that you have a replacement fan tray at hand.

Before you remove a fan tray from an ACX710 router, ensure that you have taken the necessary precautions to prevent electrostatic discharge (ESD) damage (see [“Prevention of Electrostatic Discharge Damage” on page 136](#)).

Ensure that you have the following parts and tools available to remove a fan tray from an ACX710 router:

- ESD grounding strap
- Antistatic bag or an antistatic mat
- Phillips (+) screwdriver, number 2

To remove a fan tray from an ACX710 router (see [Figure 23 on page 77](#)):

1. Place the antistatic bag or the antistatic mat on a flat, stable surface.
2. Wrap and fasten one end of the ESD grounding strap around your bare wrist, and connect the other end of the strap to an ESD point.
3. Using a Phillips screwdriver, loosen the locking screw (three or four turns).
4. Grasp the fan tray and pull firmly to detach the fan tray from the chassis.
5. Place the fan tray in the antistatic bag or on the antistatic mat that is placed on a flat, stable surface.

**Figure 23: Remove a Fan Tray from an ACX710 Router**



**NOTE:** When you remove a fan tray, the CLI message **Fan/Blower is Absent** is logged in the system log, and Junos OS raises a minor alarm.

### Install a Fan Tray in an ACX710 Router

Before you install a fan tray in an ACX710 router, ensure that you have taken the necessary precautions to prevent electrostatic discharge (ESD) damage (see [“Prevention of Electrostatic Discharge Damage” on page 136](#)).

Ensure that you have the following parts and tools available to install a fan tray in an ACX710 router:

- Replacement fan tray
- ESD grounding strap
- Antistatic bag or an antistatic mat
- Phillips (+) screwdriver, number 2

To install a fan tray in an ACX710 router (see [Figure 24 on page 78](#)):

1. Wrap and fasten one end of the ESD grounding strap around your bare wrist, and connect the other end of the strap to an ESD point.
2. Taking care not to touch the connectors, remove the fan tray from its bag.
3. Align the fan tray with the open slot on the rear panel of the chassis.
4. Attach the fan tray by turning the locking screw until it is tight, using a Phillips screwdriver.

**Figure 24: Install a Fan Tray in an ACX710 Router**

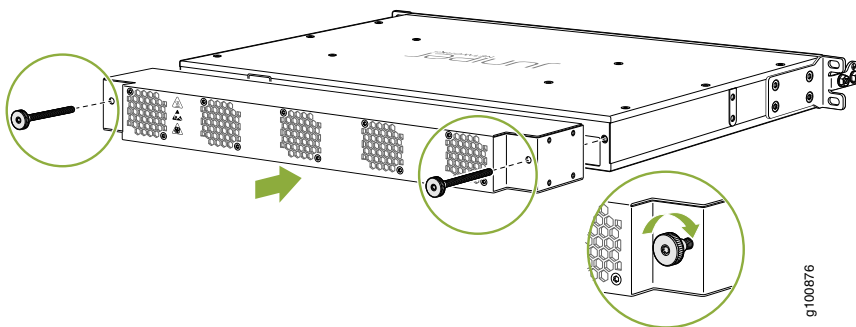

SEE ALSO

| [Cooling System and Airflow in ACX710 Routers](#) | 27

## Replace an SFP, SFP+, or QSFP+ Transceiver

### IN THIS SECTION

- [Remove a Transceiver | 79](#)
- [Install a Transceiver | 81](#)

The transceivers for Juniper Networks devices are hot-removable and hot-insertable field-replaceable units (FRUs). You can remove and replace them without powering off the device or disrupting the device functions.

### Remove a Transceiver

Before you begin removing a transceiver from a device, ensure that you have taken the necessary precautions for the safe handling of lasers (see [“Laser and LED Safety Guidelines and Warnings” on page 123](#)).

Ensure that you have the following parts and tools available:

- An antistatic bag or an antistatic mat
- Rubber safety caps to cover the transceiver and fiber-optic cable connector
- A dust cover to cover the port or a replacement transceiver

**NOTE:** After you remove a transceiver or when you change the media-type configuration, wait for 6 seconds for the interface to display the operational commands.

To remove a transceiver:

1. Place the antistatic bag or antistatic mat on a flat, stable surface.
2. Wrap and fasten one end of the ESD grounding strap around your bare wrist, and connect the other end of the strap to an ESD point.
3. Label the cables connected to the transceiver so that you can reconnect them correctly later.
4. Remove the cable connected to the transceiver (see *Disconnect a Fiber-Optic Cable*). Cover the transceiver and the end of each fiber-optic cable connector with a rubber safety cap immediately after disconnecting the fiber-optic cables.



**WARNING:** Do not look directly into a fiber-optic transceiver or into the ends of fiber-optic cables. Fiber-optic transceivers and fiber-optic cables connected to a transceiver emit laser light that can damage your eyes.



**WARNING:** Do not leave a fiber-optic transceiver uncovered except when inserting or removing a cable. The rubber safety cap keeps the port clean and prevents accidental exposure to laser light.

- If there is a cable management system, arrange the cable in the cable management system to prevent it from dislodging or developing stress points. Secure the cable so that it does not support its own weight as it hangs to the floor. Place excess cable out of the way in a neatly coiled loop in the cable management system. Placing fasteners on the loop helps to maintain its shape.



**CAUTION:** Do not bend the fiber-optic cable beyond its minimum bend radius. An arc smaller than a few inches in diameter can damage the cable and cause problems that are difficult to diagnose.

- By using your fingers, pull open the ejector lever on the transceiver to unlock the transceiver.



**CAUTION:** Ensure that you open the ejector handle completely until you hear it click. Doing this prevents damage to the transceiver.

Figure 25 on page 80 shows how to remove an SFP transceiver. The procedure is the same for SFP+ and QSFP+ transceivers.

**Figure 25: Small Form-Factor Pluggable (SFP) Transceiver**

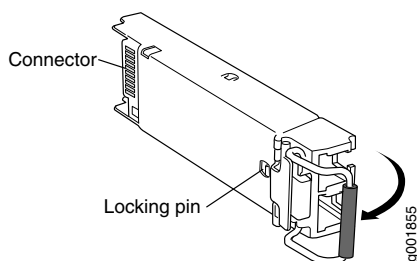



7. Grasp the transceiver ejector handle, and pull the transceiver approximately 0.5 in. (1.3 cm) out of the interface port.
8. Using your fingers, grasp the body of the transceiver, and pull it the rest of the way out of the interface port.
9. Place a rubber safety cap over the transceiver.
10. Place the removed transceiver on an antistatic mat or in an electrostatic bag.
11. Place the dust cover over the empty port or install the replacement transceiver.



**CAUTION:** After removing a transceiver from the chassis, wait at least 30 seconds before reinserting it or inserting a transceiver into a different slot.

## Install a Transceiver

Before you begin to install a transceiver in a device, ensure that you have taken the necessary precautions for safe handling of lasers (see [“Laser and LED Safety Guidelines and Warnings”](#) on page 123).

Ensure that you have a rubber safety cap available to cover the transceiver.

**NOTE:** After you insert a transceiver or after you change the media-type configuration, wait for 6 seconds for the interface to display operational commands.

**NOTE:** We recommend that you use only optical transceivers and optical connectors purchased from Juniper Networks with your Juniper Networks device.



**CAUTION:** If you face a problem running a Juniper Networks device that uses a third-party optic or cable, the Juniper Networks Technical Assistance Center (JTAC) can help you diagnose the source of the problem. Your JTAC engineer might recommend that you check the third-party optic or cable and potentially replace it with an equivalent Juniper Networks optic or cable that is qualified for the device.



6. Close the ejector handle of the transceiver.
7. Remove the rubber safety cap from the transceiver and from the end of the cable. Insert the cable into the transceiver.



**WARNING:** Do not look directly into a fiber-optic transceiver or into the ends of fiber-optic cables. Fiber-optic transceivers and fiber-optic cables connected to a transceiver emit laser light that can damage your eyes.

## Replace a QSFP28 Transceiver

### IN THIS SECTION

- [Remove a QSFP28 Transceiver | 83](#)
- [Install a QSFP28 Transceiver | 85](#)

28-Gbps quad small form-factor pluggable (QSFP28) transceivers are hot-insertable and hot-removable. Removing a QSFP28 transceiver does not interrupt router functioning, but the removed QSFP28 transceiver no longer receives or transmits data.

### Remove a QSFP28 Transceiver

The transceivers for Juniper Networks devices are hot-removable and hot-insertable field-replaceable units (FRUs). You can remove and replace them without powering off the device or disrupting the device functions.

**NOTE:** After you insert a transceiver or after you change the media-type configuration, wait for 6 seconds for the interface to display operational commands.

**NOTE:** We recommend that you use only optical transceivers and optical connectors purchased from Juniper Networks with your Juniper Networks device.

Before you begin to remove a transceiver from a device, ensure that you have taken the necessary precautions for safe handling of lasers (see [“Laser and LED Safety Guidelines and Warnings”](#) on page 123).

Ensure that you have the following parts and tools available:

- An antistatic bag or an antistatic mat
- Rubber safety caps to cover the transceiver and fiber-optic cable connector
- A dust cover to cover the port or a replacement transceiver

To remove a QSFP28 transceiver (see [Figure 27](#) on page 85):

1. Place an electrostatic bag or antistatic mat on a flat, stable surface to receive the QSFP28 transceiver. Have ready a rubber safety cap for the QSFP28 transceiver and the cable.
2. Wrap and fasten one end of the ESD grounding strap around your bare wrist, and connect the other end of the strap to an ESD point.
3. Label the cable connected to the QSFP28 transceiver so that you can later reconnect the cable to the correct QSFP28 transceiver.
4. Disconnect the cable from the transceiver. Immediately cover the transceiver and the end of the cable with a rubber safety cap.



**WARNING:** Do not look directly into a fiber-optic transceiver or into the ends of fiber-optic cables. Fiber-optic transceivers and fiber-optic cable connected to a transceiver emit laser light that can damage your eyes.



**CAUTION:** Do not leave a fiber-optic transceiver uncovered except when inserting or removing a cable. The safety cap keeps the port clean and prevents accidental exposure to laser light.

5. If there is a cable management system, arrange the cable in the cable management system to prevent it from dislodging or developing stress points. Secure the cable so that it does not support its own weight as it hangs to the floor. Place excess cable out of the way in a neatly coiled loop in the cable management system. Placing fasteners on the loop helps to maintain its shape.



**CAUTION:** Avoid bending the fiber-optic cable beyond its minimum bend radius. An arc smaller than a few inches in diameter can damage the cable and cause problems that are difficult to diagnose.

6. Pull the transceiver's rubber handle straight back.

The locking pins on the transceiver automatically releases the transceiver.

**Figure 27: 28-Gbps Quad Small Form-Factor Pluggable (QSFP28) Transceiver**

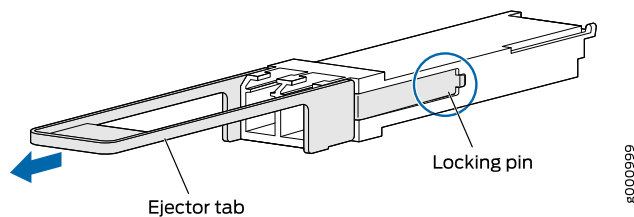

7. Place the transceiver on the antistatic mat or in the electrostatic bag.
8. Place the dust cover over the empty port or install the replacement transceiver.

### Install a QSFP28 Transceiver

The transceivers for Juniper Networks devices are hot-removable and hot-insertable field-replaceable units (FRUs): You can remove and replace them without powering off the device or disrupting the device functions.

**NOTE:** After you insert a transceiver or after you change the media-type configuration, wait for 6 seconds for the interface to display operational commands.

**NOTE:** We recommend that you use only optical transceivers and optical connectors purchased from Juniper Networks with your Juniper Networks device.



**CAUTION:** If you face a problem running a Juniper Networks device that uses a third-party optic or cable, the Juniper Networks Technical Assistance Center (JTAC) can help you diagnose the source of the problem. Your JTAC engineer might recommend that you check the third-party optic or cable and potentially replace it with an equivalent Juniper Networks optic or cable that is qualified for the device.

Before you begin to install a transceiver in a device, ensure that you have taken the necessary precautions for safe handling of lasers (see [“Laser and LED Safety Guidelines and Warnings”](#) on page 123).

Ensure that you have a rubber safety cap available to cover the transceiver.

To install a replacement QSFP28 transceiver (see [Figure 28](#) on page 86):

1. Wrap and fasten one end of the ESD grounding strap around your bare wrist, and connect the other end of the strap to an ESD point.
2. Verify that a rubber safety cap covers the QSFP28 transceiver. If it is not, cover the transceiver with a safety cap.
3. Orient the transceiver in front of the port so that the QSFP28 connector faces the appropriate direction.

**Figure 28: Install a QSFP28 Transceiver**

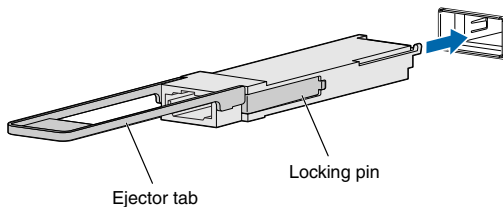

4. Slide the transceiver into the slot until the locking pins lock in place. If there is resistance, remove the transceiver and flip it so that the connector faces the other direction.
5. Remove the rubber safety cap from the transceiver and from the end of the cable, and insert the cable into the transceiver.



**WARNING:** Do not look directly into a fiber-optic transceiver or into the ends of fiber-optic cables. Fiber-optic transceivers and fiber-optic cable connected to a transceiver emit laser light that can damage your eyes.



**CAUTION:** Do not leave a fiber-optic transceiver uncovered except when inserting or removing a cable. The safety cap keeps the port clean and prevents accidental exposure to laser light.

6. If there is a cable management system, arrange the cable in the cable management system to prevent the cable from dislodging or developing stress points. Secure the cable so that it does not support its own weight as it hangs to the floor. Place excess cable out of the way in a neatly coiled loop in the cable management system. Placing fasteners on the loop helps to maintain its shape.



**CAUTION:** Do not let the fiber-optic cable hang free from the connector. Do not allow fastened loops of the cable to dangle, which stresses the cable at the fastening point.



**CAUTION:** Avoid bending the fiber-optic cable beyond its minimum bend radius. An arc smaller than a few inches in diameter can damage the cable and cause problems that are difficult to diagnose.

7. Verify that the status LEDs on the router indicate that the QSFP28 transceiver is functioning correctly. You can also verify that the interface port is functioning by running the **show chassis fpc pic-status** command.

## How to Handle Fiber-Optic Cables

Fiber-optic cables connect to optical transceivers that are installed in Juniper Networks devices.

To maintain fiber-optic cables:

- When you unplug a fiber-optic cable from a transceiver, place rubber safety caps over the transceiver and on the end of the cable.
- Anchor fiber-optic cables to prevent stress on the connectors. When attaching a fiber-optic cable to a transceiver, be sure to secure the fiber-optic cable so that it does not support its own weight as it hangs to the floor. Never let a fiber-optic cable hang free from the connector.

- Avoid bending fiber-optic cables beyond their minimum bend radius. Bending fiber-optic cables into arcs smaller than a few inches in diameter can damage the cables and cause problems that are difficult to diagnose.
- Frequent plugging and unplugging of fiber-optic cables in and out of optical instruments can damage the instruments, which are expensive to repair. Attach a short fiber extension to the optical equipment. Any wear and tear due to frequent plugging and unplugging is then absorbed by the short fiber extension, which is easier and less expensive to replace than the instruments.
- Keep fiber-optic cable connections clean. Microdeposits of oil and dust in the canal of the transceiver or cable connector can cause loss of light, reduction in signal power, and possibly intermittent problems with the optical connection.
  - To clean the transceiver canal, use an appropriate fiber-cleaning device such as RIFOCS Fiber Optic Adaptor Cleaning Wands (part number 946). Follow the instructions in the cleaning kit you use.
  - After cleaning the transceiver, make sure that the connector tip of the fiber-optic cable is clean. Use only an approved alcohol-free fiber-optic cable cleaning kit such as the Opptex Cletop-S Fiber Cleaner. Follow the instructions in the cleaning kit you use.

## Remove an ACX710 Router

### IN THIS SECTION

- [Power Off an ACX710 Router | 88](#)
- [Remove an ACX710 Router from a Rack or Cabinet | 90](#)

### Power Off an ACX710 Router

Before you power off an ACX710 router:

- Ensure that you have taken the necessary precautions to prevent electrostatic discharge (ESD) damage. See [“Prevention of Electrostatic Discharge Damage” on page 136](#).
- Ensure that you do not need to forward traffic through the router.
- Ensure that you have the following parts and tools available to power off the router:



- An ESD grounding strap
- An external management device such as a PC
- An RJ-45 to DB-9 rollover cable to connect the external management device to the console port
- A Phillips number 2 screwdriver

To power off your ACX710 router:

1. Connect to the router from an external management device using one of the following methods:

- Connect a management device to the console (**CON**) port on the router. For instructions about connecting a management device to the console (**CON**) port, see [“Connect an ACX710 Router to a Management Console” on page 67](#).
- Connect to a management device on your out-of-band management network to shut down the router. For instructions about connecting a management device to the management (**LMT**) port, see [“Connect an ACX710 Router to a Network for Out-of-Band Management” on page 69](#).

2. Shut down Junos OS from the external management device by issuing the **request vmhost halt** operational mode CLI command.

This command shuts down the router gracefully and preserves system state information. A message is displayed on the console, confirming that the operating system has halted. For more information about the command, see the [CLI Explorer](#)

You see the following output (or something similar, depending on the hardware that is being shut down) after entering the command:

```
Initiating vmhost halt... ok
Initiating Junos shutdown... shutdown: [pid 14318]
Shutdown NOW!
ok
Junos shutdown is in progress...
*** FINAL System shutdown message ***

System going down IMMEDIATELY

...
...
Operating system halted.
Please press any key to reboot.
```

3. Wrap and fasten one end of the ESD grounding strap around your bare wrist, and connect the other end of the strap to an ESD point.

4. Disconnect power to the router by switching the circuit breaker on the panel board that services the DC circuit to the off position.
5. Remove the power source cable by gently pulling out the power cord that is connected to the power supply module.
6. Disconnect all cables from the router before removing it from the rack or cabinet.

## Remove an ACX710 Router from a Rack or Cabinet

If you need to relocate an installed ACX710 router, use the procedure described in this topic.

**NOTE:** When you remove multiple devices from a rack, remove the device in the top of the rack first, and proceed to remove the rest of the devices from top to bottom.

Before removing your ACX710 router from its rack:

- Ensure that the rack is stable and secured to the building.
- Ensure that there is enough space to transport the removed router along the path to the new location and to place the router in its new location.
- Read [“General Safety Guidelines and Warnings” on page 104](#).
- Use the appropriate power-off sequence to safely power off the device. See [“Power Off an ACX710 Router” on page 88](#).
- Disconnect the power cords.
- Ensure that you have disconnected any cables or wires attached to the router ports.
- Ensure that you have the following parts and tools available:
  - A Phillips (+) screwdriver, number 2 or number 3, depending on the size of your rack mounting screws.

To remove an ACX710 router from a rack or cabinet:

1. Have one person support the weight of the router while another person uses the screwdriver to remove the front mounting screws that attach the chassis mounting rails to the rack or cabinet.
2. Slowly slide the router out of the rack, with the mounting rails attached to its sides.

3. Use the screwdriver to remove the mounting screws that attach the mounting blades that are attached to the rear of the rack or cabinet.
4. Place the removed screws and mounting blades in a labeled bag. You will need them when you reinstall the router.
5. Transport the router to your new location.

# 5

CHAPTER

## Troubleshooting Hardware

---

Troubleshoot an ACX710 Router | **93**

---

# Troubleshoot an ACX710 Router

## IN THIS SECTION

- [Alarm Types and Severity Classes on ACX Series Routers | 93](#)

## Alarm Types and Severity Classes on ACX Series Routers

Before monitoring the alarms on the router, become familiar with the terms defined in [Table 27 on page 93](#).

Table 27: Alarm Terms

Term	Definition
Alarm	Signal alerting you to conditions that might prevent normal operation. On a router, the alarm signal is the red system LED that is lit on the front of the chassis.
Alarm condition	Failure event that triggers an alarm.
Alarm severity	Seriousness of the alarm. The level of severity can be either major (steady red) or minor (blinking red).
Chassis alarm	Predefined alarm triggered by a physical condition on the router, such as a power failure, excessive component temperature, or media failure.
System alarm	Predefined alarm triggered by a missing rescue configuration or failure to install a license for a licensed software feature.

### Alarm Types

The router supports these alarms:

- Chassis alarms indicate a failure on the router or one of its components. Chassis alarms are preset and cannot be modified.
- System alarms indicate a missing rescue configuration. System alarms are preset and cannot be modified, although you can configure them to appear automatically in the J-Web interface display or CLI display.

## Alarm Severity Classes

Alarms on ACX Series routers have two severity classes:

- Major (steady red)—Indicates a critical situation on the router that has resulted from one of the following conditions. A major alarm condition requires immediate action.
  - One or more hardware components have failed.
  - One or more hardware components have exceeded temperature thresholds.
  - An alarm condition configured on an interface has triggered a critical warning.
- Minor (blinking red)—Indicates a noncritical condition on the router that, if left unchecked, might cause an interruption in service or degradation in performance. A minor alarm condition requires monitoring or maintenance.

A missing rescue configuration generates a minor system alarm.

# 6

CHAPTER

## Contacting Customer Support and Returning the Chassis or Components

---

Contacting Customer Support and Returning the Chassis or Components | 96

---

# Contacting Customer Support and Returning the Chassis or Components

## IN THIS SECTION

- [How to Return a Hardware Component to Juniper Networks, Inc. | 96](#)
- [How to Locate the Serial Number on an ACX710 Router or Component | 97](#)
- [Contact Customer Support to Obtain Return Material Authorization | 100](#)
- [Guidelines for Packing Hardware Components for Shipment | 100](#)

## How to Return a Hardware Component to Juniper Networks, Inc.

If a hardware component fails, please contact Juniper Networks, Inc. to obtain a Return Material Authorization (RMA) number. This number is used to track the returned material at the factory and to return repaired or new components to the customer as needed.

**NOTE:** Do not return any component to Juniper Networks, Inc. unless you have first obtained an RMA number. Juniper Networks, Inc. reserves the right to refuse shipments that do not have an RMA. Refused shipments are returned to the customer by collect freight.

For more information about return and repair policies, see the customer support webpage at <https://support.juniper.net/support/>.

For product problems or technical support issues, contact the Juniper Networks Technical Assistance Center (JTAC) by using the Service Request Manager link at <https://support.juniper.net/support/> or at 1-888-314-JTAC (within the United States) or 1-408-745-9500 (from outside the United States).

To return a defective hardware component:

1. Determine the part number and serial number of the defective component.
2. Obtain an RMA number from the Juniper Networks Technical Assistance Center (JTAC). You can send e-mail or telephone as described above.
3. Provide the following information in your e-mail message or during the telephone call:



- Part number and serial number of component
  - Your name, organization name, telephone number, and fax number
  - Description of the failure
4. The support representative validates your request and issues an RMA number for return of the component.
  5. Pack the component for shipment.

## How to Locate the Serial Number on an ACX710 Router or Component

### IN THIS SECTION

- [List the Chassis and Component Details Using the CLI | 97](#)
- [Locate the Chassis Serial Number ID Label on an ACX710 Router | 99](#)
- [Locate the Serial Number ID Label on an ACX710 Fan Tray | 99](#)

If you are returning a router or component to Juniper Networks for repair or replacement, you must locate the serial number of the router or component. You must provide the serial number to the Juniper Networks Technical Assistance Center (JTAC) when you contact them to obtain a Return Materials Authorization (RMA). See *Contacting Customer Support*.

If the router is operational and you can access the command-line interface (CLI), you can list serial numbers for the router and for some components by using a CLI command. If you do not have access to the CLI or if the serial number for the component does not appear in the command output, you can locate the serial number ID label on the router or component.

**NOTE:** If you want to find the serial number ID label on a component, you need to remove the component from the router chassis, for which you must have the required parts and tools available.

### List the Chassis and Component Details Using the CLI

To list the components and serial numbers of ACX710 routers, use the **show chassis hardware** CLI operational mode command.

The **show chassis hardware** output for ACX710:

user@device> **show chassis hardware**

```

Hardware inventory:
Item              Version  Part number  Serial number  Description
Chassis           TU8SA38553  ACX710
Midplane         REV 01   650-103474  TU8SA38553    ACX710-DC
Pseudo CB 0
Routing Engine 0          BUILTTIN    BUILTTIN      RE-ACX710
FPC 0             BUILTTIN    BUILTTIN      FPC-BUILTTIN
  CPU             BUILTTIN    BUILTTIN      FPC CPU
  MIC 0           BUILTTIN    BUILTTIN      ACX710 24x1GE/24x10GE SFP
MIC
  PIC 0           BUILTTIN    BUILTTIN      ACX710 24x1GE/24x10GE SFP
MIC
  Xcvr 0         REV 02   740-011613  NSN0UU3       SFP-SX
  Xcvr 1         REV 02   740-011613  PJ21K1R       SFP-SX
  Xcvr 2         REV 02   740-011613  PH10G75       SFP-SX
  Xcvr 3         REV 02   740-011613  AM0943SEMXZ   SFP-SX
  Xcvr 4         REV 01   740-031851  AM17492R9RV   SFP-SX
  Xcvr 5         REV 01   740-031980  MTB0J44       SFP+-10G-SR
  Xcvr 6         REV 01   740-031851  PQ362N5       SFP-SX
  Xcvr 7         REV 01   740-011613  PDD41TM       SFP-SX
  Xcvr 8         REV 02   740-011613  NTMOD6Z       SFP-SX
  Xcvr 9         REV 01   740-021308  AQA092Z       SFP+-10G-SR
  Xcvr 10        REV 01   740-031980  ALM0X1A       SFP+-10G-SR
  Xcvr 11        REV 01   740-031851  PUK0YC3       SFP-SX
  Xcvr 12        REV 01   740-031980  CH08KN0TF     SFP+-10G-SR
  Xcvr 13        REV 01   740-031980  MVD0FHJ       SFP+-10G-SR
  Xcvr 14        REV 01   740-031980  ARP1379       SFP+-10G-SR
  Xcvr 15        REV 01   740-030658  AA1227AYAPN   SFP+-10G-USR
  Xcvr 16        REV 01   740-031980  A1MAF3D       SFP+-10G-SR
  Xcvr 17        REV 01   740-031980  ARPOUY1       SFP+-10G-SR
  Xcvr 18        REV 01   740-031980  B11E01488     SFP+-10G-SR
  Xcvr 19        REV 01   740-031980  AA15433VANU   SFP+-10G-SR
  Xcvr 20        REV 02   740-011613  AM0943SENC0   SFP-SX
  Xcvr 21        REV 01   740-021308  AQD2CTC       SFP+-10G-SR
  Xcvr 22        REV 01   740-021308  AQE1553       SFP+-10G-SR
  Xcvr 23        REV 01   740-031851  PL1786S       SFP-SX
MIC 1
  PIC 1           BUILTTIN    BUILTTIN      ACX710 16x10/25GE
4x40/100GE SFP MIC
  PIC 1           BUILTTIN    BUILTTIN      ACX710 16x10/25GE
4x40/100GE SFP MIC
  Xcvr 0         REV 01   740-064980  1ACS72362UK   QSFP28-100G-AOC-30M

```

Xcvr 1	REV 01	740-061405	1ACQ1402064	QSFP-100G-SR4-T2
Xcvr 2	REV 01	740-061405	1ACQ1402059	QSFP-100G-SR4-T2
Xcvr 3	REV 01	740-058734	1ACQ13150N0	QSFP-100GBASE-SR4
Power Supply 0 B, Airflow out	REV 1		TU8XCN0585R	Assy,Pwr Sply,DC Feed A
Fan Tray 0 (AFO)	REV 1		CE51006XQPB	Fan Module, Airflow Out

### Locate the Chassis Serial Number ID Label on an ACX710 Router

On the ACX710 router, the chassis serial number ID label is located on the front panel, as shown in [Figure 29 on page 99](#).

Figure 29: ACX710 Chassis Serial Number Label

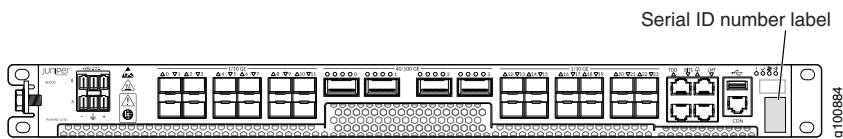

### Locate the Serial Number ID Label on an ACX710 Fan Tray

The fan tray installed in an ACX710 is a field-replaceable unit (FRU). You must remove the FRU from the router chassis to see the serial number ID label of the fan tray.

Figure 30: ACX710 Fan Tray Serial Number Label

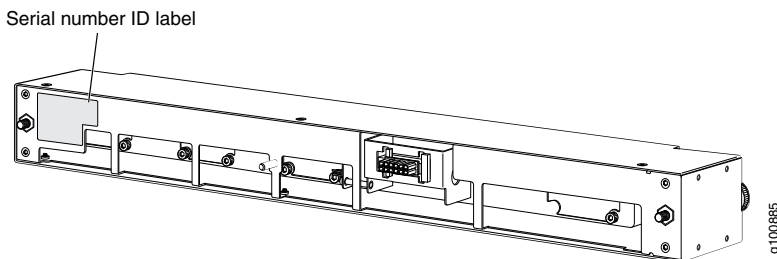

## Contact Customer Support to Obtain Return Material Authorization

If you are returning a device or hardware component to Juniper Networks for repair or replacement, obtain a Return Material Authorization (RMA) number from Juniper Networks Technical Assistance Center (JTAC).

After locating the serial number of the device or hardware component you want to return, open a service request with Juniper Networks Technical Assistance Center (JTAC) on the Web or by telephone.

Before you request an RMA number from JTAC, be prepared to provide the following information:

- Your existing service request number, if you have one
- Serial number of the component
- Your name, organization name, telephone number, fax number, and shipping address
- Details of the failure or problem
- Type of activity being performed on the device when the problem occurred
- Configuration data displayed by one or more **show** commands

You can contact JTAC 24 hours a day, seven days a week on the Web or by telephone:

- Service Request Manager: <https://support.juniper.net/support>
- Telephone: +1-888-314-JTAC (+1-888-314-5822), toll free in U.S., Canada, and Mexico

**NOTE:** For international or direct-dial options in countries without toll free numbers, see <https://support.juniper.net/support>

If you are contacting JTAC by telephone, enter your 12-digit service request number followed by the pound (#) key for an existing case, or press the star (\*) key to be routed to the next available support engineer.

The support representative validates your request and issues an RMA number for return of the component.

## Guidelines for Packing Hardware Components for Shipment

To pack and ship individual components:

- When you return components, make sure that they are adequately protected with packing materials and packed so that the pieces are prevented from moving around inside the carton.
- Use the original shipping materials if they are available.

- Place individual components in antistatic bags.
- Write the RMA number on the exterior of the box to ensure proper tracking.



**CAUTION:** Do not stack any of the hardware components.

# 7

CHAPTER

## Safety and Compliance Information

---

General Safety Guidelines and Warnings | **104**

Definitions of Safety Warning Levels | **105**

Qualified Personnel Warning | **108**

Warning Statement for Norway and Sweden | **109**

Fire Safety Requirements | **109**

Installation Instructions Warning | **111**

Restricted Access Warning | **112**

Ramp Warning | **114**

Rack-Mounting and Cabinet-Mounting Warnings | **115**

Grounded Equipment Warning | **121**

Radiation from Open Port Apertures Warning | **122**

Laser and LED Safety Guidelines and Warnings | **123**

Maintenance and Operational Safety Guidelines and Warnings | **126**

General Electrical Safety Guidelines and Warnings | **135**

Prevention of Electrostatic Discharge Damage | **136**

Site Electrical Wiring Guidelines | **137**

DC Power Electrical Safety Guidelines | **138**

DC Power Copper Conductors Warning | **139**

DC Power Disconnection Warning | **140**

DC Power Grounding Requirements and Warning | **142**

DC Power Wiring Sequence Warning | **144**

DC Power Wiring Terminations Warning | **147**

Multiple Power Supplies Disconnection Warning | **150**

Action to Take After an Electrical Accident | **151**

Agency Approvals for ACX710 Routers | **151**

Compliance Statements for NEBS | **152**

Compliance Statements for EMC Requirements | **152**

Compliance Statements for Environmental Requirements | **154**

---

# General Safety Guidelines and Warnings

The following guidelines help ensure your safety and protect the device from damage. The list of guidelines might not address all potentially hazardous situations in your working environment, so be alert and exercise good judgment at all times.

- Perform only the procedures explicitly described in the hardware documentation for this device. Make sure that only authorized service personnel perform other system services.
- Keep the area around the device clear and free from dust before, during, and after installation.
- Keep tools away from areas where people could trip over them while walking.
- Do not wear loose clothing or jewelry, such as rings, bracelets, or chains, which could become caught in the device.
- Wear safety glasses if you are working under any conditions that could be hazardous to your eyes.
- Do not perform any actions that create a potential hazard to people or make the equipment unsafe.
- Never attempt to lift an object that is too heavy for one person to handle.
- Never install or manipulate wiring during electrical storms.
- Never install electrical jacks in wet locations unless the jacks are specifically designed for wet environments.
- Operate the device only when it is properly grounded.
- Follow the instructions in this guide to properly ground the device to earth.
- Replace fuses only with fuses of the same type and rating.
- Do not open or remove chassis covers or sheet-metal parts unless instructions are provided in the hardware documentation for this device. Such an action could cause severe electrical shock.
- Do not push or force any objects through any opening in the chassis frame. Such an action could result in electrical shock or fire.
- Avoid spilling liquid onto the chassis or onto any device component. Such an action could cause electrical shock or damage the device.
- Avoid touching uninsulated electrical wires or terminals that have not been disconnected from their power source. Such an action could cause electrical shock.
- Some parts of the chassis, including AC and DC power supply surfaces, power supply unit handles, SFB card handles, and fan tray handles might become hot. The following label provides the warning of the hot surfaces on the chassis:





- Always ensure that all modules, power supplies, and cover panels are fully inserted and that the installation screws are fully tightened.

## Definitions of Safety Warning Levels

The documentation uses the following levels of safety warnings (there are two *Warning* formats):

**NOTE:** You might find this information helpful in a particular situation, or you might overlook this important information if it was not highlighted in a Note.



**CAUTION:** You need to observe the specified guidelines to prevent minor injury or discomfort to you or severe damage to the device.



**WARNING:** This symbol alerts you to the risk of personal injury from a laser.





**WARNING:** This symbol means danger. You are in a situation that could cause bodily injury. Before you work on any equipment, be aware of the hazards involved with electrical circuitry and be familiar with standard practices for preventing accidents.

**Waarschuwing** Dit waarschuwingssymbool betekent gevaar. U verkeert in een situatie die lichamelijk letsel kan veroorzaken. Voordat u aan enige apparatuur gaat werken, dient u zich bewust te zijn van de bij elektrische schakelingen betrokken risico's en dient u op de hoogte te zijn van standaard maatregelen om ongelukken te voorkomen.

**Varoitus** Tämä varoitusmerkki merkitsee vaaraa. Olet tilanteessa, joka voi johtaa ruumiinvammaan. Ennen kuin työskentelet minkään laitteiston parissa, ota selvää sähkökytkentöihin liittyvistä vaaroista ja tavanomaisista onnettomuuksien ehkäisykeinoista.

**Attention** Ce symbole d'avertissement indique un danger. Vous vous trouvez dans une situation pouvant causer des blessures ou des dommages corporels. Avant de travailler sur un équipement, soyez conscient des dangers posés par les circuits électriques et familiarisez-vous avec les procédures couramment utilisées pour éviter les accidents.

**Warnung** Dieses Warnsymbol bedeutet Gefahr. Sie befinden sich in einer Situation, die zu einer Körperverletzung führen könnte. Bevor Sie mit der Arbeit an irgendeinem Gerät beginnen, seien Sie sich der mit elektrischen Stromkreisen verbundenen Gefahren und der Standardpraktiken zur Vermeidung von Unfällen bewußt.

**Avvertenza** Questo simbolo di avvertenza indica un pericolo. La situazione potrebbe causare infortuni alle persone. Prima di lavorare su qualsiasi apparecchiatura, occorre conoscere i pericoli relativi ai circuiti elettrici ed essere al corrente delle pratiche standard per la prevenzione di incidenti.

**Advarsel** Dette varselsymbolet betyr fare. Du befinner deg i en situasjon som kan føre til personskade. Før du utfører arbeid på utstyr, må du være oppmerksom på de faremomentene som elektriske kretser innebærer, samt gjøre deg kjent med vanlig praksis når det gjelder å unngå ulykker.

**Aviso** Este símbolo de aviso indica perigo. Encontra-se numa situação que lhe poderá causar danos físicos. Antes de começar a trabalhar com qualquer equipamento, familiarize-se com os perigos relacionados com circuitos eléctricos, e com quaisquer práticas comuns que possam prevenir possíveis acidentes.

**¡Atención!** Este símbolo de aviso significa peligro. Existe riesgo para su integridad física. Antes de manipular cualquier equipo, considerar los riesgos que entraña la corriente eléctrica y familiarizarse con los procedimientos estándar de prevención de accidentes.

**Varning!** Denna varningssymbol signalerar fara. Du befinner dig i en situation som kan leda till personskada. Innan du utför arbete på någon utrustning måste du vara medveten om farorna med elkretsar och känna till vanligt förfarande för att förebygga skador.

## Qualified Personnel Warning



**WARNING:** Only trained and qualified personnel should install or replace the device.

**Waarschuwing** Installatie en reparaties mogen uitsluitend door getraind en bevoegd personeel uitgevoerd worden.

**Varoitus** Ainoastaan koulutettu ja pätevä henkilökunta saa asentaa tai vaihtaa tämän laitteen.

**Attention** Tout installation ou remplacement de l'appareil doit être réalisé par du personnel qualifié et compétent.

**Warnung** Gerät nur von geschultem, qualifiziertem Personal installieren oder auswechseln lassen.

**Avvertenza** Solo personale addestrato e qualificato deve essere autorizzato ad installare o sostituire questo apparecchio.

**Advarsel** Kun kvalifisert personell med riktig opplæring bør montere eller bytte ut dette utstyret.

**Aviso** Este equipamento deverá ser instalado ou substituído apenas por pessoal devidamente treinado e qualificado.

**¡Atención!** Estos equipos deben ser instalados y reemplazados exclusivamente por personal técnico adecuadamente preparado y capacitado.

**Varning!** Denna utrustning ska endast installeras och bytas ut av utbildad och kvalificerad personal.

## Warning Statement for Norway and Sweden



**WARNING:** The equipment must be connected to an earthed mains socket-outlet.

**Advarsel** Apparatet skal kobles til en jordet stikkontakt.

**Varning!** Apparaten skall anslutas till jordat nätuttag.

## Fire Safety Requirements

In the event of a fire emergency, the safety of people is the primary concern. You should establish procedures for protecting people in the event of a fire emergency, provide safety training, and properly provision fire-control equipment and fire extinguishers.

In addition, you should establish procedures to protect your equipment in the event of a fire emergency. Juniper Networks products should be installed in an environment suitable for electronic equipment. We recommend that fire suppression equipment be available in the event of a fire in the vicinity of the equipment and that all local fire, safety, and electrical codes and ordinances be observed when you install and operate your equipment.

### Fire Suppression

In the event of an electrical hazard or an electrical fire, you should first turn power off to the equipment at the source. Then use a Type C fire extinguisher, which uses noncorrosive fire retardants, to extinguish the fire.

### Fire Suppression Equipment

Type C fire extinguishers, which use noncorrosive fire retardants such as carbon dioxide and Halotron™, are most effective for suppressing electrical fires. Type C fire extinguishers displace oxygen from the point of combustion to eliminate the fire. For extinguishing fire on or around equipment that draws air from the environment for cooling, you should use this type of inert oxygen displacement extinguisher instead of an extinguisher that leaves residues on equipment.

Do not use multipurpose Type ABC chemical fire extinguishers (dry chemical fire extinguishers). The primary ingredient in these fire extinguishers is monoammonium phosphate, which is very sticky and difficult to clean. In addition, in the presence of minute amounts of moisture, monoammonium phosphate can become highly corrosive and corrodes most metals.

Any equipment in a room in which a chemical fire extinguisher has been discharged is subject to premature failure and unreliable operation. The equipment is considered to be irreparably damaged.

**NOTE:** To keep warranties effective, do not use a dry chemical fire extinguisher to control a fire at or near a Juniper Networks device. If a dry chemical fire extinguisher is used, the unit is no longer eligible for coverage under a service agreement.

We recommend that you dispose of any irreparably damaged equipment in an environmentally responsible manner.

# Installation Instructions Warning



**WARNING:** Read the installation instructions before you connect the device to a power source.

**Waarschuwing** Raadpleeg de installatie-aanwijzingen voordat u het systeem met de voeding verbindt.

**Varoitus** Lue asennusohjeet ennen järjestelmän yhdistämistä virtälähteeseen.

**Attention** Avant de brancher le système sur la source d'alimentation, consulter les directives d'installation.

**Warnung** Lesen Sie die Installationsanweisungen, bevor Sie das System an die Stromquelle anschließen.

**Avvertenza** Consultare le istruzioni di installazione prima di collegare il sistema all'alimentatore.

**Advarsel** Les installasjonsinstruksjonene før systemet kobles til strømkilden.

**Aviso** Leia as instruções de instalação antes de ligar o sistema à sua fonte de energia.

**¡Atención!** Ver las instrucciones de instalación antes de conectar el sistema a la red de alimentación.

**Varning!** Läs installationsanvisningarna innan du kopplar systemet till dess strömförsörjningsenhet.

# Restricted Access Warning





**WARNING:** This unit is intended for installation in restricted access areas. A restricted access area is an area to which access can be gained only by service personnel through the use of a special tool, lock and key, or other means of security, and which is controlled by the authority responsible for the location.

**Waarschuwing** Dit toestel is bedoeld voor installatie op plaatsen met beperkte toegang. Een plaats met beperkte toegang is een plaats waar toegang slechts door servicepersoneel verkregen kan worden door middel van een speciaal instrument, een slot en sleutel, of een ander veiligheidsmiddel, en welke beheerd wordt door de overheidsinstantie die verantwoordelijk is voor de locatie.

**Varoitus** Tämä laite on tarkoitettu asennettavaksi paikkaan, johon pääsy on rajoitettua. Paikka, johon pääsy on rajoitettua, tarkoittaa paikkaa, johon vain huoltohenkilöstö pääsee jonkin erikoistyökalun, lukkoon sopivan avaimen tai jonkin muun turvalaitteen avulla ja joka on paikasta vastuussa olevien toimivaltaisten henkilöiden valvoma.

**Attention** Cet appareil est à installer dans des zones d'accès réservé. Ces dernières sont des zones auxquelles seul le personnel de service peut accéder en utilisant un outil spécial, un mécanisme de verrouillage et une clé, ou tout autre moyen de sécurité. L'accès aux zones de sécurité est sous le contrôle de l'autorité responsable de l'emplacement.

**Warnung** Diese Einheit ist zur Installation in Bereichen mit beschränktem Zutritt vorgesehen. Ein Bereich mit beschränktem Zutritt ist ein Bereich, zu dem nur Wartungspersonal mit einem Spezialwerkzeugs, Schloß und Schlüssel oder anderer Sicherheitsvorkehrungen Zugang hat, und der von dem für die Anlage zuständigen Gremium kontrolliert wird.

**Avvertenza** Questa unità deve essere installata in un'area ad accesso limitato. Un'area ad accesso limitato è un'area accessibile solo a personale di assistenza tramite un'attrezzo speciale, lucchetto, o altri dispositivi di sicurezza, ed è controllata dall'autorità responsabile della zona.

**Advarsel** Denne enheten er laget for installasjon i områder med begrenset adgang. Et område med begrenset adgang gir kun adgang til servicepersonale som bruker et spesielt verktøy, lås og nøkkel, eller en annen sikkerhetsanordning, og det kontrolleres av den autoriteten som er ansvarlig for området.

**Aviso** Esta unidade foi concebida para instalação em áreas de acesso restrito. Uma área de acesso restrito é uma área à qual apenas tem acesso o pessoal de serviço autorizado, que possui uma ferramenta, chave e fechadura especial, ou qualquer outra forma de segurança. Esta área é controlada pela autoridade responsável pelo local.

**¡Atención!** Esta unidad ha sido diseñada para instalarse en áreas de acceso restringido. Área de acceso restringido significa un área a la que solamente tiene acceso el personal de servicio mediante la utilización de una herramienta especial, cerradura con llave, o algún otro medio de seguridad, y que está bajo el control de la autoridad responsable del local.

**Varning!** Denna enhet är avsedd för installation i områden med begränsat tillträde. Ett område med begränsat tillträde får endast tillträdas av servicepersonal med ett speciellt verktyg, lås och nyckel, eller annan säkerhetsanordning, och kontrolleras av den auktoritet som ansvarar för området.

## Ramp Warning



**WARNING:** When installing the device, do not use a ramp inclined at more than 10 degrees.

**Waarschuwing** Gebruik een oprijplaat niet onder een hoek van meer dan 10 graden.

**Varoitus** Älä käytä sellaista kaltevaa pintaa, jonka kaltevuus ylittää 10 astetta.

**Attention** Ne pas utiliser une rampe dont l'inclinaison est supérieure à 10 degrés.

**Warnung** Keine Rampen mit einer Neigung von mehr als 10 Grad verwenden.

**Avvertenza** Non usare una rampa con pendenza superiore a 10 gradi.

**Advarsel** Bruk aldri en rampe som heller mer enn 10 grader.

**Aviso** Não utilize uma rampa com uma inclinação superior a 10 graus.

**¡Atención!** No usar una rampa inclinada más de 10 grados

**Varning!** Använd inte ramp med en lutning på mer än 10 grader.

# Rack-Mounting and Cabinet-Mounting Warnings

Ensure that the rack or cabinet in which the device is installed is evenly and securely supported. Uneven mechanical loading could lead to a hazardous condition.





**WARNING:** To prevent bodily injury when mounting or servicing the device in a rack, take the following precautions to ensure that the system remains stable. The following directives help maintain your safety:

- The device must be installed in a rack that is secured to the building structure.
- The device should be mounted at the bottom of the rack if it is the only unit in the rack.
- When mounting the device on a partially filled rack, load the rack from the bottom to the top with the heaviest component at the bottom of the rack.
- If the rack is provided with stabilizing equipment, install the stabilizers before mounting or servicing the device in the rack.

**Waarschuwing** Om lichamelijk letsel te voorkomen wanneer u dit toestel in een rek monteert of het daar een servicebeurt geeft, moet u speciale voorzorgsmaatregelen nemen om ervoor te zorgen dat het toestel stabiel blijft. De onderstaande richtlijnen worden verstrekt om uw veiligheid te verzekeren:

- De Juniper Networks switch moet in een stellage worden geïnstalleerd die aan een bouwsel is verankerd.
- Dit toestel dient onderaan in het rek gemonteerd te worden als het toestel het enige in het rek is.
- Wanneer u dit toestel in een gedeeltelijk gevuld rek monteert, dient u het rek van onderen naar boven te laden met het zwaarste onderdeel onderaan in het rek.
- Als het rek voorzien is van stabiliseringshulpmiddelen, dient u de stabilisatoren te monteren voordat u het toestel in het rek monteert of het daar een servicebeurt geeft.

**Varoitus** Kun laite asetetaan telineeseen tai huolletaan sen ollessa telineessä, on noudatettava erityisiä varotoimia järjestelmän vakavuuden säilyttämiseksi, jotta vältetään loukkaantumiselta. Noudata seuraavia turvallisuusohjeita:

- Juniper Networks switch on asennettava telineeseen, joka on kiinnitetty rakennukseen.
- Jos telineessä ei ole muita laitteita, aseta laite telineen alaosaan.
- Jos laite asetetaan osaksi täytettyyn telineeseen, aloita kuormittaminen sen alaosasta kaikkein raskaimmalla esineellä ja siirry sitten sen yläosaan.
- Jos telinettä varten on vakaimet, asenna ne ennen laitteen asettamista telineeseen tai sen huoltamista siinä.

**Attention** Pour éviter toute blessure corporelle pendant les opérations de montage ou de réparation de cette unité en casier, il convient de prendre des précautions spéciales afin de maintenir la stabilité du système. Les directives ci-dessous sont destinées à assurer la protection du personnel:

- Le rack sur lequel est monté le Juniper Networks switch doit être fixé à la structure du bâtiment.
- Si cette unité constitue la seule unité montée en casier, elle doit être placée dans le bas.
- Si cette unité est montée dans un casier partiellement rempli, charger le casier de bas en haut en plaçant l'élément le plus lourd dans le bas.
- Si le casier est équipé de dispositifs stabilisateurs, installer les stabilisateurs avant de monter ou de réparer l'unité en casier.

**Warnung** Zur Vermeidung von Körperverletzung beim Anbringen oder Warten dieser Einheit in einem Gestell müssen Sie besondere Vorkehrungen treffen, um sicherzustellen, daß das System stabil bleibt. Die folgenden Richtlinien sollen zur Gewährleistung Ihrer Sicherheit dienen:

- Der Juniper Networks switch muß in einem Gestell installiert werden, das in der Gebäudestruktur verankert ist.
- Wenn diese Einheit die einzige im Gestell ist, sollte sie unten im Gestell angebracht werden.
- Bei Anbringung dieser Einheit in einem zum Teil gefüllten Gestell ist das Gestell von unten nach oben zu laden, wobei das schwerste Bauteil unten im Gestell anzubringen ist.
- Wird das Gestell mit Stabilisierungszubehör geliefert, sind zuerst die Stabilisatoren zu installieren, bevor Sie die Einheit im Gestell anbringen oder sie warten.

**Avvertenza** Per evitare infortuni fisici durante il montaggio o la manutenzione di questa unità in un supporto, occorre osservare speciali precauzioni per garantire che il sistema rimanga stabile. Le seguenti direttive vengono fornite per garantire la sicurezza personale:

- Il Juniper Networks switch deve essere installato in un telaio, il quale deve essere fissato alla struttura dell'edificio.
- Questa unità deve venire montata sul fondo del supporto, se si tratta dell'unica unità da montare nel supporto.
- Quando questa unità viene montata in un supporto parzialmente pieno, caricare il supporto dal basso all'alto, con il componente più pesante sistemato sul fondo del supporto.
- Se il supporto è dotato di dispositivi stabilizzanti, installare tali dispositivi prima di montare o di procedere alla manutenzione dell'unità nel supporto.

**Advarsel** Unngå fysiske skader under montering eller reparasjonsarbeid på denne enheten når den befinner seg i et kabinett. Vær nøye med at systemet er stabilt. Følgende retningslinjer er gitt for å verne om sikkerheten:

- Juniper Networks switch må installeres i et stativ som er forankret til bygningsstrukturen.
- Denne enheten bør monteres nederst i kabinettet hvis dette er den eneste enheten i kabinettet.
- Ved montering av denne enheten i et kabinett som er delvis fylt, skal kabinettet lastes fra bunnen og opp med den tyngste komponenten nederst i kabinettet.
- Hvis kabinettet er utstyrt med stabiliseringsutstyr, skal stabilisatorene installeres før montering eller utføring av reparasjonsarbeid på enheten i kabinettet.

**Aviso** Para se prevenir contra danos corporais ao montar ou reparar esta unidade numa estante, deverá tomar precauções especiais para se certificar de que o sistema possui um suporte estável. As seguintes directrizes ajudá-lo-ão a efectuar o seu trabalho com segurança:

- O Juniper Networks switch deverá ser instalado numa prateleira fixa à estrutura do edifício.
- Esta unidade deverá ser montada na parte inferior da estante, caso seja esta a única unidade a ser montada.
- Ao montar esta unidade numa estante parcialmente ocupada, coloque os itens mais pesados na parte inferior da estante, arrumando-os de baixo para cima.
- Se a estante possuir um dispositivo de estabilização, instale-o antes de montar ou reparar a unidade.

**¡Atención!** Para evitar lesiones durante el montaje de este equipo sobre un bastidor, oerriormente durante su mantenimiento, se debe poner mucho cuidado en que el sistema quede bien estable. Para garantizar su seguridad, proceda según las siguientes instrucciones:

- El Juniper Networks switch debe instalarse en un bastidor fijado a la estructura del edificio.
- Colocar el equipo en la parte inferior del bastidor, cuando sea la única unidad en el mismo.
- Cuando este equipo se vaya a instalar en un bastidor parcialmente ocupado, comenzar la instalación desde la parte inferior hacia la superior colocando el equipo más pesado en la parte inferior.
- Si el bastidor dispone de dispositivos estabilizadores, instalar éstos antes de montar o proceder al mantenimiento del equipo instalado en el bastidor.

**Warning!** För att undvika kroppsskada när du installerar eller utför underhållsarbete på denna enhet på en ställning måste du vidta särskilda försiktighetsåtgärder för att försäkra dig om att systemet står stadigt. Följande riktlinjer ges för att trygga din säkerhet:

- Juniper Networks switch måste installeras i en ställning som är förankrad i byggnadens struktur.
- Om denna enhet är den enda enheten på ställningen skall den installeras längst ned på ställningen.
- Om denna enhet installeras på en delvis fylld ställning skall ställningen fyllas nedifrån och upp, med de tyngsta enheterna längst ned på ställningen.
- Om ställningen är försedd med stabiliseringsdon skall dessa monteras fast innan enheten installeras eller underhålls på ställningen.



## Grounded Equipment Warning



**WARNING:** This device must be properly grounded at all times. Follow the instructions in this guide to properly ground the device to earth.

**Waarschuwing** Dit apparaat moet altijd goed geaard zijn. Volg de instructies in deze gids om het apparaat goed te aarden.

**Varoitus** Laitteen on oltava pysyvästi maadoitettu. Maadoita laite asianmukaisesti noudattamalla tämän oppaan ohjeita.

**Attention** L'appareil doit être correctement mis à la terre à tout moment. Suivez les instructions de ce guide pour correctement mettre l'appareil à la terre.

**Warnung** Das Gerät muss immer ordnungsgemäß geerdet sein. Befolgen Sie die Anweisungen in dieser Anleitung, um das Gerät ordnungsgemäß zu erden.

**Avvertenza** Questo dispositivo deve sempre disporre di una connessione a massa. Seguire le istruzioni indicate in questa guida per connettere correttamente il dispositivo a massa.

**Advarsel** Denne enheten på jordes skikkelig hele tiden. Følg instruksjonene i denne veiledningen for å jorde enheten.

**Aviso** Este equipamento deverá estar ligado à terra. Siga las instrucciones en esta guía para conectar correctamente este dispositivo a tierra.

**¡Atención!** Este dispositivo debe estar correctamente conectado a tierra en todo momento. Siga las instrucciones en esta guía para conectar correctamente este dispositivo a tierra.

**Warning!** Den här enheten måste vara ordentligt jordad. Följ instruktionerna i den här guiden för att jorda enheten ordentligt.

## Radiation from Open Port Apertures Warning



**WARNING:** Because invisible radiation might be emitted from the aperture of the port when no fiber cable is connected, avoid exposure to radiation and do not stare into open apertures.

**Waarschuwing** Aangezien onzichtbare straling vanuit de opening van de poort kan komen als er geen fiberkabel aangesloten is, dient blootstelling aan straling en het kijken in open openingen vermeden te worden.

**Varoitus** Koska portin aukosta voi emittoitua näkymätöntä säteilyä, kun kuitukaapelia ei ole kytkettynä, vältä säteilylle altistumista äläkä katso avoimiin aukkoihin.

**Attention** Des radiations invisibles à l'il nu pouvant traverser l'ouverture du port lorsqu'aucun câble en fibre optique n'y est connecté, il est recommandé de ne pas regarder fixement l'intérieur de ces ouvertures.

**Warnung** Aus der Port-Öffnung können unsichtbare Strahlen emittieren, wenn kein Glasfaserkabel angeschlossen ist. Vermeiden Sie es, sich den Strahlungen auszusetzen, und starren Sie nicht in die Öffnungen!

**Avvertenza** Quando i cavi in fibra non sono inseriti, radiazioni invisibili possono essere emesse attraverso l'apertura della porta. Evitate di esporvi alle radiazioni e non guardate direttamente nelle aperture.

**Advarsel** Unngå utsettelse for stråling, og stirr ikke inn i åpninger som er åpne, fordi usynlig stråling kan emitteres fra portens åpning når det ikke er tilkoblet en fiberkabel.

**Aviso** Dada a possibilidade de emissão de radiação invisível através do orifício da via de acesso, quando esta não tiver nenhum cabo de fibra conectado, deverá evitar a exposição à radiação e não deverá olhar fixamente para orifícios que se encontrarem a descoberto.

**¡Atención!** Debido a que la apertura del puerto puede emitir radiación invisible cuando no existe un cable de fibra conectado, evite mirar directamente a las aperturas para no exponerse a la radiación.

**Warning!** Osynlig stråling kan avges från en portöppning utan ansluten fiberkabel och du bör därför undvika att bli utsatt för stråling genom att inte stirra in i oskyddade öppningar.

# Laser and LED Safety Guidelines and Warnings

## IN THIS SECTION

- [General Laser Safety Guidelines | 123](#)
- [Class 1 Laser Product Warning | 124](#)
- [Class 1 LED Product Warning | 125](#)
- [Laser Beam Warning | 126](#)

Juniper Networks devices are equipped with laser transmitters, which are considered a Class 1 Laser Product by the U.S. Food and Drug Administration and are evaluated as a Class 1 Laser Product per EN 60825-1 requirements.

Observe the following guidelines and warnings:

## General Laser Safety Guidelines

When working around ports that support optical transceivers, observe the following safety guidelines to prevent eye injury:

- Do not look into unterminated ports or at fibers that connect to unknown sources.
- Do not examine unterminated optical ports with optical instruments.
- Avoid direct exposure to the beam.



**WARNING:** Unterminated optical connectors can emit invisible laser radiation. The lens in the human eye focuses all the laser power on the retina, so focusing the eye directly on a laser source—even a low-power laser—could permanently damage the eye.

## Class 1 Laser Product Warning



**WARNING:** Class 1 laser product.

**Waarschuwing** Klasse-1 laser produkt.

**Varoitus** Luokan 1 lasertuote.

**Attention** Produit laser de classe I.

**Warnung** Laserprodukt der Klasse 1.

**Avvertenza** Prodotto laser di Classe 1.

**Advarsel** Laserprodukt av klasse 1.

**Aviso** Produto laser de classe 1.

**¡Atención!** Producto láser Clase I.

**Varning!** Laserprodukt av klass 1.

## Class 1 LED Product Warning



**WARNING:** Class 1 LED product.

**Waarschuwing** Klasse 1 LED-product.

**Varoitus** Luokan 1 valodiodituote.

**Attention** Alarme de produit LED Class I.

**Warnung** Class 1 LED-Produktwarnung.

**Avvertenza** Avvertenza prodotto LED di Classe 1.

**Advarsel** LED-produkt i klasse 1.

**Aviso** Produto de classe 1 com LED.

**¡Atención!** Aviso sobre producto LED de Clase 1.

**Varning!** Lysdiodprodukt av klass 1.

## Laser Beam Warning



**WARNING:** Do not stare into the laser beam or view it directly with optical instruments.

**Waarschuwing** Niet in de straal staren of hem rechtstreeks bekijken met optische instrumenten.

**Varoitus** Älä katso säteeseen äläkä tarkastele sitä suoraan optisen laitteen avulla.

**Attention** Ne pas fixer le faisceau des yeux, ni l'observer directement à l'aide d'instruments optiques.

**Warnung** Nicht direkt in den Strahl blicken und ihn nicht direkt mit optischen Geräten prüfen.

**Avvertenza** Non fissare il raggio con gli occhi né usare strumenti ottici per osservarlo direttamente.

**Advarsel** Stirr eller se ikke direkte p strlen med optiske instrumenter.

**Aviso** Não olhe fixamente para o raio, nem olhe para ele directamente com instrumentos ópticos.

**¡Atención!** No mirar fijamente el haz ni observarlo directamente con instrumentos ópticos.

**Warning!** Rikta inte blicken in mot strålen och titta inte direkt på den genom optiska instrument.

# Maintenance and Operational Safety Guidelines and Warnings

## IN THIS SECTION

- [Battery Handling Warning | 128](#)
- [Jewelry Removal Warning | 129](#)
- [Lightning Activity Warning | 131](#)

- Operating Temperature Warning | 132
- Product Disposal Warning | 134

While performing the maintenance activities for devices, observe the following guidelines and warnings:

## Battery Handling Warning



**WARNING:** Replacing a battery incorrectly might result in an explosion. Replace a battery only with the same or equivalent type recommended by the manufacturer. Dispose of used batteries according to the manufacturer's instructions.

**Waarschuwing** Er is ontplofingsgevaar als de batterij verkeerd vervangen wordt. Vervang de batterij slechts met hetzelfde of een equivalent type dat door de fabrikant aanbevolen is. Gebruikte batterijen dienen overeenkomstig fabrieksvoorschriften weggeworpen te worden.

**Varoitus** Räjähdyksen vaara, jos akku on vaihdettu väärään akkuun. Käytä vaihtamiseen ainoastaan saman- tai vastaaventyypistä akkua, joka on valmistajan suosittelema. Hävitä käytetyt akut valmistajan ohjeiden mukaan.

**Attention** Danger d'explosion si la pile n'est pas remplacée correctement. Ne la remplacer que par une pile de type semblable ou équivalent, recommandée par le fabricant. Jeter les piles usagées conformément aux instructions du fabricant.

**Warnung** Bei Einsetzen einer falschen Batterie besteht Explosionsgefahr. Ersetzen Sie die Batterie nur durch den gleichen oder vom Hersteller empfohlenen Batterietyp. Entsorgen Sie die benutzten Batterien nach den Anweisungen des Herstellers.

**Advarsel** Det kan være fare for eksplosjon hvis batteriet skiftes på feil måte. Skift kun med samme eller tilsvarende type som er anbefalt av produsenten. Kasser brukte batterier i henhold til produsentens instruksjoner.

**Avvertenza** Pericolo di esplosione se la batteria non è installata correttamente. Sostituire solo con una di tipo uguale o equivalente, consigliata dal produttore. Eliminare le batterie usate secondo le istruzioni del produttore.

**Aviso** Existe perigo de explosão se a bateria for substituída incorrectamente. Substitua a bateria por uma bateria igual ou de um tipo equivalente recomendado pelo fabricante. Destrua as baterias usadas conforme as instruções do fabricante.

**¡Atención!** Existe peligro de explosión si la batería se reemplaza de manera incorrecta. Reemplazar la batería exclusivamente con el mismo tipo o el equivalente recomendado por el fabricante. Desechar las baterías gastadas según las instrucciones del fabricante.

**Warning!** Explosionsfara vid felaktigt batteribyte. Ersätt endast batteriet med samma batterityp som rekommenderas av tillverkaren eller motsvarande. Följ tillverkarens anvisningar vid kassering av använda batterier.



## Jewelry Removal Warning



**WARNING:** Before working on equipment that is connected to power lines, remove jewelry, including rings, necklaces, and watches. Metal objects heat up when connected to power and ground and can cause serious burns or can be welded to the terminals.

**Waarschuwing** Alvorens aan apparatuur te werken die met elektrische leidingen is verbonden, sieraden (inclusief ringen, kettingen en horloges) verwijderen. Metalen voorwerpen worden warm wanneer ze met stroom en aarde zijn verbonden, en kunnen ernstige brandwonden veroorzaken of het metalen voorwerp aan de aansluitklemmen lassen.

**Varoitus** Ennen kuin työskentelet voimavirtajohtoihin kytkettyjen laitteiden parissa, ota pois kaikki korut (sormukset, kaulakorut ja kellot mukaan lukien). Metalliesineet kuumentuvat, kun ne ovat yhteydessä sähkövirran ja maan kanssa, ja ne voivat aiheuttaa vakavia palovammoja tai hitsata metalliesineet kiinni liitännänpoihin.

**Attention** Avant d'accéder à cet équipement connecté aux lignes électriques, ôter tout bijou (anneaux, colliers et montres compris). Lorsqu'ils sont branchés à l'alimentation et reliés à la terre, les objets métalliques chauffent, ce qui peut provoquer des blessures graves ou souder l'objet métallique aux bornes.

**Warnung** Vor der Arbeit an Geräten, die an das Netz angeschlossen sind, jeglichen Schmuck (einschließlich Ringe, Ketten und Uhren) abnehmen. Metallgegenstände erhitzen sich, wenn sie an das Netz und die Erde angeschlossen werden, und können schwere Verbrennungen verursachen oder an die Anschlußklemmen angeschweißt werden.

**Avvertenza** Prima di intervenire su apparecchiature collegate alle linee di alimentazione, togliersi qualsiasi monile (inclusi anelli, collane, braccialetti ed orologi). Gli oggetti metallici si riscaldano quando sono collegati tra punti di alimentazione e massa: possono causare ustioni gravi oppure il metallo può saldarsi ai terminali.

**Advarsel** Fjern alle smykker (inkludert ringe, halskjeder og klokke) før du skal arbeide på utstyr som er koblet til kraftledninger. Metallgjenstander som er koblet til kraftledninger og jord blir svært varme og kan forårsake alvorlige brannskader eller smelte fast til polene.

**Aviso** Antes de trabalhar em equipamento que esteja ligado a linhas de corrente, retire todas as jóias que estiver a usar (incluindo anéis, fios e relógios). Os objectos metálicos aquecerão em contacto com a corrente e em contacto com a ligação à terra, podendo causar queimaduras graves ou ficarem soldados aos terminais.

**¡Atención!** Antes de operar sobre equipos conectados a líneas de alimentación, quitarse las joyas (incluidos anillos, collares y relojes). Los objetos de metal se calientan cuando

se conectan a la alimentación y a tierra, lo que puede ocasionar quemaduras graves o que los objetos metálicos queden soldados a los bornes.

**Warning!** Tag av alla smycken (inklusive ringar, halsband och armbandsur) innan du arbetar på utrustning som är kopplad till kraftledning. Metallobjekt hettas upp när de kopplas ihop med ström och jord och kan förorsaka allvarliga brännskador; metallobjekt kan också sammansvetsas med kontakterna.

## Lightning Activity Warning



**WARNING:** Do not work on the system or connect or disconnect cables during periods of lightning activity.

**Waarschuwing** Tijdens onweer dat gepaard gaat met bliksem, dient u niet aan het systeem te werken of kabels aan te sluiten of te ontkoppelen.

**Varoitus** Älä työskentele järjestelmän parissa äläkä yhdistä tai irrota kaapeleita ukkosilmalla.

**Attention** Ne pas travailler sur le système ni brancher ou débrancher les câbles pendant un orage.

**Warnung** Arbeiten Sie nicht am System und schließen Sie keine Kabel an bzw. trennen Sie keine ab, wenn es gewittert.

**Avvertenza** Non lavorare sul sistema o collegare oppure scollegare i cavi durante un temporale con fulmini.

**Advarsel** Utfør aldri arbeid på systemet, eller koble kabler til eller fra systemet når det tordner eller lyner.

**Aviso** Não trabalhe no sistema ou ligue e desligue cabos durante períodos de mau tempo (trovoada).

**¡Atención!** No operar el sistema ni conectar o desconectar cables durante el transcurso de descargas eléctricas en la atmósfera.

**Warning!** Vid åska skall du aldrig utföra arbete på systemet eller ansluta eller koppla loss kablar.

## Operating Temperature Warning



**WARNING:** To prevent the device from overheating, do not operate it in an area that exceeds the maximum recommended ambient temperature. To prevent airflow restriction, allow at least 6 in. (15.2 cm) of clearance around the ventilation openings.

**Waarschuwing** Om te voorkomen dat welke switch van de Juniper Networks router dan ook oververhit raakt, dient u deze niet te bedienen op een plaats waar de maximale aanbevolen omgevingstemperatuur van 40° C wordt overschreden. Om te voorkomen dat de luchtstroom wordt beperkt, dient er minstens 15,2 cm speling rond de ventilatie-openingen te zijn.

**Varoitus** Ettei Juniper Networks switch-sarjan reititin ylikuumentuisi, sitä ei saa käyttää tilassa, jonka lämpötila ylittää korkeimman suositellun ympäristölämpötilan 40° C. Ettei ilmanvaihto estyisi, tuuletusaukkojen ympärille on jätettävä ainakin 15,2 cm tilaa.

**Attention** Pour éviter toute surchauffe des routeurs de la gamme Juniper Networks switch, ne l'utilisez pas dans une zone où la température ambiante est supérieure à 40° C. Pour permettre un flot d'air constant, dégagez un espace d'au moins 15,2 cm autour des ouvertures de ventilations.

**Warnung** Um einen Router der switch vor Überhitzung zu schützen, darf dieser nicht in einer Gegend betrieben werden, in der die Umgebungstemperatur das empfohlene Maximum von 40° C überschreitet. Um Lüftungsverschluß zu verhindern, achten Sie darauf, daß mindestens 15,2 cm lichter Raum um die Lüftungsöffnungen herum frei bleibt.

**Avvertenza** Per evitare il surriscaldamento dei switch, non adoperateli in un locale che ecceda la temperatura ambientale massima di 40° C. Per evitare che la circolazione dell'aria sia impedita, lasciate uno spazio di almeno 15.2 cm di fronte alle aperture delle ventole.

**Advarsel** Unngå overoppheting av eventuelle rutere i Juniper Networks switch Disse skal ikke brukes på steder der den anbefalte maksimale omgivelsestemperaturen overstiger 40° C (104° F). Sørg for at klaringen rundt lufteåpningene er minst 15,2 cm (6 tommer) for å forhindre nedsatt luftsirkulasjon.

**Aviso** Para evitar o sobreaquecimento do encaminhador Juniper Networks switch, não utilize este equipamento numa área que exceda a temperatura máxima recomendada de 40° C. Para evitar a restrição à circulação de ar, deixe pelo menos um espaço de 15,2 cm à volta das aberturas de ventilação.

**¡Atención!** Para impedir que un encaminhador de la serie Juniper Networks switch se recaliente, no lo haga funcionar en un área en la que se supere la temperatura ambiente máxima recomendada de 40° C. Para impedir la restricción de la entrada de aire, deje un espacio mínimo de 15,2 cm alrededor de las aberturas para ventilación.

**Warning!** Förhindra att en Juniper Networks switch överhettas genom att inte använda den i ett område där den maximalt rekommenderade omgivningstemperaturen på 40° C överskrids. Förhindra att luftcirkulationen inskränks genom att se till att det finns fritt utrymme på minst 15,2 cm omkring ventilationsöppningarna.

## Product Disposal Warning



**WARNING:** Disposal of this device must be handled according to all national laws and regulations.

**Waarschuwing** Dit produkt dient volgens alle landelijke wetten en voorschriften te worden afgedankt.

**Varoitus** Tämän tuotteen lopullisesta hävittämisestä tulee huolehtia kaikkia valtakunnallisia lakeja ja säännöksiä noudattaen.

**Attention** La mise au rebut définitive de ce produit doit être effectuée conformément à toutes les lois et réglementations en vigueur.

**Warnung** Dieses Produkt muß den geltenden Gesetzen und Vorschriften entsprechend entsorgt werden.

**Avvertenza** L'eliminazione finale di questo prodotto deve essere eseguita osservando le normative italiane vigenti in materia

**Advarsel** Endelig disponering av dette produktet må skje i henhold til nasjonale lover og forskrifter.

**Aviso** A descartagem final deste produto deverá ser efectuada de acordo com os regulamentos e a legislação nacional.

**¡Atención!** El desecho final de este producto debe realizarse según todas las leyes y regulaciones nacionales

**Warning!** Slutlig kassering av denna produkt bör skötas i enlighet med landets alla lagar och föreskrifter.

## General Electrical Safety Guidelines and Warnings



**WARNING:** Certain ports on the device are designed for use as intrabuilding (within-the-building) interfaces only (Type 2 or Type 4 ports as described in GR-1089-CORE) and require isolation from the exposed outside plant (OSP) cabling. To comply with NEBS requirements and protect against lightning surges and commercial power disturbances, the intrabuilding ports *must not* be metallicity connected to interfaces that connect to the OSP or its wiring. The intrabuilding ports on the device are suitable for connection to intrabuilding or unexposed wiring or cabling only. The addition of primary protectors is not sufficient protection for connecting these interfaces metallicity to OSP wiring.



**CAUTION:** Before removing or installing components of a device, connect an electrostatic discharge (ESD) grounding strap to an ESD point and wrap and fasten the other end of the strap around your bare wrist. Failure to use an ESD grounding strap could result in damage to the device.

- Install the device in compliance with the following local, national, and international electrical codes:
  - United States—National Fire Protection Association (NFPA 70), United States National Electrical Code.
  - Other countries—International Electromechanical Commission (IEC) 60364, Part 1 through Part 7.
  - Evaluated to the TN power system.
  - Canada—Canadian Electrical Code, Part 1, CSA C22.1.
  - Suitable for installation in Information Technology Rooms in accordance with Article 645 of the National Electrical Code and NFPA 75.

Peut être installé dans des salles de matériel de traitement de l'information conformément à l'article 645 du National Electrical Code et à la NFPA 75.
- Locate the emergency power-off switch for the room in which you are working so that if an electrical accident occurs, you can quickly turn off the power.
- Make sure that grounding surfaces are cleaned and brought to a bright finish before grounding connections are made.
- Do not work alone if potentially hazardous conditions exist anywhere in your workspace.
- Never assume that power is disconnected from a circuit. Always check the circuit before starting to work.

- Carefully look for possible hazards in your work area, such as moist floors, ungrounded power extension cords, and missing safety grounds.
- Operate the device within marked electrical ratings and product usage instructions.
- To ensure that the device and peripheral equipment function safely and correctly, use the cables and connectors specified for the attached peripheral equipment, and make certain they are in good condition.

You can remove and replace many device components without powering off or disconnecting power to the device, as detailed elsewhere in the hardware documentation for this device. Never install equipment that appears to be damaged.

## Prevention of Electrostatic Discharge Damage

Device components that are shipped in antistatic bags are sensitive to damage from static electricity. Some components can be impaired by voltages as low as 30 V. You can easily generate potentially damaging static voltages whenever you handle plastic or foam packing material or if you move components across plastic or carpets. Observe the following guidelines to minimize the potential for electrostatic discharge (ESD) damage, which can cause intermittent or complete component failures:

- Always use an ESD wrist strap when you are handling components that are subject to ESD damage, and make sure that it is in direct contact with your skin.

If a grounding strap is not available, hold the component in its antistatic bag (see [Figure 31 on page 137](#)) in one hand and touch the exposed, bare metal of the device with the other hand immediately before inserting the component into the device.



**WARNING:** For safety, periodically check the resistance value of the ESD grounding strap. The measurement must be in the range 1 through 10 Mohms.

- When handling any component that is subject to ESD damage and that is removed from the device, make sure the equipment end of your ESD wrist strap is attached to the ESD point on the chassis.  
If no grounding strap is available, touch the exposed, bare metal of the device to ground yourself before handling the component.
- Avoid contact between the component that is subject to ESD damage and your clothing. ESD voltages emitted from clothing can damage components.
- When removing or installing a component that is subject to ESD damage, always place it component-side up on an antistatic surface, in an antistatic card rack, or in an antistatic bag (see [Figure 31 on page 137](#)). If you are returning a component, place it in an antistatic bag before packing it.



Figure 31: Placing a Component into an Antistatic Bag

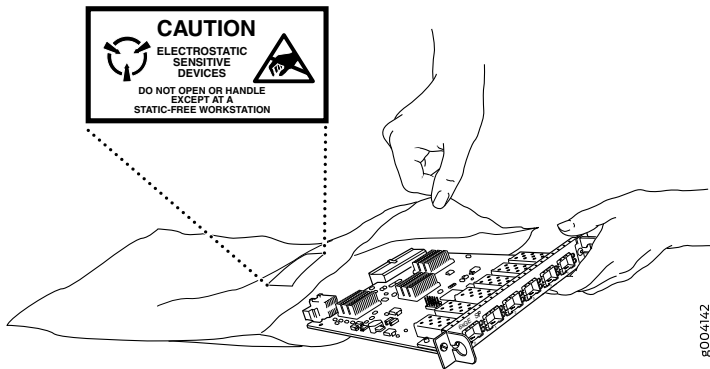

**CAUTION:** ANSI/TIA/EIA-568 cables such as Category 5e and Category 6 can get electrostatically charged. To dissipate this charge, always ground the cables to a suitable and safe earth ground before connecting them to the system.

## Site Electrical Wiring Guidelines

Table 9 on page 32 describes the factors you must consider while planning the electrical wiring at your site.



**WARNING:** You must provide a properly grounded and shielded environment and use electrical surge-suppression devices.

Table 28: Site Electrical Wiring Guidelines

Site Wiring Factor	Guidelines
Signaling limitations	<p>If your site experiences any of the following problems, consult experts in electrical surge suppression and shielding:</p> <ul style="list-style-type: none"> <li>• Improperly installed wires cause radio frequency interference (RFI).</li> <li>• Damage from lightning strikes occurs when wires exceed recommended distances or pass between buildings.</li> <li>• Electromagnetic pulses (EMPs) caused by lightning damage unshielded conductors and electronic devices.</li> </ul>
Radio frequency interference	<p>To reduce or eliminate RFI from your site wiring, do the following:</p> <ul style="list-style-type: none"> <li>• Use a twisted-pair cable with a good distribution of grounding conductors.</li> <li>• If you must exceed the recommended distances, use a high-quality twisted-pair cable with one ground conductor for each data signal when applicable.</li> </ul>
Electromagnetic compatibility	<p>If your site is susceptible to problems with electromagnetic compatibility (EMC), particularly from lightning or radio transmitters, seek expert advice.</p> <p>Some of the problems caused by strong sources of electromagnetic interference (EMI) are:</p> <ul style="list-style-type: none"> <li>• Destruction of the signal drivers and receivers in the device</li> <li>• Electrical hazards as a result of power surges conducted over the lines into the equipment</li> </ul>

## DC Power Electrical Safety Guidelines

- A DC-powered device is equipped with a DC terminal block that is rated for the power requirements of a maximally configured device.
- For permanently connected equipment, a readily accessible disconnect device shall be incorporated external to the equipment.
- For pluggable equipment, the socket-outlet shall be installed near the equipment and shall be easily accessible.
- Be sure to connect the ground wire or conduit to a solid central office earth ground.
- A closed loop ring is recommended for terminating the ground conductor at the ground stud.
- Run two wires from the circuit breaker box to a source of 48 VDC.

- A DC-powered device that is equipped with a DC terminal block is intended only for installation in a restricted-access location. In the United States, a restricted-access area is one in accordance with Articles 110-16, 110-17, and 110-18 of the National Electrical Code ANSI/NFPA 70.

**NOTE:** Primary overcurrent protection is provided by the building circuit breaker. This breaker must protect against excess currents, short circuits, and earth grounding faults in accordance with NEC ANSI/NFPA 70.

- Ensure that the polarity of the DC input wiring is correct. Under certain conditions, connections with reversed polarity might trip the primary circuit breaker or damage the equipment.
- The marked input voltage of -48 VDC for a DC-powered device is the nominal voltage associated with the battery circuit, and any higher voltages are only to be associated with float voltages for the charging function.
- Because the device is a positive ground system, you must connect the positive lead to the terminal labeled **RTN**, the negative lead to the terminal labeled -48 VDC, and the earth ground to the device grounding points.

## DC Power Copper Conductors Warning



**WARNING:** Use copper conductors only.

**Waarschuwing** Gebruik alleen koperen geleiders.

**Varoitus** Käytä vain kuparijohtimia.

**Attention** Utilisez uniquement des conducteurs en cuivre.

**Warnung** Verwenden Sie ausschließlich Kupferleiter.

**Avvertenza** Usate unicamente dei conduttori di rame.

**Advarsel** Bruk bare kobberledninger.

**Aviso** Utilize apenas fios condutores de cobre.

**¡Atención!** Emplee sólo conductores de cobre.

**Varning!** Använd endast ledare av koppar.

# DC Power Disconnection Warning



**WARNING:** Before performing any of the DC power procedures, ensure that power is removed from the DC circuit. To ensure that all power is off, locate the circuit breaker on the panel board that services the DC circuit, switch the circuit breaker to the OFF position, and tape the device handle of the circuit breaker in the OFF position.

**Waarschuwing** Voordat u een van de onderstaande procedures uitvoert, dient u te controleren of de stroom naar het gelijkstroom circuit uitgeschakeld is. Om u ervan te verzekeren dat alle stroom UIT is geschakeld, kiest u op het schakelbord de stroomverbreker die het gelijkstroom circuit bedient, draait de stroomverbreker naar de UIT positie en plakt de schakelaarhendel van de stroomverbreker met plakband in de UIT positie vast.

**Varoitus** Varmista, että tasavirtapiirissä ei ole virtaa ennen seuraavien toimenpiteiden suorittamista. Varmistaaksesi, että virta on KATKAISTU täysin, paikanna tasavirrasta huolehtivassa kojetaulussa sijaitseva suojakytkin, käännä suojakytkin KATKAISTU-asentoon ja teippaa suojakytkimen varsi niin, että se pysyy KATKAISTU-asennossa.

**Attention** Avant de pratiquer l'une quelconque des procédures ci-dessous, vérifiez que le circuit en courant continu n'est plus sous tension. Pour en être sûr, localiser le disjoncteur situé sur le panneau de service du circuit en courant continu, placer le disjoncteur en position fermée (OFF) et, à l'aide d'un ruban adhésif, bloquer la poignée du disjoncteur en position OFF.

**Warnung** Vor Ausführung der folgenden Vorgänge ist sicherzustellen, daß die Gleichstromschaltung keinen Strom erhält. Um sicherzustellen, daß sämtlicher Strom abgestellt ist, machen Sie auf der Schalttafel den Unterbrecher für die Gleichstromschaltung ausfindig, stellen Sie den Unterbrecher auf AUS, und kleben Sie den Schaltergriff des Unterbrechers mit Klebeband in der AUS-Stellung fest.

**Avvertenza** Prima di svolgere una qualsiasi delle procedure seguenti, verificare che il circuito CC non sia alimentato. Per verificare che tutta l'alimentazione sia scollegata (OFF), individuare l'interruttore automatico sul quadro strumenti che alimenta il circuito CC, mettere l'interruttore in posizione OFF e fissarlo con nastro adesivo in tale posizione.

**Advarsel** Før noen av disse prosedyrene utføres, kontroller at strømmen er frakoblet likestrømkretsen. Sørg for at all strøm er slått AV. Dette gjøres ved å lokalisere strømbryteren på brytertavlen som betjener likestrømkretsen, slå strømbryteren AV og teipe bryterhåndtaket på strømbryteren i AV-stilling.

**Aviso** Antes de executar um dos seguintes procedimentos, certifique-se que desligou a fonte de alimentação de energia do circuito de corrente contínua. Para se assegurar

que toda a corrente foi DESLIGADA, localize o disjuntor no painel que serve o circuito de corrente contínua e coloque-o na posição OFF (Desligado), segurando nessa posição a manivela do interruptor do disjuntor com fita isoladora.

**¡Atención!** Antes de proceder con los siguientes pasos, comprobar que la alimentación del circuito de corriente continua (CC) esté cortada (OFF). Para asegurarse de que toda la alimentación esté cortada (OFF), localizar el interruptor automático en el panel que alimenta al circuito de corriente continua, cambiar el interruptor automático a la posición de Apagado (OFF), y sujetar con cinta la palanca del interruptor automático en posición de Apagado (OFF).

**Warning!** Innan du utför någon av följande procedurer måste du kontrollera att strömförsörjningen till likströmskretsen är bruten. Kontrollera att all strömförsörjning är BRUTEN genom att slå AV det överspänningsskydd som skyddar likströmskretsen och tejpa fast överspänningsskyddets omkopplare i FRÅN-läget.

## DC Power Grounding Requirements and Warning

An insulated grounding conductor that is identical in size to the grounded and ungrounded branch circuit supply conductors but is identifiable by green and yellow stripes is installed as part of the branch circuit that supplies the device. The grounding conductor is a separately derived system at the supply transformer or motor generator set.



**WARNING:** When you install the device, the ground connection must always be made first and disconnected last.

**Waarschuwing** Bij de installatie van het toestel moet de aardverbinding altijd het eerste worden gemaakt en het laatste worden losgemaakt.

**Varoitus** Laitetta asennettaessa on maahan yhdistäminen aina tehtävä ensiksi ja maadoituksen irti kytkeminen viimeiseksi.

**Attention** Lors de l'installation de l'appareil, la mise à la terre doit toujours être connectée en premier et déconnectée en dernier.

**Warnung** Der Erdanschluß muß bei der Installation der Einheit immer zuerst hergestellt und zuletzt abgetrennt werden.

**Avvertenza** In fase di installazione dell'unità, eseguire sempre per primo il collegamento a massa e disconnetterlo per ultimo.

**Advarsel** Når enheten installeres, må jordledningen alltid tilkobles først og frakobles sist.

**Aviso** Ao instalar a unidade, a ligação à terra deverá ser sempre a primeira a ser ligada, e a última a ser desligada.

**¡Atención!** Al instalar el equipo, conectar la tierra la primera y desconectarla la última.

**Warning!** Vid installation av enheten måste jordledningen alltid anslutas först och kopplas bort sist.

## DC Power Wiring Sequence Warning





**WARNING:** Wire the DC power supply using the appropriate lugs. When connecting power, the proper wiring sequence is ground to ground, +RTN to +RTN, then -48 V to -48 V. When disconnecting power, the proper wiring sequence is -48 V to -48 V, +RTN to +RTN, then ground to ground. Note that the ground wire must always be connected first and disconnected last.

**Waarschuwing** De juiste bedradingsvolgorde verbonden is aarde naar aarde, +RTN naar +RTN, en -48 V naar -48 V. De juiste bedradingsvolgorde losgemaakt is en -48 naar -48 V, +RTN naar +RTN, aarde naar aarde.

**Varoitus** Oikea yhdistettävä kytkentäjäjestys on maajohto maajohtoon, +RTN varten +RTN, -48 V varten -48 V. Oikea irrotettava kytkentäjäjestys on -48 V varten -48 V, +RTN varten +RTN, maajohto maajohtoon.

**Attention** Câblez l'alimentation CC En utilisant les crochets appropriés à l'extrémité de câblage. En reliant la puissance, l'ordre approprié de câblage est rectifié pour rectifier, +RTN à +RTN, puis -48 V à -48 V. En débranchant la puissance, l'ordre approprié de câblage est -48 V à -48 V, +RTN à +RTN, a alors rectifié pour rectifier. Notez que le fil de masse devrait toujours être relié d'abord et débranché pour la dernière fois. Notez que le fil de masse devrait toujours être relié d'abord et débranché pour la dernière fois.

**Warnung** Die Stromzufuhr ist nur mit geeigneten Ringösen an das DC Netzteil anzuschliessen. Die richtige Anschlusssequenz ist: Erdanschluss zu Erdanschluss, +RTN zu +RTN und dann -48V zu -48V. Die richtige Sequenz zum Abtrennen der Stromversorgung ist -48V zu -48V, +RTN zu +RTN und dann Erdanschluss zu Erdanschluss. Es ist zu beachten dass der Erdanschluss immer zuerst angeschlossen und als letztes abgetrennt wird.

**Avvertenza** Mostra la morsettiera dell alimentatore CC. Cablare l'alimentatore CC usando i connettori adatti all'estremità del cablaggio, come illustrato. La corretta sequenza di cablaggio è da massa a massa, da positivo a positivo (da linea ad L) e da negativo a negativo (da neutro a N). Tenere presente che il filo di massa deve sempre venire collegato per primo e scollegato per ultimo.

**Advarsel** Riktig tilkoples tilkoplingssekvens er jord til jord, +RTN til +RTN, -48 V til -48 V. Riktig frakoples tilkoplingssekvens er -48 V til -48 V, +RTN til +RTN, jord til jord.

**Aviso** Ate con alambre la fuente de potencia cc Usando los terminales apropiados en el extremo del cableado. Al conectar potencia, la secuencia apropiada del cableado se muele para moler, +RTN a +RTN, entonces -48 V a -48 V. Al desconectar potencia, la secuencia apropiada del cableado es -48 V a -48 V, +RTN a +RTN, entonces molió

para moler. Observe que el alambre de tierra se debe conectar siempre primero y desconectar por último. Observe que el alambre de tierra se debe conectar siempre primero y desconectar por último.

**¡Atención!** Wire a fonte de alimentação de DC Usando os talões apropriados na extremidade da fiação. Ao conectar a potência, a seqüência apropriada da fiação é moída para moer, +RTN a +RTN, então -48 V a -48 V. Ao desconectar a potência, a seqüência apropriada da fiação é -48 V a -48 V, +RTN a +RTN, moeu então para moer. Anote que o fio à terra deve sempre ser conectado primeiramente e desconectado por último. Anote que o fio à terra deve sempre ser conectado primeiramente e desconectado por último.

**Varning!** Korrekt kopplingssekvens ar jord till jord, +RTN till +RTN, -48 V till -48 V. Korrekt kopplas kopplingssekvens ar -48 V till -48 V, +RTN till +RTN, jord till jord.

## DC Power Wiring Terminations Warning



**WARNING:** When stranded wiring is required, use approved wiring terminations, such as closed-loop or spade-type with upturned lugs. These terminations must be the appropriate size for the wires and must clamp both the insulation and conductor.

**Waarschuwing** Wanneer geslagen bedrading vereist is, dient u bedrading te gebruiken die voorzien is van goedgekeurde aansluitingspunten, zoals het gesloten-lus type of het grijperschop type waarbij de aansluitpunten omhoog wijzen. Deze aansluitpunten dienen de juiste maat voor de draden te hebben en dienen zowel de isolatie als de geleider vast te klemmen.

**Varoitus** Jos säikeellinen johdin on tarpeen, käytä hyväksyttyä johdinliitääntä, esimerkiksi suljettua silmukkaa tai kourumaista liitääntä, jossa on ylöspäin käännetyt kiinnityskorvat. Tällaisten liitääntöjen tulee olla kooltaan johtimiin sopivia ja niiden tulee puristaa yhteen sekä eristeen että johdinosan.

**Attention** Quand des fils torsadés sont nécessaires, utiliser des douilles terminales homologuées telles que celles à circuit fermé ou du type à plage ouverte avec cosses rebroussées. Ces douilles terminales doivent être de la taille qui convient aux fils et doivent être refermées sur la gaine isolante et sur le conducteur.

**Warnung** Wenn Litzenverdrahtung erforderlich ist, sind zugelassene Verdrahtungsabschlüsse, z.B. für einen geschlossenen Regelkreis oder gabelförmig, mit nach oben gerichteten Kabelschuhen zu verwenden. Diese Abschlüsse sollten die angemessene Größe für die Drähte haben und sowohl die Isolierung als auch den Leiter festklemmen.

**Avvertenza** Quando occorre usare trecce, usare connettori omologati, come quelli a occhiello o a forcella con linguette rivolte verso l'alto. I connettori devono avere la misura adatta per il cablaggio e devono serrare sia l'isolante che il conduttore.

**Advarsel** Hvis det er nødvendig med flertrådede ledninger, brukes godkjente ledningsavslutninger, som for eksempel lukket sløyfe eller spadetype med oppoverbøyde kabelsko. Disse avslutningene skal ha riktig størrelse i forhold til ledningene, og skal klemme sammen både isolasjonen og lederen.

**Aviso** Quando forem requeridas montagens de instalação eléctrica de cabo torcido, use terminações de cabo aprovadas, tais como, terminações de cabo em circuito fechado e planas com terminais de orelha voltados para cima. Estas terminações de cabo deverão ser do tamanho apropriado para os respectivos cabos, e deverão prender simultaneamente o isolamento e o fio condutor.

**¡Atención!** Cuando se necesite hilo trenzado, utilizar terminales para cables homologados, tales como las de tipo "bucle cerrado" o "espada", con las lengüetas de

conexión vueltas hacia arriba. Estos terminales deberán ser del tamaño apropiado para los cables que se utilicen, y tendrán que sujetar tanto el aislante como el conductor.

**Varning!** När flertrådiga ledningar krävs måste godkända ledningskontakter användas, t.ex. kabelsko av sluten eller öppen typ med uppåtvänd tapp. Storleken på dessa kontakter måste vara avpassad till ledningarna och måste kunna hålla både isoleringen och ledaren fastklämda.

## Multiple Power Supplies Disconnection Warning



**WARNING:** The network device has more than one power supply connection. All connections must be removed completely to remove power from the unit completely.

**Waarschuwing** Deze eenheid heeft meer dan één stroomtoevoerverbinding; alle verbindingen moeten volledig worden verwijderd om de stroom van deze eenheid volledig te verwijderen.

**Varoitus** Tässä laitteessa on useampia virtalähdekytkentöjä. Kaikki kytkennät on irrotettava kokonaan, jotta virta poistettaisiin täysin laitteesta.

**Attention** Cette unité est équipée de plusieurs raccordements d'alimentation. Pour supprimer tout courant électrique de l'unité, tous les cordons d'alimentation doivent être débranchés.

**Warnung** Diese Einheit verfügt über mehr als einen Stromanschluß; um Strom gänzlich von der Einheit fernzuhalten, müssen alle Stromzufuhren abgetrennt sein.

**Avvertenza** Questa unità ha più di una connessione per alimentatore elettrico; tutte le connessioni devono essere completamente rimosse per togliere l'elettricità dall'unità.

**Advarsel** Denne enheten har mer enn én strømtilkobling. Alle tilkoblinger må kobles helt fra for å eliminere strøm fra enheten.

**Aviso** Este dispositivo possui mais do que uma conexão de fonte de alimentação de energia; para poder remover a fonte de alimentação de energia, deverão ser desconectadas todas as conexões existentes.

**¡Atención!** Esta unidad tiene más de una conexión de suministros de alimentación; para eliminar la alimentación por completo, deben desconectarse completamente todas las conexiones.

**Warning!** Denna enhet har mer än en strömförsörjningsanslutning; alla anslutningar måste vara helt avlägsnade innan strömtillförseln till enheten är fullständigt bruten.

# Action to Take After an Electrical Accident

If an electrical accident results in an injury, take the following actions in this order:

1. Use caution. Be aware of potentially hazardous conditions that could cause further injury.
2. Disconnect power from the device.
3. If possible, send another person to get medical aid. Otherwise, assess the condition of the victim, then call for help.

## Agency Approvals for ACX710 Routers

The ACX710 router complies with the following standards:

- Safety
  - CAN/CSA-C22.2 No. 60950-1 Information Technology Equipment - Safety
  - UL 60950-1 (2nd Edition) Information Technology Equipment - Safety
  - IEC 60950-1: 2005/A2:2013 Information Technology Equipment – Safety CB Scheme
  - EN 60825-1 Safety of Laser Products - Part 1: Equipment classification and requirements
  - CAN/CSA C22.2 No. 62368-1-2014, Audio/Video, Information and Communication Technology Equipment – Safety
- EMC
  - EN 300 386 V1.6.1 (2012-09) Electromagnetic compatibility and Radio spectrum Matters (ERM) Telecommunication network equipment
  - EN 300 386 V2.1.1 (2016-07) Telecommunication network equipment; EMC requirements; Harmonized Standard covering the essential requirements of the Directive 2014/30/EU
  - EN 55032:2012 (CISPR 32:2012) Electromagnetic compatibility of multimedia equipment - Emission requirements
  - EN 55024:2010 (CISPR 24:2010) Information technology equipment - Immunity characteristics - Limits and methods of measurement
  - GR-1089-CORE Issue 7 EMC and Electrical Safety for Network Telecommunications Equipment
  - IEC/EN 61000 Immunity Test

- AS/NZS CISPR 32:2015 Australia/New Zealand Radiated and Conducted Emissions
- FCC 47 CFR Part 15 USA Radiated and Conducted Emissions
- ICES-003 Canada Radiated and Conducted Emissions
- VCCI-CISPR 32:2016 Japanese Radiated and Conducted Emissions
- BSMI CNS 13438 Taiwan Radiated and Conducted Emissions (at 10 Meter)
- KN32/KN35 Korea Radiated Emission and Immunity Characteristics (at 10 Meter)
- KN61000 Korea Immunity Test
- TEC/SD/DD/EMC-221/05/OCT-16 India EMC standard

#### RELATED DOCUMENTATION

## Compliance Statements for NEBS

- The equipment is suitable for installation as part of the Common Bonding Network (CBN).
- The equipment is suitable for installation in locations where the National Electrical Code (NEC) applies.
- The battery return connection is to be treated as an isolated DC return (that is, DC-I), as defined in GR-1089-CORE.
- You must provision a readily accessible device outside of the equipment to disconnect power. The device must also be rated based on local electrical code practice.

## Compliance Statements for EMC Requirements

#### IN THIS SECTION

- [Canada | 153](#)
- [European Community | 153](#)
- [Israel | 153](#)



- Japan | 153
- United States | 154

## Canada

CAN ICES-3 (A)/NMB-3(A)

## European Community

This is a Class A product. In a domestic environment, this product might cause radio interference in which case the user might be required to take adequate measures.

## Israel

**אזהרה**

מוצר זה הוא מוצר Class A.  
בסביבה ביתית, מוצר זה עלול לגרום הפרעות בתדר רדיו, ובמקרה זה, המשתמש עשוי להידרש  
לנקוט אמצעים מתאימים.

Translation from Hebrew—Warning: This product is Class A. In residential environments, the product might cause radio interference, and in such a situation, the user might be required to take adequate measures.

## Japan

この装置は、クラス A 情報技術装置です。この装置を家庭環境で使用すると電波妨害を引き起こすことがあります。この場合には使用者が適切な対策を講ずるよう要求されることがあります。

VCCI-A

The preceding translates as follows:

This is a Class A product based on the standard of the Voluntary Control Council for Interference by Information Technology Equipment (VCCI). If this product is used near a radio or television receiver in a domestic environment, it might cause radio interference. Install and use the equipment according to the instruction manual. VCCI-A.

## United States

The hardware equipment has been tested and found to comply with the limits for a Class A digital device, pursuant to Part 15 of the FCC Rules. These limits are designed to provide reasonable protection against harmful interference when the equipment is operated in a commercial environment. This equipment generates, uses, and can radiate radio frequency energy and, if not installed and used in accordance with the instruction manual, might cause harmful interference to radio communications. Operation of this equipment in a residential area is likely to cause harmful interference in which case the user will be required to correct the interference at his own expense.

## Compliance Statements for Environmental Requirements

Batteries in this product are not based on mercury, lead, or cadmium substances. The batteries used in this product are in compliance with EU Directives 91/157/EEC, 93/86/EEC, and 98/101/EEC. The product documentation includes instructional information about the proper method of reclamation and recycling.