



User's Guide

Multimedia Projector

EB-755F

EB-750F

EB-735Fi

EB-735F

EB-725Wi

EB-725W

EB-720

Notations Used in This Guide **8**

Using the Manual to Search for Information **9**

- Searching by Keyword 9
- Jumping Directly from Bookmarks..... 9
- Printing Only the Pages You Need..... 9

Getting the Latest Version of the Documents..... **10**

Introduction to Your Projector **11**

Projector Features..... **12**

- Long-life Laser Light Source..... 12
- Unique Interactive Functions..... 12
- Quick and Easy Setup 13
- Flexible Connectivity..... 13
 - Connect with Computers 13
 - Connect with Mobile Devices 14
- Projecting for Exhibitions..... 14

Projector Parts and Functions **16**

- Projector Parts - Front/Side 16
- Projector Parts - Top/Side 17
- Projector Parts - Rear..... 18
- Projector Parts - Base 19
- Projector Parts - Control Panel 20
- Projector Parts - Remote Control 21
- Projector Parts - Interactive Pens 23
- Projector Parts - Pen Stand..... 24
- Projector Parts - Touch Unit 25
- Safety Instructions for Magnet..... 26

Setting Up the Projector **27**

Projector Placement **28**

- Projector Setup and Installation Options..... 29
- Settings when Using the Interactive Features 30
 - Settings when Using the Touch Unit..... 31

Projector Connections **32**

- Connecting to a Computer..... 32
 - Connecting to a Computer for VGA Video and Audio 32
 - Connecting to a Computer for USB Video and Audio..... 33
 - Connecting to a Computer for HDMI Video and Audio 34
 - Connecting to a Mini PC Installed on a Wall Plate..... 34
 - Connecting a Computer for Use with PC Interactive Features 35
- Connecting to Video Sources 36
 - Connecting to an HDMI Video Source 36
 - Connecting to a Composite Video Source..... 37
- Connecting to External USB Devices 37
 - USB Device Projection 37
 - Connecting to a USB Device 38
 - Disconnecting a USB Device 38
- Connecting to a Document Camera 39
- Connecting a Printer 39
- Connecting to External Devices..... 39
 - Connecting to a VGA Monitor 39
 - Connecting to External Speakers 40
 - Connecting a Microphone 41
- Connecting Multiple Projectors of the Same Model 41

Installing Batteries in the Remote Control **44**

Installing Batteries in the Pens **45**

Remote Control Operation **46**

Using Basic Projector Features **47**

Turning On the Projector **48**

- Home Screen..... 49

Turning Off the Projector	51	Adjusting the Gamma	85
Setting the Date and Time	52	Adjusting the Image Resolution	87
Selecting the Language for the Projector Menus	54	Adjusting the Brightness.....	89
Projection Modes	55	Constant Brightness Usage Hours	90
Changing the Projection Mode Using the Remote Control.....	55	Light Source Operation Time.....	91
Changing the Projection Mode Using the Menus.....	55	Controlling the Volume with the Volume Buttons	92
Setting the Screen Type	57	Using the Interactive Features	93
Adjusting the Image Position Using Screen Position.....	57	<hr/>	
Focusing the Image.....	59	Interactive Feature Modes	94
Adjusting the Image Height.....	62	Preparing Before Using Interactive Features.....	96
Image Shape	63	Safety Instructions for Interactive Features.....	96
Correcting the Image Shape with the Keystone Buttons	63	Using the Interactive Pens	96
Correcting the Image Shape with Quick Corner	64	Using Interactive Touch Operations with Your Finger	98
Correcting Image Shape with Arc Correction.....	66	Safety Instructions for Interactive Touch Operations.....	99
Correcting Image Shape with Point Correction.....	69	Whiteboard Screens (Whiteboard Mode).....	101
Loading Image Shape Setting from Memory	71	Safety Instructions for Whiteboard Mode	101
Correcting Image Shape with Corner Markers.....	71	Starting Whiteboard Mode	101
Resizing the Image with the Buttons	73	Whiteboard Mode Toolbar	102
Adjusting the Image Position	74	Importing Images in Whiteboard Mode.....	105
Selecting an Image Source	75	Compatible File Types for Opening in Whiteboard Mode.....	106
Image Aspect Ratio	77	Draw on the Projected Image Using Annotation Mode.....	107
Changing the Image Aspect Ratio	77	Starting Annotation Mode	107
Available Image Aspect Ratios	77	Annotation Mode Toolbar	108
Projected Image Appearance with Each Aspect Mode	78	Sharing Drawings.....	111
Adjusting Image Quality (Color Mode).....	82	Sending Drawing Contents via Email.....	111
Changing the Color Mode	82	Creating an Address Book	113
Available Color Modes.....	82	Available Directory Service.....	113
Turning On Automatic Luminance Adjustment.....	82	Saving Drawing Contents.....	113
Adjusting the Image Color	84	Available File Format in Whiteboard Mode.....	115
Adjusting the Hue, Saturation, and Brightness.....	84	Printing Drawing Contents	115
		Available Printer Control Commands in Whiteboard Mode.....	116

Control Computer Features from a Projected Screen (Computer Interactive Mode)	117
Computer Interactive Mode System Requirements	117
Installing Easy Interactive Driver on Mac.....	118
Using Computer Interactive Mode.....	118
Adjusting the Pen Operation Area.....	119
Controlling a Document Camera	121
SD Card Viewer.....	121
Selecting Network Device Display	122
Using the Interactive Features over a Network	124
Precautions when Connecting to a Projector on a Different Subnet.....	124
Using Split Screen Projection	125
Adjusting Projector Features	126
<hr/>	
Projecting Multiple Images Simultaneously	127
Unsupported Input Source Combinations for Split Screen Projection	129
Split Screen Projection Restrictions	129
Projecting a PC Free Presentation	130
Supported PC Free File Types	130
Precautions on PC Free Projection.....	131
Starting a PC Free Slide Show.....	131
Starting a PC Free Movie Presentation.....	133
PC Free Display Options.....	134
Projecting in Content Playback Mode	135
Switching to Content Playback Mode	135
Projecting Your Playlists.....	136
Creating Playlists Using Epson Web Control	136
Adding Effects to Your Projected Image.....	138
Content Playback Mode Restrictions.....	139
Shutting Off the Image and Sound Temporarily	141

Stopping Video Action Temporarily	142
Zooming Images	143
Saving a User's Logo Image	144
Saving a User Pattern	146
Saving Settings to Memory and Using Saved Settings	148
Using Multiple Projectors	149
Projector Identification System for Multiple Projector Control.....	149
Setting the Projector ID.....	150
Selecting the Projector You want to Operate.....	150
Adjusting Color Uniformity	151
Blending the Image Edges	153
Matching the Image Colors.....	154
Adjusting the Black Level.....	156
Modifying the Black Level Adjustment Area	157
Adjusting RGBCMY	158
Scaling an Image.....	160
Projector Security Features	162
Password Security Types.....	162
Setting a Password	162
Selecting Password Security Types	163
Entering a Password to Use the Projector.....	164
Locking the Projector's Buttons	164
Unlocking the Projector's Buttons.....	165
Installing a Security Cable	165
Using the Projector on a Network	167
<hr/>	
Wired Network Projection	168
Connecting to a Wired Network	168
Selecting Wired Network Settings.....	168
Wireless Network Projection	172
Safety Instructions for Built-in Wireless LAN Module.....	172

- Connection Methods for Wireless Network Projection 172
- Installing the Wireless LAN Module 173
- Selecting Wireless Network Settings Manually 174
- Selecting Wireless Network Settings in Windows 177
- Selecting Wireless Network Settings in Mac 177
- Setting Up Wireless Network Security for Simple AP Mode 177
- Setting Up Wireless Network Security for Infrastructure Mode 178
 - Supported Client and CA Certificates 180
- Using a QR Code to Connect a Mobile Device 180
- Using a USB Key to Connect a Windows Computer 181

Wireless Network Projection from a Mobile Device (Screen Mirroring)..... 182

- Selecting Screen Mirroring Settings 182
- Connecting Using Screen Mirroring with the Miracast Function 184
- Connecting Using Screen Mirroring in Windows 10 185
- Connecting Using Screen Mirroring in Windows 8.1 185

Secure HTTP..... 187

- Importing a Web Server Certificate Using the Menus 187
 - Supported Web Server Certificates 188

Screen Sharing 189

- Receiving Shared Screen Images 189
- Drawing on Shared Screen Images 189

Monitoring and Controlling the Projector 191

Epson Projector Management 192

Controlling a Networked Projector Using a Web Browser 193

- Web Control Options 194

Registering Digital Certificates from a Web Browser..... 201

Setting Up Projector Network E-Mail Alerts 202

- Network Projector E-mail Alert Messages 202

Setting Up Monitoring Using SNMP 203

Using ESC/VP21 Commands 204

- ESC/VP21 Command List 204
- Cable Layouts 204

PJLink Support 205

Art-Net Channel Definitions..... 206

Crestron Connected Support 209

- Setting Up Crestron Connected Support 209

Setting Projector Event Schedules 210

Adjusting the Menu Settings 213

Using the Projector's Menus 214

Using the Displayed Keyboard 215

- Available Text Using the Displayed Keyboard 215

Image Quality Settings - Image Menu 216

Input Signal Settings - Signal I/O Menu..... 218

Projector Installation Settings - Installation Menu 220

Projector Display Settings - Display Menu 222

Projector Feature Settings - Operation Menu..... 224

Projector Administration Settings - Management Menu 226

- Event ID Code List 227

Projector Network Settings - Network Menu 230

- Network Menu - Network Settings Menu 230
- Network Menu - Wireless LAN Menu 231
- Network Menu - Wired LAN Menu 233
- Network Menu - Mail Notification Menu 234
- Network Menu - Projector Control Menu 234
- Network Menu - Network Projection Settings 235

Projector Pen And Touch Setup Settings - Pen/Touch Menu 237

- Projector Interactive Settings - Interactive Menu 238**
 - Interactive Menu - Print Menu..... 238
 - Interactive Menu - Save Menu..... 239
 - Interactive Menu - Mail Menu..... 240
 - Interactive Menu - Directory Menu..... 240
- Multiple Projector Operation Settings - Multi-Projection Menu 242**
- Image Quality Memory Settings - Memory Menu..... 244**
- Projector Setup Settings - ECO Menu 245**
- Projector Initial Settings and Reset Options - Initial/All Settings Menu 246**
- Copying Menu Settings Between Projectors (Batch Setup) 247**
 - Transferring Settings From a USB Flash Drive 247
 - Transferring Settings From a Computer 248
 - Batch Setup Error Notification 249
-
- Maintaining the Projector 250**
-
- Projector Maintenance 251**
- Cleaning the Projection Window..... 252**
- Cleaning the Obstacle Sensor..... 253**
- Cleaning the Projector Case..... 254**
- Air Filter and Vent Maintenance 255**
 - Cleaning the Air Filter 255
 - Replacing the Air Filter 256
- Replacing the Interactive Pen Tip 259**
 - Replacing the Soft Pen Tip 259
 - Replacing the Soft Pen Tip with the Hard Pen Tip..... 260
- Updating the Firmware 261**
 - Updating Firmware Using a USB Storage Device 261

- Updating Firmware Using a Computer and USB Cable 262

Solving Problems 264

- Projection Problems 265**
- Projector Indicator Status 266**
- Solving Image or Sound Problems..... 269**
 - Solutions When No Image Appears..... 269
 - Solutions When Image is Incorrect Using the USB Display Function 269
 - Solutions When "No Signal" Message Appears 270
 - Displaying From a Windows Laptop..... 270
 - Displaying From a Mac Laptop..... 270
 - Solutions When "Not Supported" Message Appears 271
 - Solutions When Only a Partial Image Appears..... 271
 - Solutions When the Image is not Rectangular..... 271
 - Solutions When the Image Contains Noise or Static..... 272
 - Solutions When the Image is Fuzzy or Blurry 272
 - Solutions When the Image Brightness or Colors are Incorrect 273
 - Solutions When an Afterimage Remains on the Projected Image 273
 - Solutions to Sound Problems..... 273
 - Solutions to Microphone Problems 274
 - Solutions When Image File Names are not Displayed Correctly in PC Free..... 274
- Solving Projector or Remote Control Operation Problems 275**
 - Solutions to Projector Power or Shut-Off Problems..... 275
 - Solutions to Problems with the Remote Control..... 275
 - Solutions to Password Problems..... 276
 - Solution When "The Battery that Saves Your Clock Settings is Running Low" Message Appears 276
- Solving Interactive Features Problems..... 277**
 - Solutions When "Error Occurred in the Easy Interactive Function" Message Appears..... 277
 - Solutions When the Interactive Pens do not Work..... 277
 - Solutions When You Cannot Operate a Computer from the Projected Screen . 278

- Solutions When the Interactive Pen Position is not Accurate 278
- Solutions When the Interactive Pens are Slow or Difficult to Use 278
- Solutions When the Interactive Touch Operation does not Work..... 278
- Solutions for Problems with Capturing, Printing, Saving, or Scanning..... 279
- Solutions When the Time is Incorrect in Whiteboard Settings 279
- Solutions When Whiteboard Mode does not Start..... 280

Solutions to Problems in Content Playback mode 281

Solving Network Problems 282

- Solutions When Wireless Authentication Fails 282
- Solutions When You Cannot Access the Projector Through the Web 282
- Solutions When Network Alert E-Mails are not Received..... 282
- Solutions When the Image Contains Static During Network Projection 283
- Solutions When You Cannot Connect Using Screen Mirroring..... 283
- Solutions When You Cannot Use Two Screen Mirroring Sources 283
- Solutions When the Image or Sound Contains Static During Screen Mirroring Connection 283
- Solutions When You Cannot Receive Shared Images..... 284

Solutions When HDMI Link does not Function 285

Appendix 286

Optional Accessories and Replacement Parts..... 287

- Screens 287
- Cables 287
- Mounts 287
- For Interactive Feature..... 287
- External Devices 288
- Replacement Parts..... 288
- For Wireless Connection 288
- Compatible Accessories from Other Projectors 288

Screen Size and Projection Distance 289

Supported Monitor Display Resolutions 292

Projector Specifications 297

- Connector Specifications 298

External Dimensions 300

USB Display System Requirements 302

Easy Interactive Driver System Requirements 303

List of Safety Symbols and Instructions 304

Laser Safety Information..... 306

- Laser Warning Labels..... 306

Glossary 307

Notices 309



- FCC Compliance Statement 309
- Indication of the manufacturer and the importer in accordance with requirements of EU directive..... 310
- Restriction of Use 310
- Operating System References..... 310
- Trademarks..... 311
- Copyright Notice 311
- Copyright Attribution..... 312

Notations Used in This Guide





Safety Symbols

The projector and its manuals use graphical symbols and labels to indicate content that tells you how to use the projector safely.

Read and carefully follow the instructions that are marked with these symbols and labels to avoid injury to persons or damage to property.

 Warning	This symbol indicates information that, if ignored, could possibly result in personal injury or even death.
 Caution	This symbol indicates information that, if ignored, could possibly result in personal injury or physical damage due to incorrect handling.

General Information Notations

Attention	This label indicates procedures that may result in damage or injury if sufficient care is not taken.
	This label indicates additional information that may be useful to know.
[Button name]	Indicates the name of the buttons on the remote control or the control panel. Example: [Esc] button
Menu/Setting name	Indicates projector menu and setting names. Example: Select the Image menu  Image > Advanced
	This label indicates links to the related pages.
	This label indicates the projector's current menu level.

» Related Links

- "Using the Manual to Search for Information" [p.9](#)
- "Getting the Latest Version of the Documents" [p.10](#)

The PDF manual allows you to search for information you are looking for by keyword, or jump directly to specific sections using the bookmarks. You can also print only the pages you need. This section explains how to use a PDF manual that has been opened in Adobe Reader X on your computer.

► Related Links

- "Searching by Keyword" p.9
- "Jumping Directly from Bookmarks" p.9
- "Printing Only the Pages You Need" p.9

- Mac OS: Hold down the command key, and then press ←.

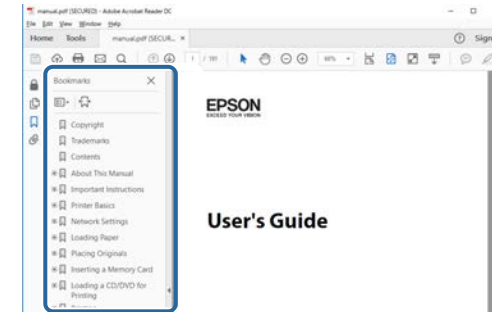

Searching by Keyword

Click **Edit > Advanced Search**. Enter the keyword (text) for information you want to find in the search window, and then click **Search**. Hits are displayed as a list. Click one of the displayed hits to jump to that page.

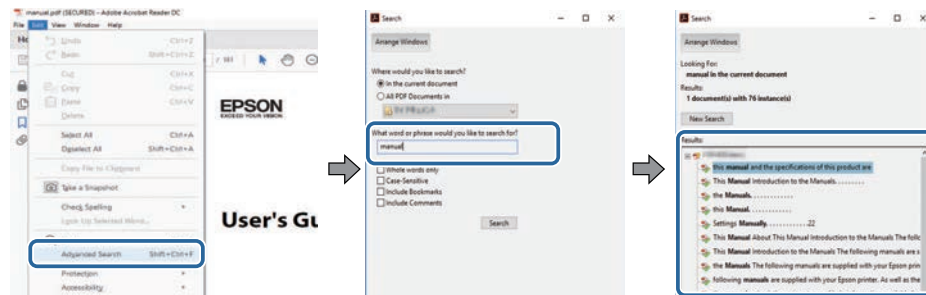

Printing Only the Pages You Need

You can extract and print only the pages you need. Click **Print** in the **File** menu, and then specify the pages you want to print in **Pages in Pages to Print**.

- To specify a series of pages, enter a hyphen between the start page and the end page.
Example: 20-25
- To specify pages that are not in series, divide the pages with commas.
Example: 5, 10, 15

Jumping Directly from Bookmarks

Click a title to jump to that page. Click + or > to view the lower level titles in that section. To return to the previous page, perform the following operation on your keyboard.

- Windows: Hold down **Alt**, and then press ←.

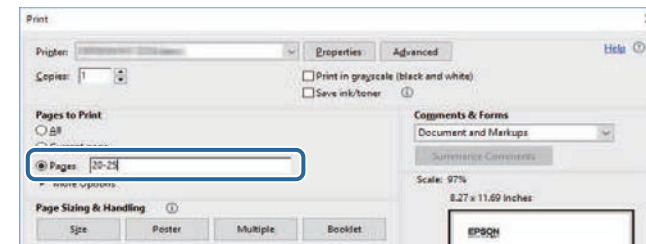

You can get the latest version of the manuals and specifications on the Epson Web site.

Visit epson.sn, and enter your projector's name.

Introduction to Your Projector

Refer to these sections to learn more about your projector's features and part names.

► **Related Links**

- "Projector Features" [p.12](#)
- "Projector Parts and Functions" [p.16](#)

This projector comes with these special features. Refer to these sections for more details.

► Related Links

- "Long-life Laser Light Source" [p.12](#)
- "Unique Interactive Functions" [p.12](#)
- "Quick and Easy Setup" [p.13](#)
- "Flexible Connectivity" [p.13](#)
- "Projecting for Exhibitions" [p.14](#)

Long-life Laser Light Source

A solid-state laser light source provides virtually maintenance-free operation until light source brightness is reduced.

Unique Interactive Functions

Easy annotation on the projected screen using the interactive pen or your finger (EB-735Fi/EB-725Wi).

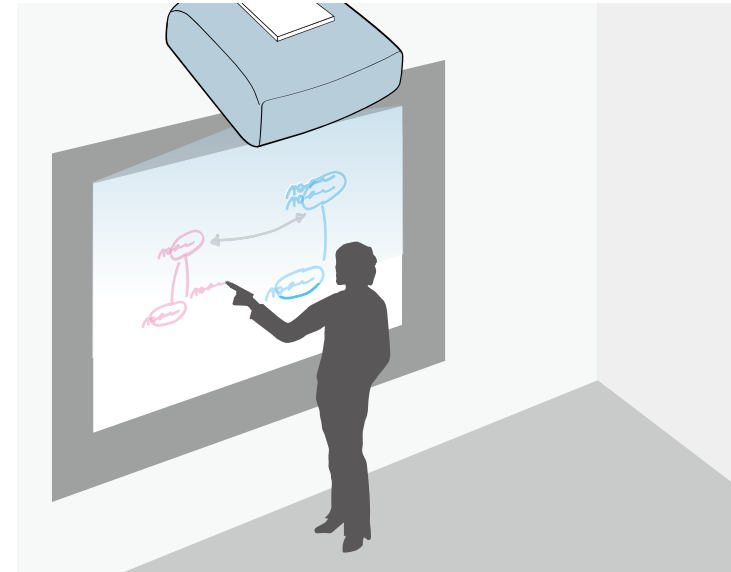

- Annotation with or without a computer.
- Annotation with two pens at the same time.
- Projector operations from the projected screen.
- Scan and display content from a connected scanner.
- Email, save, or print your content without a computer.
- Import content from a USB drive.
- Computer operations from the projected screen.
- Touch-based interactivity using your finger. (Optional Touch Unit is required.)

► Related Links

- "Using the Interactive Features" [p.93](#)

Quick and Easy Setup

- Direct Power On feature to turn on the projector as soon as you plug it in.
- Auto Power On feature to turn on the projector when the projector detects an image signal from the port you specified as the **Auto Power On** source.
- Home screen feature to easily select an input source and useful functions.



» Related Links

- "Home Screen" [p.49](#)
- "Turning On the Projector" [p.48](#)

Flexible Connectivity

This projector supports a wide variety of easy-to-use connectivity options as shown below.

» Related Links

- "Connect with Computers" [p.13](#)
- "Connect with Mobile Devices" [p.14](#)

Connect with Computers

- Connect with one USB cable to project images and output audio (USB Display).

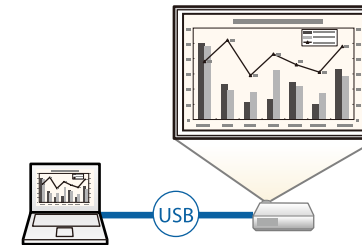

- Epson iProjection (Windows/Mac) to project up to four images at the same time by splitting the projected screen. You can project images from computers on the network, or from smartphones or tablet devices on which Epson iProjection is installed.

See the *Epson iProjection Operation Guide (Windows/Mac)* for details.

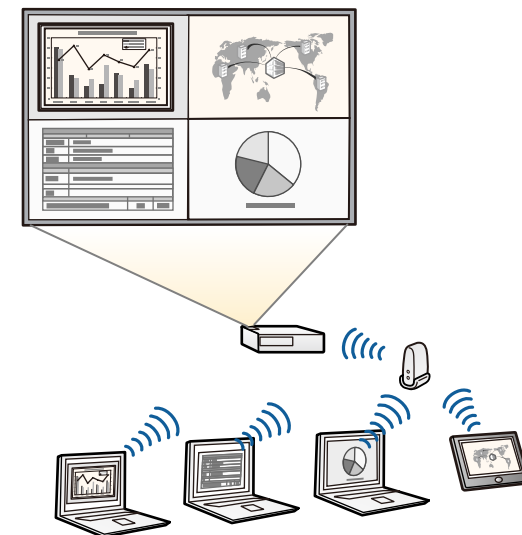



- You can download the necessary software and manuals from the following Web site:
epson.sn

» Related Links

- "Wired Network Projection" [p.168](#)
- "Wireless Network Projection" [p.172](#)
- "Connecting to a Computer for USB Video and Audio" [p.33](#)

Connect with Mobile Devices

- Screen Mirroring to connect your projector and mobile device wirelessly using Miracast technology.



- Epson iProjection (iOS/Android) to connect your projector and mobile device wirelessly using the app available on the App Store or Google Play.



Any fees incurred when communicating with the App Store or Google Play are the responsibility of the customer.

- Epson iProjection (Chromebook) to connect your projector and Chromebook device wirelessly using the app available on the Chrome Web Store.



Any fees incurred when communicating with the Chrome Web Store are the responsibility of the customer.

» Related Links

- "Wireless Network Projection from a Mobile Device (Screen Mirroring)" [p.182](#)

Projecting for Exhibitions

Your projector allows you to project your content for exhibitions as digital signage (EB-755F/EB-750F).



- Content Playback mode to play your playlists, and add color and shape effects to your projected image.
- You can use one of the following methods to create content played in Content Playback mode.
 - Epson Projector Content Manager software allows you to create playlists and save them on an external storage device. You can also add color and shape effects to your projected image, and schedule playlists.
See the *Epson Projector Content Manager Operation Guide* for details.

- Epson Web Control allows you to create playlists using a Web browser and save them to an external storage device connected to a projector on a network. You can also add color and shape effects to your projected image.
- The Epson Creative Projection app allows you to create content on iOS devices. You can also transfer content to the projector wirelessly. You can download Epson Creative Projection from the App Store. Any fees incurred when communicating with the App Store are the responsibility of the customer.



You can download the necessary software and manuals from the following Web site:

epson.sn

► Related Links

- "Projecting in Content Playback Mode" [p.135](#)

The following sections explain the projector parts and their functions.

All of the features in this guide are explained using illustrations of EB-735Fi unless otherwise mentioned.

► **Related Links**

- ["Projector Parts - Front/Side" p.16](#)
- ["Projector Parts - Top/Side" p.17](#)
- ["Projector Parts - Rear" p.18](#)
- ["Projector Parts - Base" p.19](#)
- ["Projector Parts - Control Panel" p.20](#)
- ["Projector Parts - Remote Control" p.21](#)
- ["Projector Parts - Interactive Pens" p.23](#)
- ["Projector Parts - Pen Stand" p.24](#)
- ["Projector Parts - Touch Unit" p.25](#)
- ["Safety Instructions for Magnet" p.26](#)

Projector Parts - Front/Side

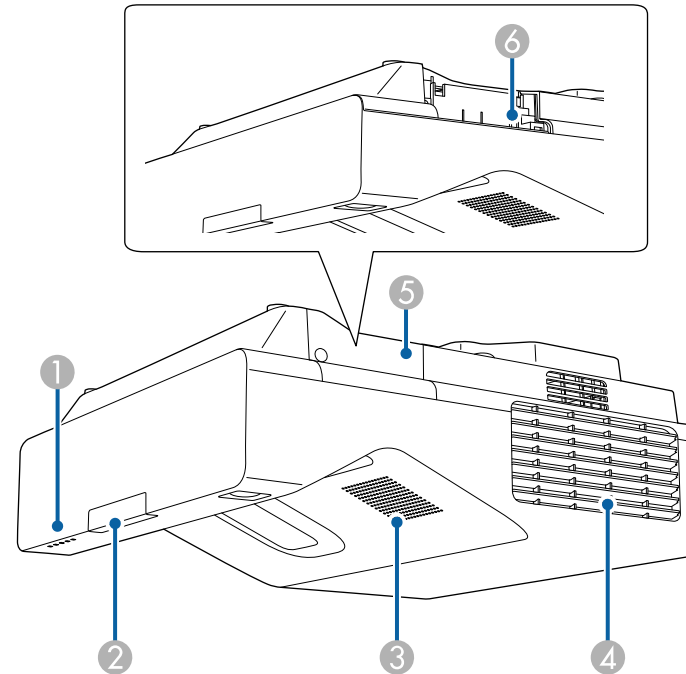

Name		Function
①	Indicator lights	Indicate the projector's status.
②	Remote receiver	Receives signals from the remote control.
③	Speaker	Outputs audio.

Name	Function
④ Air exhaust vent	Exhaust vent for air used to cool the projector internally. <div style="border: 1px solid black; background-color: #ffffcc; padding: 5px;"> <p>⚠ Caution</p> <p>While projecting, do not put your face or hands near the air exhaust vent, and do not place objects that may become warped or damaged by heat near the vent. Hot air from the air exhaust vent could cause burns, warping, or accidents to occur.</p> </div>
⑤ Wireless LAN module cover	Open to access the wireless LAN module slot.
⑥ Wireless LAN module slot	Install the optional wireless LAN module. Use to connect a USB memory device to save error and operation log files. (Turn on the Wireless LAN Power setting in the projector's Management menu first.)

► **Related Links**

- "Projector Indicator Status" [p.266](#)

Projector Parts - Top/Side

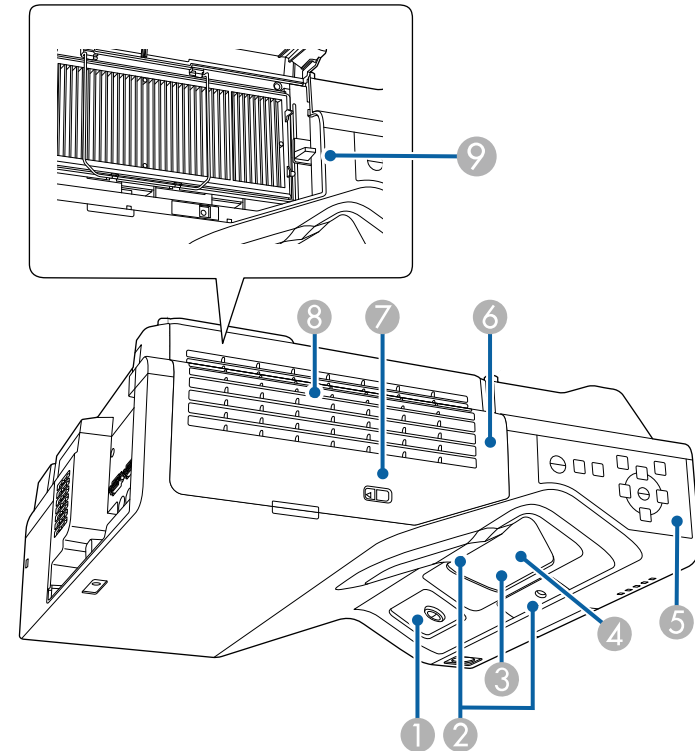

Name	Function
① Interactive pen receiver (EB-735Fi/EB-725Wi)	Receives signals from the interactive pen.
② Obstacle sensors	Detect obstacles that are interfering with the projection area.

Name	Function
③ Projection window	Images are projected from here. <div style="border: 1px solid black; padding: 5px; background-color: #ffffcc;"> <p>⚠ Warning</p> <ul style="list-style-type: none"> Do not look into the projection window while projecting. Do not place any objects or put your hand near the projection window. It could cause burns, fire, or the object to warp because this area reaches a high temperature due to the concentrated projection light. </div>
④ Remote receiver	Receives signals from the remote control.
⑤ Control panel	Operates the projector.
⑥ Air filter cover	Open to access the air filter.
⑦ Filter cover latch	Opens and closes the air filter cover.
⑧ Air intake vent (air filter)	Takes in air to cool the projector internally.
⑨ Focus lever	Adjusts the image focus.

» **Related Links**

- "Air Filter and Vent Maintenance" [p.255](#)
- "Projector Parts - Control Panel" [p.20](#)
- "Using the Interactive Pens" [p.96](#)
- "Focusing the Image" [p.59](#)

Projector Parts - Rear

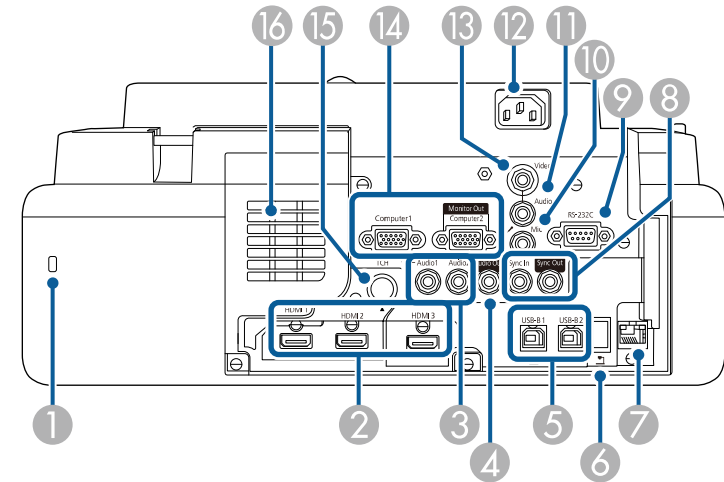

Name	Function
① Security slot	The security slot is compatible with the Microsaver Security System manufactured by Kensington.
② HDMI1/HDMI2/DMI3 ports	Input video signals from HDMI compatible video equipment and computers. This port is compatible with HDCP2.3.
③ Audio 1/Audio 2 ports	Audio 1: Inputs audio from equipment connected to the Computer1 port. Audio 2: Inputs audio from equipment connected to the Computer2 port. When you project image from the optional document camera, the audio is input from this port.
④ Audio Out port	Outputs audio from the current input source to an external speaker.

Name	Function
5 USB-B1/USB-B2 ports (EB-735Fi/EB-725Wi) USB-B port (EB-755F/EB-750F/EB-735F/EB-725W/EB-720)	<p>USB-B1: Use to connect a USB cable to a computer to use the interactive pen as a mouse.</p> <p>Use to connect a USB cable to the computer to project computer images. (Turn on the USB Display setting in the projector's Signal I/O menu first.)</p> <p>USB-B2: Use to connect a USB cable to enable use of interactive features with a mini-PC. Select the USB-B2 settings in the projector's Pen/Touch menu to select this input port.</p> <p>Pen/Touch > PC Interactivity > USB-B2</p> <p>USB-B: Use to connect a USB cable to the computer to project computer images.</p>
6 USB-A port	<p>Use to connect a USB memory device or digital camera for projecting movies or images using the PC Free feature or in Content Playback mode (EB-755F/EB-750F only).</p> <p>Use to connect the optional document camera.</p> <p>Use to connect a USB memory device to save error and operation log files.</p> <p>You cannot install the wireless LAN module.</p>
7 LAN port	Use to connect a LAN cable to connect to a network.
8 SYNC IN/OUT ports (EB-735Fi/EB-725Wi)	When using the interactive features in the same room as multiple versions of the same projector, you need to connect the optional remote control cable set to the projectors. When the cable set is connected, the interactive pen operates stably.
9 RS-232C port	Use to connect an RS-232C cable to control the projector from a computer. (This port is for control use and should not normally be used.)
10 Mic port (EB-735Fi/EB-735F/EB-725Wi/EB-725W/EB-720)	Inputs audio from the microphone.
11 Audio port	Inputs audio from equipment connected to the Video port.
12 Power inlet	Connects the power cord to the projector.

Name	Function
13 Video port	Inputs composite video signals from video sources.
14 Computer1/Computer2/Monitor Out ports	<p>Input image signals from a computer.</p> <p>When you change the Monitor Out Port setting in the projector's Signal I/O menu, you can use the Computer2/Monitor Out port to output analog RGB signal input from the Computer1 port.</p>
15 TCH port (EB-735Fi/EB-725Wi)	Use to connect the Touch Unit connection cable to the Touch Unit.
16 Air intake vent	Takes in air to cool the projector internally.

» **Related Links**

- "Projector Connections" [p.32](#)
- "Installing a Security Cable" [p.165](#)

Projector Parts - Base

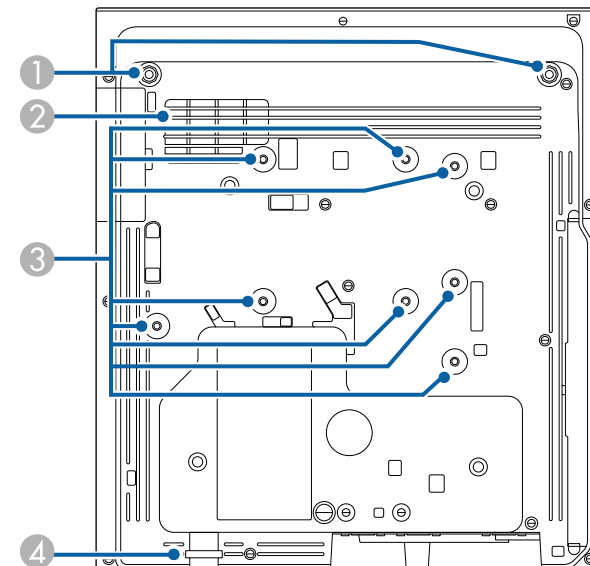



Name	Function
① Front feet fixing points (two points)	Attach the feet when using the projector on a surface such as a desk. (Only models with feet supplied)
② Air intake vent	Takes in air to cool the projector internally. <div style="border: 1px solid black; padding: 5px; background-color: #ffffcc;"> <p>⚠ Warning</p> <p>To avoid blocking the air intake vent beneath the projector, do not allow objects such as cloth or paper to lay under the projector.</p> </div>
③ Fixing points (eight points)	Use these points to attach the optional mount or commercially available mount compatible with the VESA Mounting Interface Standard (100 × 100 mm) when installing the projector on a wall, or mounting the projector from a ceiling or vertically on a desk.
④ Security cable attachment point	Pass the theft-prevention wire lock through here and lock it in place. You can also attach the safety wire here to prevent the projector from falling from the ceiling or wall.

» **Related Links**

- "Installing a Security Cable" [p.165](#)

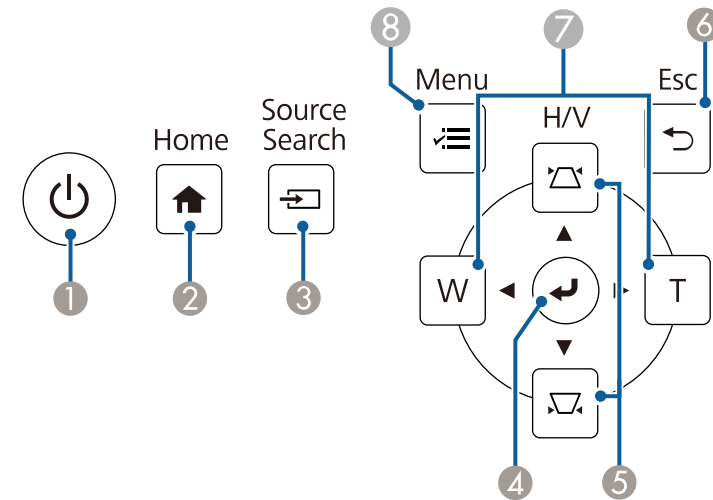
Projector Parts - Control Panel



Name	Function
① Power button []	Turns the projector on or off.
② [Home] button	Displays and closes the Home screen.
③ [Source Search] button	Changes to the next input source.
④ [Enter] button []	Enters the current selection and moves to the next level while displaying the projector's menu. When projecting an analog RGB signal from the Computer port, optimizes the Analog Signal Adjustment settings (Tracking , Sync. , and Position).
⑤ Keystone adjustment buttons and arrow buttons	Displays the Keystone screen allowing you to correct keystone distortion. Selects menu items while displaying the projector's menu.

Name	Function
6 [Esc] button	Stops the current function. Moves back to the previous menu level while displaying the projector's menu.
7 Wide/Tele buttons and arrow buttons	[W]: Enlarges the size of the projected image. [T]: Reduces the size of the projected image. Corrects keystone distortion in the horizontal direction when the Keystone screen is displayed. Selects menu items while displaying the projector's menu.
8 [Menu] button	Displays and closes the projector's menu.

» **Related Links**

- "Home Screen" [p.49](#)
- "Correcting the Image Shape with the Keystone Buttons" [p.63](#)
- "Selecting an Image Source" [p.75](#)
- "Resizing the Image with the Buttons" [p.73](#)
- "Adjusting the Menu Settings" [p.213](#)

Projector Parts - Remote Control

EB-755F/EB-750F

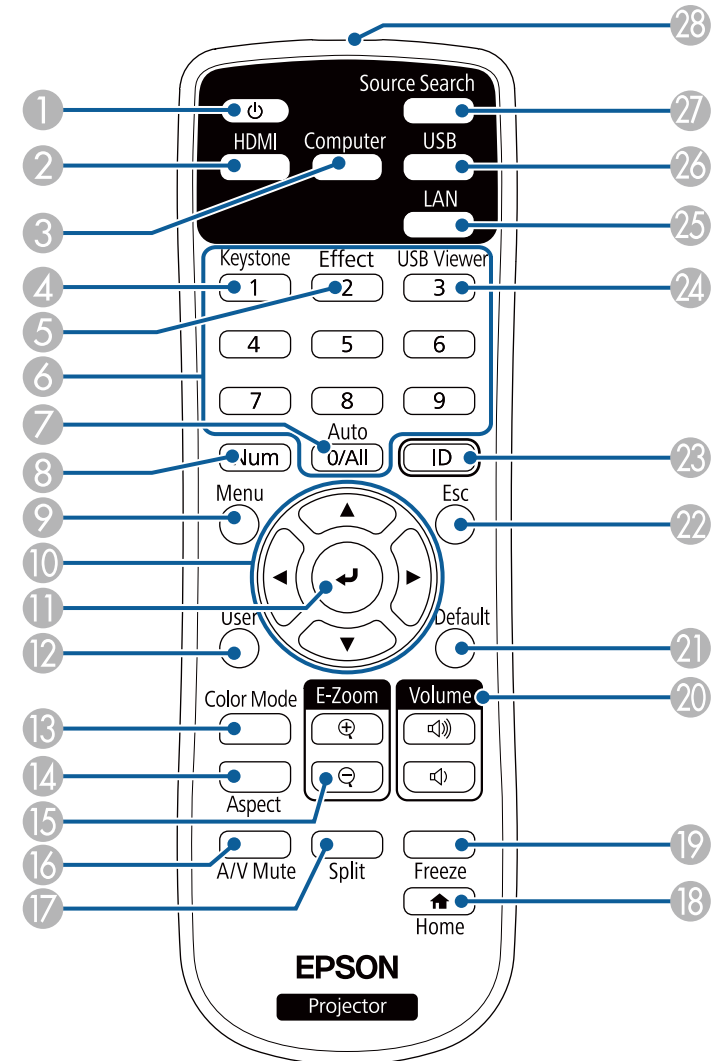

EB-735Fi/EB-735F/EB-725Wi/EB-725W/EB-720

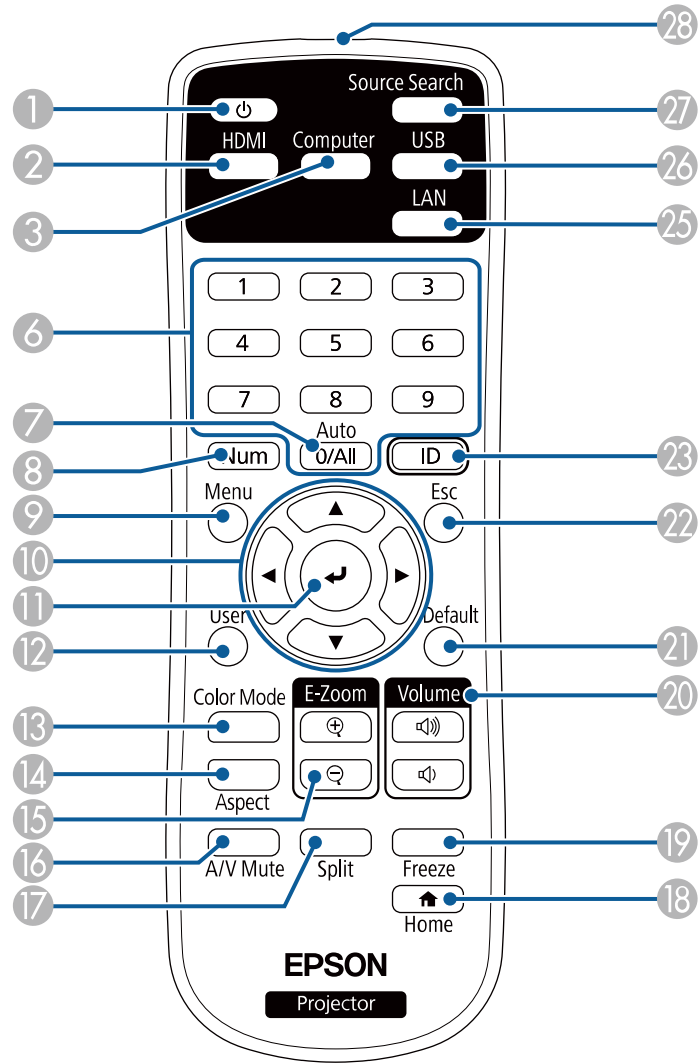

Name	Function
② [HDMI] button	Switches the image source to the HDMI ports.
③ [Computer] button	Switches the image source to the Computer ports.
④ [Keystone] button (EB-755F/EB-750F)	Displays the Geometry Correction screen allowing you to correct keystone distortion of the projected image.
⑤ [Effect] button (EB-755F/EB-750F)	Displays the Overlay Effect menu in Content Playback mode.
⑥ Numeric buttons	Enters numbers in the projector's menu while holding down the [Num] button. In Content Playback mode, enter numbers while holding down the [Num] button to play back your favorite playlists (EB-755F/EB-750F).
⑦ [Auto] button	When projecting an analog RGB signal from the Computer port, optimizes the Analog Signal Adjustment settings (Tracking, Sync., and Position).
⑧ [Num] button	Hold down this button to enter numbers using the numeric buttons.
⑨ [Menu] button	Displays and closes the projector's menu.
⑩ Arrow buttons	Selects menu items while displaying the projector's menu.
⑪ [Enter] button [↵]	Enters the current selection and moves to the next level while displaying the projector's menu.
⑫ [User] button	Performs settings assigned in the User Button setting in the projector's Management menu.
⑬ [Color Mode] button	Changes the color mode.
⑭ [Aspect] button	Changes the aspect mode.
⑮ [E-Zoom] +/- buttons	Resizes the projected image.
⑯ [A/V Mute] button	Turns the video and audio on or off temporarily.
⑰ [Split] button	Projects up to four images from different image sources simultaneously by splitting the projected screen.
⑱ [Home] button	Displays and closes the Home screen.
⑲ [Freeze] button	Pauses or resumes images.

Name	Function
① Power button [⏻]	Turns the projector on or off.

Name	Function
20 [Volume] up/down buttons	Adjusts the speaker volume.
21 [Default] button	Returns the selected setting to its default value.
22 [Esc] button	Stops the current function. Moves back to the previous menu level while displaying the projector's menu.
23 [ID] button	Hold down this button and press the numeric buttons to select the ID for the projector you want to operate using the remote control.
24 [USB Viewer] button (EB-755F/EB-750F)	Starts the USB Viewer in Content Playback mode.
25 [LAN] button	Switches the image source between the network connected devices.
26 [USB] button	Switches the image source between the USB Display and USB-A port.
27 [Source Search] button	Switches to the next input source.
28 Remote control light emitting area	Outputs remote control signals.

Projector Parts - Interactive Pens

The interactive pens come with the EB-735Fi/EB-725Wi only.

Hold the pen to turn it on automatically. Pens turn off automatically after 15 seconds when you put them down.

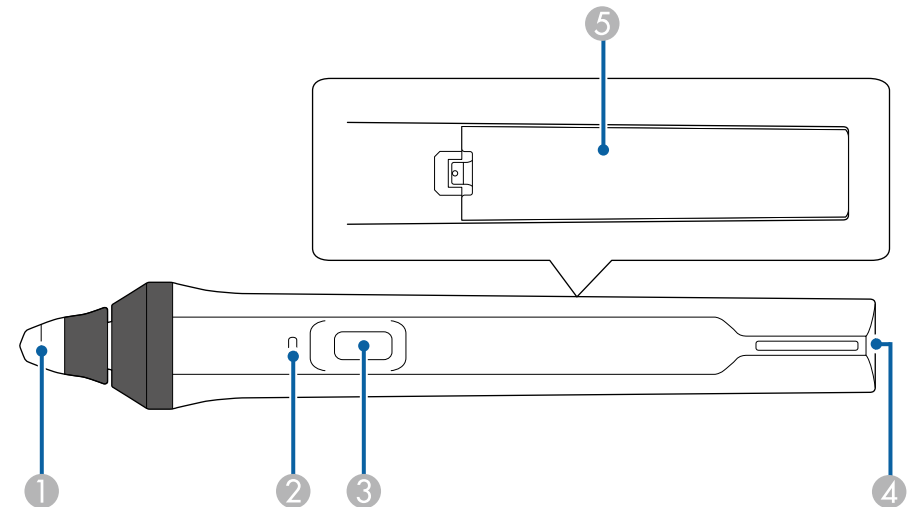

» Related Links

- "Projecting in Content Playback Mode" [p.135](#)
- "Adjusting Image Quality (Color Mode)" [p.82](#)
- "Image Aspect Ratio" [p.77](#)
- "Home Screen" [p.49](#)
- "Selecting an Image Source" [p.75](#)
- "Zooming Images" [p.143](#)
- "Shutting Off the Image and Sound Temporarily" [p.141](#)
- "Projecting Multiple Images Simultaneously" [p.127](#)
- "Stopping Video Action Temporarily" [p.142](#)
- "Controlling the Volume with the Volume Buttons" [p.92](#)
- "Setting the Projector ID" [p.150](#)
- "Adjusting the Menu Settings" [p.213](#)

Name	Function
1 Pen tip	Replaceable soft pen tip. If the soft tip is hard to use on a textured surface, replace it with the hard tip.
2 Battery indicator	Press the button on the side of the pen to indicate the remaining battery power. <ul style="list-style-type: none"> • When the battery is charged, the indicator turns blue until you release the button. • When the battery is running low, the indicator flashes blue until you release the button. • Does not light when the battery is exhausted. Change the battery.

Name	Function
③ Button	Performs function assigned as the Pen Button Function setting in the projector's Interactive menu. Press the button to perform a right-click operation while using the pen as a mouse.
④ Strap attachment point	Allows you to attach a commercially available strap.
⑤ Battery cover	Open this cover when replacing the battery.

Name	Function
① Front cover	Attach it after installing the pen stand.
② Pen tip storage space	Keep the pen tips here.
③ Pen storage space	Keep the pens here with the pen tip facing down.
④ Battery storage space	Keep the AA batteries here.
⑤ Screw holes (for installation)	The screw holes for securing the pen stand.
⑥ Installation magnets	Magnets used for installation.

» **Related Links**

- "Replacing the Interactive Pen Tip" [p.259](#)
- "Using the Interactive Pens" [p.96](#)
- "Installing Batteries in the Pens" [p.45](#)

Projector Parts - Pen Stand

The pen stand comes with the EB-735Fi/EB-725Wi only.

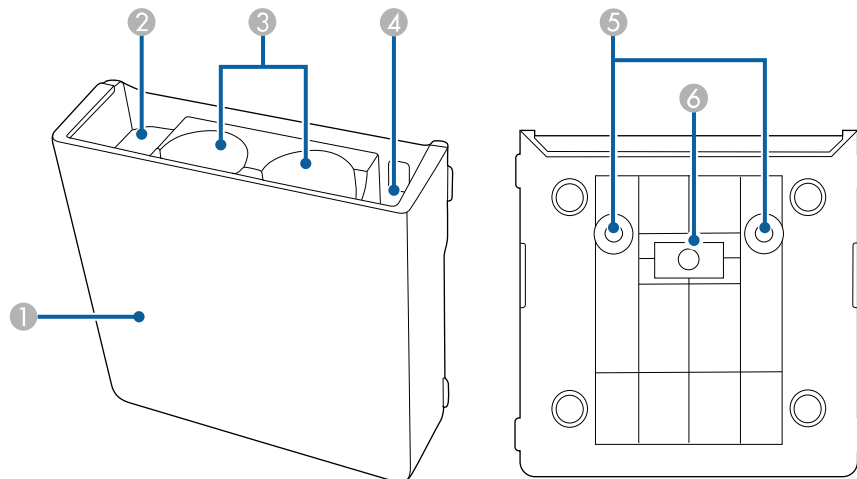

Projector Parts - Touch Unit

The Touch Unit is only available for the EB-735Fi/EB-725Wi.

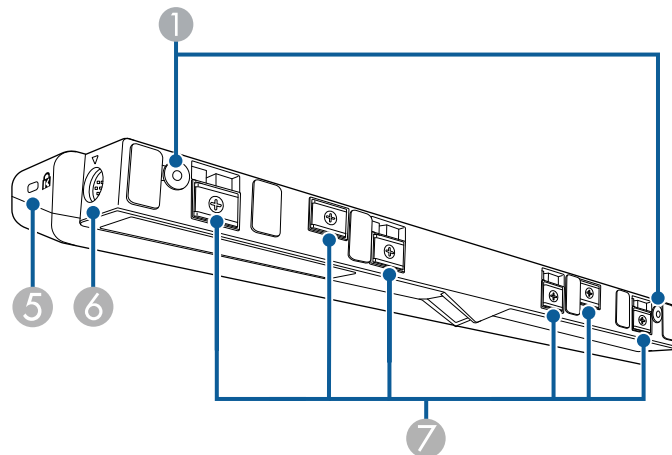
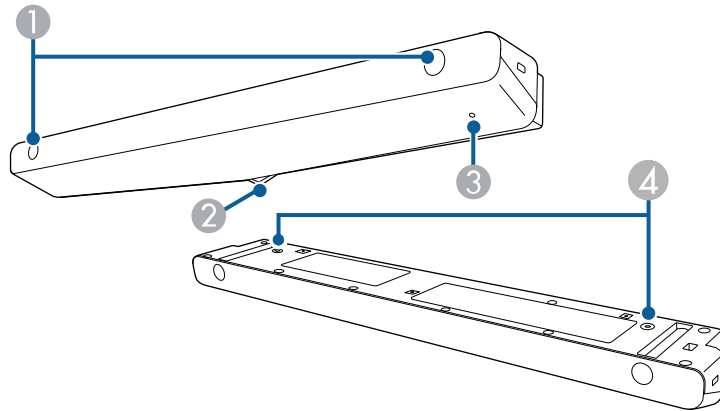

Name	Function
① Screw holes (for installation)	The screw holes for securing the Touch Unit. Remove the rubber caps from the screw holes, attach the Touch Unit, and replace the rubber caps to hide the screws.
② Laser diffusion ports	Diffuse laser light to detect the position of fingers.
③ Indicator light	Lit when the Touch Unit is turned on.
④ Screw holes (for installation)	The screw holes for securing the Touch Unit to a commercially available table mount when installing vertically on a desk.
⑤ Security slot	The security slot is compatible with the Microsaver Security System manufactured by Kensington.
⑥ TCH port	Connects the projector to the Touch Unit with the Touch Unit connection cable.
⑦ Installation magnets	Magnets used for installation.

Attention

- Do not connect the Touch Unit to any devices except for EB-735Fi/EB-725Wi. The device could malfunction, or laser light could leak beyond the limit.
- Make sure you use the supplied Touch Unit connection cable. Operations are not possible with a commercially available cable.
- When disposing of the Touch Unit, do not disassemble it. Dispose according to your local or national laws and regulations.



See your projector's *Installation Guide* for the Touch Unit installation methods and angle adjustment methods.

» Related Links

- "Safety Instructions for Interactive Touch Operations" [p.99](#)
- "Using Interactive Touch Operations with Your Finger" [p.98](#)
- "Getting the Latest Version of the Documents" [p.10](#)

Safety Instructions for Magnet

Both the pen stand and touch unit contain powerful magnets. Be sure to follow these important guidelines when using these devices.

Warning

Do not use the device near medical equipment such as pace makers. Furthermore, when using the device, make sure there is no medical equipment such as pacemakers, in the surrounding area. Electromagnetic interference may cause medical equipment to malfunction.

Caution

- Do not use the device near magnetic storage media such as magnetic cards, or precision electronic devices such as computers, digital watches, or cell phones. Data could be corrupted or a malfunction could occur.
- When installing the device on a magnetic surface, be careful not to trap your fingers or any other part of your body between the magnet and the installation surface.

Setting Up the Projector

Follow the instructions in these sections to set up your projector.

► Related Links

- "Projector Placement" [p.28](#)
- "Projector Connections" [p.32](#)
- "Installing Batteries in the Remote Control" [p.44](#)
- "Installing Batteries in the Pens" [p.45](#)
- "Remote Control Operation" [p.46](#)

You can install the projector on a wall or ceiling, or place it on a table to project images.

To install the projector on a wall, or mount the projector from a ceiling or vertically on a desk, you can use an optional mount or a commercially available mount compatible with the VESA Mounting Interface Standard (100 × 100 mm).

The projector can be installed at various angles without interactive features. There is no vertical or horizontal limit to how the projector can be installed.

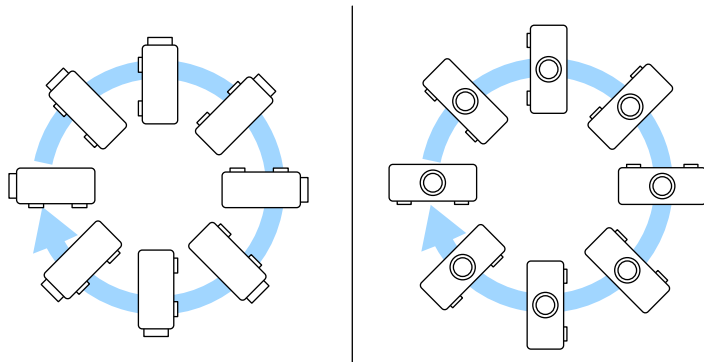

When using interactive features, the projector can be tilted up to 3°, regardless of the projector placement (EB-735Fi/EB-725Wi).

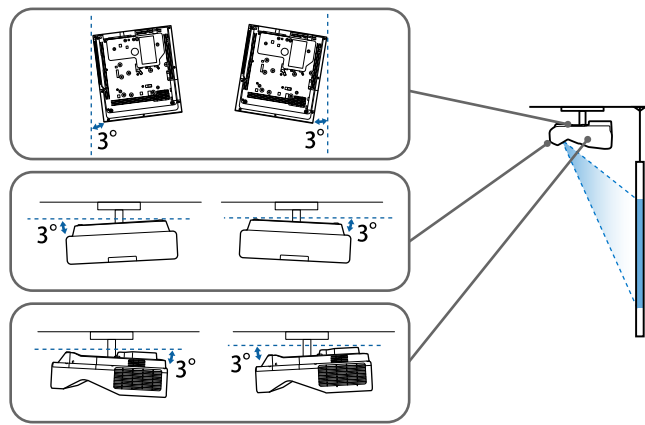

Note the following points when selecting a projector location:

- Place the projector on a sturdy, level surface or install it using a compatible mount.
- Leave plenty of space around and under the projector for ventilation, and do not place it on top of or next to anything that could block the vents.

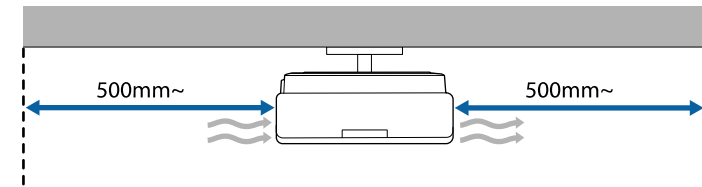

- Place the projector so it squarely faces the screen, not at an angle.



If you cannot install the projector squarely facing the screen, correct any resulting keystone distortion using the projector controls. For the best quality images, we recommend adjusting the installation position of the projector to achieve the correct image size and shape.

- When you install the projector to a fixed location, turn on the **Fixed Installation** setting in the projector's **Installation** menu.
- When you place the projector vertically, turn on the **Vertical Installation** setting in the projector's **Installation** menu.

Warning

- A special method of installation is required when suspending the projector from a wall or ceiling. If you do not install the projector correctly, it could fall and cause damage or injury.
- Do not use adhesives on the wall mount plate fixing points or other mount fixing points to prevent the screws from loosening, or use lubricants, oils, or similar substances on the projector; the projector case may crack causing it to fall from its mount. This could cause serious injury to anyone under the mount and could damage the projector.
- Failure to install the ceiling mount and projector may cause the projector to fall. After installing the specific Epson mount that supports your projector, make sure you secure the mount to all of the projector's ceiling mount fixing points. Also, secure the projector and the mounts using wire that is strong enough to hold their weight.
- Do not install the projector in a location subject to high levels of dust or humidity, or in a location subject to smoke or steam. Otherwise, it could cause a fire or electric shock to occur. The projector's case could also deteriorate and be damaged causing the projector to fall from the mount.

Examples of environments that could cause the projector to fall due to case deterioration

- Locations subject to excessive smoke or airborne oil particles, such as factories or kitchens
- Locations containing volatile solvents or chemicals, such as factories or laboratories
- Locations where the projector could be subjected to detergents or chemicals, such as factories or kitchens
- Locations in which aroma oils are often used, such as relaxation rooms
- Near devices that produce excessive smoke, airborne oil particles, or foam at events

Warning

- Do not cover the projector's air intake or air exhaust vents. If the vents are covered, the internal temperature could rise and cause a fire.
- Do not use or store the projector in locations where it will be subject to dust or dirt. Otherwise, the quality of the projected image may decline, or the air filter may become clogged, resulting in a malfunction or fire.
- Do not install the projector on an unstable surface or in a location beyond the weight specifications of the projector. Otherwise, it could fall or topple causing an accident and injury.
- When installing the projector in a high position, take measures to prevent falling by using wires to ensure safety in an emergency, such as an earthquake, and to prevent accidents. If it is not installed correctly, it could fall causing an accident and injury.
- Do not install in locations where salt damage could occur, or in locations subject to corrosive gas such as sulphuric gas from hot springs. Otherwise, corrosion could cause the projector to fall. It could also cause the projector to malfunction.

Attention

- If you are using the projector at altitudes above 1,500 m, set the **High Altitude Mode** setting to **On** in the projector's **Installation** menu to ensure the projector's internal temperature is regulated properly.
- Try not to setup the projector in locations subject to high humidity and dust, or in locations subject to smoke from fires or tobacco smoke.

» Related Links

- "Projector Setup and Installation Options" [p.29](#)
- "Settings when Using the Interactive Features" [p.30](#)

Projector Setup and Installation Options

You can set up or install your projector in the following ways:

Front/Rear

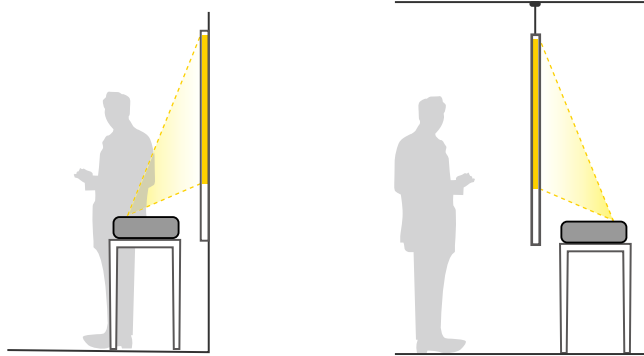

 Attach the feet (if supplied) when using the projector on a surface such as a desk.

Front Upside Down/Rear Upside Down

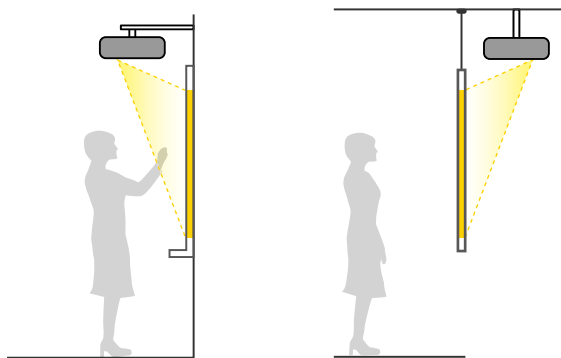

Front Upside Down/Rear Upside Down (Vertically)

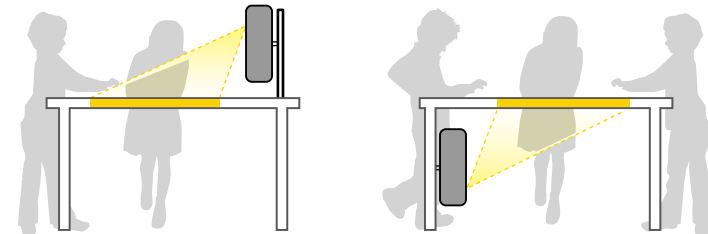

Select the correct **Projection** option in the projector's **Installation** menu according to the installation method being used. If necessary, turn on the **Inv Direction Button** setting in the projector's **Operation** menu and adjust the **Menu Rotation** setting in the projector's **Display** menu.

-  • The default **Projection** setting is **Front/Upside Down**.
• You can change the **Projection** setting as follows by pressing down the [A/V Mute] button on the remote control for about 5 seconds.
- Switch **Front** to/from **Front/Upside Down**
 - Switch **Rear** to/from **Rear/Upside Down**

» **Related Links**

- "Projection Modes" [p.55](#)

Settings when Using the Interactive Features

When using the interactive features, project from in front of the screen (EB-735Fi/EB-725Wi).

Set **Projection** to **Front/Upside Down** or **Front**.

Attention

The interactive features are operated using infrared communication. Note the following points when installing the projector.

- Do not install the projector tilted at an angle of 3° or more. The interactive features may not operate correctly.
- Make sure there is no strong light or sunlight shining on the interactive pen receiver, the projection screen, the projector itself, or the rear of the projector.
- Do not install the projector where it could be subjected to direct sunlight through a window. This could cause the interactive features to malfunction.
- Install the projector so that the interactive pen receiver is not too close to fluorescent lights. If the surrounding area is too bright, the interactive features may not operate correctly.
- If there is any dust stuck to the interactive pen receiver, it could interfere with infrared communication and the interactive features may not operate correctly. Clean the receiver if it is dirty.
- Do not put paint or any stickers on the cover of the interactive pen receiver.
- When using the interactive features, do not use an infrared remote control or microphone in the same room. The interactive pen could malfunction.
- Do not use devices that generate powerful noise, such as rotary devices or transformers, near the projector, as the interactive features may not operate correctly.



- We recommend using a smooth, board type screen without any unevenness. If the projection screen is uneven, there may be distortions in the projected image.
- Distortions may occur in the projected image depending on the material of the screen and the installation method.
- When using the interactive features, install the projector so that the projected screen is a rectangle without any distortion.
- When using the interactive features in the same room as multiple projectors, interactive pen operations may become unstable. In this case, connect the optional remote control cable set to the projectors, and change **Sync of Projectors** to **Wired** in the projector's **Pen/Touch** menu.
☛ **Pen/Touch > Installation of Projectors > Sync of Projectors**

- "Connecting a Computer for Use with PC Interactive Features" [p.35](#)

Settings when Using the Touch Unit

When using the Touch Unit, install the projector using one of the following methods. The Touch Unit cannot be used if another installation method is used.

- Mount the projector on a wall or suspend it from a ceiling and project images from in front of the screen (the setting plate or a commercially available ceiling mount is required).
- Install vertically on a desk and project from the front of the desk (a commercially available table mount is required).

See your projector's *Installation Guide* for the Touch Unit installation methods and angle adjustment methods.

» Related Links

- "Safety Instructions for Interactive Touch Operations" [p.99](#)
- "Using Interactive Touch Operations with Your Finger" [p.98](#)
- "Getting the Latest Version of the Documents" [p.10](#)

» Related Links

- "Settings when Using the Touch Unit" [p.31](#)

You can connect the projector to a variety of computer, video, and audio sources to display presentations, movies, or other images, with or without sound.

Attention

Check the shape and orientation of the connectors on any cable you plan to connect. Do not force a connector into a port if it does not fit. The device or your projector could be damaged or could malfunction.



See the *Quick Start Guide* for a list of cables supplied with your projector. Purchase optional or commercially available cables when necessary.

- Connect a computer that has a USB port, standard video output (monitor) port, or HDMI port.
- For video projection, connect devices such as DVD players, gaming consoles, digital cameras, and smartphones with compatible video output ports.
- If your presentation or video includes sound, you can connect audio input cables.
- For slide shows or presentations without a computer, you can connect USB devices (such as a flash drive or camera) or the optional Epson document camera.

» Related Links

- "Connecting to a Computer" [p.32](#)
- "Connecting to Video Sources" [p.36](#)
- "Connecting to External USB Devices" [p.37](#)
- "Connecting to a Document Camera" [p.39](#)
- "Connecting a Printer" [p.39](#)
- "Connecting to External Devices" [p.39](#)
- "Connecting Multiple Projectors of the Same Model" [p.41](#)
- "Getting the Latest Version of the Documents" [p.10](#)

Connecting to a Computer

Follow the instructions in these sections to connect a computer to the projector.

» Related Links

- "Connecting to a Computer for VGA Video and Audio" [p.32](#)
- "Connecting to a Computer for USB Video and Audio" [p.33](#)
- "Connecting to a Computer for HDMI Video and Audio" [p.34](#)
- "Connecting to a Mini PC Installed on a Wall Plate" [p.34](#)
- "Connecting a Computer for Use with PC Interactive Features" [p.35](#)

Connecting to a Computer for VGA Video and Audio

You can connect the projector to your computer using a VGA computer cable.

You can play sound through the projector's speaker system by connecting a commercially available 3.5 mm stereo mini-jack audio cable.



- To connect a computer that does not have a VGA video port, you need an adapter that allows you to connect to the projector's VGA video port.
- To project an image source connected to the Computer2/Monitor Out port, set **Monitor Out Port to Computer2** in the projector's **Signal I/O** menu.
- You can also set the port to input audio when projecting the computer source as the **Audio Output** setting in the projector's **Signal I/O** menu.
- Make sure the audio cable is labeled "No resistance".

- 1** Connect the VGA computer cable to your computer's monitor port.

2 Connect the other end to a Computer port on the projector.

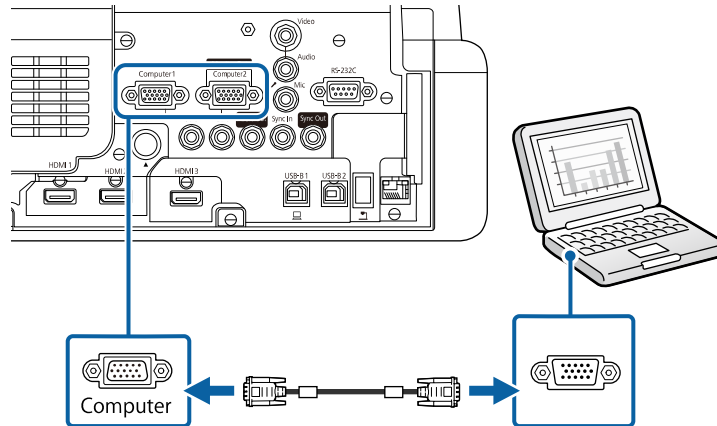

3 Tighten the screws on the VGA connector.

4 Connect the audio cable to your laptop's headphone or audio-out jack, or your desktop's speaker or audio-out port.

5 Connect the other end to the Audio port that corresponds to the Computer port you are using.

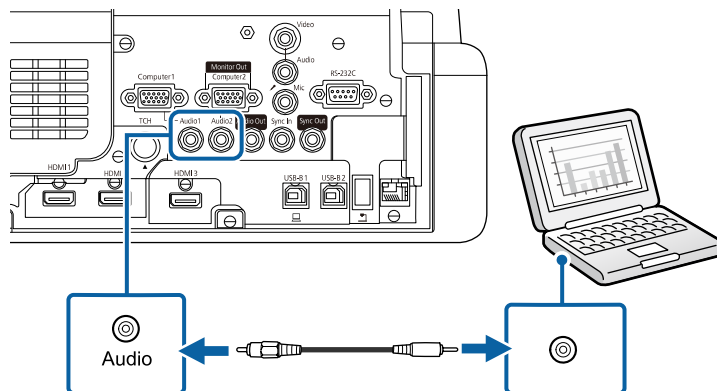

Connecting to a Computer for USB Video and Audio

If your computer meets the system requirements, you can send video and audio output to the projector through the computer's USB port. This function is called USB Display. Connect the projector to your computer using a USB cable.



- If you use a USB hub, the connection may not operate correctly. Connect the USB cable directly to the projector.
- To use the USB Display function, set the **USB Display** setting to **On** in the projector's **Signal I/O** menu (EB-735Fi/EB-725Wi).

1 Connect the cable to your projector's USB-B1 or USB-B port.

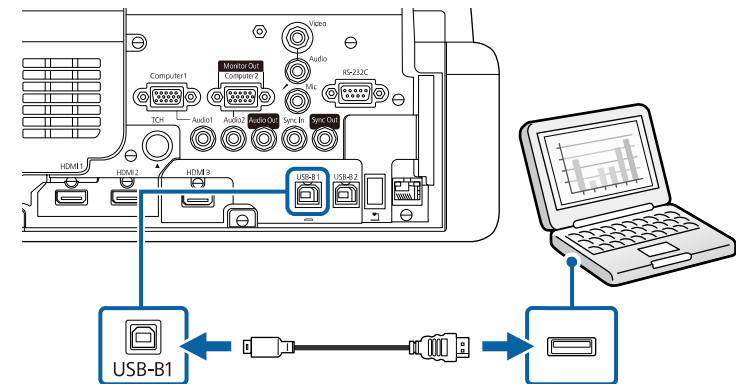

2 Connect the other end to any available USB port on your computer.

3 Turn on the projector and your computer.

4 Do one of the following to install the Epson USB Display software:



You only need to install this software the first time you connect the projector to the computer.

- Windows: Select **Run EMP_UDSE.EXE** in the dialog box that is displayed to install the Epson USB Display software.
- Mac: The Epson USB Display setup folder is displayed on your screen. Select **USB Display Installer** and follow the on-screen instructions to install the Epson USB Display software. If the USB Display **Setup** folder is not displayed automatically, double-click **EPSON_PJ_UD > USB Display Installer**.

5 Follow any on-screen instructions.

Do not disconnect the USB cable or turn off the projector until the projector displays an image.

The projector displays the image from your computer's desktop and outputs sound if your presentation contains audio.



- If the projector does not project any images, do one of the following:
 - Windows: Click **All Programs > EPSON Projector > Epson USB Display > Epson USB Display Ver.x.xx**.
 - Mac: Double-click the **USB Display** icon in the **Application** folder.
- When you finish projection, do one of the following:
 - Windows: Disconnect the USB cable. You do not need to operate **Safely Remove Hardware**.
 - Mac: Select **Disconnect** from the **USB Display** icon menu on the menu bar or **Dock**, and then disconnect the USB cable.

» Related Links

- "USB Display System Requirements" [p.302](#)

Connecting to a Computer for HDMI Video and Audio

If your computer has an HDMI port, you can connect it to the projector using an HDMI cable and send the computer's audio with the projected image.



To connect a Mac that does not have an HDMI port, you need an adapter that allows you to connect to the projector's HDMI port. Contact Apple for compatible adapter options. Older Mac computers (2009 and earlier) may not support audio through the HDMI port.

- 1 Connect the HDMI cable to your computer's HDMI output port.
- 2 Connect the other end to the projector's HDMI port.

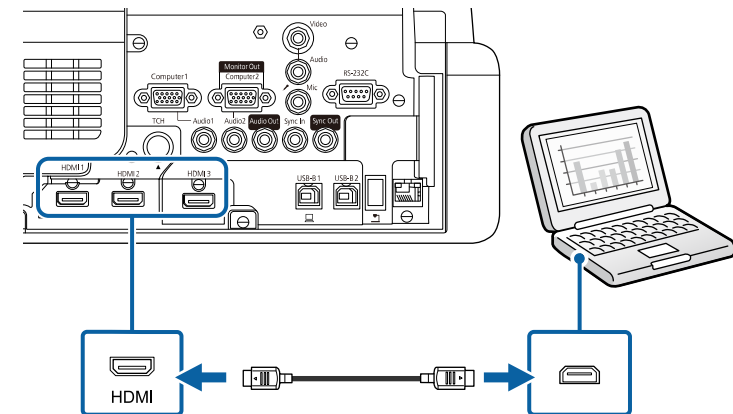

If you have problems hearing audio through the HDMI connection, connect one end of a commercially available 3.5 mm stereo mini-jack audio cable to the projector's Audio port and the other end to your computer's audio out port. Select the audio input port you connected to as the **HDMI Audio Output** setting in the projector's **Signal I/O** menu.

Connecting to a Mini PC Installed on a Wall Plate

You can connect your projector to a mini PC that is installed on a wall plate (EB-735Fi/EB-725Wi).

Attention

Do not cover the mini PC's air intake vents or air exhaust vents. If the vents are covered, the internal temperature could rise and malfunction.

- 1 Connect the mini PC and the projector's HDMI port using the HDMI cable.

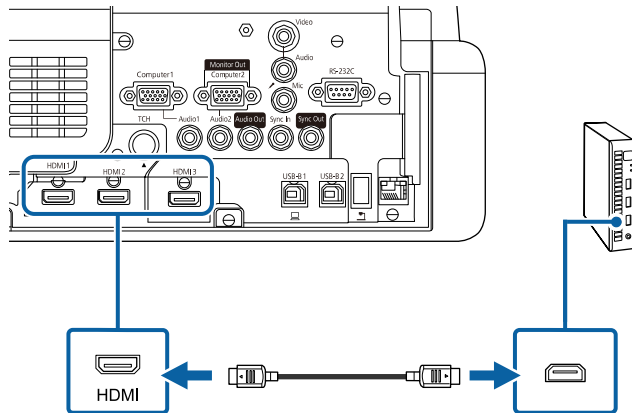

- 2 If you use the interactive features, connect the USB cable to your projector's USB-B2 port.

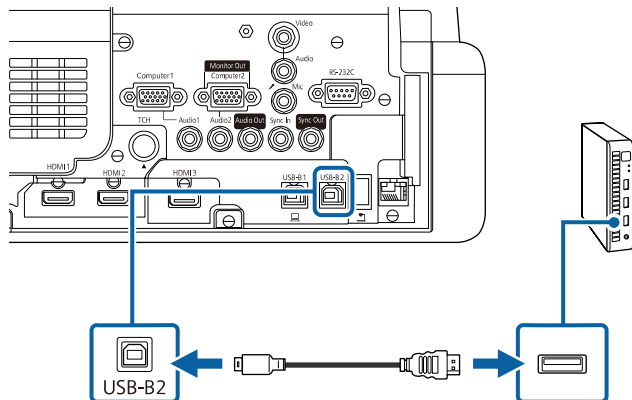

- 3 Connect the other end to any available USB port on your computer.
- 4 Turn on the projector and your computer.
- 5 If you connected a USB cable, set the **USB-B2** setting in the **Pen/Touch** menu to the HDMI port you used to connect your mini PC to the projector.

☛ **Pen/Touch > PC Interactivity > USB-B2**



If you have problems hearing audio through the HDMI connection, connect one end of a commercially available 3.5 mm stereo mini-jack audio cable to the projector's Audio port and the other end to your computer's audio out port. Select the audio input port you connected to as the **HDMI Audio Output** setting in the projector's **Signal I/O** menu.

Connecting a Computer for Use with PC Interactive Features

When the projector is connected to a computer with a USB cable, you can operate the computer from the projected screen using the interactive pens or your finger, just as you would with a mouse (EB-735Fi/EB-725Wi). You can navigate, select, and interact with your computer programs from the projected screen.



If you use a USB hub, the connection may not operate correctly. Connect the USB cable directly to the projector.

- 1 Connect the computer to your projector using an image signal cable other than a USB cable.

- 2 Connect a USB cable to your projector's USB-B1 port.

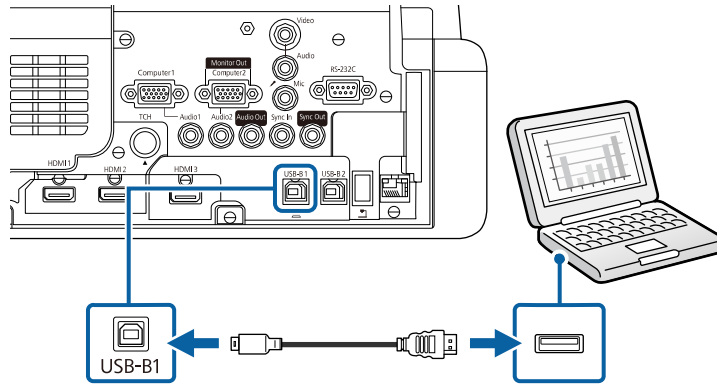

- 3 Connect the other end to any available USB port on your computer.

Connecting to Video Sources

Follow the instructions in these sections to connect video devices to the projector.



- If the port on the device you connect has an unusual shape, use the cable supplied with the device or an optional cable to connect to the projector.
- The cable differs depending on the output signal from the connected video devices.
- Some video devices are capable of outputting different types of signals. See your video device manual to confirm what type of signals can be output.

» Related Links

- "Connecting to an HDMI Video Source" p.36
- "Connecting to a Composite Video Source" p.37

Connecting to an HDMI Video Source

If your video source has an HDMI port, you can connect it to the projector using an HDMI cable and send the image source's audio with the projected image.

Attention

Do not turn on the video source before connecting it to the projector. Doing so could damage the projector.

- 1 Connect the HDMI cable to your video source's HDMI output port.
- 2 Connect the other end to the projector's HDMI port.

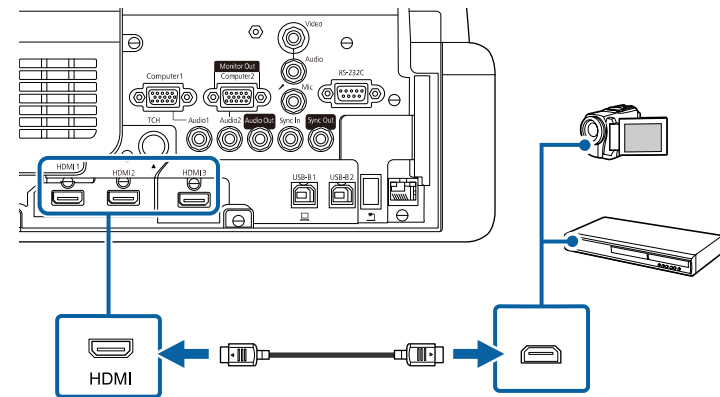

If you have problems hearing audio through the HDMI connection, connect one end of a commercially available 3.5 mm stereo mini-jack audio cable to the projector's Audio port and the other end to your video source's audio out port. Select the audio input port you connected to as the **HDMI Audio Output** setting in the projector's **Signal I/O** menu.

Connecting to a Composite Video Source

If your video source has a composite video port, you can connect it to the projector using a RCA-style video or A/V cable.

You can play sound through the projector's speaker system by connecting a stereo mini-jack audio cable.



Make sure the audio cable is labeled "No resistance".

1 Connect the cable with the yellow connector to your video source's yellow video output port.

2 Connect the other end to the projector's Video port.

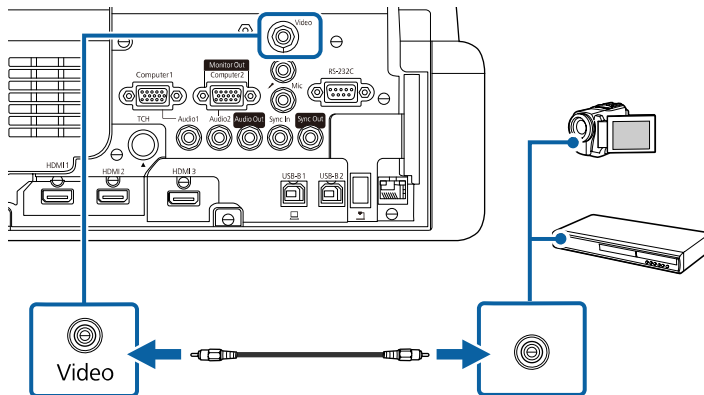

3 Connect the audio cable to your video source's audio-out ports.

4 Connect the other end to the projector's Audio port.

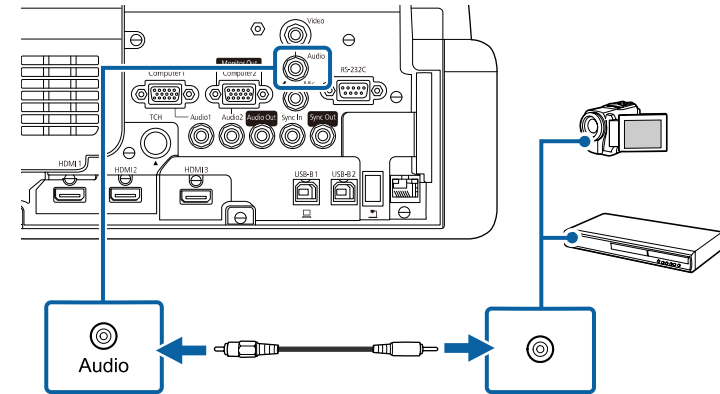

Connecting to External USB Devices

Follow the instructions in these sections to connect external USB devices to the projector.

► Related Links

- "USB Device Projection" [p.37](#)
- "Connecting to a USB Device" [p.38](#)
- "Disconnecting a USB Device" [p.38](#)

USB Device Projection

You can project images and other content without using a computer or video device by connecting any of these devices to your projector:

- USB flash drive
- Digital camera or smartphone
- USB hard drive



- Digital cameras or smartphones must be USB-mounted devices, not TWAIN-compliant devices, and must be USB Mass Storage Class-compliant.
- USB hard drives must meet these requirements:
 - USB Mass Storage Class-compliant (not all USB Mass Storage Class devices are supported)
 - Formatted in FAT16/32
 - Self-powered by their own AC power supplies (bus-powered hard drives are not recommended)
 - Avoid using hard drives with multiple partitions

You can project slide shows from image files on a connected USB device.

You can also project playlists that contain images and movies saved on a USB flash drive in Content Playback mode (EB-755F/EB-750F).

» Related Links

- "Projecting in Content Playback Mode" [p.135](#)
- "Projecting a PC Free Presentation" [p.130](#)

Connecting to a USB Device

You can connect your USB device to the projector's USB-A port and use it to project images and other content.

- 1** If your USB device came with a power adapter, plug the device into an electrical outlet.

- 2** Connect the USB cable or USB flash drive to the projector's USB-A port as shown.

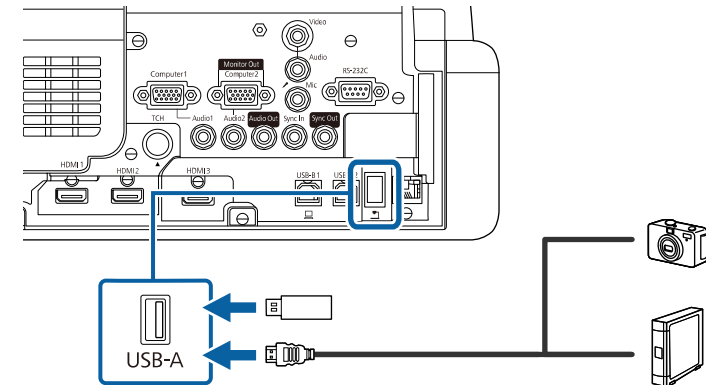

Attention

- Use the USB cable supplied with or specified for use with the device.
- Do not connect a USB hub or a USB cable longer than 3 meters, or the device may not operate correctly.

- 3** Connect the other end to your device, if necessary.

Disconnecting a USB Device

When you have finished presenting with a connected USB device, disconnect the device from the projector.

- 1** Turn off and unplug the device, if necessary.
- 2** Disconnect the USB device from the projector.

Connecting to a Document Camera

You can connect a document camera to your projector to project images viewed by the camera.

The connection method varies depending on your Epson document camera model. See the document camera manual for details.

Depending on your projector and document camera models, you can control the document camera using the interactive features.

▶ Related Links

- "Getting the Latest Version of the Documents" [p.10](#)
- "Controlling a Document Camera" [p.121](#)

Connecting a Printer

You can connect an Epson printer or all-in-one device to the USB-A port and use it to print your projected and annotated content from the whiteboard (EB-735Fi/EB-725Wi).



- Make sure the printer meets the control command requirements.
- You can also connect a network printer through the **Print** setting in the projector's **Interactive** menu.

- 1** Connect the USB cable to projector's USB-A port. Make sure the cable is no longer than 5 m.

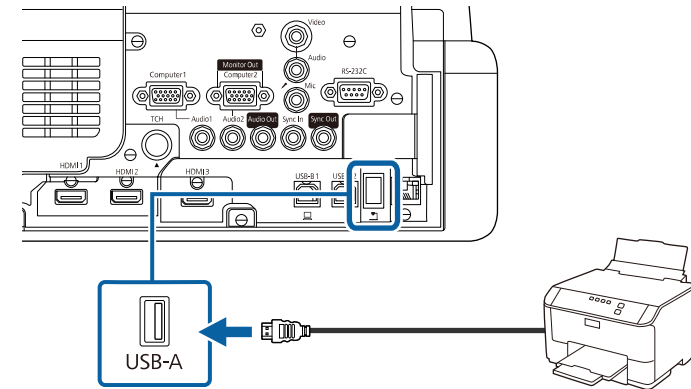

- 2** Connect the other end of the cable to printer's USB type B port.

▶ Related Links

- "Printing Drawing Contents" [p.115](#)

Connecting to External Devices

Follow the instructions in these sections to connect external devices to the projector.

▶ Related Links

- "Connecting to a VGA Monitor" [p.39](#)
- "Connecting to External Speakers" [p.40](#)
- "Connecting a Microphone" [p.41](#)

Connecting to a VGA Monitor

If you connected the projector to a computer using a Computer port, you can also connect an external monitor to the projector. This lets you see your

presentation on the external monitor even when the projected image is not visible.

To output images to an external monitor, set the **Monitor Out Port** setting to **Monitor Out** in the projector's **Signal I/O** menu.



- If you want to output images to an external monitor when the projector does not project any images, set the **A/V Output** setting to **Always On** in the projector's **Signal I/O** menu.
- Content drawn on the screen using the interactive features is not displayed on an external monitor (EB-735Fi/EB-725Wi). To display the drawn content on an external monitor, use Easy Interactive Tools.
- Monitors that use a refresh rate of less than 60 Hz may not be able to display images correctly.

1 Make sure your computer is connected to the projector's Computer port.



- If there are two computer ports, make sure you use the Computer1 port.
- Only analog RGB signals from the Computer1 port can be output to an external monitor. You cannot output signals input from other ports.

2 Connect the external monitor's cable to your projector's Monitor Out port.

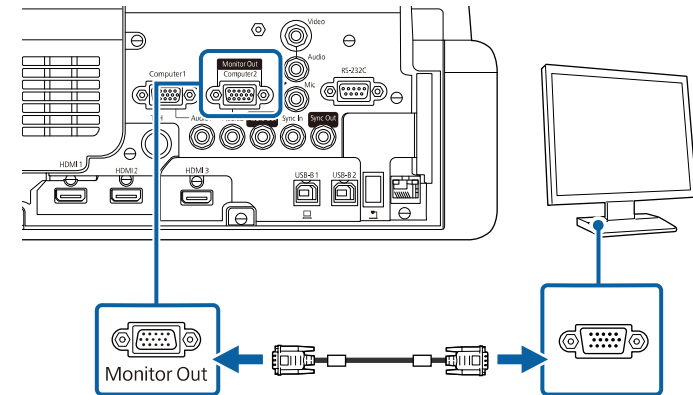

Connecting to External Speakers

To enhance the sound from your presentation, you can connect the projector to external self-powered speakers. You can control the volume using the projector's remote control.

To output audio from external speakers, set the **Audio Out Device** setting to **AV System** in the projector's **Signal I/O** menu. When an audio/video system is not connected to the projector, audio is output from the projector even if **Audio Out Device** is set to **AV System**.

☛ **Signal I/O > HDMI Link > Audio Out Device**



- If you want to output audio from the external speakers when the projector does not project any images, set the **A/V Output** setting to **Always On** in the projector's **Signal I/O** menu.
- You can also connect the projector to an amplifier with speakers.
- The projector's built-in speaker system is disabled when you connect external speakers.

1 Make sure your computer or video source is connected to the projector with both audio and video cables as necessary.

- 2** Locate the appropriate cable to connect your external speakers, such as a stereo mini-jack-to-pin-jack cable, or another type of cable or adapter.
- 3** Connect one end of the cable to your external speakers as necessary.
- 4** Connect the stereo mini-jack end of the cable to your projector's Audio Out port.

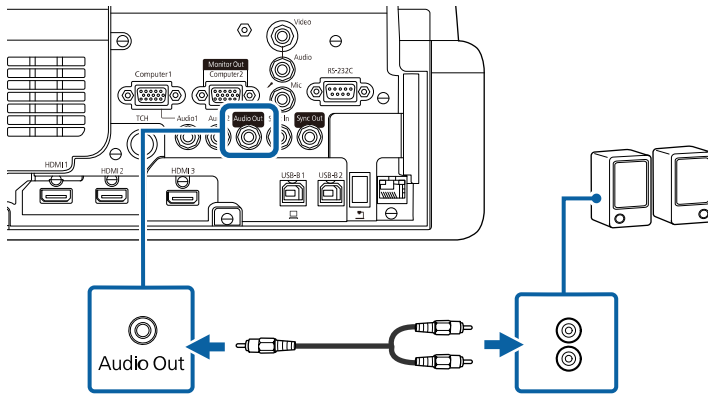

Connecting a Microphone

You can connect a microphone to the projector's Mic port to provide audio support during presentations (EB-735Fi/EB-735F/EB-725Wi/EB-725W/EB-720).



- Plug-in-power is not supported.
- If you want to output audio from a microphone when the projector does not project any images, set the **A/V Output** setting to **Always On** in the projector's **Signal I/O** menu.
- Adjust the **Mic Input Level** setting in the projector's **Signal I/O** menu if the microphone audio is difficult to hear, or if it is too loud resulting in a crackling sound.

- 1** Connect the microphone cable to the projector's Mic port.

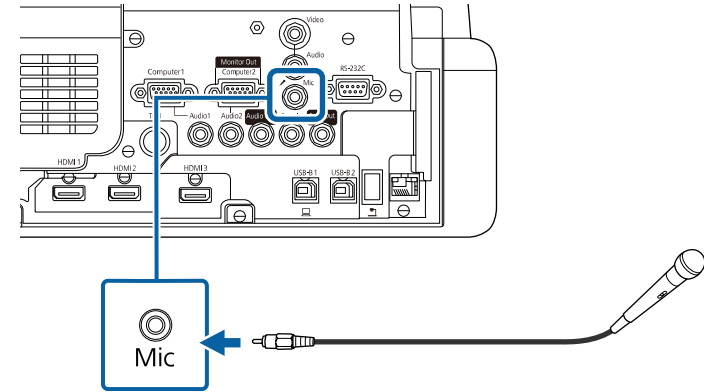

- 2** Turn on the microphone, if necessary.

Connecting Multiple Projectors of the Same Model

When using multiple projectors and interactive features in the same room, connect the optional remote control cable set to the SYNC port on each projector (EB-735Fi/EB-725Wi). By doing so, the interactive pen operates stably.

- 1** Connect the optional remote control cable set to the SYNC OUT port on one projector, and connect the other end to the SYNC IN port on the other projector.

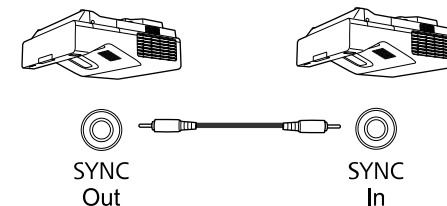

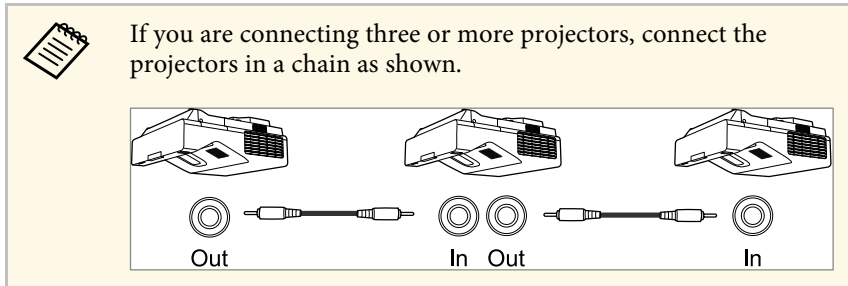

2 Press the [Menu] button on the control panel or remote control.

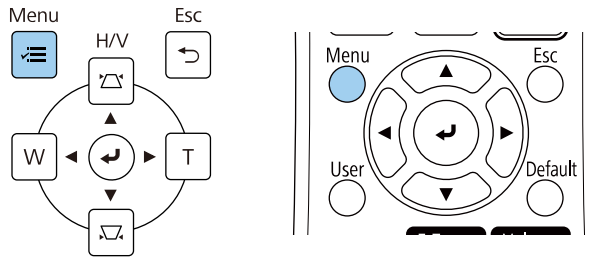

3 Select the **Pen/Touch** menu and press [Enter].

Frequently Used Items	Pen/Touch
Image	Auto Calibration
Signal I/O	Manual Calibration
Installation	Touch Unit
Display	Installation of Projectors
Operation	Pen Hovering On
Management	PC Interactivity
Network	Reset Pen/Touch Settings
Pen/Touch	Interactive
Interactive	Drawing Function On
Memory	Display Toolbars Always Show
ECO	Display Drawing Area
Initial/All Settings	Confirm Clear Screen On
	Pen Button Function Eraser
	Display Clock Date & Time ^
	Date YYYY-MM-DD
	Time HH:MM
	Print

4 Select the **Installation of Projectors** setting and press [Enter].

- 5** Select the **Sync of Projectors** setting and select **Wired**.

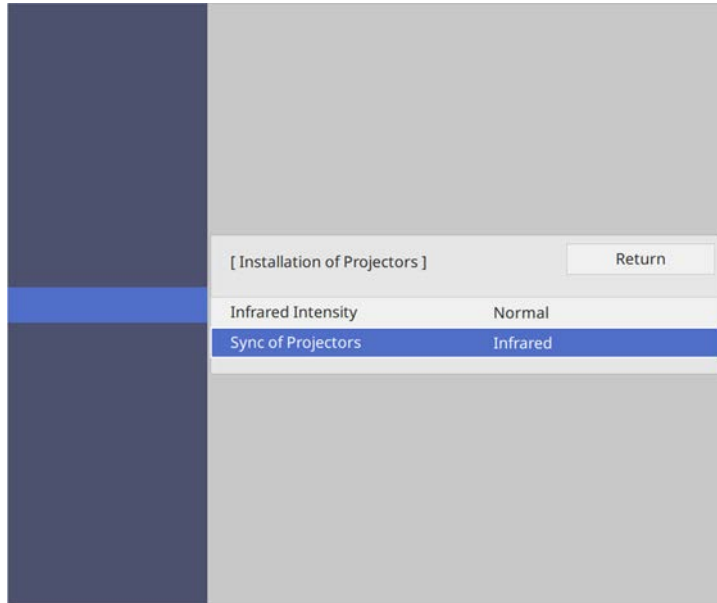

- 6** Press [Menu] or [Esc] to exit the menus.

The remote control uses the two AA batteries that came with the projector.

Attention

Make sure you read the *Safety Instructions* before handling the batteries.



Replace the batteries as soon as they run out. The remote control uses two AA manganese or alkaline batteries.

- 1** Remove the battery cover as shown.

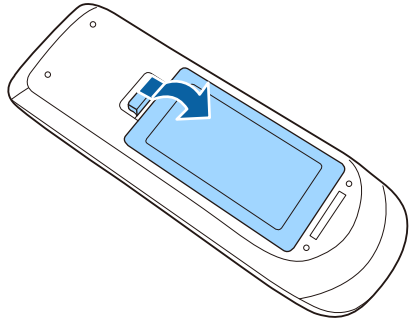

- 2** Remove the old batteries, if necessary.



Dispose of used batteries according to local regulations.

- 3** Insert the batteries with the + and – ends facing as shown.

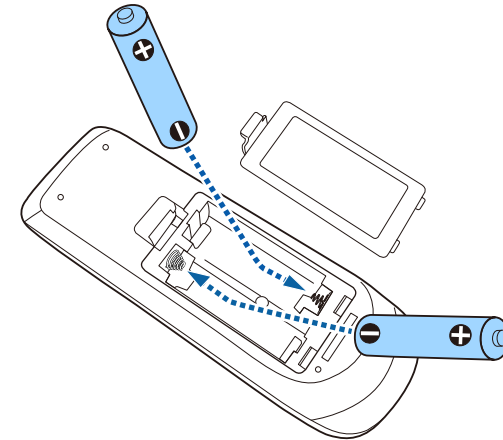

Warning

Check the positions of the (+) and (-) marks inside the battery holder to ensure the batteries are inserted the correct way. If the batteries are not used correctly, they could explode or leak causing a fire, injury, or damage to the product.

- 4** Replace the battery cover and press it down until it clicks into place.

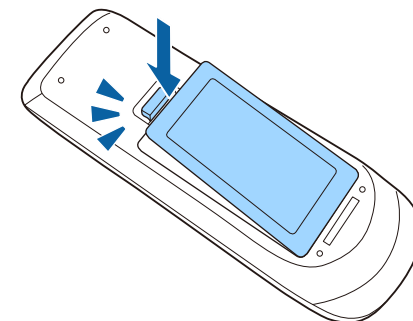

The interactive pen uses the one AA battery that came with the pen.

Attention

Make sure you read the *Safety Instructions* before handling the battery.



When the battery is low, the pen indicator flashes when you press the button on the side of the pen.

When the battery runs out, the pen indicator turns off. Replace the battery as soon as it runs out. The interactive pen uses one AA manganese battery, AA alkaline battery, or Eneloop (BK-3MCC) rechargeable battery.

- 1 Open the battery cover as shown.

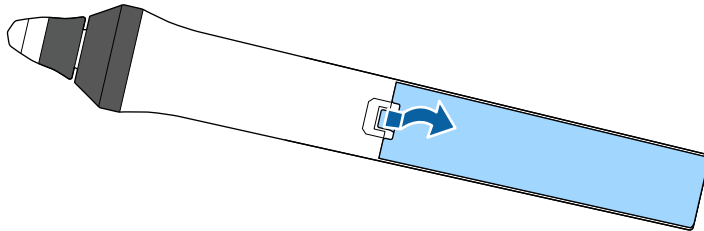

- 2 Remove the old batteries, if necessary.



Dispose of used batteries according to local regulations.

- 3 Insert the battery with the + and – ends facing as shown.

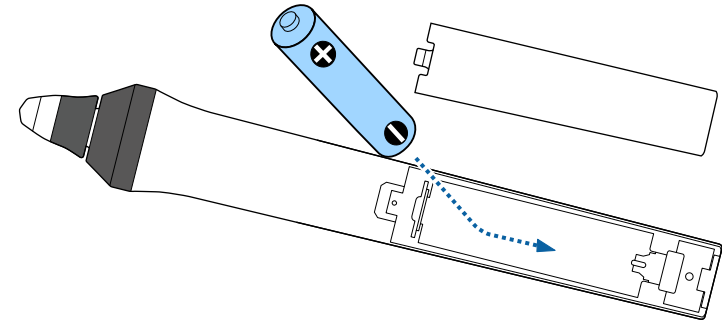

Warning

Check the positions of the (+) and (–) marks inside the battery holder to ensure the battery are inserted the correct way. If the battery is not used correctly, it could explode or leak causing a fire, injury, or damage to the product.

- 4 Replace the battery cover and press it down until it clicks into place.

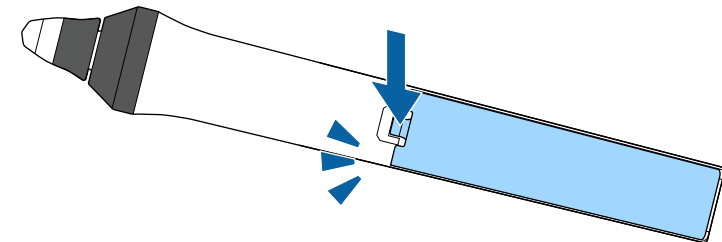

The remote control lets you control the projector from almost anywhere in the room.

Make sure that you aim the remote control at the projector's receivers within the distance and angles listed here.

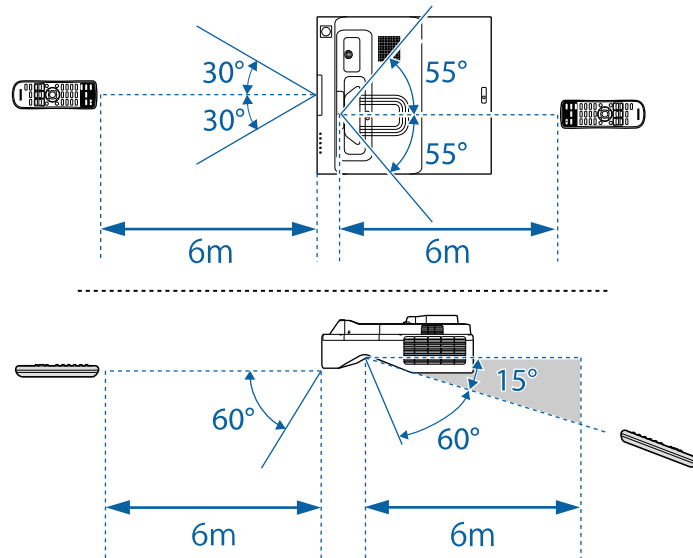

Avoid using the remote control in conditions with bright fluorescent lights or in direct sunlight, or the projector may not respond to commands. If you are not going to use the remote control for a long time, remove the batteries.

Using Basic Projector Features

Follow the instructions in these sections to use your projector's basic features.

► Related Links

- "Turning On the Projector" [p.48](#)
- "Turning Off the Projector" [p.51](#)
- "Setting the Date and Time" [p.52](#)
- "Selecting the Language for the Projector Menus" [p.54](#)
- "Projection Modes" [p.55](#)
- "Setting the Screen Type" [p.57](#)
- "Focusing the Image" [p.59](#)
- "Adjusting the Image Height" [p.62](#)
- "Image Shape" [p.63](#)
- "Resizing the Image with the Buttons" [p.73](#)
- "Adjusting the Image Position" [p.74](#)
- "Selecting an Image Source" [p.75](#)
- "Image Aspect Ratio" [p.77](#)
- "Adjusting Image Quality (Color Mode)" [p.82](#)
- "Adjusting the Image Color" [p.84](#)
- "Adjusting the Image Resolution" [p.87](#)
- "Adjusting the Brightness" [p.89](#)
- "Controlling the Volume with the Volume Buttons" [p.92](#)

Turn on the computer or video equipment you want to use after you turn on the projector.

- 1** Connect the power cord to the projector's power inlet and plug it into an electrical outlet.

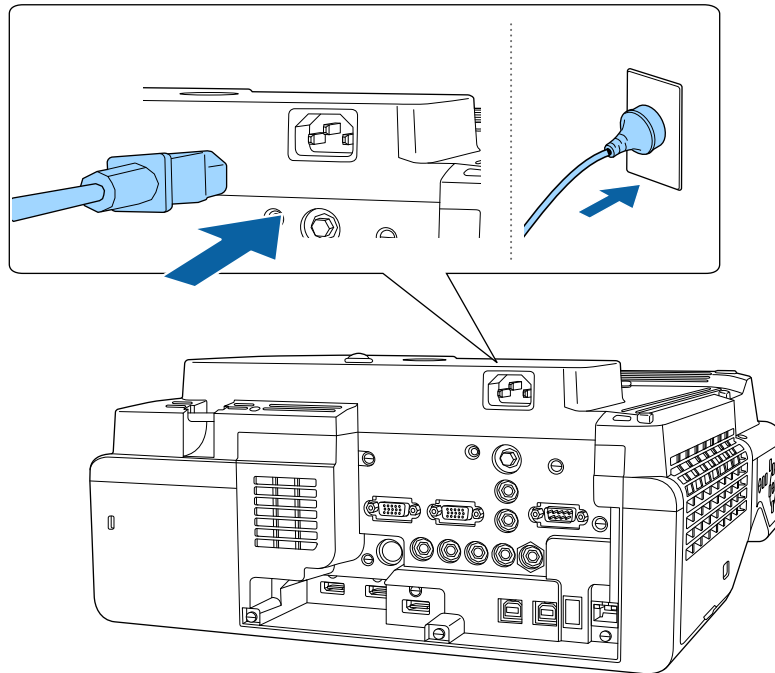

The projector's power indicator turns blue. This indicates that the projector is receiving power, but is not yet turned on (it is in standby mode).

- 2** Press the power button on the control panel or remote control to turn on the projector.

The projector beeps and the status indicator flashes blue as the projector warms up. Once the projector is warmed up, the status indicator stops flashing and turns blue.



- When **Quick Startup** is enabled in the projector's **Operation** menu, the projector becomes ready for use in several seconds the next time you press the power button.

Try the following if you do not see a projected image.

- Turn on the connected computer or video device.
- Change the screen output from the computer when using a laptop computer.
- Insert a DVD or other video media, and press play (if necessary).
- Press the [Source Search] button on the control panel or remote control to detect the source.
- Press the button for the desired video source on the remote control.
- If the Home screen is displayed, select the source you want to project.

Warning

- Never look into the projector lens when the light source is on. This can damage your eyes and is especially dangerous for children.
- When turning on the projector at a distance using the remote control, make sure there is no one looking into the lens.
- If the light from the projector is blocked, the area on which the light shines becomes hot which could cause it to melt, burn, or start a fire. Also, the lens may get hot due to the reflected light which could cause the projector to malfunction. To stop projection, use the A/V Mute function, or turn off the projector.



- When the **Direct Power On** setting is set to **On** in the projector's **Operation** menu, the projector turns on as soon as you plug it in. Note that the projector also turns on automatically in cases such as recovery from a power outage.
- If you select a specific port as the **Auto Power On** setting in the projector's **Operation** menu, the projector turns on as soon as it detects a signal or cable connection from that port.

» **Related Links**

- "Home Screen" [p.49](#)

- "Projector Feature Settings - Operation Menu" [p.224](#)

Home Screen

The Home screen feature allows you to easily select an image source and access useful functions. You can display the Home screen by pressing the [Home] button on the control panel or remote control. The Home screen is also displayed when you turn on the projector and no signal is being input.

Press the arrow buttons on the control panel or remote control to select a menu item, and then press [Enter].

You can also select menu items using the interactive pen or your finger (EB-735Fi/EB-725Wi).



- 1 Selects the source you want to project.
A check mark appears on the upper right of the current input source.
You can check a preview of the current input image for most sources as a thumbnail (other than the USB input source in Content Playback mode).
- 2 Turns off the projector (EB-735Fi/EB-725Wi).
- 3 Closes the home screen (EB-735Fi/EB-725Wi).

- 4 Starts the whiteboard mode (EB-735Fi/EB-725Wi).
- 5 Projects images from two or four different image sources simultaneously in a grid format.
- 6 Displays the guide screen to receive the distributed image from other projector that is connected to the same network.
- 7 Displays the Connection Guide. You can select the wireless connection methods according to the devices you are using, such as smartphones or computers.
- 8 Lets you select the following common projector settings (settings may vary depending on other selected settings):
 - **Color Mode**
 - **Brightness Level**
 - **Volume**
 - **Geometry Correction (H/V-Keystone and Quick Corner are available.)**
 - **Auto Calibration (EB-735Fi/EB-725Wi)**
 - **Aspect**

 • The **Geometry Correction** setting is only displayed when **Fixed Installation** is set to **Off** and **Geometry Correction** is set to **H/V-Keystone** or **Quick Corner** in the projector's **Installation** menu.

• After performing Geometry Correction using the interactive pens or your finger, you need to calibrate the system again (EB-735Fi/EB-725Wi).

- 9 Moves to the previous or next page if there are more than nine available input sources.
- 10 Displays the projector name and the projector keyword.
- 11 Displays the current time.

 The Home screen disappears after 10 minutes of inactivity.

- **Related Links**
- "Whiteboard Screens (Whiteboard Mode)" [p.101](#)
 - "Screen Sharing" [p.189](#)

- "Projecting Multiple Images Simultaneously" [p.127](#)

Turn off the projector after use.



- Turn off this product when it is not in use to prolong the life of the projector. Light source life varies depending on the mode selected, environmental conditions, and usage. Brightness decreases over time.
- If the **Light Source Calibration** setting is set to **Run Periodically** in the projector's **Management** menu, light source calibration starts automatically if you turn off the projector and the following conditions are present:
 - 100 hours have passed since the last light source calibration
 - You have used the projector continuously for more than 20 minutes

- 1** Press the power button on the control panel or remote control.
The projector displays a shutdown confirmation screen.

Power Off?

Yes: Press  button

No : Press any other button

- 2** Press the power button again. (To leave it on, press any other button.)
The projector beeps twice, the light source turns off, and the status indicator turns off.
- 3** To transport or store the projector, make sure the power indicator is blue (but not flashing) and the status indicator is off, then unplug the power cord.

You can set the date and time for the projector.

- 1** Turn on the projector.
- 2** Press the [Menu] button on the control panel or remote control.

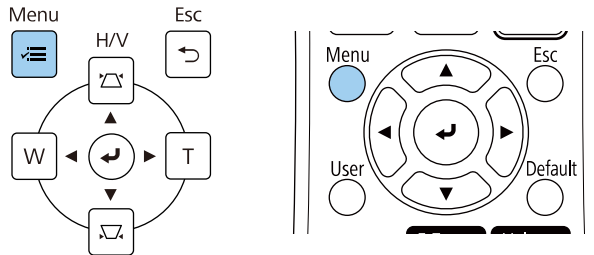

- 3** Select the **Management** setting and press [Enter].

Frequently Used Items	Management
Image	User Button Light Source Mode
Signal I/O	User's Logo
Installation	User Pattern
Display	Control Panel Lock Off
Operation	Color Uniformity
Management	Refresh Mode
Network	Light Source Calibration
Pen/Touch	Date & Time
Interactive	Schedule Settings
Memory	Wireless LAN Power
ECO	Wireless LAN Diagnosis 1
Initial/All Settings	Log Save Destination USB and Internal Memory
	Batch Setup Range
	Language English
	Information
	Display Logs
	Reset Management Settings
	Network

- 4** Select the **Date & Time** setting and press [Enter].

- 5** Select the **Date & Time** setting and press [Enter].
You see this screen:

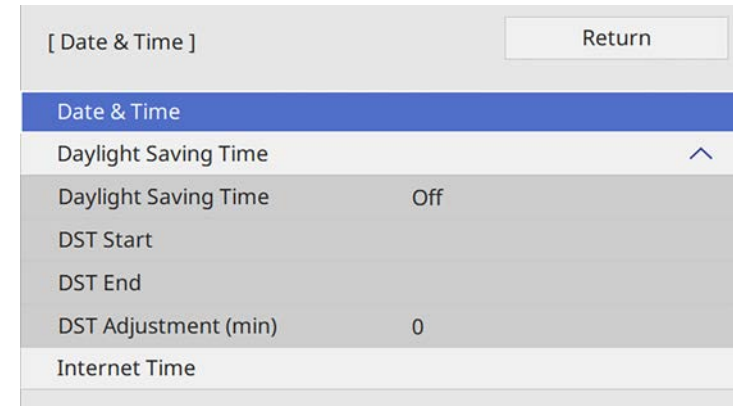

- 6** Select **Date**, press [Enter], and use the displayed keyboard to enter today's date.
- 7** Select **Time**, press [Enter], and use the displayed keyboard to enter the current time.
- 8** Select **Time Difference (UTC)**, press [Enter], and set the time difference from Coordinated Universal Time.
- 9** When you are finished, select **Set** and press [Enter].

- 10** To activate daylight saving time, select the **Daylight Saving Time** setting and set it to **On**. Then select settings.

[Daylight Saving Time]		Return
Daylight Saving Time	On	^
DST Adjustment (min)	0	
DST Start		
Month	1	
Week	1	
Day of the Week	Mon	
Time	00:00	
DST End		
Month	1	
Week	1	
Day of the Week	Mon	
Time	00:00	
		Set

- 11** When you are finished, select **Set** and press [Enter].

- 12** To update the time automatically through an Internet time server, select the **Internet Time** setting and set it to **On**. Then select settings.

[Use Internet Time]		Return
Use Internet Time	On	^
Internet Time Server	0.0.0.0	
		Set

- 13** When you are finished, select **Set** and press [Enter].

- 14** Press [Menu] or [Esc] to exit the menus.

If you want to view the projector's menus and messages in another language, you can change the **Language** setting.

- 1** Turn on the projector.
- 2** Press the [Menu] button on the control panel or remote control.

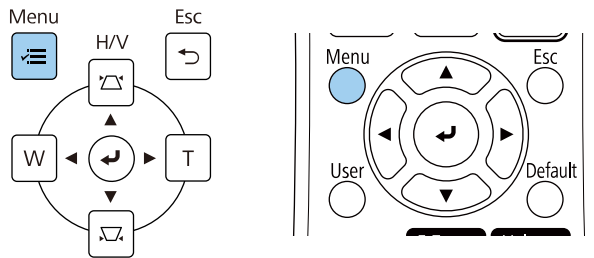

- 4** Select the **Language** setting and press [Enter].
- 5** Select the language you want to use and press [Enter].
- 6** Press [Menu] or [Esc] to exit the menus.

- 3** Select the **Management** setting and press [Enter].

Frequently Used Items	Management
Image	User Button Light Source Mode
Signal I/O	User's Logo
Installation	User Pattern
Display	Control Panel Lock Off
Operation	Color Uniformity
Management	Refresh Mode
Network	Light Source Calibration
Pen/Touch	Date & Time
Interactive	Schedule Settings
Memory	Wireless LAN Power
ECO	Wireless LAN Diagnosis 1
Initial/All Settings	Log Save Destination USB and Internal Memory
	Batch Setup Range
	Language English
	Information
	Display Logs
	Reset Management Settings
	Network

Depending on how you positioned the projector, you may need to change the projection mode so your images project correctly.

- **Front** lets you project from a table in front of the screen.
- **Front/Upside Down** flips the image over top-to-bottom to project upside-down from a wall mount or ceiling.
- **Rear** flips the image horizontally to project from behind a translucent screen.
- **Rear/Upside Down** flips the image over top-to-bottom and horizontally to project from a wall mount or ceiling and behind a translucent screen.

» **Related Links**

- "Changing the Projection Mode Using the Remote Control" [p.55](#)
- "Changing the Projection Mode Using the Menu" [p.55](#)
- "Projector Setup and Installation Options" [p.29](#)

- 3 To change projection back to the original mode, hold down the [A/V Mute] button for 5 seconds again.

Changing the Projection Mode Using the Remote Control

You can change the projection mode to flip the image over top-to-bottom.

- 1 Turn on the projector and display an image.
- 2 Hold down the [A/V Mute] button on the remote control for 5 seconds.

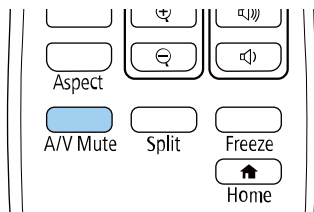

The image disappears briefly and reappears flipped top-to-bottom.

Changing the Projection Mode Using the Menu

You can change the projection mode to flip the image over top-to-bottom and/or left-to-right using the projector menus.

- 1 Turn on the projector and display an image.
- 2 Press the [Menu] button on the control panel or remote control.

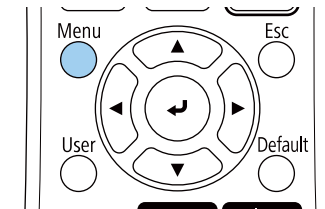
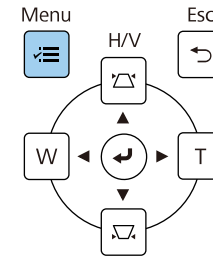

- 3** Select the **Installation** menu and press [Enter].

Frequently Used Items	Installation
Image	Fixed Installation Off
Signal I/O	Test Pattern
Installation	Setting Plate Installation Guide
Display	Vertical Installation No
Operation	Projection Front/Upside Down
Management	Auto Screen Adjustment
Network	Geometry Correction Point Correction
Pen/Touch	Digital Zoom
Interactive	Connect ELPCB02 Off
Memory	Touch Unit
ECO	Remote Receiver Off
Initial/All Settings	Projector ID Off
	Screen Type 16:9
	High Altitude Mode Off
	Reset Installation Settings
	Display
	Pattern Display

- 4** Select **Projection** and press [Enter].

- 5** Select a projection mode and press [Enter].

[Projection]	Return
Front	
✓ Front/Upside Down	
Rear	
Rear/Upside Down	

- 6** Press [Menu] or [Esc] to exit the menus.

You can use the **Screen Type** setting to match the aspect ratio of the displayed image to the screen you are using.

- 1 Turn on the projector and display an image.
- 2 Press the [Menu] button on the control panel or remote control.

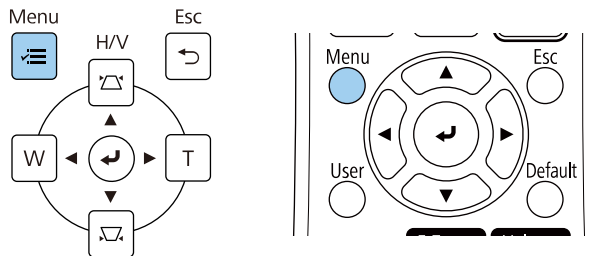

- 3 Select the **Installation** menu and press [Enter].

Frequently Used Items	Installation
Image	Fixed Installation Off
Signal I/O	Test Pattern
Installation	Setting Plate Installation Guide
Display	Vertical Installation No
Operation	Projection Front/UpSide Down
Management	Auto Screen Adjustment
Network	Geometry Correction Point Correction
Pen/Touch	Digital Zoom
Interactive	Connect ELPCB02 Off
Memory	Touch Unit
ECO	Remote Receiver Off
Initial/All Settings	Projector ID Off
	Screen Type 16:9
	High Altitude Mode Off
	Reset Installation Settings
	Display
	Pattern Display

- 4 Select **Screen Type** and press [Enter].
- 5 Select your screen's aspect ratio and press [Enter].

[Screen Type]	Return
4:3	
16:6	
✓ 16:9	
16:10	

- 6 Press [Menu] to exit the menus.



You may need to restart the projector. Follow the on-screen instructions.

- 7 Adjust the aspect ratio for the projected image, if necessary.

» Related Links

- "Adjusting the Image Position Using Screen Position" p.57

Adjusting the Image Position Using Screen Position

You can adjust the image position if there are margins between the edge of the image and the projected screen frame.



You cannot adjust the screen position if you set the **Screen Type** setting to the same aspect ratio as the projector resolution.

- 1 Turn on the projector and display an image.

2 Press the [Menu] button on the control panel or remote control.

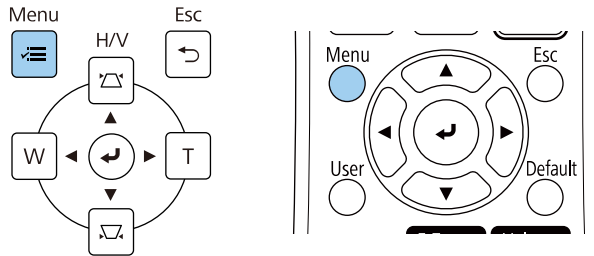

3 Select the **Installation** menu and press [Enter].

Frequently Used Items	Installation
Image	Fixed Installation Off
Signal I/O	Test Pattern
Installation	Setting Plate Installation Guide
Display	Vertical Installation No
Operation	Projection Front/Upside Down
Management	Auto Screen Adjustment
Network	Geometry Correction Point Correction
Pen/Touch	Digital Zoom
Interactive	Connect ELPCB02 Off
Memory	Touch Unit
ECO	Remote Receiver Off
Initial/All Settings	Projector ID Off
	Screen Type 16:9
	High Altitude Mode Off
	Reset Installation Settings
	Display
	Pattern Display

4 Select **Screen Position**, and press [Enter].

5 Use the arrow buttons on the control panel or remote control to adjust the position of the image.



When using the interactive features with an aspect ratio of 16:6, set the **Screen Position** to a vertically central or higher position (EB-735Fi).

6 When you are finished, press [Menu].

You can display the test pattern, and then adjust the focus.

 We recommend adjusting the focus at least 30 minutes after you start projecting, because images are not stable right after turning on the projector.

- 1** Turn on the projector.
- 2** Press the [Menu] button on the control panel or remote control.

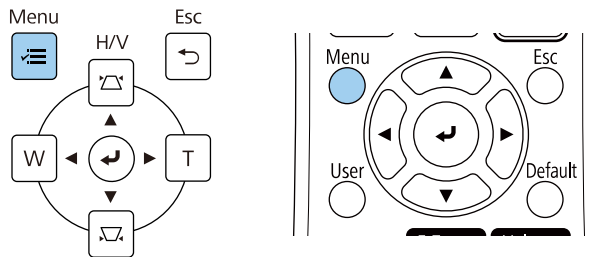

- 3** Select the **Installation** menu and press [Enter].

Frequently Used Items	Installation	
Image	Fixed Installation	Off
Signal I/O	Test Pattern	
Installation	Setting Plate Installation Guide	
Display	Vertical Installation	No
Operation	Projection	Front/Upside Down
Management	Auto Screen Adjustment	
Network	Geometry Correction	Point Correction
Pen/Touch	Digital Zoom	▼
Interactive	Connect ELPCB02	Off
Memory	Touch Unit	
ECO	Remote Receiver	Off
Initial/All Settings	Projector ID	Off
	Screen Type	16:9 ▼
	High Altitude Mode	Off
	Reset Installation Settings	
	Display	
	Pattern Display	

- 4** Select **Test Pattern** and press [Enter].

5 If the **Screen Type** is set to **16:9**, select the test pattern, and then press [Enter] to display the pattern you want (EB-755F/EB-750F).

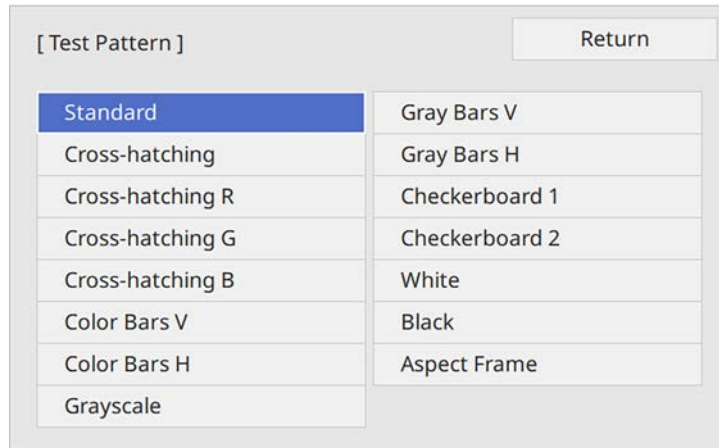

6 Open the air filter cover.

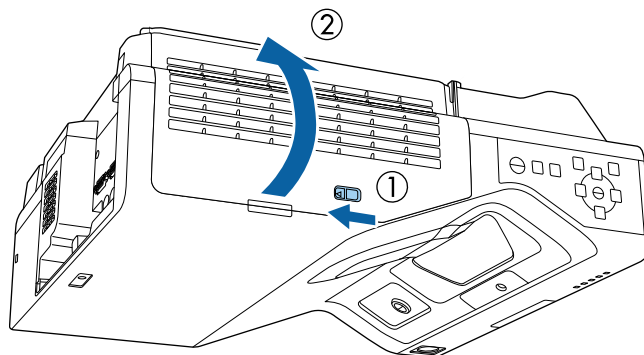

7 Move the focus lever and focus to the center-bottom of the projected screen.

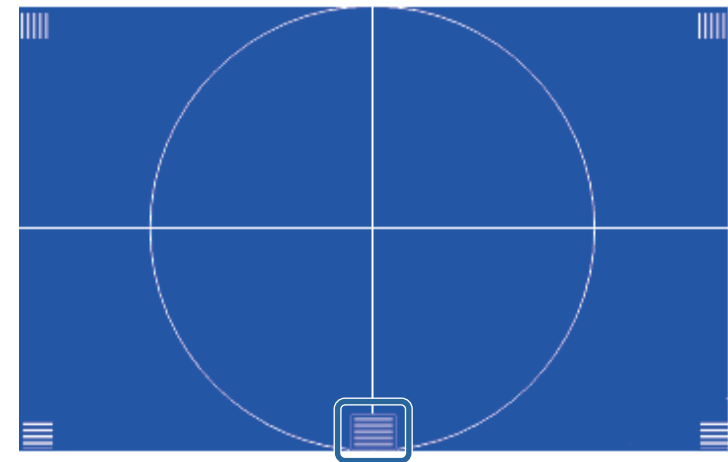
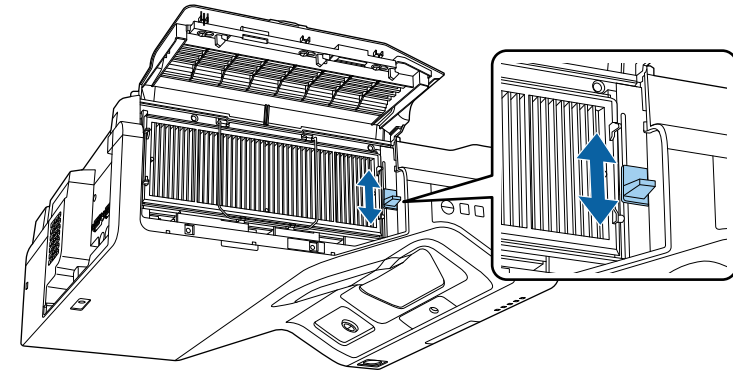

 If you see a different test pattern, adjust the focus while viewing the test pattern.

- 8** Check that the focus matches the corners of the projected screen.

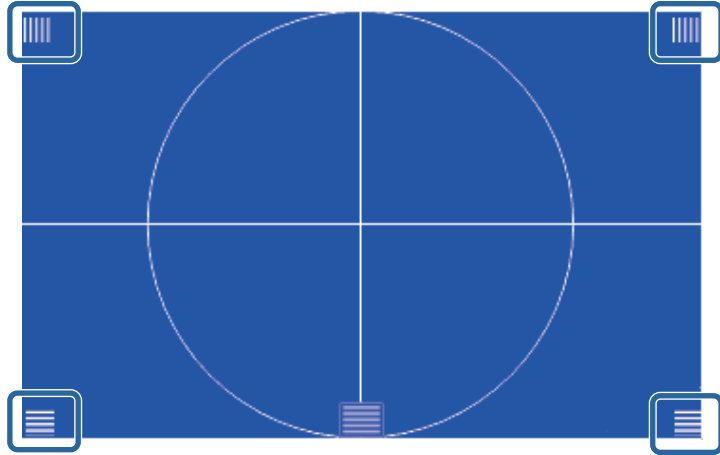

If any areas are out of focus, use the focus lever to adjust until the corners are the same focus.

- 9** To remove the test pattern, press [Esc].

If you are projecting from a table or other flat surface and the image is too high or low, you can adjust the image height using the projector's adjustable feet (only for models supplied with the feet).

The larger the angle of tilt, the harder it becomes to focus. Locate the projector so that it only needs to be tilted at a small angle.

- 1** Turn on the projector and display an image.
- 2** To adjust the image height, rotate the front feet to extend or retract them.

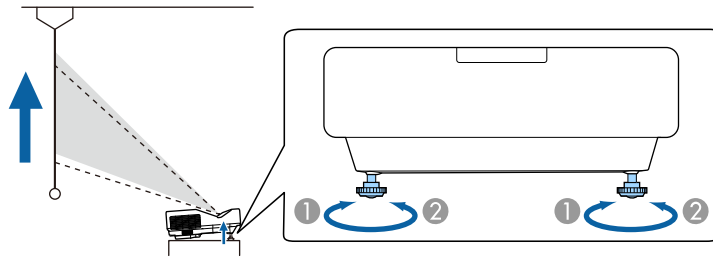

- 1** Extend the front foot
- 2** Retract the front foot

- 3** If the image is tilted, rotate the front feet to adjust their height.

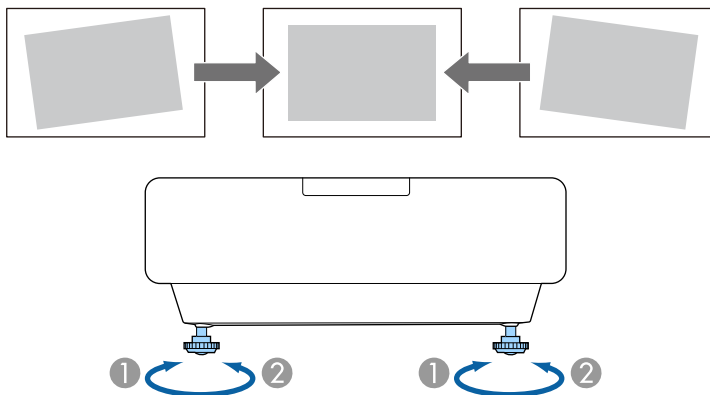

If the projected image is unevenly rectangular, you need to adjust the image shape.

You can project an even, rectangular image by placing the projector directly in front of the center of the screen and keeping it level. If you place the projector at an angle to the screen, or tilt it up or down, or off to the side, you may need to correct the image shape.

After correction, your image is slightly smaller.

For the best quality images, we recommend adjusting the installation position of the projector to achieve the correct image size and shape.

► **Related Links**

- "Correcting the Image Shape with the Keystone Buttons" [p.63](#)
- "Correcting the Image Shape with Quick Corner" [p.64](#)
- "Correcting Image Shape with Arc Correction" [p.66](#)
- "Correcting Image Shape with Point Correction" [p.69](#)
- "Loading Image Shape Setting from Memory" [p.71](#)
- "Correcting Image Shape with Corner Markers" [p.71](#)

Correcting the Image Shape with the Keystone Buttons

You can use the projector's keystone correction buttons to correct the shape of an image that is unevenly rectangular.

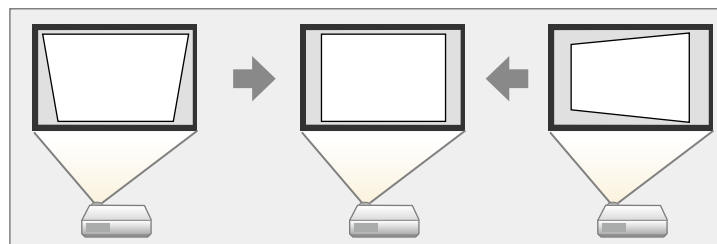

You can use keystone buttons to correct images up to 3° right, left, up, or down.



- If you change the **Screen Type** and **Screen Position** settings, the adjustments are reset.
- You cannot combine with other correction methods.

- 1** Turn on the projector and display an image.
- 2** Press one of the keystone adjustment buttons on the control panel to display the Keystone adjustment screen.

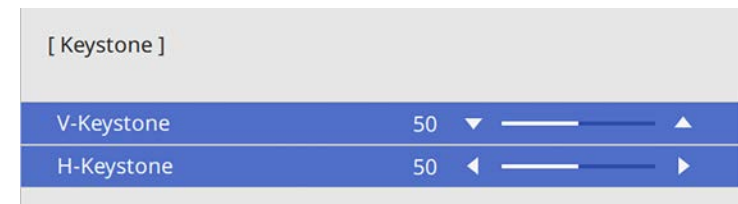
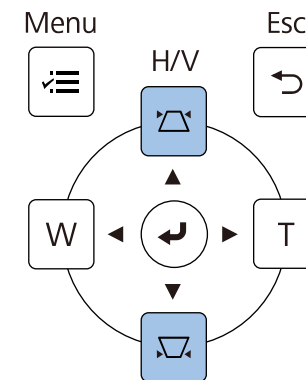

3 Press a keystone button to adjust the image shape.

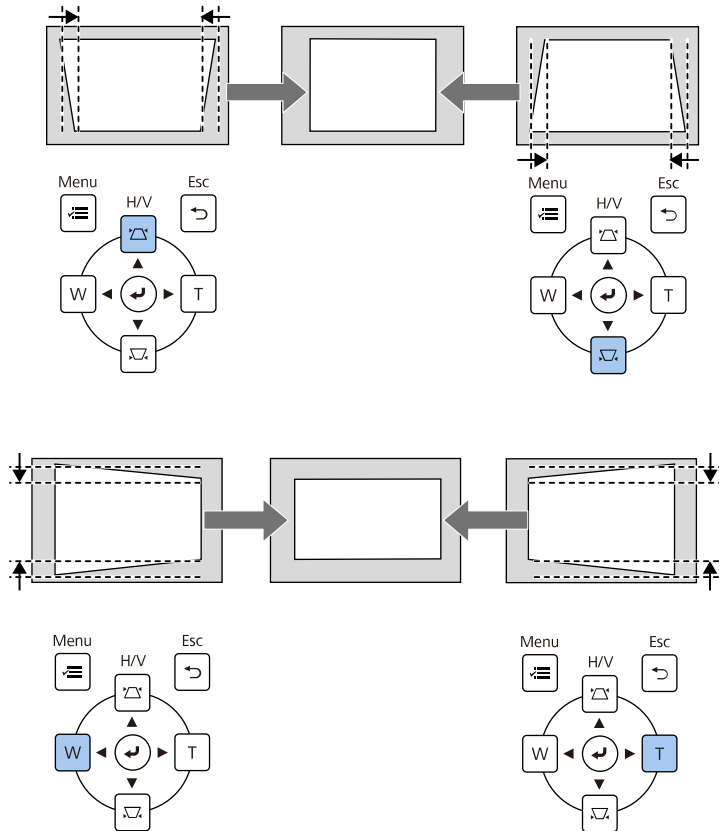

- If the projector is installed out of your reach, you can also correct the shape of the image using the remote control.
 - **Installation > Geometry Correction > H/V-Keystone**
- You can also correct the shape of the image using the [Keystone] button on the remote control (EB-755F/EB-750F).
- To save the current shape of an image you have adjusted, select **Save Memory**. You can save up to three image shapes in the memory.
 - **Installation > Geometry Correction > Memory > Save Memory**

Correcting the Image Shape with Quick Corner

You can use the projector's **Quick Corner** setting to correct the shape and size of an image that is unevenly rectangular.

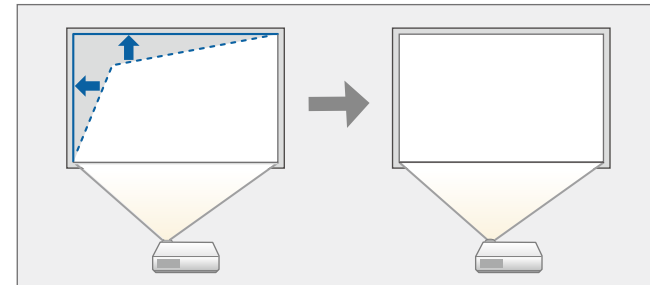

 If you change the **Screen Type** and **Screen Position** settings, the adjustments are reset.

- 1** Turn on the projector and display an image.
- 2** Press the [Menu] button on the control panel or remote control.

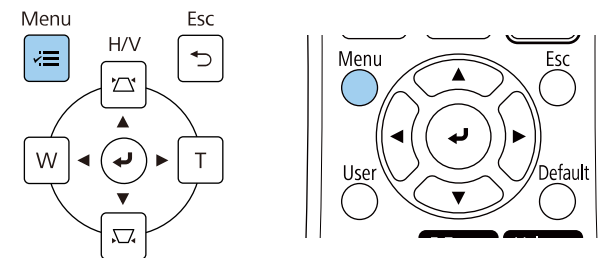

 You can also open the **Geometry Correction** screen using the [Keystone] button on the remote control (EB-755F/EB-750F). Press the [Keystone] button and go to step 5.

3 Select the **Installation** menu and press [Enter].

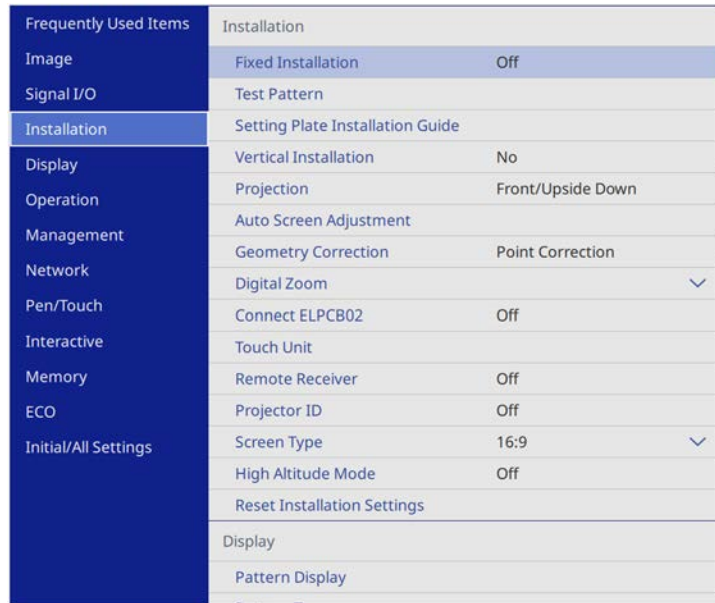

4 Select **Geometry Correction** and press [Enter].

5 Select **Quick Corner** and press [Enter]. Then press [Enter] again if necessary.

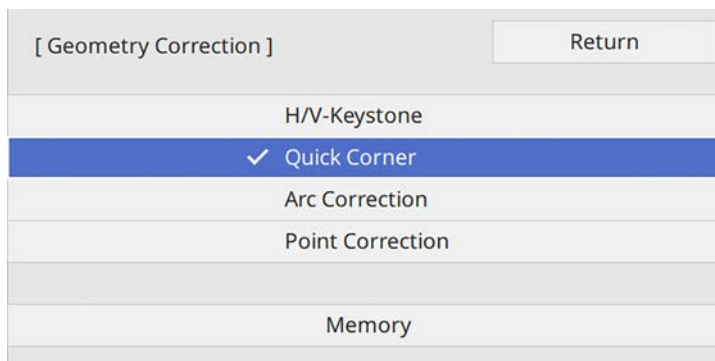

You see the area selection screen.

6 Use the arrow buttons to select the area of the image you want to adjust. Then press [Enter].

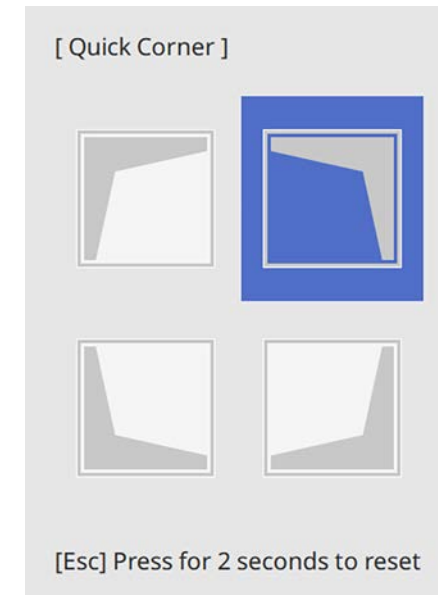

To reset the **Quick Corner** corrections, hold down [Esc] for about 2 seconds while the area selection screen is displayed, and then select **Yes**.

7 Press the arrow buttons to adjust the image shape as necessary. To return to the area selection screen, press [Enter].



- You can also select the area by pressing the following numeric buttons on the remote control:
 - [1] selects the upper left area.
 - [3] selects the upper right area.
 - [7] selects the lower left area.
 - [9] selects the lower right area.
- If you see this screen, you cannot adjust the shape any further in the direction indicated by the gray triangle.

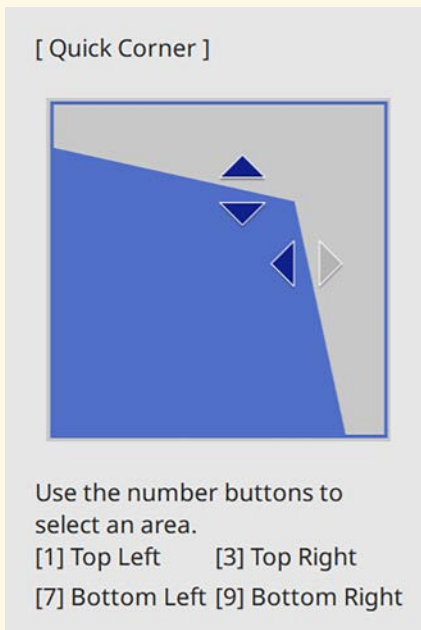

- To save the current shape of an image you have adjusted, select **Save Memory**. You can save up to three image shapes in the memory.
- ☛ **Installation > Geometry Correction > Memory > Save Memory**

Correcting Image Shape with Arc Correction

You can use the projector's **Arc Correction** setting to adjust the shape of an image projected on a curved or spherical surface.

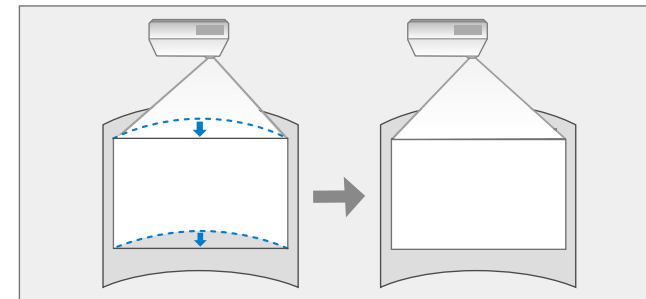

If you change the **Screen Type** and **Screen Position** settings, the adjustments are reset.

- Repeat steps 6 and 7 as needed to adjust any remaining corners.
- When you are finished, press [Esc].

The **Geometry Correction** setting is now set to **Quick Corner** in the projector's **Installation** menu. The next time you press the keystone adjustment buttons on the control panel, the area selection screen is displayed.

- Turn on the projector and display an image.
- Press the [Menu] button on the control panel or remote control.

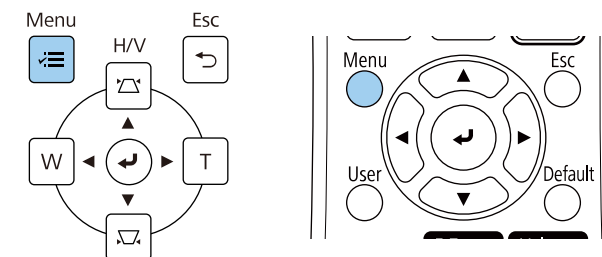



You can also open the **Geometry Correction** screen using the [Keystone] button on the remote control (EB-755F/EB-750F). Press the [Keystone] button and go to step 5.

3 Select the **Installation** menu and press [Enter].

Frequently Used Items	Installation	
Image	Fixed Installation	Off
Signal I/O	Test Pattern	
Installation	Setting Plate Installation Guide	
Display	Vertical Installation	No
Operation	Projection	Front/UpSide Down
Management	Auto Screen Adjustment	
Network	Geometry Correction	Point Correction
Pen/Touch	Digital Zoom	▼
Interactive	Connect ELPCB02	Off
Memory	Touch Unit	
ECO	Remote Receiver	Off
Initial/All Settings	Projector ID	Off
	Screen Type	16:9 ▼
	High Altitude Mode	Off
	Reset Installation Settings	
	Display	
	Pattern Display	

4 Select **Geometry Correction** and press [Enter].

5 Select **Arc Correction** and press [Enter].

[Geometry Correction]	Return
H/V-Keystone	
Quick Corner	
✓ Arc Correction	
Point Correction	
Memory	

6 Select **Arc Correction** and press [Enter].

[Arc Correction]	Return
Quick Corner	
Arc Correction	
Point Correction	
Reset	

You see the area selection screen.

- 7** Use the arrow buttons to select the area of the image you want to adjust, then press [Enter].

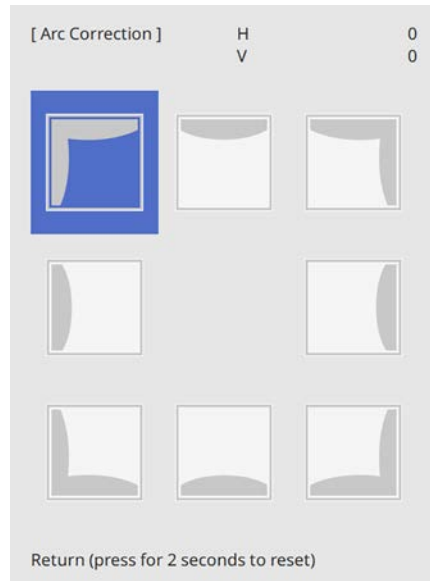

- 8** Press the arrow buttons to adjust the image shape of the selected area as necessary.
To return to the area selection screen, press [Enter].

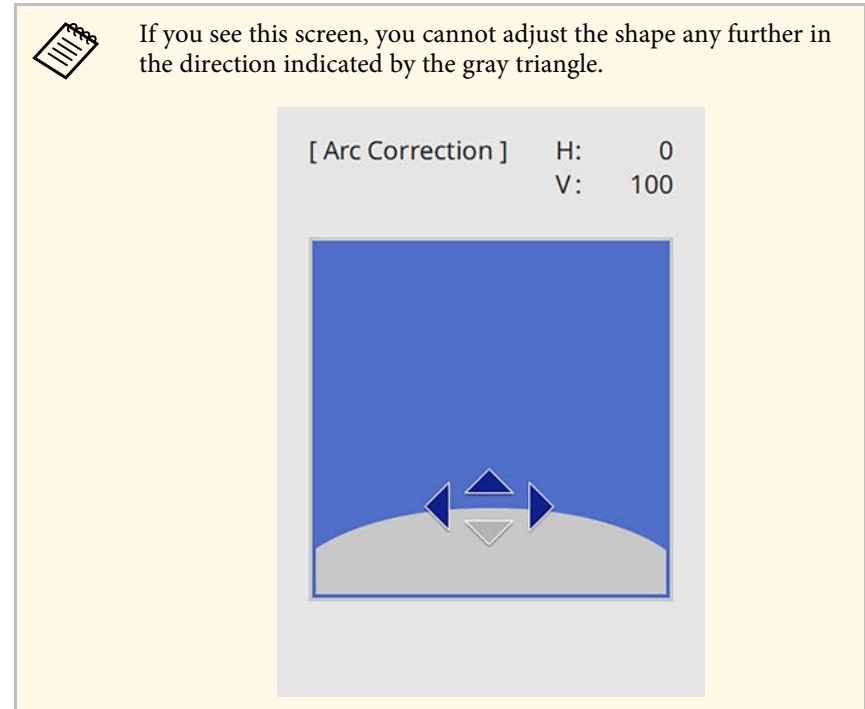

- 9** Repeat steps 7 and 8 as needed to adjust any remaining corners.
- 10** When you are finished, press [Esc].

- You can fine tune the corrected results. Use **Quick Corner** to adjust the tilt of the image, and then use **Point Correction** for fine tuning. Select **Quick Corner** or **Point Correction** on the screen in step 6.
- To save the current shape of an image you have adjusted, select **Save Memory**. You can save up to three image shapes in the memory.
 🖱️ **Installation > Geometry Correction > Memory > Save Memory**
- To reset the **Arc Correction** settings, hold down [Esc] for about 2 seconds while the area selection screen is displayed, and then select **Yes**.

» **Related Links**

- "Correcting the Image Shape with Quick Corner" p.64
- "Correcting Image Shape with Point Correction" p.69

 You can also open the **Geometry Correction** screen using the [Keystone] button on the remote control (EB-755F/EB-750F). Press the [Keystone] button and go to step 5.

Correcting Image Shape with Point Correction

You can use the projector's **Point Correction** setting to fine-tune the image shape in portions of an image. The image is divided into a grid which allows you to move intersection points on the grid as necessary to correct distortion.

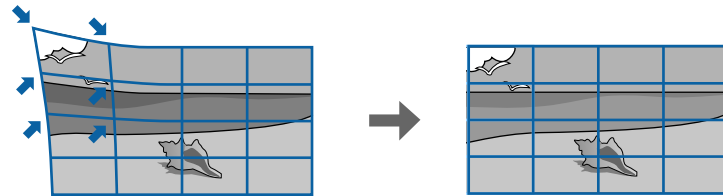

 If you change the **Screen Type** and **Screen Position** settings, the adjustments are reset.

- 1** Turn on the projector and display an image.
- 2** Press the [Menu] button on the control panel or remote control.

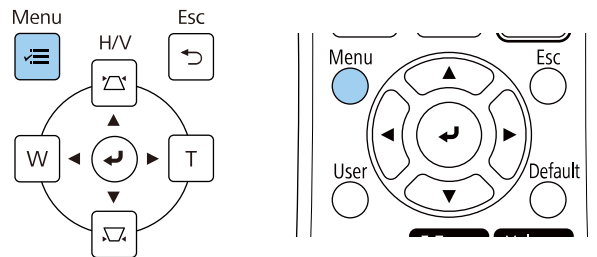

- 3** Select the **Installation** menu and press [Enter].

Frequently Used Items	Installation	
Image	Fixed Installation	Off
Signal I/O	Test Pattern	
Installation	Setting Plate Installation Guide	
Display	Vertical Installation	No
Operation	Projection	Front/Upside Down
Management	Auto Screen Adjustment	
Network	Geometry Correction	Point Correction
Pen/Touch	Digital Zoom	▼
Interactive	Connect ELPCB02	Off
Memory	Touch Unit	
ECO	Remote Receiver	Off
Initial/All Settings	Projector ID	Off
	Screen Type	16:9 ▼
	High Altitude Mode	Off
	Reset Installation Settings	
	Display	
	Pattern Display	

- 4** Select **Geometry Correction** and press [Enter].

- 5** Select **Point Correction** and press [Enter].

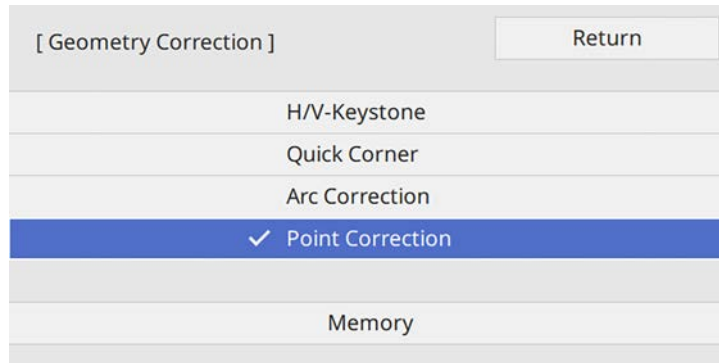

- 6** Select **Point Correction** and press [Enter].



For fine tuning, select **Quick Corner** to correct the shape and size of an image roughly, and then select **Point Correction** to adjust them precisely.

- 7** Select the point number and press [Enter].

You see the grid on the projected image.



If you want to change the grid color for visibility, press [Esc], then select a different **Pattern Color** setting in the **Point Correction** menu.

- 8** Use the arrow buttons to move to the point you want to correct, then press [Enter].

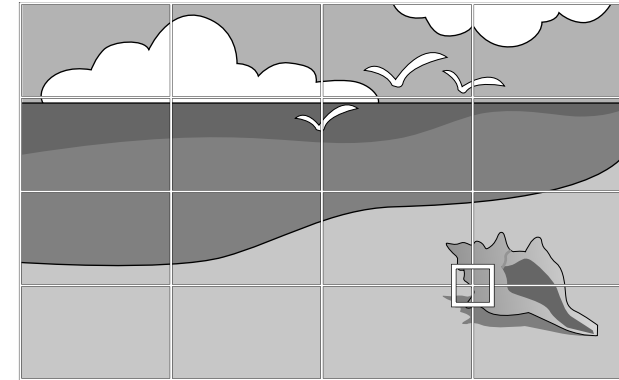

- 9** Use the arrow buttons to correct distortion as necessary.

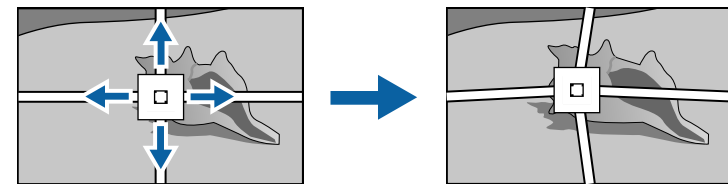

- 10** To correct any remaining points, press [Esc] to return to the previous screen, then repeat steps 8 and 9.

- 11** When you are finished, press [Esc].



- To save the current shape of an image you have adjusted, select **Save Memory**. You can save up to three image shapes in the memory.
Installation > Geometry Correction > Memory > Save Memory
- To reset the **Point Correction** settings to their original positions, select **Reset** on the **Point Correction** screen.

» **Related Links**

- "Correcting the Image Shape with Quick Corner" [p.64](#)

Loading Image Shape Setting from Memory

You can load the image shape settings you selected and saved to the projector's memory and apply them to the current image.

- 1 Turn on the projector and display an image.
- 2 Hold down the [Num] button on the remote control, and then press the numeric button (1, 2, or 3) that matches the number of the saved setting.

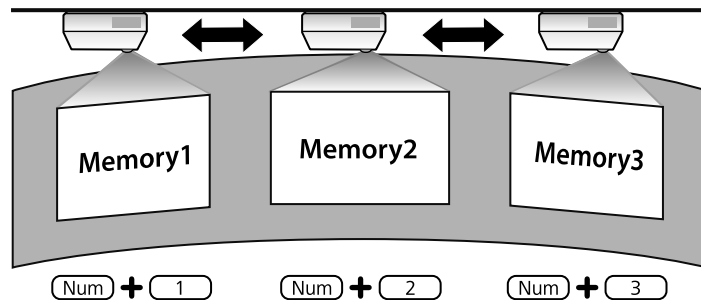

 The illustration above is only an example.

- 3 When you have finished loading the settings, follow the on-screen instructions.

Correcting Image Shape with Corner Markers

If you have installed corner markers on the projection surface, you can use the projector's **Auto Screen Adjustment** setting to correct the shape of an image automatically (EB-735Fi/EB-725Wi).

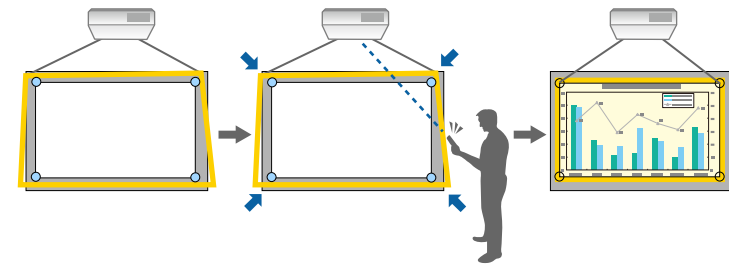

- The **Auto Screen Adjustment** may not work properly depending on the surface of the projected screen. You can perform the **Auto Screen Adjustment** in the following situations:
 - The screen surface is flat.
 - The projection surface is not patterned or dirty and there are no other obstructions on the screen surface.
 - Before performing the **Auto Screen Adjustment**, set the screen type setting. The adjustments reset when you change the **Screen Type**.

Auto Screen Adjustment can correct projected image distortion in these conditions:

- Screen size is 100 inches or less
- Projection angle is within about 1° of squarely facing the projection surface in all directions

- 1 Turn on the projector and display an image.

2 Press the [Menu] button on the control panel or remote control.

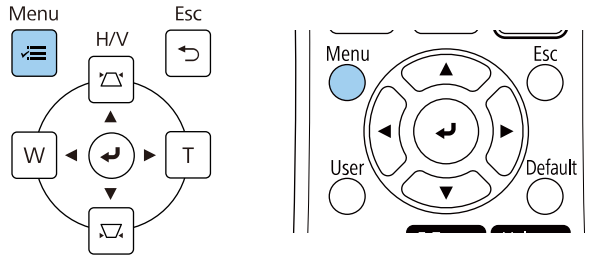

3 Select the **Installation** menu and press [Enter].

Frequently Used Items	Installation
Image	Fixed Installation Off
Signal I/O	Test Pattern
Installation	Setting Plate Installation Guide
Display	Vertical Installation No
Operation	Projection Front/Upside Down
Management	Auto Screen Adjustment
Network	Geometry Correction Point Correction
Pen/Touch	Digital Zoom
Interactive	Connect ELPCB02 Off
Memory	Touch Unit
ECO	Remote Receiver Off
Initial/All Settings	Projector ID Off
	Screen Type 16:9
	High Altitude Mode Off
	Reset Installation Settings
	Display
	Pattern Display

4 Select **Auto Screen Adjustment** and press [Enter].

Frequently Used Items	Installation
Image	Fixed Installation Off
Signal I/O	Test Pattern
Installation	Setting Plate Installation Guide
Display	Vertical Installation No
Operation	Projection Front/Upside Down
Management	Auto Screen Adjustment
Network	Geometry Correction Point Correction
Pen/Touch	Digital Zoom
Interactive	Connect ELPCB02 Off
Memory	Touch Unit
ECO	Remote Receiver Off
Initial/All Settings	Projector ID Off
	Screen Type 16:9
	High Altitude Mode Off
	Reset Installation Settings
	Display
	Pattern Display

You see a guide screen.

5 Follow the on-screen instructions to adjust the position of the projected image so that the corner markers appear just inside the yellow area.

6 Press [Enter].
The guide pattern appears and the projector starts adjusting the image shape.

If there are any distortions in the shape of the projected images as a result of the adjustments, correct the image shape using the **Quick Corner** correction.

You can resize the image using the Wide and Tele buttons.



- For the best quality images, we recommend adjusting the installation position of the projector to achieve the correct image size and shape.
- We recommend adjusting the image size at least 30 minutes after you start projecting, because images are not stable right after turning on the projector.

- 1** Turn on the projector and display an image.
- 2** Press the Wide button on the projector's control panel to enlarge the image size. Press the Tele button to reduce the image size.

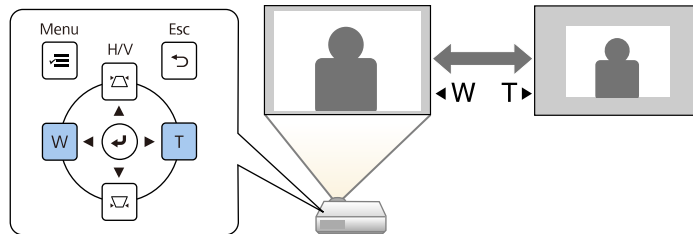

You can also adjust the **Digital Zoom** setting in the projector's **Installation** menu.

You can use the **Image Shift** feature to adjust the image position without moving the projector.



- This feature is not available if the Zoom option is set to the widest setting.
- We recommend adjusting the image position at least 30 minutes after you start projecting, because images are not stable right after turning on the projector.

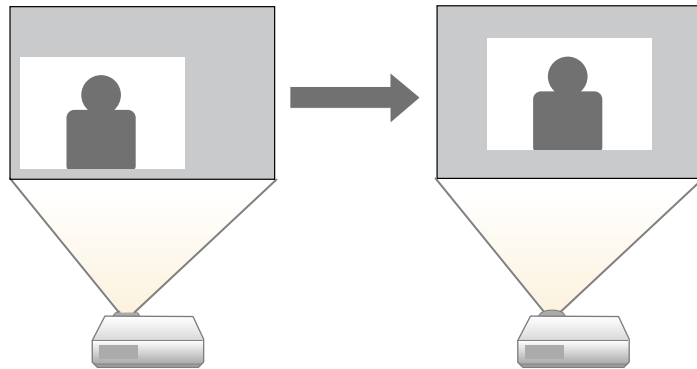

- 1** Turn on the projector and display an image.
- 2** Adjust the image size using the Wide and Tele buttons.
After you adjust the image size, the Image Shift screen is displayed automatically.

- 3** Use the arrow buttons to adjust the image position.

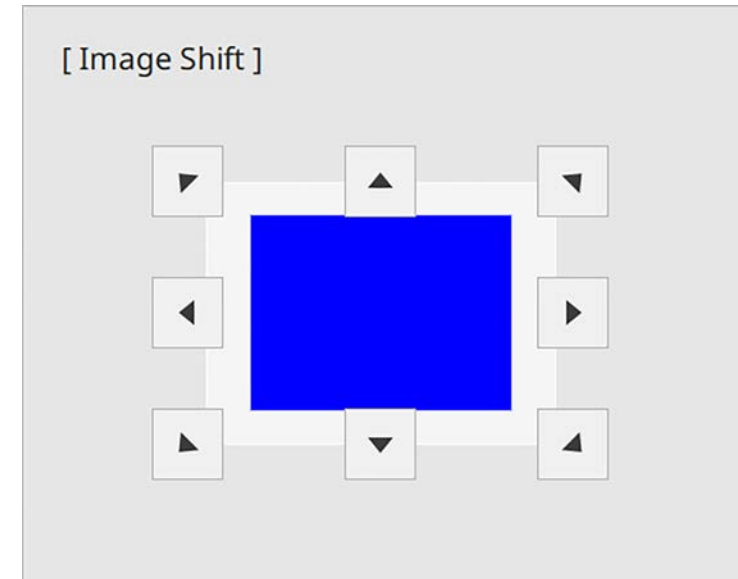

- 4** Press the [Esc] button to close the adjustment screen.
The adjustment screen disappears if no operation is performed after approximately 10 seconds.



- The Image Shift setting is retained even if the projector is turned off. You need to re-adjust the position if you change the installation location or angle of the projector.
- You can also adjust the **Image Shift** setting in the projector's **Installation** menu.

When multiple image sources are connected to the projector, such as a computer and DVD player, you can switch from one image source to the other.

- 1** Make sure the connected image source you want to use is turned on.
- 2** For video image sources, insert a DVD or other video media and press play.
- 3** Do one of the following:
 - Press the [Source Search] button on the control panel or remote control until you see the image from the source you want.

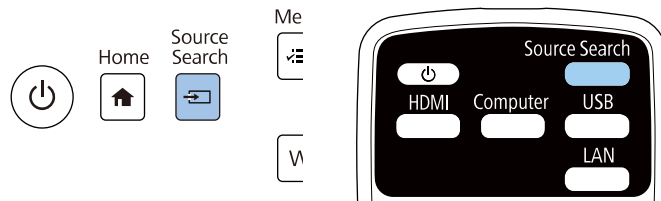

 This screen is displayed when no image signal is detected. Check the cable connections between the projector and image source.

[Source Search]	
	Signal Status
HDMI1	Off
HDMI2	Off
HDMI3	Off
Computer1	Off
Computer2	Off
Video	Off
USB Display	Off
USB	Off
LAN	Off
Screen Mirroring1	Off
Screen Mirroring2	Off

Input an image signal.
Press to select the source.

- Press the button for the source you want on the remote control. If there is more than one port for that source, press the button again to cycle through the sources.

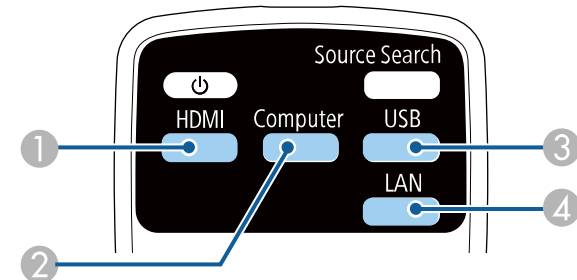

- 1 Video and HDMI sources (Video, HDMI1, HDMI2, and HDMI3 ports)
 - 2 Computer port source (Computer1 and Computer2 ports)
 - 3 USB port sources (USB-B port and external devices connected to the USB-A ports)
 - 4 Network source (LAN and Screen Mirroring)
- Press the [Home] button on the control panel or remote control.

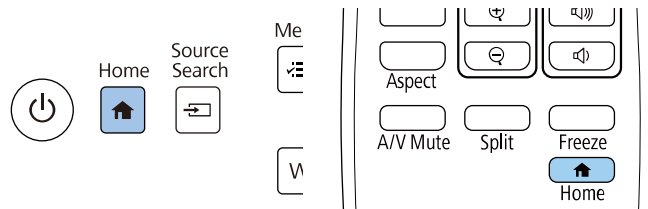

Then select the source you want to use from the screen displayed.

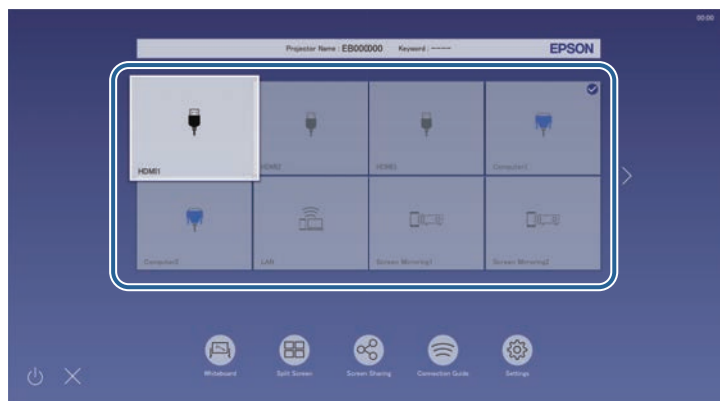

- The display order of the input sources changes when the projector detects an input signal. (The detected input source appears in the upper left position.)
- A check mark appears on the image from the current input source. You can check a preview of the current input image for most sources as a thumbnail (other than the USB input source in Content Playback mode).
- If there are more than nine available input sources, your desired source may appear on the next page. Select the right arrow to move to the next page.

The projector can display images in different width-to-height ratios called aspect ratios. Normally, the input signal from your video source determines the image's aspect ratio. However, for certain images you can change the aspect ratio to fit your screen.

If you always want to use a particular aspect ratio for a certain video input source, you can select it using the projector's **Image** menu.

► **Related Links**

- "Changing the Image Aspect Ratio" [p.77](#)
- "Available Image Aspect Ratios" [p.77](#)
- "Projected Image Appearance with Each Aspect Mode" [p.78](#)

Changing the Image Aspect Ratio

You can change the aspect ratio of the displayed image.



- Set the **Screen Type** setting in the projector's **Installation** menu before changing the aspect ratio.
- This setting is available only when the **Scale** setting is turned off or the **Scale Mode** setting is set to **Full Display**. (EB-755F/EB-750F)
 **Image > Scale > Scale Mode**

1 Turn on the projector and switch to the image source you want to use.

2 Press the [Aspect] button on the remote control.

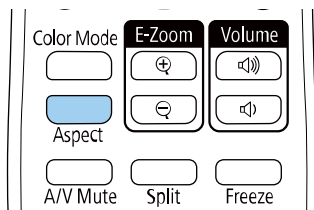

The shape and size of the displayed image changes, and the name of the aspect ratio appears briefly on the screen.

3 To cycle through the available aspect ratios for your input signal, press the [Aspect] button repeatedly.



To display images without black bars, set **Resolution** to **Wide** or **Normal** in the projector's **Image** menu according to the computer's resolution.

Available Image Aspect Ratios

You can select the following image aspect ratios, depending on the selected **Screen Type** setting and the input signal from your image source.



- Note that using the aspect ratio function of the projector to reduce, enlarge, or split the projected image for commercial purposes or for public viewing may infringe upon the rights of the copyright holder of that image based on copyright law.

Aspect mode	Description
Auto	Automatically sets the aspect ratio according to the input signal and the Resolution setting.
Full	Displays images using the full size of the projection area, but does not maintain the aspect ratio.
Zoom	Displays images using the full width of the projection area and maintains the aspect ratio of the image. Areas that exceed the edges of the projected screen are not projected.
Native	Displays images as is (aspect ratio and resolution are maintained). Areas that exceed the edges of the projected screen are not projected.

Projected Image Appearance with Each Aspect Mode

Black bands and cropped images may project in certain aspect ratios, depending on the aspect ratio and resolution of your input signal. See the following table to confirm the position of black bands and cropped images.



- The black parts show the image area in the projection area and the gray parts show the area where the image is not displayed according to the aspect ratio setting.
- The available aspect ratio setting varies depending on the input signal.
- If there are margins between the edge of the image and the projected screen frame, you can adjust the position of the image using the **Screen Position** setting in the projector's **Installation** menu.
☛ Installation > Screen Type > Screen Position

EB-755F/EB-750F/EB-735Fi/EB-735F:

Screen type setting: 16:9

Aspect mode	Aspect ratio for input signals		
	16:10	16:9	4:3
Auto			
Full			
Zoom			
Native			

Screen type setting: 16:10

Aspect mode	Aspect ratio for input signals		
	16:10	16:9	4:3
Auto			
Full			
Zoom			
Native			

Screen type setting: 4:3

Aspect mode	Aspect ratio for input signals		
	16:10	16:9	4:3
Auto			
Full			

Aspect mode	Aspect ratio for input signals		
	16:10	16:9	4:3
Zoom			
Native			

Screen type setting: 16:6

Aspect mode	Aspect ratio for input signals			
	16:10	16:9	4:3	16:6
Auto				
Full				

EB-725Wi/EB-725W:

Screen type setting: 16:10

Aspect mode	Aspect ratio for input signals		
	16:10	16:9	4:3
Auto			
Full			
Zoom			
Native			

Screen type setting: 16:9

Aspect mode	Aspect ratio for input signals		
	16:10	16:9	4:3
Auto			

Aspect mode	Aspect ratio for input signals		
	16:10	16:9	4:3
Full			
Zoom			
Native			

Aspect mode	Aspect ratio for input signals		
	16:10	16:9	4:3
Native			

EB-720:







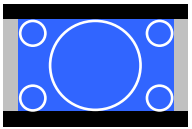
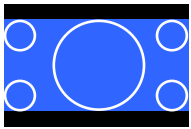
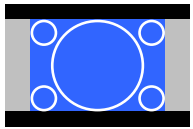
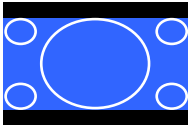

Screen type setting: 4:3

Screen type setting: 4:3

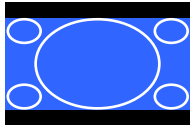
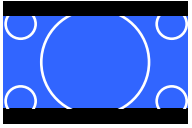
Aspect mode	Aspect ratio for input signals		
	16:10	16:9	4:3
Auto			
Full			
Zoom			



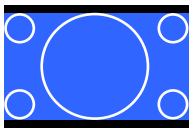
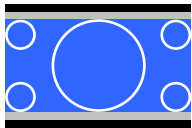
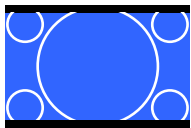
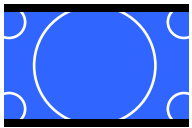
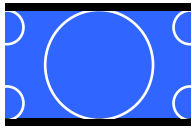
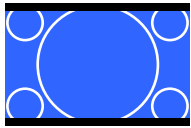

Aspect mode	Aspect ratio for input signals		
	16:10	16:9	4:3
Auto			
Full			
Zoom			
Native			

Screen type setting: 16:9

Aspect mode	Aspect ratio for input signals		
	16:10	16:9	4:3
Auto			
Full			
Zoom			
Native			

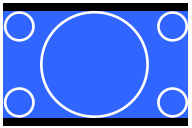
Aspect mode	Aspect ratio for input signals		
	16:10	16:9	4:3
Zoom			
Native			

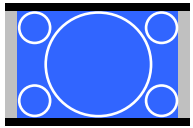
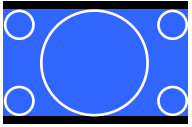
Screen type setting: 16:10

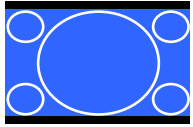
Aspect mode	Aspect ratio for input signals		
	16:10	16:9	4:3
Auto			
Full			

The projector offers different color modes to provide optimum brightness, contrast, and color for a variety of viewing environments and image types. You can select the mode designed to match your image and environment, or experiment with the available modes.

► **Related Links**

- "Changing the Color Mode" [p.82](#)
- "Available Color Modes" [p.82](#)
- "Turning On Automatic Luminance Adjustment" [p.82](#)

 You can also set the **Color Mode** setting in the projector's **Image** menu.

Changing the Color Mode

You can change the projector's Color Mode using the remote control to optimize the image for your viewing environment.

- 1** Turn on the projector and switch to the image source you want to use.
- 2** Press the [Color Mode] button on the remote control to change the Color Mode.

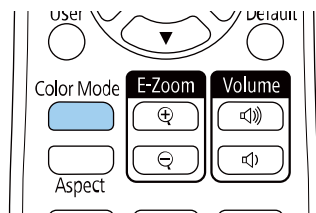

The name of the Color Mode appears briefly on the screen and then image appearance changes.

- 3** To cycle through all of the available color modes for your input signal, press the [Color Mode] button repeatedly.

Available Color Modes

You can set the projector to use these color modes, depending on the input source you are using:

Color mode	Description
Dynamic	This is the brightest mode. Best for prioritizing brightness.
Presentation	Best for projecting vivid images.
Cinema	Best for enjoying content such as movies.
sRGB	Best for faithfully reproducing the color of the source image.
Blackboard (EB-735Fi/EB-735F/EB-725 Wi/EB-725W/EB-720)	Best for projecting images directly on a green chalkboard.
DICOM SIM (EB-755F/EB-750F)	Best for projecting X-ray photographs and other medical images. This mode is for reference purposes only and should not be used to make medical diagnoses.
Multi-Projection (EB-755F/EB-750F)	Best for projecting from multiple projectors (reduces the color tone difference between images).

Turning On Automatic Luminance Adjustment

You can turn on Dynamic Contrast to automatically optimize the image luminance. This improves the image contrast based on the brightness of the content you project.

- 1** Turn on the projector and switch to the image source you want to use.

2 Press the [Menu] button on the control panel or remote control.

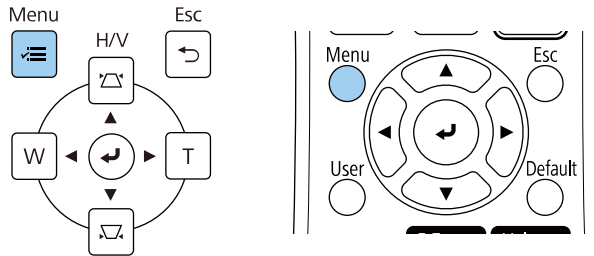

- **High Speed** to adjust brightness as soon as the scene changes.

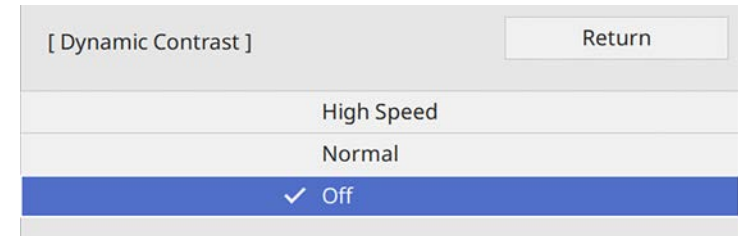

3 Select the **Image** menu and press [Enter].

Frequently Used Items	Image	
Image	Color Mode	Presentation
Signal I/O	Brightness	50
Installation	Contrast	50
Display	Color Saturation	50
Operation	Tint	50
Management	Sharpness	50
Network	White Balance	
Pen/Touch	Dynamic Contrast	Off
Interactive	Image Enhancement	
Memory	Gamma	0
ECO	RGBCMY	
Initial/All Settings	Reset to Defaults	
	Source	Computer1
	Resolution	Auto
	Aspect	Auto
	Analog Signal Adjustment	
	Reset to Defaults	
	Reset Image Settings	

6 Press [Menu] or [Esc] to exit the menus.

4 Select **Dynamic Contrast** and press [Enter].

5 Choose one of the following options and press [Enter]:

- **Normal** for standard brightness adjustment.

You can fine-tune various aspects of how colors are displayed in your projected images.

» **Related Links**

- "Adjusting the Hue, Saturation, and Brightness" [p.84](#)
- "Adjusting the Gamma" [p.85](#)

Adjusting the Hue, Saturation, and Brightness

You can adjust the Hue, Saturation, and Brightness settings for individual image colors.

- 1 Turn on the projector and switch to the image source you want to use.
- 2 Press the [Menu] button on the control panel or remote control.

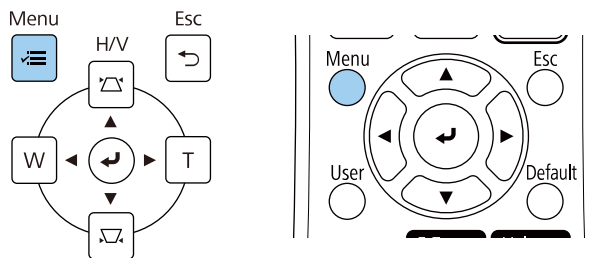

- 3 Select the **Image** menu and press [Enter].

Frequently Used Items	Image	
Image	Color Mode	Presentation
Signal I/O	Brightness	50
Installation	Contrast	50
Display	Color Saturation	50
Operation	Tint	50
Management	Sharpness	50
Network	White Balance	
Pen/Touch	Dynamic Contrast	Off
Interactive	Image Enhancement	
Memory	Gamma	0
ECO	RGBCMY	
Initial/All Settings	Reset to Defaults	
	Source	Computer1
	Resolution	Auto
	Aspect	Auto
	Analog Signal Adjustment	
	Reset Image Settings	

- 4 Select **RGBCMY** and press [Enter].
- 5 Select the color to adjust, and press [Enter].

[RGBCMY]		Return	
	Hue	Saturation	Brightness
R	50	50	50
G	50	50	50
B	50	50	50
C	50	50	50
M	50	50	50
Y	50	50	50

- 6** Do the following as necessary for each setting:
- To adjust the overall hue of the color, bluish - greenish - reddish, adjust the **Hue** setting.
 - To adjust the overall vividness of the color, adjust the **Saturation** setting.
 - To adjust the overall color brightness of the color, adjust the **Brightness** setting.



- 7** Press [Menu] or [Esc] to exit the menus.

- 3** Select the **Image** menu and press [Enter].

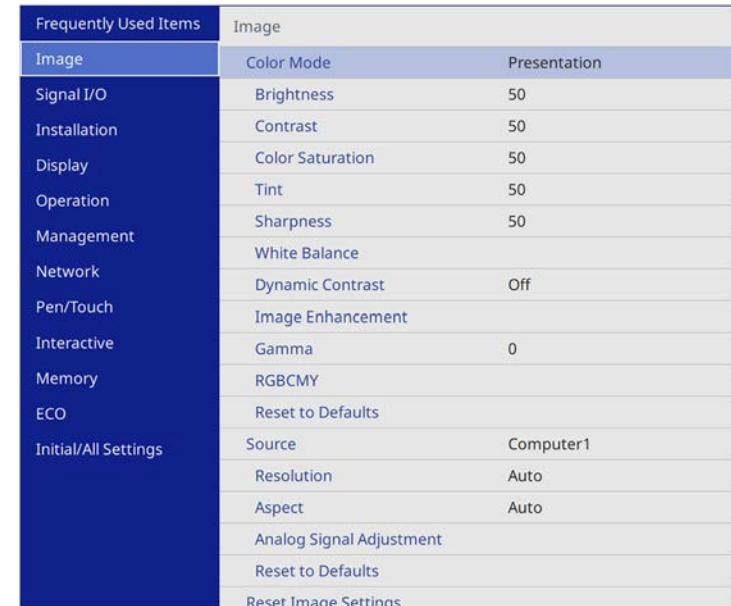

Adjusting the Gamma

You can correct differences in projected image colors that occur between different image sources by adjusting the Gamma setting.

- 1** Turn on the projector and switch to the image source you want to use.
- 2** Press the [Menu] button on the control panel or remote control.

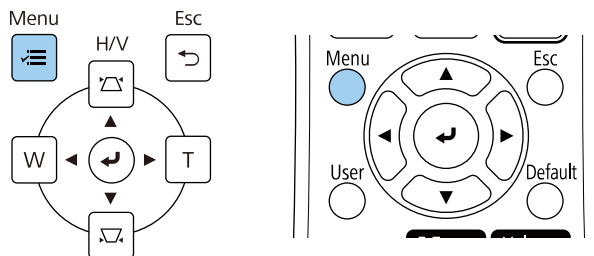

- 4** Select **Gamma** and press [Enter].

- 5** Select and adjust the correction value.

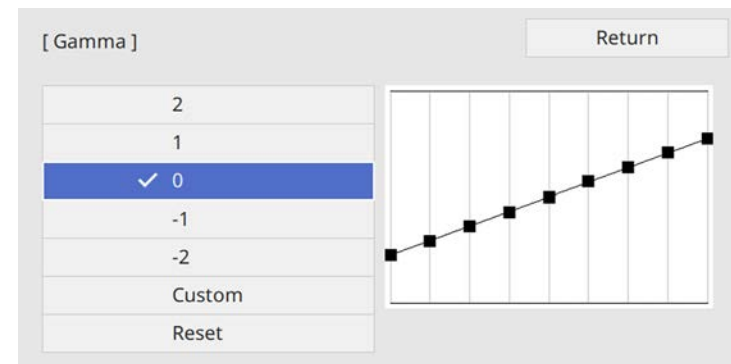

When you select a smaller value, you can reduce the overall brightness of the image to make the image sharper. When you select a larger value, the dark areas of images become brighter, but the color saturation for lighter areas may become weaker.

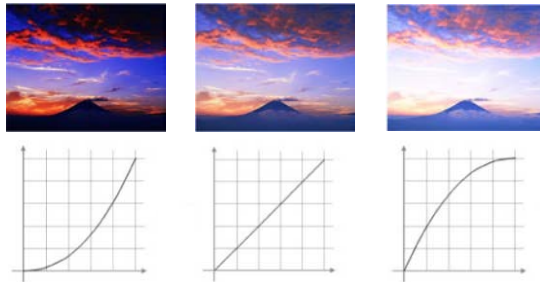

- If you set the **Color Mode** setting to **DICOM SIM** in the projector's **Image** menu, select the adjustment value according to the projection size (EB-755F/EB-750F).
- If the projection size is 80 inches or less, select a small value.
- If the projection size is 80 inches or more, select a large value.
- Medical images may not be reproduced correctly depending on your settings and screen specifications.

6 If you want to make finer adjustments, select **Customized** and press [Enter].

7 Press the left or right arrow buttons to select the color tone you want to adjust on the gamma adjustment graph. Then press the up or down arrow button to adjust the value and press [Enter].

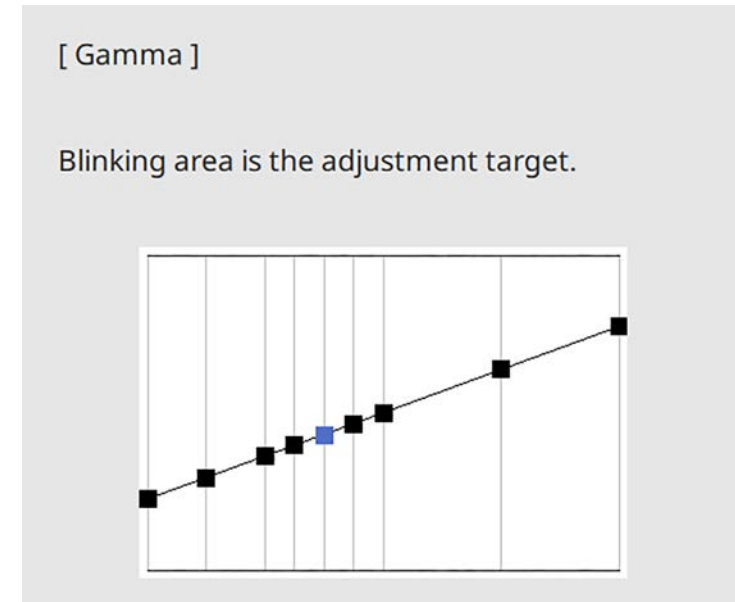

8 Press [Menu] or [Esc] to exit the menus.

You can adjust the resolution of the image to reproduce a clear image with an emphatic texture and material feel.

- 1** Turn on the projector and switch to the image source you want to use.
- 2** Press the [Menu] button on the control panel or remote control.

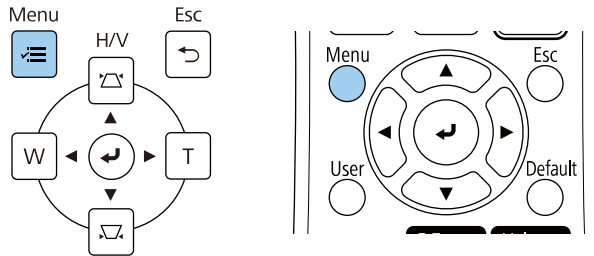

- 3** Select the **Image** menu and press [Enter].

Frequently Used Items	Image	
Image	Color Mode	Presentation
Signal I/O	Brightness	50
Installation	Contrast	50
Display	Color Saturation	50
Operation	Tint	50
Management	Sharpness	50
Network	White Balance	
Pen/Touch	Dynamic Contrast	Off
Interactive	Image Enhancement	
Memory	Gamma	0
ECO	RGBCMY	
Initial/All Settings	Reset to Defaults	
	Source	Computer1
	Resolution	Auto
	Aspect	Auto
	Analog Signal Adjustment	
	Reset to Defaults	
	Reset Image Settings	

- 4** Select **Image Enhancement** and press [Enter].
- 5** Select **Image Preset Mode** and press [Enter].

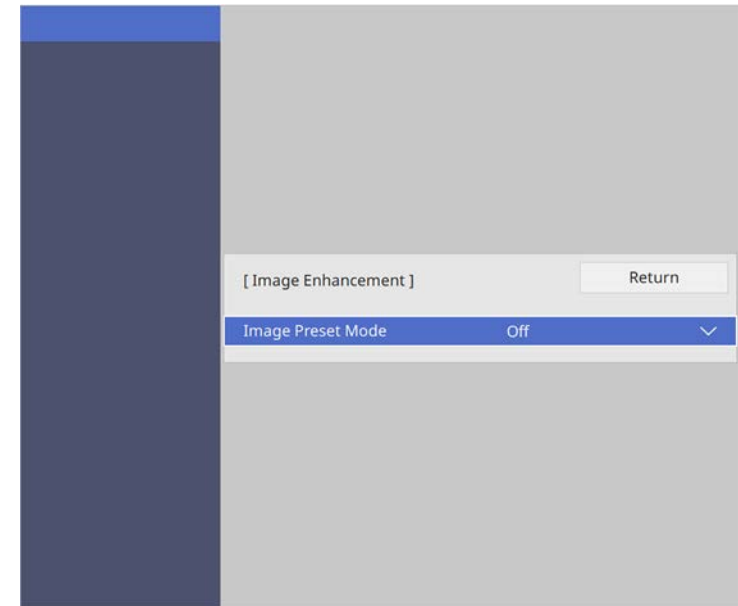

- 6** Select the preset option and press [Enter].

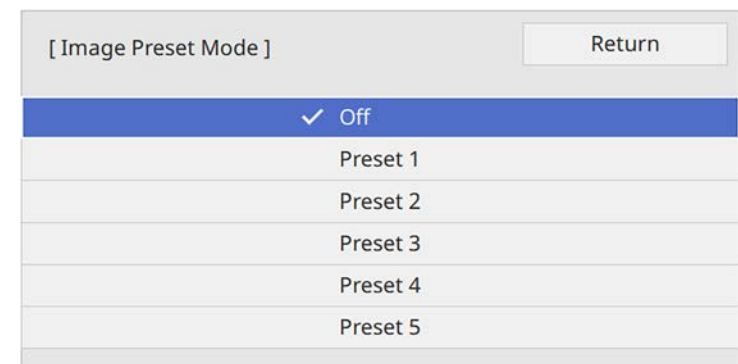

The following settings saved in the preset option are applied to the image.

- **Noise Reduction**
- **MPEG Noise Reduction**
- **Deinterlacing**
- **Super-resolution**
- **Detail Enhancement**

7 Adjust each setting in the projector's **Image** menu individually as necessary.

- To reduce flickering in images, adjust the **Noise Reduction** setting.
- To reduce the noise or artifacts seen in MPEG video, adjust the **MPEG Noise Reduction** setting.
- To convert interlaced-to-progressive signals for certain video image types, adjust the **Deinterlacing** setting.
 - **Off**: for fast-moving video images.
 - **Video**: for most video images.
 - **Film/Auto**: for movies, computer graphics, and animation.



Setting is only displayed when the current signal is interlaced signal (480i/576i/1080i).

- To reduce blurring appeared when projecting low resolution image, adjust the **Super-resolution** setting.
- To create a more emphatic texture and material feel of the image, adjust the **Detail Enhancement** setting.



The settings value in the preset option are overwritten.

8 Press [Menu] or [Esc] to exit the menus.

You can adjust the brightness of your projector's light source.

- 1 Turn on the projector and switch to the image source you want to use.
- 2 Press the [Menu] button on the control panel or remote control.

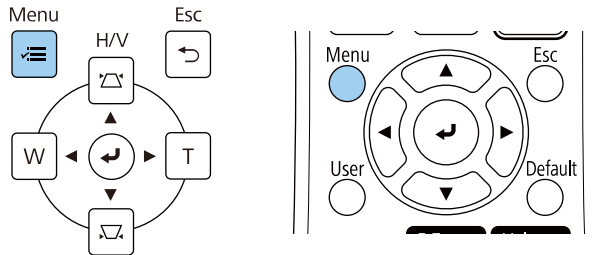

- 3 Select the **Operation** menu and press [Enter].

Frequently Used Items	Operation
Image	Auto Source Search On
Signal I/O	Light Source Brightness Cont...
Installation	Direct Power On Off
Display	Auto Power On Off
Operation	Sleep Mode On
Management	Sleep Mode Timer 10 min.
Network	AV Mute Timer On
Pen/Touch	Standby Mode Communication On
Interactive	Port Wired LAN
Memory	Quick Startup Off
ECO	Indicators On
Initial/All Settings	Inv Direction Button Off
	Reset Operation Settings
	Management
	User Button Light Source Mode
	User's Logo
	User Pattern

- 4 Select **Light Source Brightness Control** and press [Enter].

- 5 If you want to maintain the brightness at a specific level, select the **Maintain Brightness** setting and select **On**.

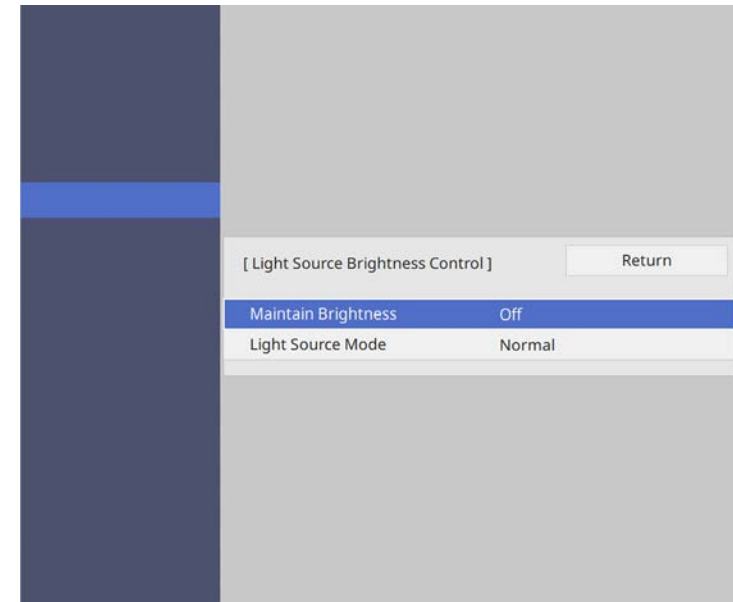

- 6 If you turn on **Maintain Brightness**, select the **Maintain Brightness Level** setting and check the **Estimated Remains** information.

- 7 If you turn off **Maintain Brightness**, select the **Light Source Mode** setting:

- **Normal** lets you set the brightness to the maximum level. This makes the light source operation time approximately 20,000 hours.
- **Quiet** lets you set the brightness to 70% and reduces fan noise. This makes the light source operation time approximately 20,000 hours.
- **Extended** lets you set the brightness to 70% and extends the life expectancy of the light source. This makes the light source operation time approximately 30,000 hours.

- **Custom** lets you to select a custom brightness level between 70 to 100%.

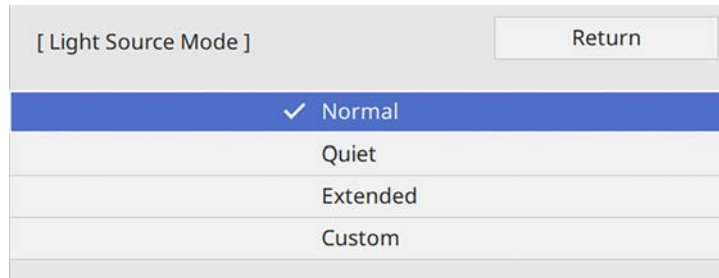

8 If you set the **Light Source Mode** setting to **Custom**, select **Brightness Level** and use the left and right arrow buttons to select the brightness.

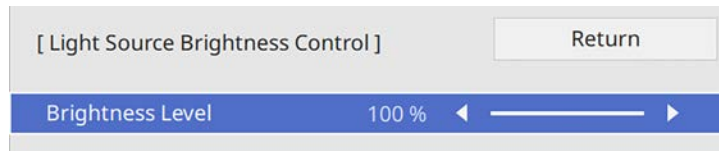

9 Press [Menu] or [Esc] to exit the menus.

 For the best results in maintaining a constant brightness, set the **Light Source Calibration** setting to **Run Periodically** in the projector's **Management** menu.





» **Related Links**

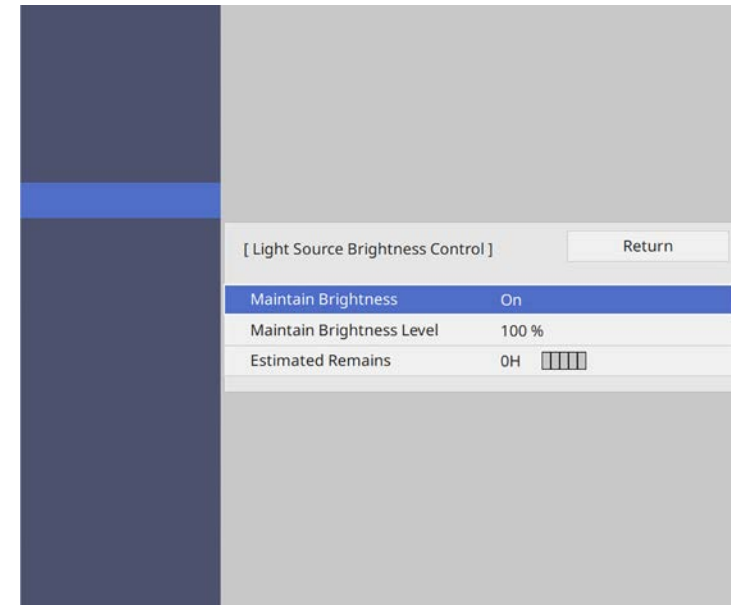

- "Constant Brightness Usage Hours" [p.90](#)
- "Light Source Operation Time" [p.91](#)
- "Projector Specifications" [p.297](#)

Constant Brightness Usage Hours

If you turn on **Maintain Brightness**, the number of hours the projector can maintain constant brightness is displayed as **Estimated Remains**.



Display level	Estimated remaining hours
	10000 or more hours
	8000 to 9999 hours
	6000 to 7999 hours
	4000 to 5999 hours

Display level	Estimated remaining hours
	2000 to 3999 hours
	0 to 1999 hours

 The number of hours displayed as **Estimated Remains** is just a guide.

Light Source Operation Time

The light source operation time varies depending on the **Brightness Level** setting and whether **Maintain Brightness** is on or off.

- 
- The light source operation time varies depending on the environmental conditions and usage.
 - The hours listed here are an approximate and are not guaranteed.
 - You may need to replace internal parts sooner than the estimated light source operation time.
 - If **Maintain Brightness** is turned on, and you have exceeded the usage hours listed here, you may not be able to select a high **Maintain Brightness Level** setting.

Maintain Brightness off

Brightness Level setting	Time before the brightness of the light source is reduced by half (approximate)
100%	20000 hours
90%	21000 hours
80%	24000 hours
70%	30000 hours

Maintain Brightness on

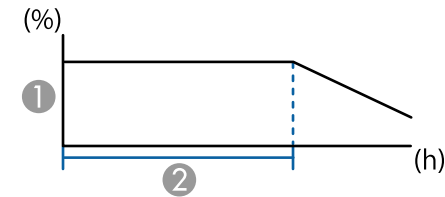

- ① Maintain brightness level
- ② Time the projector can maintain constant brightness (approximate)

Maintain Brightness Level setting	Time the projector can maintain constant brightness (approximate)
85%	6000 hours
80%	10000 hours
70%	19000 hours

The volume buttons control the projector's internal speaker system.

You can also control the volume of any external speakers you connected to the projector.

You must adjust the volume separately for each connected input source.

- 1** Turn on the projector and start a presentation.
- 2** To lower or raise the volume, press the [Volume] buttons on the remote control as shown.

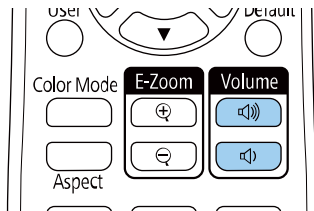

A volume gauge appears on the screen.

- 3** To set the volume to a specific level for an input source, select **Volume** in the projector's **Signal I/O** menu.

Caution

Do not start a presentation at a high volume setting. Sudden loud noises may cause hearing loss.

Always lower the volume before powering off, so that you can power on and then gradually increase the volume.

Using the Interactive Features

Follow the instructions in these sections to use the interactive features.

► Related Links

- "Interactive Feature Modes" [p.94](#)
- "Preparing Before Using Interactive Features" [p.96](#)
- "Whiteboard Screens (Whiteboard Mode)" [p.101](#)
- "Draw on the Projected Image Using Annotation Mode" [p.107](#)
- "Sharing Drawings" [p.111](#)
- "Control Computer Features from a Projected Screen (Computer Interactive Mode)" [p.117](#)
- "Controlling a Document Camera" [p.121](#)
- "Selecting Network Device Display" [p.122](#)
- "Using the Interactive Features over a Network" [p.124](#)
- "Using Split Screen Projection" [p.125](#)

You can perform the following operations with the interactive features.



- The interactive features are only available for EB-735Fi/EB-725Wi.
- To perform touch operations with your finger, you need to install the optional Touch Unit. See your projector's *Installation Guide* for details.

- In whiteboard mode, you can use interactive pens or your finger to write on the projected "whiteboard".

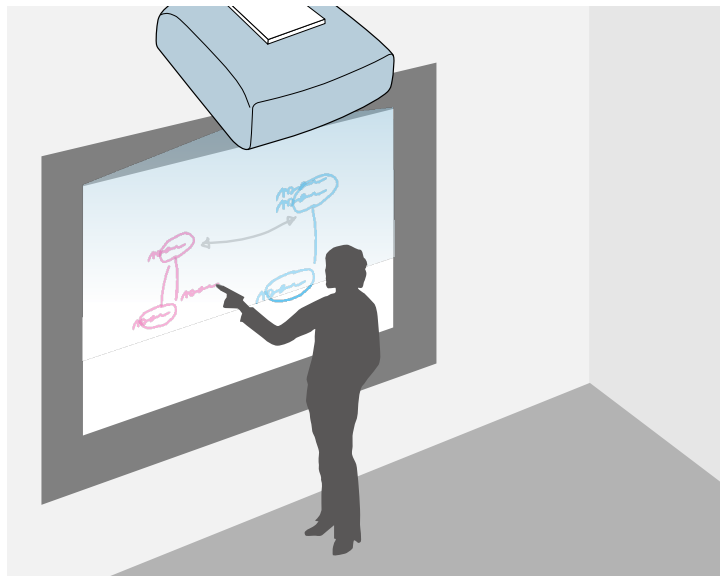

You do not need to use a computer or install any additional software to use the built-in whiteboard drawing feature. This is useful in meetings as a substitute for a whiteboard.

You can share the drawing contents you create with other projectors, save it as a PDF or PNG file, and print it or send it as an email.

- In annotation mode, you can use interactive pens or your finger to add notes to content projected from a computer, tablet, document camera, or other source.



This helps you emphasize projected information or include additional notes for more effective lessons or presentations.

You can capture your annotated pages, then save or print them.

- In computer interactive mode, you can use interactive pens or your finger as you would use a mouse. This allows you to navigate, select, and scroll through content projected from your computer.

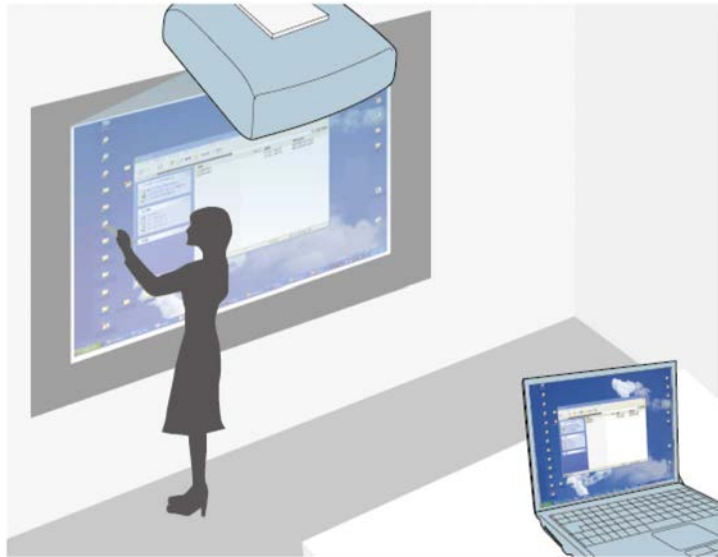

- You can also use the Easy Interactive Tools software to provide additional interactive features, such as saving and printing your annotations. See the *Easy Interactive Tools Operation Guide* for instructions.

► Related Links

- "Whiteboard Screens (Whiteboard Mode)" [p.101](#)
- "Draw on the Projected Image Using Annotation Mode" [p.107](#)
- "Control Computer Features from a Projected Screen (Computer Interactive Mode)" [p.117](#)
- "Getting the Latest Version of the Documents" [p.10](#)

This section provides safety instructions on setting up and using the interactive pens or performing touch operations with your finger. Read these instructions before using the interactive features.

► Related Links

- "Safety Instructions for Interactive Features" [p.96](#)
- "Using the Interactive Pens" [p.96](#)
- "Using Interactive Touch Operations with Your Finger" [p.98](#)

Safety Instructions for Interactive Features

The interactive feature operates by infrared communication. Note the following important points when using this feature.

- Make sure there is no strong light or sunlight shining on the interactive pen receiver and the projection screen.
- If there is any dust stuck to the interactive pen receiver, it could interfere with infrared communication and you may not be able to use the features normally. Clean the receiver if it is dirty.
- Do not put paint or any stickers on the cover of the interactive pen receiver.
- Do not use an infrared remote control or infrared microphone in the same room because the interactive pen may malfunction.
- Do not use devices that generate powerful noise, such as rotary devices or transformers, near the projector. You may not be able to operate the interactive features.

Using the Interactive Pens

Before using the interactive pens, set up the system and calibrate the pens. See your projector's *Installation Guide* for instructions.



You need to calibrate the system again if you notice any discrepancy in positioning after doing any of the following:

- Performing Geometry Correction
- Adjusting the image size
- Using the Image Shift feature
- Changing the projector position

Your projector comes with a blue pen and an orange pen, identified by the color on the end of the pen. You can use either pen, or both at the same time (one of each color).

Make sure the pen batteries are installed.

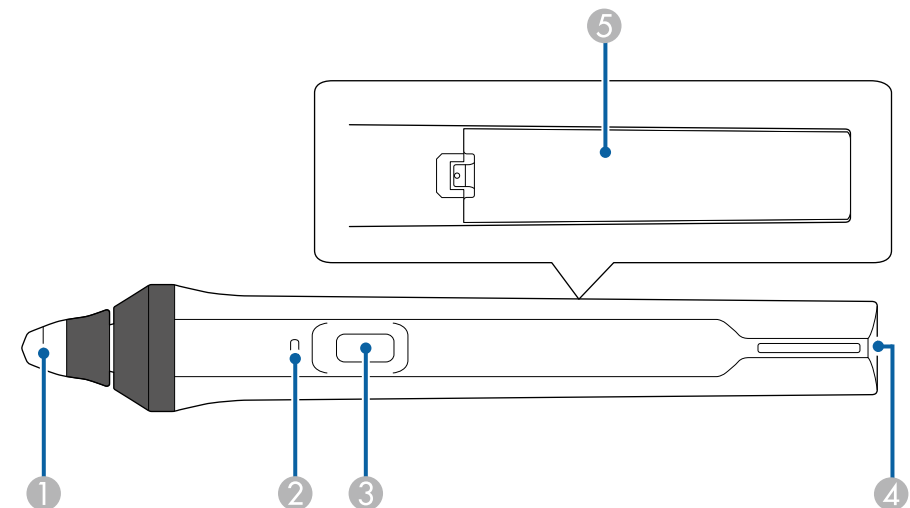

- 1 Pen tip
- 2 Battery indicator
- 3 Button
- 4 Strap attachment point
- 5 Battery cover

Hold the pen to turn it on.

When you are finished using the pen, leave the pen as it is far from the projection screen.

Attention

- Do not use interactive pens with wet hands or in locations where the pens may get wet. The interactive pens are not waterproof.
- Keep the projector and projection screen out of direct sunlight, or the interactive features may not work.



- Pens turn off automatically after 15 seconds when they are placed on. Hold the pen to turn it back on.
- For best performance, hold the pen perpendicular to the board, as shown below. Do not cover the black band near the tip of the pen.

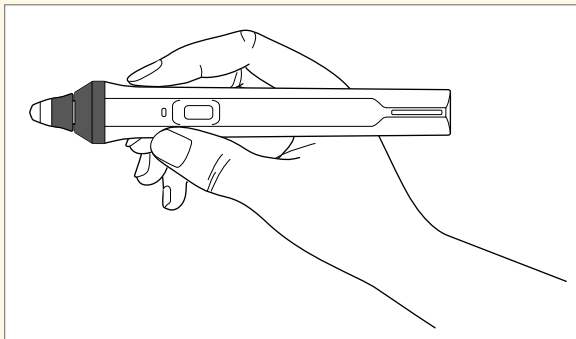

You can do the following using the pen:

- Write or draw on the projection surface in whiteboard mode and annotation mode.

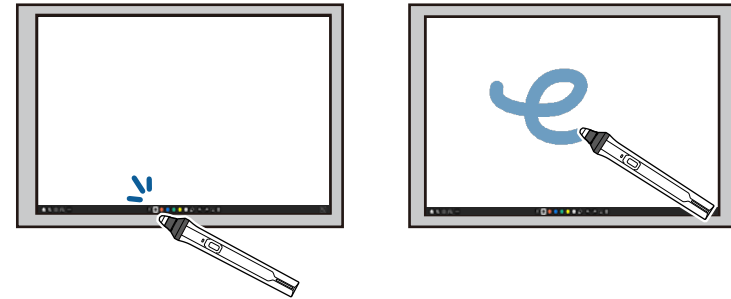

- To select a projected item, such as an icon, tap the projection surface with the pen tip.
- To draw on the projected screen, tap the projection surface with the pen and drag it as necessary.
- To move the projected pointer, hover over the surface without touching it.
- To switch the pen operation selected in the projector's **Interactive** menu, press the button on the side.

Interactive > Pen Button Function

- Use the pen as a mouse in computer interactive mode.



- To left-click, tap the projection surface with the pen tip.

- To double-click, tap twice with the pen tip.
- To right-click, press the button on the side.
- To click and drag, tap and drag with the pen.
- To move the cursor, hover over the board without touching it.



- If you do not want to use the hovering feature, you can turn it off using the **Pen Hovering** setting in the projector's **Pen/Touch** menu.
- To make a long press of the pen act as a right-click, set the **Pen Tracking Mode** setting to **Mouse Mode** and set the **Press and Hold** setting to **Right Click** in the projector's **Pen/Touch** menu.
 - ☛ **Pen/Touch > PC Interactivity > Pen Tracking Mode**
 - ☛ **Pen/Touch > PC Interactivity > Press and Hold**

» Related Links

- "Getting the Latest Version of the Documents" [p.10](#)

Using Interactive Touch Operations with Your Finger

You can use your finger to interact with the projected screen, just as you would use an interactive pen. You can use either a pen or your finger, or use both at the same time.

The projector recognizes up to six touch points in computer interactive mode. When performing touch operations with your finger, you can use two fingers in annotation and whiteboard modes.

Do the following before using your finger for touch operations:

- Install the Touch Unit
- Calibrate the system manually for the pen
- Perform angle adjustment for the Touch Unit
- Calibrate the system for touch operations

See your projector's *Installation Guide* for details on these operations.

The Touch Unit turns on and is ready for touch operation with your finger when you turn on the projector and the indicator lights up in blue.

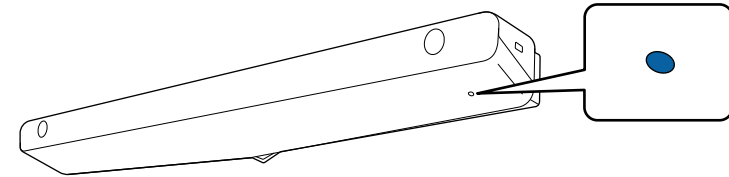

- Check the following if the Touch Unit does not turn on.
 - The projector is operating normally.
 - When the **Vertical Installation** setting is set to **Yes**, make sure the **Projection** setting is set to **Front** or **Front/Upside Down** in the **Installation** menu.
 - When the **Vertical Installation** setting is set to **No**, make sure the **Projection** setting is set to **Front/Upside Down** or **Rear/Upside Down** in the **Installation** menu.
 - The **Power** setting is set to **On** in the **Touch Unit** menu.
 - ☛ **Pen/Touch > Touch Unit > Power**
 - The Touch Unit is connected to the projector's TCH port with a Touch Unit connection cable.
- Positioning discrepancies may occur depending on the angle of your finger or the direction you point.
- Touch operations with your finger may not work properly with long or artificial nails, or with your fingers wrapped in bandages.
- Touch operations may not be recognized correctly if your fingers or the pens are too close together or crossed.
- If clothing or another part of your body comes close to or touches the screen, the touch operations may work incorrectly.
- If you touch the screen with your free hand during touch operations, the touch operations may work incorrectly.

You can perform the following touch operations with your finger:

- Write or draw on the projection surface in annotation mode and whiteboard mode.



- To select a projected item, such as an icon, tap the projection surface with your finger.
- To draw on the projected screen for the first time after turning on the projector, select a pen in the toolbar and tap the projection surface with your finger. If you do not do this, your finger works as an eraser the first time you use touch operations.
- To zoom in or out, touch an item using two fingers, and either move your fingers away from each other (stretch to zoom in) or toward each other (pinch to zoom out).
- To rotate the image, touch the image using two fingers and then rotate your hand.

- Use your finger as a mouse in computer interactive mode.



- To left-click, tap the projection surface with your finger.
- To double-click, tap twice with your finger.
- To right-click, press the board with your finger for about 3 seconds (Windows).
- To click and drag, press on and drag an item with your finger.



- If your device supports these functions, you can also do the following:
 - To zoom in or out, touch an item using two fingers, and either move your fingers away from each other (stretch to zoom in) or toward each other (pinch to zoom out).
 - To rotate the image, touch the image using two fingers and then rotate your hand.
 - To scroll up or down the page, or move backward or forward in a browser window, use gestures such as flicks.
 - You can only use one tool with one finger at a time.

» Related Links

- "Safety Instructions for Interactive Touch Operations" [p.99](#)
- "Getting the Latest Version of the Documents" [p.10](#)

Safety Instructions for Interactive Touch Operations

Touch operation with your finger is enabled by installing the Touch Unit with a built-in high-power laser.

The laser radiates from the laser diffusion ports on the bottom of the Touch Unit:

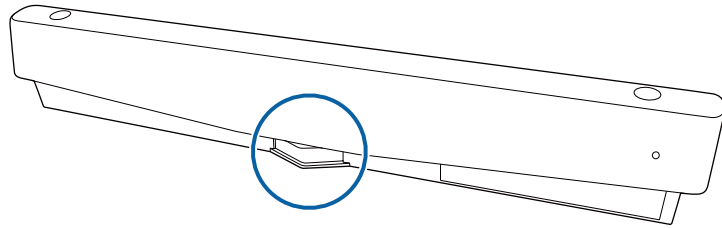

Note the following important points when performing touch operations.

⚠ Warning

- Children using touch operations with their fingers should always be accompanied by an adult.
- Never open any cases on the projector or the Touch Unit. Never attempt to disassemble or modify the projector or the Touch Unit. Electrical voltages inside the projector can cause severe injury.
- Do not allow the laser light emitted from the Touch Unit to pass through or be reflected by any optical object, such as a magnifying glass or mirror. Continued use of the Touch Unit may result in fire or accidents, and also cause injury.
- Unplug the projector from the outlet and refer all repairs to qualified service personnel if any problems occur with the projector or the Touch Unit. Continued use of the Touch Unit may result in fire or accidents, and can also damage your eyes.
- Do not look at the laser light using an optical device (for example, eye lope, magnifying glass, or microscope) within a distance of 70 mm from the laser diffusion ports of the Touch Unit. This could damage your eyes.

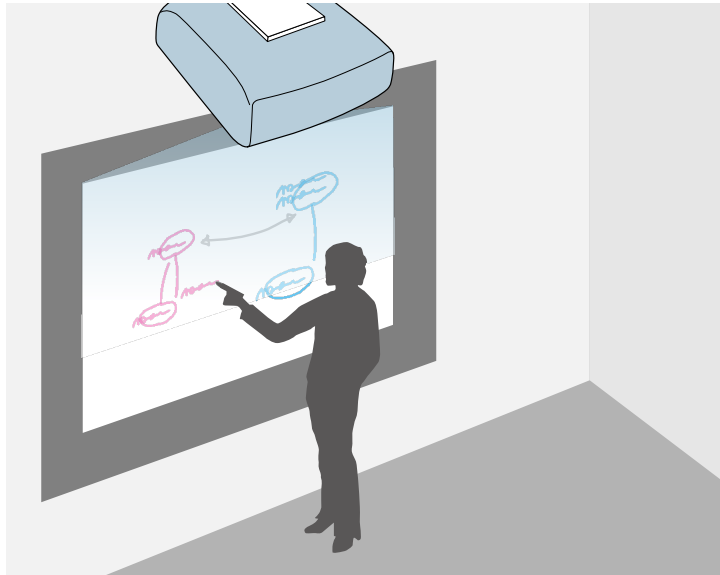

You can use your projector to project a whiteboard image onto a plain surface. You can then use the interactive pens or your finger to draw letters and shapes on the image as if it were a whiteboard. This is useful in locations that do not have a whiteboard.



In whiteboard mode, you can also use both pens, or both pens and your finger, at the same time.

» Related Links

- "Safety Instructions for Whiteboard Mode" [p.101](#)
- "Starting Whiteboard Mode" [p.101](#)

Safety Instructions for Whiteboard Mode

Note the following important points when using this feature.

- All drawing data is cleared when the projector is turned off.

- Users are responsible for managing this data. Epson takes no responsibility for direct or indirect damage caused by loss, damage, or disclosure of the user's data or data for third parties through the use of this projector. Make sure you understand these points before use.

Starting Whiteboard Mode

You can draw on the whiteboard screen using the whiteboard mode toolbar.

- 1** Turn on the projector.
- 2** Press the [Home] button.

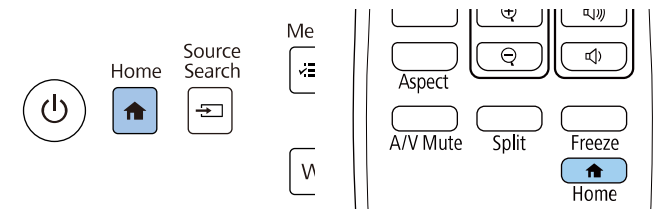

- 3** Select **Whiteboard**.

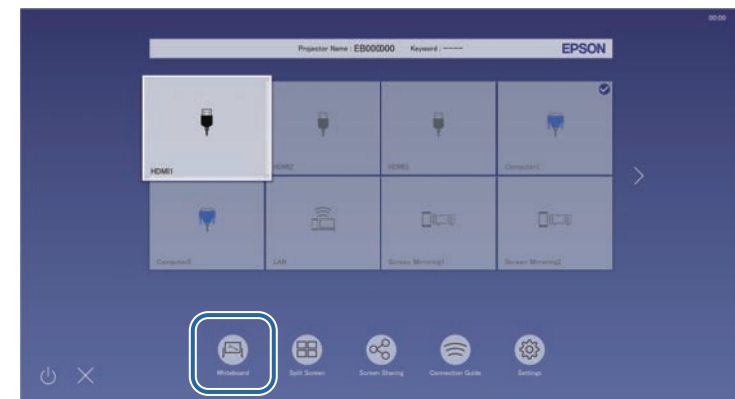

You see the whiteboard screen and toolbar.

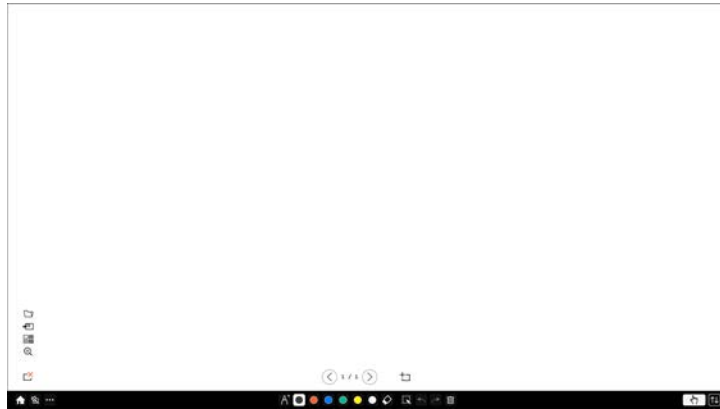

- You can move the toolbar to the right, left, top, or bottom of the screen by dragging it.
- You can also start whiteboard mode by clicking  on the toolbar.
- Any drawings that you create in whiteboard mode are retained if you change to annotation mode or other image sources.

4 Select the drawing tool you want to use from the toolbar displayed on the bottom of the screen and draw on the projected screen using the interactive pen or your finger.

» Related Links



- "Whiteboard Mode Toolbar" [p.102](#)
- "Importing Images in Whiteboard Mode" [p.105](#)
- "Compatible File Types for Opening in Whiteboard Mode" [p.106](#)









Whiteboard Mode Toolbar









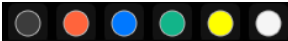

The whiteboard mode toolbar lets you draw and write on the projected screen. The whiteboard mode toolbar is shown in the following illustration.



- You can also use the mini toolbox by pressing the button on the side of the pen anywhere in the drawing area. You can switch the type of pen or eraser on the mini toolbox.
- When performing touch operations with your finger, you cannot display the mini toolbox.

 Home	Displays the Home screen.
 A/V Mute	Turns the video and audio off. Tap the button again to turn the video and audio back on.

 <p>Other tools</p>	<p>Displays additional tools.</p> <ul style="list-style-type: none">  Mail: Sends the projected screen by email. Set up the Mail settings in the projector's Interactive menu first.  Save: Saves the displayed screen. Set up the Save settings in the projector's Interactive menu first.  Print: Prints the projected screen. Set up the Print settings in the projector's Interactive menu first.  Timer: Counts the time up or down.  Deliver screen: Shares the current screen using Epson iProjection software.  Participant List: Displays the user selection screen so you can project from devices connected to the projector over a network.  Help: Displays the help screen for the toolbar functions. Select Close to close the help screen. Clear all drawing contents: Clears all the current drawing content and images, and returns whiteboard mode to its default status.
 <p>Pen</p>	<p>Displays the available pen type, thickness, or shape.</p>
 <p>Color</p>	<p>Switches the color for the drawings.</p>



 <p>Eraser</p>	<p>Switches to an eraser. Select the size of the eraser.</p>
 <p>Select</p>	<p>Selects drawn content or an inserted image so you can perform operations such as moving the item or adjusting its size.</p> <ul style="list-style-type: none"> Select the  icon at the bottom right of the selected object or image to perform operations. To paste the copied object or image, tap the screen, select the  icon, and select Paste. Drag the edge of the area to enlarge or reduce the object or image. Drag  at the top of the area to rotate the selected object or image.
 <p>Undo</p>	<p>Undoes the previous operation.</p>
 <p>Redo</p>	<p>Cancels an undo operation and restores the previous status.</p>
 <p>Clear screen</p>	<p>Clears all drawing from the displayed page.</p>
 <p>Turn off Touch/Turn on Touch</p>	<p>Disables touch operations temporarily to prevent any unintended operation. Also enables touch operations that you disabled.</p>
 <p>Minimize</p>	<p>Hides the toolbar.</p>











- You can display the following number and size of images on the whiteboard screen.
 - Up to 1920 × 1080 pixels × 2 files for one page
 - Up to 20 pages
- Drawn objects are displayed at the front of the imported image.
- If objects or images are moved out of the projected screen, you may not be able to select them.

Additional Buttons for Use in Whiteboard Mode

The buttons on the whiteboard mode lets you use whiteboard mode features.



①	 <p>Open Opens a file and reads the data into a new page.</p>
②	 <p>Add image Imports an image file to the current page.</p>

③	 <p>Background Selects a background template. Select  to add user templates.</p>
④	 <p>Zoom Enlarges or reduces the projected image.</p> <ul style="list-style-type: none"> •  : Reduces the image. •  : Enlarges the image. •  : Returns to the original size. •  : Enlarges the selected area.
⑤	 <p>Delete page Deletes the current page.</p>
⑥	 <p>Previous page Displays the previous page.</p>
⑦	 <p>Next page Displays the next page.</p>
⑧	 <p>New page Adds a new page after the currently displayed page. You can add up to 20 pages.</p>

- » **Related Links**
- "Home Screen" [p.49](#)
 - "Shutting Off the Image and Sound Temporarily" [p.141](#)
 - "Sending Drawing Contents via Email" [p.111](#)
 - "Saving Drawing Contents" [p.113](#)

- "Printing Drawing Contents" p.115
- "Selecting Network Device Display" p.122

Importing Images in Whiteboard Mode

You can import images into the current page in whiteboard mode. You can import files from a connected USB storage device or network folder, or you can scan an image from a network scanner and import it.

- To import images from a USB storage or a network folder, setup the **Save** settings in the projector's **Interactive** menu first.
- To scan a paper document, make sure a supported printer with scanning capabilities is connected to the projector and setup the **Print** settings in the projector's **Interactive** menu first.



- Printers with ESC/P-R commands are supported.
- Certain products, such as standalone scanners, cannot use this feature. For a list of supported products, contact Epson for help.
- You cannot scan documents when the printer is in an unprintable status such as when ink has run out.

When scanning using your product, you cannot use the following scanning functions even if they are available:

- Using the scan button on your product.
- Scanning parts of the document.
- Scanning originals using an Automatic Document Feeder (ADF).

1 If you scan a paper document, load your original in the product.

2 Select the  icon on the lower left of the whiteboard.
You see the **Add image** screen.

3 Select the following save settings on the Scan screen.

- From a USB storage or a network folder

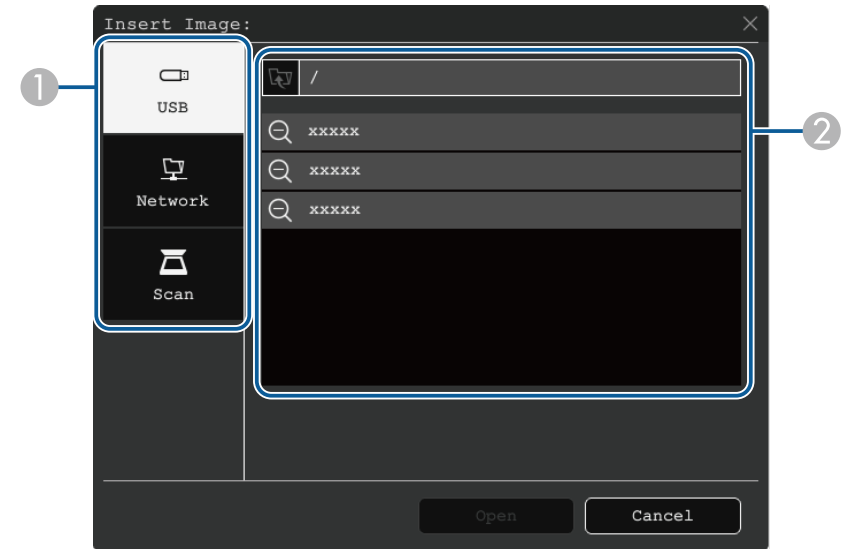

- From a scanner

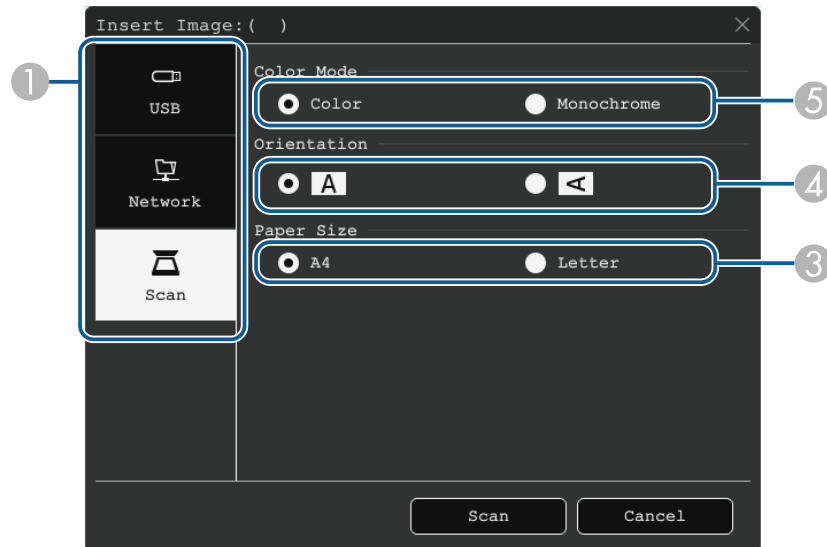

- Select the location of the image you want to import.
- Select the file you want to import.
- Select the paper size.
- Select the orientation of the scanned document.
- Select **Color** or **Monochrome**.

4 Select **Open** or **Scan**.

After importing or scanning, the image is projected as a current page in whiteboard mode.

Compatible File Types for Opening in Whiteboard Mode

The following file types can be opened and read into a page in whiteboard mode. Images larger than a page are reduced to fit.

When you select the or icon on the lower left of the whiteboard, you can select .jpg or .png only.

Type	File Type (Extension)	Notes
Image	.jpg	The following cannot be read. <ul style="list-style-type: none"> Images with a resolution greater than 2048 × 2048 * Files with the extension ".jpeg" CMYK color mode formats Progressive formats
	.png	Cannot read images with a resolution greater than 2048 × 2048. *
PDF	.pdf	You can open PDF files for version 1.7 or earlier. Specify the page number to open a PDF file. If the file is password protected, enter the password.
EWF2	.ewf2	Specify the page number to open an EWF2 (Epson Whiteboard Format) file. If the file is password protected, enter the password.

* You can use the image up to 1920 × 1080 resolution size as a background template. When you use the image with a smaller than 1920 × 1080, the image is placed in the center of the screen.



You see the toolbar on the projected image, for example:

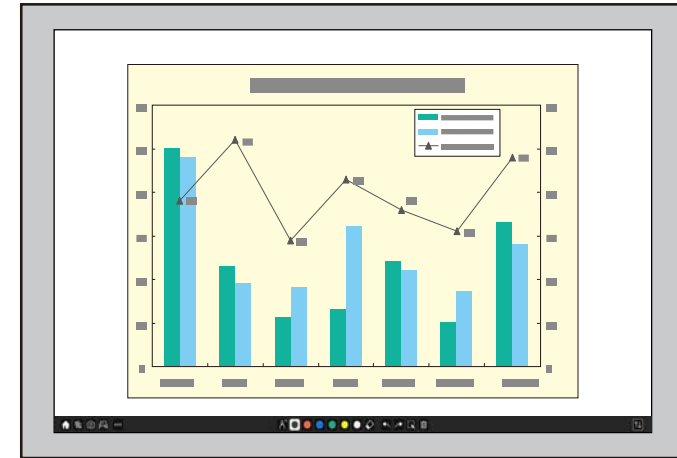

Annotation mode lets you project from a computer, tablet, video device, or other source and add notes to your projected content using the interactive pens or your finger. You can use both pens at the same time. You can also use both pens and your finger at the same time.

» Related Links

- "Starting Annotation Mode" [p.107](#)

Starting Annotation Mode

To draw on the projected screen using annotation mode, you need to display the annotation mode toolbar.

Before you begin, make sure the **Drawing Function** setting is set to **On** in the projector's **Interactive** menu to enable the annotation mode.

- 1** Project an image from a connected device.



- You can move the toolbar to the right, left, top, or bottom of the screen by dragging it.
- You can display the whiteboard screen by clicking  on the toolbar. To enlarge whiteboard to fit the entire screen, drag the bar in the center to the edge of the screen.

- 2** Select the drawing tool you want to use from the toolbar displayed on the bottom of the screen and draw on the projected screen using the interactive pen or your finger.

» Related Links



- "Annotation Mode Toolbar" [p.108](#)





Annotation Mode Toolbar











The annotation mode toolbar lets you draw and write on the projected screen. The appearance of the toolbar varies depending on how you are projecting and whether you are projecting a shared image.















- You can also use the mini toolbox by pressing the button on the side of the pen anywhere in the drawing area. You can switch the type of pen or eraser on the mini toolbox.
- When performing touch operations with your finger, you cannot display the mini toolbox.

 Whiteboard	(Not available when you have split the screen into halves or quarters) Displays the whiteboard screen.
 Split Screen	(Available only when you have split the screen into halves or quarters) Specifies the split screen settings.
 Image Shift	(Available only when Screen Type is set to 16:6) Specifies the horizontal position of the image inside the ultra-wide display.

 Home	Displays the Home screen.
 A/V Mute	Turns the video and audio off. Tap the button again to turn the video and audio back on.
 Zoom	(Not available when you have split the screen into halves or quarters) Enlarges or reduces the projected image.
 Capture	Captures the current screen and copies it to the whiteboard. <ul style="list-style-type: none"> • Full Screen captures the entire screen image. • Select Area lets you select a portion of the image to capture. If you want to capture the Screen Mirroring image, set Capture to Enabled in the projector's Network menu first. 🖱️ Network > Network Settings > Network Projection > Screen Mirroring > Capture

 <p>Other tools</p>	<p>Displays additional tools.</p> <ul style="list-style-type: none">  Mail: Sends the projected screen by email. Set up the Mail settings in the projector's Interactive menu first.  Save: Saves the displayed screen. Set up the Save settings in the projector's Interactive menu first.  Print: Prints the projected screen. Set up the Print settings in the projector's Interactive menu first.  Timer: Counts the time up or down.  Volume: Adjusts the volume of projector's speaker system.  Deliver screen: Shares the current screen using Epson iProjection software.  Participant List: Displays the user selection screen so you can project from devices connected to the projector over a network.  Help: Displays the help screen for the toolbar functions. Select Close to close the help screen. Clear all drawing contents: Clears all the current drawing content and images, and returns annotation mode to its default status.
 <p>Pen</p>	<p>Displays the available pen type, thickness, or shape.</p>
 <p>Color</p>	<p>Switches the color for the drawings.</p>

 <p>Eraser</p>	<p>Switches to an eraser. Select the size of the eraser.</p>
 <p>Select</p>	<p>Selects drawn content or an inserted image so you can perform operations such as moving the item or adjusting its size.</p> <ul style="list-style-type: none"> Select the  icon at the bottom right of the selected object or image to perform operations. To paste the copied object or image, tap the screen, select the  icon, and select Paste. Drag the edge of the area to enlarge or reduce the object or image. Drag  at the top of the area to rotate the selected object or image.
 <p>Undo</p>	<p>Undoes the previous operation.</p>
 <p>Redo</p>	<p>Cancels an undo operation and restores the previous status.</p>
 <p>Clear screen</p>	<p>Clears all drawing from the displayed page.</p>
 <p>Turn off Touch/Turn on Touch</p>	<p>Disables touch operations temporarily to prevent any unintended operation. Also enables touch operations that you disabled.</p>
 <p>Stop Sharing</p>	<p>(Available only when projecting a shared image) Stops screen sharing.</p>

 PC Interactivity	(Not available when projecting a shared image) Switches to computer interactive mode. Set the PC Interactivity setting to On to control the computer using the interactive pen or your finger.
 Minimize	Hides the toolbar.



- Drawn objects are displayed at the front of the projected image.
- If objects or images are moved out of the projected screen, you may not be able to select them.

» Related Links

- "Whiteboard Screens (Whiteboard Mode)" [p.101](#)
- "Control Computer Features from a Projected Screen (Computer Interactive Mode)" [p.117](#)
- "Home Screen" [p.49](#)
- "Shutting Off the Image and Sound Temporarily" [p.141](#)
- "Zooming Images" [p.143](#)
- "Projecting Multiple Images Simultaneously" [p.127](#)
- "Sending Drawing Contents via Email" [p.111](#)
- "Saving Drawing Contents" [p.113](#)
- "Printing Drawing Contents" [p.115](#)
- "Selecting Network Device Display" [p.122](#)

You can share the contents of drawings you create by saving or printing them, or sending an email containing the content.

» **Related Links**

- "Sending Drawing Contents via Email" [p.111](#)
- "Saving Drawing Contents" [p.113](#)
- "Printing Drawing Contents" [p.115](#)

Sending Drawing Contents via Email

You can attach an image of your drawings to an email and send it.

Set up the **Mail** settings in the projector's **Interactive** menu first. To be able to search for an email address using a directory service, set up the **Directory** settings in the projector's **Interactive** menu.



- The address set for the sender in the projector's **Mail** menu is used as the sender's address. If the sender's address has not been set, the address set for the recipient as displayed as the sender.
- You cannot edit the text in the email.

1 Select the  icon on the toolbar.

2 Select the  icon.
You see the **Mail** screen.

3 Select the following save settings on the **Mail** screen.

- For Whiteboard mode

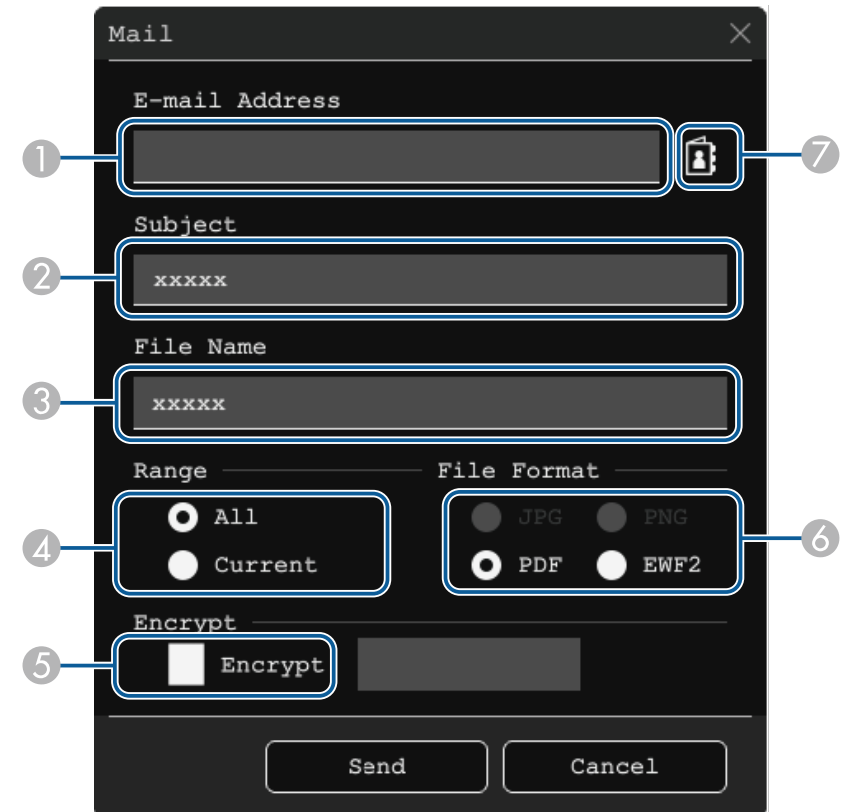

- For Annotation mode

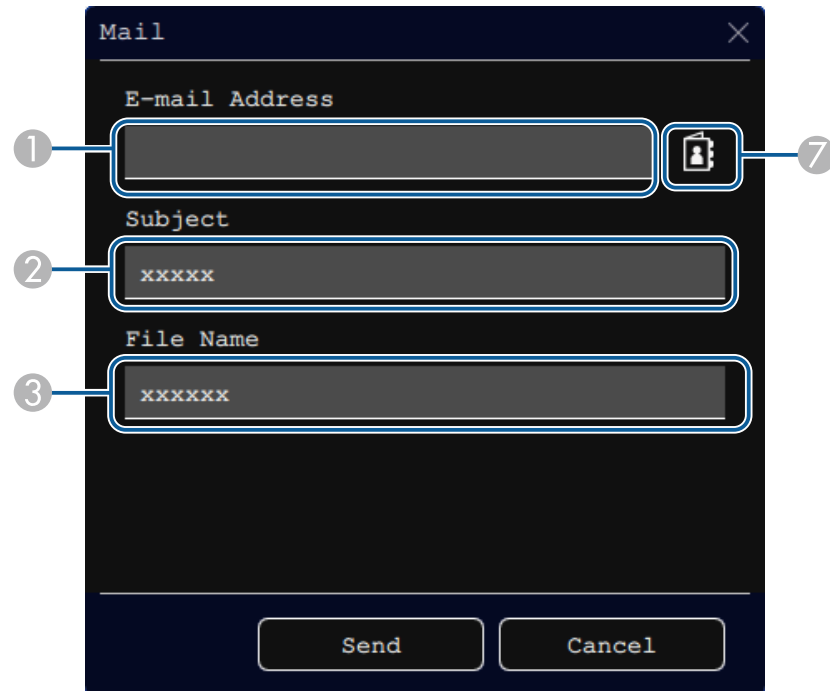

- 1 Enter the email address for the recipient using the displayed keyboard. The email address you set is stored until you clear the all drawings or turn off the projector.

 When you set the **Disallow Address Input** setting to **On** in the projector's **Interactive** menu, you cannot enter the email address directly. Set **Disallow Address Input** to **Off** first.

 **Interactive > Mail > Disallow Address Input**

- 2 Enter the subject for the email.
- 3 Enter the file name for the attachment.

- 4 Select whether to send all the whiteboard pages or only the current projected image.
- 5 For PDFs or EWF2s, select the check box and enter a password to encrypt the file.

Attention

- When you enter a password, it is displayed on the screen.
- When encrypting a file, make sure you do not forget the password.

- 6 Select the format for the attached file (JPG, PDF, PNG, or EWF2).
- 7 Specify the email address for the recipient using the displayed E-mail Address dialog box. You can specify up to 50 addresses.
You can set the address book using the directory service in the projector's **Interactive** menu.

4 Select Send.

 If you save drawings in the annotation mode, the image is saved in a jpg format.

- If there is a lot of content on the projected screen, it may take a while to send the email.
- You may not be able to send the email depending on the destination mail server settings. Contact your network administrator about the mail server settings in advance.

» Related Links

- "Creating an Address Book" [p.113](#)
- "Available Directory Service" [p.113](#)
- "Interactive Menu - Mail Menu" [p.240](#)
- "Interactive Menu - Directory Menu" [p.240](#)

Creating an Address Book

When sending e-mails of your drawings, you can choose e-mail addresses from an address book. You can create the address book by loading a text file of up to 999 addresses through the Web Control screen.



Addresses are displayed in the order they appear in the text file.

- 1** Create the text file containing the list of addresses you want to add to the address book. The file must have the following characteristics:
 - Tab-delimited
 - Each line must contain a pair of strings separated by a tab: <name> <tab> <email_address>
 - Each line can contain up to 256 characters.
 - Filename with a .txt extension
 - Character code must be UTF-16 with BOM

An example of a text file:

```
Joe Smith      xxxxxx@xxxxx.com
Mary Jones-Smith  xxxxxxx@xxxx.com
John Q. Public  xxxx@xxxxxx.com
```

- 2** Make sure the projector is turned on.
- 3** Start your Web browser on a computer connected to the network.
- 4** Select **Interactive > Mail > Address Book Settings > Address Book File** and select the Choose File button.
- 5** Select the address book file and select **Set**.
The address book file is uploaded to the projector.

- 6** To delete the address book, select **Interactive > Mail > Address Book Settings > Delete Address Book** and select **Send**.

Available Directory Service

The following directory service servers are supported.

Server type	Directory service server
Operating system	Windows Server 2012 R2 Windows Server 2016
Port	Variable (default is 389)
Authentication	Anonymous (no authentication) Simple Digest-MD5
Encryption	SASL layer encryption (SSL/TLS is not supported)

Notes for search

- Up to 200 matched addresses are listed.
- You can search addresses using alphanumeric characters.

Saving Drawing Contents

You can save the content you created on the projected screen to a file.

Setup the **Save** settings in the projector's **Interactive** menu first.

Caution

If you are using a multi-card reader or USB hub, operations may not be performed correctly. For best results, connect directly to the projector.



You may not be able to use USB storage devices that incorporate security functions.

1 Select the icon on the toolbar.

2 Select the icon.
You see the Save screen.

3 Select the following save settings on the Save screen.

- For Whiteboard mode

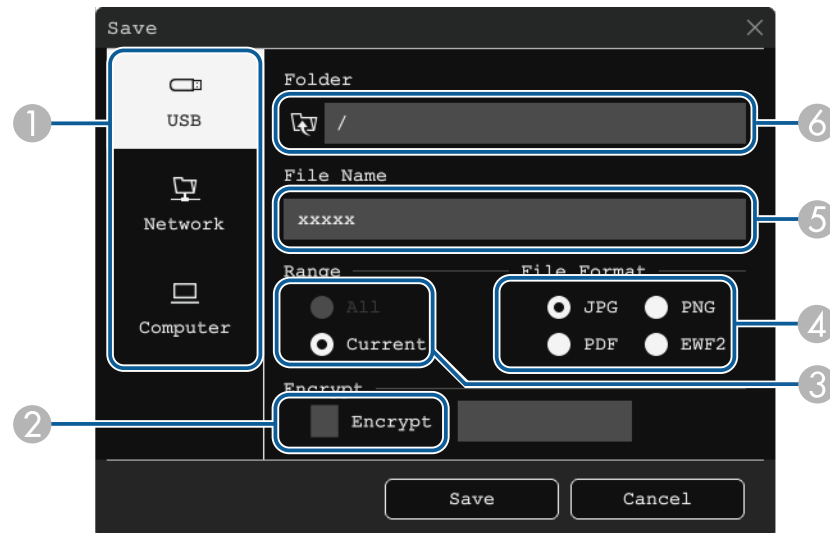

- For Annotation mode

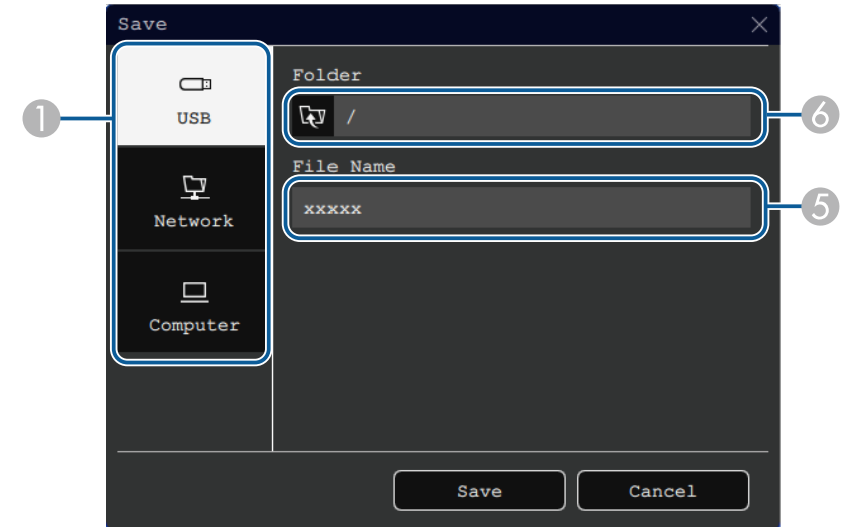

- 1 Select the destination where you want to save the file.
 - Select **USB** or **Network** to save to a connected USB storage device or network folder.
 - Select **Computer** to temporarily save the file on the projector and make it available for copying from the computer. After the file is copied, it is erased. You cannot save the file to a computer when the input source is USB Display, or when you have split the screen into halves or quarters.
- 2 For PDFs or EWF2s, select the check box and enter a password to encrypt the file.

Attention

- When you enter a password, it is displayed on the screen.
- When encrypting a file, make sure you do not forget the password.

- 3 Select whether to save all the whiteboard pages or only the current projected image.
- 4 Select the save format (JPG, PDF, PNG, or EWF2).

- 5 Enter a file name.
- 6 For **USB** or **Network**, select the target folder using the displayed **Open** dialog box.

4 Select **Save (Next for Computer)**.



- If you save drawings in the annotation mode, the image is saved in a jpg format.
- When **Computer** is selected as the file save destination, the drawing content is temporarily saved on the projector and the instruction dialog box appears. Follow the on-screen instructions to save the data on your computer.

» Related Links

- "Available File Format in Whiteboard Mode" [p.115](#)
- "Interactive Menu - Save Menu" [p.239](#)

Available File Format in Whiteboard Mode

You can save in the following file formats:



- PNG (Resolution: 1920 × 1080)
- JPG (Resolution: 1920 × 1080)
- PDF (set a password if necessary)
- EWF2 (set a password if necessary)

When saving the file as editable, select the EWF2 format. The EWF2 format is supported with the interactive projectors and Easy Interactive Tools.

Printing Drawing Contents

You can print your pages directly from the projector to a supported printer (USB or networked).

Setup the **Print** settings in the projector's **Interactive** menu first.

- 1 Select the  icon on the toolbar.
- 2 Select the  icon.
You see the Print screen.
- 3 Select the following save settings on the **Print** screen.
 - For Whiteboard mode

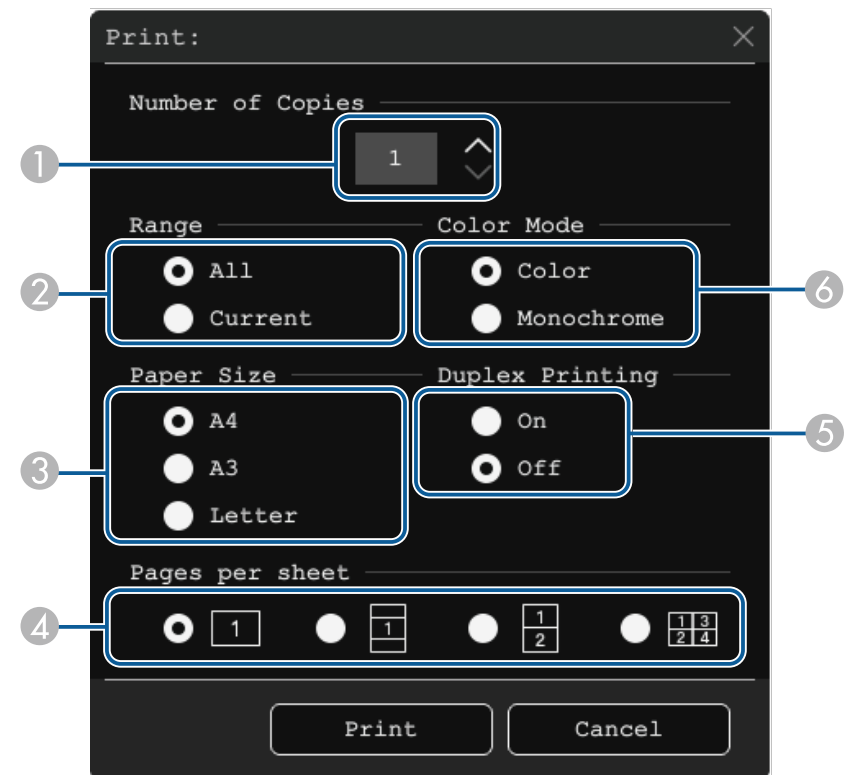

- For Annotation mode

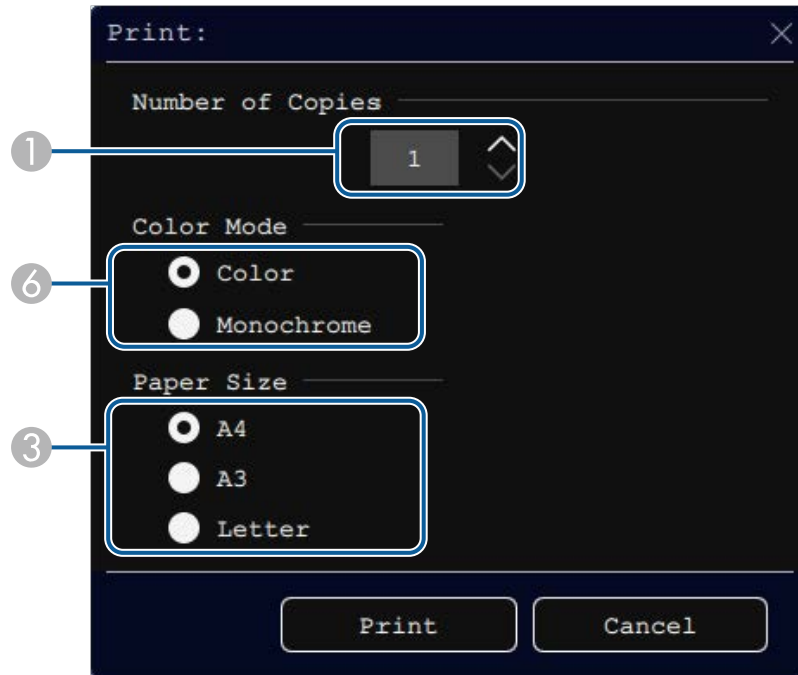

- 1 Set the number of copies. You can specify up to 20 sheets.
- 2 Select whether to print all the whiteboard pages or only the current projected image.
- 3 Set the print paper size.
- 4 Set the number of pages per sheet.
- 5 If your printer supports double-sided printing, select whether to print on both sides.
- 6 Set the print color.

4 Select **Print**.

» Related Links

- "Available Printer Control Commands in Whiteboard Mode" [p.116](#)
- "Interactive Menu - Print Menu" [p.238](#)

Available Printer Control Commands in Whiteboard Mode

The following printer* control commands are supported.

Control commands	Connection method
ESC/P-R	USB or over a network
PCL6	Over a network

* Not all printers are supported. For more details on supported models, contact Epson for help.

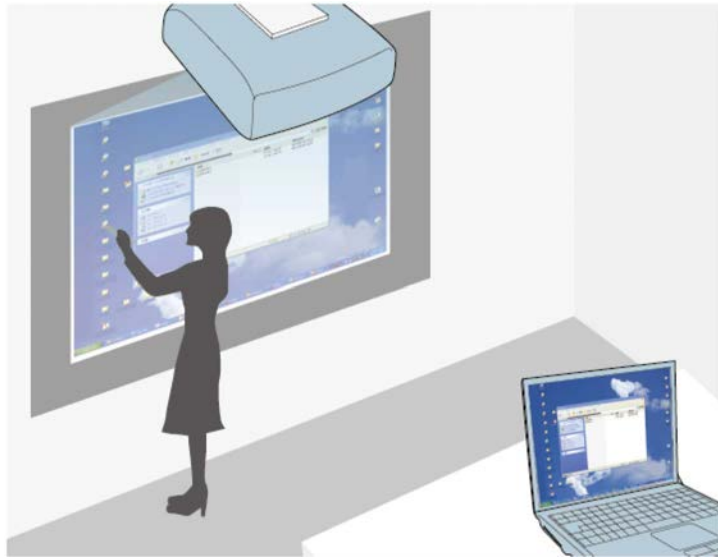

When the projector is connected to a computer with a USB cable, Epson iProjection, or a Screen Mirroring, you can operate the computer from the projected screen using the interactive pens or your finger, just as you would use with a mouse. You can navigate, select, and interact with your computer programs from the projected screen.



- When you use multiple displays with Windows 7 or later and use computer interactive mode on the secondary display, make the following settings:
 - Set the **Pen Tracking Mode** setting to **Pen Mode** in the projector's **Pen/Touch** menu.
 - ☛ **Pen/Touch > PC Interactivity > Pen Tracking Mode**
 - Go to **Control Panel > Hardware and Sound > Table PC Settings > Setup** to launch the setup program and configure the interactive features.

If you set up a third display, you cannot use interactive features with that display.

You cannot write or draw across multiple screens.

- To use computer interactive mode over a network, you need to install Epson iProjection (Windows/Mac).

» Related Links

- "Computer Interactive Mode System Requirements" [p.117](#)
- "Installing Easy Interactive Driver on Mac" [p.118](#)
- "Using Computer Interactive Mode" [p.118](#)
- "Adjusting the Pen Operation Area" [p.119](#)

Computer Interactive Mode System Requirements

Your computer must use one of the following operating systems to use the computer interactive mode.

Windows

- Windows 7 Service Pack 1
 - Ultimate (32- and 64-bit)
 - Enterprise (32- and 64-bit)
 - Professional (32- and 64-bit)
 - Home Premium (32- and 64-bit)
- Windows 8.1
 - Windows 8.1 (32- and 64-bit)
 - Windows 8.1 Pro (32- and 64-bit)

- Windows 8.1 Enterprise (32- and 64-bit)
- Windows 10
 - Windows 10 Home (32- and 64-bit)
 - Windows 10 Pro (32- and 64-bit)
- When you connect a computer to the projector using Screen Mirroring
 - Windows 10
 - Support for UIBC (User Input Back Channel)

Mac

macOS

- 10.12.x
- 10.13.x
- 10.14.x
- 10.15.x

Ubuntu

- 16.04 LTS
- 18.04 LTS
- 19.04

Installing Easy Interactive Driver on Mac

Install Easy Interactive Driver on your computer to use computer interactive mode.

- 1** Turn on your computer.
- 2** Download the software from the Epson Web site.
- 3** Follow the on-screen instructions to install the software.
- 4** Restart your computer.

» Related Links

- "Easy Interactive Driver System Requirements" [p.303](#)

Using Computer Interactive Mode

You can control your computer programs from the projected screen using computer interactive mode.

- 1** If you are using Mac, install the Easy Interactive Driver on your computer the first time you use the interactive features.
- 2** When you want to use a USB connection, connect the projector to your computer using a USB cable.



- If you want to use computer interactive mode with USB Display, turn on the **USB Display** setting in the projector's **Signal I/O** menu. When projecting using USB Display, response time may be slower.
- When using computer interactive mode over a network, you do not need a USB cable.

- 3** Turn on the projector.
- 4** Project your computer screen.
- 5** Select the **Pen Tracking Mode** setting in the projector's **Pen/Touch** menu that matches your computer operating system.

☛ Pen/Touch > PC Interactivity > Pen Tracking Mode

- Windows and Mac: Select **Pen Mode**.
- Ubuntu: Select **Mouse Mode**.



Using two interactive pens at the same time may cause interference in some applications. Move the unused interactive pen away from the projection screen.

- 6** When connecting using a Screen Mirroring, hold down the Windows key and press **K** on your keyboard at the same time, then select **Allow mouse, keyboard, touch, and pen input from this device**.
- 7** Make sure you have calibrated the first time you use your projector.
- 8** Hold an interactive pen close to the projected screen, or touch the projected screen with your finger.
- 9** Make sure that the **PC Interactivity** is turned on in the toolbar. If not, select the button to enable feature.



You can now operate the computer using the interactive pen or your finger. You can also operate the following:

- The Tablet PC input panel in Windows 7.
- Ink Tools for annotation in Microsoft Office applications.

- 2** Press the [Menu] button, select the **Pen/Touch** menu, and then press [Enter].

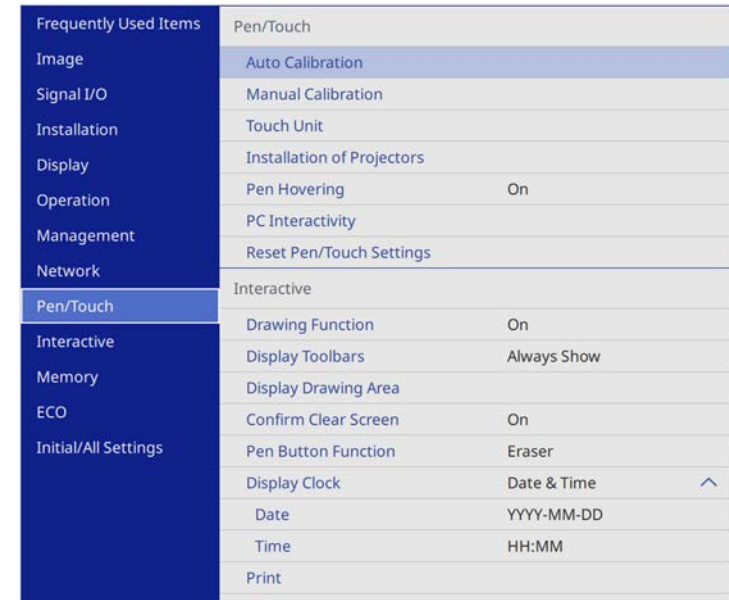

Adjusting the Pen Operation Area

The pen operation area is normally adjusted automatically if you connect a different computer or adjust the computer's resolution. If you notice that the pen position is incorrect when you operate your computer from the projected screen (computer interactive mode), you can adjust the pen area manually.



Manual adjustment is not available when projecting from a LAN source.

- 1** Switch to computer interactive mode, if necessary.

- 3** Select the **PC Interactivity** setting and press [Enter].

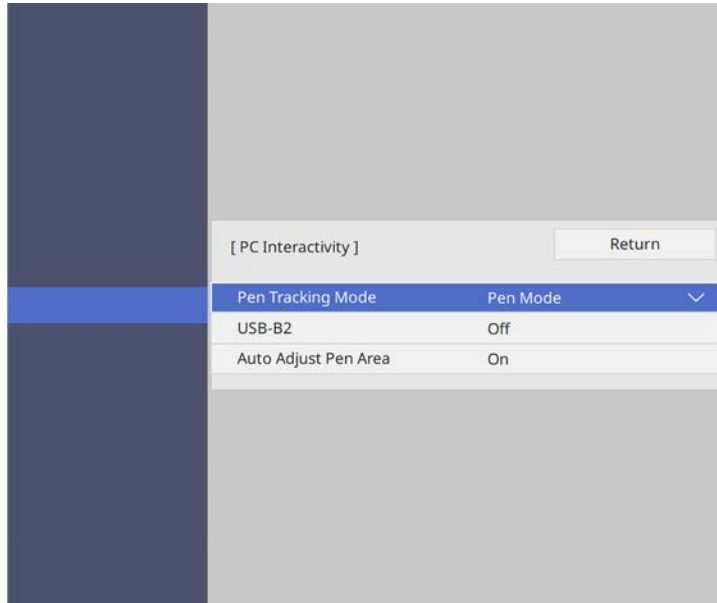

- 4** Make sure you turn off the **Auto Adjust Pen Area** setting and select **Manual Adj. Pen Area** and press the [Enter] button.

- 5** Select **Yes** and press the [Enter] button.

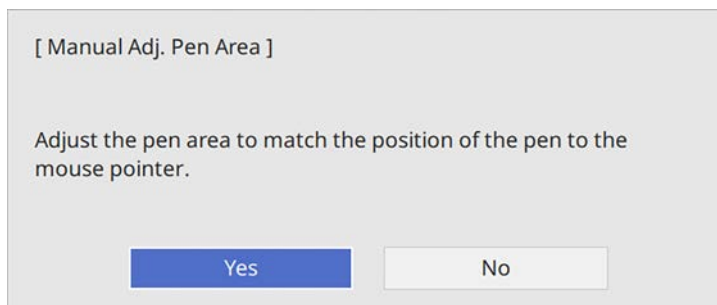

The mouse pointer moves toward the top left corner.

- 6** When the mouse pointer stops at the top left corner of the image, touch the tip of the pointer with the pen.

The mouse pointer moves toward the bottom right corner.

- 7** When the mouse pointer stops at the bottom right corner of the image, touch the tip of the pointer with the pen.

When you connect an Epson document camera, you can adjust the images as necessary and save them as an image or movie file, depending on the document camera model. See your document camera manual for details.

- 1** Connect an Epson document camera to the projector.
You see the document camera control screen.
- 2** Select the following operations as necessary on the document camera control screen.

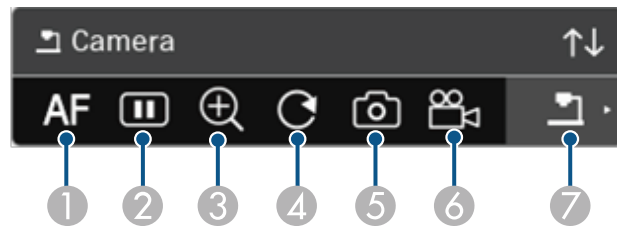

- ① Automatically focuses the image.
- ② Freezes the image temporarily.
- ③ Enlarges the image.
- ④ Rotates the image 180°.
- ⑤ Saves the currently displayed image and drawings as a still image.
- ⑥ Records the image.
- ⑦ Switches to the SD Card Viewer.

» **Related Links**

- "SD Card Viewer" [p.121](#)
- "Getting the Latest Version of the Documents" [p.10](#)

SD Card Viewer

The SD Card Viewer lets you display saved images and movies on the SD card inserted into the document camera as a slideshow. The SD Card Viewer is shown in the following illustration.

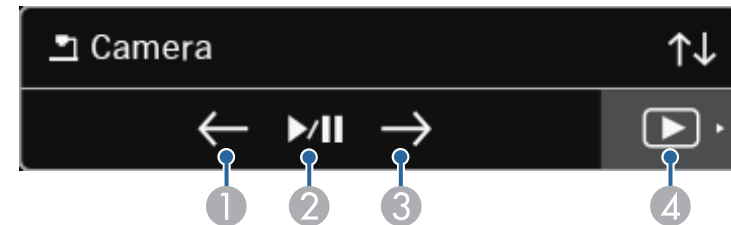

①	Displays the previous file.
②	Plays and pauses a slideshow.
③	Displays the next file.
④	Switches to the document camera control screen.

If you have connected devices to the projector via a network, you can select to project an image from those devices.

You can select the image source from computers that are running Epson iProjection (Windows/Mac), and smartphones or tablets that are running Epson iProjection (iOS/Android).



You can select any connected network device for projection, even if the user connected using the Epson iProjection software with the moderator feature enabled. See the *Epson iProjection Operation Guide (Windows/Mac)* for details about the moderator feature.

- 1 Select the  icon on the toolbar, and then select **Participant List**.

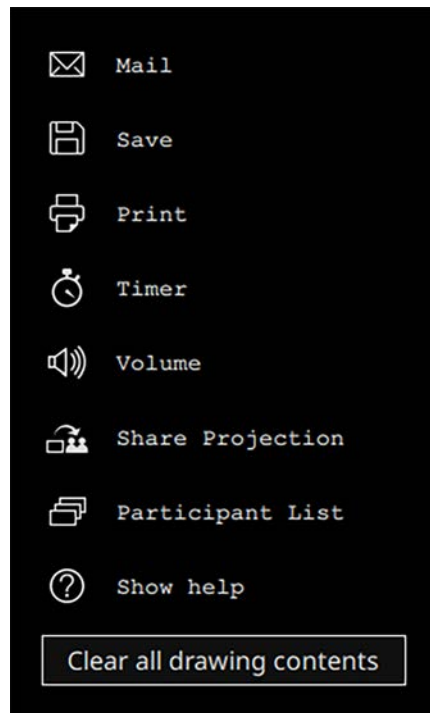

The user selection screen is displayed.

- 2 Select the user name for the device you want to project from.

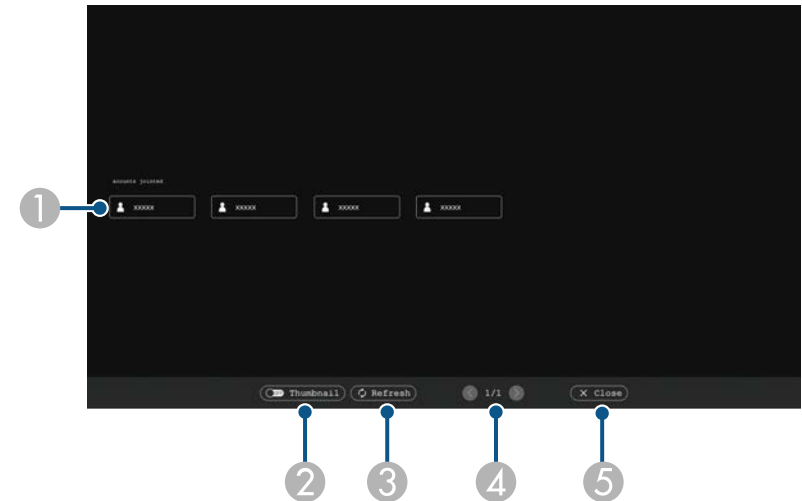

- 1 Displays the user names for network devices connected to the projector. When displaying thumbnails, each device screen is displayed as a thumbnail.
The  icon is shown next to the user name of the currently projected device.
- 2 Switches the display for the user selection screen between thumbnails or icons.
- 3 Refreshes the user selection screen.
When an additional user connects to the projector via a network, select this button to update the user list.
Refreshing information takes a few seconds.
- 4 Click to move to the previous page or the next page.
- 5 Closes the user selection screen and returns to the previous screen.



- On the user selection screen, you can use two pens or one finger at a time.

You see the selected user's screen image.

When you change the user, repeat these steps.



- You cannot access the Participant List screen when connecting to multiple projectors by using Epson iProjection (Windows/Mac) and projecting the same image (mirroring).
- If pen operations or touch operations do not work on the user selection screen, you can return to the previous screen by pressing the [Esc] button on the remote control or the control panel.

► Related Links

- "Getting the Latest Version of the Documents" [p.10](#)

You can use your projector in computer interactive mode over a network.

If you want to annotate when using computer interactive mode over a network, you need to use Easy Interactive Tools (or another annotation program). Easy Interactive Tools allows you to use various drawing tools, treat the drawing area as a page, and save your drawings as a file for a later use. You can download the software from the Epson website.

Use Epson iProjection (Windows/Mac) to setup your projector on a computer network and use computer interactive mode over the network.

Select **Use Interactive Pen** on the **General settings** tab and **Transfer layered window** on the **Adjust performance** tab.

See the *Epson iProjection Operation Guide (Windows/Mac)* for instructions.



- Number of pens or fingers you can use at the same time is as follows:
 - Windows: two pens and six fingers
 - Mac: one pen or one finger
- The response may be slower over the network.
- You can connect up to four projectors at one time using Epson iProjection. When connected to multiple projectors, computer interactive mode functions for any projector. Operations performed on one projector are reflected in other projectors.

» **Related Links**

- "Precautions when Connecting to a Projector on a Different Subnet" [p.124](#)
- "Getting the Latest Version of the Documents" [p.10](#)

- Make sure that you get an echo reply back from the network projector when sending an echo request by the ping command. When the Internet Control Message Protocol (ICMP) option is disabled on the router, you can connect to the projector at remote locations even if you cannot get the echo reply back.
- Make sure the following ports are opened.

Port	Protocol	Usage	Communication
3620	TCP/UDP	For connection and control	two-way
3621	TCP	For transferring images	two-way
3629	TCP	For controlling projector	two-way

- Make sure that the MAC address filtering and application filtering options are configured properly on the router.
- When bandwidth management is applied for communications between locations, and Epson iProjection goes over the controlled bandwidth, you may not be able to connect to the projector at remote locations.



Epson does not guarantee the connection to the projector on a different subnet using Epson iProjection even if you meet the above requirements. When considering the implementation, be sure to test the connection in your network environment.

Precautions when Connecting to a Projector on a Different Subnet

Follow these precautions when you connect to a projector on a different subnet using Epson iProjection (Windows/Mac) and use interactive features:

- Search for the projector on the network by specifying the projector's IP address. You cannot search for it by specifying the projector name.

When you project images in PC Free Annotation mode or PC Interactive mode, you can split the screen so you can also display the whiteboard screen. Follow the steps below to control split screen projection using the toolbar.



This feature is not available when you have split the screen into halves or quarters.

1 Project an image.

2 Select  on the toolbar.

You see the whiteboard screen on the left half of the screen. The currently selected input source moves to the right of the screen.

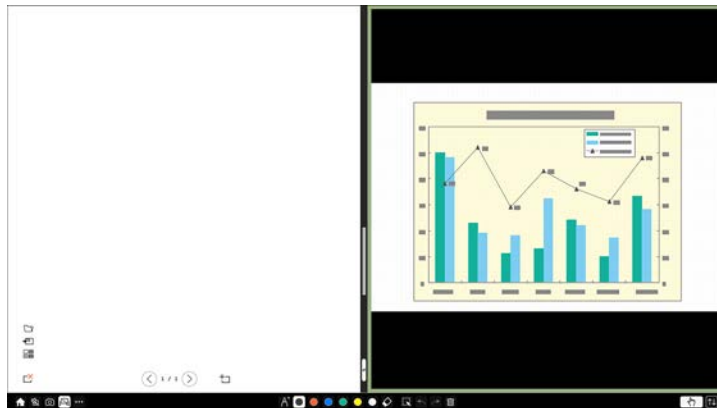

3 To enlarge one image while reducing the other image, drag the bar in the center to the left or right.



To enlarge one image to fit the entire screen, drag the bar to the edge of the screen.

4 To swap the projected images from left to right, select  in the center bar.

Adjusting Projector Features

Follow the instructions in these sections to use your projector's adjustment features.

► Related Links

- "Projecting Multiple Images Simultaneously" [p.127](#)
- "Projecting a PC Free Presentation" [p.130](#)
- "Projecting in Content Playback Mode" [p.135](#)
- "Shutting Off the Image and Sound Temporarily" [p.141](#)
- "Stopping Video Action Temporarily" [p.142](#)
- "Zooming Images" [p.143](#)
- "Saving a User's Logo Image" [p.144](#)
- "Saving a User Pattern" [p.146](#)
- "Saving Settings to Memory and Using Saved Settings" [p.148](#)
- "Using Multiple Projectors" [p.149](#)
- "Projector Security Features" [p.162](#)

You can use the split screen feature to simultaneously project two or four images from different image sources.

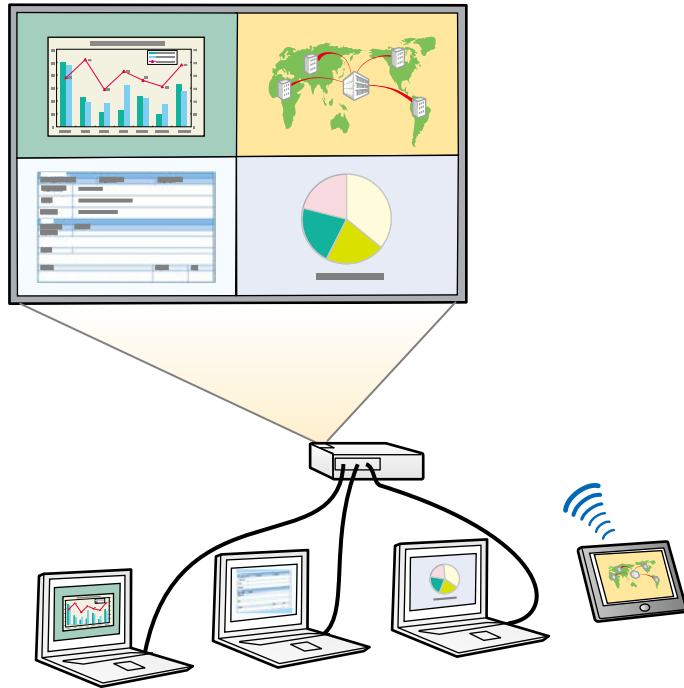

- While using the split screen feature, other projector features may not be available and some settings may be automatically applied to all images.
- You cannot perform split screen projection when the **Content Playback** setting is set to **On** in the projector's **Operation** menu (EB-755F/EB-750F).
- You cannot perform split screen projection when the **Connect ELPCB02** setting is set to **On** in the projector's **Installation** menu (EB-735Fi/EB-735F/EB-725Wi/EB-725W/EB-720).

1 Press the [Split] button on the remote control.

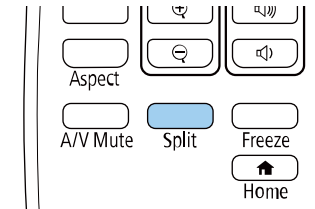

2 Select **2 Screens** or **4 Screens**.

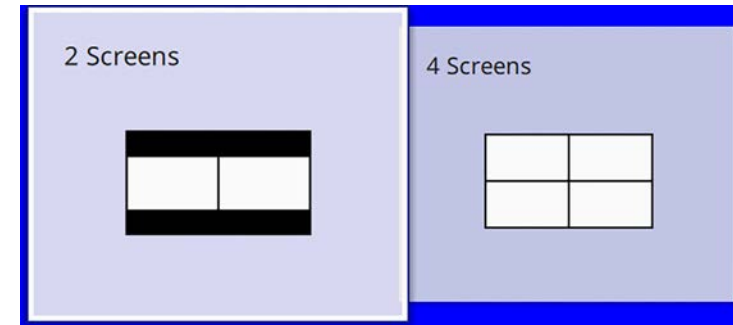

When splitting screen into halves, the currently selected input source moves to the left of the screen.

When you have split screen into quarters previously, the input sources of the previous split screen projection are selected and are projected at the same position.

3 Press the [Menu] button.

4 When splitting screen into halves, do the following as necessary:

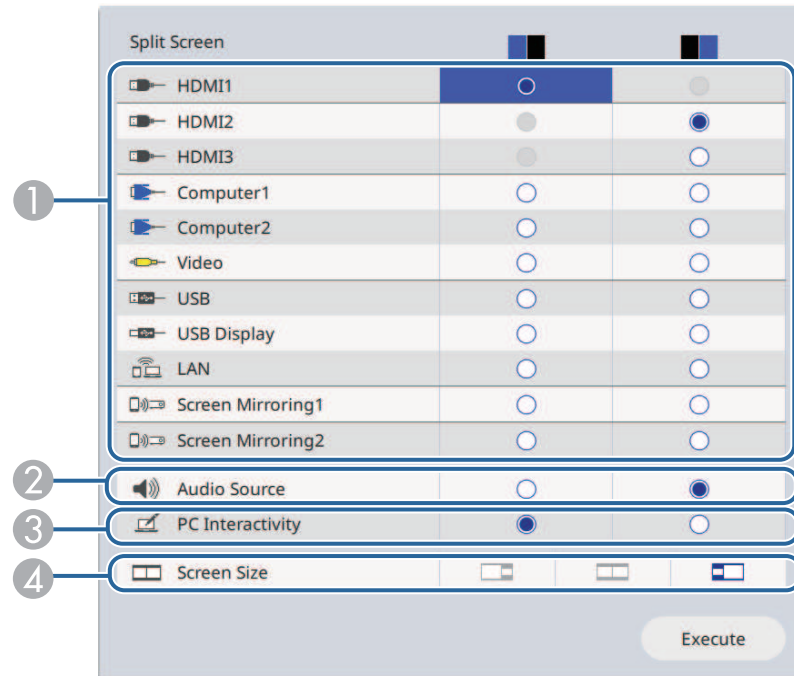

1 Select the input source.

 You can only select input sources that can be combined.

- 2 Select the screen from which you want to hear audio.
- 3 Select the screen from which you want to operate the computer using the interactive pens or your finger (EB-735Fi/EB-725Wi).
- 4 Select the screen size.

5 When splitting screen into quarters, do the following as necessary:

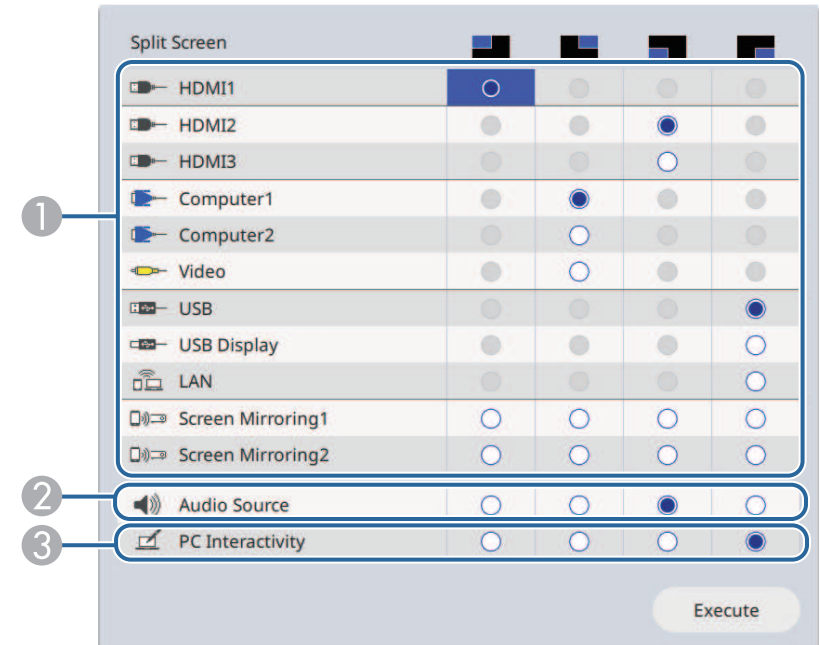

1 Select the input source.

 You can only select input sources that can be combined.

- 2 Select the screen from which you want to hear audio.
- 3 Select the screen from which you want to operate the computer using the interactive pens or your finger (EB-735Fi/EB-725Wi).

6 Select **Execute** and press [Enter].

7 To exit the split screen feature, press [Split] or [Esc].

» Related Links

- "Unsupported Input Source Combinations for Split Screen Projection" [p.129](#)
- "Split Screen Projection Restrictions" [p.129](#)

Unsupported Input Source Combinations for Split Screen Projection

These input source combinations cannot be projected simultaneously.

- Computer1, Computer2, and Video
- HDMI2 and HDMI3
- USB, USB Display, and LAN



When you split the screen into quarters and select the USB input source, you can select only Screen Mirroring1 or Screen Mirroring2 for the other input sources.

Split Screen Projection Restrictions

Operating restrictions

The following operations cannot be performed during split screen projection.

- Setting the projector's menu
- E-Zoom
- Switching the aspect mode (the aspect mode is set to **Auto**)
- Operations using the [User] button on the remote control, other than displaying the network information on the projected surface.
- Applying the **Dynamic Contrast** setting
- Displaying the network information on the projected surface by a method other than pressing the [User] button.
- Displaying the Screen Mirroring information bar

Image restrictions

Even if you set **No-signal Screen** to **Logo** in the projector's **Display** menu, the blue screen appears when no image signal is being input.

» Related Links

- "Image Aspect Ratio" [p.77](#)
- "Zooming Images" [p.143](#)
- "Turning On Automatic Luminance Adjustment" [p.82](#)
- "Adjusting the Menu Settings" [p.213](#)

You can use your projector's PC Free feature whenever you connect a USB device that contains compatible presentation files. This lets you quickly and easily display a presentation and control it using the projector's remote control.

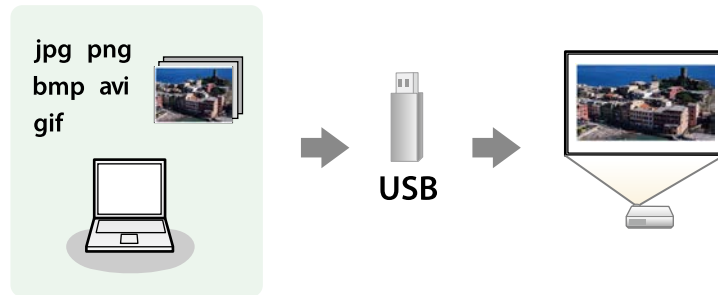

» **Related Links**

- "Supported PC Free File Types" [p.130](#)
- "Precautions on PC Free Projection" [p.131](#)
- "Starting a PC Free Slide Show" [p.131](#)
- "Starting a PC Free Movie Presentation" [p.133](#)
- "PC Free Display Options" [p.134](#)

File contents	File type (extension)	Details
Image	.jpg	Make sure the file is not: <ul style="list-style-type: none"> • CMYK format • Progressive format • Highly compressed • Above 8192 × 8192 resolution
	.bmp	Make sure the file is not: <ul style="list-style-type: none"> • Above 1280 × 800 resolution
	.gif	Make sure the file is not: <ul style="list-style-type: none"> • Above 1280 × 800 resolution • Animated • Interlaced
	.png	Make sure the file is not: <ul style="list-style-type: none"> • Above 1920 × 1080 resolution • Interlaced When you use a projector with a resolution of 1080p, you can project a file with a maximum resolution of 1920 × 1200.

Supported PC Free File Types

You can project these types of files using the projector's PC Free feature.

- For best results, place your files on media that is formatted in FAT16/32.
- If you have trouble projecting from media formatted for non-Windows file systems, try formatting the media for Windows instead.

File contents	File type (extension)	Details
Movie	.avi (Motion JPEG)	<ul style="list-style-type: none"> • Version: AVI 1.0 only • Resolution: 1280 × 720 or less • Size: 2 GB or less • Movie Codec: Motion JPEG • Frame Rate: up to 30 fps • Audio Codec: LPCM or IMA ADPCM • Audio Sampling Rate: 11.025 kHz, 16 kHz, 22.05 kHz, 24 kHz, 32 kHz, or 44.1 kHz

File contents	File type (extension)	Details
Movie	.mp4/.mov (H.264, H265)	<ul style="list-style-type: none"> • Resolution: 1920 × 1200 or less • Size: 2 GB or less • Movie Codec: H.264/MPEG-4 AVC or H.265/MPEG-H HEVC • Frame Rate: up to 30 fps • Profile: <ul style="list-style-type: none"> • H.264/MPEG-4 AVC: Baseline Profile, Main Profile, High Profile • H.265/MPEG-H HEVC: Main Profile • Color Format: YUV420 • Audio Codec: MPEG-2 AAC-LC, MPEG-4 AAC-LC, or LPCM • Audio Channel: up to 2ch (channel 2) • Audio Bit: 8 bits or 16 bits • Audio Sampling Rate: <ul style="list-style-type: none"> • MPEG-2 AAC-LC: 44.1 kHz, 48 kHz • MPEG-4 AAC-LC: 44.1 kHz, 48 kHz • LPCM: 11.025 kHz, 16 kHz, 22.05 kHz, 24 kHz, 32 kHz, 44.1 kHz, or 48 kHz • Single slice structure

Precautions on PC Free Projection

Note the following precautions when using PC Free features.

- You cannot use a USB key for PC Free features.
- Do not disconnect the USB storage device while it is being accessed; otherwise, PC Free may not operate correctly.
- You may not be able to use the security features on certain USB storage devices with PC Free features.

- When connecting a USB device that includes an AC adapter, connect the AC adapter to an electrical outlet when you use the device with your projector.
- Some commercially available USB card readers may not be compatible with the projector.
- The projector can recognize up to 5 cards inserted into the connected card reader at one time.
- You can use the following functions while projecting in PC Free.
 - Freeze
 - A/V Mute
 - E-Zoom

▶ Related Links

- "Stopping Video Action Temporarily" [p.142](#)
- "Shutting Off the Image and Sound Temporarily" [p.141](#)
- "Zooming Images" [p.143](#)

Starting a PC Free Slide Show

After connecting a USB device to the projector, you can switch to the USB input source and start your slide show.



- You can change the PC Free operation options or add special effects by highlighting **Option** at the bottom of the screen and pressing [Enter].
- In computer interactive mode, you can operate your slide show using the interactive pen or your finger instead of the remote control (EB-735Fi/EB-725Wi).

- 1 Press the [USB] button on the remote control until the PC Free file list screen appears.



- If the Select Drive screen is displayed, press the arrow buttons to select the drive and press [Enter].
- To display images on the other USB drive, highlight **Select Drive** at the top of the file list screen and press [Enter].

- 2 Do one of the following to locate your files:
 - If you need to display files inside a subfolder on your device, press the arrow buttons to highlight the folder and press [Enter].
 - To move back up a folder level on your device, highlight **Back to Top** and press [Enter].
 - To view additional files in a folder, highlight **Next Page** or **Previous Page** and press [Enter], or press the [Page] up or down buttons on the remote control.

- 3 Do one of the following:
 - To display an individual image, press the arrow buttons to highlight the image and press [Enter]. (Press the [Esc] button to return to the file list screen.)

- To display a slide show of all the images in a folder, press the arrow buttons to highlight the **Slideshow** option at the bottom of the screen and press [Enter].

- You can change the image switching time by highlighting **Option** at the bottom of the screen and pressing [Enter].
- If any file names are longer than the display area or include unsupported symbols, the file names may be shortened or changed only on the screen display.

- 4 While projecting, use the following commands to control the display:
 - To rotate a displayed image, press the up or down arrow button. You can also rotate the image by flicking it using the interactive pen or your finger (EB-735Fi/EB-725Wi).

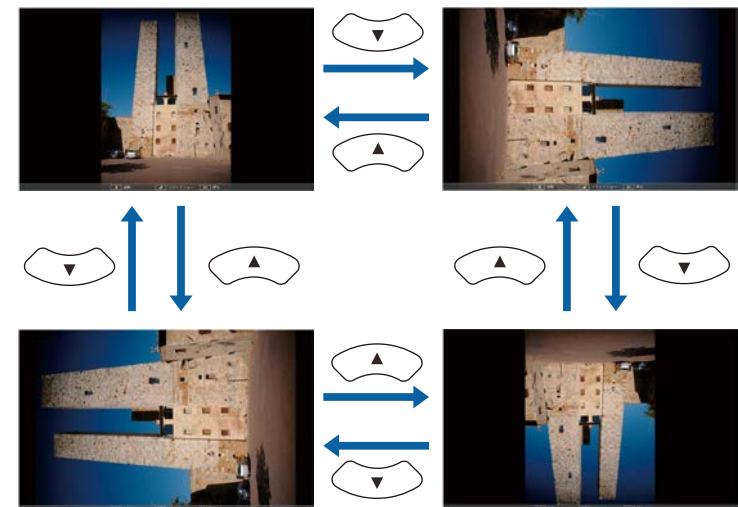

- To move to the next or previous image, press the left or right arrow button. You can also move forward or backward by flicking the image using the interactive pen or your finger (EB-735Fi/EB-725Wi).

- 5 To stop the display, follow the on-screen instructions or press the [Esc] button.

You return to the file list screen.

- 6 Turn off the USB device, if necessary, and then disconnect the device from the projector.

► Related Links

- "PC Free Display Options" [p.134](#)
- "Connecting to a USB Device" [p.38](#)

Starting a PC Free Movie Presentation

After connecting a USB device to the projector, you can switch to the USB input source and start your movie.



- You can change the PC Free operation options by highlighting **Option** at the bottom of the screen and pressing [Enter].

- 1 Press the [USB] button on the remote control until the PC Free file list screen appears.



- If the Select Drive screen is displayed, press the arrow buttons to select the drive and press [Enter].
- To display images on the other USB drive, highlight **Select Drive** at the top of the file list screen and press [Enter].

- 2 Do one of the following to locate your files:
 - If you need to display files inside a subfolder on your device, press the arrow buttons to highlight the folder and press [Enter].
 - To move back up a folder level on your device, highlight **Back to Top** and press [Enter].
 - To view additional files in a folder, highlight **Next Page** or **Previous Page** and press [Enter], or press the [Page] up or down buttons on the remote control.

- 3 To play back a movie, press the arrow buttons to highlight the file and press [Enter].



- If any file names are longer than the display area or include unsupported symbols, the file names may be shortened or changed only on the screen display.
- If you want to play back all the movies in a folder in sequence, select the **Slideshow** option at the bottom of the screen.

- 4 To stop movie playback, press the [Esc] button, highlight **Exit**, and press [Enter].

You return to the file list screen.

- 5 Turn off the USB device, if necessary, and then disconnect the device from the projector.

► Related Links

- "PC Free Display Options" [p.134](#)
- "Connecting to a USB Device" [p.38](#)

PC Free Display Options

You can select these display options when using PC Free. To access this screen, highlight **Option** at the bottom of the PC Free file list screen and press [Enter].



Setting	Options	Description
Effect	No	No effect
	Wipe	Transitions between images using a wipe effect
	Dissolve	Transitions between images using a dissolve effect
	Random	Transitions between images using a random variety of effects

Setting	Options	Description
Display Order	Name Order	Displays files in name order
	Date Order	Displays files in date order
Sort Order	In Ascending	Sorts files in first-to-last order
	In Descending	Sorts files in last-to-first order
Continuous Play	On	Displays a slide show continuously
	Off	Displays a slide show once
Screen Switching Time	No	Does not display the next file automatically
	1 Second to 60 Seconds	Displays files for the selected time and switches to the next file automatically; high resolution images may switch at a slightly slower rate

Your projector's Content Playback feature allows you to project your content for exhibitions as digital signage (EB-755F/EB-750F). You can easily project playlists that contain images and movies saved on an external storage device. You can also add color and shape effects to your projected image.



» Related Links

- "Switching to Content Playback Mode" [p.135](#)
- "Projecting Your Playlists" [p.136](#)
- "Adding Effects to Your Projected Image" [p.138](#)
- "Content Playback Mode Restrictions" [p.139](#)

Switching to Content Playback Mode

Before you project your playlists, you need to switch to Content Playback mode.

1 Turn on the projector.

2 Press the [Menu] button, select the **Operation** menu, and then press [Enter].

Frequently Used Items	Operation
Image	Auto Source Search On
Signal I/O	Light Source Brightness Cont...
Installation	Direct Power On Off
Display	Auto Power On Off
Operation	Sleep Mode On ^
Management	Sleep Mode Timer 10 min.
Network	A/V Mute Timer On
Multi-Projection	Standby Mode Communication On ^
Memory	Port Wired LAN
ECO	Quick Startup Off
Initial/All Settings	Indicators On
	Inv Direction Button Off
	Content Playback Off v
	Reset Operation Settings
	Management
	User Button Light Source Mode
	User's Logo

3 Select the **Content Playback** setting and set it to **On**. You see a confirmation prompt.

4 Turn off the projector, then turn it on again to enable Content Playback mode.

Projecting Your Playlists

You can project playlists that contain images and movies in Content Playback mode.



1 Create your playlists and export them to a USB flash drive using one of the following methods:

- Epson Projector Content Manager software lets you create playlists and save them on an external storage device. You can also add color and shape effects to your projected image, and schedule playlists.

You can download and install Epson Projector Content Manager from the following Web site.

epson.sn

See the *Epson Projector Content Manager Operation Guide* for instructions.

- Epson Web Control allows you to create playlists using a Web browser and save them to an external storage device connected to a projector on a network. You can also add color and shape effects to your projected image.
- The Epson Creative Projection app lets you create content on iOS devices. You can also transfer content to the projector wirelessly.

You can download Epson Creative Projection from the App Store. Any fees incurred when communicating with the App Store are the responsibility of the customer.

2 In Content Playback mode, connect the USB flash drive into the projector's USB-A port.

3 Press the [USB] button on the remote control.

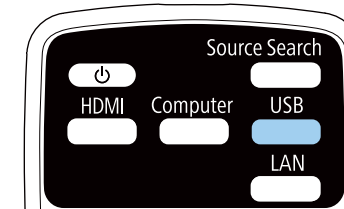

The playlist that was played last is projected. If there is a timetable assigned, the playlist will play back according to the schedule in the timetable.



- You can also hold down the [Num] and numeric buttons to project your favorite playlist. You can set a remote control shortcut key using the software you used to create the playlists.
- To select the target playlist from the list, press the [USB Viewer] button on the remote control, and then use the arrow buttons.

» Related Links

- "Creating Playlists Using Epson Web Control" [p.136](#)
- "Getting the Latest Version of the Documents" [p.10](#)

Creating Playlists Using Epson Web Control

In Content Playback mode, you can create playlists using a Web browser and save them to a USB flash drive connected to a projector on a network.

Attention

Do not remove the USB flash drive from the projector or disconnect the projector's power cord while creating playlists. Data saved on the USB flash drive may be damaged.

1 Make sure the projector is operating in Content Playback mode.

- 2 Make sure your computer or device is connected to the same network as the projector.
- 3 Make sure a USB flash drive is connected to the projector's USB-A port.
- 4 Start your Web browser on your computer or device.
- 5 Go to the Epson Web Control screen by entering the projector's IP address into the browser's address box. When entering an IPv6 address, wrap the address with [and].
- 6 Select **USB Memory Device**.

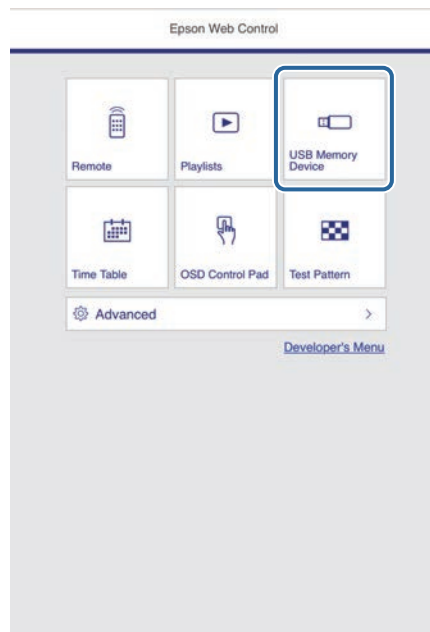

- 7 Select **Upload Data**.

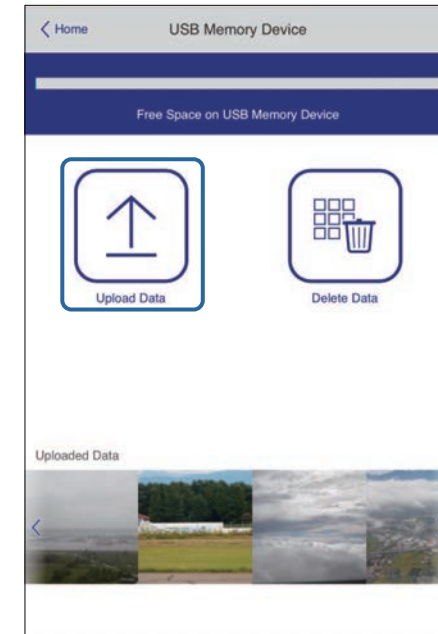

- 8 Select the images or movies you want to add to the playlist.



You cannot upload .mp4 or .mov files.

If you want to add .mp4 or .mov files to the playlist, use Epson Projector Content Manager software or the Epson Creative Projection app.

The selected files are copied to the connected USB flash drive.

- 9 Do one of the following:
 - To add them to the existing playlist, select **Add to Playlist** and select the playlist you want to add them to.
 - To create a new playlist and add them to it, select **Create New Playlist**.

10 Edit the playlist.

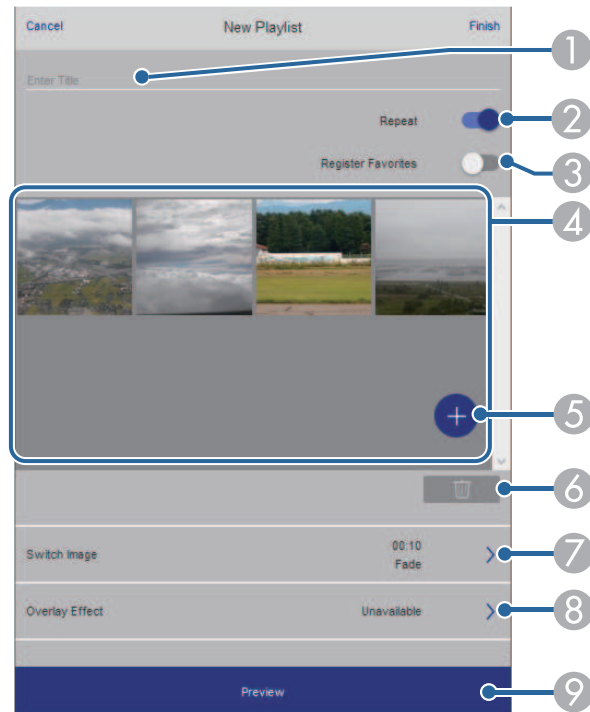

- 1 Edits the playlist name.
- 2 Selects whether to enable repeat playback or not.
- 3 Registers the playlist to your favorites.
When a playlist has been registered as a favorite, you can start playback quickly using the **Remote** screen or the remote control.
- 4 Displays the images or movies you have added to the playlist. The playlist plays the images or movies in order.
- 5 Adds images or movies to the playlist.
- 6 Deletes images or movies from the playlist.

- 7 Opens the **Switch Image** screen.
You can specify the time interval to switch to the next image file. You can also select a transition effect.
- 8 Opens the **Effects** screen.
You can add predefined color and shape effect filters to a playlist. You can also create a customized effect.
- 9 Previews the playlist.

11 When you have finished editing the playlist, select **Finish**.



- You can play the playlist from the **Remote** or **Playlist** screen.
- When you want to specify when the playlist starts and finishes, schedule the playlist using Epson Projector Content Manager software.

» Related Links

- "Web Control Options" [p.194](#)

Adding Effects to Your Projected Image

You can add color and shape effects to the projected image in Content Playback mode.





- To use the effect functions, make sure you perform **Refresh Mode** regularly.
 - Management > Refresh Mode**
- This feature is not available when using the **Edge Blending** feature.



You can add your images as customized shapes using the Epson Projector Content Manager software. See the *Epson Projector Content Manager Operation Guide* for details.

- In Content Playback mode, press the [Effect] button on the remote control.

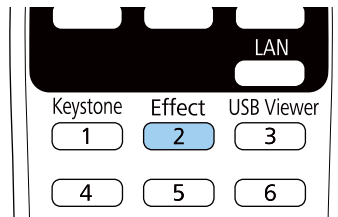

- Select **On** as the **Overlay Effect** setting and press [Enter].

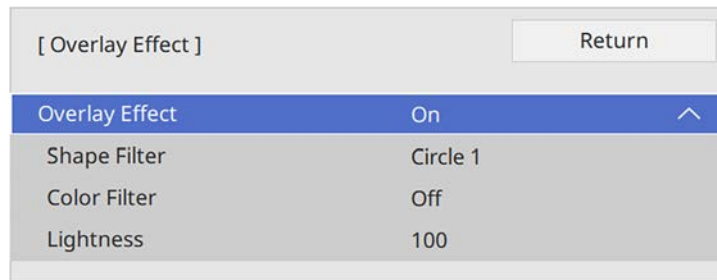

- Select **Shape Filter** and press [Enter].
- Adjust each of the following options as necessary:
 - Shape** to select the shape effect you want from circles, rectangles, or customized shapes.

- Filter Effect** to select whether to mask inside or outside of the selected shape.
- Size** to set the shape size.
- Position** to set the shape position.

- Select **Color Filter** and press [Enter].
- Adjust each of the following options as necessary:
 - Color Filter** to select the color.
 - Custom** to set a customized color by adjusting **Red**, **Green**, and **Blue** individually.
- Select **Lightness** to set the brightness level.
- When you are finished, press [Menu] to exit the menus.

Content Playback Mode Restrictions

Operating restrictions

The following operations cannot be performed in Content Playback mode.

- Changing the **Color Temp.** setting in the **Image** menu (when **Warm White** or **Cool White** is selected as **Color Filter**)
- Split Screen
- Changing the **Screen Type** setting in the **Installation** menu
- Detecting the input signal automatically
- Changing **Remote Password** in the **Network Settings** menu
- PC Free

- Document camera
- Screen delivery function using the Epson iProjection software

» **Related Links**

- "Image Quality Settings - Image Menu" [p.216](#)
- "Network Menu - Network Settings Menu" [p.230](#)
- "Projecting Multiple Images Simultaneously" [p.127](#)
- "Setting the Screen Type" [p.57](#)
- "Projecting a PC Free Presentation" [p.130](#)

You can temporarily turn off the projected image and sound if you want to redirect your audience's attention during a presentation. Any sound or video action continues to run, however, so you cannot resume projection at the point that you stopped it.

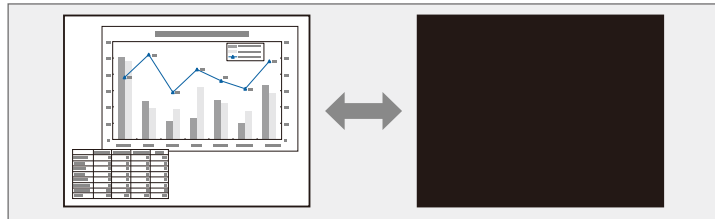

- 1 Press the [A/V Mute] button on the remote control to temporarily stop projection and mute any sound.

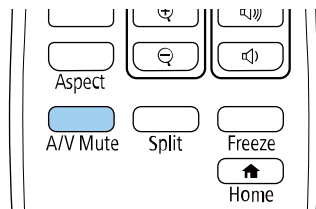

- 2 To turn the image and sound back on, press [A/V Mute] again.



- You can also stop projection using the interactive toolbar (EB-735Fi/EB-725Wi).
- The projector's power automatically turns off 30 minutes after A/V Mute is enabled. You can disable this feature.
 - 🖱️ **Operation > A/V Mute Timer**

» Related Links

- "Whiteboard Mode Toolbar" [p.102](#)
- "Annotation Mode Toolbar" [p.108](#)

You can temporarily stop the action in a video or computer presentation and keep the current image on the screen. Any sound or video action continues to run, however, so you cannot resume projection at the point that you stopped it.

- 1** Press the [Freeze] button on the remote control to stop the video action.

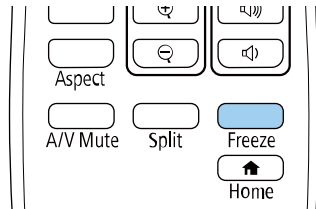

- 2** To restart the video action in progress, press [Freeze] again.

You can draw attention to parts of a presentation by zooming into a portion of the image and enlarging it on the screen.

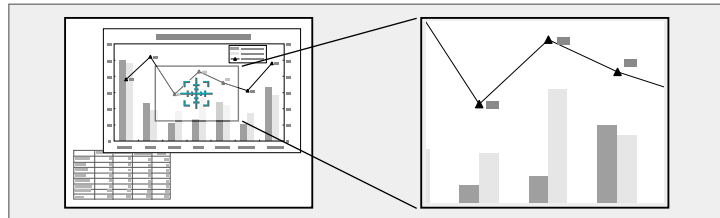

- To zoom out of the image, press the [E-Zoom] – button.
- To return to the original image size, press [Esc].

The enlarged image is projected and the enlargement ratio is displayed on the screen.

You can enlarge the selected area to between one to four times in 25 incremental steps.

When projecting images from an Epson document camera using a USB connection, you can enlarge the selected area from one to eight times its size in 57 incremental steps.



This feature is unavailable if the **Scale** setting in the projector's **Image** menu is enabled (EB-755F/EB-750F).

- 1** Press the [E-Zoom] + button on the remote control.

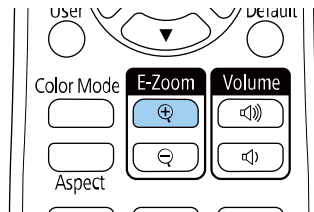

You see a crosshair on the screen indicating the center of the zoom area.

- 2** Use the following buttons on the remote control to adjust the zoomed image:
 - Use the arrow buttons to position the crosshair in the image area you want to zoom into. To move the crosshair diagonally, press any pair of adjacent arrow buttons at the same time.
 - Press the [E-Zoom] + button repeatedly to zoom into the image area. Press and hold the [E-Zoom] + button to zoom in more quickly.
 - To pan around the zoomed image area, use the arrow buttons.

You can save an image on the projector and display it whenever the projector turns on. You can also display the image when the projector is not receiving an input signal. This image is called the user's logo screen.

You can select a photo, graphic, or company logo as the user's logo, which is useful in identifying the projector's owner to help deter theft. You can prevent changes to the user's logo by setting up password protection.



- If you turned on **Menu Protection** for the **User's Logo** setting, set it to **Off** before performing the steps here to save the user's logo.
- When you copy the menu settings from one projector to another using the batch setup feature, user's logo is also copied. Do not register the information that you do not want to share between multiple projectors as a user's logo.
- You cannot save content that is protected by HDCP.
- You cannot display the user's logo when **Content Playback** is set to **On**. (EB-755F/EB-750F)

1 Display the image you want to project as the user's logo.

2 Press the [Menu] button, select the **Management** menu, and press [Enter].

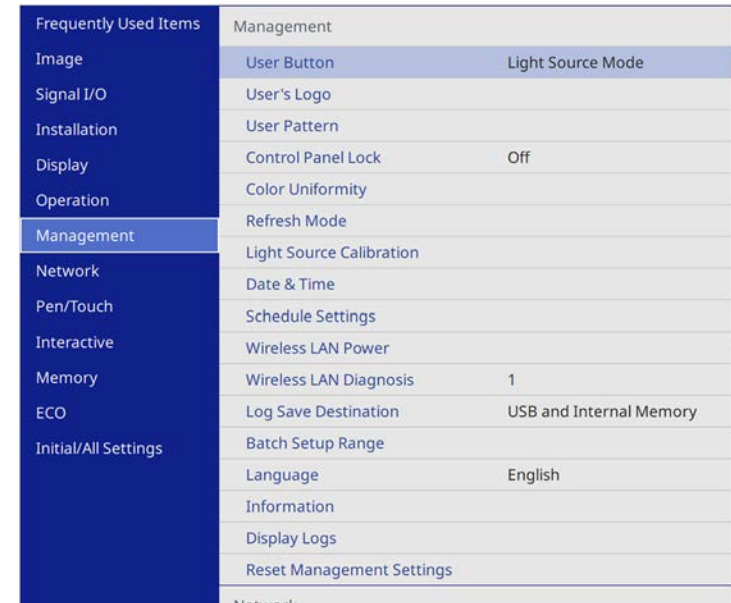

3 Select **User's Logo > Start Setting** and press [Enter].

You see a prompt asking if you want to use the displayed image as a user's logo.



Adjustments such as **Geometry Correction**, **E-Zoom**, **Aspect**, **Scale** (EB-755F/EB-750F only), or **Screen Type** are temporarily canceled when you select **User's Logo**.

4 Select **Yes** and press [Enter].



Depending on the current image signal, the screen size may change to match the resolution of the image signal.

- 5** Check the displayed image, and then select **Yes** to save it as the user's logo.

The user's logo is overwritten and a completion message is displayed.

- 6** Press [Esc] to exit the message screen.

- 7** Select the **Display** menu and press [Enter].



Frequently Used Items	Display
Image	Pattern Display
Signal I/O	Pattern Type
Installation	No-signal Screen Blue
Display	Startup Screen On
Operation	Home Screen Auto Disp. On
Management	Messages On
Network	Menu Rotation Off
Pen/Touch	Split Screen Setting
Interactive	Reset Display Settings
Memory	Operation
ECO	Auto Source Search On
Initial/All Settings	Light Source Brightness Cont...
	Direct Power On Off
	Auto Power On Off
	Sleep Mode On
	Sleep Mode Timer 10 min.
	A/V Mute Timer On

- 8** Select when you want to display the User's Logo screen:

- To display it whenever there is no input signal, select **No-signal Screen** and set it to **Logo**.
- To display it whenever you turn the projector on, select **Startup Screen** and set it to **On**.



To prevent changes to the **User's Logo** settings, turn on **Menu Protection** for the **User's Logo** setting and set the password.

» Related Links

- "Selecting Password Security Types" [p.163](#)

There are four types of patterns pre-registered in the projector, such as ruled lines and grid patterns. You can project these patterns to aid in presentations using the **Pattern Display** settings.

You can also save the image that is currently being projected as a User Pattern.



- Once you save a User Pattern, the pattern cannot be returned to the factory default.
- You cannot save content that is protected by HDCP.

- 1** Project the image you want to save as the User Pattern.
- 2** Press the [Menu] button, select the **Management** menu, and press [Enter].

Frequently Used Items	Management	
Image	User Button	Light Source Mode
Signal I/O	User's Logo	
Installation	User Pattern	
Display	Control Panel Lock	Off
Operation	Color Uniformity	
Management	Refresh Mode	
Network	Light Source Calibration	
Pen/Touch	Date & Time	
Interactive	Schedule Settings	
Memory	Wireless LAN Power	
ECO	Wireless LAN Diagnosis	1
Initial/All Settings	Log Save Destination	USB and Internal Memory
	Batch Setup Range	
	Language	English
	Information	
	Display Logs	
	Reset Management Settings	
	Network	

- 3** Select **User Pattern** and press [Enter].

You see a prompt asking if you want to use the displayed image as a User Pattern.



Adjustments such as Keystone, E-Zoom, **Aspect**, Adjust Zoom, or **Image Shift** are temporarily cancelled when you select **User Pattern**.

- 4** Select **Yes** and press [Enter].
You see a prompt asking if you want to save the image as the User Pattern.
- 5** Select **Yes** and press [Enter].
You see a completion message.
- 6** Select the **Display** menu and press [Enter].

Frequently Used Items	Display	
Image	Pattern Display	
Signal I/O	Pattern Type	
Installation	No-signal Screen	Blue
Display	Startup Screen	On
Operation	Home Screen Auto Disp.	On
Management	Messages	
Network	Menu Rotation	
Pen/Touch	Split Screen Setting	
Interactive	Reset Display Settings	
Memory	Operation	
ECO	Auto Source Search	On
Initial/All Settings	Light Source Brightness Cont...	
	Direct Power On	Off
	Auto Power On	Off
	Sleep Mode	On
	Sleep Mode Timer	10 min.
	A/V Mute Timer	On

- 7** Select **Pattern Type** and set it to **User Pattern**.

- 8 Select **Pattern Display** and press [Enter].
The saved image is projected.

You can save customized settings and then select the saved settings whenever you want to use them.

- 1** Turn on the projector and display an image.
- 2** Press the [Menu] button, select the **Memory** menu, and press [Enter].

Frequently Used Items	Save
Image	Mail
Signal I/O	Directory
Installation	Reset Interactive Settings
Display	Memory
Operation	Save Memory
Management	Load Memory
Network	Rename Memory
Pen/Touch	Erase Memory
Interactive	Reset Memory Settings
Memory	ECO
ECO	Light Source Mode Normal
Initial/All Settings	Sleep Mode On ^
	Sleep Mode Timer 10 min.
	A/V Mute Timer On
	Standby Mode Communication On
	Initial/All Settings
	Reset All

- 3** Select one of the following options:
 - **Save Memory** lets you save your current settings to memory (10 memories with different names are available).



- You can save the following settings:
 - **Image** menu settings for each color mode
 - **Video Range** and **Overscan** in the **Signal I/O** menu
 - **Light Source Mode** and **Brightness Level** in the **Operation** menu
 - **Color Matching** in the **Multi-Projection** menu (EB-755F/EB-750F)
 - A memory name that has already been used is indicated by a blue mark. Saving over a previously saved memory overwrites the settings with your current settings.

- **Load Memory** lets you overwrite your current settings with saved settings.
- **Rename Memory** lets you rename a saved memory.
- **Erase Memory** lets you erase the selected memory settings.

- 4** Press [Menu] or [Esc] to exit the menus.



- The saved Color Mode is displayed on the right of the memory name.
- To delete all saved memories, select **Reset Memory Settings**.

» **Related Links**

- "Image Quality Settings - Image Menu" [p.216](#)
- "Input Signal Settings - Signal I/O Menu" [p.218](#)
- "Projector Feature Settings - Operation Menu" [p.224](#)
- "Multiple Projector Operation Settings - Multi-Projection Menu" [p.242](#)

You can combine the projected images from two or more projectors to create one unified image area.

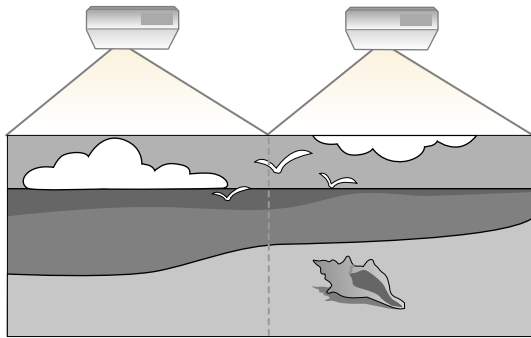

- Before starting projection, make sure you set the **Color Mode** setting to **Multi-Projection** in the projector's **Image** menu for all of the projectors (EB-755F/EB-750F).

For best results, select settings and adjustments for multiple projector images in this order:

EB-755F/EB-750F:

- Setting the Projector ID
- Adjusting Color Uniformity
- Blending the Image Edges
- Matching the Image Colors
- Adjusting the Black Level
- Adjusting RGBCMY
- Scaling an Image

EB-735Fi/EB-735F/EB-725Wi/EB-725W/EB-720:

- Setting the Projector ID
- Adjusting Color Uniformity
- Setting the **Light Source Mode** to **Custom** and adjusting the **Brightness Level** in the projector's **Operation** menu.

☛ Operation > Light Source Brightness Control > Light Source Mode

- Adjusting RGBCMY



We recommend adjusting the image at least 30 minutes after you start projecting, because images are not stable right after turning on the projector.

» Related Links

- "Projector Identification System for Multiple Projector Control" [p.149](#)
- "Adjusting Color Uniformity" [p.151](#)
- "Blending the Image Edges" [p.153](#)
- "Matching the Image Colors" [p.154](#)
- "Adjusting the Black Level" [p.156](#)
- "Adjusting RGBCMY" [p.158](#)
- "Scaling an Image" [p.160](#)

Projector Identification System for Multiple Projector Control

When lining up multiple projectors to project images, you can correct the brightness and color tone of each projector's image so that the images match closely.

You can set a unique projector ID for each projector to operate them individually using a remote control, and then correct the brightness and color for each projector.



- In some cases the brightness and color tone may not match completely even after correction.
- If brightness and color tone differences become more noticeable over time, repeat the adjustments.

» Related Links

- "Setting the Projector ID" [p.150](#)
- "Selecting the Projector You want to Operate" [p.150](#)

Setting the Projector ID

To control multiple projectors from a remote control, give each projector a unique ID.

- 1 Press the [Menu] button and do the following:
 - **EB-755F/EB-750F:** select the **Multi-Projection** menu and press [Enter].
 - **EB-735Fi/EB-735F/EB-725Wi/EB-725W/EB-720:** select the **Installation** menu and press [Enter].
- 2 Select **Projector ID** and press [Enter].
- 3 Use the arrow buttons to select the identification number you want to use for the projector. Then press [Enter].

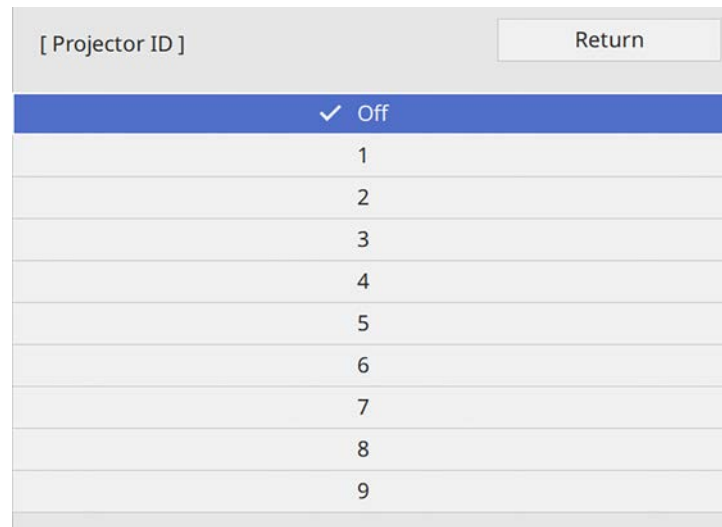

- 4 Press [Menu] or [Esc] to exit the menus.
- 5 Repeat these steps for all the other projectors you want to operate from one remote control.

Selecting the Projector You want to Operate

After setting the projector's ID, select the ID for the projector you want to operate using the remote control.

- 1 Aim the remote control at the target projector and press the [ID] button.

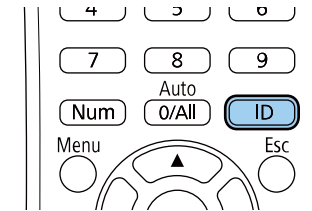

The current Projector ID is displayed on the projected screen. It disappears after about 3 seconds.

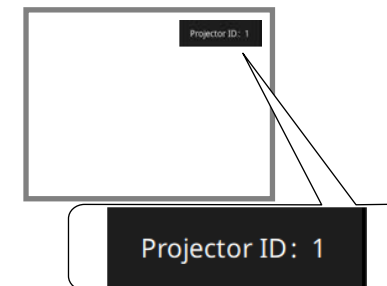

- 2** While holding the [ID] button, press the number button that matches the ID of the projector you want to operate.

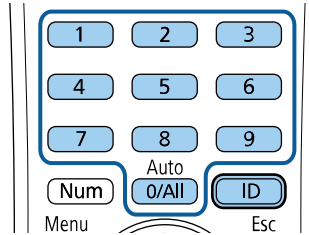

The projector you want to operate is selected.

- When you select [0/All] on the remote control, you can operate all projectors regardless the **Projector ID** setting.
- When you set the **Projector ID** setting to **Off**, you can operate the projector using the remote control whichever ID you select on the remote control.
- The projector ID setting is saved in the remote control. Even if the remote control batteries are removed to replace them and so on, the saved ID setting is retained. However, if the batteries are left out of the remote control for an extended period, the ID returns to its default setting (0/All).
- When you use multiple remote controls at the same time, you may not be able to operate projectors as intended due to infrared interference.

- 1** Press the [Menu] button, select the **Management** menu, and press [Enter].

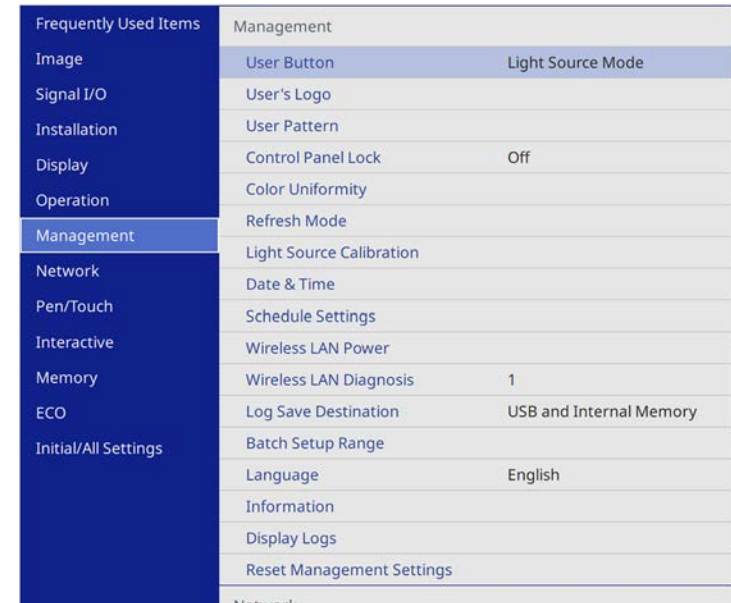

Adjusting Color Uniformity

If the color tone of the image is uneven, you can adjust the color tone balance. Adjust the **Color Uniformity** setting for each projector.

- The color tone may not be uniform even after adjusting the color uniformity.

- 2** Select **Color Uniformity** and press [Enter].

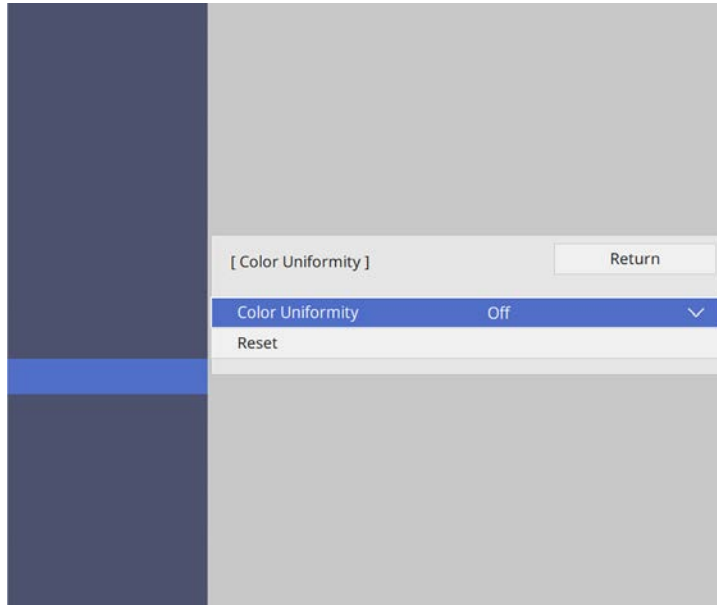

There are eight adjustment levels, from white to gray to black. You can adjust each level individually.

- 7** Select **Start Adjustments** and press [Enter].

- 8** Select the area of the image you want to adjust and press [Enter].

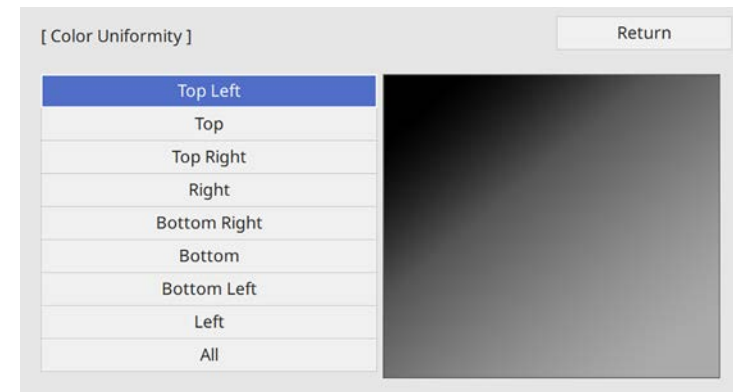

- 3** Select **Color Uniformity** again and press [Enter].

- 4** Select **On** and press [Enter]. Then press [Esc].

- 5** Select **Adjustment Level** and press [Enter].

- 6** Select the first adjustment level you want to adjust and press [Esc].



Adjust each area individually, then select **All** and adjust the entire screen.

- 9** Select **Red, Green, or Blue** and adjust the color tone, if necessary.

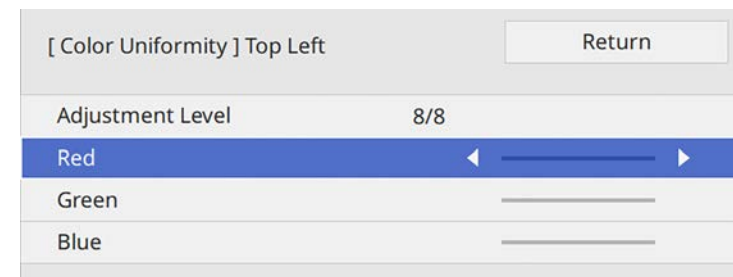



The adjustment screen changes each time you press [Enter].

- 10** Press [Esc] to return to the area selection screen.
- 11** Repeat the color adjustments to each area.
- 12** Return to step 5 and repeat all steps to adjust other levels.
- 13** When you are finished, press [Menu] to exit.

Blending the Image Edges

You can use the projector's **Edge Blending** feature to create a seamless image from multiple projectors (EB-755F/EB-750F).

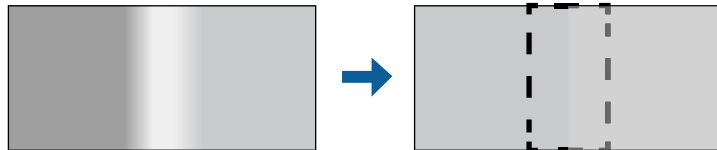

- 1** Press the [Menu] button, select the **Multi-Projection** menu, and press [Enter].

Frequently Used Items	Multi-Projection
Image	Projector ID Off
Signal I/O	Geometry Correction Point Correction
Installation	Edge Blending
Display	Scale
Operation	Color Uniformity
Management	Light Source Mode Normal
Network	Color Matching
Multi-Projection	RGBCMY
Memory	Reset Multi-Projection Settings
ECO	Memory
Initial/All Settings	Save Memory
	Load Memory
	Rename Memory
	Erase Memory
	Reset Memory Settings
	ECO
	Light Source Mode Normal

- 2** Select **Edge Blending** and press [Enter].
- 3** Turn on the **Edge Blending**, **Line Guide**, and **Pattern Guide** settings.



Select the different **Guide Color** setting for each projector so that you can see the blended area clearly.

- 4** Select the edge you want to blend on each projector and press [Enter].

You see a screen like this:

[Top Edge]	Return	
Blending	Off	
Blend Start Position	0	_____
Blend Range	0	_____
Blend Curve	0	

- 5** Select the **Blending** setting and select **On**.
- 6** Select the **Blend Start Position** setting and adjust the blending start position
- 7** Select the **Blend Range** setting and use the arrow buttons to select the width of the blended area so that the displayed guides are at the edges of the overlapping area between the two images.

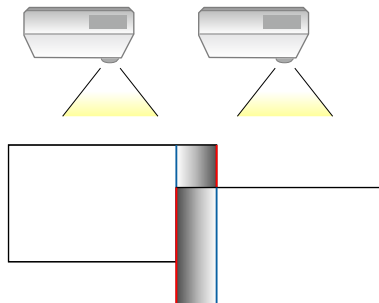

- 8** Press [Esc] to return to the previous screen.
- 9** Select the **Blend Curve** setting and select a gradient for the shaded area on the projectors.

10 When the edges are blended, turn off the **Line Guide** and **Pattern Guide** settings on each projector to check the final settings.

11 When you are finished, press [Menu].

 If the blended area does not overlap exactly, correct the shape of the blended area using **Point Correction**.

Matching the Image Colors

You can match the display quality of multiple projectors that will project next to each other (EB-755F/EB-750F).

Before you begin, turn on all the projectors so you can select image quality settings that match on the unified screen.

- 1 Press the [Menu] button, select the **Multi-Projection** menu, and press [Enter].

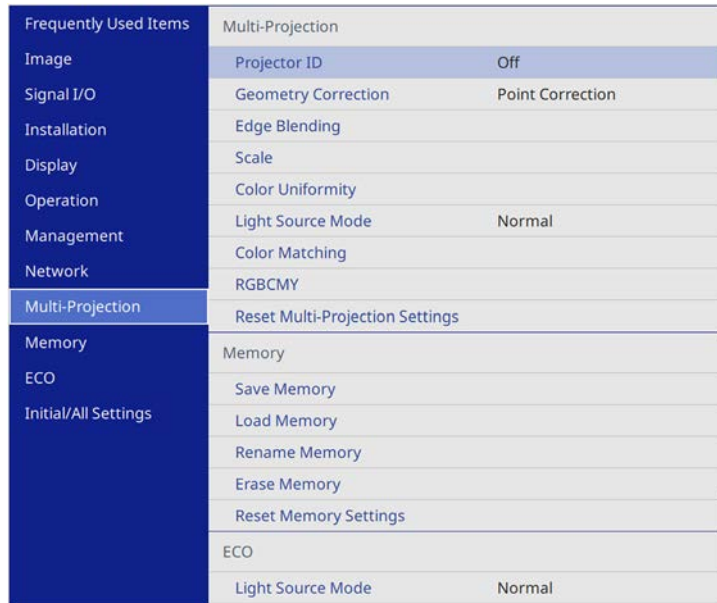

- 2 Select **Color Matching** and press [Enter].

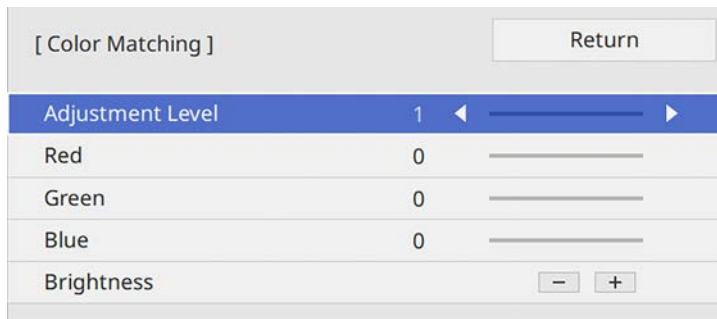

- 3 Set the **Adjustment Level** to 8.

- 4 Select **Brightness** and adjust the value.
- 5 Select **Red**, **Green**, or **Blue** and adjust the color tone, if necessary.
- 6 Go back to the top level menu and select the **Operation** menu and press [Enter].
- 7 Select **Light Source Brightness Control** and press [Enter].
- 8 Set the **Light Source Mode** to **Custom**.
- 9 Adjust the **Brightness Level**.
- 10 Repeat steps 1 through 5 multiple times, each time selecting to adjust levels 7 through 2 in the same way.
- 11 When you are finished, press [Menu].

Adjusting the Black Level

You can adjust the brightness and color tone of the areas where the images do not overlap to create a seamless image (EB-755F/EB-750F).

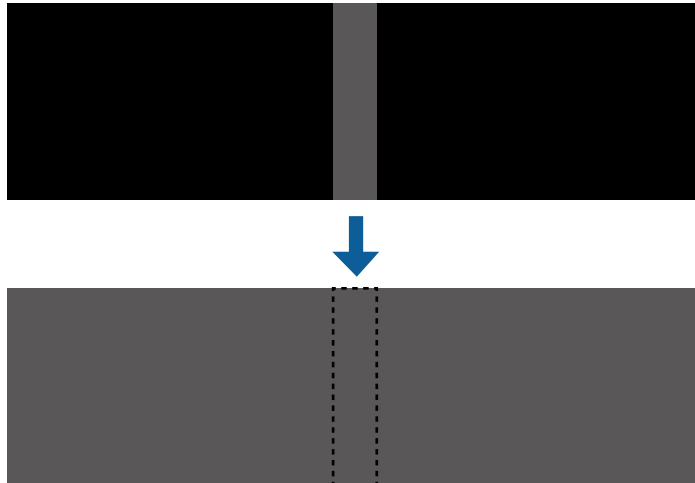

- You cannot adjust the **Black Level** setting when a test pattern is displayed.
- If the **Geometry Correction** value is very large, you may not be able to adjust the **Black Level** correctly.
- The brightness and tone may differ in areas where the images overlap as well as in other areas even after performing the **Black Level** adjustment.
- If you change the **Edge Blending** setting, the **Black Level** setting returns to its default value.

- 1 Press the [Menu] button, select the **Multi-Projection** menu, and press [Enter].

Frequently Used Items	Multi-Projection
Image	Projector ID Off
Signal I/O	Geometry Correction Point Correction
Installation	Edge Blending
Display	Scale
Operation	Color Uniformity
Management	Light Source Mode Normal
Network	Color Matching
	RGBCMY
	Reset Multi-Projection Settings
Multi-Projection	
Memory	Memory
ECO	Save Memory
Initial/All Settings	Load Memory
	Rename Memory
	Erase Memory
	Reset Memory Settings
	ECO
	Light Source Mode Normal

- 2 Select **Black Level** and press [Enter].
- 3 Select **Color Adjustment** and press [Enter].
The adjustment areas are displayed based on the **Edge Blending** setting.
- 4 Use the arrow buttons to select the area you want to adjust and press [Enter].

The selected area is displayed in orange.

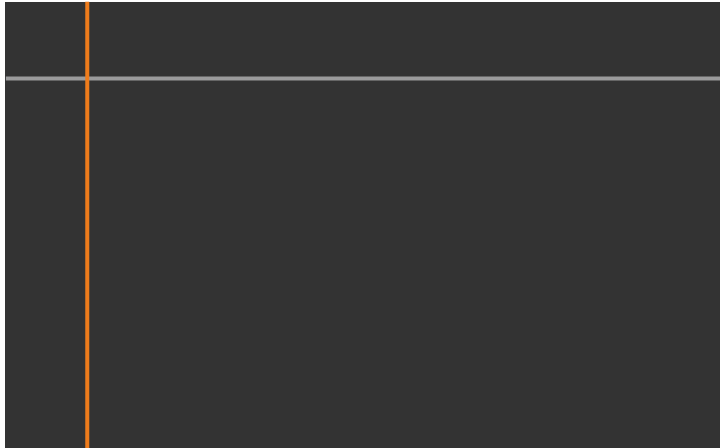

When multiple screens are overlapping, adjust based on the area with the most overlap (the brightest area). In the illustration below, first align (2) with (1), and then adjust so that (3) aligns with (2).

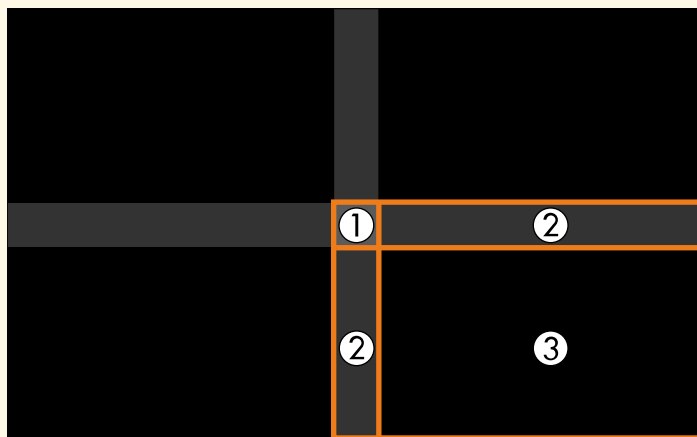

5 Adjust the black tone.

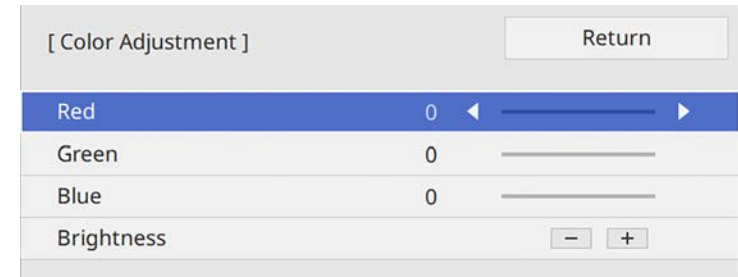

You can use the **Brightness** buttons to adjust the RGB values at the same time.

6 Repeat steps 4 and 5 as needed to adjust any remaining screen areas.

7 When you are finished, press [Menu].

» **Related Links**

- "Modifying the Black Level Adjustment Area" [p.157](#)

Modifying the Black Level Adjustment Area

If there are areas where the color does not match after adjusting the **Black Level** setting, you can adjust them individually.

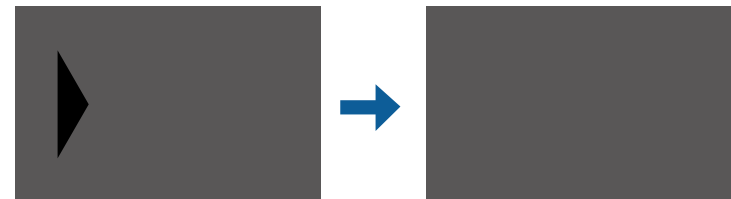

1 Select **Area Correction** in the **Black Level** setting and press [Enter].

- 2** Select **Start Adjustments** and press [Enter].
Boundary lines indicating where images overlap are displayed. The lines are displayed based on the **Edge Blending** setting.

- 3** Use the arrow buttons to select the boundary line you want to adjust. Then press [Enter].
The selected line is displayed in orange.



- 4** Use the arrow buttons to adjust the line position. Then press [Enter].
- 5** Use the arrow buttons to select the point you want to move. Then press [Enter].
The selected point is displayed in orange.

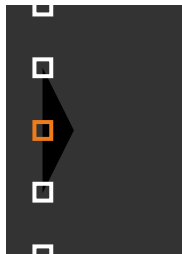

You can change the number of the displayed points using the **Points** setting.

- 6** Use the arrow buttons to move the point.
- 7** To continue to move another point, press [Esc] and then repeat steps 5 and 6.
- 8** To adjust another boundary line, press [Esc] until the screen shown in step 3 is displayed.
- 9** When you are finished, press [Menu].

Adjusting RGBCMY

You can adjust the **Hue**, **Saturation**, and **Brightness** settings for R (red), G (green), B (blue), C (cyan), M (magenta), and Y (yellow) color components.

Before you begin, turn on all the projectors so you can select color tone settings that match on the unified screen.

1 Press the [Menu] button, select the **Image** menu, and press [Enter].

Frequently Used Items	Image	
Image	Color Mode	Presentation
Signal I/O	Brightness	50
Installation	Contrast	50
Display	Color Saturation	50
Operation	Tint	50
Management	Sharpness	50
Network	White Balance	
Pen/Touch	Dynamic Contrast	Off
Interactive	Image Enhancement	
Memory	Gamma	0
ECO	RGBCMY	
Initial/All Settings	Reset to Defaults	
	Source	Computer1
	Resolution	Auto
	Aspect	Auto
	Analog Signal Adjustment	
	Reset to Defaults	
	Reset Image Settings	

2 Select **RGBCMY** and press [Enter].

3 Select the color to adjust, and press [Enter].

[RGBCMY]		Return		
	Hue	Saturation	Brightness	
R	50	50	50	
G	50	50	50	
B	50	50	50	
C	50	50	50	
M	50	50	50	
Y	50	50	50	

4 Do the following as necessary for each setting:

- To adjust the overall hue of the color, bluish - greenish - reddish, adjust the **Hue** setting.
- To adjust the overall vividness of the color, adjust the **Saturation** setting.
- To adjust the overall color brightness of the color, adjust the **Brightness** setting.

[R]		Return	
Hue	50	M	Y
Saturation	50		
Brightness	50		

5 When you are finished, press [Menu].

Scaling an Image

You can project the same image from multiple projectors and use the **Scale** feature to crop and combine them into one unified image area (EB-755F/EB-750F).

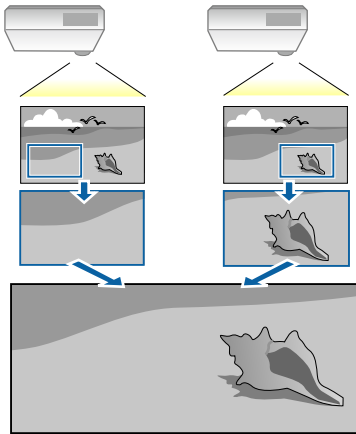

1 Input the image signal to display the image.

2 Press the [Menu] button, select the **Multi-Projection** menu, and press [Enter].

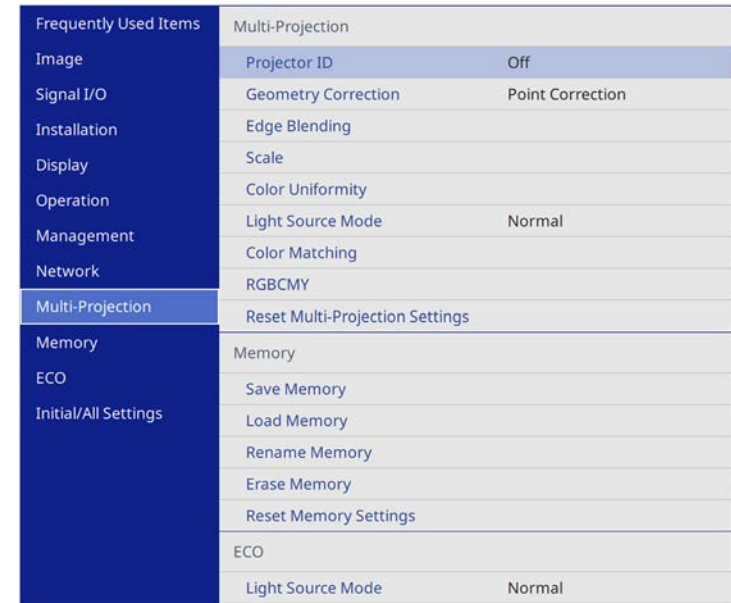

3 Select **Scale** and press [Enter].

You see this screen:

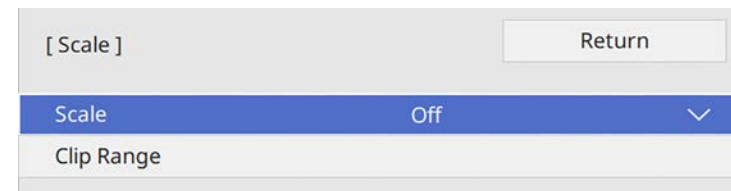

4 Select the **Scale** setting and select **On**.

5 Select the **Scale Mode** setting and select one of these options:

- **Zoom Display** to maintain the image aspect ratio as you scale the image.

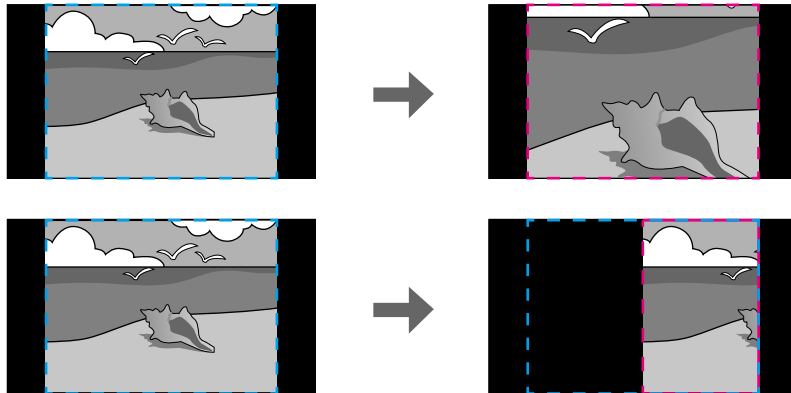

- **Full Display** to adjust the image to the projector's screen size as you scale the image.

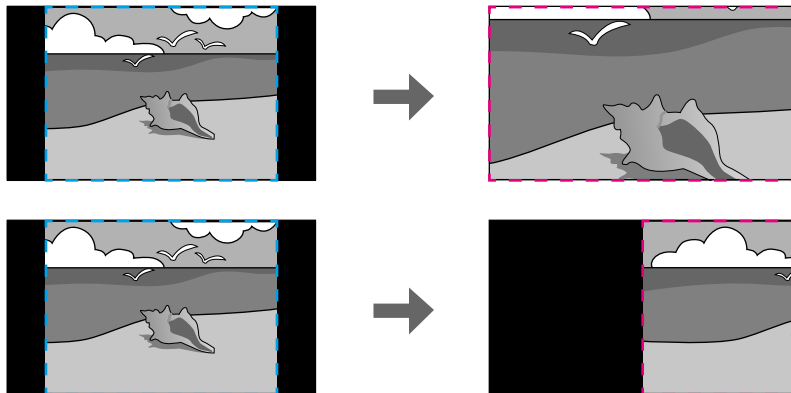

6 Select one or more of the following scaling options and adjust it as necessary:

- - or + to scale the image horizontally and vertically at the same time.

- **Scale Vertically** to scale the image vertically only.
- **Scale Horizontally** to scale the image horizontally only.

7 Select the **Clip Adjustment** setting and use the arrow buttons to adjust the coordinates and size of each image as you view the screen.

8 Select **Clip Range** to preview the clipped area you selected.

9 When you are finished, press [Menu].

You can secure your projector to deter theft or prevent unintended use by setting up the following security features:

- Password security to prevent people who do not know the password from using the projector, and prevent changes to the startup screen and other settings.
This acts as an anti-theft function as the projector cannot be used even if it is stolen, and you can limit who can use the projector.
- Button lock security to block operation of the projector using the buttons on the control panel.
This is useful at events or shows when you want to deactivate all buttons during projection or at schools when you want to limit button operation.
- Security cabling to physically secure the projector in place.

► Related Links

- "Password Security Types" [p.162](#)
- "Locking the Projector's Buttons" [p.164](#)
- "Installing a Security Cable" [p.165](#)

Password Security Types

You can set up the following types of password security using one shared password:

- **Power On Protection** prevents anyone from using the projector without first entering a password. When plugging the power cord and turning on the projector at first time, you must enter the correct password. This also applies to **Direct Power On** and **Auto Power On**.
- **Menu Protection of User's Logo** prevents anyone from changing the custom screen displayed when the projector turns on or receives an input signal. The custom screen deters theft by identifying the projector's owner.
- **Menu Protection of Schedule** prevents anyone from changing the projector's schedule settings.
- **Menu Protection of Network** prevents anyone from changing the projector's **Network** settings.

- **Menu Protection of Interactive** prevents anyone from changing the projector's **Interactive** settings (EB-735Fi/EB-725Wi).

► Related Links

- "Setting a Password" [p.162](#)
- "Selecting Password Security Types" [p.163](#)
- "Entering a Password to Use the Projector" [p.164](#)

Setting a Password

To use password security, you must set a password.



The default password is set to "0000". Change this to your own password.

1

Hold down the [Freeze] button on the remote control for about 5 seconds.

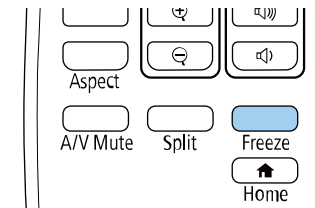

You see the Password Protection setting menu.



If Password Protection is already activated, you must enter the correct password to display the Password Protection setting menu.

- 2** Select **Password** and press [Enter].

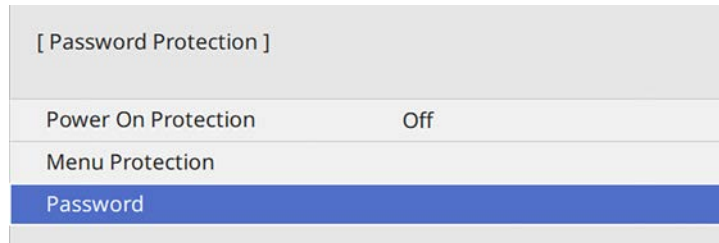

You see the prompt "Change the password?".

- 3** Select **Yes** and press [Enter].



If you select **No**, the Password Protection setting menu is displayed again.

- 4** Hold down the [Num] button on the remote control and use the numeric buttons to set a four-digit password.

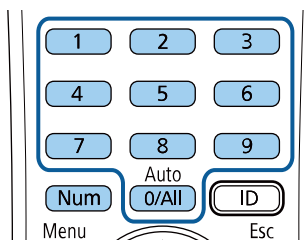

The password displays as **** as it is entered. A confirmation prompt is displayed when you enter the fourth digit.

- 5** Enter the password again.

You see the message "Password accepted". If you enter the password incorrectly, a message is displayed prompting you to re-enter the password.

- 6** Press [Esc] to return to the menu.

- 7** Make a note of the password and keep it in a safe place.

Selecting Password Security Types

After setting a password, you see this menu, allowing you to select the password security types you want to use.



If you do not see this menu, hold down the [Freeze] button on the remote control for 5 seconds until the menu appears.

- To prevent unauthorized use of the projector, set the **Power On Protection** setting to **On**.
- To prevent changes to the projector's settings, select the **Menu Protection** setting, press [Enter], and select the options as necessary.
- To prevent changes to the User's Logo screen or related display settings, set the **User's Logo** setting to **On**.
- To prevent changes to the projector's schedule settings, set the **Schedule** setting to **On**.
- To prevent changes to projector's network settings, set the **Network** setting to **On**.
- To prevent changes to the projector's **Interactive** settings, set the **Interactive** setting to **On**. (EB-735Fi/EB-725Wi)

You can attach the password protect sticker to the projector as an additional theft deterrent.



Be sure to keep the remote control in a safe place; if you lose it, you will not be able to enter the password.

Entering a Password to Use the Projector

When the password screen is displayed, enter the correct password.

[Password]

Enter the password.

See your documentation for more information.

Attention

- If an incorrect password is entered three times in succession, the message "The projector's operation will be locked." is displayed for approximately 5 minutes, and the projector switches to standby mode. If this happens, disconnect the power plug from the electrical outlet, reinsert it, and turn the projector back on. The projector displays the password entry screen again so that you can enter the correct password.
- If you have forgotten the password, make a note of the "**Request Code:** xxxxx" number that appears on the screen and contact Epson for help.
- If you continue to repeat the above operation and input the wrong password 30 times in succession, the message "The projector's operation will be locked. Contact Epson as described in your documentation." is displayed and the projector does not accept any more password entries. Contact Epson for help.

Locking the Projector's Buttons

You can lock the buttons on the control panel to prevent anyone from using the projector. The projector can still be operated using the remote control.

- 1 Hold down the [Num] button on the remote control while you enter the password using the numeric buttons.

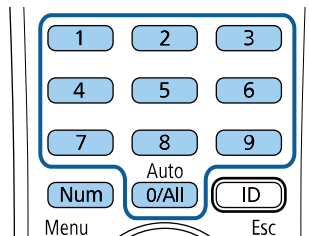

The password screen closes.

- 2 If the password is incorrect, you see a message and a prompt to try again. Enter the correct password to proceed.

- 1 Press the [Menu] button, select the **Management** menu, and press [Enter].

Frequently Used Items	Management
Image	User Button Light Source Mode
Signal I/O	User's Logo
Installation	User Pattern
Display	Control Panel Lock Off
Operation	Color Uniformity
Management	Refresh Mode
Network	Light Source Calibration
Pen/Touch	Date & Time
Interactive	Schedule Settings
Memory	Wireless LAN Power
ECO	Wireless LAN Diagnosis 1
Initial/All Settings	Log Save Destination USB and Internal Memory
	Batch Setup Range
	Language English
	Information
	Display Logs
	Reset Management Settings

- 2 Select **Control Panel Lock** and press [Enter].
- 3 Select one of these lock types and press [Enter]:
 - To lock all of the projector's buttons, select **Full Lock**.
 - To lock all buttons except the power button, select **Except for Power**.

[Control Panel Lock]	Return
Full Lock	
Except for Power	
✓ Off	

You see a confirmation prompt.

- 4 Select **Yes** and press [Enter].
The **Control Panel Lock** setting takes effect.

» Related Links

- "Unlocking the Projector's Buttons" [p.165](#)

Unlocking the Projector's Buttons

If the projector's buttons have been locked, do one of the following to unlock them.

- Hold down the [Enter] button on the control panel for 7 seconds. A message is displayed and the lock is released.
- Set the **Control Panel Lock** setting to **Off** in the projector's **Management** menu.

Installing a Security Cable

You can install the security cable on the projector to deter theft.

- Use the security slot on the projector to attach a Kensington Microsaver Security system.



For more details on the Microsaver Security System, visit the Kensington Web site.

<https://www.kensington.com/>

- Use the security cable attachment point on the projector to attach a wire cable and secure it to a room fixture or heavy furniture.

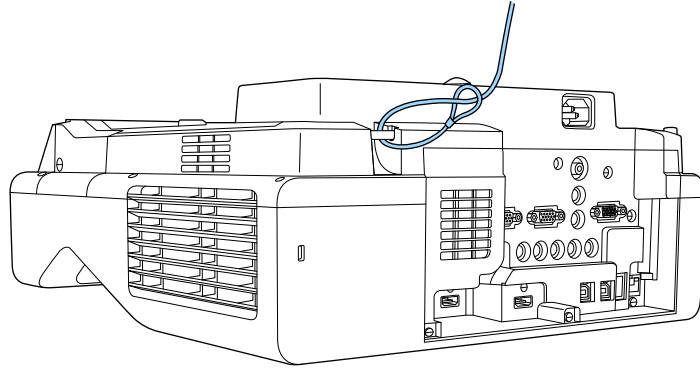

If the safety wire lock attachment comes with the setting plate, you can use it to secure the projector. You can also use a commercially available theft-prevention wire lock. See the documentation supplied with the wire lock for locking instructions.

Using the Projector on a Network

Follow the instructions in these sections to set up your projector for use on a network.

► Related Links

- "Wired Network Projection" [p.168](#)
- "Wireless Network Projection" [p.172](#)
- "Wireless Network Projection from a Mobile Device (Screen Mirroring)" [p.182](#)
- "Secure HTTP" [p.187](#)
- "Screen Sharing" [p.189](#)

You can send images to your projector through a wired network. To do this, connect the projector to your network, and then set up your projector and computer for network projection.

After connecting and setting up the projector as described here, download and install Epson iProjection (Windows/Mac) from the following Web site.

epson.sn

Epson iProjection software sets up your computer for network projection. It also allows you to hold interactive meetings by projecting user's computer screens over a network. See the *Epson iProjection Operation Guide (Windows/Mac)* for instructions.

▶ Related Links

- "Connecting to a Wired Network" [p.168](#)
- "Selecting Wired Network Settings" [p.168](#)

Connecting to a Wired Network

To connect the projector to a wired local area network (LAN), use a 100Base-TX or 10Base-T network cable. To ensure proper data transmission, use a Category 5 shielded cable or better.

- 1** Connect one end of the network cable to your network hub, switch, or router.

- 2** Connect the other end of the cable to the projector's LAN port.

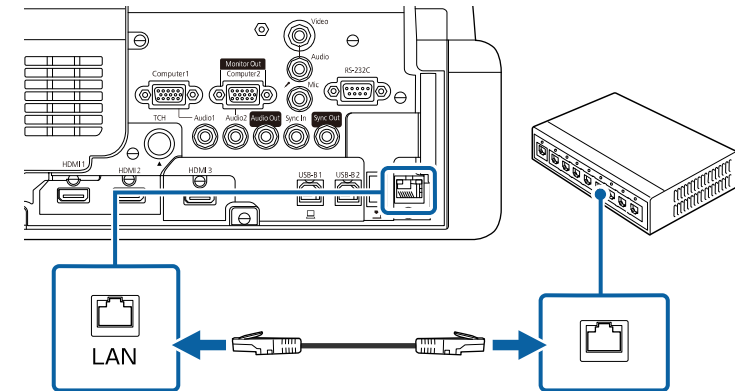

Selecting Wired Network Settings

Before you can project from computers on your network, you need to select network settings on the projector.



Make sure you already connected the projector to your wired network using the LAN port.

1 Press the [Menu] button, select the **Network** menu, and press [Enter].

Frequently Used Items	Network
Image	Wireless LAN Info.
Signal I/O	Wired LAN Info.
Installation	Network Settings
Display	Reset Network Settings
Operation	Pen/Touch
Management	Auto Calibration
Network	Manual Calibration
Pen/Touch	Touch Unit
Interactive	Installation of Projectors
Memory	Pen Hovering On
ECO	PC Interactivity
Initial/All Settings	Reset Pen/Touch Settings
	Interactive
	Drawing Function On
	Display Toolbars Always Show
	Display Drawing Area
	Confirm Clear Screen On

2 Select **Network Settings** and press [Enter].

3 To identify the projector over the network, select **Projector Name** and enter a name up to 16 alphanumeric characters long.

4 Set the **Priority Control Interface** setting to **Wired LAN**.

5 Select the **Wired LAN** menu and press [Enter].

[Wired LAN]	Return
IP Settings	
DNS Server 1	0.0.0.0
DNS Server 2	0.0.0.0
IPv6	Off
IP Address Display	On

6 Assign the IP settings for your network as necessary.

- If your network assigns addresses automatically, select **IP Settings** to set the **DHCP** setting to **On**.
- If you must set addresses manually, select **IP Settings** to set the **DHCP** setting to **Off**, and then enter the projector's **IP Address**, **Subnet Mask**, and **Gateway Address** as necessary.

7 To prevent the IP address from being displayed on the network information screen, set the **IP Address Display** setting to **Off**.

8 Select the **Network Projection** menu and press [Enter].

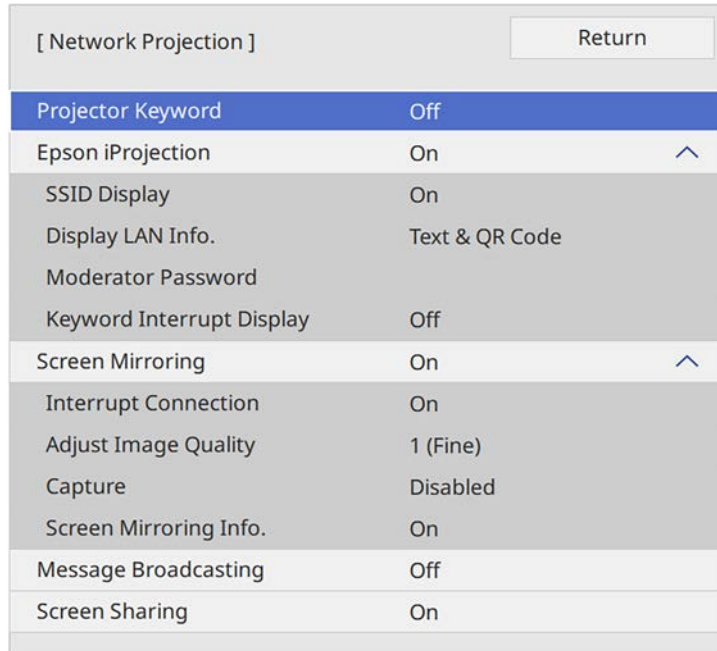

9 Turn on the **Projector Keyword** setting if you want to prevent access to the projector by anyone not in the room with it.



When you turn on this setting, you must enter a displayed, randomized keyword from a computer using Epson iProjection to access the projector and share the current screen.

10 Set the **Epson iProjection** setting to **On**.

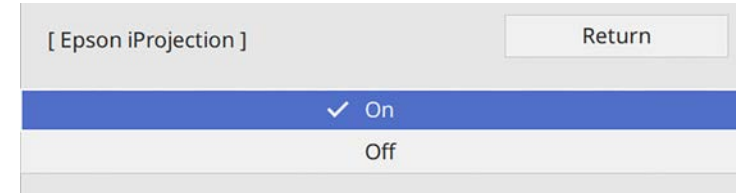



11 Select the options as necessary.

- **Display LAN Info.** lets you set the display format for the projector's network information.
- **Moderator Password** lets you enter a four-digit number password for accessing the projector as a moderator using Epson iProjection. (No password is set by default.)
- **Keyword Interrupt Display** lets you select whether to display a projector keyword on the projected image when accessing the projector using Epson iProjection.

12 When you finish selecting settings, go back to the **Network Settings** screen, select **Set**, and follow the on-screen instructions to save your settings and exit the menus.

13 Press the [LAN] button on the remote control.

The wired network settings complete when you see the correct IP address on the network information screen.

```
[ LAN ]
Projector Name      : MYNAME
SSID                : MYSSID
IP Address       : WIRED.DHCP.ID
IP Address  : WIRELESS.DHCP.ID
Keyword             : ----

Event ID           : 0434
```

» Related Links

- "Using the Displayed Keyboard" [p.215](#)

You can send images to your projector through a wireless network.

To do this, you must set up your projector and computer for wireless projection.

You can connect the projector to your wireless network by configuring the connection manually using the projector's **Network** menus.

After setting up the projector, download and install the network software from the following Web site.

epson.sn

Use the following software and documentation to set up and control wireless projection:

- Epson iProjection (Windows/Mac) software allows you to hold interactive meetings by projecting the computer screens of users over a network. See the *Epson iProjection Operation Guide (Windows/Mac)* for instructions.

- Epson iProjection (iOS/Android) app allows you to project from iOS or Android devices.

You can download Epson iProjection from the App Store or Google Play. Any fees incurred when communicating with the App Store or Google Play are the responsibility of the customer.

- Epson iProjection (Chromebook) app allows you to project from Chromebook devices.

You can download Epson iProjection from the Chrome Web Store. Any fees incurred when communicating with the Chrome Web Store are the responsibility of the customer.

► Related Links

- "Safety Instructions for Built-in Wireless LAN Module" [p.172](#)
- "Connection Methods for Wireless Network Projection" [p.172](#)
- "Installing the Wireless LAN Module" [p.173](#)
- "Selecting Wireless Network Settings Manually" [p.174](#)
- "Selecting Wireless Network Settings in Windows" [p.177](#)
- "Selecting Wireless Network Settings in Mac" [p.177](#)
- "Setting Up Wireless Network Security for Simple AP Mode" [p.177](#)
- "Setting Up Wireless Network Security for Infrastructure Mode" [p.178](#)
- "Using a QR Code to Connect a Mobile Device" [p.180](#)
- "Using a USB Key to Connect a Windows Computer" [p.181](#)

Safety Instructions for Built-in Wireless LAN Module

This projector contains built-in wireless LAN modules. Be sure to follow these important guidelines when using a wireless LAN connection.

Warning

- Do not use the device near medical equipment such as pace makers. Furthermore, when using the device, make sure there is no medical equipment such as pace makers, in the surrounding area. Electromagnetic interference may cause medical equipment to malfunction.
- Electromagnetic interference may cause automatically controlled equipment to malfunction which could cause an accident. Do not use the device near automatically controlled equipment such as automatic doors or fire alarms.

Caution

Make sure you keep a distance of at least 20 cm between the device and your body. Otherwise, it could cause you to feel unwell.

Connection Methods for Wireless Network Projection

Choose a connection method for connecting your computer and projector over a network based on your network environment.

- Simple AP mode lets you directly connect to smartphones, tablets, or computers using your projector as an access point. When you use this

method, connect the projector using **Quick Connection Mode** of the Epson iProjection software or use Screen Mirroring.



Your projector has built-in wireless LAN modules. If you install an additional optional wireless LAN module, you can use both network connection methods at the same time. When you install the wireless LAN module, set the **Simple AP** setting to **On**.

☛ **Network > Network Settings > Simple AP**

Installing the Wireless LAN Module

To use the additional wireless connections, install the Epson wireless LAN module. Do not install any other type of wireless LAN module.

Attention

Never remove the module while its indicator is blue or flashing, or while you are projecting wirelessly. This could damage the module or lose data.

- Infrastructure mode lets you connect to smartphones, tablets, or computers over a wireless network access point. When you use this method, connect the projector using **Advanced Connection Mode** of the Epson iProjection software.

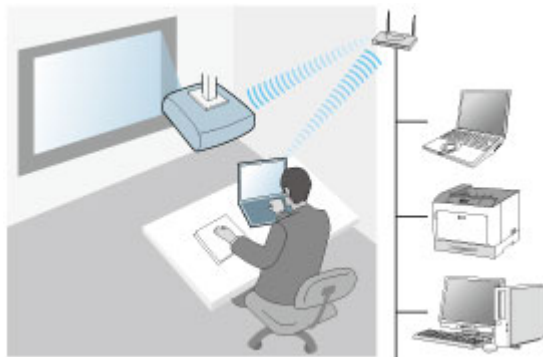

- 1 Remove the screw to open the wireless LAN module cover.

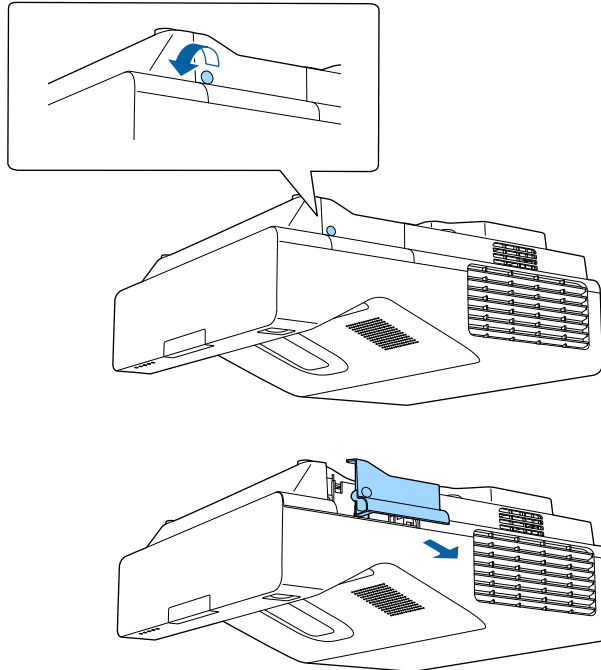

- 2 Connect the wireless LAN module to the wireless LAN module slot.

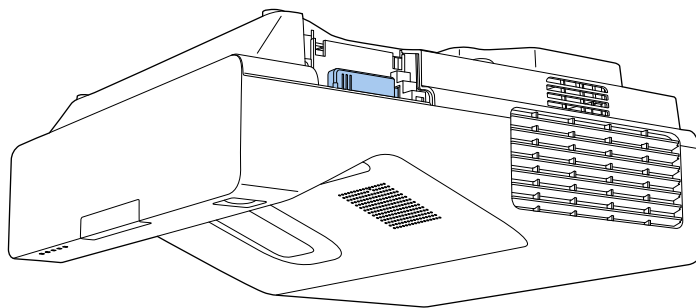

Selecting Wireless Network Settings Manually

Before you can project from your wireless network, you need to select network settings for the projector.

- 1 Press the [Menu] button, select the **Management** menu, and press [Enter].

Frequently Used Items	Management	
Image	User Button	Light Source Mode
Signal I/O	User's Logo	
Installation	User Pattern	
Display	Control Panel Lock	Off
Operation	Color Uniformity	
Management	Refresh Mode	
Network	Light Source Calibration	
Pen/Touch	Date & Time	
Interactive	Schedule Settings	
Memory	Wireless LAN Power	
ECO	Wireless LAN Diagnosis	1
Initial/All Settings	Log Save Destination	USB and Internal Memory
	Batch Setup Range	
	Language	English
	Information	
	Display Logs	
	Reset Management Settings	

- 2 Set the **Wireless LAN Power** setting to **On**.

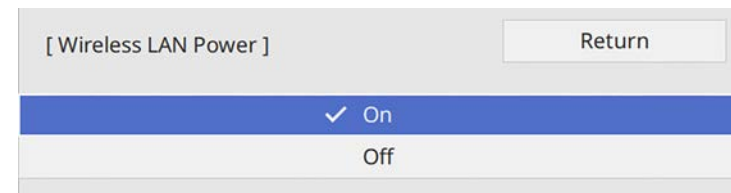

3 Select the **Network** menu and press [Enter].

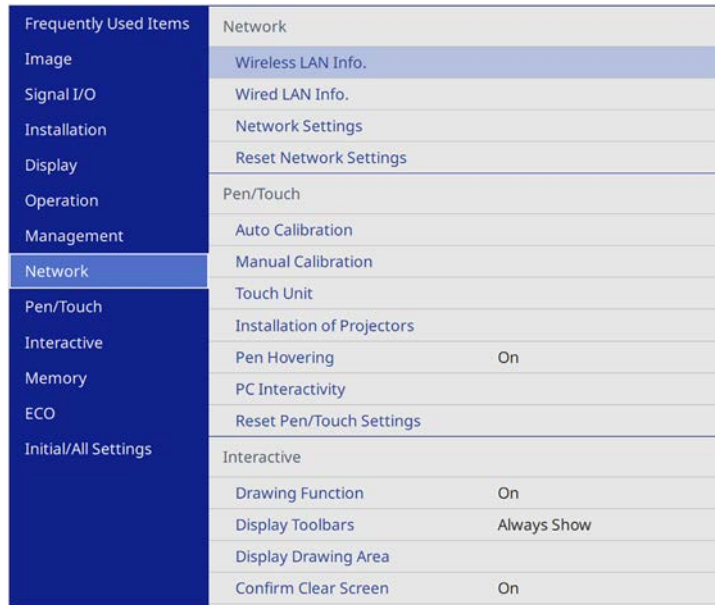

4 Select **Network Settings** and press [Enter].

5 To identify the projector over the network, select **Projector Name** and enter a name up to 16 alphanumeric characters long.

6 Set the **Priority Control Interface** setting to **Wireless LAN**.

7 Select the connection method.

- For simple AP mode, set the **Simple AP** setting to **On** and go to step 12.
- For infrastructure mode, set the **Simple AP** setting to **Off** and go to next step.

- If you installed the optional wireless LAN module and want to use both connection methods at the same time, set the **Simple AP** setting to **On** and go to next step.

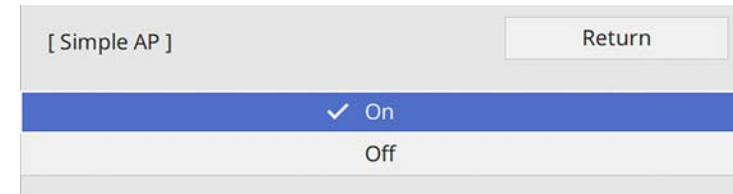

8 Select the **Wireless LAN** menu and press [Enter].

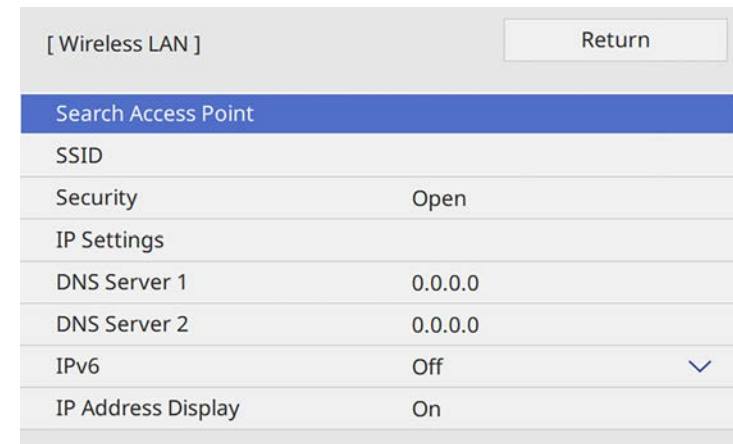

The projector starts searching for access points.

 You can also search for access points using the **Search Access Point** setting manually.

9 Select the access point you want to connect to.



If you need to assign the SSID manually, select **SSID** to enter the SSID.

- 10** Assign the IP settings for your network as necessary.
- If your network assigns addresses automatically, select **IP Settings** to set the **DHCP** setting to **On**.
 - If you must set addresses manually, select **IP Settings** to set the **DHCP** setting to **Off**, and then enter the projector's **IP Address**, **Subnet Mask**, and **Gateway Address** as necessary.

11 To prevent the IP address from being displayed on the network information screen, set the **IP Address Display** setting to **Off**.

12 Select the **Network Projection** menu and press [Enter].

[Network Projection]		Return
Projector Keyword	Off	
Epson iProjection	On	^
SSID Display	On	
Display LAN Info.	Text & QR Code	
Moderator Password		
Keyword Interrupt Display	Off	
Screen Mirroring	On	^
Interrupt Connection	On	
Adjust Image Quality	1 (Fine)	
Capture	Disabled	
Screen Mirroring Info.	On	
Message Broadcasting	Off	
Screen Sharing	On	

13 Turn on the **Projector Keyword** setting if you want to prevent access to the projector by anyone not in the room with it.



When you turn on this setting, you must enter a displayed, randomized keyword from a computer using Epson iProjection to access the projector and share the current screen.

14 Set the **Epson iProjection** setting to **On**.

[Epson iProjection]		Return
✓ On		
Off		

15 Select the options as necessary.

- **SSID Display** lets you select whether to display projector's SSID on the network information screen and Home screen.
- **Display LAN Info.** lets you set the display format for the projector's network information.
- **Moderator Password** lets you enter a four-digit number password for accessing the projector as a moderator using Epson iProjection. (No password is set by default.)
- **Keyword Interrupt Display** lets you select whether to display a projector keyword on the projected image when accessing the projector using Epson iProjection.

16 When you finish selecting settings, go back to the **Network Settings** screen, select **Set**, and follow the on-screen instructions to save your settings and exit the menus.

17 Press the [LAN] button on the remote control.

The wireless network settings are complete when you see the correct IP address on the network information screen.

[LAN]	
Projector Name	: MYNAME
SSID	: MYSSID
IP Address 	: WIRED.DHCP.ID
IP Address 	: WIRELESS.DHCP.ID
Keyword	: ----
Event ID	: 0434

When you have finished making wireless settings for your projector, you need to select the wireless network on your computer. Then start the network software to send images to your projector through a wireless network.

» Related Links

- "Using the Displayed Keyboard" [p.215](#)

Selecting Wireless Network Settings in Windows

Before connecting to the projector, select the correct wireless network on your computer.

- 1** To access your wireless utility software, click the network icon on the Windows taskbar.
- 2** When connecting to devices over a wireless network access point, select the network name (SSID) of the network the projector is connecting to.

- 3** Click **Connect**.

Selecting Wireless Network Settings in Mac

Before connecting to the projector, select the correct wireless network in Mac.

- 1** Click the Wi-Fi icon on the menu bar at the top of the screen.
- 2** When connecting to devices over a wireless network access point, make sure Wi-Fi is turned on and select the network name (SSID) of the network the projector is connecting to.

Setting Up Wireless Network Security for Simple AP Mode

You can set up security for your projector to use on a wireless network with simple AP mode. You can use WPA2-PSK security.



Contact your network administrator for guidance on entering the correct information.

- 1** Press the [Menu] button, select the **Network** menu, and press [Enter].
- 2** Select **Network Settings** and press [Enter].

- 3** Select **Passphrase**, press [Enter], and enter a passphrase from 8 to 63 characters long.

- 4** When you finish entering a passphrase, go back to the **Network Settings** screen, select **Set**, and follow the on-screen instructions to save your settings and exit the menus.

Setting Up Wireless Network Security for Infrastructure Mode

You can set up security for your projector to use on a wireless network with infrastructure mode. Set up one of the following security types to match the settings used on your network:

- WPA3-PSK security
- WPA2/WPA3-PSK security
- WPA3-EAP security
- WPA2/WPA3-EAP security



Contact your network administrator for guidance on entering the correct information.

- 1** If you want to set up WPA3-EAP or WPA2/WPA3-EAP security, make sure your digital certificate file is compatible with projector registration type and placed directly on a USB storage device.

- 2** Press the [Menu] button, select the **Network** menu, and press [Enter].

- 3** Select **Network Settings** and press [Enter].

- 4** Select the **Wireless LAN** menu and press [Enter].

- 5** Select the **Security** setting and press [Enter].

6 Select the security settings to match your network settings.

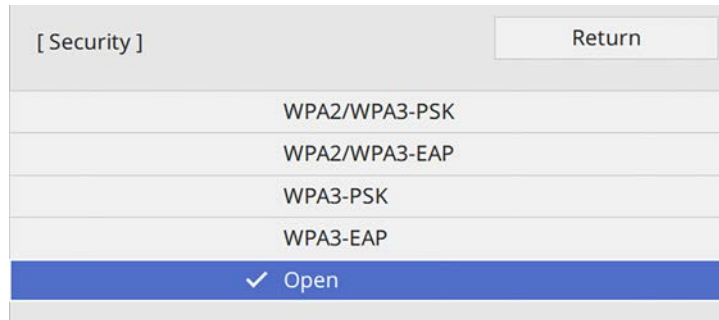

7 Do one of the following according to the security you selected.

- **WPA3-PSK** or **WPA2/WPA3-PSK**: Select **Passphrase**, press [Enter], and enter a passphrase from 8 to 63 characters long. Then go to step 16.
- **WPA3-EAP** or **WPA2/WPA3-EAP**: Select **EAP Type** and press [Enter].

8 Select the protocol for authentication as the **EAP Type** setting.

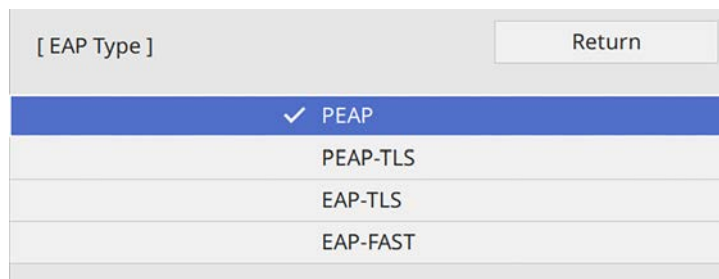

9 To import your certificate, select the certificate type and press [Enter].

- **Client Certificate** for the **PEAP-TLS** or **EAP-TLS** type
- **CA certificate** for all EAP types



You can also register the digital certificates using your Web browser. However, be sure to register just once or the certificate may not install correctly.

10 Select **Save** and press [Enter].

11 Follow the on-screen instructions to connect a USB storage device to the projector's USB-A port.

12 Press [Enter] to display the certificate list.

13 Select the certificate to import using the displayed list.

A message is displayed prompting you to enter the password for the certificate.

14 Enter a password and press [Enter].

The certificate is imported and a completion message appears.

15 Select your EAP settings as necessary.

- **User name** lets you enter a user name using up to 64 alphanumeric characters. When importing a client certificate, the name the certificate was issued to is automatically set.
- **Password** lets you enter a password using up to 64 alphanumeric characters for authentication when using the **PEAP** or **EAP-FAST** type.
- **Verify Server Certificate** lets you select whether or not to verify the server certificate when a CA certificate has been set.
- **RADIUS Server Name** lets you enter the server name to be verified.

16 When you finish making settings, go back to the **Network Settings** screen, select **Set**, and follow the on-screen instructions to save your settings and exit the menus.

» **Related Links**

- "Supported Client and CA Certificates" p.180

Supported Client and CA Certificates

You can register these types of digital certificates.

Client Certificate (PEAP-TLS/EAP-TLS)

Specification	Description
Format	PKCS#12
Extension	PEM, P12
Encryption	RSA
Hashes	MD5/SHA-1/SHA-256/SHA-384/SHA-512
Key length	512/1024/2048/4096 bit
Password	Up to 64 alphanumeric characters; required

CA Certificate (PEAP/PEAP-TLS/EAP-TLS/EAP-FAST)

Specification	Description
Format	X509v3
Extension	DER/CER/PEM
Encryption	RSA
Hashes	MD5/SHA-1/SHA-256/SHA-384/SHA-512
Key length	512/1024/2048/4096 bit
Encoding	BASE64/Binary



- Make sure you have installed the latest version of Epson iProjection on your device.
- You can download Epson iProjection for free from the App Store or Google Play. Any fees incurred when communicating with the App Store or Google Play are the responsibility of the customer.
- When using Epson iProjection in Quick connection mode, we recommend making security settings.

- 1** Press the [LAN] button on the remote control.
The QR code is displayed on the projected surface.



- If you do not see the QR code, set the **Display LAN Info.** setting to **Text & QR Code** in the projector's **Network** menu.
 ☛ **Network > Network Settings > Network Projection > Epson iProjection > Display LAN Info.**
- To hide the QR code, press [Esc].
- When the QR code is hidden, press [Enter] to display the code.

- 2** Start Epson iProjection on your mobile device.
- 3** Read the projected QR code using Epson iProjection to connect it to the projector.



To correctly read the QR code, make sure you face the screen squarely and closely enough so that the projected code fits into the guide of the mobile device's QR code reader. If you are too far from the screen, the code may not be read.

When a connection is established, select **Contents** menu from , and then select the file you want to project.

Using a QR Code to Connect a Mobile Device

After selecting the wireless network settings for your projector, you can display a QR code on the screen and use it to connect a mobile device using the Epson iProjection (iOS/Android) app.

Using a USB Key to Connect a Windows Computer

You can set up your USB flash drive as a USB key to quickly connect the projector to a wireless LAN supported Windows computer. After creating the USB key, you can quickly project images from the network projector.

- 1** Set up the USB key using **USB Key Setup Tool** of the Epson iProjection (Windows/Mac) software.



See the *Epson iProjection Operation Guide (Windows/Mac)* for instructions.

- 2** Make sure the wireless LAN module is installed or built into your projector.
- 3** Turn on the projector.
- 4** Press the [LAN] button on the remote control.
You see the network information screen. Verify that an SSID and IP address are displayed.
- 5** Connect the USB key to the projector's USB-A port.
You see a projected message that the network information update is complete.
- 6** Remove the USB key.
- 7** Connect the USB key to a USB port on your computer.
- 8** Follow the on-screen instructions to install the necessary application.



- If the Windows Firewall message is displayed, click **Yes** to disable the firewall.
- You need administrator authority to install the software.
- If it is not installed automatically, double-click **MPPLaunch.exe** in the USB key.

After a few minutes, your computer image is displayed by the projector.

- 9** When you have finished projecting wirelessly, select the **Safely Remove Hardware** option in the Windows taskbar, and then remove the USB key from your computer.



You may need to restart your computer to reactivate your wireless LAN connection.

» Related Links

- ["Getting the Latest Version of the Documents" p.10](#)

You can send image to your projector from mobile devices such as laptops, smartphones, and tablets using Miracast technology.

You can connect two devices that use Miracast technology at the same time. The projector detects the input sources as Screen Mirroring1 and Screen Mirroring2. You need to set the **Interrupt Connection** setting to **Off**.

☛ **Network > Network Settings > Network Projection > Screen Mirroring > Interrupt Connection**

If your device supports Miracast, you do not need to install any additional software. When using a Windows computer, make sure the necessary adapter for the Miracast connection is available.

Note the following limitations when using Screen Mirroring features.

- You cannot play an interlaced image.
- You can only play audio saved using the LPCM or AAC-LC audio codec.
- You cannot play multi-channel audio over 3ch (channel 3).
- You may not be able to project images depending the resolution and frame rate.
- You cannot play 3D video.
- You can only play movies saved using the H.264 or H.265 movie codec. (H.265 only supports the Main Profile.)
- You may not be able to view contents with copyright protection with a Miracast connection depending on your device.
- Do not change the projector's **Screen Mirroring** setting during Screen Mirroring projection. Doing so may cause the projector to disconnect and it may take a while to re-connect.

☛ **Network > Network Settings > Network Projection > Screen Mirroring**

- Do not turn off the projector directly by the breaker during Screen Mirroring projection.



Mobile devices with Android installed or Windows 8.1 or later installed mainly support Miracast.
Support for Miracast varies depending on the mobile device. See your mobile device manual for details.

» Related Links

- "Selecting Screen Mirroring Settings" [p.182](#)
- "Connecting Using Screen Mirroring with the Miracast Function" [p.184](#)
- "Connecting Using Screen Mirroring in Windows 10" [p.185](#)
- "Connecting Using Screen Mirroring in Windows 8.1" [p.185](#)

Selecting Screen Mirroring Settings

You must select **Screen Mirroring** settings for your projector to project images from your mobile device.



If you use Windows 10, you can cast images using the following connections:

- Casting images from your device to the projector directly
- Casting images via local area network

When you cast images via local area network, the connection is more stable and secure. Do one of the following to connect your projector to a local area network:

- Connect a LAN cable.
- Select the **Wireless LAN** setting to connect to the wireless access point.

To connect to a wireless access point, you need to install the optional wireless LAN module.

1 Press the [Menu] button, select the **Management** menu, and press [Enter].

Frequently Used Items	Management	
Image	User Button	Light Source Mode
Signal I/O	User's Logo	
Installation	User Pattern	
Display	Control Panel Lock	Off
Operation	Color Uniformity	
Management	Refresh Mode	
Network	Light Source Calibration	
Pen/Touch	Date & Time	
Interactive	Schedule Settings	
Memory	Wireless LAN Power	
ECO	Wireless LAN Diagnosis	1
Initial/All Settings	Log Save Destination	USB and Internal Memory
	Batch Setup Range	
	Language	English
	Information	
	Display Logs	
	Reset Management Settings	

2 Set the **Wireless LAN Power** setting to **On**.

[Wireless LAN Power]	Return
✓ On	
Off	

3 Select the **Network** menu and press [Enter].

Frequently Used Items	Network	
Image	Wireless LAN Info.	
Signal I/O	Wired LAN Info.	
Installation	Network Settings	
Display	Reset Network Settings	
Operation	Pen/Touch	
Management	Auto Calibration	
Network	Manual Calibration	
Pen/Touch	Touch Unit	
Interactive	Installation of Projectors	
Memory	Pen Hovering	On
ECO	PC Interactivity	
Initial/All Settings	Reset Pen/Touch Settings	
	Interactive	
	Drawing Function	On
	Display Toolbars	Always Show
	Display Drawing Area	
	Confirm Clear Screen	On

4 Select **Network Settings** and press [Enter].

5 Select **Priority Control Interface** and press [Enter].

6 Choose one of the following options:

- If you cast the data via local area network using the wired LAN, select **Wired LAN**.
- If you cast the data directly or via wireless access point, select **Wireless LAN**.
- If your device only supports casting data directly, select **Wireless LAN**.

7 Set the **Simple AP** setting to **On**.

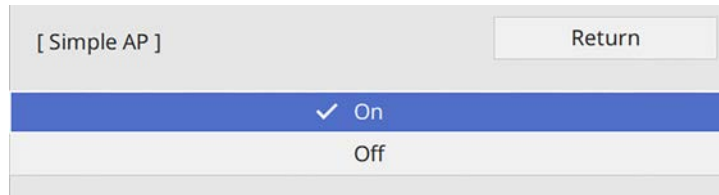

8 Go back to the **Network Settings** screen and select **Network Projection**.

9 Set the **Screen Mirroring** setting to **On**.

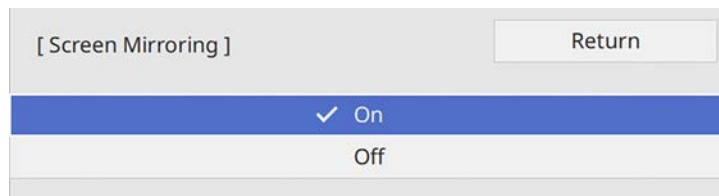

10 Select the options as necessary.

- **Interrupt Connection** lets you select to connect to another mobile device during Screen Mirroring projection or to exclusively connect to one device. If you want to use two Screen Mirroring sources, set this to **Off**.
- **Adjust Image Quality** lets you adjust the screen mirroring speed/quality. Select a small number to improve the quality and select large number to increase the speed.
- **Capture** lets you capture the projected image and paste it on a page in whiteboard mode (EB-735Fi/EB-725Wi). If you select **Enabled**, the HDCP and H.265 codec features are disabled and you may not be able to project content with the HDCP and H.265 codec features.
- **Screen Mirroring Info** displays connection information when projecting the Screen Mirroring source.

11 When you finish selecting settings, go back to the **Network Settings** screen, select **Set**, and follow the on-screen instructions to save your settings and exit the menus.

Connecting Using Screen Mirroring with the Miracast Function

If your mobile device such as a smartphone supports Miracast, you can connect it to the projector wirelessly and project images. You can play audio through the projector's speaker system by connecting using Screen Mirroring.

- 1** Select the **Screen Mirroring** setting on your projector as necessary.
- 2** Press the [LAN] button on the remote control to switch to the Screen Mirroring source.
You see the network information screen.
- 3** On your mobile device, use your Miracast function to search for the projector.
You see a list of available devices.
- 4** Select the projector's Projector Name from the list.
- 5** If you see the PIN entry screen on your mobile device, enter the PIN code displayed on the network information screen or at the upper left of the projected image.
The projector displays the image from your mobile device.



It may take some time until the connection is established. While connecting, do not disconnect the projector's power cord. Doing so may cause your device to freeze or malfunction.

Depending on the mobile device, you may need to delete a device when connecting. Follow the on-screen instructions on your device.

Connecting Using Screen Mirroring in Windows 10

You can set up your computer for wireless projection and play audio through the projector's speaker system by connecting using Screen Mirroring.

- 1** Select the **Screen Mirroring** setting on your projector as necessary.
- 2** Press the [LAN] button on the remote control to switch to the Screen Mirroring source.
You see the network information screen.
- 3** Hold down the Windows key and press **K** on your keyboard at the same time.
You see a list of available devices.
- 4** Select the projector's Projector Name from the list.

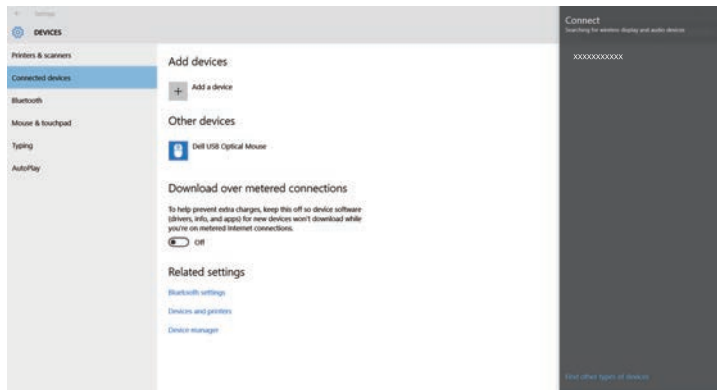

- 5** If you see the PIN entry screen on your computer, enter the PIN code displayed on the network information screen or at the bottom right of the projected image.
The projector displays the image from your computer.



It may take some time until the connection is established. While connecting, do not disconnect the projector's power cord. Doing so may cause your device to freeze or malfunction.

Connecting Using Screen Mirroring in Windows 8.1

You can set up your computer for wireless projection from Charms in Windows 8.1. You can play audio through the projector's speaker system by connecting using Screen Mirroring.

- 1** Select the **Screen Mirroring** setting on your projector as necessary.
- 2** Press the [LAN] button on the remote control to switch to the Screen Mirroring source.
You see the network information screen.
- 3** On your computer, select **Devices** from Charms and select **Project**.



4 Select Add a wireless display.



It may take some time until the connection is established. While connecting, do not disconnect the projector's power cord. Doing so may cause your device to freeze or malfunction.

You see a list of available devices.

5 Select the projector's Projector Name from the list.

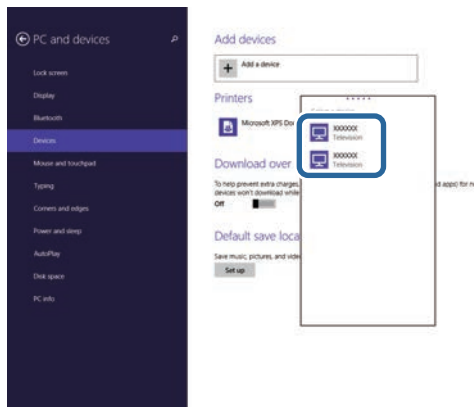

6 If you see the PIN entry screen on your computer, enter the PIN code displayed on the network information screen or at the bottom right of the projected image.

The projector displays the image from your computer.

You can use the HTTPS protocol to increase security between the projector and a Web browser communicating with it. To do this, you create a server certificate, install it on the projector, and turn on the **Secure HTTP** setting in the projector menus to verify the reliability of the Web browser.

Even if you do not install a server certificate, the projector automatically creates a self-signed certificate and allows communication. However, because the self-signed certificate cannot verify reliability from a Web browser, you see a warning about the server's reliability when you access the projector from a Web browser. This warning does not prevent communication.

» Related Links

- "Importing a Web Server Certificate Using the Menus" [p.187](#)

Importing a Web Server Certificate Using the Menus

You can create your Web server certificate, and import it using the projector menus and a USB flash drive.



You can also register the digital certificates from your Web browser. However, be sure to register just once or the certificate may not install correctly.

- 1** Make sure your digital certificate file is compatible with projector registration and directly placed on the USB storage device.
- 2** Press the [Menu] button, select the **Network** menu, and press [Enter].
- 3** Select **Network Settings** and press [Enter].

- 4** Select the **Projector Control** menu and press [Enter].

[Projector Control]		Return
PJLink	Off	▼
SNMP	Off	▼
AMX Device Discovery	Off	
Crestron Connected	Off	
Control4 SDDP	Off	
Secure HTTP	On	▲
Web Server Certificate		

- 5** Set the **Secure HTTP** setting to **On**.
- 6** Select **Web Server Certificate** and press [Enter].
- 7** Select **Save** and press [Enter].
- 8** Follow the on-screen instructions to connect a USB storage device to the projector's USB-A port.
- 9** Press [Enter] to display the certificate list.
- 10** Select the certificate to import using the displayed list.
A message is displayed prompting you to enter the password for the certificate.
- 11** Enter a password and press [Enter].
The certificate is imported and a completion message appears.

» Related Links

- "Supported Web Server Certificates" [p.188](#)

Supported Web Server Certificates

You can register these types of digital certificates.

Web Server Certificate (Secure HTTP)

Specification	Description
Format	PKCS#12
Extension	PFX, P12
Encryption	RSA
Hashes	MD5/SHA-1/SHA-256/SHA-384/SHA-512
Key length	512/1024/2048/4096 bit
Common name	Network host name
Organization	Optional
Password	Up to 64 alphanumeric characters; required

You can receive images shared from other projectors connected to the same network. This allows you to view images from other projectors at the same time.



You cannot distribute images to other projectors.

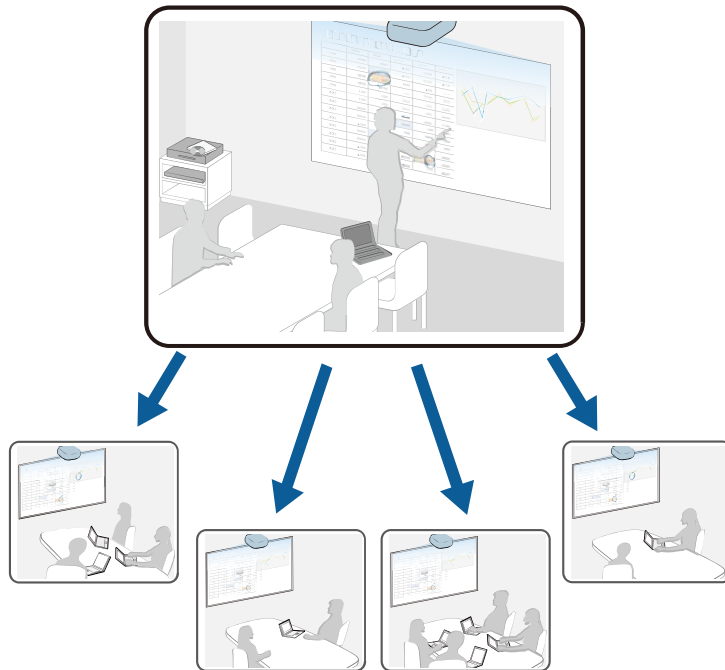

Note the following limitations when using the Screen Sharing function.

- You can share the screen with projectors that support the screen sharing feature.
- If the firmware version amongst the projectors sharing the screen is not the same, you may need to update the projector's firmware to share your screen.
- You cannot change the projector's **Network** settings during Screen Sharing.

» Related Links

- "Receiving Shared Screen Images" [p.189](#)
- "Drawing on Shared Screen Images" [p.189](#)

Receiving Shared Screen Images

Before receiving the screen, you need to select settings on your projector.

- Connect the projectors to the same network as the projector that is sharing images.
- Make sure that no other device is connecting to the projector using the Epson iProjection software.
- Make sure the **Screen Sharing** setting is set to **On**.
 - ☛ **Network > Network Settings > Network Projection > Screen Sharing**

When the other projector starts sharing screen, the shared screen image is automatically displayed.

If not, press the [LAN] button on the remote control.

To remove the shared image during projection, press the [Esc] button.



If you do not have the IP address for your projector, press the [Home] button and select **Screen Sharing**. You can check the IP address displayed on the guide screen.

Drawing on Shared Screen Images

You can draw on shared images using the interactive toolbar (EB-735Fi/EB-725Wi). The drawings are also shared between projectors.

The toolbar is shown in the following illustration.





- You can also use the mini toolbox by pressing the button on the side of the pen anywhere in the drawing area. You can switch the type of pen or eraser on the mini toolbox.
- When performing touch operations with your finger, you cannot display the mini toolbox.

See the Annotation Mode Toolbar for the functions of each tool.



- You cannot draw on shared images when the shared image is being projected as part of a split screen image.
- When you draw on shared screen images, you cannot use the highlighter tool and the **Clear all drawing contents** function.

» Related Links

- "Annotation Mode Toolbar" [p.108](#)

Monitoring and Controlling the Projector

Follow the instructions in these sections to monitor and control the projector over a network.

► Related Links

- "Epson Projector Management" [p.192](#)
- "Controlling a Networked Projector Using a Web Browser" [p.193](#)
- "Registering Digital Certificates from a Web Browser" [p.201](#)
- "Setting Up Projector Network E-Mail Alerts" [p.202](#)
- "Setting Up Monitoring Using SNMP" [p.203](#)
- "Using ESC/VP21 Commands" [p.204](#)
- "PJLink Support" [p.205](#)
- "Art-Net Channel Definitions" [p.206](#)
- "Crestron Connected Support" [p.209](#)
- "Setting Projector Event Schedules" [p.210](#)

Epson Projector Management software (Windows only) lets you monitor and control your projector through the network. See the *Epson Projector Management Operation Guide* for instructions.

You can download Epson Projector Management from the following Web site.

epson.sn

Once you have connected your projector to your network, you can select projector settings and control projection using a compatible Web browser. This lets you access the projector remotely.

In Content Playback mode, you can also edit playlists (EB-755F/EB-750F).



- Make sure the computer and projector are connected to the network. If you are connecting wirelessly, connect to devices over a wireless network access point.
- You can use the following Web browsers.
 - Internet Explorer 11 or later (Windows)
 - Microsoft Edge (Windows)
 - Safari (Mac, iOS)
 - Chrome (Android)
- While using the Web browser, do not connect using a proxy server. You cannot select all of the projector menu settings or control all projector functions using a Web browser.
- If you set the **Standby Mode** setting to **Communication On** in the projector's **Operation** menu, you can use a Web browser to select settings and control projection even if the projector is in standby mode (when the power is off).
- You can also control the projector using a Web browser through the Epson iProjection (iOS/Android) app.

Attention

In Content Playback mode, do not remove the USB flash drive from the projector or disconnect the projector's power cord in the following situations (EB-755F/EB-750F). Data saved on the USB flash drive may be damaged.

- When the Playlists screen is displayed
- When the USB Memory Device screen is displayed

- 1** Make sure the projector is turned on.
- 2** Make sure your computer or device is connected to the same network as the projector.
- 3** Start your Web browser on the computer or device.

- 4** Go to the Epson Web Control screen by entering the projector's IP address into the browser's address box. When entering an IPv6 address, wrap the address with [and].

You see the Epson Web Control screen.

- In normal mode

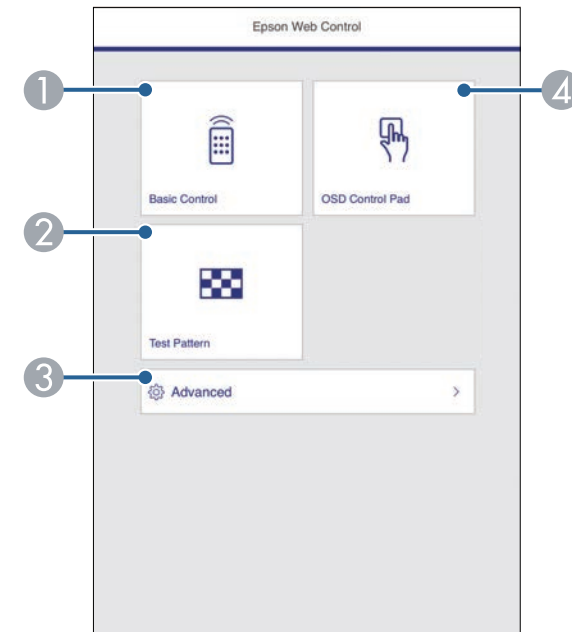

- 1** Controls the projector remotely.
- 2** Displays a test pattern.
- 3** Sets detailed projector settings.
- 4** Operates the projector's menu settings with your finger or mouse.

- In Content Playback mode (EB-755F/EB-750F)

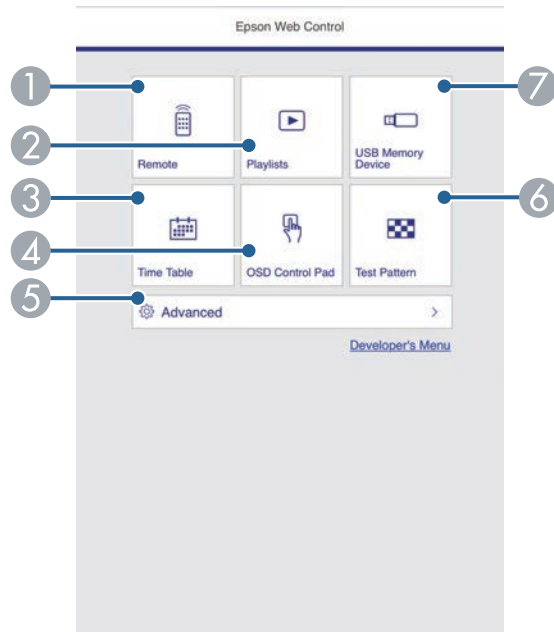

- 1 Controls the projector remotely.
- 2 Selects the playlist you want to play, and allows you to create or edit playlists.
- 3 Displays the Time Table screen.
- 4 Operates the projector's menu settings with your finger or mouse.
- 5 Sets detailed projector settings.
- 6 Displays a test pattern.
- 7 Registers or deletes the data for a playlist on the USB flash drive.

- 5 Select the option corresponding to the projector function you want to control.



- You may need to log in to access some of the options on the Epson Web Control screen. If you see a log in window, enter your user name and password.
- When accessing the **Basic Control** option, the user name is **EPSONREMOTE** and the default password is **guest**.
- When accessing other options, the user name is **EPSONWEB** and the default password is **admin**.
- You can change the password in the projector's **Network** menu.
 - ☛ **Network > Network Settings > Remote Password**
 - ☛ **Network > Network Settings > Web Control Password**

» Related Links

- "Web Control Options" [p.194](#)

Web Control Options

Basic Control

Options on the **Basic Control** screen allow you to select the input source and control the projector.



- If you see a log in window, enter your user name and password. (The user name is **EPSONREMOTE** and the default password is **guest**.)
- You can change the password in the projector's **Network** menu.
 ● **Network > Network Settings > Remote Password**

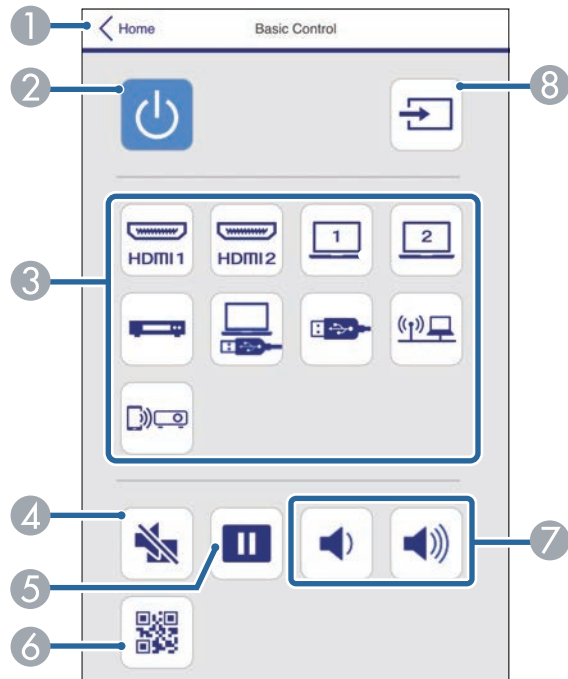

- 1 Returns to the Epson Web Control screen.
- 2 Turns the projector on or off.
- 3 Selects the input source. (The available sources vary depending on your projector model.)
- 4 Turns the video and audio on or off temporarily.
- 5 Pauses or resumes images.
- 6 Displays the QR code.
- 7 Adjusts the speaker volume.

- 8 Searches for sources.

OSD Control Pad

Options on the **OSD Control Pad** screen allow you to display the projector's setting menus and select them moving your finger or mouse on the pad.

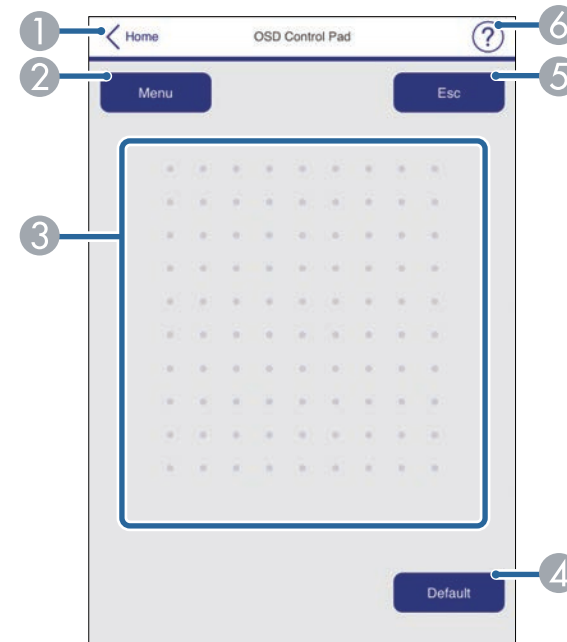

- 1 Returns to the Epson Web Control screen.
- 2 Displays the projector's setting menus.
- 3 Use your finger or mouse to navigate the menus.
- 4 Resets the selected setting to its default value.
- 5 Returns to the previous menu.
- 6 Displays help topics.

Test Pattern

The **Test Pattern** screen displays the available test patterns and allow you to select to project it.

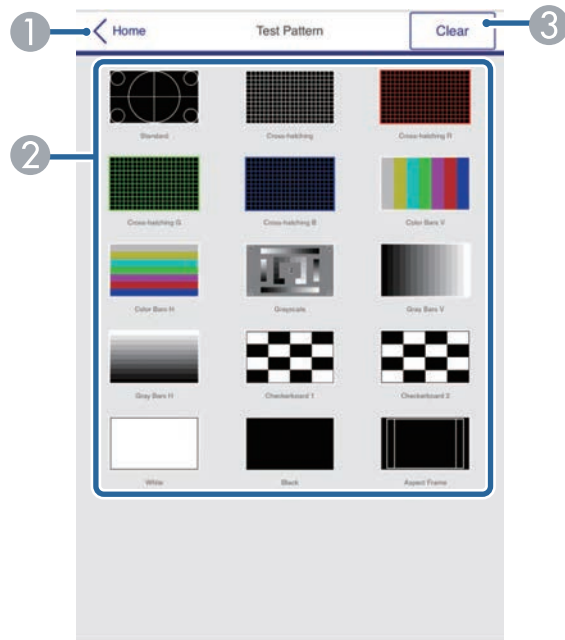

- 1 Returns to the Epson Web Control screen.
- 2 Displays available test patterns; select to project a test pattern. (The available test patterns vary depending on your projector model.)
- 3 Turns off test pattern display.

Advanced

The **Advanced** screen allow you to select the projector's settings.



If the default **Web Control Password** is set, a screen prompting to change the password appears before you can view the Advanced screen. Follow the on-screen instructions to change the password. It is strongly recommended to change password regularly to prevent an unauthorized access to your projector.

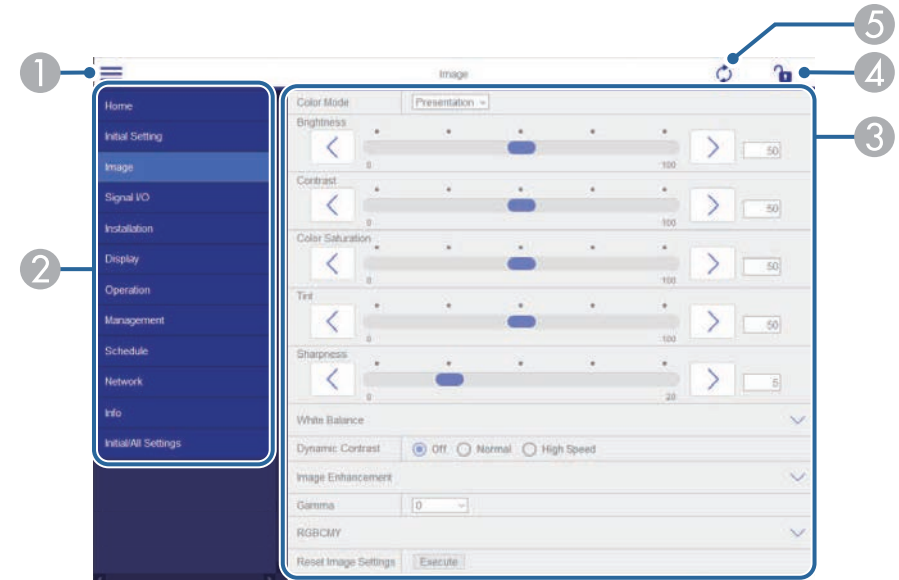

- 1 Opens the menus.
- 2 Displays the menu name you selected.
- 3 Specifies the projector settings. (The available settings vary depending on your projector model.)
- 4 Lock/unlock the projector settings.
- 5 Updates the projector settings.



You cannot change the following settings using Epson Web Control.

- **EDID** (EB-755F/EB-750F/EB-735Fi/EB-735F)
- **USB Display** (EB-735Fi/EB-725Wi)
- **HDMI Link**
- **Fixed Installation**
- **Setting Plate Installation Guide**
- **Auto Screen Adjustment** (EB-735Fi/EB-725Wi)
- **Image Shift**
- **Connect ELPCB02**
(EB-735Fi/EB-735F/EB-725Wi/EB-725W/EB-720)
- **Touch Unit** (EB-735Fi/EB-725Wi)
- **Pattern Display**
- **Split Screen Setting**
- **Content Playback** (EB-755F/EB-750F)
- **User Button**
- **User's Logo**
- **User Pattern**
- **Language**
- **Display Logs**
- **Search Access Point**
- **Crestron Connected**
- **Pen/Touch menu** (EB-735Fi/EB-725Wi)
- **Test Print** (EB-735Fi/EB-725Wi)
- **Check Connection** (EB-735Fi/EB-725Wi)
- **Send a test e-mail** (EB-735Fi/EB-725Wi)
- **Event ID**
- **Antenna Level**
- **ECO menu**
- **Reset Network Settings**
- **Firmware Update**



You can select the following settings only with Epson Web Control.

- **Monitor Password** (up to 16 alphanumeric characters)
- **IPv6 Settings** (manual)
- **HTTP port** (port number used for Web Control except for 80 [default], 843, 3620, 3621, 3625, 3629, 4352, 4649, 5357, 10000, 10001, 41794)

Remote (only in Content Playback mode)

Options on the **Remote** screen allow you to select the input source, control the projector, and start projecting playlists.

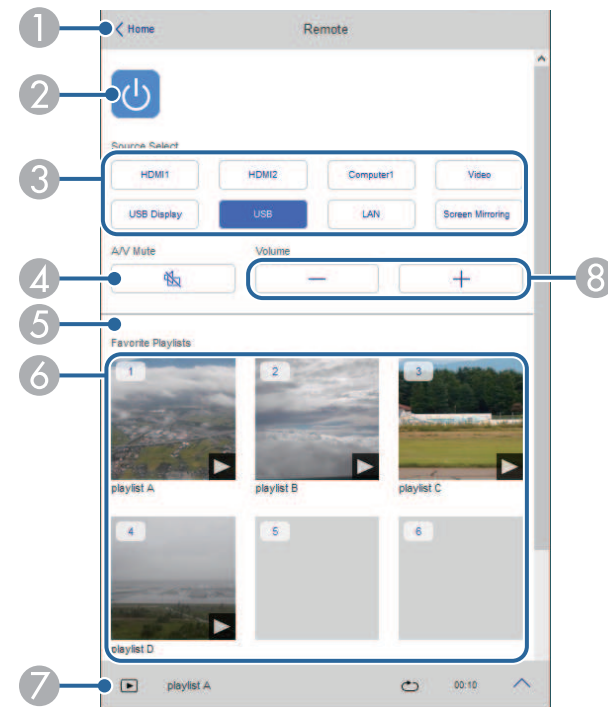

- 1 Returns to the Epson Web Control screen.
- 2 Turns the projector on or off.

- 3 Selects the input source. (The available sources vary depending on your projector model.)
- 4 Turns the video and audio on or off temporarily.
- 5 **Overlay Effect** option is displayed when the current source is anything other than USB.
Turns **Overlay Effect** on or off to add color and shape effects to a playlist.
When turning on, the **Effects** screen is displayed. You can add predefined color and shape effect filters to a playlist. You can also create a customized effect.
- 6 Displays your favorite playlists. Select a playlist to start projecting.
- 7 Displays information for the playlist being projected.
The icons indicate the playlist settings.
🔦 : Overlay effects have been applied
🔄 : Repeat playback has been applied
🕒 : Length of the playlist
Select the arrow at the bottom-left to display the following screen.
- 8 Adjusts the speaker volume.

Screen displayed while projecting playlist (only in Content Playback mode)

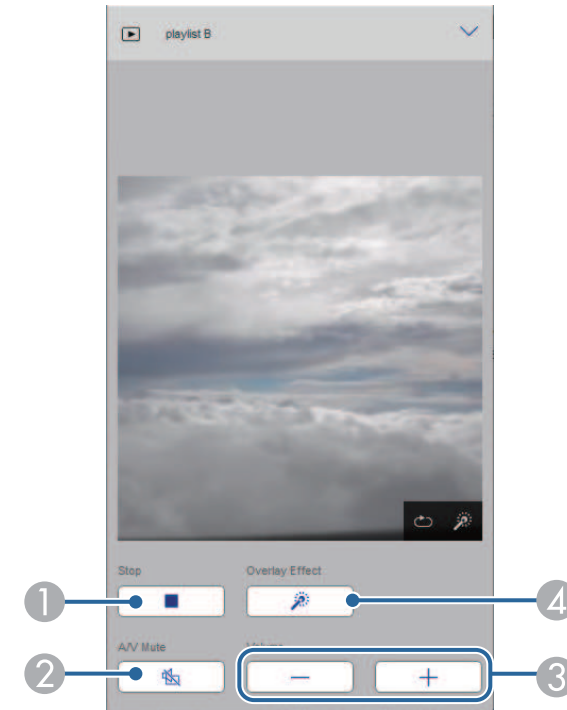

- 1 Stops projection.
- 2 Turns the video and audio on or off temporarily. However, the audio and video continue to run so you cannot resume projection at the point you activated this function.
- 3 Adjusts the speaker volume.
- 4 Opens the **Effects** screen. You can select preset effects or select individual brightness, color, and shape effect filters.

Playlist (only in Content Playback mode)

Options on the **Playlist** screen allow you to select the playlist you want to play from the list, and create or edit playlists.

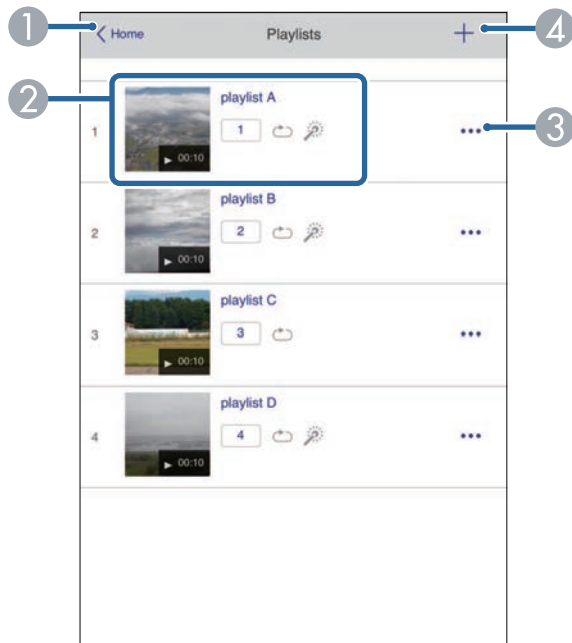

- 1 Returns to the Epson Web Control screen.
- 2 Starts projecting the playlist.
The icons indicate the playlist settings.
 - 1: Number assigned to your favorite playlists
 - ☺: Repeat playback has been applied
 - 🌟: Overlay effects have been applied
- 3 Opens the menu that allows you to edit, copy, register to your favorites, or delete the playlist.
When you select **Edit** or **Duplicate**, the edit playlist screen is displayed.
- 4 Opens the create playlist screen where you can create a new playlist.

Create or edit playlist screen (only in Content Playback mode)

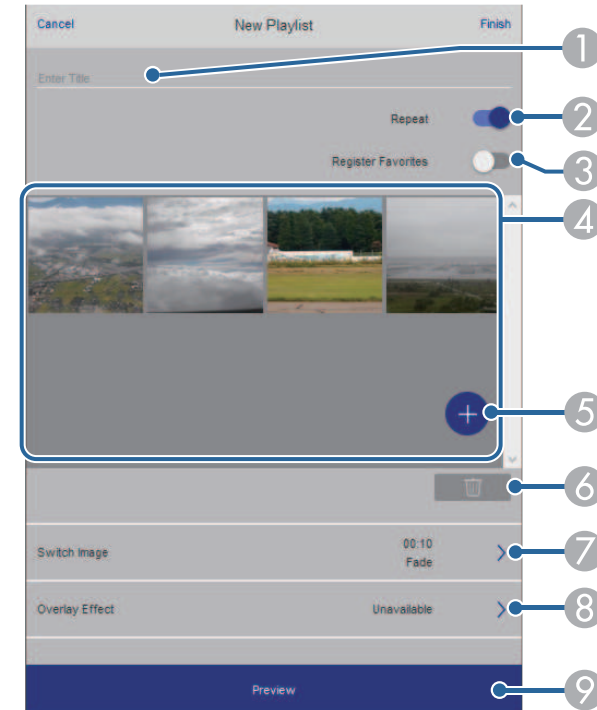

- 1 Edits the playlist name.
- 2 Selects whether to enable repeat playback or not.
- 3 Registers the playlist as favorites.
When registering favorites, you can quickly start playback of the favorite playlist using the **Remote** screen or the remote control.
- 4 Displays the images or movies you have added to the playlist. The playlist plays the images or movies in order.
- 5 Adds images or movies to the playlist.
- 6 Deletes images or movies from the list.

- 7 Opens the **Switch Image** screen.
You can specify the time interval to switch to the next image file. You can also select a transition effect.
- 8 Opens the **Effects** screen.
You can add predefined color and shape effect filters to a playlist. You can also create a customized effect.
- 9 Previews the playlist.

USB Memory Device (only in Content Playback mode)

Options on the **USB Memory Device** screen allow you to upload data for a playlist to the USB flash drive or delete the data on the USB flash drive.

 You cannot upload the .mp4 and .mov files.
If you want to add the .mp4 and .mov files to the playlist, use Epson Projector Content Manager software or Epson Creative Projection app.



- 1 Returns to the Epson Web Control screen.
- 2 Copies images or movies you want to add to playlists to a USB flash drive.
- 3 Deletes images or movies on the USB flash drive.

Time Table (only in Content Playback mode)

Options on the **Time Table** screen allow you to enable or disable the specified time table features.

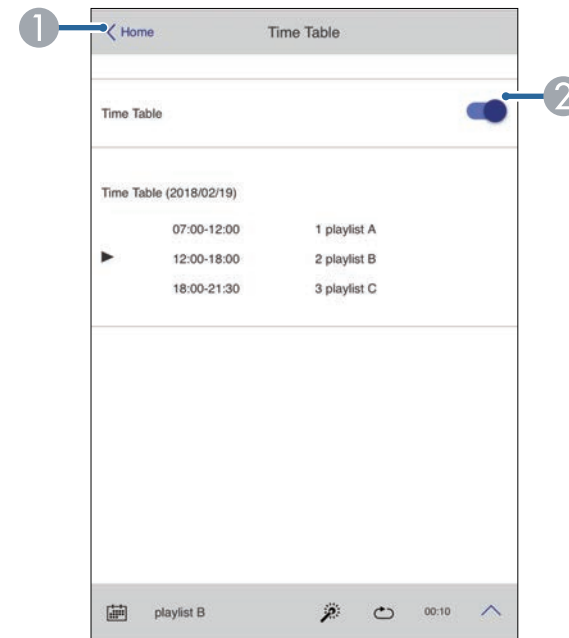

- 1 Returns to the Epson Web Control screen.
- 2 Turns the time table on or off.

 You can specify when each playlist starts and finishes using the time table feature in the Epson Projector Content Manager software.
For details, see the *Epson Projector Content Manager Operation Guide*.

You can register the digital certificates on the projector to provide security for your presentation files.



You can also register the digital certificates in the projector's **Network** menu. However, be sure to register just once or the certificate may not install correctly.

- ☛ **Network > Network Settings > Wireless LAN > Client Certificate**
- ☛ **Network > Network Settings > Wireless LAN > CA certificate**
- ☛ **Network > Network Settings > Projector Control > Secure HTTP > Web Server Certificate**

- 1** Make sure your digital certificate file is compatible with projector registration.
- 2** Make sure the projector is turned on.
- 3** Start your Web browser on a computer or device connected to the network.
- 4** Go to the Epson Web Control screen by entering the projector's IP address into the browser's address box.
- 5** Select **Advanced**.



- You may need to log in before you see the Advanced screen. If a login screen is displayed, enter your user name and password. (The user name is **EPSONWEB** and the default password is **admin**.)
- You can change the password in the projector's **Network** menu.
 - ☛ **Network > Network Settings > Web Control Password**

- 6** Select  to open the menus, select **Network**, and select **Certificate**.

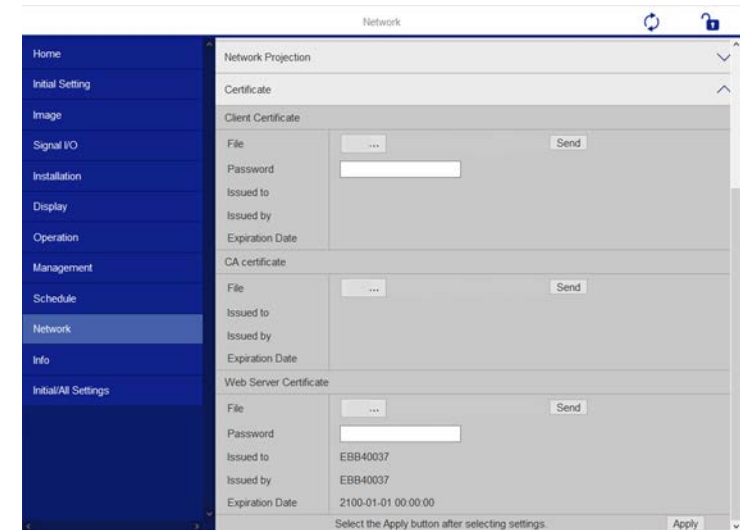

- 7** Select the certificate file you want to register.
- 8** Enter the password in the **Password** box, and then click **Send**.
- 9** When you finish registering the certificate, click **Apply** to finalize your changes and complete the registration.

You can set up the projector to send you an e-mail alert over the network if there is a problem with the projector.

If you set the **Standby Mode** setting to **Communication On** in the projector's **Operation** menu, you can receive the e-mail alerts even if the projector is in standby mode (when the power is off).

- 1 Press the [Menu] button, select the **Network** menu, and press [Enter].
- 2 Select **Network Settings** and press [Enter].
- 3 Select the **Mail Notification** menu and press [Enter].

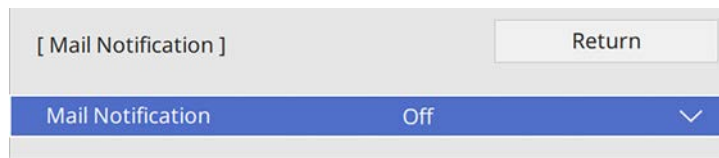

- 4 Set the **Mail Notification** setting to **On**.
- 5 Enter the IP address for the **SMTP Server** option.



Do not use "127.x.x.x" (where x is a number from 0 to 255) for the **SMTP Server**.

- 6 Select a type of **Authentication** of SMTP server.
- 7 Select a number for the SMTP server **Port Number**, from 0 to 65535 (default is 25).
- 8 Enter a **User Name** for the SMTP server.
- 9 Enter a **Password** for the SMTP server authentication.
- 10 Enter the e-mail address to be indicated as the sender in **From**.

- 11 Choose an address field, enter the e-mail address, and select the alerts you want to receive. Repeat for up to three addresses.



Your e-mail address can be up to 64 alphanumeric characters long.

- 12 When you finish selecting settings, go back to the **Network Settings** screen, select **Set**, and follow the on-screen instructions to save your settings and exit the menus.



If a critical problem causes a projector to shut down, you may not receive an e-mail alert.

» Related Links

- "Network Projector E-mail Alert Messages" [p.202](#)

Network Projector E-mail Alert Messages

When a problem occurs with a projector on the network, and you selected to receive e-mail alerts, you receive an e-mail containing the following information:

- The email address set in **From** as the mail sender
- **Epson Projector** in the subject line
- The name of the projector experiencing a problem
- The IP address of the affected projector
- Detailed information about the problem

Network administrators can install SNMP (Simple Network Management Protocol) software on network computers so they can monitor projectors. If your network uses this software, you can set up the projector for SNMP monitoring.

- 1 Press the [Menu] button, select the **Network** menu, and press [Enter].
- 2 Select **Network Settings** and press [Enter].
- 3 Select the **Projector Control** menu and press [Enter].

[Projector Control]		Return
PJLink	Off	▼
SNMP	Off	▼
AMX Device Discovery	Off	
Crestron Connected	Off	
Control4 SDDP	Off	
Secure HTTP	On	▲
Web Server Certificate		

- 4 Set the **SNMP** setting to **On**.
- 5 Enter up to two IP addresses to receive SNMP notifications, using 0 to 255 for each address field.



Do not use these addresses: 224.0.0.0 through 255.255.255.255 (where x is a number from 0 to 255). This projector supports SNMP agent version 1 (SNMPv1).

- 6 Enter the SNMP **Community Name** up to 32 alphanumeric characters long.

- 7 When you finish selecting settings, go back to the **Network Settings** screen, select **Set**, and follow the on-screen instructions to save your settings and exit the menus.

You can control the projector from an external device using ESC/VP21.

► **Related Links**

- "ESC/VP21 Command List" [p.204](#)
- "Cable Layouts" [p.204](#)

ESC/VP21 Command List

When the power ON command is transmitted to the projector, the power turns on and it enters warm-up mode. When the projector's power has turned on, a colon ":" (3Ah) is returned.

When a command is input, the projector executes the command and returns a ":", and then accepts the next command.

If the command being processed terminates abnormally, an error message is output and a ":" is returned.

You can check the available commands in the projector's *Specifications*.

► **Related Links**

- "Getting the Latest Version of the Documents" [p.10](#)

Cable Layouts

Serial connection

- Connector shape: D-Sub 9-pin (male)
- Projector input port name: RS-232C
- Cable type: Crossover (null modem) cable

In the following illustration, the projector side is shown on the left, and the computer side on the right:

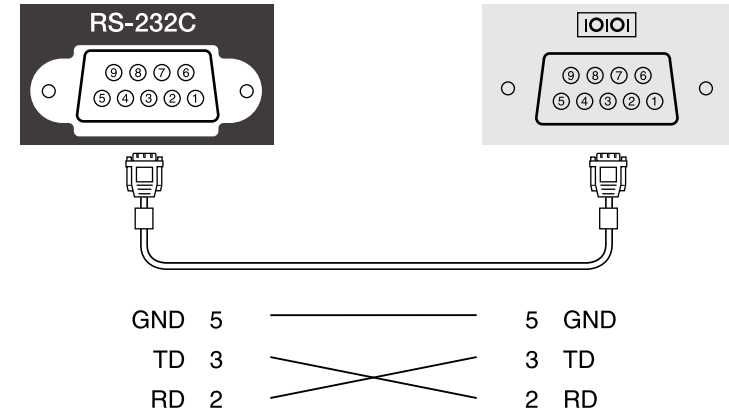

Signal name	Function
GND	Signal wire ground
TD	Transmit data
RD	Receive data

Communications protocol

- Default baud rate setting: 9600 bps
- Data length: 8 bit
- Parity: None
- Stop-bit: 1 bit
- Flow control: None

PJLink was established by the JBMIA (Japan Business Machine and Information System Industries Association) as a standard protocol for controlling network-compatible projector's as part of their efforts to standardize projector control protocols.

The projector complies with the PJLink Class2 standard established by the JBMIA.

The port number used for the PJLink search function is 4352 (UDP).

You need to make network settings before you can use PJLink.

It complies with all commands except for the following commands defined by PJLink Class2, and agreement was confirmed by the PJLink standard adaptability verification.

<http://pjlink.jbmia.or.jp/english/>

- Non-compatible commands
You can check the non-compatible commands in the projector's *Specifications*.
- Input ports and corresponding input source number

Input port name	Input source number
Computer1	11
Computer2	12
Video	21
HDMI1	32
HDMI2	33
HDMI3	36
USB	41
LAN	52
USB Display	53
Screen Mirroring1	57
Screen Mirroring2	58

- Manufacturer name displayed for "Manufacture name information query"

EPSON

- Model name displayed for "Product name information query"
 - EPSON 755F/750F
 - EPSON 735Fi
 - EPSON 735F
 - EPSON 725Wi
 - EPSON 725W
 - EPSON 720

» Related Links

- "Getting the Latest Version of the Documents" [p.10](#)

Art-Net is an Ethernet communication protocol based on the TCP/IP protocol. You can control the projector by using a DMX controller or an application system (EB-755F/EB-750F).

The following table lists the channel definitions used to control the projector in Art-Net.

Channel/Function	Operation	Parameters	Default value	Description
1 Adjusting light (dimming)	0% to 100%	0 to 255	0	Adjusts the image brightness.
2 Shutter control	Shutter open	0 to 63	128	Enables/disables A/V Mute.
	Non-operational	64 to 191		
	Shutter closed	192 to 255		
3 Switch source	Non-operational	0 to 7	0	Switches to the specified source.
	HDMI1	8 to 15		
	HDMI2	16 to 23		
	HDMI3	24 to 31		
	Non-operational (DVI-D)	32 to 39		
	Non-operational (Display Port)	40 to 47		
	Non-operational (SDI)	48 to 55		
	Computer1	56 to 63		
	Computer2	64 to 71		
	Non-operational (BNC)	72 to 79		
	LAN	80 to 87		
	Screen Mirroring1	88 to 95		
	Screen Mirroring2	96 to 103		
	USB Display	104 to 111		

Channel/Function	Operation	Parameters	Default value	Description
	USB	112 to 119		
	Non-operational (Spotlight)	120 to 127		
	Video	128 to 135		
	Non-operational	136 to 143		
	Non-operational	144 to 255		
7 Zoom	Electronic Tele/Wide	0 to 255	255	Zooms using the specified amount of movement.
10 Content playback	Non-operational	0 to 3	0	Plays the specified playlist.
	Playlist 1	4 to 7		
	Playlist 2	8 to 11		
	Playlist 3	12 to 15		
	Playlist 4	16 to 19		
	Playlist 5	20 to 23		
	Playlist 6	24 to 27		
	Playlist 7	28 to 31		
	Playlist 8	32 to 35		
	Playlist 9	36 to 39		
	Playlist 10	40 to 43		
	Playlist 11	44 to 47		
	Playlist 12	48 to 51		
	Playlist 13	52 to 55		
	Playlist 14	56 to 59		
	Playlist 15	60 to 63		
	Playlist 16	64 to 67		
Playlist 17	68 to 71			

Channel/Functi on	Operation	Parameters	Default value	Description
	Playlist 18	72 to 75		
	Playlist 19	76 to 79		
	Playlist 20	80 to 83		
	Playlist 21	84 to 87		
	Playlist 22	88 to 91		
	Playlist 23	92 to 95		
	Playlist 24	96 to 99		
	Playlist 25	100 to 103		
	Playlist 26	104 to 107		
	Playlist 27	108 to 111		
	Playlist 28	112 to 115		
	Playlist 29	116 to 119		
	Playlist 30	120 to 123		
	Playlist 31	124 to 127		
	Playlist 32	128 to 131		
	Playlist 33	132 to 135		
	Playlist 34	136 to 139		
	Playlist 35	140 to 143		
	Playlist 36	144 to 147		
	Playlist 37	148 to 151		
	Playlist 38	152 to 155		
	Playlist 39	156 to 159		
	Playlist 40	160 to 163		
	Playlist 41	164 to 167		
	Playlist 42	168 to 171		
	Playlist 43	172 to 175		
	Playlist 44	176 to 179		

Channel/Functi on	Operation	Parameters	Default value	Description
	Playlist 45	180 to 183		
	Playlist 46	184 to 187		
	Playlist 47	188 to 191		
	Playlist 48	192 to 195		
	Playlist 49	196 to 199		
	Playlist 50	200 to 203		
	Non-operational	204 to 255		
11 Power control	Power off	0 to 63	128	Turns the projector power on or off.
	Non-operational	64 to 191		
	Power on	192 to 255		
12 Geometry Correction	Non-operational	0 to 15	255	Corrects the image shape.
	H/V-Keystone	16 to 31		
	Quick Corner	32 to 47		
	Point Correction	48 to 63		
	Arc Correction	64 to 79		
	Non-operational	80 to 95		
	Load Memory1	96 to 111		Loads image shape setting from memory.
	Load Memory2	112 to 127		
	Load Memory3	128 to 143		
Non-operational	144 to 255			
13 Lock	Cannot control	0 to 127	0	Enables/disables Art-Net operations.
	Can control	128 to 255		



If you are controlling the projector using Art-Net and operating it from the remote control, settings made by the DMX controller or application software may differ from the projector's actual status. If you want to apply all the channel controls to the projector, set Channel 13 to "Cannot control", then set it back to "Can control".

If you are using the Crestron Connected network monitoring and control system, you can set up your projector for use on the system. Crestron Connected lets you control and monitor your projector using a Web browser.



- You cannot use the Message Broadcasting feature in Epson Projector Management when you use Crestron Connected.
- If you set the **Standby Mode** setting to **Communication On** in the projector's **Operation** menu, you can control the projector even if the projector is in standby mode (when the power is off).

For additional information on Crestron Connected, visit the Crestron Web site.

<https://www.crestron.com/products/line/crestron-connected>

To monitor devices in the system, you can use Crestron RoomView Express or Crestron Fusion provided by Crestron. You can communicate with the help desk and send emergency messages. See the following Web site for details.

<http://www.crestron.com/getroomview>

This manual describes how to perform operations on your computer using a Web browser.

» Related Links

- "Setting Up Crestron Connected Support" p.209

Setting Up Crestron Connected Support

To set up your projector for monitoring and control using a Crestron Connected system, make sure your computer and projector are connected to the network. If you are connecting wirelessly, connect to devices over a wireless network access point.

- 1** Press the [Menu] button, select the **Network** menu, and press [Enter].
- 2** Select **Network Settings** and press [Enter].

- 3** Select the **Projector Control** menu and press [Enter].

[Projector Control]		Return
PJLink	Off	▼
SNMP	Off	▼
AMX Device Discovery	Off	
Crestron Connected	Off	
Control4 SDDP	Off	
Secure HTTP	On	▲
Web Server Certificate		

- 4** Set the **Crestron Connected** setting to **On** to allow the projector to be detected.
- 5** When you finish selecting settings, go back to the **Network Settings** screen, select **Set**, and follow the on-screen instructions to save your settings and exit the menus.
- 6** Turn off the projector, and then turn it on again to enable the setting.
- 7** Start your Web browser on a computer or device connected to the network.
- 8** Go to the Epson Web Control screen by entering the projector's IP address into the browser's address box.
- 9** Select the **Crestron Connected** settings. See the Crestron Web site for details.

You can schedule up to 30 events to occur automatically on your projector, such as turning the projector on or off or switching the input source. The projector performs the selected events on the specified date and time in the schedule you set up.

Warning

Do not place flammable objects in front of the lens. If you schedule the projector to turn on automatically, flammable objects in front of the lens could catch on a fire.



- If you set a **Menu Protection** of **Schedule** to **On**, turn it off first.
- **Light Source Calibration** does not start if the projector is not used continuously for more than 20 minutes, or regularly turned off by shutting off the power outlet. Set **Light Source Calibration** events to occur only after 100 hours of usage.

- 1** Set the date and time in the **Date & Time** menu in the projector's **Management** menu.
- 2** Press the [Menu] button, select the **Management** menu, and press [Enter].
- 3** Select **Schedule Settings** and press [Enter].
- 4** Select **Schedule** and press [Enter].

- 5** Select **Add New** and press [Enter].

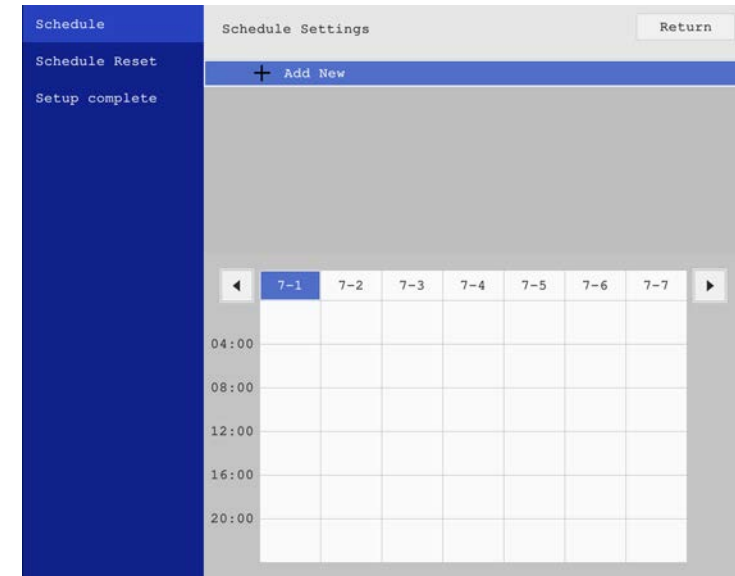

6 Select the event details you want to perform.

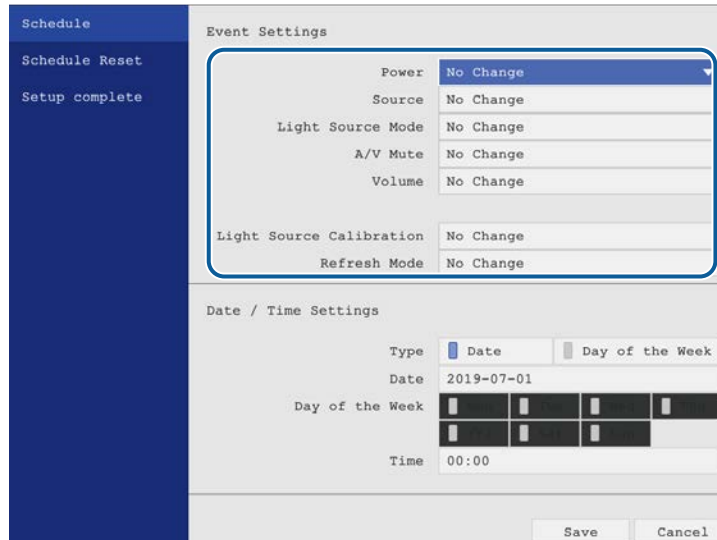



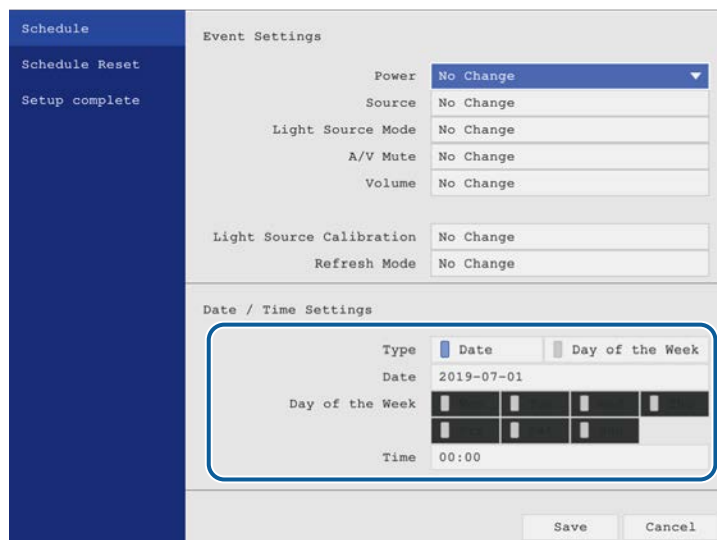



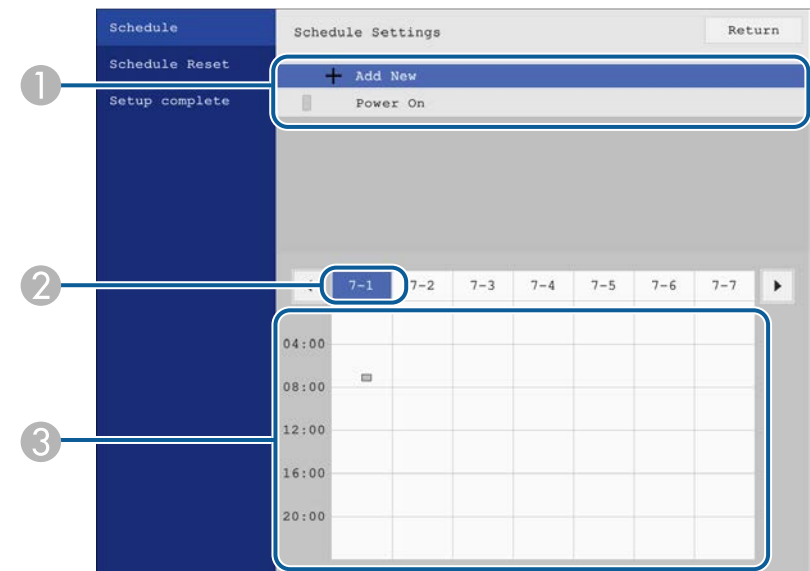

7 Select the date and time at which you want the event to occur.



8 Select **Save** and press [Enter].

The scheduled events are displayed on the screen with icons indicating the event status.



- ① : valid schedule
- : regular schedule
- : invalid schedule
- ② The date currently selected (highlighted)
- ③ : one time schedule
- : regular schedule
- : standby schedule (turns communication on or off during standby)
- : invalid schedule

9 To edit a scheduled event, select the schedule and press [Enter].

- 10** Select an option from the menu displayed.
- **On** or **Off** lets you enable or disable the selected event.
 - **Edit** lets you change the event details or date and time.
 - **Clear** lets you remove the scheduled event from a list.

- 11** Select **Setup complete**, then select **Yes**.

To delete all scheduled events, select **Schedule Reset**.

» **Related Links**

- "Selecting Password Security Types" [p.163](#)

Adjusting the Menu Settings

Follow the instructions in these sections to access the projector menu system and change projector settings.

► Related Links

- "Using the Projector's Menus" [p.214](#)
- "Using the Displayed Keyboard" [p.215](#)
- "Image Quality Settings - Image Menu" [p.216](#)
- "Input Signal Settings - Signal I/O Menu" [p.218](#)
- "Projector Installation Settings - Installation Menu" [p.220](#)
- "Projector Display Settings - Display Menu" [p.222](#)
- "Projector Feature Settings - Operation Menu" [p.224](#)
- "Projector Administration Settings - Management Menu" [p.226](#)
- "Projector Network Settings - Network Menu" [p.230](#)
- "Projector Pen And Touch Setup Settings - Pen/Touch Menu" [p.237](#)
- "Projector Interactive Settings - Interactive Menu" [p.238](#)
- "Multiple Projector Operation Settings - Multi-Projection Menu" [p.242](#)
- "Image Quality Memory Settings - Memory Menu" [p.244](#)
- "Projector Setup Settings - ECO Menu" [p.245](#)
- "Projector Initial Settings and Reset Options - Initial/All Settings Menu" [p.246](#)
- "Copying Menu Settings Between Projectors (Batch Setup)" [p.247](#)

You can use the projector's menus to adjust the settings that control how your projector works. The projector displays the menus on the screen.

- 1 Press the [Menu] button on the control panel or remote control.

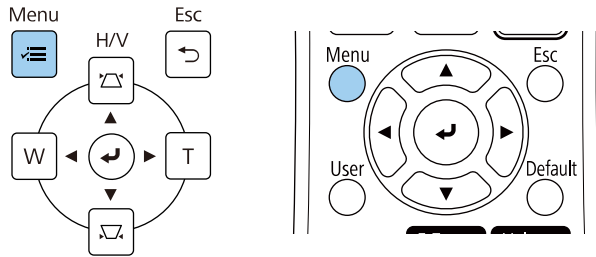

You see the menu screen.

Frequently Used Items	Image	
Image	Color Mode	Presentation
Signal I/O	Brightness	50
Installation	Contrast	50
Display	Color Saturation	50
Operation	Tint	50
Management	Sharpness	50
Network	White Balance	
Pen/Touch	Dynamic Contrast	Off
Interactive	Image Enhancement	
Memory	Gamma	0
ECO	RGBCMY	
Initial/All Settings	Reset to Defaults	
	Source	Computer1
	Resolution	Auto
	Aspect	Auto
	Analog Signal Adjustment	
	Reset to Defaults	
	Reset Image Settings	

- 2 Press the up or down arrow buttons to move through the menus listed on the left. The settings for each menu are displayed on the right.



The available settings depend on the current input source.

- 3 To change settings in the displayed menu, press [Enter].
- 4 Press the up or down arrow button to move through the settings.
- 5 To return all the menu settings to their default values, select **Initial/All Settings**.
- 6 When you finish changing settings on a menu, press [Esc].
- 7 Press [Menu] or [Esc] to exit the menus.



The  arrow indicates that the menu contains sub items. When you turn on a menu setting or select a specific value for it, the menu system displays the sub items.



If interactive pen or finger touch operations are available with your projector, you can select menus and settings using the interactive pen or finger touch operation. When you exit the menus, select .

You can use the displayed keyboard to enter numbers and characters.

- 1 Use the arrow buttons on the control panel or remote control to highlight the number or character you want to enter and press the [Enter] button.

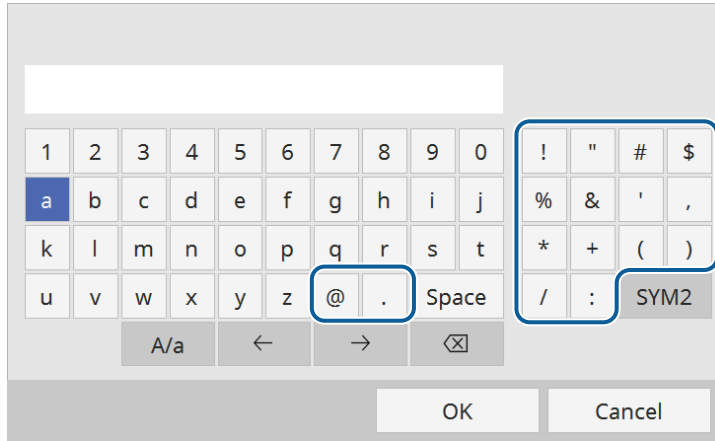

 Each time you select the **A/a** key, the characters change between upper case and lower case. Each time you select the **SYM1/2** key, the symbols enclosed by the frame change.

- 2 After entering the text, select **OK** on the keyboard to confirm your entries. Select **Cancel** to cancel entering text.

 You can select projector settings and control projection over a network using a Web browser from your computer. Some symbols cannot be entered using the displayed keyboard. Use your Web browser to enter the text.

Available Text Using the Displayed Keyboard

You can enter the following text when using the displayed keyboard.

Text type	Details
Numbers	0123456789
Alphabet	ABCDEFGHIJKLMNOPQRSTUVWXYZ abcdefghijklmnopqrstuvwxyz
Symbols	!"#\$%&'()*+,-./:;<=>?@[\] ^_`{ }~

» Related Links

- "Available Text Using the Displayed Keyboard" [p.215](#)

Settings on the **Image** menu let you adjust the quality of your image. The available settings depend on the currently selected color mode and input source.

Frequently Used Items	Image	
Image	Color Mode	Presentation
Signal I/O	Brightness	50
Installation	Contrast	50
Display	Color Saturation	50
Operation	Tint	50
Management	Sharpness	50
Network	White Balance	
Pen/Touch	Dynamic Contrast	Off
Interactive	Image Enhancement	
Memory	Gamma	0
ECO	RGBCMY	
Initial/All Settings	Reset to Defaults	
	Source	Computer1
	Resolution	Auto
	Aspect	Auto
	Analog Signal Adjustment	
	Reset to Defaults	
	Reset Image Settings	

Setting	Options	Description
Color Mode	See the list of available color modes	Adjusts the vividness of image colors for various image types and environments.
Brightness	Various levels available	Lightens or darkens the overall image.
Contrast	Various levels available	Adjusts the difference between light and dark areas of the image.
Color Saturation	Various levels available	Adjusts the intensity of the image colors.
Tint	Various levels available	Adjusts the balance of green to magenta tones in the image.

Setting	Options	Description
Sharpness	Various levels available	Adjusts the sharpness or softness of image details.
White Balance	Color Temp.	Sets the color temperature according to the color mode you selected. Higher values tint the image blue and lower values tint the image red. Setting is only displayed when Color Filter is not set to Warm White or Cool White . (EB-755F/EB-750F)
	G-M Correction	Makes fine adjustments to the color tone. Higher values tint the image green and lower values tint the image red.
	Custom	Adjusts the individual R (red), G (green), and B (blue) components of the offset and gain.
Dynamic Contrast	High Speed Normal Off	Adjusts the projected luminance based on the image brightness.
Image Enhancement	Image Preset Mode	Sets the Image Enhancement options as a batch using preset values.
	Noise Reduction	Reduces flickering in images.
	MPEG Noise Reduction	Reduces the noise or artifacts seen in MPEG video.
	Deinterlacing	Sets whether or not to convert interlaced-to-progressive signals for certain video image types. <ul style="list-style-type: none"> • Off: for fast-moving video images. • Video: for most video images. • Film/Auto: for movies, computer graphics, and animation. Setting is only displayed when the current signal is interlaced signal (480i/576i/1080i).
	Super-resolution	Reduces blurring when projecting low resolution images.

Setting	Options	Description
	Detail Enhancement	Creates a more emphatic texture and material feel of the image.
	Reset	Resets all adjustment values on the Image Enhancement setting to their default settings.
Gamma	-2 to 2 Custom	Adjusts the coloring by selecting one of the gamma correction values, or referring to a gamma graph.
RGBCMY	Various levels available	Adjusts the hue, saturation, and brightness of each color R (red), G (green), B (blue), C (cyan), M (magenta), Y (yellow) individually.
Reset to Defaults	—	Resets all settings for the current color mode.
Source	—	Displays settings saved for each input source. To change settings for an input source, make sure the source is connected and select that source.
Resolution	Auto Normal Wide	Sets the input signal resolution if not detected automatically using the Auto option. Setting is only displayed when the current source is Computer.
Aspect	See the list of available aspect ratios	Sets the aspect ratio (width-to-height ratio) for the selected input source. (Turn off the Scale setting or set the Scale Mode setting to Full Display first (EB-755F/EB-750F).) Setting is only displayed when the current source is Computer, Video or HDMI.
Scale (EB-755F/EB-750F)	Various scale options	When using multiple projectors to project one image, adjusts the scale of the image displayed by each projector.

Setting	Options	Description
Analog Signal Adjustment	Auto Setup	Set to On to automatically optimize computer image quality. Setting is only displayed when the current source is Computer.
	Tracking	Adjusts the signal to eliminate vertical stripes in computer images. Setting is only displayed when the current source is Computer.
	Sync.	Adjusts the signal to eliminate fuzziness or flickering in computer images. Setting is only displayed when the current source is Computer.
	Position	Adjusts the image location on the screen. Setting is only displayed when the current source is Computer or Video.
Reset to Defaults	—	Resets all settings for current input source.
Reset Image Settings	—	Resets all adjustment values on the Image menu to their default settings.



- The **Brightness** setting does not affect light source brightness. To change the light source brightness, select the **Light Source Brightness Control** setting in the projector's **Operation** menu.
- You can restore the default settings of the **Tracking**, **Sync.**, and **Position** settings by pressing the [Auto] button on the remote control.

» **Related Links**

- "Available Color Modes" [p.82](#)
- "Available Image Aspect Ratios" [p.77](#)
- "Scaling an Image" [p.160](#)
- "Adjusting the Image Color" [p.84](#)

Normally the projector automatically detects and optimizes the input signal settings. If you need to customize the settings, you can use the **Signal I/O** menu. The available settings depend on the currently selected input source.

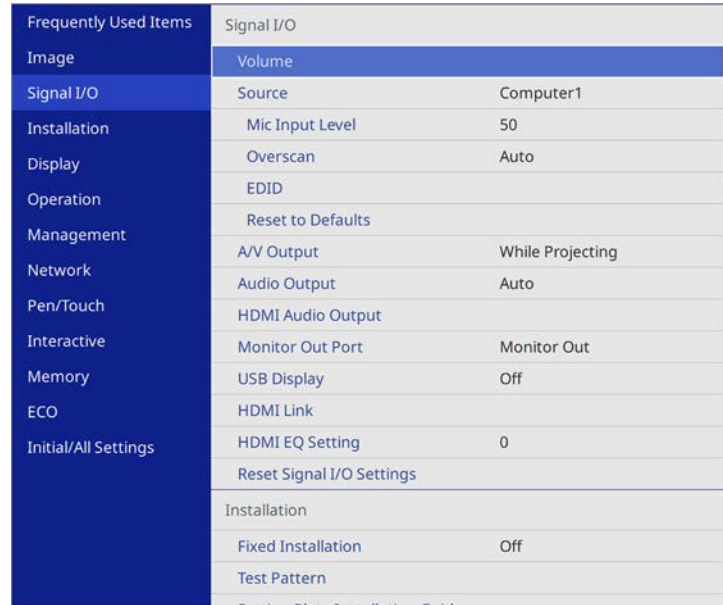

Setting	Options	Description
Volume	Various levels available for each source	Adjusts the volume of projector's speaker system. You can also adjust the volume of external speakers. Setting is only displayed when the audio is not output to AV system.
Source	—	Displays settings saved for each input source. To change settings for an input source, make sure the source is connected and select that source.

Setting	Options	Description
Signal Format	Video Signal	Sets the signal type from the input sources. If interference appears or no image appears when set to Auto , select the appropriate signal according to the connected equipment. Setting is only displayed when the current source is Video.
	Video Range	Sets the video range to match the setting of input source. Setting is only displayed when the current source is HDMI.
Mic Input Level (EB-735Fi/EB-735F /EB-725Wi/EB-725 W/EB-720)	Various levels available	Adjusts the input level from a microphone. When Mic Input Level is turned up, the volume of the other connected device is turned down; when it is turned down, the volume of the other connected device is turned up. Setting is only displayed when the audio is not output to AV system.
Overscan	Auto Off 4% 8%	Changes the projected image ratio to make the edges visible by a selectable percentage or automatically. Setting is only displayed when the input signal is component signal.
EDID (EB-755F/EB-750F/EB-735Fi/EB-735F)	HDMI1 HDMI2 HDMI3	Describes the display capabilities of your projector. Change this setting as necessary according to the resolution of the current input source. You can select the EDID settings for individual input sources without changing the input source.
Reset to Defaults	—	Resets all settings for current input source.

Setting	Options	Description
A/V Output	While Projecting Always On	Set to Always On to output audio and images to external devices when the projector does not project any images. Setting is only displayed when Quick Startup is set to Off .
Audio Output	Auto Audio Audio1 Audio2	Sets the audio input port when projecting from any sources other than the HDMI, LAN, and Screen Mirroring.
HDMI Audio Output	HDMI1 Audio Output HDMI2 Audio Output HDMI3 Audio Output	Sets the audio input port when projecting from HDMI ports.
Monitor Out Port	Monitor Out Computer2	Changes the input and output for the Computer2/Monitor Out port. When outputting images to an external monitor, select Monitor Out . When inputting image signals from a computer, select Computer2 .
USB Display (EB-735Fi/EB-725 Wi)	On Off	Set to On to enable the USB Display feature for a computer connected to the USB-B1 port.
HDMI Link	Device Connections	Lists the devices connected to the HDMI ports. Setting is only displayed when HDMI Link is set to On .
	HDMI Link	Set to On to enable the HDMI Link features.
	Audio Out Device	Selects whether to output audio from the internal speakers or a connected audio/video system.

Setting	Options	Description
	Power On Link	Controls what happens when you turn on the projector or connected device. <ul style="list-style-type: none"> • Bidirectional: automatically turns on the connected device when you turn on the projector, and vice versa. • Device -> PJ: automatically turns on the projector when you turn on the connected device. • PJ -> Device: automatically turns on the connected device when you turn on the projector.
	Power Off Link	Controls whether connected devices are turned off when you turn off the projector.
HDMI EQ Setting	1 2 3	Adjusts the HDMI input signal level depending on the devices connected to the HDMI port. If there is a lot of interference in the image, or if a problem such as no image being projected occurs, change the setting. If no images are displayed using a thumb-sized media streaming device, select 1 .
Reset Signal I/O Settings	—	Resets all adjustment values on the Signal I/O menu to their default settings.

Settings on the **Installation** menu help you set up your projector in your installation environment.

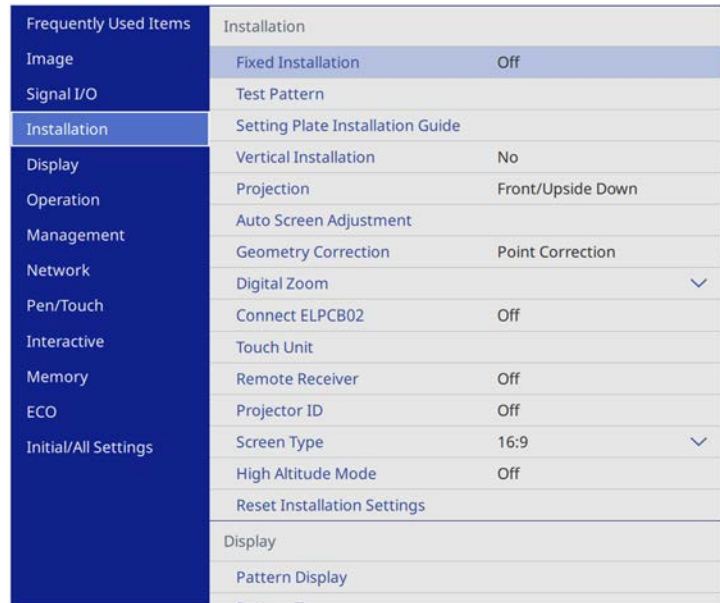

Setting	Options	Description
Fixed Installation	On Off	Set to On if you installed the projector in a fixed location.
Test Pattern	—	Displays a test pattern to assist in focusing and zooming the image and correcting image shape (press the [Esc] button to cancel pattern display).
Setting Plate Installation Guide	—	Displays a guide screen when installing the projector.
Vertical Installation	Yes No	Set to Yes if you installed the projector in a vertical position.

Setting	Options	Description
Projection	Front Rear Front/Upside Down Rear/Upside Down	Sets the way the projector faces the screen so the image is oriented correctly.
Auto Screen Adjustment (EB-735Fi/EB-725 Wi)	—	Automatically corrects the image shape when you have placed corner markers on the projection surface.
Geometry Correction	H/V-Keystone	Manually corrects horizontal and vertical sides.
	Quick Corner	Corrects image shape and alignment using an on-screen display.
	Arc Correction	Corrects the corners and sides of an image projected on a curved surface.
	Point Correction	Divides the projected image into a grid and corrects the distortion by moving the selected point of intersection from side to side and up and down.
	Memory	Save customized sets of settings to memory. <ul style="list-style-type: none"> • Save Memory: saves the current shape of an image you have adjusted. • Load Memory: loads the settings you made and saved. • Rename Memory: changes the name of the memory settings. • Erase Memory: deletes a saved memory. • Reset Memory: Resets all saved memories.
Digital Zoom	Various levels available	Adjusts the size of the projected image.

Setting	Options	Description
Image Shift	Various positions available	Shifts the image position horizontally and vertically. This feature is not available if the Digital Zoom option is set to the widest setting.
Connect ELPCB02 (EB-735Fi/EB-735F/EB-725Wi/EB-725W/EB-720)	On Off	Set to On to switch the input source between HDMI2 and HDMI3 each time you press the [HDMI2] button on the optional interface box (ELPCB02).
Touch Unit (EB-735Fi/EB-725Wi)	—	See the Pen/Touch menu table for details on the Touch Unit settings.
Remote Receiver	Front/Rear Front Rear Off	Limits reception of remote control signals by the selected receiver; Off turns off all receivers.
Projector ID (EB-735Fi/EB-735F/EB-725Wi/EB-725W/EB-720)	Off 1 through 9	Assigns an ID for the projector when you use multiple projectors.
Screen Type	4:3 16:6 16:9 16:10	Sets the aspect ratio of the screen to fit the image into the projection area. 16:6 is available with EB-755F/EB-750F/EB-735Fi/EB-735F only. Setting is only displayed when Content Playback is set to Off . (EB-755F/EB-750F)
Screen Position	Various positions available	Shifts the image position horizontally and vertically. This feature is not available if you set the Screen Type setting to the same aspect ratio as the projector resolution.
High Altitude Mode	On Off	Regulates the projector's operating temperature at altitudes above 1500 m.

Setting	Options	Description
Reset Installation Settings	—	Resets all adjustment values on the Installation menu to their default settings, except for the following: <ul style="list-style-type: none"> • Digital Zoom • Image Shift

► **Related Links**

- "Projection Modes" [p.55](#)
- "Image Shape" [p.63](#)
- "Projector Setup and Installation Options" [p.29](#)
- "Projector Pen And Touch Setup Settings - Pen/Touch Menu" [p.237](#)
- "Focusing the Image" [p.59](#)
- "Resizing the Image with the Buttons" [p.73](#)
- "Setting the Screen Type" [p.57](#)

Settings on the **Display** menu let you customize various projector display features.

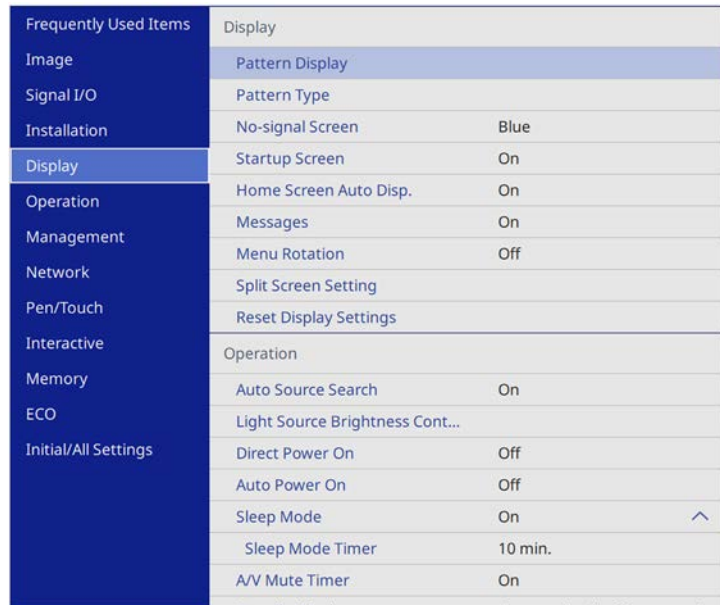

Setting	Options	Description
Pattern Type	Pattern 1 to Pattern 4 User Pattern	Sets a display pattern type. Patterns 1 to 4 are ruled line or grid patterns supplied by the projector. To create a custom display pattern, select User Pattern in the Management menu, then return to this menu and select User Pattern .
No-signal Screen	Black Blue Logo	Sets the screen color or logo to display when no signal is received. Setting is only displayed when Content Playback is set to Off . (EB-755F/EB-750F)
Startup Screen	On Off	Set to On to display a logo when the projector starts up.
Home Screen Auto Disp.	On Off	Set to On to display the Home screen automatically when there is no input signal when turning on the projector.
Messages	On Off	Set to On to display messages such as input source name, color mode name, aspect ratio, no signal message, or high temperature warning on your projected image.
Menu Rotation	Right 90 Degree Left 90 Degree Off	Rotates the menu display 90°.
Split Screen Setting	Display Audio Output Source	Set to On to display an icon with the source providing audio output during split screen projection. Setting is only displayed in the following cases. <ul style="list-style-type: none"> • Content Playback is set to Off. (EB-755F/EB-750F) • Connect ELPCB02 is set to Off. (EB-735Fi/EB-735F/EB-725Wi/EB-725W/EB-720)

Setting	Options	Description
Pattern Display	—	Displays the selected pattern type on the screen to aid in presentation. <div style="border: 1px solid black; padding: 5px; margin-top: 10px;"> <p>Attention If a pattern is displayed for a long time, a residual image may be visible in projected images.</p> </div>

Setting	Options	Description
	Align	<p>If you have split two screen images, select the position of the images to be aligned at the Top or Middle of the image area.</p> <p>Setting is only displayed in the following cases.</p> <ul style="list-style-type: none"> • Content Playback is set to Off. (EB-755F/EB-750F) • Connect ELPCB02 is set to Off. (EB-735Fi/EB-735F/EB-725Wi/EB-725W/EB-720)
Reset Display Settings	—	Resets all adjustment values on the Display menu to their default settings.



If you turn on **Menu Protection** of **User's Logo**, you cannot change the following user's logo display settings; you must turn off **Menu Protection** of **User's Logo** first.

- **No-signal Screen**
- **Startup Screen**

» Related Links

- "Projecting Multiple Images Simultaneously" [p.127](#)

Settings on the **Operation** menu let you customize various projector features.

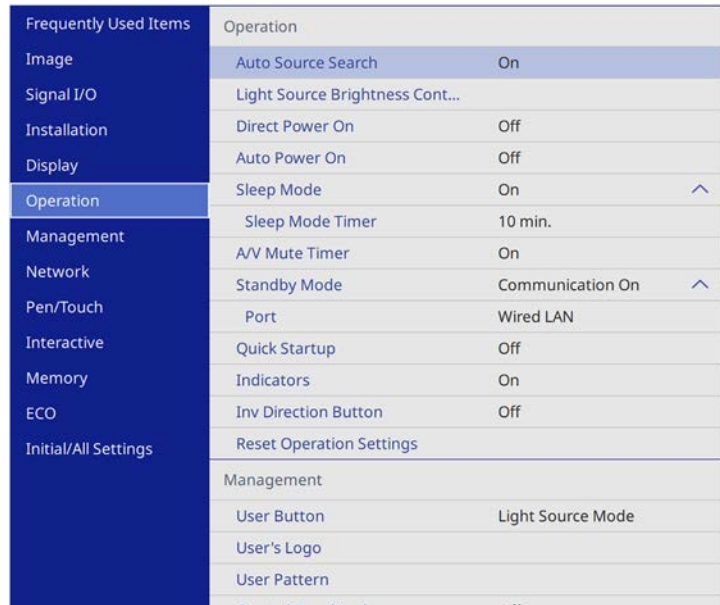

Setting	Options	Description
	Estimated Remains	Displays how long the projector can maintain constant brightness. Setting is only displayed when Maintain Brightness is set to On .
	Light Source Mode	Select the brightness for the light source. <ul style="list-style-type: none"> • Normal: maximum brightness. • Quiet: 70% brightness with reduced fan noise. • Extended: 70% brightness and extends the life expectancy of the light source. • Custom: select a custom brightness level. Setting is only displayed when Maintain Brightness is set to Off .
	Brightness Level	Select the Custom brightness level you want. Setting is only displayed when Maintain Brightness is set to Off .
Direct Power On	On Off	Set to On to turn on the projector by plugging it in without pressing the power button.
Auto Power On	HDMI1 Computer1 USB Display Off	Sets the image source from which you want to automatically start projection. When the projector detects the input signal from the selected image source, it projects automatically in standby mode. USB Display is only displayed when USB Display is set to On . (EB-735Fi/EB-725Wi)
Sleep Mode	On Off	Set to On to automatically turns off the projector after an interval of inactivity.
Sleep Mode Timer	1 to 30 minutes	Sets the interval for Sleep Mode .
A/V Mute Timer	On Off	Turns off the projector automatically if A/V Mute is enabled and 30 minutes of inactivity has passed.

Setting	Options	Description
Auto Source Search	On Off	Set to On to detect the input signal automatically and project images when there is no input signal. This function is disabled when you turn on the projector in the Quick Startup mode. Setting is only displayed when Content Playback is set to Off . (EB-755F/EB-750F)
Light Source Brightness Control	Maintain Brightness	Set to On to maintain a constant brightness for the light source.
	Maintain Brightness Level	Select the brightness level you want to maintain constantly. Setting is only displayed when Maintain Brightness is set to On .

Setting	Options	Description
Standby Mode	Communication On Communication Off	Set to Communication On to allow monitoring and controlling the projector over a network when the projector is in standby mode. Setting is only displayed when A/V Output is set to While Projecting .
Port	Wired LAN Wireless LAN	Sets the port to use while the Standby Mode setting is set to Communication On .
Startup Source (EB-755F/EB-750F)	Various input sources available	Select the image source you want to project when the projector is turned on in Content Playback mode.
Quick Startup	20min. 60min. 90min. Off	Sets the time period for Quick Startup mode. The projector enters this mode when you turn it off. You can start projecting in approximately 5 seconds by pressing the power button. (Set A/V Output to While Projecting first.) However, it may take longer to become ready for use in the following situations: <ul style="list-style-type: none"> • When projecting from the projector's USB port • When projecting using the Screen Mirroring features • If whiteboard sharing was terminated in the previous session (EB-735Fi/EB-725Wi) • If you want to restore the whiteboard contents from the previous session (EB-735Fi/EB-725Wi)
Indicators	On Off	Set to Off to turn off the indicator lights on the projector.
Inv Direction Button	On Off	Set to On to invert the control panel arrow button direction to match the projector installation position.

Setting	Options	Description
Content Playback (EB-755F/EB-750F)	On Off	Set to On to play back a playlist.
Overlay Effect (EB-755F/EB-750F)	Overlay Effect Shape Filter Color Filter Lightness	Adds color and shape effects to the projected image. Setting is not displayed when using the Edge Blending feature.
USB Viewer (EB-755F/EB-750F)	—	Selects and plays back a playlist saved on the USB flash drive.
Reset Operation Settings	—	Resets all adjustment values on the Operation menu to their default settings.

» **Related Links**

- "Projecting in Content Playback Mode" [p.135](#)
- "Adjusting the Brightness" [p.89](#)

Settings on the **Management** menu let you customize various projector administrative features.

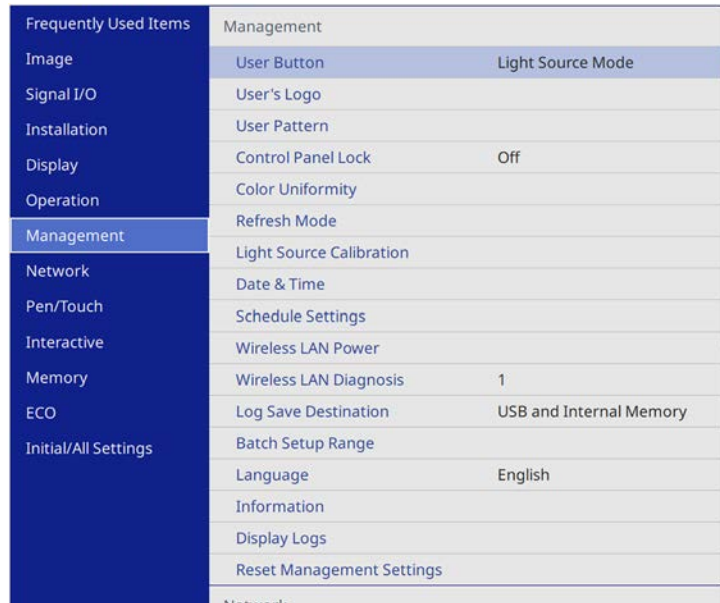

Setting	Options	Description
User Button	Various menu options available	Assigns a menu option to the [User] button on the remote control for one-touch access.
User's Logo	Start Setting Reset	Creates a screen that the projector displays to identify itself and enhance security.
User Pattern	—	Captures a projected screen and saves it as a pattern for display. Select Pattern Display on the Display menu to display the saved pattern.

Setting	Options	Description
Control Panel Lock	Full Lock Except for Power Off	Controls projector button locking to secure the projector: <ul style="list-style-type: none"> • Full Lock: locks all buttons. • Except for Power: locks all buttons except the power button. • Off: no buttons locked.
Color Uniformity	Color Uniformity	Set to On to adjust the color tone balance for the whole screen.
	Adjustment Level	Sets the adjustment level.
	Start Adjustments	Adjusts the red, green, and blue color tones individually for the selected area.
	Reset	Resets all adjustment values on the Color Uniformity menu to their default settings.
Refresh Mode	Timer	Sets a time period during which the projector displays the refresh image.
	Messages	Set to On to display a message informing you that the projector is in refresh mode.
	Start	Starts the refresh mode process to clear any projected afterimage and turn off the projector after a specified period of time. Press any button on the remote control to cancel this process.
Light Source Calibration	Run Now	Starts light source calibration to optimize the color balance of the currently projected image. You may not be able to start calibration if the projector's environmental temperature is out of range. (Wait 30 minutes after turning on the projector before starting calibration for the best results.)
	Run Periodically	Set to On to perform light source calibration periodically every 100 hours of usage.
	Last Run	Displays the date and time of the last light source calibration.

Setting	Options	Description
Date & Time	Date & Time Daylight Saving Time Internet Time	Adjusts the projector's system time and date settings. Select Daylight Saving Time to set daylight saving time settings for your region. Select Internet Time to automatically acquire the time from an Internet time server.
Schedule Settings	—	Schedules projector events to occur automatically at selected dates and times.
Wireless LAN Power	On Off	Set to On to project images via a wireless LAN. If you do not want to connect via wireless LAN, turn it off to prevent unauthorized access by others.
Wireless LAN Diagnosis	Ping IP Address Ping until stopped Start	Transmits Ping to confirm communication status.
Log Save Destination	Internal Memory USB and Internal Memory	Sets the location in which to save error and operation log files. Setting is only displayed when Content Playback is set to Off . (EB-755F/EB-750F)
Batch Setup Range	All Limited	Select All to copy all of the projector menu settings using the batch setup feature. Select Limited , if you do not want to copy the following settings: <ul style="list-style-type: none"> • Password Protection settings • EDID in the Signal I/O menu • Network menu settings
Language	Various languages available	Select the language for projector menu and message displays.
Information	Various information	Displays information about the projector and input sources. The displayed items vary depending on the current input source.

Setting	Options	Description
Display Logs	Temp Warning Info Power On/Off History	Displays log data saved to the location specified in the Log Save Destination setting.
Reset Management Settings	—	Resets all adjustment values on the Management menu to their default settings, except for the following: <ul style="list-style-type: none"> • User Pattern • Language

 When you set **Menu Protection** of **Schedule** to **On**, you cannot change settings on the **Schedule Settings**. Set **Menu Protection** of **Schedule** to **Off** first.

» Related Links



- "Event ID Code List" [p.227](#)
- "Saving a User's Logo Image" [p.144](#)
- "Saving a User Pattern" [p.146](#)
- "Locking the Projector's Buttons" [p.164](#)
- "Adjusting Color Uniformity" [p.151](#)
- "Setting the Date and Time" [p.52](#)
- "Setting Projector Event Schedules" [p.210](#)
- "Selecting the Language for the Projector Menus" [p.54](#)

Event ID Code List

If the **Event ID** option on the **Information** screen displays a code number, check this list of Event ID codes for the solution to the projector problem associated with the code.

If you cannot resolve the problem, contact your network administrator or Epson for technical support.

Event ID code	Cause and solution
0026 0032 0036 0037	A screen mirroring communication error has occurred. Turn the projector off and then on again, or restart the network software.
0027 0028 0029 0030 0031 0035	Unstable screen mirroring communication. Check the network communication status, wait a few moments, and try connecting to the network again.
0023 0024 0025	Connection failed. If you see the PIN entry screen on your computer, enter the PIN code displayed on the network information screen or at the bottom right of the projected image. If this does not solve the problem, restart the projector and the connected devices, and then check the connection settings.
0043	The video format is not supported. Change the resolution of the mobile device, and then reconnect. Or change the Adjust Image Quality setting for the projector, and then reconnect.
0432 0435	The network software did not start. Turn the projector off and then on again.
0433	Cannot display the transferred images. Restart the network software.
0434 0481 0482 0485	Unstable network communication. Check the network communication status, wait a few moments, and try connecting to the network again.
0483 04FE	The network software quit unexpectedly. Check the network communication status, then turn the projector off and then on again.
0484	Communication with computer was disconnected. Restart the network software.
0479 04FF	A projector system error has occurred. Turn the projector off and then on again.

Event ID code	Cause and solution
0891	Cannot find an access point with the same SSID. Set your computer, access point, and projector to the same SSID.
0892	The WPA/WPA2/WPA3 authentication type does not match. Make sure the wireless network security settings are correct.
0893	The TKIP/AES encryption type does not match. Make sure the wireless network security settings are correct.
0894	Communication with an unauthorized access point was disconnected. Contact your network administrator.
0895	Communication with a connected device was disconnected. Check your device connection status.
0898	Failed to acquire DHCP. Make sure the DHCP server is operating correctly. If you are not using DHCP, set the DHCP setting to Off in the projector's Network menu.  Network > Network Settings > Wired LAN > IP Settings > DHCP  Network > Network Settings > Wireless LAN > IP Settings > DHCP
0899	Other communication errors.
089A	The EAP authentication type does not match the network. Check the wireless LAN security settings and make sure that the security certificate is installed correctly.
089B	EAP server authentication failed. Check the wireless LAN security settings and make sure that the security certificate is installed correctly.
089C	EAP client authentication failed. Check the wireless LAN security settings and make sure that the security certificate is installed correctly.
089D	Key exchange failed. Check the wireless LAN security settings and make sure that the security certificate is installed correctly.
0920	The internal battery that saves the projector's date and time settings is running low. Contact Epson for help.

Event ID code	Cause and solution
0B01	The internal storage could not be detected correctly. Turn off the projector and disconnect the power cord, then reconnect the power cord and turn the projector back on. When the projector is turned on, the security certificate and address book are deleted. If that does not solve the problem, contact Epson for help.
0BFF	An error has occurred in the whiteboard function. Restart the projector.

Settings on the **Network** menu let you view network information and set up the projector for controlling over a network.

Frequently Used Items	Network
Image	Wireless LAN Info.
Signal I/O	Wired LAN Info.
Installation	Network Settings
Display	Reset Network Settings
Operation	Pen/Touch
Management	Auto Calibration
Network	Manual Calibration
Pen/Touch	Touch Unit
Interactive	Installation of Projectors
Memory	Pen Hovering On
ECO	PC Interactivity
Initial/All Settings	Reset Pen/Touch Settings
	Interactive
	Drawing Function On
	Display Toolbars Always Show
	Display Drawing Area
	Confirm Clear Screen On

Setting	Options	Description
Network Settings	—	Configures your projector network settings. See the network menu table for details on the Network Settings .
Reset Network Settings	—	Resets all adjustment values on the Network menu to their default settings.

 Once you have connected your projector to your network, you can select projector settings and control projection using a compatible Web browser. This allows you to access the projector remotely.

» **Related Links**

- "Network Menu - Network Settings Menu" [p.230](#)
- "Art-Net Channel Definitions" [p.206](#)

Network Menu - Network Settings Menu

Settings on the **Network Settings** menu let you select the basic network settings.

 If you are connecting via wireless LAN, make sure the followings to enable wireless LAN settings:

- Turn on the **Wireless LAN Power** setting in the projector's **Management** menu.

 When you set **Menu Protection** of **Network** to **On**, you cannot change the network settings. Set **Menu Protection** of **Network** to **Off** first.

Setting	Options	Description
Wireless LAN Info.	Various information	Displays wireless network status and details.
Wired LAN Info.	Various information	Displays wired network status and details.
Art-Net Channel Information (EB-755F/EB-750F)	Various information	Displays the projector's features and the settings assigned to the Art-Net channels.

Setting	Options	Description
Projector Name	Up to 16 alphanumeric characters (do not use " * + , / : ; < = > ? [\] ` spaces)	Enter a name to identify the projector over the network.

Setting	Options	Description
Remote Password	Up to 8 alphanumeric characters (do not use * : spaces)	Enter a password for accessing the projector using the Basic Control. (User name is EPSONREMOTE ; default password is guest .) Setting is only displayed when Content Playback is set to Off . (EB-755F/EB-750F)
Web Control Password	Up to 8 alphanumeric characters (do not use * : spaces)	Enter a password for accessing the projector over the Web. (User name is EPSONWEB ; default password is admin .)
Priority Control Interface	Wired LAN Wireless LAN	Sets the priority gateway.
Simple AP	On Off	Set to On to enable simple access point mode for direct connection between your projector and input devices. Make sure you are also doing the following: <ul style="list-style-type: none"> • Using Quick Connection Mode of Epson iProjection • Using Screen Mirroring connection Setting is only displayed when Wireless LAN Power is set to On .
SSID	Automatically assigned SSID	Displays the SSID of the projector for selection on your device in simple AP connections.
Security	WPA2-PSK	Displays the security type for simple AP connections.
Passphrase	Various passphrases from 8 to 63 characters	Enter the passphrase of the projector for entry on your device in simple AP connections.
Channel	Various channels available	Set the frequency band (channel) using in simple AP connections.
Wireless LAN	—	See the Wireless LAN menu table for details.

Setting	Options	Description
Wired LAN	—	See the Wired LAN menu table for details.
Mail Notification	—	See the Mail Notification menu table for details.
Projector Control	—	See the Projector Control menu table for details.
Network Projection	—	See the Network Projection menu table for details.

► Related Links

- "Network Menu - Wireless LAN Menu" [p.231](#)
- "Network Menu - Wired LAN Menu" [p.233](#)
- "Network Menu - Mail Notification Menu" [p.234](#)
- "Network Menu - Projector Control Menu" [p.234](#)
- "Network Menu - Network Projection Settings" [p.235](#)

Network Menu - Wireless LAN Menu

Settings on the **Wireless LAN** menu let you select the wireless LAN settings.



- Turn on the **Wireless LAN Power** setting in the projector's **Management** menu.
- If you did not install an optional wireless LAN module, turn off the **Simple AP** setting to enable you to select wireless LAN settings.

When connecting to a wireless network, it is strongly recommended that you set security. When setting security, follow the instructions from the administrator of the network system you want to connect to.

WPA is an encryption standard that improves the security for wireless networks. The projector supports AES encryption methods.



WPA2/WPA3-EAP and WPA3-EAP do not support WPA3 192-bit security.

Setting	Options	Description
Search Access Point	To Search View	Search for available wireless network access points. Depending on the access point settings, they may not be displayed in the list.
SSID	Up to 32 alphanumeric characters	Enter the SSID (network name) of the wireless LAN system the projector is connecting to.
Security	WPA2/WPA3-PSK	Connects in WPA2/WPA3 personal mode. Encryption method is selected automatically according to the access point settings. Set a passphrase which is the same for the access point.
	WPA2/WPA3-EAP	Connects in WPA2/WPA3 enterprise mode. Encryption method is selected automatically according to the access point settings.
	WPA3-PSK	Connects in WPA3 personal mode. Communication is performed using WPA3 security. Uses AES method for encryption. When establishing a connection from a computer to the projector, enter the value set in the passphrase.
	WPA3-EAP	Connects in WPA3 enterprise mode. Encryption method is selected automatically according to the access point settings.
	Open	Security is not set.
Passphrase (For WPA2/WPA3-PSK and WPA3-PSK security)	Various passphrases from 8 to 63 characters	Enter the pre-shared passphrase used on the network. When the passphrase is entered and the [Enter] button is pressed, the value is set and displayed as an asterisk (*). We recommend changing the passphrase periodically for security. If the network settings are initialized, it returns to the initial passphrase.

Setting	Options	Description
EAP Type (For WPA2/WPA3-EAP and WPA3-EAP security)	PEAP	Authentication protocol widely used in Windows Server.
	PEAP-TLS	Authentication protocol used in Windows Server. Select this when using a client certificate.
	EAP-TLS	Authentication protocol widely used to use a client certificate.
	EAP-FAST	Select this when these authentication protocols are used.
User name	Up to 64 alphanumeric characters	Enter a user name for the network. To include a domain name, add it before a backslash and the user name (domain\username). When importing a client certificate, the name the certificate was issued to is automatically set.
Password	Up to 64 alphanumeric characters	Enter a password for authentication. After you enter the password and select Set , the password is displayed as an asterisk (*). Setting is only displayed when EAP Type is set to PEAP or EAP-FAST .
Client Certificate	—	Imports the client certificate. Setting is only displayed when EAP Type is set to PEAP-TLS or EAP-TLS .
Verify Server Certificate	On Off	Set to On to verify the server certificate when a CA certificate has been set.
CA certificate	—	Imports the CA certificate.
RADIUS Server Name	Up to 64 alphanumeric characters	Enter the server name to verify.

Setting	Options	Description
IP Settings	DHCP IP Address Subnet Mask Gateway Address	Set DHCP to On if your network assigns addresses automatically; set to Off to manually enter the network's IP Address, Subnet Mask, and Gateway Address using 0 to 255 for each address field. Do not use these addresses: 0.0.0.0, 127.x.x.x, 192.0.2.x or 224.0.0.0 through 255.255.255.255 (where x is a number from 0 to 255) for IP Address, 255.255.255.255 or 0.0.0.0 through 254.255.255.255 for Subnet Mask, and 0.0.0.0, 127.x.x.x or 224.0.0.0 through 255.255.255.255 for Gateway Address.
DNS Server 1 DNS Server 2	Various IP addresses	Enter the IP address for the DNS server, using 0 to 255 for each address field. The DNS server resolves the host name. Do not use the following IP addresses: 127.x.x.x (where x is a number from 0 to 255). When these settings are not set and remain 0.0.0.0, DNS server information is acquired using DHCP. After acquiring, the value remains 0.0.0.0.
IPv6	On Off	Set to On if you want to connect the projector to the network using IPv6. IPv6 is supported to monitor and control the projector over a network using Epson Web Control and PjLink.
Auto Configuration	On Off	Set to On to assign addresses automatically according to the Router Advertisement.
Use Temporary Address	On Off	Set to On if you want to use a temporary IPv6 address.
IP Address Display	On Off	Set to On to display the IP address on the network information screen and Home screen.

Network Menu - Wired LAN Menu

Settings on the **Wired LAN** menu let you select the wired LAN settings.

Setting	Options	Description
IP Settings	DHCP IP Address Subnet Mask Gateway Address	Set DHCP to On if your network assigns addresses automatically; set to Off to manually enter the network's IP Address, Subnet Mask, and Gateway Address using 0 to 255 for each address field. Do not use these addresses: 0.0.0.0, 127.x.x.x, 192.0.2.x or 224.0.0.0 through 255.255.255.255 (where x is a number from 0 to 255) for IP Address, 255.255.255.255 or 0.0.0.0 through 254.255.255.255 for Subnet Mask, and 0.0.0.0, 127.x.x.x or 224.0.0.0 through 255.255.255.255 for Gateway Address.
DNS Server 1 DNS Server 2	Various IP addresses	Enter the IP address for the DNS server, using 0 to 255 for each address field. The DNS server resolves the host name. You cannot use the following IP addresses: 127.x.x.x (where x is a number from 0 to 255). When these settings are not set and remain 0.0.0.0, DNS server information is acquired using DHCP. After acquiring, the value remains 0.0.0.0.
IPv6	On Off	Set to On if you want to connect the projector to the network using IPv6. IPv6 is supported to monitor and control the projector over a network using Epson Web Control and PjLink.
Auto Configuration	On Off	Set to On to assign addresses automatically according to the Router Advertisement.
Use Temporary Address	On Off	Set to On if you want to use a temporary IPv6 address.

Setting	Options	Description
IP Address Display	On Off	Set to On to display the IP address on the network information screen and Home screen.

Network Menu - Mail Notification Menu

Settings on the **Mail Notification** menu let you receive an email notification if a problem or warning occurs in the projector.

Setting	Options	Description
Mail Notification	On Off	Set to On to send an email to the preset addresses when a problem or warning occurs with a projector.
SMTP Server	Various IP addresses	Enter the IP address for the projector's SMTP server using 0 to 255 for each address field. Do not use these addresses: 127.x.x.x, 192.0.2.x or 224.0.0.0 through 255.255.255.255 (where x is a number from 0 to 255).
Authentication	Open Auth SSL TLS	Select the authentication type of the SMTP server.
Port Number	1 to 65535 (default is 25)	Enter a number for the SMTP server Port Number.
User Name	Up to 64 alphanumeric characters	Enter a user name for the SMTP server.
Password	Up to 64 alphanumeric characters	Enter a password for authentication on the SMTP server.

Setting	Options	Description
From	Up to 64 alphanumeric characters (do not use " () , ; ; < > [\] spaces)	Enter the email address of the sender.
Address 1 Setting		Enter the e-mail address, and select the alerts you want to receive.
Address 2 Setting Address 3 Setting		

Network Menu - Projector Control Menu

Settings on the **Projector Control** menu let you select settings for controlling the projector over a network.

Setting	Options	Description
PJLink	On Off	Set to On to enable the PJLink notification function.
PJLink Password	Up to 32 alphanumeric characters (do not use spaces and any symbols other than @)	Enter a password for using the PJLink protocol for projector control.
Notified IP Address	Various IP addresses	Enter the IP address to receive the projector's operating status when the PJLink notification function is enabled. Enter the addresses using 0 to 255 for each address field. Do not use these addresses: 127.x.x.x or 224.0.0.0 through 255.255.255.255 (where x is a number from 0 to 255).
SNMP	On Off	Set to On to monitor the projector using SNMP. To monitor the projector, you need to install the SNMP manager program on your computer. SNMP should be managed by a network administrator.

Setting	Options	Description
Trap IP Address 1 Trap IP Address 2	Various IP addresses	Enter up to two IP addresses to receive SNMP notifications, using 0 to 255 for each address field. Do not use these addresses: 127.x.x.x or 224.0.0.0 through 255.255.255.255 (where x is a number from 0 to 255).
Community Name	Up to 32 alphanumeric characters (do not use spaces and any symbols other than @)	Enter the SNMP community name.
AMX Device Discovery	On Off	Set to On when you want to allow the projector to be detected by AMX Device Discovery.
Crestron Connected	On Off	Set to On only when monitoring or controlling the projector over the network using Crestron Connected. Enabling Crestron Connected disables the Epson Message Broadcasting feature in the Epson Projector Management software.
Control4 SDDP	On Off	Set to On to allow device information to be acquired using Control4 Simple Device Discovery Protocol (SDDP).

Setting	Options	Description
Art-Net (EB-755F/EB-750F)	On Off	Set to On when you want to control the projector using Art-Net. <ul style="list-style-type: none"> • Net: enter a number for the projector's Net using 0 to 127 (default is 0). • Sub-Net: enter a number for the projector's Sub-Net using 0 to 15 (default is 0). • Universe: enter a number for the projector's Universe using 0 to 15 (default is 0). • Start Channel: enter the start channel that handles Art-Net using 1 to 500 (default is 1).
Secure HTTP	On Off	To strengthen security, communication between the projector and computer in Web control is encrypted. When setting security with Web control, it is recommended to set this to On .
Web Server Certificate	—	Imports the Web server certificate for secure HTTP.

Network Menu - Network Projection Settings

Settings on the **Network Projection** menu let you select the settings relates to network projection.

Setting	Options	Description
Projector Keyword	On Off	Set to On to enable a security password to prevent access to the projector by anyone not in the same room as the projector. You must enter a displayed, randomized keyword from a computer using Epson iProjection to access the projector and share the current screen.
Epson iProjection	On Off	Set to On to use Epson iProjection.

Setting	Options	Description
SSID Display	On Off	Set to On to display the SSID on the network information screen and Home screen.
Display LAN Info.	Text & QR Code Text	Sets the display format for the projector's network information. By simply reading the QR code with Epson iProjection, you can connect the mobile device to the projector through a network.
Moderator Password	Four-digit number	Enter a password for accessing the projector as a moderator using Epson iProjection. (No password is set by default.)
Keyword Interrupt Display	On Off	Set to On to display a projector keyword on the projected image when accessing the projector using Epson iProjection. Available when Projector Keyword is set to On .
Screen Mirroring	On Off	Set to On to use the Screen Mirroring feature.
Interrupt Connection	On Off	Set to On to allows interruption of image projection by another user. If you want to use two Screen Mirroring sources, set this to Off .
Adjust Image Quality	1 2 3 4	Adjusts the screen mirroring speed/quality. 1: increases image quality. 4: increases processing speed.
Capture (EB-735Fi/EB-725 Wi)	Enabled Disabled	Set to Enabled to enable screen captures of Screen Mirroring images from the whiteboard screen toolbar tools. If you set to Enabled , the HDCP feature is disabled and you may not be able to project content with HDCP feature.

Setting	Options	Description
Screen Mirroring Info.	On Off	Set to On to display connection information when projecting from a Screen Mirroring source.
Message Broadcasting	On Off	Set to On to receive the message delivered by Epson Projector Management. See the <i>Epson Projector Management Operation Guide</i> for details. Setting is only displayed when Crestron Connected is set to Off .
Screen Sharing	On Off	Set to On to enable screen sharing between network projectors.

» **Related Links**

- "Screen Sharing" [p.189](#)
- "Getting the Latest Version of the Documents" [p.10](#)

Settings on the **Pen/Touch** menu let you setup the interactive pen and finger touch operation.

This menu appears for EB-735Fi/EB-725Wi only.

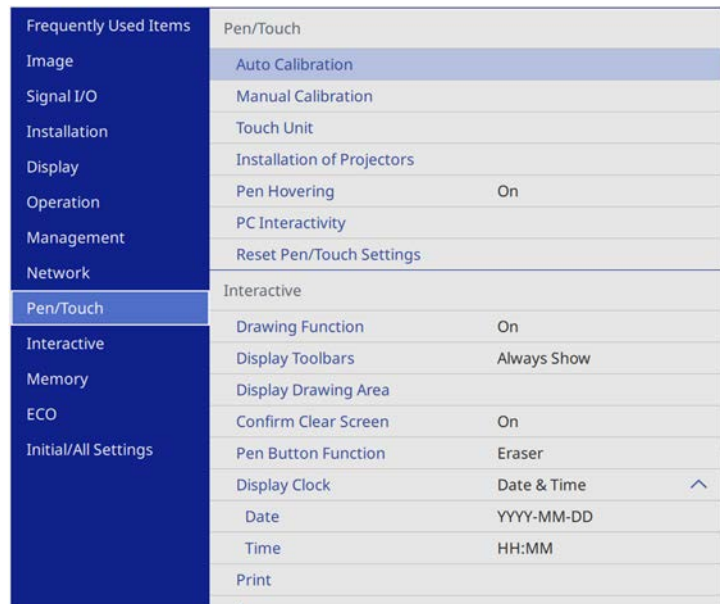

Setting	Options	Description
Auto Calibration	—	Starts calibration for pen operations.
Manual Calibration		
Touch Unit	Power	Set to On to turn on the Touch Unit power.
	Touch Unit Setup	Adjusts angle for laser diffusion so it can precisely detect finger touch positions.
	Touch Calibration	Performs calibration for touch operations with your finger.
	Calibration Range	If finger touch operations are recognized as drag operations, select Wide to widen the calibration range.

Setting	Options	Description
Installation of Projectors	Infrared Intensity	If interactive pen performance is unstable due to infrared interference, select Strong .
	Sync of Projectors	If the projectors are connected using the optional remote control cable set, select Wired .
Pen Hovering	On Off	When set to On , the pointer follows the pen tip as you hover it over the screen and move it around.
PC Interactivity	Pen Tracking Mode	Selects the device type of the pen recognized from your OS. For Windows or Mac (including the computer's ink feature), select Pen Mode and for Ubuntu, select Mouse Mode .
	Press and Hold	When set to Right Click , a long press by the pen tip or finger acts as a right-click operation.
	Pen Tip Behavior	Assigns either Right Click or Left Click to the pen tip.
	USB-B2	Sets the HDMI port used for the computer connected to the USB-B2 port when using interactive features with this computer.
	Auto Adjust Pen Area	Set to On to automatically adjust the pen area as the resolution for the connected computer changes. Set to Off if you do not want to automatically adjust the pen area that has been manually adjusted.
	Manual Adj. Pen Area	Adjusts the pen area manually. Setting is only displayed when turning on PC Interactivity .
Reset Pen/Touch Settings	—	Resets all adjustment values on the Pen/Touch menu to their default settings.

Settings on the **Interactive** menu let you customize various projector's interactive features.

This menu appears for EB-735Fi/EB-725Wi only.

Frequently Used Items	Interactive
Image	Drawing Function On
Signal I/O	Display Toolbars Always Show
Installation	Display Drawing Area
Display	Confirm Clear Screen On
Operation	Pen Button Function Eraser
Management	Display Clock Date & Time ^
Network	Date YYYY-MM-DD
Pen/Touch	Time HH:MM
Interactive	Print
Memory	Save
ECO	Mail
Initial/All Settings	Directory
	Reset Interactive Settings
	Memory
	Save Memory
	Load Memory
	Rename Memory



When you set **Menu Protection of Interactive** to **On**, you cannot change settings on the **Interactive** menu. Set **Menu Protection of Interactive** to **Off** first.

Setting	Options	Description
Confirm Clear Screen	On Off	Set to On to display a confirmation screen before clearing all the content drawn on the projected screen.
Pen Button Function	Drawing Toolbar Eraser Clear Screen Off	Sets the function of the button on the side of the interactive pen.
Display Clock	Date & Time Date Time Off	Sets the date and time display on the whiteboard mode bottom toolbar. Set the Date & Time setting in the projector's Management menu first.
Print	—	See the Print menu table for details.
Save	—	See the Save menu table for details.
Mail	—	See the Mail menu table for details.
Directory	—	See the Directory menu table for details.
Reset Interactive Settings	—	Resets all adjustment values on the Interactive menu to their default settings.

» Related Links

- "Interactive Menu - Print Menu" [p.238](#)
- "Interactive Menu - Save Menu" [p.239](#)
- "Interactive Menu - Mail Menu" [p.240](#)
- "Interactive Menu - Directory Menu" [p.240](#)

Setting	Options	Description
Drawing Function	On Off	Set to On to display the interactive toolbar.
Display Toolbars	Always Show Hide for Set Time	Sets when to display the interactive toolbar.
Display Drawing Area	On Off	Set to On to display the drawing area.

Interactive Menu - Print Menu

Settings on the **Print** menu let you select the print settings.

Setting	Options	Description
Printer	USB Printer Network Printer Off	Sets the default printer used when printing.
Printer Address	Various IP addresses	Enter the IP address for the network printer. You cannot use the following IP addresses: 127.x.x.x, 192.0.2.x, or 224.0.0.0 through 255.255.255.255 (where x is a number from 0 to 255). To return the IP address to its default value, enter 0.0.0.0.
Printer Type	Auto Detect PCL6 Compatible ESC/P-R	Sets the type of connected printer. In most cases, you should leave this as Auto Detect .
PCL Type	Normal Mode 1 Mode 2	If printing fails when using a PCL6 printer in the Normal mode, try changing to Mode 1 or Mode 2 . You may not be able to print correctly if this setting does not match the printer type and settings of the connected network printer.
Test Print	—	Prints a test page.
Default Paper Size	A4 Letter	Sets the default paper size.

Setting	Options	Description
PC via USB Cable	On Off	Set to On to save the file to a device connected to the projector with a USB cable.
Network Folder	On Off	Set to On to save the file to the network folder.
CIFS Server	Up to 64 alphanumeric characters (do not use " * + , ; < = > ? [\] ` and spaces)	Enter the IP address or FQDN (Fully Qualified Domain Name) for the CIFS server. You cannot use the following IP addresses: 127.x.x.x, 192.9.2.x, or 224.0.0.0 through 255.255.255.255 (where x is a number from 0 to 255). If you specify an FQDN, you must configure a DNS server.
Shared Folder Path	Up to 64 alphanumeric characters (do not use " * / : < > ? and)	Enter the network folder name in "share name\folder name" or "share name".
User name	Up to 64 alphanumeric characters (do not use : and spaces)	Enter a user name that will have read/write privileges on the network folder. You can enter a domain name by adding it before the user name and separating them with a backslash (domain\username).
Password	Up to 64 alphanumeric characters (do not use : and spaces)	Enter a password for the user name. After you enter the password and select OK , the password is displayed as an asterisk (*).
Check Connection	—	Tests the network connection.
Always apply password	On Off	Set to On to always set a password on a file. When set to On , you can save files only in whiteboard mode and as a PDF or EWF2 format.

Interactive Menu - Save Menu

Settings on the **Save** menu let you select the save settings.

Setting	Options	Description
USB Storage	On Off	Set to On to save the file to a USB memory device.

Interactive Menu - Mail Menu

Settings on the **Mail** menu let you select the email settings.

Setting	Options	Description
Mail Function	On Off	Set to On to enable sending of emails containing captured whiteboard drawings.
SMTP Server	Up to 64 alphanumeric characters (do not use " * + , ; ; < = > ? [\] ` and spaces)	Enter the IP address or FQDN (Fully Qualified Domain Name) for the SMTP server. You cannot use the following IP addresses: 127.x.x.x, 192.0.2.x, or 224.0.0.0 through 255.255.255.255 (where x is a number from 0 to 255). If you specify an FQDN, you must configure a DNS server.
Authentication	Open Auth SSL TLS	Sets the type of authentication expected by the SMTP server.
Port Number	1 to 65535	The default port varies depending on the Authentication setting: 25 for Open , 465 for SSL , and 587 for TLS .
User name	Up to 64 alphanumeric characters (do not use : and spaces)	Enter a user name for the SMTP server.
Password	Up to 64 alphanumeric characters (do not use : and spaces)	Enter a password for the SMTP server.

Setting	Options	Description
From	Up to 64 alphanumeric characters (do not use " () , ; ; < > [\] and spaces)	Enter the email address to be displayed to the sender.
Default e-mail address	Up to 64 alphanumeric characters (do not use " () , ; ; < > [\] and spaces)	Enter the default email address used to send emails. You can also specify the domain name following an at mark to aid email address input; for example, "@xxx.co.jp".
Send a test e-mail	—	Connects to the SMTP server and sends a test email to the address you set as the default.
Disallow Address Input	On Off	Set to On to choose e-mail addresses only from an address book or directory service.

Interactive Menu - Directory Menu

Settings on the **Directory** menu let you select the directory service settings.

Setting	Options	Description
Directory Access Function	On Off	Set to On to search for user names and email addresses from a directory service.
LDAP Server	Up to 64 alphanumeric characters (do not use " * + , ; ; < = > ? [\] ` and spaces)	Enter the IP address or FQDN (Fully Qualified Domain Name) for the LDAP server. You cannot use the following IP addresses: 127.x.x.x, 192.9.2.x, or 224.0.0.0 through 255.255.255.255 (where x is a number from 0 to 255). If you specify an FQDN, you must configure a DNS server.
Port Number	1 to 65535	Enter a port number for the LDAP server. The default port is 389. Specify "3268" to search the global catalog.

Setting	Options	Description
Authentication	Anonymous Simple Digest-MD5	Sets the type of authentication expected by the LDAP server. If you want to select Digest-MD5 or Simple as an authentication method when an IP address is set for LDAP Server , you must configure the DNS server to enable reverse DNS lookup.
User Name	Up to 64 alphanumeric characters (do not use : and spaces)	Enter a user name for the LDAP server. Use one of the following methods when entering the user name with the domain name: <ul style="list-style-type: none"> • "domain name\user name" • "user name@domain name"
Password	Up to 64 alphanumeric characters (do not use : and spaces)	Enter a password for the LDAP server.
Check Connection	—	Tests the network connection.
Search Base DN	Up to 64 alphanumeric characters (do not use : and spaces)	Enter the DN (Distinguished Name) where the search for user names and email addresses should start. Make sure you specify all OU (Organizational Unit) and DC (Domain Component) as necessary in the order of OU then DC; for example, "OU=accounts,DC=example,DC=com". The DN must be at or below the DC level in the database structure.
User Attributes	Up to 64 alphanumeric characters (do not use : and spaces)	Enter the attribute for user name; for example, "cn".

Setting	Options	Description
Mail Attributes	Up to 64 alphanumeric characters (do not use : and spaces)	Enter the attribute for mail address; for example, "mail".
Group Attributes	Up to 64 alphanumeric characters (do not use : and spaces)	Enter the attribute for a user group name.
Search target attributes	Up to 64 alphanumeric characters (do not use : and spaces)	Enter the search key for user name, email address, and user group name. The default value is "cn". You can specify up to three keys separated by comma(s). Do not use three or more commas, commas right at the start or the end, and continuous commas. The search is performed using forward matching.
Additional filter	Up to 64 alphanumeric characters (do not use : and spaces)	Enter an additional search filter to Search target attributes .

Settings on the **Multi-Projection** menu let you set up multiple projectors to project a single unified image.

This menu appears for EB-755F/EB-750F only.

Frequently Used Items	Multi-Projection	
Image	Projector ID	Off
Signal I/O	Geometry Correction	Point Correction
Installation	Edge Blending	
Display	Scale	
Operation	Color Uniformity	
Management	Light Source Mode	Normal
Network	Color Matching	
	RGBCMY	
Multi-Projection	Reset Multi-Projection Settings	
Memory	Memory	
ECO	Save Memory	
Initial/All Settings	Load Memory	
	Rename Memory	
	Erase Memory	
	Reset Memory Settings	
	ECO	
	Light Source Mode	Normal

Setting	Options	Description
Projector ID	—	See the Installation menu table for details on the Projector ID settings.
Geometry Correction	—	See the Installation menu table for details on the Geometry Correction settings.

Setting	Options	Description
Edge Blending	Edge Blending Top Edge Bottom Edge Left Edge Right Edge Line Guide Pattern Guide Guide Color	Blends the border between multiple images to create a seamless screen.
Black Level	Color Adjustment Area Correction Reset	Adjusts the black color of the overlapping image area
Scale	—	See the Image menu table for details on the Scale settings.
Color Uniformity	—	See the Management menu table for details on the Color Uniformity settings.
Light Source Mode	—	See the Operation menu table for details on the Light Source Mode settings.
Color Matching	Adjustment Level Red Green Blue Brightness	Corrects the difference between the tint and brightness of each projected image.
RGBCMY	—	See the Image menu table for details on the RGBCMY settings.
Reset Multi-Projection Settings	—	Resets all adjustment values on the Multi-Projection menu to their default settings.

» **Related Links**

- "Projector Identification System for Multiple Projector Control" [p.149](#)
- "Projector Installation Settings - Installation Menu" [p.220](#)
- "Image Quality Settings - Image Menu" [p.216](#)
- "Projector Administration Settings - Management Menu" [p.226](#)

- "Projector Feature Settings - Operation Menu" [p.224](#)
- "Blending the Image Edges" [p.153](#)
- "Adjusting the Black Level" [p.156](#)
- "Matching the Image Colors" [p.154](#)

Settings on the **Memory** menu let you manage saving and loading of image quality settings in the projector's memory.

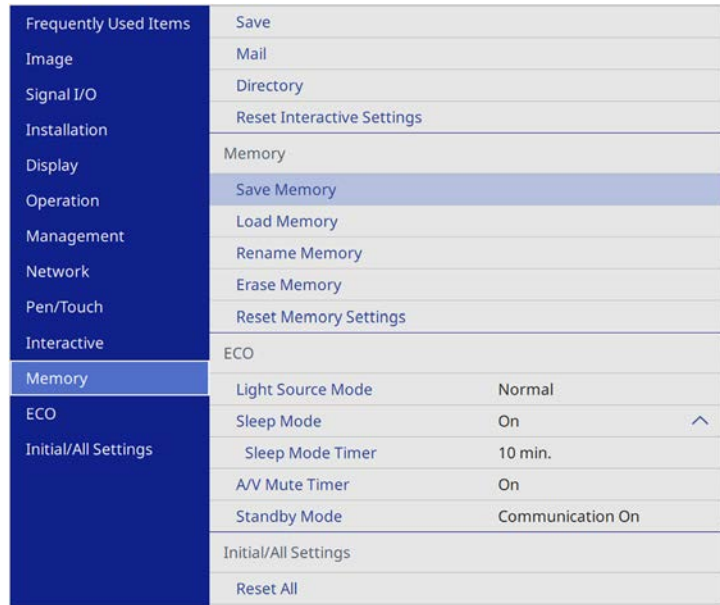

Setting	Options	Description
Save Memory	Memory 1 to 10	Saves customized sets of settings to memory.
Load Memory	Memory 1 to 10	Loads saved memory settings and applies them to the current image.
Rename Memory	Memory 1 to 10	Changes the name of the memory settings.
Erase Memory	Memory 1 to 10	Deletes a saved memory.
Reset Memory Settings	—	Resets all saved memories.

» **Related Links**

- "Loading Image Shape Setting from Memory" [p.71](#)

Settings on the **ECO** menu let you customize projector functions to save power.

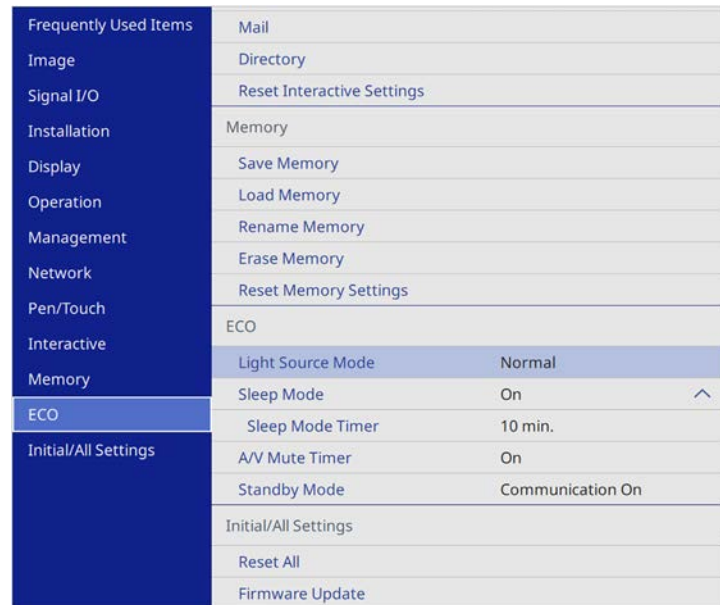

Setting	Options	Description
Light Source Mode	—	See the Operation menu table for details on the Light Source Mode settings.
Sleep Mode	—	See the Operation menu table for details on the Sleep Mode settings.
Sleep Mode Timer	—	See the Operation menu table for details on the Sleep Mode Timer settings.
A/V Mute Timer	—	See the Operation menu table for details on the A/V Mute Timer settings.
Standby Mode	—	See the Operation menu table for details on the Standby Mode settings.

» **Related Links**

- "Projector Feature Settings - Operation Menu" [p.224](#)

Settings on the **Initial/All Settings** menu let you reset certain projector settings to their default values and place the projector in firmware update mode so you can update the firmware.

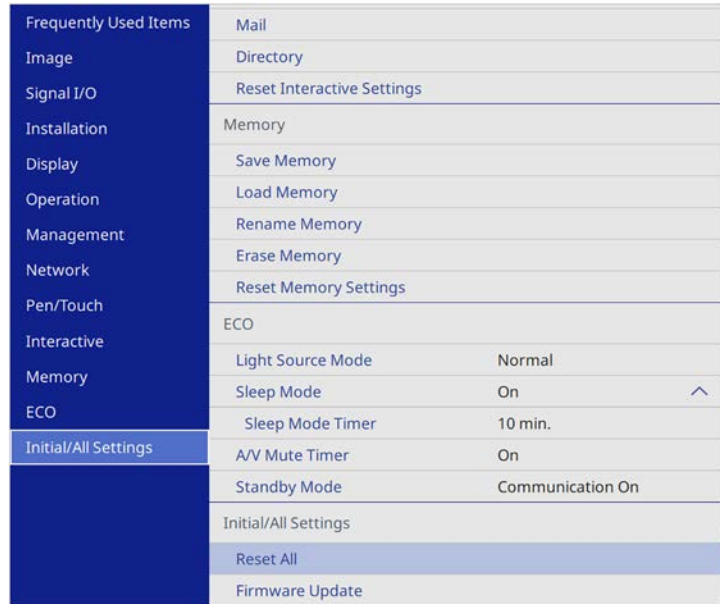

Setting	Options	Description
Reset All	—	Lets you select menus for resetting the settings to default values.
Firmware Update	—	Enters the firmware update mode and ready to update firmware using the USB-A or USB-B port.

Reset All options

When you select **Reset All**, you see the following screen.

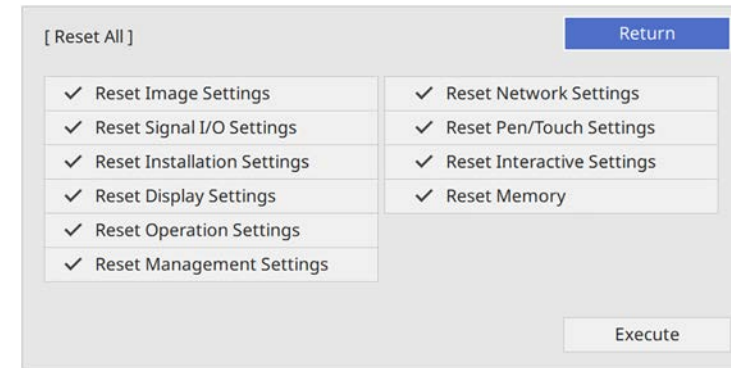

If you do not want to reset values in particular menus, deselect the check box next to the menu name. When you are ready to reset setting values, select **Execute**.

You cannot reset the following settings:

- Digital Zoom
- Image Shift
- User Pattern
- Language



For the **Network** and **Interactive** menu, the settings do not return to their default value with the **Reset All** option, if you turn on the **Menu Protection** setting.

» Related Links

- "Updating the Firmware" [p.261](#)

After selecting the projector's menu settings for one projector, you can use the following methods to copy the settings to other projectors, as long as they are the same model.

- by using a USB flash drive
- by connecting a computer and projector using a USB cable
- by using Epson Projector Management

You cannot copy any information unique to an individual projector, such as **Light Source Hours** or **Status**.



- Perform batch setup before adjusting the image settings such as keystone distortion correction. Since image adjustment values are also copied to another projector, the adjustments you made before performing the batch setup are overwritten and the projected screen you adjusted may change.
 - When copying the menu settings from one projector to another, user's logo is also copied. Do not register the information that you do not want to share between multiple projectors as a user's logo.
 - Make sure **Batch Setup Range** is set to **Limited** if you do not want to copy the following settings:
 - **Password Protection** settings
 - **EDID** in the **Signal I/O** menu
 - **Network** menu settings
- ☛ **Management > Batch Setup Range**

Caution

Epson takes no responsibility for batch setup failures and associated repair costs due to power outages, communication errors, or other problems that may cause such failures.

» Related Links

- "Transferring Settings From a USB Flash Drive" [p.247](#)
- "Transferring Settings From a Computer" [p.248](#)

Transferring Settings From a USB Flash Drive

You can copy menu settings from one projector to another of the same model using a USB flash drive.



The USB flash drive must use a FAT format and not incorporate any security function. Delete any files on the drive before using it for batch setup or the settings may not be saved correctly.

- 1** Disconnect the power cord from the projector, and check that all of the projector's indicators have turned off.
- 2** Connect an empty USB flash drive directly to the projector's USB-A port.
- 3** Hold down the [Esc] button on the remote control or the control panel and connect the power cord to the projector.
- 4** When all of the projector's indicators turn on, release the [Esc] button. The indicators start flashing and the batch setup file is written to the USB flash drive. When writing is finished, the projector turns off.

Caution

Do not disconnect the power cord or the USB flash drive from the projector while the file is being written. If the power cord or USB flash drive is disconnected, the projector may not start correctly.

- 5** Remove the USB flash drive.



The file name for the batch setup file is PJCONFDATA.bin. If you need to change the file name, add text after PJCONFDATA using only alphanumeric characters. If you change the PJCONFDATA section of the file name, the projector may not be able to recognize the file correctly.

- 6 Disconnect the power cord from the projector to which you want to copy settings, and check that all of the projector's indicators have turned off.
- 7 Connect the USB flash drive containing the saved batch setup file to the projector's USB-A port.
- 8 Hold down the [Menu] button on the remote control or the control panel and connect the power cord to the projector.
- 9 When all of the projector's indicators turn on, release the [Menu] button. (The indicators remain on for approximately 75 seconds.)

When all of the indicators start flashing, the settings are being written. When writing is finished, the projector turns off.

Caution

Do not disconnect the power cord or the USB flash drive from the projector while the file is being written. If the power cord or USB flash drive is disconnected, the projector may not start correctly.

- 10 Remove the USB flash drive.

Transferring Settings From a Computer

You can copy menu settings from one projector to another of the same model by connecting the computer and projector with a USB cable.



You can use this batch setup method with the following operating system versions:

- Windows 7 and later
- OS X 10.11.x and later

- 1 Disconnect the power cord from the projector, and check that all of the projector's indicators have turned off.

- 2 Connect a USB cable to the computer's USB port and to the projector's USB-B1 or USB-B port.
- 3 Hold down the [Esc] button on the remote control or the control panel and connect the power cord to the projector.
- 4 When all of the projector's indicators turn on, release the [Esc] button. The computer recognizes the projector as a removable disk.
- 5 Open the removable disk icon or folder, and save the batch setup file to the computer.



The file name for the batch setup file is PJCONFDATA.bin. If you need to change the file name, add text after PJCONFDATA using only alphanumeric characters. If you change the PJCONFDATA section of the file name, the projector may not be able to recognize the file correctly.

- 6 Eject the USB device (Windows) or drag the removable disk icon to the Trash (Mac).
- 7 Disconnect the USB cable. The projector turns off.
- 8 Disconnect the power cord from the projector to which you want to copy settings, and check that all of the projector's indicators have turned off.
- 9 Connect a USB cable to the computer's USB port and to the projector's USB-B1 or USB-B port.
- 10 Hold down the [Menu] button on the remote control or the control panel and connect the power cord to the projector.
- 11 When all of the projector's indicators turn on, release the [Menu] button.

The computer recognizes the projector as a removable disk.

- Copy the batch setup file (PJCONFDATA.bin) that you saved to your computer to the top level folder of the removable disk.

 Do not copy any files or folders other than the batch setup file to the removable disk.

- Eject the USB device (Windows) or drag the removable disk icon to the Trash (Mac).

- Disconnect the USB cable.
When all of the indicators start flashing, the settings are being written. When writing is finished, the projector turns off.

 **Caution**
Do not disconnect the power cord from the projector while the file is being written. If the power cord is disconnected, the projector may not start correctly.

» **Related Links**

- "Batch Setup Error Notification" [p.249](#)

Batch Setup Error Notification

The projector's indicators notify you if an error occurs during a batch setup operation. Check the status of the projector's indicators and follow the instructions described in the table here.

Indicator status	Problem and solutions
<ul style="list-style-type: none"> Power: Blue - flashing fast Status: Blue - flashing fast Laser: Orange - flashing fast Temp: Orange - flashing fast 	<p>Writing the settings may have failed and an error may have occurred in the projector's firmware.</p> <p>Stop using the projector, remove the power plug from the electrical outlet. Contact Epson for help.</p>

Indicator status	Problem and solutions
<ul style="list-style-type: none"> Laser: Orange - flashing fast Temp: Orange - flashing fast 	<p>The batch setup file may be corrupt, or the USB flash drive may not be connected correctly.</p> <p>Disconnect the USB flash drive, unplug and then plug in the projector's power cord, and then try again.</p>

Maintaining the Projector

Follow the instructions in these sections to maintain your projector.

► Related Links

- "Projector Maintenance" [p.251](#)
- "Cleaning the Projection Window" [p.252](#)
- "Cleaning the Obstacle Sensor" [p.253](#)
- "Cleaning the Projector Case" [p.254](#)
- "Air Filter and Vent Maintenance" [p.255](#)
- "Replacing the Interactive Pen Tip" [p.259](#)
- "Updating the Firmware" [p.261](#)

You may need to clean the projection window and obstacle sensor periodically, and clean the air filter and air vents to prevent the projector from overheating due to blocked ventilation.

The only parts you should replace are the air filter, remote control batteries, interactive pen batteries, and interactive pen tips. If any other part needs replacing, contact Epson or an authorized Epson servicer.

Warning

Before cleaning any part of the projector, turn it off and unplug the power cord. Never open any cover on the projector, except as specifically explained in this manual. Dangerous electrical voltages in the projector can injure you severely.

Clean the projection window periodically, or whenever you notice dust or smudges on the surface. To remove dust or smudges, gently wipe the projection window with lens-cleaning paper.

 **Warning**

Do not use a lens cleaner that contains flammable gas. The high heat generated by the projector may cause a fire.

Attention

Do not use glass cleaner or any harsh materials to clean the projection window and do not subject the projection window to any impacts; otherwise, it could be damaged.

Clean the projector's obstacle sensor glass periodically, or if you see a message telling you to remove any obstacles that are interfering with the projection area. To remove dust or smudges, gently wipe the lens with lens-cleaning paper.

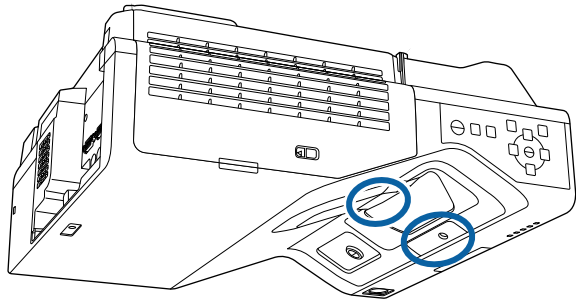

Warning

Do not use a lens cleaner that contains flammable gas to clean the obstacle sensor. The high heat generated by the projector may cause a fire.

Attention

Do not use glass cleaner or any harsh materials to clean the obstacle sensor and do not subject the obstacle sensor to any impacts. Damage on the surface of the sensor may cause malfunctions.

Before cleaning the projector case, turn off the projector and unplug the power cord.

- To remove dust or dirt, use a soft, dry, lint-free cloth.
- To remove stubborn dirt, use a soft cloth moistened with water and mild soap. Do not spray liquid directly on the projector.

Attention

Do not use wax, alcohol, benzene, paint thinner, or other chemicals to clean the projector case. These can damage the case. Do not use canned air, or the gases may leave a flammable residue.

Regular filter maintenance is important to maintaining your projector. Clean the air filter when a message appears telling you the temperature inside the projector has reached a high level. It is recommended that you clean these parts over a 12,000 hour period. Clean them more often than this if you use the projector in a environment that is dustier than expected. (Assuming the projector is used in an atmosphere in which airborne particulate matter is less than 0.04 to 0.2 mg/m³.)

Attention

If regular maintenance is not performed, your Epson projector will notify you when the temperature inside the projector has reached a high level. Do not wait until this warning appears to maintain your projector filter as prolonged exposure to high temperatures may reduce the life of your projector.

► Related Links

- "Cleaning the Air Filter" [p.255](#)
- "Replacing the Air Filter" [p.256](#)

Cleaning the Air Filter

You need to clean the projector's air filters in the following situations:

- The filter or vents get dusty.
- You see a message telling you to clean it.

1 Turn off the projector and unplug the power cord.

2 Slide the air filter cover latch and open the air filter cover.

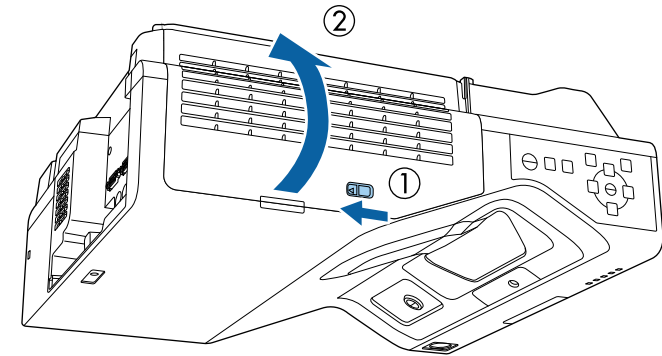

3 Open the stopper.

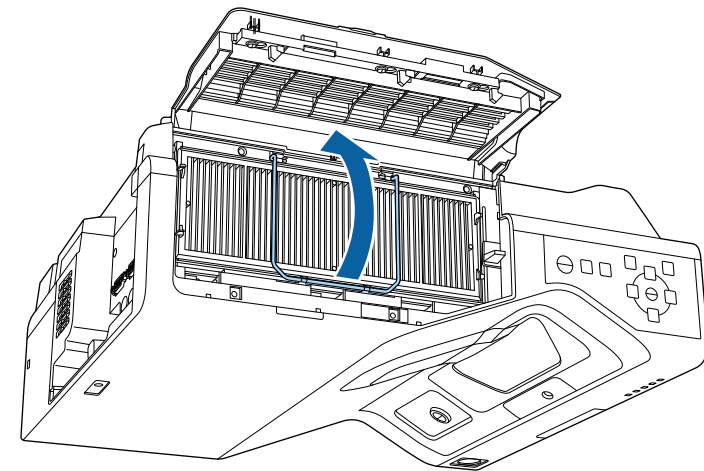

4 Pull the air filter out of the projector.

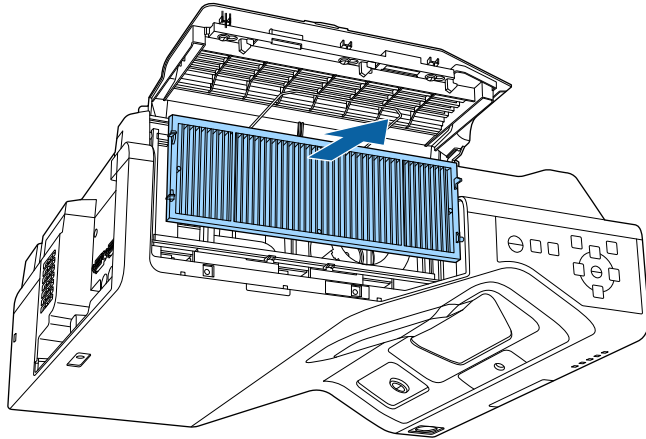

5 Vacuum the front of the air filter (the side with the tabs) to remove any remaining dust.

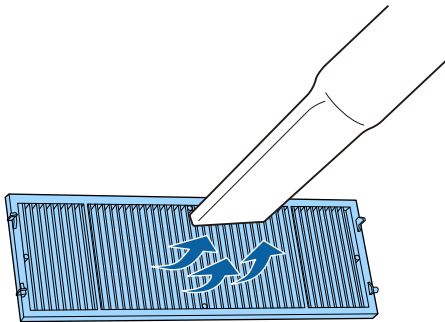

Attention

- Do not rinse the air filter in water, or use any detergent or solvent to clean it.
- Do not use canned air. The gases may leave a flammable residue or push dust and debris into the projector's optics or other sensitive areas.

6 Place the air filter in the projector as shown.

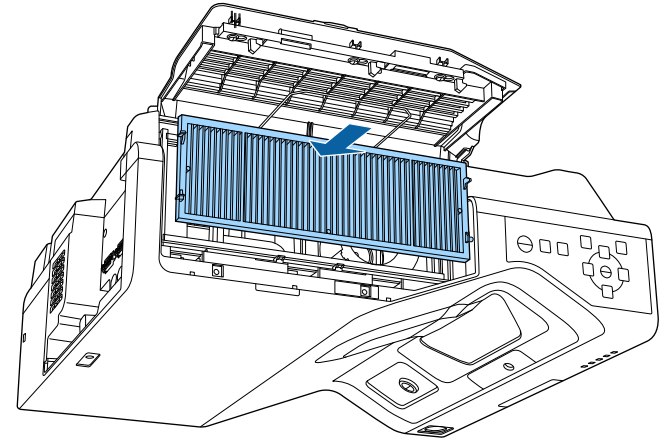

7 Close the stopper until it clicks into place.

8 Close the air filter cover.

Replacing the Air Filter

You need to replace the air filter in the following situations:

- After cleaning the air filter, you see a message telling you to clean or replace it.
- The air filter is torn or damaged.

You can replace the air filter while the projector is mounted to the ceiling or placed on a table.

1 Turn off the projector and unplug the power cord.

2 Slide the air filter cover latch and open the air filter cover.

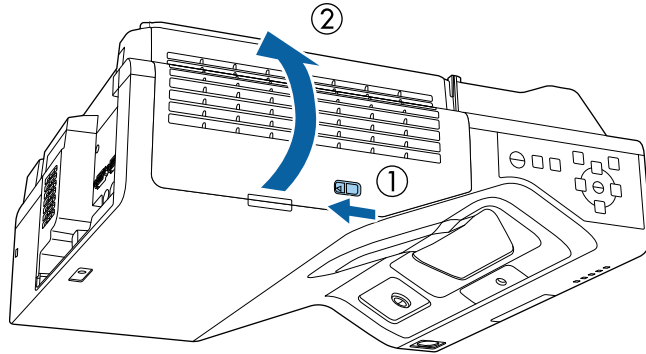

3 Open the stopper.

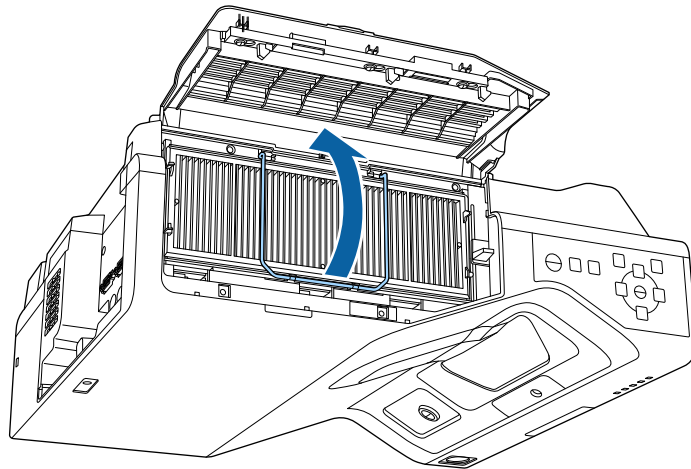

4 Pull the air filter out of the projector.

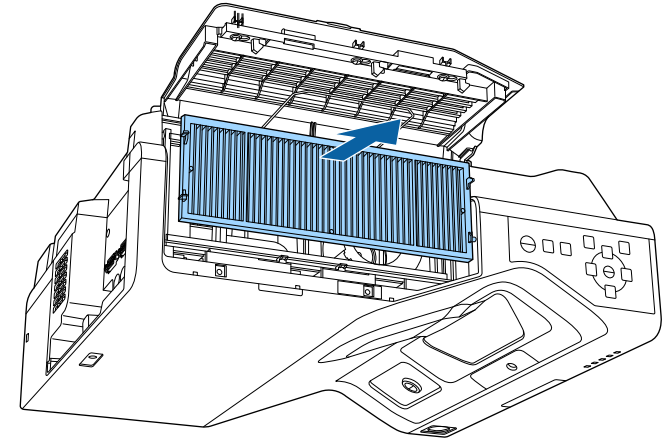

Dispose of used air filters according to local regulations.

- Filter frame: Polypropylene
- Filter: Polypropylene, PET

5 Place the new air filter in the projector as shown.

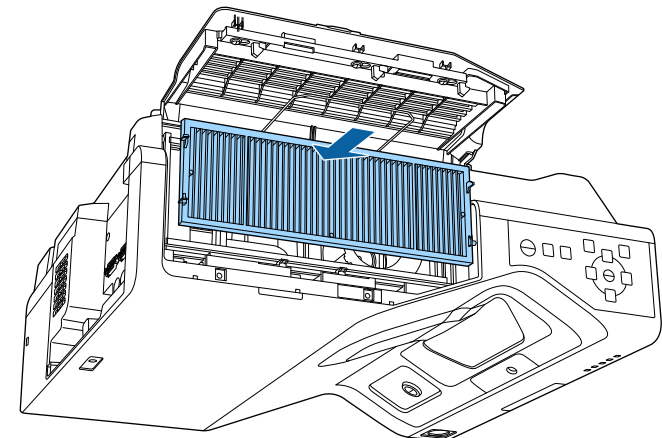

6 Close the stopper until it clicks into place.

7 Close the air filter cover.

Two interactive pens come with two types of pen tips, soft tips and hard tips. The soft pen tips are installed on the pens by default (EB-735Fi/EB-725Wi).

- If the soft tip gets dirty or damaged, it becomes less responsive. Replace it with a new one supplied with the product.
- If the soft tip is hard to use on a textured surface, replace it with the hard tip.



If the hard tip is worn down or damaged, replace it with a new one.

» Related Links

- "Replacing the Soft Pen Tip" [p.259](#)
- "Replacing the Soft Pen Tip with the Hard Pen Tip" [p.260](#)

Replacing the Soft Pen Tip

- 1** Twist off the tip of the interactive pen to remove it.

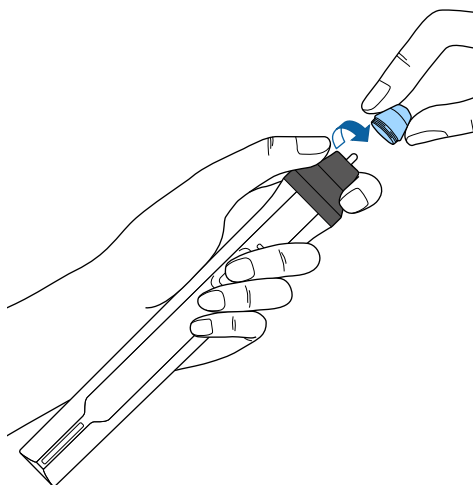

- 2** Pull the soft tip straight out.

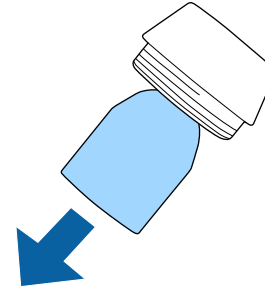

- 3** Insert the new tip.

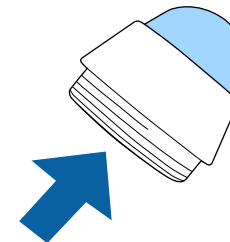

4 Twist on the pen tip.

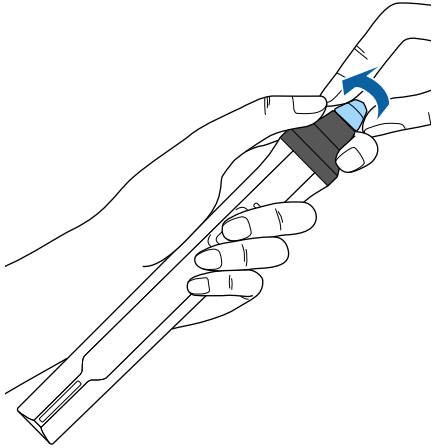

2 Twist on the hard pen tip.

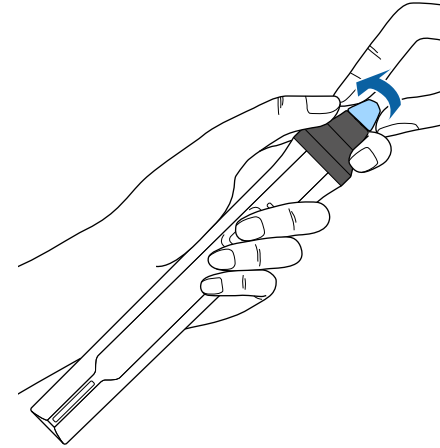

Replacing the Soft Pen Tip with the Hard Pen Tip

1 Twist off the tip of the interactive pen to remove it.

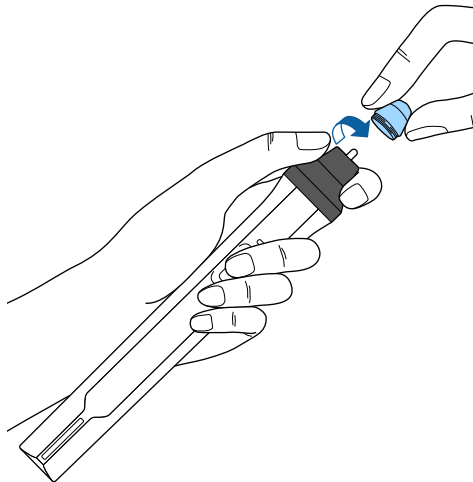

When you select the **Firmware Update** option in the projector's **Initial/All Settings** menu, the projector enters firmware update mode and is ready to perform a firmware update using the USB-A or USB-B port.

» **Related Links**

- "Updating Firmware Using a USB Storage Device" [p.261](#)
- "Updating Firmware Using a Computer and USB Cable" [p.262](#)

Updating Firmware Using a USB Storage Device

You can update the projector's firmware using a USB storage device.

 Responsibility for updating the firmware lies with the customer. If a firmware update fails due to problems such as a power failure or communication problems, a fee will be charged for any necessary repairs.

1 Download the projector firmware file from the Epson Web site.

2 Copy the downloaded firmware file to the root folder (highest folder in the hierarchy) of the USB storage device.

- 
- The USB storage device must be formatted in FAT format.
 - Do not copy any other files to the USB storage device.
 - Do not change the firmware's file name. If the file name is changed, the firmware update will not start.
 - Check that the firmware file you copied is the correct file for your projector model. If the firmware file is not correct, the firmware update will not start.

3 Connect the USB storage device to the projector's USB-A port.

 Connect the USB storage device directly to the projector. If the USB storage device is connected using a USB hub, the firmware update may not be applied correctly.

4 Press the [Menu] button, select the **Initial/All Settings** menu, and press [Enter].

Frequently Used Items	Mail
Image	Directory
Signal I/O	Reset Interactive Settings
Installation	Memory
Display	Save Memory
Operation	Load Memory
Management	Rename Memory
Network	Erase Memory
Pen/Touch	Reset Memory Settings
Interactive	ECO
Memory	Light Source Mode Normal
ECO	Sleep Mode On ^
Initial/All Settings	Sleep Mode Timer 10 min.
	A/V Mute Timer On
	Standby Mode Communication On
	Initial/All Settings
	Reset All
	Firmware Update

5 Select **Firmware Update** and press [Enter].

6 Select **Yes** to start the firmware update.

- 
- Do not disconnect the power cord from the projector while the firmware is updating. If the power cord is disconnected, the projector may not start correctly.
 - Do not disconnect the USB storage device from the projector while the firmware is updating. If the USB storage device is disconnected, the update may not be applied correctly.

All of the projector's indicators start flashing and the firmware update starts. When the update finishes normally, the projector enters standby status (only the power indicator is lit blue). If **Direct Power On** is set to **On** in the projector's **Operation** menu, the projector turns back on again.

When the update finishes, check the **Information** menu in the projector's **Management** menu to make sure that the **Version** information has been updated to the correct firmware version.

 When all indicators flash rapidly, the firmware update may have failed. Disconnect the power cord from the projector, and then reconnect it to the projector. If the indicators continue to flash even after reconnecting the power cord, remove the power plug from the electrical outlet and contact Epson.

Updating Firmware Using a Computer and USB Cable

You can update the projector's firmware using a computer and a USB cable.

 Responsibility for updating the firmware lies with the customer. If a firmware update fails due to problems such as a power failure or communication problems, a fee will be charged for any necessary repairs.

- Your computer must be running one of the following operating systems to update the firmware.
 - Windows 8.1 (32- and 64-bit)
 - Windows 10 (32- and 64-bit)
 - macOS 10.13.x (64-bit)
 - macOS 10.14.x (64-bit)
 - macOS 10.15.x (64-bit)

1 Download the projector firmware file from the Epson Web site.

 Do not change the firmware's file name. If the file name is changed, the firmware update will not start.

- Check that the firmware file you copied is the correct file for your projector model. If the firmware file is not correct, the firmware update will not start.

2 Connect the USB cable to the computer's USB port and to the projector's USB-B1 or USB-B port.

3 Press the [Menu] button, select the **Initial/All Settings** menu, and press [Enter].

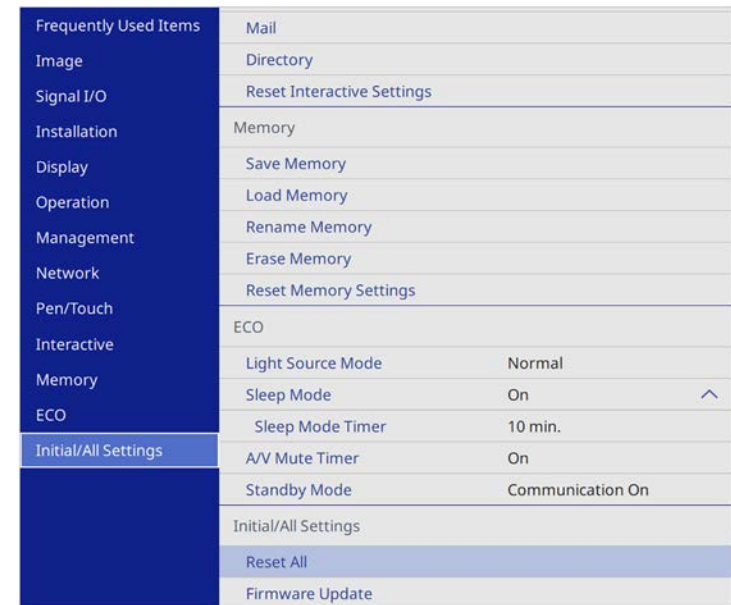

4 Select **Firmware Update** and press [Enter].

5 Select **Yes** to start the firmware update.

 Do not disconnect the power cord from the projector while the firmware is updating. If the power cord is disconnected, the projector may not start correctly.

All of the projector's indicators turn on and the projector enters firmware update mode. The computer recognizes the projector as a removable disk.

- 6** On the computer, copy the firmware file to the root folder (highest folder in the hierarchy) of the removable disk.



- Do not copy any other files or folders to the removable disk. Otherwise, the files or folders may be lost.
- The projector turns off automatically if the USB cable or the power cord are disconnected before the firmware file can be copied to the removable disk. If this occurs, perform the procedure again.

- 7** Perform the steps to safely remove a USB device from the computer and disconnect the USB cable from the projector.

All of the projector's indicators start flashing and the firmware update starts. When the update finishes normally, the projector enters standby status (only the power indicator is lit blue). If **Direct Power On** is set to **On** in the projector's **Operation** menu, the projector turns back on again.

When the update finishes, check the **Information** menu in the projector's **Management** menu to make sure that the **Version** information has been updated to the correct firmware version.



- When all indicators flash rapidly, the firmware update may have failed. Disconnect the power cord from the projector, and then reconnect it to the projector. If the indicators continue to flash even after reconnecting the power cord, remove the power plug from the electrical outlet and contact Epson.
- If no operations are performed for 20 minutes in update mode, the projector turns off automatically. If this occurs, perform the procedure again.

Solving Problems

Check the solutions in these sections if you have any problems using the projector.

► Related Links

- "Projection Problems" [p.265](#)
- "Projector Indicator Status" [p.266](#)
- "Solving Image or Sound Problems" [p.269](#)
- "Solving Projector or Remote Control Operation Problems" [p.275](#)
- "Solving Interactive Features Problems" [p.277](#)
- "Solutions to Problems in Content Playback mode" [p.281](#)
- "Solving Network Problems" [p.282](#)
- "Solutions When HDMI Link does not Function" [p.285](#)

If the projector is not working properly, turn it off, unplug it, and then plug it back in and turn it on.

If this does not solve the problem, check the following:

- The indicators on the projector may indicate the problem.
- The solutions in this manual can help you solve many problems.

If none of these solutions help, contact Epson for technical support.

The indicators on the projector indicate the projector status and let you know when a problem occurs. Check the status and color of the indicators and then refer to this table for a solution.



- If the indicators display a pattern not listed in the table below, turn the projector off, unplug it, and contact Epson for help.
- When the **Indicators** setting is set to **Off** in the projector's **Operation** menu, all indicators are off under normal projection conditions.

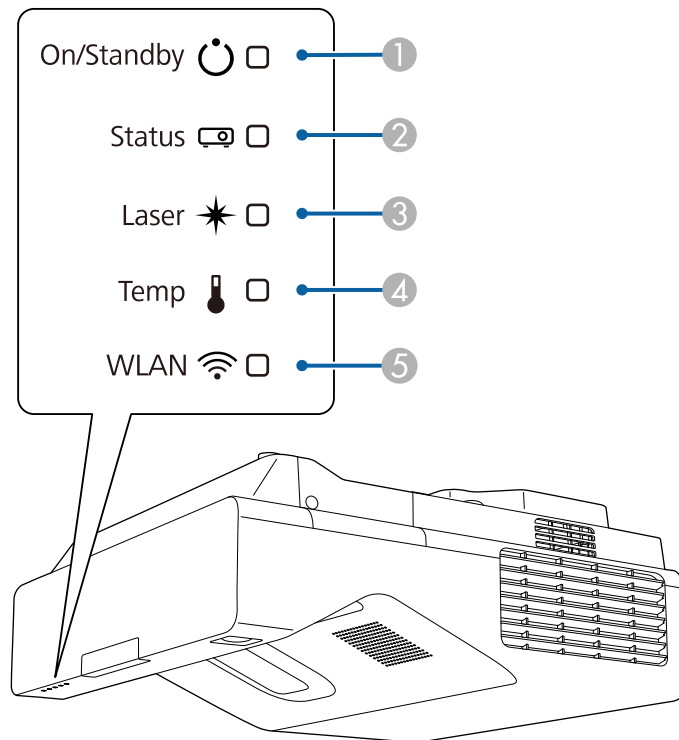

- ① On/Standby (power) indicator
- ② Status indicator

- ③ Laser indicator
- ④ Temp (temperature) indicator
- ⑤ WLAN (wireless LAN) indicator

Projector status

Indicator and status	Problem and solutions
Power: Lit blue Status: Lit blue Laser: Off Temp: Off	Normal operation.
Power: Lit blue Status: Flashing blue Laser: Off Temp: Off	Warming up, shutting down, or cooling down. When warming up, wait about 30 seconds for an image to appear. All buttons are disabled during warm-up, shutting down, and cooling down.
Power: Lit blue Status: Off Laser: Off Temp: Off	Standby, sleep mode, or monitoring. When you press the power button, projection starts.
Power: Flashing blue Status: Off Laser: Off Temp: Off	Preparing for monitoring or quick startup mode. All features are disabled.
Power: Indicator status varies Status: Flashing blue Laser: Flashing orange Temp: Indicator status varies	Refresh Mode is in progress. ☛ Management > Refresh Mode

Indicator and status	Problem and solutions
Power: Flashing blue Status: Indicator status varies Laser: Indicator status varies Temp: Flashing orange	Projector is too hot. <ul style="list-style-type: none"> • Make sure that the vents and air filter are not clogged with dust or obstructed by nearby objects. • Clean or replace the air filter. • Make sure the environmental temperature is not too hot.
Power: Off Status: Flashing blue Laser: Off Temp: Lit orange	Projector has overheated and turned off. Leave it turned off to cool down for 5 minutes. <ul style="list-style-type: none"> • Make sure that the vents and air filter are not clogged with dust or obstructed by nearby objects. • Make sure the environmental temperature is not too hot. • Clean or replace the air filter. • If operating the projector at high altitude, set the High Altitude Mode setting to On in the projector's Installation menu. • If the problem persists, unplug the projector and contact Epson for help.
Power: Flashing blue Status: Indicator status varies Laser: Flashing orange Temp: Indicator status varies	Laser warning. Turn the projector off, unplug it, and contact Epson for help.
Power: Off Status: Flashing blue Laser: Lit orange Temp: Off	Laser has a problem. Turn the projector off, unplug it, and contact Epson for help.
Power: Off Status: Flashing blue Laser: Off Temp: Flashing orange	A fan or sensor has a problem. Turn the projector off, unplug it, and contact Epson for help.

Indicator and status	Problem and solutions
Power: Off Status: Flashing blue Laser: Flashing orange Temp: Off	Internal projector error. Turn the projector off, unplug it, and contact Epson for help.
Power: Flashing blue Status: Indicator status varies Laser: Flashing orange Temp: Flashing orange	Obstacle detection warning. A beep sounds, and the message "For safety purposes remove any obstacles blocking the lens." is displayed. <ul style="list-style-type: none"> • Make sure that there are no obstacles interfering with the projection window. Remove any obstacles. • Clean the obstacle sensor if there are no obstacles. The projector turns off automatically if no action is taken.
Power: Off Status: Flashing blue Laser: Lit orange Temp: Lit orange	Obstacle detection error. If there are no obstacles interfering with the projection window, turn the projector off, unplug it, and contact Epson for help.

Wireless LAN status

Wireless LAN indicator status	Problem and solutions
Lit blue	Wireless LAN is available.
Flashing blue (quickly)	Connecting to a device.
Flashing blue (slowly)	An error has occurred. Turn off the projector and then on again.
Off	Wireless LAN is not available. Make sure the Wireless LAN Power setting is set to On in the projector's Management menu.

» Related Links

- "Projector Administration Settings - Management Menu" [p.226](#)
- "Cleaning the Air Filter" [p.255](#)
- "Replacing the Air Filter" [p.256](#)

- "Cleaning the Obstacle Sensor" [p.253](#)

Check the solutions in these sections if you have any problems with projected images or sound.

► Related Links

- "Solutions When No Image Appears" [p.269](#)
- "Solutions When Image is Incorrect Using the USB Display Function" [p.269](#)
- "Solutions When "No Signal" Message Appears" [p.270](#)
- "Solutions When "Not Supported" Message Appears" [p.271](#)
- "Solutions When Only a Partial Image Appears" [p.271](#)
- "Solutions When the Image is not Rectangular" [p.271](#)
- "Solutions When the Image Contains Noise or Static" [p.272](#)
- "Solutions When the Image is Fuzzy or Blurry" [p.272](#)
- "Solutions When the Image Brightness or Colors are Incorrect" [p.273](#)
- "Solutions When an Afterimage Remains on the Projected Image" [p.273](#)
- "Solutions to Sound Problems" [p.273](#)
- "Solutions to Microphone Problems" [p.274](#)
- "Solutions When Image File Names are not Displayed Correctly in PC Free" [p.274](#)

Solutions When No Image Appears

If no image appears, try the following solutions:

- Press the [A/V Mute] button on the remote control to see if the image was temporarily turned off.
- Make sure all necessary cables are securely connected and the power is on for the projector and connected video sources.
- Press the projector's power button to wake it from standby or sleep mode. Also, check if the connected computer is in sleep mode or displaying a blank screen saver.
- If the projector does not respond when you press the control panel buttons, the buttons may be locked for security. Unlock the buttons in the **Control Panel Lock** setting in the projector's **Management** menu or use the remote control to turn on the projector.

- To project an image source connected to the Computer2/Monitor Out port, set the **Monitor Out Port** setting to **Computer2** in the projector's **Signal I/O** menu.
- Adjust the **Brightness** setting in the projector's **Image** menu for individual image colors.
- Adjust the brightness of your projector's light source.
☛ **Operation > Light Source Brightness Control**
- Make sure the **Messages** setting is set to **On** in the projector's **Display** menu.
- The projector may not be able to project copyrighted videos that you play back on a computer. For more details, see the manual supplied with the computer.
- For images projected with Windows Media Center, reduce the screen size from full screen mode.
- For images projected from applications using Windows DirectX, turn off DirectX functions.

► Related Links

- "Projector Administration Settings - Management Menu" [p.226](#)
- "Input Signal Settings - Signal I/O Menu" [p.218](#)
- "Image Quality Settings - Image Menu" [p.216](#)
- "Projector Feature Settings - Operation Menu" [p.224](#)
- "Projector Display Settings - Display Menu" [p.222](#)
- "Unlocking the Projector's Buttons" [p.165](#)

Solutions When Image is Incorrect Using the USB Display Function

If no image appears or if the image appears incorrectly using the USB Display function, try the following solutions:

- Press the [USB] button on the remote control.
- Disconnect the USB cable, and reconnect it.
- Make sure the **USB Display** setting is set to **On** in the projector's **Signal I/O** menu (EB-735Fi/EB-725Wi).

- Make sure the Epson USB Display software has been installed correctly. Depending on your OS or computer settings, the software may not have been installed automatically. Download the latest software from the following Web site and install it.
epson.sn
- For Mac, select the **USB Display** icon in the **Dock** folder. If the icon does not appear on the **Dock**, double-click **USB Display** in the **Applications** folder.
If you select **Exit** from the **USB Display** icon menu on the **Dock**, USB Display does not start automatically when you connect the USB cable.
- If the mouse cursor flickers, select **Make the movement of the mouse pointer smooth** in the **Epson USB Display Settings** program on your computer.
- Turn off the **Transfer layered window** setting in the **Epson USB Display Settings** program on your computer.
- If you change the computer resolution during projection, the performance and quality of the video may decline.
- For images projected with Windows Media Center, reduce the screen size from full screen mode.
- For images projected from applications using Windows DirectX, turn off DirectX functions.

» Related Links

- "Connecting to a Computer for USB Video and Audio" [p.33](#)

Solutions When "No Signal" Message Appears

If the "No Signal" message appears, try the following solutions:

- Press the [Source Search] button and wait a few seconds for an image to appear.
- Turn on the connected computer or video source, and press play to begin your presentation, if necessary.
- Check that all cables required for projection are securely connected.

- If you are projecting from a laptop computer, make sure it is set up to display on an external monitor.
- If necessary, turn off the projector and the connected computer or video source, and then turn them back on.
- If you are projecting from an HDMI source, replace the HDMI cable with the shorter one.
- If you are projecting from an HDMI source, change the **HDMI EQ Setting** setting in the projector's **Signal I/O** menu.
- If you are projecting using a thumb-sized media streaming device, set the **HDMI EQ Setting** setting to **1** in the projector's **Signal I/O** menu.

» Related Links

- "Displaying From a Windows Laptop" [p.270](#)
- "Displaying From a Mac Laptop" [p.270](#)

Displaying From a Windows Laptop

If the message "No Signal" is displayed when projecting from a laptop, you need to set up the Windows laptop to display on an external monitor.

- 1** Hold down the Windows key and press **P** on your keyboard at the same time, then click **Duplicate**.
- 2** If the same image is not displayed by the laptop and projector, check the Windows **Display** utility to make sure the external monitor port is enabled and extended desktop mode is disabled.
- 3** If necessary, check your video card settings and set the multiple display option to **Mirror** or **Duplicate**.

Displaying From a Mac Laptop

If the message "No Signal" is displayed when projecting from a Mac laptop, you need to set up the laptop for mirrored display. (See your laptop manual for details.)

- 1** Open the **System Preferences** utility and select **Displays**.

- 2** Select the **Display** or **Color LCD** option, if necessary.
- 3** Click the **Arrange** or **Arrangement** tab.
- 4** Select **Mirror Displays**.

Solutions When "Not Supported" Message Appears

If the message "Not supported" is displayed, try the following solutions:

- Make sure the correct input signal is selected in the projector's **Signal I/O** menu.
- Make sure the computer's display resolution does not exceed the projector's resolution and frequency limits. If necessary, select a different display resolution for your computer.

» Related Links

- "Input Signal Settings - Signal I/O Menu" [p.218](#)
- "Supported Monitor Display Resolutions" [p.292](#)

Solutions When Only a Partial Image Appears

If only a partial computer image appears, try the following solutions:

- If you are projecting from a computer using a VGA computer cable, press the [Auto] button on the remote control to optimize the image signal.
- Make sure you selected the correct **Screen Type** setting in the projector's **Installation** menu for the screen you are using.
If there are margins between the edge of the image and the projected screen frame, adjust the position of the image.
- Make sure the **Scale** setting is turned off in the projector's **Image** menu (EB-755F/EB-750F).
- Try adjusting the image position using the **Position** setting in the projector's **Image** menu.
☛ **Image > Analog Signal Adjustment > Position**

If you have adjusted the image size using the Wide and Tele buttons or corrected keystone distortion, perform Image Shift to adjust the image position.

☛ **Installation > Digital Zoom > Image Shift**

- Press the [Aspect] button on the remote control to select a different image aspect ratio.
- Change the **Resolution** setting in the projector's **Image** menu according to the signal for the connected equipment.
- If you zoomed into or out of the image using the [E-Zoom] buttons, press the [Esc] button until the projector returns to a full display.
- Check your computer display settings to disable dual display and set the resolution within the projector's limits.
- Check the resolution assigned to your presentation files to see if they are created for a different resolution.
- When projecting in Content Playback mode, make sure you are using the appropriate **Overlay Effect** settings (EB-755F/EB-750F).
☛ **Operation > Content Playback > Overlay Effect**
- Make sure you selected the correct **Projection** setting in the projector's **Installation** menu.

» Related Links

- "Projector Installation Settings - Installation Menu" [p.220](#)
- "Image Quality Settings - Image Menu" [p.216](#)
- "Supported Monitor Display Resolutions" [p.292](#)
- "Adjusting the Image Position Using Screen Position" [p.57](#)
- "Adding Effects to Your Projected Image" [p.138](#)

Solutions When the Image is not Rectangular

If the projected image is not evenly rectangular, try the following solutions:

- Place the projector directly in front of the center of the screen, facing it squarely, if possible.
- Press the keystone buttons on the projector to adjust the image shape.
- Adjust the Quick Corner setting to correct the image shape.

☛ Installation > Geometry Correction > Quick Corner

- Adjust the **Arc Correction** setting to correct the image shape projected on a curved surface.

☛ Installation > Geometry Correction > Arc Correction

- Adjust the **Point Correction** setting to correct slight distortion which occurs partially.

☛ Installation > Geometry Correction > Point Correction

» Related Links

- "Correcting the Image Shape with the Keystone Buttons" [p.63](#)
- "Correcting the Image Shape with Quick Corner" [p.64](#)
- "Correcting Image Shape with Arc Correction" [p.66](#)
- "Correcting Image Shape with Point Correction" [p.69](#)

Solutions When the Image Contains Noise or Static

If the projected image contains electronic interference (noise) or static, try the following solutions:

- Check the cables connecting your computer or video source to the projector. They should be:
 - Separated from the power cord to prevent interference
 - Securely connected at both ends
 - Not connected to an extension cable
- Adjust the **Noise Reduction**, **MPEG Noise Reduction**, and **Deinterlacing** settings in the projector's **Image** menu.
 - ☛ **Image > Image Enhancement > Noise Reduction**
 - ☛ **Image > Image Enhancement > MPEG Noise Reduction**
 - ☛ **Image > Image Enhancement > Deinterlacing**
- Set the **Resolution** setting to **Auto** in the projector's **Image** menu.
- Select a computer video resolution and refresh rate that are compatible with the projector.
- If you are projecting from a computer using a VGA computer cable, press the [Auto] button on the remote control to automatically adjust the **Tracking** and **Sync.** settings. If the images are not adjusted correctly,

manually adjust the **Tracking** and **Sync.** settings in the projector's **Image** menu.

☛ Image > Analog Signal Adjustment > Tracking

☛ Image > Analog Signal Adjustment > Sync.

- If you adjusted the image shape using the projector controls, try decreasing the **Sharpness** setting in the projector's **Image** menu to improve image quality.
- If you connected an extension power cable, try projecting without it to see if it caused interference in the signal.
- Make sure you selected the correct **Signal Format** or **EDID** setting in the projector's **Signal I/O** menu, if available for your image source.
- If you are using the USB Display function, turn off the **Transfer layered window** setting in the **Epson USB Display Settings** program on your computer.

» Related Links

- "Image Quality Settings - Image Menu" [p.216](#)
- "Supported Monitor Display Resolutions" [p.292](#)
- "Input Signal Settings - Signal I/O Menu" [p.218](#)

Solutions When the Image is Fuzzy or Blurry

If the projected image is fuzzy or blurry, try the following solutions:

- Display a test pattern and use it to adjust the image focus using the focus lever.
- Position the projector close enough to the screen.
- Position the projector so the keystone adjustment angle is not so wide that it distorts the image.
- Clean the projection window.



To avoid condensation on the lens after bringing the projector in from a cold environment, let the projector warm up to room temperature before using it.

- Adjust the **Sharpness** setting in the projector's **Image** menu to improve image quality.
- If you are projecting from a computer using a VGA computer cable, press the [Auto] button on the remote control to automatically adjust the **Tracking** and **Sync.** settings. If any bands or overall blurriness remain, display a uniformly patterned image on the screen and manually adjust the **Tracking** and **Sync.** settings.
 - ☛ **Image > Analog Signal Adjustment > Tracking**
 - ☛ **Image > Analog Signal Adjustment > Sync.**
- If you are projecting from a computer, use a lower resolution or select a resolution that matches the projector's native resolution.

» Related Links

- "Image Quality Settings - Image Menu" [p.216](#)
- "Input Signal Settings - Signal I/O Menu" [p.218](#)
- "Supported Monitor Display Resolutions" [p.292](#)
- "Focusing the Image" [p.59](#)
- "Cleaning the Projection Window" [p.252](#)

Solutions When the Image Brightness or Colors are Incorrect

If the projected image is too dark or light, or the colors are incorrect, try the following solutions:

- Press the [Color Mode] button on the remote control to try different color modes for the image and environment.
- Check your video source settings.
- Adjust the available settings in the projector's **Image** menu for the current input source, such as **Brightness**, **Contrast**, **Tint**, **Color Saturation**, and **RGBCMY**.
- Make sure you selected the correct **Signal Format** or **EDID** setting in the projector's **Signal I/O** menu, if available for your image source.
- Make sure all the cables are securely connected to the projector and your video device. If you connected long cables, try connecting shorter cables.

- Position the projector close enough to the screen.
- When using multiple projectors, make sure the **Light Source Calibration** setting in the projector's **Management** menu is set to the same option on all the projectors and that the projectors have been calibrated recently. If certain projectors are not calibrated recently, the white balance and brightness level may not match the other projectors.

» Related Links

- "Image Quality Settings - Image Menu" [p.216](#)
- "Input Signal Settings - Signal I/O Menu" [p.218](#)
- "Projector Administration Settings - Management Menu" [p.226](#)
- "Adjusting Image Quality (Color Mode)" [p.82](#)

Solutions When an Afterimage Remains on the Projected Image

If you see an afterimage in the projected image, use the **Refresh Mode** feature to clear it. Select **Refresh Mode > Start** in the projector's **Management** menu.

» Related Links

- "Projector Administration Settings - Management Menu" [p.226](#)

Solutions to Sound Problems

If there is no sound or the volume is too low or high, try the following solutions:

- Adjust the projector's volume settings.
- Press the [A/V Mute] button on the remote control to resume video and audio if they were temporarily stopped.
- Check your computer or video source to make sure the volume is turned up and the audio output is set for the correct source.
- Check the audio cable connections between the projector and your video source.

- Make sure any connected audio cables are labeled "No Resistance".
- If you are using the USB Display function, turn on the **Output audio from the projector** setting in the **Epson USB Display Settings** program on your computer.
- Select the correct audio input port.
 - ☛ **Signal I/O > Audio Output**
 - ☛ **Signal I/O > HDMI Audio Output**
- If you want to output audio from a connected audio source when the projector does not project any images, select these settings in the projector's menus:
 - Turn off **Quick Startup** in the **Operation** menu.
 - Set the **A/V Output** setting to **Always On** in the **Signal I/O** menu.
- Select the correct audio output in the **Audio Out Device** setting.
 - ☛ **Signal I/O > HDMI Link > Audio Out Device**
- If you do not hear sound from an HDMI source, set the connected device to PCM output.
- When you are connecting the projector to a Mac using an HDMI cable, make sure your Mac supports audio through the HDMI port. If not, you need to connect an audio cable.
- If the volume for the computer is set to the minimum while the projector is set to the maximum, the noise may be mixed. Turn up the computer's volume and turn down the projector's volume. (When you use Epson iProjection (Windows/Mac) or USB Display.)

▶ **Related Links**

- "Projector Connections" [p.32](#)
- "Input Signal Settings - Signal I/O Menu" [p.218](#)
- "Controlling the Volume with the Volume Buttons" [p.92](#)

- Check the **Mic Input Level** setting in the projector's **Signal I/O** menu. If the setting is too high, the sound of other connected devices will be too low.

▶ **Related Links**

- "Input Signal Settings - Signal I/O Menu" [p.218](#)
- "Connecting a Microphone" [p.41](#)

Solutions When Image File Names are not Displayed Correctly in PC Free

If any file names are longer than the display area or include unsupported symbols, the file names are shortened or changed in PC Free. Shorten or change the file name.

Solutions to Microphone Problems

If there is no sound when you use a microphone connected to the projector, try the following solutions (EB-735Fi/EB-735F/EB-725Wi/EB-725W/EB-720):

- Make sure the microphone is securely connected to the projector.

Check the solutions in these sections if you have problems operating the projector or remote control.

» Related Links

- "Solutions to Projector Power or Shut-Off Problems" [p.275](#)
- "Solutions to Problems with the Remote Control" [p.275](#)
- "Solutions to Password Problems" [p.276](#)
- "Solution When "The Battery that Saves Your Clock Settings is Running Low" Message Appears" [p.276](#)

Solutions to Projector Power or Shut-Off Problems

If the projector does not turn on when you press the power button or it turns off unexpectedly, try the following solutions:

- Make sure the power cord is securely connected to the projector and to a working electrical outlet.
- If the power button on the remote control does not turn on the projector, check its batteries and make sure at least one of the remote receivers are available in the **Remote Receiver** setting in the projector's **Installation** menu.
- The projector's buttons may be locked for security. Unlock the buttons in the **Control Panel Lock** setting in the projector's **Management** menu or use the remote control to turn on the projector.
- If the projector's light source turns off unexpectedly, it may have entered sleep mode after a period of inactivity. Perform any operation to wake the projector. To turn off sleep mode, set the **Sleep Mode** setting to **Off** in the projector's **Operation** menu.
- If the projector's light source turns off unexpectedly, the A/V mute timer may be enabled. Set the **A/V Mute Timer** setting to **Off** in the projector's **Operation** menu.
- If the projector's light source turns off, the status indicator is flashing, and the temp (temperature) indicator is lit, the projector has overheated and turned off.

- The cooling fans may run in standby status depending on the projector settings. Also, when the projector wakes from standby status, the fans may cause an unexpected noise. This is not a malfunction.
- The power cord may be defective. Disconnect the cord and contact Epson for help.

» Related Links

- "Projector Administration Settings - Management Menu" [p.226](#)
- "Projector Feature Settings - Operation Menu" [p.224](#)
- "Projector Installation Settings - Installation Menu" [p.220](#)
- "Unlocking the Projector's Buttons" [p.165](#)

Solutions to Problems with the Remote Control

If the projector does not respond to remote control commands, try the following solutions:

- Check that the remote control batteries are installed correctly and have power. If necessary, replace the batteries.
- Make sure you are operating the remote control within the reception angle and range of the projector.
- Make sure the projector is not warming up or shutting down.
- Check to see if a button on the remote control is stuck down, causing it to enter sleep mode. Release the button to wake the remote control up.
- Strong fluorescent lighting, direct sunlight, or infrared device signals may be interfering with the projector's remote receivers. Dim the lights or move the projector away from the sun or interfering equipment.
- Make sure at least one of the remote receivers are available in the **Remote Receiver** setting in the projector's **Installation** menu.
- If the **Remote Receiver** setting is disabled, hold down the [Menu] button on the remote control for at least 15 seconds to reset the setting to its default.
- If you assigned an ID number to the projector to operate multiple projectors from the remote control, you may need to check or change the ID setting.

- Press the 0 (zero) button on the remote control while holding down the [ID] button. By selecting 0 on the remote control, you can operate all of the projectors regardless of the projector ID settings.
- If you lose the remote control, you can order another one from Epson.

► Related Links

- "Remote Control Operation" [p.46](#)
- "Projector Installation Settings - Installation Menu" [p.220](#)
- "Installing Batteries in the Remote Control" [p.44](#)
- "Selecting the Projector You want to Operate" [p.150](#)

Solutions to Password Problems

If you cannot enter or remember a password, try the following solutions:

- You may have turned on password protection without first setting a password. Try entering **0000** using the remote control.
- If you have entered an incorrect password too many times and see a message displaying a request code, write down the code and contact Epson for help. Provide the request code and proof of ownership for assistance in unlocking the projector.
- If you set a Epson Web Control password and forgot the user ID or password, try entering the following:
 - User ID: **EPSONWEB**
 - Default password: **admin**
- If you set a Remote password (in Epson Web Control) and forgot the user ID or password, try entering the following:
 - User ID: **EPSONREMOTE**
 - Default password: **guest**
- If you lose the remote control you cannot enter a password. Order a new one from Epson.

Solution When "The Battery that Saves Your Clock Settings is Running Low" Message Appears

If the message "The battery that saves your clock settings is running low." is displayed, contact Epson for help.

Check the solutions in these sections if you have problems using the interactive features (EB-735Fi/EB-725Wi).

► Related Links

- "Solutions When "Error Occurred in the Easy Interactive Function" Message Appears" [p.277](#)
- "Solutions When the Interactive Pens do not Work" [p.277](#)
- "Solutions When You Cannot Operate a Computer from the Projected Screen" [p.278](#)
- "Solutions When the Interactive Pen Position is not Accurate" [p.278](#)
- "Solutions When the Interactive Pens are Slow or Difficult to Use" [p.278](#)
- "Solutions When the Interactive Touch Operation does not Work" [p.278](#)
- "Solutions for Problems with Capturing, Printing, Saving, or Scanning" [p.279](#)
- "Solutions When the Time is Incorrect in Whiteboard Settings" [p.279](#)
- "Solutions When Whiteboard Mode does not Start" [p.280](#)

Solutions When "Error Occurred in the Easy Interactive Function" Message Appears

If the "Error occurred in the Easy Interactive Function" message appears, contact Epson for help.

Solutions When the Interactive Pens do not Work

If the interactive pens do not work, try the following solutions:

- Make sure you are not covering the black section near the tip of the pen.
- Try holding the pen at a different angle so that your hand is not blocking the signal.
- Press the button on the side of the pen to check the remaining battery power. If the battery indicator does not turn on, replace the battery.
- Make sure the pen tip is securely attached to the pen.
- If the pen tip is worn out or damaged, you may need to replace it.

- Make sure nothing is blocking the signal between the pen and the interactive pen receiver on the projector.
- Make sure the cable cover is in place to keep cables from blocking the signal.
- Dim the room lights and turn off any fluorescent lights. Make sure the projection surface and pen receiver are not in direct sunlight or other sources of bright lighting.
- Make sure the interactive pen receiver on the projector is clean and free from dust.
- Make sure there is no interference from infrared remote controls, mice, or infrared microphones.
- Make sure you perform pen calibration when using the interactive pen for the first time so that the projector recognizes the position of the pen correctly. See your projector's *Installation Guide* for details.
- When using multiple projectors and interactive pens in the same room, interference may cause pen operations to become unstable. Connect the projectors using the optional remote control cable set and set the **Sync of Projectors** setting to **Wired**.

☛ Pen/Touch > Installation of Projectors > Sync of Projectors

If you do not have a remote control cable set, set the **Infrared Intensity** setting to **Strong** in the projector's **Pen/Touch** menu.

☛ Pen/Touch > Installation of Projectors > Infrared Intensity

- Try replacing the soft pen tip with the hard pen tip. Doing so may improve pen operations because some of the projector models do not support the soft pen tip.

► Related Links

- "Replacing the Interactive Pen Tip" [p.259](#)
- "Using the Interactive Pens" [p.96](#)
- "Installing Batteries in the Pens" [p.45](#)
- "Getting the Latest Version of the Documents" [p.10](#)
- "Projector Pen And Touch Setup Settings - Pen/Touch Menu" [p.237](#)

Solutions When You Cannot Operate a Computer from the Projected Screen

If you cannot operate a computer from the projected screen, try the following solutions:

- Make sure you perform pen calibration when using the interactive pen for the first time so that the projector recognizes the position of the pen correctly. See your projector's *Installation Guide* for details.
- Make sure the USB cable is securely connected. Disconnect the USB cable, and then reconnect it.
- Make sure **PC Interactivity** is turned on in the toolbar.
- When connecting using a Screen Mirroring, you need to set up your computer. Hold down the Windows key and press **K** on your keyboard at the same time, then select **Allow mouse, keyboard, touch, and pen input from this device**.

» Related Links

- "Replacing the Interactive Pen Tip" [p.259](#)
- "Annotation Mode Toolbar" [p.108](#)
- "Getting the Latest Version of the Documents" [p.10](#)
- "Connecting to a Computer for USB Video and Audio" [p.33](#)
- "Connecting to a Mini PC Installed on a Wall Plate" [p.34](#)

Solutions When the Interactive Pen Position is not Accurate

If the pen position is not the same as the mouse pointer, try the following solutions:

- Make sure you perform pen calibration when using the interactive pen for the first time so that the projector recognizes the position of the pen correctly. If the cursor location and pen position do not match after auto calibration, you can calibrate manually. See your projector's *Installation Guide* for details.
- Try adjusting the pen operation area.

☛ Pen/Touch > PC Interactivity > Manual Adj. Pen Area

- If you use the [E-Zoom] + button on the remote control to enlarge the image, the pen position is not accurate. When you return the image to the original size, the position should be correct.

» Related Links

- "Getting the Latest Version of the Documents" [p.10](#)
- "Adjusting the Pen Operation Area" [p.119](#)

Solutions When the Interactive Pens are Slow or Difficult to Use

If the pens are difficult to use or respond too slowly, try the following solutions:

- For easier operation, hold the pen perpendicular to the projection surface.
- For the best performance, connect your computer to the projector using a VGA or HDMI cable for display and the USB cable for the interactive features.
- If you are using USB Display in Windows, you may need to disable Windows Aero in the **Epson USB Display Settings** program on your computer.

» Related Links

- "Projector Connections" [p.32](#)

Solutions When the Interactive Touch Operation does not Work

If the interactive touch operation using your finger does not work, try the following solutions:

- Make sure the Finger Touch Unit is installed correctly and the power cable is properly connected. See your projector's *Installation Guide* for details.

- If the **Turn off Touch** feature is activated, touch operations disable temporarily. Select the **Turn on Touch** feature on the toolbar.
 - If the indicator on the Finger Touch Unit is not on, check that the **Power** setting is set to **On** in the projector's **Pen/Touch** menu.
 - ☛ **Pen/Touch > Touch Unit > Power**
 - Adjust the angle on the Finger Touch Unit. See your projector's *Installation Guide* for details.
 - Make sure there are no obstacles (such as cables or pen stand) between the Finger Touch Unit's laser diffusion port and the projection surface. If there are any obstacles that are difficult to move, attach the infrared deflectors to the projection surface. See your projector's *Installation Guide* for details.
 - Make sure there is no interference from infrared remote controls, mice, or infrared microphones.
 - If your finger position and the cursor position on the screen do not match, perform **Touch Calibration** in the projector's **Pen/Touch** menu.
 - ☛ **Pen/Touch > Touch Unit > Touch Calibration**
 - If touch operations do not work correctly even after performing calibration, check the **Calibration Range** setting in the projector's **Pen/Touch** menu.
 - ☛ **Pen/Touch > Touch Unit > Calibration Range**
 - If touch operations are mistakenly recognized as dragging operations, select **Wide**.
 - If mouse operations are not performed smoothly, select **Narrow**.
 - If there are any people within 10 cm in front of or around the projection screen or any obstacles causing interference, the touch operations may not work properly.
 - If clothing, or any part of your body comes close to the screen, the touch operations may not work properly. Move at least 1 cm away from the screen.
- » **Related Links**
- "Whiteboard Mode Toolbar" [p.102](#)
 - "Annotation Mode Toolbar" [p.108](#)
 - "Using Interactive Touch Operations with Your Finger" [p.98](#)
 - "Getting the Latest Version of the Documents" [p.10](#)
 - "Projector Pen And Touch Setup Settings - Pen/Touch Menu" [p.237](#)

Solutions for Problems with Capturing, Printing, Saving, or Scanning

If you are having trouble capturing and pasting, or printing, saving, or scanning, try the following solutions:

- If you are having trouble pasting a captured image, make sure the image is not protected.
 - If a black frame appears around a pasted image, it may be because the image was shifted or resized.
 - If you are having trouble printing or scanning, make sure the printer is not out of ink, jammed, or in any other error state.
 - For USB printing or scanning, make sure a USB cable is connected between the projector's USB-A port and the printer's USB type B port.
 - For USB printing or scanning, try connecting a different USB cable, and make sure the cables are less than 4.9 m long.
 - Connect only one printer or multifunction device at a time, and make sure the device is supported by the projector.
 - Check the settings in the projector's **Interactive** menu.
- » **Related Links**
- "Projector Interactive Settings - Interactive Menu" [p.238](#)
 - "Connecting a Printer" [p.39](#)

Solutions When the Time is Incorrect in Whiteboard Settings

If the time is incorrect on internal storage settings for whiteboard mode, you may need to update the **Date & Time** settings in the projector's **Management** menu.

- » **Related Links**
- "Projector Administration Settings - Management Menu" [p.226](#)

Solutions When Whiteboard Mode does not Start

If whiteboard mode does not start, try the following solutions:

- Turn on the **Drawing Function** setting in the projector's **Interactive** menu.
- When the Easy Interactive Tools software is in use, whiteboard mode does not start.

▶ **Related Links**

- "Home Screen" [p.49](#)

If you cannot play back a playlist correctly, try the following solutions (EB-755F/EB-750F):

- Make sure **Content Playback** is set to **On**.
 - ☛ **Operation > Content Playback**
- Make sure the USB flash drive contains a playlist.
- Make sure the USB flash drive is directly connected to the projector. Do not use a multi-card reader or a USB hub to expand a USB port.
- If the USB flash drive is partitioned, you may not be able to play back playlists. Delete all of the partitions before saving the playlists on the USB flash drive.
- Do not share a playlist between projectors that are different in resolution. Color and shape effects added by using **Overlay Effect** may not be reproduced correctly.

☛ **Operation > Content Playback > Overlay Effect**

» **Related Links**

- "Projector Feature Settings - Operation Menu" [p.224](#)
- "Getting the Latest Version of the Documents" [p.10](#)

Check the solutions in these sections if you have problems using the projector on a network.

► Related Links

- "Solutions When Wireless Authentication Fails" [p.282](#)
- "Solutions When You Cannot Access the Projector Through the Web" [p.282](#)
- "Solutions When Network Alert E-Mails are not Received" [p.282](#)
- "Solutions When the Image Contains Static During Network Projection" [p.283](#)
- "Solutions When You Cannot Connect Using Screen Mirroring" [p.283](#)
- "Solutions When You Cannot Use Two Screen Mirroring Sources" [p.283](#)
- "Solutions When the Image or Sound Contains Static During Screen Mirroring Connection" [p.283](#)
- "Solutions When You Cannot Receive Shared Images" [p.284](#)

Solutions When Wireless Authentication Fails

If you are having trouble with the authentication, try the following solutions:

- If the wireless settings are correct, but authentication fails, you may need to update the **Date & Time** settings in the projector's **Management** menu.
- Check the **Security** settings in the projector's **Network** menu.
 - ☛ **Network > Network Settings > Wireless LAN > Security**
- If the access point security is WPA3-EAP, change the access point setting to WPA2/WPA3-EAP.

► Related Links

- "Projector Administration Settings - Management Menu" [p.226](#)
- "Network Menu - Wireless LAN Menu" [p.231](#)

Solutions When You Cannot Access the Projector Through the Web

If you are unable to access the projector through a Web browser, make sure you are using the correct ID and password.

- For the user ID, enter **EPSONWEB**. (You cannot change the user ID.)
- For the password, enter the password set in the projector's **Network** menu. The default password is **admin**.
- For the infrastructure mode, make sure you have access to the network the projector is on.
- If your Web browser is set up to connect via a proxy server, the **Epson Web Control** screen cannot be displayed. Make settings for a connection without using a proxy server.
- If you set the **Standby Mode** setting to **Communication On** in the projector's **Operation** menu, make sure the network device is turned on. After turning on the network device, turn on the projector.



The user ID and password are case sensitive.

► Related Links

- "Network Menu - Network Settings Menu" [p.230](#)
- "Projector Feature Settings - Operation Menu" [p.224](#)

Solutions When Network Alert E-Mails are not Received

If you do not receive an e-mail alerting you to problems with a projector over the network, try the following solutions:

- Make sure the projector is turned on and connected to the network correctly. (If an error shuts down the projector, the email may not be delivered.)
- Make sure you set up the projector e-mail alert settings correctly in the projector's network **Mail Notification** menu or in the network software.
- Set the **Standby Mode** setting to **Communication On** in the projector's **Operation** menu so that the network software can monitor the projector in standby mode.
And change the **Port** setting according to your network environment.

» Related Links

- "Network Menu - Mail Notification Menu" [p.234](#)
- "Projector Feature Settings - Operation Menu" [p.224](#)

Solutions When the Image Contains Static During Network Projection

If the projected image contains static during network projection, try the following solutions:

- Check for any obstacles between the access point, the computer, the mobile device, and the projector, and change their positions to improve communication.
- Make sure that the access point, the computer, the mobile device and the projector are not too far apart. Move them closer together and try to connect again.
- Check for interference from other equipment, such as a Bluetooth device or microwave. Move the interfering device farther away or expand your wireless bandwidth.
- Reduce the number of connected devices if the connection speed declines.

Solutions When You Cannot Connect Using Screen Mirroring

If you are unable to connect to the projector using Screen Mirroring, try the following solutions:

- Check the projector's settings.
 - Set the **Simple AP** setting to **On**.
 - ☛ **Network > Network Settings > Simple AP**
 - Set the **Screen Mirroring** setting to **On**.
 - ☛ **Network > Network Settings > Network Projection > Screen Mirroring**
- Select the **Screen Mirroring** setting to **Off** and select **On** again.

☛ **Network > Network Settings > Network Projection > Screen Mirroring**

- Check the mobile device's settings.
 - Make sure the settings on the mobile device are correct.
 - When connecting again immediately after disconnecting, it may take some time until the connection is established. Reconnect after waiting for a while.
 - Restart the mobile device.
 - Once you have connected using Screen Mirroring, the projector connection information may be recorded on the mobile device. However, you may not be able to reconnect to the projector from the recorded information. Select the projector from the list of available devices.

» Related Links

- "Network Menu - Network Settings Menu" [p.230](#)
- "Network Menu - Network Projection Settings" [p.235](#)

Solutions When You Cannot Use Two Screen Mirroring Sources

If you are unable to use two Screen Mirroring sources at the same time, set the **Interrupt Connection** setting to **Off**.

☛ **Network > Network Settings > Network Projection > Screen Mirroring**

» Related Links

- "Network Menu - Network Projection Settings" [p.235](#)

Solutions When the Image or Sound Contains Static During Screen Mirroring Connection

If the projected image or sound contains static when connecting using Screen Mirroring, try the following solutions:

- Avoid covering the Wi-Fi antenna of the mobile device.

- If you use a Screen Mirroring connection and an internet connection at the same time, the image may stop or contain noise. Disconnect the internet connection to expand your wireless bandwidth and improve the connection speed of the mobile device.
- Make sure the projection contents meet the Screen Mirroring requirements.
- Depending on the settings of the mobile device, the connection may be lost when the device enters power saving mode. Check the electrical power saving settings on the mobile device.
- Update to the latest version of the wireless driver or firmware on the mobile device.

Solutions When You Cannot Receive Shared Images

If you cannot receive shared images from other projectors, try the following solutions:

- Connect the projector to the same network as the projector that is sharing images.
- Make sure the **Screen Sharing** setting is set to **On**.
 - ☛ **Network > Network Settings > Network Projection > Screen Sharing**
- Make sure that no other device is connecting to the projector using the Epson iProjection software.
- If the firmware version amongst the projectors sharing the screen is not the same, you may need to update the projector's firmware to share your screen.

» Related Links

- "Network Menu - Network Projection Settings" [p.235](#)

If you cannot operate the connected devices using the HDMI Link features, try the following solutions:

- Make sure the cable meets the HDMI CEC standard.
- Make sure the connected device meets the HDMI CEC standard. See the documentation supplied with the device for more information.
- Check that all cables required for HDMI Link are securely connected.
- Make sure the connected devices are turned on and in standby status. See the documentation supplied with the device for more information.
- If you connected a speaker, set it to PCM output.
- If you connect a new device or change the connection, set the CEC function for the connected device again and restart the device.
- Do not connect 4 or more multi-media players. You can connect up to 3 multi-media players that meet the HDMI CEC standard at the same time.
- If the device does not appear in the Device Connections list, it does not meet the HDMI CEC standards. Connect a different device.

» Related Links

- "Multiple Projector Operation Settings - Multi-Projection Menu" [p.242](#)

Appendix

Check these sections for the technical specifications and important notices about your projector.

► **Related Links**

- "Optional Accessories and Replacement Parts" [p.287](#)
- "Screen Size and Projection Distance" [p.289](#)
- "Supported Monitor Display Resolutions" [p.292](#)
- "Projector Specifications" [p.297](#)
- "External Dimensions" [p.300](#)
- "USB Display System Requirements" [p.302](#)
- "Easy Interactive Driver System Requirements" [p.303](#)
- "List of Safety Symbols and Instructions" [p.304](#)
- "Laser Safety Information" [p.306](#)
- "Glossary" [p.307](#)
- "Notices" [p.309](#)

The following optional accessories and replacement parts are available. Please purchase these products as and when needed.

The following list of optional accessories and replacement parts is current as of: May 2020.

Details of accessories are subject to change without notice and availability may vary depending on the country of purchase.

► Related Links

- "Screens" [p.287](#)
- "Cables" [p.287](#)
- "Mounts" [p.287](#)
- "For Interactive Feature" [p.287](#)
- "External Devices" [p.288](#)
- "Replacement Parts" [p.288](#)
- "For Wireless Connection" [p.288](#)
- "Compatible Accessories from Other Projectors" [p.288](#)

Screens

The following items are only available for EB-735Fi/EB-725Wi.

50" portable screen ELPSC32/ES1000

A compact screen that can be carried easily. (aspect ratio 4:3)

Cables

Computer cable ELPKC02 (1.8 m - for mini D-sub 15-pin/mini D-Sub 15pin)

Computer cable ELPKC09 (3 m - for mini D-sub 15-pin/mini D-Sub 15pin)

Computer cable ELPKC10 (20 m - for mini D-sub 15-pin/mini D-Sub 15pin)

Use when connecting to the Computer port.

Remote Control Cable Set ELPKC28 (EB-735Fi/EB-725Wi)

Use when connecting multiple projectors that support the interactive feature.

USB Extension cable ELPKC31

Use when connecting to a USB cable if the cable is too short.

Mounts

Setting plate ELPMB62

Use when installing the projector on a wall.

Ceiling mount ELPMB23

Use when installing the projector on a ceiling.

Ceiling pipe (450 mm) ELPFP13

Ceiling pipe (700 mm) ELPFP14

Use when installing the projector on a high ceiling.

Interactive Table Mount ELPMB29 (EB-735Fi/EB-725Wi)

Use when installing the projector on a table.

Wall Mount for Finger Touch Unit ELPMB63 (EB-735Fi/EB-725Wi)

Use when installing Finger Touch Unit on a wall.



Special expertise is required to suspend the projector from a ceiling. Contact Epson for help.

For Interactive Feature

The interactive features are only available for EB-735Fi/EB-725Wi.

Interactive Pen ELPPN05A

Interactive Pen ELPPN05B

Use when operating the computer screen on the projection surface.

Replacement Hard Pen Tips ELPPS03

Replacement Soft Pen Tips ELPPS04

Replacement pen tips for the interactive pen.

External Devices

Document Camera ELPDC21**Document Camera ELPDC07**

Use when projecting image such as books, OHP documents, or slides.

External Speaker ELSP02

External self-powered speaker.

Wireless Microphone ELPMC02 (EB-735Fi/EB-725Wi/EB-725W)

Microphone without a physical cable.

Connection and Control Box ELPCB03

When the projector is mounted on a wall or suspended from a ceiling, install the remote control to operate the projector at hand.

Finger Touch Unit ELPFT01 (EB-735Fi/EB-725Wi)

Install this to use your fingers for interactive touch operations.

Replacement Parts

Air filter ELPAF60

Use as a replacement for used air filters.

For Wireless Connection

Wireless LAN module ELPAP11

Use this to project images from a computer via a wireless communication.

Compatible Accessories from Other Projectors

The following optional accessories are compatible.

Mounts

Setting plate ELPMB53**Setting plate ELPMB46****Setting plate ELPMB43****Setting plate ELPMB28**

Use when installing the projector on a wall.

For Interactive Feature (EB-735Fi/EB-725Wi)**Interactive Pen ELPPN04A/B****Interactive Pen ELPPN03A/B**

Use when operating the computer screen on the projection surface.

External Devices

Document Camera ELPDC20**Document Camera ELPDC12****Document Camera ELPDC11****Document Camera ELPDC06**

Use when projecting image such as books, OHP documents, or slides.

Connection and Control Box ELPCB02**Connection and Control Box ELPCB01**

When the projector is mounted on a wall or suspended from a ceiling, install the remote control to operate the projector at hand.

Check the table here to determine how far to place the projector from the screen based on the size of the projected image.

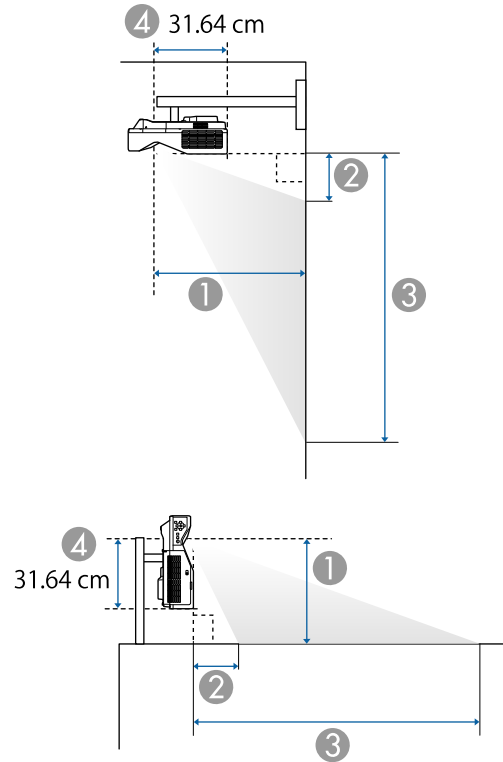

- ① Projection distance (cm)
- ② Distance from the projector to the top of the screen (when mounting on a wall or ceiling, or installing vertically) (cm)
- ③ Distance from the projector to the bottom of the screen (when mounting on a wall or ceiling, or installing vertically) (cm)
- ④ Distance from the center of the lens to the rear of the projector (cm)

EB-755F/EB-750F/EB-735Fi/EB-735F

16:9 screen size		①	②	③
		Minimum (Wide)	Minimum (Wide)	Minimum (Wide)
65"	143.9 × 80.9	37.2	13.9	94.8
70"	155.0 × 87.2	40.2	15.4	102.6
75"	166.0 × 93.4	43.3	17.0	110.4
80"	177.1 × 99.6	46.3	18.5	118.2
85"	188.2 × 105.8	49.3	20.1	126.0
90"	199.2 × 112.1	52.3	21.7	133.7
100"	221.4 × 124.5	58.3	24.8	149.3
110" *	243.5 × 137.0	64.3	27.9	164.9
120" *	265.7 × 149.4	70.3	31.0	180.4

4:3 screen size		①	②	③
		Minimum (Wide)	Minimum (Wide)	Minimum (Wide)
54"	109.7 × 82.3	37.9	14.2	96.5
55"	111.8 × 83.8	38.6	14.6	98.4
60"	121.9 × 91.4	42.3	16.5	107.9
65"	132.1 × 99.1	46.0	18.4	117.5
70"	142.2 × 106.7	49.7	20.3	127.0
75"	152.4 × 114.3	53.3	22.2	136.5
80"	162.6 × 121.9	57.0	24.1	146.0
85"	172.7 × 129.5	60.7	26.0	155.6
90"	182.9 × 137.2	64.4	27.9	165.1
98"	199.1 × 149.4	70.3	31.0	180.3

16:10 screen size		①	②	③
		Minimum (Wide)	Minimum (Wide)	Minimum (Wide)
65"	140.0 × 87.5	40.4	15.5	103.0
70"	150.8 × 94.2	43.7	17.2	111.4
75"	161.5 × 101.0	46.9	18.9	119.8
80"	172.3 × 107.7	50.2	20.6	128.3
85"	183.1 × 114.4	53.4	22.2	136.7
90"	193.9 × 121.2	56.7	23.9	145.1
100"	215.4 × 134.6	63.1	27.3	161.9
110" *	236.9 × 148.1	69.6	30.6	178.7

16:6 screen size		①	②	③
		Minimum (Wide)	Minimum (Wide)	Minimum (Wide)
60"	142.7 × 53.5	36.9	27.1	80.6
65"	154.6 × 58.0	40.1	29.9	87.9
70"	166.5 × 62.4	43.4	32.7	95.1
75"	178.4 × 66.9	46.6	35.4	102.3
80"	190.3 × 71.3	49.8	38.2	109.6
85"	202.2 × 75.8	53.1	41.0	116.8
90"	214.0 × 80.3	56.3	43.8	124.1
100"	237.8 × 89.2	62.7	49.4	138.6
110"	261.6 × 98.1	69.2	54.9	153.0

* Available only for EB-755F/EB-750F/EB-735F.

EB-725Wi/EB-725W

16:10 screen size		①	②	③
		Minimum (Wide)	Minimum (Wide)	Minimum (Wide)
65"	140.0 × 87.5	38.5	11.9	99.4
70"	150.8 × 94.2	41.6	13.3	107.6
75"	161.5 × 101.0	44.7	14.7	115.7
80"	172.3 × 107.7	47.7	16.1	123.8
85"	183.1 × 114.4	50.8	17.5	132.0
90"	193.9 × 121.2	53.9	18.9	140.1
100"	215.4 × 134.6	60.1	21.7	156.4
110" *	236.9 × 148.1	66.3	24.5	172.6
120" *	258.5 × 161.5	72.5	27.3	188.9

4:3 screen size		①	②	③
		Minimum (Wide)	Minimum (Wide)	Minimum (Wide)
58"	117.9 × 88.4	38.9	12.1	100.5
60"	121.9 × 91.4	40.3	12.7	104.2
65"	132.1 × 99.1	43.8	14.3	113.4
70"	142.2 × 106.7	47.3	15.9	122.6
75"	152.4 × 114.3	50.8	17.5	131.8
80"	162.6 × 121.9	54.3	19.1	141.0
85"	172.7 × 129.5	57.8	20.7	150.2
90"	182.9 × 137.2	61.3	22.3	159.4
100"	203.2 × 152.4	68.3	25.4	177.8
106" *	215.4 × 161.5	72.5	27.3	188.9

16:9 screen size		①	②	③
		Minimum (Wide)	Minimum (Wide)	Minimum (Wide)
64"	141.7 × 79.7	39.0	16.6	96.3
65"	143.9 × 80.9	39.6	16.9	97.9
70"	155.0 × 87.2	42.8	18.7	105.9
75"	166.0 × 93.4	45.9	20.5	113.9
80"	177.1 × 99.6	49.1	22.3	121.9
85"	188.2 × 105.8	52.3	24.1	129.9
90"	199.2 × 112.1	55.5	25.9	137.9
100"	221.4 × 124.5	61.8	29.4	154.0
110"	243.5 × 137.0	68.2	33.0	170.0
116" *	256.8 × 144.5	72.0	35.2	179.6

16:10 screen size		①	②	③
		Minimum (Wide)	Minimum (Wide)	Minimum (Wide)
62"	133.5 × 83.5	42.2	19.1	102.6
65"	140.0 × 87.5	44.3	20.4	107.9
70"	150.8 × 94.2	47.8	22.4	116.7
75"	161.5 × 101.0	51.3	24.5	125.4
80"	172.3 × 107.7	54.8	26.5	134.2
85"	183.1 × 114.4	58.3	28.6	143.0
90"	193.9 × 121.2	61.8	30.6	151.8
100"	215.4 × 134.6	68.8	34.7	169.4
103"	221.9 × 138.7	70.9	36.0	174.6

* Available only for EB-725W.

EB-720

4:3 screen size		①	②	③
		Minimum (Wide)	Minimum (Wide)	Minimum (Wide)
65"	132.1 × 99.1	41.7	10.6	109.7
70"	142.2 × 106.7	45.0	11.9	118.6
75"	152.4 × 114.3	48.3	13.2	127.5
80"	162.6 × 121.9	51.6	14.5	136.4
85"	172.7 × 129.5	54.9	15.8	145.3
90"	182.9 × 137.2	58.2	17.1	154.3
100"	203.2 × 152.4	64.9	19.7	172.1
110"	223.5 × 167.6	71.5	22.3	190.0

16:9 screen size		①	②	③
		Minimum (Wide)	Minimum (Wide)	Minimum (Wide)
60"	132.8 × 74.7	41.9	23.2	97.9
65"	143.9 × 80.9	45.5	25.6	106.5
70"	155.0 × 87.2	49.1	28.1	115.2
75"	166.0 × 93.4	52.8	30.5	123.9
80"	177.1 × 99.6	56.4	33.0	132.6
85"	188.2 × 105.8	60.0	35.4	141.3
90"	199.2 × 112.1	63.6	37.9	150.0
100"	221.4 × 124.5	70.8	42.8	167.3
101"	223.6 × 125.8	71.5	43.3	169.1

The table here lists the compatible refresh rate and resolution for each compatible video display format.

PC

Compatible Mode

Mode	Computer		HDMI			
	YCbCr	RGBH V	YCbCr			RGB
			4:2:0	4:2:2	4:4:4	
			8	8	8	
VGA60		✓				✓
VGA72		✓				
VGA75		✓				
VGA85		✓				
SVGA60		✓				✓
SVGA72		✓				
SVGA75		✓				
SVGA85		✓				
XGA60		✓				✓
XGA70		✓				
XGA75		✓				
XGA85		✓				
WXGA60-1		✓				
WXGA60		✓				✓
WXGA75		✓				
WXGA85		✓				
WXGA60-3		✓				✓
WXGA+60		✓				✓
WXGA+75		✓				
WXGA+85		✓				

Mode	Computer		HDMI			
	YCbCr	RGBH V	YCbCr			RGB
			4:2:0	4:2:2	4:4:4	
			8	8	8	8
WXGA++		✓				✓
SXGA1_70		✓				
SXGA1_75		✓				
SXGA1_85		✓				
SXGA2_60		✓				✓
SXGA2_75		✓				
SXGA2_85		✓				
SXGA3_60		✓				✓
SXGA3_75		✓				
SXGA3_85		✓				
SXGA+60		✓				✓
SXGA+75		✓				
WSXGA+60		✓*				✓
UXGA60		✓				✓
1920×1080_50		✓				✓
1920×1080_60		✓				✓
WUXGA60 (Reduced Blanking)		✓				✓
QXGA						✓
WQHD						✓
WQXGA (Reduced Blanking)						✓

* Only compatible when **Wide** is selected as the **Resolution** setting in the projector's **Image** menu.

Mode Information

Mode	Resolution (dot)		H Sync (KHz)	Refresh Rate (Hz)	Dotclk (MHz)	Scan Type
VGA60	640	480	31.47	60	25.175	Progressive
VGA72	640	480	37.86	72	31.500	Progressive
VGA75	640	480	37.50	75	31.500	Progressive
VGA85	640	480	43.27	85	36.000	Progressive
SVGA60	800	600	37.88	60	40.000	Progressive
SVGA72	800	600	48.08	72	50.000	Progressive
SVGA75	800	600	46.88	75	49.500	Progressive
SVGA85	800	600	53.67	85	56.250	Progressive
XGA60	1024	768	48.36	60	65.000	Progressive
XGA70	1024	768	56.48	70	75.000	Progressive
XGA75	1024	768	60.02	75	78.750	Progressive
XGA85	1024	768	68.68	85	94.500	Progressive
WXGA60-1	1280	768	47.78	60	79.500	Progressive
WXGA60	1280	800	49.70	60	83.500	Progressive
WXGA75	1280	800	62.80	75	106.500	Progressive
WXGA85	1280	800	71.55	85	122.500	Progressive
WXGA60-3	1366	768	47.71	60	85.500	Progressive
WXGA+60	1440	900	55.94	60	106.500	Progressive
WXGA+75	1440	900	70.64	75	136.750	Progressive
WXGA+85	1440	900	80.43	85	157.000	Progressive
WXGA++	1600	900	60.00	60	108.000	Progressive
SXGA1_70	1152	864	63.85	70	94.500	Progressive
SXGA1_75	1152	864	67.50	75	108.000	Progressive
SXGA1_85	1152	864	77.09	85	121.500	Progressive
SXGA2_60	1280	960	60.00	60	108.000	Progressive
SXGA2_75	1280	960	75.00	75	126.000	Progressive
SXGA2_85	1280	960	85.94	85	148.500	Progressive

Mode	Resolution (dot)		H Sync (KHz)	Refresh Rate (Hz)	Dotclk (MHz)	Scan Type
SXGA3_60	1280	1024	63.98	60	108.000	Progressive
SXGA3_75	1280	1024	79.98	75	135.000	Progressive
SXGA3_85	1280	1024	91.15	85	157.500	Progressive
SXGA+60	1400	1050	65.32	60	121.750	Progressive
SXGA+75	1400	1050	82.28	75	156.000	Progressive
WSXGA+60	1680	1050	65.29	60	146.250	Progressive
UXGA60	1600	1200	75.00	60	162.000	Progressive
1920×1080_50	1920	1080	56.25	50	148.500	Progressive
1920×1080_60	1920	1080	67.50	60	148.500	Progressive
WUXGA60 (Reduced Blanking)	1920	1200	74.04	60	154.000	Progressive
QXGA	2048	1536	95.45	60	267.250	Progressive
WQHD	2560	1440	88.79	60	241.500	Progressive
WQXGA (Reduced Blanking)	2560	1600	98.71	60	268.500	Progressive

Video

Compatible Mode

Mode	Resolution (dot)		H Sync (KHz)	Refresh Rate (Hz)	Dotclk (MHz)	Scan Type
NTSC	720	480	15.73	60	13.500	Interlace
NTSC4.43	720	480	15.73	60	13.500	Interlace
PAL	720	576	15.63	50	13.500	Interlace
M-PAL	720	576	15.73	60	13.500	Interlace
N-PAL	720	576	15.63	50	13.500	Interlace
PAL60	720	576	15.73	60	13.500	Interlace

Mode	Resolution (dot)		H Sync (KHz)	Refresh Rate (Hz)	Dotclk (MHz)	Scan Type
SECAM	720	576	15.63	50	13.500	Interlace

SD

Compatible Mode

Mode	Computer		HDMI			
	YCbCr	RGBHV	YCbCr			RGB
			4:2:0	4:2:2	4:4:4	
			8	8	8	8
SDTV (480i)				✓	✓	✓
SDTV (576i)				✓	✓	✓
SDTV (480p)		✓		✓	✓	✓
SDTV (576p)		✓		✓	✓	✓

Mode Information

Mode	Resolution (dot)		H Sync (KHz)	Refresh Rate (Hz)	Dotclk (MHz)	Scan Type
SDTV (480i)	720	480	15.73	59.94	13.500	Interlace
SDTV (576i)	720	576	15.63	50	13.500	Interlace
SDTV (480p)	720	480	31.47	59.94	27.000	Progressive
SDTV (576p)	720	576	31.25	50	27.000	Progressive

HD

Compatible Mode

Mode	Computer		HDMI			
	YCbCr	RGBHV	YCbCr			RGB
			4:2:0	4:2:2	4:4:4	
			8	8	8	8
HDTV (720p)_50		✓		✓	✓	✓
HDTV (720p)_59.94		✓		✓	✓	✓
HDTV (720p)_60		✓		✓	✓	✓
HDTV (1080i)_50				✓	✓	✓
HDTV (1080i)_59.94				✓	✓	✓
HDTV (1080i)_60				✓	✓	✓
HDTV (1080p)_23.98				✓	✓	✓
HDTV (1080p)_24				✓	✓	✓
HDTV (1080p)_29.97				✓	✓	✓
HDTV (1080p)_30				✓	✓	✓
HDTV (1080p)_50		✓		✓	✓	✓
HDTV (1080p)_59.94		✓		✓	✓	✓
HDTV (1080p)_60		✓		✓	✓	✓

Mode Information

Mode	Resolution (dot)		H Sync (KHz)	Refresh Rate (Hz)	Dotclk (MHz)	Scan Type
HDTV (720p)_50	1280	720	37.50	50	74.250	Progressive
HDTV (720p)_59.94	1280	720	44.96	59.94	74.176	Progressive
HDTV (720p)_60	1280	720	45.00	60	74.250	Progressive
HDTV (1080i)_50	1920	1080	28.13	50	74.250	Interlace

Mode	Resolution (dot)		H Sync (KHz)	Refresh Rate (Hz)	Dotclk (MHz)	Scan Type
HDTV (1080i)_59.94	1920	1080	33.72	59.94	74.176	Interlace
HDTV (1080i)_60	1920	1080	33.75	60	74.250	Interlace
HDTV (1080p)_23.98	1920	1080	26.97	23.98	74.176	Progressive
HDTV (1080p)_24	1920	1080	27.00	24	74.250	Progressive
HDTV (1080p)_29.97	1920	1080	33.72	29.97	74.176	Progressive
HDTV (1080p)_30	1920	1080	33.75	30	74.250	Progressive
HDTV (1080p)_50	1920	1080	56.25	50	148.500	Progressive
HDTV (1080p)_59.94	1920	1080	67.43	59.94	148.352	Progressive
HDTV (1080p)_60	1920	1080	67.50	60	148.500	Progressive

Mode	HDMI			
	YCbCr			RGB
	4:2:0	4:2:2	4:4:4	
	8	8	8	8
4K (3840×2160)_30		✓	✓	✓
4K (3840×2160)_50	✓			
4K (3840×2160)_59.94	✓			
4K (3840×2160)_60	✓			
4K(4096×2160) (SMPTE)_23.98		✓	✓	✓
4K(4096×2160) (SMPTE)_24		✓	✓	✓
4K(4096×2160) (SMPTE)_50	✓			
4K(4096×2160) (SMPTE)_59.94	✓			
4K(4096×2160) (SMPTE)_60	✓			

4K

Compatible Mode

Mode	HDMI			
	YCbCr			RGB
	4:2:0	4:2:2	4:4:4	
	8	8	8	8
4K (3840×2160)_23.98		✓	✓	✓
4K (3840×2160)_24		✓	✓	✓
4K (3840×2160)_25		✓	✓	✓
4K (3840×2160)_29.97		✓	✓	✓

Mode Information

Mode	Resolution (dot)		H Sync (KHz)	Refresh Rate (Hz)	Dotclk (MHz)	Scan Type
4K (3840×2160)_23.98	3840	2160	53.95	23.98	296.703	Progressive
4K (3840×2160)_24	3840	2160	54.00	24	297.000	Progressive
4K (3840×2160)_25	3840	2160	56.25	25	297.000	Progressive
4K (3840×2160)_29.97	3840	2160	67.43	29.97	296.703	Progressive
4K (3840×2160)_30	3840	2160	67.50	30	297.000	Progressive
4K (3840×2160)_50	3840	2160	112.50	50	297.000	Progressive

Mode	Resolution (dot)		H Sync (KHz)	Refresh Rate (Hz)	Dotclk (MHz)	Scan Type
4K (3840×2160)_59.94	3840	2160	134.87	59.94	296.703	Progressive
4K (3840×2160)_60	3840	2160	135.00	60	297.000	Progressive
4K(4096×2160) (SMPTE)_23.98	4096	2160	53.95	23.98	296.703	Progressive
4K(4096×2160) (SMPTE)_24	4096	2160	54.00	24	297.000	Progressive
4K(4096×2160) (SMPTE)_50	4096	2160	112.50	50	297.000	Progressive
4K(4096×2160) (SMPTE)_59.94	4096	2160	134.87	59.94	296.703	Progressive
4K(4096×2160) (SMPTE)_60	4096	2160	135.00	60	297.000	Progressive

Product name	EB-755F/EB-750F/EB-735Fi/EB-735F/EB-725Wi/EB-725W/EB-720
Dimensions	356 (W) × 133 (H) × 395 (D) mm (not including raised section)
LCD panel size	EB-755F/EB-750F/EB-735Fi/EB-735F: 0.61" EB-725Wi/EB-725W: 0.59" EB-720: 0.55"
Display method	Poly-silicon TFT active matrix
Resolution	EB-755F/EB-750F/EB-735Fi/EB-735F: 2,073,600 dots 1080p (1920 (W) × 1080 (H) dots) × 3 EB-725Wi/EB-725W: 1,024,000 dots WXGA (1280 (W) × 800 (H) dots) × 3 EB-720: 786,432 dots XGA (1024 (W) × 768 (H) dots) × 3
Focus adjustment	Manual
Zoom adjustment	1.0 to 1.35 (Digital Zoom)
Light source	Laser diode
Light source output power	Up to 81 W
Wavelength	449 to 461 nm
Light source life *	Light Source Mode: Normal or Quiet: Up to about 20,000 hours Light Source Mode: Extended: Up to about 30,000 hours
Max. audio output	16 W
Speaker	1
Power supply	100-240V AC±10% 50/60Hz 2.7 - 1.2 A

Operating power consumption (100 to 120 V area)	Light Source Mode: Normal, Custom: 267 W Light Source Mode: Quiet, Extended: 206 W
Operating power consumption (220 to 240 V area)	Light Source Mode: Normal, Custom: 255 W Light Source Mode: Quiet, Extended: 197 W
Standby power consumption	Communication On: 2.0 W Communication Off: 0.5 W
Operating altitude	Altitude 0 to 3,048 m
Operating temperature (when using a single projector installation) **	Altitude of 0 to 2,286 m: 0 to +40°C (No condensation) Altitude of 2,287 to 3,048 m: 0 to +35°C (Humidity of 20 to 80%, No condensation)
Operating temperature (when using a multiple projector installation) **	Altitude of 0 to 2,286 m: 0 to +35°C (No condensation) Altitude of 2,287 to 3,048 m: 0 to +30°C (Humidity of 20 to 80%, No condensation)
Storage temperature	-10 to +60°C (Humidity of 10 to 90%, No condensation)
Mass	EB-755F/EB-750F/EB-735F/EB-725W/EB-720: Approx. 5.7 kg EB-735Fi/EB-725Wi: Approx. 5.8 kg

* Approximate time until the light source brightness decreases to half of its original value. (Assuming the projector is used in an atmosphere in which airborne particulate matter is less than 0.04 to 0.2mg/m3. The estimated time varies depending on the projector usage and operating conditions.)

** Light source brightness automatically dims if the surrounding temperature gets too high. (Approximately 35°C at an altitude of 0 to 2,286 m, and approximately 30°C at an altitude of 2,287 to 3,048 m; however, this may vary depending on the surrounding environment.)

This product is also designed for IT power distribution system with phase-to-phase voltage 230V.

Angle of tilt when using interactive features (EB-735Fi/EB-725Wi)

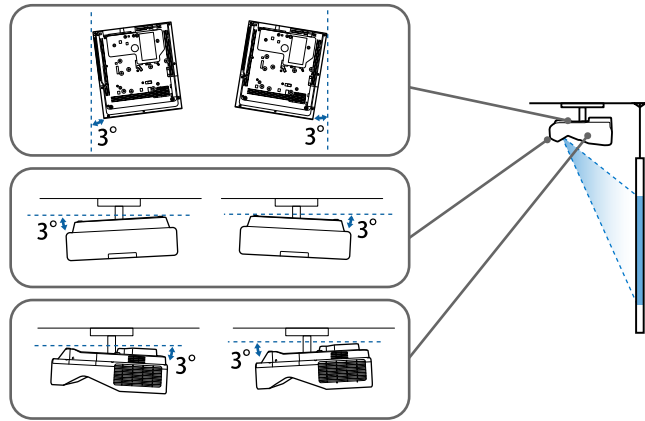

Regardless of the projector placement, if you use the projector tilted at an angle of more than 3°, it could be damaged and cause an accident.

Angle of tilt when not using interactive features

If you do are not planning to use the interactive features or your projector does not have interactive features, you can install the projector at various angles. There is no vertical or horizontal limit to how the projector can be installed.

» Related Links

- "Connector Specifications" [p.298](#)

Connector Specifications

EB-755F/EB-750F

Computer1 port	1	Mini D-Sub15-pin (female)
Computer2/Monitor Out port	1	Mini D-Sub15-pin (female)

Video port	1	RCA pin jack
HDMI port	3	HDMI (Audio is only supported by PCM)
Audio ports	3	Stereo mini pin jack
Audio Out port	1	Stereo mini pin jack
RS-232C port	1	Mini D-Sub 9-pin (male)
USB-A port	2	USB connector (Type A)
USB-B port	1	USB connector (Type B)
LAN port	1	RJ-45

EB-735Fi/EB-725Wi

Computer1 port	1	Mini D-Sub15-pin (female)
Computer2/Monitor Out port	1	Mini D-Sub15-pin (female)
Video port	1	RCA pin jack
HDMI port	3	HDMI (Audio is only supported by PCM)
Audio ports	3	Stereo mini pin jack
Audio Out port	1	Stereo mini pin jack
Mic port	1	Stereo mini pin jack
RS-232C port	1	Mini D-Sub 9-pin (male)
SYNC ports	2	Stereo mini pin jack
TCH port	1	Mini DIN 8-pin
USB-A port	2	USB connector (Type A)
USB-B port	2	USB connector (Type B)
LAN port	1	RJ-45

EB-735F/EB-725W/EB-720

Computer1 port	1	Mini D-Sub15-pin (female)
----------------	---	---------------------------

Computer2/Monitor Out port	1	Mini D-Sub15-pin (female)
Video port	1	RCA pin jack
HDMI port	3	HDMI (Audio is only supported by PCM)
Audio ports	3	Stereo mini pin jack
Audio Out port	1	Stereo mini pin jack
Mic port	1	Stereo mini pin jack
RS-232C port	1	Mini D-Sub 9-pin (male)
USB-A port	2	USB connector (Type A)
USB-B port	1	USB connector (Type B)
LAN port	1	RJ-45



- USB-A and USB-B port supports USB 2.0. However, USB ports are not guaranteed to operate all devices that support USB.
- USB-B port does not support USB 1.1.

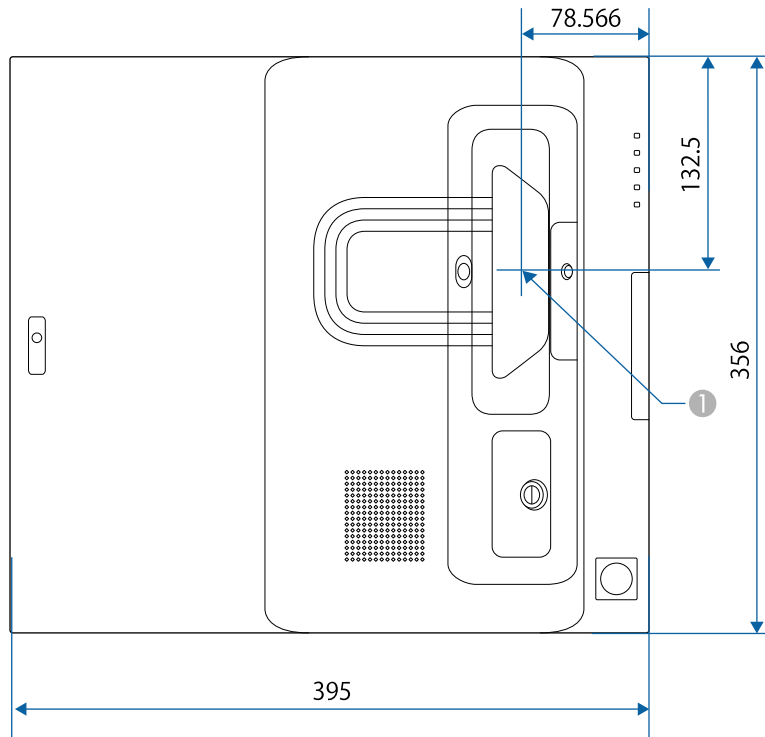

1 Center of the projection lens

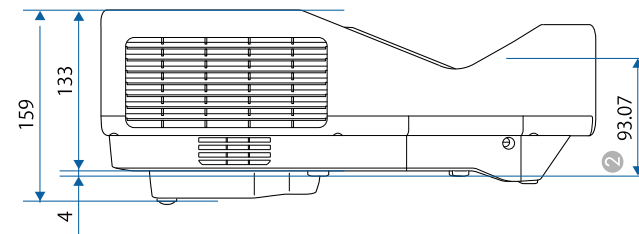
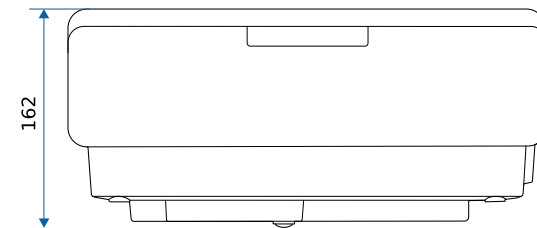
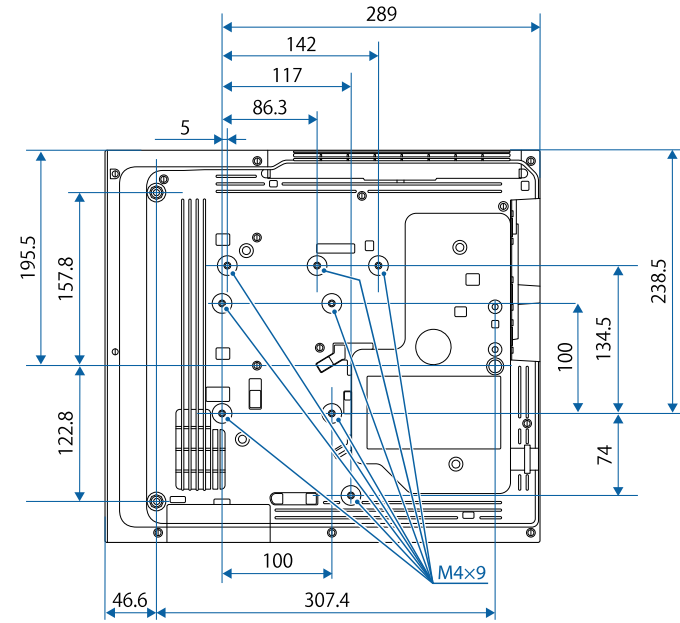

- ② Distance from the center of the projection lens to the ceiling mount fixing points

The unit in these illustrations is mm.

To use the projector's Epson USB Display software, your computer must meet the following system requirements.

Requirement	Windows	Mac
Operating system	Windows 7 <ul style="list-style-type: none"> • Ultimate (32- and 64-bit) • Enterprise (32- and 64-bit) • Professional (32- and 64-bit) • Home Premium (32- and 64-bit) • Home Basic (32-bit) • Starter (32-bit) 	OS X <ul style="list-style-type: none"> • 10.11.x (64-bit)
	Windows 8.1 <ul style="list-style-type: none"> • Windows 8.1 (32- and 64-bit) • Windows 8.1 Pro (32- and 64-bit) • Windows 8.1 Enterprise (32- and 64-bit) 	macOS <ul style="list-style-type: none"> • 10.12.x (64-bit) • 10.13.x (64-bit) • 10.14.x (64-bit) • 10.15.x (64-bit)
	Windows 10 <ul style="list-style-type: none"> • Windows 10 Home (32- and 64-bit) • Windows 10 Pro (32- and 64-bit) • Windows 10 Enterprise (32- and 64-bit) 	
CPU	Intel Core2Duo or faster (Intel Core i3 or faster recommended)	Intel Core2Duo or faster (Intel Core i5 or faster recommended)
Memory	2 GB or more (4 GB or more recommended)	
Hard disk space	20 MB or more	
Display	Resolution between 640 × 480 and 1920 × 1200 16-bit color or greater	









To use computer interactive mode on a Mac, you must install the Easy Interactive Driver on your Mac. Make sure your Mac meets the software system requirements below.



















You only need to install this software for the EB-735Fi/EB-725Wi.

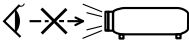

Requirement	Mac
Operating system	macOS <ul style="list-style-type: none">• 10.12.x (64-bit)• 10.13.x (64-bit)• 10.14.x (64-bit)• 10.15.x (64-bit)
CPU	Core2 Duo 1.2 GHz or faster (Core i5 or faster recommended)
Memory	2 GB or more Recommended: 4 GB or more
Hard disk space	100 MB or more
Display	Resolutions no lower than XGA (1024 × 768) and no higher than WUXGA (1920 × 1200) 16-bit color or greater

The following table lists the meaning of the safety symbols labeled on the equipment.

No.	Symbol mark	Approved standards	Description
1		IEC60417 No. 5007	"ON" (power) To indicate connection to the mains.
2		IEC60417 No. 5008	"OFF" (power) To indicate disconnection from the mains.
3		IEC60417 No. 5009	Stand-by To identify the switch or switch position by means of which part of the equipment is switched on in order to bring it into the stand-by condition.
4		ISO7000 No. 0434B, IEC3864-B3.1	Caution To identify general caution when using the product.
5		IEC60417 No. 5041	Caution, hot surface To indicate that the marked item can be hot and should not be touched without taking care.
6		IEC60417 No. 6042 ISO3864-B3.6	Caution, risk of electric shock To identify equipment that has risk of electric shock.
7		IEC60417 No. 5957	For indoor use only To identify electrical equipment designed primarily for indoor use.
8		IEC60417 No. 5926	Polarity of d.c. power connector To identify the positive and negative connections (the polarity) on a piece of equipment to which a d.c. power supply may be connected.

No.	Symbol mark	Approved standards	Description
9		—	The same as No. 8.
10		IEC60417 No. 5001B	Battery, general On battery powered equipment. To identify a device for instance a cover for the battery compartment, or the connector terminals.
11		IEC60417 No. 5002	Positioning of cell To identify the battery holder itself and to identify the positioning of the cell(s) inside the battery holder.
12		—	The same as No. 11.
13		IEC60417 No. 5019	Protective earth To identify any terminal which is intended for connection to an external conductor for protection against electric shock in case of a fault, or the terminal of a protective earth electrode.
14		IEC60417 No. 5017	Earth To identify an earth (ground) terminal in cases where neither the symbol No. 13 is explicitly required.
15		IEC60417 No. 5032	Alternating current To indicate on the rating plate that the equipment is suitable for alternating current only; to identify relevant terminals.
16		IEC60417 No. 5031	Direct current To indicate on the rating plate that the equipment is suitable for direct current only; to identify relevant terminals.

No.	Symbol mark	Approved standards	Description
17		IEC60417 No. 5172	Class II equipment To identify equipment meeting the safety requirements specified for Class II equipment according to IEC 61140.
18		ISO 3864	General prohibition To identify actions or operations that are prohibited.
19		ISO 3864	Contact prohibition To indicate injury that could occur due to touching a specific part of the equipment.
20		—	Never look into the optical lens while the projector is on.
21		—	To indicate that the marked item don't place anything on projector.
22		ISO3864 IEC60825-1	Caution, laser radiation To indicate the equipment has a laser radiation part.
23		ISO 3864	Disassembly prohibition To indicate a risk of injury, such as electric shock, if the equipment is disassembled.
24		IEC60417 No. 5266	Standby, partial standby To indicate that part of the equipment is in the ready status.
25		ISO3864 IEC60417 No. 5057	Caution, movable parts To indicate that you must keep away from movable parts according to protection standards.
26		IEC60417 No. 6056	Caution (Moving Fan Blades) As a safety precaution, stay away from the moving fan blades.

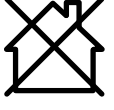
No.	Symbol mark	Approved standards	Description
27		IEC60417 No. 6043	Caution (Sharp Corners) To indicate sharp corners that should not be touched.
28		—	To indicate that looking into the lens while projecting is prohibited.
29		ISO7010 No. W027 ISO 3864	Warning, Optical radiation (such as UV, visible radiation, IR) Taking care to avoid injury to eyes and skin when in the vicinity of optical radiation.
30		IEC60417 No. 5109	Not to be used in residential areas. To identify electrical equipment which is not suitable for a residential area.

Follow these safety instructions when using the projector.

Warning

- Do not open the projector's case. The projector contains a high-powered laser.
- Possibly hazardous optical radiation emitted from this product. Do not look at operating light source. Eye injury may result.

Caution

Do not disassemble the projector when disposing of it. Dispose according to your local or national laws and regulations.



The projector uses a laser as the light source. The laser has the following characteristics.

- Depending on the surroundings, the brightness of the light source may decline. The brightness declines a lot when the temperature gets too high.
- The brightness of the light source declines the longer it is used. You can change the relationship between usage time and decline in brightness settings.

▶ Related Links

- "Laser Warning Labels" [p.306](#)

Laser Warning Labels

Laser warning labels are attached on the projector.

This projector is a Class 1 laser product that complies with the IEC/EN60825-1:2014 international standard for lasers.

Follow these safety instructions when using the projector.

As with any bright source, do not stare into the beam, RG2 IEC/EN 62471-5:2015.

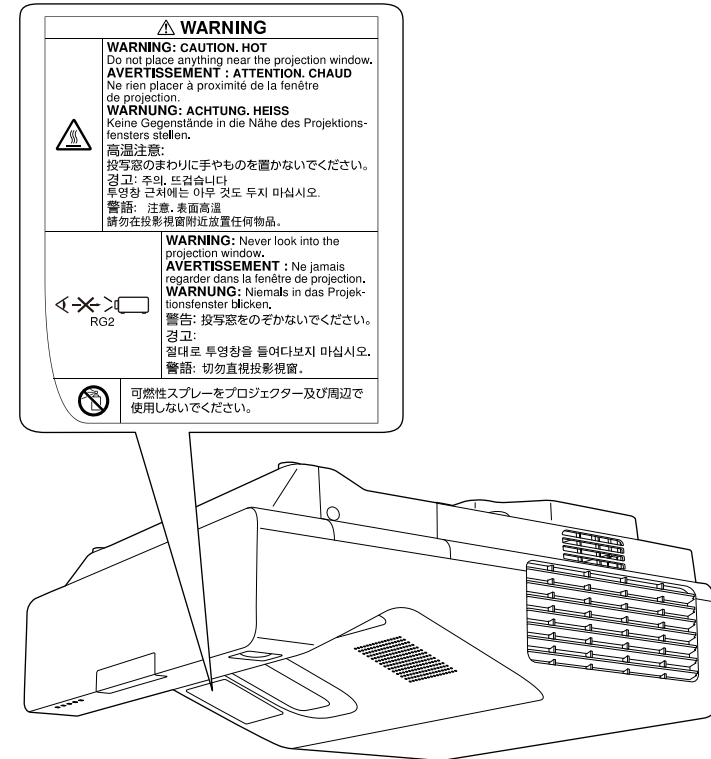

Complies with FDA performance standards for laser products except for conformance as a Risk Group 2 LIP as defined in IEC 62471-5: Ed. 1.0. For more information see Laser Notice No. 57, dated May 8, 2019.

This section briefly explains the difficult terms that are not explained in the text of this guide. For details, refer to other commercially available publications.

AMX Device Discovery	AMX Device Discovery is a technology developed by AMX to facilitate AMX control systems for easy operation of the target equipment. Epson have implemented this protocol technology, and have provided a setting to enable the protocol function (ON). See the AMX Web site for more details. URL http://www.amx.com/
Aspect Ratio	The ratio between an image's length and its height. Screens with a horizontal:vertical ratio of 16:9, such as HDTV screens, are known as wide screens. SDTV and general computer displays have an aspect ratio of 4:3.
Composite Video	A method that combines the video signal into a luminance component and a color component for transmission down a single cable.
Contrast	The relative brightness of the light and dark areas of an image can be increased or decreased to make text and graphics stand out more clearly, or to make them appear softer. Adjusting this particular property of an image is called contrast adjustment.
DHCP	An abbreviation of Dynamic Host Configuration Protocol, this protocol automatically assigns an IP address to equipment connected to a network.
DICOM	An acronym for Digital Imaging and Communications in Medicine. An international standard that defines image standards and a communications protocol for medical images.
Gateway Address	This is a server (router) for communicating across a network (subnet) divided according to subnet mask.

HDCP	HDCP is an abbreviation for High-bandwidth Digital Content Protection. It is used to prevent illegal copying and protect copyrights by encrypting digital signals sent over DVI and HDMI ports. Because the HDMI port on this projector supports HDCP, it can project digital images protected by HDCP technology. However, the projector may not be able to project images protected with updated or revised versions of HDCP encryption.
HDMI™	An abbreviation for High Definition Multimedia Interface. HDMI™ is a standard aimed at digital consumer electronics and computers. This is the standard by which HD images and multichannel audio signals are digitally transmitted. By not compressing the digital signal, the image can be transferred at the highest quality possible. It also provides an encryption function for the digital signal.
HDTV	An abbreviation for High-Definition Television that refers to high-definition systems which satisfy the following conditions: <ul style="list-style-type: none"> • Vertical resolution of 720p or 1080i or greater (p = Progressive, i = Interlace) • Screen aspect ratio of 16:9
Infrastructure mode	A method for wireless LAN connection in which devices communicate through access points.
Interlace	Transmits information needed to create one screen by sending every other line, starting from the top of the image and working down to the bottom. Images are more likely to flicker because one frame is displayed every other line.
IP Address	A number to identify a computer connected to a network.
Progressive	Projects information to create one screen at a time, displaying the image for one frame. Even though the number of scan lines is the same, the amount of flicker in images decreases because the volume of information has doubled compared with an interlace system.

Refresh Rate	<p>The light-emitting element of a display maintains the same luminosity and color for an extremely short time.</p> <p>Because of this, the image must be scanned many times per second to refresh the light-emitting element.</p> <p>The number of refresh operations per second is called the Refresh rate and is expressed in hertz (Hz).</p>
SDTV	An abbreviation for Standard Definition Television that refers to standard television systems which do not satisfy the conditions for HDTV High-Definition Television.
SNMP	An abbreviation for Simple Network Management Protocol, which is the protocol for monitoring and controlling devices such as routers and computers connected to a TCP/IP network.
sRGB	An international standard for color intervals that was formulated so that colors that are reproduced by video equipment can be handled easily by computer operating systems (OS) and the Internet. If the connected source has an sRGB mode, set both the projector and the connected signal source to sRGB.
SSID	SSID is identification data for connecting to another device on a wireless LAN. Wireless communication is possible between devices with the same SSID.
Subnet Mask	This is a numerical value that defines the number of bits used for the network address on a divided network (subnet) from the IP address.
SVGA	A screen size standard with a resolution of 800 (horizontal) × 600 (vertical) dots.
SXGA	A screen size standard with a resolution of 1,280 (horizontal) × 1,024 (vertical) dots.
Sync.	<p>The signals output from computers have a specific frequency.</p> <p>If the projector frequency does not match this frequency, the resulting images are not of a good quality.</p> <p>The process of matching the phases of these signals (the relative position of the crests and the troughs in the signal) is called Synchronization.</p> <p>If the signals are not synchronized, flickering, blurriness, and horizontal interference occur.</p>

Tracking	<p>The signals output from computers have a specific frequency.</p> <p>If the projector frequency does not match this frequency, the resulting images are not of a good quality.</p> <p>The process of matching the frequency of these signals (the number of crests in the signal) is called Tracking.</p> <p>If Tracking is not carried out correctly, wide vertical stripes appear in the signal.</p>
Trap IP Address	This is the IP address for the destination computer used for error notification in SNMP.
VGA	A screen size standard with a resolution of 640 (horizontal) × 480 (vertical) dots.
XGA	A screen size standard with a resolution of 1,024 (horizontal) × 768 (vertical) dots.
WXGA	A screen size standard with a resolution of 1,280 (horizontal) × 800 (vertical) dots.
WUXGA	A screen size standard with a resolution of 1,920 (horizontal) × 1,200 (vertical) dots.

Check these sections for important notices about your projector.

► **Related Links**

- "FCC Compliance Statement" [p.309](#)
- "Indication of the manufacturer and the importer in accordance with requirements of EU directive" [p.310](#)
- "Restriction of Use" [p.310](#)
- "Operating System References" [p.310](#)
- "Trademarks" [p.311](#)
- "Copyright Notice" [p.311](#)
- "Copyright Attribution" [p.312](#)

FCC Compliance Statement

Supplier's DECLARATION of CONFORMITY

According to 47CFR, Part 2 and 15
 Class B Personal Computers and Peripherals; and/or
 CPU Boards and Power Supplies used with Class B Personal Computers

We: Epson America, Inc.

Located at: 3131 Katella Avenue, Los Alamitos, CA

Tel: 562-981-3840

Declare under sole responsibility that the product identified herein, complies with 47CFR Part 2 and 15 of the FCC rules as a Class B digital device. Each product marketed, is identical to the representative unit tested and found to be compliant with the standards. Records maintained continue to reflect the equipment being produced can be expected to be within the variation accepted, due to quantity production and testing on a statistical basis as required by 47CFR 2.906. Operation is subject to the following two conditions: (1) this device may not cause harmful interference, and (2) this device must accept any interface received, including interference that may cause undesired operation.

Trade Name: EPSON

Type of Product: LCD Projector

Model: H997B/H998B/H999B/HA00B/HA01B/HA08B

Options:

Product name	Model
Remote controller	2198635 xx (x=0-9), 2197353 xx (x=0-9)

Supplier's DECLARATION of CONFORMITY

According to 47CFR, Part 2 and 15 for
 Other Class B digital devices & peripherals

We: Epson America, Inc.

Located at: 3131 Katella Avenue, Los Alamitos, CA

Tel: 562-981-3840

Declare under sole responsibility that the product identified herein, complies with 47CFR Part 2 and 15 of the FCC rules as a Class B digital device. Each product marketed, is identical to the representative unit tested and found to be compliant with the standards. Records maintained continue to reflect the equipment being produced can be expected to be within the variation accepted, due to quantity production and testing on a statistical basis as required by 47CFR 2.906. Operation is subject to the following two conditions: (1) this device may not cause harmful interference, and (2) this device must accept any interface received, including interference that may cause undesired operation.

Trade Name: EPSON

Type of Product: FINGER TOUCH UNIT

Model: ELPFT01

Since the Easy Interactive Pen is small, FCC Statement is written in the manual.

FCC Statement for the Easy Interactive Pen

This device complies with Part 15 of the FCC Rules. Operation is subject to the following two conditions: (1) this device may not cause harmful interference, and (2) this device must accept any interference received, including interference that may cause undesired operation.

FCC Compliance Statement For United States Users

This device complies with part 15 of the FCC Rules. Operation is subject to the following two conditions: (1) This device may not cause harmful interference, and (2) this device must accept any interference received, including interference that may cause undesired operation.

This equipment has been tested and found to comply with the limits for a Class B digital device, pursuant to Part 15 of the FCC Rules. These limits are designed to provide reasonable protection against harmful interference in a residential installation. This equipment generates, uses, and can radiate radio frequency energy and, if not installed and used in accordance with the instructions, may cause harmful interference to radio communications. However, there is no guarantee that interference will not occur in a particular installation. If this equipment does cause interference to radio and television reception, which can be determined by turning the equipment off and on, the user is encouraged to try to correct the interference by one or more of the following measures.

- Reorient or relocate the receiving antenna.
- Increase the separation between the equipment and receiver.
- Connect the equipment into an outlet on a circuit different from that to which the receiver is connected.
- Consult the dealer or an experienced radio/TV technician for help.

WARNING

The connection of a non-shielded equipment interface cable to this equipment will invalidate the FCC Certification or Declaration of this device and may cause interference levels which exceed the limits established by the FCC for this equipment. It is the responsibility of the user to obtain and use a shielded equipment interface cable with this device. If this equipment has more than one interface connector, do not leave cables connected to unused interfaces. Changes or modifications not expressly approved by the manufacturer could void the user's authority to operate the equipment.

Indication of the manufacturer and the importer in accordance with requirements of EU directive

Manufacturer: SEIKO EPSON CORPORATION

Address: 3-5, Owa 3-chome, Suwa-shi, Nagano-ken 392-8502 Japan

Telephone: 81-266-52-3131

<http://www.epson.com/>

Importer: EPSON EUROPE B.V.

Address: Atlas Arena, Asia Building, Hoogoorddreef 5,1101 BA Amsterdam
Zuidoost

The Netherlands

Telephone: 31-20-314-5000

<http://www.epson.eu/>

Restriction of Use

When this product is used for applications requiring high reliability/safety such as transportation devices related to aviation, rail, marine, automotive etc.; disaster prevention devices; various safety devices etc; or functional/precision devices etc, you should use this product only after giving consideration to including fail-safes and redundancies into your design to maintain safety and total system reliability. Because this product was not intended for use in applications requiring extremely high reliability/safety such as aerospace equipment, main communication equipment, nuclear power control equipment, or medical equipment related to direct medical care etc, please make your own judgment on this product's suitability after a full evaluation.

Operating System References

- Microsoft® Windows® 7 operating system

- Microsoft® Windows® 8.1 operating system
- Microsoft® Windows® 10 operating system
- Microsoft® Windows Server® 2012 operating system
- Microsoft® Windows Server® 2016 operating system

In this guide, the operating systems above are referred to as "Windows 7", "Windows 8.1", "Windows 10", "Windows Server 2012", and "Windows Server 2016". Furthermore, the collective term "Windows" is used to refer to them all.

- OS X 10.11.x
- macOS 10.12.x
- macOS 10.13.x
- macOS 10.14.x
- macOS 10.15.x

In this guide, the operating systems above are referred to as "OS X 10.11.x", "macOS 10.12.x", "macOS 10.13.x", "macOS 10.14.x", and "macOS 10.15.x". Furthermore, the collective term "Mac" is used to refer to them all.

Trademarks

EPSON is a registered trademark, EXCEED YOUR VISION and its logos are registered trademarks or trademarks of Seiko Epson Corporation.

Mac, OS X, and macOS are trademarks of Apple Inc.

Microsoft, Windows, and Windows Server are trademarks or registered trademarks of Microsoft Corporation in the United States and/or other countries.

Wi-Fi™, WPA2™, WPA3™, and Miracast™ are trademarks of Wi-Fi Alliance®.

App Store is a service mark of Apple Inc.

Chrome, Chromebook, and Google Play are trademarks of Google LLC.

HDMI, the HDMI Logo and High-Definition Multimedia Interface are trademarks or registered trademarks of HDMI Licensing Administrator, Inc.



"QR Code" is a registered trademark of DENSO WAVE INCORPORATED.

PJLink trademark is a trademark applied for registration or is already registered in Japan, the United States of America and other countries and areas.

Foxit PDF SDK Copyright ©2011, Foxit Software Company
www.foxitsoftware.com, All rights reserved.

Crestron®, Crestron Connected®, Crestron Fusion®, Crestron Control®, and Crestron RoomView® are registered trademarks of Crestron Electronics, Inc.

Art-Net™ Designed by and Copyright Artistic Licence Holdings Ltd.

Ubuntu and Canonical are registered trademarks of Canonical Ltd.

Intel® is a registered trademark of Intel Corporation in the U.S. and/or other countries.

Eneloop® is a registered trademark of the Panasonic Group.

Other product names used herein are also for identification purposes only and may be trademarks of their respective owners. Epson disclaims any and all rights in those marks.

Copyright Notice

All rights reserved. No part of this publication may be reproduced, stored in a retrieval system, or transmitted in any form or by any means, electronic, mechanical, photocopying, recording, or otherwise, without the prior written permission of Seiko Epson Corporation. No patent liability is assumed with respect to the use of the information contained herein. Neither is any liability assumed for damages resulting from the use of the information contained herein.

Neither Seiko Epson Corporation nor its affiliates shall be liable to the purchaser of this product or third parties for damages, losses, costs, or expenses incurred by the purchaser or third parties as a result of: accident, misuse, or abuse of this product or unauthorized modifications, repairs, or alterations to this product, or (excluding the U.S.) failure to strictly comply with Seiko Epson Corporation's operating and maintenance instructions.

Seiko Epson Corporation shall not be liable against any damages or problems arising from the use of any options or any consumable products other than

those designated as Original Epson Products or Epson Approved Products by Seiko Epson Corporation.

The contents of this guide may be changed or updated without further notice.

Illustrations in this guide and the actual projector may differ.

Copyright Attribution

This information is subject to change without notice.

© 2020 Seiko Epson Corporation

2020.5 413960700EN