

# Canon



*ivy*  
**cliq+2**

**Instant Camera Printer**  
User Manual

# CONTENT

<b>SAFETY INFORMATION</b> Read Before Use	<b>P. 3-4</b>
<b>OVERVIEW</b> Supplied Items Product Features	<b>P. 5</b>
<b>SETUP</b> Charging Loading Paper External Memory	<b>P. 6-9</b>
<b>OPERATION</b> Power ON/OFF Taking and Printing a Photo Viewfinder Selfie Mirror Shooting Modes Filter and Border Buttons Live View Shoot	<b>P. 10-15</b>
<b>LED INDICATOR</b> Troubleshooting	<b>P. 16-18</b>
<b>SPECIFICATIONS</b>	<b>P. 19</b>
<b>INSTALLING APP</b>	<b>P. 20-21</b>
<b>PAIRING MOBILE DEVICE &amp; INSTANT CAMERA PRINTER</b> Android and iOS Pairing Android Pairing (with NFC)	<b>P. 22-24</b>
<b>USER INTERFACE</b> Home Screen Main Menu Printer Setting Photo Album Send a Photo to Mini Print App Edit Photo Using Tile Print Using Collage Print Pre-cut Sticker Print Smartphone Camera Print from IVY CLIQ+2 MicroSD Card Print Quene	<b>P. 25-38</b>

# SAFETY INFORMATION

## READ BEFORE USE

Please read the following instructions and safety precautions before using the device.

For regulatory and additional safety information, refer to the Regulation and Warranty Information sheet included in your package contents.

### RMN: PP2002

Regulatory Model Identification Number is assigned for regulatory identification purpose.



## WARNING

Used to indicate a potentially hazardous situation which, if not avoided, could result in death or serious injury.

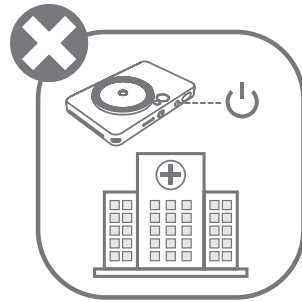
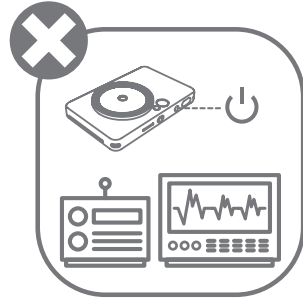
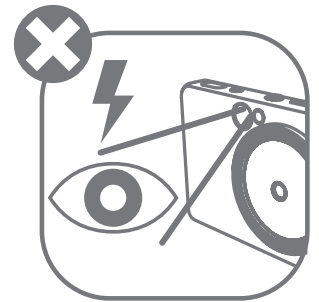
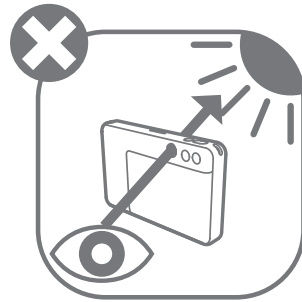
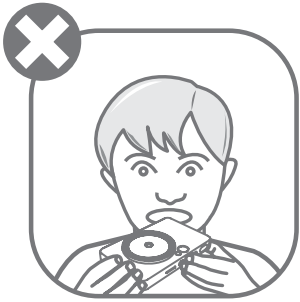

- Keep away from children and infants. Improper use of this product may cause suffocation or accident.
- Stop using the device immediately if it emits smoke or a strange smell, or otherwise behaves abnormally.
- Do not look at the sun or bright lights through the viewfinder or the lens. Blindness or vision problems could result.
- Do not fire the flash near the eyes. It may hurt the eyes.
- A strap wound around a child's neck may result in asphyxiation. If your product uses a power cord, mistakenly winding the cord around a child's neck may result in asphyxiation.
- Turn the device off in places where camera use is prohibited. The electromagnetic waves emitted by the camera may interfere with the operation of electronic instruments and other devices. Exercise adequate caution when using the product in places where use of electronic devices is restricted, such as inside airplanes and medical facilities.



## CAUTION

Used to indicate the level of a hazard or damage which, if product is handled erroneously, may result in injury or property damage other than product faults.

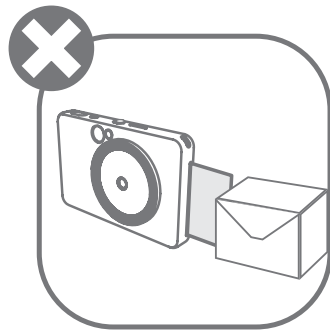
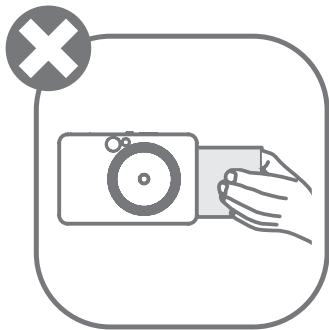
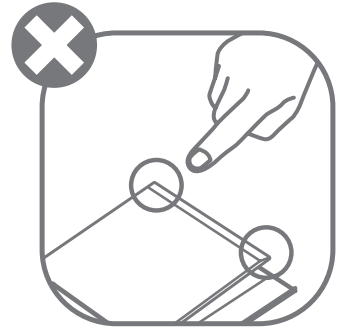
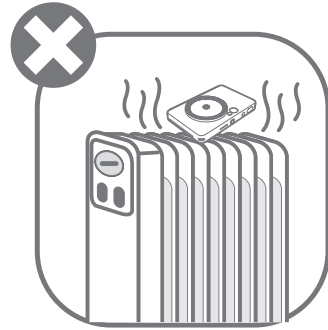

- When operating in extreme weather, the device might not print. Let the printer temperature adjust to the recommended operating temperature of 59° to 90°F (15° to 32°C), before attempting to print again.
- When charging, please charge the device at the recommended temperature of 59° to 90°F (15° to 32°C).
- Use a soft dry cloth to clean the device. Do not clean with a damp cloth or volatile liquids such as paint thinner.
- Keep the top cover closed to avoid dust and other particles from entering the inside of the device.
- If the device is not functioning properly, please contact the dealer you purchased this product from or Canon Service & Support at [www.usa.canon.com/support](http://www.usa.canon.com/support)
- Never expose the battery to high temperatures, direct heat, or dispose by incineration.
- Electromagnetic interference or electrostatic discharge may cause the device to malfunction or the memory to be lost or altered. Should this occur, use a pin, or similar item to press the [RESET] button at the bottom of the device.

# OVERVIEW

## SUPPLIED ITEMS

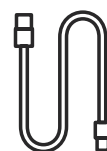
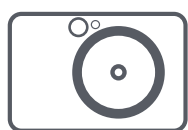

Instant Camera Printer

Quick Start Guide

Regulation and  
Warranty  
Information sheet

CANON ZINK®  
Photo Paper  
(10 sheet)

USB Cable

Wrist Strap

## PRODUCT FEATURES

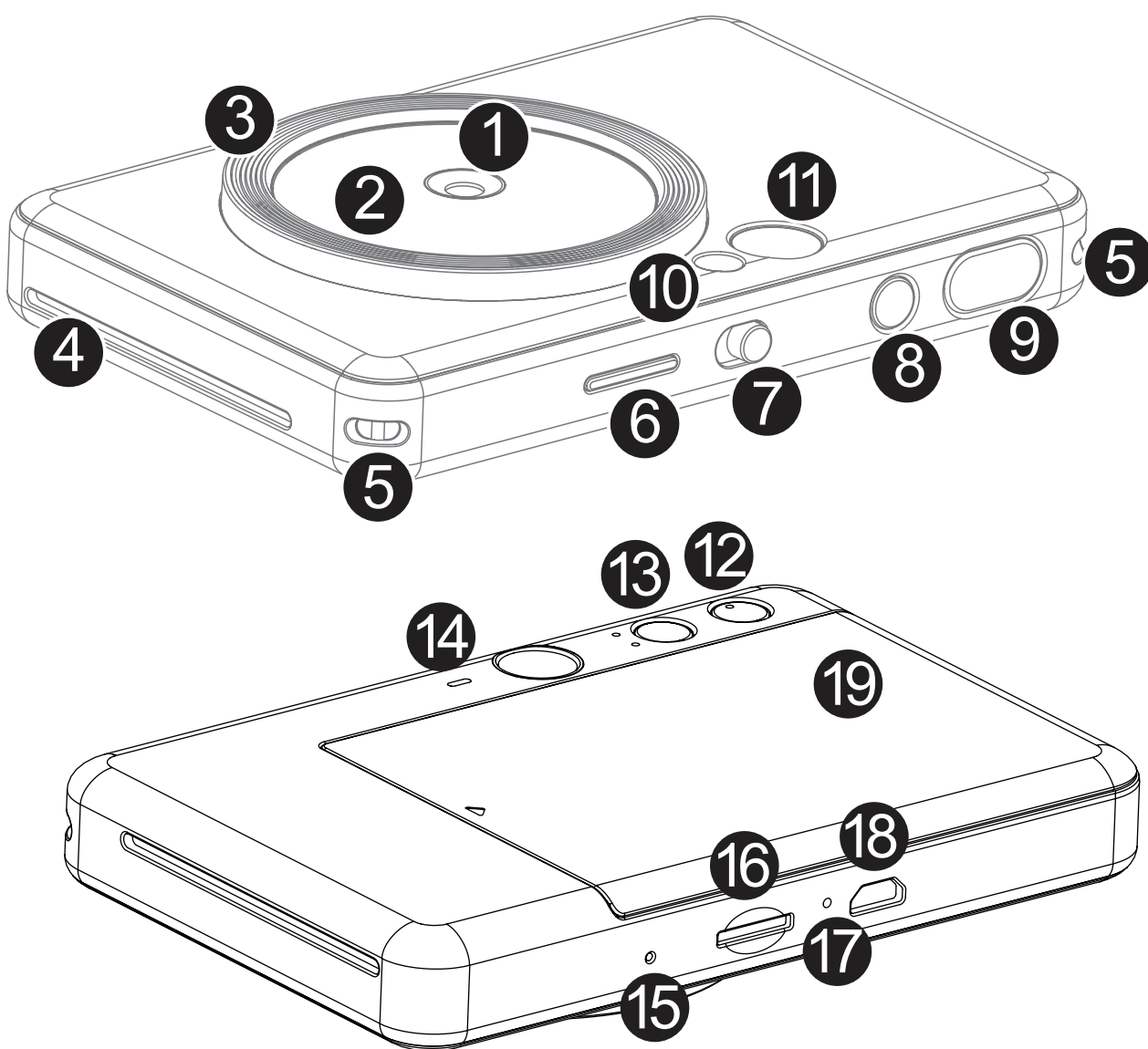

- 1 Camera Lens
- 2 Selfie Mirror
- 3 Ring Light (8 LEDs)
- 4 Print Output Slot
- 5 Wristband Eyelet
- 6 Status LED
- 7 Slide Switch
- 8 Power Button
- 9 Shutter Button
- 10 Flash
- 11 Viewfinder
- 12 Border Button
- 13 Filter Button
- 14 Speaker
- 15 Reset Button  
\*To reset the device, press with a pin
- 16 MicroSD Card Slot (up to 256GB)
- 17 Charging Status LED
- 18 Micro USB Port
- 19 Printer Cover

# SETUP

## CHARGING

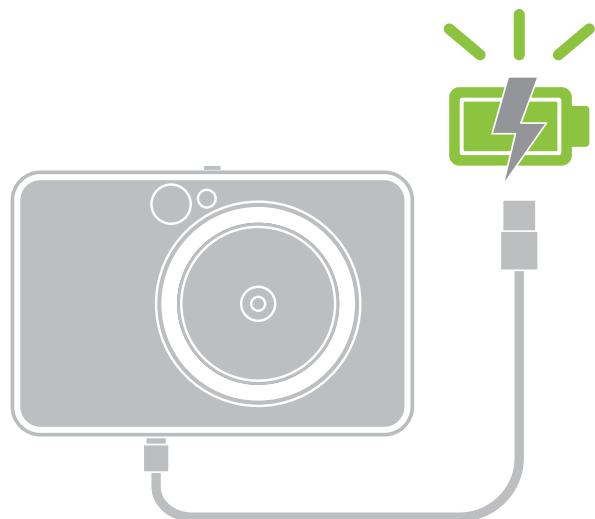

### Charging status LED

Charging: Red

Fully Charged: Green



The device has a built-in battery. Please fully charge the device via the USB cable provided before using.

- 1 Insert the smaller end of the supplied USB cable into the device and other end into a chargeable USB adapter.
- 2 The charging LED light will turn red to indicate charging.
- 3 Once fully charged, the charging LED will turn green.
  - Operating time may vary depending on the battery status, operational status and environment conditions.

**\* Make sure to fully-charge your IVY CLIQ product(s) at least once every three (3) months. If the product is not charged/used for an extended period of time, you may not be able to charge the built-in battery and the product may no longer power on.**

## NOTE

### ABOUT USB CABLE

#### HANDLE THE USB CABLE WITH CARE WHILE CHARGING

- Do not place any heavy objects on top of the cable.
- Do not place the USB cable near heat.
- Do not scratch, damage, twist or pull hard on the cable.
- Do not plug or unplug the cable with wet hands.
- Avoid too high/too low temperature or humid conditions.
- Please unplug the USB cable from power source after charging.
- Please use the supplied USB cable for charging.

## LOADING PAPER

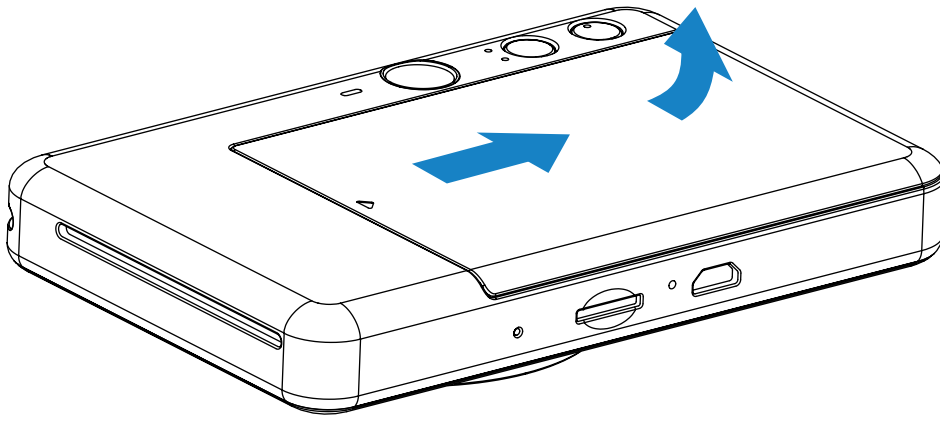

- 1 Remove the cover by sliding it forward in the direction of the arrow.

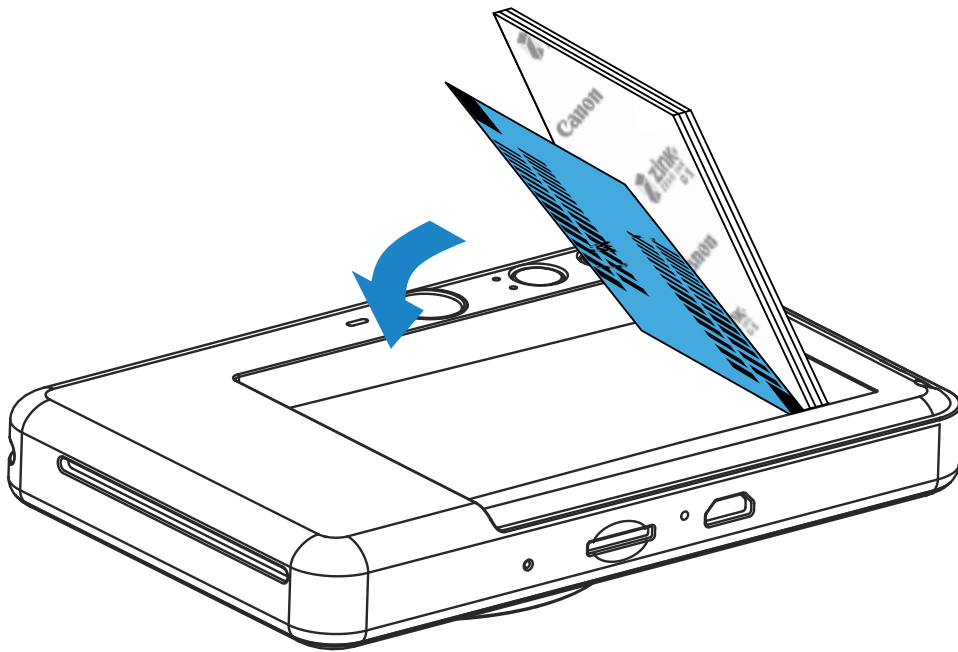

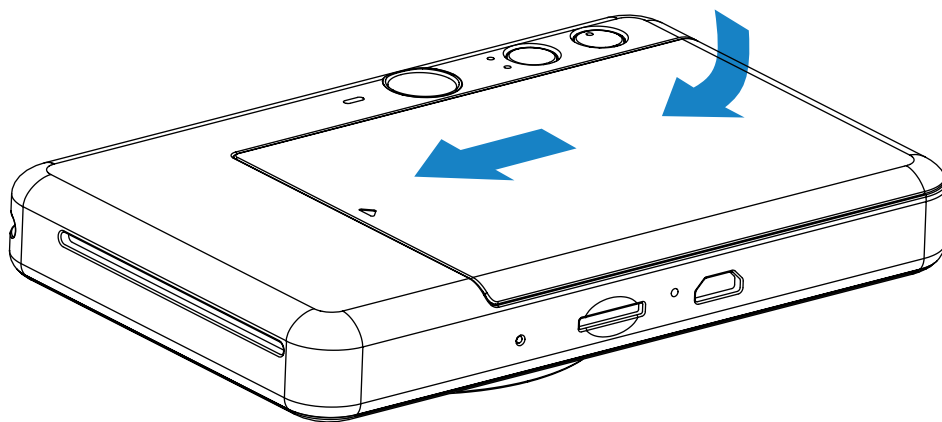

- 2 Open a single pouch of photo paper (10 sheets + blue SMART SHEET®).
- 3 Place all 10 photo paper sheets and the one blue SMART SHEET® into the photo paper compartment.
  - Stack the photo paper on top of the blue SMART SHEET®, making sure the barcode and the photo paper logos are facing down.

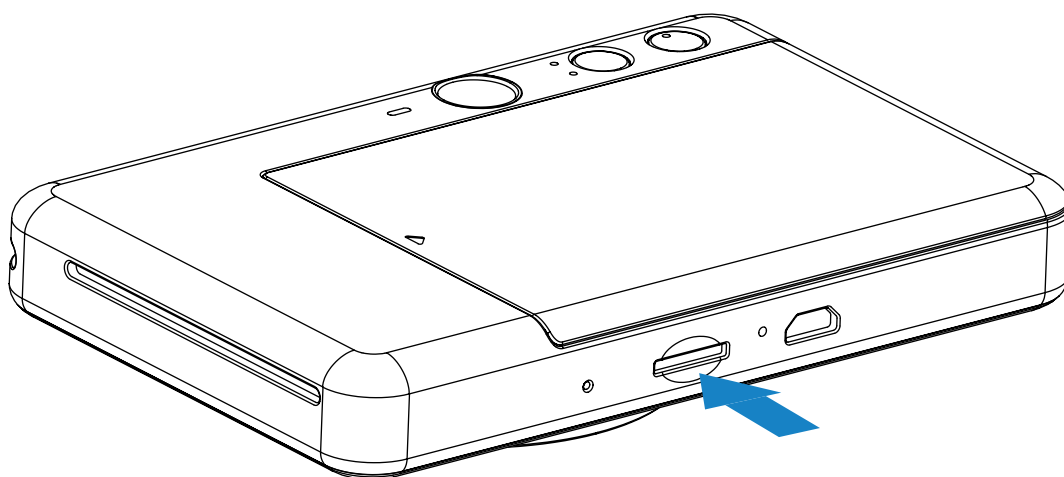

- 4 Place the top cover back onto the device. It should click into place when closed properly.
  - The blue SMART SHEET® will be sent through the device automatically before the first print.

## EXTERNAL MEMORY



 An external MicroSD card (up to 256 GB) is needed for saving captured photos. Only FAT16, FAT32 and exFAT format are supported.

### PREPARING A MEMORY CARD

Use the following memory cards (sold separately)

- MicroSD memory cards \*1
- MicroSDHC memory cards \*1 \*2
- MicroSDXC memory cards \*1 \*2

\*1 Cards conforming to SD standards. However, not all memory cards have been verified to work with the camera.

\*2 UHS-I memory cards are also supported.

### INSERT AND REMOVE THE MicroSD CARD

- Insert the MicroSD card into the slot at the bottom of the device. You will feel a slight click when the card is fully inserted .
- Push on the top of the card to release it. Gently pull to fully remove the card from the device.
- If there is an error reading /writing to the MicroSD card, the MicroSD Error LED indication will be displayed. Remove the MicroSD card and restart the device.
- Connect the device to a computer with the USB cable provided. Double-click the external drive image when it appears on the computer to view and save the photos.

### NOTE

#### MAINTAINING THE DEVICE

- Use and keep the device in the recommended environment of 59° to 90° F (15° to 32° C) and 40-55% relative humidity.
- Keep your device firmware up-to-date. Connect your device with the Canon Mini Print App. "Firmware Upgrade" icon will be appeared on the menu bar if new firmware is available.
  - Make sure your mobile device has an internet connection before checking. If you need to upgrade the firmware, your printer must be charged to 50% or higher.
- Make sure you're using the latest Canon Mini Print app version. If your apps don't automatically update, go to app store and check if you need to update.



## NOTE

---

### WHEN USING PHOTO PAPER



- Only load 10 photo paper sheets and 1 blue SMART SHEET®. Do not load more as it can result in paper jams or printing errors.
- For optimal print results, use photo paper for Canon Ivy.
  - You may purchase additional photo papers within the Canon Mini Print App by tapping "Buy Paper" in the main menu.
- If there is a paper jam, simply turn the printer OFF and ON to automatically clear the paper jam. Don't try to pull the paper out.
- While the device is printing, don't pull or tug on the photo paper.
- Handle photo paper carefully to avoid damage or bending.
- Keep the photo paper clean when loading. If photo paper is dirty or damaged, it may result in a paper jam or print error.
- Don't open a new pouch of photo paper until you are ready to load it into your device.
- Don't expose photo paper to direct sunlight or moisture.
- Don't leave your photo paper in an area where the temperature or humidity is out of the suggested conditions indicated on the pouch. It may reduce the quality of the printed photo.

### ABOUT THE BLUE SMART SHEET®

- Each pouch of photo paper contains 10 sheets of photo paper and 1 blue SMART SHEET®.
- Load the blue SMART SHEET® and photo paper from within the same pouch for optimal print quality. Each blue SMART SHEET® is specifically tuned for the pouch of paper it is contained in.
- The blue SMART SHEET® will be sent through the device automatically before the first print to clean the printer and optimize print quality for that specific paper pouch (10 sheets).
- Keep the blue SMART SHEET® and only discard after you have printed all 10 sheets of photo paper in the pouch. If print quality is not as expected, you can reuse the blue SMART SHEET® if the paper is still from the same pouch. Simply slide the blue SMART SHEET® with its barcode-side down underneath the remaining photo paper.
- Using a blue SMART SHEET® from a different pouch may result in reduced print quality.

# OPERATIONS

## POWER ON/OFF

- 1 Press and hold the Power button  until the LED indicator light turns on.
- 2 When the LED indicator turns to a steady white, the device is ready to Use.
- 3 Press and hold the Power button  to turn off the device.

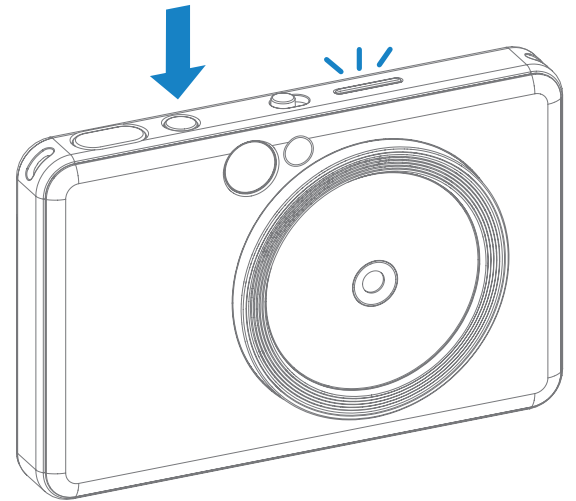

### AUTO POWER OFF

- When the device is idle for about 3 minutes (default), it will automatically power off. User can resume the device by pressing the Power button again.
- User can change the time (3 minutes / 5 minutes / 10 minutes) in the APP.

## TAKING AND PRINTING A PHOTO

- 1 Hold the device, confirm the desired composition of the image.
- 2 Press the Shutter button  to take a photo. The camera will automatically trigger the flash if it is necessary for the lighting conditions.
- 3 The photo will be printed out immediately after taking the photo, if paper is inserted. The device can hold up to around 10 images at a time to print, it depends on MicroSD card\* capacity.

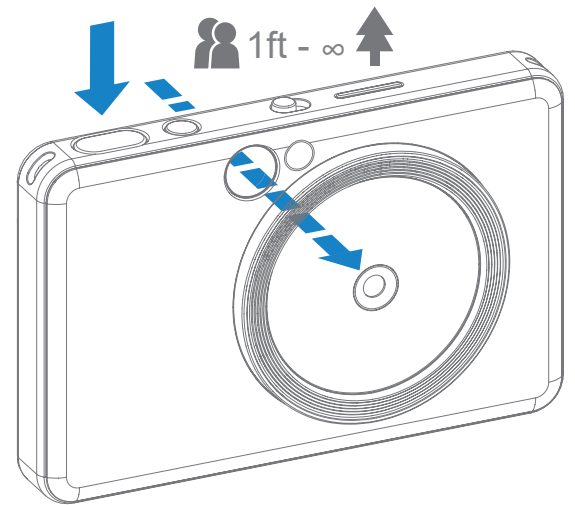

- \* Print queue will be cleared once the device is powered off and cannot be resumed.
  - \* If no MicroSD card is inserted, the device can hold up to 5 images at a time to print.
- 4 User can take photos with the device even with no paper if MicroSD card is inserted, photos will be saved in MicroSD card.

## VIEWFINDER

Compose an image with the frame mark in the viewfinder.

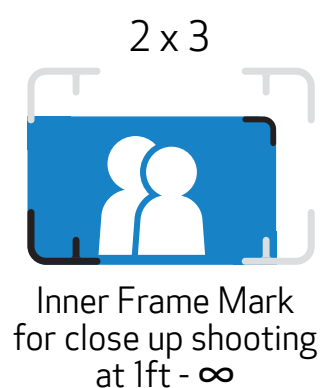
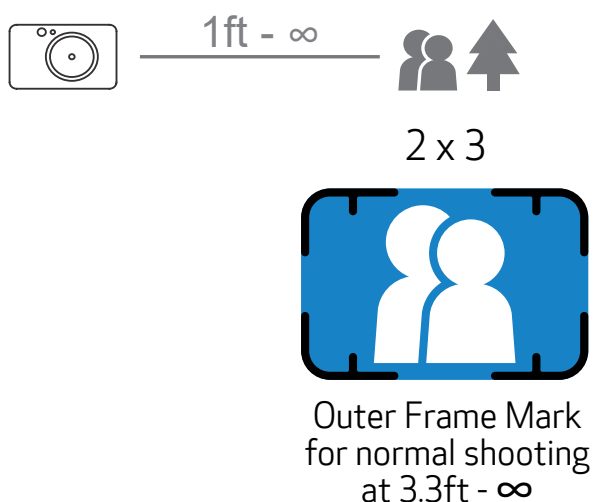

## SELFIE MIRROR

Compose an image with the frame mark in the Selfie Mirror.

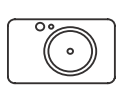

1.6ft - ∞



2 x 3



Focusing distance  
at 1.6ft



## SHOOTING MODES

You can select the different camera modes by the Slide Switch at the top of the device for different scenarios.



Mode	Landscape	Portrait	Selfie
<b>Symbols</b>			
<b>Metering (Metering in case Human Face)</b>	Center Average (Keep Center Average)	Center Average (Face area weighted)	Center Average (Face area weighted)
<b>Focusing (Focusing in case Human Face detectd)</b>	Center (Keep Center)	Center (Focus to human face)	Center (Focus to human face)
<b>Flash</b>	Flash OFF & Ring Light OFF	Flash AUTO & Ring Light OFF	Flash ON & Ring Light ON

Note: If you are about to take a selfie, the ring shape 8 LED Ring Light around the lens gives you uniform illumination on your face. It reduces the level of shadow and allows you to take beautiful shots of your face as a whole, and create a uniform brightness across the entire photo.

\* Effective Ring Light Range: 30cm - 60cm

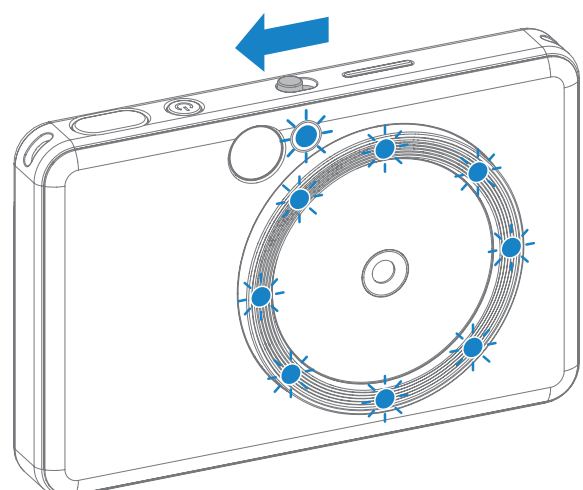

## FILTER AND BORDER BUTTONS

Easily add a filter or border to your photos right on the camera.



### FILTER

User can add either black and white or vivid filter to a photo by pressing  button before taking photo.



Without Filter  
without Border





Black & White Filter  
without Border



Vivid Filter  
without Border

### BORDER

- User can add border to a photo by pressing  button before taking photo.
- User can customize border through Canon Mini Print App after connected the device with compatible smartphone (white border is default).

- 1 Go to the Home Screen, press "Go wireless!" --> "Snap".
- 2 Press  to edit border.  
Setting
- 3 Select type of border you like and choose a color, then press  to confirm.

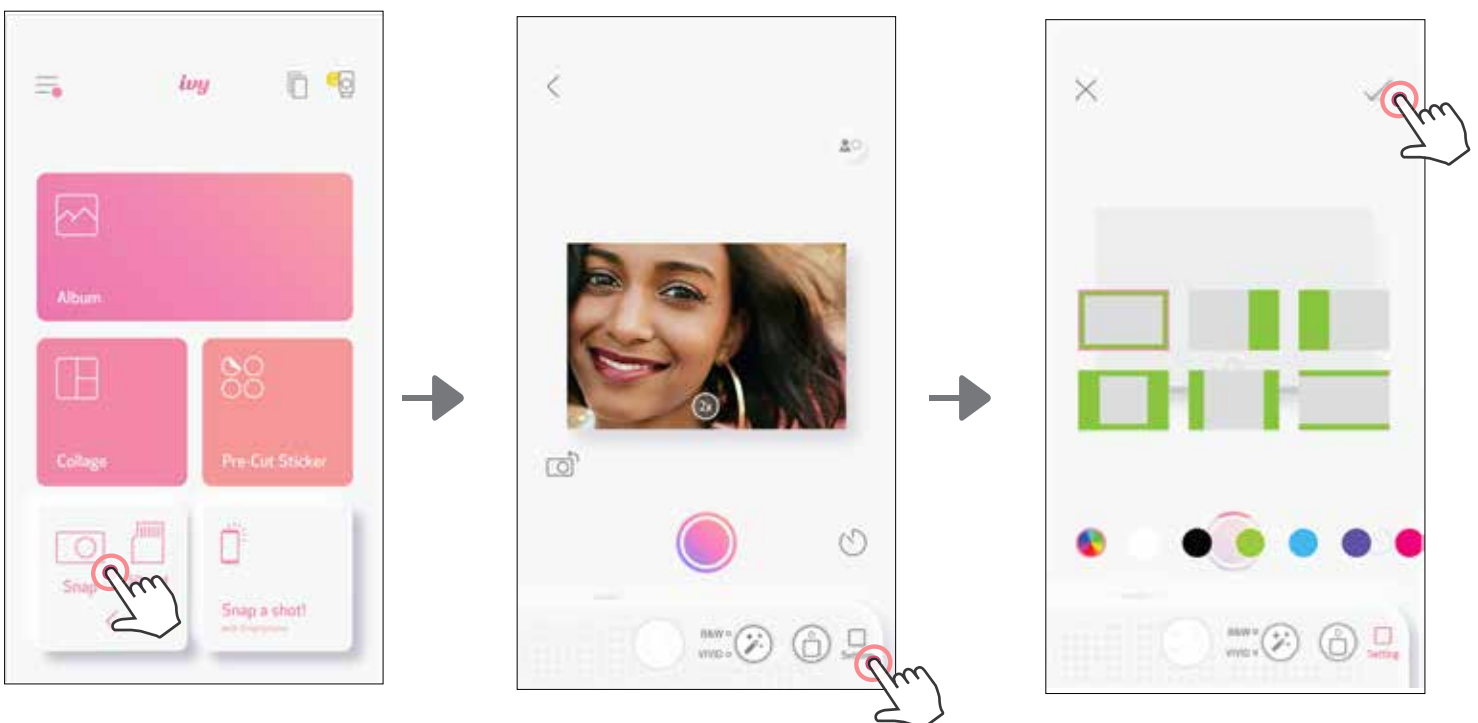

# LIVE VIEW SHOOT

User can remotely control the device through the App such as taking photos.  
Go to the Home Screen to enter the Live View Page.

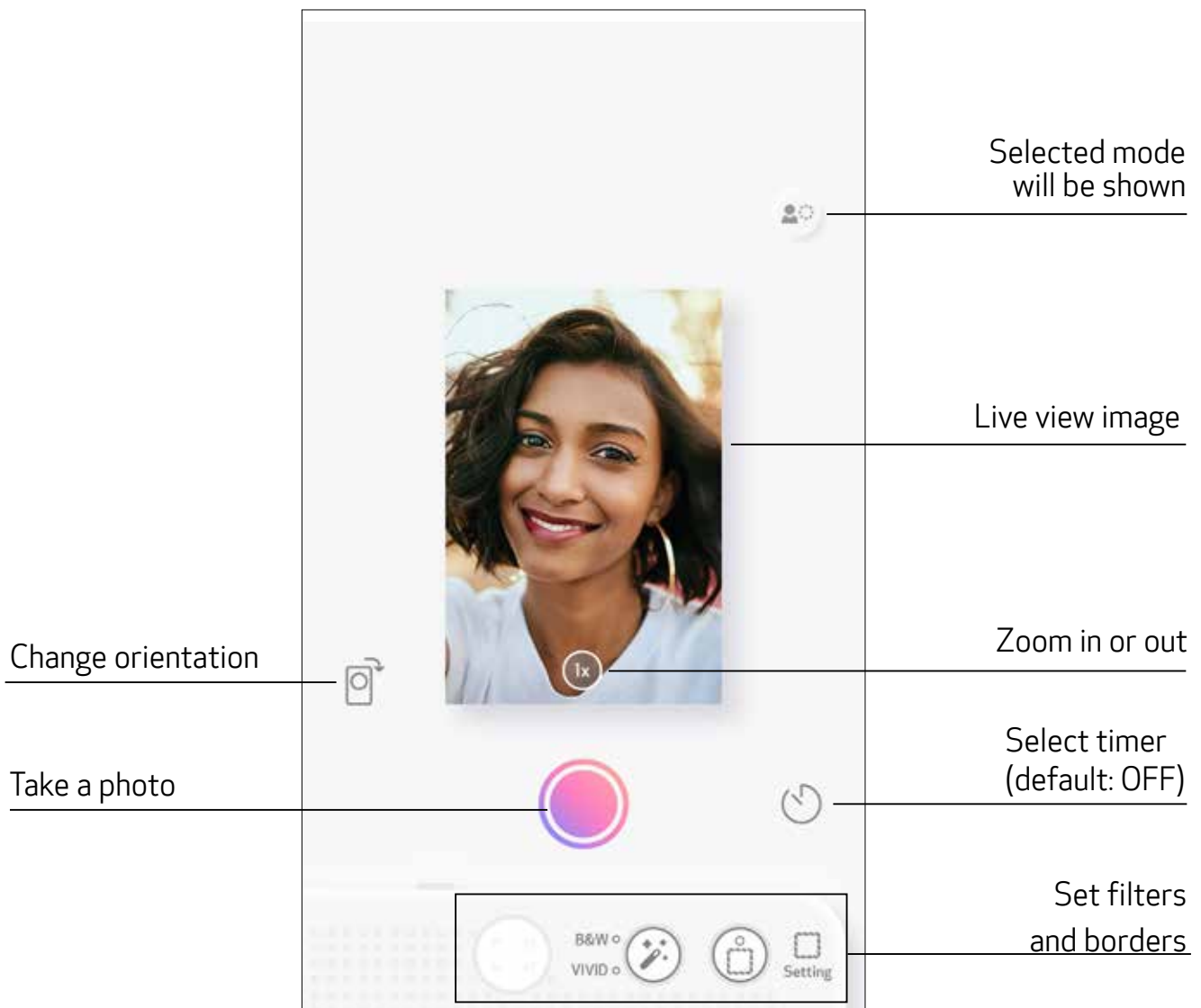

## SHOOT & PRINT

Press  to capture a photo. And press  to confirm to print.

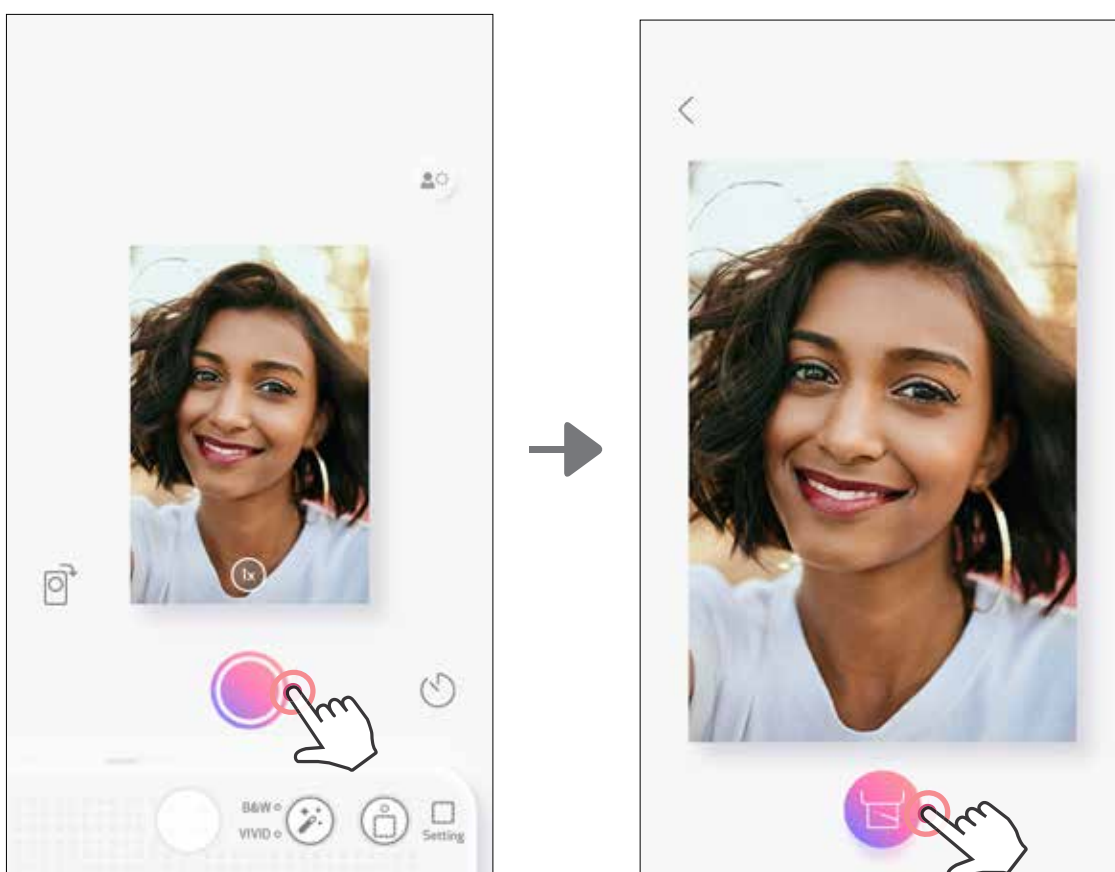

## TIMER

Press  to capture a photo instantly. Press  and select 3 seconds/ 5 seconds/ 10 seconds timer (default: OFF), press  to begin the countdown.

- The LED light around the selfie mirror will alert you if the timer is enabled.

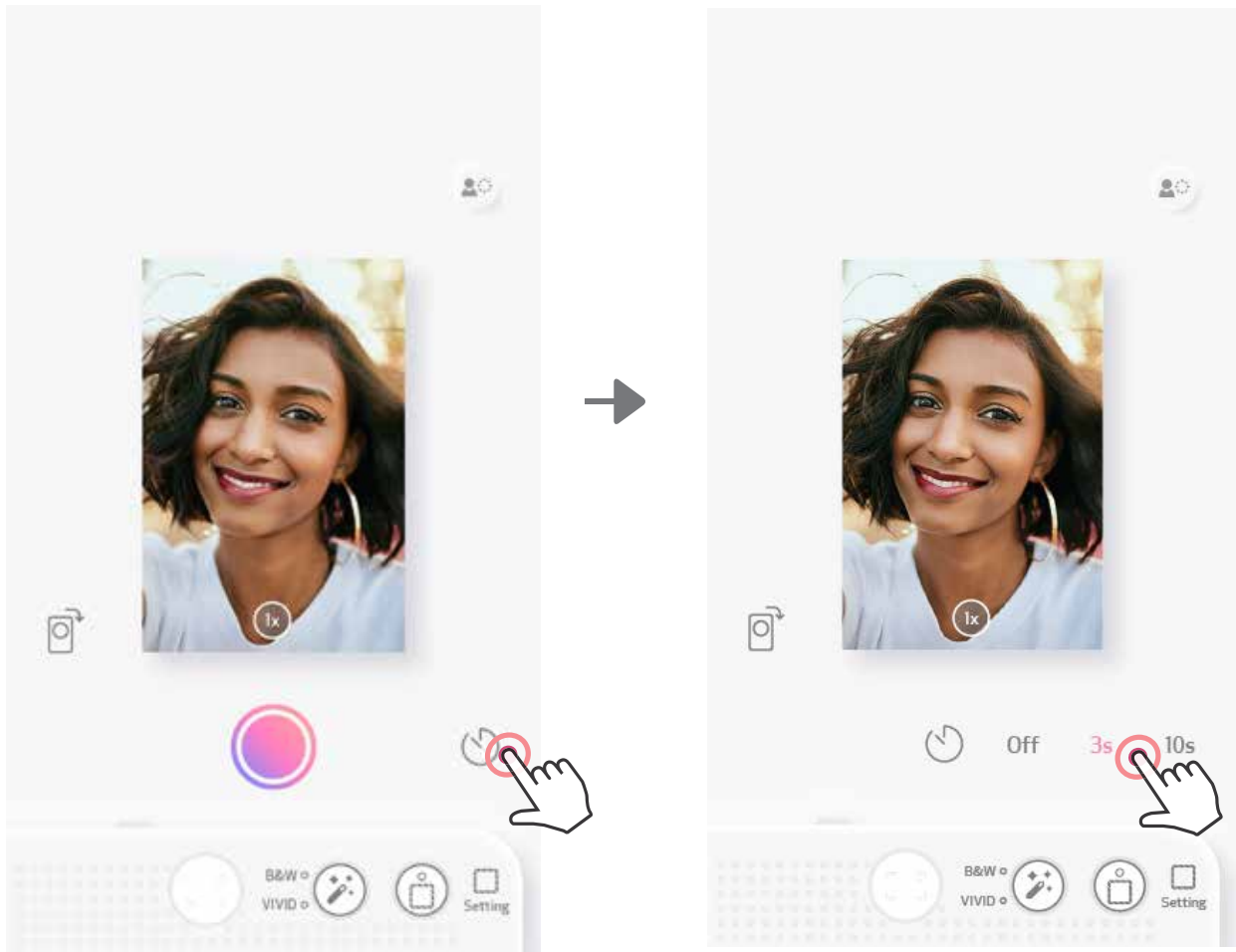

## ZOOM

Press  to zoom in.

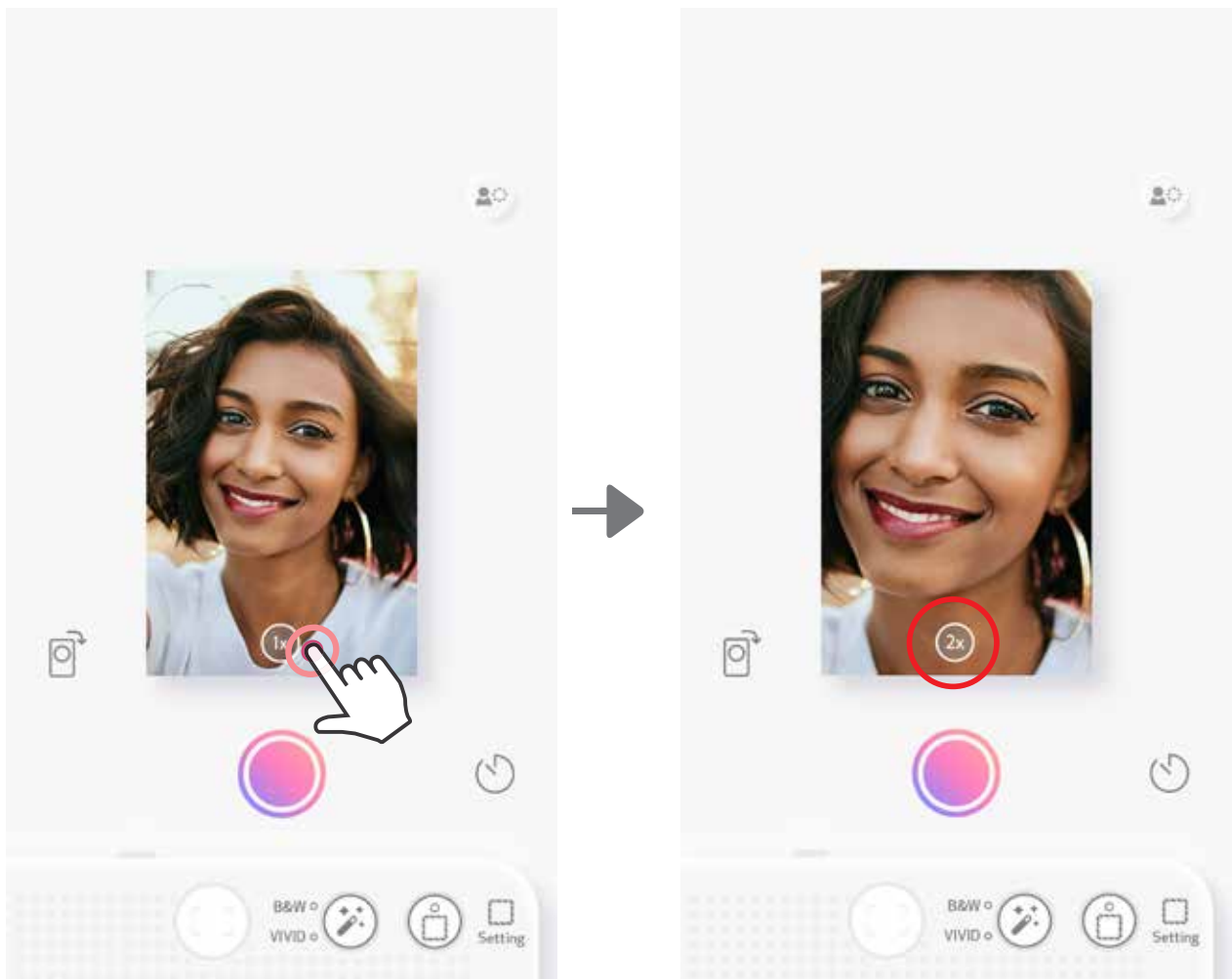





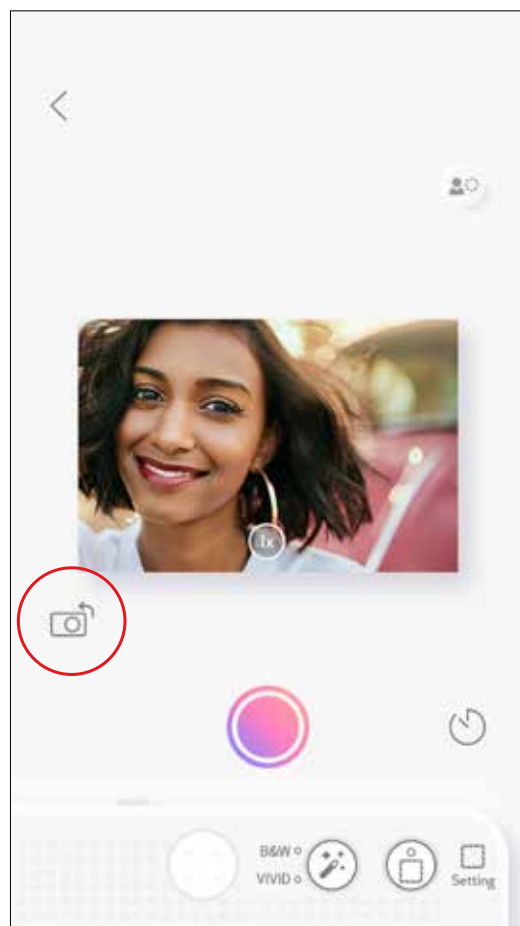
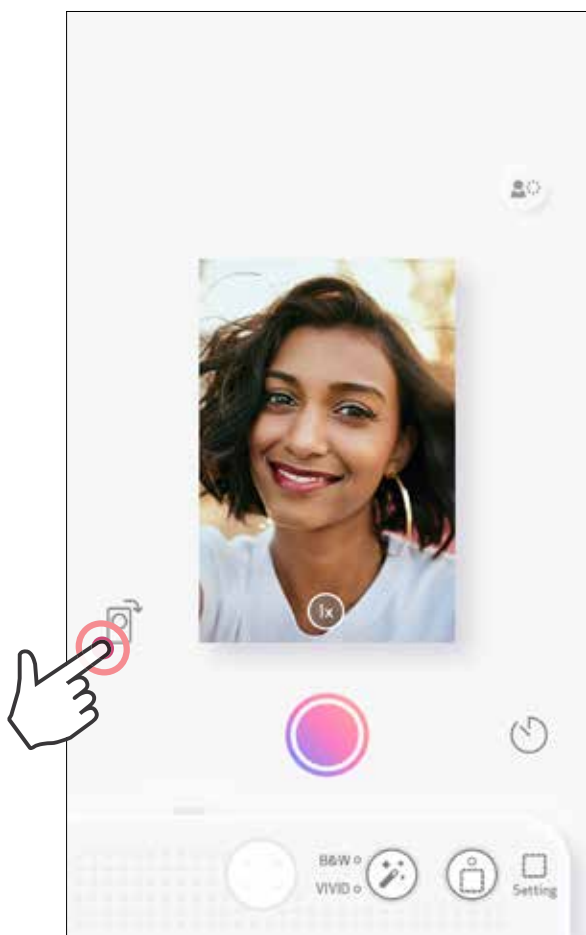





## ORIENTATION

Press  to switch between horizontal and vertical.



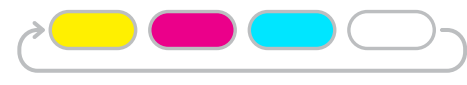

# LED INDICATOR



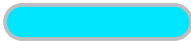
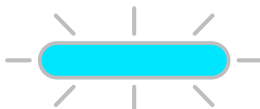

Status	Mode LED	Status LED
<b>Power On</b>	Press and hold Power button	 >  White White
<b>Standby</b>	After the device is powered on	 White
<b>Power Off</b>	Press and hold Power button	 Off
<b>Blue SMART SHEET® Error</b>	When the device detects wrong blue SMART SHEET® is inserted, or other blue SMART SHEET® error	 Blue
<b>Processing blue SMART SHEET®</b>	When the device is loading blue SMART SHEET®	 White
<b>No Paper and no SD card inserted</b>	When the device has on paper and no SD card inserted, the device will not allow for taking a photo.	 Red
<b>Paper Jam/ Cover Open</b>	When there is a paper jam or the printer cover is opened	 Red
<b>Get Ready for Printing</b>	Preparing for printing	 White
<b>Printing Photo</b>	When the device is printing a photo	 Yellow >Magenta>Cyan>White (Looping)
<b>MS Mode (Mass Storage Mode)</b>	Device is connected to a computer	 Magenta
<b>MicroSD Card Error</b>	Cannot write data into MicroSD Card	 Magenta



# LED INDICATOR

Status	Mode LED	Status LED
<b>Temperature Too High</b>	When device temperature is too hot	 Red (Until temperature returns to normal)
<b>Temperature Too Low</b>	When device temperature is too cold	 Cyan (Until temperature returns to normal)
<b>Printer Head Cooling</b>	Checking the printer head temperature and letting it cool down before printing	 Cyan
<b>Low Battery</b>	When battery level down to 20%	 White>Red (Looping)
<b>Firmware Upgrading</b>	When the device is updating firmware	 White

## TROUBLESHOOTING

Status	LED Indication	Actions
<b>MicroSD Card Error</b>	 Magenta	<ul style="list-style-type: none"> <li>• Check if the MicroSD card is inserted properly</li> <li>• Check if the MicroSD card is full</li> <li>• Check if the MicroSD card is corrupted</li> <li>• Check if the MicroSD card is compatible</li> </ul>
<b>Paper Feeding Failed</b>	 Red	<ul style="list-style-type: none"> <li>• Open the paper compartment cover to check if Canon ZINK® photo paper is inserted</li> </ul>
<b>Paper Jam</b>	 Red	<ul style="list-style-type: none"> <li>• Power off and on the device, the photo paper will be fed out automatically</li> </ul>
<b>Printer Cover is not closed properly</b>	 Red	<ul style="list-style-type: none"> <li>• Close the printer cover properly</li> </ul>
<b>Connection</b>	N/A	<ul style="list-style-type: none"> <li>• Make sure the smartphone bluetooth connection is properly set up</li> <li>• Make sure selection of device on the App is correct</li> <li>• Make sure smartphone OS is compatible and up to date</li> </ul>
<b>Remote Control Failed</b>	N/A	<ul style="list-style-type: none"> <li>• Make sure the device is connected with the App</li> <li>• Make sure the App and firmware are up to date</li> </ul>
<b>Customized Sound Failed</b>	N/A	<ul style="list-style-type: none"> <li>• Make sure the device is connected with the App</li> <li>• Make sure the app and firmware are up to date</li> </ul>
<b>Device does not Work</b>	N/A	<ul style="list-style-type: none"> <li>• Make sure the battery level is not too low. If it is, recharge the device</li> </ul>

# SPECIFICATIONS

Printing Technology	ZINK®
Printing Resolution	314 x 600 dpi (dots per inch)
Printing Speed	Approximately 50 seconds - Motor starts and stops, at room temperature 77 °F (25 °C)
Photo Aspect Ratio	2" x 3"
Compatible Paper	Canon Photo Paper : ZP-2030-20 (20 sheets) ZP-2030-50 (50 sheets) / 2" x 3" / Peel-and-Stick Back
Paper Capacity	Up to 10 sheets of photo paper + 1 blue SMART SHEET®
Photo Resolution	8MP
Focal Length	2.6mm
Aperture	f 2.2
Focusing Range	1ft (30 cm) - ∞
Sensitivity	Auto (ISO 100 - 1600)
Flash	YES (Auto)
Flash Range	1.6ft (0.5m)- 3.2ft (1m)
Memory Card	MicroSD Card, up to 256GB
Photo Format	JPEG
Power Source	Built-in Rechargeable Li-Polymer Battery 700mAh, 7.4V
Charging Speed	Approximately 120 minutes (Full Charge)
Power Adapter	Output Current : 1A (min) Voltage : 5V
Environment Parameters	<ul style="list-style-type: none"> <li>- Recommended Printing Operating, Charging, and Storage Temperature : 59° to 90° F (15° to 32° C)</li> <li>- Recommended Printing Operating, Charging, and Storage Humidity : 40-55% RH</li> <li>- Operating Temperature : 41° to 104° F (5° to 40° C)</li> <li>- Operating Humidity : &lt; 70% RH</li> </ul>
Automatically Power-Off	3 minutes / 5 minutes / 10 minutes (selectable in-app)
Dimension	4.8" (W) x 3.2" (H) x 0.9" (D) / 121mm (W) x 80.3mm (H) x 22.5mm (D)
Weight	6.6 oz / 188 g
Compatible OS (for computer)	Windows 7 / 8 / 8.1 / 10 Mac OSX 10.10-10.15
Connectivity	Bluetooth 5.0
Compatible OS	iOS 9.0 or above & Android 4.4 or above
Mobile Application	Canon Mini Print
Connection for Charging and Data Transfer	USB 2.0 (Micro USB)

All specifications are subject to change without notice

# INSTALLING APP

## OPTION ① SEARCH FOR "CANON MINI PRINT" IN APP STORES

For Android™ - from Google Play™

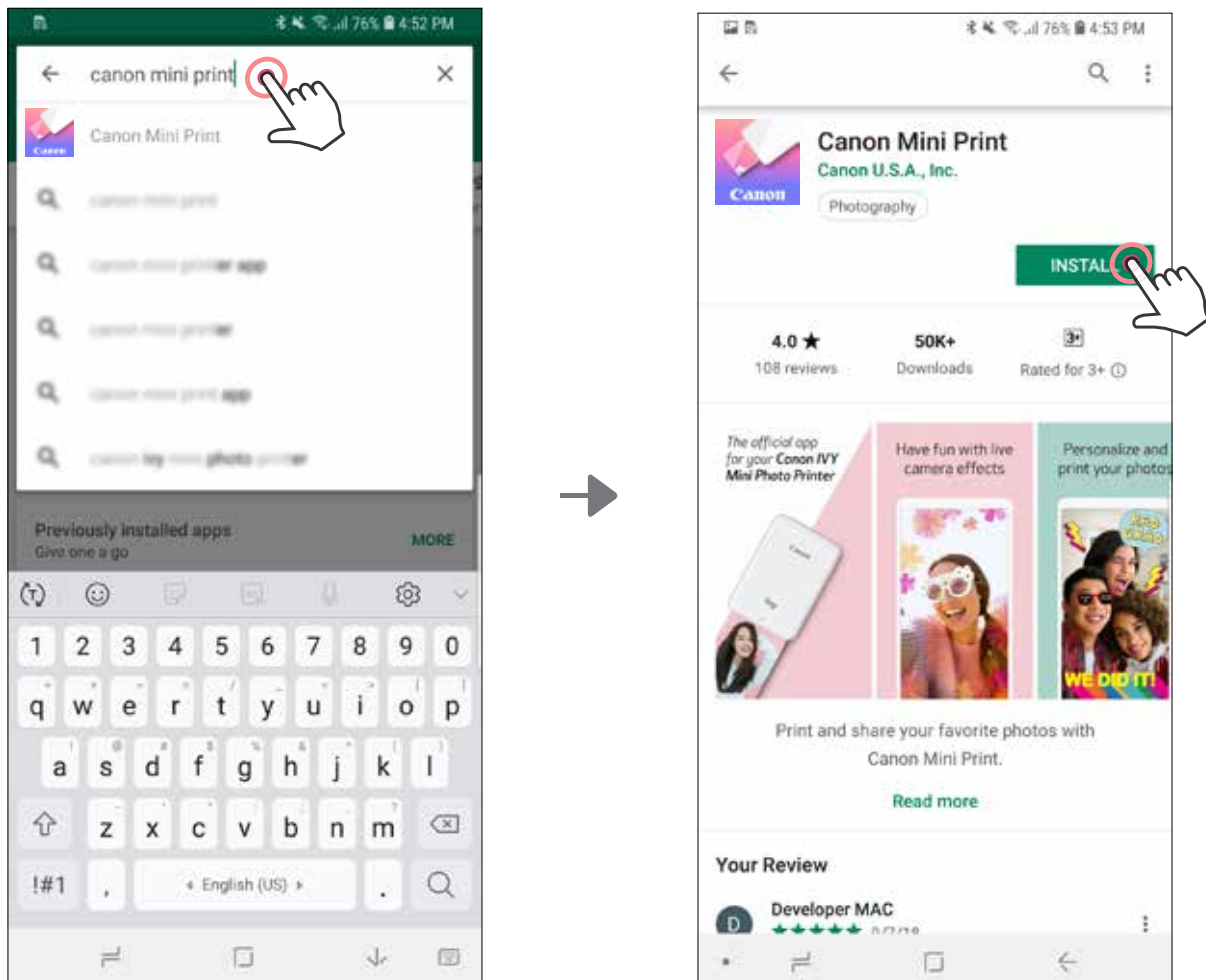

For iOS® - from the App Store®

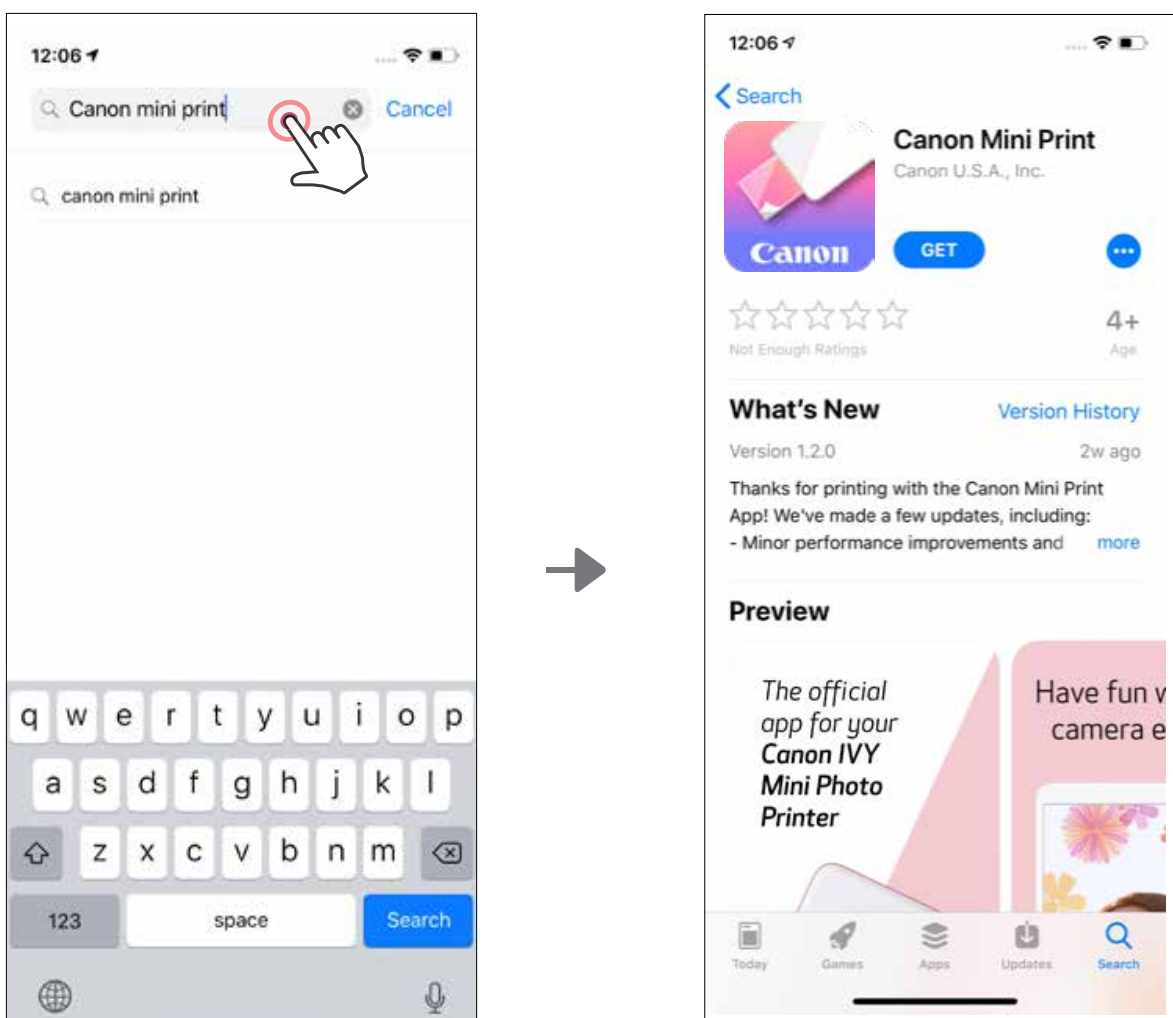

# OPTION ② USING QR CODE - SCAN THE QR CODE ON THE "QUICK START GUIDE"



For Android

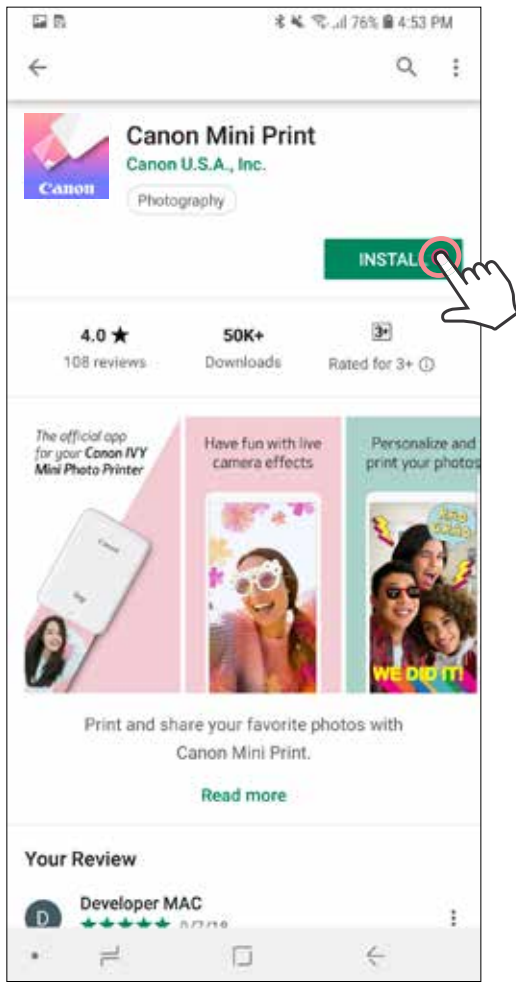

For iOS

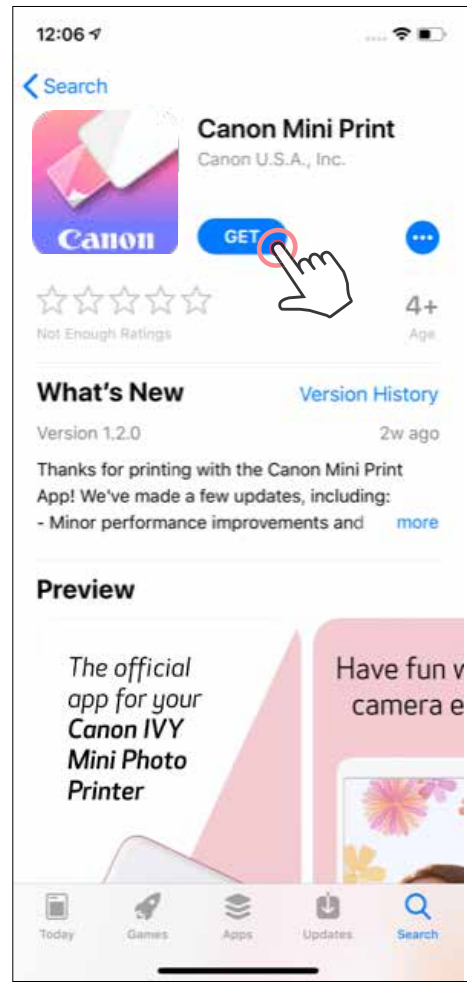

# OPTION ③ GO TO [HTTPS://APP.CANONMINIPRINT.COM/](https://app.canonminiprint.com/) WITH YOUR DEVICE INTERNET BROWSER

# OPTION ④ USING NFC - ANDROID ONLY

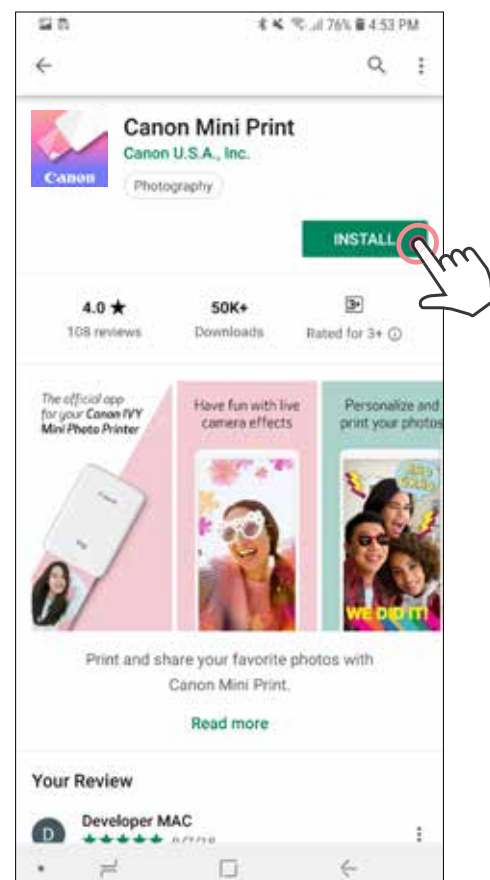
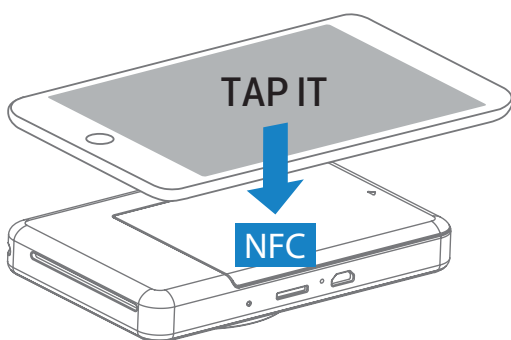

# PAIRING MOBILE DEVICE & INSTANT CAMERA PRINTER

## Android and iOS Pairing

- ① Turn on the printer by pressing and holding the Power button until the status LED light turns on.  
Open mobile device "Settings" to enable Bluetooth and pair it with the printer.
- ② **Pair** - Tap on the icon on the top right corner and choose your printer. The icon will change to indicate battery level after connected.

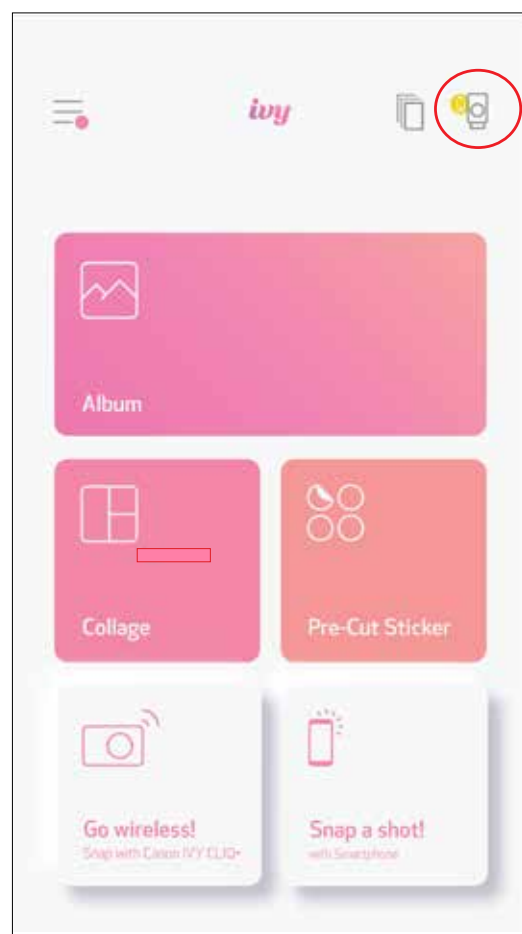
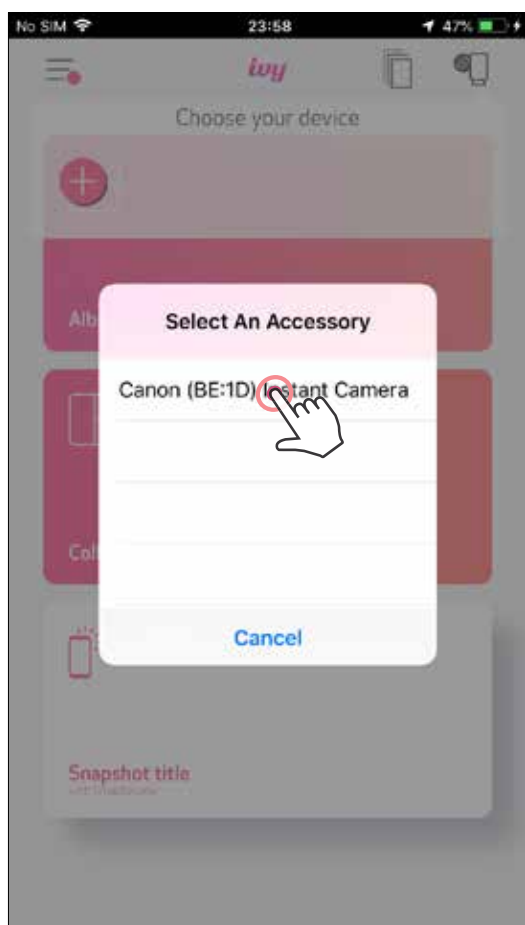
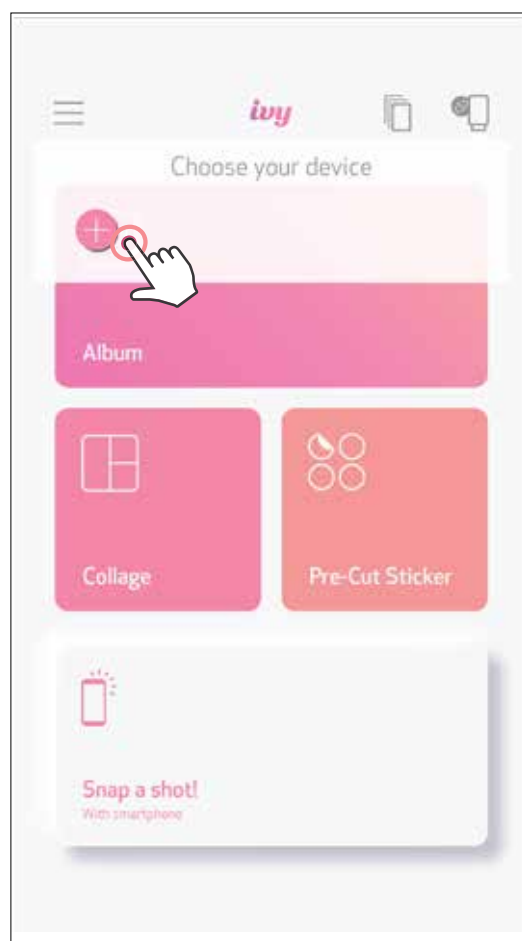
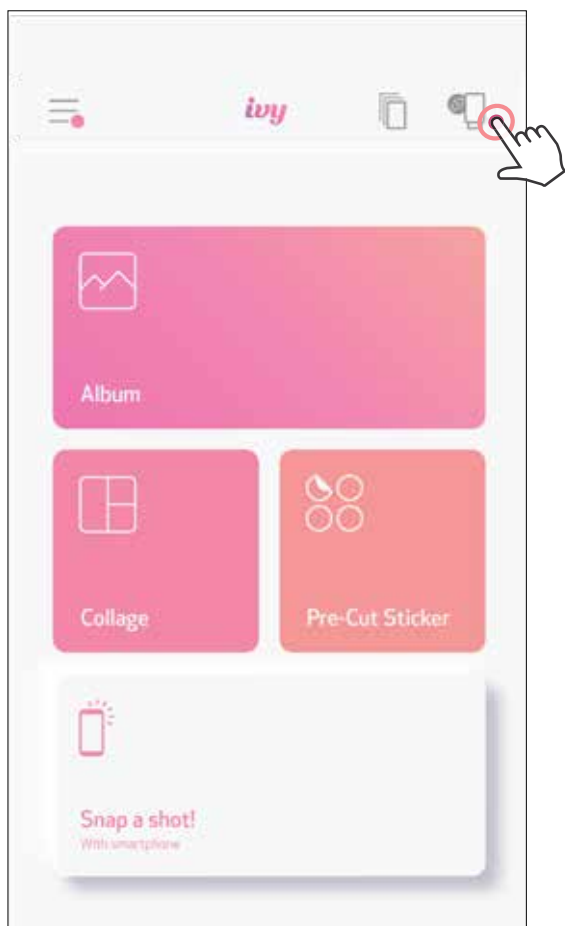

- ③ **Reconnect Printer** - The printer will automatically reconnect to the app once paired already. If the printer has not connect to the app, tap on the icon on the top right corner and choose your printer on the list.

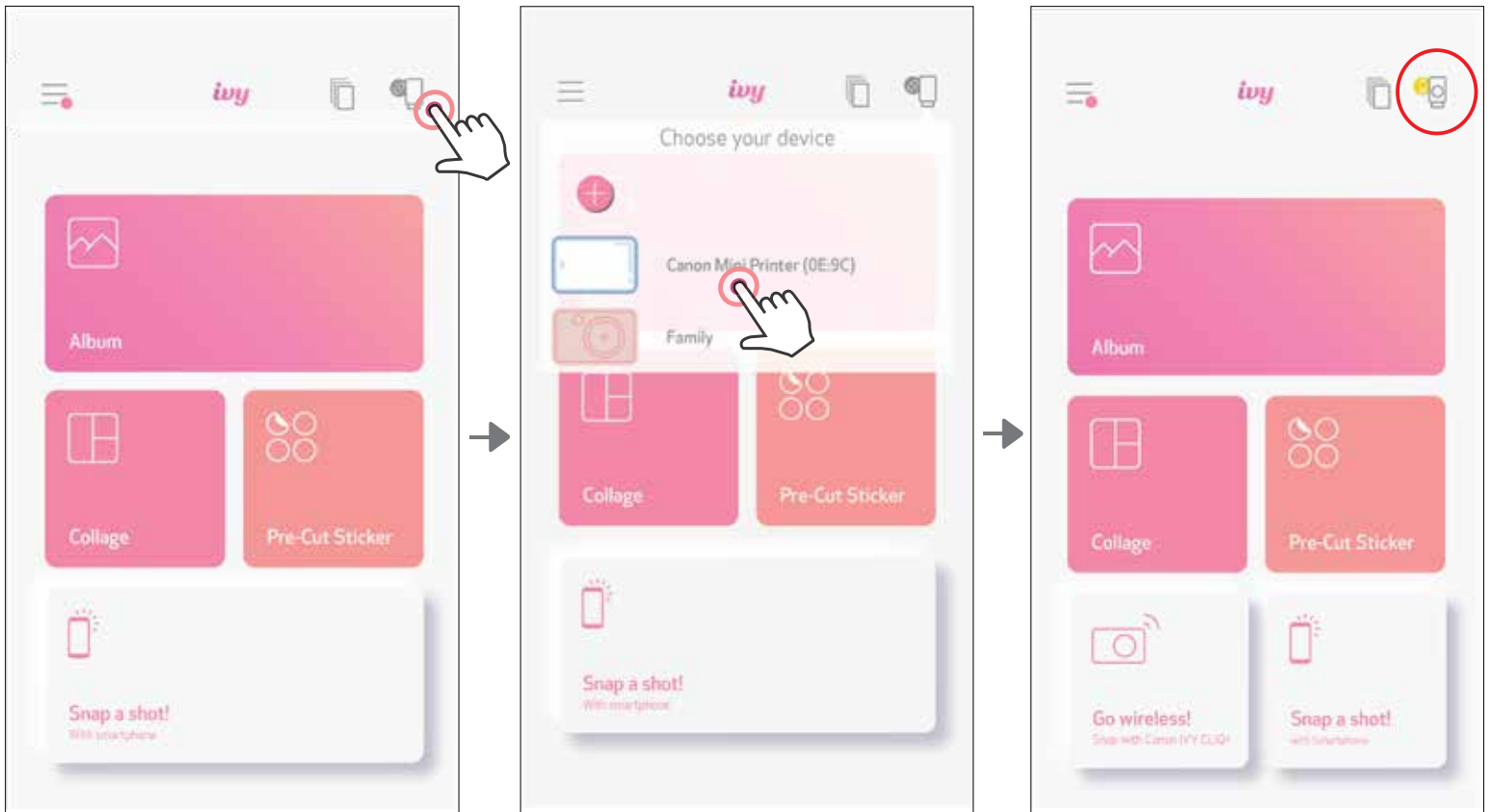

## Android Pairing (with NFC)

- ① On your mobile device, ensure that NFC and Bluetooth are enabled.
- ② Open the Canon Mini Print app.
- ③ Place your mobile device on top of the printer.
- ④ Follow the onscreen instructions to complete the pairing and connection for the first time. Or the printer will pair automatically with the mobile device.

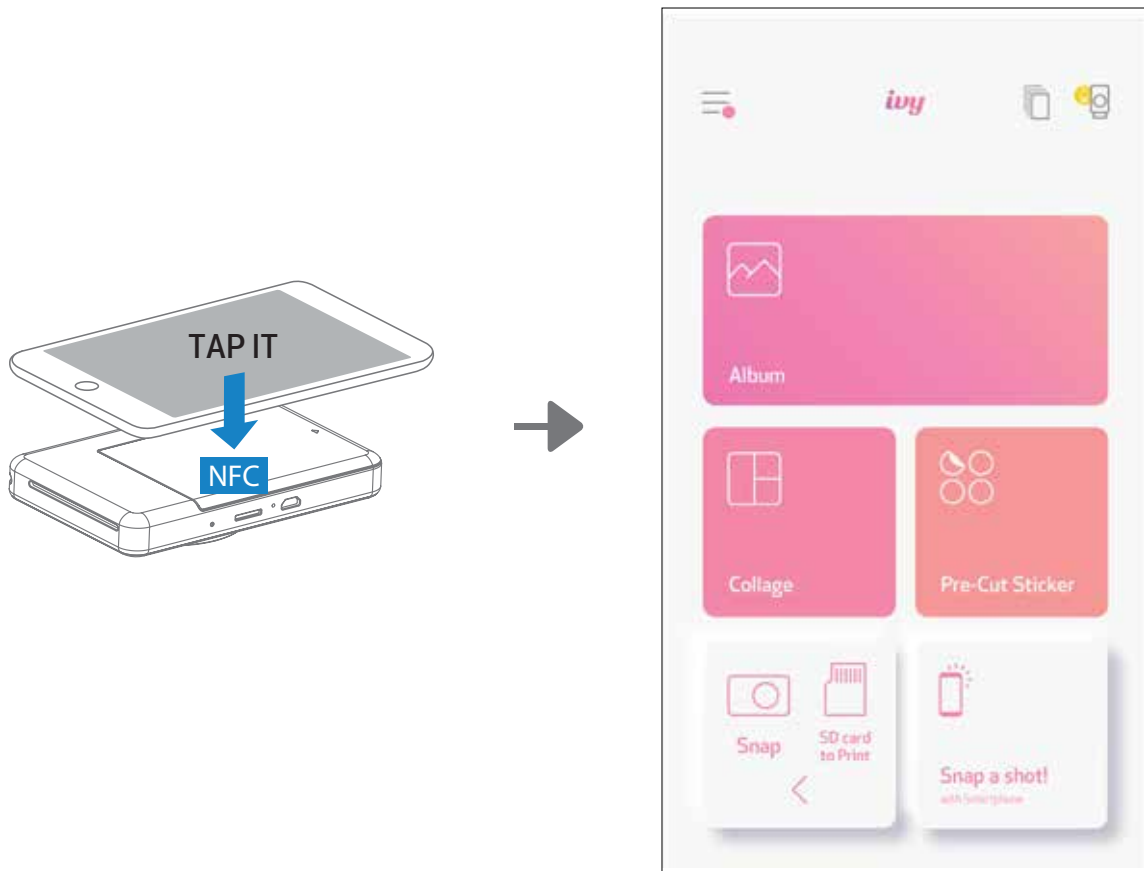

### ! NOTE

#### Printer Status Icon (shown in App)



Printer not connected

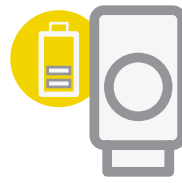

Printer connected  
(Battery status shown)

#### About Pairing

- One printer can be paired with only one iOS/Android device.
- One iOS/Android device can be connected to multiple printers.  
To pair an additional printer, go to home page and tap on the icon on the top right and press " + " to choose the printer.
- Search for and pair a printer named "Canon (xx:xx) Instant Camera".  
Match the last 4 digits of the MACnumber (xx:xx) on the label inside the printer.
- Bluetooth searching and transferring may fail depending on the environment.  
Check the Bluetooth setting on your mobile device and try again.

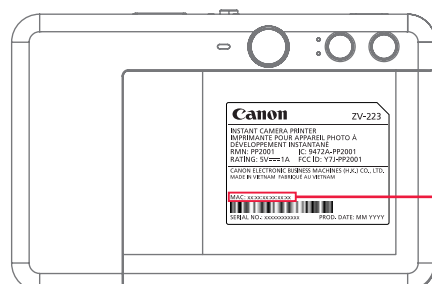
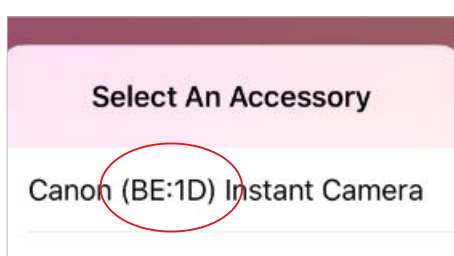

MAC: xx:xx:xx:xx:xx:xx



# USER INTERFACE

## HOME SCREEN

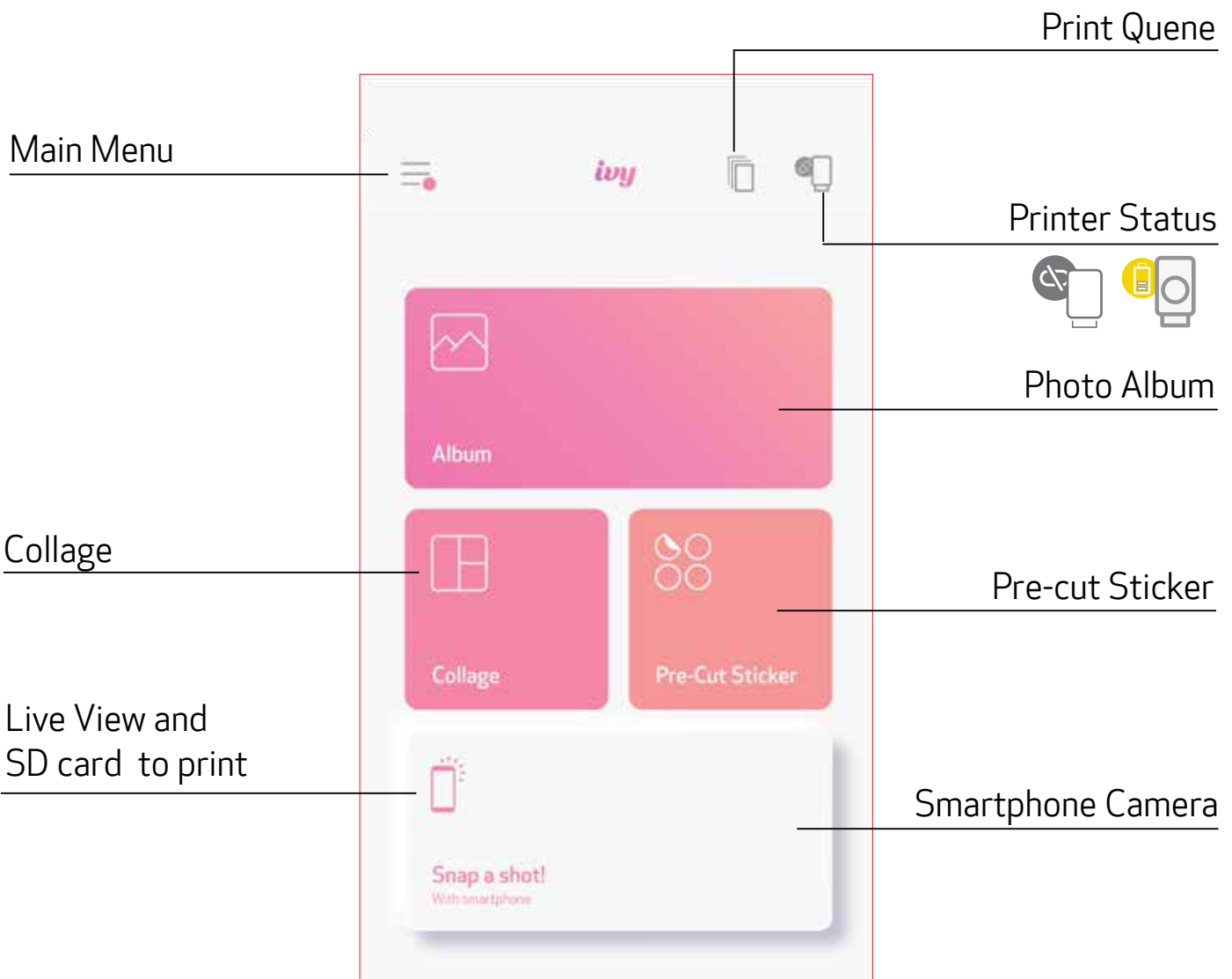

## MAIN MENU

- View in-app messages
- Access paired printer information & settings
- View Online User Manual & FAQ
- Purchase photo paper from Online Store
- Check App version, user Agreement and Privacy Statement
- Connected Printer - User can check the printer information, customize the printer name, voice and auto power off time at anytime.

- Online Albums\* (Login / Logout)
- Facebook
- Instagram
- Google Photos

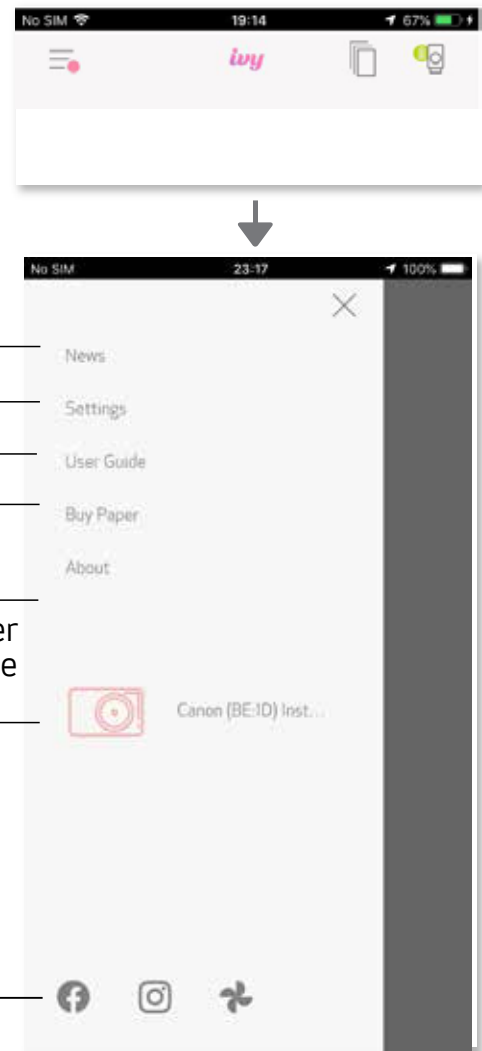

App experience, features, and available Online Albums may vary depending on your device and region.

\* Internet Connection Required. Requires active social media or Cloud account(s) to use.

# PRINTER SETTING

When the printer is connected with a mobile device, user can customize the printer name, voice and auto power off time.

Tap , select your device to customize the printer name, voice and auto power off time through the App.

## RENAME

User can customize the printer name as you wish.

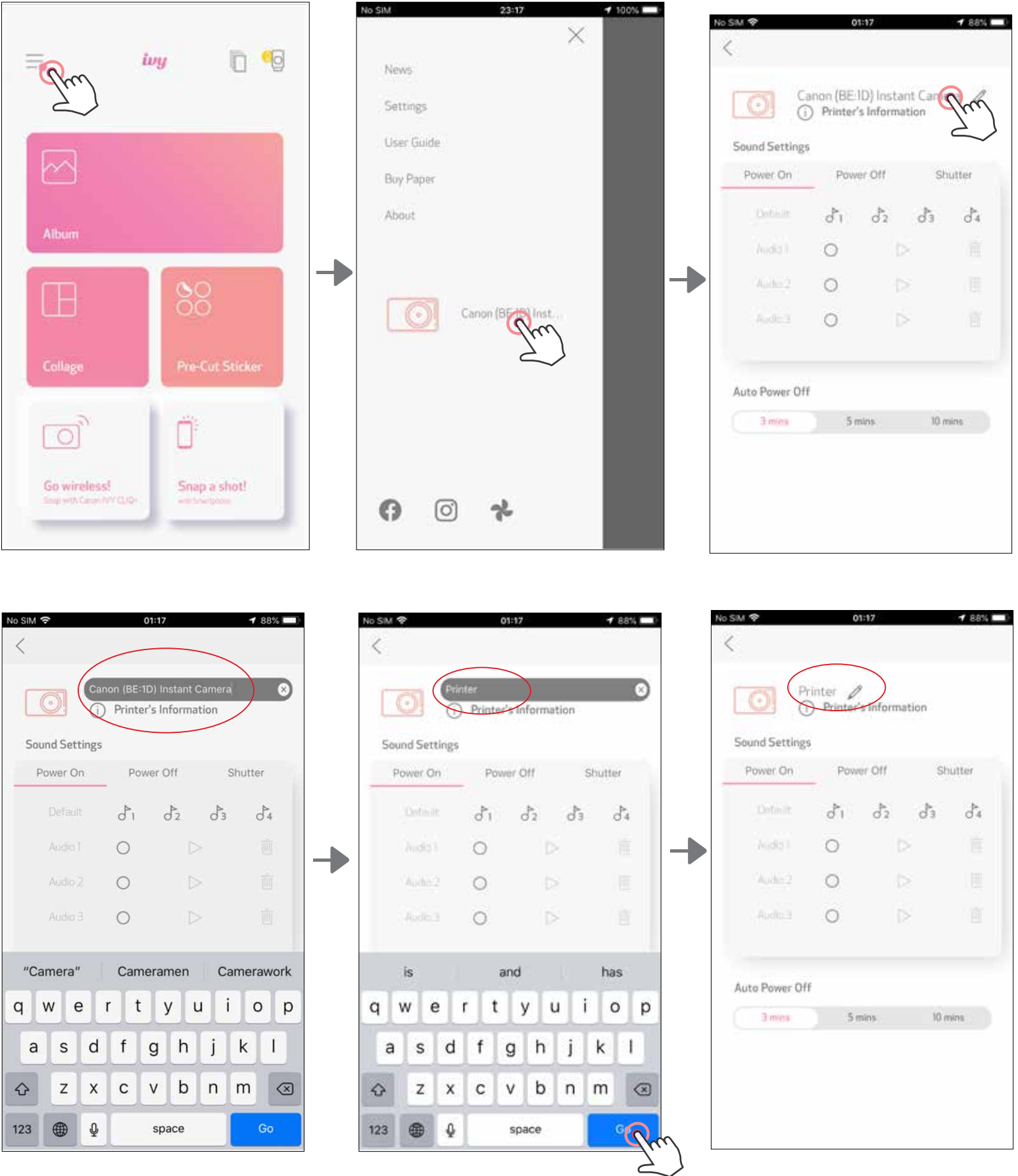



## VOICE

The user can customize the sound effects for "Power On", "Power Off", and "Shutter". User can record 3 sound files for printer voice.

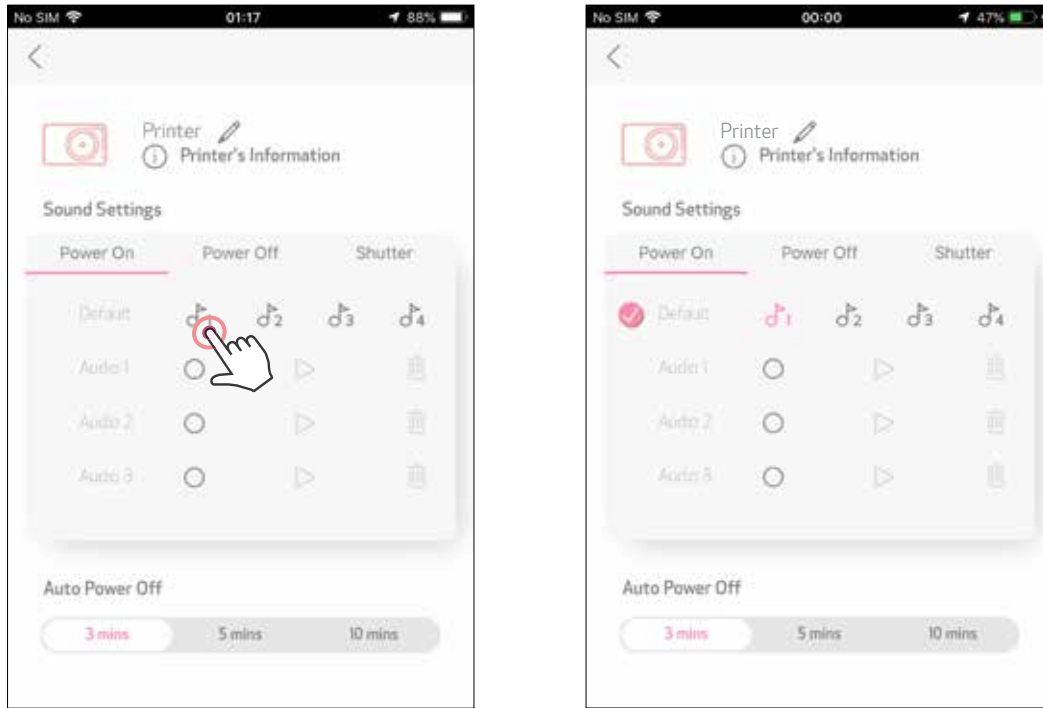
Tap on the desired sound file icon to apply the sound.



To start a recording, tap on the desired sound file icon .

Press  for audio playback and the playback audio will be automatically selected.

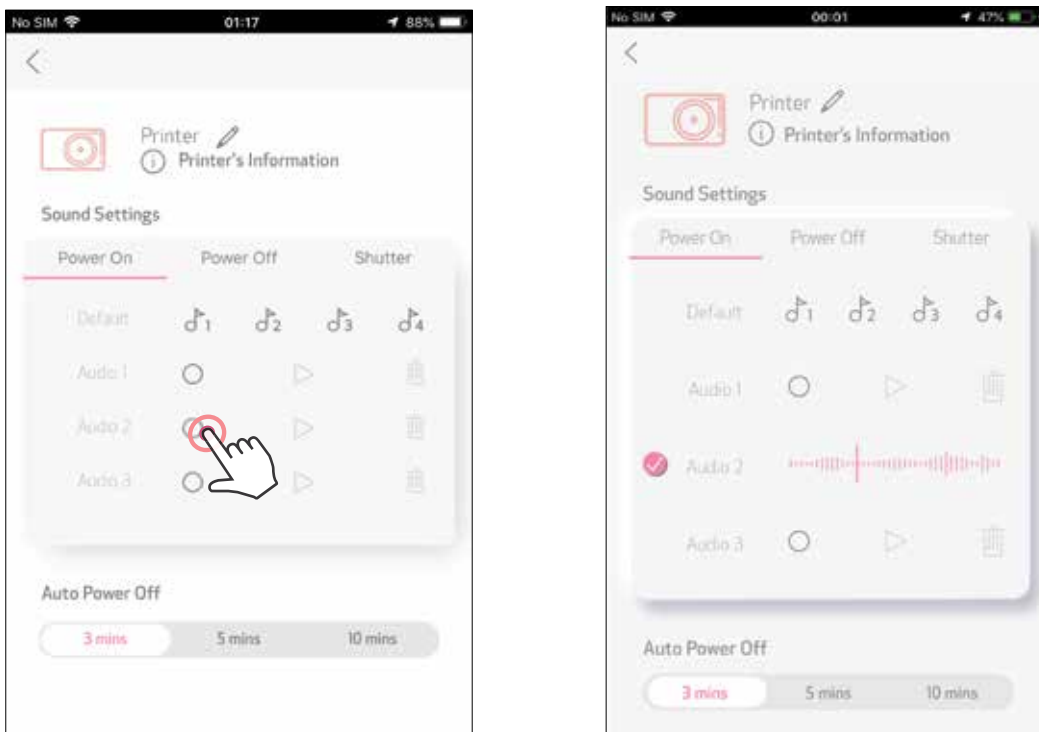

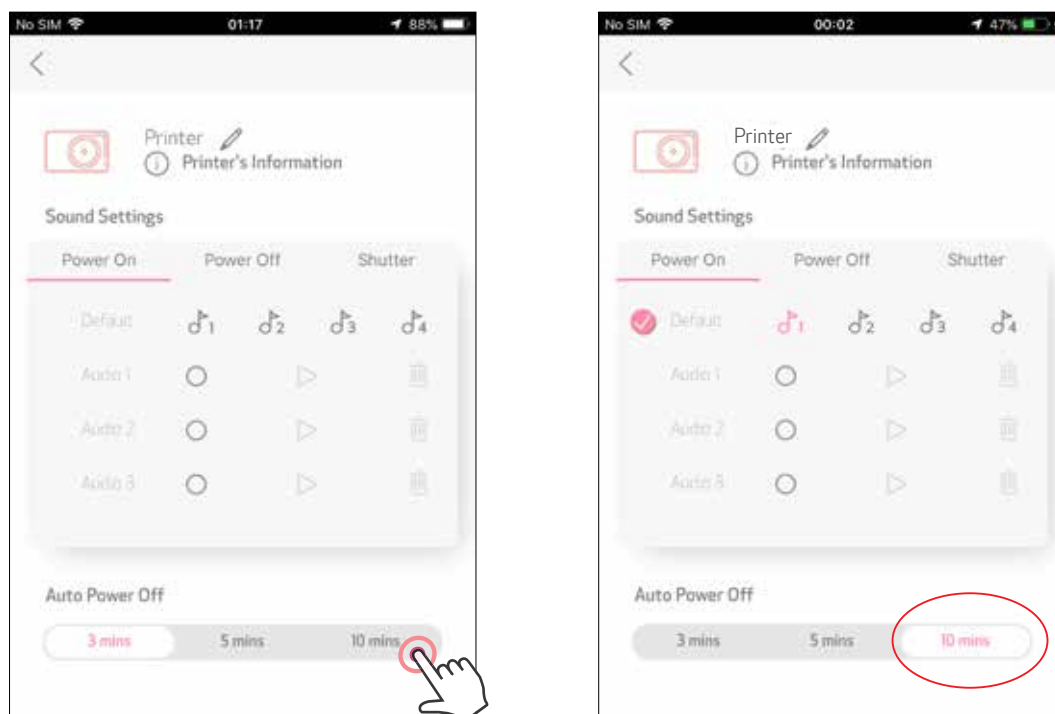

## AUTO POWER OFF

Tap to change the auto power off time.



# PHOTO ALBUM

You can browse photos in the Photo Album, with filters by folders and search by date.

- ① On the Home Screen, Tap  to view the Photo Album.
- ② Once you've selected a photo, you can Print, Edit, Share, or Save.
- ③ To print, tap .

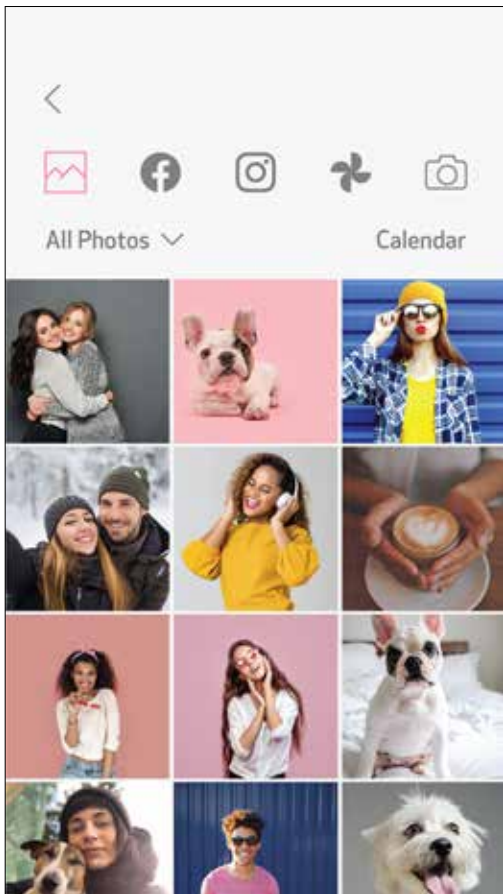
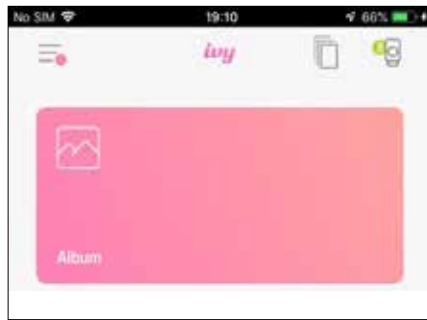

All Photos - Gallery

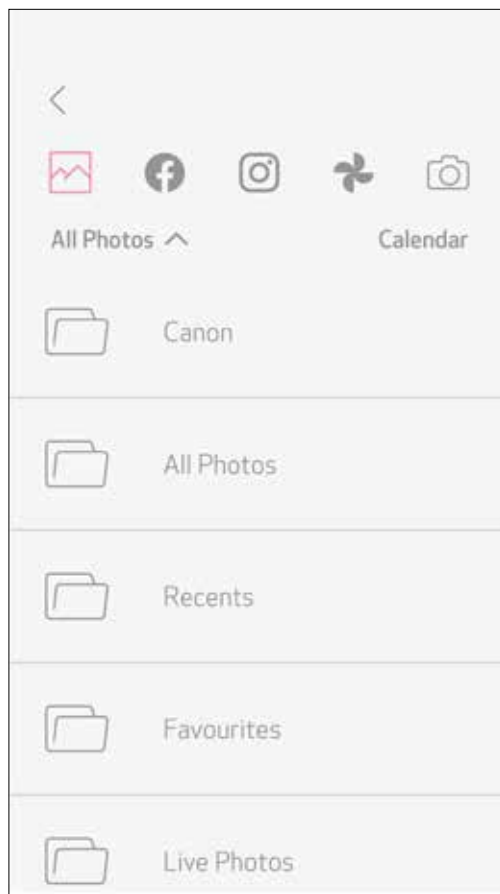

Filter by Folder

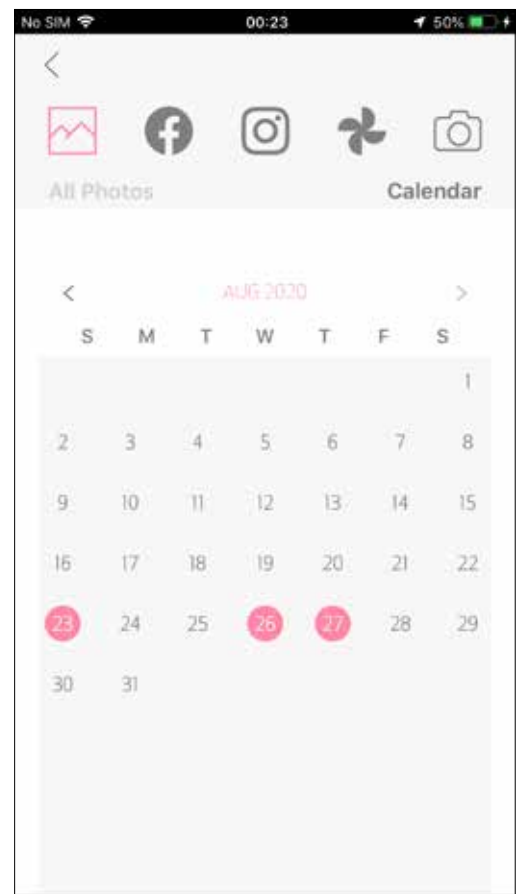

Search by Date

You can also browse from online albums.

# SEND A PHOTO TO MINI PRINT APP

SEND A PHOTO IN YOUR DEVICE'S PHOTO GALLERY OR CAMERA ROLL TO THE CANON MINI PRINT APP

## For Android

- ① Find a photo in your device Gallery and tap the share button.
- ② Tap the Mini Print Icon to send the photo to the app so that you can edit and print.

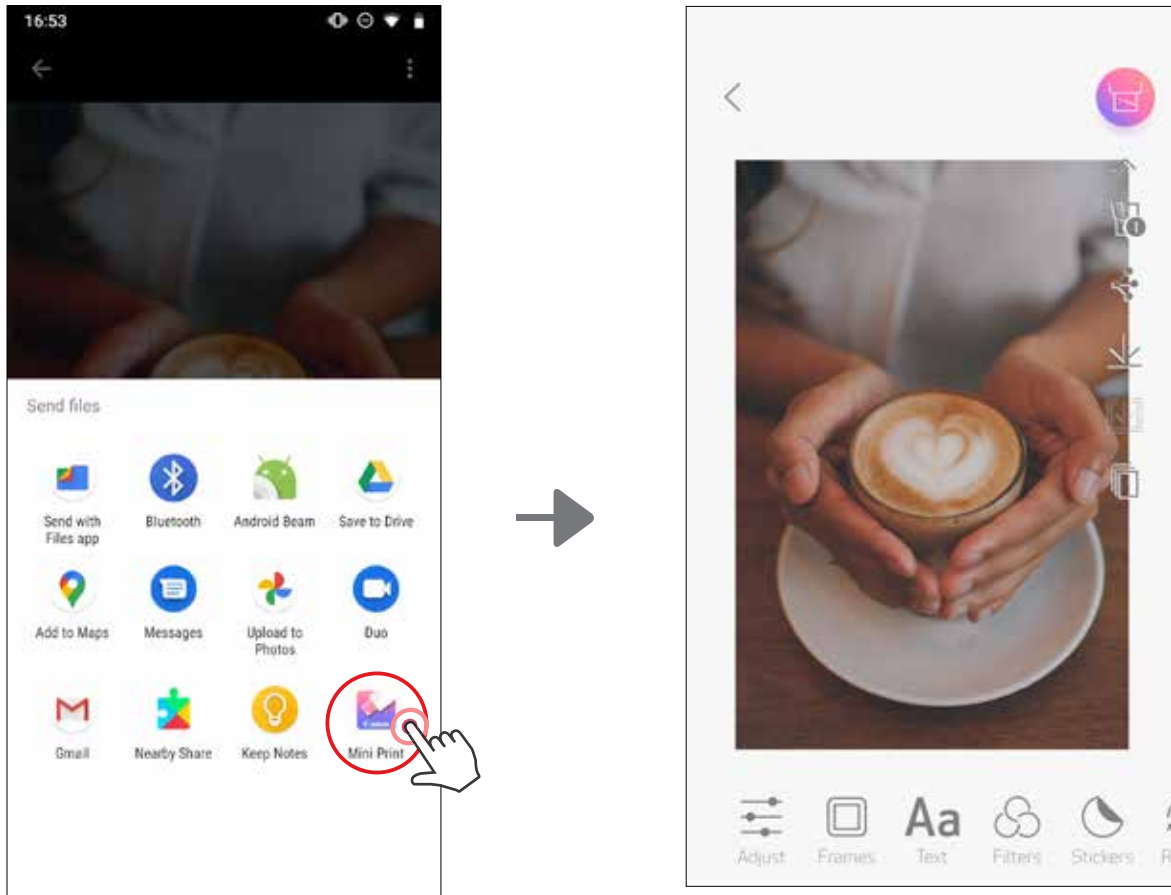

## For iOS

- ① Find a photo in your device Gallery and tap the share button.
- ② **OPTION A** - Tap "Open in Mini Print" to send the photo to the app editing screen where you can edit and print.
- ③ **OPTION B** - Tap the "Print to Canon" to send the photo directly to the print queue.

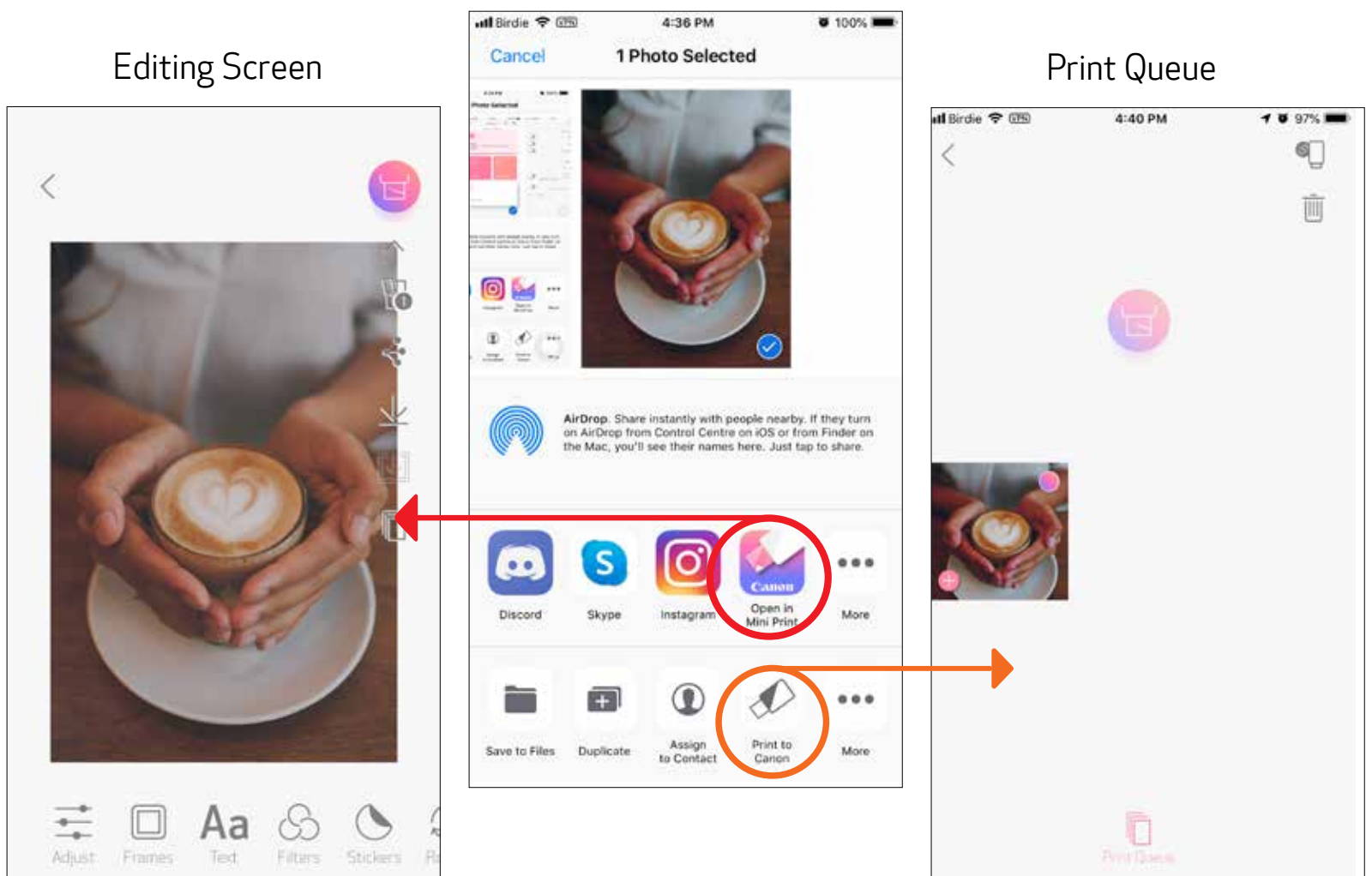

# EDIT PHOTO

You can customize your image with edits like filters, stickers, text, and more.

- ① Tap the icons on the bottom bar of your screen.
- ② Customize as you wish.
- ③ Don't forget to Save, Share, or Print your changes before you exit the screen.

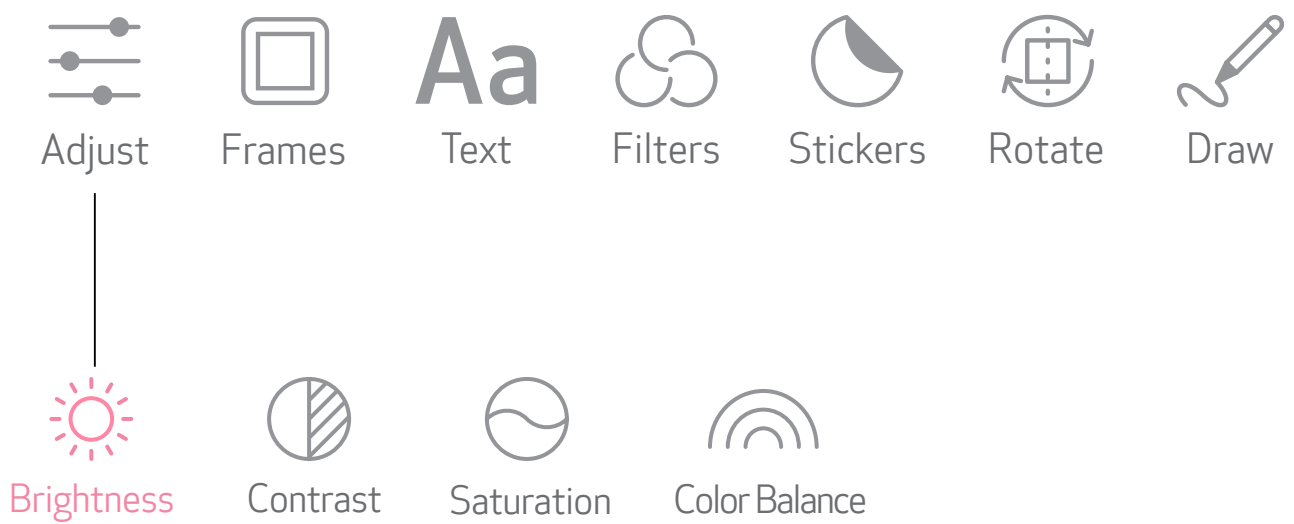
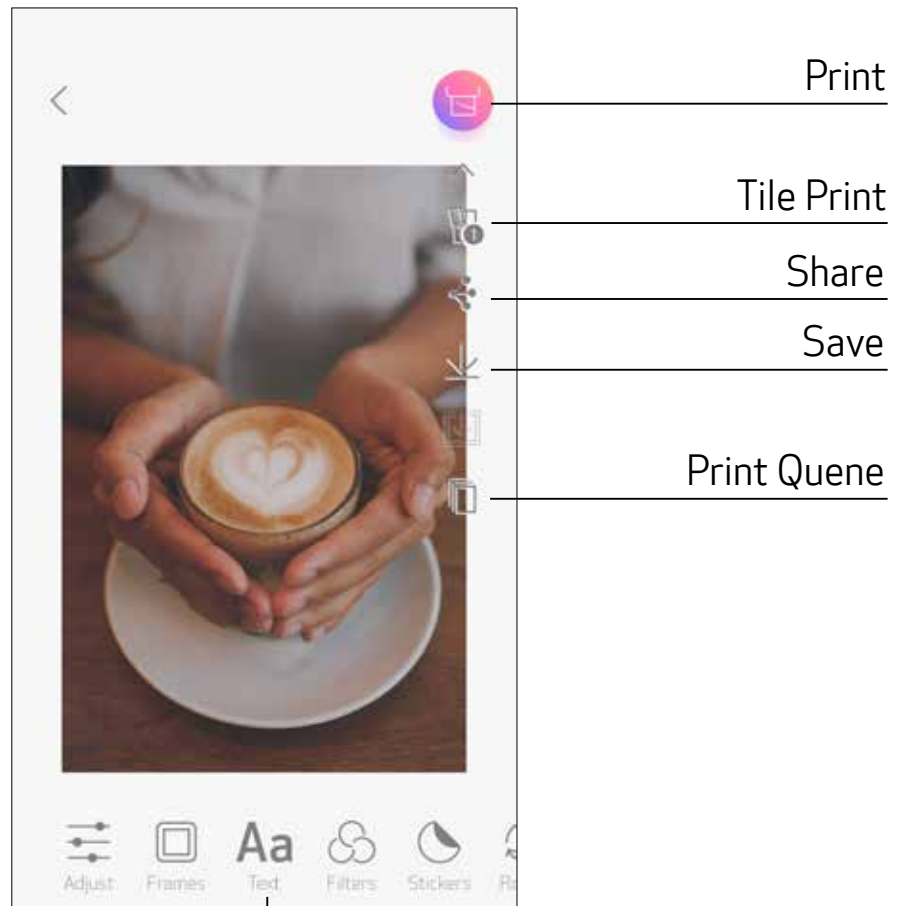

## USING TILE PRINT

Use the Tile Print function to print a single photo onto multiple sheets to create a large tiled photo.

- ① When you're ready to print, tap on  and tap the tiled choice of 2 x 2 or 3 x 3 prints. (Lines will appear to show how your image will be split.)

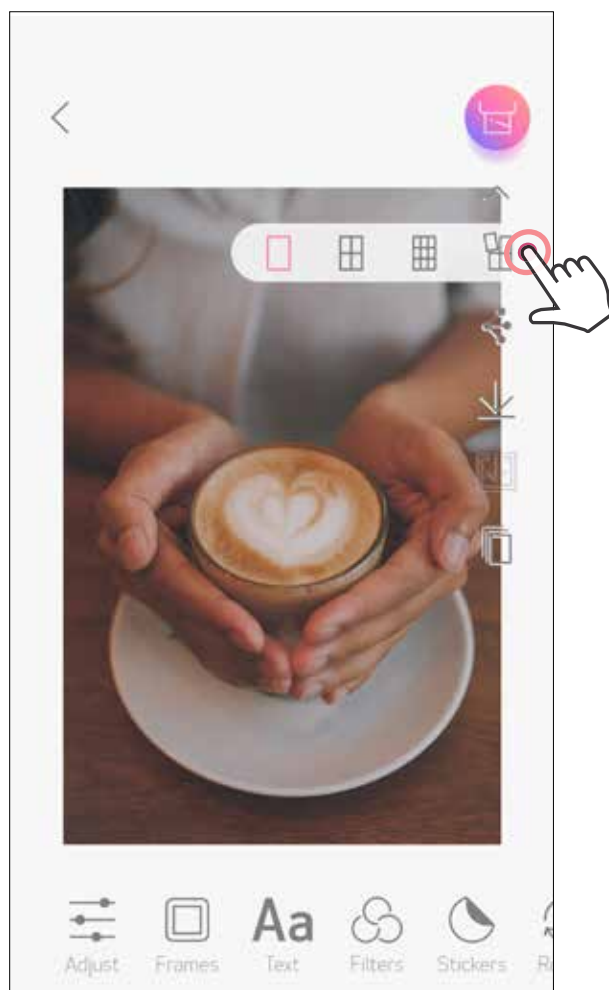

- ② Tap  to print your tiles and then put them together to create a larger tiled print.



## USING COLLAGE PRINT

Use the Collage function to print up to 6 photos on one 2x3 sheet.

- ① Tap  in Home Screen.



- ② Tap on the photos to add into collage. Number of photos selected will be shown.

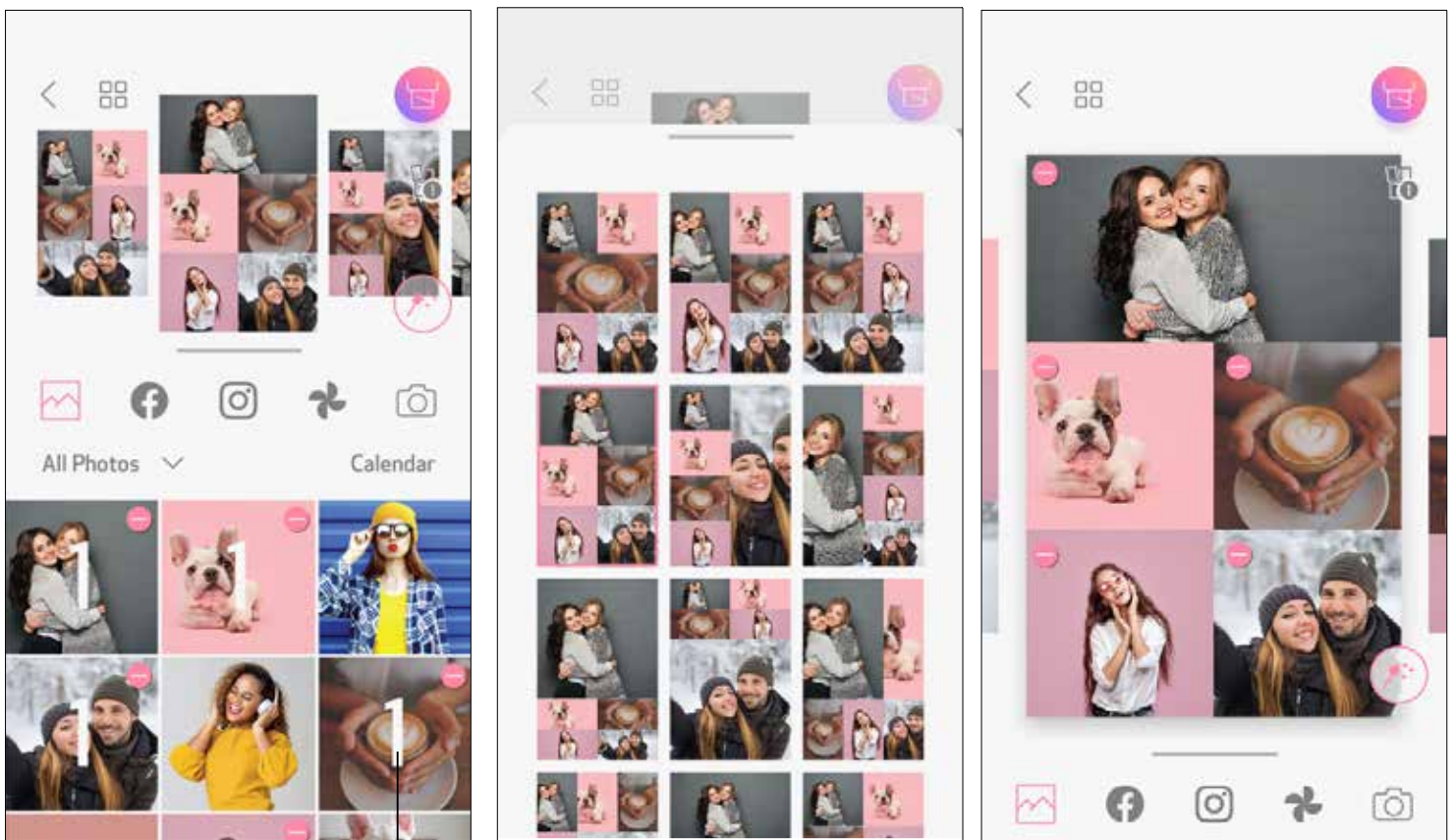

- ③ You can choose different template by pressing , or swapping right to left on the image preview.  
You can also enlarge the preview by swapping the album bar downwards.



No. of print

- ④ Select the template you like and go into edit page by pressing .



- ⑤ Edit and adjust the images in your collage as you'd like and then tap  to print,  to share or  to save.

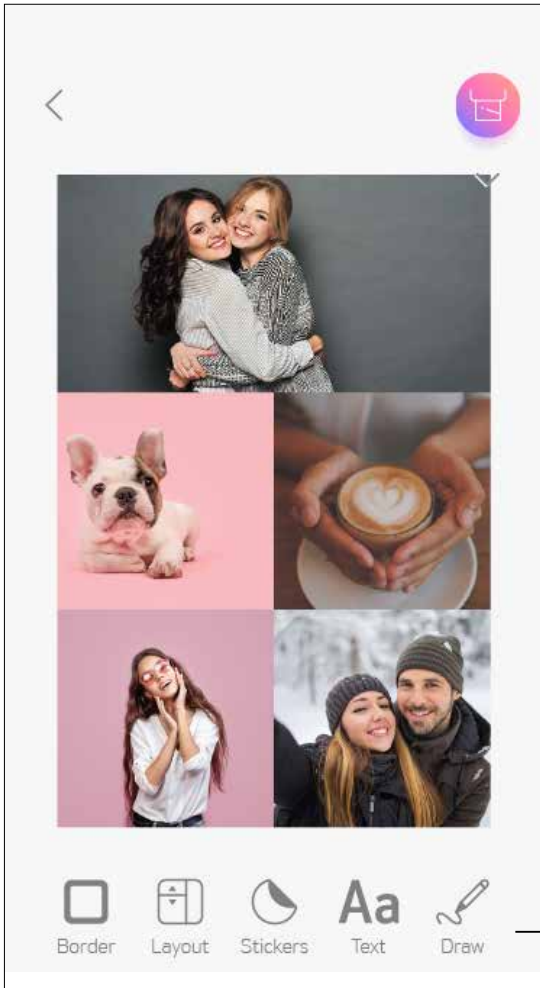

Collage (Edit as whole image)

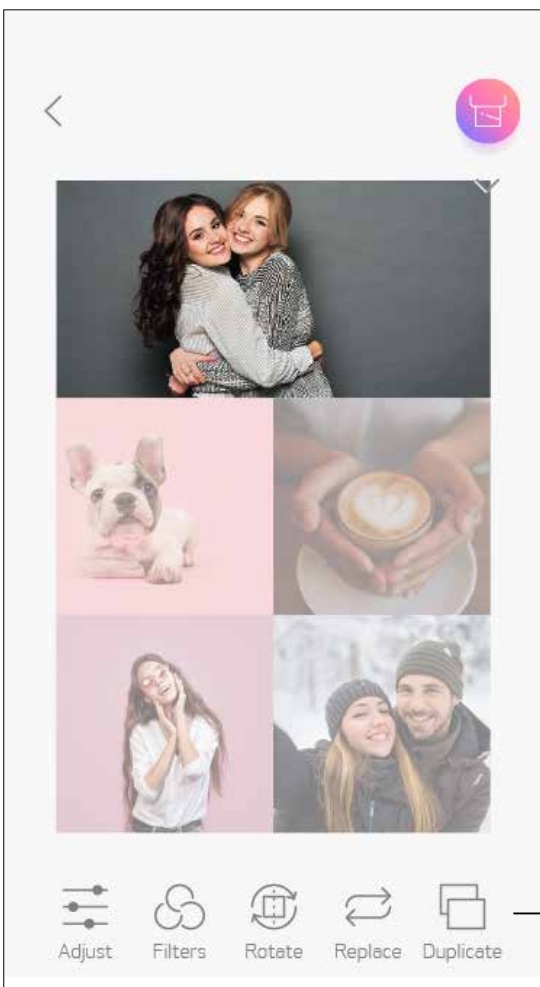

Collage (Edit specified image)

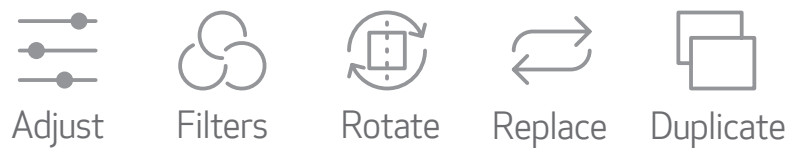

# PRE-CUT STICKER PRINT

Use the Pre-cut sticker function to print up the photo/text on the circle sticker.

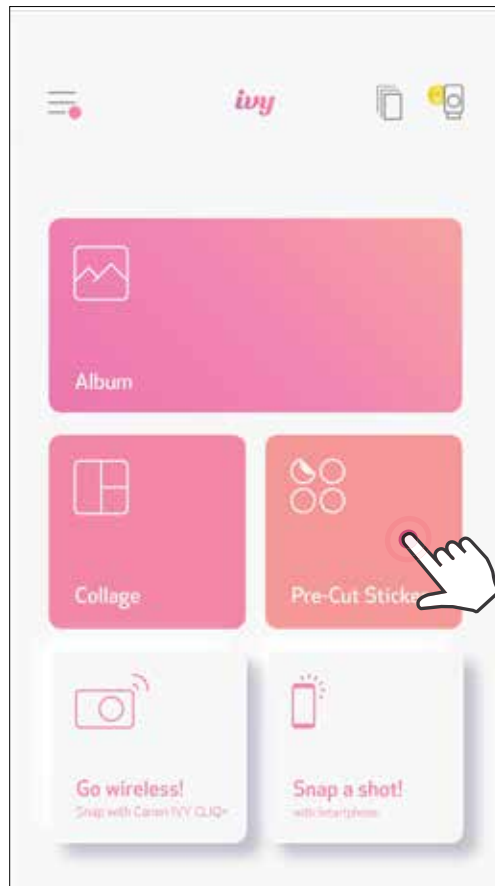

① Tap  in Home Screen.



② Tap on the photos to add into the circle sticker.

③ Press  to edit the pre-cut sticker.



- ④ Adjust the images in your sticker as you'd like and then tap  to print,  to share or  to save.

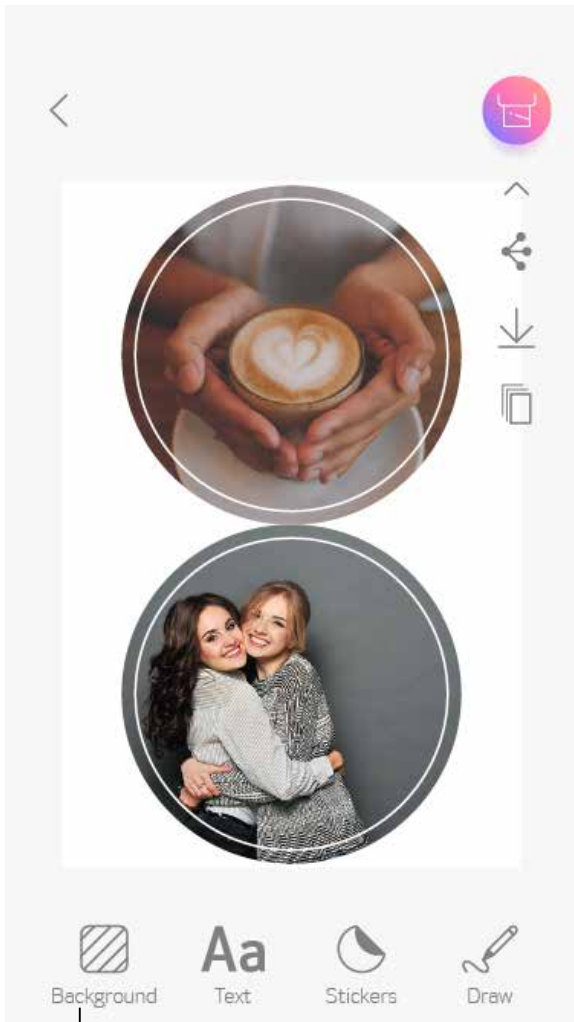

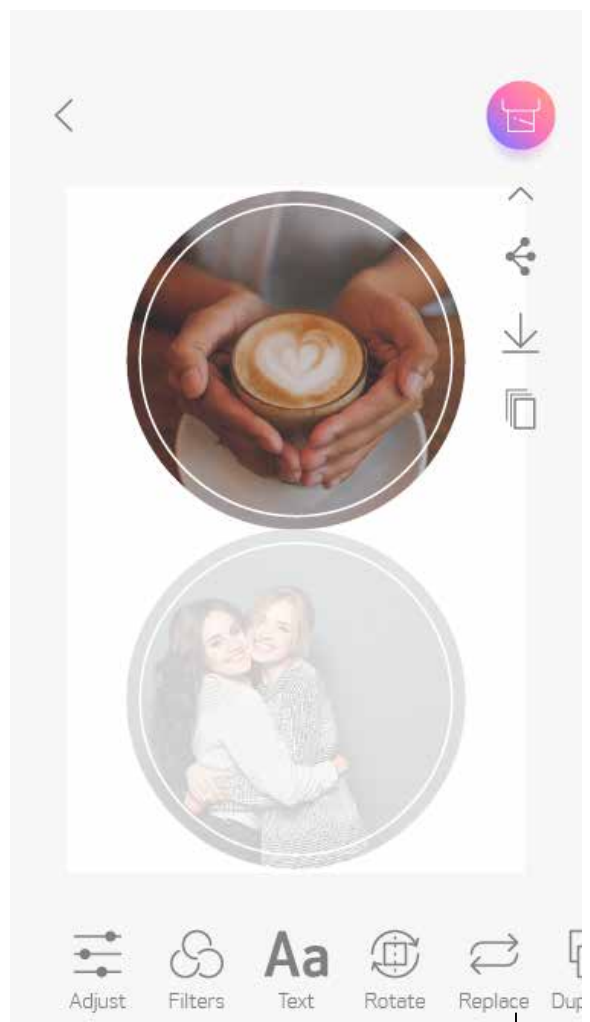
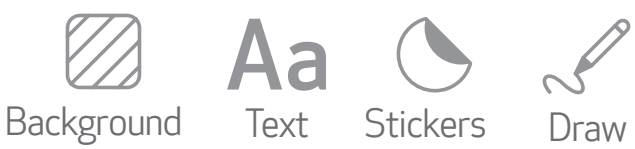

Pre-cut sticker  
(Edit as whole image)

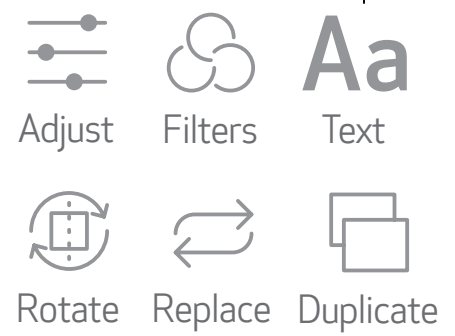

Pre-cut sticker  
(Edit specified image)



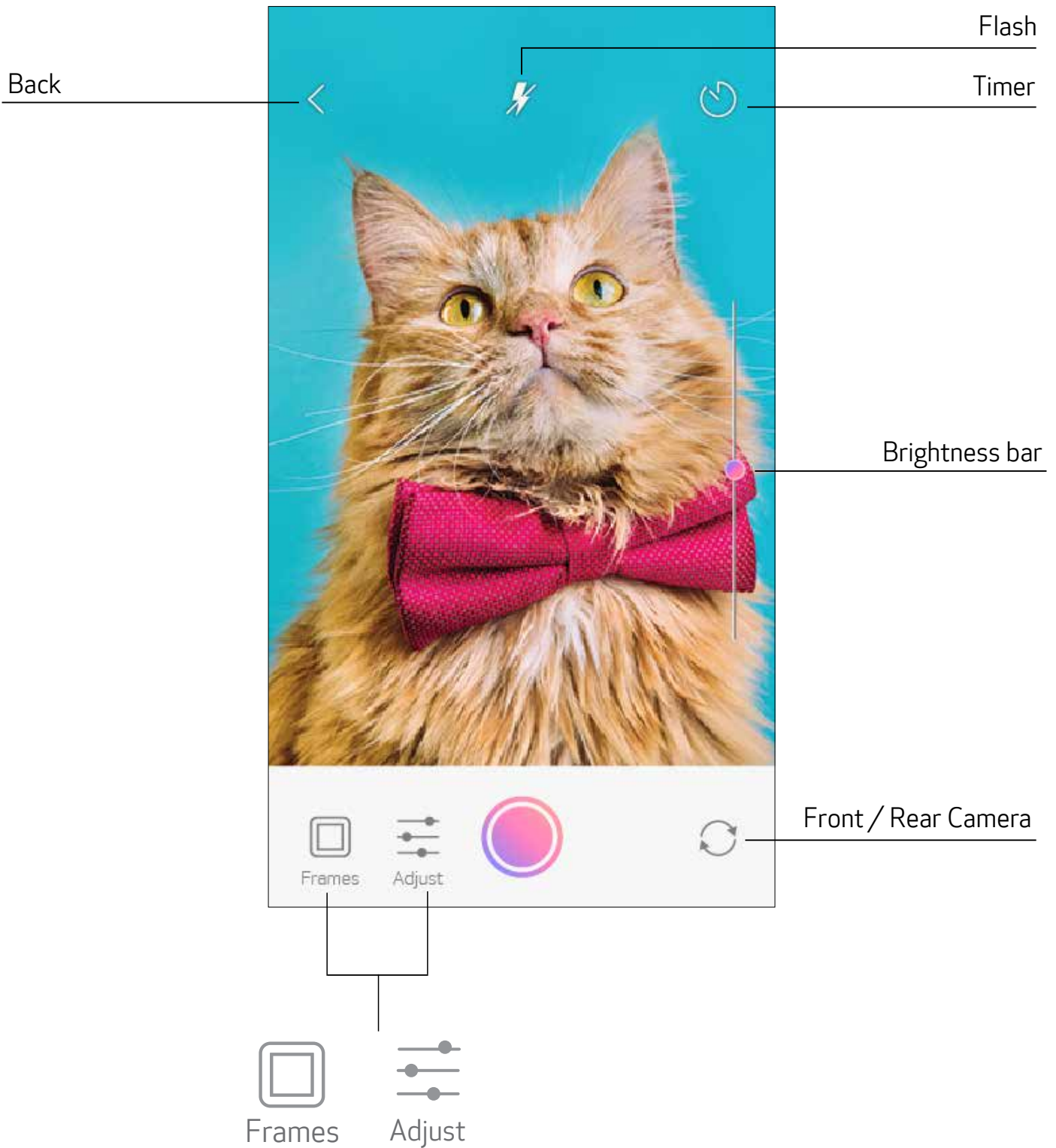

# SMARTPHONE CAMERA

- ① On the Home Screen, tap  to take a photo with your smartphone camera. (Optional, tap on the icons at the bottom to take a photo with effects.)
- ② Once you've taken a photo, you can Print, Edit, Share, or Save.
- ③ To print, tap .



# PRINT FROM IVY CLIQ+2 MicroSD CARD

- ① On the Home Screen , tap "Go Wireless!", then tap "SD Card to print".
- ② Tap on the photo you want to print, then press  .
- ③ You can also delete the photo in microSD card by pressing the  .

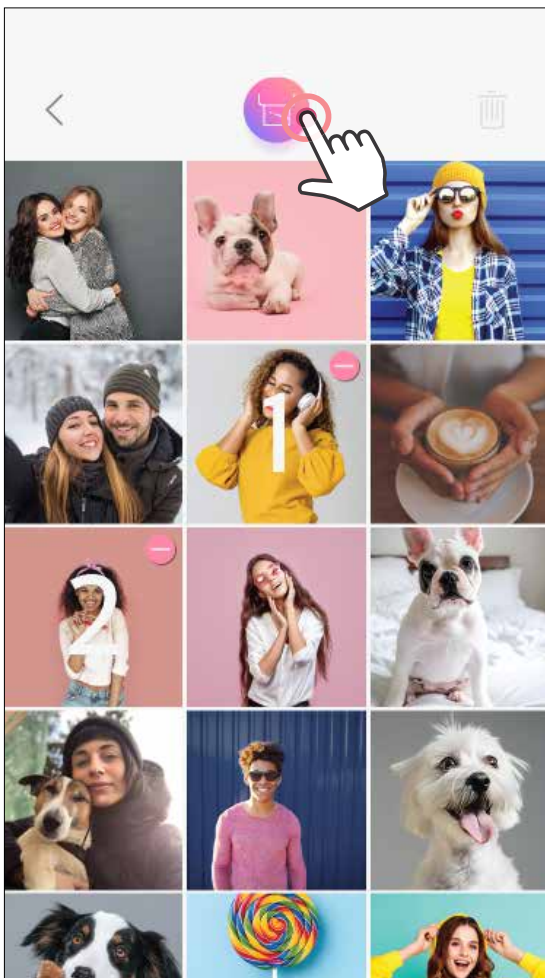
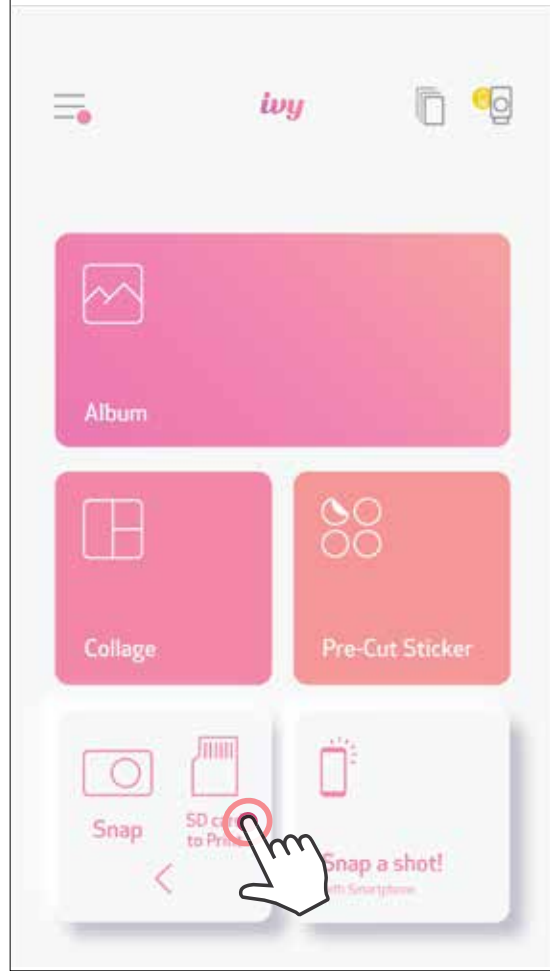

Print

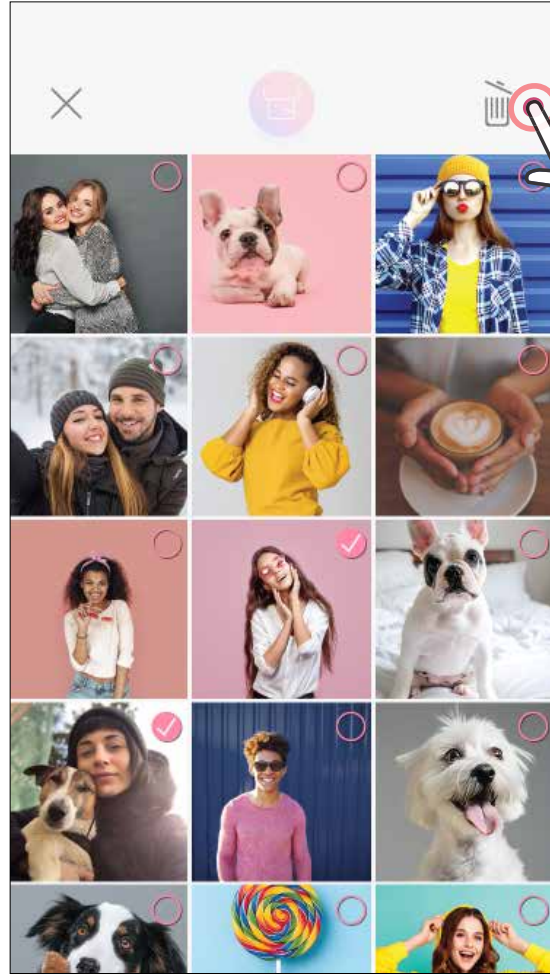



Delete

# PRINT QUENE

To manage your print queue, tap  .



In the Print queue page, you can

- ① Tap  to remove photo in print queue
- ② To change the print order, tap and hold on a photo, and reposition its order.
- ③ Tap on the specified photo you would not want to print it at the moment, a pause sign will be shown.
- ④ Tap  to duplicate a photo

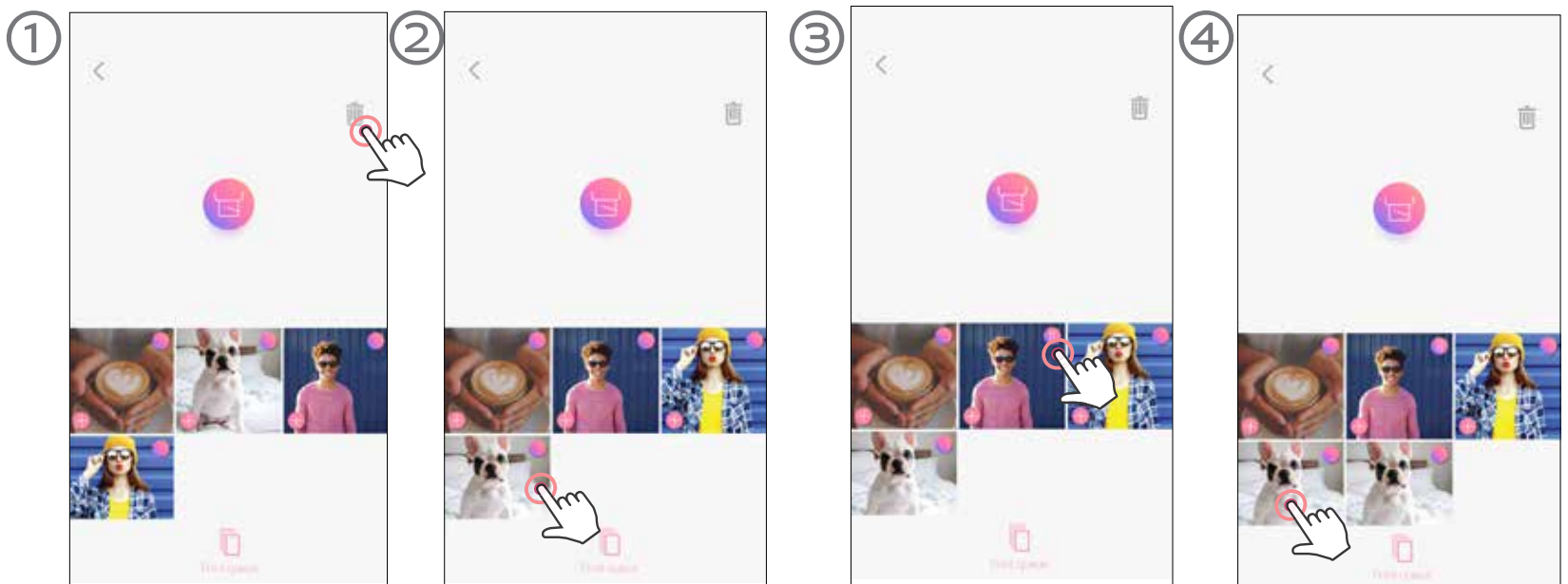

**Note about Print Queue:** Your image will be stored in the Print Queue if your printer is not on and connected when you send a print.

To release the print, simply turn your printer on and reconnect, you will be asked if you want to print the image in your queue.

## NOTE

- The printed image may differ from the original image due to the "screen technology" used to display color on mobile device is difference from the "print technology" used to print color on paper. (Thermal transfer printing).
- Do not pull the paper out by force during printing or paper jam.
- Do not open the top cover during printing. It may affect print quality.
- If the printer is vibrated or shaken, photo print quality may be affected.



If the device is not functioning properly, please contact the dealer you purchased this product from or Canon Service & Support at [www.usa.canon.com/support](http://www.usa.canon.com/support)

#### FCC REGULATIONS

This device complies with Part 15 of the FCC Rules. Operation is subject to the following two conditions: (1) this device may not cause harmful interference, and (2) this device must accept any interference received, including interference that may cause undesired operation.

Canon U.S.A., Inc. Canon is a registered trademark of Canon Inc. in the United States and may be a registered trademark, or trademark, in other countries. IVY is a trademark of Canon U.S.A., Inc. in the United States. SMART SHEET, the ZINK Technology and ZINK Trademarks are owned by ZINK Holdings LLC. Used under license.