



Professional Online UPS

**OL1000HV / OL1000SHV / OL1500HV / OL2000HV /
OL2000SHV / OL3000HV / OL1000LV / OL1000SLV /
OL1500LV / OL2000LV / OL2000SLV / OL3000LV**

User Manual



EMC Information

FEDERAL COMMUNICATIONS COMMISSION INTERFERENCE STATEMENT: This equipment has been tested and found to comply with the limits for a Class A digital device, pursuant to Part 15 of the FCC Rules. These limits are designed to provide reasonable protection against harmful interference when the equipment is operated in a commercial environment. This equipment generates, uses, and can radiate radio frequency energy and, if not installed and used in accordance with the instruction manual, may cause harmful interference to radio communications. Operation of this equipment in a residential area is likely to cause harmful interference in which case the user will be required to correct the interference at his own expense.

FCC Caution: Any changes or modifications not expressly approved by the party responsible for compliance could void the user's authority to operate this equipment.

Warning: Operation of this equipment in a residential environment could cause radio interference.

Warning: For currents lower than 16A, this is a category C2 UPS product. In a residential environment, this product may cause radio interference, in which case the user may be required to take additional measures.

Warning: For currents greater than 16A, this is a product for commercial and industrial application in the second environment installation restrictions or additional measures may be needed to prevent disturbances.

This device complies with Part 15 of the FCC Rules. Operation is subject to the following two conditions:

- (1) this device may not cause harmful interference, and
- (2) this device must accept any interference received, including interference that may cause undesired operation.



KCC Statement

이 기기는 업무용 (A 급) 전자파적합기기로서 판매자 또는 사용자는 이 점을 주의하시기 바라며, 가정외의 지역에서 사용하는 것을 목적으로 합니다.

RoHS

This product is RoHS compliant.

User Information

Online Registration

Be sure to register your product at our online support center:

International	http://eservice.aten.com
---------------	---

Telephone Support

For telephone support, call this number:

International	886-2-8692-6959
China	86-400-810-0-810
Japan	81-3-5615-5811
Korea	82-2-467-6789
North America	1-888-999-ATEN ext 4988 1-949-428-1111

User Notice

All information, documentation, and specifications contained in this manual are subject to change without prior notification by the manufacturer. The manufacturer makes no representations or warranties, either expressed or implied, with respect to the contents hereof and specifically disclaims any warranties as to merchantability or fitness for any particular purpose. Any of the manufacturer's software described in this manual is sold or licensed as *is*. Should the programs prove defective following their purchase, the buyer (and not the manufacturer, its distributor, or its dealer), assumes the entire cost of all necessary servicing, repair and any incidental or consequential damages resulting from any defect in the software.

The manufacturer of this system is not responsible for any radio and/or TV interference caused by unauthorized modifications to this device. It is the responsibility of the user to correct such interference.

The manufacturer is not responsible for any damage incurred in the operation of this system if the correct operational voltage setting was not selected prior to operation. PLEASE VERIFY THAT THE VOLTAGE SETTING IS CORRECT BEFORE USE.

Package Contents

The UPS package consists of:

- ◆ 1 Online UPS
- ◆ 1 Rack Mounting Kit
- ◆ 1 Rail Slide Kit
- ◆ 1 RS-232 Cable
- ◆ 1 USB Type A to B Cable
- ◆ 4 Power Cables (HV Models only 1xIEC C13/C14+1xIEC C13/Schuko+1xIEC C13/UK+1xIEC C13/AU(10A))
- ◆ 1 Tower Stand set
- ◆ 1 User Instructions*

*Features may have been added to the UPS since this manual was printed. Please visit our website to download the most up-to-date version of the manual.

Check to make sure that all the components are present and that nothing got damaged in shipping. If you encounter a problem, contact your dealer. Read this manual thoroughly and follow the installation and operation procedures carefully to prevent any damage to the unit, and/or any of the devices connected to it.

Copyright © 2020 ATEN® International Co., Ltd.
Manual Date: 2020-09-17

The ATEN logo are registered trademarks of ATEN International Co., Ltd. All rights reserved. All other brand names and trademarks are the registered property of their respective owners.

Contents

EMC Information	ii
RoHS	iii
User Information	iv
Online Registration	iv
Telephone Support	iv
User Notice	iv
Package Contents	v
Contents	vi
About this Manual	viii
Conventions	ix
Product Information	ix
Battery Information	x
Internal Battery	x
External Battery Package	x

Chapter 1.

Introduction

Overview	1
Features	3
Operation Principle	4
Components	5
UPS Front View for all series	5
UPS HV Series Rear View	6
UPS LV Series Rear View	7

Chapter 2.

Hardware Setup

Mounting	9
Rack Mount	9
Vertical (Tower) Desktop Mount	13
Mounting UPS with Battery Box	15
Connecting Internal Battery	18
Installation	20
External Battery Connection	22

Chapter 3.

General Operations

Turn On the UPS	25
EPO Function	25
Install Software	25

Chapter 4.

LCD/Button Operations

Overview	27
Button Operation	27

LCD Panel	28
Audible Alarm	30
LCD Display Wordings Index	31
UPS Setting	33
Suggested Battery Charger Current	41
Operating Mode Description	44
Faults Reference Code	45
Warning Indicator	46

Appendix

Safety Instructions	49
Transportation	49
Preparation	49
Installation	49
Operation	50
Maintenance, service and faults	51
Technical Support	53
International	53
North America	53
Specifications	54
HV Series	54
LV Series	57
Troubleshooting	60
Limited Warranty	63

About this Manual

This user manual is provided to help you get the most from your UPS unit. It covers all aspects of installation, configuration and operation. An overview of the information found in the manual is provided below.

Chapter 1, Introduction, introduces you to the Professional Online UPS. Its purpose, features and benefits are presented, and its front and back panel components are described.

Chapter 2, Hardware Setup, provides step-by-step instructions to setting up your unit, and explains the connections in detail.

Chapter 3, General Operations, explains the general operations of the unit.

Chapter 4, LCD/Button Operations, describes the LCD and its button operations in more details.

An Appendix, at the end of the manual provides technical and troubleshooting information.

Conventions

This manual uses the following conventions:

- Monospaced Indicates text that you should key in.
- [] Indicates keys you should press. For example, [Enter] means to press the **Enter** key. If keys need to be chorded, they appear together in the same bracket with a plus sign between them: [Ctrl+Alt].
1. Numbered lists represent procedures with sequential steps.
- ◆ Bullet lists provide information, but do not involve sequential steps.
- Indicates selecting the option (on a menu or dialog box, for example), that comes next. For example, Start → Run means to open the *Start* menu, and then select *Run*.
-  Indicates critical information.

Product Information

For information about all ATEN products and how they can help you connect without limits, visit ATEN on the Web or contact an ATEN Authorized Reseller. Visit ATEN on the Web for a list of locations and telephone numbers:

International	http://www.aten.com
North America	http://www.aten-usa.com

Battery Information

Please only install battery package from your dealer. Refer to the battery package information below:

Internal Battery

Rated	Description	Model Name
1000VA(2B)	2x9AH, 2 pcs batteries in total	BC24V9AH
1000VA(3B)	3x7AH, 3 pcs batteries in total	BC36V7AH
1500VA(3B)	3x9AH, 3 pcs batteries in total	BC36V9AH
2000VA(4B)	4x9AH, 4 pcs batteries in total	BC48V9AH
2000VA(6B)	6x7AH, 6 pcs batteries in total	BC72V7AH
3000VA(6B)	6x9AH, 6 pcs batteries in total	BC72V9AH

External Battery Package

Rated	Description	Model Name
1000VA(2B)	2*2x9AH, 4 pcs batteries in total	BP24V18AH
1000VA(3B)	2*3x9AH, 6 pcs batteries in total	BP36V18AH
1500VA(3B)	2*3x9AH, 6 pcs batteries in total	BP36V18AH
2000VA(4B)	2*4x9AH, 8 pcs batteries in total	BP48V18AH
2000VA(6B)	2*6x9AH, 12 pcs batteries in total	BP72V18AH
3000VA(6B)	2*6x9AH, 12 pcs batteries in total	BP72V18AH

Chapter 1

Introduction

Overview

Aten Professional Online UPS is an excellent electrical apparatus that provides emergency power to a load when the input power source or when the mains fails. The basic technology of an online UPS is the same as in a standby or line-interactive UPS, however, Aten Professional Online UPS provides a much greater current AC-to-DC battery-charger/rectifier where the rectifier and inverter are designed to run continuously with improved cooling systems.

In all our years of working with computers, the vast majority of hardware failures can be directly attributed to the stress hardware components experience during the shut-down and startup process, especially if power surges or blackouts are involved. With severe weather, the aging electrical grid and hazards lurk inside your own walls, your equipment is under constant attack from power problems. Even a brief loss of power, sags or a momentary surge can ruin your equipment and destroy irreplaceable data. Desktop computers don't have batteries built-in like laptops do. If you had been working on a desktop during that power outage, the system would come to an immediate halt. Not only would you lose your work, but the process imposes unnecessary stress on your machine.

If UPS is present and a power loss occurs, the batteries of the UPS keep the power steady and unchanged. Aten Professional Online UPS adjusts incoming AC power, provides battery backup to pass through most outages and saves open files automatically. When power is restored, the UPS begins recharging its batteries.

The Online UPS unit continuously filters the wall power through the battery system. Since the attached electronics run completely off the battery (that are always topped off by the external power supply), there is never a single millisecond of power interruption when there is power loss or voltage regulation issues. The Online UPS unit is then effectively an electronic firewall between your devices and the outside world by stabilizing all the electricity your devices are ever exposed to.

The UPS has one USB port and one Serial port that allow connection and communication between the UPS and the connected computer. A

power management software installed on the connected computer(s) gives IT professionals with the tools they need to easily monitor and manage their backup power. This advanced software allows users to access vital UPS battery conditions, load levels, and runtime information as well as provide graceful unattended shut down of network computers and virtual machines connected to a battery backup during a power event.

Aten Professional Online UPS offers you a different way to access to detailed UPS setting and information with LCD screen. The illuminated LCD screen displays input voltage, battery capacity, etc. and includes a three-button configuration interface and audible alarms for different modes of operation.

Features

- ◆ True double-conversion – Output power factor is 1, which means all of the power supplied is being used for productive work and makes work the most efficient
- ◆ Output voltage regulation < 1% – Provides higher performance and efficiency for critical applications
- ◆ Programmable power management outlets – Users can easily and independently control load segments. During power failure, this feature enables users to extend battery time to mission-critical devices by shutting down the noncritical devices
- ◆ Emergency power off function (EPO) – EPO connector at rear panel allows emergency UPS Power Off from a remote location
- ◆ SNMP + USB + RS-232 multiple communications – Allows either USB or RS-232 communication port to work with SNMP interface simultaneously
- ◆ Hot swappable battery design – All potential UPS maintenance, including complete power module exchange, can be performed without powering down connected equipment. As long as utility power is on, you may leave the UPS and connected equipment on while replacing a new battery
- ◆ ECO mode for energy saving – Offers up to 97% efficiency to cut energy usage and cost. UPS power application via static bypass, timely returning to online double conversion when the need arises
- ◆ Provides over voltage cut-off protection and surge immunity by MOV for full time equipment protection
- ◆ High power factor charger up to 1000W capacity with very low ripple current when charging battery
- ◆ Multi-functional LCD interface – Displays immediate, detailed information on input voltage, battery capacity, power status, battery status, operating status and assessed backup runtime, etc.
- ◆ Smart battery charger design to optimize battery performance – It will adjust charging voltage according to outside temperature and extend the useful service life of batteries.

Operation Principle

The operation principle of the UPS is shown in the diagram below:

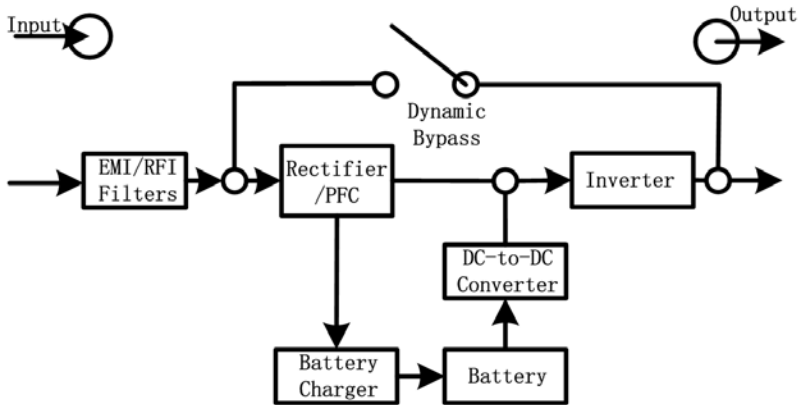

The UPS is composed of mains input, EMI/RFI filters, rectifier/PFC, inverter, battery charger, DC-to-DC converter, battery, dynamic bypass and UPS output.

Components

UPS Front View for all series

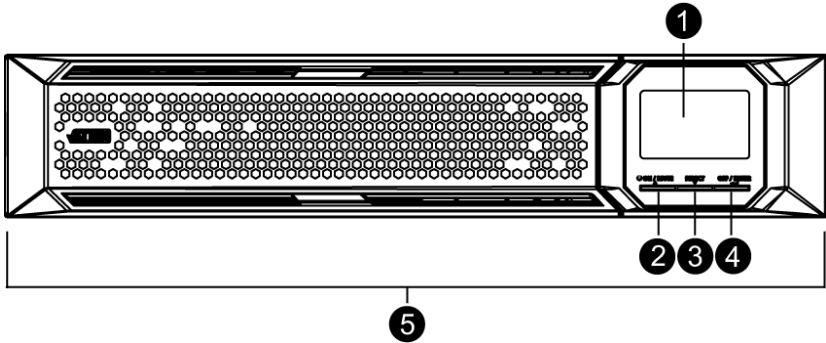

No.	Component	Description
1	Display LCD	
2	On / Mute Button	Click this to turn on the LCD
3	Select Button	Click this to jump to the next selection
4	Off / Enter Button	Click this to turn off the LCD
5	Removable Front Panel	

UPS HV Series Rear View

1K / 1.5K (OL1000HV / OL1000SHV / OL1500HV)

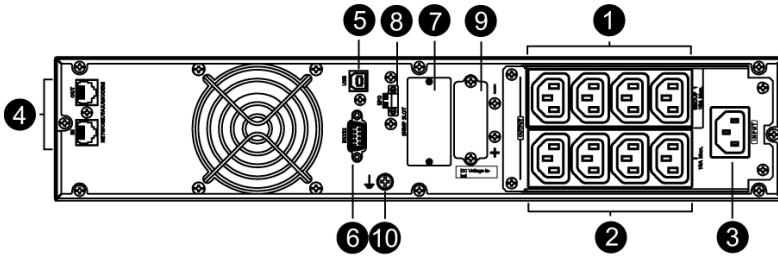

2K (OL2000HV / OL2000SHV)

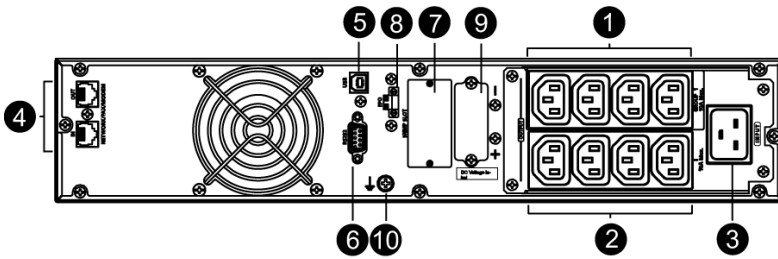

3K (OL3000HV)

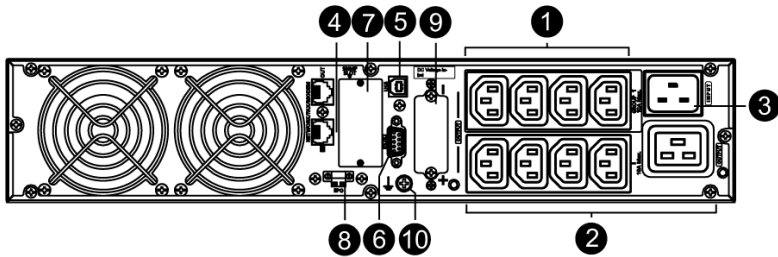

UPS LV Series Rear View

1K / 1.5K (OL1000LV / OL1000SLV / OL1500LV)

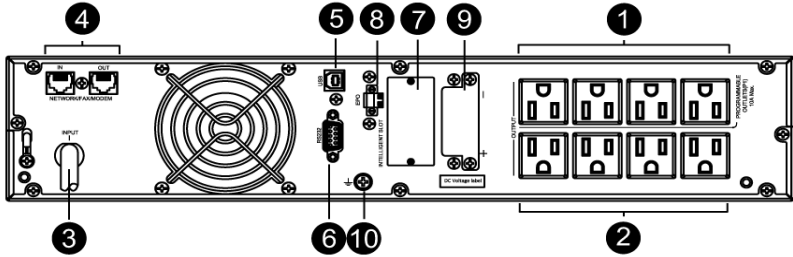

2K (OL2000LV / OL2000SLV)

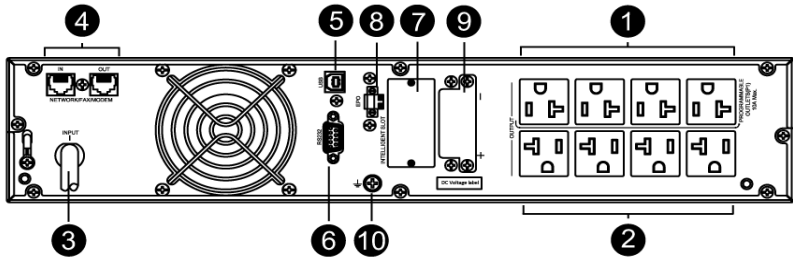

3K (OL3000LV)

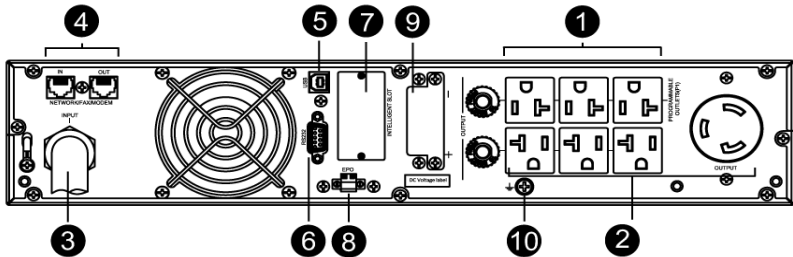

No.	Component	Description
1	Programmable Outlets	For non-critical load connection. These outlets can be programmed to provide backup power and surge protection.
2	Backup and Surge Protected Outlets	For critical load connection. These outlets provide backup power and surge protection.

No.	Component	Description
3	AC Input	For HV models, connect the included Power Cable between this port and an AC power socket. For LV models, this serves as a power cable. Connect the power cable to an AC power socket.
4	Network / Fax / Modem Surge Protection	Protects standard RJ-45-based products (LAN lines) and cabling systems from surges.
5	USB Communication Port	For scheduled UPS shutdown / start-up and status monitoring.
6	RS-232 Communication Port	For scheduled UPS shutdown / start-up and status monitoring.
7	SNMP Intelligent Slot	The UPS is equipped with intelligent slot perfect for SNMP. When installing SNMP in the UPS, it will provide advanced communication and monitoring options.
8	Emergency Power Off Function Connector (EPO)	Enables an emergency UPS Power Off from a remote location.
9	External Battery Connection Port	This port connects to external battery pack for backup power. For external battery pack, please refer to <i>Battery Information</i> on page x.
10	Grounding Terminal	Connect to a suitable grounding object.

Chapter 2

Hardware Setup



1. Important safety information regarding the placement of this device is provided on *Safety Instructions* on page 49. Please review it before proceeding.
2. Make sure that power to all the devices you will be installing has been turned off. You must unplug the power cords of any computers that have the Keyboard Power On

Mounting

The unit can be either desktop mounted (vertically or horizontally) or rack mounted (in a 19" rack chassis).

Rack Mount

A rail slide kit and rack mounting kit is provided in the package for rack mounting. The rail slide kit is installed on the rack and the rack mounting kit installs the UPS to the rack. To mount the UPS, do the following:

1. Make sure the rail slide kit includes all the components. The components include 2 slide rails (1 for each side, indicated by L and R in the diagram below), 6 M6 nuts, 4 fixing studs and 8 M6 screws, as shown in the diagram below:

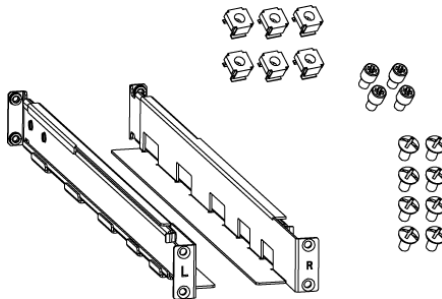

2. Insert the 4 fixing studs: Two screw holes are available on both ends of a slide rail. Screw a fixing stud into the top screw hole as shown:

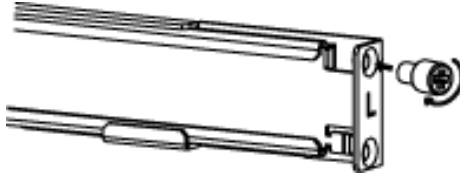

3. Have the rail near the supporting columns, pull the two ends of the rail slider apart. While at it, fit the fixing studs into the columns' holes on the same level. This step serves to hold the slider rail in place for the latter steps.

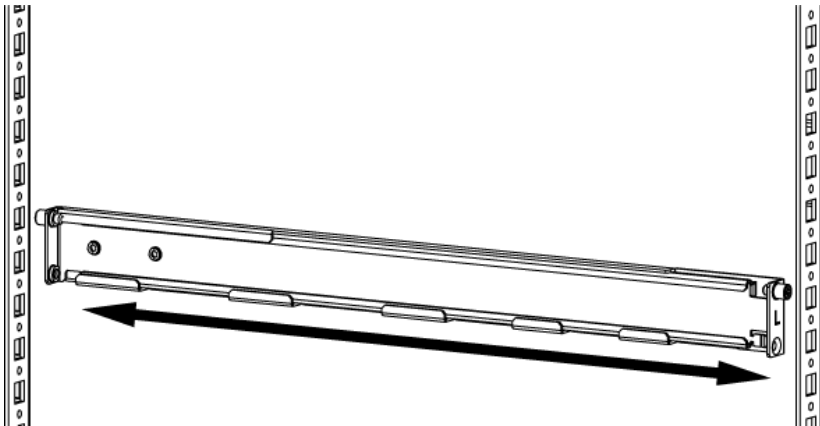

4. Screw a M6 screw into each of the bottom holes to fix the rail slider in place for both ends of the rail, and for both rail sliders (a total of 4 M6 screws are used here).

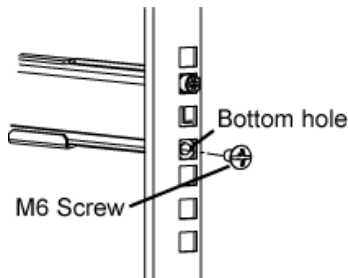

5. Insert the M6 nuts onto the support columns as show below:

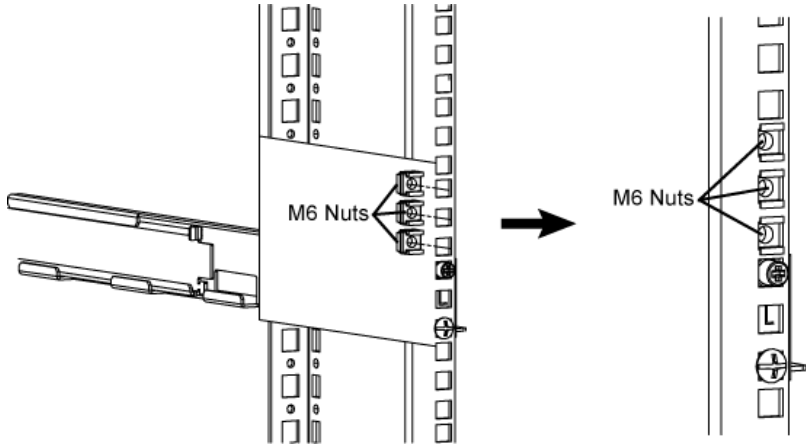

6. Attach the mounting kit onto the UPS by screwing M4 screws into the mounting kit screw holes and the UPS as shown:

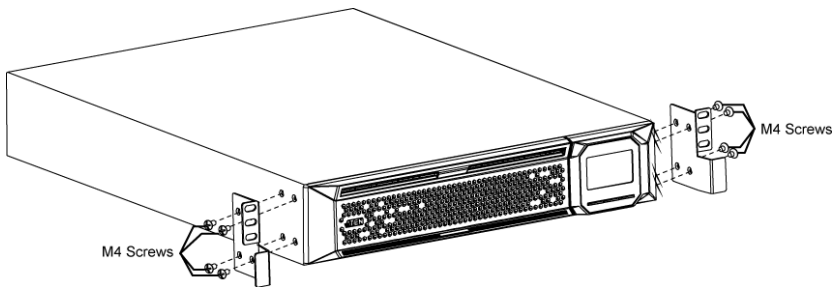

7. Fit the UPS onto the rack rails and stabilize the mounting kit (M6 screws) onto the rack as shown:

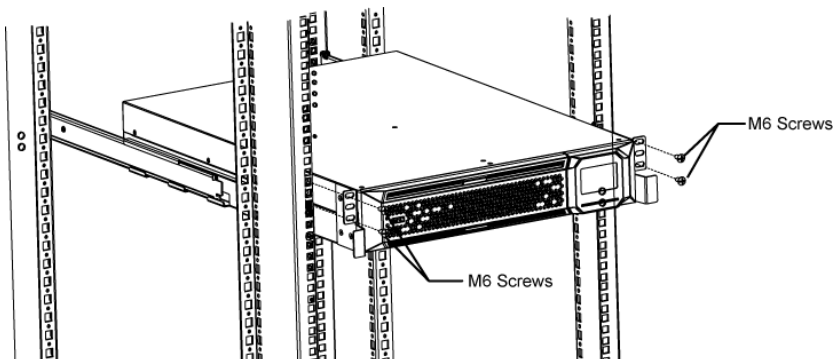

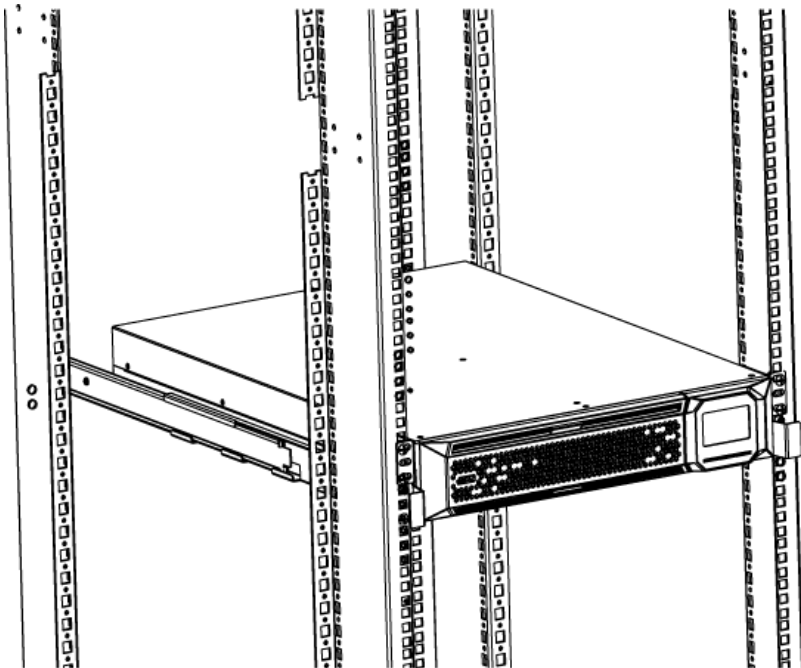

Vertical (Tower) Desktop Mount

1. You can mount the unit onto the Tower Stand set (a set includes 2 tower stands) from the package content. Place the unit onto the tower stands.

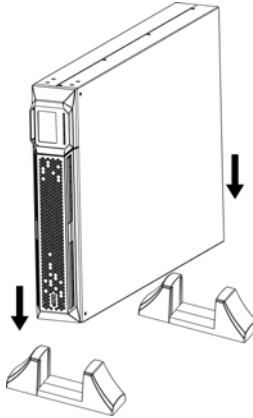

2. Remove the front panel. Pull to loosen the hooks and withdraw the panel.

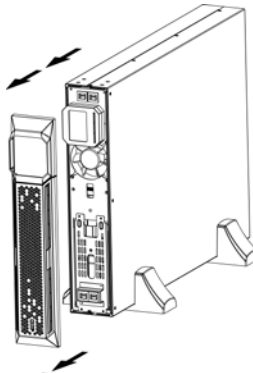

3. Turn the LCD panel such that the buttons are below the LCD screen.

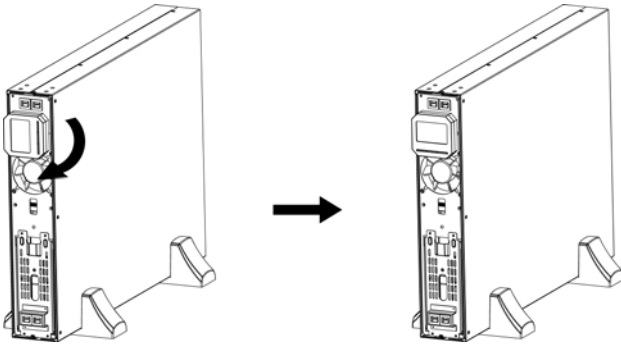

4. Replace the front panel back to the unit.

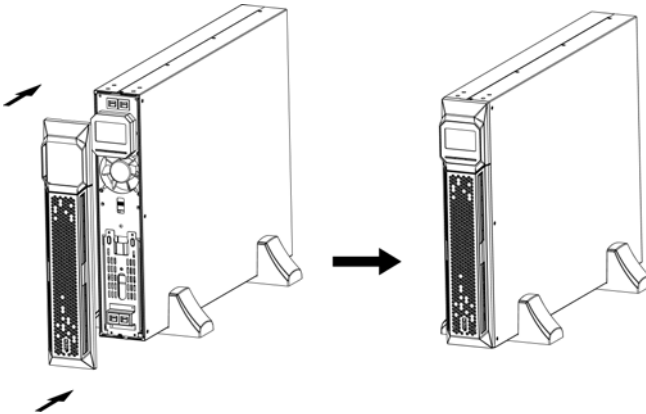

Mounting UPS with Battery Box

If you have an extra battery box, you may vertically mount your UPS and the battery box in a single configuration if you use the extended tower stands.

2 Stand Extenders are used to extend one tower stand. The Stand Extenders (4 pcs) are from the package content of the battery box.

Follow the instructions below to assemble the extended tower stands.

1. Remove the screws from the bottom of the tower stand.

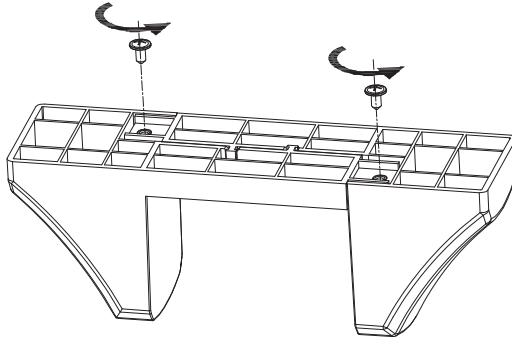

2. Bend the tower stand as shown in the diagram below:

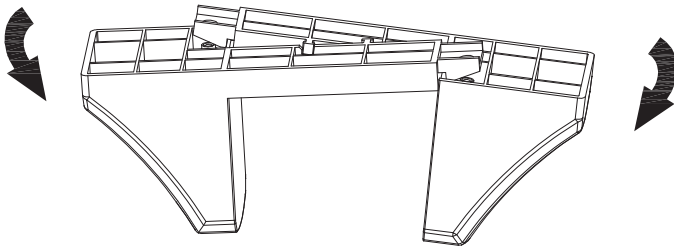

The separated tower stand pieces and two stand extenders (from the package content of the battery box) are shown below:

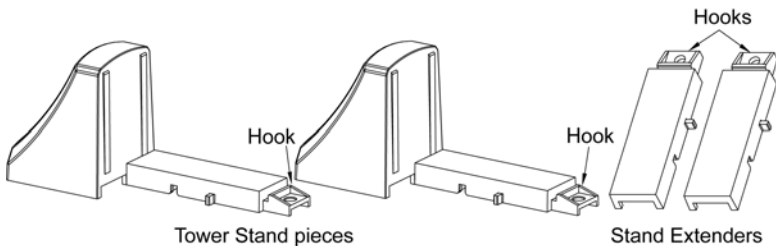

3. Orient the stand extenders as shown in the diagram below. Level and connect the extenders to the bottom of the tower stand pieces as indicated by the arrow. Make sure the hooks are properly hooked into the tower stand pieces.

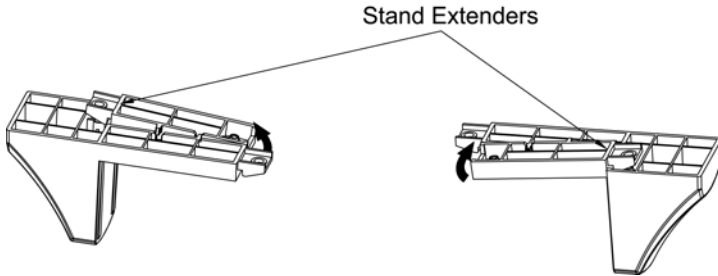

4. Stabilize the stand extenders by screwing M4 screws from the hooks to the tower stand pieces.

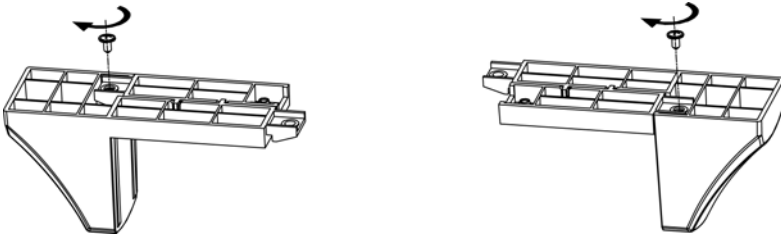

5. Orient the extended tower stand pieces as shown in the diagram below. Level and connect the hooks.

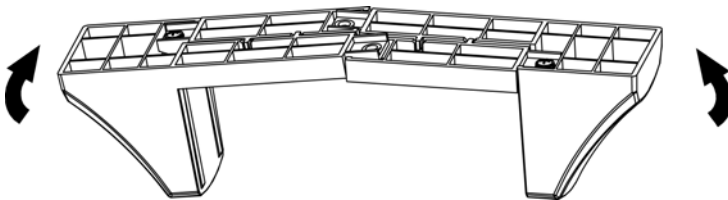

6. Stabilize the extended tower stand by screwing M4 screws from the hooks to the tower stand pieces.

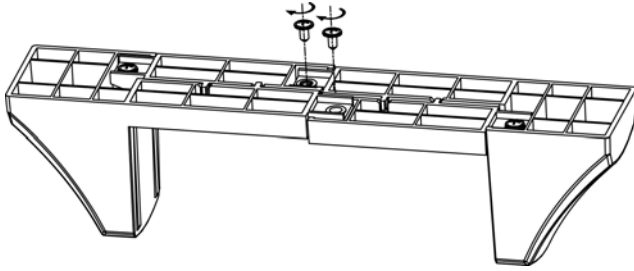

A completed extended tower stand is shown below:

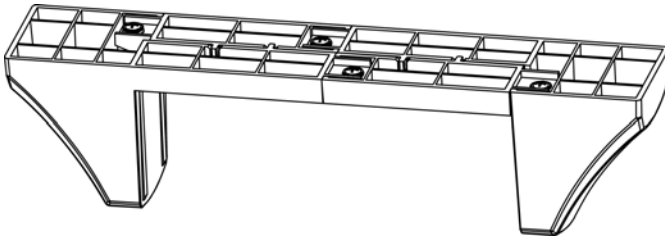

7. You can now place the UPS and a battery box onto the extended tower stands.

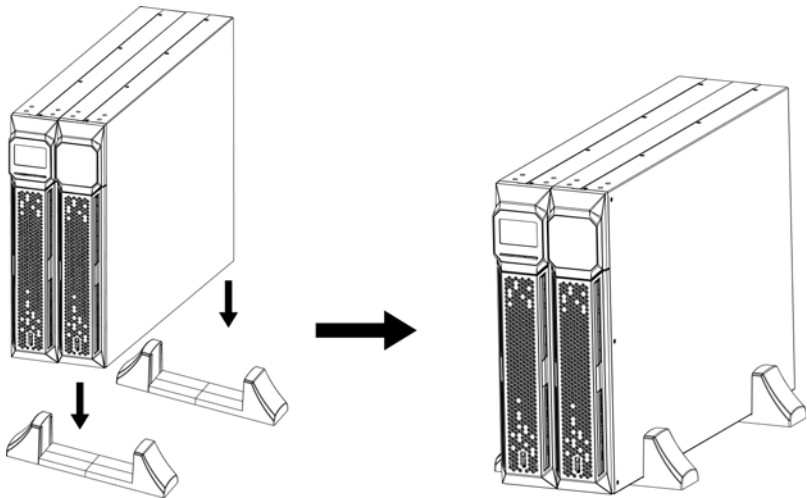

Connecting Internal Battery

For safety, the internal battery of the unit is disconnected by default. Please follow the steps below to reconnect battery wires.

Note: It is recommended that no power is connected during this time to prevent electric shock.

1. Remove the front panel. Pull to loosen the hooks and withdraw the panel.

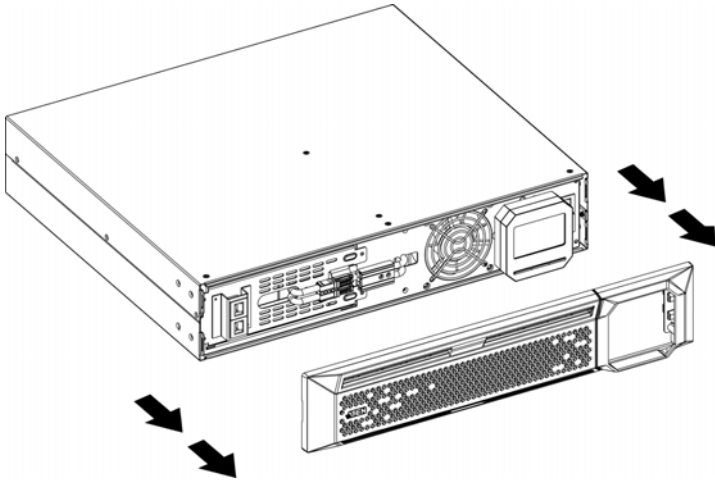

2. Connect the power connectors of the battery and the unit together.

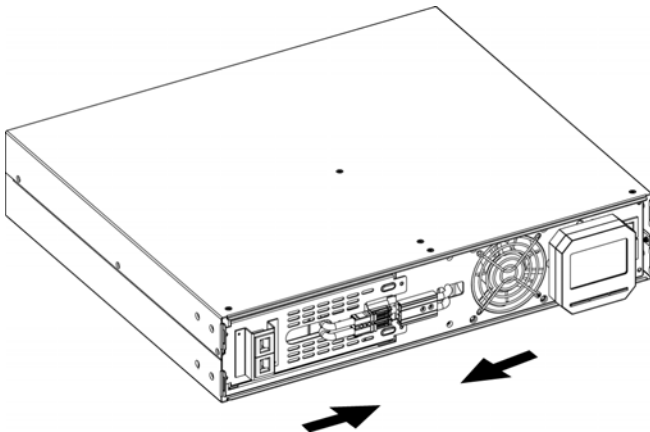

3. Replace the front panel back to the unit.

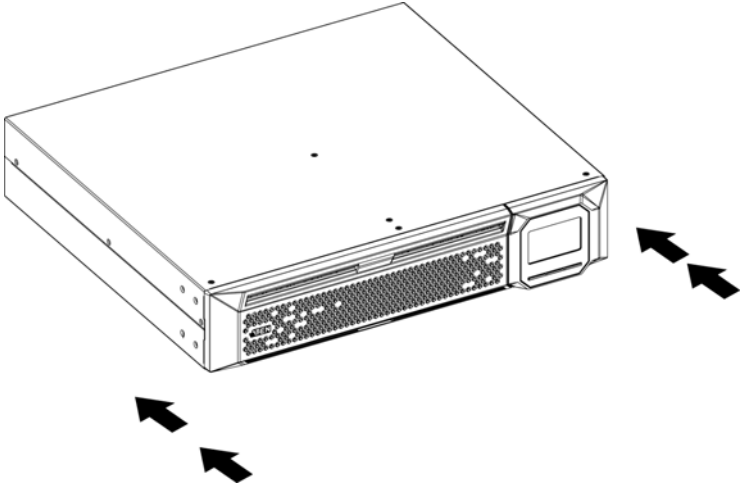

Installation

Refer to the diagram following the steps below to connect the UPS:

Note: OL1000HV is the example used here.

1. Connect the unit's grounding terminal to a suitable grounded object.
2. Connect electrical appliances to the non-critical power outlets.
3. Connect electrical appliances (that you do not wish to have power cut off) to the critical power outlets.
4. (Optional) Connect external battery to the External Battery Connection Port. Refer to *External Battery Connection* on page 22.
5. (Optional) Connect a modem/phone/fax source (using a corresponding cable) into the surge-protected "IN" outlet. Connect an equipment (you wish to have surge protection for) to the "OUT" outlet using another modem/fax/phone cable.
6. (Optional) Connect the USB Type B end of the included USB Type A to B cable to the unit and the Type A end to a USB port on your PC.
7. (Optional) Connect the included RS-232 cable between the RS-232 port of the unit and a communication port of your PC.
8. (Optional) Connect either SNMP or AS400 card for advanced communication and monitoring options.
9. For HV models, connect the included power cable between this port and an AC power socket.
For LV models, connect this power cable to an AC power socket.

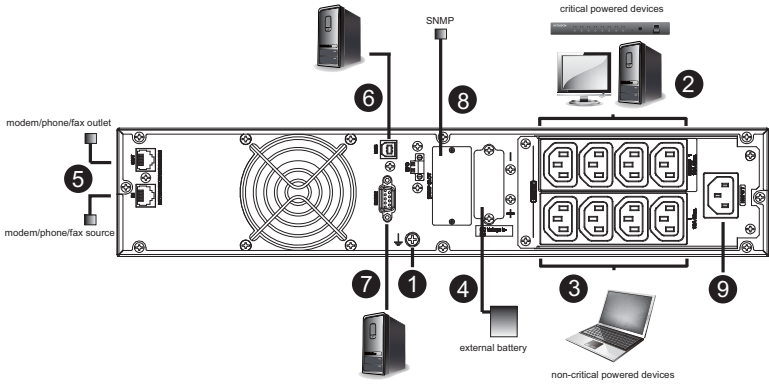

External Battery Connection

External batteries can be purchased separately.

Note: When connecting external battery packs, please connect the polarity correctly. Connect positive pole of external battery pack to the positive pole of external battery connector on the UPS and negative pole of battery pack to negative pole of external battery connector on the UPS. Polarity misconnection will cause internal fault in the UPS. It is recommended to add a breaker between the positive pole of battery pack and positive pole of external battery connector on the UPS to prevent damage.

The required specification of breaker: Voltage ≥ 1.25 battery voltage/set; current $\geq 50A$.

Please choose battery size and connected numbers according to backup time requirement and UPS specifications. To extend battery lifecycle, it's recommended to use them in the temperature range of 15°C to 25°C.

Follow the steps below to connect an external battery:

1. Turn of the unit by removing the power plug from the mains.
2. Remove the front panel and disconnect the internal battery connector.

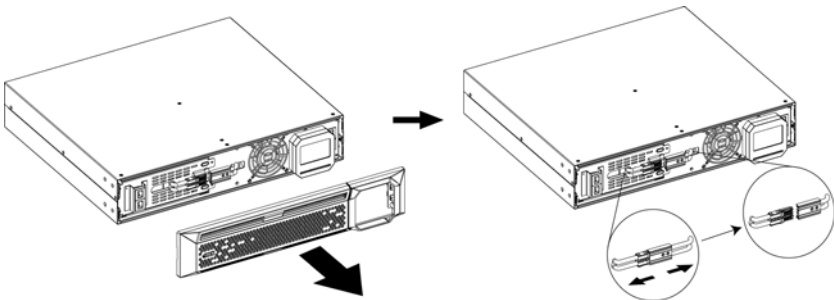

3. Remove the cover of the External Battery Connection Port using a screwdriver.

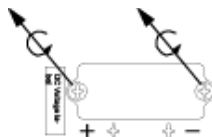

4. Plug the cable connector into the External Battery Connection Port of the unit and the battery pack(s).

Note: If you have multiple battery packs available, connect them serially. An example is shown in the diagram below (connecting the second battery connection port of the first battery pack to the first battery connection port of the second battery pack).

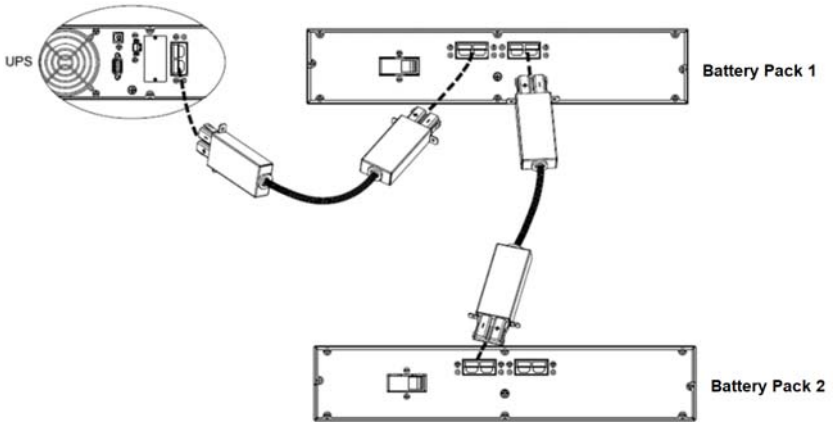

5. Stabilize the connectors to the unit and the battery pack(s) using screws. An example is shown below:

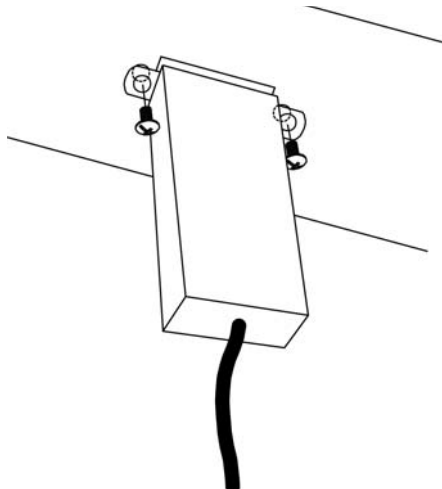

6. On the front side of the unit, reconnect the battery connector and reattach the front cover.

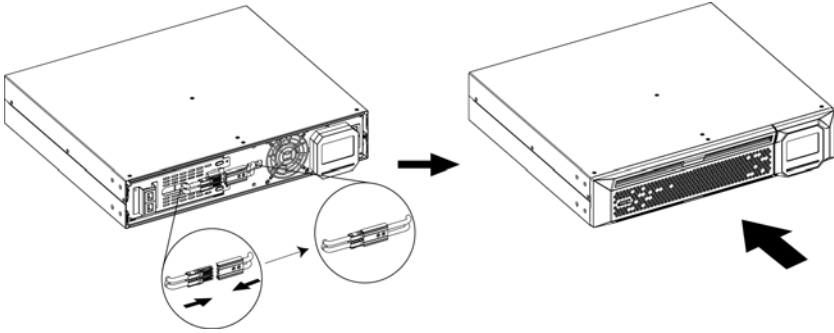

Chapter 3

General Operations

Turn On the UPS

Press the ON/Mute button on the front panel for two seconds to power on the UPS.

Note: The battery charges fully during the first five hours of normal operation. Do not expect full battery run capability during this initial charge period.

EPO Function

This UPS is equipped with EPO function. By default, the UPS is delivered from factory with Pin 1 and pin 2 closed (a metal plate is connected to Pin 1 and Pin2) for UPS normal operation. To activate EPO function, remove two screws on EPO port and metal plate will be removed.

Note: The EPO function logic can be set up via LCD setting. Please refer to *EPO Logic Setting* on page 39 for details.

Install Software

For optimal computer system protection, install UPS monitoring software to fully configure UPS shutdown. Use supplied RS-232 or USB communication cable to connect RS-232/USB port of UPS and RS-232/USB port of PC. Then, follow below steps to install monitoring software.

1. Insert the included installation CD into CD-ROM drive and then follow the on-screen instructions to proceed software installation. If there no screen shows 1 minute after inserting the CD, please execute setup.exe file for initiating software installation.
2. Follow the on-screen instructions to install the software.

When your computer restarts, the monitoring software will appear as an orange plug icon located in the system tray, near the clock.

This Page Intentionally Left Blank

Chapter 4

LCD/Button Operations

Overview

The unit includes an LCD display with a three-button configuration interface.

Button Operation

Button	Function
On / Mute Button	<ul style="list-style-type: none">◆ Turn on the UPS: Press and hold ON/Mute button for at least 2 seconds to turn on the UPS.◆ Mute the alarm: After the UPS is turned on in battery mode, press and hold this button for at least 3 seconds to disable or enable the alarm system. But it's not applied to the situations when warnings or errors occur.◆ Up key: Press this button to display previous selection in UPS setting mode.◆ Switch to UPS self-test mode: Press ON/Mute buttons for 3 seconds to enter UPS self-testing while in AC mode, ECO mode, or converter mode.
Off / Enter Button	<ul style="list-style-type: none">◆ Turn off the UPS: Press and hold this button at least 2 seconds to turn off the UPS. UPS will be in standby mode under power normal or transfer to Bypass mode if the Bypass enable setting by pressing this button.◆ Confirm selection key: Press this button to confirm selection in UPS setting mode.
Select Button	<ul style="list-style-type: none">◆ Switch LCD message: Press this button to change the LCD message for input voltage, input frequency, input current, battery voltage, battery current, battery capacity, ambient temperature, output voltage, output frequency, load current and load percent.◆ Setting mode: Press and hold this button for 3 seconds to enter UPS setting mode when Standby and Bypass mode.◆ Down key: Press this button to display next selection in UPS setting mode

Button	Function
On / Mute Button + Select Button	<ul style="list-style-type: none"> Switch to bypass mode: When the main power is normal, press ON/Mute and Select buttons simultaneously for 3 seconds. Then UPS will enter to bypass mode. This action will be ineffective when the input voltage is out of acceptable range. Exit setting mode or return to the upper menu: When working in setting mode, press ON/Mute and Select buttons simultaneously for 0.2 seconds to return to the upper menu. If it's already in top menu, press these two buttons at the same time to exit the setting mode.





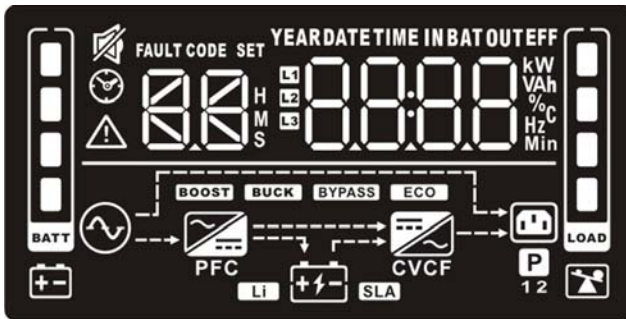





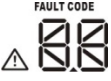

LCD Panel



The LCD Panel is shown below:





The function is described below:

Display	Function
Backup time Information	
	Indicates the estimated backup time. H: hours, M: minute, S: second.
Configuration and fault information	
	Indicates the configuration items, and the configuration items are listed in details in <i>UPS Setting</i> on page 33.

Display	Function
	Indicates the warning and fault codes, and the codes are listed in details in <i>Faults Reference Code</i> on page 45 and <i>Warning Indicator</i> on page 46.
Mute operation	
	Indicates that the UPS alarm is disabled.
Input, Battery, Temperature, Output & Load information	
	Indicate the input voltage, input frequency, input current, battery voltage, battery current, battery capacity, ambient temperature, output voltage, output frequency, load current and load percent. k: kilo, W: watt, V: voltage, A: ampere, %: percent, °C: centigrade degree, Hz: frequency
Load Information	
	Indicates the load level by 0-24%, 25-49%, 50-74% and 75-100%.
	Indicates overload
Programmable outlets information	
	Indicates that programmable management outlets are working.
Mode operation information	
	Indicates the UPS connects to the mains.
	Indicates the battery is working.
	Indicates charging status
	Indicates the bypass circuit is working.
	Indicates the ECO mode is enabled.
	Indicates the AC to DC circuit is working.

Display	Function
PFC	Indicates the PFC circuit is working.
	Indicates the inverter circuit is working.
CVCF	Indicates the UPS is working in converter mode.
	Indicates the output is working.

Battery information

	Indicates the battery level by 0-24%, 25-49%, 50-74%, and 75-100%.
	Indicates low battery.

Audible Alarm

Mode	Alarm Pattern
Battery Mode	Beep once every 5 seconds
Low Battery	Beep once every 2 seconds
Overload	Beep once every second
Fault	Beeps continuously
Bypass Mode	Beep every 10 seconds

LCD Display Wordings Index

English Letter	Display	Definition
ENA	ENR	Enable
DIS	di S	Disable
ESC	ESC	Escape
HLS	HLS	High loss
LLS	LLS	Low loss
AO	AO	Active open
AC	AC	Active close
EAT	EAt	Estimated autonomy time
RAT	rAt	Running autonomy Time
SD	Sd	Shutdown
OK	OK	OK
ON	ON	ON
BL	bL	Battery Low
OL	OL	Overload
OI	OI	Over input current
NC	NC	Battery no connect

English Letter	Display	Definition
OC	OC	Overcharge
SF	SF	Site wiring fault
EP	EP	EPO
TP	TP	Temperature
CH	CH	Charger
BF	BF	Battery fault
BV	BV	Bypass out range
FU	FU	Bypass frequency unstable
BR	BR	Battery replace
EE	EE	EEPROM error

UPS Setting

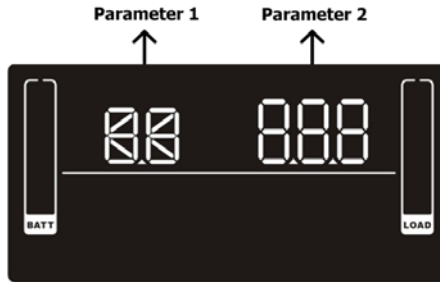

There are two parameters for the UPS as displayed in the picture below:









Parameter 1: The number shown here determines the settings you can adjust. Please refer to the table below for the settings.





Parameter 2: The number shown here is the option or value for the settings determined in parameter 1.



Parameter 1 & Interface Display	Parameter 2 Description
<p>Output Voltage Setting Display: 01</p> 	<p>Parameter 2: Output voltage</p> <p>For 200/208/220/230/240 VAC models, you may choose the following output voltages:</p> <ul style="list-style-type: none"> 200: 200vac output voltage 208: 208vac output voltage 220: 220vac output voltage 230: 230vac output voltage (Default) 240: 240vac output voltage <p>For 100/110/115/120/127 VAC models, you may choose the following output voltages:</p> <ul style="list-style-type: none"> 100: 100vac output voltage 110: 110vac output voltage 115: 115vac output voltage 120: 120vac output voltage (Default) 125: 125vac output voltage 127: 127vac output voltage (not applicable for U.S. region)

Parameter 1 & Interface Display	Parameter 2 Description
<p>Enable/Disable Frequency Converter Mode Display: 02</p>  <p>The display shows '02' under 'SET' and 'd15' under 'OUT'. A 'CVCF' indicator is visible at the bottom center. 'BATT' and 'LOAD' indicators are on the left and right respectively.</p>	<p>Parameter 2: Enable or disable converter mode.</p> <p>You may choose the following two options:</p> <p>ENA: Enable Converter mode DIS: Disable Converter mode (Default)</p>
<p>Output Frequency Setting Display: 03</p>  <p>The display shows '03' under 'SET' and '500 Hz' under 'OUT'. A 'CVCF' indicator is visible at the bottom center. 'BATT' and 'LOAD' indicators are on the left and right respectively.</p>	<p>Parameter 2: Output frequency.</p> <p>You may set the initial frequency on battery mode:</p> <p>BAT 50: 50Hz output frequency BAT 60: 60Hz output frequency</p> <p>If converter mode is enabled, you may choose the following output frequencies:</p> <p>CF 50: 50Hz output frequency CF 60: 60Hz output frequency</p>
<p>Enable/Disable ECO Display: 04</p>  <p>The display shows '04' under 'SET' and 'd15' under 'OUT'. An 'ECO' indicator is visible at the bottom center. 'BATT' and 'LOAD' indicators are on the left and right respectively.</p>	<p>Parameter 2: Enable or disable ECO function.</p> <p>You may choose the following two options:</p> <p>ENA: Enable ECO mode DIS: Disable ECO mode (Default)</p>



Parameter 1 & Interface Display	Parameter 2 Description
<p data-bbox="164 177 443 201">ECO Voltage Range Setting</p> <p data-bbox="164 204 270 228">Display: 05</p>  <p data-bbox="164 477 277 501">Display: HS</p> 	<p data-bbox="539 177 947 280">Parameter 2: Acceptable high voltage point and low voltage point for ECO mode. Press the Up or Down key to adjust the values.</p> <p data-bbox="539 292 918 341">HLS: High loss voltage in ECO mode in parameter 2.</p> <p data-bbox="539 352 958 432">For 200/208/220/230/240 VAC models, the setting range for parameter 3 is +7V to +24V of the nominal voltage. (Default: +12V)</p> <p data-bbox="539 443 958 523">For 100/110/115/120/127 VAC models, the setting range for parameter 3 is +3V to +12V of the nominal voltage.</p> <p data-bbox="539 534 674 558">(Default: +6V)</p> <p data-bbox="539 569 910 619">LLS: Low loss voltage in ECO mode in parameter 2.</p> <p data-bbox="539 630 953 710">For 200/208/220/230/240 VAC models, the setting range for parameter 3 is -7V to -24V of the nominal voltage.</p> <p data-bbox="539 721 683 745">(Default: -12V)</p> <p data-bbox="539 756 958 836">For 100/110/115/120/127 VAC models, the setting voltage for parameter 3 is -3V to -12V of the nominal voltage.</p> <p data-bbox="539 847 670 871">(Default: -6V)</p>
<p data-bbox="164 887 506 936">Enable/Disable Bypass when UPS is off</p> <p data-bbox="164 940 270 963">Display: 06</p> 	<p data-bbox="539 887 931 936">Parameter 2: Enable or disable Bypass function.</p> <p data-bbox="539 948 943 971">You may choose the following two options:</p> <p data-bbox="539 983 740 1007">ENA: Enable bypass</p> <p data-bbox="539 1018 823 1042">DIS: Disable bypass (Default)</p>

Parameter 1 & Interface Display	Parameter 2 Description
<p>Bypass Voltage Range Setting Display: 07</p>  <p>Display: HS</p> 	<p>Parameter 2: Acceptable high voltage point and acceptable low voltage point for Bypass mode. Press the Up or Down key to adjust the values.</p> <p>HLS: Bypass high voltage point For 200/208/220/230/240 VAC models: 230-264: setting the high voltage point range of parameter 3 to between 230Vac and 264Vac. (Default: 264Vac) For 100/110/115/120/127 VAC models: 120-140: setting the high voltage point range of parameter 3 to between 120Vac and 140Vac. (Default: 132Vac)</p> <p>LLS: Bypass low voltage point For 200/208/220/230/240 VAC models: 170-220: setting the low voltage point range of parameter 3 to between 170Vac and 220Vac. (Default: 170Vac) For 100/110/115/120/127 VAC models: 85-115: setting the low voltage point range of parameter 3 to between 85Vac and 115Vac. (Default: 85Vac)</p>
<p>Bypass Frequency Range Setting Display: 08</p>  <p>Display: HS</p> 	<p>Parameter 2: Acceptable high frequency point and acceptable low frequency point for Bypass mode. Press the Up or Down key to adjust the values.</p> <p>HLS: Bypass high frequency point For 50Hz output frequency models: 51-55Hz: setting the frequency high loss point from 51Hz to 55HZ(Default: 53.0Hz) For 60Hz output frequency models: 61-65Hz: setting the frequency high loss point from 61Hz to 65Hz(Default: 63.0Hz)</p> <p>LLS: Bypass low Frequency point For 50Hz output frequency models: 45-49Hz: setting the frequency low loss point from 45Hz to 49HZ(Default: 47.0Hz) For 60Hz output frequency models: 55-59Hz: setting the frequency low loss point from 55Hz to 59Hz(Default: 57.0Hz)</p>

Parameter 1 & Interface Display	Parameter 2 Description
<p>Enable/Disable Programmable Outlets Display: 09</p> 	<p>Parameter 2: Enable or disable programmable outlets. ENA: Enable Programmable outlets DIS: Disable Programmable outlets (Default)</p>
<p>Programmable Outlet Backup Time Setting Display: 10</p> 	<p>Parameter 2: Backup time limits for programmable outlets. 0-999: setting the backup time limits in minutes from 0-999 for programmable outlets which connect to non-critical devices on battery mode. (Default: 999)</p>
<p>Autonomy Limitation Setting Display: 11</p> 	<p>Parameter 2: Backup time on battery mode for general outlets. 0-999: Set the backup time (in minutes) from 0-999 for general outlets on battery mode. DIS: Disable the autonomy limitation and the backup time will depend on battery capacity. (Default) Note: When setting as “0”, the backup time will be only 10 seconds.</p>
<p>Battery Total AH setting Display: 12</p> 	<p>Parameter 2: Battery total AH of the UPS. 7-999: Set the battery total capacity from 7-999 in AH. Please set the correct battery total capacity if external battery pack is connected.</p>

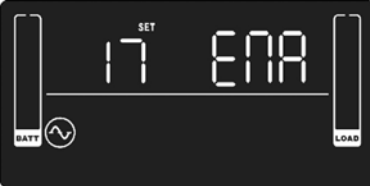
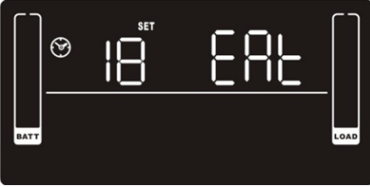
Parameter 1 & Interface Display	Parameter 2 Description
<p>Maximum Charger Current Setting Display: 13</p> 	<p>Parameter 2: Charger maximum current. For low voltage model with 24/36/48VDC 1/2/4/6/8: Set maximum charger current to 1/2/4/6/8 Ampere. (Default: 2A) For high voltage model with 24/36/48VDC 1/2/4/6/8/10/12: Set maximum charger current to 1/2/4/6/8/10/12 Ampere. (Default: 2A) For low voltage and high voltage model with 72/96VDC 1/2/4/6/8: Set maximum charger current to 1/2/4/6/8 Ampere. (Default: 2A) Note: Please set the appropriate charger current based on battery capacity used. The recommended charging current is 0.1C~0.3C of battery capacity as following table for reference.</p> <p>Warning: Setting the current too high may cause damage to the device. For the recommended charger current, please refer to <i>Suggested Battery Charger Current</i> on page 41.</p>
<p>Charger Boost Voltage Setting Display 14</p> 	<p>Parameter 2: Charger boost voltage. 2.25-2.40: setting the charger boost voltage from 2.25 V/cell to 2.40V/cell. (Default: 2.36V/cell)</p>
<p>Charger Float Voltage Setting Display: 15</p> 	<p>Parameter 2: Charger float voltage. 2.20-2.33: Set the charger float voltage from 2.20 V/cell to 2.33V/cell. (Default: 2.28V/cell)</p>

Parameter 1 & Interface Display	Parameter 2 Description
<p>EPO Logic Setting Display: 16</p>  <p>The LCD display shows the number '16' on the left and 'AO' on the right. Above the numbers is the word 'SET'. On the left side of the display, there is a vertical bar labeled 'BATT' and a small battery icon. On the right side, there is a vertical bar labeled 'LOAD' and a small load icon.</p>	<p>Parameter 2: EPO function control logic.</p> <p>AO: Active Open (Default). When selected, it will activate EPO function with Pin 1 and Pin 2 in open status.</p> <p>AC: Active Close. When selected, it will activate EPO function with Pin 1 and Pin 2 in close status.</p>
<p>Enable/Disable Site Fault Detection Display: 17</p>  <p>The LCD display shows the number '17' on the left and 'ENA' on the right. Above the numbers is the word 'SET'. On the left side of the display, there is a vertical bar labeled 'BATT' and a small battery icon with a checkmark. On the right side, there is a vertical bar labeled 'LOAD' and a small load icon.</p>	<p>Parameter 2: Enable/disable sit fault detection.</p> <p>ENA: Enable (Default).</p> <p>DIS: Disable.</p>
<p>Display Setting for Autonomy Time Display: 18</p>  <p>The LCD display shows the number '18' on the left and 'EAT' on the right. Above the numbers is the word 'SET'. On the left side of the display, there is a vertical bar labeled 'BATT' and a small battery icon with a clock symbol. On the right side, there is a vertical bar labeled 'LOAD' and a small load icon.</p>	<p>Parameter 2: Display setting for autonomy time</p> <p>EAT: when selected, the remaining autonomy time will be displayed. (Default)</p> <p>RAT: When selected, the accumulated autonomy time so far will be displayed.</p>

Parameter 1 & Interface Display	Parameter 2 Description
<p>Acceptable Input Voltage Range Setting Display: 19</p>  <p>Display: HS</p> 	<p>Parameter 2: Acceptable high voltage point and acceptable low voltage point for input voltage range. Press the Up or Down key to adjust the values.</p> <p>HLS: Input high voltage point For 200/208/220/230/240 VAC models: 280/290/300: setting the high voltage point in parameter 2. (Default: 300Vac) For 100/110/115/120/127 VAC models: 140/145/150: setting the high voltage point in parameter 2. (Default: 150Vac)</p> <p>LLS: Bypass low voltage point For 200/208/220/230/240 VAC models: 110/120/130/140/150/160: setting the low voltage point in parameter 2. (Default: 110Vac) For 100/110/115/120/127 VAC models: 55/60/65/70/75/80: setting the low voltage point in parameter 2. (Default: 55Vac)</p>
<p>Exit Display: 00</p> 	<p>Exit UPS Setting.</p>

Suggested Battery Charger Current

	AH	Suggested Charging Current
1000VA (2B)	9	2
+1 BP24V18AH	27	4
+2 BP24V18AH	45	6
+3 BP24V18AH	63	8
+4 BP24V18AH	81	10
+5 BP24V18AH	99	10
+6 BP24V18AH	117	12
+7 BP24V18AH	135	12
+8 BP24V18AH	153	12
+9 BP24V18AH	171	12
+10 BP24V18AH	189	12
1000VA (3B)	7	2
+1 BP36V18AH	25	4
+2 BP36V18AH	43	6
+3 BP36V18AH	61	8
+4 BP36V18AH	79	8
+5 BP36V18AH	97	10
+6 BP36V18AH	115	12
+7 BP36V18AH	133	12
+8 BP36V18AH	151	12
+9 BP36V18AH	169	12
+10 BP36V18AH	187	12
1500VA (3B)	9	2
+1 BP36V18AH	27	4





	AH	Suggested Charging Current
+2 BP36V18AH	45	6
+3 BP36V18AH	63	8
+4 BP36V18AH	81	10
+5 BP36V18AH	99	10
+6 BP36V18AH	117	12
+7 BP36V18AH	135	12
+8 BP36V18AH	153	12
+9 BP36V18AH	171	12
+10 BP36V18AH	189	12

2000VA (4B)	9	2
+1 BP48V18AH	27	4
+2 BP48V18AH	45	6
+3 BP48V18AH	63	8
+4 BP48V18AH	81	10
+5 BP48V18AH	99	10
+6 BP48V18AH	117	12
+7 BP48V18AH	135	12
+8 BP48V18AH	153	12
+9 BP48V18AH	171	12
+10 BP48V18AH	189	12

2000VA (6B)	7	2
+1 BP72V18AH	25	4
+2 BP72V18AH	43	6
+3 BP72V18AH	61	8
+4 BP72V18AH	79	8

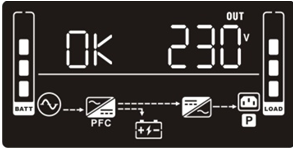
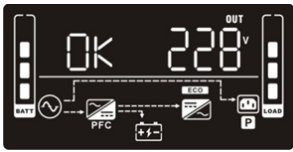
	AH	Suggested Charging Current
+5 BP72V18AH	97	10
+6 BP72V18AH	115	12
+7 BP72V18AH	133	12
+8 BP72V18AH	151	12
+9 BP72V18AH	169	12
+10 BP72V18AH	187	12
3000VA (6B)	9	2
+1 BP72V18AH	27	4
+2 BP72V18AH	45	6
+3 BP72V18AH	63	8
+4 BP72V18AH	81	10
+5 BP72V18AH	99	10
+6 BP72V18AH	117	12
+7 BP72V18AH	135	12
+8 BP72V18AH	153	12
+9 BP72V18AH	171	12
+10 BP72V18AH	189	12

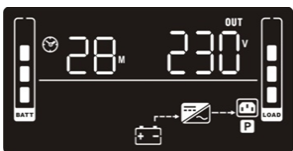
Operating Mode Description

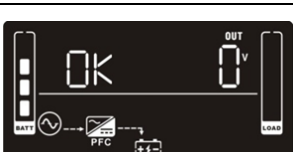

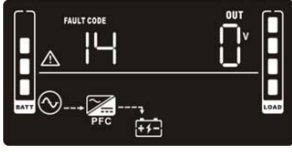









Operating Mode	LCD Display	Description
Online Mode	 <p>The LCD display shows 'OK' on the left, '230V' on the right, and 'OUT' above the voltage. Below the main display are icons for BATT (battery), PFC (power factor correction), a battery charging symbol, and a load icon.</p>	<p>When the input voltage is within acceptable range, the UPS will provide pure and stable AC power for output. The UPS will also charge the battery.</p>
ECO Mode	 <p>The LCD display shows 'OK' on the left, '228V' on the right, and 'OUT' above the voltage. Below the main display are icons for BATT, PFC, an ECO icon, and a load icon.</p>	<p>The energy saving mode: When the input voltage is within the voltage regulation range, the UPS will bypass voltage for output to save energy. The UPS will also charge the battery.</p>
Frequency Converter Mode	 <p>The LCD display shows 'OK' on the left, '230V' on the right, and 'OUT' above the voltage. Below the main display are icons for BATT, PFC, a CVCF icon, and a load icon.</p>	<p>When the input frequency is within 40 Hz to 70 Hz, the UPS can be set at a constant output frequency of 50 Hz or 60 Hz. The UPS will also charge the battery.</p>
Battery Mode	 <p>The LCD display shows a battery icon on the left, '28W' in the middle, and '230V' on the right, with 'OUT' above the voltage. Below the main display are icons for BATT, a battery charging symbol, and a load icon.</p>	<p>When the input voltage is beyond the acceptable range or power failure, the UPS will provide backup power from the battery and alarm will beep every 5 seconds.</p>
Bypass Mode	 <p>The LCD display shows 'OK' on the left, '228V' on the right, and 'OUT' above the voltage. Below the main display are icons for BATT, PFC, an EPP333 icon, and a load icon.</p>	<p>When the input voltage is within acceptable range but the UPS is overloaded, the UPS will enter bypass mode. Alternatively, you can set the UPS to bypass mode using the front panel. Alarm will beep every 10 seconds.</p>
Standby Mode	 <p>The LCD display shows 'OK' on the left and '0V' on the right, with 'OUT' above the voltage. Below the main display are icons for BATT, PFC, a battery charging symbol, and a load icon.</p>	<p>The UPS is powered off and will not output power. The UPS will charge the battery.</p>

Operating Mode	LCD Display	Description
Fault Mode		When a fault has occurred, the ERROR icon and the fault code will be displayed.

Faults Reference Code

Fault Event	Fault Code	Icon	Fault Event	Fault Code	Icon
Bus start fail	01	x	Battery voltage too high	27	x
Bus over	02	x	Battery voltage too low	28	x
Bus under	03	x	Charger output short	2A	x
Inverter soft start fail	11	x	Over temperature	41	x
Inverter voltage high	12	x	Overload	43	
Inverter voltage low	13	x	Charger failure	45	x
Inverter output short	14	x	Over input current	49	x

Warning Indicator

Warning	Icon (Flashing)	Code	Alarm
Low Battery		BL	Beeps every 2 seconds
Overload		OL	Beeps every second
Over input current		OI	Beeps twice every 10 seconds
Battery is not connected		NC	Beeps every 2 seconds
Over Charge		OC	Beeps every 2 seconds
Site wiring fault		SF	Beeps every 2 seconds
EPO enable		EP	Beeps every 2 seconds
Over temperature		TP	Beeps every 2 seconds
Charger failure		CH	Beeps every 2 seconds
Battery fault		BF	Beeps every 2 seconds (UPS will be off to remind users something is wrong with the battery)
Out of bypass voltage range		bV	Beeps every 2 seconds
Bypass frequency unstable		FU	Beeps every 2 seconds
Battery replacement		br	Beeps every 2 seconds

Warning	Icon (Flashing)	Code	Alarm
EEPROM error		EE	Beeps every 2 seconds

NOTE: “Site Wiring Fault” function can be enabled/disabled via software. Please check the software manual for the details.

This Page Intentionally Left Blank

Safety Instructions

Transportation

- ◆ Please only transport the UPS system in the original package for shock and impact protection.

Preparation

- ◆ Condensation may occur if the UPS system is moved directly from cold to warm environment. The UPS system must be absolutely dry before being installed. Please allow at least two hours for the UPS system to acclimate the environment.
- ◆ Do not install the UPS system near water or in moist environment.
- ◆ Do not install the UPS system in direct sunlight exposure or near heating sources.
- ◆ Do not block ventilation holes in the UPS housing.

Installation

- ◆ Do not connect appliances or devices which would overload the UPS system (e.g. laser printers) to the UPS output sockets.
- ◆ Place cables in such a way that no one can step on or trip over them.
- ◆ Do not connect domestic appliances such as hair dryers to UPS output sockets.
- ◆ The UPS can be operated by any individuals with no previous experience.
- ◆ Connect the UPS system only to an earthed shockproof outlet which must be easily accessible and close to the UPS system.
- ◆ Please use only VDE-tested, CE-marked (or UL-marked for 120 VAC models) mains cable (e.g. the mains cable of your computer) to connect the UPS system to the building wiring outlet (shockproof outlet).
- ◆ Please use only VDE-tested, CE-marked (or UL-marked for 120 VAC models) power cables to connect the loads to the UPS system.

- ◆ When installing the equipment, it should ensure that the sum of the leakage current of the UPS and the connected devices does not exceed 3.5mA.
- ◆ Temperature Rating - Units are considered acceptable for use in a maximum ambient of 40°C (104°F).
- ◆ For Pluggable Equipment - The socket-outlet shall be installed near the equipment and shall be easily accessible.
- ◆ For normal operation of the UPS (at full load UPS), it is required to keep the unit below a maximum altitude of 3000m.

Operation

- ◆ Do not disconnect the mains cable on the UPS system or the building wiring outlet (shockproof socket outlet) during operations since this would cancel the protective earthing of the UPS system and of all connected loads.
- ◆ The UPS system features its own, internal current source (batteries). The UPS output sockets or output terminals block may be electrically live even if the UPS system is not connected to the building wiring outlet.
- ◆ In order to fully disconnect the UPS system, first press the OFF/ Enter button to disconnect the mains.
- ◆ Prevent no fluids or other foreign objects from entering the inside of the UPS system.
- ◆ To reduce the risk of fire, connect only to a circuit provided with X (in ampere, refer to the table below) maximum branch circuit overcurrent protection in accordance with the National Electrical Code, ANSI/NFPA 70 and the Canadian Electrical Code, Part I, C22.1.

Model	X
OL1000LV, OL1000SLV, OL1500LV, OL2000LV, OL2000SLV	20A
OL3000LV	40A

Maintenance, service and faults

- ◆ The UPS system operates with hazardous voltages. Repairs may be carried out only by qualified maintenance personnel.
- ◆ **Caution** - Risk of electric shock. Even after the unit is disconnected from the mains (building wiring outlet), components inside the UPS system are still connected to the battery and electrically live and dangerous.
- ◆ Before carrying out any kind of service and/or maintenance, disconnect the batteries and verify that no current is present and no hazardous voltage exists in the terminals of high capability capacitor such as BUS-capacitors.
- ◆ Only persons are adequately familiar with batteries and with the required precautionary measures may replace batteries and supervise operations. Unauthorized persons must be kept well away from the batteries.
- ◆ **Caution** - Risk of electric shock. The battery circuit is not isolated from the input voltage. Hazardous voltages may occur between the battery terminals and the ground. Before touching, please verify that no voltage is present!
- ◆ **Caution** - Do not dispose of batteries in a fire. The batteries may explode.
- ◆ **Caution** - Do not open or mutilate batteries. Released electrolyte is harmful to the skin and eyes. It may be toxic.
- ◆ Batteries may cause electric shock and have a high short-circuit current. Please take the precautionary measures specified below and any other measures necessary when working with batteries:
 - ◆ Remove watches, rings, or other metal objects.
 - ◆ Use tools with insulated handles.
 - ◆ Wear rubber gloves and boots.
 - ◆ Do not lay tools or metal parts on top of batteries.
 - ◆ Disconnect charging source and load prior to installing or maintaining the battery.
 - ◆ Remove battery grounds during installation and maintenance to reduce likelihood of shock. Remove the connection from ground if any part of the battery is determined to be grounded.
- ◆ For internal battery:

- ◆ Instructions shall carry sufficient information to enable the replacement of the battery with a suitable manufacturer and catalogue number.
- ◆ Safety instructions to allow access by Service Personnel shall be stated in the installation/service handbook.
- ◆ If batteries are to be installed by Service Personnel, instructions for interconnections, including terminal torque, shall be provided.
- ◆ Do not attempt to dispose of batteries by burning them. This could cause battery explosion.
- ◆ Do not open or destroy batteries. Escaping electrolyte can cause injury to the skin and eyes. It may be toxic.
- ◆ Please replace the fuse only with the same type and amperage in order to avoid fire hazards.
- ◆ Do not dismantle the UPS system.
- ◆ **WARNING:** This is a category C2 UPS product. In a residential environment, this product may cause radio interference, in which case the user may be required to take additional measures. (only for 220/230/240 VAC system)

Only for 110/120 VAC system:

- ◆ **NOTE:** This equipment has been tested and found to comply with the limits for a Class A digital device, pursuant to part 15 of the FCC Rules. These limits are designed to provide reasonable protection against harmful interference when the equipment is operated in a commercial environment. This equipment generates, uses, and can radiate radio frequency energy and, if not installed and used in accordance with the instruction manual, may cause harmful interference to radio communications. Operation of this equipment in a residential area is likely to cause harmful interference in which case the user will be required to correct the interference at his own expense.
- ◆ **WARNING:** Changes or modifications not expressly approved by the party responsible for compliance could void the user's authority to operate the equipment.

Technical Support

International

- ◆ For online technical support – including troubleshooting, documentation, and software updates: **<http://eservice.aten.com>**
- ◆ For telephone support, see *Telephone Support* on page iv.

North America

Email Support		support@aten-usa.com
Online Technical Support	Troubleshooting Documentation Software Updates	http://eservice.aten.com
Telephone Support		1-888-999-ATEN ext 4988 1-949-428-1111

When you contact us, please have the following information ready beforehand:

- ◆ Product model number, serial number, and date of purchase.
- ◆ Your computer configuration, including operating system, revision level, expansion cards, and software.
- ◆ Any error messages displayed at the time the error occurred.
- ◆ The sequence of operations that led up to the error.
- ◆ Any other information you feel may be of help.

Specifications

HV Series

Aten Model Name	OL1000 HV	OL1000 SHV	OL1500 HV	OL2000 HV	OL2000 SHV	OL3000 HV
-----------------	-----------	------------	-----------	-----------	------------	-----------

General

UPS Topology	Double-Conversion					
Energy Saving (max)	>96% (ECO) >89% (AC) >88% (Batt)		>96% (ECO) >90% (AC) >89% (Batt)	>96% (ECO) >90% (AC) >90% (Batt)	>96% (ECO) >91% (AC) >90% (Batt)	>96% (ECO) >91% (AC) >90% (Batt)

Input

Voltage	200/208/220/230/240 VAC					
Input Voltage Range	160-300 VAC \pm 5% @ 100% load 110-300 VAC \pm 5% @ 50% load Derate capacity to 80% when the output voltage is adjusted to 200VAC/208VAC.					
Input Frequency Range	40Hz - 70Hz					
Rated input current	4.8A	4.8A	7.2A	9.7A	9.7A	14.5A
Input Power Factor	\geq 0.99 @ nominal voltage (100% load)					
Cold Start	Yes					
Plug Type	IEC 320 C14			IEC 320 C20		
Power Cord	6ft					

Output

VA	1000	1000	1500	2000	2000	3000
Watts	1000	1000	1500	2000	2000	3000
On Battery Waveform	Sine Wave					
On Battery Voltage	200*/208*/220/230/240V					

Aten Model Name	OL1000 HV	OL1000 SHV	OL1500 HV	OL2000 HV	OL2000 SHV	OL3000 HV
On Battery Frequency	50/60Hz \pm 3Hz					
Outlets - Total	8					9
Outlet Type	(8) IEC 320 C13					(8) IEC 320 C13 + (1) IEC 320 C19
Outlets - Battery & Surge Protected	8					9
Rated Power Factor	>0.96		0.97			0.96
Crest Factor	3:1					
Harmonic Distortion	\leq 2 % THDi (Linear Load) \leq 4 % THDi (Non-linear Load)					
Voltage Regulation	\pm 1% (Batt)					
Transfer Time (AC to Batt.)	0ms					
Transfer Time (Inverter to Bypass)	4ms (ECO)					

Battery

Runtime at Half Load (min)	Half load 10.1	Half load 12.9	Half load 10.3	Half load 10.0	Half load 12.8	Half load 10.1
Runtime at Full Load (min)	Full load 2.95	Full load 4.44	Full load 2.96	Full load 2.95	Full load 4.37	Full load 2.96
Battery Type	Sealed Lead-Acid					
Battery Pack Voltage	24V	36V	36V	48V	72V	72V
Battery Size	12V/9AH	12V/7AH	12V/9AH	12V/9AH	12V/7AH	12V/9AH
Battery Quantity	2	3	3	4	6	6
Hot-Swappable	Yes					

Aten Model Name	OL1000 HV	OL1000 SHV	OL1500 HV	OL2000 HV	OL2000 SHV	OL3000 HV
Typical Recharge Time	3 hours recover to 95% capacity @2A charging current. Max charger current 12A				3 hours recover to 95% capacity @2A charging current. Max charger current 8A	
Extended Battery Module	BP24V18 AH	BP36V18 AH	BP36V18 AH	BP48V18 AH	BP72V18 AH	BP72V18 AH
Replacement Battery Pack	BC24V9A H	BC36V7A H	BC36V9A H	BC48V9A H	BC72V7A H	BC72V9A H
Replacement Battery Pack Quantity	1	1	1	1	1	1

Physical Properties

Rack Size	2U					
Form Factor	Rack/Tower					
Dimensions (WxHxD) (mm ³)	438 x 88 x 410			438 x 88 x 510	438 x 88 x 630	
Weight (kg.)	11.6/14.1	11.6/14.1	15.5	19.5	23.3	27.5

Environmental

Temperature (Operating / Storage)	0-40°C (non-condensing) / -20 to +50°C					
Humidity (Operating / Storage)	20-90% RH / 10% to 95% (No condensing)					
Audible noise at 1.5M from surface of unit	Less than 50dB					

Certifications	EN62040-2 C2 for CE models					
-----------------------	----------------------------	--	--	--	--	--

LV Series

Aten Model Name	OL1000 LV	OL1000 SLV	OL1500 LV	OL2000 LV	OL2000 SLV	OL3000 LV
General						
UPS Topology	Double-Conversion					
Energy Saving (max)	>96% (ECO) >89% (AC) >88% (Batt)		>96% (ECO) >90% (AC) >89% (Batt)	>96% (ECO) >90% (AC) >90% (Batt)	>96% (ECO) >90% (AC) >90% (Batt)	>96% (ECO) >91% (AC) >90% (Batt)
Input						
Voltage	100/110/115/120/125/127 VAC (127VAC not applicable for U.S. region)					
Input Voltage Range	80-150 VAC \pm 5% @ 100% load 55-150 VAC \pm 5% @ 50% load Derate capacity to 80% when the output voltage is adjusted to 100VAC					
Input Frequency Range	40Hz - 70Hz					
Rated input current	9.3A	9.3A	13.2A	17.6A	17.6A	26.4A
Input Power Factor	\geq 0.99 @ nominal voltage (100% load)					
Cold Start	Yes					
Plug Type	NEMA 5-15P			NEMA 5-20P		NEMA L5-30P
Power Cord	6ft					
Output						
VA	1000	1000	1500	2000	2000	3000
Watts	1000	1000	1450	1930	1930	2880
On Battery Waveform	Sine Wave					
On Battery Voltage	100*/110*/115/120/125/127VAC (127VAC not applicable for U.S. region)					
On Battery Frequency	50/60Hz \pm 3Hz					

Aten Model Name	OL1000 LV	OL1000 SLV	OL1500 LV	OL2000 LV	OL2000 SLV	OL3000 LV
Total Outlets	8					9
Outlet Type	(8) NEMA 5-15R			NEMA 5-20R		(8) NEMA 5-20R + (1) NEMA L5-30R
Outlets - Battery & Surge Protected	8					9
Rated Power Factor	>0.96		0.97			0.96
Crest Factor	3:1					
Harmonic Distortion	$\leq 2\%$ THDv (Linear Load) $\leq 4\%$ THDv (Non-linear Load)					
Voltage Regulation	$\pm 1\%$ (Batt)					
Transfer Time (AC to Batt.)	0ms					
Transfer Time (Inverter to Bypass)	4ms (ECO)					

Battery

Runtime at Half Load (min)	Half load 10.1	Half load 12.9	Half load 10.3	Half load 10.0	Half load 12.8	Half load 10.1
Runtime at Full Load (min)	Full load 2.95	Full load 4.44	Full load 2.96	Full load 2.95	Full load 4.37	Full load 2.96
Battery Type	Sealed Lead-Acid					
Battery Pack Voltage	24V	36V	36V	48V	72V	72V
Battery Size	12V/9AH	12V/7AH	12V/9AH	12V/9AH	12V/7AH	12V/9AH
Battery Quantity	2	3	3	4	6	6
Hot-Swappable	Yes					
Typical Recharge Time	3 hours recover to 95% capacity @2A charging current. Max charger current 8A					
Extended Battery Module	BP24V18 AH	BP36V18 AH	BP36V18 AH	BP48V18 AH	BP72V18 AH	BP72V18 AH

Aten Model Name	OL1000 LV	OL1000 SLV	OL1500 LV	OL2000 LV	OL2000 SLV	OL3000 LV
Replacement Battery Pack	BC24V9A H	BC36V7A H	BC36V9A H	BC48V9A H	BC72V7A H	BC72V9A H
Replacement Battery Pack Quantity	1	1	1	1	1	1

Physical Properties









Rack Size	2U					
Form Factor	Rack/Tower					
Dimensions (WxHxD) (mm ³)	438 x 88 x 410			438 x 88 x 510	438 x 88 x 630	
Weight (kg.)	11.6/14.1	11.6/14.1	15.5	19.5	23.3	27.5





Environmental

Temperature (Operating / Storage)	0-40°C (non-condensing) / -20 to +50°C					
Humidity (Operating / Storage)	20-90% RH / 10% to 95% (No condensing)					
Audible noise at 1.5M from surface of unit	Less than 50dB					
Certifications	cTUVus Complied with UL 1778: 2018 & CSA C22.2 No. 107.3-14					

Troubleshooting

Operation problems can be due to a variety of causes. The first step in solving them is to make sure that all cables are securely attached and seated completely in their sockets.

Symptom	Possible Cause	Action
No indication and alarm even though the mains is normal	The AC input power is not connected well.	Check if input power cord firmly connected to the mains.
	The AC input is connected to the UPS output.	Plug AC input power cord to AC input correctly.
The icon  and the warning code  flash on LCD display and alarm is sounding every 2 seconds.	EPO function is activated.	Set the circuit in closed position to disable EPO function.
The icons of  and  and the warning code  flash on LCD display. Alarm is sounding every 2 seconds.	Line and neutral conductors of UPS input are reversed.	Rotate mains power socket by 180° and then connect to UPS system.
The icons of  and  and the warning code  flash on LCD display. Alarm is sounding every 2 seconds.	The external or internal battery is incorrectly connected.	Check if all batteries are connected well.
Fault code is shown as 27 on LCD display and alarm is continuously sounding.	Battery voltage is too high or the charger is fault.	Please contact your dealer.
Fault code is shown as 28 on LCD display and alarm is continuously sounding.	Battery voltage is too low or the charger is fault.	Please contact your dealer.

Symptom	Possible Cause	Action
<p>The icons  and  and the warning code  flash on LCD display. Alarm is sounding every second.</p>	UPS is overload	Remove excess loads from UPS output.
	UPS is overloaded. Devices connected to the UPS are fed directly by the electrical network via the Bypass.	Remove excess loads from UPS output.
	After repetitive overloads, the UPS is locked in the Bypass mode. Connected devices are fed directly by the mains.	Remove excess loads from UPS output first. Then shut down the UPS and restart it.
Fault code is shown as 49 on LCD display and alarm is continuously sounding.	UPS is over input current.	Remove excess loads from UPS output.
Fault code is shown as 43 and the icon  is lighting on LCD display. Alarm is continuously sounding.	The UPS shut down automatically because of overload at the UPS output.	Remove excess loads from UPS output and restart it.
Fault code is shown as 14 on LCD display and alarm is continuously sounding.	The UPS shut down automatically because short circuit occurs on the UPS output.	Check output wiring and if connected devices are in short circuit status.
Fault code is shown as 01, 02, 03, 11, 12, 13 and 41 on LCD display and alarm is continuously sounding.	<p>A UPS internal fault has occurred. There are two possible results:</p> <ol style="list-style-type: none"> 1. The load is still supplied, but directly from AC power via bypass. 2. The load is no longer supplied by power. 	Please contact your dealer.
Battery backup time is shorter than nominal value.	Batteries are not fully charged	Charge the batteries for at least 5 hours and then check capacity. If the problem still persists, consult your dealer.
	Batteries defect	Contact your dealer to replace the battery.

Symptom	Possible Cause	Action
Fault code is shown as 2A on LCD display and alarm is continuously sounding.	The short circuit occurs on the charger output.	Check if battery wiring of connected external pack is in short circuit status.
Fault code is shown as 45 on LCD display. At the same time, alarm is continuously sounding.	The charger does not have output and battery voltage is less than 10V/PC.	Please contact your dealer.

Limited Warranty

ATEN warrants its hardware in the country of purchase against flaws in materials and workmanship for a Warranty Period of two [2] years (warranty period may vary in certain regions/countries) commencing on the date of original purchase. This warranty period includes the LCD panel of ATEN LCD KVM switches. Select products are warranted for an additional year (see *A+ Warranty* for further details). Cables and accessories are not covered by the Standard Warranty.

What is covered by the Limited Hardware Warranty

ATEN will provide a repair service, without charge, during the Warranty Period. If a product is defective, ATEN will, at its discretion, have the option to (1) repair said product with new or repaired components, or (2) replace the entire product with an identical product or with a similar product which fulfills the same function as the defective product. Replaced products assume the warranty of the original product for the remaining period or a period of 90 days, whichever is longer. When the products or components are replaced, the replacing articles shall become customer property and the replaced articles shall become the property of ATEN.

To learn more about our warranty policies, please visit our website:

<http://www.aten.com/global/en/legal/policies/warranty-policy/>