



# **MB2442, MB2546, MX421, MX521, MX522, XM1242, XM1246 MFPs**

---

## **User's Guide**

**July 2024**

**[www.lexmark.com](http://www.lexmark.com)**

---

Machine type:

7017

Models:

476, 478, 496, 636, 676, 678, 679, 686

# Contents

- Safety information.....7**
  - Conventions.....7
  - Product statements.....7
  
- Learning about the printer..... 11**
  - Finding information about the printer..... 11
  - Finding the printer serial number.....12
  - Selecting a location for the printer..... 13
  - Printer configurations..... 14
  - Attaching cables..... 15
  - Using the control panel.....17
  - Understanding the status of the power button and indicator light..... 17
  - Printing the Network Setup Page.....18
  
- Setting up and using the home screen applications..... 19**
  - Using the home screen.....19
  - Customizing the home screen.....20
  - Supported applications..... 20
  - Setting up Card Copy.....20
  - Creating a shortcut..... 21
  - Using Display Customization..... 21
  - Configuring Eco-Settings..... 22
  - Using Customer Support.....22
  - Using QR Code Generator.....22
  - Setting up Scan Center.....23
  - Setting up Device Quotas..... 23
  - Creating a Cloud Connector profile..... 23
  - Managing bookmarks.....24
  - Managing contacts.....25
  
- Setting up and using the accessibility features.....27**
  - Activating Voice Guidance..... 27
  - Navigating the screen using gestures..... 27
  - Enabling Magnification mode..... 28
  - Adjusting the Voice Guidance speech rate.....28

Using the keyboard on the display.....28  
Enabling spoken passwords or personal identification numbers..... 28

**Loading paper and specialty media..... 29**

Setting the paper size and type..... 29  
Configuring Universal paper settings..... 29  
Loading trays..... 29  
Loading the multipurpose feeder.....31  
Linking trays.....32

**Paper support.....33**

Supported paper sizes..... 33  
Supported paper types..... 35  
Supported paper weights..... 36  
Using recycled paper..... 36  
Unacceptable paper..... 37

**Printing.....38**

Printing from a computer..... 38  
Printing from a mobile device..... 38  
Printing from a flash drive..... 40  
Supported flash drives and file types.....41  
Configuring confidential jobs..... 42  
Printing confidential and other held jobs..... 42  
Printing from a Cloud Connector profile..... 43  
Printing a font sample list..... 43  
Printing a directory list.....43  
Canceling a print job.....43

**Copying..... 45**

Using the automatic document feeder and scanner glass..... 45  
Making copies..... 45  
Copying photos.....45  
Copying on letterhead..... 46  
Copying on both sides of the paper.....46  
Reducing or enlarging copies..... 46  
Collating copies..... 46

Placing separator sheets between copies..... 46  
Copying multiple pages onto a single sheet.....47  
Creating a copy shortcut..... 47

**E-mailing..... 48**

Using the automatic document feeder and scanner glass..... 48  
Configuring the e-mail SMTP settings..... 48  
Sending an e-mail..... 56  
Creating an e-mail shortcut..... 56

**Faxing..... 57**

Setting up the printer to fax..... 57  
Using the automatic document feeder and scanner glass..... 66  
Sending a fax..... 67  
Scheduling a fax..... 67  
Creating a fax destination shortcut..... 68  
Changing the fax resolution..... 68  
Adjusting the fax darkness..... 68  
Printing a fax log..... 68  
Blocking junk faxes..... 68  
Holding faxes..... 69  
Forwarding a fax..... 69

**Scanning..... 70**

Using the automatic document feeder and scanner glass..... 70  
Scanning to a computer.....70  
Scanning to an FTP server..... 71  
Scanning to a network folder..... 72  
Creating an FTP shortcut..... 72  
Scanning to a flash drive..... 72  
Scanning to a Cloud Connector profile..... 73

**Understanding the printer menus..... 74**

Menu map.....74  
Device.....75  
Print..... 88  
Paper..... 96

Copy.....99

Fax..... 102

E-mail.....115

FTP..... 121

USB Drive.....126

Network/Ports..... 131

Security.....145

Reports..... 152

Help..... 154

Troubleshooting..... 154

Printing the Menu Settings Page..... 154

**Securing the printer..... 155**

Locating the security slot..... 155

Erasing printer memory..... 155

Erasing printer hard disk memory..... 155

Encrypting the printer hard disk..... 156

Restoring factory default settings.....156

Statement of Volatility.....156

**Maintaining the printer..... 158**

Adjusting the speaker volume..... 158

Networking..... 158

Cleaning printer parts..... 162

Ordering parts and supplies..... 166

Replacing parts and supplies.....170

Moving the printer..... 182

Saving energy and paper..... 183

Recycling..... 184

**Clearing jams..... 185**

Avoiding jams..... 185

Identifying jam locations..... 186

Paper jam in door A..... 187

Paper jam in the rear door.....191

Paper jam in the standard bin.....192

Paper jam in the duplex unit..... 192

Paper jam in trays..... 193  
Paper jam in the multipurpose feeder.....194  
Paper jam in the automatic document feeder.....195

**Troubleshooting..... 197**

Print quality problems..... 197  
Printing problems.....198  
Network connection problems.....226  
Hardware options problems..... 229  
Issues with supplies..... 231  
Paper feed problems..... 232  
E-mailing problems.....235  
Faxing problems.....236  
Scanning problems.....241  
Contacting customer support..... 248

**Upgrading and migrating.....249**

Hardware..... 249  
Software..... 264  
Firmware..... 266

**Notices.....269**

**Index..... 289**

# Safety information

## Conventions





**Note:** A *note* identifies information that could help you.

**Warning:** A *warning* identifies something that could damage the product hardware or software.







**WARNING (in full capitals):** A *WARNING* indicates a risk of death or serious injury if not avoided.









**CAUTION:** A *caution* indicates a potentially hazardous situation that could injure you.







Different types of caution statements include:

-  **CAUTION—POTENTIAL INJURY:** Indicates a risk of injury.
-  **CAUTION—SHOCK HAZARD:** Indicates a risk of electrical shock.
-  **CAUTION—HOT SURFACE:** Indicates a risk of burn if touched.
-  **CAUTION—TIPPING HAZARD:** Indicates a crush hazard.
-  **CAUTION—PINCH HAZARD:** Indicates a risk of being caught between moving parts.

## Product statements

-  **CAUTION—POTENTIAL INJURY:** To avoid the risk of fire or electrical shock, connect the power cord to an appropriately rated and properly grounded electrical outlet that is near the product and easily accessible.
-  **CAUTION—POTENTIAL INJURY:** To avoid the risk of fire or electrical shock, use only the power cord provided with this product or the manufacturer's authorized replacement.
-  **CAUTION—POTENTIAL INJURY:** Do not use this product with extension cords, multioutlet power strips, multioutlet extenders, or UPS devices. The power capacity of these types of accessories can be easily overloaded by a laser printer and may result in a risk of fire, property damage, or poor printer performance.
-  **CAUTION—POTENTIAL INJURY:** Only a Lexmark Inline Surge Protector that is properly connected between the printer and the power cord provided with the printer may be used with this product. The use of non-Lexmark surge protection devices may result in a risk of fire, property damage, or poor printer performance.
-  **CAUTION—POTENTIAL INJURY:** To reduce the risk of fire, use only a 26 AWG or larger telecommunications (RJ-11) cord when connecting this product to the public switched telephone network. For users in Australia, the cord must be approved by the Australian Communications and Media Authority.
-  **CAUTION—SHOCK HAZARD:** To avoid the risk of electrical shock, do not place or use this product near water or wet locations.

-  **CAUTION—SHOCK HAZARD:** To avoid the risk of electrical shock, do not set up this product or make any electrical or cabling connections, such as the power cord, fax feature, or telephone, during a lightning storm.
-  **CAUTION—POTENTIAL INJURY:** Do not cut, twist, bind, crush, or place heavy objects on the power cord. Do not subject the power cord to abrasion or stress. Do not pinch the power cord between objects such as furniture and walls. If any of these things happen, a risk of fire or electrical shock results. Inspect the power cord regularly for signs of such problems. Remove the power cord from the electrical outlet before inspecting it.
-  **CAUTION—SHOCK HAZARD:** To avoid the risk of electrical shock, make sure that all external connections (such as Ethernet and telephone system connections) are properly installed in their marked plug-in ports.
-  **CAUTION—SHOCK HAZARD:** To avoid the risk of electrical shock, if you are accessing the controller board or installing optional hardware or memory devices sometime after setting up the printer, then turn the printer off, and unplug the power cord from the electrical outlet before continuing. If you have any other devices attached to the printer, then turn them off as well, and unplug any cables going into the printer.
-  **CAUTION—SHOCK HAZARD:** To avoid the risk of electrical shock, do not use the fax feature during a lightning storm.
-  **CAUTION—SHOCK HAZARD:** To avoid the risk of electrical shock when cleaning the exterior of the printer, unplug the power cord from the electrical outlet and disconnect all cables from the printer before proceeding.
-  **CAUTION—POTENTIAL INJURY:** If the printer weight is greater than 20 kg (44 lb), then it may require two or more people to lift it safely.
-  **CAUTION—POTENTIAL INJURY:** When moving the printer, follow these guidelines to avoid personal injury or printer damage:
- Make sure that all doors and trays are closed.
  - Turn off the printer, and then unplug the power cord from the electrical outlet.
  - Disconnect all cords and cables from the printer.
  - If the printer has separate floor-standing optional trays or output options attached to it, then disconnect them before moving the printer.
  - If the printer has a caster base, then carefully roll it to the new location. Use caution when passing over thresholds and breaks in flooring.
  - If the printer does not have a caster base but is configured with optional trays or output options, then remove the output options and lift the printer off the trays. Do not try to lift the printer and any options at the same time.
  - Always use the handholds on the printer to lift it.
  - Any cart used to move the printer must have a surface able to support the full footprint of the printer.
  - Any cart used to move the hardware options must have a surface able to support the dimensions of the options.
  - Keep the printer in an upright position.
  - Avoid severe jarring movements.
  - Make sure that your fingers are not under the printer when you set it down.
  - Make sure that there is adequate clearance around the printer.

-  **CAUTION—TIPPING HAZARD:** Installing one or more options on your printer or MFP may require a caster base, furniture, or other feature to prevent instability causing possible injury. For more information on supported configurations, see [www.lexmark.com/multifunctionprinters](http://www.lexmark.com/multifunctionprinters).
-  **CAUTION—TIPPING HAZARD:** To reduce the risk of equipment instability, load each tray separately. Keep all other trays closed until needed.
-  **CAUTION—HOT SURFACE:** The inside of the printer might be hot. To reduce the risk of injury from a hot component, allow the surface to cool before touching it.
-  **CAUTION—PINCH HAZARD:** To avoid the risk of a pinch injury, use caution in areas marked with this label. Pinch injuries may occur around moving parts, such as gears, doors, trays, and covers.
-  **CAUTION—POTENTIAL INJURY:** This product uses a laser. Use of controls or adjustments or performance of procedures other than those specified in the *User's Guide* may result in hazardous radiation exposure.
-  **CAUTION—POTENTIAL INJURY:** The lithium battery in this product is not intended to be replaced. There is a danger of explosion if a lithium battery is incorrectly replaced. Do not recharge, disassemble, or incinerate a lithium battery. Discard used lithium batteries according to the manufacturer's instructions and local regulations.



## WARNING

- **INGESTION HAZARD:** This product contains a button cell or coin battery.
- **DEATH** or serious injury can occur if ingested.
- A swallowed button cell or coin battery can cause **Internal Chemical Burns** in as little as **2 hours**.
- **KEEP** new and used batteries **OUT OF REACH of CHILDREN**.
- **Seek immediate medical attention** if a battery is suspected to be swallowed or inserted inside any part of the body.



Remove and immediately recycle or dispose of used batteries according to local regulations and keep away from children. Do not dispose of batteries in household trash or incinerate. Even used batteries may cause severe injury or death. Call a local poison control center for treatment information.

Battery type: CR6821

Nominal battery voltage: 3V

Do not force discharge, recharge, disassemble, heat above 60°C (140°F), or incinerate. Doing so may result in injury due to venting, leakage, or explosion resulting in chemical burns.

This product is designed, tested, and approved to meet strict global safety standards with the use of specific manufacturer's components. The safety features of some parts may not always be obvious. The manufacturer is not responsible for the use of other replacement parts.

Refer service or repairs, other than those described in the user documentation, to a service representative.

This product uses a printing process that heats the print media, and the heat may cause the media to release emissions. You must understand the section in your operating instructions that discusses the guidelines for selecting print media to avoid the possibility of harmful emissions.

This product may produce small amounts of ozone during normal operation, and may be equipped with a filter designed to limit ozone concentrations to levels well below the recommended exposure limits. To avoid high

ozone concentration levels during extensive usage, install this product in a well-ventilated area and replace the ozone and exhaust filters if instructed to do so in the product maintenance instructions. If there are no references to filters in the product maintenance instructions, then there are no filters requiring replacement for this product.

**SAVE THESE INSTRUCTIONS.**

# Learning about the printer

## Finding information about the printer

What are you looking for?	Find it here
Initial setup instructions	See the setup documentation that came with the printer.
<ul style="list-style-type: none"> <li>• Printer software</li> <li>• Print or fax driver</li> <li>• Printer firmware</li> <li>• Utility</li> </ul>	Go to <a href="http://www.lexmark.com/downloads">www.lexmark.com/downloads</a> , search for your printer model, and then in the Type menu, select the driver, firmware, or utility that you need.
<ul style="list-style-type: none"> <li>• Selecting and storing paper and specialty media</li> <li>• Loading paper</li> <li>• Configuring printer settings</li> <li>• Viewing and printing documents and photos</li> <li>• Configuring the printer on a network</li> <li>• Caring for and maintaining the printer</li> <li>• Troubleshooting and solving problems</li> </ul>	<p>Information Center—Go to <a href="https://infoserve.lexmark.com">https://infoserve.lexmark.com</a>.</p> <p>How-to videos—Go to <a href="https://infoserve.lexmark.com/idv/">https://infoserve.lexmark.com/idv/</a>.</p> <p>Help Menu Pages—Access the guides on the printer firmware, or go to <a href="http://support.lexmark.com">http://support.lexmark.com</a>.</p> <p>Touch Screen Guide—Go to <a href="http://support.lexmark.com">http://support.lexmark.com</a>.</p>
Setting up and configuring the accessibility features of your printer	<i>Lexmark Accessibility Guide</i> —Go to <a href="http://support.lexmark.com">http://support.lexmark.com</a> .
Help information for using the printer software	<p>Help for Microsoft Windows or Macintosh operating systems—Open a printer software program or application, and then click <b>Help</b>.</p> <p>Click  to view context-sensitive information.</p> <p><b>Notes:</b></p> <ul style="list-style-type: none"> <li>• Help is automatically installed with the printer software.</li> <li>• Depending on the operating system, the printer software is either in the printer program folder or on the desktop.</li> </ul>

What are you looking for?	Find it here
<ul style="list-style-type: none"> <li>• Documentation</li> <li>• Live chat support</li> <li>• E-mail support</li> <li>• Voice support</li> </ul>	<p>Go to <a href="http://support.lexmark.com">http://support.lexmark.com</a>.</p> <p><b>Note:</b> Select your country or region, and then select your product to view the appropriate support site.</p> <p>Support contact information for your country or region can be found on the website or on the printed warranty that came with the printer.</p> <p>Have the following information ready when you contact customer support:</p> <ul style="list-style-type: none"> <li>• Place and date of purchase</li> <li>• Machine type and serial number</li> </ul> <p>For more information, see <a href="#">“Finding the printer serial number” on page 12</a>.</p>
<ul style="list-style-type: none"> <li>• Safety information</li> <li>• Regulatory information</li> <li>• Warranty information</li> <li>• Environmental information</li> </ul>	<p>Warranty information varies by country or region:</p> <ul style="list-style-type: none"> <li>• <b>In the U.S.</b>—See the Statement of Limited Warranty included with the printer, or go to <a href="http://support.lexmark.com">http://support.lexmark.com</a>.</li> <li>• <b>In other countries and regions</b>—See the printed warranty that came with the printer.</li> </ul> <p><i>Product Information Guide</i>—See the documentation that came with the printer or go to <a href="http://support.lexmark.com">http://support.lexmark.com</a>.</p>

## Finding the printer serial number

- 1 Open the front door.

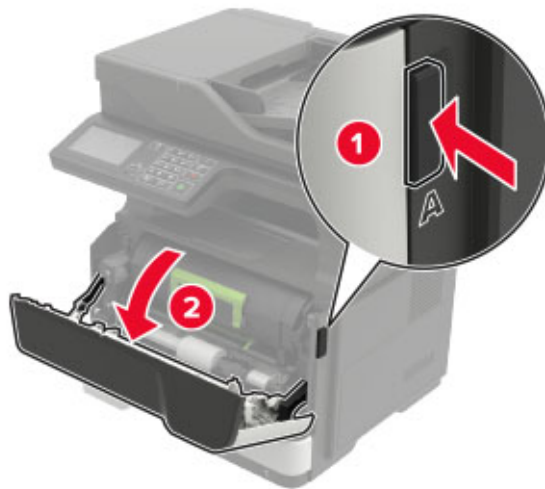

- 2 Locate the printer serial number behind the front door.



## Selecting a location for the printer

- Leave enough room to open trays, covers, and doors and to install hardware options.
- Set up the printer near an electrical outlet.

**⚠ CAUTION—POTENTIAL INJURY:** To avoid the risk of fire or electrical shock, connect the power cord to an appropriately rated and properly grounded electrical outlet that is near the product and easily accessible.

**⚠ CAUTION—SHOCK HAZARD:** To avoid the risk of electrical shock, do not place or use this product near water or wet locations.

- Make sure that airflow in the room meets the latest revision of the ASHRAE 62 standard or the CEN Technical Committee 156 standard.
- Provide a flat, sturdy, and stable surface.
- Keep the printer:
  - Clean, dry, and free of dust
  - Away from stray staples and paper clips
  - Away from the direct airflow of air conditioners, heaters, or ventilators
  - Free from direct sunlight and humidity extremes
- Observe the recommended temperatures and avoid fluctuations.

Ambient temperature	10 to 32.2°C (50 to 90°F)
Storage temperature	0 to 40°C (32 to 104°F)

- Allow the following recommended amount of space around the printer for proper ventilation:

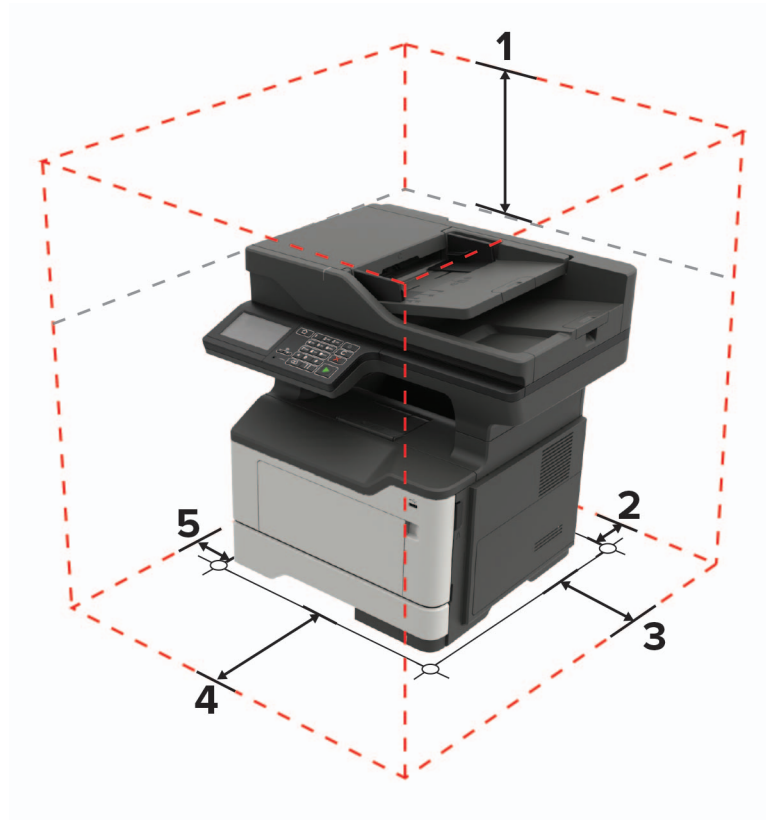

1	Top	737 mm (29 in.)
2	Rear	203 mm (8 in.)
3	Right side	305 mm (12 in.)
4	Front	510 mm (20 in.) <b>Note:</b> The minimum space needed in front of the printer is 76 mm (3 in.).
5	Left side	203 mm (8 in.)

## Printer configurations



**CAUTION—TIPPING HAZARD:** Installing one or more options on your printer or MFP may require a caster base, furniture, or other feature to prevent instability causing possible injury. For more information on supported configurations, see [www.lexmark.com/multifunctionprinters](http://www.lexmark.com/multifunctionprinters).



**CAUTION—TIPPING HAZARD:** To reduce the risk of equipment instability, load each tray separately. Keep all other trays closed until needed.

You can configure your printer by adding optional 250- or 550-sheet trays. For more information, see [“Installing optional trays” on page 263](#).

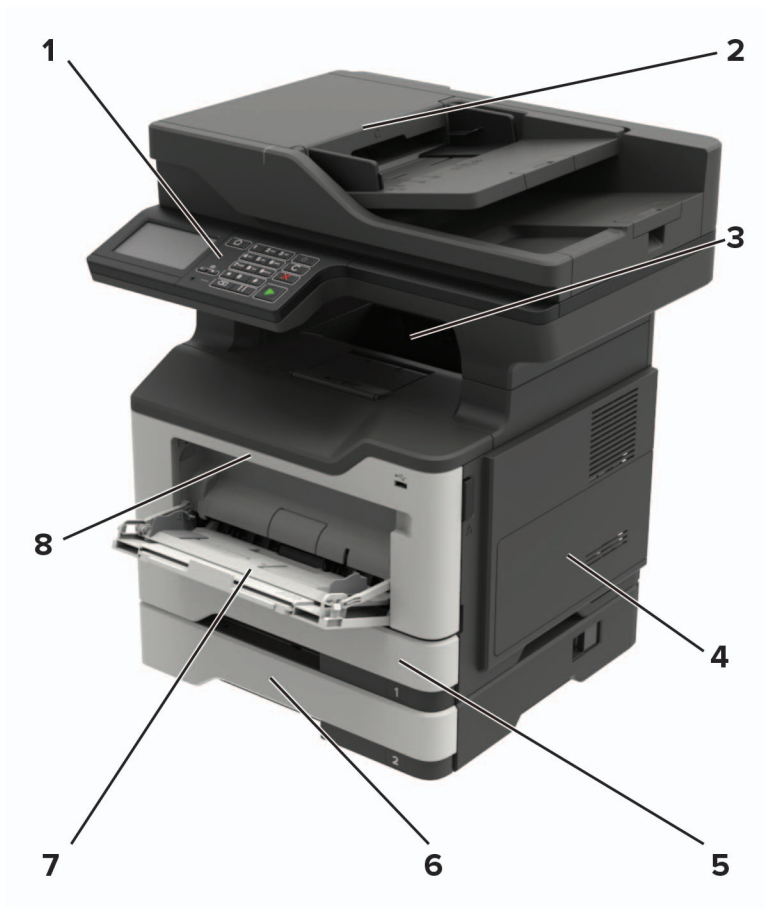

1	Control panel
2	Automatic document feeder (ADF)
3	Standard bin
4	Controller board access cover
5	Standard 250-sheet tray
6	Optional 250- or 550-sheet tray
7	Multipurpose feeder
8	Door A

## Attaching cables

- ⚡ **CAUTION—SHOCK HAZARD:** To avoid the risk of electrical shock, do not set up this product or make any electrical or cabling connections, such as the power cord, fax feature, or telephone, during a lightning storm.
- ⚠ **CAUTION—POTENTIAL INJURY:** To avoid the risk of fire or electrical shock, connect the power cord to an appropriately rated and properly grounded electrical outlet that is near the product and easily accessible.
- ⚠ **CAUTION—POTENTIAL INJURY:** To avoid the risk of fire or electrical shock, use only the power cord provided with this product or the manufacturer's authorized replacement.

**⚠ CAUTION—POTENTIAL INJURY:** To reduce the risk of fire, use only a 26 AWG or larger telecommunications (RJ-11) cord when connecting this product to the public switched telephone network. For users in Australia, the cord must be approved by the Australian Communications and Media Authority.

**Warning—Potential Damage:** To avoid loss of data or printer malfunction, do not touch the USB cable, any wireless network adapter, or the printer in the areas shown while actively printing.



	Printer port	Function
1	Power cord socket	Connect the printer to an electrical outlet.
2	Ethernet port	Connect the printer to an Ethernet network.
3	LINE port <b>Note:</b> Available only in some printer models.	Connect the printer to an active telephone line through a standard wall jack (RJ-11), DSL filter, or VoIP adapter, or any other adapter that allows you to access the telephone line to send and receive faxes.
4	EXT port <b>Note:</b> Available only in some printer models	Connect more devices (telephone or answering machine) to the printer and the telephone line. Use this port if you do not have a dedicated fax line for the printer and if this connection method is supported in your country or region.
5	USB port <b>Note:</b> Available only in some printer models.	Attach a keyboard or any compatible option.
6	USB printer port	Connect the printer to a computer.

## Using the control panel

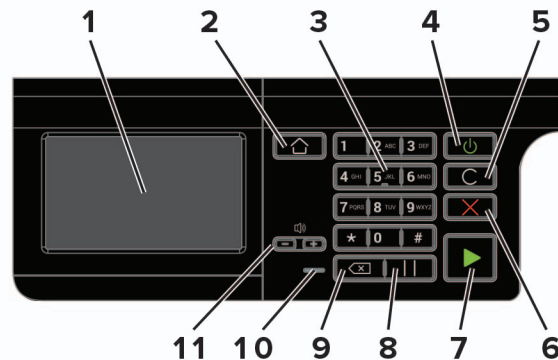

	Use the	To
1	Display	<ul style="list-style-type: none"> <li>View the printer messages and supply status.</li> <li>Set up and operate the printer.</li> </ul>
2	Home button	Go to the home screen.
3	Numeric keypad	Enter numbers or symbols in an input field.
4	Power button	Turn on or turn off the printer. <b>Note:</b> To turn off the printer, press and hold the power button for five seconds.
5	Clear all or Reset button	Reset the default settings of a function such as copying, faxing, or scanning.
6	Stop or Cancel button	Stop the current printer task.
7	Start button	Start a printer task, depending on which mode is selected.
8	Pause button	Place a dial pause in a fax number.
9	Backspace button	Move the cursor backward and delete a character in an input field.
10	Indicator light	Check the printer status.
11	Volume buttons	Adjust the speaker volume.

## Understanding the status of the power button and indicator light

Indicator light	Printer status
Off	The printer is off or in Hibernate mode.
Blue	The printer is ready or processing data.
Red	The printer requires user intervention.

Power button light	Printer status
Off	The printer is off, ready, or processing data.
Solid amber	The printer is in Sleep mode.
Blinking amber	The printer is in Hibernate mode.

## Printing the Network Setup Page

From the home screen, touch **Settings** > **Reports** > **Network** > **Network Setup Page**.

# Setting up and using the home screen applications

## Using the home screen

**Note:** Your home screen may vary depending on your home screen customization settings, administrative setup, and active embedded solutions.

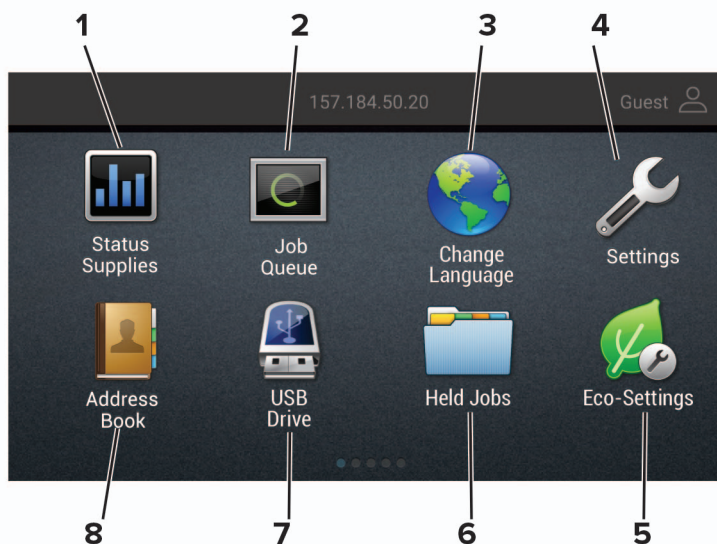

Touch	To
1	<p>Status/Supplies</p> <ul style="list-style-type: none"> <li>Show a warning or error message whenever the printer requires intervention to continue processing.</li> <li>View more information on the printer warning or message, and on how to clear it.</li> </ul> <p><b>Note:</b> You can also access this setting by touching the top section of the home screen.</p>
2	<p>Job Queue</p> <p>Show all the current print jobs.</p> <p><b>Note:</b> You can also access this setting by touching the top section of the home screen.</p>
3	<p>Change Language</p> <p>Change the language on the display.</p>
4	<p>Settings</p> <p>Access the printer menus.</p>
5	<p>Eco-Settings</p> <p>Manage energy consumption, noise, toner, and paper usage settings.</p>
6	<p>Held Jobs</p> <p>Show the print jobs that are held in the printer memory.</p>
7	<p>USB Drive</p> <p>Print photos and documents from a flash drive.</p>
8	<p>Address Book</p> <p>Manage a contact list that other applications on the printer can access.</p>

Customizing the home screen

## Customizing the home screen

- 1 From the control panel, touch **Settings > Device > Visible Home Screen Icons**.
- 2 Select the icons that you want to appear on the home screen.
- 3 Apply the changes.

## Supported applications

Application	Printer models
Scan Center	MB2442, MB2546, MX421, MX521, MX522, XM1242, XM1246
Shortcut Center	MB2442, MB2546, MX421, MX521, MX522, XM1242, XM1246
Card Copy	MX522, XM1246
Display Customization	MX522, XM1246
Customer Support	XM1242, XM1246
Device Quotas	XM1246
QR Code	XM1242, XM1246
Eco-Settings	XM1242, XM1246
Cloud Connector	MB2442, MB2546, XM1242, XM1246

## Setting up Card Copy

**Note:** This application is supported only in some printer models. For more information, see [“Supported applications” on page 20](#).

- 1 Open a web browser, and then type the printer IP address in the address field.

**Notes:**

- View the printer IP address on the printer home screen. The IP address appears as four sets of numbers separated by periods, such as 123.123.123.123.
- If you are using a proxy server, then temporarily disable it to load the web page correctly.

- 2 Click **Apps > Card Copy > Configure**.

**Notes:**

- Make sure that Display Icon is enabled.
- Make sure that E-mail Settings and Network Share Settings are configured.
- When scanning a card, make sure that the scan resolution does not exceed 200 dpi for color and 400 dpi for black and white.
- When scanning multiple cards, make sure that the scan resolution does not exceed 150 dpi for color and 300 dpi for black and white.
- You need a printer hard disk to scan multiple cards.

- 3 Apply the changes.

## Creating a shortcut

- 1 From the home screen, touch **Shortcut Center**.

**Note:** The icon and name may have been changed. For more information, contact your administrator.

- 2 Select a printer function, and then touch **Create Shortcut**.

**Note:** The Secure E-mail function is not supported.

- 3 Configure the settings, and then touch **Save**.

- 4 Type a unique shortcut name.

**Note:** To avoid clipped names on the home screen, type only up to 25 characters.

- 5 Touch **OK**.

The application automatically generates a unique shortcut number. To launch the shortcut, press **#** and then the shortcut number.

## Using Display Customization

**Note:** This application is supported only in some printer models. For more information, see [“Supported applications” on page 20](#).

Before using the application, make sure to do the following:

- From the Embedded Web Server, click **Apps > Display Customization > Configure**.
- Enable and configure the screen saver, slideshow, and wallpaper settings.

### Managing screen saver and slide show images

- 1 From the Screen Saver and Slideshow Images section, add, edit, or delete an image.

**Notes:**

- You can add up to 10 images.
- When enabled, the status icons appear on the screen saver only when there are errors, warnings, or cloud-based notifications.

- 2 Apply the changes.

### Changing the wallpaper image

- 1 From the home screen, touch **Change Wallpaper**.
- 2 Select an image to use.
- 3 Apply the changes.

### Running a slide show from a flash drive

- 1 Insert a flash drive into the USB port.
- 2 From the home screen, touch **Slideshow**.  
Images appear in alphabetical order.

**Note:** You can remove the flash drive after the slide show starts, but the images are not stored in the printer. If the slide show stops, then insert the flash drive again to view the images.

## Configuring Eco-Settings

**Note:** This application is supported only in some printer models. For more information, see [“Supported applications” on page 20](#).

- 1 From the home screen, touch **Eco-Settings**.
- 2 Configure the Eco-Mode settings or schedule a power-saving mode.

## Using Customer Support

**Note:** This application is supported only in some printer models. For more information, see [“Supported applications” on page 20](#).

- 1 From the home screen, touch **Customer Support**.
- 2 Print or e-mail the information.

**Note:** For information on configuring the application settings, see the *Customer Support Administrator’s Guide*.

## Using QR Code Generator

### Notes:

- This application is supported only in some printer models. For more information, see [“Supported applications” on page 20](#).
- You may need administrative rights to access the application.

- 1 Open a web browser, and then type the printer IP address in the address field.

### Notes:

- View the printer IP address on the printer home screen. The IP address appears as four sets of numbers separated by periods, such as 123.123.123.123.
- If you are using a proxy server, then temporarily disable it to load the web page correctly.

- 2 Click **Apps > QR Code Generator > Configure**.
- 3 Do either of the following:
  - Select a default QR code value.
  - Type a QR code value.
- 4 Apply the changes.

## Setting up Scan Center

- 1 From the home screen, touch **Scan Center**.
- 2 Select and create a destination, and then configure the settings.

**Notes:**

- When creating a network destination, make sure to validate and adjust the settings until no errors occur.
- Only destinations created from the Embedded Web Server are saved. For more information, see the documentation that came with the solution.

- 3 Apply the changes.

## Setting up Device Quotas

**Notes:**

- This application is supported only in some printer models. For more information, see [“Supported applications” on page 20](#).
- You may need administrative rights to access the application.

- 1 Open a web browser, and then type the printer IP address in the address field.

**Notes:**

- View the printer IP address on the printer home screen. The IP address appears as four sets of numbers separated by periods, such as 123.123.123.123.
- If you are using a proxy server, then temporarily disable it to load the web page correctly.

- 2 Click **Apps > Device Quotas > Configure**.
- 3 In the User Accounts section, add or edit a user, and then set the user quota.
- 4 Apply the changes.

**Note:** For information on how to configure the application and its security settings, see the *Device Quotas Administrator’s Guide*.

## Creating a Cloud Connector profile

**Note:** This application is available only in certain country or region. For more information, contact your Lexmark representative.

- 1 From the home screen, touch **Cloud Connector**.
- 2 Select a cloud service provider.
- 3 Touch **Create** or .
- 4 Type a unique profile name.

**Note:** We recommend creating a PIN to protect the profile.

- 5 Touch **OK**, and then take note of the authorization code.  
**Note:** The authorization code is valid only for 24 hours.
- 6 Open a web browser, and then go to <https://lexmark.cloud-connect.co>.
- 7 Click **Next**, and then accept the Terms of Use.
- 8 Enter the authorization code, and then click **Connect**.
- 9 Log in to your cloud service provider account.
- 10 Grant permissions.  
**Note:** To complete the authorization process, open the profile within 72 hours.

## Managing bookmarks

### Creating bookmarks

Use bookmarks to print frequently accessed documents that are stored in servers or on the web.

- 1 Open a web browser, and then type the printer IP address in the address field.

**Notes:**

- View the printer IP address on the printer home screen. The IP address appears as four sets of numbers separated by periods, such as 123.123.123.123.
- If you are using a proxy server, then temporarily disable it to load the web page correctly.

- 2 Click **Bookmarks > Add Bookmark**, and then type a bookmark name.
- 3 Select an Address protocol type, and then do one of the following:
  - For HTTP and HTTPS, type the URL that you want to bookmark.
  - For HTTPS, make sure to use the host name instead of the IP address. For example, type **myWebsite.com/sample.pdf** instead of typing **123.123.123.123/sample.pdf**. Make sure that the host name also matches the Common Name (CN) value in the server certificate. For more information on obtaining the CN value in the server certificate, see the help information for your web browser.
  - For FTP, type the FTP address. For example, **myServer/myDirectory**. Enter the FTP port. Port 21 is the default port for sending commands.
  - For SMB, type the network folder address. For example, **myServer/myShare/myFile.pdf**. Type the network domain name.
  - If necessary, select the Authentication type for FTP and SMB.

To limit access to the bookmark, enter a PIN.

**Note:** The application supports the following file types: PDF, JPEG, TIFF, and HTML-based web pages. Other file types such as DOCX and XLXS are supported in some printer models.

- 4 Click **Save**.

### Creating folders

- 1 Open a web browser, and then type the printer IP address in the address field.

**Notes:**

- View the printer IP address on the printer home screen. The IP address appears as four sets of numbers separated by periods, such as 123.123.123.123.
- If you are using a proxy server, then temporarily disable it to load the web page correctly.

**2** Click **Bookmarks > Add Folder**, and then type a folder name.

**Note:** To limit access to the folder, enter a PIN.

**3** Click **Save**.

**Note:** You can create folders or bookmarks inside a folder. To create a bookmark, see [“Creating bookmarks” on page 24](#).

## Managing contacts

### Adding contacts

**1** Open a web browser, and then type the printer IP address in the address field.

**Notes:**

- View the printer IP address on the printer home screen. The IP address appears as four sets of numbers separated by periods, such as 123.123.123.123.
- If you are using a proxy server, then temporarily disable it to load the web page correctly.

**2** Click **Address Book**.

**3** From the Contacts section, add a contact.

**Note:** You can assign the contact to one or more groups.

**4** If necessary, specify a login method to allow application access.

**5** Apply the changes.

### Adding groups

**1** Open a web browser, and then type the printer IP address in the address field.

**Notes:**

- View the printer IP address on the printer home screen. The IP address appears as four sets of numbers separated by periods, such as 123.123.123.123.
- If you are using a proxy server, then temporarily disable it to load the web page correctly.

**2** Click **Address Book**.

**3** From the Contact Groups section, add a group name.

**Note:** You can assign one or more contacts to the group.

**4** Apply the changes.

## Editing contacts or groups

1 Open a web browser, and then type the printer IP address in the address field.

**Notes:**

- View the printer IP address on the printer home screen. The IP address appears as four sets of numbers separated by periods, such as 123.123.123.123.
- If you are using a proxy server, then temporarily disable it to load the web page correctly.

2 Click **Address Book**.

3 Do either of the following:

- From the Contacts section, click a contact name, and then edit the information.
- From the Contact Groups section, click a group name, and then edit the information.

4 Apply the changes.

## Deleting contacts or groups

1 Open a web browser, and then type the printer IP address in the address field.

**Notes:**

- View the printer IP address on the printer home screen. The IP address appears as four sets of numbers separated by periods, such as 123.123.123.123.
- If you are using a proxy server, then temporarily disable it to load the web page correctly.

2 Click **Address Book**.

3 Do either of the following:

- From the Contacts section, select a contact that you want to delete.
- From the Contact Groups section, select a group name that you want to delete.

# Setting up and using the accessibility features

## Activating Voice Guidance

### From the control panel

- 1 Press and hold the **5** key until you hear a voice message.
- 2 Select **OK**.

### From the keyboard

- 1 Press and hold the **5** key until you hear a voice message.
- 2 Press **Tab** to navigate the focus cursor to the OK button, and then press **Enter**.

### Notes:

- Voice Guidance is also activated when you insert headphones into the headphone jack.
- To adjust the volume, use the volume buttons at the bottom part of the control panel.
- Voice Guidance has limited language support in some printer models.

## Navigating the screen using gestures

### Notes:

- The gestures are applicable only when Voice Guidance is activated.
- Enable Magnification to use the zoom and pan gestures.
- Use a physical keyboard to type characters and adjust certain settings.

Gesture	Function
Double-tap	Select an option or item on the screen.
Triple-tap	Zoom in or zoom out text and images.
Swipe right or swipe down	Move to the next item on the screen.
Swipe left or swipe up	Move to the previous item on the screen.
Pan	Access parts of the zoomed image that are beyond the limits of the screen. <b>Note:</b> This gesture requires the use of two fingers to drag across a zoomed image.
Swipe up then left	Exit an application and return to the home screen.
Swipe down then left	<ul style="list-style-type: none"> <li>• Cancel a job.</li> <li>• Go back to the previous setting.</li> <li>• Exit the screen that appears without changing any setting or value.</li> </ul>
Swipe up then down	Repeat a spoken prompt.

## Enabling Magnification mode

- 1 From the control panel, press and hold the **5** key until you hear a voice message.
- 2 Select **Magnification mode**.
- 3 Select **OK**.

For more information on navigating a magnified screen, see [“Navigating the screen using gestures” on page 27](#).

## Adjusting the Voice Guidance speech rate

- 1 From the home screen, select **Settings > Device > Accessibility > Speech Rate**.
- 2 Select the speech rate.

## Using the keyboard on the display

Do one or more of the following:

- Drag a finger over the key to announce the character.
- Lift the finger to enter or type the character in the field.
- Select **Backspace** to delete characters.
- To hear the content in the input field, select **Tab**, and then select **Shift + Tab**.

## Enabling spoken passwords or personal identification numbers

- 1 From the home screen, select **Settings > Device > Accessibility > Speak Passwords/PINs**.
- 2 Enable the setting.

# Loading paper and specialty media

## Setting the paper size and type

- 1 From the home screen, navigate to:  
**Settings > Paper > Tray Configuration > Paper Size/Type** > select a paper source
- 2 Set the paper size and type.

## Configuring Universal paper settings

- 1 From the home screen, touch **Settings > Paper > Media Configuration > Universal Setup**.
- 2 Configure the settings.

## Loading trays

 **CAUTION—TIPPING HAZARD:** To reduce the risk of equipment instability, load each tray separately. Keep all other trays closed until needed.

- 1 Remove the tray.

**Note:** To avoid paper jams, do not remove trays while the printer is busy.



- 2** Adjust the paper guides to match the size of the paper that you are loading.

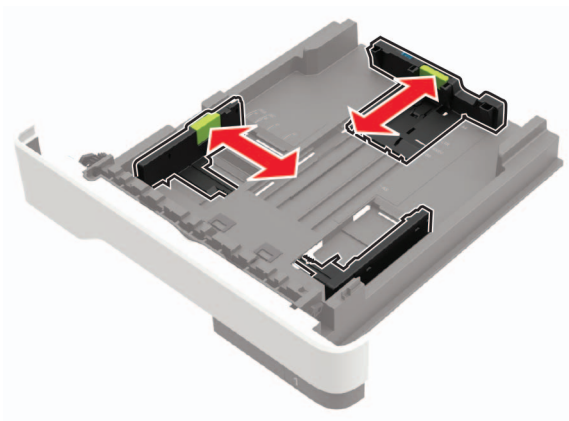

- 3** Flex, fan, and align the paper edges before loading.

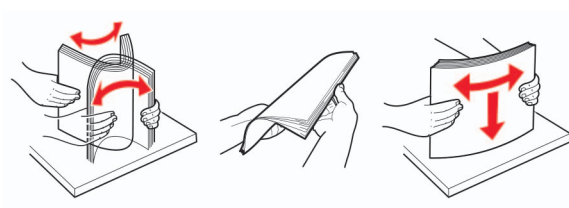

- 4** Load the paper stack with the printable side facedown, and then make sure that the side guides fit snugly against the paper.

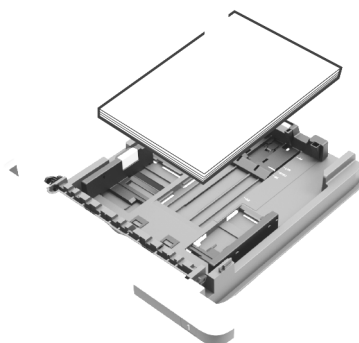

**Notes:**

- Load letterhead facedown with the top edge of the sheet toward the front of the tray for one-sided printing.
- Load letterhead faceup with the bottom edge of the sheet toward the front of the tray for two-sided printing.
- Do not slide paper into the tray.
- To avoid paper jams, make sure that the stack height is below the maximum paper fill indicator.

- 5** Insert the tray.

If necessary, set the paper size and paper type from the control panel to match the paper loaded.

## Loading the multipurpose feeder

- 1 Open the multipurpose feeder.

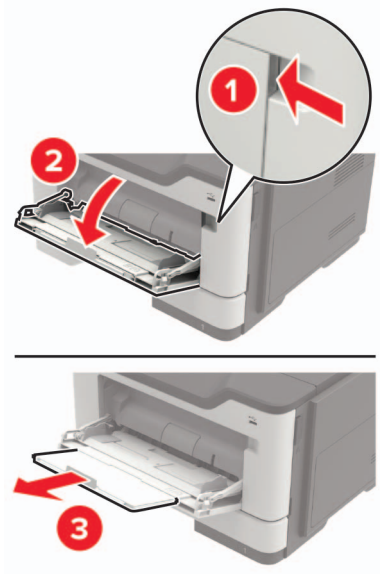

- 2 Adjust the guide to match the size of the paper that you are loading.

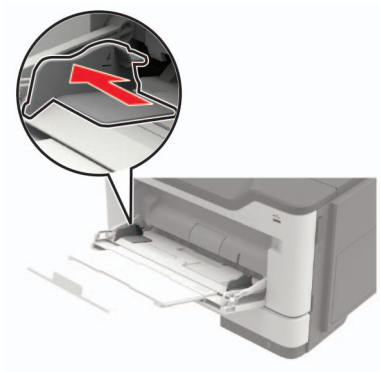

- 3 Flex, fan, and align the paper edges before loading.

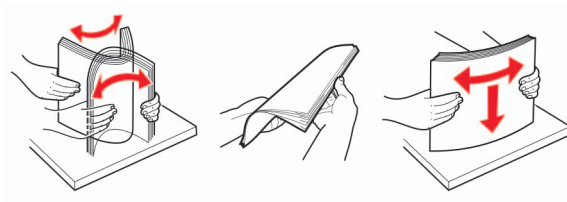

- 4 Load paper with the printable side faceup.

**Notes:**

- Load letterhead faceup with the top edge of the sheet toward the front of the tray for one-sided printing.
- Load letterhead facedown with the bottom edge of the sheet toward the front of the tray for two-sided printing.

- Load envelopes with the flap facedown on the left side.
- Load European envelopes with the flap facedown and entering the printer first.

**Warning—Potential Damage:** Do not use envelopes with stamps, clasps, snaps, windows, coated linings, or self-stick adhesives.

**5** From the control panel, set the paper size and paper type to match the paper loaded.

## Linking trays

- 1** From the home screen, touch **Settings > Paper > Tray Configuration** > select a paper source.
- 2** Set the same paper size and paper type for the trays that you are linking.
- 3** From the home screen, touch **Settings > Device > Maintenance > Configuration Menu > Tray Configuration > Tray Linking**.
- 4** Touch **Automatic**.

To unlink trays, make sure that no trays have the same paper size and paper type settings.

**Warning—Potential Damage:** The temperature of the fuser varies according to the specified paper type. To avoid printing issues, match the paper type setting in the printer with the paper loaded in the tray.

# Paper support

Supported paper sizes

## Supported paper sizes

Paper size	Standard 550-sheet tray	Optional 250- or 550-sheet tray	Multipurpose feeder	Two-sided printing	ADF	Scanner glass
<b>A4</b> 210 x 297 mm (8.3 x 11.7 in.)	✓	✓	✓	✓	✓	✓
<b>A5</b> 210 x 148 mm (8.3 x 5.8 in.)	✓	✓	✓	✗	✓	✓
<b>A5 LEF</b> 148 x 210 mm (5.8 x 8.3 in.)	✓	✗	✓	✗	✓	✓
<b>A6</b> 105 x 148 mm (4.1 x 5.8 in.)	✓	✗	✓	✗	✓	✓
<b>JIS B5</b> 182 x 257 mm (7.2 x 10.1 in.)	✓	✓	✓	✗	✓	✓
<b>Oficio (Mexico)</b> 216 x 340 mm (8.5 x 13.4 in.)	✓	✓	✓	✓	✓	✓
<b>Hagaki</b> 100 x 148 mm (3.9 x 5.8 in.)	✗	✗	✓	✗	✗	✓
<b>Business card</b> 50.8 x 88.9 mm (2 x 3.5 in.)	✗	✗	✗	✗	✗	✓
<b>Statement</b> 140 x 216 mm (5.5 x 8.5 in.)	✓	✓	✓	✗	✓	✓
<b>Executive</b> 184 x 267 mm (7.3 x 10.5 in.)	✓	✓	✓	✗	✓	✓

Paper size	Standard 550-sheet tray	Optional 250- or 550-sheet tray	Multipurpose feeder	Two-sided printing	ADF	Scanner glass
<b>Letter</b> 216 x 279 mm (8.5 x 11 in.)	✓	✓	✓	✓	✓	✓
<b>Legal</b> 216 x 356 mm (8.5 x 14 in.)	✓	✓	✓	✓	✓	✓
<b>Folio</b> 216 x 330 mm (8.5 x 13 in.)	✓	✓	✓	✓	✓	✓
<b>Universal</b> 76.2 x 127 mm to 216 x 356 mm (3 x 5 in. to 8.5 x 14 in.)	X	X	✓	X	X	✓
<b>Universal</b> 105 x 148 mm to 216 x 356 mm (4.13 x 5.83 in. to 8.5 x 14 in.)	✓	X	X	X	✓	✓
<b>Universal</b> 148 x 210 mm to 216 x 356 mm (5.83 x 8.27 in. to 8.5 x 14 in.)	X	✓	X	X	X	✓
<b>7 3/4 Envelope (Monarch)</b> 98 x 191 mm (3.9 x 7.5 in.)	X	X	✓	X	X	✓
<b>9 Envelope</b> 98 x 225 mm (3.9 x 8.9 in.)	X	X	✓	X	X	✓
<b>10 Envelope</b> 105 x 241 mm (4.1 x 9.5 in.)	X	X	✓	X	X	✓
<b>DL Envelope</b> 110 x 220 mm (4.3 x 8.7 in.)	X	X	✓	X	X	✓

Paper size	Standard 550-sheet tray	Optional 250- or 550-sheet tray	Multipurpose feeder	Two-sided printing	ADF	Scanner glass
<b>C5 Envelope</b> 162 x 229 mm (6.4 x 9 in.)	X	X	✓	X	X	✓
<b>B5 Envelope</b> 176 x 250 mm (6.9 x 9.8 in.)	X	X	✓	X	X	✓
<b>Other Envelope</b> 76.2 x 127 mm to 216 x 356 mm (3 x 5 in. to 8.5 x 14 in.)	X	X	✓	X	X	✓

Supported paper types

## Supported paper types

Paper type	Standard 550-sheet tray	Optional 250- or 550-sheet tray	Multipurpose feeder	Two-sided printing	ADF	Scanner glass
<b>Plain paper</b>	✓	✓	✓	✓	✓	✓
<b>Card stock</b>	X	X	✓	X	X	✓
<b>Transparency</b>	✓	X	✓	X	X	✓
<b>Recycled</b>	✓	✓	✓	✓	✓	✓
<b>Paper labels<sup>1</sup></b>	✓	✓	✓	X	X	✓
<b>Bond<sup>2</sup></b>	✓	✓	✓	✓	✓	✓
<b>Letterhead</b>	✓	✓	✓	✓	✓	✓
<b>Preprinted</b>	✓	✓	✓	✓	✓	✓
<b>Colored paper</b>	✓	✓	✓	✓	✓	✓

<sup>1</sup> One-sided paper labels designed for laser printers are supported for occasional use. It is recommended to print 20 or fewer pages of paper labels per month. Vinyl, pharmacy, and two-sided labels are not supported.

<sup>2</sup> Bond and Heavy paper are supported in two-sided printing up to 90-g/m<sup>2</sup> (24-lb) paper weight.

Paper type	Standard 550-sheet tray	Optional 250- or 550-sheet tray	Multipurpose feeder	Two-sided printing	ADF	Scanner glass
Light paper	✓	✓	✓	✓	✓	✓
Heavy paper <sup>2</sup>	✓	✓	✓	✓	✓	✓
Rough/Cotton	✓	✓	✓	✓	✓	✓
Envelope	X	X	✓	X	X	✓
Rough envelope	X	X	✓	X	X	✓

<sup>1</sup> One-sided paper labels designed for laser printers are supported for occasional use. It is recommended to print 20 or fewer pages of paper labels per month. Vinyl, pharmacy, and two-sided labels are not supported.

<sup>2</sup> Bond and Heavy paper are supported in two-sided printing up to 90-g/m<sup>2</sup> (24-lb) paper weight.

## Supported paper weights

Paper type	Tray	Multipurpose feeder	ADF	Two-sided printing
Plain Paper	60–120 g/m <sup>2</sup> (16–32 lb)	60–216 g/m <sup>2</sup> (16–58 lb)	Standard-sized paper: 52–120 g/m <sup>2</sup> (14–32 lb) Universal-sized media: 60–90 g/m <sup>2</sup> (16–24 lb)	60–90 g/m <sup>2</sup> (16–24 lb)
Card Stock	N/A	60–216 g/m <sup>2</sup> (16–58 lb)	52–120 g/m <sup>2</sup> (14–32 lb)	N/A
Transparency	60–120 g/m <sup>2</sup> (16–32 lb)	60–216 g/m <sup>2</sup> (16–58 lb)	N/A	N/A
Labels*	60–120 g/m <sup>2</sup> (16–32 lb)	60–216 g/m <sup>2</sup> (16–58 lb)	N/A	N/A
Envelopes	N/A	N/A	60–216 g/m <sup>2</sup> (16–58 lb)	N/A

\* One-sided paper labels designed for laser printers are supported for occasional use. It is recommended to print 20 or fewer pages of paper labels per month. Vinyl, pharmacy, and two-sided labels are not supported.

## Using recycled paper

Lexmark works to reduce the environmental impact of paper by providing customers choices when it comes to printing. One way we achieve this is by testing products to ensure recycled paper may be used—specifically, papers made with 30%, 50%, and 100% post-consumer recycled content. Our expectation is that recycled

papers perform as well as virgin paper in our printers. While no official standard exists for office equipment use of paper, Lexmark uses European Standard EN 12281 as a minimum properties standard. To ensure breadth of testing, test paper includes 100% recycled papers from North America, Europe, and Asia, and tests are conducted at 8–80% relative humidity. Testing includes duplex printing. Office paper using renewable, recycled, or chlorine-free content may all be used.

## Unacceptable paper

The following paper types are not recommended for use with the printer:

- Chemically treated papers that are used to make copies without carbon paper. They are also known as carbonless papers, carbonless copy paper (CCP), or no carbon required (NCR) paper.
- Preprinted papers with chemicals that may contaminate the printer.
- Preprinted papers that can be affected by the temperature in the printer fuser.
- Preprinted papers that require a registration (the precise print location on the page) greater than  $\pm 2.3$  mm ( $\pm 0.09$  in.). For example, optical character recognition (OCR) forms.

Sometimes, registration can be adjusted with a software app to print successfully on these forms.

- Coated papers (erasable bond), synthetic papers, or thermal papers.
- Rough-edged, rough or heavily textured surface papers, or curled papers.
- Papers that fail EN12281:2002 (European).
- Paper weighing less than  $60 \text{ g/m}^2$  (16 lb).
- Multiple-part forms or documents.

# Printing

## Printing from a computer

**Note:** For labels, card stock, and envelopes, set the paper size and type in the printer before printing the document.

- 1 From the document that you are trying to print, open the Print dialog.
- 2 If necessary, adjust the settings.
- 3 Print the document.

## Printing from a mobile device

Printing from a mobile device using Lexmark Mobile Print

### Printing from a mobile device using Lexmark Mobile Print

Lexmark™ Mobile Print allows you to send documents and images directly to a supported Lexmark printer.

- 1 Open the document, and then send or share the document to Lexmark Mobile Print.



**Note:** Some third-party applications may not support the send or share feature. For more information, see the documentation that came with the application.

- 2 Select a printer.
- 3 Print the document.

### Printing from a mobile device using Mopria Print Service

Mopria® Print Service is a mobile printing solution for mobile devices running on Android™ version 5.0 or later. It allows you to print directly to any Mopria-certified printer.

**Note:** Make sure that you download the Mopria Print Service application from the Google Play™ store and enable it in the mobile device.

- 1 From your Android mobile device, launch a compatible application or select a document from your file manager.
- 2 Tap  > **Print**.
- 3 Select a printer, and then adjust the settings, if necessary.
- 4 Tap .

## Printing from a mobile device using AirPrint

The AirPrint software feature is a mobile printing solution that allows you to print directly from Apple devices to an AirPrint-certified printer.

### Notes:

- Make sure that the Apple device and the printer are connected to the same network. If the network has multiple wireless hubs, then make sure that both devices are connected to the same subnet.
- This application is supported only in some Apple devices.

**1** From your mobile device, select a document from your file manager or launch a compatible application.

**2** Tap  > **Print**.

**3** Select a printer, and then adjust the settings, if necessary.

**4** Print the document.



## Printing from a mobile device using Wi-Fi Direct®

Wi-Fi Direct® is a printing service that lets you print to any Wi-Fi Direct-ready printer.

**Note:** Make sure that the mobile device is connected to the printer wireless network. For more information, see [“Connecting a mobile device to the printer” on page 160](#).

**1** From your mobile device, launch a compatible application or select a document from your file manager.

**2** Depending on your mobile device, do one of the following:

- Tap  > **Print**.
- Tap  > **Print**.
- Tap  > **Print**.

**3** Select a printer, and then adjust the settings, if necessary.

**4** Print the document.

## Printing from a flash drive

- 1 Insert the flash drive.



### Notes:

- If you insert the flash drive when an error message appears, then the printer ignores the flash drive.
- If you insert the flash drive while the printer is processing other print jobs, then **Busy** appears on the display.

- 2 From the display, touch the document that you want to print.

If necessary, configure other print settings.

- 3 Send the print job.

To print another document, touch **USB Drive**.

**Warning—Potential Damage:** To avoid loss of data or printer malfunction, do not touch the flash drive or the printer in the area shown while actively printing, reading, or writing from the memory device.



## Supported flash drives and file types

### Flash drives

- Lexar JumpDrive S70 (16GB and 32GB)
- SanDisk Cruzer (16GB and 32GB)
- PNY Attache (16GB and 32GB)

### Notes:

- The printer supports high-speed USB flash drives with full-speed standard.
- USB flash drives must support the File Allocation Table (FAT) system.

### File types

#### Documents

- PDF (version 1.7 or earlier)
- XPS
- Microsoft file formats (.doc, .docx, .xls, .xlsx, .ppt, .pptx)

#### Images

- .dcx
- .gif
- .JPEG or .jpg
- .bmp
- .pcx
- .TIFF or .tif
- .png

## Configuring confidential jobs

1 From the control panel, navigate to:  
**Settings > Security > Confidential Print Setup**

2 Configure the settings.

Use	To
Max Invalid PIN	Set the number of times an invalid PIN can be entered. <b>Note:</b> When the limit is reached, the print jobs for that user name are deleted.
Confidential Job Expiration	Set the expiration time for confidential print jobs. <b>Note:</b> Confidential held jobs are stored in the printer until they are released or deleted manually.
Repeat Job Expiration	Set the expiration time for a repeat print job. <b>Note:</b> Repeat held jobs are stored in the printer memory for reprinting.
Verify Job Expiration	Set the expiration time that the printer prints a copy before printing the remaining copies. <b>Note:</b> Verify jobs print one copy to check if it is satisfactory before printing the remaining copies.
Reserve Job Expiration	Set the expiration time that the printer stores print jobs. <b>Note:</b> Reserve held jobs are automatically deleted after printing.
Require All Jobs to be Held	Set the printer to hold all print jobs.
Keep duplicate documents	Set the printer to print all documents with the same file name.

## Printing confidential and other held jobs

### For Windows users

- 1 With a document open, click **File > Print**.
- 2 Click **Properties, Preferences, Options, or Setup**.
- 3 Click **Print and Hold**.
- 4 Select **Use Print and Hold**, and then assign a user name.
- 5 Select the print job type (Confidential, Repeat, Reserve, or Verify).  
 If the print job is confidential, then enter a four-digit PIN.
- 6 Click **OK** or **Print**.
- 7 From the printer home screen, release the print job.
  - For confidential print jobs, touch **Held jobs** > select your user name > **Confidential** > enter the PIN > select the print job > configure the settings > **Print**.
  - For other print jobs, touch **Held jobs** > select your user name > select the print job > configure the settings > **Print**.

## For Macintosh users

- 1 With a document open, choose **File > Print**.
- 2 From the Preview or Media & Quality menu, choose **PIN Printing**.
- 3 Enable **Print with PIN**, and then enter a four-digit PIN.
- 4 Click **Print**.
- 5 From the printer home screen, release the print job. Touch **Held jobs > select your computer name > Confidential > enter the PIN > select the print job > Print**.

## Printing from a Cloud Connector profile

- 1 From the home screen, touch **Cloud Connector**.
- 2 Select a cloud service provider, and then select a profile.  
**Note:** For more information on creating a Cloud Connector profile, see [“Creating a Cloud Connector profile” on page 23](#).
- 3 Touch **Print**, and then select a file.  
If necessary, change the settings.  
**Note:** Make sure to select a supported file.
- 4 Print the document.

## Printing a font sample list

- 1 From the home screen, touch **Settings > Reports > Print > Print Fonts**.
- 2 Touch **PCL Fonts** or **PS Fonts**.

## Printing a directory list

From the home screen, touch **Settings > Reports > Print > Print Directory**.

## Canceling a print job

### From the printer control panel



- 1 From the home screen, touch **Job Queue**.  
**Note:** You can also access this setting by touching the top section of the home screen.
- 2 Select the job to cancel.

**From the computer**

- 1** Depending on the operating system, do either of the following:
  - Open the printers folder, and then select your printer.
  - From the System Preferences in the Apple menu, navigate to your printer.
- 2** Select the job to cancel.

# Copying

## Using the automatic document feeder and scanner glass

Automatic document feeder (ADF)	Scanner glass
 <ul style="list-style-type: none"> <li>• Use the ADF for multiple-page or two-sided documents.</li> <li>• Load an original document faceup. For multiple-page documents, make sure to align the leading edge before loading.</li> <li>• Make sure to adjust the ADF guides to match the width of the paper that you are loading.</li> </ul>	 <ul style="list-style-type: none"> <li>• Use the scanner glass for single-page documents, book pages, small items (such as postcards or photos), transparencies, photo paper, or thin media (such as magazine clippings).</li> <li>• Place the document facedown in the corner with the arrow.</li> </ul>

## Making copies

- 1 Load an original document into the ADF tray or on the scanner glass.

**Note:** To avoid a cropped image, make sure that the original document and output have the same paper size.

- 2 From the home screen, touch **Copy**, and then specify the number of copies.

If necessary, adjust the copy settings.

- 3 Copy the document.

**Note:** To make a quick copy, from the control panel, press .

## Copying photos

- 1 Place a photo on the scanner glass.

- 2 From the control panel, navigate to:

**Copy > Settings > Content > Content Type > Photo**

- 3 From the Content Source menu, select the setting that best matches the original photo.

- 4 Copy the document.

## Copying on letterhead

- 1 Load an original document into the ADF tray or on the scanner glass.
- 2 From the home screen, touch **Copy** > **Copy From** > select the size of the original document.
- 3 Touch **Copy To**, and then select the paper source that contains the letterhead.  
If you loaded the letterhead into the multipurpose feeder, then navigate to:  
**Copy To** > **Multipurpose Feeder** > select a paper size > **Letterhead**
- 4 Copy the document.

## Copying on both sides of the paper

- 1 Load an original document into the ADF tray or on the scanner glass.
- 2 From the home screen, touch **Copy** > **Settings** > **Sides**.
- 3 Adjust the settings.
- 4 Copy the document.

## Reducing or enlarging copies

- 1 Load an original document into the ADF tray or on the scanner glass.
- 2 From the control panel, navigate to:  
**Copy** > **Settings** > **Scale** > specify a scale value  
**Note:** Changing the size of the original document or output after setting Scale restores the scale value to Auto.
- 3 Copy the document.

## Collating copies

- 1 Load an original document into the ADF tray or on the scanner glass.
- 2 From the control panel, navigate to:  
**Copy** > **Settings** > **Collate** > **On [1,2,1,2,1,2]**
- 3 Copy the document.

## Placing separator sheets between copies

- 1 Load an original document into the ADF tray or on the scanner glass.
- 2 From the control panel, navigate to:  
**Copy** > **Settings** > **Separator Sheets** > adjust the settings
- 3 Copy the document.

## Copying multiple pages onto a single sheet



- 1 Load an original document into the ADF tray or on the scanner glass.
- 2 From the control panel, navigate to:  
**Copy > Settings > Pages per Side** > adjust the settings
- 3 Copy the document.

## Creating a copy shortcut

- 1 From the home screen, touch **Copy**.
- 2 Configure the settings, and then touch .
- 3 Create a shortcut.

## E-mailing

### Using the automatic document feeder and scanner glass

Automatic document feeder (ADF)	Scanner glass
 <ul style="list-style-type: none"> <li>• Use the ADF for multiple-page or two-sided documents.</li> <li>• Load an original document faceup. For multiple-page documents, make sure to align the leading edge before loading.</li> <li>• Make sure to adjust the ADF guides to match the width of the paper that you are loading.</li> </ul>	 <ul style="list-style-type: none"> <li>• Use the scanner glass for single-page documents, book pages, small items (such as postcards or photos), transparencies, photo paper, or thin media (such as magazine clippings).</li> <li>• Place the document facedown in the corner with the arrow.</li> </ul>

## Configuring the e-mail SMTP settings

Configure the Simple Mail Transfer Protocol (SMTP) settings to send a scanned document through e-mail. The settings vary with each e-mail service provider.

Before you begin, make sure that the printer is connected to a network and that the network is connected to the Internet.

### Using the Embedded Web Server

- 1 Open a web browser, and then type the printer IP address in the address field.

**Notes:**

- View the printer IP address on the printer home screen. The IP address appears as four sets of numbers separated by periods, such as 123.123.123.123.
- If you are using a proxy server, then temporarily disable it to load the web page correctly.

- 2 Click **Settings** > **E-mail**.

- 3 From the E-mail Setup section, configure the settings.

**Notes:**

- For more information on the password, see the list of [e-mail service providers](#).

- For e-mail service providers that are not on the list, contact your provider and ask for the settings.

**4** Click **Save**.

## Using the Settings menu in the printer

**1** From the home screen, touch **Settings > E-mail > E-mail Setup**.

**2** Configure the settings.

### Notes:

- For more information on the password, see the list of [e-mail service providers](#).
- For e-mail service providers that are not on the list, contact your provider and ask for the settings.

## E-mail service providers

- [AOL Mail](#)
- [Comcast Mail](#)
- [Gmail](#)
- [iCloud Mail](#)
- [Mail.com](#)
- [NetEase Mail \(mail.126.com\)](#)
- [NetEase Mail \(mail.163.com\)](#)
- [NetEase Mail \(mail.yeah.net\)](#)
- [Outlook Live or Microsoft 365](#)
- [QQ Mail](#)
- [Sina Mail](#)
- [Sohu Mail](#)
- [Yahoo! Mail](#)
- [Zoho Mail](#)

### Notes:

- If you encounter errors using the settings provided, then contact your e-mail service provider.
- For e-mail service providers that are not on the list, contact your provider.

## AOL Mail

Setting	Value
<b>Primary SMTP Gateway</b>	smtp.aol.com
<b>Primary SMTP Gateway Port</b>	587
<b>Use SSL/TLS</b>	Required
<b>Require Trusted Certificate</b>	Disabled
<b>Reply Address</b>	Your e-mail address
<b>SMTP Server Authentication</b>	Login / Plain
<b>Device-Initiated E-mail</b>	Use Device SMTP Credentials

Setting	Value
<b>Device UserID</b>	Your e-mail address
<b>Device Password</b>	App password <b>Note:</b> To create an app password, go to the <a href="#">AOL Account Security</a> page, log in to your account, and then click <b>Generate app password</b> .

### Comcast Mail

Setting	Value
<b>Primary SMTP Gateway</b>	smtp.comcast.net
<b>Primary SMTP Gateway Port</b>	587
<b>Use SSL/TLS</b>	Required
<b>Require Trusted Certificate</b>	Disabled
<b>Reply Address</b>	Your e-mail address
<b>SMTP Server Authentication</b>	Login / Plain
<b>Device-Initiated E-mail</b>	Use Device SMTP Credentials
<b>Device UserID</b>	Your e-mail address
<b>Device Password</b>	Account password

### Gmail™

**Note:** Make sure that two-step verification is enabled on your Google account. To enable two-step verification, go to the [Google Account Security](#) page, log in to your account, and then from the “Signing in to Google” section, click **2-Step Verification**.

Setting	Value
<b>Primary SMTP Gateway</b>	smtp.gmail.com
<b>Primary SMTP Gateway Port</b>	587
<b>Use SSL/TLS</b>	Required
<b>Require Trusted Certificate</b>	Disabled
<b>Reply Address</b>	Your e-mail address
<b>SMTP Server Authentication</b>	Login / Plain
<b>Device-Initiated E-mail</b>	Use Device SMTP Credentials
<b>Device UserID</b>	Your e-mail address
<b>Device Password</b>	App password <b>Notes:</b> <ul style="list-style-type: none"> <li>To create an app password, go to the <a href="#">Google Account Security</a> page, log in to your account, and then from the “Signing in to Google” section, click <b>App passwords</b>.</li> <li>“App passwords” shows only if two-step verification is enabled.</li> </ul>

## iCloud Mail

**Note:** Make sure that two-step verification is enabled on your account.

Setting	Value
<b>Primary SMTP Gateway</b>	smtp.mail.me.com
<b>Primary SMTP Gateway Port</b>	587
<b>Use SSL/TLS</b>	Required
<b>Require Trusted Certificate</b>	Disabled
<b>Reply Address</b>	Your e-mail address
<b>SMTP Server Authentication</b>	Login / Plain
<b>Device-Initiated E-mail</b>	Use Device SMTP Credentials
<b>Device UserID</b>	Your e-mail address
<b>Device Password</b>	App password <b>Note:</b> To create an app password, go to the <a href="#">iCloud Account Management</a> page, log in to your account, and then from the Security section, click <b>Generate Password</b> .

## Mail.com

Setting	Value
<b>Primary SMTP Gateway</b>	smtp.mail.com
<b>Primary SMTP Gateway Port</b>	587
<b>Use SSL/TLS</b>	Required
<b>Require Trusted Certificate</b>	Disabled
<b>Reply Address</b>	Your e-mail address
<b>SMTP Server Authentication</b>	Login / Plain
<b>Device-Initiated E-mail</b>	Use Device SMTP Credentials
<b>Device UserID</b>	Your e-mail address
<b>Device Password</b>	Account password

## NetEase Mail (mail.126.com)

**Note:** Make sure that the SMTP service is enabled on your account. To enable the service, from the NetEase Mail home page, click **Settings > POP3/SMTP/IMAP**, and then enable either **IMAP/SMTP service** or **POP3/SMTP service**.

Setting	Value
<b>Primary SMTP Gateway</b>	smtp.126.com
<b>Primary SMTP Gateway Port</b>	465
<b>Use SSL/TLS</b>	Required
<b>Require Trusted Certificate</b>	Disabled

Setting	Value
<b>Reply Address</b>	Your e-mail address
<b>SMTP Server Authentication</b>	Login / Plain
<b>Device-Initiated E-mail</b>	Use Device SMTP Credentials
<b>Device UserID</b>	Your e-mail address
<b>Device Password</b>	Authorization password <b>Note:</b> The authorization password is provided when IMAP/SMTP service or POP3/SMTP service is enabled.

### NetEase Mail (mail.163.com)

**Note:** Make sure that the SMTP service is enabled on your account. To enable the service, from the NetEase Mail home page, click **Settings > POP3/SMTP/IMAP**, and then enable either **IMAP/SMTP service** or **POP3/SMTP service**.

Setting	Value
<b>Primary SMTP Gateway</b>	smtp.163.com
<b>Primary SMTP Gateway Port</b>	465
<b>Use SSL/TLS</b>	Required
<b>Require Trusted Certificate</b>	Disabled
<b>Reply Address</b>	Your e-mail address
<b>SMTP Server Authentication</b>	Login / Plain
<b>Device-Initiated E-mail</b>	Use Device SMTP Credentials
<b>Device UserID</b>	Your e-mail address
<b>Device Password</b>	Authorization password <b>Note:</b> The authorization password is provided when IMAP/SMTP service or POP3/SMTP service is enabled.

### NetEase Mail (mail.yeah.net)

**Note:** Make sure that the SMTP service is enabled on your account. To enable the service, from the NetEase Mail home page, click **Settings > POP3/SMTP/IMAP**, and then enable either **IMAP/SMTP service** or **POP3/SMTP service**.

Setting	Value
<b>Primary SMTP Gateway</b>	smtp.yeah.net
<b>Primary SMTP Gateway Port</b>	465
<b>Use SSL/TLS</b>	Required
<b>Require Trusted Certificate</b>	Disabled
<b>Reply Address</b>	Your e-mail address
<b>SMTP Server Authentication</b>	Login / Plain

Setting	Value
<b>Device-Initiated E-mail</b>	Use Device SMTP Credentials
<b>Device UserID</b>	Your e-mail address
<b>Device Password</b>	Authorization password <b>Note:</b> The authorization password is provided when IMAP/SMTP service or POP3/SMTP service is enabled.

## Outlook Live or Microsoft 365

These settings apply to outlook.com and hotmail.com e-mail domains, and Microsoft 365 accounts.

Setting	Value
<b>Primary SMTP Gateway</b>	smtp.office365.com
<b>Primary SMTP Gateway Port</b>	587
<b>Use SSL/TLS</b>	Required
<b>Require Trusted Certificate</b>	Disabled
<b>Reply Address</b>	Your e-mail address
<b>SMTP Server Authentication</b>	Login / Plain
<b>Device-Initiated E-mail</b>	Use Device SMTP Credentials
<b>Device UserID</b>	Your e-mail address
<b>Device Password</b>	Account password or app password <b>Notes:</b> <ul style="list-style-type: none"> <li>• For accounts with two-step verification disabled, use your account password.</li> <li>• For outlook.com or hotmail.com accounts with two-step verification enabled, use an app password. To create an app password, go to the <a href="#">Outlook Live Account Management</a> page, and then log in to your account.</li> </ul>

**Note:** For additional setup options for business using Microsoft 365, go to the [Microsoft 365 help page](#).

## QQ Mail

**Note:** Make sure that the SMTP service is enabled on your account. To enable the service, from the QQ Mail home page, click **Settings > Account**. From the POP3/IMAP/SMTP/Exchange/CardDAV/CalDAV Service section, enable either **POP3/SMTP service** or **IMAP/SMTP service**.

Setting	Value
<b>Primary SMTP Gateway</b>	smtp.qq.com
<b>Primary SMTP Gateway Port</b>	587
<b>Use SSL/TLS</b>	Required
<b>Require Trusted Certificate</b>	Disabled
<b>Reply Address</b>	Your e-mail address

Setting	Value
<b>SMTP Server Authentication</b>	Login / Plain
<b>Device-Initiated E-mail</b>	Use Device SMTP Credentials
<b>Device UserID</b>	Your e-mail address
<b>Device Password</b>	Authorization code <b>Note:</b> To generate an authorization code, from the QQ Mail home page, click <b>Settings &gt; Account</b> , and then from the POP3/IMAP/SMTP/Exchange/CardDAV/CalDAV Service section, click <b>Generate authorization code</b> .

### Sina Mail

**Note:** Make sure that the POP3/SMTP service is enabled on your account. To enable the service, from the Sina Mail home page, click **Settings > More settings > User-end POP/IMAP/SMTP**, and then enable **POP3/SMTP service**.

Setting	Value
<b>Primary SMTP Gateway</b>	smtp.sina.com
<b>Primary SMTP Gateway Port</b>	587
<b>Use SSL/TLS</b>	Required
<b>Require Trusted Certificate</b>	Disabled
<b>Reply Address</b>	Your e-mail address
<b>SMTP Server Authentication</b>	Login / Plain
<b>Device-Initiated E-mail</b>	Use Device SMTP Credentials
<b>Device UserID</b>	Your e-mail address
<b>Device Password</b>	Authorization code <b>Note:</b> To create an authorization code, from the e-mail home page, click <b>Settings &gt; More settings &gt; User-end POP/IMAP/SMTP</b> , and then enable <b>Authorization code status</b> .

### Sohu Mail

**Note:** Make sure that the SMTP service is enabled on your account. To enable the service, from the Sohu Mail home page, click **Options > Settings > POP3/SMTP/IMAP**, and then enable either **IMAP/SMTP service** or **POP3/SMTP service**.

Setting	Value
<b>Primary SMTP Gateway</b>	smtp.sohu.com
<b>Primary SMTP Gateway Port</b>	465
<b>Use SSL/TLS</b>	Required
<b>Require Trusted Certificate</b>	Disabled
<b>Reply Address</b>	Your e-mail address
<b>SMTP Server Authentication</b>	Login / Plain

Setting	Value
<b>Device-Initiated E-mail</b>	Use Device SMTP Credentials
<b>Device UserID</b>	Your e-mail address
<b>Device Password</b>	Independent password <b>Note:</b> The independent password is provided when IMAP/SMTP service or POP3/SMTP service is enabled.

### Yahoo! Mail

Setting	Value
<b>Primary SMTP Gateway</b>	smtp.mail.yahoo.com
<b>Primary SMTP Gateway Port</b>	587
<b>Use SSL/TLS</b>	Required
<b>Require Trusted Certificate</b>	Disabled
<b>Reply Address</b>	Your e-mail address
<b>SMTP Server Authentication</b>	Login / Plain
<b>Device-Initiated E-mail</b>	Use Device SMTP Credentials
<b>Device UserID</b>	Your e-mail address
<b>Device Password</b>	App password <b>Note:</b> To create an app password, go to the <a href="#">Yahoo Account Security</a> page, log in to your account, and then click <b>Generate app password</b> .

### Zoho Mail

Setting	Value
<b>Primary SMTP Gateway</b>	smtp.zoho.com
<b>Primary SMTP Gateway Port</b>	587
<b>Use SSL/TLS</b>	Required
<b>Require Trusted Certificate</b>	Disabled
<b>Reply Address</b>	Your e-mail address
<b>SMTP Server Authentication</b>	Login / Plain
<b>Device-Initiated E-mail</b>	Use Device SMTP Credentials
<b>Device UserID</b>	Your e-mail address

Setting	Value
<b>Device Password</b>	Account password or app password <b>Notes:</b> <ul style="list-style-type: none"> <li>• For accounts with two-step verification disabled, use your account password.</li> <li>• For accounts with two-step verification enabled, use an app password. To create an app password, go to the <a href="#">Zoho Mail Account Security</a> page, log in to your account, and then from the Application-Specific Passwords section, click <b>Generate New Password</b>.</li> </ul>

## Sending an e-mail

Before you begin, make sure that the SMTP settings are configured. For more information, see [“Configuring the e-mail SMTP settings” on page 48](#).

### Using the control panel

- 1 Load an original document into the ADF tray or on the scanner glass.
- 2 From the home screen, touch **E-mail**, and then enter the needed information.
- 3 If necessary, configure the output file type settings.
- 4 Send the e-mail.

### Using a shortcut number

- 1 Load an original document into the ADF tray or on the scanner glass.
- 2 From the home screen, touch **Shortcuts > E-mail**.
- 3 Select the shortcut number.
- 4 Send the e-mail.

## Creating an e-mail shortcut

- 1 From the home screen, touch **E-mail**.
- 2 Configure the settings, and then touch .
- 3 Create a shortcut.

# Faxing

## Setting up the printer to fax

### Notes:

- The following connection methods are applicable only in some countries or regions.
- During the initial printer setup, clear the fax function check box and any other function you plan to set up later, and then select **Continue**.
- If the fax function is enabled and not fully set up, then the indicator light may blink red.

**Warning—Potential Damage:** To avoid loss of data or printer malfunction, do not touch cables or the printer in the area shown while actively sending or receiving a fax.

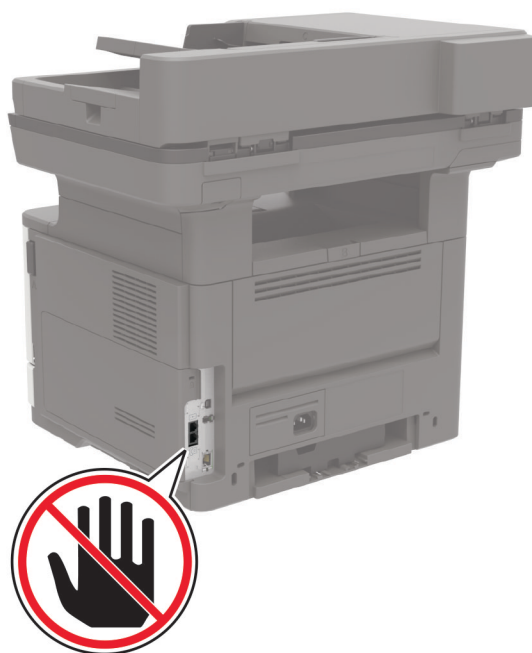

### Supported fax

Printer model	Analog fax	etherFAX <sup>1</sup>	Fax server	Fax over IP (FoIP) <sup>2</sup>
MB2442adwe	✓	✓	✓	✓
MB2546ade	✓	✓	✓	✓
MB2546adwe	✓	✓	✓	✓

<sup>1</sup> Needs a subscription. For more information, go to <https://www.etherfax.net/lexmark> or contact the place where you purchased the printer.

<sup>2</sup> Needs an installed license bundle. For more information, contact the place where you purchased the printer.

Printer model	Analog fax	etherFAX <sup>1</sup>	Fax server	Fax over IP (FoIP) <sup>2</sup>
MX421ade	✓	✓	✓	✓
MX521de	x	✓	✓	✓
MX521ade	✓	✓	✓	✓
MX522adhe	✓	✓	✓	✓
MX522dhe	x	✓	✓	✓
XM1242	✓	✓	✓	✓
XM1246	✓	✓	✓	✓
XM1246i	x	✓	✓	✓

<sup>1</sup> Needs a subscription. For more information, go to <https://www.etherfax.net/lexmark> or contact the place where you purchased the printer.

<sup>2</sup> Needs an installed license bundle. For more information, contact the place where you purchased the printer.

## Setting up the fax function using analog fax

### Notes:

- This feature is available only in some printer models.
- Some connection methods are applicable only in some countries or regions.
- If the fax function is enabled and not fully set up, then the indicator light may blink red.
- If you do not have a TCP/IP environment, then use the control panel to set up fax.

**Warning—Potential Damage:** To avoid loss of data or printer malfunction, do not touch cables or the printer in the area shown while actively sending or receiving a fax.

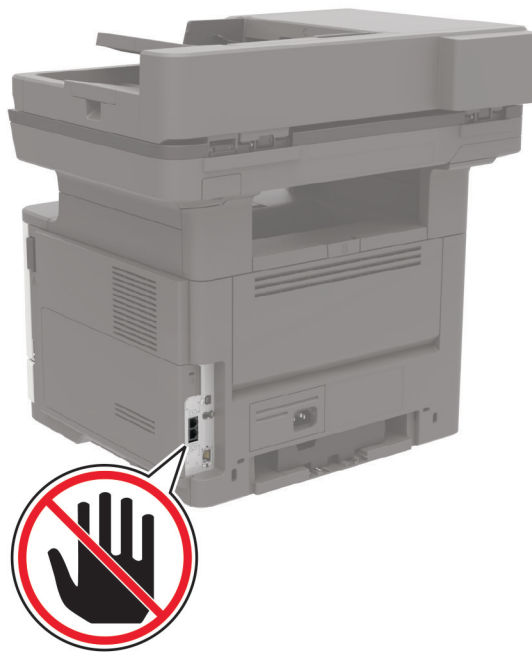

### Using the Settings menu in the printer

- 1 From the home screen, touch **Settings** > **Fax** > **Fax Setup** > **General Fax settings**.
- 2 Configure the settings.

### Using the Embedded Web Server

- 1 Open a web browser, and then type the printer IP address in the address field.

**Notes:**

- View the printer IP address on the home screen. The IP address appears as four sets of numbers separated by periods, such as 123.123.123.123.
- If you are using a proxy server, then temporarily disable it to load the web page correctly.

- 2 Click **Settings** > **Fax** > **Fax Setup** > **General Fax Settings**.
- 3 Configure the settings.
- 4 Apply the changes.

## Setting up the fax function using etherFAX

### Notes:

- The printer firmware must be updated to the latest version. For more information, see the “Updating firmware” section.
- An appropriate license bundle must be installed in your printer. For more information, contact etherFAX.
- Make sure that you have registered your printer to the etherFAX portal. For more information, go to <https://www.etherfax.net/lexmark>.
- The printer serial number is required on registration. To locate the serial number, see [“Finding the printer serial number” on page 12](#).

**1** Open a web browser, and then type the printer IP address in the address field.

### Notes:

- View the printer IP address on the home screen. The IP address appears as four sets of numbers separated by periods, such as 123.123.123.123.
- If you are using a proxy server, then temporarily disable it to load the web page correctly.

**2** Click **Settings > Fax > Fax Setup > General Fax Settings**.

**Note:** Fax Setup appears only if Fax Mode is set to Fax.

**3** In the Fax Name field, type a unique name.

**4** In the Fax Number field, enter the fax number that etherFAX provided.

**5** From the Fax Transport menu, select **etherFAX**.

### Notes:

- This menu shows up only when more than one fax transport is available.
- If the printer only has etherFAX installed, then it is automatically configured.

**6** Apply the changes.

## Setting up the fax function using fax server

### Notes:

- This feature lets you send fax messages to a fax service provider that supports e-mail receiving.
- This feature supports outgoing fax messages only. To support fax receive, make sure that you have a device-based fax, such as analog fax, etherFAX, or Fax over IP (FoIP), configured in your printer.

**1** Open a web browser, and then type the printer IP address in the address field.

### Notes:

- View the printer IP address on the home screen. The IP address appears as four sets of numbers separated by periods, such as 123.123.123.123.
- If you are using a proxy server, then temporarily disable it to load the web page correctly.

**2** Click **Settings > Fax**.

**3** From the Fax Mode menu, select **Fax Server**, and then click **Save**.

**4** Click **Fax Server Setup**.

**5** In the To Format field, type **[#]@myfax.com**, where **[#]** is the fax number and **myfax.com** is the fax provider domain.

**Notes:**

- If necessary, configure the Reply Address, Subject, or Message fields.
- To let the printer receive fax messages, enable the device-based fax receive setting. Make sure that you have a device-based fax configured.

**6** Click **Save**.

**7** Click **Fax Server E-mail Settings**, and then do either of the following:

- Enable **Use E-mail SMTP Server**.

**Note:** If the E-mail SMTP settings are not configured, then see [“Configuring the e-mail SMTP settings” on page 48](#).

- Configure the SMTP settings. For more information, contact your e-mail service provider.

**8** Apply the changes.

## Setting up fax using a standard telephone line

**Note:** These instructions apply only to printers that support analog fax. For more information, see [“Supported fax” on page 57](#).



**CAUTION—SHOCK HAZARD:** To avoid the risk of electrical shock, do not set up this product or make any electrical or cabling connections, such as the power cord, fax feature, or telephone, during a lightning storm.



**CAUTION—SHOCK HAZARD:** To avoid the risk of electrical shock, do not use the fax feature during a lightning storm.



**CAUTION—POTENTIAL INJURY:** To reduce the risk of fire, use only a 26 AWG or larger telecommunications (RJ-11) cord when connecting this product to the public switched telephone network. For users in Australia, the cord must be approved by the Australian Communications and Media Authority.

### Setup 1: Printer is connected to a dedicated fax line

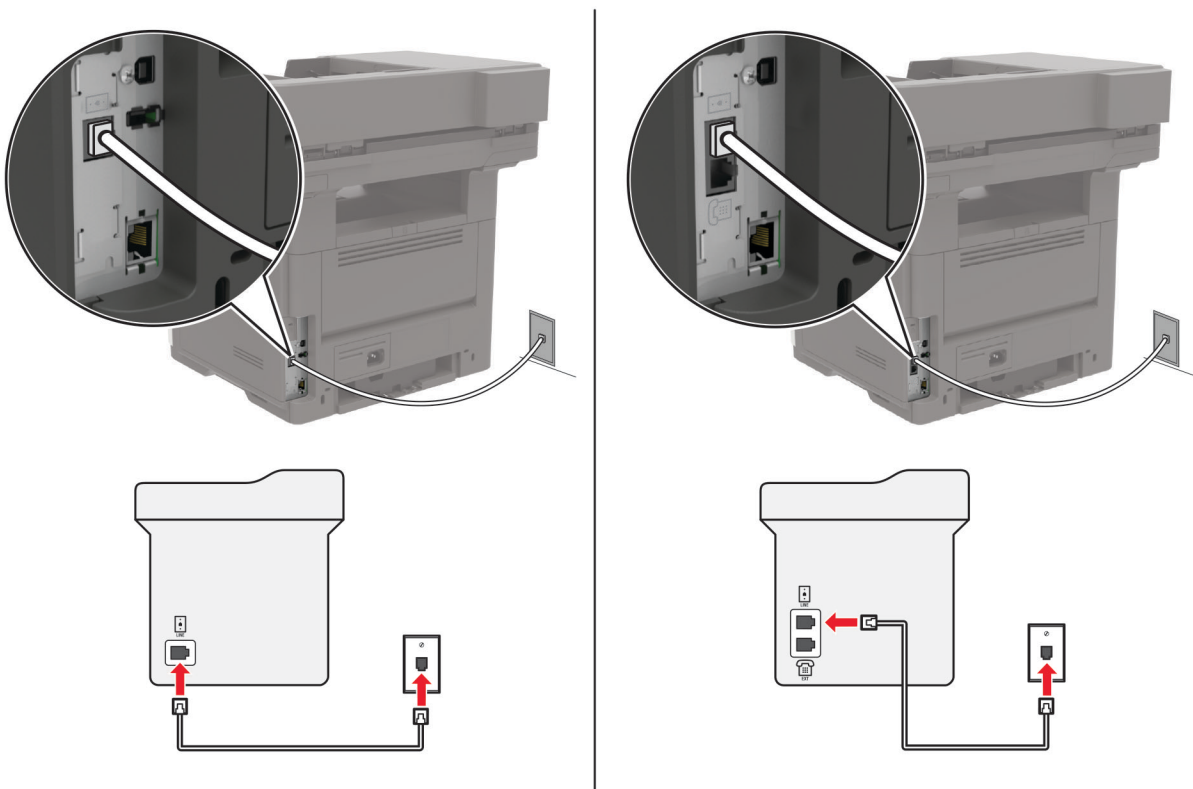

- 1 Connect one end of the telephone cable to the line port of the printer.
- 2 Connect the other end of the cable to an active analog telephone wall jack.

#### Notes:

- You can set the printer to receive faxes automatically (set Auto Answer to **On**) or manually (set Auto Answer to **Off**).
- If you want to receive faxes automatically, then set the printer to pick up on a specified number of rings.

### Setup 2: Printer is sharing the line with an answering machine

**Note:** If you subscribe to a distinctive ring service, then make sure that you set the correct ring pattern for the printer. Otherwise, the printer does not receive faxes even if you have set it to receive faxes automatically.

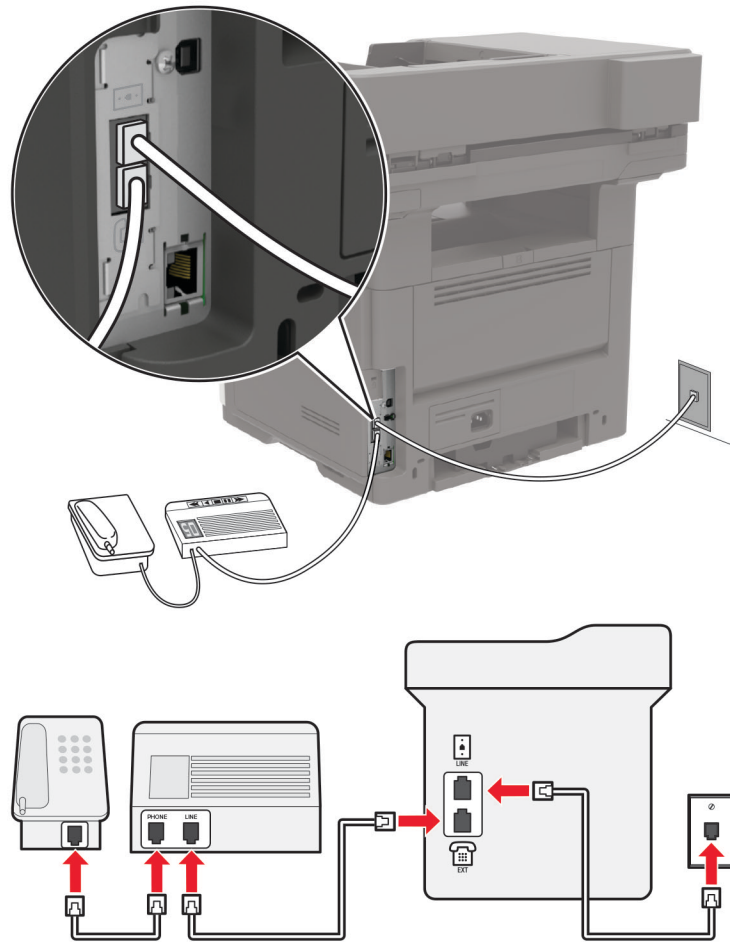
**Connected to the same telephone wall jack**

**Note:** These instructions apply only to printers that have EXT and line ports.

- Connect one end of the telephone cable to the line port of the printer.
- Connect the other end of the cable to an active analog wall jack.
- Connect the answering machine to the telephone port of the printer.

**Connected to different wall jacks**

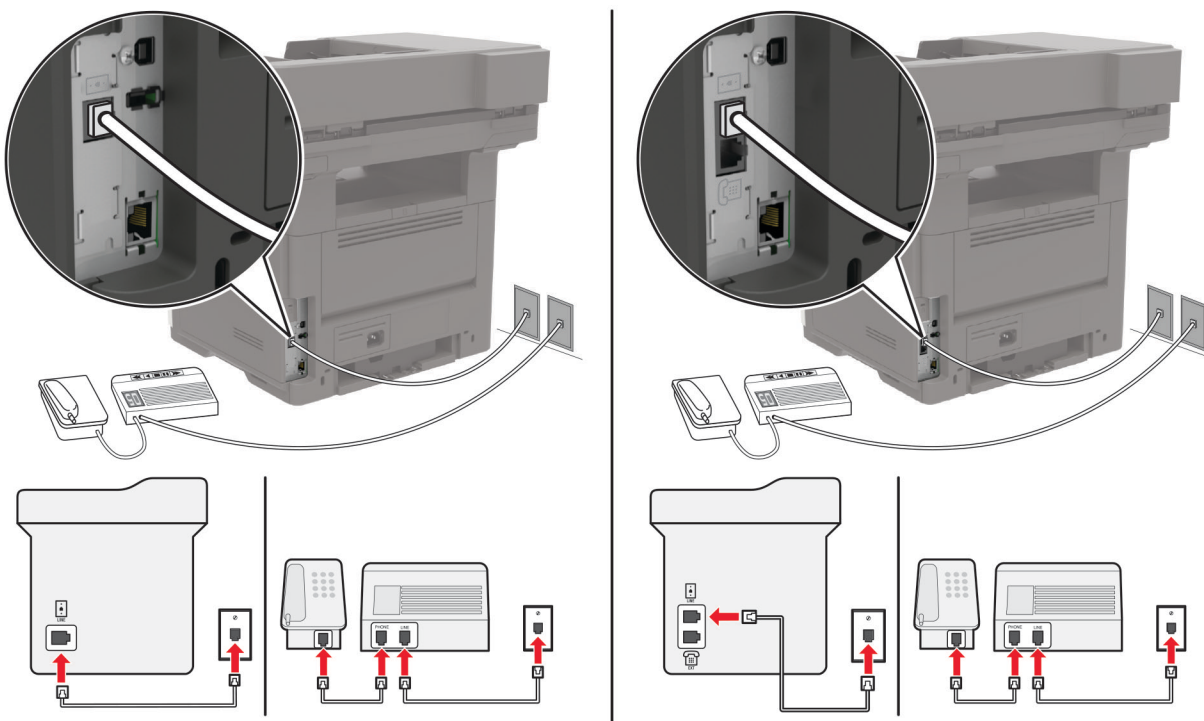

- 1 Connect one end of the telephone cable to the line port of the printer.
- 2 Connect the other end of the cable to an active analog wall jack.

**Notes:**

- If you have only one telephone number on your line, then set the printer to receive faxes automatically.
- Set the printer to pick up calls two rings after the answering machine. For example, if the answering machine picks up calls after four rings, then set the printer Rings to Answer setting to **6**.

**Setting up fax in countries or regions with different telephone wall jacks and plugs**

**Note:** These instructions apply only to printers that support analog fax. For more information, see [“Supported fax” on page 57](#).

- ⚡ CAUTION—SHOCK HAZARD:** To avoid the risk of electrical shock, do not set up this product or make any electrical or cabling connections, such as the power cord, fax feature, or telephone, during a lightning storm.
- ⚡ CAUTION—SHOCK HAZARD:** To avoid the risk of electrical shock, do not use the fax feature during a lightning storm.
- ⚠ CAUTION—POTENTIAL INJURY:** To reduce the risk of fire, use only a 26 AWG or larger telecommunications (RJ-11) cord when connecting this product to the public switched telephone network. For users in Australia, the cord must be approved by the Australian Communications and Media Authority.

The standard wall jack adopted by most countries or regions is RJ-11. If the wall jack or equipment in your facility is not compatible with this type of connection, then use a telephone adapter. An adapter for your country or region may not come with your printer, and you may need to purchase it separately.

There may be an adapter plug installed in the telephone port of the printer. Do not remove the adapter plug from the telephone port of the printer if you are connecting to a serial or cascaded telephone system.

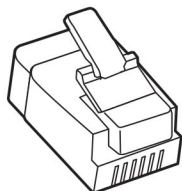

Part name	Part number
Lexmark adapter plug	40X8519

### Connecting the printer to a non-RJ-11 wall jack

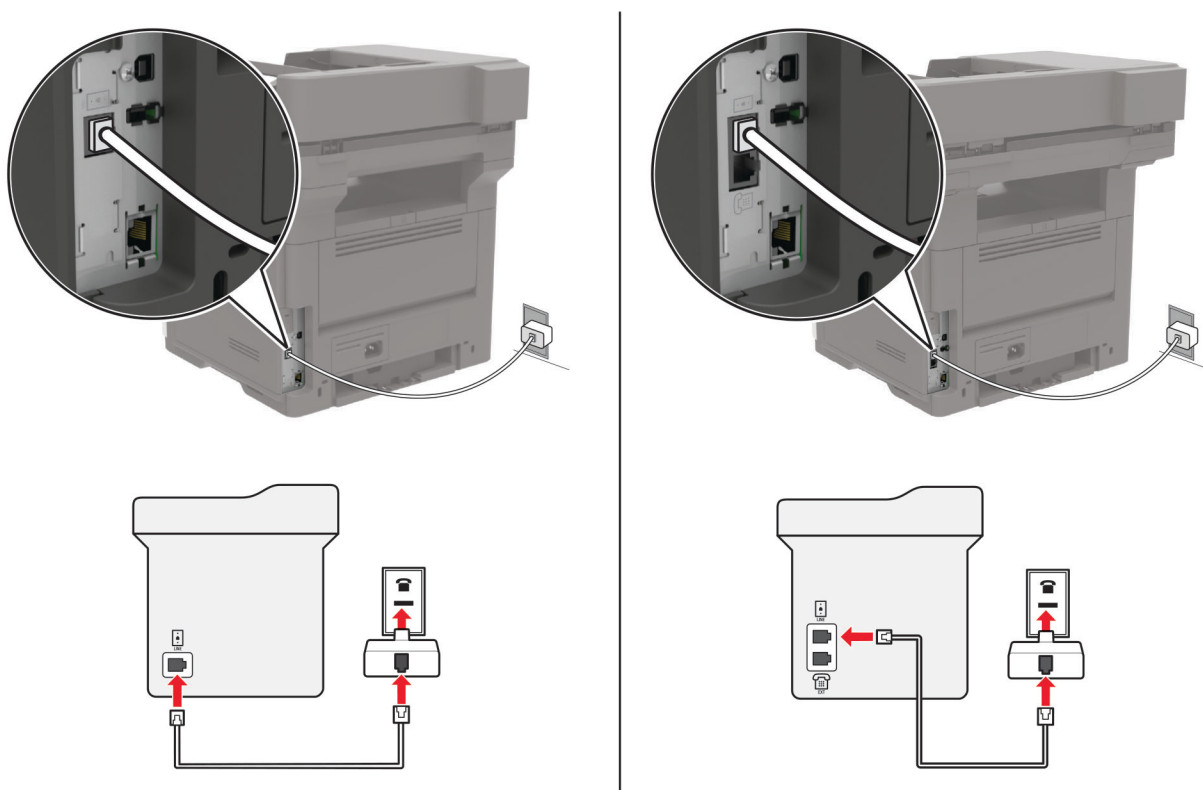

- 1** Connect one end of the telephone cable to the line port of the printer.
- 2** Connect the other end of the cable to the RJ-11 adapter, and then connect the adapter to the wall jack.
- 3** If you want to connect another device with a non-RJ-11 connector to the same wall jack, then connect it directly to the telephone adapter.

## Connecting to a distinctive ring service

A distinctive ring service lets you have multiple telephone numbers on one telephone line. Each telephone number is assigned a different ring pattern.

**Note:** These instructions apply only to printers that support analog fax. For more information, see [“Supported fax” on page 57](#).

- 1 From the home screen, touch **Settings > Fax > Fax Setup > Fax Receive Settings > Admin Controls > Answer On**.
- 2 Select a ring pattern.

## Setting the fax date and time

**Note:** Make sure that fax is configured. For more information, see [“Setting up the printer to fax” on page 57](#).



- 1 From the home screen, touch **Settings > Device > Preferences > Date and Time > Configure**.
- 2 Configure the settings.

## Configuring daylight saving time

**Note:** Make sure that fax is configured. For more information, see [“Setting up the printer to fax” on page 57](#).

- 1 From the home screen, touch **Settings > Device > Preferences > Date and Time > Configure**.
- 2 In the Time Zone menu, select **(UTC+user) Custom**.
- 3 Configure the settings.

## Using the automatic document feeder and scanner glass

Automatic document feeder (ADF)	Scanner glass
 <ul style="list-style-type: none"> <li>• Use the ADF for multiple-page or two-sided documents.</li> <li>• Load an original document faceup. For multiple-page documents, make sure to align the leading edge before loading.</li> <li>• Make sure to adjust the ADF guides to match the width of the paper that you are loading.</li> </ul>	 <ul style="list-style-type: none"> <li>• Use the scanner glass for single-page documents, book pages, small items (such as postcards or photos), transparencies, photo paper, or thin media (such as magazine clippings).</li> <li>• Place the document facedown in the corner with the arrow.</li> </ul>

## Sending a fax

**Note:** Make sure that fax is configured. For more information, see [“Setting up the printer to fax” on page 57.](#)

### Using the control panel

- 1 Load an original document into the ADF tray or on the scanner glass.
- 2 From the home screen, touch **Fax**, and then enter the needed information.  
If necessary, adjust the settings.
- 3 Send the fax.

### Using the computer

Before you begin, make sure that the fax driver is installed. For more information, see [“Installing the fax driver” on page 265.](#)

#### For Windows users

- 1 From the document that you are trying to fax, open the Print dialog.
- 2 Select the printer, and then click **Properties, Preferences, Options,** or **Setup.**
- 3 Click **Fax > Enable fax > Always display settings prior to faxing,** and then enter the recipient number.  
If necessary, configure other fax settings.
- 4 Send the fax.

#### For Macintosh users

- 1 With a document open, choose **File > Print.**
- 2 Select the printer that has - **Fax** added after its name.
- 3 In the To field, enter the recipient number.  
If necessary, configure other fax settings.
- 4 Send the fax.

## Scheduling a fax

**Note:** Make sure that fax is configured. For more information, see [“Setting up the printer to fax” on page 57.](#)

- 1 Load an original document into the ADF tray or on the scanner glass.
- 2 From the home screen, touch **Fax > To > enter the fax number > Done.**
- 3 Touch **Send Time**, configure the date and time, and then touch **OK.**
- 4 Send the fax.

## Creating a fax destination shortcut

**Note:** Make sure that fax is configured. For more information, see [“Setting up the printer to fax” on page 57](#).

- 1 From the home screen, touch **Fax > To**.
- 2 Enter the recipient number, and then touch **Done**.
- 3 Touch .
- 4 Create a shortcut.

## Changing the fax resolution

**Note:** Make sure that fax is configured. For more information, see [“Setting up the printer to fax” on page 57](#).

- 1 Load an original document into the ADF tray or on the scanner glass.
- 2 From the home screen, touch **Fax**, and then enter the needed information.
- 3 Touch **Resolution**, and then adjust the setting.
- 4 Send the fax.

## Adjusting the fax darkness

**Note:** Make sure that fax is configured. For more information, see [“Setting up the printer to fax” on page 57](#).

- 1 Load an original document into the ADF tray or on the scanner glass.
- 2 From the home screen, touch **Fax**, and then enter the needed information.
- 3 Touch **Darkness**, and then adjust the setting.
- 4 Send the fax.

## Printing a fax log

**Note:** Make sure that fax is configured. For more information, see [“Setting up the printer to fax” on page 57](#).

- 1 From the home screen, touch **Settings > Reports > Fax**.
- 2 Touch **Fax Job Log** or **Fax Call Log**.

## Blocking junk faxes

**Note:** Make sure that fax is configured. For more information, see [“Setting up the printer to fax” on page 57](#).

- 1 From the home screen, touch **Settings > Fax > Fax Setup > Fax Receive Settings > Admin Controls**.
- 2 Set Block No Name Fax to **On**.

## Holding faxes

**Note:** Make sure that fax is configured. For more information, see [“Setting up the printer to fax” on page 57](#).

- 1 From the home screen, touch **Settings > Fax > Fax Setup > Fax Receive Settings > Holding Faxes**.
- 2 Select a mode.

## Forwarding a fax

**Note:** Make sure that fax is configured. For more information, see [“Setting up the printer to fax” on page 57](#).



- 1 Create a destination shortcut.
  - a From the home screen, touch **Shortcut Center**.

**Note:** The icon and name may have been changed. For more information, contact your administrator.
  - b Select a printer function, and then touch **Create Shortcut**.
  - c Configure the settings, and then touch **Save**.
  - d Type a unique shortcut name.
  - e Touch **OK**.

**Note:** Take note of the shortcut number.
- 2 From the home screen, touch **Settings > Fax > Fax Setup > Fax Receive Settings > Admin Controls**.
- 3 Touch **Fax Forwarding** and then touch **Forward** or **Print and Forward**.
- 4 Touch **Forward to**, and then select a destination.
- 5 Select a destination type, and then enter the shortcut number of the destination.

# Scanning

## Using the automatic document feeder and scanner glass

Automatic document feeder (ADF)	Scanner glass
 <ul style="list-style-type: none"> <li>• Use the ADF for multiple-page or two-sided documents.</li> <li>• Load an original document faceup. For multiple-page documents, make sure to align the leading edge before loading.</li> <li>• Make sure to adjust the ADF guides to match the width of the paper that you are loading.</li> </ul>	 <ul style="list-style-type: none"> <li>• Use the scanner glass for single-page documents, book pages, small items (such as postcards or photos), transparencies, photo paper, or thin media (such as magazine clippings).</li> <li>• Place the document facedown in the corner with the arrow.</li> </ul>

Scanning to a computer

## Scanning to a computer

Before you begin, make sure that:

- The printer firmware is updated. For more information, see the “Updating firmware” section.
- The computer and the printer are connected to the same network.

### For Windows users

#### Using Lexmark ScanBack Utility

- 1 From the computer, run Lexmark ScanBack Utility, and then click **Next**.

**Note:** To download the utility, go to [www.lexmark.com/downloads](http://www.lexmark.com/downloads).

- 2 Click **Setup**, and then add the printer IP address.

**Note:** View the printer IP address on the printer home screen. The IP address appears as four sets of numbers separated by periods, such as 123.123.123.123.

- 3 Click **Close > Next**.

- 4 Select the size of the original document, and then click **Next**.

- 5 Select a file format and scan resolution, and then click **Next**.

- 6 Type a unique scan profile name, and then click **Next**.
- 7 Browse to the location you want to save the scanned document, create a file name, and then click **Next**.  
**Note:** To reuse the scan profile, enable **Create Shortcut**, and then create a unique shortcut name.
- 8 Click **Finish**.
- 9 Load an original document into the automatic document feeder or on the scanner glass.
- 10 From the printer control panel, select **Scan to Computer**, and then select a scan profile.  
**Note:** Make sure that Scan to Computer is enabled. From the control panel, navigate to **Settings > Device > Visible Home Screen Icons > Scan to Computer > Display**.

### Using Windows Fax and Scan

**Note:** Make sure that the printer is added to the computer. For more information, see [“Adding printers to a computer” on page 265](#).

- 1 Load an original document into the automatic document feeder or on the scanner glass.
- 2 From the computer, open **Windows Fax and Scan**.
- 3 From the Source menu, select a scanner source.
- 4 If necessary, change the scan settings.
- 5 Scan the document.

### For Macintosh users

**Note:** Make sure that the printer is added to the computer. For more information, see [“Adding printers to a computer” on page 265](#).

- 1 Load an original document into the automatic document feeder or on the scanner glass.
- 2 From the computer, do either of the following:
  - Open **Image Capture**.
  - Open **Printers & Scanners**, and then select a printer. Click **Scan > Open Scanner**.
- 3 From the Scanner window, do one or more of the following:
  - Select where you want to save the scanned document.
  - Select the size of the original document.
  - To scan from the ADF, select **Document Feeder** from the Scan Menu or enable **Use Document Feeder**.
  - If necessary, configure the scan settings.
- 4 Click **Scan**.

## Scanning to an FTP server

- 1 Load the original document into the ADF tray or on the scanner glass.
- 2 From the home screen, touch **FTP**, and then enter the needed information.
- 3 If necessary, configure other FTP settings.
- 4 Send the FTP job.

## Scanning to a network folder

1 Load the document into the ADF tray or on the scanner glass.

2 From the home screen, touch **Scan Center**.

**Note:** This application is supported only in some printer models. For more information, see [“Supported applications” on page 20](#).

3 Do either of the following:

- Select a destination.

**Note:** For SFTP, set the port number to **22**.

- Use a shortcut. Touch ★, and then select the shortcut from the list.

4 Scan the document.

## Creating an FTP shortcut

1 From the home screen, touch **FTP**.

2 Enter the FTP server address, and then touch ★.

3 Create a shortcut.

## Scanning to a flash drive

This feature is available only in some printer models.

1 Load an original document into the ADF tray or on the scanner glass.

2 Insert the flash drive.



3 Touch **Scan to USB** and adjust the settings if necessary.

**Notes:**

- To save the scanned document to a folder, touch **Scan to**, select a folder, and then touch **Scan Here**.
- If the USB Drive screen does not appear, then touch **USB Drive** on the control panel.

4 Scan the document.

**Warning—Potential Damage:** To avoid loss of data or printer malfunction, do not touch the flash drive or the printer in the area shown while actively printing, reading, or writing from the memory device.



## Scanning to a Cloud Connector profile

1 Load an original document into the ADF tray or on the scanner glass.

2 From the home screen, touch **Cloud Connector**.

3 Select a cloud service provider, and then select a profile.

**Note:** For more information on creating a Cloud Connector profile, see [“Creating a Cloud Connector profile” on page 23](#).

4 Touch **Scan**, and then assign a filename and destination folder.

5 Touch **Scan Here**.

If necessary, change the scan settings.

6 Scan the document.

# Understanding the printer menus

## Menu map

Device	<ul style="list-style-type: none"> <li>• <a href="#">Preferences</a></li> <li>• <a href="#">Eco-Mode</a></li> <li>• <a href="#">Remote Operator Panel</a></li> <li>• <a href="#">Notifications</a></li> <li>• <a href="#">Power Management</a></li> <li>• <a href="#">Anonymous Data Collection</a></li> </ul>	<ul style="list-style-type: none"> <li>• <a href="#">Accessibility</a></li> <li>• <a href="#">Restore Factory Defaults</a></li> <li>• <a href="#">Maintenance</a></li> <li>• <a href="#">Visible Home Screen Icons</a></li> <li>• <a href="#">About this Printer</a></li> </ul>
Print	<ul style="list-style-type: none"> <li>• <a href="#">Layout</a></li> <li>• <a href="#">Setup</a></li> <li>• <a href="#">Quality</a></li> <li>• <a href="#">Job Accounting</a></li> <li>• <a href="#">XPS</a></li> </ul>	<ul style="list-style-type: none"> <li>• <a href="#">PDF</a></li> <li>• <a href="#">PostScript</a></li> <li>• <a href="#">PCL</a></li> <li>• <a href="#">HTML</a></li> <li>• <a href="#">Image</a></li> </ul>
Paper	<ul style="list-style-type: none"> <li>• <a href="#">Tray Configuration</a></li> </ul>	<ul style="list-style-type: none"> <li>• <a href="#">Media Configuration</a></li> </ul>
Copy	<a href="#">Copy Defaults</a>	
Fax	<a href="#">Fax Defaults</a>	
E-mail	<ul style="list-style-type: none"> <li>• <a href="#">E-mail Setup</a></li> <li>• <a href="#">E-mail Defaults</a></li> </ul>	<ul style="list-style-type: none"> <li>• <a href="#">Web Link Setup</a></li> </ul>
FTP	<a href="#">FTP Defaults</a>	
USB Drive	<ul style="list-style-type: none"> <li>• <a href="#">Flash Drive Scan</a></li> </ul>	<ul style="list-style-type: none"> <li>• <a href="#">Flash Drive Print</a></li> </ul>
Network/Ports	<ul style="list-style-type: none"> <li>• <a href="#">Network Overview</a></li> <li>• <a href="#">Wireless</a></li> <li>• <a href="#">Wi-Fi Direct</a></li> <li>• <a href="#">Ethernet</a></li> <li>• <a href="#">TCP/IP</a></li> <li>• <a href="#">SNMP</a></li> <li>• <a href="#">IPSec</a></li> </ul>	<ul style="list-style-type: none"> <li>• <a href="#">802.1x</a></li> <li>• <a href="#">LPD Configuration</a></li> <li>• <a href="#">HTTP/FTP Settings</a></li> <li>• <a href="#">ThinPrint</a></li> <li>• <a href="#">USB</a></li> <li>• <a href="#">Restrict external network access</a></li> </ul>
Security	<ul style="list-style-type: none"> <li>• <a href="#">Login Methods</a></li> <li>• <a href="#">Schedule USB Devices</a></li> <li>• <a href="#">Security Audit Log</a></li> <li>• <a href="#">Login Restrictions</a></li> <li>• <a href="#">Confidential Print Setup</a></li> </ul>	<ul style="list-style-type: none"> <li>• <a href="#">Disk Encryption</a></li> <li>• <a href="#">Erase Temporary Data Files</a></li> <li>• <a href="#">Solutions LDAP Settings</a></li> <li>• <a href="#">Mobile Services Management</a></li> <li>• <a href="#">Miscellaneous</a></li> </ul>
Reports	<ul style="list-style-type: none"> <li>• <a href="#">Menu Settings Page</a></li> <li>• <a href="#">Device</a></li> <li>• <a href="#">Print</a></li> </ul>	<ul style="list-style-type: none"> <li>• <a href="#">Shortcuts</a></li> <li>• <a href="#">Fax</a></li> <li>• <a href="#">Network</a></li> </ul>

<a href="#">Help</a>	<ul style="list-style-type: none"> <li>• Print All Guides</li> <li>• Connection Guide</li> <li>• Copy Guide</li> <li>• E-mail Guide</li> <li>• Fax Guide</li> <li>• FTP Guide</li> </ul>	<ul style="list-style-type: none"> <li>• Information Guide</li> <li>• Media Guide</li> <li>• Mono Quality Guide</li> <li>• Moving Guide</li> <li>• Print Quality Guide</li> <li>• Supplies Guide</li> </ul>
<a href="#">Troubleshooting</a>	Print Quality Test Pages	Cleaning the Scanner

## Device

### Preferences

Menu item	Description
<b>Display Language</b> [List of languages]	Set the language of the text that appears on the display.
<b>Country/Region</b> [List of countries or regions]	Identify the country or region where the printer is configured to operate.
<b>Run initial setup</b> On Off*	Run the setup wizard.
<b>Keyboard</b> Keyboard Type [List of languages]	Select a language as a keyboard type. <b>Note:</b> All the Keyboard Type values may not appear or may require special hardware to appear.
<b>Displayed information</b> Display Text 1 [IP Address*] Display Text 2 [Date/Time*] Custom Text 1 Custom Text 2	Specify the information to appear on the home screen.
<b>Date and Time</b> Configure Current Date and Time Manually Set Date and Time Date Format [MM-DD-YYYY*] Time Format [12 hour A.M./P.M.*] Time Zone [Eastern Time*]	Configure the printer date and time.
<b>Date and Time</b> Network Time Protocol Enable NTP [On*] NTP Server Enable Authentication	Configure the settings for Network Time Protocol (NTP). <b>Note:</b> When Enable Authentication is set to MD5 key, Key ID and Password appear.
<b>Note:</b> An asterisk (*) next to a value indicates the factory default setting.	

Menu item	Description
<b>Paper Sizes</b> U.S.* Metric	Specify the unit of measurement for paper sizes. <b>Note:</b> The country or region selected in the initial setup wizard determines the initial paper size setting.
<b>Screen Brightness</b> 20–100% (100*)	Adjust the brightness of the display.
<b>Flash Drive Access</b> Enabled* Disabled	Enable access to the flash drive.
<b>Allow Background Removal</b> On* Off	Specify whether background removal is allowed.
<b>Allow Custom Job scans</b> On* Off	Scan multiple jobs to one file. <b>Note:</b> This menu setting appears only when a hard disk is installed.
<b>One Page Flatbed Scanning</b> On Off*	Set copies from the scanner glass to only one page at a time.
<b>Audio Feedback</b> Button Feedback On* Off	Enable audio feedback for button presses, panel interactions, paper loaded prompts, and error notifications.
<b>Audio Feedback</b> Volume 1–10 (5*)	Adjust the volume of the printer speakers. <b>Note:</b> Changes to the volume are applied after the current user session ends.
<b>Screen Timeout</b> 10–300 (60*)	Set the idle time in seconds before the display shows the home screen, or before the printer logs off a user account automatically.
<b>Note:</b> An asterisk (*) next to a value indicates the factory default setting.	

## Eco-Mode

Menu item	Description
<b>Print</b> Sides 1-Sided* 2-Sided	Specify whether to print on one side or two sides of the paper.
<b>Note:</b> An asterisk (*) next to a value indicates the factory default setting.	

Menu item	Description
<p><b>Print</b></p> <p>Pages per Side</p> <ul style="list-style-type: none"> <li>Off*</li> <li>2 pages per side</li> <li>3 pages per side</li> <li>4 pages per side</li> <li>6 pages per side</li> <li>9 pages per side</li> <li>12 pages per side</li> <li>16 pages per side</li> </ul>	<p>Print multiple page images on one side of a sheet of paper.</p>
<p><b>Print</b></p> <p>Toner Darkness</p> <ul style="list-style-type: none"> <li>1–10 (8*)</li> </ul>	<p>Determine the lightness or darkness of text images.</p>
<p><b>Copy</b></p> <p>Sides</p> <ul style="list-style-type: none"> <li>1 sided to 1 sided*</li> <li>1 sided to 2 sided</li> <li>2 sided to 1 sided</li> <li>2 sided to 2 sided</li> </ul>	<p>Specify the scanning behavior based on the original document.</p>
<p><b>Copy</b></p> <p>Pages per Side</p> <ul style="list-style-type: none"> <li>Off*</li> <li>2 Portrait pages</li> <li>4 Portrait pages</li> <li>2 Landscape pages</li> <li>4 Landscape pages</li> </ul>	<p>Specify the scanning behavior based on the original document.</p>
<p><b>Copy</b></p> <p>Darkness</p> <ul style="list-style-type: none"> <li>1–9 (5*)</li> </ul>	<p>Determine the darkness of the scanned text images.</p>
<p><b>Note:</b> An asterisk (*) next to a value indicates the factory default setting.</p>	

## Remote Operator Panel

Menu item	Description
<p><b>External VNC Connection</b></p> <ul style="list-style-type: none"> <li>Don't Allow*</li> <li>Allow</li> </ul>	<p>Connect an external Virtual Network Computing (VNC) client to the remote control panel.</p>
<p><b>Authentication Type</b></p> <ul style="list-style-type: none"> <li>None*</li> <li>Standard Authentication</li> </ul>	<p>Set the authentication type when accessing the VNC client server.</p>
<p><b>Note:</b> An asterisk (*) next to a value indicates the factory default setting.</p>	

Menu item	Description
<b>VNC Password</b>	Specify the password to connect to the VNC client server. <b>Note:</b> This menu item appears only if Authentication Type is set to Standard Authentication.
<b>Note:</b> An asterisk (*) next to a value indicates the factory default setting.	

## Notifications

Menu item	Description
<b>ADF Loaded Beep</b> Off On*	Enable a sound when loading paper into the ADF.
<b>Alarm Control</b> Off Single* Continuous	Set the number of times that the alarm sounds when the printer requires user intervention.
<b>Supplies</b> Show Supply Estimates Show estimates* Do not show estimates	Show the estimated status of the supplies.
<b>Supplies</b> Cartridge Alarm Off* Single Continuous	Set the number of times that the alarm sounds when the toner cartridge is low.
<b>Supplies</b> Custom Supply Notifications	Configure notification settings when the printer requires user intervention. <b>Note:</b> This menu item appears only in the Embedded Web Server.
<b>Note:</b> An asterisk (*) next to a value indicates the factory default setting.	

Menu item	Description
<p><b>E-mail Alerts Setup</b></p> <ul style="list-style-type: none"> <li>Primary SMTP Gateway</li> <li>Primary SMTP Gateway Port (25*)</li> <li>Secondary SMTP Gateway</li> <li>Secondary SMTP Gateway Port (25*)</li> <li>SMTP Timeout (30 seconds*)</li> <li>Reply Address</li> <li>Always use SMTP default Reply Address (Off*)</li> <li>Use SSL/TLS (Disabled*)</li> <li>Require Trusted Certificate (On*)</li> <li>SMTP Server Authentication (No authentication required*)</li> <li>Device-Initiated E-mail (None*)</li> <li>User-Initiated E-mail (None*)</li> <li>Use Active Directory Device Credentials (Off*)</li> <li>Device Userid</li> <li>Device Password</li> <li>Kerberos 5 REALM</li> <li>NTLM Domain</li> <li>Disable "SMTP server not set up" error (Off*)</li> </ul>	<p>Configure the printer to send e-mail alerts to a list of contacts when the printer requires user intervention.</p>
<p><b>E-mail Alerts Setup</b></p> <ul style="list-style-type: none"> <li>Setup E-mail Lists and Alerts                             <ul style="list-style-type: none"> <li>E-mail List 1</li> <li>E-mail List 2</li> <li>Subject Text</li> <li>E-mail Events</li> </ul> </li> </ul>	<p>Specify the e-mail addresses and enable the e-mail alert events.</p> <p><b>Note:</b> This menu item appears only in the Embedded Web Server.</p>
<p><b>Error Prevention</b></p> <ul style="list-style-type: none"> <li>Jam Assist                             <ul style="list-style-type: none"> <li>Off</li> <li>On*</li> </ul> </li> </ul>	<p>Set the printer to flush automatically blank pages or pages with partial prints after a jammed page is cleared.</p>
<p><b>Error Prevention</b></p> <ul style="list-style-type: none"> <li>Auto Continue                             <ul style="list-style-type: none"> <li>Enabled</li> <li>5–255 (5*)</li> </ul> </li> </ul>	<p>Let the printer to continue processing or printing a job automatically after clearing certain attendance conditions.</p>
<p><b>Error Prevention</b></p> <ul style="list-style-type: none"> <li>Auto Reboot                             <ul style="list-style-type: none"> <li>Auto Reboot                                     <ul style="list-style-type: none"> <li>Reboot when idle</li> <li>Reboot always*</li> <li>Reboot never</li> </ul> </li> </ul> </li> </ul>	<p>Set the printer to restart when an error occurs.</p>
<p><b>Note:</b> An asterisk (*) next to a value indicates the factory default setting.</p>	

Menu item	Description
<p><b>Error Prevention</b>                      Auto Reboot                      Max Auto Reboots                      1–20 (2*)</p>	<p>Set the number of automatic reboots that the printer can perform.</p>
<p><b>Error Prevention</b>                      Auto Reboot                      Auto Reboot Window                      1–525600 (720*)</p>	<p>Set the number of seconds before the printer performs an automatic reboot.</p>
<p><b>Error Prevention</b>                      Auto Reboot                      Auto Reboot Counter</p>	<p>Show a read-only information of the reboot counter.</p>
<p><b>Error Prevention</b>                      Auto Reboot                      Reset Auto Reboot Counter                      Cancel                      Continue</p>	<p>Reset the values of the Auto Reboot Counter.</p>
<p><b>Error Prevention</b>                      Display Short Paper Error                      On                      Auto-clear*</p>	<p>Set the printer to show a message when a short paper error occurs.  <b>Note:</b> Short paper refers to the size of the paper loaded.</p>
<p><b>Error Prevention</b>                      Page Protect                      Off*                      On</p>	<p>Set the printer to process the entire page into the memory before printing it.</p>
<p><b>Jam Content Recovery</b>                      Jam Recovery                      Off                      On                      Auto*</p>	<p>Set the printer to reprint jammed pages.</p>
<p><b>Jam Content Recovery</b>                      Scanner Jam Recovery                      Job level                      Page level*</p>	<p>Specify how to restart a scan job after resolving a paper jam.</p>

**Note:** An asterisk (\*) next to a value indicates the factory default setting.

## Power Management

Menu item	Description
<b>Sleep Mode Profile</b> Print from Sleep Mode Stay awake after printing Enter Sleep Mode after printing*	Set the printer to stay in Ready mode or return to Sleep mode after printing.
<b>Timeouts</b> Sleep Mode 1–120 minutes (15*)	Set the idle time before the printer begins operating in Sleep mode.
<b>Timeouts</b> Hibernate Timeout Disabled 1 hour 2 hours 3 hours 6 hours 1 day 2 days 3 days* 1 week 2 weeks 1 month	Set the time before the printer turns off.
<b>Timeouts</b> Hibernate Timeout on Connection Hibernate Do Not Hibernate*	Set Hibernate Timeout to turn off the printer while an active Ethernet connection exists.
<b>Schedule Power Modes</b> Schedules Add New Schedule	Schedule the printer when to enter Sleep or Hibernate mode.
<b>Note:</b> An asterisk (*) next to a value indicates the factory default setting.	

## Anonymous Data Collection

Menu item	Description
<b>Anonymous Data Collection</b> Device Usage and Performance Information None*	Send printer usage and performance information to Lexmark.  <b>Note:</b> Anonymous Data Send Time appears only when you set Anonymous Data Collection to Device Usage and Performance.
<b>Anonymous Data Send Time</b> Start Time Stop Time	
<b>Note:</b> An asterisk (*) next to a value indicates the factory default setting.	

## Accessibility

Menu item	Description
<b>Duplicate Key Strike Interval</b> 0–5 (0*)	Set the interval in seconds during which the printer ignores duplicate key presses on an attached keyboard.
<b>Key Repeat Initial Delay</b> 0.25–5 (1*)	Set the initial length of delay in seconds before a repeating key starts repeating. <b>Note:</b> This menu item appears only when a keyboard is attached to the printer.
<b>Key Repeat Rate</b> 0.5–30 (30*)	Set the number of presses per second for a repeating key. <b>Note:</b> This menu item appears only when a keyboard is attached to the printer.
<b>Prolong Screen Timeout</b> Off* On	Let the user remain in the same location and reset the Screen Timeout timer when it expires instead of returning to the home screen.
<b>Headphone Volume</b> 1–10 (5*)	Adjust the headphone volume. <b>Note:</b> This menu item appears only when a headphone is attached to the printer.
<b>Enable Voice Guidance When Headphone Is Attached</b> Off* On	Enable Voice Guidance when a headphone is attached to the printer.
<b>Speak Passwords/PINs</b> Off* On	Set the printer to read out loud passwords or personal identification numbers. <b>Note:</b> This menu item appears only when a headphone or a speaker is attached to the printer.
<b>Speech Rate</b> Very Slow Slow Normal* Fast Faster Very Fast Rapid Very Rapid Fastest	Set the Voice Guidance speech rate. <b>Note:</b> This menu item appears only when a headphone or a speaker is attached to the printer.
<b>Note:</b> An asterisk (*) next to a value indicates the factory default setting.	

## Restore Factory Defaults

Menu item	Description
<b>Restore Settings</b> Restore all settings Restore printer settings Restore network settings Restore fax settings Restore app settings	Restore the printer factory default settings.

## Maintenance

### Configuration Menu

Menu item	Description
<b>USB Configuration</b> USB PnP 1* 2	Change the USB driver mode of the printer to improve its compatibility with a personal computer.
<b>USB Configuration</b> USB Scan to Local On* Off	Set whether the USB device driver enumerates as a USB Simple device (single interface) or as a USB Composite device (multiple interfaces).
<b>USB Configuration</b> USB Speed Full Auto*	Set the USB port to run at full speed and disable its high-speed capabilities.
<b>Tray Configuration</b> Tray Linking Automatic* Off	Set the printer to link the trays that have the same paper type and paper size settings.
<b>Tray Configuration</b> Show Tray Insert Message Off Only for unknown sizes* Always	Display a message to select paper size and type after inserting the tray.
<b>Tray Configuration</b> A5 Loading Short Edge* Long Edge	Specify the page orientation when loading A5 paper size.

**Note:** An asterisk (\*) next to a value indicates the factory default setting.

Menu item	Description
<b>Tray Configuration</b> Paper Prompts Auto* Multipurpose Feeder Manual Paper	Set the paper source that the user fills when a prompt to load paper appears.
<b>Tray Configuration</b> Envelope Prompts Auto* Multipurpose Feeder Manual Envelope	Set the paper source that the user fills when a prompt to load envelope appears.
<b>Tray Configuration</b> Action for Prompts Prompt user* Continue Use current	Set the printer to resolve paper- or envelope-related change prompts.
<b>Reports</b> Menu Settings Page Event Log Event Log Summary HealthCheck Statistics	Print reports about printer menu settings, status, and event logs.
<b>Supply Usage And Counters</b> Clear Supply Usage History Reset Black Cartridge Counter Reset Maintenance Counter	Reset the supply page counter or view the total printed pages.
<b>Printer Emulations</b> PPDS Emulation Off* On	Set the printer to recognize and use the PPDS data stream.
<b>Printer Emulations</b> PS Emulation Off On*	Set the printer to recognize and use the PS data stream.
<b>Printer Emulations</b> Emulator Security Page Timeout 0–60 (60*)	Set the page timeout during emulation.
<b>Printer Emulations</b> Emulator Security Reset Emulator After Job Off* On	Reset the emulator after a print job.
<b>Note:</b> An asterisk (*) next to a value indicates the factory default setting.	

Menu item	Description
<b>Printer Emulations</b> Emulator Security Disable Printer Message Access On* Off	Disable access to the printer message during emulation.
<b>Fax Configuration</b> Fax Low Power Support Disable Sleep Permit Sleep Auto*	Set fax to enter Sleep mode whenever the printer determines that it should.  <b>Note:</b> This menu item appears only in some printer models.
<b>Print Configuration</b> Font Sharpening 0–150 (24*)	Set a text point-size value below which the high-frequency screens are used when printing font data.
<b>Print Configuration</b> Print Density Disabled* 1–5 Copy Density Disabled* 1–5	Adjust the toner density when printing or copying documents.
<b>Device Operations</b> Quiet Mode Off* On	Set the printer to reduce the amount of noise that it makes when printing.  <b>Note:</b> Enabling this setting slows down the overall performance of the printer.
<b>Device Operations</b> Panel Menus Enable* Disable	Set the printer to show the control panel menus.  <b>Note:</b> This menu item appears only in the Embedded Web Server.
<b>Device Operations</b> Safe Mode Off* On	Set the printer to operate in a special mode, in which it attempts to continue offering as much functionality as possible, despite known issues.  For example, when set to On, and the duplex motor is nonfunctional, the printer performs one-sided printing of the documents even if the job is two-sided printing.
<b>Device Operations</b> Minimum Copy Memory 20MB* 30MB 50MB 80MB 100MB	Set the memory allocation for storing copy jobs.  <b>Note:</b> The values appear only if the amount of installed DRAM is at least twice the amount of the value.
<b>Note:</b> An asterisk (*) next to a value indicates the factory default setting.	

Menu item	Description
<b>Device Operations</b> Clear Custom Status	Erase all custom messages.
<b>Device Operations</b> Clear all remotely-installed messages	Erase all remotely-installed messages.
<b>Device Operations</b> Automatically Display Error Screens On* Off	Show existing error messages on the display after the printer remains inactive on the home screen for a length of time equal to the Screen Timeout setting.
<b>Device Operations</b> Honor orientation on fast path copy On Off*	Enable the printer to use the Orientation setting under the Copy menu when sending quick copy jobs.
<b>App Configuration</b> LES Applications On* Off	Enable the Lexmark Embedded Solutions (LES) applications.
<b>Scanner Configuration</b> Scanner Manual Registration Print Quick Test	Print a Quick Test target page.  <b>Note:</b> Make sure that the margin spacing on the target page is uniform all the way around the target. If it is not, then reset the printer margins.
<b>Scanner Configuration</b> Scanner Manual Registration Front ADF Registration Rear ADF Registration Flatbed Registration	Manually register the flatbed and ADF after replacing the ADF, scanner glass, or controller board.
<b>Scanner Configuration</b> Edge Erase Flatbed Edge Erase 0–6 (3*) ADF Edge Erase 0–6 (3*)	Set the size, in millimeters, of the no-print area around an ADF or flatbed scan job.
<b>Scanner Configuration</b> ADF Deskew ADF Mechanical Deskew Off On Auto*	Set the printer to perform ADF mechanical skew adjustment.
<b>Note:</b> An asterisk (*) next to a value indicates the factory default setting.	

Menu item	Description
<b>Scanner Configuration</b> Disable Scanner Enabled* Disabled ADF Disabled	Disable the scanner if it is not working properly.
<b>Scanner Configuration</b> Tiff Byte Order CPU Endianness* Little Endian Big Endian	Set the byte order of a TIFF-formatted scan output.
<b>Scanner Configuration</b> Exact Tiff Rows Per Strip On* Off	Set the RowsPerStrip tag value of a TIFF-formatted scan output.
<b>Note:</b> An asterisk (*) next to a value indicates the factory default setting.	

### Out of Service Erase

Menu item	Description
<b>Memory Last Sanitized</b> <b>Hard Disk Last Sanitized</b>	Show information on when the printer memory or hard disk was last sanitized. <b>Note:</b> Hard Disk Last Sanitized appears only when a hard disk is installed.
<b>Sanitize all information on nonvolatile memory</b> Erase all printer and network settings Erase all apps and app settings Erase all shortcuts and shortcut settings  <b>Sanitize all information on hard disk</b> Erase downloads (Erase all macros, fonts, PFOs, etc.) Erase buffered jobs Erase Held jobs	Clear all information on nonvolatile memory and information on the hard disk. <b>Note:</b> Sanitize all information on hard disk appears only when a hard disk is installed.

## Visible Home Screen Icons

Menu	Description
<b>Visible Home Screen Icons</b> Copy E-mail Fax Status/Supplies Job Queue Change Language Shortcut Center Address Book Bookmarks Held Jobs USB FTP Scan Profiles App Profiles Scan Center	Specify which icons to show on the home screen.

## About this Printer

Menu item	Description
<b>Asset Tag</b>	Show the serial number of the printer.
<b>Printer's Location</b>	Identify the printer location. The maximum length is 63 characters.
<b>Contact</b>	Personalize the printer name. The maximum length is 63 characters.
<b>Export Configuration File to USB</b>	Export the configuration file to a flash drive.
<b>Export Compressed Logs to USB</b>	Export the compressed log files to a flash drive.
<b>Send Logs</b> Cancel Send	Send diagnostic information to Lexmark.

## Print

### Layout

Menu item	Description
<b>Sides</b> 1-Sided* 2-Sided	Specify whether to print on one side or both sides of the paper.
<b>Note:</b> An asterisk (*) next to a value indicates the factory default setting.	

Menu item	Description
<b>Flip Style</b> Long Edge* Short Edge	Determine which side of the paper is bound when performing two-sided printing.
<b>Blank Pages</b> Print Do Not Print*	Print blank pages that are included in a print job.
<b>Collate</b> Off (1,1,1,2,2,2) On (1,2,1,2,1,2)*	Keep the pages of a print job stacked in sequence, particularly when printing multiple copies of the job.
<b>Separator Sheets</b> None* Between Copies Between Jobs Between Pages	Insert blank separator sheets when printing.
<b>Separator Sheet Source</b> Tray [x] (1*) Multipurpose Feeder	Specify the paper source for the separator sheet.
<b>Pages per Side</b> Off* 2 pages per side 3 pages per side 4 pages per side 6 pages per side 9 pages per side 12 pages per side 16 pages per side	Print multiple page images on one side of a sheet of paper.
<b>Pages per Side Ordering</b> Horizontal* Reverse Horizontal Vertical Reverse Vertical	Specify the positioning of multiple page images when using the Pages per Side menu.
<b>Pages per Side Orientation</b> Auto* Landscape Portrait	Specify the orientation of multiple page images when using the Pages per Side menu.
<b>Pages per Side Border</b> None* Solid	Print a border around each page image when using the Pages per Side menu.
<b>Copies</b> 1–9999 (1*)	Specify the number of copies for each print job.
<b>Note:</b> An asterisk (*) next to a value indicates the factory default setting.	

Menu item	Description
<b>Print Area</b> Normal* Whole Page	Set the printable area on a sheet of paper.
<b>Note:</b> An asterisk (*) next to a value indicates the factory default setting.	

## Setup

Menu item	Description
<b>Printer Language</b> PCL Emulation* PS Emulation	Set the printer language.  <b>Note:</b> Setting a printer language default does not prevent a software program from sending print jobs that use another printer language.
<b>Job Waiting</b> Off* On	Preserve print jobs requiring supplies so that jobs not requiring the missing supplies can print.  <b>Note:</b> This menu item appears only when a hard disk is installed.
<b>Job Hold Timeout</b> 0–255 (30*)	Set the time in seconds that the printer waits for user intervention before it holds jobs that require unavailable resources and continues to print other jobs in the print queue.  <b>Note:</b> This menu item appears only when a hard disk is installed.
<b>Download Target</b> RAM* Disk	Specify where to save all permanent resources, such as fonts and macros, that have been downloaded to the printer.  <b>Note:</b> This menu item appears only when a hard disk is installed.
<b>Resource Save</b> Off* On	Determine what the printer does with downloaded resources, such as fonts and macros, when it receives a job that requires more than the available memory.  <b>Notes:</b> <ul style="list-style-type: none"> <li>• When set to Off, the printer retains downloaded resources only until memory is needed. Resources associated with the inactive printer language are deleted.</li> <li>• When set to On, the printer preserves all the permanent downloaded resources across all language switches. When necessary, the printer shows memory full messages instead of deleting permanent resources.</li> </ul>
<b>Print All Order</b> Alphabetical* Newest First Oldest First	Specify the order in which held and confidential jobs are printed when Print All is selected.  <b>Note:</b> This menu item appears only when a hard disk is installed.
<b>Note:</b> An asterisk (*) next to a value indicates the factory default setting.	

## Quality

Menu item	Description
<b>Print Resolution</b> 300 dpi 600 dpi* 1200 Image Q 2400 Image Q 1200 dpi	Set the resolution for the text and images on the printed output. <b>Note:</b> Resolution is determined in dots per inch or image quality.
<b>Pixel Boost</b> Off* Fonts Horizontally Vertically Both directions	Enable more pixels to print in clusters for clarity, in order to enhance text and images.
<b>Toner Darkness</b> 1–10 (8*)	Determine the lightness or darkness of text images.
<b>Halftone</b> Normal* Detail	Enhance the printed output to have smoother lines with sharper edges.
<b>Brightness</b> -6 to 6 (0*)	Adjust the brightness of the printed output.
<b>Contrast</b> 0–5 (0*)	Adjust the contrast of the printed output.
<b>Gray Correction</b> Auto* Off	Adjust the contrast enhancement applied to images.
<b>Note:</b> An asterisk (*) next to a value indicates the factory default setting.	

## Job Accounting

Menu item	Description
<b>Job Accounting</b> Off* On	Set the printer to create a log of the print jobs that it receives. <b>Note:</b> This menu item appears only when a flash memory or hard disk is installed.
<b>Accounting Log Frequency</b> Daily Weekly Monthly*	Specify how often the printer creates a log file.
<b>Note:</b> An asterisk (*) next to a value indicates the factory default setting.	

Menu item	Description
<b>Log Action at End of Frequency</b> None* E-mail Current Log E-mail & Delete Current Log Post Current Log Post & Delete Current Log	Specify how the printer responds when the frequency threshold expires. <b>Note:</b> The value defined in Accounting Log Frequency determines when this action is triggered.
<b>Log Action at Near Full</b> None* E-mail Current Log E-mail & Delete Current Log E-mail & Delete Oldest Log Post Current Log Post & Delete Current Log Post & Delete Oldest Log Delete Current Log Delete Oldest Log Delete All But Current Delete All Logs	Specify how the printer responds when the hard disk is nearly full.
<b>Log Action at Full</b> None* E-mail & Delete Current Log E-mail & Delete Oldest Log Post & Delete Current Log Post & Delete Oldest Log Delete Current Log Delete Oldest Log Delete All But Current Delete All Logs	Specify how the printer responds when hard disk usage reaches the maximum limit (100MB).
<b>URL to Post Log</b>	Specify where the printer posts job accounting logs.
<b>E-mail Address to Send Logs</b>	Specify the e-mail address to which the printer sends job accounting logs.
<b>Log File Prefix</b>	Specify the prefix for the log files. <b>Note:</b> The current host name defined in the TCP/IP menu is used as the default log file prefix.
<b>Note:</b> An asterisk (*) next to a value indicates the factory default setting.	

## XPS

Menu item	Description
<b>Print Error Pages</b> Off* On	Print a test page that contains information on errors.
<b>Note:</b> An asterisk (*) next to a value indicates the factory default setting.	

Menu item	Description
<b>Minimum Line Width</b> 1–30 (2*)	Set the minimum stroke width of any job printed in 1200 dpi.
<b>Note:</b> An asterisk (*) next to a value indicates the factory default setting.	

## PDF

Menu item	Description
<b>Scale To Fit</b> Off* On	Scale the page content to fit the selected paper size.
<b>Annotations</b> Print Do Not Print*	Specify whether to print annotations in the PDF.
<b>Print PDF Error</b> Off On*	Enable the printing of PDF error.
<b>Note:</b> An asterisk (*) next to a value indicates the factory default setting.	

## PostScript

Menu item	Description
<b>Print PS Error</b> Off* On	Print a page that describes the PostScript® error. <b>Note:</b> When an error occurs, processing of the job stops, the printer prints an error message, and the rest of the print job is flushed.
<b>Minimum Line Width</b> 1–30 (2*)	Set the minimum stroke width. <b>Note:</b> Jobs printed in 1200 dpi use the value directly.
<b>Lock PS Startup Mode</b> Off On*	Disable the SysStart file.
<b>Font Priority</b> Resident* Flash/Disk	Establish the font search order. <b>Notes:</b> <ul style="list-style-type: none"> <li>Resident sets the printer to search its memory for the requested font before searching the flash memory or printer hard disk.</li> <li>Flash/Disk sets the printer to search the flash memory or printer hard disk for the requested font before searching the printer memory.</li> <li>This menu item appears only when a flash memory or hard disk is installed.</li> </ul>
<b>Note:</b> An asterisk (*) next to a value indicates the factory default setting.	

Menu item	Description
<b>Wait Timeout</b> Off On* (40 seconds)	Enable the printer to wait for more data before canceling a print job.
<b>Note:</b> An asterisk (*) next to a value indicates the factory default setting.	

## PCL

Menu item	Description
<b>Font Source</b> Resident* Disk Download Flash All	Select the source which contains the default font selection.  <b>Notes:</b> <ul style="list-style-type: none"> <li>• Disk and Flash appear only when a non-defective, non-protected hard disk or flash memory is installed.</li> <li>• Download appears only if downloaded fonts exist in the printer memory.</li> </ul>
<b>Font Name</b> [List of available fonts] (Courier*)	Select a font from the specified font source.
<b>Symbol Set</b> [List of available symbol set] (10U PC-8*)	Specify the symbol set for each font name.  <b>Note:</b> A symbol set is a set of alphabetic and numeric characters, punctuation, and special symbols. Symbol sets support the different languages or specific programs such as math symbols for scientific text.
<b>Pitch</b> 0.08–100.00 (10.00*)	Specify the pitch for fixed or monospaced fonts.  <b>Note:</b> Pitch refers to the number of fixed-space characters in a horizontal inch of type.
<b>Orientation</b> Portrait* Landscape Reverse Portrait Reverse Landscape	Specify the orientation of text and graphics on the page.
<b>Lines per Page</b> 1–255 (60*)	Specify the number of lines of text for each page printed through the PCL® data stream.  <b>Notes:</b> <ul style="list-style-type: none"> <li>• This menu item activates vertical escapement that causes the selected number of requested lines to print between the default margins of the page.</li> <li>• 60 is the U.S. factory default setting. 64 is the international factory default setting.</li> </ul>
<b>PCL5 Minimum Line Width</b> 1–30 (2*)	Set the initial minimum stroke width.
<b>PCLXL Minimum Line Width</b> 1–30 (2*)	
<b>Note:</b> An asterisk (*) next to a value indicates the factory default setting.	

Menu item	Description
<b>A4 Width</b> 198 mm* 203 mm	Set the width of the logical page on A4-size paper. <b>Note:</b> Logical page is the space on the physical page where data is printed.
<b>Auto CR after LF</b> On Off*	Set the printer to perform a carriage return after a line feed control command. <b>Note:</b> Carriage return is a mechanism that commands the printer to move the position of the cursor to the first position on the same line.
<b>Auto LF after CR</b> On Off*	Set the printer to perform a line feed after a carriage return control command.
<b>Tray Renumber</b> Assign Tray [x]	Configure the printer to work with a different print driver or custom application that uses a different set of source assignments to request a given paper source.
<b>Tray Renumber</b> View Factory Defaults	Show the factory default value assigned for each paper source.
<b>Tray Renumber</b> Restore Defaults	Return all tray assignments to factory default values.
<b>Print Timeout</b> Off On* (90 seconds)	Set the printer to end a print job after it has been idle for the specified amount of time.
<b>Note:</b> An asterisk (*) next to a value indicates the factory default setting.	

## HTML

Menu item	Description
<b>Font Name</b> Times*	Set the font to use when printing HTML documents.
<b>Font Size</b> 1–255 (12*)	Set the font size to use when printing HTML documents.
<b>Scale</b> 1–400% (100*)	Scale HTML documents for printing.
<b>Orientation</b> Portrait* Landscape	Set the page orientation for HTML documents.
<b>Margin Size</b> 8–255 mm (19*)	Set the page margin for HTML documents.
<b>Backgrounds</b> Do Not Print Print*	Print background information or graphics in HTML documents.
<b>Note:</b> An asterisk (*) next to a value indicates the factory default setting.	

## Image

Menu item	Description
<b>Auto Fit</b> On Off*	Select the best available paper size and orientation setting for an image. <b>Note:</b> When set to On, this menu item overrides the scaling and orientation settings for the image.
<b>Invert</b> Off* On	Invert bitonal monochrome images. <b>Note:</b> This menu item does not apply to GIF or JPEG image formats.
<b>Scaling</b> Anchor Top Left Best Fit* Anchor Center Fit Height/Width Fit Height Fit Width	Adjust the image to fit the printable area. <b>Note:</b> When Auto Fit is set to On, Scaling is automatically set to Best Fit.
<b>Orientation</b> Portrait* Landscape Reverse Portrait Reverse Landscape	Specify the orientation of text and graphics on the page.
<b>Note:</b> An asterisk (*) next to a value indicates the factory default setting.	

## Paper

### Tray Configuration

Menu item	Description
<b>Default Source</b> Tray [x] (1*) MP Feeder Manual Paper Manual Envelope	Set the paper source for all print jobs. <b>Note:</b> MP Feeder appears only when Configure MP is set to Cassette.
<b>Paper Size/Type</b> Tray [x] MP Feeder Manual Paper Manual Envelope	Specify the paper size or paper type loaded in each paper source.
<b>Note:</b> An asterisk (*) next to a value indicates the factory default setting.	

Menu item	Description
<b>Substitute Size</b> Off Statement/A5 Letter/A4 All Listed*	Set the printer to substitute a specified paper size if the requested size is not loaded in any paper source.  <b>Notes:</b> <ul style="list-style-type: none"> <li>• Off prompts the user to load the required paper size.</li> <li>• Statement/A5 prints A5-size document on statement when loading statement, and statement-size jobs on A5 paper size when loading A5.</li> <li>• Letter/A4 prints A4-size document on letter when loading letter, and letter-size jobs on A4 paper size when loading A4.</li> <li>• All Listed substitutes Letter/A4.</li> </ul>
<b>Configure MP</b> Cassette* Manual First	Set the printer when to pick paper loaded in the multipurpose feeder.  <b>Notes:</b> <ul style="list-style-type: none"> <li>• When set to Cassette, the printer treats the multipurpose feeder like a tray.</li> <li>• When set to Manual, the printer treats the multipurpose feeder like a manual feeder.</li> <li>• When set to First, the printer picks paper from the multipurpose feeder until it is empty, regardless of the required paper source or paper size.</li> </ul>
<b>Note:</b> An asterisk (*) next to a value indicates the factory default setting.	

## Media Configuration

### Universal Setup

Menu item	Description
<b>Units of Measure</b> Inches Millimeters	Specify the unit of measurement for the universal paper.  <b>Note:</b> Inches is the U.S. factory default setting. Millimeters is the international factory default setting.
<b>Portrait Width</b> 3.00–14.17 inches (8.50*) 76–360 mm (216*)	Set the portrait width of the universal paper.
<b>Portrait Height</b> 3.00–14.17 inches (14*) 76–360 mm (356*)	Set the portrait height of the universal paper.
<b>Feed Direction</b> Short Edge* Long Edge	Set the printer to pick paper from the short edge or long edge direction.  <b>Note:</b> Long Edge appears only when the longest edge is shorter than the maximum width supported.
<b>Note:</b> An asterisk (*) next to a value indicates the factory default setting.	

### Custom Scan Sizes

Menu item	Description
<p><b>Custom Scan Size [x]</b></p> <ul style="list-style-type: none"> <li>Scan Size Name</li> <li>Width                             <ul style="list-style-type: none"> <li>1–8.5 inches (8.5*)</li> <li>25.4–215.9 mm (215.9*)</li> </ul> </li> <li>Height                             <ul style="list-style-type: none"> <li>1–25 inches (14*)</li> <li>25.4–635 mm (355.6*)</li> </ul> </li> <li>Orientation                             <ul style="list-style-type: none"> <li>Portrait*</li> <li>Landscape</li> </ul> </li> <li>2 scans per side                             <ul style="list-style-type: none"> <li>Off*</li> <li>On</li> </ul> </li> </ul>	<p>Assign a scan size name and configure the scan settings.</p>

### Media Types

Menu item	Description
<ul style="list-style-type: none"> <li>Plain</li> <li>Transparency</li> <li>Recycled</li> <li>Labels</li> <li>Bond</li> <li>Envelope</li> <li>Letterhead</li> <li>Preprinted</li> <li>Colored Paper</li> <li>Light</li> <li>Heavy</li> <li>Custom Type [X]</li> </ul>	<p>Specify the texture, weight, and orientation of the paper loaded.</p>

# Copy

## Copy Defaults

Menu item	Description
<b>Content Type</b> Text Text/Photo* Photo Graphics	Improve the output result based on the content of the original document.
<b>Content Source</b> Black and White Laser* Color Laser Inkjet Photo/Film Magazine Newspaper Press Other	Improve the output result based on the source of the original document.
<b>Sides</b> 1 sided to 1 sided* 1 sided to 2 sided 2 sided to 1 sided 2 sided to 2 sided	Specify the scanning behavior based on the original document.
<b>Separator Sheets</b> None* Between Copies Between Jobs Between Pages	Specify whether to insert blank separator sheets when printing.
<b>Separator Sheet Source</b> Tray [x] (1*) Multipurpose Feeder	Specify the paper source for the separator sheet.
<b>Pages per Side</b> Off* 2 Portrait pages 4 Portrait pages 2 Landscape pages 4 Landscape pages	Specify the number of page images to print on one side of a sheet of paper.
<b>Print Page Borders</b> Off* On	Place a border around each image when printing multiple pages on a single page.

**Note:** An asterisk (\*) next to a value indicates the factory default setting.

Menu item	Description
<b>Collate</b> Off [1,1,1,2,2,2] On [1,2,1,2,1,2]*	Print multiple copies in sequence.
<b>“Copy from” Size</b>	Set the paper size of the original document. <b>Note:</b> Letter is the U.S. factory default setting. A4 is the international factory default setting.
<b>“Copy to” Source</b> Tray [x] (1*) Multipurpose Feeder Auto Size Match	Specify the paper source for the copy job.
<b>Darkness</b> 1 to 9 (5*)	Adjust the darkness of the scanned image.
<b>Number of Copies</b> 1–9999 (1*)	Specify the number of copies.
<b>Header/Footer</b> Left Header Middle Header Right Header Left Footer Middle Footer Right Footer	Specify the header or footer information on the scanned image.
<b>Overlay</b> Confidential Copy Draft Urgent Custom Off*	Specify the overlay text to print on each copy.
<b>Custom overlay</b>	Type the text for the Custom choice in Overlay menu.
<b>Note:</b> An asterisk (*) next to a value indicates the factory default setting.	

### Advanced Imaging

Menu item	Description
<b>Color Dropout</b> Color Dropout (None*) Default Red Threshold (128*) Default Green Threshold (128*) Default Blue Threshold (128*)	Specify which color to drop during scanning, and adjust the dropout setting for that color.
<b>Note:</b> An asterisk (*) next to a value indicates the factory default setting.	

Menu item	Description
<b>Contrast</b> Best for content* 0–5	Specify the contrast for the scanned image.
<b>Background Removal</b> Background Detection (Content-based*) Level (0*)	Remove the background color or image noise from the original document.  <b>Notes:</b> <ul style="list-style-type: none"> <li>• Content-based removes the background color from the original document .</li> <li>• Fixed removes image noise from a photo.</li> </ul>
<b>Auto Center</b> Off* On	Align the content at the center of the page.
<b>Mirror Image</b> Off* On	Create a mirror image of the original document.
<b>Negative Image</b> Off* On	Create a negative image of the original document.
<b>Shadow Detail</b> -4 to 4 (0*)	Adjust the shadow detail in the original document.
<b>Scan Edge to Edge</b> Off* On	Scan the original document from edge to edge.
<b>Sharpness</b> 1–5 (3*)	Adjust the sharpness of the scanned image.
<b>Note:</b> An asterisk (*) next to a value indicates the factory default setting.	

### Admin Controls

Menu item	Description
<b>Transparency Separators</b> Off On*	Insert a blank sheet between transparencies.
<b>Allow Priority Copies</b> Off On*	Interrupt a print job to make copies.
<b>Custom Job Scanning</b> Off* On	Set the printer to scan the first set of original documents using the specified settings, and then scan the next set with the same or different settings.  <b>Note:</b> This menu item appears only when a hard disk is installed.
<b>Note:</b> An asterisk (*) next to a value indicates the factory default setting.	

Menu item	Description
<b>Allow Save as Shortcut</b> Off On*	Save copy settings as a shortcut.
<b>Sample copy</b>	Print a sample copy to check the quality before printing the remaining copies.
<b>Note:</b> An asterisk (*) next to a value indicates the factory default setting.	

## Fax

### Fax Mode

Menu item	Description
<b>Fax Mode</b> Fax Fax Server Disabled	Select a fax mode. <b>Note:</b> Depending on your printer model, the factory default setting may vary.

### Fax Setup

#### General Fax Settings

Menu item	Description
<b>Fax Name</b>	Identify your fax machine.
<b>Fax Number</b>	Identify your fax number.
<b>Fax ID</b> Fax Name Fax Number*	Notify fax recipients of your fax name or fax number.
<b>Enable Manual Fax</b> On Off*	Set the printer to fax manually. <b>Note:</b> Use a regular telephone line to answer an incoming fax job and to dial a fax number.
<b>Memory Use</b> All receive Mostly receive Equal* Mostly send All send	Set the amount of internal printer memory allocated for faxing. <b>Note:</b> This menu item prevents memory buffer conditions and failed faxes.
<b>Cancel Faxes</b> Allow* Don't Allow	Cancel outgoing faxes before they are transmitted, or cancel incoming faxes before they finish printing.
<b>Note:</b> An asterisk (*) next to a value indicates the factory default setting.	

Menu item	Description
<b>Caller ID</b> Off On* Alternate	Show the telephone number of the person sending the fax. <b>Note:</b> This menu item appears only if multiple caller ID patterns are supported, and Fax Mode is set to Analog.
<b>Fax Number Masking</b> Off* From Left From Right	Specify the format for masking an outgoing fax number.
<b>Digits to Mask</b> 0–58 (0*)	Specify the number of digits to mask in an outgoing fax number.
<b>Enable Line Connected Detection</b> On* Off	Determine whether a telephone line is connected to the printer. <b>Note:</b> Detection takes place when turning on the printer and before each call.
<b>Enable Extension in Use Support</b> On Off*	Determine whether a telephone line is used by another device such as another phone on the same line. <b>Note:</b> This menu item is monitored continuously after turning on the printer.
<b>Optimize Fax Compatibility</b>	Configure the printer fax functionality for optimal compatibility with other fax machines.
<b>Fax Transport</b> Analog* etherFAX None HTTPS Fax	Set the fax transport method.
<b>Note:</b> An asterisk (*) next to a value indicates the factory default setting.	

## Fax Send Settings

Menu item	Description
<b>Resolution</b> Standard* Fine Super Fine Ultra Fine	Set the resolution of the scanned image. <b>Note:</b> A higher resolution increases fax transmission time and requires higher memory.
<b>Original Size</b> [List of paper sizes]	Specify the size of the original document. <b>Note:</b> Mixed Sizes is the U.S. factory default setting. A4 is the international factory default setting.
<b>Orientation</b> Portrait* Landscape	Specify the orientation of the original document.
<b>Note:</b> An asterisk (*) next to a value indicates the factory default setting.	

Menu item	Description
<b>Sides</b> Off* Long Edge Short Edge	Specify the page orientation of text and graphics when scanning a two-sided document.
<b>Content Type</b> Text* Text/Photo Photo Graphics	Improve the output result based on the content of the original document.
<b>Content Source</b> Black and White Laser* Color Laser Inkjet Photo/Film Magazine Newspaper Press Other	Improve the output result based on the source of the original document.
<b>Darkness</b> 1–9 (5*)	Adjust the darkness of the scanned image.
<b>Behind a PABX</b> Off* On	Set the printer to dial a fax number without waiting to recognize the dial tone.  <b>Note:</b> Private Automated Branch Exchange (PABX) is a telephone network that allows a single access number to offer multiple lines to outside callers.
<b>Dial Mode</b> Tone* Pulse	Specify the dial mode for incoming or outgoing faxes.
<b>Note:</b> An asterisk (*) next to a value indicates the factory default setting.	

### Advanced Imaging

Menu item	Description
<b>Color Balance</b> -4 to 4 (0*)	Adjust the amount of toner used for each color.
<b>Note:</b> An asterisk (*) next to a value indicates the factory default setting.	

Menu item	Description
<b>Color Dropout</b> None* Red Green Blue  <b>Default Red Threshold</b> 0–255 (128*)  <b>Default Green Threshold</b> 0–255 (128*)  <b>Default Blue Threshold</b> 0–255 (128*)	Specify which color to drop during scanning, and adjust the dropout setting for that color.
<b>Contrast</b> Best for Content* 0 1 2 3 4 5	Set the contrast of the output.
<b>Background Removal</b> Background Detection Content-based* Fixed Level -4 to 4 (0*)	Adjust the amount of background visible on a scanned image.  <b>Notes:</b> <ul style="list-style-type: none"> <li>• If you want to remove the background color from the original document, then set Background Detection to Content-based.</li> <li>• If you want to remove image noise from a photo, then set Background Detection to Fixed.</li> </ul>
<b>Mirror Image</b> Off* On	Create a mirror image of the original document.
<b>Negative Image</b> Off* On	Create a negative image of the original document.
<b>Shadow Detail</b> -4 to 4 (0*)	Adjust the amount of shadow detail visible on a scanned image.
<b>Scan Edge to Edge</b> Off* On	Allow edge-to-edge scanning of the original document.
<b>Sharpness</b> 1–5 (3*)	Adjust the sharpness of the scanned image.
<b>Temperature</b> -4 to 4 (0*)	Specify whether to generate a cooler or warmer output.
<b>Note:</b> An asterisk (*) next to a value indicates the factory default setting.	

**Admin Controls**

Menu item	Description
<b>Automatic Redial</b> 0–9 (5*)	Adjust the number of redial attempts based on the activity levels of recipient fax machines.
<b>Redial Frequency</b> 1–200 minutes (3*)	Increase the time between redial attempts to increase the chance of sending fax successfully.
<b>Enable ECM</b> Off On*	Activate Error Correction Mode (ECM) for fax jobs. <b>Note:</b> ECM detects and corrects errors in the fax transmission process that are caused by telephone line noise and poor signal strength.
<b>Enable Fax Scans</b> Off On*	Fax documents that are scanned at the printer.
<b>Driver to Fax</b> Off On*	Allow the print driver to send fax.
<b>Allow Save as Shortcut</b> Off On*	Save fax numbers as shortcuts in the printer.
<b>Max Speed</b> 33600* 14400 9600 4800 2400	Set the maximum speed for sending fax.
<b>Custom Job Scanning</b> Off* On	Turn on scanning of custom jobs by default. <b>Note:</b> This menu item appears only when a hard disk is installed.
<b>Scan Preview</b> Off* On	Show a preview of the scan on the display. <b>Note:</b> This menu item appears only when a hard disk is installed.
<b>Enable Color Fax Scans</b> Off by default* On by default Never use Always use	Enable color scans for fax.
<b>Auto Convert Color Faxes to Mono Faxes</b> Off On*	Convert all outgoing color faxes to black and white.
<b>Note:</b> An asterisk (*) next to a value indicates the factory default setting.	

Menu item	Description
<b>Confirm Fax Number</b> Off* On	Ask the user to confirm the fax number.
<b>Dial Prefix</b>	Set a dialing prefix.
<b>Dialing Prefix Rules</b> Prefix Rule [x]	Establish a dialing prefix rule.
<b>Note:</b> An asterisk (*) next to a value indicates the factory default setting.	

## Fax Receive Settings

Menu item	Description
<b>Fax Job Waiting</b> None* Toner Toner and Supplies	Remove fax jobs that request specific unavailable resources from the print queue.
<b>Rings to Answer</b> 1–25 (3*)	Set the number of rings for incoming fax.
<b>Auto Reduction</b> On* Off	Scale incoming fax to fit on the page.
<b>Paper Source</b> Tray [x] MP Feeder Auto*	Set the paper source for printing incoming fax.
<b>Sides</b> On Off*	Print on both sides of the paper.
<b>Separator Sheets</b> None* Before Job After Job	Specify whether to insert blank separator sheets when printing.
<b>Separator Sheet Source</b> Tray [x] (1*) MP Feeder	Specify the paper source for the separator sheet.
<b>Output Bin</b> Standard Bin* Bin [x]	Specify the output bin for received faxes.
<b>Fax Footer</b> On Off*	Print the transmission information at the bottom of each page from a received fax.
<b>Note:</b> An asterisk (*) next to a value indicates the factory default setting.	

Menu item	Description
<b>Fax Footer Time Stamp</b> Receive* Print	Print the time stamp at the bottom of each page from a received fax.
<b>Holding Faxes</b> Held Fax Mode Off* Always On Manual Scheduled	Hold received faxes from printing until they are released.
<b>Note:</b> An asterisk (*) next to a value indicates the factory default setting.	

**Admin Controls**

Menu item	Description
<b>Enable Fax Receive</b> On* Off	Set the printer to receive fax.
<b>Enable Color Fax Receive</b> On* Off	Set the printer to receive color fax.
<b>Enable Caller ID</b> On* Off	Show the number that is sending the incoming fax.
<b>Block No Name Fax</b> On Off*	Block incoming faxes sent from devices with no station ID or fax ID specified.
<b>Banned Fax List</b> Add Banned Fax	Specify the phone numbers that you want to block.
<b>Answer On</b> All Rings* Single Ring Only Double Ring Only Triple Ring Only Single or Double Rings Only Single or Triple Rings Only Double or Triple Rings Only	Set a distinctive ring pattern for incoming fax.
<b>Auto Answer</b> On* Off	Set the printer to receive fax automatically.
<b>Note:</b> An asterisk (*) next to a value indicates the factory default setting.	

Menu item	Description
<b>Manual Answer Code</b> 0–9 (9*)	Manually enter a code on the telephone number pad to begin receiving fax.  <b>Notes:</b> <ul style="list-style-type: none"> <li>• This menu item appears only when the printer shares a line with a telephone.</li> <li>• This menu item appears only when you set the printer to receive fax manually.</li> </ul>
<b>Fax Forwarding</b> Print* Print and Forward Forward	Specify how to forward received fax.
<b>Forward to</b> Destination [x] Type Shortcut Number	Specify where to forward received fax.
<b>Confirmation E-mail</b>	Send a confirmation e-mail when fax forwarding is successful.  <b>Note:</b> The e-mail is sent only when forwarding to FTP or Network Share destinations.
<b>Max Speed</b> 33600* 14400 9600 4800 2400	Set the maximum speed for transmitting fax.
<b>Note:</b> An asterisk (*) next to a value indicates the factory default setting.	

### Fax Cover Page

Menu item	Description
<b>Fax Cover Page</b> Off by Default* On by Default Never Use Always Use	Configure the settings for the fax cover page.
<b>Include To field</b> Off* On	
<b>Include From field</b> Off* On	
<b>From</b>	
<b>Include Message Field</b> Off* On	
<b>Message:</b>	
<b>Include Logo</b> Off* On	
<b>Include Footer [x]</b> Off* On	
<b>Footer [x]</b>	
<b>Note:</b> An asterisk (*) next to a value indicates the factory default setting.	

### Fax Log Settings

Menu item	Description
<b>Transmission Log Frequency</b> Always* Never Only for Error	Specify how often the printer creates a transmission log.
<b>Transmission Log Action</b> Print Off On* E-mail Off* On	
<b>Note:</b> An asterisk (*) next to a value indicates the factory default setting.	

Menu item	Description
<b>Receive Error Log</b> Print Never* Print on Error	Print a log for fax-receive failures.
<b>Auto Print Logs</b> On* Off	Print all fax activity.
<b>Log Paper Source</b> Tray [x] (1*) Multipurpose Feeder	Specify the paper source for printing logs.
<b>Logs Display</b> Remote Fax Name* Dialed Number	Identify the sender by remote fax name or fax number.
<b>Enable Job Log</b> On* Off	View a summary of all fax jobs.
<b>Enable Call Log</b> On* Off	View a summary of fax dialing history.
<b>Log Output Bin</b> Standard Bin* Bin [x]	Specify the output bin for printed logs.
<b>Note:</b> An asterisk (*) next to a value indicates the factory default setting.	

### Speaker Settings

Menu item	Description
<b>Speaker Mode</b> Always Off Always On On until Connected*	Set the fax speaker mode.
<b>Speaker Volume</b> Low* Medium High	Adjust the fax speaker volume.
<b>Ringer Volume</b> Off On*	Enable the ringer volume.
<b>Note:</b> An asterisk (*) next to a value indicates the factory default setting.	

## Fax Server Setup

### General Fax Settings

Menu item	Description
<b>To Format</b>	Specify a fax recipient. <b>Note:</b> If you want to use the fax number, then type the number sign (#) before a number.
<b>Reply Address</b>	Specify a reply address for sending fax.
<b>Subject</b>	Specify the fax subject and message.
<b>Message</b>	
<b>Enable analog receive</b> Off* On	Set the printer to receive analog faxes.
<b>Note:</b> An asterisk (*) next to a value indicates the factory default setting.	

### Fax Server E-mail Settings

Menu item	Description
<b>Use E-mail SMTP Server</b> Off On*	Use the e-mail SMTP server when configuring the fax server e-mail settings.
<b>Primary SMTP Gateway</b>	Type the IP address or host name of the primary Simple Mail Transfer Protocol (SMTP) server for sending e-mail.
<b>Primary SMTP Gateway Port</b> 1–65535 (25*)	Enter the port number of the primary SMTP server.
<b>Secondary SMTP Gateway</b>	Type the server IP address or host name of your secondary or backup SMTP server.
<b>Secondary SMTP Gateway Port</b> 1–65535 (25*)	Enter the server port number of your secondary or backup SMTP server.
<b>SMTP Timeout</b> 5–30 (30*)	Set the time before the printer times out if the SMTP server does not respond.
<b>Reply Address</b>	Specify a reply address for sending fax.
<b>Always use SMTP default Reply Address</b> Off* On	Specify the SMTP reply address for sending fax.
<b>Note:</b> An asterisk (*) next to a value indicates the factory default setting.	

Menu item	Description
<b>Use SSL/TLS</b> Disabled* Negotiate Required	Specify whether to send fax using an encrypted link.
<b>Require Trusted Certificate</b> Off On*	Specify a trusted certificate when accessing the SMTP server.
<b>SMTP Server Authentication</b> No authentication required* Login / Plain NTLM CRAM-MD5 Digest-MD5 Kerberos 5	Set the authentication type for the SMTP server.
<b>Device-Initiated E-mail</b> None* Use Device SMTP Credentials	Specify whether credentials are required for device-initiated e-mail.
<b>User-Initiated E-mail</b> None* Use Device SMTP Credentials Use Session User ID and Password Use Session E-mail address and Password Prompt user	Specify whether credentials are required for user-initiated e-mail.
<b>Use Active Directory Device Credentials</b> Off* On	Enable user credentials and group destinations to connect to the SMTP server.
<b>Device Userid</b>	Specify the user ID and password to connect to the SMTP server.
<b>Device Password</b>	
<b>Kerberos 5 REALM</b>	Specify the realm for the Kerberos 5 authentication protocol.
<b>NTLM Domain</b>	Specify the domain name for the NTLM security protocol.
<b>Disable "SMTP server not set up" error</b> Off* On	Hide the "SMTP server not set up" error message.
<b>Note:</b> An asterisk (*) next to a value indicates the factory default setting.	

## Fax Server Scan Settings

Menu item	Description
<b>Image Format</b> PDF (.pdf)* TIFF (.tif) XPS (.xps)	Specify the file format for the scanned image.
<b>Content Type</b> Text* Text/Photo Photo Graphics	Improve the output result based on the content of the original document.
<b>Content Source</b> Black and White Laser* Color Laser Inkjet Photo/Film Magazine Newspaper Press Other	Improve the output result based on the source of the original document.
<b>Fax Resolution</b> Standard* Fine Super Fine Ultra Fine	Set the fax resolution.
<b>Sides</b> Off* Short Edge Long Edge	Specify the page orientation of text and graphics when scanning a two-sided document.
<b>Darkness</b> 1 -9 (5*)	Set the darkness of the output.
<b>Orientation</b> Portrait* Landscape	Specify the orientation of text and graphics on the page.
<b>Original Size</b> [List of paper sizes]	Set the paper size of the original document. <b>Note:</b> Mixed Sizes is the U.S. factory default setting. A4 is the international factory default setting.
<b>Use Multi-Page TIFF</b> Off On*	Choose between single- and multiple-page TIFF files.
<b>Note:</b> An asterisk (*) next to a value indicates the factory default setting.	

# E-mail

## E-mail Setup

Menu item	Description
<b>Primary SMTP Gateway</b>	Type the IP address or host name of the primary SMTP server for sending e-mail.
<b>Primary SMTP Gateway Port</b> 1–65535 (25*)	Enter the port number of the primary SMTP server.
<b>Secondary SMTP Gateway</b>	Type the server IP address or host name of your secondary or backup SMTP server.
<b>Secondary SMTP Gateway Port</b> 1–65535 (25*)	Enter the server port number of your secondary or backup SMTP server.
<b>SMTP Timeout</b> 5–30 seconds (30*)	Set the time before the printer times out if the SMTP server does not respond.
<b>Reply Address</b>	Specify a reply address in the e-mail.
<b>Always use SMTP default Reply Address</b> On* Off	Always use the default reply address in the SMTP server.
<b>Use SSL/TLS</b> Disabled* Negotiate Required	Specify whether to send e-mail using an encrypted link.
<b>Require Trusted Certificate</b> Off On*	Require a trusted certificate when accessing the SMTP server.
<b>SMTP Server Authentication</b> No authentication required* Login / Plain NTLM CRAM-MD5 Digest-MD5 Kerberos 5	Set the authentication type for the SMTP server.
<b>Device-Initiated E-mail</b> None* Use Device SMTP Credentials	Specify whether credentials are required for device-initiated e-mail.
<b>Note:</b> An asterisk (*) next to a value indicates the factory default setting.	

Menu item	Description
<b>User-Initiated E-mail</b> None* Use Device SMTP Credentials Use Session User ID and Password Use Session E-mail address and Password Prompt user	Specify whether credentials are required for user-initiated e-mail.
<b>Use Active Directory Device Credentials</b> Off* On	Enable user credentials and group designations to connect to the SMTP server.
<b>Device Userid</b>	Specify the user ID and password to connect to the SMTP server.
<b>Device Password</b>	
<b>Kerberos 5 REALM</b>	Specify the realm for the Kerberos 5 authentication protocol.
<b>NTLM Domain</b>	Specify the domain name for the NTLM security protocol.
<b>Disable “SMTP server not set up” error</b> Off* On	Hide the “SMTP server not set up” error message.
<b>Note:</b> An asterisk (*) next to a value indicates the factory default setting.	

## E-mail Defaults

Menu item	Description
<b>Subject:</b>	Specify the e-mail subject and message.
<b>Message:</b>	
<b>File Name</b>	Specify the filename for the scanned document.
<b>Format</b> JPEG (.jpg) PDF (.pdf)* TIFF (.tif) XPS (.xps) TXT (.txt) RTF (.rtf) DOCX (.docx) CSV (.csv)	Specify the file format of the scanned document. <b>Note:</b> The menu items may vary depending on your printer model.
<b>Note:</b> An asterisk (*) next to a value indicates the factory default setting.	

Menu item	Description
<b>Global OCR Settings</b> Recognized Languages Auto Rotate Despeckle Auto Contrast Enhance	Configure the settings for optical character recognition (OCR). <b>Note:</b> This menu item appears only if you have purchased and installed an OCR solution.
<b>PDF Settings</b> PDF Version (1.5*) Archival Version (A-1a*) Highly Compressed (Off*) Secure (Off*) Archival (PDF/A) (Off*)	Configure the PDF settings of the scanned document. <b>Notes:</b> <ul style="list-style-type: none"> <li>• Archival Version and Archival (PDF/A) are supported only when PDF Version is set to 1.4.</li> <li>• Highly Compressed appears only when a hard disk is installed.</li> </ul>
<b>Content Type</b> Text Text/Photo* Photo Graphics	Improve the output result based on the content type of the original document.
<b>Content Source</b> Black and White Laser* Color Laser Inkjet Photo/Film Magazine Newspaper Press Other	Improve the output result based on the content source of the original document.
<b>Color</b> Black and White Gray Color* Auto	Set the printer to capture file content in color or in mono.
<b>Resolution</b> 75 dpi 150 dpi* 200 dpi 300 dpi 400 dpi 600 dpi	Set the resolution of the scanned image.
<b>Darkness</b> 1–9 (5*)	Adjust the darkness of the scanned image.
<b>Orientation</b> Portrait* Landscape	Specify the orientation of the original document.
<b>Note:</b> An asterisk (*) next to a value indicates the factory default setting.	

Menu item	Description
<b>Original Size</b> Mixed Sizes*	Set the paper size of the original document.
<b>Sides</b> Off* Short Edge Long Edge	Specify the orientation of the original document when scanning on both sides of the document.
<b>Note:</b> An asterisk (*) next to a value indicates the factory default setting.	

**Advanced Imaging**

Menu item	Description
<b>Color Balance</b> Cyan (0*) Magenta (0*) Yellow (0*)	Adjust the color intensity for cyan, magenta, and yellow.
<b>Color Dropout</b> Color Dropout None* Red Green Blue Default Red Threshold 0–255 (128*) Default Green Threshold 0–255 (128*) Default Blue Threshold 0–255 (128*)	Specify which color to drop during scanning, and adjust the dropout setting for that color.
<b>Auto Color Detect</b> Color Sensitivity 1–9 (5*) Area Sensitivity 1–9 (5*) E-mail Bit Depth 1 bit* 8 bit Minimum Scan Resolution 75 dpi 150 dpi 200 dpi 300 dpi*	Configure the auto color detection setting.
<b>Note:</b> An asterisk (*) next to a value indicates the factory default setting.	

Menu item	Description
<b>JPEG Quality</b> Best for content* 5–95	Set the JPEG quality of the scanned image.
<b>Contrast</b> Best for content* 0–5	Specify the contrast for the scanned image.
<b>Background Removal</b> Background Detection Content-based* Fixed Level -4 to 4 (0*)	Remove the background color or image noise from the original document.  <b>Notes:</b> <ul style="list-style-type: none"> <li>• Content-based removes the background color from the original document.</li> <li>• Fixed removes image noise from a photo.</li> </ul>
<b>Mirror Image</b> Off* On	Create a mirror image of the original document.
<b>Negative Image</b> Off* On	Create a negative image of the original document.
<b>Shadow Detail</b> -4 to 4 (0*)	Adjust the shadow detail in the scanned image.
<b>Scan Edge to Edge</b> Off* On	Scan the original document from edge to edge.
<b>Sharpness</b> 1–5 (3*)	Adjust the sharpness in the scanned image.
<b>Temperature</b> -4 to 4 (0*)	Generate a bluer or redder output of the original document.
<b>Blank Pages</b> Blank Page Removal (Do Not Remove*) Blank Page Sensitivity (5*)	Set the sensitivity of scans in relation to blank pages in the original document.
<b>Note:</b> An asterisk (*) next to a value indicates the factory default setting.	

### Admin Controls

Menu item	Description
<b>Max E-mail Size</b> 0–65535 (0*)	Set the allowable file size for each e-mail.
<b>Size Error Message</b>	Specify an error message that the printer sends when an e-mail exceeds its allowable file size.  <b>Note:</b> You can type up to 1024 characters.
<b>Note:</b> An asterisk (*) next to a value indicates the factory default setting.	

Menu item	Description
<b>Limit Destinations</b>	Limit sending of e-mail only to the specified list of domain name. <b>Note:</b> Use a comma to separate each domain.
<b>Send Me a Copy</b> Never appears* On by Default Off by Default Always On	Send a copy of the e-mail to yourself.
<b>Allow self e-mails only</b> Off* On	Set the printer to send e-mails to yourself only.
<b>Use cc:/bcc:</b> Off* On	Enable carbon copy and blind carbon copy in e-mail.
<b>Use Multi-Page TIFF</b> Off On*	Enable scanning of multiple TIFF images in one TIFF file.
<b>TIFF Compression</b> JPEG LZW*	Specify the compression type for TIFF files.
<b>Text Default</b> 5–95 (75*)	Set the text quality in the content being scanned.
<b>Text/Photo Default</b> 5–95 (75*)	Set the text and photo quality in the content being scanned.
<b>Photo Default</b> 5–95 (50*)	Set the photo quality of the content being scanned.
<b>Adjust ADF Skew</b> Off* On	Set the printer to adjust the skewed images from documents that are scanned from the ADF.
<b>Transmission Log</b> Print log* Do Not Print Log Print Only For Error	Print a transmission log for e-mail scans.
<b>Log Paper Source</b> Tray [x] (1*) Multipurpose Feeder	Specify the paper source for printing e-mail logs.
<b>Custom Job Scanning</b> Off* On	Set the printer to scan the first set of original documents using the specified settings, and then next set with the same or different settings. <b>Note:</b> This menu item appears only when a hard disk is installed.
<b>Note:</b> An asterisk (*) next to a value indicates the factory default setting.	

Menu item	Description
<b>Scan Preview</b> Off On*	Show a scan preview of the original document. <b>Note:</b> This menu item appears only when a hard disk is installed.
<b>Allow Save as Shortcut</b> Off On*	Save an e-mail address as a shortcut.
<b>E-mail Images Sent As</b> Attachment* Web Link	Specify how to send the images that are included in the e-mail.
<b>Reset E-mail Information After Sending</b> Off On*	Reset the To, Subject, Message, and Filename fields to their default values after sending an e-mail.
<b>Note:</b> An asterisk (*) next to a value indicates the factory default setting.	

## Web Link Setup

Menu item	Description
<b>Server</b> <b>Login</b> <b>Password</b> <b>Path</b> <b>File Name</b> <b>Web Link</b>	Specify the credentials of the server that is hosting the images that are included in the e-mail.

## FTP

### FTP Defaults

Menu item	Description
<b>Format</b> JPEG (.jpg) PDF (.pdf)* TIFF (.tif) XPS (.xps) TXT (.txt) RTF (.rtf) DOCX (.docx) CSV (.csv)	Specify the file format for the scanned image. <b>Note:</b> The menu items may vary depending on your printer model.
<b>Note:</b> An asterisk (*) next to a value indicates the factory default setting.	

Menu item	Description
<b>Global OCR Settings</b> Recognized Languages Auto Rotate Despeckle Auto Contrast Enhance	Configure the settings for optical character recognition (OCR). <b>Note:</b> This menu item appears only if you have purchased and installed an OCR solution.
<b>PDF Settings</b> PDF Version (1.5*) Archival Version (A-1a*) Highly Compressed (Off*) Secure (Off*) Archival (PDF/A) (Off*)	Configure the PDF settings for the scanned image. <b>Notes:</b> <ul style="list-style-type: none"> <li>• Archival Version and Archival (PDF/A) are supported only when PDF Version is set to 1.4.</li> <li>• Highly Compressed appears only when a hard disk is installed.</li> </ul>
<b>Content Type</b> Text Text/Photo* Photo Graphics	Improve the output result based on the content type of the original document.
<b>Content Source</b> Black and White Laser* Color Laser Inkjet Photo/Film Magazine Newspaper Press Other	Improve the output result based on the content source of the original document.
<b>Color</b> Black and White Gray Color* Auto	Set the printer to capture file content in color or in mono.
<b>Resolution</b> 75 dpi 150 dpi* 200 dpi 300 dpi 400 dpi 600 dpi	Set the resolution of the scanned image.
<b>Darkness</b> 1–9 (5*)	Adjust the darkness of the scanned image.
<b>Orientation</b> Portrait* Landscape	Specify the orientation of the original document.
<b>Note:</b> An asterisk (*) next to a value indicates the factory default setting.	

Menu item	Description
<b>Original Size</b> Mixed Sizes*	Set the paper size of the original document.
<b>Sides</b> Off* Long Edge Short Edge	Specify the orientation when scanning on both sides of the document.
<b>File Name</b>	Specify the file name of the scanned image.
<b>Note:</b> An asterisk (*) next to a value indicates the factory default setting.	

**Advanced Imaging**

Menu item	Description
<b>Color Balance</b> Cyan (0*) Magenta (0*) Yellow (0*)	Adjust the color intensity for cyan, magenta, and yellow.
<b>Color Dropout</b> Color Dropout None* Red* Green* Blue* Default Red Threshold 0–255 (128*) Default Green Threshold 0–255 (128*) Default Blue Threshold 0–255 (128*)	Specify which color to drop during scanning, and adjust the dropout setting for that color.
<b>Auto Color Detect</b> Color Sensitivity 1–9 (5*) Area Sensitivity 1–9 (5*) FTP Bit Depth 1 bit* 8 bit Minimum Scan Resolution 75 dpi 150 dpi 200 dpi 300 dpi*	Configure the auto color detection setting.

**Note:** An asterisk (\*) next to a value indicates the factory default setting.

Menu item	Description
<b>JPEG Quality</b> Best for content* 5–95	Set the JPEG quality of the scanned image.
<b>Contrast</b> Best for content* 0 1 2 3 4 5	Specify the contrast for the scanned image.
<b>Background Removal</b> Background Detection Content-based* Fixed Level -4 to 4 (0*)	Remove the background color or image noise from the original document.  <b>Notes:</b> <ul style="list-style-type: none"> <li>• Content-based removes the background color from the original document .</li> <li>• Fixed removes image noise from a photo.</li> </ul>
<b>Mirror Image</b> Off* On	Create a mirror image of the original document.
<b>Negative Image</b> Off* On	Create a negative image of the original document.
<b>Shadow Detail</b> -4 to 4 (0*)	Adjust the shadow detail in the scanned image.
<b>Scan Edge to Edge</b> Off* On	Allow edge-to-edge scanning of the original document.
<b>Sharpness</b> 1–5 (3*)	Adjust the sharpness in the scanned image.
<b>Temperature</b> -4 to 4 (0*)	Generate a bluer or redder output of the original document.
<b>Blank Pages</b> Blank Page Removal Do Not Remove* Remove Blank Page Sensitivity 1–9 (5*)	Set the sensitivity of scans in relation to blank pages in the original document.
<b>Note:</b> An asterisk (*) next to a value indicates the factory default setting.	

## Admin Controls

Menu item	Description
<b>Text Default</b> 5–95 (75*)	Set the quality of text on the scanned image.
<b>Text/Photo Default</b> 5–95 (75*)	Set the quality of text and photo on the scanned image.
<b>Photo Default</b> 5–95 (50*)	Set the quality of photo on the scanned image.
<b>Use Multi-Page TIFF</b> On* Off	Enable scanning of multiple TIFF images in one TIFF file.
<b>TIFF Compression</b> LZW* JPEG	Specify the compression type for TIFF files.
<b>Transmission Log</b> Print Log* Do Not Print Log Print Only For Error	Print a transmission log for FTP scans.
<b>Log Paper Source</b> Tray [x] (1*) Multipurpose Feeder	Specify the paper source for printing FTP logs.
<b>Custom Job Scanning</b> Off* On	Turn on scanning of custom jobs by default. <b>Note:</b> This menu item appears only when a hard disk is installed.
<b>Scan Preview</b> Off On*	Show a preview of the scan on the display. <b>Note:</b> This menu item appears only when a hard disk is installed.
<b>Allow Save as Shortcut</b> Off On*	Save an FTP address as a shortcut.
<b>Adjust ADF Skew</b> Off* On	Set the printer to adjust the skewed images from documents that are scanned from the ADF.
<b>Note:</b> An asterisk (*) next to a value indicates the factory default setting.	

## USB Drive

### Flash Drive Scan

Menu item	Description
<b>Format</b> JPEG (.jpg) PDF (.pdf)* TIFF (.tif) XPS (.xps) TXT (.txt) RTF (.rtf) DOCX (.docx) CSV (.csv)	Specify the file format for the scanned image. <b>Note:</b> The menu items may vary depending on your printer model.
<b>Global OCR Settings</b> Recognized Languages Auto Rotate Despeckle Auto Contrast Enhance	Configure the settings for optical character recognition (OCR). <b>Note:</b> This menu item appears only if you have purchased and installed an OCR solution.
<b>PDF Settings</b> PDF Version (1.5*) Archival Version (A-1a*) Highly Compressed (Off*) Secure (Off*) Archival (PDF/A) (Off*)	Configure the PDF settings of the scanned image. <b>Notes:</b> <ul style="list-style-type: none"> <li>Archival Version and Archival (PDF/A) are supported only when PDF Version is set to 1.4.</li> <li>Highly Compressed appears only when a hard disk is installed.</li> </ul>
<b>Content Type</b> Text Text/Photo* Photo Graphics	Improve the output result based on the content type of the original document.
<b>Content Source</b> Black and White Laser* Color Laser Inkjet Photo/Film Magazine Newspaper Press Other	Improve the output result based on the content source of the original document.
<b>Note:</b> An asterisk (*) next to a value indicates the factory default setting.	

Menu item	Description
<b>Color</b> Black and White Gray Color* Auto	Set the printer to capture file content in color or in mono.
<b>Resolution</b> 75 dpi 150 dpi* 200 dpi 300 dpi 400 dpi 600 dpi	Set the resolution of the scanned image.
<b>Darkness</b> 1–9 (5*)	Adjust the darkness of the scanned image.
<b>Orientation</b> Portrait* Landscape	Specify the orientation of the original document.
<b>Original Size</b> Mixed Sizes*	Set the paper size of the original document.
<b>Sides</b> Off* Long edge Short edge	Specify the orientation of the original document when scanning on both sides of the document.
<b>File Name</b>	Specify the file name of the scanned image.
<b>Note:</b> An asterisk (*) next to a value indicates the factory default setting.	

### Advanced Imaging

Menu item	Description
<b>Color Balance</b> Cyan (0*) Magenta (0*) Yellow (0*)	Adjust the color intensity for cyan, magenta, and yellow.
<b>Note:</b> An asterisk (*) next to a value indicates the factory default setting.	

Menu item	Description
<b>Color Dropout</b> Color Dropout None* Red Green Blue Default Red Threshold 0–255 (128*) Default Green Threshold 0–255 (128*) Default Blue Threshold 0–255 (128*)	Specify which color to drop during scanning, and adjust the dropout setting for that color.
<b>Auto Color Detect</b> Color Sensitivity 1–9 (5*) Area Sensitivity 1–9 (5*) Scan Bit Depth 1 bit* 8 bit Minimum Scan Resolution 75 dpi 150 dpi 200 dpi 300 dpi*	Configure the auto color detection setting.
<b>JPEG Quality</b> Best for content* 5–95	Set the JPEG quality of the scanned image.
<b>Contrast</b> Best for content* 0–5	Specify the contrast for the scanned image.
<b>Background Removal</b> Background Detection Content-based* Fixed Level (0*)	Remove the background color or image noise from the original document. <b>Notes:</b> <ul style="list-style-type: none"> <li>• Content-based removes the background color from the original document.</li> <li>• Fixed removes image noise from a photo.</li> </ul>
<b>Mirror Image</b> Off* On	Create a mirror image of the original document.
<b>Negative Image</b> Off* On	Create a negative image of the original document.
<b>Note:</b> An asterisk (*) next to a value indicates the factory default setting.	

Menu item	Description
<b>Shadow Detail</b> -4 to 4 (0*)	Adjust the shadow detail in the scanned image.
<b>Scan Edge to Edge</b> Off* On	Scan the original document from edge to edge.
<b>Sharpness</b> 1–5 (3*)	Adjust the sharpness in the scanned image.
<b>Temperature</b> -4 to 4 (0*)	Generate a bluer or redder output of the original document.
<b>Blank Pages</b> Blank Page Removal Do Not Remove* Remove Blank Page Sensitivity 1–9 (5*)	Set the sensitivity of scans in relation to blank pages in the original document.
<b>Note:</b> An asterisk (*) next to a value indicates the factory default setting.	

### Admin Controls

Menu item	Description
<b>Text Default</b> 5–95 (75*)	Set the quality of text on the scanned image.
<b>Text/Photo Default</b> 5–95 (75*)	Set the quality of text and photo on the scanned image.
<b>Photo Default</b> 5–95 (50*)	Set the quality of a photo on the scanned image.
<b>Use Multi-Page TIFF</b> Off On*	Enable scanning of multiple TIFF images in one TIFF file.
<b>TIFF Compression</b> LZW* JPEG	Specify the compression type for TIFF files.
<b>Custom Job Scanning</b> Off* On	Turn on scanning of custom jobs by default. <b>Note:</b> This menu item appears only when a hard disk is installed.
<b>Scan Preview</b> Off On*	Show a preview of the scan on the display. <b>Note:</b> This menu item appears only when a hard disk is installed.
<b>Note:</b> An asterisk (*) next to a value indicates the factory default setting.	

Menu item	Description
<b>Adjust ADF Skew</b> Off* On	Set the printer to adjust the skewed images from documents that are scanned from the ADF.
<b>Note:</b> An asterisk (*) next to a value indicates the factory default setting.	

## Flash Drive Print

Menu item	Description
<b>Number of Copies</b> 1–9999 (1*)	Set the number of copies.
<b>Paper Source</b> Tray [x] (1*) Multipurpose Feeder Manual Paper Manual Envelope	Set the paper source for the print job.
<b>Collate</b> (1,1) (2,2,2) (1,2,3) (1,2,3)*	Keep the pages of a print job stacked in sequence, particularly when printing multiple copies of the job.
<b>Sides</b> 1-Sided* 2-Sided	Specify whether to print on one side or both sides of the paper.
<b>Flip Style</b> Long Edge* Short Edge	Determine which side of the paper is bound when performing two-sided printing.
<b>Pages per Side</b> Off* 2 pages per side 3 pages per side 4 pages per side 6 pages per side 9 pages per side 12 pages per side 16 pages per side	Print multiple page images on one side of a sheet of paper.
<b>Pages per Side Ordering</b> Horizontal* Reverse Horizontal Reverse Vertical Vertical	Specify the positioning of multiple page images when using Pages per Side menu.
<b>Note:</b> An asterisk (*) next to a value indicates the factory default setting.	

Menu item	Description
<b>Pages per Side Orientation</b> Auto* Landscape Portrait	Specify the orientation of multiple page images when using Pages per Side menu.
<b>Pages per Side Border</b> None* Solid	Print a border around each page image when using Pages per Side menu.
<b>Separator Sheets</b> Off* Between Copies Between Jobs Between Pages	Insert blank separator sheets when printing.
<b>Separator Sheet Source</b> Tray [x] (1*) Multipurpose Feeder	Specify the paper source for the separator sheet.
<b>Blank Pages</b> Do Not Print* Print	Print blank pages in a print job.
<b>Note:</b> An asterisk (*) next to a value indicates the factory default setting.	

## Network/Ports

### Network Overview

Menu item	Description
<b>Active Adapter</b> Auto* Standard Network Wireless	Specify the type of the network connection.  <b>Note:</b> Wireless is available only in printers connected to a wireless network.
<b>Network Status</b>	Show the connectivity status of the printer network.
<b>Display Network Status on Printer</b> Off On*	Show the network status on the display.
<b>Speed, Duplex</b>	Show the speed of the currently active network card.
<b>IPv4</b>	Show the IPv4 address.
<b>All IPv6 Addresses</b>	Show all IPv6 addresses.
<b>Note:</b> An asterisk (*) next to a value indicates the factory default setting.	

Menu item	Description
<b>Reset Print Server</b>	Reset all active network connections to the printer. <b>Note:</b> This setting removes all network configuration settings.
<b>Network Job Timeout</b> Off On* (90 seconds)	Set the time before the printer cancels a network print job.
<b>Banner Page</b> Off* On	Print a banner page.
<b>Scan to PC Port Range</b>	Specify a valid port range for printers that are behind a port blocking firewall.
<b>Enable Network Connections</b> Off On*	Enable the printer to connect to a network.
<b>Enable LLDP</b> Off* On	Enable Link Layer Discovery Protocol (LLDP) in the printer.
<b>Note:</b> An asterisk (*) next to a value indicates the factory default setting.	

## Wireless

**Note:** This menu is available only in printers connected to a Wi-Fi network or printers that have a wireless network adapter.

Menu item	Description
<b>Setup Using Mobile App</b>	Configure the Wi-Fi connection using Lexmark Mobile Assistant.
<b>Setup On Printer Panel</b> Choose Network Add Wi-Fi Network Network Name Network Mode Infrastructure Wireless Security Mode Disabled* WEP WPA2/WPA - Personal WPA2 - Personal 802.1x - RADIUS	Configure the Wi-Fi connection using the control panel. <b>Note:</b> 802.1x - RADIUS can be configured only from the Embedded Web Server.

Menu item	Description
<b>Wi-Fi Protected Setup</b> WPS Auto Detect Off On* Start Push Button Method Start PIN Method	Establish a Wi-Fi network and enable network security.  <b>Notes:</b> <ul style="list-style-type: none"> <li>• WPS Auto Detect appears only when the Wireless Security Mode is set to WEP.</li> <li>• Start Push-Button Method connects the printer to a Wi-Fi network when buttons on both the printer and the access point (wireless router) are pressed within a given time.</li> <li>• Start PIN Method connects the printer to a Wi-Fi network when a PIN on the printer is entered into the wireless settings of the access point.</li> </ul>
<b>Network Mode</b> BSS Type Infrastructure*	Specify the network mode.
<b>Enable Wi-Fi Direct</b> On Off*	Enable Wi-Fi Direct-capable devices to connect directly to the printer.
<b>Compatibility</b> 802.11b/g/n (2.4GHz)* 802.11a/b/g/n/ac (2.4GHz/5GHz) 802.11a/n/ac (5GHz)	Specify the standard for the Wi-Fi network.  <b>Note:</b> 802.11a/b/g/n/ac (2.4GHz/5GHz) and 802.11a/n/ac (5GHz) only appear when a Wi-Fi option is installed.
<b>Wireless Security Mode</b> Disabled* WEP WPA2/WPA-Personal WPA2-Personal 802.1x - RADIUS	Set the security mode for connecting the printer to Wi-Fi devices.  <b>Note:</b> 802.1x - RADIUS can be configured only from the Embedded Web Server.
<b>WEP Authentication Mode</b> Auto* Open Shared	Set the type of Wireless Encryption Protocol (WEP) for the printer.  <b>Note:</b> This menu item appears only when the Wireless Security Mode is set to WEP.
<b>Set WEP Key</b>	Specify a WEP password for secure Wi-Fi connection.
<b>WPA2/WPA Personal</b> AES	Enable Wi-Fi security through Wi-Fi Protected Access (WPA).  <b>Note:</b> This menu item appears only when the Wireless Security Mode is set to WPA2/WPA-Personal.
<b>Set Pre-Shared Key</b>	Set the password for secure Wi-Fi connection.
<b>WPA2-Personal</b> AES	Enable Wi-Fi security through WPA2.  <b>Note:</b> This menu item appears only when the Wireless Security Mode is set to WPA2-Personal.

Menu item	Description
<b>802.1x Encryption Mode</b> WPA+ WPA2*	Enable Wi-Fi security through 802.1x standard.  <b>Notes:</b> <ul style="list-style-type: none"> <li>• This menu item appears only when the Wireless Security Mode is set to 802.1x - RADIUS.</li> <li>• 802.1x - RADIUS can be configured only from the Embedded Web Server.</li> </ul>
<b>IPv4</b> Enable DHCP On* Off Set Static IP Address IP Address Netmask Gateway	Enable and configure IPv4 settings in the printer.
<b>IPv6</b> Enable IPv6 On* Off Enable DHCPv6 On Off* Stateless Address Autoconfiguration On* Off DNS Server Address Manually Assigned IPv6 Address Manually Assigned IPv6 Router Address Prefix All IPv6 Addresses All IPv6 Router Addresses	Enable and configure IPv6 settings in the printer.
<b>Network Address</b> UAA LAA	View the network addresses.
<b>PCL SmartSwitch</b> Off On*	Set the printer to switch automatically to PCL emulation when a print job requires it, regardless of the default printer language.  <b>Note:</b> If PCL SmartSwitch is off, then the printer does not examine incoming data and uses the default printer language specified in the Setup menu.
<b>PS SmartSwitch</b> Off On*	Set the printer to switch automatically to PS emulation when a print job requires it, regardless of the default printer language.  <b>Note:</b> If PS SmartSwitch is off, then the printer does not examine incoming data and uses the default printer language specified in the Setup menu.

Menu item	Description
<b>Job Buffering</b> On Off*	Temporarily store print jobs in the printer hard disk before printing. <b>Note:</b> This menu item appears only when a hard disk is installed.
<b>Mac Binary PS</b> Auto* On Off	Set the printer to process Macintosh binary PostScript print jobs. <b>Notes:</b> <ul style="list-style-type: none"> <li>• On processes raw binary PostScript print jobs.</li> <li>• Off filters print jobs using the standard protocol.</li> </ul>

## Wi-Fi Direct

Menu item	Description
<b>Enable Wi-Fi Direct</b> On Off*	Set the printer to connect directly to Wi-Fi devices.
<b>Wi-Fi Direct Name</b>	Specify the name of the Wi-Fi Direct network.
<b>Wi-Fi Direct Password</b>	Set the password to authenticate and validate users on a Wi-Fi connection.
<b>Show Password on Setup Page</b> Off On*	Show the Wi-Fi Direct Password on the Network Setup Page.
<b>Preferred Channel Number</b> 1–11 Auto*	Set the preferred channel of the Wi-Fi network.
<b>Group Owner IP Address</b>	Specify the IP address of the group owner.
<b>Auto-Accept Push Button Requests</b> Off* On	Accept requests to connect to the network automatically. <b>Note:</b> Accepting clients automatically is not secured.
<b>Note:</b> An asterisk (*) next to a value indicates the factory default setting.	

## Ethernet

Menu item	Description
<b>Network Speed</b>	Show the speed of an active network adapter.
<b>IPv4</b> Enable DHCP Off On*	Enable Dynamic Host Configuration Protocol (DHCP). <b>Note:</b> DHCP is a standard protocol that allows a server to distribute IP addressing and configuration information dynamically to clients.
<b>Note:</b> An asterisk (*) next to a value indicates the factory default setting.	

Menu item	Description
<b>IPv4</b> Set Static IP Address IP Address Netmask Gateway	Set the static IP address of your printer.
<b>IPv6</b> Enable IPv6 Off On*	Enable IPv6 in the printer.
<b>IPv6</b> Enable DHCPv6 Off* On	Enable DHCPv6 in the printer.
<b>IPv6</b> Stateless Address Autoconfiguration Off On*	Set the network adapter to accept the automatic IPv6 address configuration entries provided by a router.
<b>IPv6</b> DNS Server Address	Specify the DNS server address.
<b>IPv6</b> Manually Assigned IPv6 Address	Assign the IPv6 address.
<b>IPv6</b> Manually Assigned IPv6 Router	Assign the IPv6 address.
<b>IPv6</b> Address Prefix 0–128 (64*)	Specify the address prefix.
<b>IPv6</b> All IPv6 Addresses	Show all IPv6 addresses.
<b>IPv6</b> All IPv6 Router Addresses	Show all IPv6 router addresses.
<b>Network Address</b> UAA LAA	Show the printer Media Access Control (MAC) addresses: Locally Administered Address (LAA) and Universally Administered Address (UAA). <b>Note:</b> You can change the printer LAA manually.
<b>PCL SmartSwitch</b> Off On*	Set the printer to switch automatically to PCL emulation when a print job requires it, regardless of the default printer language. <b>Note:</b> If PCL SmartSwitch is off, then the printer does not examine incoming data and uses the default printer language specified in the Setup menu.

**Note:** An asterisk (\*) next to a value indicates the factory default setting.

Menu item	Description
<b>PS SmartSwitch</b> Off On*	Set the printer to switch automatically to PS emulation when a print job requires it, regardless of the default printer language.  <b>Note:</b> If PS SmartSwitch is off, then the printer does not examine incoming data and uses the default printer language specified in the Setup menu.
<b>Job Buffering</b> Off On*	Temporarily store jobs on the printer hard disk before printing.  <b>Note:</b> This menu item appears only when a hard disk is installed.
<b>Mac Binary PS</b> Auto* On Off	Set the printer to process Macintosh binary PostScript print jobs.  <b>Notes:</b> <ul style="list-style-type: none"> <li>• On processes raw binary PostScript print jobs.</li> <li>• Off filters print jobs using the standard protocol.</li> </ul>
<b>Energy Efficient Ethernet</b> Off On*	Reduce power consumption when the printer does not receive data from the Ethernet network.
<b>Note:</b> An asterisk (*) next to a value indicates the factory default setting.	

## TCP/IP

**Note:** This menu appears only in network printers or printers attached to print servers.

Menu item	Description
<b>Set Hostname</b>	Set the current TCP/IP host name.
<b>Domain Name</b>	Set the domain name.
<b>Allow DHCP/BOOTP to update NTP server</b> On* Off	Allow the DHCP and BOOTP clients to update the NTP settings of the printer.
<b>Zero Configuration Name</b>	Specify a service name for the zero configuration network.
<b>Enable Auto IP</b> On* Off	Assign an IP address automatically.
<b>DNS Server Address</b>	Specify the current Domain Name System (DNS) server address.
<b>Backup DNS Server Address</b>	Specify the backup DNS server addresses.
<b>Backup DNS Server Address 2</b>	
<b>Backup DNS Server Address 3</b>	
<b>Domain Search Order</b>	Specify a list of domain names to locate the printer and its resources that reside in different domains on the network.
<b>Note:</b> An asterisk (*) next to a value indicates the factory default setting.	

Menu item	Description
<b>Enable DDNS</b> Off* On	Update the Dynamic DNS settings.
<b>DDNS TTL</b> 300–31536000 seconds (3600*)	Specify the current DDNS settings.
<b>Default TTL</b> 5–254 seconds (254*)	
<b>DDNS Refresh Time</b> 300–31536000 seconds (604800*)	
<b>Enable mDNS</b> On* Off	Update multicast DNS settings.
<b>WINS Server Address</b>	Specify a server address for Windows Internet Name Service (WINS).
<b>Enable BOOTP</b> Off* On	Allow the BOOTP to assign a printer IP address.
<b>Restricted Server List</b>	Specify an IP address for the TCP connections.  <b>Notes:</b> <ul style="list-style-type: none"> <li>• Use a comma to separate each IP address.</li> <li>• You can add up to 50 IP addresses.</li> </ul>
<b>Restricted Server List Options</b> Block All Ports* Block Printing Only Block Printing and HTTP Only	Specify how the IP addresses in the list can access the printer functionality.
<b>MTU</b> 256–1500 (1500*)	Specify a maximum transmission unit (MTU) parameter for the TCP connections.
<b>Raw Print Port</b> 1–65535 (9100*)	Specify a raw port number for printers connected on a network.
<b>Outbound Traffic Maximum Speed</b> Disabled* Enabled 100–1000000 (100000*)	Enable the printer maximum transfer rate.
<b>Enable TLSv1.0</b> On* Off	Enable the TLSv1.0 protocol.

**Note:** An asterisk (\*) next to a value indicates the factory default setting.

Menu item	Description
<b>Enable TLSv1.1</b> On* Off	Enable the TLSv1.1 protocol.
<b>SSL Cipher List</b>	Specify the cipher algorithms to use for the SSL or the TLS connections.
<b>Note:</b> An asterisk (*) next to a value indicates the factory default setting.	

## SNMP

**Note:** This menu appears only in network printers or printers that are attached to print servers.

Menu item	Description
<b>SNMP Versions 1 and 2c</b> Enabled Off On* Allow SNMP Set Off On* Enable PPM MIB Off On* SNMP Community	Configure Simple Network Management Protocol (SNMP) versions 1 and 2c to install print drivers and applications.
<b>Note:</b> An asterisk (*) next to a value indicates the factory default setting.	

Menu item	Description
<b>SNMP Version 3</b> Enabled Off On* Context Name Set Read/Write Credentials User Name Authentication Password Privacy Password Set Read-only Credentials User Name Authentication Password Privacy Password Authentication Hash MD5 SHA1* Minimum Authentication Level No Authentication, No Privacy Authentication, No Privacy Authentication, Privacy* Privacy Algorithm DES AES-128*	Configure SNMP version 3 to install and update the printer security.
<b>Note:</b> An asterisk (*) next to a value indicates the factory default setting.	

## IPSec

**Note:** This menu appears only in network printers or printers that are attached to print servers.

Menu item	Description
<b>Enable IPSec</b> Off* On	Enable Internet Protocol Security (IPSec).
<b>Base Configuration</b> Default* Compatibility Secure	Set the IPSec base configuration. <b>Note:</b> This menu item appears only when Enable IPSec is set to On.
<b>DH (Diffie-Hellman) Group Proposal</b> modp2048 (14)* modp3072 (15) modp4096 (16) modp6144 (17)	Set the IPSec base configuration. <b>Note:</b> This menu item appears only when Base Configuration is set to Compatibility.
<b>Note:</b> An asterisk (*) next to a value indicates the factory default setting.	

Menu item	Description
<b>Proposed Encryption Method</b> 3DES AES*	Set the encryption method. <b>Note:</b> This menu item appears only when Base Configuration is set to Compatibility.
<b>Proposed Authentication Method</b> SHA1 SHA256* SHA512	Set the authentication method. <b>Note:</b> This menu item appears only when Base Configuration is set to Compatibility.
<b>IKE SA Lifetime (Hours)</b> 1 2 4 8 24*	Specify the IKE SA expiry period. <b>Note:</b> This menu item appears only when Base Configuration is set to Secure.
<b>IPSec SA Lifetime (Hours)</b> 1 2 4 8* 24	Specify the IPSec SA expiry period. <b>Note:</b> This menu item appears only when Base Configuration is set to Secure.
<b>IPSec Device Certificate</b>	Specify an IPSec certificate. <b>Note:</b> This menu item appears only when Enable IPSec is set to On.
<b>Pre-Shared Key Authenticated Connections</b> Host [x]	Configure the authenticated connections of the printer. <b>Note:</b> These menu items appear only when Enable IPSec is set to On.
<b>Certificate Authenticated Connections</b> Host [x] Address[/subnet]	
<b>Note:</b> An asterisk (*) next to a value indicates the factory default setting.	

## 802.1x

**Note:** This menu appears only in network printers or printers that are attached to print servers.

Menu item	Description
<b>Active</b> Off* On	Let the printer join networks that require authentication before allowing access.
<b>Note:</b> An asterisk (*) next to a value indicates the factory default setting.	

## LPD Configuration

**Note:** This menu appears only in network printers or printers that are attached to print servers.

Menu item	Description
<b>LPD Timeout</b> 0–65535 seconds (90*)	Set the time-out value to stop the Line Printer Daemon (LPD) server from waiting indefinitely for hung or invalid print jobs.
<b>LPD Banner Page</b> Off* On	Print a banner page for all LPD print jobs. <b>Note:</b> A banner page is the first page of a print job used as a separator of print jobs and to identify the originator of the print job request.
<b>LPD Trailer Page</b> Off* On	Print a trailer page for all LPD print jobs. <b>Note:</b> A trailer page is the last page of a print job.
<b>LPD Carriage Return Conversion</b> Off* On	Enable carriage return conversion. <b>Note:</b> Carriage return is a mechanism that commands the printer to move the position of the cursor to the first position on the same line.
<b>Note:</b> An asterisk (*) next to a value indicates the factory default setting.	

## HTTP/FTP Settings

Menu item	Description
<b>Enable HTTP Server</b> Off On*	Access the Embedded Web Server to monitor and manage the printer.
<b>Enable HTTPS</b> Off On*	Enable Hypertext Transfer Protocol Secure (HTTPS) to encrypt data transferring to and from the print server.
<b>Force HTTPS Connections</b> On Off*	Force the printer to use HTTPS connections.
<b>Enable FTP/TFTP</b> Off On*	Send files using FTP/TFTP.
<b>Local Domains</b>	Specify domain names for HTTP and FTP servers.
<b>HTTP Proxy IP Address</b>	Configure the HTTP and FTP server settings.
<b>FTP Proxy IP Address</b>	
<b>HTTP Default IP Port</b>	
<b>HTTPS Device Certificate</b>	
<b>FTP Default IP Port</b>	
<b>Timeout for HTTP/FTP Requests</b> 1–299 (30*)	Specify the amount of time before the server connection stops.
<b>Note:</b> An asterisk (*) next to a value indicates the factory default setting.	

Menu item	Description
<b>Retries for HTTP/FTP Requests</b> 1–299 (3*)	Set the number of retries to connect to the HTTP/FTP server.
<b>Note:</b> An asterisk (*) next to a value indicates the factory default setting.	

## ThinPrint

Menu item	Description
<b>Enable ThinPrint</b> Off* On	Print using ThinPrint.
<b>Port Number</b> 4000–4999 (4000*)	Set the port number for the ThinPrint server.
<b>Bandwidth (bits/sec)</b> 100–1000000 (0*)	Set the speed to transmit data in a ThinPrint environment.
<b>Packet Size (kbytes)</b> 0–64000 (0*)	Set the packet size for data transmission.
<b>Note:</b> An asterisk (*) next to a value indicates the factory default setting.	

## USB

Menu item	Description
<b>PCL SmartSwitch</b> Off On*	Set the printer to switch to PCL emulation when a print job received through a USB port requires it, regardless of the default printer language. <b>Note:</b> When this setting is disabled, the printer does not examine incoming data and uses the default printer language specified in the Setup menu.
<b>PS SmartSwitch</b> Off On*	Set the printer to switch to PostScript emulation when a print job received through a USB port requires it, regardless of the default printer language. <b>Note:</b> When this setting is disabled, the printer does not examine incoming data and uses the default printer language specified in the Setup menu.
<b>Job Buffering</b> Off* On	Temporarily store jobs on the hard disk before printing. <b>Note:</b> This menu item appears only when a hard disk is installed.
<b>Mac Binary PS</b> Auto* On Off	Set the printer to process Macintosh binary PostScript print jobs. <b>Notes:</b> <ul style="list-style-type: none"> <li>• Auto processes print jobs from computers using either Windows or Macintosh operating systems.</li> <li>• Off filters PostScript print jobs using the standard protocol.</li> </ul>
<b>Note:</b> An asterisk (*) next to a value indicates the factory default setting.	

Menu item	Description
<b>Enable USB Port</b> Off On*	Enable the front USB drive port.
<b>Note:</b> An asterisk (*) next to a value indicates the factory default setting.	

## Restrict external network access

Menu item	Description
<b>Restrict external network access</b> Off* On	Restrict access to network sites.
<b>External network address</b>	Specify the network addresses with restricted access.
<b>E-mail address for notification</b>	Specify an e-mail address to send a notification of logged events.
<b>Ping frequency</b> 1–300 (10*)	Specify the network query interval in seconds.
<b>Subject</b>	Specify the subject and message of the notification e-mail.
<b>Message</b>	
<b>Note:</b> An asterisk (*) next to a value indicates the factory default setting.	

# Security

## Login Methods

### Manage Permissions

Menu item	Description
<p><b>Function Access</b></p> <ul style="list-style-type: none"> <li>Access Address Book in Apps</li> <li>Modify Address Book</li> <li>Manage Shortcuts</li> <li>Create Profiles</li> <li>Manage Bookmarks</li> <li>Flash Drive Print</li> <li>Flash Drive Scan</li> <li>Copy Function</li> <li>Color Dropout</li> <li>E-mail Function</li> <li>Fax Function</li> <li>FTP Function</li> <li>Release Held Faxes</li> <li>Held Jobs Access</li> <li>User Profiles</li> <li>Cancel Jobs at the Device</li> <li>Change Language</li> <li>Internet Printing Protocol (IPP)</li> <li>Initiate Scans Remotely</li> <li>B/W Print</li> <li>Network Folder - Scan</li> </ul>	<p>Control access to the printer functions.</p>
<p><b>Administrative Menus</b></p> <ul style="list-style-type: none"> <li>Security Menu</li> <li>Network/Ports Menu</li> <li>Paper Menu</li> <li>Reports Menu</li> <li>Function Configuration Menus</li> <li>Supplies Menu</li> <li>Option Card Menu</li> <li>SE Menu</li> <li>Device Menu</li> </ul>	<p>Control access to the printer menu settings.</p>

Menu item	Description
<p><b>Device Management</b></p> <ul style="list-style-type: none"> <li>Remote Management</li> <li>Firmware Updates</li> <li>Apps Configuration</li> <li>Import/Export All Settings</li> <li>Out of Service Erase</li> <li>Embedded Web Server Access</li> </ul>	<p>Control access to the printer management options.</p>
<p><b>Apps</b></p> <ul style="list-style-type: none"> <li>New Apps</li> <li>Scan Center</li> <li>Scan Center Custom 1</li> <li>Scan Center Custom 2</li> <li>Scan Center Custom 3</li> <li>Scan Center Custom 4</li> <li>Scan Center Custom 5</li> <li>Scan Center Custom 6</li> <li>Scan Center Custom 7</li> <li>Scan Center Custom 8</li> <li>Scan Center Custom 9</li> <li>Scan Center Custom 10</li> </ul>	<p>Control access to printer applications.</p>

**Local Accounts**

Menu item	Description
<p><b>Manage Groups/Permissions</b></p> <ul style="list-style-type: none"> <li>Add Group                             <ul style="list-style-type: none"> <li>Import Access Controls</li> <li>Function Access</li> <li>Administrative Menus</li> <li>Device Management</li> <li>Apps</li> </ul> </li> <li>All Users                             <ul style="list-style-type: none"> <li>Import Access Controls</li> <li>Function Access</li> <li>Administrative Menus</li> <li>Device Management</li> <li>Apps</li> </ul> </li> <li>Admin</li> </ul>	<p>Control group or user access to the printer functions, applications, and security settings.</p>

Menu item	Description
<b>Add User</b> User Name/Password User Name Password PIN	Create local accounts to manage access to the printer functions.
<b>User Name/Password Accounts</b> Add User	
<b>User Name Accounts</b> Add User	
<b>Password Accounts</b> Add User	
<b>PIN Accounts</b> Add User	

### Schedule USB Devices

Menu item	Description
<b>Schedules</b> Add New Schedule	Schedule access to the front USB port.

### Security Audit Log

Menu item	Description
<b>Enable Audit</b> Off* On	Record the events in the secure audit log and remote syslog.
<b>Enable Remote Syslog</b> Off* On	Send audit logs to a remote server.
<b>Remote Syslog Server</b>	Specify the remote syslog server.
<b>Remote Syslog Port</b> 1–65535 (514*)	Specify the remote syslog port.
<b>Remote Syslog Method</b> Normal UDP* Stunnel	Specify a syslog method to transmit logged events to a remote server.

**Note:** An asterisk (\*) next to a value indicates the factory default setting.

Menu item	Description
<p><b>Remote Syslog Facility</b></p> <ul style="list-style-type: none"> <li>0 - Kernel Messages</li> <li>1 - User-Level Messages</li> <li>2 - Mail System</li> <li>3 - System Daemons</li> <li>4 - Security/Authorization Messages*</li> <li>5 - Messages Generated Internally by Syslogs</li> <li>6 - Line Printer Subsystem</li> <li>7 - Network News Subsystem</li> <li>8 - UUCP Subsystem</li> <li>9 - Clock Daemon</li> <li>10 - Security/Authorization Messages</li> <li>11 - FTP Daemon</li> <li>12 - NTP Subsystem</li> <li>13 - Log Audit</li> <li>14 - Log Alert</li> <li>15 - Clock Daemon</li> <li>16 - Local Use 0 (local0)</li> <li>17 - Local Use 1 (local1)</li> <li>18 - Local Use 2 (local2)</li> <li>19 - Local Use 3 (local3)</li> <li>20 - Local Use 4 (local4)</li> <li>21 - Local Use 5 (local5)</li> <li>22 - Local Use 6 (local6)</li> <li>23 - Local Use 7 (local7)</li> </ul>	<p>Specify a facility code that the printer uses when sending log events to a remote server.</p>
<p><b>Severity of Events to Log</b></p> <ul style="list-style-type: none"> <li>0 - Emergency</li> <li>1 - Alert</li> <li>2 - Critical</li> <li>3 - Error</li> <li>4 - Warning*</li> <li>5 - Notice</li> <li>6 - Informational</li> <li>7 - Debug</li> </ul>	<p>Specify the priority level cutoff for logging messages and events.</p>
<p><b>Remote Syslog Non-Logged Events</b></p> <ul style="list-style-type: none"> <li>Off*</li> <li>On</li> </ul>	<p>Send all events, regardless of severity level, to the remote server.</p>
<p><b>Admin's E-mail Address</b></p>	<p>Send e-mail notification of logged events to the administrator.</p>
<p><b>Note:</b> An asterisk (*) next to a value indicates the factory default setting.</p>	

Menu item	Description
<b>E-mail Log Cleared Alert</b> Off* On	Send e-mail notification to the administrator when a log entry is deleted.
<b>E-mail Log Wrapped Alert</b> Off* On	Send e-mail notification to the administrator when the log becomes full and begins to overwrite the oldest entries.
<b>Log Full Behavior</b> Wrap Over Older Entries* E-mail Log Then Delete All Entries	Resolve log storage issues when the log fills its allotted memory.
<b>E-mail % Full Alert</b> Off* On	Send e-mail notification to the administrator when the log fills its allotted memory.
<b>% Full Alert Level</b> 1–99 (90*)	
<b>E-mail Log Exported Alert</b> Off* On	Send e-mail notification to the administrator when a log is exported.
<b>E-mail Log Settings Changed Alert</b> Off* On	Send e-mail notification to the administrator when Enable Audit is set.
<b>Log Line Endings</b> LF (\n)* CR (\r) CRLF (\r\n)	Specify how the log file terminates the end of each line.
<b>Digitally Sign Exports</b> Off* On	Add a digital signature to each exported log file.
<b>Clear Log</b>	Delete all audit logs.
<b>Export Log</b> Syslog (RFC 5424) Syslog (RFC 3164) CSV	Export a security log to a flash drive.
<b>Note:</b> An asterisk (*) next to a value indicates the factory default setting.	

## Login Restrictions

Menu item	Description
<b>Login failures</b> 1–10 (3*)	Specify the number of failed login attempts before the user gets locked out.
<b>Failure time frame</b> 1–60 minutes (5*)	Specify the time frame between failed login attempts before the user gets locked out.
<b>Lockout time</b> 1–60 minutes (5*)	Specify the lockout duration.
<b>Web Login Timeout</b> 1–120 minutes (10*)	Specify the delay for a remote login before the user is logged off automatically.
<b>Note:</b> An asterisk (*) next to a value indicates the factory default setting.	

## Confidential Print Setup

Menu item	Description
<b>Max Invalid PIN</b> 2–10	Set the number of times an invalid PIN can be entered.  <b>Notes:</b> <ul style="list-style-type: none"> <li>• A value of zero turns off this setting.</li> <li>• When the limit is reached, the print jobs for that user name and PIN are deleted.</li> </ul>
<b>Confidential Job Expiration</b> Off* 1 Hour 4 Hours 24 Hours 1 Week	Set the expiration time for confidential print jobs.  <b>Notes:</b> <ul style="list-style-type: none"> <li>• If this menu item is changed while confidential print jobs reside in the printer memory or hard disk, then the expiration time for those print jobs does not change to the new default value.</li> <li>• If the printer is turned off, then all confidential jobs held in the printer memory are deleted.</li> </ul>
<b>Repeat Job Expiration</b> Off* 1 Hour 4 Hours 24 Hours 1 Week	Set the expiration time for a print job that you want to repeat.
<b>Verify Job Expiration</b> Off* 1 Hour 4 Hours 24 Hours 1 Week	Set the expiration time that the printer prints a copy for the user to examine its quality, before printing the remaining copies.
<b>Note:</b> An asterisk (*) next to a value indicates the factory default setting.	

Menu item	Description
<b>Reserve Job Expiration</b> Off* 1 Hour 4 Hours 24 Hours 1 Week	Set the expiration time that the printer stores print jobs for printing later.
<b>Require All Jobs to be Held</b> Off* On	Set the printer to hold all print jobs.
<b>Keep duplicate documents</b> Off* On	Set the printer to print other documents with the same file name without overwriting any of the print jobs.
<b>Note:</b> An asterisk (*) next to a value indicates the factory default setting.	

## Disk Encryption

**Note:** This menu appears only when a hard disk is installed.

Menu item	Description
<b>Status</b> Enabled Disabled	Enable disk encryption.
<b>Start encryption</b>	

## Erase Temporary Data Files

Menu item	Description
<b>Stored in onboard memory</b> Off* On	Delete all files stored on the printer memory.
<b>Note:</b> An asterisk (*) next to a value indicates the factory default setting.	

## Solutions LDAP Settings

Menu item	Description
<b>Follow LDAP Referrals</b> Off* On	Search the different servers in the domain for the logged-in user account.
<b>LDAP Certificate Verification</b> Yes No*	Enable verification of LDAP certificates.

## Mobile Services Management

Use	To
<b>AirPrint</b> Print Scan Fax	Enable functions in the AirPrint software feature.

## Miscellaneous

Menu item	Description
<b>Protected Features</b> Show* Hide	Show all the features that Function Access Control (FAC) protects regardless of the security permission that the user has. <b>Note:</b> Hide displays only FAC-protected features that the user has access.
<b>Print Permission</b> Off* On	Let the user log in before printing.
<b>Default Print Permission Login</b> User Name/Password* User Name	Set the default login for Print Permission.
<b>Security Reset Jumper</b> Enable "Guest" access* No Effect	Specify user access to the printer. <b>Notes:</b> <ul style="list-style-type: none"> <li>• The jumper is located beside a lock icon on the controller board.</li> <li>• Enable "Guest" access provides anyone access to all aspects of the printer.</li> <li>• No Effect may make access to the printer impossible when the required security information is unavailable.</li> </ul>
<b>Minimum Password Length</b> 0–32	Specify the password length.
<b>Note:</b> An asterisk (*) next to a value indicates the factory default setting.	

## Reports

### Menu Settings Page

Menu item	Description
<b>Menu Settings Page</b>	Print a report that contains the printer menus.

## Device

Menu item	Description
<b>Device Information</b>	Print a report that contains information about the printer.
<b>Device Statistics</b>	Print a report about printer usage and supply status.
<b>Profiles List</b>	Print a list of profiles that are stored in the printer.
<b>Asset Report</b>	Print a report that contains the printer serial number and model name.

## Print

Menu item	Description
<b>Print Fonts</b> PCL Fonts PS Fonts	Print samples and information about the fonts that are available in each printer language.
<b>Print Demo</b> Demo Page	Print a page that shows the printer capabilities and supported solutions.
<b>Print Directory</b>	Print the resources that are stored in the flash drive or printer hard disk. <b>Note:</b> This menu item appears only when a flash drive or printer hard disk is installed.

## Shortcuts

Menu item	Description
<b>All Shortcuts</b>	Print a report that lists the shortcuts that are stored in the printer. <b>Note:</b> Fax Shortcuts appears only in some printer models.
<b>Fax Shortcuts</b>	
<b>Copy Shortcuts</b>	
<b>E-mail Shortcuts</b>	
<b>FTP Shortcuts</b>	
<b>Network Folder Shortcuts</b>	

## Fax

**Note:** This menu appears only in some printer models.

Menu item	Description
<b>Fax Job Log</b>	Print a report about the last 200 completed fax jobs. <b>Note:</b> This menu item appears only when Enable Job Log is set to On.
<b>Fax Call Log</b>	Print a report about the last 100 attempted, received, and blocked calls. <b>Note:</b> This menu item appears only when Enable Job Log is set to On.

## Network

Menu item	Description
<b>Network Setup Page</b>	Print a page that shows the configured network and wireless settings on the printer. <b>Note:</b> This menu item appears only in network printers or printers connected to print servers.
<b>Wi-Fi Direct Connected Clients</b>	Print a page that shows the list of devices that are connected to the printer using Wi-Fi Direct. <b>Note:</b> This menu item appears only when Enable Wi-Fi Direct is set to On.

## Help

Menu item	Description
Print All Guides	Prints all the guides
Connection Guide	Provides information about connecting the printer locally (USB) or to a network
Copy Guide	Provides information about making copies and configuring the settings
E-mail Guide	Provides information about sending e-mails and configuring the settings
Fax Guide	Provides information about sending faxes and configuring the settings
FTP Guide	Provides information about scanning documents and configuring the settings
Information Guide	Provides more information sources about the printer
Media Guide	Provides information about loading paper and specialty media
Mono Quality Guide	Provides information about mono print quality settings
Moving Guide	Provides information about moving, locating, or shipping the printer
Print Quality Guide	Provides information about solving print quality issues
Supplies Guide	Provides information about ordering supplies

## Troubleshooting

Menu item	Description
<b>Print Quality Test Pages</b>	Print sample pages to identify and correct print quality defects.
<b>Cleaning the Scanner</b>	Print instructions on how to clean the scanner.

## Printing the Menu Settings Page

From the home screen, touch **Settings > Reports > Menu Settings Page**.

## Securing the printer

### Locating the security slot

The printer is equipped with a security lock feature. Attach a security lock compatible with most laptop computers in the location shown to secure the printer in place.

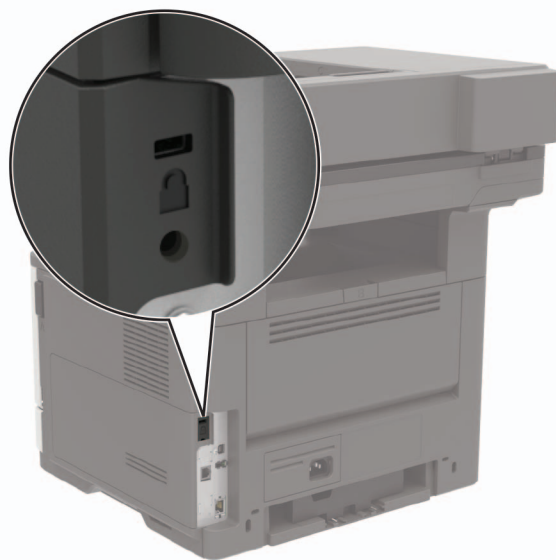

### Erasing printer memory

To erase volatile memory or buffered data in your printer, turn off the printer.

To erase non-volatile memory or individual settings, device and network settings, security settings, and embedded solutions, do the following:

- 1 From the home screen, touch **Settings** > **Device** > **Maintenance** > **Out of Service Erase**.
- 2 Select the **Sanitize all information on nonvolatile memory** check box, and then touch **OK**.
- 3 Select either **Start initial setup** or **Leave printer offline**, and then touch **OK**.

### Erasing printer hard disk memory

- 1 From the home screen, touch **Settings** > **Device** > **Maintenance** > **Out of Service Erase**.
- 2 Select the **Sanitize all information on hard disk** check box, and then touch **ERASE**.
- 3 Select a method to erase data.
- 4 Start the operation.

**Note:** This process can take from several minutes to more than an hour, making the printer unavailable for other tasks.

## Encrypting the printer hard disk

This process erases all contents in the hard disk. If necessary, back up important data from the printer before starting the encryption.

- 1 From the home screen, touch **Settings** > **Security** > **Disk Encryption** > **Start encryption**.
- 2 Follow the instructions on the display.

**Notes:**

- To avoid loss of data, do not turn off the printer during the encryption process.
- This process can take from several minutes to more than an hour, making the printer unavailable for other tasks.
- After encryption, the printer automatically restarts.

## Restoring factory default settings

- 1 From the home screen, touch **Settings** > **Device** > **Restore Factory Defaults**.
- 2 In the Restore Settings menu, select the settings that you want to restore.
- 3 Touch **RESTORE**.
- 4 Follow the instructions on the display.

## Statement of Volatility

Type of memory	Description
Volatile memory	The printer uses standard random access memory (RAM) to buffer temporarily user data during simple print and copy jobs.
Non-volatile memory	The printer may use two forms of non-volatile memory: EEPROM and NAND (flash memory). Both types are used to store the operating system, printer settings, network information, scanner and bookmark settings, and embedded solutions.
Hard disk memory	Some printers may have a hard disk drive installed. The printer hard disk is designed for printer-specific functionality. The hard disk lets the printer retain buffered user data from complex print jobs, form data, and font data.

Erase the content of any installed printer memory in the following circumstances:

- The printer is decommissioned.
- The printer hard disk is replaced.
- The printer is moved to a different department or location.
- The printer is serviced by someone from outside your organization.
- The printer is removed from your premises for service.
- The printer is sold to another organization.

### Disposing of a printer hard disk

- **Degaussing**—Flushes the hard disk with a magnetic field that erases stored data
- **Crushing**—Physically compresses the hard disk to break component parts and render them unreadable
- **Milling**—Physically shreds the hard disk into small metal bits

**Note:** To guarantee that all data are completely erased, destroy physically each hard disk where data is stored.

# Maintaining the printer

**Warning—Potential Damage:** Failure to maintain optimum printer performance, or to replace parts and supplies, may cause damage to your printer.

## Adjusting the speaker volume

### Adjusting the default headphone volume

1 From the control panel, navigate to:

**Settings > Device > Accessibility**

2 Adjust the headphone volume.

**Note:** The volume resets to the default value after the session is logged out or when the printer wakes from Sleep or Hibernate mode.

### Configuring the fax speaker settings

**Note:** Make sure that fax is configured. For more information, see [“Setting up the printer to fax” on page 57](#).

1 From the home screen, touch **Settings > Fax > Fax Setup > Speaker Settings**.

2 Do the following:

- Set Speaker Mode to **Always On**.
- Set Speaker Volume to **High**.
- Enable Ringer Volume.

## Networking

**Note:** For information on installing the wireless network adapter, see the setup sheet that came with the adapter.

### Connecting the printer to a Wi-Fi network

Make sure that Active Adapter is set to Auto. From the home screen, touch **Settings > Network/Ports > Network Overview > Active Adapter**.

#### Using the control panel

1 From the home screen, touch **Settings > Network/Ports > Wireless > Setup On Printer Panel > Choose Network**.

2 Select a Wi-Fi network, and then type the network password.

**Note:** For Wi-Fi-network-ready printer models, a prompt for Wi-Fi network setup appears during initial setup.

## Using Lexmark Mobile Assistant

- 1 Depending on your mobile device, download the Lexmark Mobile Assistant application from either the Google Play store or App Store online store.
- 2 From the printer home screen, touch **Settings > Network/Ports > Wireless > Setup Using Mobile App > Printer ID**.
- 3 From your mobile device, launch the application, and then accept the Terms of Use.  
**Note:** If necessary, grant permissions.
- 4 Tap **Connect to Printer > Go to Wi-Fi Settings**.
- 5 Connect your mobile device to the printer wireless network.
- 6 Return to the application, and then tap **Setup Wi-Fi Connection**
- 7 Select a Wi-Fi network, and then type the network password.
- 8 Tap **Done**.

## Connecting the printer to a wireless network using Wi-Fi Protected Setup (WPS)

Before you begin, make sure that:

- The access point (wireless router) is WPS-certified or WPS-compatible. For more information, see the documentation that came with your access point.
- A wireless network adapter is installed in your printer. For more information, see the instructions that came with the adapter.
- Active Adapter is set to Auto. From the home screen, touch **Settings > Network/Ports > Network Overview > Active Adapter**.

### Using the Push Button method

- 1 From the home screen, touch **Settings > Network/Ports > Wireless > Wi-Fi Protected Setup > Start Push Button Method**.
- 2 Follow the instructions on the display.

### Using the personal identification number (PIN) method

- 1 From the home screen, touch **Settings > Network/Ports > Wireless > Wi-Fi Protected Setup > Start PIN Method**.
- 2 Copy the eight-digit WPS PIN.
- 3 Open a web browser, and then type the IP address of your access point in the address field.

**Notes:**

- To know the IP address, see the documentation that came with your access point.
  - If you are using a proxy server, then temporarily disable it to load the web page correctly.
- 4 Access the WPS settings. For more information, see the documentation that came with your access point.
  - 5 Enter the eight-digit PIN, and then save the changes.

## Configuring Wi-Fi Direct

Wi-Fi Direct® is a Wi-Fi-based peer-to-peer technology that allows wireless devices to connect directly to a Wi-Fi Direct-enabled printer without using an access point (wireless router).

- 1 From the home screen, touch **Settings > Network/Ports > Wi-Fi Direct**.
- 2 Configure the settings.
  - **Enable Wi-Fi Direct**—Enables the printer to broadcast its own Wi-Fi Direct network.
  - **Wi-Fi Direct Name**—Assigns a name for the Wi-Fi Direct network.
  - **Wi-Fi Direct Password**—Assigns the password for negotiating the wireless security when using the peer-to-peer connection.
  - **Show Password on Setup Page**—Shows the password on the Network Setup Page.
  - **Auto-Accept Push Button Requests**—Lets the printer accept connection requests automatically.

**Note:** Accepting push-button requests automatically is not secured.

### Notes:

- By default, the Wi-Fi Direct network password is not visible on the printer display. To show the password, enable the password peek icon. From the home screen, touch **Settings > Security > Miscellaneous > Enable Password/PIN Reveal**.
- To know the password of the Wi-Fi Direct network without showing it on the printer display, from the home screen touch **Settings > Reports > Network > Network Setup Page**.

## Connecting a mobile device to the printer

Before connecting your mobile device, make sure that Wi-Fi Direct has been configured. For more information, see [“Configuring Wi-Fi Direct” on page 160](#).

### Connecting using Wi-Fi Direct

**Note:** These instructions apply only to Android mobile devices.

- 1 From the mobile device, go to the settings menu.
- 2 Enable **Wi-Fi**, and then tap **Wi-Fi Direct**.
- 3 Select the printer Wi-Fi Direct name.
- 4 Confirm the connection on the printer control panel.

### Connecting using Wi-Fi

- 1 From the mobile device, go to the settings menu.
- 2 Tap **Wi-Fi**, and then select the printer Wi-Fi Direct name.

**Note:** The string DIRECT-xy (where x and y are two random characters) is added before the Wi-Fi Direct name.

- 3 Enter the Wi-Fi Direct password.

## Connecting a computer to the printer

Before connecting your computer, make sure that Wi-Fi Direct has been configured. For more information, see [“Configuring Wi-Fi Direct” on page 160](#).

### For Windows users

- 1 Open **Printers & scanners**, and then click **Add a printer or scanner**.
- 2 Click **Show Wi-Fi Direct printers**, and then select the printer Wi-Fi Direct name.
- 3 From the printer display, take note of the eight-digit PIN of the printer.
- 4 Enter the PIN on the computer.

**Note:** If the print driver is not already installed, then Windows downloads the appropriate driver.

### For Macintosh users

- 1 Click the wireless icon, and then select the printer Wi-Fi Direct name.

**Note:** The string DIRECT-xy (where x and y are two random characters) is added before the Wi-Fi Direct name.

- 2 Type the Wi-Fi Direct password.

**Note:** Switch your computer back to its previous network after disconnecting from the Wi-Fi Direct network.

## Deactivating the Wi-Fi network

- 1 From the home screen, touch **Settings > Network/Ports > Network Overview > Active Adapter > Standard Network**.
- 2 Follow the instructions on the display.

## Changing the printer port settings after installing an internal solutions port

### Notes:

- If the printer has a static IP address, then do not change the configuration.
- If the computers are configured to use the network name instead of an IP address, then do not change the configuration.
- If you are adding a wireless internal solutions port (ISP) to a printer previously configured for an Ethernet connection, then disconnect the printer from the Ethernet network.

### For Windows users

- 1 Open the printers folder.
- 2 From the shortcut menu of the printer with the new ISP, open the printer properties.
- 3 Configure the port from the list.
- 4 Update the IP address.
- 5 Apply the changes.

### For Macintosh users

- 1 From System Preferences in the Apple menu, navigate to the list of printers, and then select + > **IP**.
- 2 Type the IP address in the address field.
- 3 Apply the changes.

### Setting up serial printing (Windows only)

- 1 Set the parameters in the printer.
  - a From the control panel, navigate to the menu for the port settings.
  - b Locate the menu for the serial port settings, and then adjust the settings, if necessary.
  - c Apply the changes.
- 2 From your computer, open the printers folder, and then select your printer.
- 3 Open the printer properties, and then select the COM port from the list.
- 4 Set the COM port parameters in Device Manager.

#### Notes:

- Serial printing reduces printing speed.
- Make sure that the serial cable is connected to the serial port on your printer.

## Cleaning printer parts

### Cleaning the printer



**CAUTION—SHOCK HAZARD:** To avoid the risk of electrical shock when cleaning the exterior of the printer, unplug the power cord from the electrical outlet and disconnect all cables from the printer before proceeding.

#### Notes:

- Perform this task after every few months.
  - Damage to the printer caused by improper handling is not covered by the printer warranty.
- 1 Turn off the printer, and then unplug the power cord from the electrical outlet.
  - 2 Remove paper from the standard bin and multipurpose feeder.
  - 3 Remove any dust, lint, and pieces of paper around the printer using a soft brush or vacuum.
  - 4 Wipe the outside of the printer with a damp, soft, lint-free cloth.

#### Notes:

- Do not use household cleaners or detergents, as they may damage the finish of the printer.

- Make sure that all areas of the printer are dry after cleaning.

5 Connect the power cord to the electrical outlet, and then turn on the printer.

**⚠ CAUTION—POTENTIAL INJURY:** To avoid the risk of fire or electrical shock, connect the power cord to an appropriately rated and properly grounded electrical outlet that is near the product and easily accessible.

## Cleaning the touch screen

**⚠ CAUTION—SHOCK HAZARD:** To avoid the risk of electric shock when cleaning the exterior of the printer, unplug the power cord from the electrical outlet and disconnect all cables from the printer before proceeding.

- 1 Turn off the printer, and then unplug the power cord from the electrical outlet.
- 2 Using a damp, soft, lint-free cloth, wipe the touch screen.

### Notes:

- Do not use household cleaners or detergents, as they may damage the touch screen.
- Make sure that the touch screen is dry after cleaning.

3 Connect the power cord to the electrical outlet, and then turn on the printer.

**⚠ CAUTION—POTENTIAL INJURY:** To avoid the risk of fire or electrical shock, connect the power cord to an appropriately rated and properly grounded electrical outlet that is near the product and easily accessible.

## Cleaning the scanner

- 1 Open the scanner cover.



**2** Using a damp, soft, lint-free cloth, wipe the following areas:

- ADF glass



- ADF glass pad



- Scanner glass



- Scanner glass pad



**3** Close the scanner cover.

**4** Open the ADF cover.

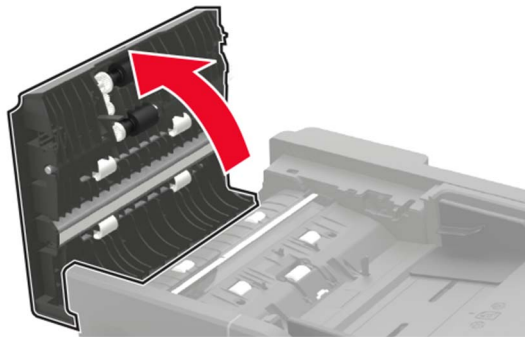

**5** Using a damp, soft, lint-free cloth, wipe the following areas:

- ADF glass pad in the ADF cover

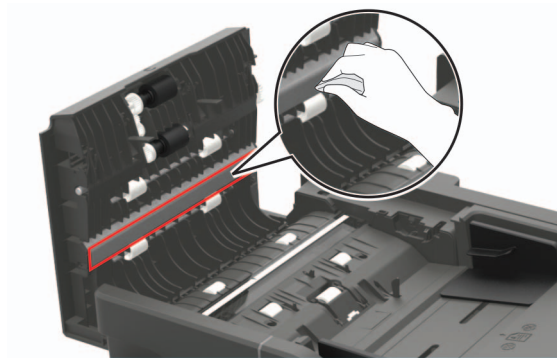

- ADF glass in the ADF cover

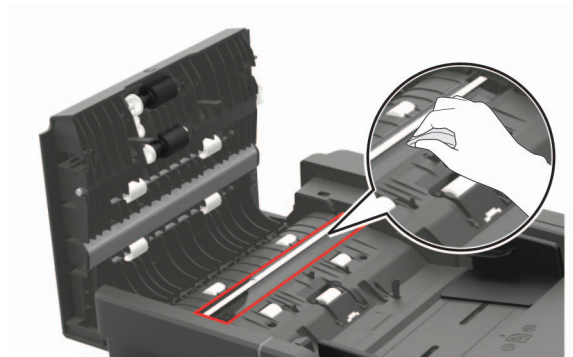

**6** Close the ADF cover.

## Ordering parts and supplies

To order parts and supplies in the U.S., contact 1-800-539-6275 for information about Lexmark authorized dealers in your area. In other countries or regions, go to [www.lexmark.com](http://www.lexmark.com) or contact the place where you purchased the printer.

**Note:** All life estimates for printer supplies assume printing on letter- or A4-size plain paper.

## Using genuine Lexmark parts and supplies

Your Lexmark printer is designed to function best with genuine Lexmark parts and supplies. Use of third-party supplies or parts may affect the performance, reliability, or life of the printer and its imaging components. It can also affect warranty coverage. Damage caused by the use of third-party parts and supplies is not covered by the warranty. All life indicators are designed to function with Lexmark parts and supplies, and may deliver unpredictable results if third-party parts and supplies are used. Imaging component usage beyond the intended life may damage your Lexmark printer or its associated components.

## Checking the status of parts and supplies

- 1** From the home screen, touch **Status/Supplies**.
- 2** Select the parts or supplies that you want to check.

**Note:** You can also access this setting by touching the top section of the home screen.

## Ordering a toner cartridge

### Notes:

- The estimated cartridge yield is based on the ISO/IEC 19752 standard.
- Extremely low print coverage for extended periods of time may negatively affect actual yield.

**Lexmark MX421, MX521, and MX522 Return Program toner cartridges**

Item	United States and Canada	European Economic Area	Rest of Asia Pacific	Latin America	Rest of Europe, Middle East, and Africa	Australia and New Zealand
Return Program toner cartridge	56F1000	56F2000	56F3000	56F4000	56F5000	56F6000
High yield Return Program toner cartridge	56F1H00	56F2H00	56F3H00	56F4H00	56F5H00	56F6H00
Extra high yield Return Program toner cartridge	56F1X00	56F2X00	56F3X00	56F4X00	56F5X00	56F6X00
Ultra high yield Return Program toner cartridge <sup>1</sup>	56F1U00	56F2U00	56F3U00	56F4U00	56F5U00	56F6U00
High yield Corporate Return Program toner cartridge <sup>2</sup>	56F1H0E	56F2H0E	56F3H0E	56F4H0E	56F5H0E	56F6H0E
Extra high yield Corporate Return Program toner cartridge <sup>2</sup>	56F1X0E	56F2X0E	56F3X0E	56F4X0E	56F5X0E	56F6X0E
Ultra high yield Corporate Return Program toner cartridge <sup>1, 2</sup>	56F1U0E	56F2U0E	56F3U0E	56F4U0E	56F5U0E	56F6U0E

<sup>1</sup> Supported only in Lexmark MX521 and MX522 printer models.

<sup>2</sup> Available only for contract-managed printers. For more information, contact your Lexmark representative or system administrator.

**Lexmark MX421, MX521, and MX522 regular toner cartridge**

Item	Worldwide
Extra high yield regular toner cartridge <sup>1</sup>	56F0XA0
Ultra high yield regular toner cartridge <sup>2</sup>	56F0UA0

<sup>1</sup> Supported only in the Lexmark MX421 printer model.

<sup>2</sup> Supported only in Lexmark MX521 and MX522 printer models.

**Lexmark XM1242 and XM1246 Return Program toner cartridges**

Item	United States, Canada, Australia, and New Zealand	European Economic Area	Rest of Asia Pacific	Latin America
XM1242 Return Program toner cartridge	24B6885	24B6888	24B6891	24B6894
XM1246 Return Program toner cartridge	24B6886	24B6889	24B6892	24B6895

**Lexmark MB2442 and MB2546 Return Program toner cartridges**

Item	United States and Canada	European Economic Area	Rest of Asia Pacific	Latin America	Rest of Europe, Middle East, and Africa	Australia and New Zealand
Return Program toner cartridge	B231000	B232000	B233000	B234000	B235000	B236000
High yield Return Program toner cartridge	B241H00	B242H00	B243H00	B244H00	B245H00	B246H00
Extra high yield Return Program toner cartridge*	B251X00	B252X00	B253X00	B254X00	B255X00	B256X00

\* Supported only in the Lexmark MB2546 printer model.

**Lexmark MB2442 and MB2546 Regular toner cartridges**

Item	Worldwide
MB2442 Regular toner cartridge	B240HA0
MB2546 Regular toner cartridge	B250XA0

**Ordering an imaging unit**

Extremely low print coverage for extended periods of time may cause imaging unit parts to fail before the toner is exhausted.

Item	Part Number
Return Program imaging unit	56F0Z00
Regular imaging unit	56F0ZA0
Corporate Return Program imaging unit*	56F0Z0E

\* This imaging unit is available only for contract-managed printers. For more information, contact your Lexmark representative or system administrator.

## Ordering a maintenance kit

Match the maintenance kit to the printer voltage.

### Notes:

- Using certain types of paper may require more frequent replacement of the maintenance kit.
- The maintenance kit includes a fuser, MPF pick roller and separator pad, pick tires, separator roller assembly, and transfer roller. These parts may be individually ordered and replaced if necessary.

Item	Part number
200K maintenance kit, 100 V	41X1230
200K maintenance kit, 110 V	41X1228
200K maintenance kit, 220 V	41X1229

**Notes:**

- Only an authorized service technician can replace the maintenance kit. Contact your service provider.
- Supported only in Lexmark MX521 and MX522 printer models.

## Configuring supply notifications

- 1 Open a web browser, and then type the printer IP address in the address field.

### Notes:

- View the printer IP address on the printer home screen. The IP address appears as four sets of numbers separated by periods, such as 123.123.123.123.
- If you are using a proxy server, then temporarily disable it to load the web page correctly.

- 2 Click **Settings > Device > Notifications**.
- 3 From the Supplies menu, click **Custom Supply Notifications**.
- 4 Select a notification for each supply item.
- 5 Apply the changes.

## Replacing parts and supplies

### Replacing the toner cartridge

- 1 Open door A.

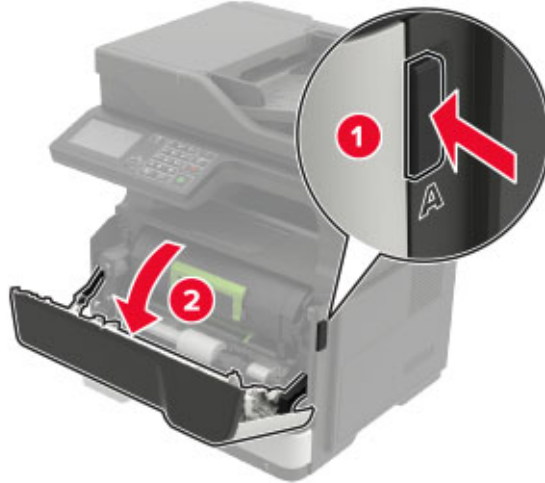

- 2 Remove the used toner cartridge.

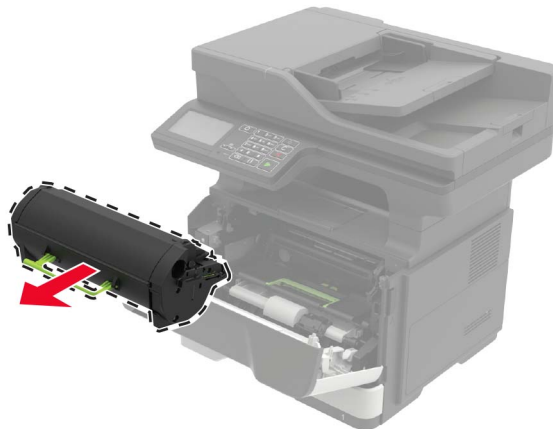

- 3 Unpack the new toner cartridge, and then shake it three times to redistribute the toner.

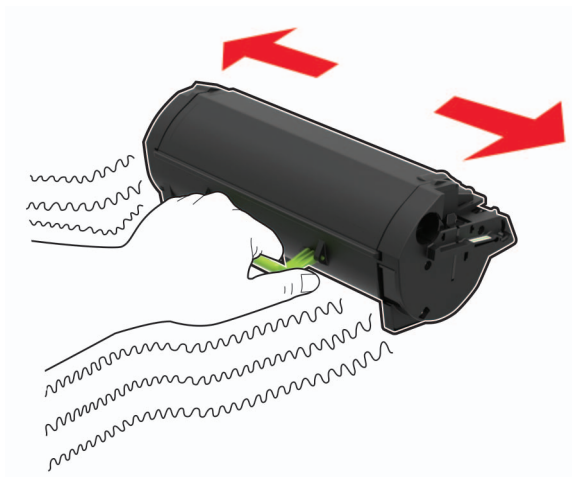

- 4 Insert the new toner cartridge.

**Note:** Use the arrows inside the printer as guides.

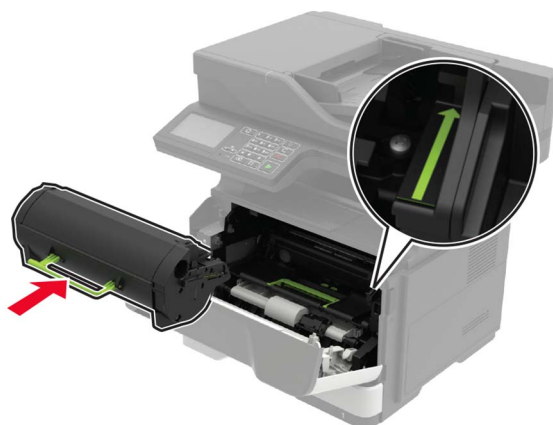

- 5 Close door A.

## Replacing the imaging unit

1 Open door A.

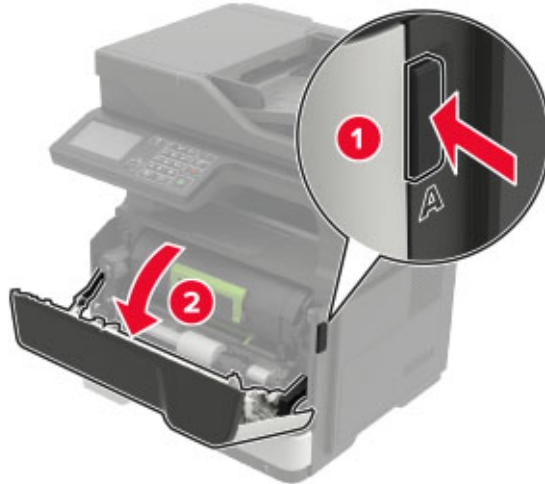

2 Remove the toner cartridge.

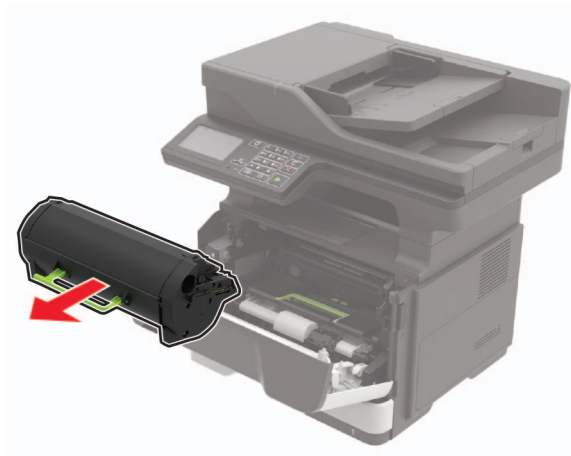

3 Remove the used imaging unit.

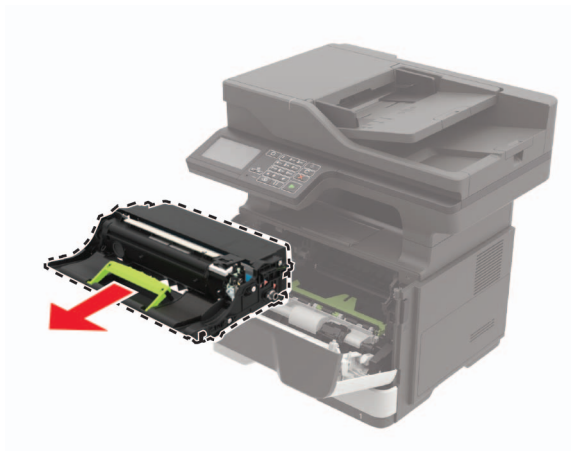

- 4 Unpack the new imaging unit, and then shake it three times to redistribute the toner.

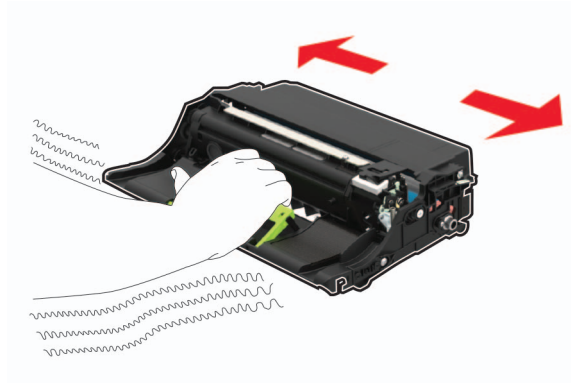

**Warning—Potential Damage:** Do not expose the imaging unit to direct light for more than 10 minutes. Extended exposure to light may cause print quality problems.

**Warning—Potential Damage:** Do not touch the photoconductor drum. Doing so may affect the quality of future print jobs.



- 5 Insert the new imaging unit.

**Note:** Use the arrows inside the printer as guides.

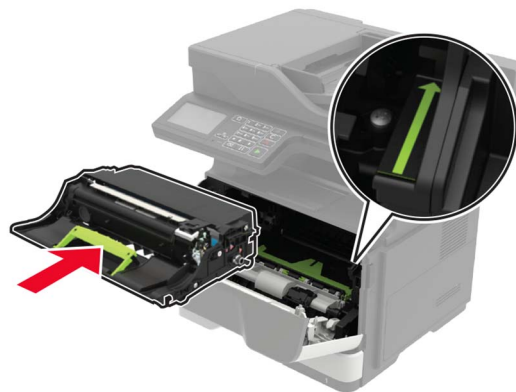

- 6 Insert the toner cartridge.

**Note:** Use the arrows inside the printer as guides.

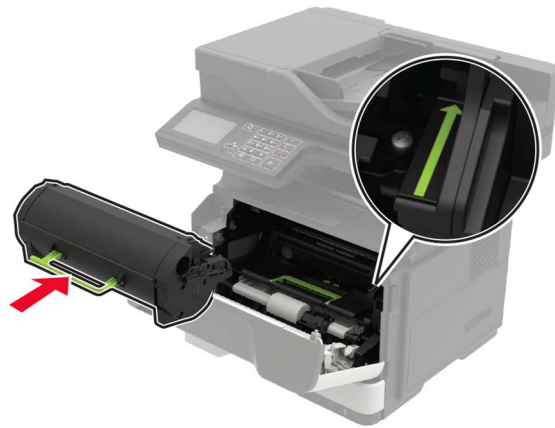

**7** Close door A.

## Replacing the pick tires

- 1** Turn off the printer.
- 2** Unplug the power cord from the electrical outlet, and then from the printer.
- 3** Remove the tray.

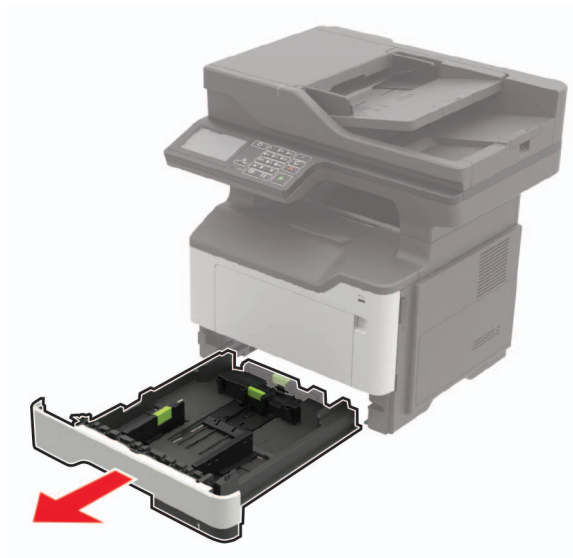

**4** Remove the used pick tires one after the other.

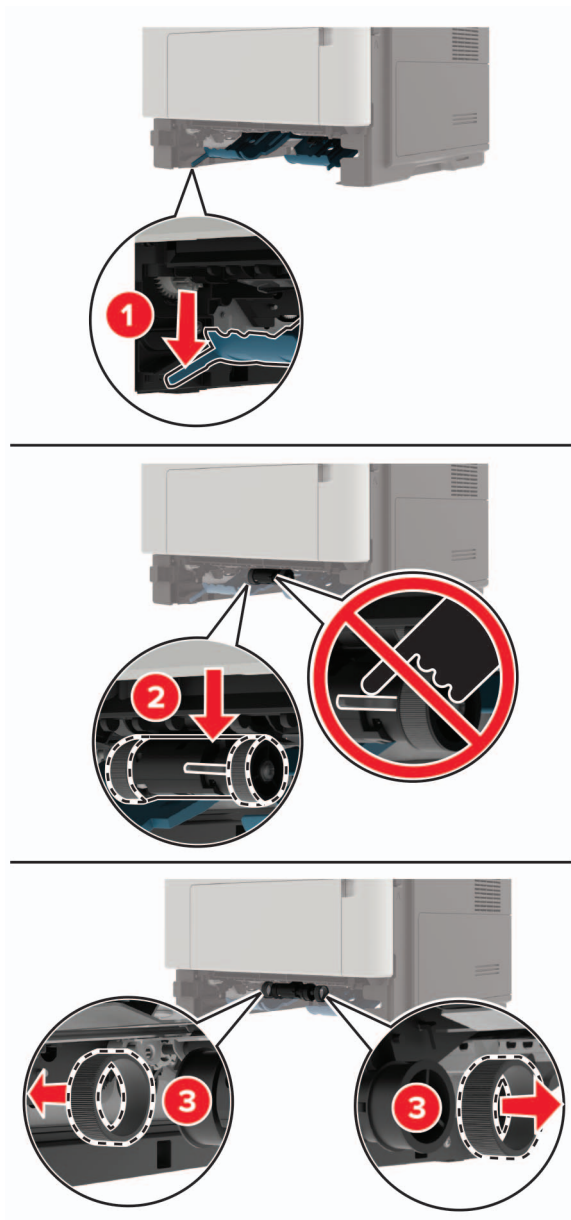

**5** Unpack the new pick tires.

- 6 Insert the new pick tires.

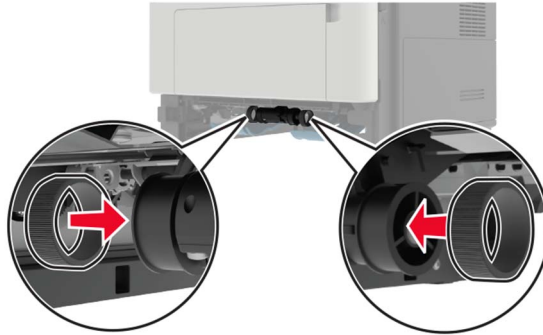

- 7 Insert the tray.
- 8 Connect the power cord to the printer, and then to the electrical outlet.

**⚠ CAUTION—POTENTIAL INJURY:** To avoid the risk of fire or electrical shock, connect the power cord to an appropriately rated and properly grounded electrical outlet that is near the product and easily accessible.

- 9 Turn on the printer.

## Replacing the pick roller assembly

- 1 Turn off the printer.
- 2 Unplug the power cord from the electrical outlet, and then from the printer.
- 3 Remove the optional tray.

**⚠ CAUTION—POTENTIAL INJURY:** If the printer weight is greater than 20 kg (44 lb), then it may require two or more people to lift it safely.

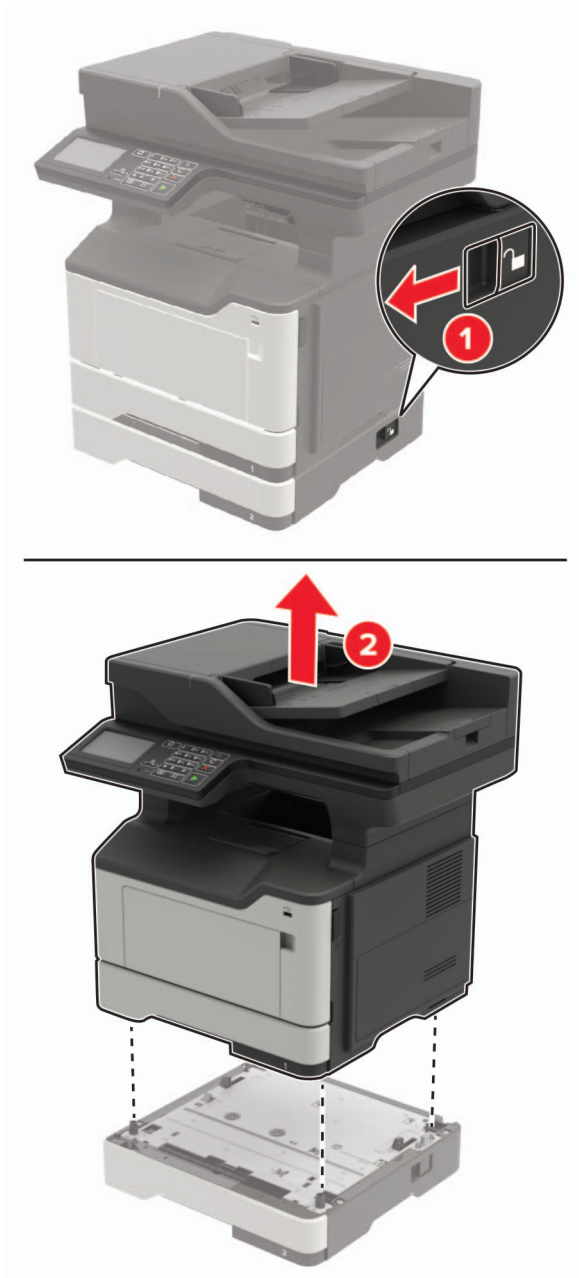

**4** Remove the tray insert, and then flip the tray base.

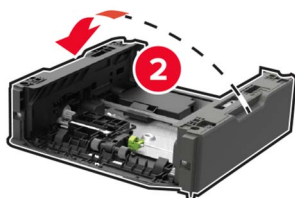
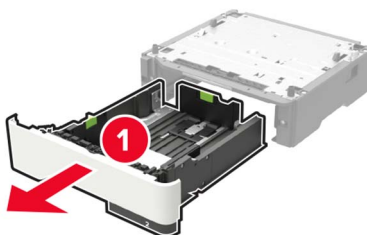

**5** Remove the used pick roller assembly.

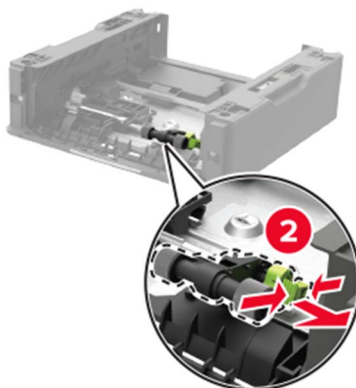
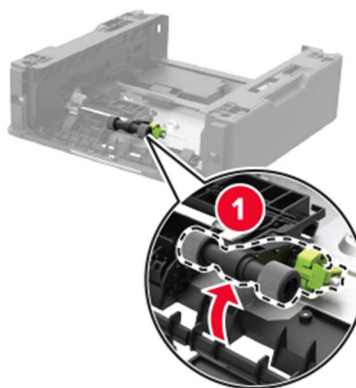

**6** Unpack the new pick roller assembly.

**7** Insert the new pick roller assembly.

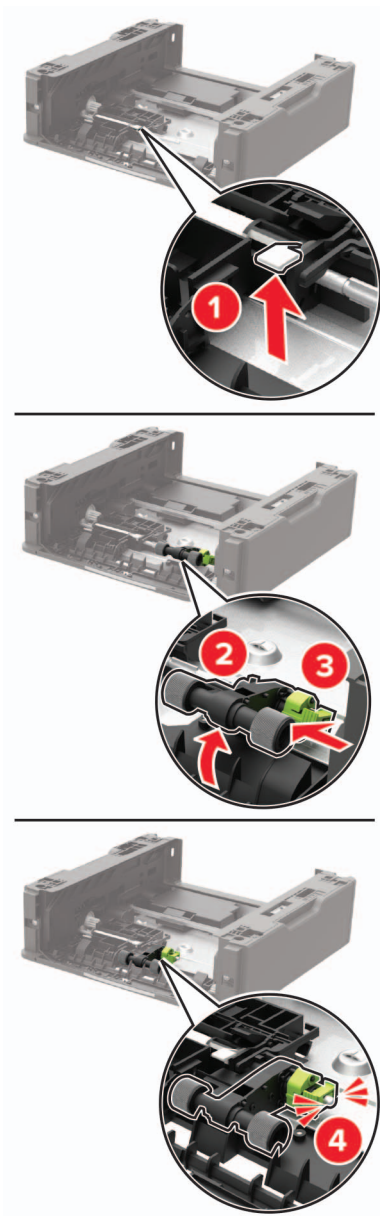

**8** Flip the tray base, and then insert the tray insert.

- 9 Align the printer with the optional tray, and then lower the printer until it *clicks* into place.

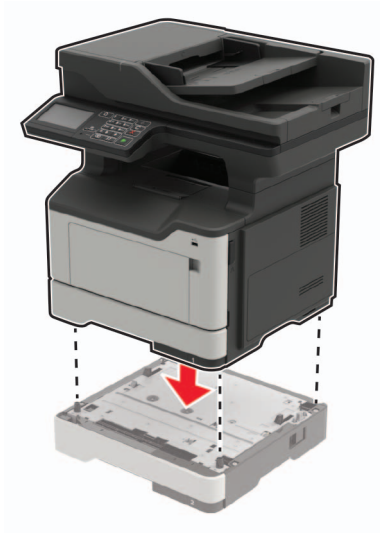

- 10 Connect the power cord to the printer, and then to the electrical outlet.

 **CAUTION—POTENTIAL INJURY:** To avoid the risk of fire or electrical shock, connect the power cord to an appropriately rated and properly grounded electrical outlet that is near the product and easily accessible.

- 11 Turn on the printer.

## Replacing the ADF separator roller

- 1 Open the ADF cover.



- 2 Remove the used ADF separator roller.

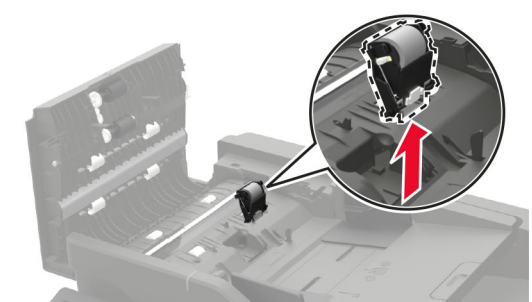
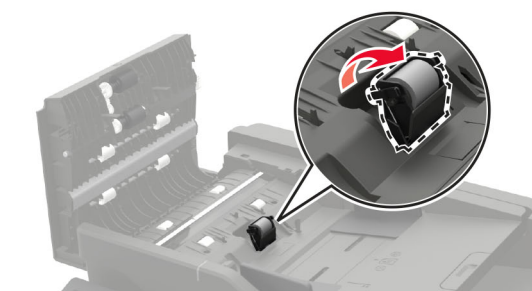
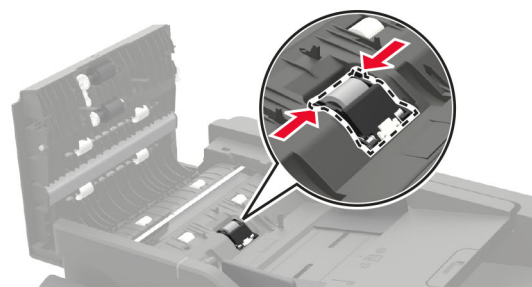

- 3 Unpack the new ADF separator roller.

**Warning—Potential Damage:** To avoid damage and poor printer performance, handle this part with clean hands.

4 Insert the new ADF separator roller until it *clicks* into place.

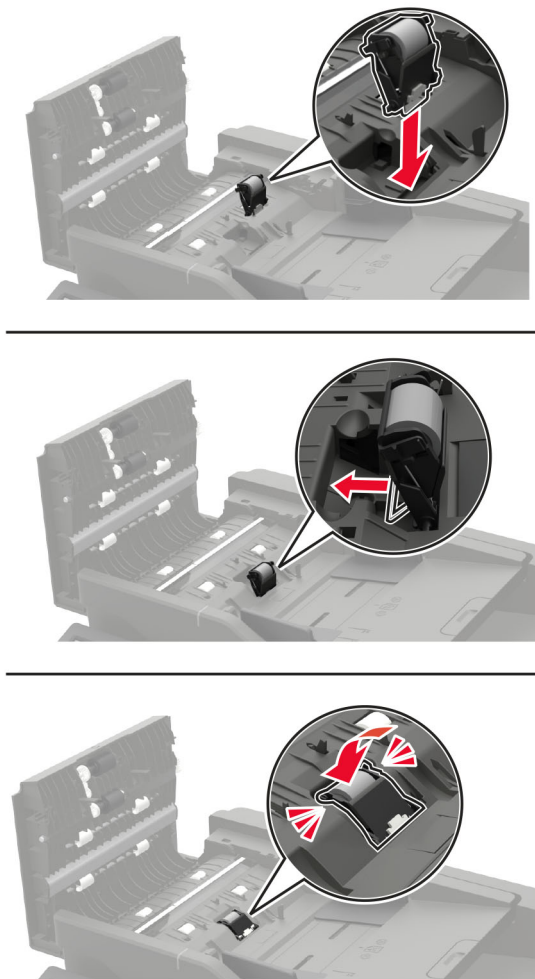

5 Close the ADF cover.

## Moving the printer

Moving the printer to another location

### Moving the printer to another location

**⚠ CAUTION—POTENTIAL INJURY:** If the printer weight is greater than 20 kg (44 lb), then it may require two or more people to lift it safely.

**⚠ CAUTION—POTENTIAL INJURY:** To avoid the risk of fire or electrical shock, use only the power cord provided with this product or the manufacturer's authorized replacement.

 **CAUTION—POTENTIAL INJURY:** When moving the printer, follow these guidelines to avoid personal injury or printer damage:

- Make sure that all doors and trays are closed.
- Turn off the printer, and then unplug the power cord from the electrical outlet.
- Disconnect all cords and cables from the printer.
- If the printer has separate floor-standing optional trays or output options attached to it, then disconnect them before moving the printer.
- If the printer has a caster base, then carefully roll it to the new location. Use caution when passing over thresholds and breaks in flooring.
- If the printer does not have a caster base but is configured with optional trays or output options, then remove the output options and lift the printer off the trays. Do not try to lift the printer and any options at the same time.
- Always use the handholds on the printer to lift it.
- Any cart used to move the printer must have a surface able to support the full footprint of the printer.
- Any cart used to move the hardware options must have a surface able to support the dimensions of the options.
- Keep the printer in an upright position.
- Avoid severe jarring movements.
- Make sure that your fingers are not under the printer when you set it down.
- Make sure that there is adequate clearance around the printer.

**Note:** Damage to the printer caused by improper moving is not covered by the printer warranty.

## Shipping the printer

For shipping instructions, go to <http://support.lexmark.com> or contact customer support.

## Saving energy and paper

### Configuring the power save mode settings

#### Sleep mode

- 1 From the home screen, touch **Settings > Device > Power Management > Timeouts > Sleep Mode**.
- 2 Specify the amount of time that the printer stays idle before it enters Sleep Mode.

#### Hibernate mode

- 1 From the home screen, touch **Settings > Device > Power Management > Timeouts > Hibernate Timeout**.
- 2 Select the amount of time that the printer stays idle before it enters Hibernate mode.

#### Notes:

- For Hibernate Timeout to work, set Hibernate Timeout on Connection to Hibernate.
- The Embedded Web Server is disabled when the printer is in Hibernate mode.

## Adjusting the brightness of the printer display

- 1 From the home screen, touch **Settings > Device > Preferences > Screen Brightness**.
- 2 Adjust the setting.

## Conserving supplies

- Print on both sides of the paper.
  - Note:** Two-sided printing is the default setting in the print driver.
- Print multiple pages on a single sheet of paper.
- Use the preview feature to see how the document looks like before printing it.
- Print one copy of the document to check its content and format for accuracy.

## Recycling

### Recycling Lexmark products

To return Lexmark products for recycling:

- 1 Go to [www.lexmark.com/recycle](http://www.lexmark.com/recycle).
- 2 Select the product you want to recycle.

**Note:** Printer supplies and hardware not listed in the Lexmark Collection and Recycling Program may be recycled through your local recycling center.

### Recycling Lexmark packaging

Lexmark continually strives to minimize packaging. Less packaging helps to ensure that Lexmark printers are transported in the most efficient and environmentally sensitive manner and that there is less packaging to dispose of. These efficiencies result in fewer greenhouse emissions, energy savings, and natural resource savings. Lexmark also offers recycling of packaging components in some countries or regions. For more information, go to [www.lexmark.com/recycle](http://www.lexmark.com/recycle), and then choose your country or region. Information on available packaging recycling programs is included with the information on product recycling.

Lexmark cartons are 100% recyclable where corrugated recycling facilities exist. Facilities may not exist in your area.

The foam used in Lexmark packaging is recyclable where foam recycling facilities exist. Facilities may not exist in your area.

When you return a cartridge to Lexmark, you can reuse the box that the cartridge came in. Lexmark recycles the box.

# Clearing jams

## Avoiding jams

### Load paper properly

- Make sure that the paper lies flat in the tray.

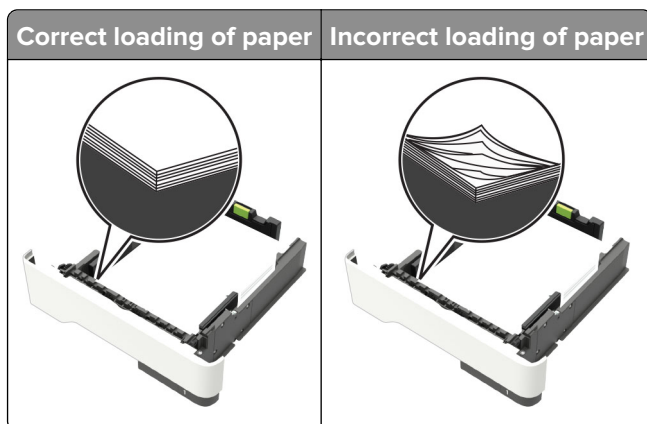

- Do not load or remove a tray while the printer is printing.
- Do not load too much paper. Make sure that the stack height is below the maximum paper fill indicator.
- Do not slide paper into the tray. Load paper as shown in the illustration.

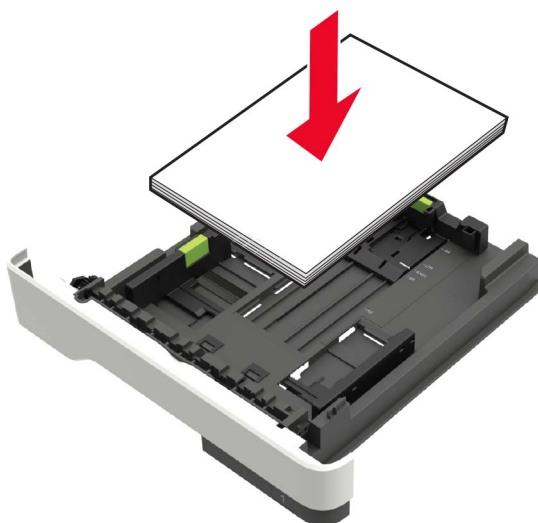

- Make sure that the paper guides are positioned correctly and are not pressing tightly against the paper or envelopes.
- Push the tray firmly into the printer after loading paper.

### Use recommended paper

- Use only recommended paper or specialty media.
- Do not load paper that is wrinkled, creased, damp, bent, or curled.

- Flex, fan, and align the paper edges before loading.

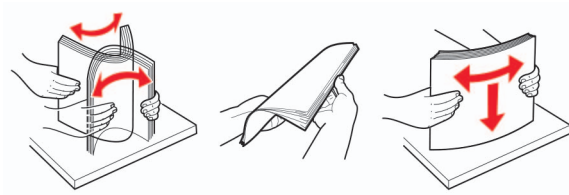

- Do not use paper that has been cut or trimmed by hand.
- Do not mix paper sizes, weights, or types in the same tray.
- Make sure that the paper size and type are set correctly on the computer or printer control panel.
- Store paper according to manufacturer recommendations.

Identifying jam locations

## Identifying jam locations

**Notes:**

- When Jam Assist is set to On, the printer automatically flushes blank pages or partially printed pages with after a jammed page is cleared. Check your printed output for blank pages.
- When Jam Recovery is set to On or Auto, the printer reprints jammed pages.

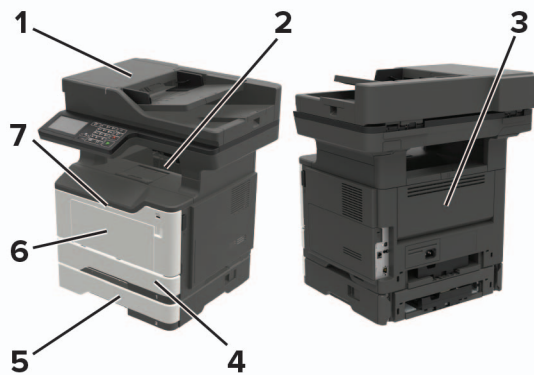

	Jam location
1	Automatic document feeder
2	Standard bin
3	Rear door
4	Standard 250-sheet tray
5	Optional 250- or 550-sheet tray
6	Multipurpose feeder
7	Door A

## Paper jam in door A

1 Remove the tray.



2 Open door A.

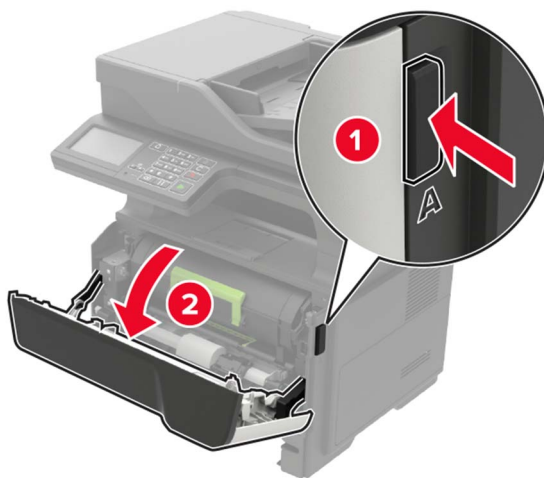

- 3 Remove the toner cartridge.

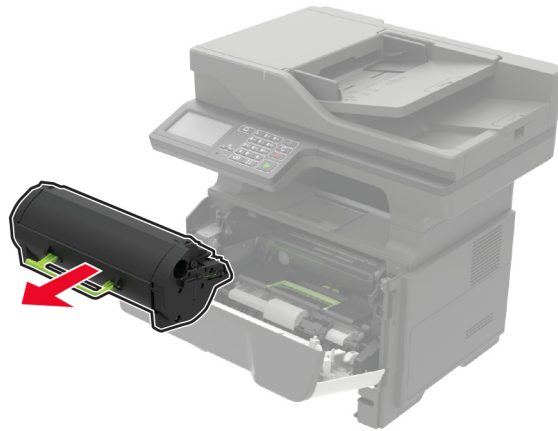

- 4 Remove the imaging unit.

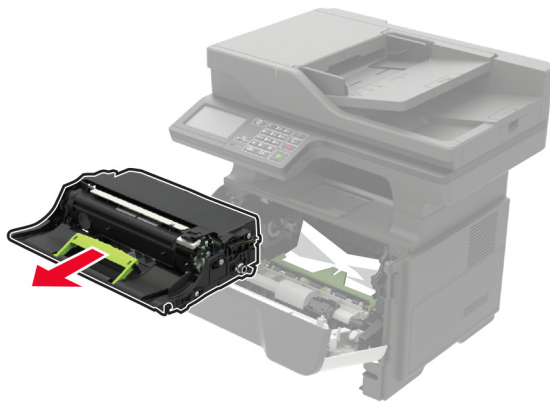

**Warning—Potential Damage:** Do not expose the imaging unit to direct light for more than 10 minutes. Extended exposure to light may cause print quality problems.

**Warning—Potential Damage:** Do not touch the photoconductor drum. Doing so may affect the quality of future print jobs.



5 Remove the jammed paper.

 **CAUTION—HOT SURFACE:** The inside of the printer might be hot. To reduce the risk of injury from a hot component, allow the surface to cool before touching it.

**Note:** Make sure that all paper fragments are removed.

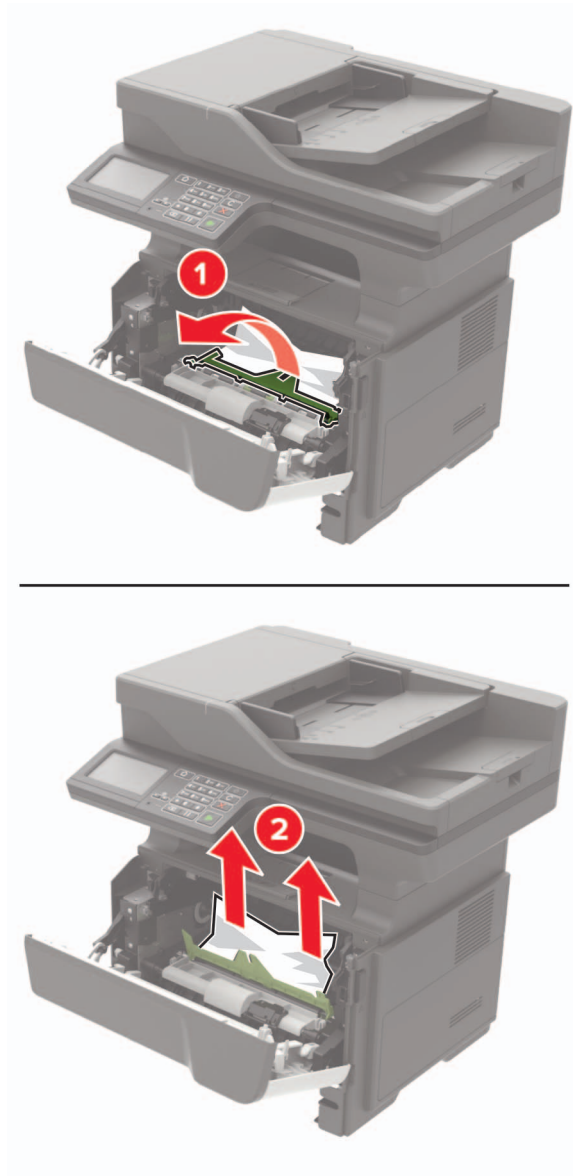

**6** Insert the imaging unit.

**Note:** Use the arrows inside the printer as guides.

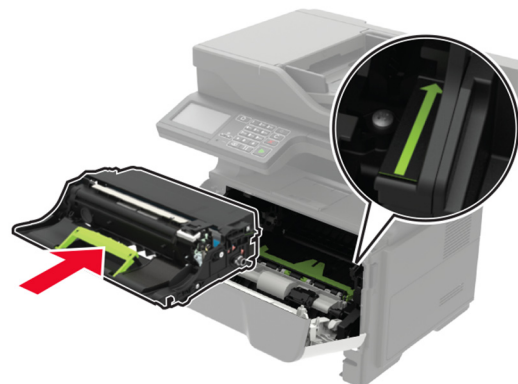

- 7 Insert the toner cartridge.

**Note:** Use the arrows inside the printer as guides.

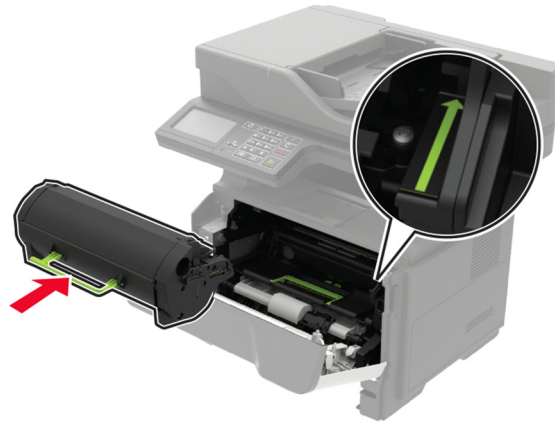

- 8 Close door A.
- 9 Insert the tray.

## Paper jam in the rear door

- 1 Open the rear door.

 **CAUTION—HOT SURFACE:** The inside of the printer might be hot. To reduce the risk of injury from a hot component, allow the surface to cool before touching it.

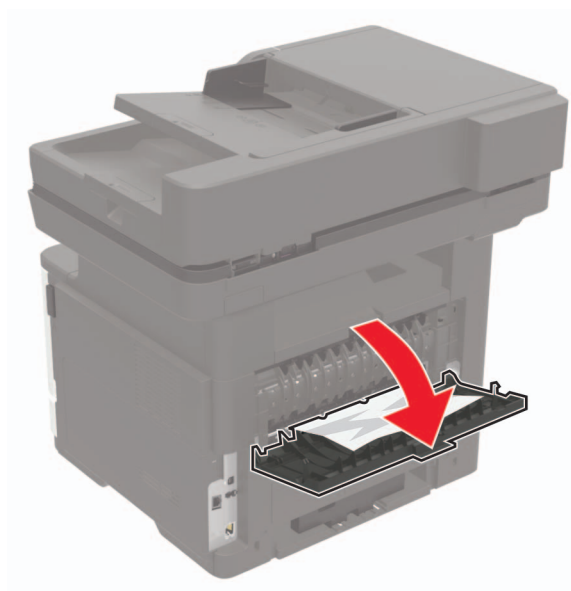

- 2 Remove the jammed paper.

**Note:** Make sure that all paper fragments are removed.

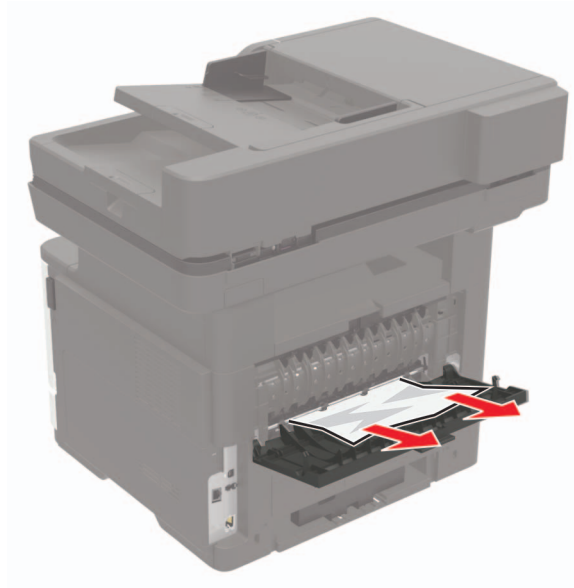

3 Close the rear door.

## Paper jam in the standard bin

Remove the jammed paper.

**Note:** Make sure that all paper fragments are removed.



## Paper jam in the duplex unit

1 Remove the tray.

**Warning—Potential Damage:** To prevent damage from electrostatic discharge, touch the metal plate at the back of the printer where the cables plug in before accessing or touching interior areas of the printer.



**2** Remove the jammed paper.

**Note:** Make sure that all paper fragments are removed.

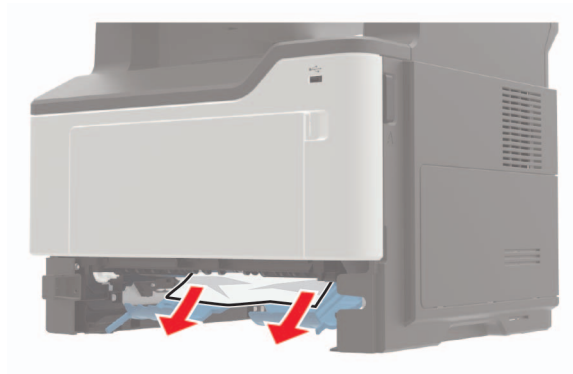

**3** Insert the tray.

## Paper jam in trays

**1** Remove the tray.

**Warning—Potential Damage:** To prevent damage from electrostatic discharge, touch the metal plate at the back of the printer where the cables plug in before accessing or touching interior areas of the printer.



**2** Remove the jammed paper.

**Note:** Make sure that all paper fragments are removed.

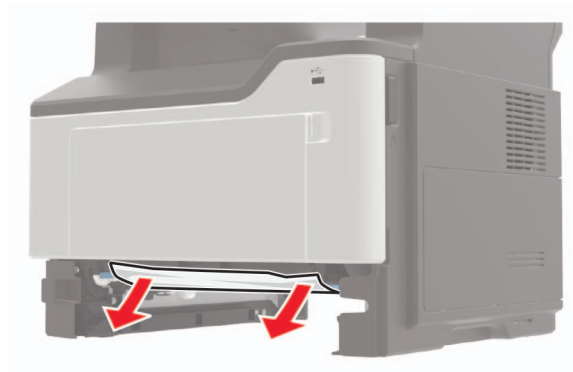

**3** Insert the tray.

## Paper jam in the multipurpose feeder

**1** Remove paper from the multipurpose feeder.

**2** Remove the jammed paper.

**Note:** Make sure that all paper fragments are removed.



**3** Flex, fan, and align the paper edges before loading.

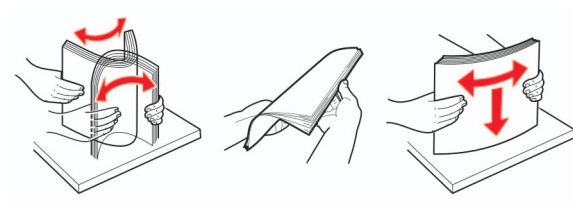

**4** Reload paper, and then adjust the paper guide.



## Paper jam in the automatic document feeder

- 1** Remove all original documents from the ADF tray.
- 2** Open the ADF cover.

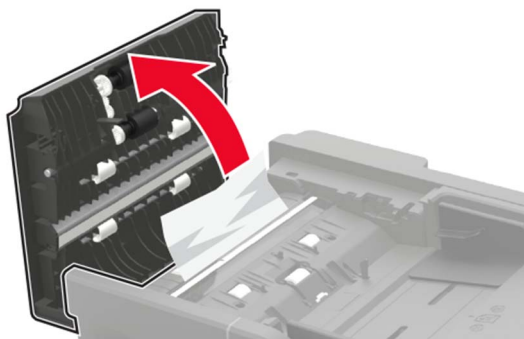

**3** Remove the jammed paper.

**Note:** Make sure that all paper fragments are removed.

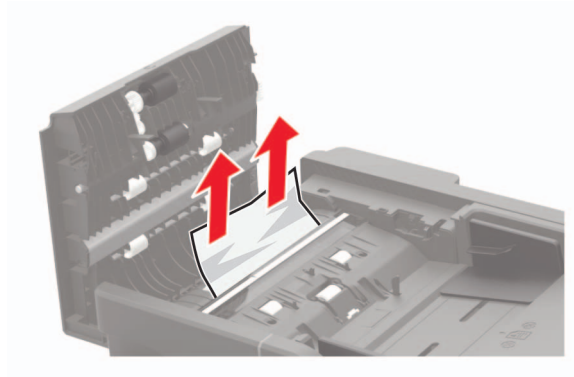

**4** Close the ADF cover.

# Troubleshooting

## Print quality problems

Find the image that resembles the print quality problem you are having, and then click the link below it to read problem-solving steps.

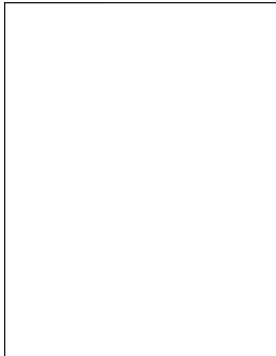

[“Blank or white pages” on page 198](#)

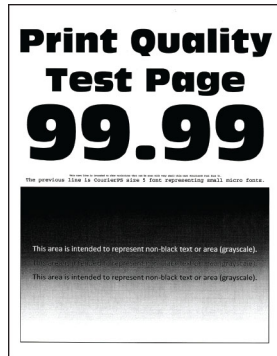

[“Dark print” on page 199](#)

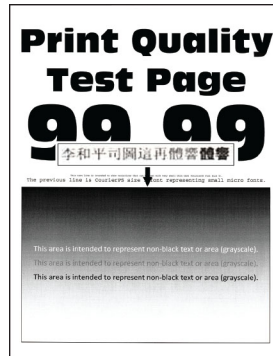

[“Fine lines are not printed correctly” on page 201](#)



[“Folded or wrinkled paper” on page 202](#)

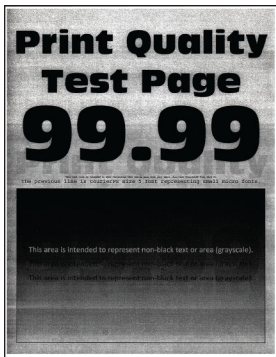

[“Gray background” on page 203](#)



[“Horizontal light bands” on page 205](#)



[“Incorrect margins” on page 205](#)

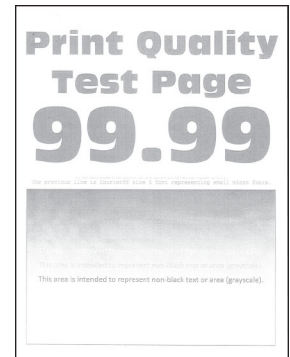

[“Light print” on page 206](#)

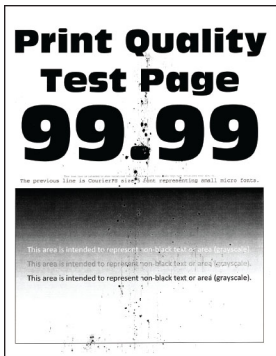

[“Mottled print and dots” on page 208](#)



[“Paper curl” on page 209](#)

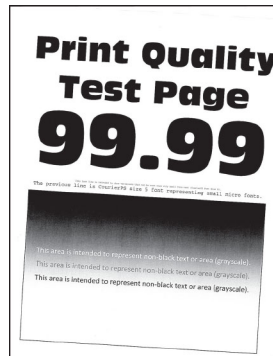

[“Print crooked or skewed” on page 210](#)



[“Repeating defects” on page 211](#)

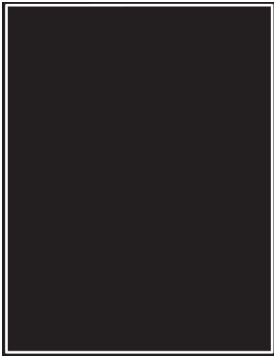

[“Solid black pages” on page 212](#)



[“Text or images cut off” on page 213](#)



[“Toner easily rubs off” on page 215](#)

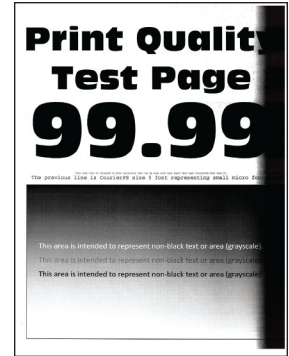

[“Vertical dark bands” on page 216](#)



[“Vertical dark lines or streaks” on page 217](#)

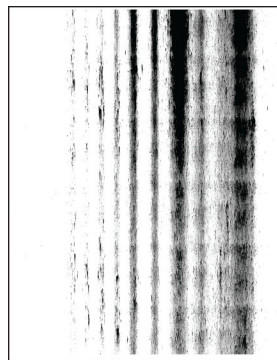

[“Vertical dark streaks with print missing” on page 218](#)



[“Vertical light bands” on page 219](#)



[“Vertical white lines” on page 220](#)

## Printing problems

### Print quality is poor

#### Blank or white pages



**Note:** Before solving the problem, print the Print Quality Test Pages. From the control panel, navigate to

**Settings > Troubleshooting > Print Quality Test Pages.** For non-touch-screen printer models, press  to navigate through the settings.

Action	Yes	No
<p><b>Step 1</b></p> <p><b>a</b> Check if the printer is using a genuine and supported Lexmark toner cartridge.</p> <p><b>Note:</b> If the cartridge is not supported, then install a supported one.</p> <p><b>b</b> Print the document.</p> <p>Is the printer printing blank or white pages?</p>	Go to step 2.	The problem is solved.
<p><b>Step 2</b></p> <p><b>a</b> Remove any packing material that is left on the imaging unit.</p> <p><b>1</b> Remove the toner cartridge, and then remove the imaging unit.</p> <p><b>Warning—Potential Damage:</b> Do not expose the imaging unit to direct light for more than 10 minutes. Extended exposure to light may cause print quality problems.</p> <p><b>Warning—Potential Damage:</b> Do not touch the photoconductor drum under the imaging unit. Doing so may affect the quality of future print jobs.</p> <p><b>2</b> Check the imaging unit for signs of damage, and replace if necessary.</p> <p><b>Note:</b> Make sure that the photoconductor drum contact is not bent or out of place.</p> <p><b>3</b> Firmly shake the imaging unit to redistribute the toner.</p> <p><b>4</b> Insert the imaging unit, and then insert the toner cartridge.</p> <p><b>b</b> Print the document.</p> <p>Is the printer printing blank or white pages?</p>	Go to step 3.	The problem is solved.
<p><b>Step 3</b></p> <p>Check the status of the toner cartridge, and replace if necessary.</p> <p><b>a</b> From the control panel, navigate to: <b>Status/Supplies &gt; Supplies</b></p> <p><b>b</b> Print the document.</p> <p>Is the printer printing blank or white pages?</p>	Contact <a href="#">customer support</a> .	The problem is solved.

**Dark print**





**Note:** Before solving the problem, print the Print Quality Test Pages. From the control panel, navigate to **Settings > Troubleshooting > Print Quality Test Pages**. For non-touch-screen printer models, press  to navigate through the settings.

Action	Yes	No
<p><b>Step 1</b></p> <p><b>a</b> Check if the printer is using a genuine and supported Lexmark toner cartridge.</p> <p><b>Note:</b> If the cartridge is not supported, then install a supported one.</p> <p><b>b</b> Print the document.</p> <p>Is the print dark?</p>	Go to step 2.	The problem is solved.
<p><b>Step 2</b></p> <p><b>a</b> Turn off the printer, wait for about 10 seconds, and then turn on the printer.</p> <p><b>b</b> Reduce toner darkness.</p> <p>From the control panel, navigate to:</p> <p><b>Settings &gt; Print &gt; Quality &gt; Toner Darkness</b></p> <p><b>c</b> Print the document.</p> <p>Is the print dark?</p>	Go to step 3.	The problem is solved.
<p><b>Step 3</b></p> <p><b>a</b> Depending on your operating system, specify the paper type from the Printing Preferences or Print dialog.</p> <p><b>Notes:</b></p> <ul style="list-style-type: none"> <li>• Make sure that the setting matches the paper loaded.</li> <li>• You can also change the setting on the printer control panel. Navigate to <b>Settings &gt; Paper &gt; Tray Configuration &gt; Paper Size/Type</b>.</li> </ul> <p><b>b</b> Print the document.</p> <p>Is the print dark?</p>	Go to step 4.	The problem is solved.
<p><b>Step 4</b></p> <p>Check if the paper has texture or rough finishes.</p> <p>Are you printing on textured or rough paper?</p>	Go to step 5.	Go to step 6.
<p><b>Step 5</b></p> <p><b>a</b> Replace textured paper with plain paper.</p> <p><b>b</b> Print the document.</p> <p>Is the print dark?</p>	Go to step 6.	The problem is solved.

Action	Yes	No
<p><b>Step 6</b></p> <p><b>a</b> Load paper from a fresh package.</p> <p><b>Note:</b> Paper absorbs moisture due to high humidity. Store paper in its original wrapper until you are ready to use it.</p> <p><b>b</b> Print the document.</p> <p>Is the print dark?</p>	Go to step 7.	The problem is solved.
<p><b>Step 7</b></p> <p><b>a</b> Remove, and then insert the imaging unit.</p> <p><b>Warning—Potential Damage:</b> Do not expose the imaging unit to direct light for more than 10 minutes. Extended exposure to light may cause print quality problems.</p> <p><b>Warning—Potential Damage:</b> Do not touch the photoconductor drum under the imaging unit. Doing so may affect the quality of future print jobs.</p> <p><b>b</b> Print the document.</p> <p>Is the print dark?</p>	Go to step 8.	The problem is solved.
<p><b>Step 8</b></p> <p><b>a</b> Replace the imaging unit.</p> <p><b>b</b> Print the document.</p> <p>Is the print dark?</p>	Contact <a href="#">customer support</a> .	The problem is solved.

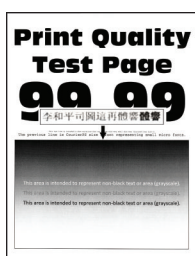
### Fine lines are not printed correctly



**Note:** Before solving the problem, print the Print Quality Test Pages. From the control panel, navigate to **Settings > Troubleshooting > Print Quality Test Pages**. For non-touch-screen printer models, press  to navigate through the settings.

Action	Yes	No
<p><b>Step 1</b></p> <p><b>a</b> Check if the printer is using a genuine and supported Lexmark toner cartridge.</p> <p><b>Note:</b> If the cartridge is not supported, then install a supported one.</p> <p><b>b</b> Print the document.</p> <p>Are fine lines not printed correctly?</p>	Go to step 2.	The problem is solved.
<p><b>Step 2</b></p> <p><b>a</b> Adjust the print quality settings.</p> <p>    <b>1</b> From the control panel, navigate to:                  <b>Settings &gt; Print &gt; Quality &gt; Pixel Boost &gt; Fonts</b></p> <p>    <b>2</b> Adjust Toner Darkness to 7. From the control panel, navigate to:                  <b>Settings &gt; Print &gt; Quality</b></p> <p><b>b</b> Print the document.</p> <p>Are fine lines not printed correctly?</p>	Contact <a href="#">customer support</a> .	The problem is solved.

**Folded or wrinkled paper**

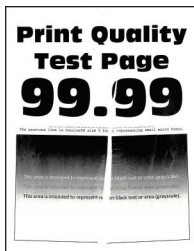

**Note:** Before solving the problem, print the Print Quality Test Pages. From the control panel, navigate to **Settings > Troubleshooting > Print Quality Test Pages**. For non-touch-screen printer models, press  to navigate through the settings.

Action	Yes	No
<p><b>Step 1</b></p> <p><b>a</b> Check if the printer is using a genuine and supported Lexmark toner cartridge.</p> <p><b>Note:</b> If the cartridge is not supported, then install a supported one.</p> <p><b>b</b> Print the document.</p> <p>Is the paper folded or wrinkled?</p>	Go to step 2.	The problem is solved.

Action	Yes	No
<p><b>Step 2</b></p> <p><b>a</b> Load paper from a fresh package.</p> <p><b>Note:</b> Paper absorbs moisture due to high humidity. Store paper in its original wrapper until you are ready to use it.</p> <p><b>b</b> Print the document.</p> <p>Is the paper folded or wrinkled?</p>	Go to step 3.	The problem is solved.
<p><b>Step 3</b></p> <p><b>a</b> Depending on your operating system, specify the paper type from the Printing Preferences or Print dialog.</p> <p><b>Notes:</b></p> <ul style="list-style-type: none"> <li>• Make sure that the setting matches the paper loaded.</li> <li>• You can also change the setting from the printer control panel. Navigate to <b>Settings &gt; Paper &gt; Tray Configuration &gt; Paper Size/Type.</b></li> </ul> <p><b>b</b> Print the document.</p> <p>Is the paper folded or wrinkled?</p>	Contact <a href="#">customer support</a> .	The problem is solved.

**Gray background**

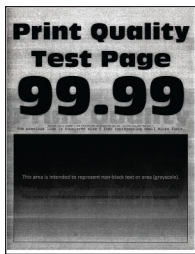

**Note:** Before solving the problem, print the Print Quality Test Pages. From the control panel, navigate to **Settings > Troubleshooting > Print Quality Test Pages.**

Action	Yes	No
<p><b>Step 1</b></p> <p><b>a</b> Turn off the printer, wait for 10 seconds, and then turn on the printer.</p> <p><b>b</b> Decrease toner darkness.</p> <p>From the control panel, navigate to <b>Settings &gt; Print &gt; Quality &gt; Toner Darkness.</b></p> <p><b>c</b> Print the document.</p> <p>Does gray background appear on prints?</p>	Go to step 2.	The problem is solved.

Action	Yes	No
<p><b>Step 2</b></p> <p><b>a</b> Check if the printer is using a genuine and supported Lexmark toner cartridge.</p> <p><b>Note:</b> If the cartridge is not supported, then install a supported one.</p> <p><b>b</b> Print the document.</p> <p>Does gray background appear on prints?</p>	<p>Go to step 3.</p>	<p>The problem is solved.</p>
<p><b>Step 3</b></p> <p><b>a</b> Depending on your operating system, specify the paper type from the Printing Preferences or Print dialog.</p> <p><b>Notes:</b></p> <ul style="list-style-type: none"> <li>• Make sure that the setting matches the paper loaded.</li> <li>• You can also change the setting from the printer control panel. Navigate to <b>Settings &gt; Paper &gt; Tray Configuration &gt; Paper Size/Type</b>.</li> </ul> <p><b>b</b> Print the document.</p> <p>Does gray background appear on prints?</p>	<p>Go to step 4.</p>	<p>The problem is solved.</p>
<p><b>Step 4</b></p> <p><b>a</b> Remove, and then insert the imaging unit.</p> <p><b>Warning—Potential Damage:</b> Do not expose the imaging unit to direct light. Extended exposure to light may cause print quality problems.</p> <p><b>Warning—Potential Damage:</b> Do not touch the photoconductor drum. Doing so may affect the quality of future print jobs.</p> <p><b>b</b> Print the document.</p> <p>Does gray background appear on prints?</p>	<p>Go to step 5.</p>	<p>The problem is solved.</p>
<p><b>Step 5</b></p> <p><b>a</b> Update the printer firmware. For more information, see the “Updating firmware” section.</p> <p><b>b</b> Print the document.</p> <p>Does gray background appear on prints?</p>	<p>Go to step 6.</p>	<p>The problem is solved.</p>
<p><b>Step 6</b></p> <p><b>a</b> Replace the imaging unit.</p> <p><b>b</b> Print the document.</p> <p>Does gray background appear on prints?</p>	<p>Contact <a href="#">customer support</a>.</p>	<p>The problem is solved.</p>

### Horizontal light bands



**Note:** Before solving the problem, print the Print Quality Test Pages. From the control panel, navigate to **Settings > Troubleshooting > Print Quality Test Pages**. For non-touch-screen printer models, press **OK** to navigate through the settings.

Action	Yes	No
<p><b>a</b> Check if the printer is using a genuine and supported Lexmark toner cartridge.</p> <p><b>Note:</b> If the cartridge is not supported, then install a supported one.</p> <p><b>b</b> Print the document.</p> <p>Do horizontal light bands appear on prints?</p>	Contact <a href="#">customer support</a> .	The problem is solved.

### Incorrect margins





**Note:** Before solving the problem, print the Print Quality Test Pages. From the control panel, navigate to **Settings > Troubleshooting > Print Quality Test Pages**. For non-touch-screen printer models, press **OK** to navigate through the settings.

Action	Yes	No
<p><b>Step 1</b></p> <p><b>a</b> Adjust the paper guides to the correct position for the paper loaded.</p> <p><b>b</b> Print the document.</p> <p>Are the margins correct?</p>	The problem is solved.	Go to step 2.

Action	Yes	No
<p><b>Step 2</b></p> <p><b>a</b> Depending on your operating system, specify the paper size from the Printing Preferences or Print dialog.</p> <p><b>Notes:</b></p> <ul style="list-style-type: none"> <li>• Make sure that the setting matches the paper loaded.</li> <li>• You can also change the setting from the printer control panel. Navigate to <b>Settings &gt; Paper &gt; Tray Configuration &gt; Paper Size/Type</b>.</li> </ul> <p><b>b</b> Print the document.</p> <p>Are the margins correct?</p>	<p>The problem is solved.</p>	<p>Contact <a href="#">customer support</a>.</p>

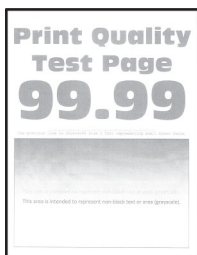
### Light print



**Note:** Before solving the problem, print the Print Quality Test Pages. From the control panel, navigate to **Settings > Troubleshooting > Print Quality Test Pages**. For non-touch-screen printer models, press  to navigate through the settings.

Action	Yes	No
<p><b>Step 1</b></p> <p><b>a</b> Check if the printer is using a genuine and supported Lexmark toner cartridge.</p> <p><b>Note:</b> If the cartridge is not supported, then install a supported one.</p> <p><b>b</b> Print the document.</p> <p>Is the print light?</p>	<p>Go to step 2.</p>	<p>The problem is solved.</p>
<p><b>Step 2</b></p> <p><b>a</b> Turn off the printer, wait for about 10 seconds, and then turn on the printer.</p> <p><b>b</b> Increase toner darkness.</p> <p>From the control panel, navigate to:</p> <p><b>Settings &gt; Print &gt; Quality &gt; Toner Darkness</b></p> <p><b>c</b> Print the document.</p> <p>Is the print light?</p>	<p>Go to step 3.</p>	<p>The problem is solved.</p>

Action	Yes	No
<p><b>Step 3</b></p> <p><b>a</b> Depending on your operating system, specify the paper type from the Printing Preferences or Print dialog.</p> <p><b>Notes:</b></p> <ul style="list-style-type: none"> <li>• Make sure that the setting matches the paper loaded.</li> <li>• You can also change the setting on the printer control panel. Navigate to <b>Settings &gt; Paper &gt; Tray Configuration &gt; Paper Size/Type</b>.</li> </ul> <p><b>b</b> Print the document.</p> <p>Is the print light?</p>	<p>Go to step 4.</p>	<p>The problem is solved.</p>
<p><b>Step 4</b></p> <p><b>a</b> Depending on your operating system, specify the print resolution from the Printing Preferences or Print dialog.</p> <p><b>b</b> Set the resolution to <b>600 dpi</b>.</p> <p><b>c</b> Print the document.</p> <p>Is the print light?</p>	<p>Go to step 5.</p>	<p>The problem is solved.</p>
<p><b>Step 5</b></p> <p><b>a</b> Remove the imaging unit.</p> <p><b>Warning—Potential Damage:</b> Do not expose the imaging unit to direct light for more than 10 minutes. Extended exposure to light can cause print quality problems.</p> <p><b>Warning—Potential Damage:</b> Do not touch the photoconductor drum under the imaging unit. Doing so may affect the quality of future print jobs.</p> <p><b>b</b> Firmly shake the imaging unit to redistribute the toner.</p> <p><b>c</b> Insert the imaging unit.</p> <p><b>d</b> Turn off the printer, wait for 10 seconds, and then turn on the printer.</p> <p><b>e</b> Print the document.</p> <p>Is the print light?</p>	<p>Go to step 6.</p>	<p>The problem is solved.</p>
<p><b>Step 6</b></p> <p><b>a</b> Check the status of the toner cartridge.</p> <p>From the control panel, navigate to:</p> <p><b>Settings &gt; Reports &gt; Device &gt; Device Statistics</b></p> <p><b>b</b> From the Supply Information section of the pages printed, check the status of the toner cartridge.</p> <p>Is the toner cartridge near end of life?</p>	<p>Go to step 7.</p>	<p>Contact <a href="#">customer support</a>.</p>

Action	Yes	No
<p><b>Step 7</b></p> <p><b>a</b> Replace the toner cartridge.</p> <p><b>b</b> Print the document.</p> <p>Is the print light?</p>	<p>Contact <a href="#">customer support</a>.</p>	<p>The problem is solved.</p>

Mottled print and dots

### Mottled print and dots



**Note:** Before solving the problem, print the Print Quality Test Pages. From the control panel, navigate to **Settings > Troubleshooting > Print Quality Test Pages**. For non-touch-screen printer models, press **OK** to navigate through the settings.

Action	Yes	No
<p><b>Step 1</b></p> <p><b>a</b> Check if the printer is using a genuine and supported Lexmark toner cartridge.</p> <p><b>Note:</b> If the toner cartridge is not supported, then install a supported one.</p> <p><b>b</b> Print the document.</p> <p>Is the print mottled?</p>	<p>Go to step 2.</p>	<p>The problem is solved.</p>
<p><b>Step 2</b></p> <p>Check the printer for leaked toner contamination.</p> <p>Is the printer free of leaked toner?</p>	<p>Go to step 4.</p>	<p>Go to step 3.</p>
<p><b>Step 3</b></p> <p><b>a</b> Replace the toner cartridge.</p> <p><b>b</b> Print the document.</p> <p>Is the print mottled?</p>	<p>Go to step 4.</p>	<p>The problem is solved.</p>

Action	Yes	No
<p><b>Step 4</b> Check the status of the imaging unit. From the control panel, navigate to: <b>Status/Supplies &gt; Supplies</b></p> <p>Is the imaging unit near end of life?</p>	Go to step 5.	Contact <a href="#">customer support</a> .
<p><b>Step 5</b> <b>a</b> Replace the imaging unit. <b>b</b> Print the document.</p> <p>Is the print mottled?</p>	Contact <a href="#">customer support</a> .	The problem is solved.

### Paper curl



Action	Yes	No
<p><b>Step 1</b> <b>a</b> Check if the printer is using a genuine and supported Lexmark toner cartridge. <b>Note:</b> If the toner cartridge is not supported, then install a supported one. <b>b</b> Print the document.</p> <p>Is the paper curled?</p>	Go to step 2.	The problem is solved.
<p><b>Step 2</b> <b>a</b> Adjust the guides in the tray to the correct position for the paper loaded. <b>b</b> Print the document.</p> <p>Is the paper curled?</p>	Go to step 3.	The problem is solved.

Action	Yes	No
<p><b>Step 3</b></p> <p><b>a</b> Depending on your operating system, specify the paper size and paper type from the Printing Preferences or Print dialog.</p> <p><b>Notes:</b></p> <ul style="list-style-type: none"> <li>• Make sure that the settings match the paper loaded.</li> <li>• You can also change the settings from the printer control panel.</li> </ul> <p><b>b</b> Print the document.</p> <p>Is the paper curled?</p>	Go to step 4.	The problem is solved.
<p><b>Step 4</b></p> <p><b>a</b> Remove paper from the tray, and then turn over the paper.</p> <p><b>b</b> Print the document.</p> <p>Is the paper curled?</p>	Go to step 5.	The problem is solved.
<p><b>Step 5</b></p> <p><b>a</b> Load paper from a fresh package.</p> <p><b>Note:</b> Paper absorbs moisture due to high humidity. Store paper in its original wrapper until you are ready to use it.</p> <p><b>b</b> Print the document.</p> <p>Is the paper curled?</p>	Go to step 6.	The problem is solved.
<p><b>Step 6</b></p> <p><b>a</b> Check if the paper loaded is supported.</p> <p><b>Note:</b> If paper is not supported, then load a supported one.</p> <p><b>b</b> Print the document.</p> <p>Is the paper curled?</p>	Contact <a href="#">customer support</a> .	The problem is solved.

**Print crooked or skewed**



**Note:** Before solving the problem, print the Print Quality Test Pages. From the home screen, touch **Settings > Troubleshooting > Print Quality Test Pages**.

Action	Yes	No
<p><b>Step 1</b></p> <p><b>a</b> Pull out the tray.</p> <p><b>b</b> Remove the paper, and then load paper from a fresh package.</p> <p><b>Note:</b> Paper absorbs moisture due to high humidity. Store paper in its original wrapper until you are ready to use it.</p> <p><b>c</b> Squeeze and slide the paper guides to the correct position for the size of the paper you are loading.</p> <p><b>d</b> Insert the tray.</p> <p><b>e</b> Print the document.</p> <p>Is the print crooked or skewed?</p>	Go to step 2.	The problem is solved.
<p><b>Step 2</b></p> <p><b>a</b> Check if you are printing on a supported paper.</p> <p><b>b</b> Print the document.</p> <p>Is the print crooked or skewed?</p>	Contact <a href="#">customer support</a> .	The problem is solved.

### Repeating defects



**Note:** Before solving the problem, print the Print Quality Test Pages. From the control panel, navigate to **Settings > Troubleshooting > Print Quality Test Pages**. For non-touch-screen printer models, press  to navigate through the settings.

Action	Yes	No
<p><b>Step 1</b></p> <p>Using the Print Quality Test Pages, check if the distance between the repeating defects is equal to any of the following:</p> <ul style="list-style-type: none"> <li>• 97 mm (3.82 in.)</li> <li>• 47 mm (1.85 in.)</li> <li>• 38 mm (1.5 in.)</li> </ul> <p>Does the distance between the repeating defects match any of the measurements?</p>	Go to step 2.	Take note of the distance, and then contact <a href="#">customer support</a> .

Action	Yes	No
<p><b>Step 2</b></p> <p><b>a</b> Replace the imaging unit.</p> <p><b>b</b> Print the document.</p> <p>Do the repeating defects appear?</p>	<p>Contact <a href="#">customer support</a>.</p>	<p>The problem is solved.</p>

### Solid black pages



**Note:** Before solving the problem, print the Print Quality Test Pages. From the control panel, navigate to **Settings > Troubleshooting > Print Quality Test Pages**. For non-touch-screen printer models, press  to navigate through the settings.

Action	Yes	No
<p><b>Step 1</b></p> <p><b>a</b> Check if the printer is using a genuine and supported Lexmark toner cartridge.</p> <p><b>Note:</b> If the toner cartridge is not supported, then install a supported one.</p> <p><b>b</b> Print the document.</p> <p>Is the printer printing solid black pages?</p>	<p>Go to step 2.</p>	<p>The problem is solved.</p>
<p><b>Step 2</b></p> <p><b>a</b> Remove, and then insert the imaging unit.</p> <p><b>Warning—Potential Damage:</b> Do not expose the imaging unit to direct light for more than 10 minutes. Extended exposure to light may cause print quality problems.</p> <p><b>Warning—Potential Damage:</b> Do not touch the photoconductor drum under the imaging unit. Doing so may affect the quality of future print jobs.</p> <p><b>b</b> Print the document.</p> <p>Is the printer printing solid black pages?</p>	<p>Go to step 3.</p>	<p>The problem is solved.</p>

Action	Yes	No
<p><b>Step 3</b></p> <p><b>a</b> Remove the imaging unit.</p> <p><b>Warning—Potential Damage:</b> Do not expose the imaging unit to direct light for more than 10 minutes. Extended exposure to light may cause print quality problems.</p> <p><b>Warning—Potential Damage:</b> Do not touch the photoconductor drum under the imaging unit. Doing so may affect the quality of future print jobs.</p> <p><b>b</b> Remove any packing material that is stuck on the imaging unit.</p>  <p><b>Note:</b> Make sure to remove any obstruction between the charge roller and photoconductor drum.</p> <p><b>c</b> Insert the imaging unit.</p> <p><b>d</b> Print the document.</p> <p>Is the printer printing solid black pages?</p>	<p>Go to step 4.</p>	<p>The problem is solved.</p>
<p><b>Step 4</b></p> <p>Check the imaging unit for signs of damage.</p> <p>Is the imaging unit free from damage?</p>	<p>Contact <a href="#">customer support</a>.</p>	<p>Go to step 5.</p>
<p><b>Step 5</b></p> <p><b>a</b> Replace the imaging unit.</p> <p><b>b</b> Print the document.</p> <p>Is the printer printing solid black pages?</p>	<p>Contact <a href="#">customer support</a>.</p>	<p>The problem is solved.</p>

Text or images cut off

**Text or images cut off**





**Note:** Before solving the problem, print the Print Quality Test Pages. From the control panel, navigate to **Settings > Troubleshooting > Print Quality Test Pages**. For non-touch-screen printer models, press **OK** to navigate through the settings.

Action	Yes	No
<p><b>Step 1</b></p> <p><b>a</b> Check if the printer is using a genuine and supported Lexmark toner cartridge.</p> <p><b>Note:</b> If the toner cartridge is not supported, then install a supported one.</p> <p><b>b</b> Print the document.</p> <p>Are text or images cut off?</p>	Go to step 2.	The problem is solved.
<p><b>Step 2</b></p> <p><b>a</b> Remove, and then insert the imaging unit.</p> <p><b>Warning—Potential Damage:</b> Do not expose the imaging unit to direct light for more than 10 minutes. Extended exposure to light may cause print quality problems.</p> <p><b>Warning—Potential Damage:</b> Do not touch the photoconductor drum under the imaging unit. Doing so may affect the quality of future print jobs.</p> <p><b>b</b> Print the document.</p> <p>Are text or images cut off?</p>	Go to step 3.	The problem is solved.
<p><b>Step 3</b></p> <p><b>a</b> Remove the imaging unit.</p> <p><b>Warning—Potential Damage:</b> Do not expose the imaging unit to direct light for more than 10 minutes. Extended exposure to light may cause print quality problems.</p> <p><b>Warning—Potential Damage:</b> Do not touch the photoconductor drum under the imaging unit. Doing so may affect the quality of future print jobs.</p> <p><b>b</b> Remove any packing material that is stuck on the imaging unit.</p> <div style="text-align: center;">  </div> <p><b>Note:</b> Make sure to remove any obstruction between the charge roller and photoconductor drum.</p> <p><b>c</b> Insert the imaging unit.</p> <p><b>d</b> Print the document.</p> <p>Are text or images cut off?</p>	Go to step 4.	The problem is solved.

Action	Yes	No
<p><b>Step 4</b></p> <p><b>a</b> Replace the imaging unit.</p> <p><b>b</b> Print the document.</p> <p>Are text or images cut off?</p>	<p>Contact <a href="#">customer support</a>.</p>	<p>The problem is solved.</p>

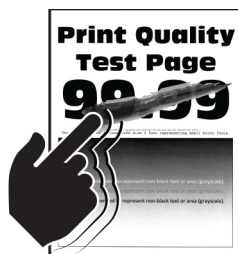
### Toner easily rubs off



**Note:** Before solving the problem, print the Print Quality Test Pages. From the control panel, navigate to **Settings > Troubleshooting > Print Quality Test Pages**. For non-touch-screen printer models, press  to navigate through the settings.

Action	Yes	No
<p><b>Step 1</b></p> <p><b>a</b> Check if the printer is using a genuine and supported Lexmark toner cartridge.</p> <p><b>Note:</b> If the toner cartridge is not supported, then install a supported one.</p> <p><b>b</b> Print the document.</p> <p>Does the toner easily rub off?</p>	<p>Go to step 2.</p>	<p>The problem is solved.</p>
<p><b>Step 2</b></p> <p><b>a</b> Depending on your operating system, specify the paper type from the Printing Preferences or Print dialog.</p> <p><b>Notes:</b></p> <ul style="list-style-type: none"> <li>• Make sure that the setting matches the paper loaded.</li> <li>• You can also change the setting on the printer control panel.</li> </ul> <p><b>b</b> Print the document.</p> <p>Does the toner easily rub off?</p>	<p>Contact <a href="#">customer support</a>.</p>	<p>The problem is solved.</p>

### Vertical dark bands

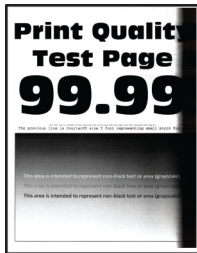

**Note:** Before solving the problem, print the Print Quality Test Pages. From the control panel, navigate to **Settings > Troubleshooting > Print Quality Test Pages**. For non-touch-screen printer models, press **OK** to navigate through the settings.

Action	Yes	No
<p><b>Step 1</b></p> <p><b>a</b> Check if the printer is using a genuine and supported Lexmark toner cartridge.</p> <p><b>Note:</b> If the toner cartridge is not supported, then install a supported one.</p> <p><b>b</b> Print the document.</p> <p>Do vertical dark bands appear on prints?</p>	Go to step 2.	The problem is solved.
<p><b>Step 2</b></p> <p><b>a</b> Remove the toner cartridge, and then remove the imaging unit.</p> <p><b>Warning—Potential Damage:</b> Do not expose the imaging unit to direct light for more than 10 minutes. Extended exposure to light may cause print quality problems.</p> <p><b>Warning—Potential Damage:</b> Do not touch the photoconductor drum under the imaging unit. Doing so may affect the quality of future print jobs.</p> <p><b>b</b> Insert the imaging unit, and then insert the cartridge.</p> <p><b>c</b> Print the document.</p> <p>Do vertical dark bands appear on prints?</p>	Go to step 3.	The problem is solved.

Action	Yes	No
<p><b>Step 3</b></p> <p><b>a</b> Remove the imaging unit.</p> <p><b>Warning—Potential Damage:</b> Do not expose the imaging unit to direct light for more than 10 minutes. Extended exposure to light may cause print quality problems.</p> <p><b>Warning—Potential Damage:</b> Do not touch the photoconductor drum under the imaging unit. Doing so may affect the quality of future print jobs.</p> <p><b>b</b> Remove any packing material that is stuck on the imaging unit.</p>  <p><b>Note:</b> Make sure to remove any obstruction between the charge roller and photoconductor drum.</p> <p><b>c</b> Insert the imaging unit.</p> <p><b>d</b> Print the document.</p> <p>Do vertical dark bands appear on prints?</p>	<p>Go to step 4.</p>	<p>The problem is solved.</p>
<p><b>Step 4</b></p> <p><b>a</b> Check if a bright light enters the right side of the printer, and move the printer if necessary.</p> <p><b>b</b> Print the document.</p> <p>Do vertical dark bands appear on prints?</p>	<p>Contact <a href="#">customer support</a>.</p>	<p>The problem is solved.</p>

**Vertical dark lines or streaks**





Action	Yes	No
<p><b>Step 1</b></p> <p><b>a</b> From the control panel, navigate to: <b>Settings &gt; Troubleshooting &gt; Cleaning the scanner</b></p> <p><b>b</b> Print the document.</p> <p>Do vertical dark lines or streaks appear on prints?</p>	<p>Go to step 3.</p>	<p>Go to step 2.</p>

Action	Yes	No
<p><b>Step 2</b></p> <p><b>a</b> Using a damp, soft, lint-free cloth, clean the scanner. For more information, see <a href="#">“Cleaning the scanner” on page 163</a>.</p> <p><b>b</b> Copy the document using the ADF.</p> <p>Do vertical dark lines or streaks appear on prints?</p>	<p>Contact <a href="#">customer support</a>.</p>	<p>The problem is solved.</p>
<p><b>Step 3</b></p> <p><b>a</b> Check if the printer is using a genuine and supported Lexmark toner cartridge.</p> <p><b>Note:</b> If the toner cartridge is not supported, then install a supported one.</p> <p><b>b</b> Print the document.</p> <p>Do vertical dark lines or streaks appear on prints?</p>	<p>Go to step 4.</p>	<p>The problem is solved.</p>
<p><b>Step 4</b></p> <p><b>a</b> Remove, and then insert the imaging unit.</p> <p><b>Warning—Potential Damage:</b> Do not expose the imaging unit to direct light for more than 10 minutes. Extended exposure to light can cause print quality problems.</p> <p><b>Warning—Potential Damage:</b> Do not touch the photoconductor drum under the imaging unit. Doing so may affect the quality of future print jobs.</p> <p><b>b</b> Print the document.</p> <p>Do vertical dark lines or streaks appear on prints?</p>	<p>Go to step 5.</p>	<p>The problem is solved.</p>
<p><b>Step 5</b></p> <p><b>a</b> Replace the imaging unit.</p> <p><b>b</b> Print the document.</p> <p>Do vertical dark lines or streaks appear on prints?</p>	<p>Contact <a href="#">customer support</a>.</p>	<p>The problem is solved.</p>

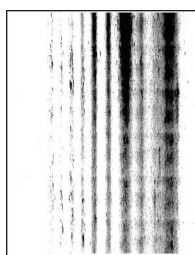
### Vertical dark streaks with print missing



**Note:** Before solving the problem, print the Print Quality Test Pages. From the control panel, navigate to **Settings > Troubleshooting > Print Quality Test Pages**. For non-touch-screen printer models, press  to navigate through the settings.

Action	Yes	No
<p><b>Step 1</b></p> <p><b>a</b> Remove the imaging unit.</p> <p><b>Warning—Potential Damage:</b> Do not expose the imaging unit to direct light for more than 10 minutes. Extended exposure to light may cause print quality problems.</p> <p><b>Warning—Potential Damage:</b> Do not touch the photoconductor drum under the imaging unit. Doing so may affect the quality of future print jobs.</p> <p><b>b</b> Remove any packing material that is stuck on the imaging unit.</p>  <p><b>Note:</b> Make sure to remove any obstruction between the charge roller and photoconductor drum.</p> <p><b>c</b> Insert the imaging unit.</p> <p><b>d</b> Print the document.</p> <p>Do vertical dark streaks with missing images appear on prints?</p>	<p>Go to step 2.</p>	<p>The problem is solved.</p>
<p><b>Step 2</b></p> <p><b>a</b> Check if the printer is using a genuine and supported Lexmark toner cartridge.</p> <p><b>Note:</b> If the toner cartridge is not supported, then install a supported one.</p> <p><b>b</b> Print the document.</p> <p>Do vertical dark streaks with missing images appear on prints?</p>	<p>Contact <a href="#">customer support</a>.</p>	<p>The problem is solved.</p>

### Vertical light bands



**Note:** Before solving the problem, print the Print Quality Test Pages. From the control panel, navigate to **Settings > Troubleshooting > Print Quality Test Pages**. For non-touch-screen printer models, press  to navigate through the settings.

Action	Yes	No
<p><b>a</b> Check if the printer is using a genuine and supported Lexmark toner cartridge.</p> <p><b>Note:</b> If the cartridge is not supported, then install a supported one.</p> <p><b>b</b> Print the document.</p> <p>Do vertical light bands appear on prints?</p>	Contact <a href="#">customer support</a> .	The problem is solved.

### Vertical white lines



**Note:** Before solving the problem, print the Print Quality Test Pages. From the control panel, navigate to **Settings > Troubleshooting > Print Quality Test Pages**. For non-touch-screen printer models, press **OK** to navigate through the settings.

Action	Yes	No
<p><b>Step 1</b></p> <p><b>a</b> Check if the printer is using a genuine and supported Lexmark toner cartridge.</p> <p><b>Note:</b> If the cartridge is not supported, then install a supported one.</p> <p><b>b</b> Print the document.</p> <p>Do vertical white lines appear on prints?</p>	Go to step 2.	The problem is solved.
<p><b>Step 2</b></p> <p><b>a</b> Depending on your operating system, specify the paper type from the Printing Preferences or Print dialog.</p> <p><b>Notes:</b></p> <ul style="list-style-type: none"> <li>• Make sure that the setting matches the paper loaded.</li> <li>• You can also change the setting on the printer control panel.</li> </ul> <p><b>b</b> Print the document.</p> <p>Do vertical white lines appear on prints?</p>	Contact <a href="#">customer support</a> .	The problem is solved.

## Print jobs do not print

Action	Yes	No
<p><b>Step 1</b></p> <p><b>a</b> From the document you are trying to print, open the Print dialog, and then check if you have selected the correct printer.</p> <p><b>b</b> Print the document.</p> <p>Is the document printed?</p>	The problem is solved.	Go to step 2.
<p><b>Step 2</b></p> <p><b>a</b> Check if the printer is on.</p> <p><b>b</b> Resolve any error messages that appear on the display.</p> <p><b>c</b> Print the document.</p> <p>Is the document printed?</p>	The problem is solved.	Go to step 3.
<p><b>Step 3</b></p> <p><b>a</b> Check if the ports are working and if the cables are securely connected to the computer and the printer. For more information, see the setup documentation that came with the printer.</p> <p><b>b</b> Print the document.</p> <p>Is the document printed?</p>	The problem is solved.	Go to step 4.
<p><b>Step 4</b></p> <p><b>a</b> Turn off the printer, wait for about 10 seconds, and then turn on the printer.</p> <p><b>b</b> Print the document.</p> <p>Is the document printed?</p>	The problem is solved.	Go to step 5.
<p><b>Step 5</b></p> <p><b>a</b> Remove, and then reinstall the print driver.</p> <p><b>b</b> Print the document.</p> <p>Is the document printed?</p>	The problem is solved.	Contact <a href="#">customer support</a> .

## Confidential and other held documents do not print

Action	Yes	No
<p><b>Step 1</b></p> <p><b>a</b> From the control panel, check if the documents appear in the Held Jobs list.</p> <p><b>Note:</b> If the documents are not listed, then print the documents using the Print and Hold options.</p> <p><b>b</b> Print the documents.</p> <p>Are the documents printed?</p>	The problem is solved.	Go to step 2.
<p><b>Step 2</b></p> <p>The print job may contain a formatting error or invalid data. Delete the print job, and then send it again.</p> <p>Are the documents printed?</p>	The problem is solved.	Go to step 3.
<p><b>Step 3</b></p> <p>If you are printing from the Internet, then the printer may be reading the multiple job titles as duplicates.</p> <p><b>For Windows users</b></p> <p><b>a</b> Open the Printing Preferences dialog.</p> <p><b>b</b> From the Print and Hold tab, click <b>Use Print and Hold</b>, and then click <b>Keep duplicate documents</b>.</p> <p><b>c</b> Enter a PIN, and then save the changes.</p> <p><b>d</b> Send the print job.</p> <p><b>For Macintosh users</b></p> <p><b>a</b> Save and name each job differently.</p> <p><b>b</b> Send the job individually.</p> <p>Are the documents printed?</p>	The problem is solved.	Go to step 4.
<p><b>Step 4</b></p> <p><b>a</b> Delete some held jobs to free up printer memory.</p> <p><b>b</b> Print the documents.</p> <p>Are the documents printed?</p>	The problem is solved.	Go to step 5.
<p><b>Step 5</b></p> <p><b>a</b> Add printer memory.</p> <p><b>b</b> Print the documents.</p> <p>Are the documents printed?</p>	The problem is solved.	Contact <a href="#">customer support</a> .

## Job prints from the wrong tray or on the wrong paper

Action	Yes	No
<p><b>Step 1</b></p> <p><b>a</b> Check if you are printing on the correct paper.</p> <p><b>b</b> Print the document.</p> <p>Is the document printed on the correct paper?</p>	Go to step 2.	Load the correct paper size and paper type.
<p><b>Step 2</b></p> <p><b>a</b> Depending on your operating system, specify the paper size and paper type from the Printing Preferences or Print dialog.</p> <p><b>Note:</b> You can also change the settings on the printer control panel. Navigate to:</p> <p><b>Settings &gt; Paper &gt; Tray Configuration &gt; Paper Size/Type</b></p> <p><b>b</b> Make sure that the settings match the paper loaded.</p> <p><b>c</b> Print the document.</p> <p>Is the document printed on the correct paper?</p>	The problem is solved.	Go to step 3.
<p><b>Step 3</b></p> <p><b>a</b> Check if the trays are linked.</p> <p>For more information, see <a href="#">“Linking trays” on page 32</a>.</p> <p><b>b</b> Print the document.</p> <p>Is the document printed from the correct tray?</p>	The problem is solved.	Contact <a href="#">customer support</a> .

## Slow printing

Action	Yes	No
<p><b>Step 1</b></p> <p><b>a</b> Make sure that the printer is not in Eco-Mode and Quiet Mode.</p> <p><b>b</b> Print the document.</p> <p>Is the printer still printing slow?</p>	Go to step 2.	The problem is solved.
<p><b>Step 2</b></p> <p><b>a</b> Depending on your operating system, specify the paper type from the Printing Preferences or Print dialog.</p> <p><b>Notes:</b></p> <ul style="list-style-type: none"> <li>• Make sure that the setting matches the paper loaded in the tray.</li> <li>• You can also change the setting from the Paper menu on the printer control panel.</li> </ul> <p><b>b</b> Print the document.</p> <p>Is the printer still printing slow?</p>	Go to step 3.	The problem is solved.

Action	Yes	No
<p><b>Step 3</b></p> <p><b>a</b> Reduce the number of pages to print.</p> <p><b>b</b> Print the document.</p> <p>Is the printer still printing slow?</p>	<p>Go to step 4.</p>	<p>The problem is solved.</p>
<p><b>Step 4</b></p> <p><b>a</b> Connect the printer cable securely to the printer and the computer, print server, option, or other network device.</p> <p><b>b</b> Print the document.</p> <p>Is the printer still printing slow?</p>	<p>Go to step 5.</p>	<p>The problem is solved.</p>
<p><b>Step 5</b></p> <p><b>a</b> From the Quality menu on the control panel, set Print Resolution to 600 dpi.</p> <p><b>b</b> Print the document.</p> <p>Is the printer still printing slow?</p>	<p>Go to step 6.</p>	<p>The problem is solved.</p>
<p><b>Step 6</b></p> <p><b>a</b> Make sure that the printer is not overheating.</p> <p><b>Notes:</b></p> <ul style="list-style-type: none"> <li>• Allow the printer to cool down after a very long print job.</li> <li>• Observe the recommended ambient temperature for the printer. For more information, see <a href="#">“Selecting a location for the printer” on page 13.</a></li> </ul> <p><b>b</b> Print the document.</p> <p>Is the printer still printing slow?</p>	<p>Go to step 7.</p>	<p>The problem is solved.</p>
<p><b>Step 7</b></p> <p><b>a</b> Add more printer memory.</p> <p><b>b</b> Print the document.</p> <p>Is the printer still printing slow?</p>	<p>Contact <a href="#">customer support</a>.</p>	<p>The problem is solved.</p>

## The printer is not responding

Action	Yes	No
<p><b>Step 1</b> Check if the power cord is connected to the electrical outlet.</p> <p> <b>CAUTION—POTENTIAL INJURY:</b> To avoid the risk of fire or electrical shock, connect the power cord to an appropriately rated and properly grounded electrical outlet that is near the product and easily accessible.</p> <p>Is the printer responding?</p>	The problem is solved.	Go to step 2.
<p><b>Step 2</b> Check if the electrical outlet is turned off by a switch or breaker.</p> <p>Is the electrical outlet turned off by a switch or breaker?</p>	Turn on the switch or reset the breaker.	Go to step 3.
<p><b>Step 3</b> Check if the printer is on.</p> <p>Is the printer on?</p>	Go to step 4.	Turn on the printer.
<p><b>Step 4</b> Check if the printer is in Sleep or Hibernate mode.</p> <p>Is the printer in Sleep or Hibernate mode?</p>	Press the power button to wake the printer.	Go to step 5.
<p><b>Step 5</b> Check if the cables connecting the printer and the computer are inserted to the correct ports.</p> <p>Are the cables inserted to the correct ports?</p>	Go to step 6.	Insert the cables to the correct ports.
<p><b>Step 6</b> Turn off the printer, install the hardware options, and then turn on the printer. For more information, see the documentation that came with the option.</p> <p>Is the printer responding?</p>	The problem is solved.	Go to step 7.
<p><b>Step 7</b> Install the correct print driver.</p> <p>Is the printer responding?</p>	The problem is solved.	Go to step 8.
<p><b>Step 8</b> Turn off the printer, wait for about 10 seconds, and then turn on the printer.</p> <p>Is the printer responding?</p>	The problem is solved.	Contact <a href="#">customer support</a> .

## Adjusting toner darkness

- 1 From the home screen, touch **Settings > Print > Quality**.
- 2 In the Toner Darkness menu, adjust the settings.

## Network connection problems

### Cannot open Embedded Web Server

Action	Yes	No
<p><b>Step 1</b> Check if the printer is on.</p> <p>Is the printer on?</p>	Go to step 2.	Turn on the printer.
<p><b>Step 2</b> Make sure that the printer IP address is correct.</p> <p><b>Notes:</b></p> <ul style="list-style-type: none"> <li>• View the IP address on the home screen.</li> <li>• An IP address appears as four sets of numbers separated by periods, such as 123.123.123.123.</li> </ul> <p>Is the printer IP address correct?</p>	Go to step 3.	Type the correct printer IP address in the address field.
<p><b>Step 3</b> Check if you are using a supported browser:</p> <ul style="list-style-type: none"> <li>• Internet Explorer version 11 or later</li> <li>• Microsoft Edge</li> <li>• Safari version 6 or later</li> <li>• Google Chrome™ version 32 or later</li> <li>• Mozilla Firefox version 24 or later</li> </ul> <p>Is your browser supported?</p>	Go to step 4.	Install a supported browser.
<p><b>Step 4</b> Check if the network connection is working.</p> <p>Is the network connection working?</p>	Go to step 5.	Contact your administrator.
<p><b>Step 5</b> Make sure that the cable connections to the printer and print server are secure. For more information, see the documentation that came with the printer.</p> <p>Are the cable connections secure?</p>	Go to step 6.	Secure the cable connections.

Action	Yes	No
<p><b>Step 6</b> Check if the web proxy servers are disabled.</p> <p>Are the web proxy servers disabled?</p>	Go to step 7.	Contact your administrator.
<p><b>Step 7</b> Access the Embedded Web Server.</p> <p>Did the Embedded Web Server open?</p>	The problem is solved.	Contact <a href="#">customer support</a> .

### Cannot connect the printer to the Wi-Fi network

Action	Yes	No
<p><b>Step 1</b> Make sure that Active Adapter is set to Auto. From the home screen, touch <b>Settings &gt; Network/Ports &gt; Network Overview &gt; Active Adapter &gt; Auto</b>.</p> <p>Can the printer connect to the Wi-Fi network?</p>	The problem is solved.	Go to step 2.
<p><b>Step 2</b> Check if the correct Wi-Fi network is selected. <b>Note:</b> Some routers may share the default SSID.</p> <p>Are you connecting to the correct Wi-Fi network?</p>	Go to step 4.	Go to step 3.
<p><b>Step 3</b> Connect to the correct Wi-Fi network. For more information, see <a href="#">“Connecting the printer to a Wi-Fi network” on page 158</a>.</p> <p>Can the printer connect to the Wi-Fi network?</p>	The problem is solved.	Go to step 4.
<p><b>Step 4</b> Check the wireless security mode. From the home screen, touch <b>Settings &gt; Network/Ports &gt; Wireless &gt; Wireless Security Mode</b>.</p> <p>Is the correct wireless security mode selected?</p>	Go to step 6.	Go to step 5.
<p><b>Step 5</b> Select the correct wireless security mode.</p> <p>Can the printer connect to the Wi-Fi network?</p>	The problem is solved.	Go to step 6.

Action	Yes	No
<p><b>Step 6</b> Make sure that you entered the correct network password. <b>Note:</b> Take note of the spaces, numbers, and capitalization in the password.</p> <p>Can the printer connect to the Wi-Fi network?</p>	The problem is solved.	Contact <a href="#">customer support</a> .

### Unable to read flash drive

Action	Yes	No
<p><b>Step 1</b> Check if the printer is not busy processing another print, copy, scan, or fax job.</p> <p>Is the printer ready?</p>	Go to step 2.	Wait for the printer to finish processing the other job.
<p><b>Step 2</b> Check if the flash drive is supported. For more information, see <a href="#">“Supported flash drives and file types” on page 41</a>.</p> <p>Is the flash drive supported?</p>	Go to step 3.	Insert a supported flash drive.
<p><b>Step 3</b> Remove, and then insert the flash drive.</p> <p>Does the printer recognize the flash drive?</p>	The problem is solved.	Contact <a href="#">customer support</a> .

### Enabling the USB port

From the home screen, touch **Settings > Network/Ports > USB > Enable USB Port**.

### Checking the printer connectivity

- From the home screen, touch **Settings > Reports > Network > Network Setup Page**.
- Check the first section of the network setup page, and confirm that the status is connected.  
If the status is not connected, then the LAN drop may be inactive, or the network cable may be malfunctioning. Contact your administrator for assistance.

# Hardware options problems

## Cannot detect internal option

Action	Yes	No
<p><b>Step 1</b> Turn off the printer, wait for about 10 seconds, and then turn on the printer.</p> <p>Does the internal option operate correctly?</p>	The problem is solved.	Go to step 2.
<p><b>Step 2</b> Print the Menu Settings Page, and then check if the internal option appears in the Installed Features list.</p> <p>Is the internal option listed in the menu settings page?</p>	Go to step 4.	Go to step 3.
<p><b>Step 3</b> Check if the internal option is installed properly into the controller board.</p> <ul style="list-style-type: none"> <li><b>a</b> Turn off the printer, and then unplug the power cord from the electrical outlet.</li> <li><b>b</b> Make sure that the internal option is installed in the appropriate connector in the controller board.</li> <li><b>c</b> Connect the power cord to the electrical outlet, and then turn on the printer.</li> </ul> <p> <b>CAUTION—POTENTIAL INJURY:</b> To avoid the risk of fire or electrical shock, connect the power cord to an appropriately rated and properly grounded electrical outlet that is near the product and easily accessible.</p> <p>Does the internal option operate correctly?</p>	The problem is solved.	Go to step 4.
<p><b>Step 4</b></p> <ul style="list-style-type: none"> <li><b>a</b> Check if the internal option is available in the print driver. <b>Note:</b> If necessary, manually add the internal option in the print driver to make it available for print jobs. For more information, see <a href="#">“Adding available options in the print driver” on page 266.</a></li> <li><b>b</b> Resend the print job.</li> </ul> <p>Does the internal option operate correctly?</p>	The problem is solved.	Contact <a href="#">customer support</a> .

### Internal solutions port does not operate correctly

Action	Yes	No
<p><b>Step 1</b> Print a menu settings page, and then check if the internal solutions port (ISP) appears in the Installed Features list.</p> <p>Is the ISP listed in the Installed Features list?</p>	Go to step 3.	Go to step 2.
<p><b>Step 2</b> Remove, and then install the ISP. For more information, see <a href="#">“Installing an internal solutions port” on page 256</a>.</p> <p><b>Note:</b> Use a supported ISP.</p> <p>Does the ISP operate correctly?</p>	The problem is solved.	Go to step 3.
<p><b>Step 3</b> Check the cable and the ISP connection.</p> <p><b>a</b> Use the correct cable, and then make sure that it is securely connected to the ISP.</p> <p><b>b</b> Check if the ISP solution interface cable is securely connected into the receptacle of the controller board.</p> <p>Does the ISP operate correctly?</p>	The problem is solved.	Contact <a href="#">customer support</a> .

### Defective flash detected

Try one or more of the following:

- Replace the defective flash memory.
- From the printer control panel, select **Continue** to ignore the message and continue printing.
- Cancel the current print job.

### Not enough free space in flash memory for resources

Try one or more of the following:

- From the printer control panel, select **Continue** to clear the message and continue printing.
- Delete fonts, macros, and other data stored in the flash memory.
- Install flash memory with larger capacity.

**Note:** Downloaded fonts and macros that are not previously stored in the flash memory are deleted.

## Unformatted flash detected

Try one or more of the following:

- From the control panel, select **Continue** to stop the defragmentation and continue printing.
- Format the flash memory.

**Note:** If the error message remains, then the flash memory may be defective and needs to be replaced.

## Issues with supplies

### Replace cartridge, printer region mismatch

To correct this problem, purchase a cartridge with the correct region that matches the printer region, or purchase a worldwide cartridge.

- The first number in the message after 42 indicates the region of the printer.
- The second number in the message after 42 indicates the region of the cartridge.

#### Printer and toner cartridge regions

Region	Numeric code
Worldwide or Undefined region	0
North America (United States, Canada)	1
European Economic Area, Western Europe, Nordic countries, Switzerland	2
Asia Pacific	3
Latin America	4
Rest of Europe, Middle East, Africa	5
Australia, New Zealand	6
Invalid region	9

**Note:** To find the region settings of the printer and toner cartridge, print the print quality test pages. From the control panel, navigate to: **Settings > Troubleshooting > Print Quality Test Pages.**

### Refilled regular [color] cartridge

The printer has detected a Lexmark Regular cartridge that has been refilled with non-genuine toner by a party other than Lexmark.

Select **OK** to continue.

All printer component life indicators are designed to function with Lexmark supplies and parts and may deliver unpredictable results when using supplies or parts in your Lexmark printer that are remanufactured by parties other than Lexmark.

For more information, see the printer statement of limited warranty.

## Non-Lexmark supply

The printer has detected a non-Lexmark supply or part installed in the printer.

Your Lexmark printer is designed to function best with genuine Lexmark supplies and parts. Use of third-party supplies or parts may affect the performance, reliability, or life of the printer and its imaging components.

All life indicators are designed to function with Lexmark supplies and parts and may deliver unpredictable results if third-party supplies or parts are used. Imaging component usage beyond the intended life may damage your Lexmark printer or associated components.

**Warning—Potential Damage:** Use of third-party supplies or parts can affect warranty coverage. Damage caused by the use of third-party supplies or parts may not be covered by the warranty.

To accept any and all of these risks and to proceed with the use of non-genuine supplies or parts in your printer, from the control panel, press and hold **X** and **#** simultaneously for 15 seconds.

If you do not want to accept these risks, then remove the third-party supply or part from your printer and install a genuine Lexmark supply or part. For more information, see [“Using genuine Lexmark parts and supplies” on page 166](#).

If the printer does not print after pressing and holding **X** and **#** simultaneously for 15 seconds, then reset the supply usage counter.

- 1 From the control panel, navigate to:  
**Settings > Device > Maintenance > Configuration Menu > Supply Usage And Counters**
- 2 Select the part or supply that you want to reset, and then select **Start**.
- 3 Read the warning message, and then select **Continue**.
- 4 Press and hold **X** and **#** simultaneously for 15 seconds to clear the message.

**Note:** If you are unable to reset the supply usage counters, then return the item to the place of purchase.

## Paper feed problems

### Envelope seals when printing

Action	Yes	No
<p><b>Step 1</b></p> <p><b>a</b> Use an envelope that has been stored in a dry environment.</p> <p><b>Note:</b> Printing on envelopes with high moisture content can seal the flaps.</p> <p><b>b</b> Send the print job.</p> <p>Does the envelope seal when printing?</p>	Go to step 2.	The problem is solved.

Action	Yes	No
<p><b>Step 2</b></p> <p><b>a</b> Make sure that paper type is set to Envelope. From the control panel, navigate to: <b>Settings &gt; Paper &gt; Tray Configuration &gt; Paper Size/Type</b></p> <p><b>b</b> Send the print job.</p> <p>Does the envelope seal when printing?</p>	<p>Contact <a href="#">customer support</a>.</p>	<p>The problem is solved.</p>

### Collated printing does not work

Action	Yes	No
<p><b>Step 1</b></p> <p><b>a</b> From the control panel, navigate to: <b>Settings &gt; Print &gt; Layout &gt; Collate</b></p> <p><b>b</b> Touch <b>On [1,2,1,2,1,2]</b>.</p> <p><b>c</b> Print the document.</p> <p>Is the document collated correctly?</p>	<p>The problem is solved.</p>	<p>Go to step 2.</p>
<p><b>Step 2</b></p> <p><b>a</b> From the document that you are trying to print, open the Print dialog, and then select <b>Collate</b>.</p> <p><b>b</b> Print the document.</p> <p>Is the document collated correctly?</p>	<p>The problem is solved.</p>	<p>Go to step 3.</p>
<p><b>Step 3</b></p> <p><b>a</b> Reduce the number of pages to print.</p> <p><b>b</b> Print the document.</p> <p>Are the pages collated correctly?</p>	<p>The problem is solved.</p>	<p>Contact <a href="#">customer support</a>.</p>

### Tray linking does not work

Action	Yes	No
<p><b>Step 1</b></p> <p><b>a</b> Check if the trays contain the same paper size and paper type.</p> <p><b>b</b> Check if the paper guides are positioned correctly.</p> <p><b>c</b> Print the document.</p> <p>Do the trays link correctly?</p>	<p>The problem is solved.</p>	<p>Go to step 2.</p>

Action	Yes	No
<p><b>Step 2</b></p> <p><b>a</b> From the control panel, touch <b>Settings &gt; Paper &gt; Tray Configuration &gt; Paper Size/Type</b></p> <p><b>b</b> Set the paper size and paper type to match the paper loaded in the linked trays.</p> <p><b>c</b> Print the document.</p> <p>Do the trays link correctly?</p>	<p>The problem is solved.</p>	<p>Go to step 3.</p>
<p><b>Step 3</b></p> <p><b>a</b> Make sure that Tray Linking is set to Automatic. For more information, see <a href="#">“Linking trays” on page 32</a>.</p> <p><b>b</b> Print the document.</p> <p>Do the trays link correctly?</p>	<p>The problem is solved.</p>	<p>Contact <a href="#">customer support</a>.</p>

### Paper frequently jams

Action	Yes	No
<p><b>Step 1</b></p> <p><b>a</b> Remove the tray.</p> <p><b>b</b> Check if paper is loaded correctly.</p> <p><b>Notes:</b></p> <ul style="list-style-type: none"> <li>• Make sure that the paper guides are positioned correctly.</li> <li>• Make sure that the stack height is below the maximum paper fill indicator.</li> <li>• Make sure to print on recommended paper size and type.</li> </ul> <p><b>c</b> Insert the tray.</p> <p><b>d</b> Print the document.</p> <p>Do paper jams occur frequently?</p>	<p>Go to step 2.</p>	<p>The problem is solved.</p>
<p><b>Step 2</b></p> <p><b>a</b> From the control panel, navigate to: <b>Settings &gt; Paper &gt; Tray Configuration &gt; Paper Size/Type</b></p> <p><b>b</b> Set the correct paper size and type.</p> <p><b>c</b> Print the document.</p> <p>Do paper jams occur frequently?</p>	<p>Go to step 3.</p>	<p>The problem is solved.</p>

Action	Yes	No
<p><b>Step 3</b></p> <p><b>a</b> Load paper from a fresh package.</p> <p><b>Note:</b> Paper absorbs moisture due to high humidity. Store paper in its original wrapper until you are ready to use it.</p> <p><b>b</b> Print the document.</p> <p>Do paper jams occur frequently?</p>	<p>Contact <a href="#">customer support</a>.</p>	<p>The problem is solved.</p>

### Jammed pages are not reprinted

Action	Yes	No
<p><b>a</b> From the control panel, navigate to: <b>Settings &gt; Device &gt; Notifications &gt; Jam Content Recovery</b></p> <p><b>b</b> In the Jam Recovery menu, select <b>On</b> or <b>Auto</b>.</p> <p><b>c</b> Print the document.</p> <p>Are the jammed pages reprinted?</p>	<p>The problem is solved.</p>	<p>Contact <a href="#">customer support</a>.</p>

## E-mailing problems

### Cannot send e-mails

Action	Yes	No
<p><b>Step 1</b></p> <p>Make sure that the e-mail SMTP settings are configured correctly. For more information, see <a href="#">“Configuring the e-mail SMTP settings” on page 48</a>.</p> <p>Can you send an e-mail?</p>	<p>The problem is solved.</p>	<p>Go to step 2.</p>
<p><b>Step 2</b></p> <p>Make sure that you are using the correct password. Depending on your e-mail service provider, use your account password, app password, or authentication password. For more information, see <a href="#">“Configuring the e-mail SMTP settings” on page 48</a>.</p> <p>Can you send an e-mail?</p>	<p>The problem is solved.</p>	<p>Go to step 3.</p>
<p><b>Step 3</b></p> <p>Make sure that the printer is connected to a network and that the network is connected to the Internet.</p> <p>Can you send an e-mail?</p>	<p>The problem is solved.</p>	<p>Contact <a href="#">customer support</a>.</p>

## Faxing problems

### Caller ID is not shown

**Note:** These instructions apply only to printers that support analog fax. For more information, see [“Setting up the printer to fax” on page 57.](#)

Action	Yes	No
<p>Enable caller ID.</p> <p>From the home screen, touch <b>Settings &gt; Fax &gt; Fax Setup &gt; Fax Receive Settings &gt; Admin Controls &gt; Enable Caller ID.</b></p> <p>Does the caller ID appear?</p>	<p>The problem is solved.</p>	<p>Contact <a href="#">customer support.</a></p>

### Cannot set up etherFAX

Action	Yes	No
<p><b>Step 1</b></p> <p>Check the printer connectivity.</p> <p><b>a</b> Print the Network Setup Page. From the home screen, touch <b>Settings &gt; Reports &gt; Network &gt; Network Setup Page.</b></p> <p><b>b</b> Check the network status.</p> <p>Is the printer connected to the network?</p>	<p>Go to step 3.</p>	<p>Go to step 2.</p>
<p><b>Step 2</b></p> <p>Make sure that the printer is connected to a network and that the network is connected to the Internet.</p> <p>Can you set up etherFAX?</p>	<p>The problem is solved.</p>	<p>Go to step 3.</p>
<p><b>Step 3</b></p> <p>Make sure that etherFAX is set up correctly. For more information, see <a href="#">“Setting up the fax function using etherFAX” on page 60.</a></p> <p>Can you set up etherFAX?</p>	<p>The problem is solved.</p>	<p>Go to <a href="https://www.etherfax.net/lexmark">https://www.etherfax.net/lexmark.</a></p>

### Cannot send or receive faxes using analog fax

Action	Yes	No
<p><b>Step 1</b> Resolve any error messages that appear on the display.</p> <p>Can you send or receive a fax?</p>	The problem is solved.	Go to step 2.
<p><b>Step 2</b> Make sure that the cable connections for the following equipment are secure:</p> <ul style="list-style-type: none"> <li>• Telephone</li> <li>• Handset</li> <li>• Answering machine</li> </ul> <p>Can you send or receive a fax?</p>	The problem is solved.	Go to step 3.
<p><b>Step 3</b> Check for a dial tone.</p> <ul style="list-style-type: none"> <li>• Call the fax number to check if it is working properly.</li> <li>• If you are using the On Hook Dial feature, then turn up the volume to check if you hear a dial tone.</li> </ul> <p>Can you hear a dial tone?</p>	Go to step 5.	Go to step 4.
<p><b>Step 4</b> Check the telephone wall jack.</p> <ol style="list-style-type: none"> <li>a Connect the analog telephone directly to the wall jack.</li> <li>b Listen for a dial tone.</li> <li>c If you do not hear a dial tone, then use a different telephone cable.</li> <li>d If you still do not hear a dial tone, then connect the analog telephone to a different wall jack.</li> <li>e If you hear a dial tone, then connect the printer to that wall jack.</li> </ol> <p>Can you send or receive a fax?</p>	The problem is solved.	Go to step 5.

Action	Yes	No
<p><b>Step 5</b></p> <p>Check if the printer is connected to an analog phone service or to the correct digital connector.</p> <ul style="list-style-type: none"> <li>• If you are using an Integrated Services for Digital Network (ISDN) telephone service, then connect to an analog telephone port of an ISDN terminal adapter. For more information, contact your ISDN provider.</li> <li>• If you are using DSL, then connect to a DSL filter or router that supports analog use. For more information, contact your DSL provider.</li> <li>• If you are using a private branch exchange (PBX) telephone service, then make sure that you are connecting to an analog connection on the PBX. If none exists, then consider installing an analog telephone line for the fax machine.</li> </ul> <p>Can you send or receive a fax?</p>	<p>The problem is solved.</p>	<p>Go to step 6.</p>
<p><b>Step 6</b></p> <p>Temporarily disconnect other equipment and disable other telephone services.</p> <ul style="list-style-type: none"> <li><b>a</b> Disconnect other equipment (such as answering machines, computers, modems, or telephone line splitters) between the printer and the telephone line.</li> <li><b>b</b> Disable call waiting and voice mail. For more information, contact your telephone company.</li> </ul> <p>Can you send or receive a fax?</p>	<p>The problem is solved.</p>	<p>Go to step 7.</p>
<p><b>Step 7</b></p> <p>Scan the original document one page at a time.</p> <ul style="list-style-type: none"> <li><b>a</b> Dial the fax number.</li> <li><b>b</b> Scan the document.</li> </ul> <p>Can you send or receive a fax?</p>	<p>The problem is solved.</p>	<p>Contact <a href="#">customer support</a>.</p>

### Cannot send or receive faxes using etherFAX

Action	Yes	No
<p><b>Step 1</b>                      Make sure that the printer is connected to a network and that the network is connected to the Internet.</p> <p>Can you send or receive faxes using etherFAX?</p>	The problem is solved.	Go to step 2.
<p><b>Step 2</b>                      a From the control panel, navigate to:  <b>Settings &gt; Fax &gt; Fax Setup &gt; General Fax Settings.</b></p> <p>For non-touch-screen printer models, press  to navigate through the settings.</p> <p>b Make sure that you have the correct fax number.                      c Make sure that Fax Transport is set to etherFAX.</p> <p>Can you send or receive faxes using etherFAX?</p>	The problem is solved.	Go to step 3.
<p><b>Step 3</b>                      Split large documents into smaller file sizes.</p> <p>Can you send or receive faxes using etherFAX?</p>	The problem is solved.	Go to <a href="https://www.etherfax.net/lexmark">https://www.etherfax.net/lexmark</a> .

### Can receive but not send faxes using analog fax

Action	Yes	No
<p><b>Step 1</b>                      Load an original document properly into the ADF tray or on the scanner glass.</p> <p>Can you send faxes?</p>	The problem is solved.	Go to step 2.
<p><b>Step 2</b>                      Set up the shortcut number properly.</p> <ul style="list-style-type: none"> <li>• Check if the shortcut number is set for the telephone number that you want to dial.</li> <li>• Dial the telephone number manually.</li> </ul> <p>Can you send faxes?</p>	The problem is solved.	Contact <a href="#">customer support</a> .

### Can send but not receive faxes using analog fax

Action	Yes	No
<p><b>Step 1</b> Make sure that the paper source is not empty.</p> <p>Can you receive faxes?</p>	The problem is solved.	Go to step 2.
<p><b>Step 2</b> Check the ring count delay settings. From the home screen, touch <b>Settings &gt; Fax &gt; Fax Setup &gt; Fax Receive Settings &gt; Rings to Answer</b>.</p> <p>Can you receive faxes?</p>	The problem is solved.	Go to step 3.
<p><b>Step 3</b> If the printer is printing blank pages, then see <a href="#">“Blank or white pages” on page 198</a>.</p> <p>Can you receive faxes?</p>	The problem is solved.	Contact <a href="#">customer support</a> .

### Poor fax print quality

Action	Yes	No
<p><b>Step 1</b> Make sure that there are no print quality defects.</p> <p><b>a</b> From the control panel, touch <b>Settings &gt; Troubleshooting &gt; Print Quality Test Pages</b>.</p> <p><b>b</b> Correct any print quality defects. For more information, see <a href="#">“Print quality is poor” on page 198</a>.</p> <p>Is the fax print quality satisfactory?</p>	The problem is solved.	Go to step 2.
<p><b>Step 2</b> Decrease the incoming fax transmission speed.</p> <p><b>a</b> From the control panel, touch <b>Settings &gt; Fax &gt; Fax Setup &gt; Fax Receive Settings &gt; Admin Controls</b>.</p> <p><b>b</b> In the Max Speed menu, select a lower transmission speed.</p> <p>Is the fax print quality satisfactory?</p>	The problem is solved.	Contact <a href="#">customer support</a> .

### Missing information on the fax cover page

Action	No	Yes
<p><b>a</b> Turn off the printer, wait for about 10 seconds, and then turn on the printer.</p> <p><b>b</b> Send or retrieve the fax.</p> <p>Is there missing information on the fax cover page?</p>	The problem is solved.	Contact <a href="#">customer support</a> .

### Cannot send the fax cover page from the computer

Action	Yes	No
<p><b>Step 1</b></p> <p><b>a</b> Make sure that the print driver is updated. For more information, see <a href="#">“Installing the printer software” on page 264</a>.</p> <p><b>b</b> Send the fax.</p> <p>Can you send the fax cover page?</p>	The problem is solved.	Go to step 2.
<p><b>Step 2</b></p> <p><b>a</b> From the document that you are trying to fax, open the Print dialog.</p> <p><b>b</b> Select the printer, and then click <b>Properties, Preferences, Options,</b> or <b>Setup</b>.</p> <p><b>c</b> Click <b>Fax</b>, and then clear the <b>Always display settings prior to faxing</b> setting.</p> <p><b>d</b> Send the fax.</p> <p>Can you send the fax cover page?</p>	The problem is solved.	Contact <a href="#">customer support</a> .

## Scanning problems

### Cannot scan to a computer

Action	Yes	No
<p><b>Step 1</b></p> <p>Perform a copy job.</p> <p>Is the copy job successful?</p>	Go to step 3.	Go to step 2.
<p><b>Step 2</b></p> <p><b>a</b> Turn off the printer, wait for about 10 seconds, and then turn it back on.</p> <p><b>b</b> Scan the document.</p> <p>Can you scan the document to a computer?</p>	The problem is solved.	Go to step 3.

Action	Yes	No
<p><b>Step 3</b>                      Check the printer connectivity.</p> <ul style="list-style-type: none"> <li><b>a</b> Print the Network Setup Page. From the control panel, navigate to:  <b>Settings &gt; Reports &gt; Network &gt; Network Setup Page.</b></li> <li><b>b</b> Check the network status.</li> </ul> <p>Is the printer connected to the network?</p>	Go to step 5.	Go to step 4.
<p><b>Step 4</b>  <ul style="list-style-type: none"> <li><b>a</b> Connect the printer to the network.</li> <li><b>b</b> Scan the document.</li> </ul>                     Can you scan the document to a computer?</p>	The problem is solved.	Go to step 5.
<p><b>Step 5</b>  <ul style="list-style-type: none"> <li><b>a</b> Make sure that the printer and the computer are connected to the same network.</li> <li><b>b</b> Scan the document.</li> </ul>                     Can you scan the document to a computer?</p>	The problem is solved.	Contact <a href="#">customer support</a> .

### Cannot scan to a network folder

Action	Yes	No
<p><b>Step 1</b>  <ul style="list-style-type: none"> <li><b>a</b> Create a network folder shortcut.</li> <li><b>b</b> Scan a document using the shortcut. For more information, see <a href="#">“Scanning to a network folder” on page 72</a>.</li> </ul>                     Can you scan a document and save it to a network folder?</p>	The problem is solved.	Go to step 2.
<p><b>Step 2</b>                      Make sure that the network folder path and format are correct. For example, <code>//server_hostname/foldername/path</code>, where <b>server_hostname</b> is a fully qualified domain (FQDN) or IP address.                      Is the network folder path and format correct?</p>	Go to step 3.	Go to step 4.
<p><b>Step 3</b>                      Make sure that you have a write access permission to the network folder.                      Can you scan a document and save it to a network folder?</p>	The problem is solved.	Go to step 4.

Action	Yes	No
<p><b>Step 4</b> Update the network folder shortcut.</p> <p><b>a</b> Open a web browser, and then type the printer IP address in the address field.</p> <p><b>Notes:</b></p> <ul style="list-style-type: none"> <li>View the printer IP address on the home screen. The IP address appears as four sets of numbers separated by periods, such as 123.123.123.123.</li> <li>If you are using a proxy server, then temporarily disable it to load the web page correctly.</li> </ul> <p><b>b</b> Click <b>Shortcuts</b>, and then select a shortcut.</p> <p><b>Note:</b> If you have multiple shortcut types, then select <b>Network Folder</b>.</p> <p><b>c</b> In the Share Path field, type the network folder path.</p> <p><b>Notes:</b></p> <ul style="list-style-type: none"> <li>If your share path is <code>\\server_hostname\foldername\path</code>, then type <code>//server_hostname/foldername/path</code>.</li> <li>Make sure that you use forward slashes when typing the share path.</li> </ul> <p><b>d</b> From the Authentication menu, select your authentication method.</p> <p><b>Note:</b> If Authentication is set to “Use assigned username and password,” then in the User Name and Password fields, type your credentials.</p> <p><b>e</b> Click <b>Save</b>.</p> <p>Can you scan a document and save it to a network folder?</p>	<p>The problem is solved.</p>	<p>Go to step 5.</p>
<p><b>Step 5</b> Make sure that the printer and the network folder are connected to the same network.</p> <p>Can you scan a document and save it to a network folder?</p>	<p>The problem is solved.</p>	<p>Contact <a href="#">customer support</a>.</p>

### Partial copies of document or photo

Action	Yes	No
<p><b>Step 1</b></p> <p><b>a</b> Make sure that the document or photo is loaded facedown on the upper left corner of the scanner glass.</p> <p><b>b</b> Copy the document or photo.</p> <p>Is the document or photo copied correctly?</p>	<p>The problem is solved.</p>	<p>Go to step 2.</p>

Action	Yes	No
<p><b>Step 2</b></p> <p><b>a</b> Match the paper size setting and the paper loaded in the tray.</p> <p><b>b</b> Copy the document or photo.</p> <p>Is the document or photo copied correctly?</p>	<p>The problem is solved.</p>	<p>Contact <a href="#">customer support</a>.</p>

### Poor copy quality

Action	Yes	No
<p><b>Step 1</b></p> <p><b>a</b> Clean the scanner glass and the ADF glass with a damp, soft, lint-free cloth. If your printer has a second ADF glass inside the ADF, then also clean that glass. For more information, see <a href="#">“Cleaning the scanner” on page 163</a>.</p> <p><b>b</b> Make sure that the document or photo is loaded facedown on the upper left corner of the scanner glass.</p> <p><b>c</b> Copy the document or photo.</p> <p>Is the copy quality satisfactory?</p>	<p>The problem is solved.</p>	<p>Go to step 2.</p>
<p><b>Step 2</b></p> <p><b>a</b> Check the quality of the original document or photo.</p> <p><b>b</b> Adjust the scan quality settings.</p> <p><b>c</b> Copy the document or photo.</p> <p>Is the copy quality satisfactory?</p>	<p>The problem is solved.</p>	<p>Contact <a href="#">customer support</a>.</p>

### Vertical dark streaks on output when scanning from the ADF

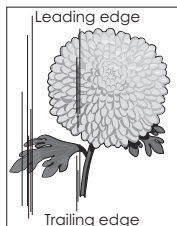
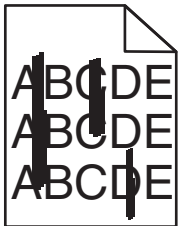

Action	Yes	No
<p><b>a</b> Open the scanner cover.</p> <p><b>b</b> Using a damp, soft, lint-free cloth, wipe the ADF glass and the ADF glass pad.</p> <p><b>c</b> Close the scanner cover.</p> <p><b>d</b> Scan the document.</p> <p>Do vertical streaks appear on scanned documents?</p>	<p>Contact <a href="#">customer support</a>.</p>	<p>The problem is solved.</p>

### Jagged image or text when scanning from the ADF

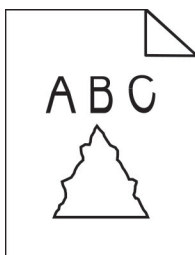

Action	Yes	No
<p><b>a</b> Load 50 sheets of clean, plain paper into the ADF.  <b>Note:</b> The plain paper helps clean or remove dust and other coating from the ADF feed rollers.</p> <p><b>b</b> From the control panel, press .</p> <p><b>c</b> Load an original document into the ADF.</p> <p><b>d</b> Scan the document.</p> <p>Do jagged images or texts appear on the output?</p>	<p>Contact <a href="#">customer support</a>.</p>	<p>The problem is solved.</p>

### Scan job was not successful

Action	Yes	No
<p><b>Step 1</b>            Check the cable connections.</p> <p><b>a</b> Make sure that the Ethernet or USB cable is securely connected to the computer and the printer.</p> <p><b>b</b> Resend the scan job.</p> <p>Is the scan job successful?</p>	<p>The problem is solved.</p>	<p>Go to step 2.</p>

Action	Yes	No
<p><b>Step 2</b></p> <p>Check the file you want to scan.</p> <ul style="list-style-type: none"> <li><b>a</b> Make sure that the file name is not already used in the destination folder.</li> <li><b>b</b> Make sure that the document or photo you want to scan is not open in another application.</li> <li><b>c</b> Resend the scan job.</li> </ul> <p>Is the scan job successful?</p>	The problem is solved.	Go to step 3.
<p><b>Step 3</b></p> <ul style="list-style-type: none"> <li><b>a</b> Make sure that the <b>Append time stamp</b> or the <b>Overwrite existing file</b> check box is selected in the destination configuration settings.</li> <li><b>b</b> Resend the scan job.</li> </ul> <p>Is the scan job successful?</p>	The problem is solved.	Contact <a href="#">customer support</a> .

### Scanner does not close

Action	Yes	No
<p>Remove obstructions that keep the scanner cover open.</p> <p>Did the scanner cover close correctly?</p>	The problem is solved.	Contact <a href="#">customer support</a> .

### Scanning takes too long or freezes the computer

Action	Yes	No
<p>Close all applications that are interfering with the scan.</p> <p>Does scanning take too long or freeze the computer?</p>	Contact <a href="#">customer support</a> .	The problem is solved.

## Scanner does not respond

Action	Yes	No
<p><b>Step 1</b></p> <p><b>a</b> Check if the power cord is connected properly to the printer and the electrical outlet.</p> <p> <b>CAUTION—POTENTIAL INJURY:</b> To avoid the risk of fire or electrical shock, connect the power cord to an appropriately rated and properly grounded electrical outlet that is near the product and easily accessible.</p> <p><b>b</b> Copy or scan the document.</p> <p>Is the scanner responding?</p>	The problem is solved.	Go to step 2.
<p><b>Step 2</b></p> <p><b>a</b> Check if the printer is turned on.</p> <p><b>b</b> Resolve any error messages that appear on the display.</p> <p><b>c</b> Copy or scan the document.</p> <p>Is the scanner responding?</p>	The problem is solved.	Go to step 3.
<p><b>Step 3</b></p> <p><b>a</b> Turn off the printer, wait for about 10 seconds, and then turn the printer on.</p> <p><b>b</b> Copy or scan the document.</p> <p>Is the scanner responding?</p>	The problem is solved.	Contact <a href="#">customer support</a> .

## Adjusting scanner registration

- 1 From the home screen, touch **Settings > Device > Maintenance > Configuration Menu > Scanner Configuration > Scanner Manual Registration**.
- 2 In the Print Quick Test menu, touch **Start**.
- 3 Place the Print Quick Test page on the scanner glass, and then touch **Flatbed Registration**.
- 4 In the Copy Quick Test menu, touch **Start**.
- 5 Compare the Copy Quick Test page with the original document.
 

**Note:** If the margins of the test page are different from the original document, then adjust Left Margin and Top Margin.
- 6 Repeat [step 4](#) and [step 5](#) until the margins of the Copy Quick Test page closely match the original document.

## Adjusting ADF registration

- 1 From the home screen, touch **Settings > Device > Maintenance > Configuration Menu > Scanner Configuration > Scanner Manual Registration**.
- 2 In the Print Quick Test menu, touch **Start**.

**3** Place the Print Quick Test page on the ADF tray.

**4** Touch **Front ADF Registration** or **Rear ADF Registration**.

**Notes:**

- To align Front ADF Registration, place the test page faceup, short edge first into the ADF.
- To align Rear ADF Registration, place the test page facedown, short edge first into the ADF.

**5** In the Copy Quick Test menu, touch **Start**.

**6** Compare the Copy Quick Test page with the original document.

**Note:** If the margins of the test page are different from the original document, then adjust Horizontal Adjust and Top Margin.

**7** Repeat [step 5](#) and [step 6](#) until the margins of the Copy Quick Test page closely match the original document.

## Contacting customer support

Before contacting customer support, make sure to have the following information:

- Printer problem
- Error message
- Printer model type and serial number

Go to <http://support.lexmark.com> to receive e-mail or chat support, or browse through the library of manuals, support documentation, drivers, and other downloads.

Technical support via telephone is also available. In the U.S. or Canada, call 1-800-539-6275. For other countries or regions, go to <http://support.lexmark.com>.

# Upgrading and migrating

## Hardware

### Available internal options

- Flash memory
- Font cards
- Firmware cards
  - Forms and Bar Code
  - IPDS
  - PRESCRIBE
- Internal solutions port
  - RS-232C Serial Interface Card
  - Parallel 1284-B Interface Card
  - MarkNet™ N8230 Fiber Ethernet
- MarkNet N8372 Wireless Print Server Interface Card
- Printer hard disk

### Accessing the controller board



**CAUTION—SHOCK HAZARD:** To avoid the risk of electrical shock, if you are accessing the controller board or installing optional hardware or memory devices sometime after setting up the printer, then turn the printer off, and unplug the power cord from the electrical outlet before continuing. If you have any other devices attached to the printer, then turn them off as well, and unplug any cables going into the printer.

- 1 Turn off the printer.
- 2 Unplug the power cord from the electrical outlet, and then from the printer.
- 3 Using a flat-head screwdriver, open the controller board access cover.

**Warning—Potential Damage:** Controller board electronic components are easily damaged by static electricity. Touch a metal surface on the printer before touching any controller board components or connectors.

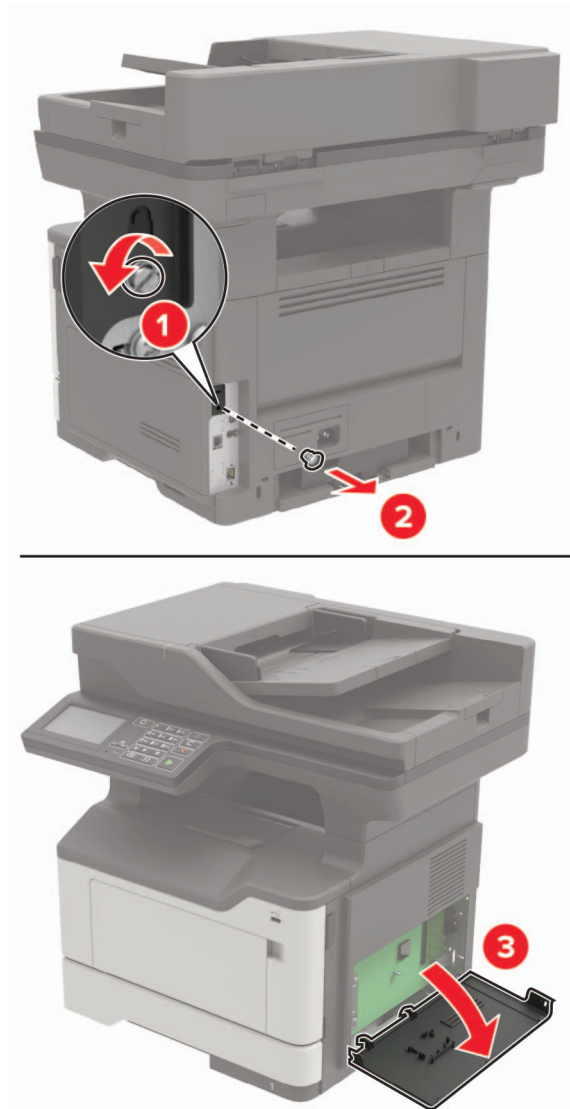

4 Close the access cover.

5 Connect the power cord to the printer, and then to the electrical outlet.

**⚠ CAUTION—POTENTIAL INJURY:** To avoid the risk of fire or electrical shock, connect the power cord to an appropriately rated and properly grounded electrical outlet that is near the product and easily accessible.

6 Turn on the printer.

## Installing a memory card

**⚠ CAUTION—SHOCK HAZARD:** To avoid the risk of electrical shock, if you are accessing the controller board or installing optional hardware or memory devices sometime after setting up the printer, then turn the printer off, and unplug the power cord from the electrical outlet before continuing. If you have any other devices attached to the printer, then turn them off as well, and unplug any cables going into the printer.

- 1 Turn off the printer.
- 2 Unplug the power cord from the electrical outlet, and then from the printer.
- 3 Open the controller board access cover.

**Warning—Potential Damage:** Controller board electronic components are easily damaged by static electricity. Touch a metal surface on the printer before touching any controller board components or connectors.

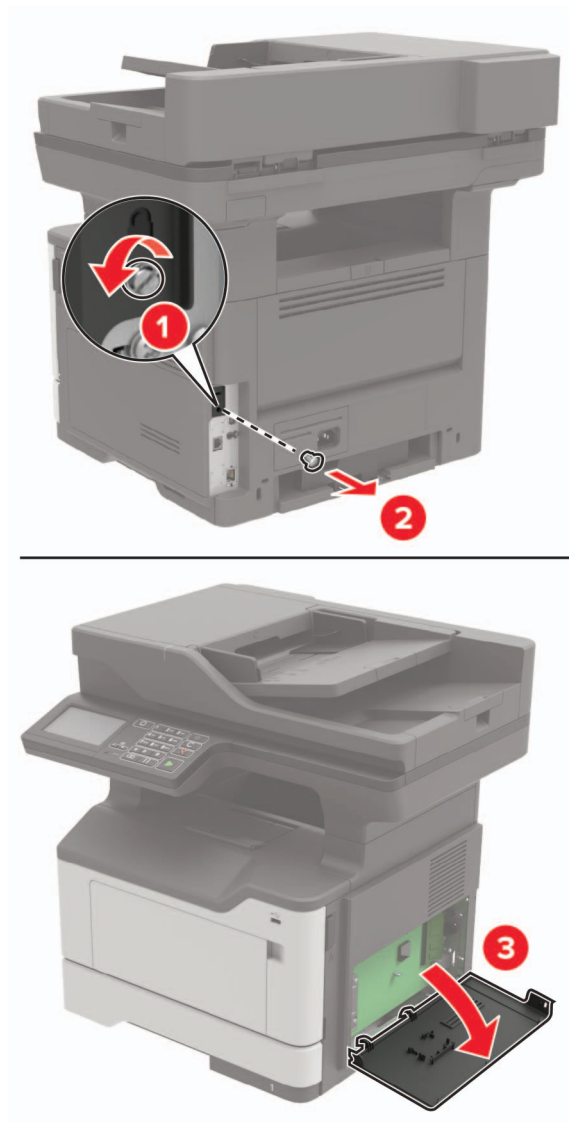

- 4 Unpack the memory card.

**Warning—Potential Damage:** Do not touch the connection points along the edge of the card.

- 5 Insert the memory card until it *clicks* into place.

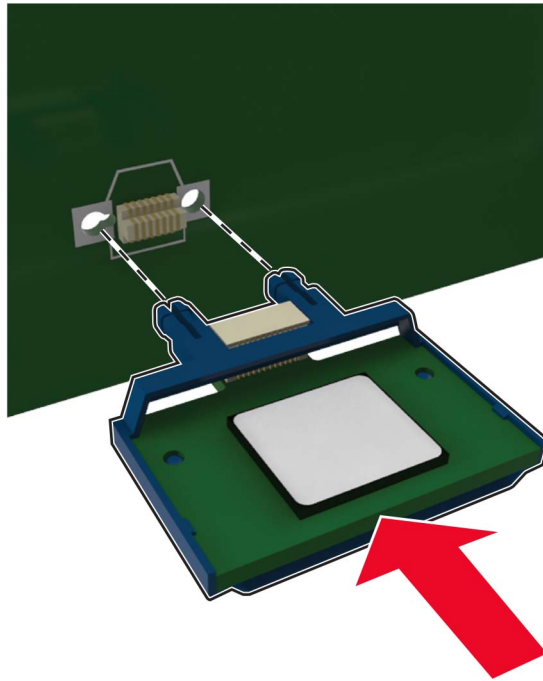

- 6 Close the controller board access cover.
- 7 Connect the power cord to the printer, and then to the electrical outlet.

**CAUTION—POTENTIAL INJURY:** To avoid the risk of fire or electrical shock, connect the power cord to an appropriately rated and properly grounded electrical outlet that is near the product and easily accessible.

- 8 Turn on the printer.

## Installing an optional card

**CAUTION—SHOCK HAZARD:** To avoid the risk of electrical shock, if you are accessing the controller board or installing optional hardware or memory devices sometime after setting up the printer, then turn the printer off, and unplug the power cord from the electrical outlet before continuing. If you have any other devices attached to the printer, then turn them off as well, and unplug any cables going into the printer.

- 1 Turn off the printer.
- 2 Unplug the power cord from the electrical outlet, and then from the printer.
- 3 Open the controller board access cover.

**Warning—Potential Damage:** Controller board electronic components are easily damaged by static electricity. Touch a metal surface on the printer before touching any components or connectors.

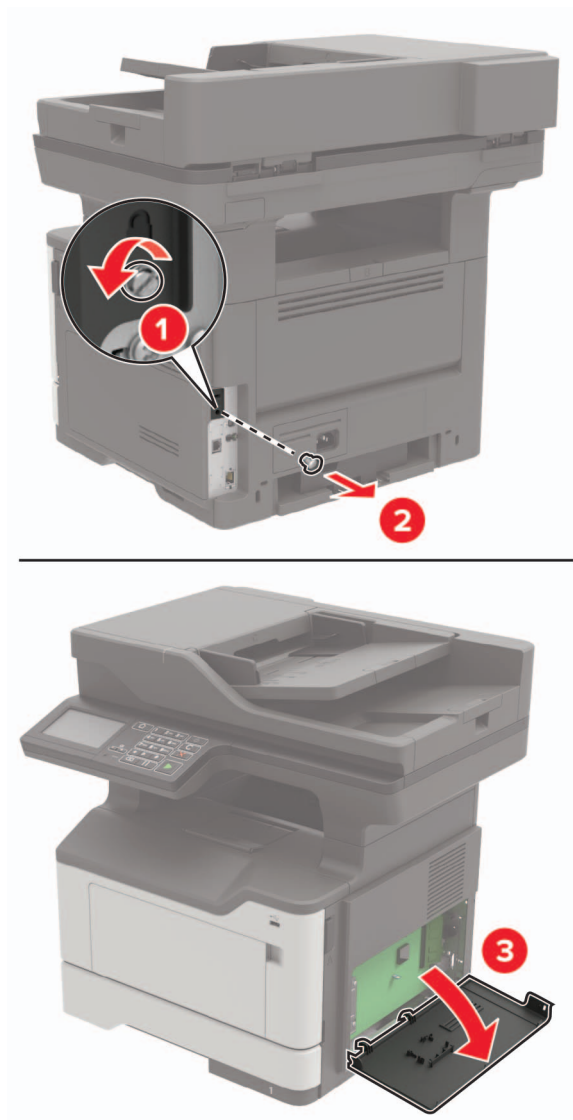

4 Unpack the optional card.

**Warning—Potential Damage:** Do not touch the connection points along the edge of the card.

- 5 Push the card firmly into place.

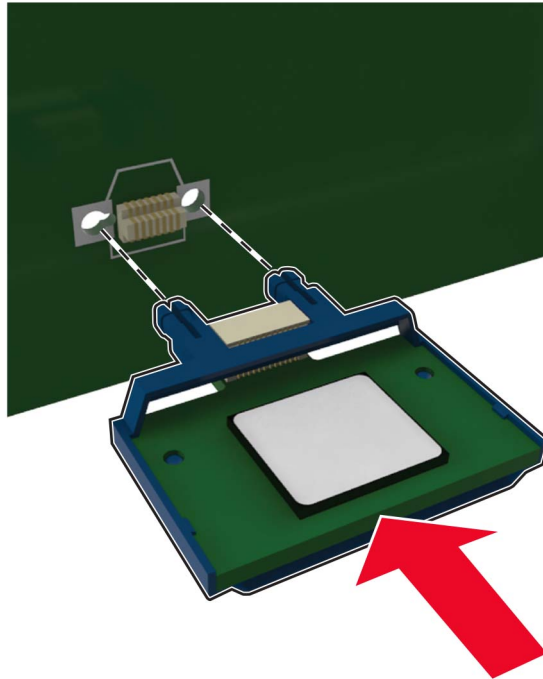

**Note:** The entire length of the connector on the card must touch and be flush against the controller board.

**Warning—Potential Damage:** Improper installation of the card may cause damage to the card and the controller board.

- 6 Close the access cover.
- 7 Connect the power cord to the printer, and then to the electrical outlet.

**CAUTION—POTENTIAL INJURY:** To avoid the risk of fire or electrical shock, connect the power cord to an appropriately rated and properly grounded electrical outlet that is near the product and easily accessible.

- 8 Turn on the printer.

## Installing a printer hard disk

**CAUTION—SHOCK HAZARD:** To avoid the risk of electrical shock, if you are accessing the controller board or installing optional hardware or memory devices sometime after setting up the printer, then turn the printer off, and unplug the power cord from the electrical outlet before continuing. If you have any other devices attached to the printer, then turn them off as well, and unplug any cables going into the printer.

- 1 Turn off the printer.
- 2 Unplug the power cord from the electrical outlet, and then from the printer.
- 3 Open the controller board access cover.

**Warning—Potential Damage:** Controller board electronic components are easily damaged by static electricity. Touch a metal surface on the printer before touching any controller board components or connectors.

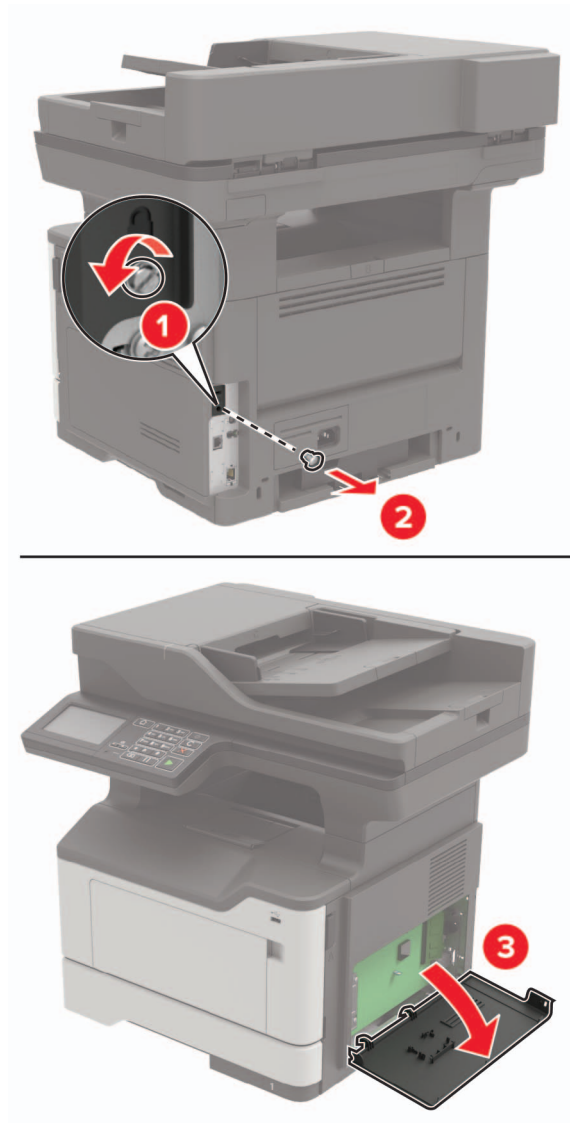

**4** Unpack the hard disk.

**5** Attach the hard disk to the controller board.

**Warning—Potential Damage:** Do not touch or press the center of the hard disk.

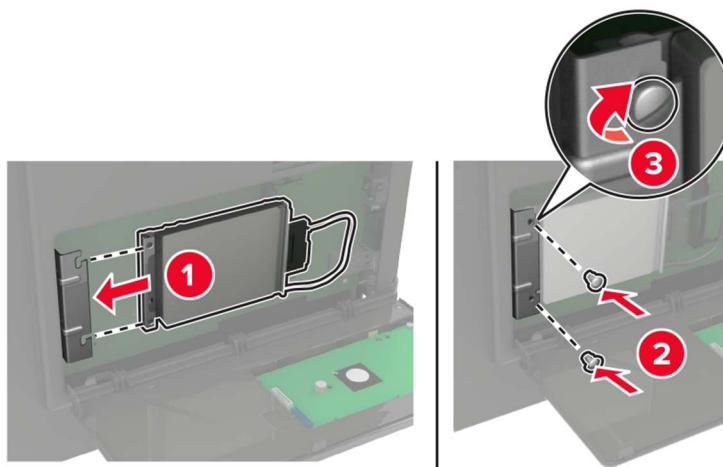

**6** Attach the hard disk interface cable to the controller board.

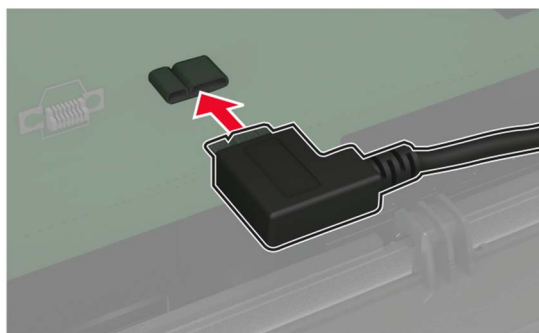

**7** Close the access cover.

**8** Connect the power cord to the printer, and then to the electrical outlet.

**⚠ CAUTION—POTENTIAL INJURY:** To avoid the risk of fire or electrical shock, connect the power cord to an appropriately rated and properly grounded electrical outlet that is near the product and easily accessible.

**9** Turn on the printer.

Installing an internal solutions port

## Installing an internal solutions port

**⚠ CAUTION—SHOCK HAZARD:** To avoid the risk of electrical shock, if you are accessing the controller board or installing optional hardware or memory devices sometime after setting up the printer, then turn the printer off, and unplug the power cord from the electrical outlet before continuing. If you have any other devices attached to the printer, then turn them off as well, and unplug any cables going into the printer.

**1** Turn off the printer.

**2** Unplug the power cord from the electrical outlet, and then from the printer.

**3** Unpack the internal solutions port (ISP) kit.

**Note:** Remove the preinstalled interface cable from the ISP.

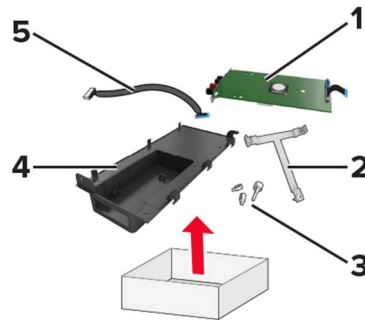

1	ISP
2	Mounting bracket
3	Thumbscrews
4	Housing
5	Interface cable

**4** Install the ISP into its housing.

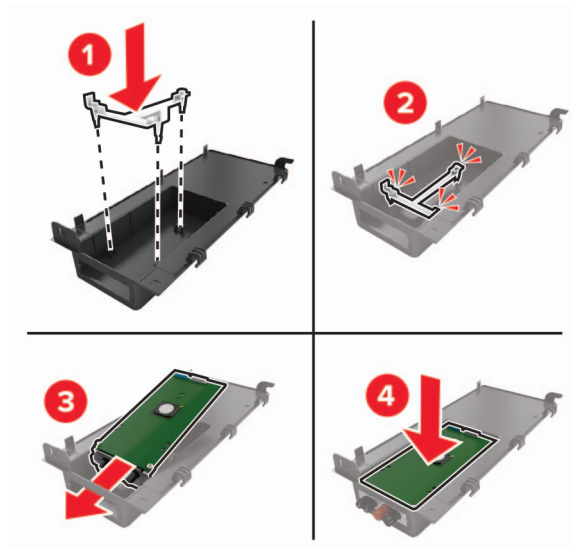

- 5 Secure the ISP in place and attach the ISP extended cable.

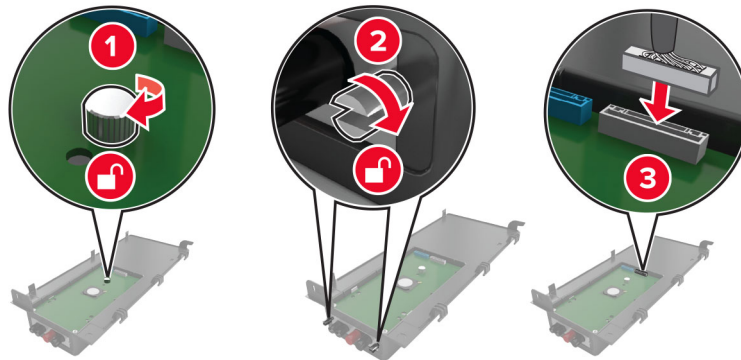

- 6 Open, and then remove the controller board access cover.

**Warning—Potential Damage:** Controller board electronic components are easily damaged by static electricity. Touch a metal surface on the printer before touching any controller board electronic components or connectors.

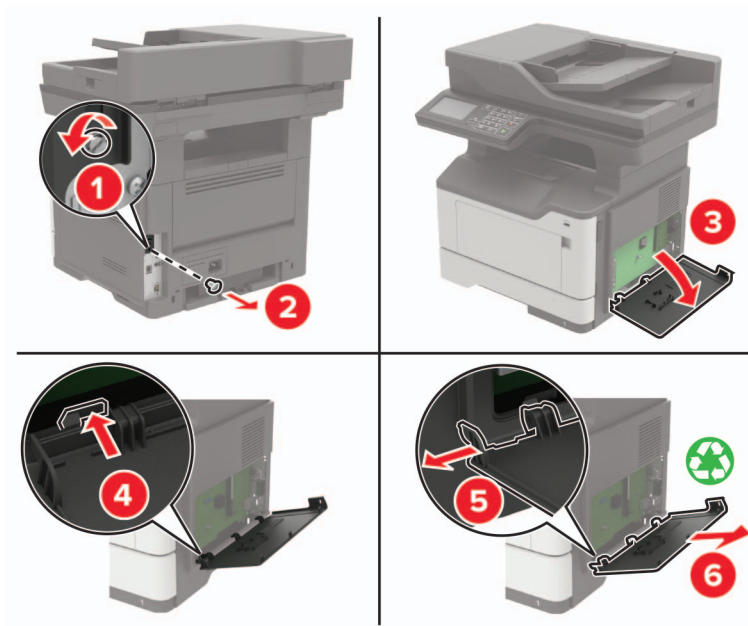

7 Attach the ISP kit to the printer.

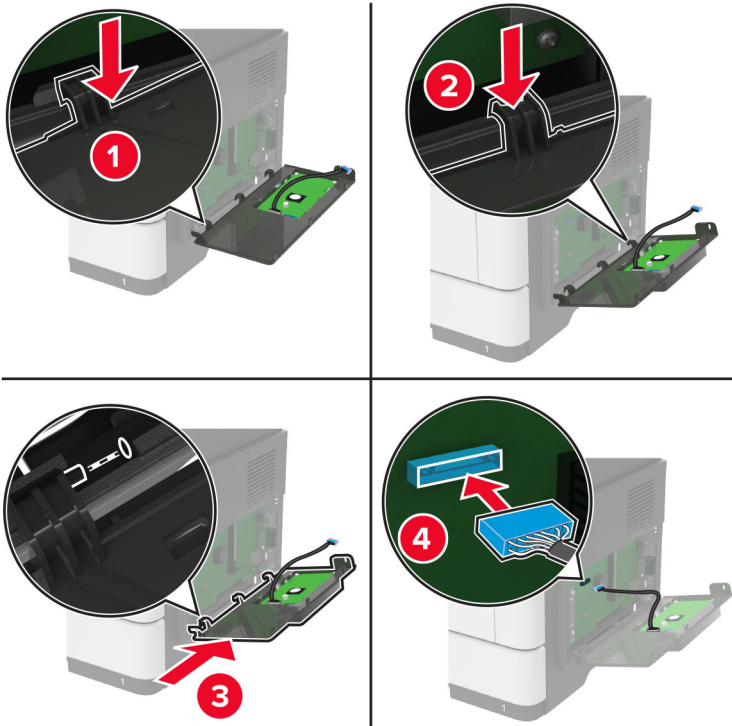

If a printer hard disk is installed, then remove the hard disk before installing the ISP.

- a** Unplug the hard disk interface cable from the controller board.

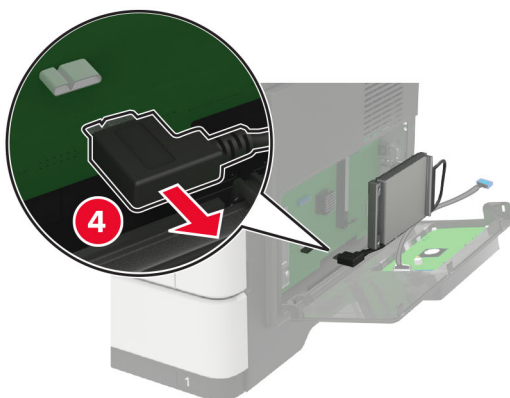
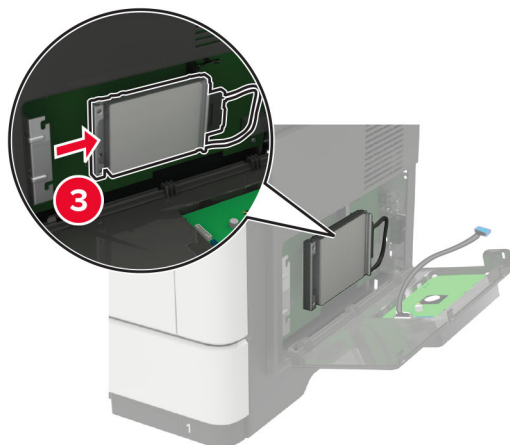
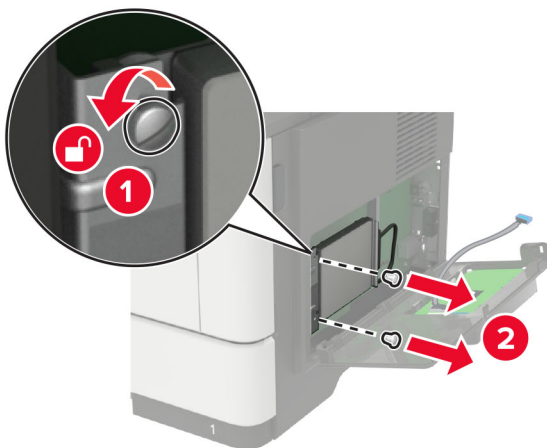

- b** Connect the ISP extended cable to the ISP connector.

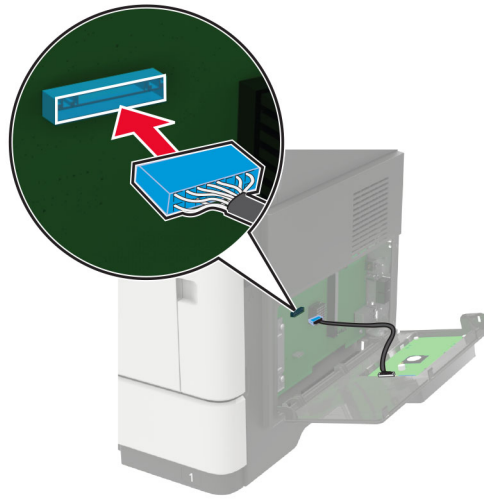

c Install the hard disk.



- 8 Close the access cover.
- 9 Connect the power cord to the printer, and then to the electrical outlet.

**⚠ CAUTION—POTENTIAL INJURY:** To avoid the risk of fire or electrical shock, connect the power cord to an appropriately rated and properly grounded electrical outlet that is near the product and easily accessible.

- 10 Turn on the printer.

## Installing optional trays

**⚠ CAUTION—SHOCK HAZARD:** To avoid the risk of electrical shock, if you are accessing the controller board or installing optional hardware or memory devices sometime after setting up the printer, then turn the printer off, and unplug the power cord from the electrical outlet before continuing. If you have any other devices attached to the printer, then turn them off as well, and unplug any cables going into the printer.

- 1 Turn off the printer.
- 2 Unplug the power cord from the electrical outlet, and then from the printer.
- 3 Unpack the optional tray, and then remove all packing material.

**Note:** If optional trays are already installed, then unlock them from the printer before lifting the printer. Do not try to lift the printer and trays at the same time.

- 4 Align the printer with the optional tray, and then lower the printer until it *clicks* into place.

**⚠ CAUTION—POTENTIAL INJURY:** If the printer weight is greater than 20 kg (44 lb), then it may require two or more people to lift it safely.



- 5 Connect the power cord to the printer, and then to the electrical outlet.

**⚠ CAUTION—POTENTIAL INJURY:** To avoid the risk of fire or electrical shock, connect the power cord to an appropriately rated and properly grounded electrical outlet that is near the product and easily accessible.

- 6 Turn on the printer.

Add the tray in the print driver to make it available for print jobs. For more information, see [“Adding available options in the print driver” on page 266](#).

## Software

### Supported operating systems

Using the software CD, you can install the printer software on the following operating systems:

- Windows 10
- Windows 8.1
- Windows Server 2012 R2
- Windows Server 2012
- Windows 7 SP1
- Windows Server 2008 R2 SP1
- Windows Server 2008 SP2
- Windows Vista SP2
- Mac OS X version 10.7 or later
- Red Hat Enterprise Linux WS
- openSUSE Linux
- SUSE Linux Enterprise Server
- Debian GNU/Linux
- Ubuntu
- Fedora
- IBM AIX
- Oracle Solaris SPARC
- Oracle Solaris x86

#### Notes:

- For Windows operating systems, the print drivers and utilities are supported in both 32- and 64-bit versions.
- For drivers and utilities that are compatible with Mac OS X version 10.6 or earlier and for specific supported Linux or UNIX operating system versions, go to <http://support.lexmark.com>.
- For more information on software compatibility with all other operating systems, contact customer support.

### Installing the printer software

#### Notes:

- The print driver is included in the software installer package.

- For Macintosh computers with macOS version 10.7 or later, you do not need to install the driver to print on an AirPrint-certified printer. If you want custom printing features, then download the print driver.
- 1 Obtain a copy of the software installer package.
    - From the software CD that came with your printer.
    - Go to [www.lexmark.com/downloads](http://www.lexmark.com/downloads).
  - 2 Run the installer, and then follow the instructions on the computer screen.

## Installing the fax driver

- 1 Go to [www.lexmark.com/downloads](http://www.lexmark.com/downloads), search for your printer model, and then download the appropriate installer package.
- 2 From your computer, click **Printer Properties**, and then navigate to the **Configuration** tab.
- 3 Select **Fax**, and then click **Apply**.

## Adding printers to a computer

Before you begin, do one of the following:

- Connect the printer and the computer to the same network. For more information on connecting the printer to a network, see [“Connecting the printer to a Wi-Fi network” on page 158](#).
- Connect the computer to the printer. For more information, see [“Connecting a computer to the printer” on page 161](#).
- Connect the printer to the computer using a USB cable. For more information, see [“Attaching cables” on page 15](#).

**Note:** The USB cable is sold separately.

### For Windows users

- 1 From a computer, install the print driver.

**Note:** For more information, see [“Installing the printer software” on page 264](#).
- 2 Open **Printers & scanners**, and then click **Add a printer or scanner**.
- 3 Depending on your printer connection, do one of the following:
  - Select a printer from the list, and then click **Add device**.
  - Click **Show Wi-Fi Direct printers**, select a printer, and then click **Add device**.
  - Click **The printer that I want isn't listed**, and then from the Add Printer window, do the following:
    - a Select **Add a printer using a TCP/IP address or hostname**, and then click **Next**.
    - b In the “Hostname or IP address” field, type the printer IP address, and then click **Next**.

#### Notes:

- View the printer IP address on the printer home screen. The IP address appears as four sets of numbers separated by periods, such as 123.123.123.123.
  - If you are using a proxy server, then temporarily disable it to load the web page correctly.
- c Select a print driver, and then click **Next**.
  - d Select **Use the print driver that is currently installed (recommended)**, and then click **Next**.

- e Type a printer name, and then click **Next**.
- f Select a printer sharing option, and then click **Next**.
- g Click **Finish**.

### For Macintosh users

- 1 From a computer, open **Printers & Scanners**.
- 2 Click **+**, and then select a printer.
- 3 From the Use menu, select a print driver.

#### Notes:

- To use the Macintosh print driver, select either **AirPrint** or **Secure AirPrint**.
- If you want custom printing features, then select the Lexmark print driver. To install the driver, see [“Installing the printer software” on page 264](#).

- 4 Add the printer.

## Adding available options in the print driver

### For Windows users

- 1 Open the printers folder.
- 2 Select the printer you want to update, and then do either of the following:
  - For Windows 7 or later, select **Printer properties**.
  - For earlier versions, select **Properties**.
- 3 Navigate to the Configuration tab, and then select **Update Now - Ask Printer**.
- 4 Apply the changes.

### For Macintosh users

- 1 From System Preferences in the Apple menu, navigate to your printer, and then select **Options & Supplies**.
- 2 Navigate to the list of hardware options, and then add any installed options.
- 3 Apply the changes.

## Firmware

### Exporting or importing a configuration file

You can export the configuration settings of your printer into a text file, and then import the file to apply the settings to other printers.

- 1 Open a web browser, and then type the printer IP address in the address field.

**Notes:**

- View the printer IP address on the printer home screen. The IP address appears as four sets of numbers separated by periods, such as 123.123.123.123.
- If you are using a proxy server, then temporarily disable it to load the web page correctly.

**2** From the Embedded Web Server, click **Export Configuration** or **Import Configuration**.

**3** Follow the instructions on the screen.

**4** If the printer supports applications, then do the following:

- a Click **Apps** > select the application > **Configure**.
- b Click **Export** or **Import**.

## Updating firmware

### Updating the firmware using the control panel

#### Using the notification center

This method is applicable only in some printer models.

- 1** From the control panel, navigate to the notification center, and then select **Firmware update available**.

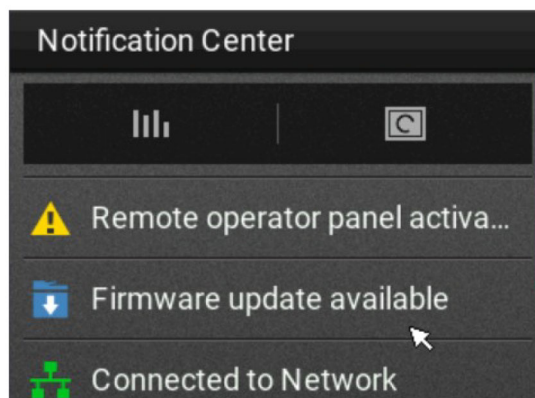

- 2** Select **Install now**.

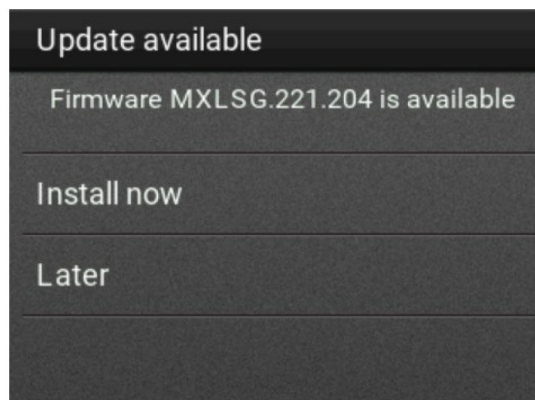

The printer reboots automatically after the update.

### Using the Settings menu

- 1 From the control panel, navigate to **Settings > Device > Update Firmware**.
- 2 Depending on your printer model, select **Check for updates** or **Check for updates now**.
- 3 If a new update is available, then select **Install now**.

The printer reboots automatically after the update.

## Updating the firmware using the Embedded Web Server

Before you begin, make sure that:

- You have downloaded the latest printer firmware from <https://support.lexmark.com> and saved it to your flash drive or computer.  
**Note:** To deploy the printer firmware, extract the .fls firmware file from the ZIP package.
- You are not using a special code on your printer to avoid losing this functionality.

**Warning—Potential Damage:** Make sure that all printers receiving firmware updates are turned on during the entire firmware update process. Turning off a printer during a firmware update can severely damage it.

If the printer is connected to the network when checking for updates, then downloading the firmware is not required.

- 1 Open a web browser, and then type the printer IP address in the address field.

#### Notes:

- View the printer IP address on the printer home screen. The IP address appears as four sets of numbers separated by periods, such as 123.123.123.123.
- If you are using a proxy server, then temporarily disable it to load the web page correctly.

- 2 Click **Device**.
- 3 Scroll down, and then click **Update Firmware**.
- 4 Depending on your printer model, click **Check for updates** or **Check for updates now**.  
If a new update is available, then click **I agree, start update**.

The printer reboots automatically after the update.

# Notices

## Product information

Product name:

Lexmark MB2442adwe; Lexmark MB2546ade, Lexmark MB2546adwe; Lexmark MX421ade; Lexmark MX521de, Lexmark MX521ade; Lexmark MX522adhe, Lexmark MX522dhe; Lexmark XM1242; Lexmark XM1246, Lexmark XM1246i MFPs

Machine type:

7017

Models:

476, 478, 496, 636, 676, 678, 679, 686

## Edition notice

July 2024

**The following paragraph does not apply to any country where such provisions are inconsistent with local law:** LEXMARK INTERNATIONAL, INC., PROVIDES THIS PUBLICATION "AS IS" WITHOUT WARRANTY OF ANY KIND, EITHER EXPRESS OR IMPLIED, INCLUDING, BUT NOT LIMITED TO, THE IMPLIED WARRANTIES OF MERCHANTABILITY OR FITNESS FOR A PARTICULAR PURPOSE. Some states do not allow disclaimer of express or implied warranties in certain transactions; therefore, this statement may not apply to you.

This publication could include technical inaccuracies or typographical errors. Changes are periodically made to the information herein; these changes will be incorporated in later editions. Improvements or changes in the products or the programs described may be made at any time.

References in this publication to products, programs, or services do not imply that the manufacturer intends to make these available in all countries in which it operates. Any reference to a product, program, or service is not intended to state or imply that only that product, program, or service may be used. Any functionally equivalent product, program, or service that does not infringe any existing intellectual property right may be used instead. Evaluation and verification of operation in conjunction with other products, programs, or services, except those expressly designated by the manufacturer, are the user's responsibility.

For Lexmark technical support, go to <http://support.lexmark.com>.

For information on Lexmark's privacy policy governing the use of this product, go to [www.lexmark.com/privacy](http://www.lexmark.com/privacy).

For information on supplies and downloads, go to [www.lexmark.com](http://www.lexmark.com).

© 2018 Lexmark International, Inc.

All rights reserved.

## GOVERNMENT END USERS

The Software Program and any related documentation are "Commercial Items," as that term is defined in 48 C.F.R. 2.101, "Computer Software" and "Commercial Computer Software Documentation," as such terms are used in 48 C.F.R. 12.212 or 48 C.F.R. 227.7202, as applicable. Consistent with 48 C.F.R. 12.212 or 48 C.F.R.

227.7202-1 through 227.7207-4, as applicable, the Commercial Computer Software and Commercial Software Documentation are licensed to the U.S. Government end users (a) only as Commercial Items and (b) with only those rights as are granted to all other end users pursuant to the terms and conditions herein.

## Trademarks

Lexmark, the Lexmark logo, and MarkNet are trademarks or registered trademarks of Lexmark International, Inc. in the United States and/or other countries.

Gmail, Android, Google Play, and Google Chrome are trademarks of Google LLC.

Macintosh, Safari, and AirPrint are trademarks of Apple Inc., registered in the U.S. and other countries. App Store and iCloud are service marks of Apple Inc., registered in the U.S. and other countries. Use of the Works with Apple badge means that an accessory has been designed to work specifically with the technology identified in the badge and has been certified by the developer to meet Apple performance standards.

The Mopria® word mark is a registered and/or unregistered trademark of Mopria Alliance, Inc. in the United States and other countries. Unauthorized use is strictly prohibited.

PCL® is a registered trademark of the Hewlett-Packard Company. PCL is Hewlett-Packard Company’s designation of a set of printer commands (language) and functions included in its printer products. This printer is intended to be compatible with the PCL language. This means the printer recognizes PCL commands used in various application programs, and that the printer emulates the functions corresponding to the commands.

PostScript is a registered trademark of Adobe Systems Incorporated in the United States and/or other countries.

Wi-Fi® and Wi-Fi Direct® are registered trademarks of Wi-Fi Alliance®.

All other trademarks are the property of their respective owners.

## Licensing notices

All licensing notices associated with this product can be viewed from the CD:\NOTICES directory of the installation software CD.

## Noise emission levels

The following measurements were made in accordance with ISO 7779 and reported in conformance with ISO 9296.

**Note:** Some modes may not apply to your product.

1-meter average sound pressure, dBA	
Printing	One-sided: 55 (MB2442, MX421, XM1242), 56 (MB2546, MX521, MX522, XM1246) Two-sided: 54 (MB2442, MX421, XM1242), 55 (MB2546, MX521, MX522, XM1246)
Scanning	51 (MX522, XM1246), 54 (MB2442, MX421, XM1242, MX521, MB2546)

1-meter average sound pressure, dBA	
Copying	57 (MB2442, MX421, XM1242, MX522, XM1246), 58 (MX521, MB2546)
Ready	14

Values are subject to change. See [www.lexmark.com](http://www.lexmark.com) for current values.

### Waste from Electrical and Electronic Equipment (WEEE) directive

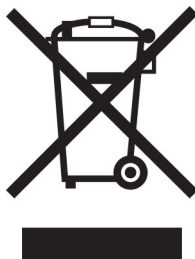

The WEEE logo signifies specific recycling programs and procedures for electronic products in countries of the European Union. We encourage the recycling of our products.

If you have further questions about recycling options, visit the Lexmark Web site at [www.lexmark.com](http://www.lexmark.com) for your local sales office phone number.

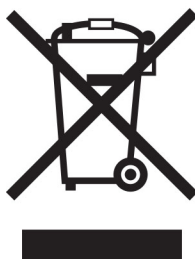

### India E-Waste notice



This product including components, consumables, parts and spares complies with the “India E-Waste Rules” and prohibits use of lead, mercury, hexavalent chromium, polybrominated biphenyls or polybrominated diphenyl ethers in concentrations exceeding 0.1% by weight and 0.01% by weight for cadmium, except for the exemption set in the Rule.

### Environmental labeling for packaging

Per Commission Regulation Decision 97/129/EC Legislative Decree 152/2006, the product packaging may contain one or more of the following symbols.

	<p>This symbol indicates that the packaging may contain corrugated fiberboard.</p>
	<p>This symbol indicates that the packaging may contain non-corrugated fiberboard.</p>
	<p>This symbol indicates that the packaging may contain paper.</p>

For more information, go to [www.lexmark.com/recycle](http://www.lexmark.com/recycle), and then choose your country or region. Information on available packaging recycling programs is included with the information on product recycling.

### Product disposal

Do not dispose of the printer or supplies in the same manner as normal household waste. Consult your local authorities for disposal and recycling options.

### Lithium-ion rechargeable battery

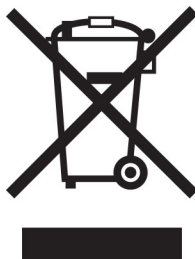

This product may contain a coin-cell, lithium-ion rechargeable battery, which should only be removed by a trained technician. Crossed-out wheeled bin means the product should not be discarded as unsorted waste but must be sent to separate collection facilities for recovery and recycling. In the event the battery is removed, do not dispose of the battery in your household waste. There may be separate collection systems for batteries in your local community, such as a battery-recycling drop-off location. The separate collection of waste batteries assures appropriate treatment of waste including reuse and recycling and prevents any potential negative effects on human health and environment. Please responsibly dispose of the batteries.

## Regulation (EU) 2023/1542

This product may contain a coin-cell lithium rechargeable battery. This battery complies with Regulation (EU) 2023/1542. Compliance is indicated by the CE marking:



This product may contain one of the following coin-cell batteries:

- Battery identification: Seiko Model Number MS621FE  
Manufacturer: Seiko Instruments Inc.  
Manufacturer address: 8, Nakase 1-chome, Mihama-ku, Chiba-shi, Chiba 261-8507, Japan
- Battery identification: Panasonic Model Number ML621  
Manufacturer: Panasonic Energy Co., Ltd.  
Manufacturer address: 1-1 Matsushita-cho, Moriguchi City, Osaka 570-8511, Japan
- Battery identification: FDK Model Number ML621  
Manufacturer: FDK Corporation  
Manufacturer address: Shibaura Crystal Shinagawa, 1-6-41 Konan, Minato-ku, Tokyo 108-8212 Japan

## Returning Lexmark cartridges for reuse or recycling

The Lexmark Cartridge Collection Program allows you to return used cartridges for free to Lexmark for reuse or recycling. One hundred percent of the empty cartridges returned to Lexmark are either reused or demanufactured for recycling. The boxes used to return the cartridges are also recycled.

To return Lexmark cartridges for reuse or recycling, do the following:

- 1 Go to [www.lexmark.com/recycle](http://www.lexmark.com/recycle).
- 2 Select your country or region.
- 3 Select **Lexmark Cartridge Collection Program**.
- 4 Follow the instructions on the screen.

Static sensitivity notice

## Static sensitivity notice

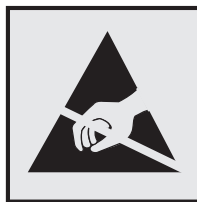

This symbol identifies static-sensitive parts. Do not touch the areas near these symbols without first touching a metal surface in an area away from the symbol.

To prevent damage from electrostatic discharge when performing maintenance tasks such as clearing paper jams or replacing supplies, touch any exposed metal frame of the printer before accessing or touching interior areas of the printer even if the symbol is not present.

## ENERGY STAR

Any Lexmark product bearing the ENERGY STAR® emblem on the product or on a start-up screen is certified to comply with Environmental Protection Agency (EPA) ENERGY STAR requirements as of the date of manufacture.



## Temperature information

Ambient operating temperature	10 to 32.2°C (50 to 90°F)
Shipping temperature	-40 to 43.3°C (-40 to 110°F)
Storage temperature and relative humidity	0 to 40°C (32 to 104°F) 8 to 80% RH

## Laser notice

The printer is certified in the U.S. to conform to the requirements of DHHS 21 CFR, Chapter I, Subchapter J for Class I (1) laser products, and elsewhere is certified as a Class I laser product conforming to the requirements of IEC 60825-1: 2014.

Class I laser products are not considered to be hazardous. The laser system and printer are designed so there is never any human access to laser radiation above a Class I level during normal operation, user maintenance, or prescribed service conditions. The printer has a non-serviceable printhead assembly that contains a laser with the following specifications:

Class: IIIb (3b) AlGaInP

Nominal output power (milliwatts): 15

Wavelength (nanometers): 650–670

## Power consumption

### Product power consumption

The following table documents the power consumption characteristics of the product.

**Note:** Some modes may not apply to your product.

Mode	Description	Power consumption (Watts)
Printing	The product is generating hard-copy output from electronic inputs.	One-sided: 570 (MB2442, MX421, XM1242), 620 (MB2546, MX521, MX522, XM1246) Two-sided: 355 (MB2442, MX421, XM1242), 385 (MB2546, MX521, MX522, XM1246)
Copy	The product is generating hard-copy output from hard-copy original documents.	590 (MB2442, MX421, XM1242), 630 (MB2546, MX521, MX522, XM1246)
Scan	The product is scanning hard-copy documents.	17.5 (MB2442, MX421, XM1242), 20 (MB2546, MX521, MX522, XM1246)
Ready	The product is waiting for a print job.	11.5 (MB2442, MX421, XM1242), 14.5 (MB2546, MX521, MX522, XM1246)
Sleep Mode	The product is in a high-level energy-saving mode.	1.3 (MB2442, MX421, XM1242), 1.5 (MB2546, MX521), 1.41 (MX522, XM1246)
Hibernate	The product is in a low-level energy-saving mode.	0.1
Off	The product is plugged into an electrical outlet, but the power switch is turned off.	0.1

The power consumption levels listed in the previous table represent time-averaged measurements. Instantaneous power draws may be substantially higher than the average.

Values are subject to change. See [www.lexmark.com](http://www.lexmark.com) for current values.

### Sleep Mode

This product is designed with an energy-saving mode called *Sleep Mode*. The Sleep Mode saves energy by lowering power consumption during extended periods of inactivity. The Sleep Mode is automatically engaged after this product is not used for a specified period of time, called the *Sleep Mode Timeout*.

Factory default Sleep Mode Timeout for this product (in minutes):	15
---	----

By using the configuration menus, the Sleep Mode Timeout can be modified between 1 minute and 120 minutes. If the print speed is less than or equal to 30 pages per minute, then you can set the timeout only up to 60 minutes. Setting the Sleep Mode Timeout to a low value reduces energy consumption, but may increase the response time of the product. Setting the Sleep Mode Timeout to a high value maintains a fast response, but uses more energy.

### Hibernate Mode

This product is designed with an ultra-low power operating mode called *Hibernate mode*. When operating in Hibernate Mode, all other systems and devices are powered down safely.

The Hibernate mode can be entered in any of the following methods:

- Using the Hibernate Timeout
- Using the Schedule Power modes

Factory default Hibernate Timeout for this product in all countries or regions	3 days
--	--------

The amount of time the printer waits after a job is printed before it enters Hibernate mode can be modified between one hour and one month.

**Notes on EPEAT-registered imaging equipment products:**

- Standby power level occurs in Hibernate or Off mode.
- The product shall automatically power down to a standby power level of  $\leq 1$  W. The auto standby function (Hibernate or Off) shall be enabled at product shipment.

**Off mode**

If this product has an off mode which still consumes a small amount of power, then to completely stop product power consumption, disconnect the power supply cord from the electrical outlet.

Total energy usage

**Total energy usage**

It is sometimes helpful to estimate the total product energy usage. Since power consumption claims are provided in power units of Watts, the power consumption should be multiplied by the time the product spends in each mode in order to calculate energy usage. The total product energy usage is the sum of each mode's energy usage.

**Applicability of Regulation (EU) 2019/2015 and (EU) 2019/2020**

Per Commission Regulation (EU) 2019/2015 and (EU) 2019/2020, the light source contained within this product or its component is intended to be used for Image Capture or Image Projection only, and is not intended for use in other applications.

**The UK Product Security and Telecommunications Infrastructure Act 2022 (PSTI Act)—Summary Statement of Compliance**

Lexmark International Inc., 740 West New Circle Road, Lexington, KY 40550 USA, declares that this product complies with the applicable security requirements in Schedule 1 of The Product Security and Telecommunications Infrastructure (Security Requirements for Relevant Connectable Products) Regulations 2023. The defined support period for this product can be found at the following web page:

<https://www.lexmark.com/firmware-eos>.

A copy of the Statement of Compliance is available for download at the following web page:

[https://www.lexmark.com/en\\_us/about/regulatory-compliance/all-regulatory-docs.html](https://www.lexmark.com/en_us/about/regulatory-compliance/all-regulatory-docs.html).

**Thailand NBTC technical standards conformity statement**

คำประกาศเรื่องการเป็นไปตามมาตรฐานทางเทคนิคของ กสทช. ประเทศไทย

This telecommunication equipment conforms to the technical standards or requirements of NBTC.

เครื่องโทรคมนาคมและอุปกรณ์นี้มีความสอดคล้องตามมาตรฐานหรือข้อกำหนดทางเทคนิคของ กสทช.

Regulatory notices for telecommunication terminal equipment

## Regulatory notices for telecommunication terminal equipment

This section contains regulatory information pertaining to products that contain the analog facsimile card:

Lexmark Regulatory Type/Model Number:

LEX-M14-002 or LEX-M03-002

## Notice to users of the US telephone network: FCC requirements

This equipment complies with Part 68 of the FCC rules and the requirements adopted by the Administrative Council for Terminal Attachments (ACTA). On the back of this equipment is a label that contains, among other information, a product identifier in the format US:AAAEQ##TXXXX. If requested, this number must be provided to your telephone company.

This equipment uses the RJ-11C Universal Service Order Code (USOC) jack.

A plug and jack used to connect this equipment to the premises' wiring and telephone network must comply with the applicable FCC Part 68 rules and requirements adopted by the ACTA. Use a compliant telephone cord (RJ-11) that is 26 AWG or larger when connecting this product to the public switched telephone network. See your setup documentation for more information.

The Ringer Equivalence Number (REN) is used to determine the number of devices that may be connected to a telephone line. Excessive RENs on a telephone line may result in the devices not ringing in response to an incoming call. In most but not all areas, the sum of RENs should not exceed five (5.0). To be certain of the number of devices that may be connected to a line, as determined by the total RENs, contact your local telephone company. For products approved after July 23, 2001, the REN for this product is part of the product identifier that has the format US:AAAEQ##TXXXX. The digits represented by ## are the REN without a decimal point (for example, 03 is a REN of 0.3). For earlier products, the REN is shown separately on the label.

If this equipment causes harm to the telephone network, the telephone company will notify you in advance that temporary discontinuance of service may be required. If advance notice is not practical, the telephone company will notify the customer as soon as possible. You will also be advised of your right to file a complaint with the FCC.

The telephone company may make changes in its facilities, equipment, operations or procedures that could affect the operation of this equipment. If this happens, the telephone company will provide advance notice in order for you to make necessary modifications to maintain uninterrupted service.

If you experience trouble with this equipment, for repair or warranty information, contact Lexmark International, Inc. at [www.lexmark.com](http://www.lexmark.com) or your Lexmark representative. If the equipment is causing harm to the telephone network, the telephone company may request that you disconnect the equipment until the problem is resolved.

This equipment contains no user serviceable parts. For repair and warranty information, contact Lexmark International, Inc. See the previous paragraph for contact information.

Connection to party line service is subject to state tariffs. Contact the state public utility commission, public service commission, or corporation commission for information.

If your home has specially wired alarm equipment connected to the telephone line, ensure the installation of this equipment does not disable your alarm equipment. If you have questions about what will disable alarm equipment, consult your telephone company or a qualified installer.

The Telephone Consumer Protection Act of 1991 makes it unlawful for any person to use a computer or other electronic device, including fax machines, to send any message unless said message clearly contains in a margin at the top or bottom of each transmitted page or on the first page of the transmission, the date and time it is sent and an identification of the business or other entity, or other individual sending the message, and the

telephone number of the sending machine or such business, other entity, or individual. (The telephone number provided may not be a 900 number or any other number for which charges exceed local or long-distance transmission charges.)

See your user documentation in order to program this information into your fax machine.

## **Notice to users of the Canadian telephone network**

This product meets the applicable Innovation, Science and Economic Development Canada technical specifications.

The Ringer Equivalence Number (REN) indicates the maximum number of devices allowed to be connected to a telephone interface. The termination of an interface may consist of any combination of devices subject only to the requirement that the sum of the RENs of all the devices not exceed five. The REN is located on the product label.

This equipment uses CA11A telephone jacks.

## **Avis réservé aux utilisateurs du réseau téléphonique du Canada**

Ce produit est conforme aux spécifications techniques d'Innovation, Sciences et Développement économique Canada.

Le numéro REN (ringer equivalence number : numéro d'équivalence de sonnerie) indique le nombre maximum d'appareils pouvant être connectés à l'interface téléphonique. En bout de ligne, le nombre d'appareils qui peuvent être connectés n'est pas directement limité, mais la somme des REN de ces appareils ne doit pas dépasser cinq. Le numéro REN est indiqué sur l'étiquette produit.

Cet équipement utilise des prises de téléphone CA11A.

Notice to users of the New Zealand telephone network

## **Notice to users of the New Zealand telephone network**

The following are special conditions for the Facsimile User Instructions. The grant of a telepermit for any item of terminal equipment indicates only that Telecom has accepted that the item complies with minimum conditions for connection to its network. It indicates no endorsement of the product by Telecom, nor does it provide any sort of warranty. Above all, it provides no assurance that any item will work correctly in all respects with another item of telepermitted equipment of a different make or model, nor does it imply that any product is compatible with all of Telecom's network services.

This equipment shall not be set up to make automatic calls to the Telecom "111" Emergency Service.

This equipment may not provide for the effective hand-over of a call to another device connected to the same line.

This equipment should not be used under any circumstances that may constitute a nuisance to other Telecom customers.

This equipment is not capable, under all operating conditions, of correct operation at the higher speeds for which it is designed. Telecom will accept no responsibility should difficulties arise in such circumstances.

The decadic (or pulse) dialing on this device is unsuitable for use on the Telecom network in New Zealand.

For correct operation, the total of all the Ringer Equivalence Numbers (RENs) of all parallel devices connected to the same telephone line may not exceed 5. The REN of this device is located on the label.

This device uses an RJ-11C modular connector. Contact your point of purchase if a BT adapter is required. The Lexmark part number is 80D1873.

Some parameters required for compliance with Telecom's telepermit requirements are dependent on the equipment associated with this device. The associated equipment shall be set to operate within the following limits for compliance to Telecom's specifications:

- There shall be no more than 10 call attempts to the same number within any 30 minute period for any single manual call initiation, and
- The equipment shall go on-hook for a period of not less than 30 seconds between the end of one attempt and the beginning of the next call attempt.
- The equipment shall be set to ensure that automatic calls to different numbers are spaced such that there is not less than 5 seconds between the end of one call attempt and the beginning of another.

### Japanese telecom notice

The installed optional modem is in compliance with Japanese Telecommunication Law and has been Certified by JATE, with the following Certification Number:

A18-0046001 or A11-0160001

	Lexmark International, Inc.
	LEX-M14-002 or LEX-M03-002
	A18-0046001 or A11-0160001

### Using this product in Switzerland

This product requires a Swiss billing tone filter (Lexmark part number 80D1877) to be installed on any line which receives metering pulses in Switzerland.

### Utilisation de ce produit en Suisse

Cet appareil nécessite l'utilisation d'un filtre de tonalité de facturation suisse (n° de référence Lexmark : 80D1877) devant être installé sur toute ligne recevant des impulsions de comptage en Suisse.

### Verwendung dieses Produkts in der Schweiz

Für dieses Produkt muss ein schweizerischer Billing Tone Filter zur Zählzeichenübertragung (Lexmark Teilenummer 80D1877) für jede Leitung installiert werden, über die in der Schweiz Zeitsteuertakte übertragen werden.

## Usò del prodotto in Svizzera

Questo prodotto richiede un filtro toni Billing svizzero, (codice Lexmark 80D1877) da installare su tutte le linee che ricevono impulsi remoti in Svizzera.

## Regulatory notices for wireless products

This section contains regulatory information that applies only to wireless models.

If in doubt as to whether your model is a wireless model, go to <http://support.lexmark.com>.

## Modular component notice

Wireless models contain one of the following modular components:

Lexmark Regulatory Type/Model Number LEX-M07-001; FCC ID:IYLLLEXM07001; Industry Canada IC:2376A-LEXM07001

Lexmark Regulatory Type/Model Number LEX-M08-001; FCC ID:IYLLLEXM08001; IC:2376A-LEXM08001

To determine which modular components are installed in your particular product, refer to the labeling on your actual product.

## Exposure to radio frequency radiation

The radiated output power of this device is far below the radio frequency exposure limits of the FCC and other regulatory agencies. A minimum separation of 20 cm (8 inches) must be maintained between the antenna and any persons for this device to satisfy the RF exposure requirements of the FCC and other regulatory agencies.

## Innovation, Science and Economic Development Canada

This device complies with Innovation, Science and Economic Development Canada license-exempt RSS standards. Operation is subject to the following two conditions: (1) this device may not cause interference, and (2) this device must accept any interference, including interference that may cause undesired operation of the device.

## Innovation, Sciences et Développement économique Canada

Cet appareil est conforme aux normes RSS exemptes de licence d'Innovation, Sciences et Développement économique Canada. Son fonctionnement est soumis aux deux conditions suivantes : (1) cet appareil ne doit pas causer d'interférences et (2) il doit accepter toutes les interférences, y compris les celles qui peuvent entraîner un fonctionnement indésirable.

## European Community (EC) directives conformity

This product is in conformity with the protection requirements of EC Council directive 2014/53/EU on the approximation and harmonization of the laws of the Member States relating to radio equipment.

The manufacturer of this product is: Lexmark International, Inc., 740 West New Circle Road, Lexington, KY, 40550 USA. The EEA/EU authorized representative is: Lexmark International Technology Hungária Kft., 8

Lechner Ödön fasor, Millennium Tower III, 1095 Budapest HUNGARY. The EEA/EU Importer is: Lexmark International Technology S.à.r.l. 20, Route de Pré-Bois, ICC Building, Bloc A, CH-1215 Genève, Switzerland. A declaration of conformity to the requirements of the Directives is available upon request from the Authorized Representative or may be obtained at [www.lexmark.com/en\\_us/about/regulatory-compliance/european-union-declaration-of-conformity.html](http://www.lexmark.com/en_us/about/regulatory-compliance/european-union-declaration-of-conformity.html).

Compliance is indicated by the CE marking:



**Restrictions**

This radio equipment is restricted to indoor use only. Outdoor use is prohibited. This restriction applies to all the countries listed in the table below:



AT	BE	BG	CH	CY	CZ	DE	DK	EE
EL	ES	FI	FR	HR	HU	IE	IS	IT
LI	LT	LU	LV	MT	NL	NO	PL	PT
RO	SE	SI	SK	TR	UK (NI)			

**EU and other countries statement of radio transmitter operational frequency bands and maximum RF power**

This radio product transmits in either the 2.4GHz (2.412–2.472 GHz in the EU) or 5GHz (5.15–5.35, 5.47–5.725 in the EU) bands. The maximum transmitter EIRP power output, including antenna gain, is ≤ 20dBm for both bands.

United Kingdom (UK) conformity

**United Kingdom (UK) conformity**

This product is in conformity with the protection requirements of the Radio Equipment Regulations 2017.

The manufacturer of this product is: Lexmark International, Inc., 740 West New Circle Road, Lexington, KY, 40550 USA. The UK Importer is: Lexmark International Ltd, Quantum House, 60 Norden Road, Maidenhead SL6 4AY, United Kingdom. A declaration of conformity is available upon request from the UK Importer or may be obtained at [www.lexmark.com/en\\_us/about/regulatory-compliance/uk-declaration-of-conformity.html](http://www.lexmark.com/en_us/about/regulatory-compliance/uk-declaration-of-conformity.html).

Compliance is indicated by the UKCA marking:



### **Restrictions or requirements in the UK**

This radio equipment is restricted to indoor use only. Outdoor use is prohibited.

### **UK statement of radio transmitter operational frequency bands and maximum RF power**

This radio product transmits in either the 2.4GHz (2.412–2.472 GHz in the UK) or 5GHz (5.15–5.35, 5.47–5.725 in the UK) bands. The maximum transmitter EIRP power output, including antenna gain, is  $\leq 20$ dBm for both bands.

### **Multiple model information**

The following information applies to all MB2546 (7017-676), MX521 (7017-636 and 7017-676), MX522 (7017-678), and XM1246 (7017-679) printer models.

### **Federal Communications Commission (FCC) compliance information statement**

This product has been tested and found to comply with the limits for a Class A digital device, pursuant to Part 15 of the FCC Rules. Operation is subject to the following two conditions: (1) this device may not cause harmful interference, and (2) this device must accept any interference received, including interference that may cause undesired operation.

The FCC Class A limits are designed to provide reasonable protection against harmful interference when the equipment is operated in a commercial environment. This equipment generates, uses, and can radiate radio frequency energy and, if not installed and used in accordance with the instruction manual, may cause harmful interference to radio communications. Operation of this equipment in a residential area is likely to cause harmful interference, in which case the user will be required to correct the interference at his own expense.

The manufacturer is not responsible for any radio or television interference caused by using other than recommended cables or by unauthorized changes or modifications to this equipment. Unauthorized changes or modifications could void the user's authority to operate this equipment.

**Note:** To assure compliance with FCC regulations on electromagnetic interference for a Class A computing device, use a properly shielded and grounded cable such as Lexmark part number 1021231 for parallel attach or 1021294 for USB attach. Use of a substitute cable not properly shielded and grounded may result in a violation of FCC regulations.

Any questions regarding this compliance information statement should be directed to:

Director of Lexmark Technology & Services  
Lexmark International, Inc.  
740 West New Circle Road  
Lexington, KY 40550  
Telephone: (859) 232-2000  
E-mail: [regulatory@lexmark.com](mailto:regulatory@lexmark.com)

## **Innovation, Science and Economic Development Canada compliance statement**

This Class A digital apparatus meets all requirements of the Canadian Interference-Causing Equipment Standard ICES-003.

## **Avis de conformité aux normes de l'Innovation, Sciences et Développement économique Canada**

Cet appareil numérique de classe A est conforme aux exigences de la norme canadienne relative aux équipements pouvant causer des interférences NMB-003.

## **Aviso aos usuários de produtos Classe A no Brasil.**

Este produto não é apropriado para uso em ambientes domésticos, pois poderá causar interferências eletromagnéticas que obrigam o usuário a tomar medidas necessárias para minimizar estas interferências.

## **European Community (EC) directives conformity**

This product is in conformity with the protection requirements of EC Council directives 2014/30/EU, 2014/35/EU, and 2011/65/EU as amended by (EU) 2015/863 on the approximation and harmonization of the laws of the Member States relating to electromagnetic compatibility, safety of electrical equipment designed for use within certain voltage limits, and on the restrictions of use of certain hazardous substances in electrical and electronic equipment.

The manufacturer of this product is: Lexmark International, Inc., 740 West New Circle Road, Lexington, KY, 40550 USA. The EEA/EU authorized representative is: Lexmark International Technology Hungária Kft., 8 Lechner Ödön fasor, Millennium Tower III, 1095 Budapest HUNGARY. The EEA/EU Importer is: Lexmark International Technology S.à.r.l. 20, Route de Pré-Bois, ICC Building, Bloc A, CH-1215 Genève, Switzerland. A declaration of conformity to the requirements of the Directives is available upon request from the Authorized Representative or may be obtained at

[www.lexmark.com/en\\_us/about/regulatory-compliance/european-union-declaration-of-conformity.html](http://www.lexmark.com/en_us/about/regulatory-compliance/european-union-declaration-of-conformity.html).

This product satisfies the Class A limits of EN 55032 and safety requirements of EN 62368-1.

United Kingdom (UK) conformity

## United Kingdom (UK) conformity

This product is in conformity with the protection requirements of the Electromagnetic Compatibility Regulations 2016, the Electrical Equipment (Safety) Regulations 2016, and the Restriction of the Use of Certain Hazardous Substances in Electrical and Electronic Equipment Regulations 2012.

The manufacturer of this product is: Lexmark International, Inc., 740 West New Circle Road, Lexington, KY, 40550 USA. The UK Importer is: Lexmark International Ltd, Quantum House, 60 Norden Road, Maidenhead SL6 4AY, United Kingdom. A declaration of conformity is available upon request from the UK Importer or may be obtained at [www.lexmark.com/en\\_us/about/regulatory-compliance/uk-declaration-of-conformity.html](http://www.lexmark.com/en_us/about/regulatory-compliance/uk-declaration-of-conformity.html).

This product satisfies the Class A limits of BS EN 55032 and safety requirements of BS EN 62368-1.

## Radio interference notice

### Warning

This is a product that complies with the emission requirements of EN 55032 Class A limits and immunity requirements of EN 55024. This product is not intended to be used in residential/domestic environments.

This is a Class A product. In a domestic environment, this product may cause radio interference, in which case the user may be required to take adequate measures.

## Model-specific information

The following information applies only to MB2442 (7017-478), MX421 (7017-476), and XM1242 (7017-496) printer models.

## Federal Communications Commission (FCC) compliance information statement

This product has been tested and found to comply with the limits for a Class B digital device, pursuant to Part 15 of the FCC Rules. Operation is subject to the following two conditions: (1) this device may not cause harmful interference, and (2) this device must accept any interference received, including interference that may cause undesired operation.

The FCC Class B limits are designed to provide reasonable protection against harmful interference when the equipment is operated in a residential installation. This equipment generates, uses, and can radiate radio frequency energy and, if not installed and used in accordance with the instructions, may cause harmful interference to radio communications. However, there is no guarantee that interference will not occur in a particular installation. If this equipment does cause harmful interference to radio or television reception, which can be determined by turning the equipment off and on, the user is encouraged to try to correct the interference by one or more of the following measures:

- Reorient or relocate the receiving antenna.
- Increase the separation between the equipment and receiver.
- Connect the equipment into an outlet on a circuit different from that to which the receiver is connected.
- Consult your point of purchase or service representative for additional suggestions.

The manufacturer is not responsible for radio or television interference caused by using other than recommended cables or by unauthorized changes or modifications to this equipment. Unauthorized changes or modifications could void the user's authority to operate this equipment.

**Note:** To assure compliance with FCC regulations on electromagnetic interference for a Class B computing device, use a properly shielded and grounded cable such as Lexmark part number 1021231 for parallel attach or 1021294 for USB attach. Use of a substitute cable not properly shielded and grounded may result in a violation of FCC regulations.

Any questions regarding this compliance information statement should be directed to:

Director of Lexmark Technology & Services  
Lexmark International, Inc.  
740 West New Circle Road  
Lexington, KY 40550  
Telephone: (859) 232-2000  
E-mail: [regulatory@lexmark.com](mailto:regulatory@lexmark.com)

## **Innovation, Science and Economic Development Canada compliance statement**

This Class B digital apparatus meets all requirements of the Canadian Interference-Causing Equipment Standard ICES-003.

## **Avis de conformité aux normes de l'Innovation, Sciences et Développement économique Canada**

Cet appareil numérique de classe B est conforme aux exigences de la norme canadienne relative aux équipements pouvant causer des interférences NMB-003.

## **European Community (EC) directives conformity**

This product is in conformity with the protection requirements of EC Council directives 2014/30/EU, 2014/35/EU, 2009/125/EC, and 2011/65/EU as amended by (EU) 2015/863 on the approximation and harmonization of the laws of the Member States relating to electromagnetic compatibility, safety of electrical equipment designed for use within certain voltage limits, the ecodesign of energy-related products, and on the restrictions of use of certain hazardous substances in electrical and electronic equipment.

The manufacturer of this product is: Lexmark International, Inc., 740 West New Circle Road, Lexington, KY, 40550 USA. The EEA/EU authorized representative is: Lexmark International Technology Hungária Kft., 8 Lechner Ödön fasor, Millennium Tower III, 1095 Budapest HUNGARY. The EEA/EU Importer is: Lexmark International Technology S.à.r.l. 20, Route de Pré-Bois, ICC Building, Bloc A, CH-1215 Genève, Switzerland. A declaration of conformity to the requirements of the Directives is available upon request from the Authorized Representative or may be obtained at

[www.lexmark.com/en\\_us/about/regulatory-compliance/european-union-declaration-of-conformity.html](http://www.lexmark.com/en_us/about/regulatory-compliance/european-union-declaration-of-conformity.html).

This product satisfies the Class B limits of EN 55032 and safety requirements of EN 62368-1.

United Kingdom (UK) conformity

## United Kingdom (UK) conformity

This product is in conformity with the protection requirements of the Electromagnetic Compatibility Regulations 2016, the Electrical Equipment (Safety) Regulations 2016, the Ecodesign for Energy-Related Products and Energy Information (Amendment) (EU Exit) Regulations 2019, and the Restriction of the Use of Certain Hazardous Substances in Electrical and Electronic Equipment Regulations 2012.

The manufacturer of this product is: Lexmark International, Inc., 740 West New Circle Road, Lexington, KY, 40550 USA. The UK Importer is: Lexmark International Ltd, Quantum House, 60 Norden Road, Maidenhead SL6 4AY, United Kingdom. A declaration of conformity is available upon request from the UK Importer or may be obtained at [www.lexmark.com/en\\_us/about/regulatory-compliance/uk-declaration-of-conformity.html](http://www.lexmark.com/en_us/about/regulatory-compliance/uk-declaration-of-conformity.html).

This product satisfies the Class B limits of BS EN 55032 and safety requirements of BS EN 62368-1.

STATEMENT OF LIMITED WARRANTY FOR LEXMARK LASER PRINTERS, LEXMARK LED PRINTERS, AND LEXMARK MULTIFUNCTION LASER PRINTERS

## STATEMENT OF LIMITED WARRANTY FOR LEXMARK LASER PRINTERS, LEXMARK LED PRINTERS, AND LEXMARK MULTIFUNCTION LASER PRINTERS

### Lexmark International, Inc., Lexington, KY

This limited warranty applies to the United States and Canada. For customers outside the U.S., refer to the country-specific warranty information that came with your product.

This limited warranty applies to this product only if it was originally purchased for your use, and not for resale, from Lexmark or a Lexmark Remarketer, referred to in this statement as “Remarketer.”

### Limited warranty

Lexmark warrants that this product:

- Is manufactured from new parts, or new and serviceable used parts, which perform like new parts
- Is, during normal use, free from defects in material and workmanship

If this product does not function as warranted during the warranty period, contact a Remarketer or Lexmark for repair or replacement (at Lexmark's option).

If this product is a feature or option, this statement applies only when that feature or option is used with the product for which it was intended. To obtain warranty service, you may be required to present the feature or option with the product.

If you transfer this product to another user, warranty service under the terms of this statement is available to that user for the remainder of the warranty period. You should transfer proof of original purchase and this statement to that user.

### Limited warranty service

The warranty period starts on the date of original purchase as shown on the purchase receipt and ends 12 months later provided that the warranty period for any supplies and for any maintenance items included with

the printer shall end earlier if it, or its original contents, are substantially used up, depleted, or consumed. Fuser Units, Transfer/Transport Units, Paper Feed items, if any, and any other items for which a Maintenance Kit is available are substantially consumed when the printer displays a “Life Warning” or “Scheduled Maintenance” message for such item.

To obtain warranty service you may be required to present proof of original purchase. You may be required to deliver your product to the Remarketer or Lexmark, or ship it prepaid and suitably packaged to a Lexmark designated location. You are responsible for loss of, or damage to, a product in transit to the Remarketer or the Lexmark designated location.

When warranty service involves the exchange of a product or part, the item replaced becomes the property of the Remarketer or Lexmark. The replacement may be a new or repaired item.

The replacement item assumes the remaining warranty period of the original product.

Replacement is not available to you if the product you present for exchange is defaced, altered, in need of a repair not included in warranty service, damaged beyond repair, or if the product is not free of all legal obligations, restrictions, liens, and encumbrances.

As part of your warranty service and/or replacement, Lexmark may update the firmware in your printer to the latest version. Firmware updates may modify printer settings and cause counterfeit and/or unauthorized products, supplies, parts, materials (such as toners and inks), software, or interfaces to stop working. Authorized use of genuine Lexmark products will not be impacted.

Before you present this product for warranty service, remove all print cartridges, programs, data, and removable storage media (unless directed otherwise by Lexmark).

For further explanation of your warranty alternatives and the nearest Lexmark authorized servicer in your area contact Lexmark on the World Wide Web.

Remote technical support is provided for this product throughout its warranty period. For products no longer covered by a Lexmark warranty, technical support may not be available or only be available for a fee.

### **Extent of limited warranty**

Lexmark does not warrant uninterrupted or error-free operation of any product or the durability or longevity of prints produced by any product.

Warranty service does not include repair of failures caused by:

- Modification or unauthorized attachments
- Accidents, misuse, abuse or use inconsistent with Lexmark user’s guides, manuals, instructions or guidance
- Unsuitable physical or operating environment
- Maintenance by anyone other than Lexmark or a Lexmark authorized servicer
- Operation of a product beyond the limit of its duty cycle
- Use of printing media outside of Lexmark specifications
- Refurbishment, repair, refilling or remanufacture by a third party of products, supplies or parts
- Products, supplies, parts, materials (such as toners and inks), software, or interfaces not furnished by Lexmark

**TO THE EXTENT PERMITTED BY APPLICABLE LAW, NEITHER LEXMARK NOR ITS THIRD PARTY SUPPLIERS OR REMARKETERS MAKE ANY OTHER WARRANTY OR CONDITION OF ANY KIND, WHETHER EXPRESS OR IMPLIED, WITH RESPECT TO THIS PRODUCT, AND SPECIFICALLY DISCLAIM THE IMPLIED WARRANTIES OR CONDITIONS OF MERCHANTABILITY, FITNESS FOR A PARTICULAR PURPOSE, AND SATISFACTORY QUALITY. ANY WARRANTIES THAT MAY NOT BE DISCLAIMED UNDER APPLICABLE LAW**

**ARE LIMITED IN DURATION TO THE WARRANTY PERIOD. NO WARRANTIES, EXPRESS OR IMPLIED, WILL APPLY AFTER THIS PERIOD. ALL INFORMATION, SPECIFICATIONS, PRICES, AND SERVICES ARE SUBJECT TO CHANGE AT ANY TIME WITHOUT NOTICE.**

### **Limitation of liability**

Your sole remedy under this limited warranty is set forth in this document. For any claim concerning performance or nonperformance of Lexmark or a Remarketer for this product under this limited warranty, you may recover actual damages up to the limit set forth in the following paragraph.

Lexmark's liability for actual damages from any cause whatsoever will be limited to the amount you paid for the product that caused the damages. This limitation of liability will not apply to claims by you for bodily injury or damage to real property or tangible personal property for which Lexmark is legally liable. **IN NO EVENT WILL LEXMARK BE LIABLE FOR ANY LOST PROFITS, LOST SAVINGS, INCIDENTAL DAMAGE, OR OTHER ECONOMIC OR CONSEQUENTIAL DAMAGES.** This is true even if you advise Lexmark or a Remarketer of the possibility of such damages. Lexmark is not liable for any claim by you based on a third party claim.

This limitation of remedies also applies to claims against any Suppliers and Remarketers of Lexmark. Lexmark's and its Suppliers' and Remarketers' limitations of remedies are not cumulative. Such Suppliers and Remarketers are intended beneficiaries of this limitation.

### **Additional rights**

Some states do not allow limitations on how long an implied warranty lasts, or do not allow the exclusion or limitation of incidental or consequential damages, so the limitations or exclusions contained above may not apply to you.

This limited warranty gives you specific legal rights. You may also have other rights that vary from state to state.

# Index

## A

- accessing the controller board 249
- activating Voice Guidance 27
- adapter plug 64
- adding a shortcut
  - copy 47
- adding contacts 25
- adding groups 25
- adding hardware options
  - print driver 266
- adding internal options
  - print driver 266
- adding printers to a computer 265
- adding shortcut
  - e-mail 56
  - fax destination 68
  - FTP address 72
- ADF registration
  - adjusting 247
- ADF separator roller
  - replacing 180
- adjusting
  - scanner registration 247
  - adjusting ADF registration 247
  - adjusting default volume
    - headphone 158
  - adjusting fax darkness 68
  - adjusting speech rate
    - Voice Guidance 28
  - adjusting the brightness
    - printer display 184
  - adjusting the brightness of the printer display 184
  - adjusting toner darkness 226
- AirPrint
  - using 39
- analog fax
  - setting up 58
- answering machine
  - setting up 61
- applications, supported 20
- assigning printer to a ring pattern 66
- attaching cables 15

- automatic document feeder (ADF)
  - using 45, 48, 66, 70
- avoiding paper jams 185

## B

- blank pages 198
- blocking junk faxes 68
- bookmarks
  - creating 24
  - creating folders for 24

## C

- cables
  - Ethernet 15
  - USB 15
- canceling a print job
  - from the computer 43
  - from the printer control panel 43
- cannot connect printer to Wi-Fi 227
- cannot open Embedded Web Server 226
- cannot receive faxes using analog fax 240
- cannot scan to a network folder 242
- cannot send e-mails 235
- cannot send or receive faxes using analog fax 237
- cannot send or receive faxes using etherFAX 239
- cannot send the fax cover page
  - from the computer 241
- Card Copy
  - setting up 20
- changing resolution
  - fax 68
- changing the printer port settings after installing ISP 161
- changing the wallpaper 21
- checking the status of parts and supplies 166
- cleaning
  - exterior of the printer 162
  - interior of the printer 162
  - cleaning the printer 162

- Cleaning the Scanner 154
- cleaning the scanner 163
- cleaning the touch screen 163
- clearing jam
  - in door A 187
  - in the duplex unit 192
  - in trays 193
- Cloud Connector profile
  - creating 23
  - printing from 43
  - scanning to 73
- collated printing does not work 233
- collating copies
  - copying 46
- computer
  - connecting to the printer 161
  - computer, scanning to 70
  - confidential documents do not print 222
  - confidential print jobs 42
    - printing 42
  - configuring daylight saving time 66
  - configuring fax speaker settings 158
  - configuring supply notifications 169
  - configuring the e-mail server settings 48
  - configuring Wi-Fi Direct 160
  - connecting a computer to the printer 161
  - connecting mobile device to printer 160
  - connecting printer to distinctive ring service 66
  - connecting the printer to a wireless network 158
  - connecting to a wireless network using PIN method 159
  - connecting to a wireless network using Push Button method 159
  - conserving supplies 184
  - contacting customer support 248
  - contacts
    - adding 25
    - deleting 26

- editing 26
- control panel
  - using 17
- controller board
  - accessing 249
- copy troubleshooting
  - partial copies of documents or photos 243
  - poor copy quality 244
  - scanner does not respond 247
- copying
  - multiple pages onto a single sheet 47
  - on both sides of the paper 46
  - on letterhead 46
  - photos 45
  - separator sheets between copies 46
  - using the automatic document feeder (ADF) 45
  - using the scanner glass 45
- copying different paper sizes 45
- copying from
  - selected tray 45
- creating a Cloud Connector profile 23
- creating a shortcut
  - copy 47
- creating bookmarks 24
- creating folders
  - for bookmarks 24
- creating shortcut
  - e-mail 56
  - fax destination 68
  - FTP address 72
- creating shortcuts 21
- crooked print 210
- Customer Support
  - using 22
- customer support
  - contacting 248
- customizing the display 21

## D

- dark print 199
- date and time
  - fax settings 66
- daylight saving time
  - configuring 66
- deactivating the Wi-Fi network 161

- default headphone volume
  - adjusting 158
- Defective flash detected 230
- deleting contacts 26
- deleting groups 26
- Device Quotas
  - setting up 23
- different paper sizes, copying 45
- directory list
  - printing 43
- Display Customization
  - using 21
- distinctive ring service, fax
  - enabling 66
- documents, printing
  - from a computer 38
  - from a mobile device 38
- dots on print 208

## E

- Eco-Settings
  - configuring 22
- editing contacts 26
- editing groups 26
- emission notices 270, 280
- enabling Magnification mode 28
- enabling personal identification numbers 28
- enabling spoken passwords 28
- enabling the USB port 228
- enabling Wi-Fi Direct 160
- encrypting
  - printer hard disk 156
- enlarging a copy size 46
- environmental settings 183
- erasing hard disk memory 155
- erasing printer memory 155, 156
- etherFAX
  - setting up fax function 60
- Ethernet port 15
- exporting a configuration file
  - using the Embedded Web Server 266
- e-mail
  - sending 56
- e-mail function
  - setting up 48
- e-mail server
  - configuring 48
- e-mail service providers 48
- e-mail shortcut
  - creating 56

- e-mail troubleshooting
  - cannot send e-mails 235
- e-mailing
  - using the automatic document feeder (ADF) 48
  - using the scanner glass 48

## F

- factory default settings
  - restoring 156
- fax
  - forwarding 69
  - holding 69
  - scheduling send time and date 67
  - sending 67
- fax darkness
  - adjusting 68
- fax destination shortcut
  - creating 68
- fax driver
  - installing 265
- fax log
  - viewing 68
- fax port 15
- fax resolution
  - changing 68
- fax server, using
  - setting up the fax function 60
- fax setup
  - country- or region-specific 64
  - standard telephone line connection 61
- fax speaker settings
  - configuring 158
- fax troubleshooting
  - caller ID is not shown 236
  - can send but not receive faxes
    - using analog fax 240
  - cannot send faxes using analog fax 239
  - cannot send or receive faxes
    - using analog fax 237
  - cannot send or receive faxes
    - using etherFAX 239
  - cannot send the fax cover page
    - from the computer 241
  - cannot set up etherFAX 236
  - missing information on the fax cover page 241
  - poor print quality 240

faxing  
  setting the date and time 66  
  using the automatic document feeder (ADF) 66  
  using the scanner glass 66  
FCC notices 280  
finding information about the printer 11  
firmware, updating  
  using the control panel 267  
  using the Embedded Web Server 268  
flash drive  
  printing from 40  
  scanning to 72  
folder paper 202  
font sample list  
  printing 43  
forwarding fax 69  
FTP address  
  creating shortcut 72  
FTP server, scanning to  
  using the control panel 71

## G

gray background on prints 203  
groups  
  adding 25  
  deleting 26  
  editing 26

## H

hard disk memory  
  erasing 155  
hardware options  
  trays 263  
hardware options, adding  
  print driver 266  
held documents do not print 222  
held jobs 42  
  printing 42  
Help menu 154  
Hibernate mode  
  configuring 183  
holding faxes 69  
home screen  
  customizing 19  
  using 19  
home screen icons 19  
  displaying 19

## I

icons on the home screen  
  showing 19  
identifying jam locations 186  
imaging unit  
  ordering 168  
  replacing 172  
importing a configuration file  
  using the Embedded Web Server 266  
incorrect margins 205  
indicator light  
  understanding the status 17  
installing a memory card 251  
installing a printer hard disk 254  
installing an internal solutions port 256  
installing an optional card 252  
installing options  
  printer hard disk 254  
installing the fax driver 265  
installing the print driver 264  
installing the printer software 264  
internal option is not detected 229  
internal options  
  firmware cards 249  
  flash memory 249  
  font cards 249  
  installing 252  
  internal solutions port 249  
  memory card 251  
  printer hard disk 249, 254  
internal options, adding  
  print driver 266  
internal solutions port  
  installing 256  
  troubleshooting 230

## J

jagged image  
  scanning from the ADF 245  
jagged text  
  scanning from the ADF 245  
jams  
  avoiding 185  
jams, clearing  
  in the automatic document feeder 195  
  in the multipurpose feeder 194

  in the standard bin 192  
junk faxes  
  blocking 68

## K

keyboard on the display  
  using 28

## L

letterhead  
  copying on 46  
Lexmark Mobile Print  
  using 38  
Lexmark ScanBack Utility 70  
light print 206  
LINE port 15  
linking trays 32  
loading  
  multipurpose feeder 31  
loading envelopes  
  in the multipurpose feeder 31  
loading trays 29  
locating paper jams 186  
locating the security slot 155

## M

Magnification mode  
  enabling 28  
maintenance kit  
  ordering 169  
making copies 45  
managing screen saver 21  
memory card  
  installing 251  
menu  
  802.1x 141  
  About this Printer 88  
  Accessibility 82  
  Anonymous Data Collection 81  
  Confidential Print Setup 150  
  Configuration Menu 83  
  Copy Defaults 99  
  Custom Scan Sizes 98  
  Device 153  
  Disk Encryption 151  
  Eco-Mode 76  
  Erase Temporary Data Files 151  
  Ethernet 135  
  E-mail Defaults 116  
  E-mail Setup 115  
  Fax 153

- Fax Cover Page 110
- Fax Log Settings 110
- Fax Mode 102
- Fax Receive Settings 107
- Fax Send Settings 103
- Fax Server E-mail Settings 112
- Fax Server Scan Settings 114
- Flash Drive Print 130
- Flash Drive Scan 126
- FTP Defaults 121
- General Fax Settings 102, 112
- HTML 95
- HTTP/FTP Settings 142
- Image 96
- IPSec 140
- Job Accounting 91
- Layout 88
- Local Accounts 146
- Login Restrictions 150
- LPD Configuration 141
- Manage Permissions 145
- Media Types 98
- Menu Settings Page 152
- Miscellaneous 152
- Mobile Services
  - Management 152
- Network 154
- Network Overview 131
- Notifications 78
- Out of Service Erase 87
- PCL 94
- PDF 93
- PostScript 93
- Power Management 81
- Preferences 75
- Print 153
- Quality 91
- Remote Operator Panel 77
- Restore Factory Defaults 83
- Restrict external network access 144
- Schedule USB Devices 147
- Security Audit Log 147
- Setup 90
- Shortcuts 153
- SNMP 139
- Solutions LDAP Settings 151
- Speaker Settings 111
- TCP/IP 137
- ThinPrint 143
- Tray Configuration 96
- Troubleshooting 154

- Universal Setup 97
- USB 143
- Visible Home Screen Icons 88
- Web Link Setup 121
- Wi-Fi Direct 135
- XPS 92
- Menu Settings Page
  - printing 154
- menus
  - Wireless 132
- missing information on the fax cover page 241
- mobile device
  - connecting to printer 160
  - printing from 38, 39
- Mopria Print Service 38
- mottled print 208
- moving the printer 13, 182
- multiple pages onto a single sheet
  - copying 47
- multipurpose feeder
  - loading 31

## N

- navigating the screen
  - using gestures 27
- navigating the screen using gestures 27
- Network Setup Page
  - printing 18
- network setup page
  - printing 228
- noise emission levels 270
- Non-Lexmark supply 232
- non-volatile memory 156
  - erasing 155
- Not enough free space in flash memory for resources 230
- notices 270, 272, 274, 275, 276, 280, 282, 284

## O

- operating systems
  - supported 264
- optional card
  - installing 252
- options
  - internal solutions port 256
- ordering
  - imaging unit 168

- ordering supplies
  - maintenance kit 169
  - toner cartridge 166

## P

- paper
  - Universal size setting 29
- paper jam in door A 187
- paper jam in the automatic document feeder 195
- paper jam in the duplex unit 192
- paper jam in the multipurpose feeder 194
- paper jam in the rear door 191
- paper jam in trays 193
- paper jam, clearing
  - in the automatic document feeder 195
  - in the multipurpose feeder 194
  - in the rear door 191
- paper jams
  - avoiding 185
- paper jams, clearing
  - in the standard bin 192
- paper sizes
  - supported 33
- paper types
  - supported 35
- paper weights
  - supported 36
- parts status
  - checking 166
- personal identification number method 159
- personal identification numbers
  - enabling 28
- photos
  - copying 45
- pick roller assembly
  - replacing 176
- pick tires
  - replacing 174
- placing separator sheets
  - between copies 46
- poor fax print quality 240
- power button light
  - understanding the status 17
- power save modes
  - configuring 183
- print driver
  - hardware options, adding 266
  - installing 264

- print job
    - canceling from the computer 43
    - canceling from the printer control panel 43
  - print jobs not printed 221
  - print quality problem
    - gray background on prints 203
  - print quality problems 197
  - Print Quality Test Pages 154
  - print quality troubleshooting
    - blank or white pages 198
    - crooked print 210
    - dark print 199
    - fine lines are not printed correctly 201
    - folded or wrinkled paper 202
    - horizontal light bands 205
    - light print 206
    - mottled print and dots 208
    - paper curl 209
    - print quality problems 197
    - repeating defects 211
    - skewed print 210
    - solid black pages 212
    - text or images cut off 213
    - toner easily rubs off 215
    - vertical dark bands 216
    - vertical dark lines or streaks 217
    - vertical dark streaks with print missing 218
    - vertical light bands 219
    - vertical white lines 220
  - print troubleshooting
    - collated printing does not work 233
    - confidential and other held documents do not print 222
    - envelope seals when printing 232
    - incorrect margins 205
    - jammed pages are not reprinted 235
    - job prints from the wrong tray 223
    - job prints on the wrong paper 223
    - paper frequently jams 234
    - print jobs do not print 221
    - slow printing 223
    - tray linking does not work 233
    - unable to read flash drive 228
  - printer
    - minimum clearances 13
    - selecting a location 13
    - shipping 183
  - printer configurations 14
  - printer display
    - adjusting the brightness 184
  - printer hard disk
    - encrypting 156
  - printer hard disk memory 156
  - printer information
    - finding 11
  - printer is not responding 225
  - printer memory
    - erasing 155
  - printer menus 74
  - printer messages
    - Defective flash detected 230
    - Non-Lexmark supply 232
    - Not enough free space in flash memory for resources 230
    - Replace cartridge, printer region mismatch 231
    - Unformatted flash detected 231
  - printer options troubleshooting
    - cannot detect internal option 229
    - internal solutions port 230
  - printer port settings
    - changing 161
  - printer ports 15
  - printer serial number
    - finding 12
  - printer settings
    - restoring factory default 156
  - printer software
    - installing 264
  - printer status 17
  - printing
    - confidential print jobs 42
    - directory list 43
    - font sample list 43
    - from a Cloud Connector profile 43
    - from a computer 38
    - from a flash drive 40
    - from a mobile device 38, 39
    - held jobs 42
    - Menu Settings Page 154
    - Network Setup Page 18
    - network setup page 228
    - using Mopria Print Service 38
    - using Wi-Fi Direct 39
  - printing a directory list 43
  - printing a font sample list 43
  - printing a network setup page 228
  - printing from a computer 38
  - printing from a flash drive 40
  - Push Button method 159
- Q**
- QR codes
    - adding 22
- R**
- recycling
    - Lexmark packaging 184
    - Lexmark products 184
  - reducing a copy size 46
  - removing jam
    - in the duplex unit 192
  - removing paper jam
    - in door A 187
    - in trays 193
  - repeat print jobs 42
  - Replace cartridge, printer region mismatch 231
  - replacing parts
    - ADF separator roller 180
  - replacing supplies
    - imaging unit 172
    - toner cartridge 170
  - replacing the pick roller assembly 176
  - replacing the pick tires 174
  - resetting
    - supply usage counters 232
  - resetting the supply usage counters 232
  - restoring factory default settings 156
  - RJ-11 adapter 64
  - running a slideshow 21
- S**
- safety information 8, 9, 10
  - saving paper 47
  - Scan Center
    - setting up 23
  - scan troubleshooting
    - cannot scan to a computer 241

- cannot scan to network folder 242
  - jagged image when scanning from the ADF 245
  - jagged text when scanning from the ADF 245
  - partial copies of documents or photos 243
  - poor copy quality 244
  - scan job was not successful 245
  - scanner does not respond 247
  - scanning freezes the computer 246
  - scanning takes too long 246
  - vertical dark streaks on output when scanning from the ADF 244
  - scanner
    - cleaning 163
  - scanner does not close 246
  - scanner glass
    - using 45, 48, 66, 70
  - scanning
    - to a Cloud Connector profile 73
    - to a computer 70
    - to a network folder 72
    - to an FTP server 71
    - to flash drive 72
    - using the automatic document feeder (ADF) 70
    - using the scanner glass 70
  - scanning from ADF
    - jagged image 245
    - jagged text 245
  - scanning quality problem 244
  - scanning to an FTP server
    - using the control panel 71
  - scheduling a fax 67
  - securing printer memory 156
  - security slot
    - locating 155
  - selecting a location for the printer 13
  - sending e-mail 56
  - sending fax 67
  - serial number, printer
    - finding 12
  - serial printing
    - setting up 162
  - setting the paper size 29
  - setting the paper type 29
  - setting the Universal paper size 29
  - setting up
    - analog fax 58
    - Card Copy 20
  - setting up Device Quotas 23
  - setting up fax
    - country- or region-specific 64
    - standard telephone line connection 61
  - setting up fax function
    - using etherFAX 60
  - setting up serial printing 162
  - setting up the fax function using fax server 60
  - shipping the printer 183
  - shortcut
    - Copy 21
    - Email 21
    - Fax 21
    - FTP 21
  - shortcut, creating
    - e-mail 56
    - fax destination 68
    - FTP address 72
  - shortcut, creating a copy 47
  - shortcuts
    - creating 21
  - skewed print 210
  - Sleep mode
    - configuring 183
  - SMTP settings
    - configuring 48
  - spoken passwords
    - enabling 28
  - statement of volatility 156
  - storing print jobs 42
  - supplies
    - conserving 184
  - supplies status
    - checking 166
  - supply notifications
    - configuring 169
  - supply usage counters
    - resetting 232
  - supported applications 20
  - supported fax 57
  - supported file types 41
  - supported flash drives 41
  - supported operating systems 264
  - supported paper sizes 33
  - supported paper types 35
  - supported paper weights 36
- ## T
- toner cartridge
    - ordering 166
    - replacing 170
  - toner darkness
    - adjusting 226
  - touch screen
    - cleaning 163
  - trays
    - installing 263
    - linking 32
    - loading 29
    - unlinking 32
  - troubleshooting
    - cannot connect printer to Wi-Fi 227
    - cannot open Embedded Web Server 226
    - print quality problems 197
    - printer is not responding 225
  - troubleshooting, copy
    - partial copies of documents or photos 243
    - poor copy quality 244
    - scanner does not close 246
    - scanner does not respond 247
  - troubleshooting, e-mail
    - cannot send e-mails 235
  - troubleshooting, fax
    - caller ID is not shown 236
    - can send but not receive faxes
      - using analog fax 240
    - cannot send faxes using analog fax 239
    - cannot send or receive faxes
      - using analog fax 237
    - cannot send or receive faxes
      - using etherFAX 239
    - cannot send the fax cover page from the computer 241
    - cannot set up etherFAX 236
    - missing information on the fax cover page 241
    - poor print quality 240
  - troubleshooting, print
    - collated printing does not work 233

- confidential and other held documents do not print 222
- envelope seals when printing 232
- incorrect margins 205
- jammed pages are not reprinted 235
- job prints from the wrong tray 223
- job prints on the wrong paper 223
- paper frequently jams 234
- print jobs do not print 221
- slow printing 223
- tray linking does not work 233
- troubleshooting, print quality
  - blank or white pages 198
  - crooked print 210
  - dark print 199
  - fine lines are not printed correctly 201
  - folded or wrinkled paper 202
  - horizontal light bands 205
  - light print 206
  - mottled print and dots 208
  - paper curl 209
  - repeating defects 211
  - skewed print 210
  - solid black pages 212
  - text or images cut off 213
  - toner easily rubs off 215
  - vertical dark bands 216
  - vertical dark lines or streaks 217
  - vertical dark streaks with print missing 218
  - vertical light bands 219
  - vertical white lines 220
- troubleshooting, printer options
  - cannot detect internal option 229
  - internal solutions port 230
- troubleshooting, scan
  - cannot scan to a computer 241
  - cannot scan to a network folder 242
  - jagged image when scanning from the ADF 245
  - jagged text when scanning from the ADF 245
  - partial copies of documents or photos 243

- poor copy quality 244
- scan job was not successful 245
- scanner does not close 246
- scanner does not respond 247
- vertical dark streaks on output when scanning from the ADF 244
- two-sided copying 46

## U

- unable to read flash drive
  - troubleshooting, print 228
- Unformatted flash detected 231
- Universal paper size setting 29
- unlinking trays 32
- updating firmware
  - using the control panel 267
  - using the Embedded Web Server 268
- USB port 15
  - enabling 228
- using
  - genuine Lexmark parts 166
  - genuine Lexmark supplies 166
  - using Customer Support 22
  - using Display Customization 21
  - using QR Code Generator 22
  - using the ADF
    - copying 45
  - using the automatic document feeder (ADF) 45, 48, 66, 70
  - using the control panel 17
  - using the home screen 19
  - using the scanner glass 45, 48, 66, 70
    - copying 45

## V

- verify print jobs 42
- vertical dark lines on prints 217
- vertical dark streaks on output when scanning from the ADF 244
- vertical streaks on prints 217
- viewing a fax log 68
- virtual keyboard
  - using 28
- Voice Guidance
  - activating 27

- speech rate 28
- Voice Guidance speech rate
  - adjusting 28
- volatile memory 156
  - erasing 155

## W

- white lines 220
- white pages 198
- Wireless menu 132
- wireless network
  - connecting the printer to 158
  - Wi-Fi Protected Setup 159
- wireless networking 158
- Wi-Fi Direct
  - configuring 160
  - enabling 160
  - printing from a mobile device 39
- Wi-Fi network
  - deactivating 161
- Wi-Fi Protected Setup
  - wireless network 159
- wrinkled paper 202