

**ASUS<sup>®</sup>**

**VY249 Series**

**LCD Monitor**

*User Guide*

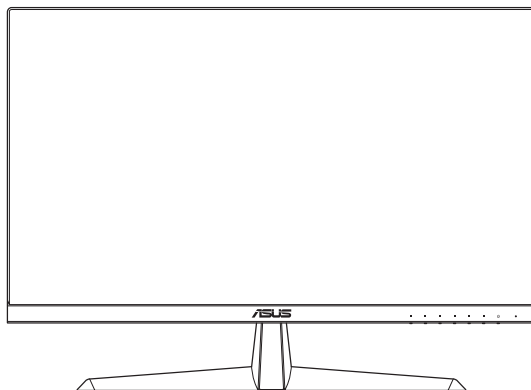

**HDMI<sup>™</sup>**  
HIGH-DEFINITION MULTIMEDIA INTERFACE

First Edition

August 2020

**Copyright © 2020 ASUSTeK COMPUTER INC. All Rights Reserved.**

No part of this manual, including the products and software described in it, may be reproduced, transmitted, transcribed, stored in a retrieval system, or translated into any language in any form or by any means, except documentation kept by the purchaser for backup purposes, without the express written permission of ASUSTeK COMPUTER INC. ("ASUS").

Product warranty or service will not be extended if: (1) the product is repaired, modified or altered, unless such repair, modification or alteration is authorized in writing by ASUS; or (2) the serial number of the product is defaced or missing.

ASUS PROVIDES THIS MANUAL "AS IS" WITHOUT WARRANTY OF ANY KIND, EITHER EXPRESS OR IMPLIED, INCLUDING BUT NOT LIMITED TO THE IMPLIED WARRANTIES OR CONDITIONS OF MERCHANTABILITY OR FITNESS FOR A PARTICULAR PURPOSE. IN NO EVENT SHALL ASUS, ITS DIRECTORS, OFFICERS, EMPLOYEES OR AGENTS BE LIABLE FOR ANY INDIRECT, SPECIAL, INCIDENTAL, OR CONSEQUENTIAL DAMAGES (INCLUDING DAMAGES FOR LOSS OF PROFITS, LOSS OF BUSINESS, LOSS OF USE OR DATA, INTERRUPTION OF BUSINESS AND THE LIKE), EVEN IF ASUS HAS BEEN ADVISED OF THE POSSIBILITY OF SUCH DAMAGES ARISING FROM ANY DEFECT OR ERROR IN THIS MANUAL OR PRODUCT.

SPECIFICATIONS AND INFORMATION CONTAINED IN THIS MANUAL ARE FURNISHED FOR INFORMATIONAL USE ONLY, AND ARE SUBJECT TO CHANGE AT ANY TIME WITHOUT NOTICE, AND SHOULD NOT BE CONSTRUED AS A COMMITMENT BY ASUS. ASUS ASSUMES NO RESPONSIBILITY OR LIABILITY FOR ANY ERRORS OR INACCURACIES THAT MAY APPEAR IN THIS MANUAL, INCLUDING THE PRODUCTS AND SOFTWARE DESCRIBED IN IT.

Products and corporate names appearing in this manual may or may not be registered trademarks or copyrights of their respective companies, and are used only for identification or explanation and to the owners' benefit, without intent to infringe.

# Contents

Notices.....	iv
TCO Certified.....	vi
Safety Information .....	vii
Care & Cleaning.....	viii
Takeback Services.....	ix

## Chapter 1: Product Introduction

1.1	Welcome! .....	1-1
1.2	Package Contents .....	1-1
1.3	Assembling the Monitor Base.....	1-2
1.4	Connect Cables .....	1-3
	1.4.1 Rear of the LCD Monitor .....	1-3
1.5	Monitor Introduction .....	1-4
	1.5.1 Using the Control Buttons .....	1-4
	1.5.2 QuickFit Function .....	1-6
	1.5.3 EyeCheck Function.....	1-8
	1.5.4 GamePlus Function .....	1-11

## Chapter 2: Setup

2.1	Detaching the Base (for VESA Wall Mount).....	2-1
2.2	Adjusting the Monitor .....	2-2

## Chapter 3: General Instructions

3.1	OSD (On-Screen Display) Menu.....	3-1
	3.1.1 How to Reconfigure .....	3-1
	3.1.2 OSD Function Introduction.....	3-2
3.2	Specifications.....	3-13
3.3	Troubleshooting (FAQ).....	3-14
3.4	Supported Timing List.....	3-15
3.5	Product Dimensions .....	3-16

# Notices

## Federal Communications Commission Statement

This device complies with Part 15 of the FCC Rules. Operation is subject to the following two conditions:

- This device may not cause harmful interference, and
- This device must accept any interference received including interference that may cause undesired operation.

This equipment has been tested and found to comply with the limits for a Class B digital device, pursuant to Part 15 of the FCC Rules. These limits are designed to provide reasonable protection against harmful interference in a residential installation. This equipment generates, uses and can radiate radio frequency energy and, if not installed and used in accordance with manufacturer's instructions, may cause harmful interference to radio communications. However, there is no guarantee that interference will not occur in a particular installation. If this equipment does cause harmful interference to radio or television reception, which can be determined by turning the equipment off and on, the user is encouraged to try to correct the interference by one or more of the following measures:

- Reorient or relocate the receiving antenna.
- Increase the separation between the equipment and receiver.
- Connect the equipment to an outlet on a circuit different from that to which the receiver is connected.
- Consult the dealer or an experienced radio/TV technician for help.



The use of shielded cables for connection of the monitor to the graphics card is required to assure compliance with FCC regulations. Changes or modifications to this unit not expressly approved by the party responsible for compliance could void the user's authority to operate this equipment.

## ENERGY STAR complied product



ENERGY STAR is a joint program of the U.S. Environmental Protection Agency and the U.S. Department of Energy helping us all save money and protect the environment through energy efficient products and practices.

All ASUS products with the ENERGY STAR logo comply with the ENERGY STAR standard, and the power management feature is enabled by default. The monitor and computer are automatically set to sleep after 10 and 30 minutes of user inactivity. To wake your computer, click the mouse or press any key on the keyboard. Please visit <http://www.energystar.gov/powermanagement> for detail information on power management and its benefits to the environment. In addition, please visit <http://www.energystar.gov> for detail information on the ENERGY STAR joint program.



NOTE: Energy Star is NOT supported on FreeDOS and Linux-based operating system.

This product implements power management functionality. In case of no signal input after 10 seconds, the product automatically goes to sleep/standby mode.

### Canadian Department of Communications Statement

This digital apparatus does not exceed the Class B limits for radio noise emissions from digital apparatus set out in the Radio Interference Regulations of the Canadian Department of Communications.

This class B digital apparatus complies with Canadian ICES-003.

This Class B digital apparatus meets all requirements of the Canadian Interference - Causing Equipment Regulations.

Cet appareil numérique de la classe B respecte toutes les exigences du Règlement sur le matériel brouiller du Canada.



# TCO Certified

A third-party certification according to ISO 14024



Toward sustainable IT products

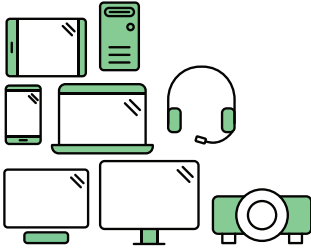

## Say hello to a more sustainable product

IT products are associated with a wide range of sustainability risks throughout their life cycle. Human rights violations are common in the factories. Harmful substances are used both in products and their manufacture. Products can often have a short lifespan because of poor ergonomics, low quality and when they are not able to be repaired or upgraded.

**This product is a better choice.** It meets all the criteria in TCO Certified, the world's most comprehensive sustainability certification for IT products. Thank you for making a responsible product choice, that help drive progress towards a more sustainable future!

Criteria in TCO Certified have a life-cycle perspective and balance environmental and social responsibility. Conformity is verified by independent and approved verifiers that specialize in IT products, social responsibility or other sustainability issues. Verification is done both before and after the certificate is issued, covering the entire validity period. The process also includes ensuring that corrective actions are implemented in all cases of factory non-conformities. And last but not least, to make sure that the certification and independent verification is accurate, both TCO Certified and the verifiers are reviewed regularly.

### Want to know more?

Read information about TCO Certified, full criteria documents, news and updates at [tcocertified.com](http://tcocertified.com). On the website you'll also find our Product Finder, which presents a complete, searchable listing of certified products.

## Safety Information

- Before setting up the monitor, carefully read all the documentation that came with the package.
- To prevent fire or shock hazard, never expose the monitor to rain or moisture.
- Never try to open the monitor cabinet. The dangerous high voltages inside the monitor may result in serious physical injury.
- If the power supply is broken, do not try to fix it by yourself. Contact a qualified service technician or your retailer.
- Before using the product, make sure all cables are correctly connected and the power cables are not damaged. If you detect any damage, contact your dealer immediately.
- Slots and openings on the back or top of the cabinet are provided for ventilation. Do not block these slots. Never place this product near or over a radiator or heat source unless proper ventilation is provided.
- The monitor should be operated only from the type of power source indicated on the label. If you are not sure of the type of power supply to your home, consult your dealer or local power company.
- Use the appropriate power plug which complies with your local power standard.
- Do not overload power strips and extension cords. Overloading can result in fire or electric shock.
- Avoid dust, humidity, and temperature extremes. Do not place the monitor in any area where it may become wet. Place the monitor on a stable surface.
- Unplug the unit during a lightning storm or if it will not be used for a long period of time. This will protect the monitor from damage due to power surges.
- Never push objects or spill liquid of any kind into the slots on the monitor cabinet.
- To ensure satisfactory operation, use the monitor only with UL listed computers which have appropriate configured receptacles marked between 100-240V AC.
- If you encounter technical problems with the monitor, contact a qualified service technician or your retailer.
- Adjustment of the volume control as well as the equalizer to other settings than the center position may increase the ear-/headphones output voltage and therefore the sound pressure level.



This symbol of the crossed out wheeled bin indicates that the product (electrical, electronic equipment, and mercury-containing button cell battery) should not be placed in municipal waste. Please check local regulations for disposal of electronic products.

**AEEE yönetmeliğine uygundur**

# Care & Cleaning

- Before you lift or reposition your monitor, it is better to disconnect the cables and power cord. Follow the correct lifting techniques when positioning the monitor. When lifting or carrying the monitor, grasp the edges of the monitor. Do not lift the display by the stand or the cord.
- Cleaning. Turn your monitor off and unplug the power cord. Clean the monitor surface with a lint-free, non-abrasive cloth. Stubborn stains may be removed with a cloth dampened with mild cleaner.
- Avoid using a cleaner containing alcohol or acetone. Use a cleaner intended for use with the LCD. Never spray cleaner directly on the screen, as it may drip inside the monitor and cause an electric shock.

## The following symptoms are normal with the monitor:

- The screen may flicker during the initial use due to the nature of the fluorescent light. Turn off the Power Switch and turn it on again to make sure that the flicker disappears.
- You may find slightly uneven brightness on the screen depending on the desktop pattern you use.
- When the same image is displayed for hours, an afterimage of the previous screen may remain after switching the image. The screen will recover slowly or you can turn off the Power Switch for hours.
- When the screen becomes black or flashes, or cannot work anymore, contact your dealer or service center to fix it. Do not repair the screen by yourself!

## Conventions used in this guide



**WARNING:** Information to prevent injury to yourself when trying to complete a task.



**CAUTION:** Information to prevent damage to the components when trying to complete a task.



**IMPORTANT:** Information that you **MUST** follow to complete a task.



**NOTE:** Tips and additional information to aid in completing a task.



## Where to find more information

Refer to the following sources for additional information and for product and software updates.

**1. ASUS websites**

The ASUS websites worldwide provide updated information on ASUS hardware and software products. Refer to <http://www.asus.com>

**2. Optional documentation**

Your product package may include optional documentation that may have been added by your dealer. These documents are not part of the standard package.

## Takeback Services

ASUS recycling and takeback programs come from our commitment to the highest standards for protecting our environment. We believe in providing solutions for our customers to be able to responsibly recycle our products, batteries and other components as well as the packaging materials.

Please go to <http://csr.asus.com/english/Takeback.htm> for detail recycling information in different region.



## 1.1 Welcome!

Thank you for purchasing the ASUS® LCD monitor!

The latest widescreen LCD monitor from ASUS provides a crisper, broader, and brighter display, plus a host of features that enhance your viewing experience.

With these features, you can enjoy the convenience and delightful visual experience that the monitor brings to you!

## 1.2 Package Contents

Check your package for the following items:

- ✓ LCD monitor
- ✓ Power cord
- ✓ Monitor base
- ✓ Quick Start Guide
- ✓ Warranty card
- ✓ L-shaped screwdriver
- ✓ 4 screws
- ✓ VGA cable (optional)
- ✓ HDMI cable (optional)



- 
- If any of the above items is damaged or missing, contact your retailer immediately.
- 



**CAUTION**

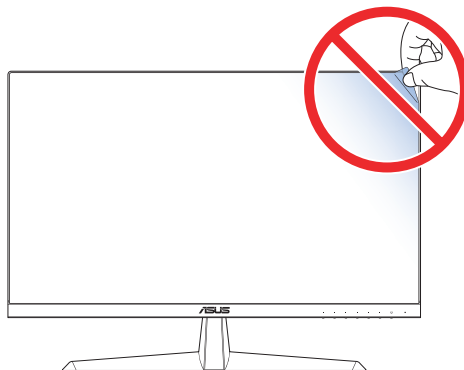

## 1.3 Assembling the Monitor Base

1. Carefully place the monitor on the EPS foam, with the screen facing down.
2. Attach the base to the arm.
3. Lift the screw ring and turn it clockwise to secure the base.
4. Place the arm hinge of the the stand assembly onto its compartment on the rear of the monitor. Then use the L-shaped screwdriver to secure it with four screws.
5. Install the stand cover to the rear of the monitor.



- 
- Base screw size: M6 x 12 mm.
  - Hinge screw size: M4 x 10 mm.
- 

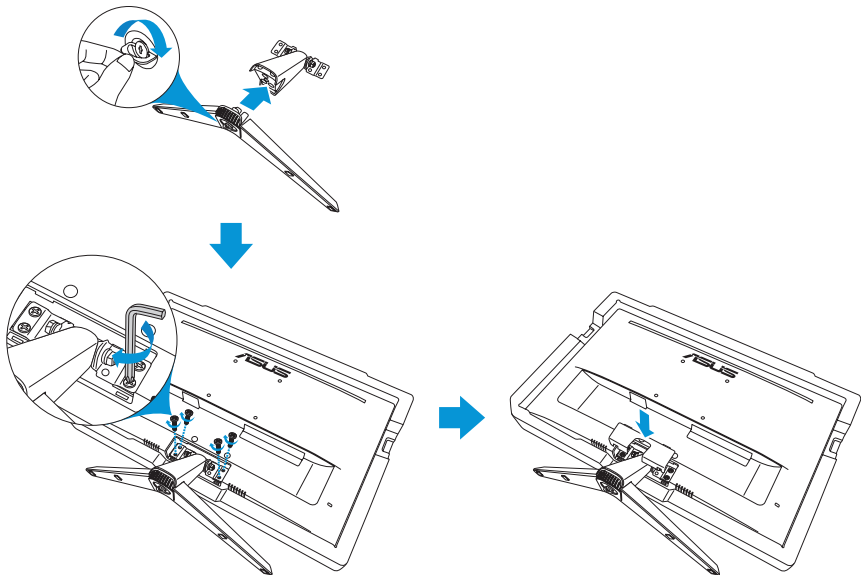

## 1.4 Connect Cables

### 1.4.1 Rear of the LCD Monitor

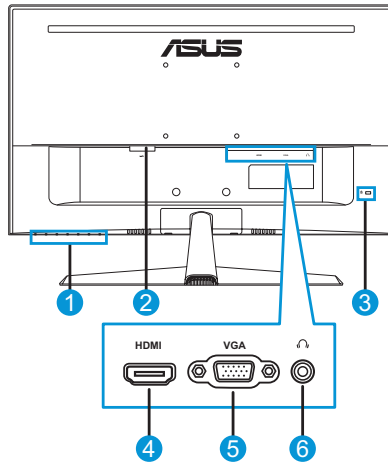

- |                    |                  |
|--------------------|------------------|
| 1. Control buttons | 4. HDMI port     |
| 2. AC-IN port      | 5. VGA port      |
| 3. Kensington Lock | 6. Earphone jack |



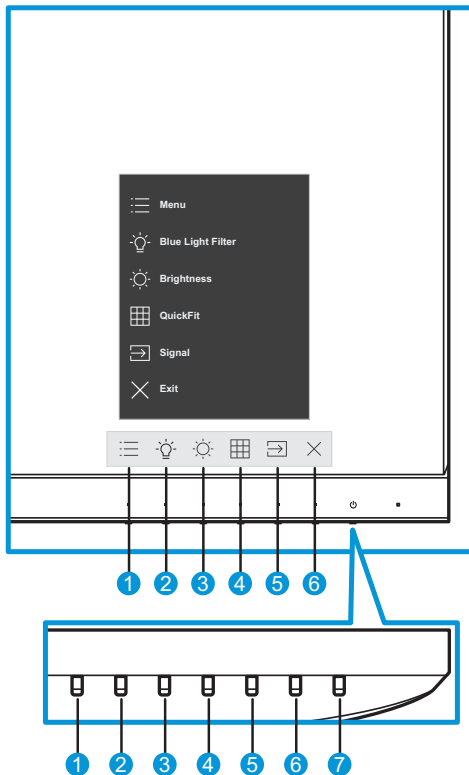

# 1.5 Monitor Introduction

## 1.5.1 Using the Control Buttons

Use the control buttons on the bottom of the monitor to adjust the image settings. Press key 1-6 to activate the key list page.



- ☰ Menu Button:
  - Enter the OSD menu.
  - Press the button for more than five seconds to activate the key lock function. To unlock, press the button again for more than five seconds.
- 💡 Shortcut Key1:
  - This is a Shortcut key. The default setting is **Blue Light Filter** with 0.

3.  Shortcut Key2:
  - This is a Shortcut key. The default setting is **Brightness**.
4.  QuickFit Button:
  - This is a hotkey to activate the **QuickFit** function designed for alignment.
  - The **QuickFit** function contains several options of common grid pattern, paper size, and photo size. See page 1-6 for details.
5.  Input Button:
  - Switch the input source.
6.  Close Button:
  - Exit the OSD menu.
7.  Power Button/Power Indicator:
  - Press this button to turn the monitor on/off.
  - The color definition of the power indicator is as the table below.

Status	Description
White	ON
Amber	Standby mode
OFF	OFF

## 1.5.2 QuickFit Function

The QuickFit function contains three patterns:

- Grid pattern: Facilitates designers and users to organize content and layout on one page and achieve a consistent look and feel.

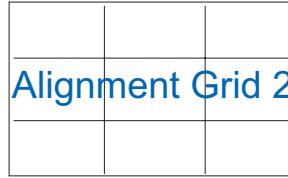
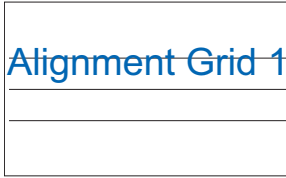

- Paper size: Provides users to view their documents in real size on the screen.

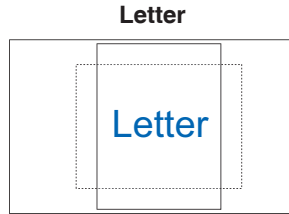
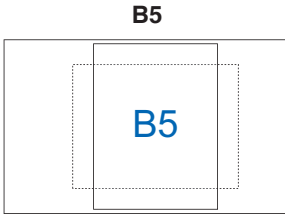



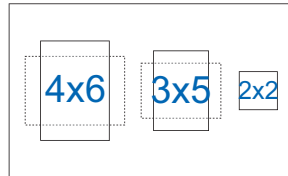
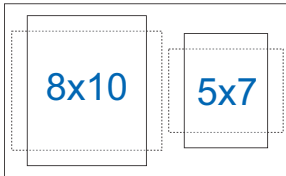

- Photo size: Provides photographers and other users to accurately view and edit their photos in real size on the screen.





To select the desired alignment pattern, do the following:

1. Press the  button to enter the **QuickFit** menu. See page 1-5 for details.
2. Press the  or  button to select an option. Then press the  button to confirm the selection.

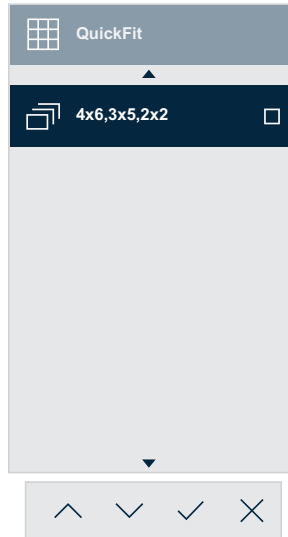
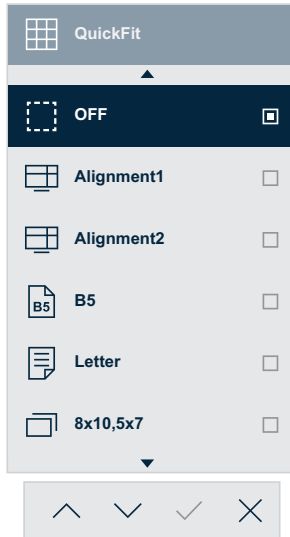

### 1.5.3 EyeCheck Function

The EyeCheck function contains three patterns:

- Snellen Chart: Select one of the three available eye charts to measure visual acuity.

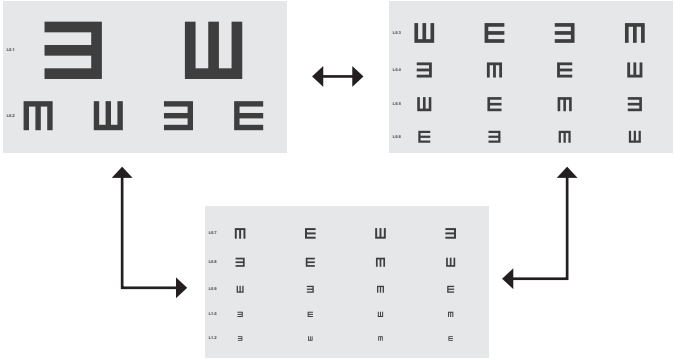

- Use the ^ or v button to toggle the selection.

- Amslter Grid: To check all lines should be straight while focusing at the center point.

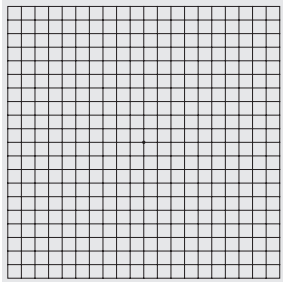

- Astigmatism: To check each line should be the same width.

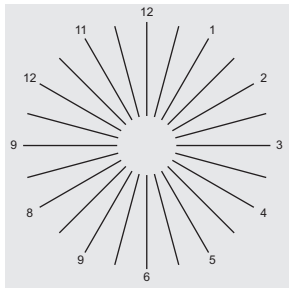





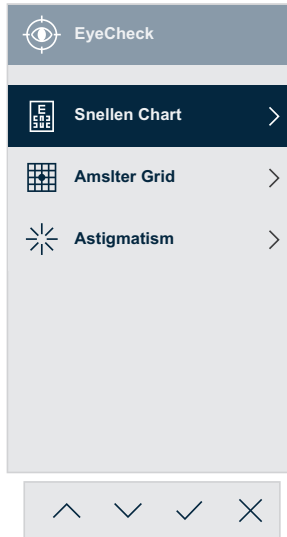











To activate EyeCheck:

1. Press the ☰ button to activate the OSD menu. See page 1-4 for details.
2. Press the ^ or v button to select **Eye Care**. Then press the > or ✓ button to enter the **Eye Care** menu.
3. Press the ^ or v button to select **EyeCheck**. Then press the > or ✓ button to enter the **EyeCheck** menu.
4. Press the ^ or v button to select an option. Then press the ✓ button to confirm the selection.



To activate EyeCheck using the assigned Shortcut key:

1. Press the  button to activate the OSD menu. See page 1-4 for details.
2. Press the  or  button to select **Shortcut**. Then press the  or  button to enter the **Shortcut** menu.
3. Press the  or  button to select **Shortcut 1** or **Shortcut 2**.
4. Press the  or  button to enter the **Shortcut 1** or **Shortcut 2** submenu.
5. Press the  or  button to select **EyeCheck**. Then press the  button to confirm the selection.
6. Press the  button to exit the OSD menu.
7. Press one of the control buttons, and then press the  button to select **EyeCheck**.
8. Press the  or  button to select the desired option. Then press the  button to confirm the selection.

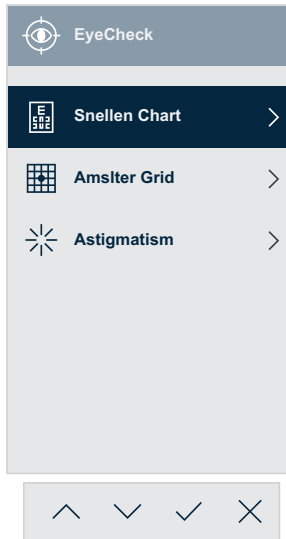













- You can also access this menu from the **Eye Care** menu.



## 1.5.4 GamePlus Function

The GamePlus Function provides a toolkit and creates a better gaming environment for users when playing different types of games. The Crosshair overlay with four different crosshair options lets you choose the one that best suits the game you're playing. The onscreen Timer can be positioned on the left of the display to keep track of the elapsed gaming time. The FPS (frames per second) counter lets you know how smooth the game is running.



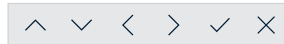
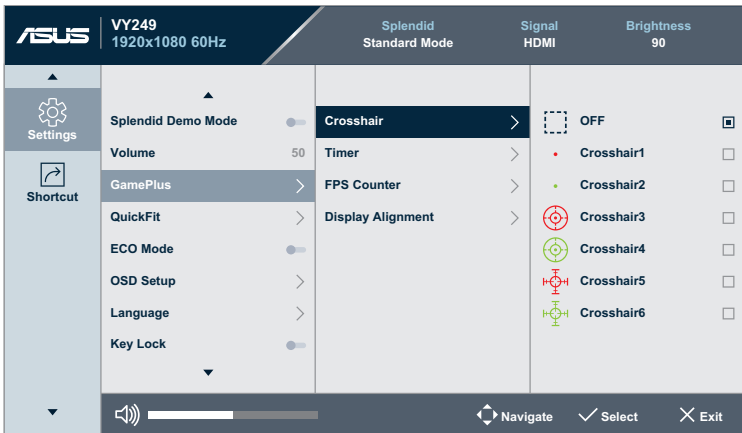















To activate GamePlus:

1. Press the  button to activate the OSD menu. See page 1-4 for details.
2. Press the  or  button to select **Settings**. Then press the  or  button to enter the **Settings** menu.
3. Press the  or  button to select **GamePlus**. Then press the  or  button to enter the **GamePlus** menu.
4. Press the  or  button to select **Crosshair**, **Timer**, **FPS Counter**, or **Display Alignment**. Then press the  or  button to enter its submenu.





5. Press the  or  button to select an option. Then press the  button to confirm the selection.

To activate GamePlus using the assigned Shortcut key:

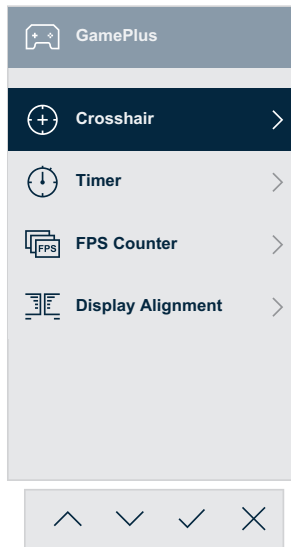
1. Press the  button to activate the OSD menu. See page 1-4 for details.
2. Press the  or  button to select **Shortcut**. Then press the  or  button to enter the **Shortcut** menu.
3. Press the  or  button to select **Shortcut 1** or **Shortcut 2**.
4. Press the  or  button to enter the **Shortcut 1** or **Shortcut 2** submenu.
5. Press the  or  button to select **GamePlus**. Then press the  button to confirm the selection.
6. Press the  button to exit the OSD menu.
7. Press one of the control buttons, and then press the  button to select **GamePlus**.
8. Press the  or  button to select **Crosshair**, **Timer**, **FPS Counter**, or **Display Alignment**. Then press the  or  button to enter its submenu.





- You can also access this menu from the **Settings** menu.

9. Press the  or  button to select the desired option. Then press the  button to confirm the selection.

### GamePlus - Crosshair

 Crosshair

 OFF





 Crosshair1

 Crosshair2

 Crosshair3

 Crosshair4

 Crosshair5

### GamePlus - Timer

 Timer

OFF





**30:00**

40:00

50:00

60:00

90:00

   





### GamePlus - FPS Counter

 FPS Counter

 OFF

 Dynamic Frame Rate Graph

 001 Real-time Frame Rate





   

### GamePlus - Display Alignment

 Display Alignment

ON

**OFF**

## 2.1 Detaching the Base (for VESA Wall Mount)

To detach the base, perform the following:

1. Disconnect power and signal cables. Carefully place the monitor on the EPS foam, with the screen facing down.
2. Remove the stand cover.
3. Use the L-shaped screwdriver to remove the four screws. Then remove the stand assembly.
4. Remove the four rubber pads. Then align and install the wall mount bracket on the rear of the monitor.

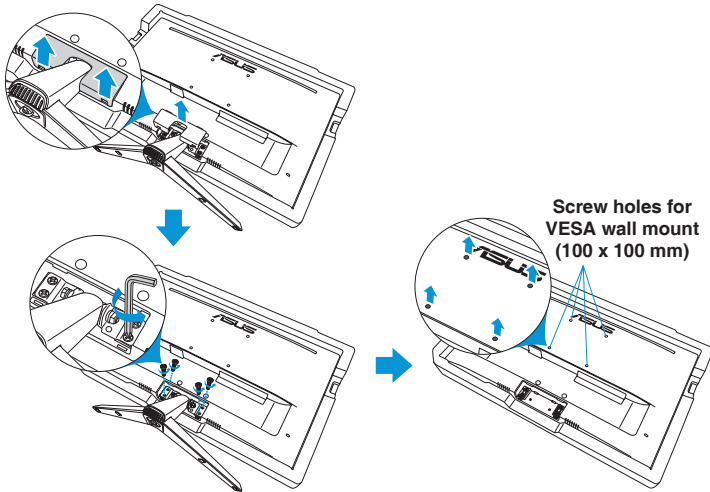

- We recommend that you cover the table surface with soft cloth to prevent damage to the monitor.
- Hold the base while removing the screw.



- The VESA wall mount kit ( 100 x 100 mm) is purchased separately.
- Use only the UL Listed Wall Mount Bracket with minimum weight/load 22.7kg (Screw size: M4 x 10 mm).



## 2.2 Adjusting the Monitor

- For optimal viewing, we recommend that you look at the full face of the monitor, then adjust the monitor to the angle that is most comfortable for you.
- Hold the stand to prevent the monitor from falling while changing its angle.



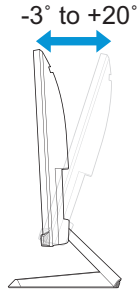





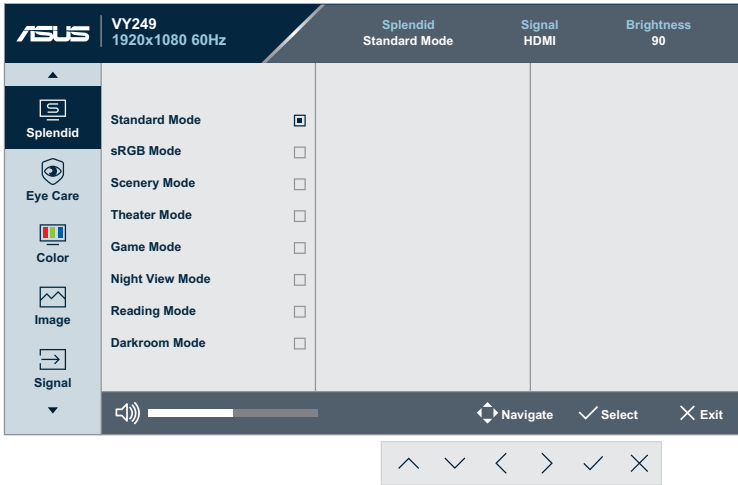





You can adjust the monitor's angle from  $-3^{\circ}$  to  $20^{\circ}$ .



## 3.1 OSD (On-Screen Display) Menu

### 3.1.1 How to Reconfigure



1. Press the  button to activate the OSD menu. See page 1-4 for details.
2. Press the  or  button to toggle between options in the Menu. As you move from one icon to another, the option name is highlighted.
3. Press the  or  button to enter its submenu.
4. Press the  or  button to select the desired option.
  - If the selected option has its submenu, press the  or  button to enter the submenu. Then use the , ,  or  button, according to the indicators on the bottom of the menu, to make your changes.
5. Press the  button to confirm the selection or press the  button to return to the previous menu.

## 3.1.2 OSD Function Introduction

### 1. Splendid

This function contains eight sub-functions that you can select for your preference.

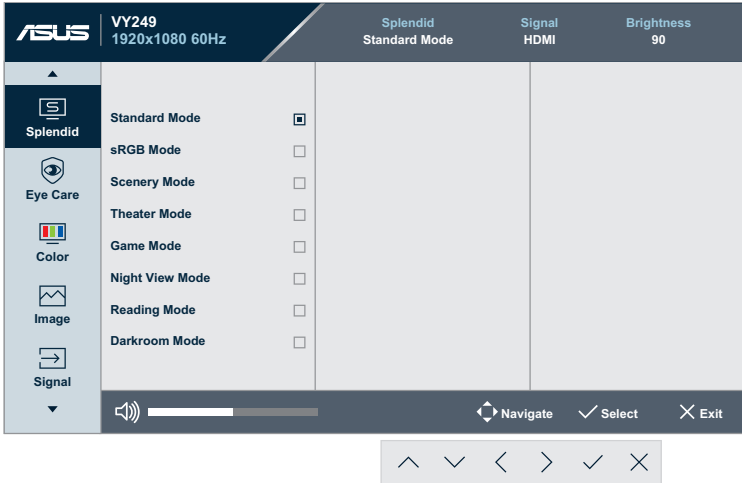

- **Standard Mode:** This is the best choice for document editing with SPLENDID™ Video Intelligence Technology.
- **sRGB Mode:** In this mode, the system will automatically utilize the settings of Gamma2.2, D65 color temperature, brightness 100 nits, and sRGB color space which is the best choice for viewing photos and graphics from PCs.
- **Scenery mode:** This is the best choice for scenery photo displaying with SPLENDID™ Video Intelligence Technology.
- **Theater Mode:** This is the best choice for movie watching with SPLENDID™ Video Intelligence Technology.
- **Game Mode:** This is the best choice for game playing with SPLENDID™ Video Intelligence Technology.
- **Night View Mode:** This is the best choice for playing dark-scene game or watching dark-scene movie with SPLENDID™ Video Intelligence Technology.
- **Reading Mode:** This is the best choice for book reading with SPLENDID™ Video Intelligence Technology.
- **Darkroom Mode:** This is the best choice for a weak ambient light environment with SPLENDID™ Video Intelligence Technology.



- In the Standard Mode, the Saturation, Skin Tone, Sharpness, and ASCR functions are not user-configurable.
- In the sRGB, the Saturation, Color Temp., SkinTone, Sharpness, Brightness, Contrast, and ASCR functions are not user-configurable.
- In the Reading Mode, the Saturation, SkinTone, ASCR, Contrast, and Color Temp. functions are not user-configurable.

## 2. Eye Care

In this function, you can adjust settings to better protect your eyes.

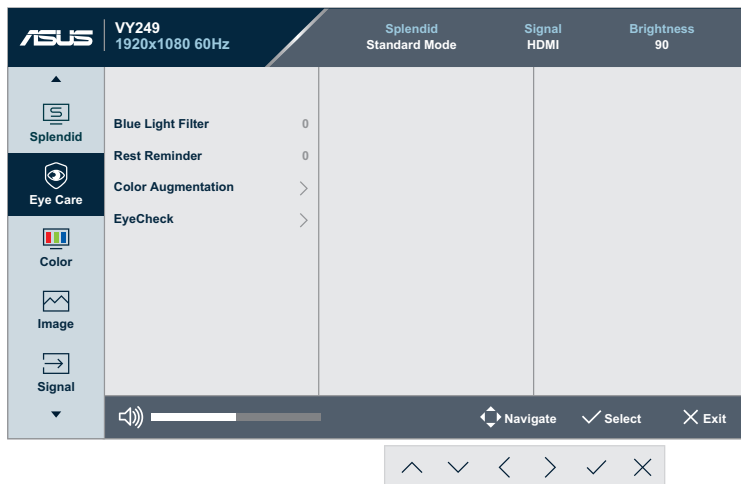

- **Blue Light Filter:** In this function, you can adjust the blue light filter from 0 to max.
  - 0: No changes.
  - Max: The higher the level, the less blue light is scattered. When blue light filter is activated, the default settings of Standard Mode will be automatically imported. Besides maximum level, the brightness is user-configurable. Maximum is the optimized setting. It is compliance with TUV low blue light certification\*. The brightness function is not user configurable.



- 
- Users should take some time away from the display if working for long hours: It is advised to take short breaks (at least 5 mins) after around 1 hour of continuous working at the computer. Taking short and frequent breaks is more effective than a single longer break.
  - To minimize eye strain and dryness in your eyes, users should rest the eye periodically by focusing on objects that are far away.
  - Eye exercises can help to reduce eye strain. Repeat these exercises often.  
If eye strain continues, please contact a physician.  
Eye exercises: (1) Repeating look up and down (2) Slowly roll your eyes (3) Move your eyes diagonal.
  - High energy blue light may lead to eye strain and AMD(Age-Related Macular Degeneration). Blue light Filter reduces 70% (max.) harmful blue light to avoid CVS(Computer Vision Syndrome) when the user adjusts the blue light filter bar to the maximum level.
  - \*The color augmentation is set to its default value (50).
  - When the level is set to maximum, the **Brightness** option in **Color** menu will be disabled.
- 

- **Rest Reminder:** This function provides you a rest reminder according to how long you set for your working time.  
For example, a user sets 30 minutes working time and there will be a pop up reminder appeared on the upper left corner of the monitor for 5 seconds. Press any key to make this reminder OSD disappeared.



- 
- When this function is enabled, the following functions are not available: Splendid Demo Mode, GamePlus, and QuickFit.
- 

- **Color Augmentation:** The adjusting range of color enhancement is from 0 to 100.



- 
- This function is not available in sRGB mode under Splendid.
  - This function is also not available in reddish and yellowish in skin tone. In other words, the **Color Augmentation** option grays out when reddish or yellowish is selected. It activates when natural under skin tone is selected.
- 

- **EyeCheck:** This function can assist you with the eyes examination using the three patterns. See page 1-8 for details.

### 3. Color

Select the image color you like from this function.

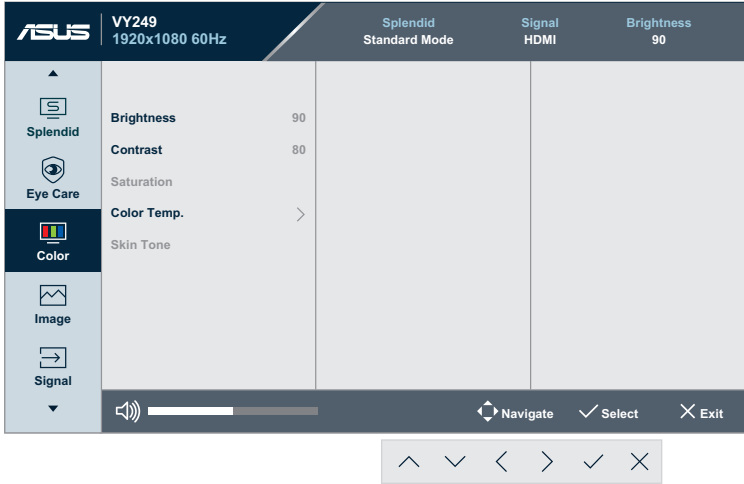

- **Brightness:** Adjust the brightness level. The adjusting range is from 0 to 100.
- **Contrast:** Adjust the contrast level. The adjusting range is from 0 to 100.
- **Saturation:** Adjust the saturation level. The adjusting range is from 0 to 100.
- **Color Temp.:** Select the desired color temperature. Available options: **Cool, Normal, Warm, and User Mode.**



- In the User Mode, colors of R (Red), G (Green), and B (Blue) are user-configurable; the adjusting range is from 0 ~ 100.

- **Skin Tone:** Select the desired skin color. Available options: **Reddish, Natural, and Yellowish.**

#### 4. Image

You can adjust the image Sharpness, Trace Free, Aspect Control, VividPixel, ASCR, Motion Sync, AMD FreeSync, Shadow Boost, Position, Focus, and Auto Adjust. from this main function.



(Page 1/2)

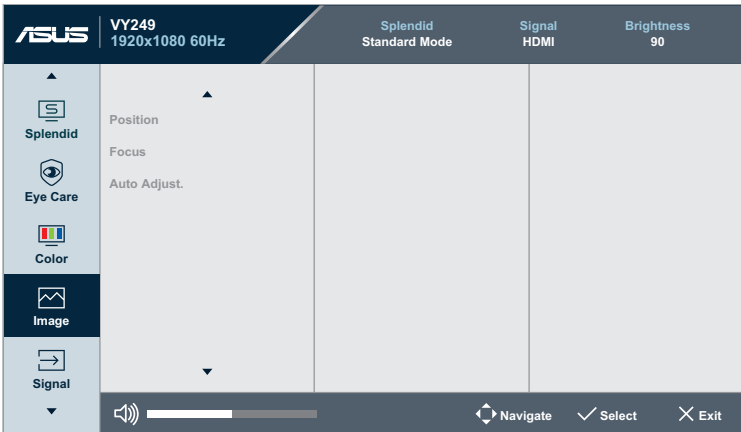

(Page 2/2)

- **Sharpness:** Adjust the picture sharpness. The adjusting range is from 0 to 100.

- **Trace Free:** Speed up the response time by Over Drive technology. The adjusting range is from lower 0 to faster 100.
- **Aspect Control:** Adjust the aspect ratio to “Full”, “4:3”, or “OverScan”.



- 4:3 is only available when the input source is in 4:3 format.
  - OverScan is only available for HDMI input.
- 

- **VividPixel:** ASUS Exclusive Technology that brings lifelike visuals for crystal-clear and detail-oriented enjoyment. The adjusting range is from 0~100.
- **ASCR:** Select **ON** or **OFF** to enable or disable dynamic contrast ratio function.
- **Motion Sync:** Offer a more clear mode while displaying motion pictures. Please note this function only works when the refresh rate is 75Hz. It includes two modes: Normal Mode and Advanced Mode, which can provide different effects.



- When this function is enabled, the system will automatically reduce the brightness level.
  - If the AMD FreeSync is enabled, the Motion Sync function is grayed out.
- 

- **AMD FreeSync:** Allows an AMD FreeSync supported graphics source (HDMI) to dynamically adjust display refresh rate based on typical content frame rates for power efficient, virtually stutter free and low-latency display update.



- If the Motion Sync is enabled, the AMD FreeSync function is grayed out.
- 

- **Shadow Boost:** Dark color enhancement adjusts the monitor gamma curve to enrich the dark tones in an image making dark scenes and objects much easier to be found.
- **Position:** Adjust the horizontal position (H-Position) and the vertical position (V-Position) of the image. The adjusting range is from 0 to 100 (only available for VGA input).
- **Focus:** Reduce the Horizontal-line noise and Vertical-line noise of the image by adjusting (Phase) and (Clock) separately. The adjusting range is from 0 to 100 (only available for VGA input).
- **Auto Adjust.:** Automatically perform Auto Adjust (only available for VGA input).



## 5. Signal

Select the input source.

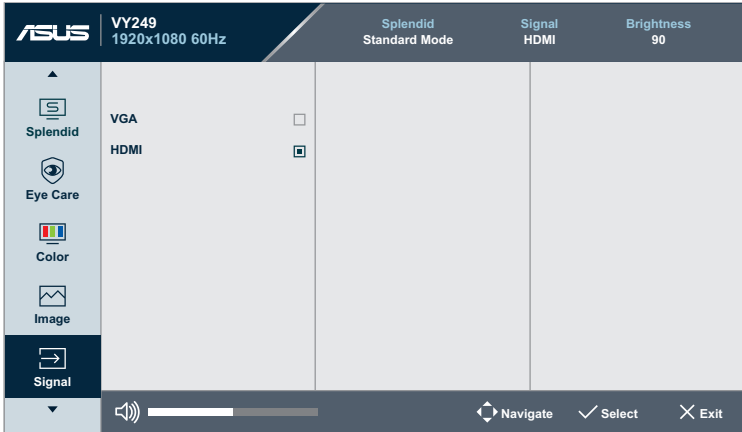

## 6. Settings

Adjust the system configuration.



(Page 1/2)

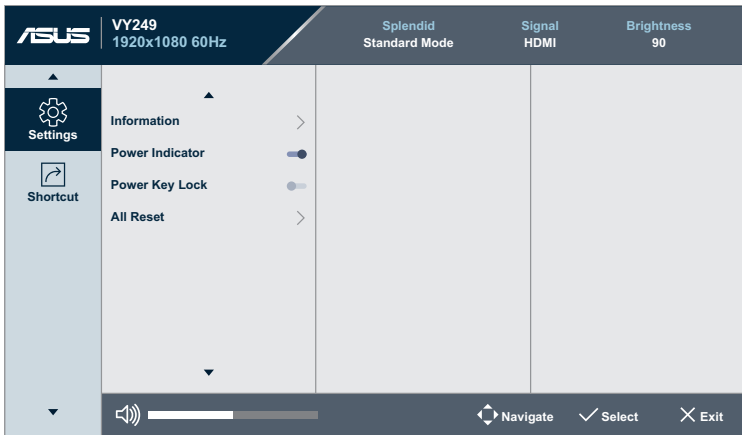

(Page 2/2)

- **Splendid Demo Mode:** Activate the demo mode for the Splendid function.
- **Volume:** Adjust the volume level.
- **GamePlus:** Configure the GamePlus function. See page 1-11 for details.
- **QuickFit:** This function contains several options of common grid pattern, paper size, and photo size. See page 1-6 for details.
- **ECO Mode:** Activate the ecology mode for power saving.
- **OSD Setup:** Adjust the **OSD Timeout**, **DDC/CI**, and **Transparency** of the OSD screen.
- **Language:** Select the OSD language.
- **Key Lock:** Enable this option to activate the key lock function. See page 1-4 for details.
- **Information:** Display the monitor information.
- **Power Indicator:** Turn the power LED indicator on/off.
- **Power Key Lock:** Disable/Enable the power key.
- **All Reset:** Select **YES** to revert all settings to the factory default mode.

## 7. Shortcut

Assign the specific function to the two shortcut keys.

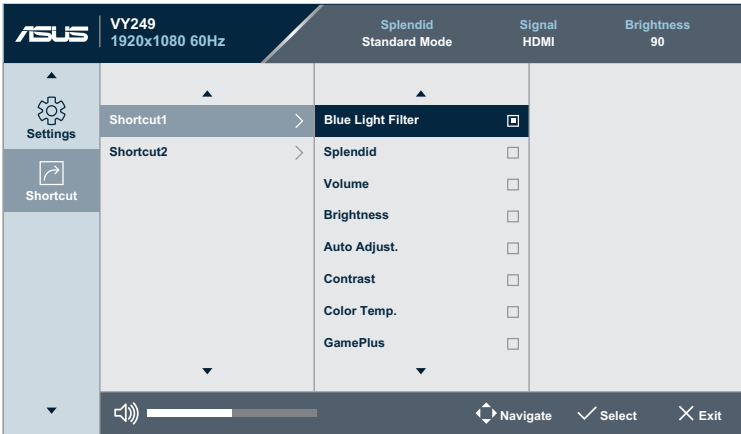

(Shortcut 1 - Page 1/2)

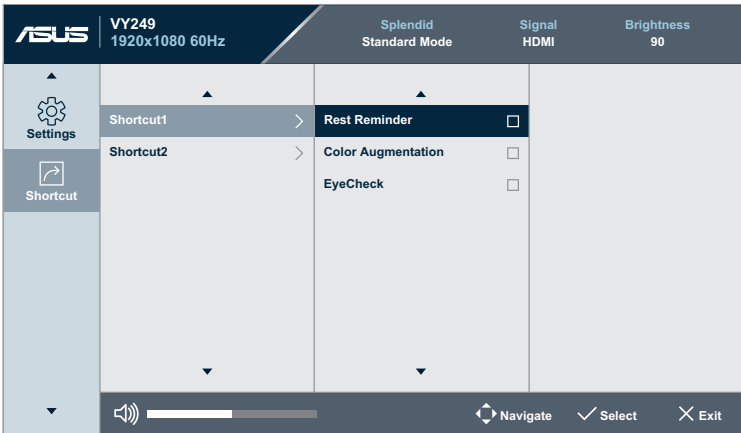

(Shortcut 1 - Page 2/2)

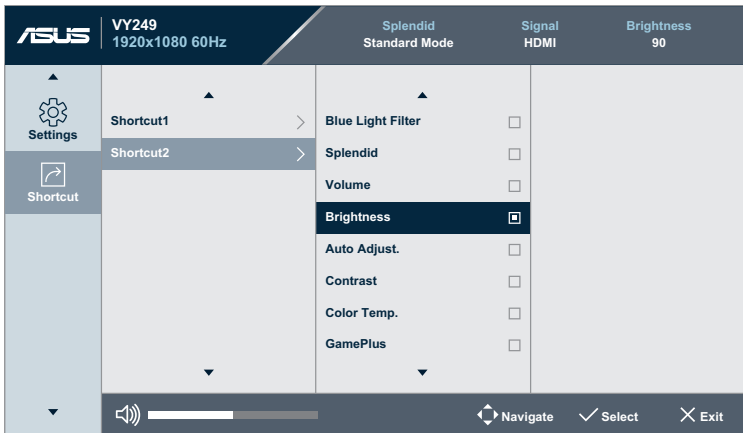

(Shortcut 2 - Page 1/2)

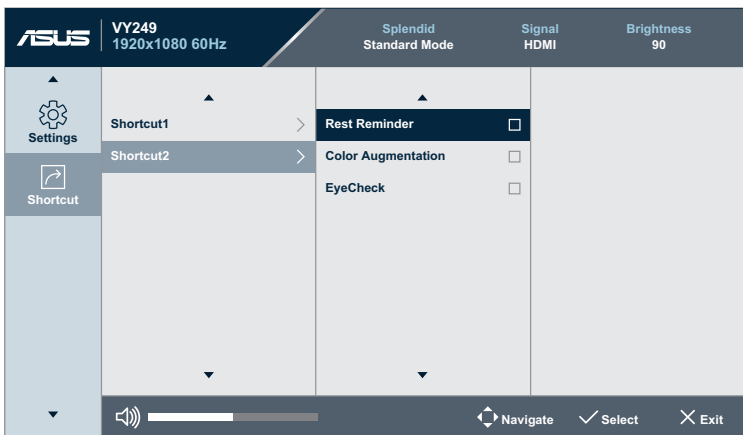

(Shortcut 2 - Page 2/2)

- Shortcut 1:** Assign a function to the Shortcut Key1.  
 Available options: **Blue Light Filter, Splendid, Volume, Brightness, Auto Adjust., Contrast, Color Temp., GamePlus, Rest Reminder, Color Augmentation, and EyeCheck.** The default setting is **Blue Light Filter.**

- **Shortcut 2:** Assign a function to the Shortcut Key2.  
Available options: **Blue Light Filter, Splendid, Volume, Brightness, Auto Adjust., Contrast, Color Temp., GamePlus, Rest Reminder, Color Augmentation, and EyeCheck.** The default setting is **Brightness.**

## 3.2 Specifications

Model		VY249HE/VY249HE-W
Panel Size	23.8 inches diagonal (Active Display Area: 527.04 (H) x 296.46 (V) mm)	
Max. Resolution	1920 x 1080	
Brightness (Typ.)	250 cd/m <sup>2</sup>	
Contrast Ratio (Typ.)	1000:1	
Viewing Angle (CR ≤ 10)	178°(V); 178°(H)	
Display Colors	16.7M colors (6 bits + A-FRC)	
Response Time	5ms (GTG)	
Terminals	Inputs:	HDMI x 1, VGA x 1
	Audio Output:	Headphone
Power Consumption	16W(Max)	
Power Consumption (Energy Star On mode)	11.6W	
Standby Power Consumption	< 0.5W at AC110V~ AC220V	
Power Off Power Consumption	< 0.3W at AC110V~ AC220V	
Phys. Dimension (incl. base) (HxWxD)	393 x 541 x 185 mm	
Box Dimension (HxWxD)	392 x 603 x 130±5 mm	
Net Weight (incl. stand)	3.38 kg	
Gross Weight (Esti.)	4.62 kg	
Voltage Rating	100~240V at 50/60Hz	
Temperature	Operating temperature: 0 ~ 40°C Storage temperature: -30 ~ 65°C	
Accessories	Power cord, Quick Start Guide, Warranty card, L-shaped screwdriver, 4 screws, HDMI cable (optional), VGA cable (optional)	
Compliance and Standards	CE, CB, FCC, CCC, CU, RCM, UL/cUL, UKrSEPRO, BSMI, KC(EK)/ MSIP(KCC)/ E-Standby(E-Boy), PSE, VCCI, Energy Star 8.0, HDMI, Windows 7 & 8.1 & 10 WHQL, MEPS, TCO8.0, China Energy Label, EU Energy Label, CEC, RoHS, WEEE, EuP(Energy Saving Only), EPEAT Bronze (VY249HE only), PC Recycle, J-MOSS, PSB, TUV Low Blue Light, TUV Flicker Free	

\*Specifications subject to change without notice.

### 3.3 Troubleshooting (FAQ)

Problem	Possible Solution
Power LED is not ON	<ul style="list-style-type: none"><li>• Press the  button to check if the monitor is turned on.</li><li>• Check if the adapter and power cord are properly connected to the monitor and the power outlet.</li><li>• Check the <b>Power Indicator</b> function in the OSD menu. Select "ON" to turn on the power LED.</li></ul>
The power LED lights amber and there is no screen image	<ul style="list-style-type: none"><li>• Check if the monitor and the computer are turned on.</li><li>• Make sure the signal cable is properly connected the monitor and the computer.</li><li>• Inspect the signal cable and make sure none of the pins are bent.</li><li>• Connect the computer with another available monitor to check if the computer is properly working.</li></ul>
Screen image is too light or dark	<ul style="list-style-type: none"><li>• Adjust the <b>Contrast</b> and <b>Brightness</b> settings via OSD.</li></ul>
Screen image bounces or a wave pattern is present in the image	<ul style="list-style-type: none"><li>• Make sure the signal cable is properly connected to the monitor and the computer.</li><li>• Move electrical devices that may cause electrical interference.</li></ul>
Screen image has color defects (white does not look white)	<ul style="list-style-type: none"><li>• Inspect the signal cable and make sure that none of the pins are bent.</li><li>• Perform <b>Reset</b> via OSD.</li><li>• Select the appropriate color temperature (<b>Color Temp.</b>) via OSD.</li></ul>
No sound or sound is low	<ul style="list-style-type: none"><li>• Adjust the volume settings of your monitor or computer.</li><li>• Make sure the computer sound card driver is properly installed and activated.</li></ul>

## 3.4 Supported Timing List

### VESA / IBM Modes Support Timing

Mode	Resolution (active dot)	Resolution (total dot)	Horizontal Frequency (KHz)	Vertical Frequency (Hz)	Nominal Pixel Color (MHz)
DOS	720x400@70Hz	900x449	31.469	70.087	28.322
VGA	640x480@60Hz	800x525	31.469	59.940	25.175
	640x480@72Hz	832x520	37.861	72.809	31.500
	640x480@75Hz	840x500	37.500	75.000	31.500
	800x600@56Hz	1024x625	35.156	56.250	36.000
SVGA	800x600@60Hz	1056x628	37.879	60.317	40.000
	800x600@72Hz	1040x666	48.077	72.188	50.000
	800x600@75Hz	1056x625	46.875	75.000	49.500
	1024x768@60Hz	1344x806	48.363	60.004	65.000
XGA	1024x768@70Hz	1328x806	56.476	70.069	75.000
	1024x768@75Hz	1312x800	60.023	75.029	78.750
	1152x864@75Hz	1600x900	67.5	75.000	108.00
VESA	1280x1024@60Hz	1688x1066	63.981	60.020	108.000
SXGA	1280x1024@75Hz	1688x1066	79.976	75.025	135.00
	1280x960@60Hz	1800x1000	60.000	60.000	108.00
	1280x800@60Hz	1680x831	49.702	59.810	83.500
WXGA	1280x720@60Hz	1650x750	45.00	60.000	74.25
	1280x768@60Hz	1664x798	47.776	59.870	79.5
	1360x768@60Hz	1792x795	47.712	60.015	85.500
	1366x768@60Hz	1792x798	47.712	59.790	85.500
	1440x900@60Hz	1904x934	55.935	59.887	106.500
UXGA	1600x1200@60Hz	2160x1250	75.000	60.000	162.000
WSXGA+	1680x1050@60Hz	2240x1089	65.290	59.954	146.250
WUXGA	1920x1080@60Hz	2200x1125	67.500	60.000	148.500
	1920x1080@75Hz	2080x1119	83.890	74.970	174.50
MAC	640x480@66.66Hz	864x525	35	66.66	30.24
SVGA	832x624@75Hz	1152x667	49.714	74.533	57.27

\* Modes not listed in the table may not be supported. For optimal resolution, we recommend that you choose a mode listed in the table above.



# 3.5 Product Dimensions

