

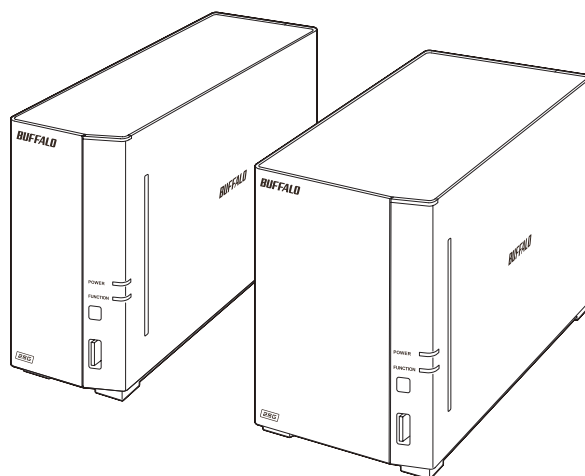

**Network Attached Storage  
LinkStation 700**

# **User Manual**



Please make sure to read this manual before using and follow the procedures. If you have any inquiries about the product, contact the number on the warranty statement or the packing box. Do not discard the included documents, the warranty statement, or the packing box.

***[www.buffaloamericas.com](http://www.buffaloamericas.com)***

35022143-05  
July 2021

# Notice

---

## Regulatory Compliance Information

---

### For Customers in the United States

This equipment has been tested and found to comply with the limits for a Class B digital device, pursuant to Part 15 of the FCC Rules. These limits are designed to provide reasonable protection against harmful interference in a residential installation. This equipment generates, uses and can radiate radio frequency energy and, if not installed and used in accordance with the instructions, may cause harmful interference to radio communications. However, there is no guarantee that interference will not occur in a particular installation. If this equipment does cause harmful interference to radio or television reception, which can be determined by turning the equipment off and on, the user is encouraged to try to correct the interference by one or more of the following measures:

- Reorient or relocate the receiving antenna.
- Increase the separation between the equipment and receiver.
- Connect the equipment into an outlet on a circuit different from that to which the receiver is connected.
- Consult the dealer or an experienced radio/TV technician for help.



This device complies with Part 15 of the FCC Rules. Operation is subject to the following two conditions: (1) This device may not cause harmful interference, and (2) this device must accept any interference received, including interference that may cause undesired operation.

---

## Warning Symbols and Graphical Icons on the Product

---

Warning symbols are used on the product for safety operation and prevention of injury to you and damage to the unit. The following explains the meanings of symbols used on the product.

	This symbol indicates important warnings or cautions for operation and maintenance. Additional information will follow this symbol.
	This symbol indicates the presence of a direct current.
	This symbol indicates polarity of DC connector.

---

## Safety Precautions

---

Before using your device, basic safety instructions should always be followed.

- (1) Read these instructions.
- (2) Keep these instructions.
- (3) Heed all warnings and follow all instructions.
- (4) Only use the cables and accessories that are included in the package. Don't use other accessories or cables unless specifically instructed to in the documentation.

# Table Of Contents

<b>Notice .....</b>	<b>1</b>
Regulatory Compliance Information.....	1
Warning Symbols and Graphical Icons on the Product.....	1
Safety Precautions .....	1
<b>Chapter 1 Getting Started .....</b>	<b>9</b>
Diagrams.....	9
Installing Software.....	11
NAS Navigator2.....	11
SmartPhone Navigator.....	11
WebAccess .....	12
NovaBACKUP.....	12
Turning the LinkStation On and Off .....	12
Creating a USB Initialization Drive .....	13
Accessing Settings .....	13
Opening Settings .....	13
Using the Setup Wizard .....	17
Checking the Device Information from Dashboard .....	19
Shutting Down or Restarting the LinkStation from Settings.....	20
<b>Chapter 2 File Sharing .....</b>	<b>22</b>
Configuring Shared Folders .....	22
Adding a Shared Folder.....	22
Recycle Bin.....	27
Read-Only Shares.....	27

Hidden Shares .....	27
<b>Configuring Users .....</b>	<b>27</b>
Adding a User .....	27
Importing User Information.....	32
<b>Adding a Group .....</b>	<b>32</b>
<b>Configuring Access Restrictions for Shared Folders .....</b>	<b>35</b>
Local Users and Groups .....	35
Active Directory .....	38
<b>Restoring Owner and Permission Settings .....</b>	<b>41</b>
<b>If a Shared Folder Cannot Be Accessed.....</b>	<b>42</b>

## **Chapter 3 RAID Modes and Drive Management .....** 44

<b>Available RAID Modes .....</b>	<b>44</b>
<b>Working with RAID Arrays .....</b>	<b>44</b>
Using JBOD .....	44
Creating a RAID Array .....	45
Shutting Down the LinkStation Automatically If an Error Occurs .....	46
Configuring Actions for If a Drive Used for the RAID Array Has Not Been Detected .....	47
Changing the RAID Mode using RMM .....	49
RAID Scanning.....	51
<b>Adding an External Drive .....</b>	<b>51</b>
Connecting an External Drive .....	51
Compatibility .....	52
<b>Dismounting Drives .....</b>	<b>52</b>
Using the Function Button .....	52
Using Settings .....	52
<b>Checking Drives .....</b>	<b>54</b>

<b>S.M.A.R.T.</b> .....	<b>55</b>
<b>Displaying S.M.A.R.T. Information</b> .....	<b>56</b>
<b>Checking the Drive Condition</b> .....	<b>57</b>
<b>Formatting Drives</b> .....	<b>57</b>
<b>Encrypting Drives</b> .....	<b>59</b>
<b>Erasing Data on the LinkStation Completely</b> .....	<b>59</b>
<b>Quotas</b> .....	<b>60</b>
<b>Quotas for Users</b> .....	<b>60</b>
<b>Quotas for Groups</b> .....	<b>61</b>
<b>Size Limits</b> .....	<b>63</b>

## **Chapter 4 Backup ..... 67**

<b>Backing Up Data on the LinkStation</b> .....	<b>67</b>
<b>Backup Modes</b> .....	<b>67</b>
<b>Preparing a Backup Destination</b> .....	<b>69</b>
<b>Configuring a Backup Job</b> .....	<b>70</b>
<b>Restoring Backup Data</b> .....	<b>74</b>
<b>Backup Logs for If Backup Fails</b> .....	<b>75</b>
<b>Backing Up Your Mac with Time Machine</b> .....	<b>77</b>
<b>Copying from a USB Device</b> .....	<b>83</b>
<b>Configuring Direct Copy</b> .....	<b>83</b>
<b>Starting Direct Copy</b> .....	<b>85</b>

## **Chapter 5 Cloud Services and Remote Access..... 88**

<b>Synchronizing with Dropbox</b> .....	<b>88</b>
<b>Configuring a New Job</b> .....	<b>88</b>
<b>Changing Job Settings</b> .....	<b>91</b>

<b>Using Microsoft Azure for Data Preservation .....</b>	<b>94</b>
<b>Creating a New Backup Job.....</b>	<b>94</b>
<b>Creating a New Restore Job .....</b>	<b>102</b>
<b>Changing Job Settings .....</b>	<b>107</b>
<b>Synchronizing with Microsoft OneDrive .....</b>	<b>109</b>
<b>Configuring a New Job .....</b>	<b>109</b>
<b>Changing Job Settings .....</b>	<b>119</b>
<b>Corrective Actions for in Case of Error .....</b>	<b>122</b>
<b>WebAccess .....</b>	<b>123</b>
<b>Configuring WebAccess .....</b>	<b>123</b>
<b>Accessing via WebAccess.....</b>	<b>130</b>
<b>Unable to Create a BuffaloNAS.com Name .....</b>	<b>131</b>
<b>FTP.....</b>	<b>133</b>

## **Chapter 6 Multimedia ..... 135**

<b>Displaying for DLNA Clients .....</b>	<b>135</b>
<b>Enabling DLNA .....</b>	<b>135</b>
<b>Configuring Public Folders .....</b>	<b>137</b>
<b>File Playback.....</b>	<b>138</b>
<b>Supported File Types .....</b>	<b>138</b>
<b>Playing Files .....</b>	<b>139</b>
<b>Changing Public File Type .....</b>	<b>139</b>
<b>Advanced Settings .....</b>	<b>140</b>
<b>Changing Device Display Name.....</b>	<b>140</b>
<b>Restricting the Device Access .....</b>	<b>141</b>
<b>Changing the Folder Display Language on DLNA Player .....</b>	<b>142</b>
<b>Managing Media Files and Folders .....</b>	<b>143</b>
<b>Creating Folders.....</b>	<b>143</b>

Moving Files .....	145
Renaming Files or Folders .....	147
Deleting Files or Folders.....	149

## **Chapter 7 Settings Backup/Restoration ..... 152**

<b>Saving and Applying Settings.....</b>	<b>152</b>
Saving Settings .....	152
Applying Settings .....	153
<b>Transferring Another Buffalo NAS Device's Settings .....</b>	<b>154</b>
Creating a Config File (.nas_config).....	154
Transferring Settings.....	155
<b>Restoring Factory Defaults.....</b>	<b>156</b>
Initializing from Settings .....	156
Initializing Using the USB Initialization Drive .....	156
<b>Resetting the Administrator Password .....</b>	<b>158</b>

## **Chapter 8 Network Settings ..... 159**

<b>Wake-on-LAN .....</b>	<b>159</b>
<b>SNMP .....</b>	<b>159</b>
<b>Proxy Server .....</b>	<b>161</b>
<b>Jumbo Frames .....</b>	<b>161</b>
<b>Changing the IP Address .....</b>	<b>163</b>
<b>Mapping IP Address and Hostname .....</b>	<b>163</b>

## **Chapter 9 Advanced Features ..... 166**

<b>Email Notification .....</b>	<b>166</b>
---------------------------------	------------

<b>Sleep Mode .....</b>	<b>168</b>
<b>UPS (Uninterruptible Power Supply) .....</b>	<b>170</b>
<b>Encrypting Data Transmission .....</b>	<b>171</b>
<b>Encrypting Settings Data .....</b>	<b>171</b>
<b>SSL.....</b>	<b>171</b>
<b>Logs .....</b>	<b>173</b>
<b>Displaying LinkStation's Logs .....</b>	<b>173</b>
<b>Transferring Logs to the Syslog Server .....</b>	<b>173</b>
<b>Creating a Shortcut to the Logs in the Shared Folder .....</b>	<b>174</b>
<b>Changing Archive Rules for File Access Logs .....</b>	<b>175</b>
<b>Updating the Firmware.....</b>	<b>176</b>
<b>Updating Manually .....</b>	<b>177</b>
<b>Updating Automatically .....</b>	<b>177</b>
<b>Configuring Update Notification.....</b>	<b>178</b>
<b>Name, Date, Time, and Language .....</b>	<b>179</b>
<b>Beep Alerts .....</b>	<b>181</b>
<b>LEDs.....</b>	<b>182</b>

## **Chapter 10 Drive Replacement and Troubleshooting ...**

---

<b>.....</b>	<b>184</b>
<b>Replacing a Defective Drive .....</b>	<b>184</b>
<b>Drive Replacement for a RAID 1 Array .....</b>	<b>184</b>
<b>Drive Replacement for a RAID 0 Array .....</b>	<b>191</b>
<b>Drive Replacement for a JBOD.....</b>	<b>194</b>
<b>Replacing a Non-Malfunctioning Drive.....</b>	<b>197</b>
<b>Manually Recovering the Firmware.....</b>	<b>197</b>



**Chapter 11 Appendix ..... 199**

**Power LED Operations ..... 199**

    Red (Errors)..... 199

    Amber (Notices) .....200

    Amber (Information Events) .....200

**Default Settings ..... 202**

**Specifications ..... 202**

# Chapter 1 Getting Started

## Diagrams

Depending on the number or type of drives in the unit, the model name will be different. Check the sticker on the packing box for your unit's model name.

### LS710D

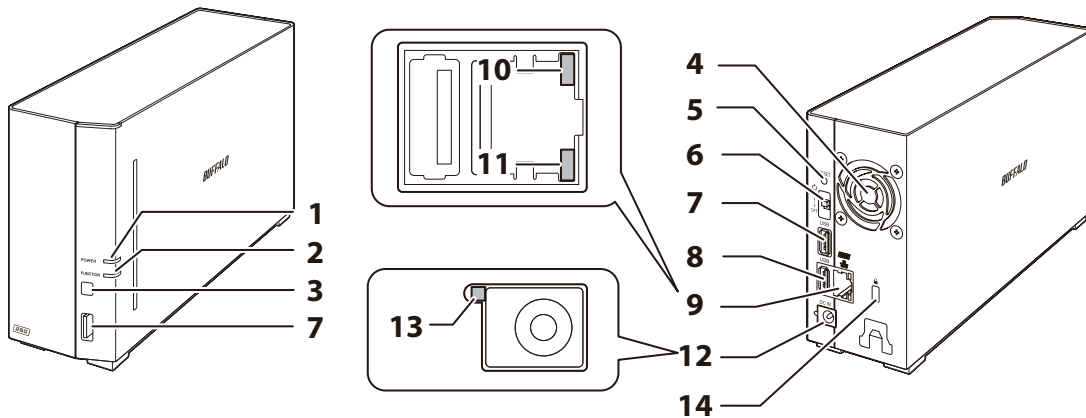

### LS720D

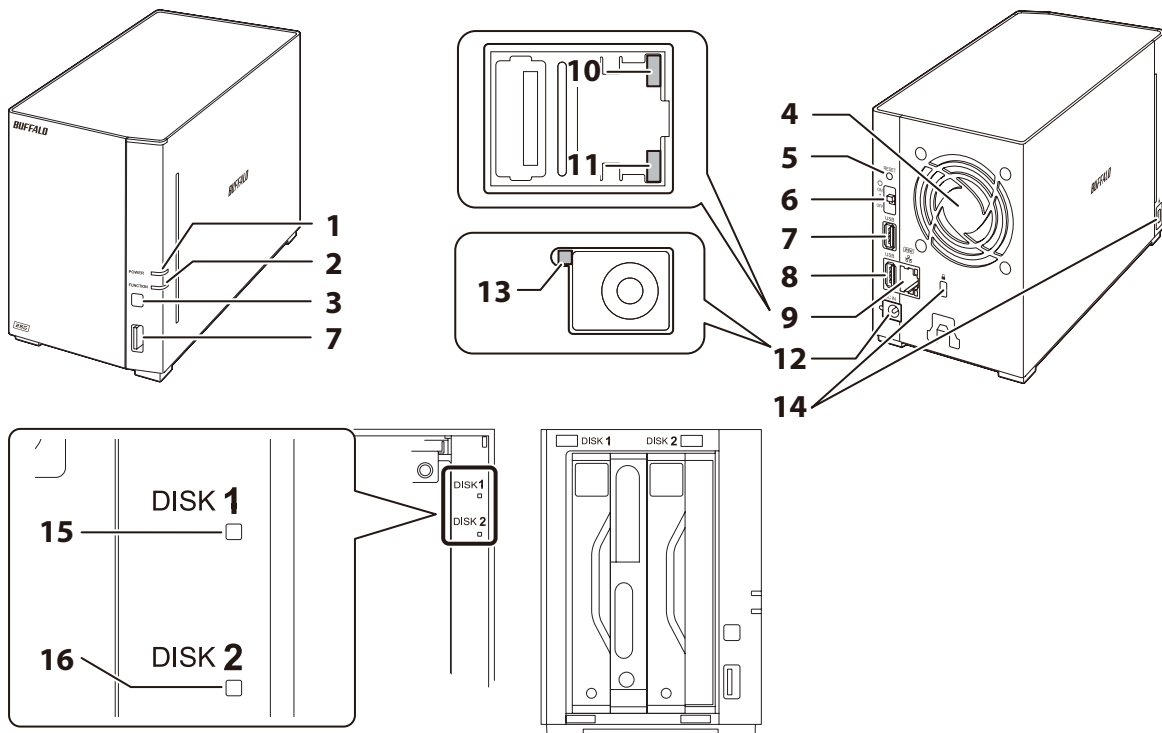

## 1 Power LED

The power LED glows white while the LinkStation is on.  
The power LED blinks white while the LinkStation is booting or shutting down.  
If an error occurs, the power LED glows red.  
If there is a status message, the power LED glows amber.

## 2 Function LED

This LED glows white when USB devices have been dismantled, or while waiting for Direct Copy. It blinks white while the LinkStation is being initialized, while dismantling USB devices, and during Direct Copy.

## 3 Function Button

Use this button for Direct Copy, dismantling USB devices, and waking up from sleep mode.

## 4 Fan

Spins to prevent overheating inside. Do not block the fan.

## 5 Init Button

Press and hold down this button for about 10 seconds to initialize the LinkStation's admin username and password, IP settings, and SSL to their factory default values. The effects of this button can be changed in Settings.

## 6 Power Switch

Move the switch up and down to power the device on and off.

## 7 USB 3.2 Gen 1 Port

Compatible USB drives, USB memory devices, digital cameras, and USB UPS devices can be connected. USB hubs are not supported.

## 8 USB 2.0 Port

Compatible USB drives, USB memory devices, digital cameras, and USB UPS devices can be connected. USB hubs are not supported.

## 9 LAN Port

Connect an Ethernet cable to use this port for your network. It is available for communicating at max. 2.5 Gbps.

## 10 Link/Act LED

Glows amber when the LinkStation is connected to a network at 10/100 Mbps, or 2.5 Gbps. It blinks when the connection is experiencing activity.

## 11 Link/Act LED

Glows green when the LinkStation is connected to a network at 1000 Mbps. It blinks when the connection is experiencing activity.

## 12 Power Connector

Use the included power cable to connect to a UPS, surge protector, or outlet. To prevent disconnecting the AC adapter accidentally, use a hook when connecting the power cable to the LinkStation as illustrated below:

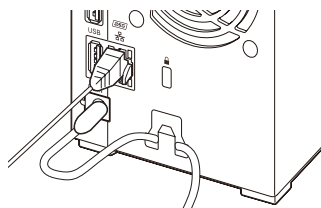

### **13** Power Status LED

Glows green when the power cable is connected.

### **14** Anti-Theft Security Slot

Use this slot to secure your LinkStation with a cable lock (not included).

### **15** Drive 1 Error LED

If there is an error on the drive in slot 1, this LED will light.

### **16** Drive 2 Error LED

If there is an error on the drive in slot 2, this LED will light.

---

## Installing Software

---

### NAS Navigator2

---

#### For Windows

- 1** Go to the d.buffalo website (<https://d.buffalo.jp/LS700/>) to download the installer.
- 2** Select the region and model to go to your specific model's d.buffalo website.
- 3** Download the NAS Navigator2 installer and install it onto your computer.

Refer to the software help for more detailed information on operating the software. To open the help, launch NAS Navigator2 and navigate to *Menu > Help*.

#### For macOS 10.13 and Later

- 1** Open Mac App Store and search for the NAS Navigator2 software.
- 2** Click *GET*, then *INSTALL*.

Refer to the software help for more detailed information on operating the software. To open the help, launch NAS Navigator2 and navigate to *Help > NAS Navigator2 Help* from the menu bar.

### SmartPhone Navigator

---

SmartPhone Navigator will allow you to open LinkStation's Settings, change the IP address, and configure WebAccess settings from a mobile device. Follow the procedure below to install the app.

- 1** Open App Store (iOS or iPadOS devices) or Google Play (Android devices).
- 2** Search for and install "SmartPhone Navigator".

You can also install the apps from the QR codes below. Use the appropriate QR code for your mobile device.

#### For iOS and iPadOS



### For Android



## WebAccess

---

WebAccess will allow you access files on the LinkStation from a mobile device. Follow the procedure below to install the app.

**1** Open App Store (iOS or iPadOS devices) or Google Play (Android devices).

**2** Search for and install “WebAccess”.

You can also install the apps from the QR codes below. Use the appropriate QR code for your mobile device.

### For iOS



### For iPadOS



### For Android



## NovaBACKUP

---

NovaBACKUP is a Windows utility that lets you back up data on your computer.

The NovaBACKUP installer is available from the d.buffalo website, accessible from <https://d.buffalo.jp/LS700/>. Select the region and model to go to your specific model’s d.buffalo website. Download the NovaBACKUP installer and install the utility onto your computer.

To download the installer, you will need the serial number of your LinkStation. The serial number is printed on the label on the back of the unit.

---

## Turning the LinkStation On and Off

---

Move the power switch to the “On” position to turn the device on.

To turn off the LinkStation, move the switch to the “Off” position and wait for the unit to fully shut down before unplugging it. Don’t unplug the AC adapter without properly shutting down the LinkStation first.

When the power LED turns off, the shutdown process is finished.

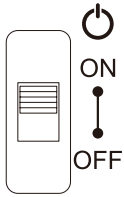

You can also shut down or restart the LinkStation remotely from Settings. For the detailed procedure, refer to the [“Shutting Down or Restarting the LinkStation from Settings”](#) section below.

---

## Creating a USB Initialization Drive

---

We recommend creating a USB initialization drive as soon as possible. This USB drive can be used to initialize the LinkStation’s settings to its factory default values or recover the system if your LinkStation encounters an error that prevents the unit from booting. For the detailed procedure, refer to the [“Creating a USB Initialization Drive”](#) subsection in chapter 7.

---

## Accessing Settings

---

Configure and manage your LinkStation using the Settings interface, accessible from a browser window. Open the interface using the appropriate procedure below or type the LinkStation’s IP address into the URL field of your browser.

**Note:** Microsoft Edge, Firefox, Google Chrome, Internet Explorer 9 or later, and Safari 9 or later are supported. If you have difficulty viewing Settings, check the following:

- If you use Internet Explorer to open Settings, the interface may not be displayed properly. In such a case, use another browser.
- If you have a proxy server enabled in the browser settings, configure the exception settings for Settings or disable the proxy server.
- With Internet Explorer, set security to *Local intranet*. On Windows Server operating systems, higher-level security is configured by default. Set the security to a lower level temporarily.
- If there are a large number of created users, groups, or shared folders, the Settings interface may take a longer time (up to 20 minutes) to load.

---

## Opening Settings

---

You can open Settings from a computer or a mobile device. Follow the appropriate procedure below to open Settings.

### Using a Computer

- 1 Double-click the NAS Navigator2 icon (  ) to start NAS Navigator2.

- 2** Right-click your LinkStation's icon and select *Open Settings*. For macOS, select the LinkStation's icon while holding down the control key, then select *Open Settings*.

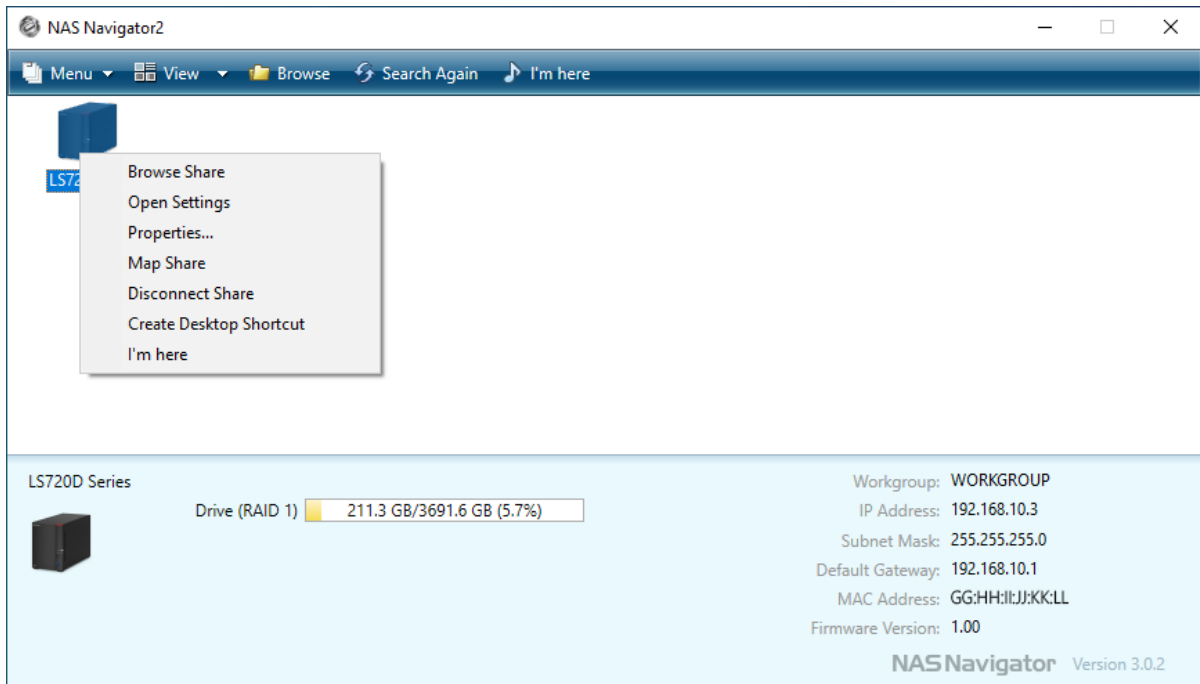

- 3** Enter the username and password, then click *OK*.

The screenshot shows the Buffalo login screen. At the top is the "BUFFALO" logo in red. Below it is a text input field containing the username "admin". Underneath is a checkbox labeled "Log in as a different user" which is currently unchecked. Below that is a password input field labeled "Password". At the bottom left, there is a "Time-Out Period" section with two radio button options: "10 minutes" (which is selected) and "Unlimited". At the bottom center is a large blue button labeled "OK". At the bottom right is a blue underlined link labeled "Secure Connection".

**Notes:**

- If the time-out period is set to "10 minutes", you will be logged out of Settings after 10 minutes of inactivity.
- Click *Secure Connection* to log in using an encrypted connection. For detailed information about encrypted connections, refer to the "[Encrypting Data Transmission](#)" section in chapter 9.

**4** Settings will open.

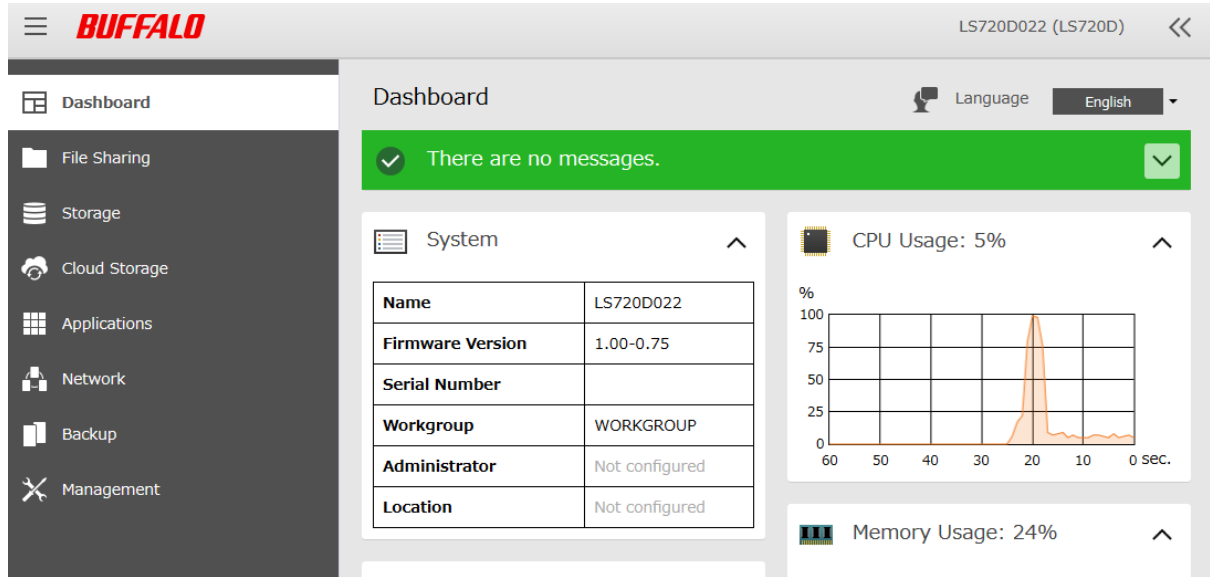

**Using a Mobile Device**

- 1** Tap the SmartPhone Navigator icon (  ) on your mobile device.
- 2** Tap your LinkStation from the list of devices.
- 3** Tap *Open Settings*.

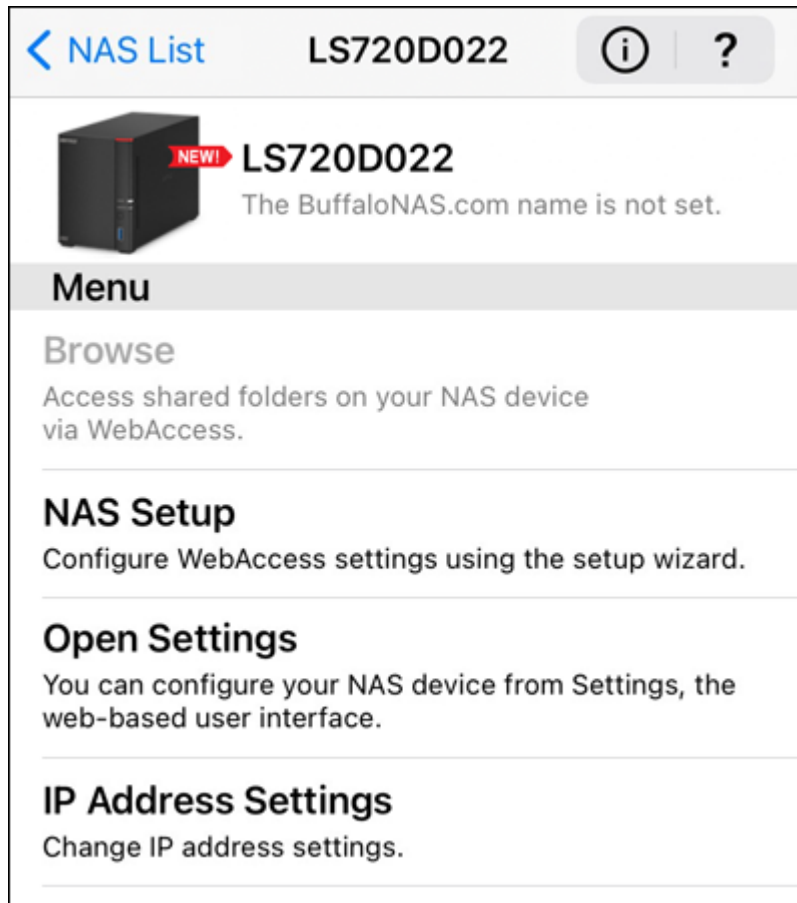



**4** Enter the username and password, then tap *Log In*.



The image shows a login screen for a Buffalo LinkStation. At the top left is the Buffalo logo in red. Below it, the text "LinkStation" and "LS720D" are displayed. There is a "Secure Connection" toggle switch which is currently turned on. Below that are two input fields: "Username" with the text "admin" entered, and "Password" which is empty. At the bottom left is a checkbox labeled "Unlimited time-out period" which is unchecked. At the bottom are two buttons: "Cancel" and "Log In".

**Note:** The default username and password are “admin” and “password”.

## 5 Settings will be displayed.

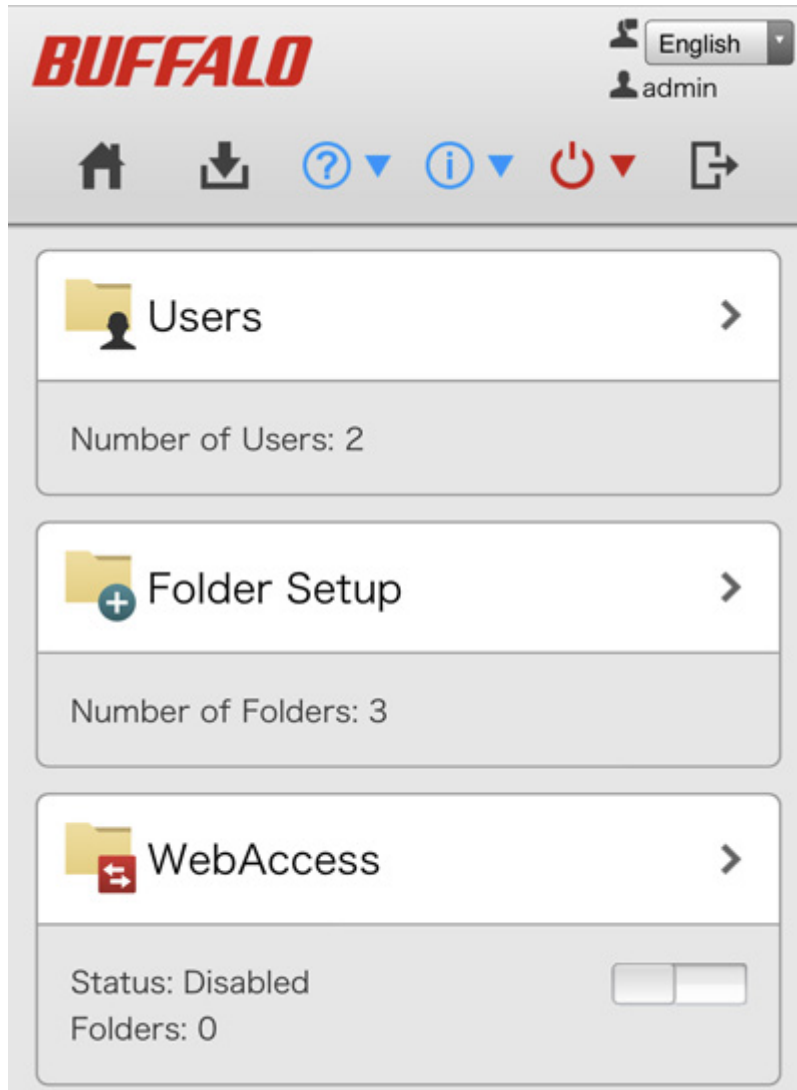

### Notes:

- Username/Password Combinations:

Username	Password	Settings Available
admin (default)	password (default)	All
guest	blank	Guest user information
Your username	Your password	If a user is assigned as an administrator, all settings are available. If assigned to a power users group, creating or editing shared folders, users, and groups is available. If assigned to a general users group, only changing the password of logged-in users is available.

- Click  at the top-right of Settings from a computer and choose *I'm here* to have the LinkStation beep so it can be located easily.

## Using the Setup Wizard

When you access Settings for the first time, or after initializing the LinkStation's settings, the setup wizard will automatically appear to help you configure several LinkStation settings, such as changing admin password and proxy server settings.

Example screens of the setup wizard are displayed below. Step through the wizard to configure any desired settings. If there is any setting you would like to configure later, click *Skip* to move to the next setup wizard screen, or click *Cancel* to exit the wizard. You may run the setup wizard at a later time after initial setup, or after system initialization.

### Example of Setup Wizard Screen from a Computer

**Change Administrator Password**

**Change the administrator password.**  
For security reasons, please enter a new admin password below.

Show entered password

Password:  ?

Enter the password again to confirm.

Confirm Password:

Skip Next

### Example of Setup Wizard Screen from a Mobile Device

**Getting Started**

**Change Administrator Password**

For security reasons, please enter a new admin password below.

Administrator Username  
admin

New Password

New Password (Confirm)

Skip OK

To launch the setup wizard at a later time, follow the procedure below.

- 1 From Settings, click *Management*.

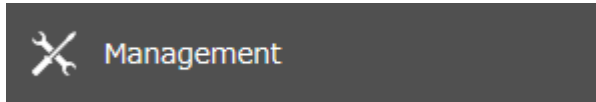

- 2 Click the settings icon (  ) to the right of "Restore/Erase".



- 3 Click *Execute Wizard*.

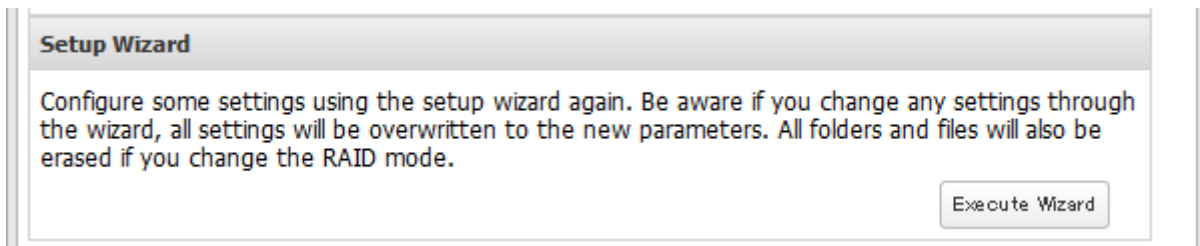

- 4 The "Confirm Operation" screen will open. Enter the confirmation number, then click *OK*.

- 5 Follow the procedure on the screen and finish the setup wizard.

## Checking the Device Information from Dashboard

When opening the Settings interface, the Dashboard page will appear first. Dashboard will show the following device information:

- Notices, such as information events and errors
- System information, such as hostname, firmware version, IP address, etc.
- Drive information, such as used space of internal drives or LVM volumes, etc.
- CPU and system memory usage
- Network information, such as IP address, link speed, sent and received rates, etc.

 A screenshot of the Buffalo LinkStation web interface. The top left shows the Buffalo logo and a hamburger menu. The top right shows the device model "LS720D022 (LS720D)" and a language dropdown set to "English". The main content area is titled "Dashboard" and features a green notification bar stating "There are no messages." Below this, there are two panels. The left panel, titled "System", contains a table with the following data:
 

Name	LS720D022
Firmware Version	1.00-0.75
Serial Number	
Workgroup	WORKGROUP
Administrator	Not configured
Location	Not configured

 The right panel, titled "CPU Usage: 5%", shows a line graph with a y-axis from 0 to 100% and an x-axis from 60 to 0 seconds. The graph shows a single peak at approximately 20 seconds. Below the graph, there is a section for "Memory Usage: 24%".

### Notes:

- If the number of files on the LinkStation increases, it will also increase the memory usage of the LinkStation. This memory usage will decrease after a certain period of time passes. To reduce the memory usage immediately, try the following operations:

- Restarting the LinkStation.
- Dismounting the USB drive.
- If there is not enough free space on the LinkStation, it may cause abnormal system behavior. Make sure that there is always at least 1 GB or more of free space on the LinkStation.

## **Shutting Down or Restarting the LinkStation from Settings**

You can shut down or restart the LinkStation remotely from a computer or a mobile device. Follow the appropriate procedure below to remotely shut down or restart the LinkStation from Settings.

### **Using a Computer**

- 1** Log in to Settings using NAS Navigator2.
- 2** Click  at the top-right of Settings and choose *Shut Down* or *Restart*.

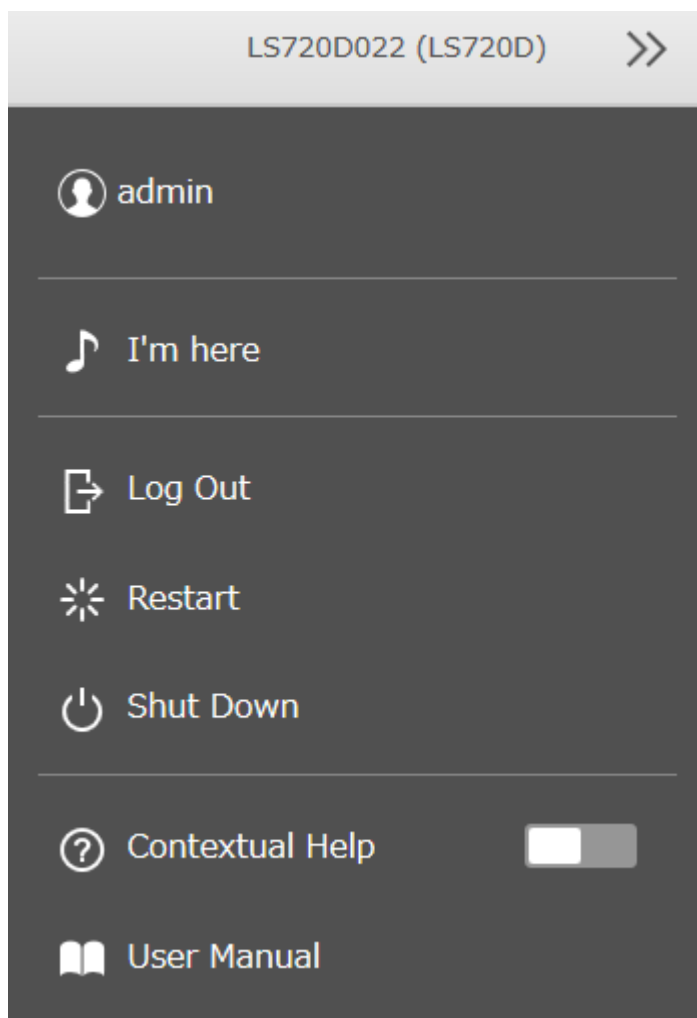

- 3** Click *Yes*.
- 4** The “Confirm Operation” screen will open. Enter the confirmation number, then click *OK*.

If shutting down the LinkStation, the shutdown process will finish once the power LED turns off. To shut down completely, move the power switch to the “Off” position. If you leave the power switch in the “On” position, you can power on the LinkStation using Wake-on-LAN remotely or the function button. If restarting the LinkStation, wait until the power LED changes to a steady white.

## Using a Mobile Device

**1** Log in to Settings using SmartPhone Navigator on your mobile device.

**2** Tap the power icon (  ) at the top-right corner of Settings.

**3** Tap *Shut Down* or *Restart*.

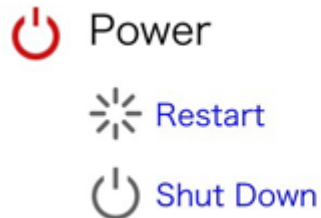

**4** Tap Yes.

**5** The “Confirm Operation” screen will open. Enter the confirmation number, then tap *OK*.

If shutting down the LinkStation, the shutdown process will finish once the power LED turns off. To shut down completely, move the power switch to the “Off” position. If you leave the power switch in the “On” position, you can power on the LinkStation using Wake-on-LAN remotely or the function button.

If restarting the LinkStation, wait until the power LED changes to a steady white.

# Chapter 2 File Sharing

You can create users and groups to access the shared folders on the LinkStation and configure access restrictions to limit access to key data.

---

## Configuring Shared Folders

---

### Adding a Shared Folder

---

You can create a shared folder from a computer or a mobile device. Follow the appropriate procedure below to create a shared folder.

#### Using a Computer

- 1 From Settings, click *File Sharing*.

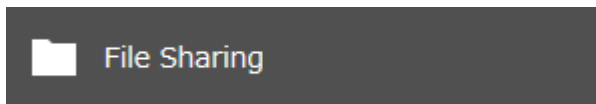

- 2 Click the settings icon (  ) to the right of "Folder Setup".



**3** Click *Create Folder*.

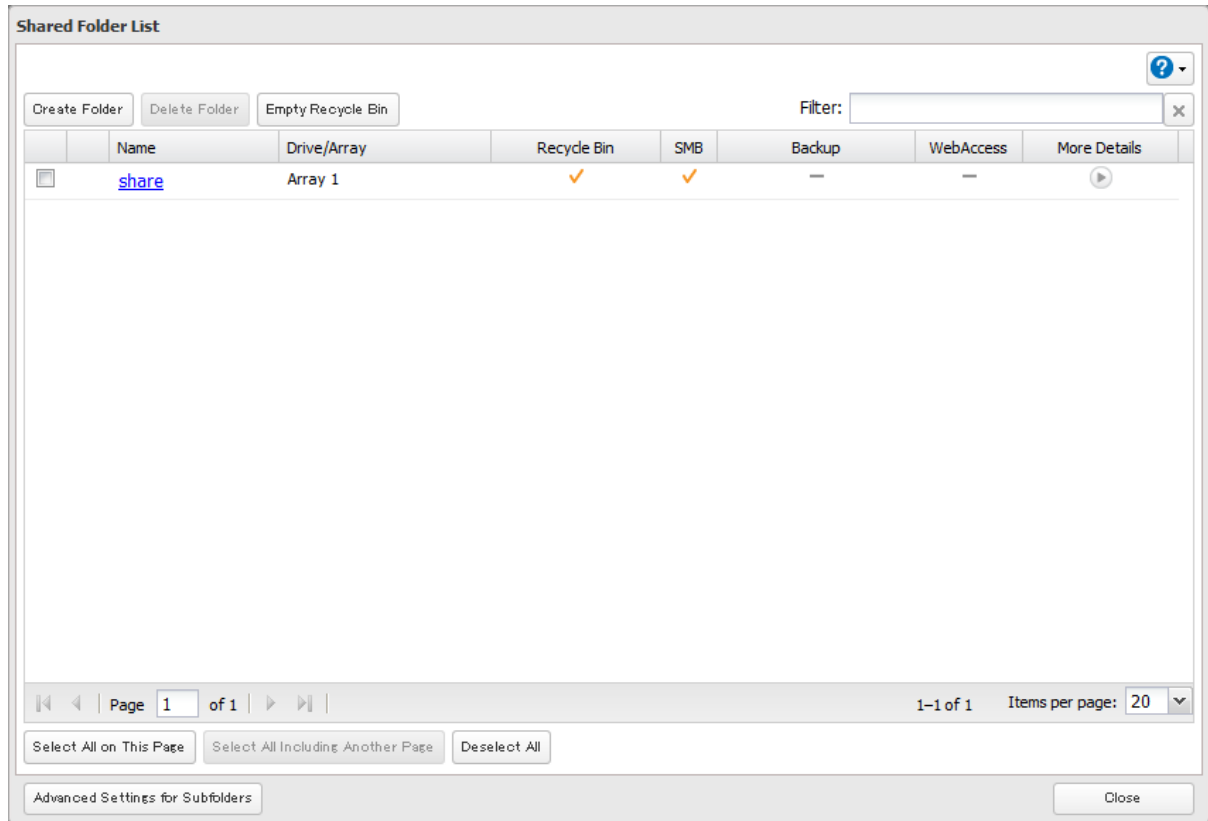



**4** Configure the desired settings, then click *OK*.

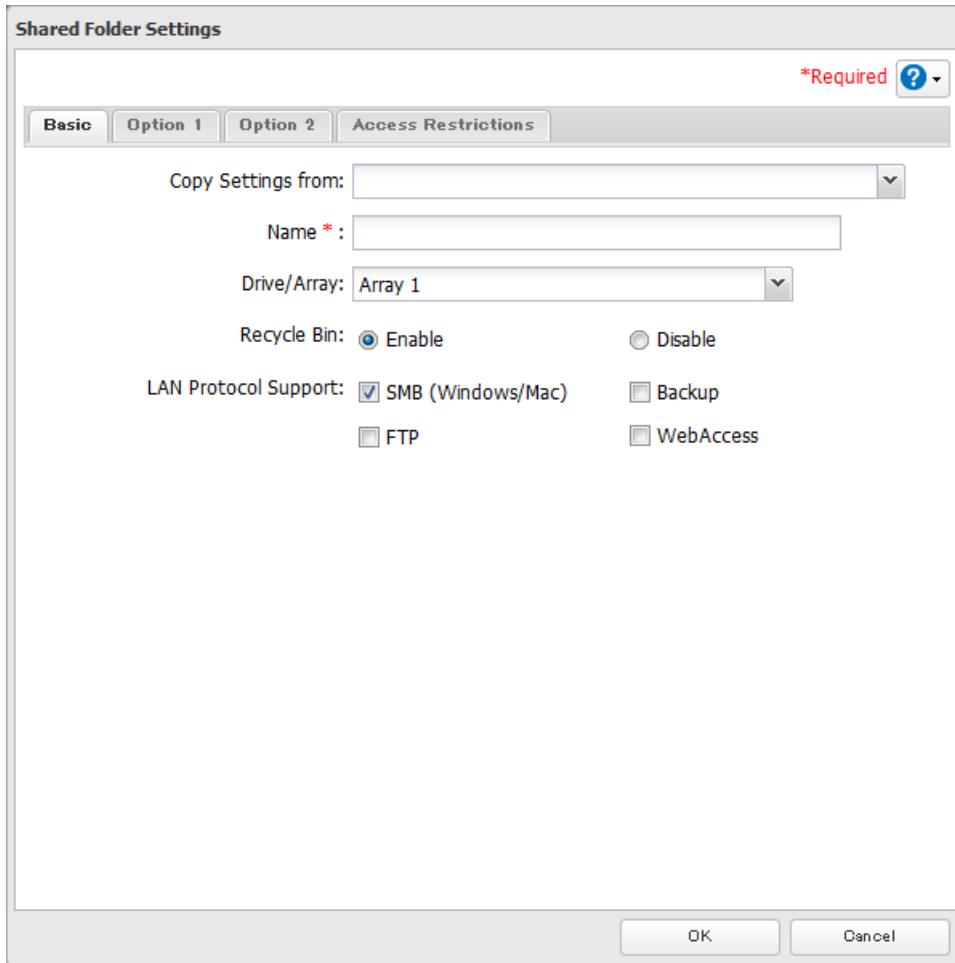

## Using a Mobile Device

**1** From Settings, tap *Folder Setup*.

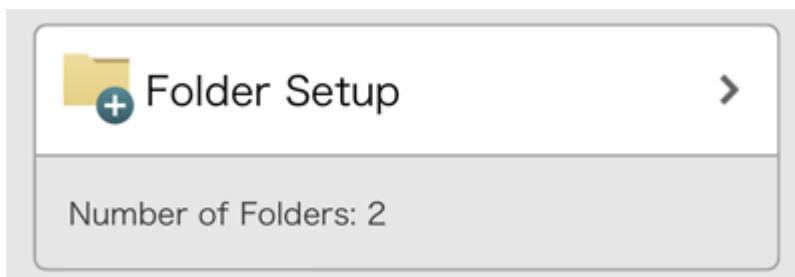

**2** Tap *Create Folder*.

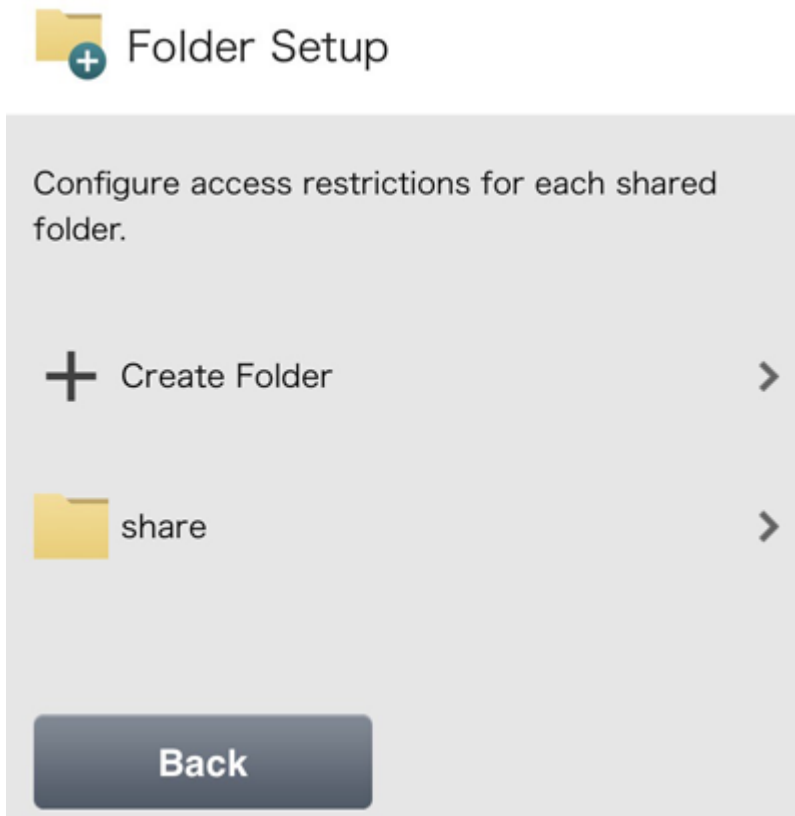

**3** Enter the desired folder name and tap *OK*.

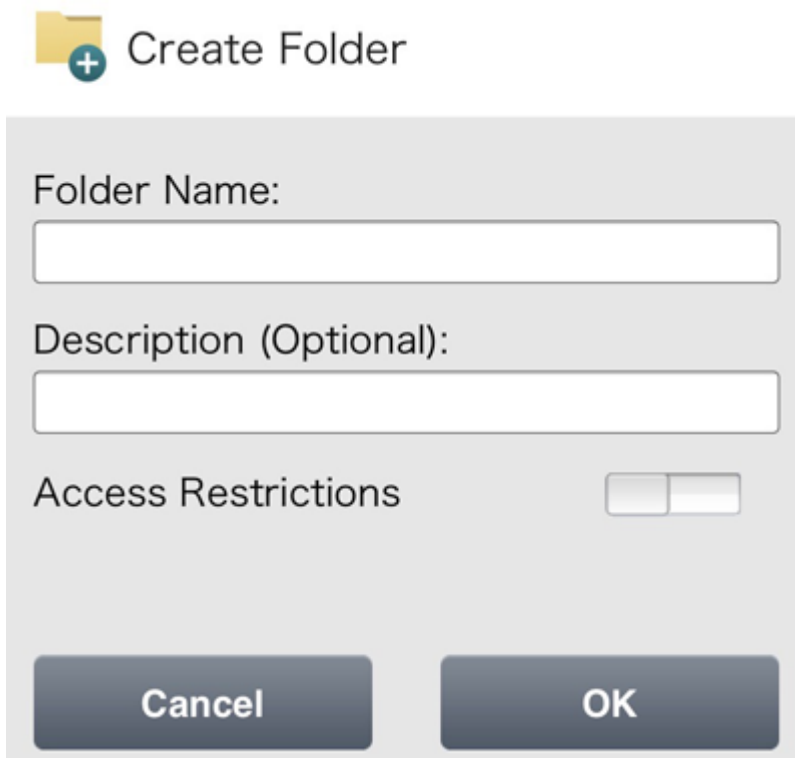

**4** Tap *OK* when finished.

**Notes:**

- Names may contain up to 27 alphanumeric characters, hyphens (-), and underscores (\_). Multibyte characters are supported. The first character should not be a symbol.
- When you click the *Option 1* tab, you can enter the folder description. Descriptions may contain up to 75 alphanumeric characters, hyphens (-), underscores (\_), and spaces. Multibyte characters are supported. The first character should not be a space.
- You may create up to 400 shared folders. However, if there are a large number of created shared folders, folders may take a longer time (up to 20 minutes) to access.
- If the names of shared folders accessed via FTP connections contain multibyte characters, configure the client language in *Management > Name/Time/Language* to match the characters. If the setting and display language do not match, the shared folder name will not be displayed correctly.
- The following characters are handled differently by macOS and Windows devices. Avoid using these characters when sharing data between macOS and Windows devices:

— ~ // - ¢ £ ¬

- Windows does not support some characters that macOS and the LinkStation allow. If you create a filename on a macOS device that includes any of the following symbols, it will not display correctly on a Windows computer. You may have to connect to the LinkStation via non-SMB connections such as FTP in order to display or copy files that contain these symbols in their filenames.
- Do not use any of the following words for the name of a shared folder as these words are reserved for internal use by the LinkStation: authtest, global, homes, info, lost+found, lp, msdfs\_root, mt-daapd, printers, ram, recorded, spool, usbdisk x (where “x” is a number, for example: usbdisk1)

?][/\= + > < ; : " , | \*

- Don't use the following unsupported characters in shared folder names, workgroup names, or filenames:

①②③④⑤⑥⑦⑧⑨⑩⑪⑫⑬⑭⑮⑯⑰⑱⑲⑳ | II III IV V VI VII VIII IX X

¡ ¢ £ ¤ ¥ ¦ § ¨ © ª « ¬ ® ¯ ° ± ² ³ ´ µ ¶ · ¸ ¹ º » ¼ ½ ¾ ¿ À Á Â Ã Ä Å Æ Ç È É Ê Ë Ì Í Î Ï Ñ Ò Ó Ô Õ Ö × Ø Ù Ú Û Ü Ý Þ ß à á â ã

ä å æ ç è é ê ë ì í î ï ð ñ ò ó ô õ ö ÷ ø ù ú û ü ý þ ÿ ı Ā ā Ȧ ȧ Ȩ ȩ Ȫ ȫ Ȭ ȭ Ȯ ȯ Ȱ ȱ Ȳ ȳ ȴ ȵ ȶ ȷ ȸ ȹ Ⱥ Ȼ ȼ Ƚ Ⱦ ȿ ̀ ́ ͂ ̓ ̈́ ͅ ͆ ͇ ͈ ͉ ͊ ͋ ͌ ͍ ͎ ͏ ͐ ͑ ͒ ͓ ͔ ͕ ͖ ͗ ͘ ͙ ͚ ͛ ͜ ͝ ͞ ͟ ͠ ͡ ͢ ͣ ͤ ͥ ͦ ͧ ͨ ͩ ͪ ͫ ͬ ͭ ͮ ͯ Ͱ ͱ Ͳ ͳ ʹ ͵ Ͷ ͷ ͸ ͹ ͺ ͻ ͼ ͽ Ϳ ̀ ́ ͂ ̓ ̈́ ͅ ͆ ͇ ͈ ͉ ͊ ͋ ͌ ͍ ͎ ͏ ͐ ͑ ͒ ͓ ͔ ͕ ͖ ͗ ͘ ͙ ͚ ͛ ͜ ͝ ͞ ͟ ͠ ͡ ͢ ͣ ͤ ͥ ͦ ͧ ͨ ͩ ͪ ͫ ͬ ͭ ͮ ͯ Ͱ ͱ Ͳ ͳ ʹ ͵ Ͷ ͷ ͸ ͹ ͺ ͻ ͼ ͽ Ϳ ̀ ́ ͂ ̓ ̈́ ͅ ͆ ͇ ͈ ͉ ͊ ͋ ͌ ͍ ͎ ͏ ͐ ͑ ͒ ͓ ͔ ͕ ͖ ͗ ͘ ͙ ͚ ͛ ͜ ͝ ͞ ͟ ͠ ͡ ͢ ͣ ͤ ͥ ͦ ͧ ͨ ͩ ͪ ͫ ͬ ͭ ͮ ͯ Ͱ ͱ Ͳ ͳ ʹ ͵ Ͷ ͷ ͸ ͹ ͺ ͻ ͼ ͽ Ϳ

- File and folder names may contain up to 255 single-byte characters.
- Folder and workgroup names whose names contain multibyte characters may not be displayed correctly.
- If shared folders are accessed from a macOS device, information files for the macOS device may be generated automatically. Do not delete these files. If they are deleted from a Windows device, this may prevent further access from a macOS device.
- The LinkStation belongs to the default zone in AppleShare; the zone cannot be specified.
- When files are copied to the LinkStation or to a USB drive connected to the LinkStation, file information such as date created, date modified, and other date information may be updated or changed.
- During a file transfer, if settings are changed, the file transfer operation may be aborted.
- File copying to the LinkStation is protected by a journaling file system. If the Ethernet cable is disconnected or a power outage occurs while copying data, the following may occur:
  - Preset data such as the LinkStation name, users, and groups may be erased.
  - An incomplete file may be copied and the file can no longer be deleted. If this occurs, restart the LinkStation, delete the file, and perform the copy operation again.

## Recycle Bin

---

To protect your data from accidental deletion, you may configure your LinkStation to use a recycle bin instead of deleting files immediately. The recycle bin will only work with SMB connections. To empty the recycle bin, click *File Sharing > Folder Setup > Empty Recycle Bin* in Settings. Data in all recycle bins in all shared folders will be deleted.

### Notes:

- You can prevent guests and other users from emptying the trash by navigating to *File Sharing > SMB* and select “Administrator only” for the “Permissions” option.
- If you use macOS, select “Keep when original file is deleted” for the “macOS Temp Files” option by navigating to *File Sharing > SMB*. If this setting is changed, files in the recycle bin may be corrupted.

## Read-Only Shares

---

By default, new shares are set with read and write access, but you may change the folder attribute. Follow the procedure below to change the shared folder attribute to read-only.

**1** From Settings, navigate to *File Sharing > Folder Setup* and choose a shared folder.

**2** Click the *Option 2* tab and change the “Attribute” option to “Read only”, then click *OK*.

Read-only shares and HFS Plus-formatted USB drives will have “(Read Only)” added to comments in File Explorer.

### Notes:

- Configure the share attribute only through Settings. Configuring folder attributes through Windows is not supported and may cause unexpected behavior.
- To set a read-only share or USB drive to another attribute, follow the procedure above and change the attribute in step 2 from “Read only” to the desired attribute.

## Hidden Shares

---

If a shared folder becomes hidden, it will not be displayed under Network, and only certain users will be allowed to access it. To hide a shared SMB folder, follow the procedure below.

**1** From Settings, navigate to *File Sharing > Folder Setup* and choose a shared folder to make hidden.

**2** Click the *Option 2* tab and select the “Hidden share (SMB only)” checkbox, then click *OK*.

### Notes:

- If protocols other than “SMB (Windows/Mac)” or “Backup” under “LAN Protocol Support” on the *Basic* tab are enabled, the hidden shares option will be grayed out and cannot be selected.
- Configure hidden share attributes only through Settings. Configuring them through Windows is not supported and may cause unexpected behavior.

To access a hidden folder, open File Explorer in your computer and enter “\\LinkStation name\shared folder name\$” into the address bar. For example, if the LinkStation name is “LS710D001” and the shared folder name is “share”, enter “\\LS710D001\share\$” to open it.

## Configuring Users

---

### Adding a User

---

You can add a user from a computer or a mobile device. Follow the appropriate procedure below to add a user.

**Note:** You may add up to 300 users, which include the default users “admin” and “guest”. However, if there are a large number of created users, folders may take a longer time (up to 20 minutes) to access.

## Using a Computer

1 From Settings, click *File Sharing*.

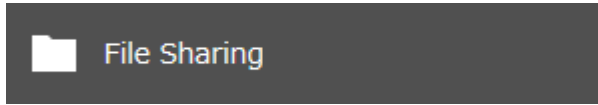

2 Click the settings icon (⚙️) to the right of "Users".



3 Click *Create User*.

The screenshot shows a "User List" window with a light grey background. At the top left, there are two tabs: "Local Users" (selected) and "Domain Users". Below the tabs are three buttons: "Create User", "Import CSV File", and "Delete User". To the right of these buttons is a "Filter:" input field with a clear "X" button. Below this is a table with the following columns: "Username", "Description", "Quota Alert Capacity", "Quota Capacity", "Group", and "Access F". The table contains two rows:

Username	Description	Quota Alert Capacity	Quota Capacity	Group	Access F
<a href="#">admin</a>	System default admin user	Disabled	Disabled	1 ▶	
<a href="#">guest</a>	System default guest user	Disabled	Disabled	1 ▶	

At the bottom of the window, there is a pagination bar showing "Page 1 of 1" and "Items per page: 20". Below the pagination bar are three buttons: "Select All on This Page", "Select All Including Another Page", and "Deselect All". A "Close" button is located at the bottom right corner of the window.

**4** Enter the desired settings, then click *OK*.

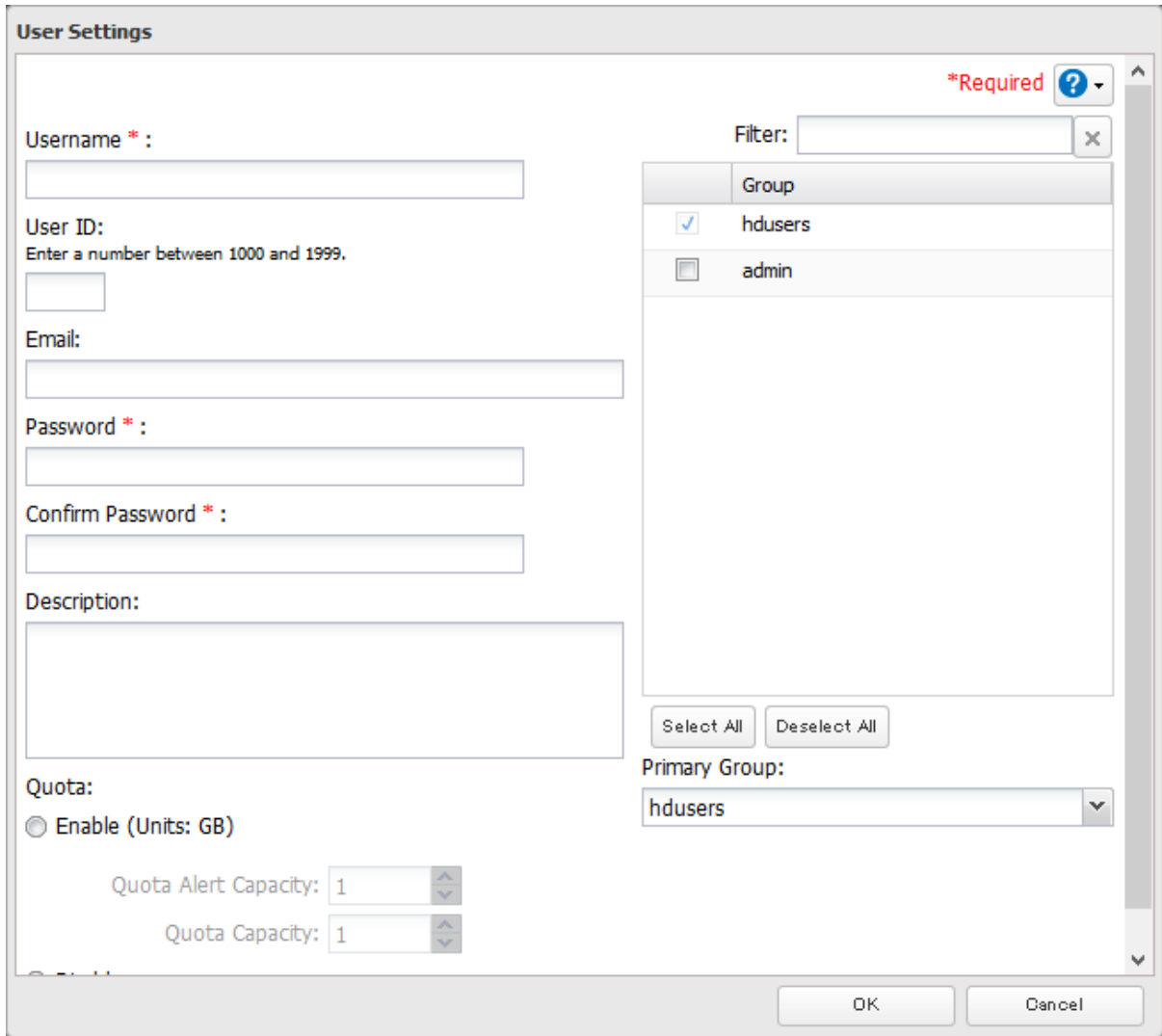

The **User Settings** dialog box contains the following fields and controls:

- Username \***: Text input field.
- User ID**: Text input field with the instruction "Enter a number between 1000 and 1999."
- Email**: Text input field.
- Password \***: Text input field.
- Confirm Password \***: Text input field.
- Description**: Text area.
- Quota**: Radio button for "Enable (Units: GB)". Below it are two spinners for "Quota Alert Capacity" and "Quota Capacity", both set to 1.
- Group Selection**: A list box with a "Filter:" field above it. The list contains "hdusers" (checked) and "admin" (unchecked). Below the list are "Select All" and "Deselect All" buttons.
- Primary Group**: A dropdown menu currently showing "hdusers".
- Buttons**: "OK" and "Cancel" buttons at the bottom right.

## Using a Mobile Device

**1** From Settings, tap *Users*.



**2** Tap *Create User*.



Configure users and passwords for your LinkStation here.

+ Create User >

 admin >  
System default admin user

 guest >  
System default guest user

Back

- 3** Enter the desired username and password (twice), then tap *OK*.

Using the same username and password that you use to log in to Windows is recommended.

Username:

Create a folder for this user

Password:

Password (Confirm):

Description (Optional):

Cancel OK

**Note:** If you select the “Create a folder for this user” option, a shared folder with the same name as the username will automatically be created.

- 4** Tap *OK* when finished.

**Notes:**

- Usernames may contain up to 128 alphanumeric characters, hyphens (-), underscores (\_), periods (.), and the symbols ! # & @ \$ \* ^ %. The first character should not be a symbol.
- The user ID should be a number from 1000 to 1999. Each user ID should be unique. If this field is left blank, a user ID is assigned automatically.
- Do not duplicate user IDs, group IDs, usernames, or group names. Each should be distinct and unique.
- User descriptions may contain up to 75 alphanumeric characters, hyphens (-), underscores (\_), and spaces. Multibyte characters are supported. The first character should not be a symbol or space.
- Passwords may contain up to 20 alphanumeric characters, hyphens (-), underscores (\_), spaces, commas (,), periods (.), semicolons (;), tildes (~), and the symbols @ ! \$ & \* + : = ? [ ^ } { \. The first character should not be a symbol unless it is an underscore.



- Use the same username and password for both Windows and the LinkStation or you may be unable to access shared folders.
- Do not use a name already in use as a group name; do not use any of the following words as a username as these words are reserved for internal use by the LinkStation: \_lldpd, adm, admin, administrator, admins, all, apache, audio, avahi, avahi-autoipd, backup, bin, cdrom, crontab, daemon, dialout, dip, disk, fax, floppy, ftp, ftpuser, fuse, games, gnats, guest, guests, halt, hdusers, irc, kmem, libuuid, list, lp, mail, man, messagebus, mysql, netdev, news, nobody, nogroup, none, ntp, openldap, operator, plugdev, proftpd, proxy, puppet, root, rpc, rpcuser, sambashare, sasl, shadow, shutdown, snmp, splx, src, ssh, sshd, staff, statd, sudo, sync, sys, syslog, tape, tmhttpd, tty, users, utmp, uucp, video, voice, winbindd\_priv, www, www-data

## Importing User Information

---

You can import users in *File Sharing > Users* by clicking *Import CSV File*.

An example format for user data: Username (required), password (required), and user description (optional).

Example 1: Importing usernames, passwords, and comments

```
username1,password1,comment1
username2,password2,comment2
username3,password3,comment3
```

Example 2: Importing usernames and passwords

```
username1,password1,
username2,password2,
username3,password3,
```

### Guidelines:

- Use commas (,) as separators. Do not put spaces before or after commas. If you don't want user descriptions, use a comma after the password at the end.
- If a line is in an incorrect format, the username entered on that line will not be registered.
- If an unavailable name is used by a user or if the username already exists, an error will occur and cancel the import process. User whose usernames were entered during or after the error occurs will not be imported.
- Do not use commas (,) in the username, password, or user description.

**Note:** Imported users are added to the "hdusers" group automatically.

---

## Adding a Group

---

**Note:** You may add up to 300 groups. However, if there is a large number of created groups, folders may take a longer time (up to 20 minutes) to access.

- 1 From Settings, click *File Sharing*.

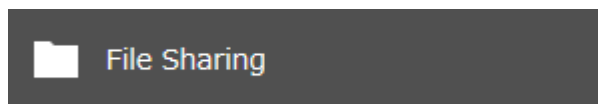

- 2 Click the settings icon (  ) to the right of "Groups".



**3** Click *Add Group*.

The screenshot shows a 'Group List' window with a search bar and two tabs: 'Local Groups' (selected) and 'Domain Groups'. Below the tabs are 'Add Group' and 'Delete Group' buttons, and a 'Filter:' input field. A table lists three local groups:

Group Name	Description	Quota Alert Capacity	Quota Capacity	Users
<a href="#">hdusers</a>	System default gene...	Disabled	Disabled	0
<a href="#">admin</a>	System default admi...	Disabled	Disabled	1 ▶
<a href="#">guest</a>	System default gues...	Disabled	Disabled	1 ▶

At the bottom, there is a pagination bar showing 'Page 1 of 1', '1-3 of 3', and 'Items per page: 20'. Below the pagination are three buttons: 'Select All on This Page', 'Select All Including Another Page', and 'Deselect All'. A 'Close' button is located at the bottom right of the window.

#### 4 Enter the desired settings, then click *OK*.

#### Notes:

- Group names may contain up to 20 alphanumeric characters, hyphens (-), underscores (\_), and periods (.). The first character should not be a symbol.
- Group descriptions may contain up to 75 alphanumeric characters, hyphens (-), underscores (\_), and spaces. Multibyte characters are supported. The first character should not be a symbol or space.
- If the group ID field is left blank, a group ID is automatically assigned. Use numbers between 1000 and 1999 to set a group ID manually. Don't use duplicate group IDs.
- If you are logged in as an administrator, you can change any setting, including other users' passwords. If you are logged in as a member of the power users group, you can create and edit shared folders, users, and groups. If you are logged in as a member of the general users group, you can only change your own password.
- Do not use a name in use as a username; do not use any of the following words as a group name as these words are reserved for internal use by the LinkStation: \_lldpd, adm, admin, administrator, admins, all, apache, audio, avahi, avahi-autoipd, backup, bin, cdrom, crontab, daemon, dialout, dip, disk, fax, floppy, ftp, ftpuser, fuse, games, gnats, guest, guests, halt, hdusers, irc, kmem, libuuid, list, lp, mail, man, messagebus, mysql, netdev, news, nobody, nogroup, none, ntp, openldap, operator, plugdev, proftpd, proxy, puppet, root, rpc, rpcuser, sambashare, sasl, shadow, shutdown, snmp, splx, src, ssh, sshd, staff, statd, sudo, sync, sys, syslog, tape, tmhttpd, tty, users, utmp, uucp, video, voice, winbindd\_priv, www, www-data

## Configuring Access Restrictions for Shared Folders

You may restrict access for specific shared folders, including external USB drives.

### Notes:

- Shared folders with limited access can still be used as backup destinations.
- If you grant both read-only and read and write access to the users or groups, the attributes will become as below:

	Group with read and write access	Group with read-only access	Group with no access
User with read and write access	R/W	R	R/W
User with read-only access	R	R	R
User with no access	R/W	R	-

R/W: Read and write, R: Read-only, -: No access

## Local Users and Groups

You can configure access restrictions using local users and groups from a computer or a mobile device. Follow the appropriate procedure below to configure access restrictions.

### Using a Computer

- 1 From Settings, click *File Sharing*.

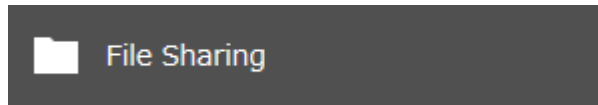

- 2 Click the settings icon (  ) to the right of "Folder Setup".



**3** Click the shared folder that you want to set access restrictions for.

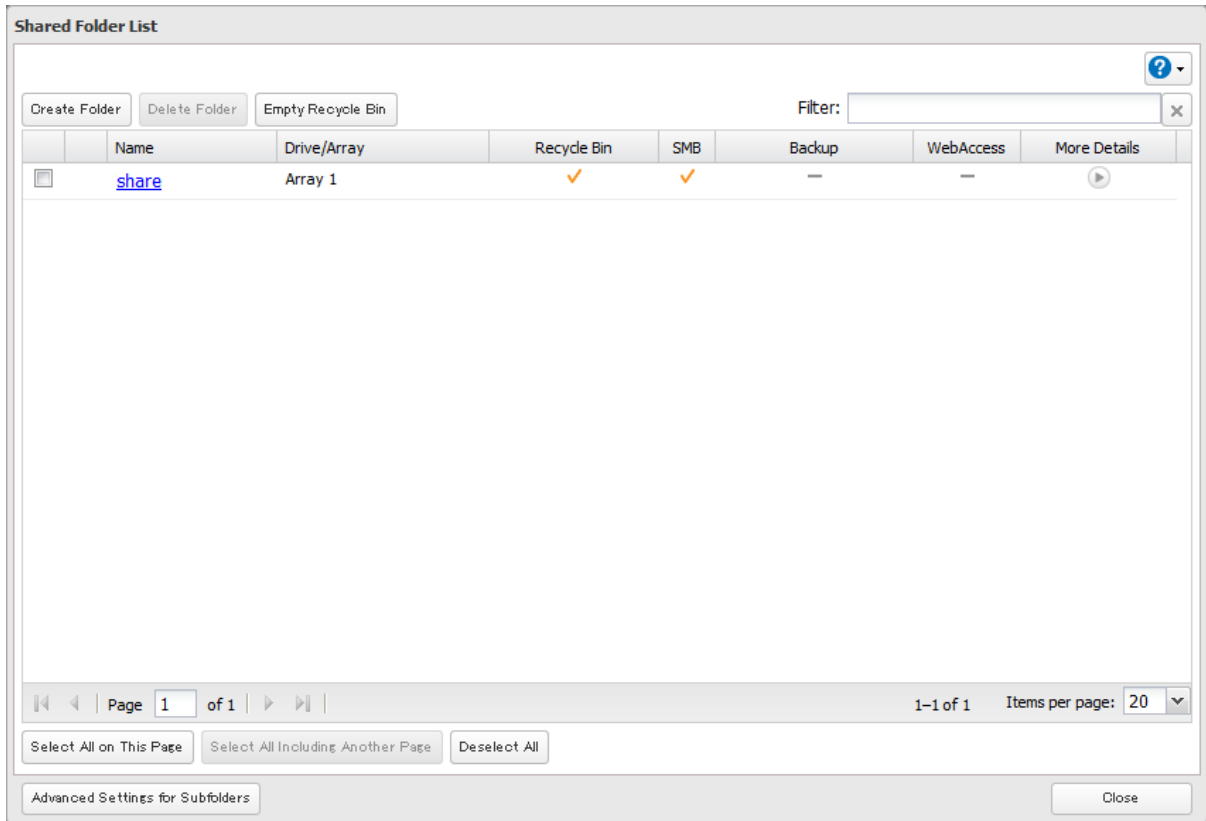

**4** Click the *Access Restrictions* tab.

**5** Enable “Access Restrictions for Shared Folders”.



**6** Select the level of access for the user or group.

: Read and write    : Read-only    : No access

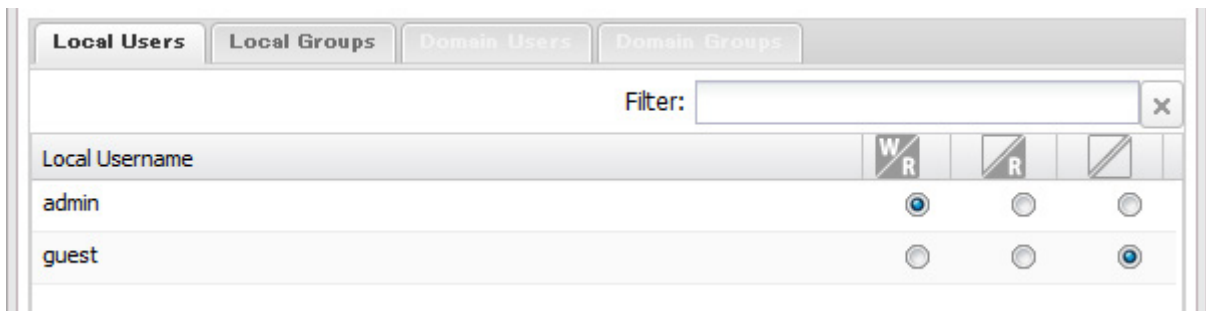

**Note:** The example above shows access restrictions by users. To restrict access by group, click the *Local Groups* tab and select group permissions.

**7** Click *OK*.

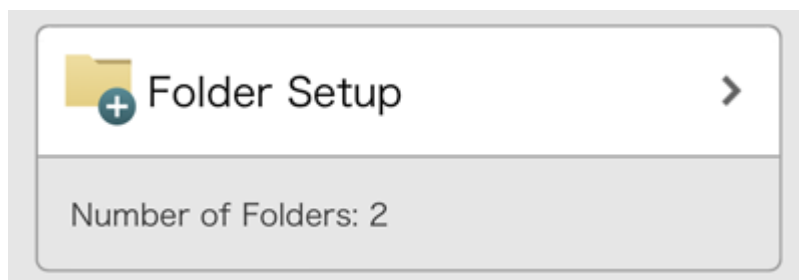

## Using a Mobile Device

- 1 From Settings, tap *Folder Setup*.

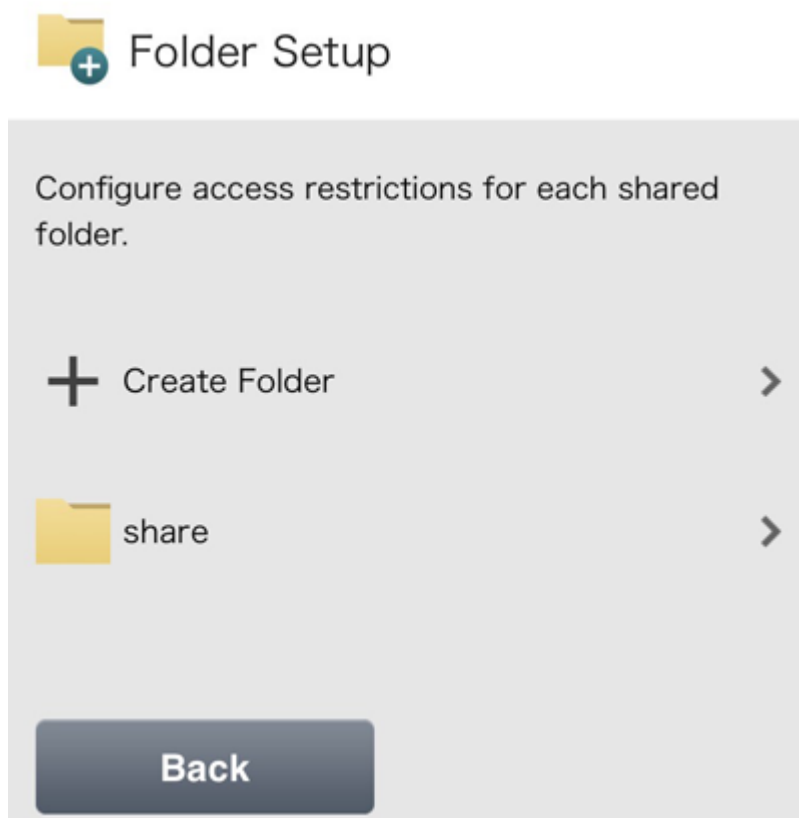

- 2 Tap the shared folder that you want to set access restrictions for.



- 3** Move the access restrictions switch (  ) to the  position to enable access restrictions.

 **Edit Folder**

Shared Folder Name:

Description (Optional):

Access Restrictions 

**Access Restrictions for Users** ▼

 admin  
 Built-in account for administering the system

 guest  
 Built-in account for guest access to the system

**Delete This Folder**

- 4** Select the level of access for the users, then tap *OK*.

## Active Directory

If there is an Active Directory environment, the LinkStation will use account information from the Active Directory domain controller to set access restrictions for LinkStation's shared folders. There is no need to perform individual account management for the LinkStation. If multiple LinkStations are installed on the network, the account information will be centrally managed in Active Directory, greatly reducing the operations required for installation and management.

### Notes:

- If usernames or group names from Active Directory include multibyte characters, you will not be able to configure access restrictions for them.
- The LinkStation supports a domain environment with a maximum of 10,000 users and groups.

- 1** From Settings, click *Network*.



- 2** Click the settings icon (  ) to the right of “Workgroup/Domain”.



- 3** Click *Edit*.
- 4** Select “Active Directory”, then click *Next*.

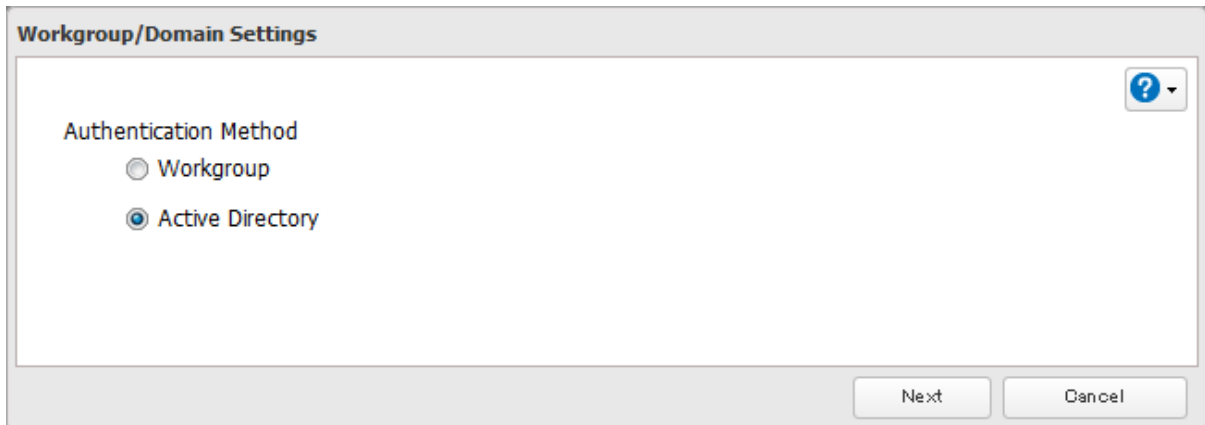

- 5** Enter the domain controller information and click *Search*. The domain controller on the same network will be detected and required settings will be populated into each field automatically. Alternatively, you can also manually enter the settings.

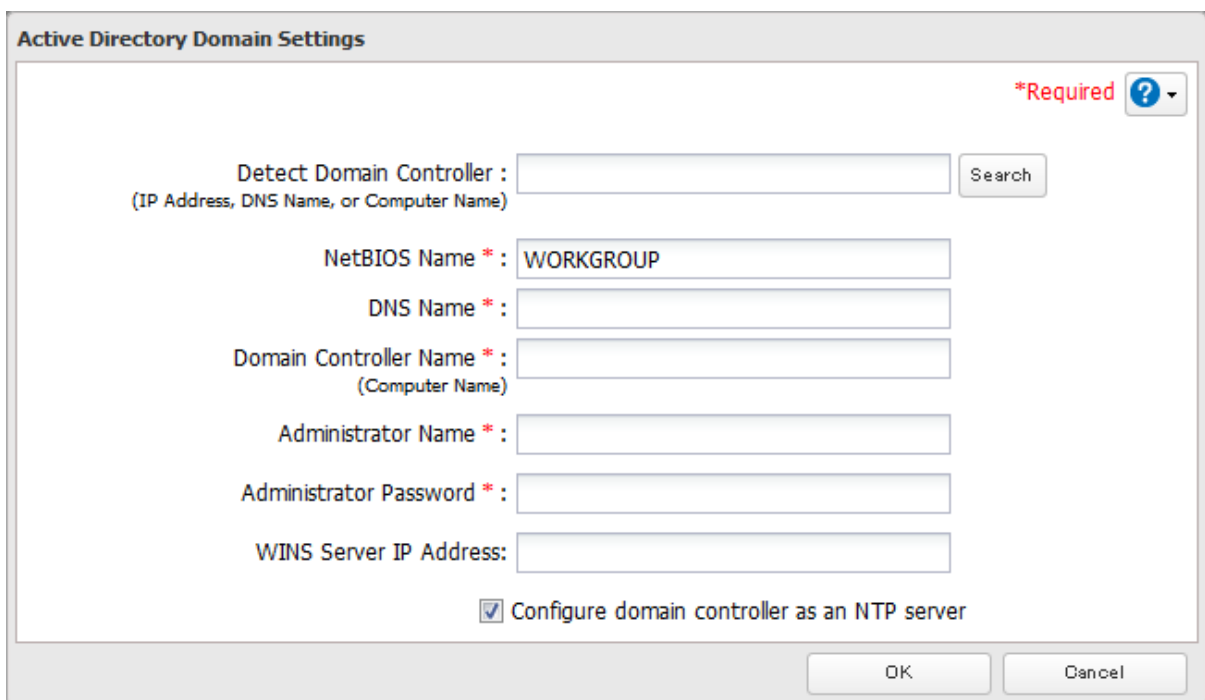

- 6** If there is a difference of more than five minutes between the LinkStation’s clock and the domain controller’s clock, joining the domain or authenticating domain users and groups may fail. For best results, select “Configure domain controller as an NTP server” if the domain controller can function as the NTP server.

- 7** Click *OK*.



**8** Click the settings icon (  ) to the right of “Folder Setup”.



**9** Click the shared folder that you want to set access restrictions for.

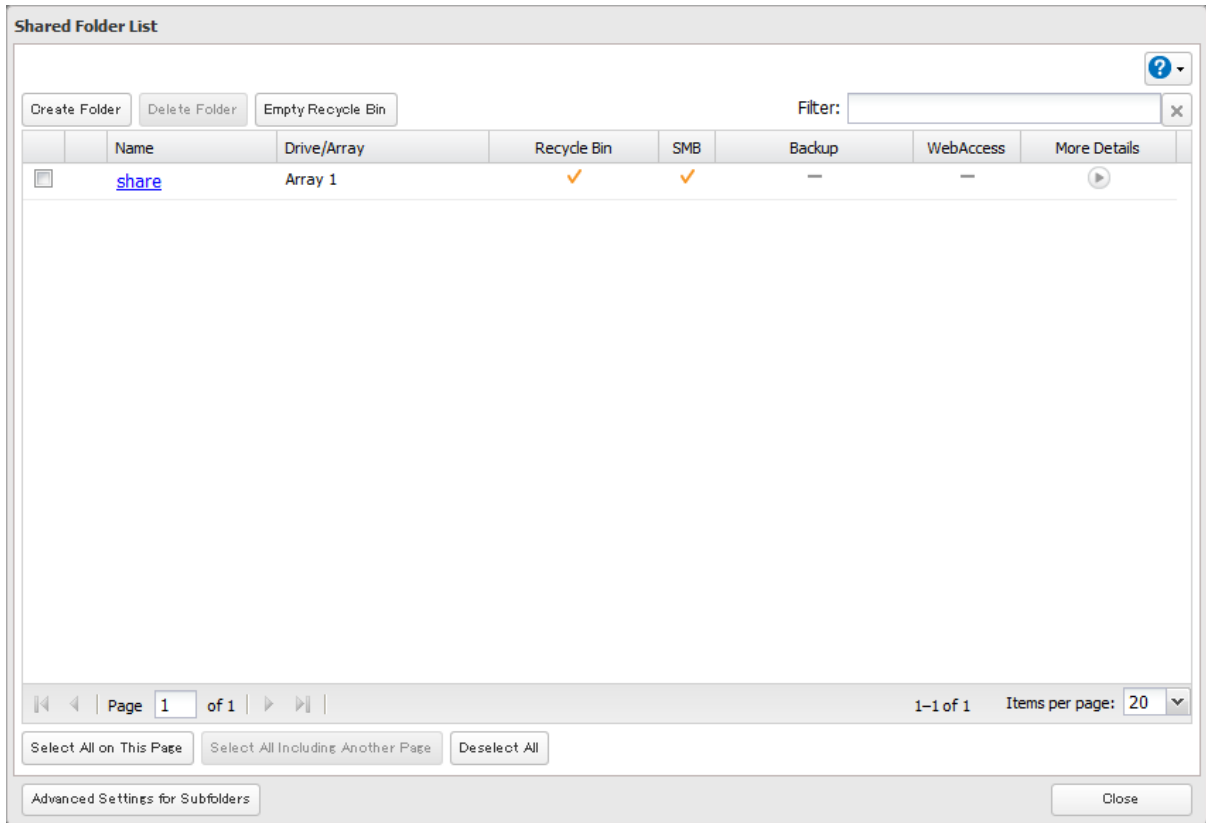

**10** Click the *Access Restrictions* tab.

**11** Enable “Access Restrictions for Shared Folders”.



**12** Select the level of access for the user or group.



**13** Click *OK*.

#### Notes:

- To have the LinkStation join an Active Directory domain, configure it to use a DNS server that can resolve names for the Active Directory domain.
- After building an Active Directory domain, the administrator password for joining the domain must be changed at least once, or joining the Active Directory domain will fail.
- The DNS name and NetBIOS name of Active Directory domains should be identical.
- If your LinkStation is a member server in an Active Directory domain and you change the authentication method to “Workgroup”, the account on the domain controller will not be deleted automatically.

- If FTP is enabled, local and domain group access restrictions from the AD network will not work. Use user access restrictions instead.
- If you allow read and write or read-only access for most users, group access restrictions are recommended.
- Depending on the domain controller's policy settings, the domain controller may force the LinkStation to leave the Active Directory domain. If this occurs, the LinkStation will lose the domain users and groups so if you have configured access restrictions using domain accounts, these users will no longer be able to access shared folders. In such a case, change the policy settings on the domain controller or let the LinkStation join the Active Directory domain again.

## Restoring Owner and Permission Settings

If you changed the owner to an unexpected user or accidentally lost permissions to a specific folder, you can follow the procedure below to restore them.

- 1 From Settings, click *File Sharing*.

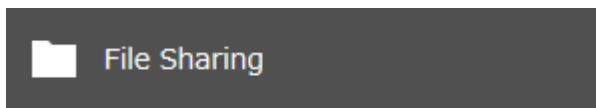

- 2 Click the settings icon (  ) to the right of "Folder Setup".



- 3 Click *Advanced Settings for Subfolders*.

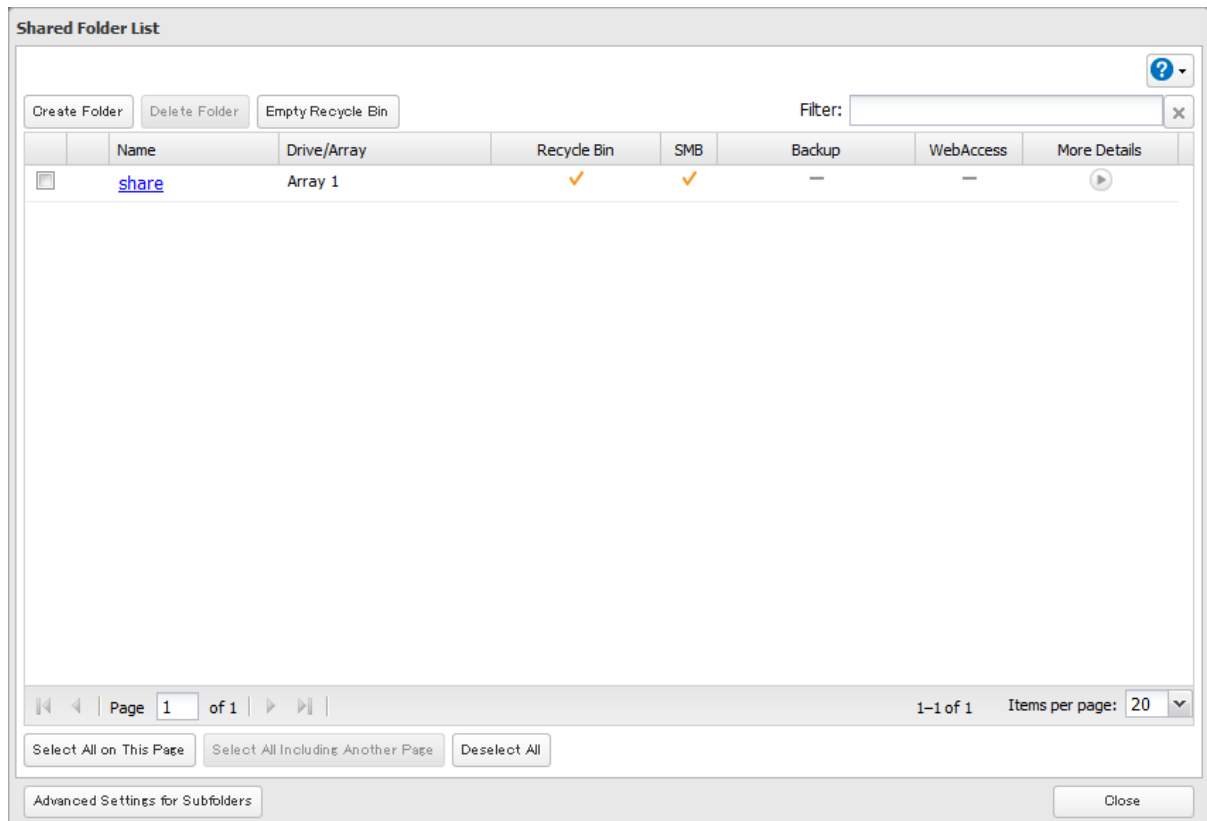

#### 4 Select a folder to restore permissions from the tree.

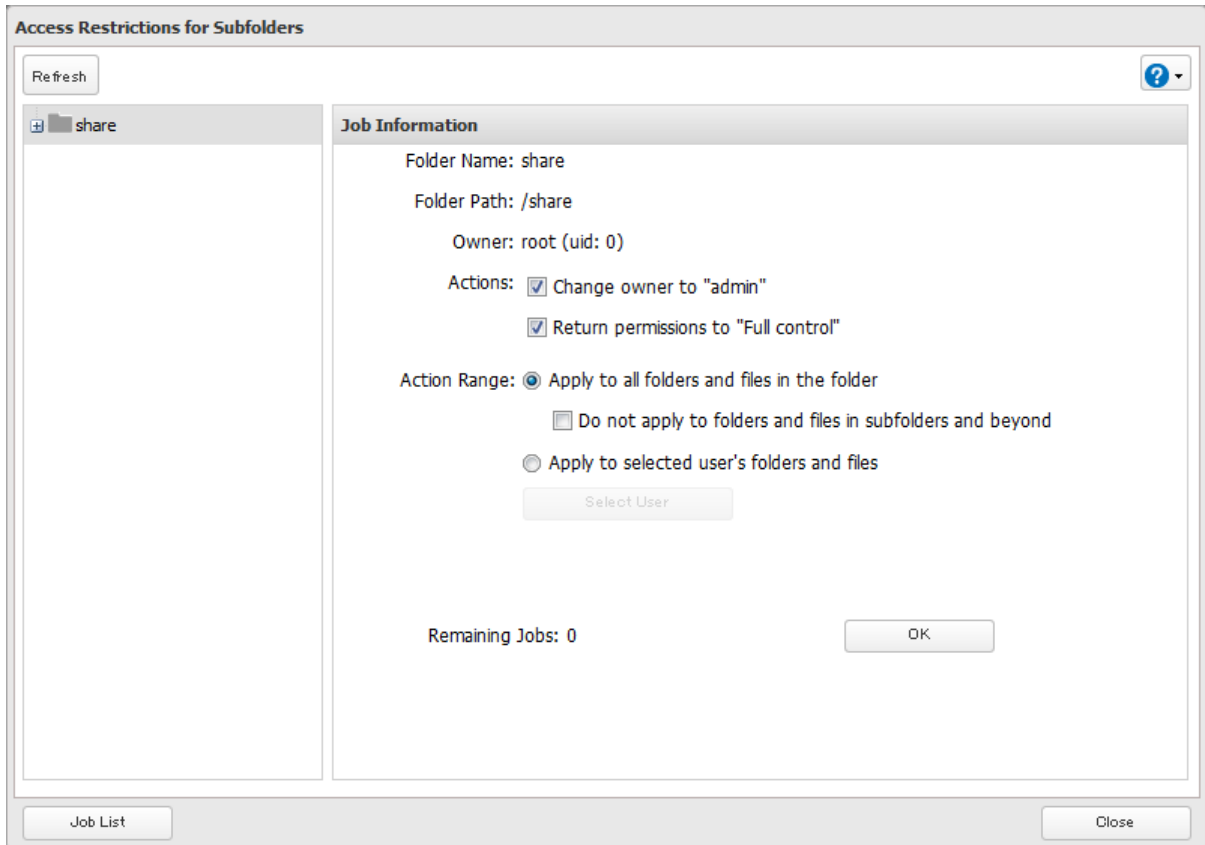

**Note:** If you select a root shared folder from the tree, the action will not apply to the recycle bin. To apply the action to the recycle bin, select it instead.

#### 5 Select the actions and action range to run, then click *OK*.

#### 6 The “Confirm Operation” screen will open. Enter the confirmation number, then click *OK*.

## If a Shared Folder Cannot Be Accessed

Due to the security reasons, you may be unable to access shared folders from computers running certain Windows versions. In such a case, try either of the following corrective actions:

- Adding a Windows credential
- Configuring the LinkStation to allow you to enter a Windows credential when a shared folder cannot be accessed

Follow the procedure below to change the LinkStation settings so you can enter a Windows credential.

#### 1 From Settings, click *File Sharing*.

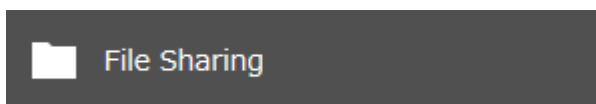

#### 2 Click the settings icon (⚙️) to the right of “SMB”.



#### 3 Click *Edit*.

**4** Under “Users”, change the “Action When Authentication Fails” to “Show network credentials window”.

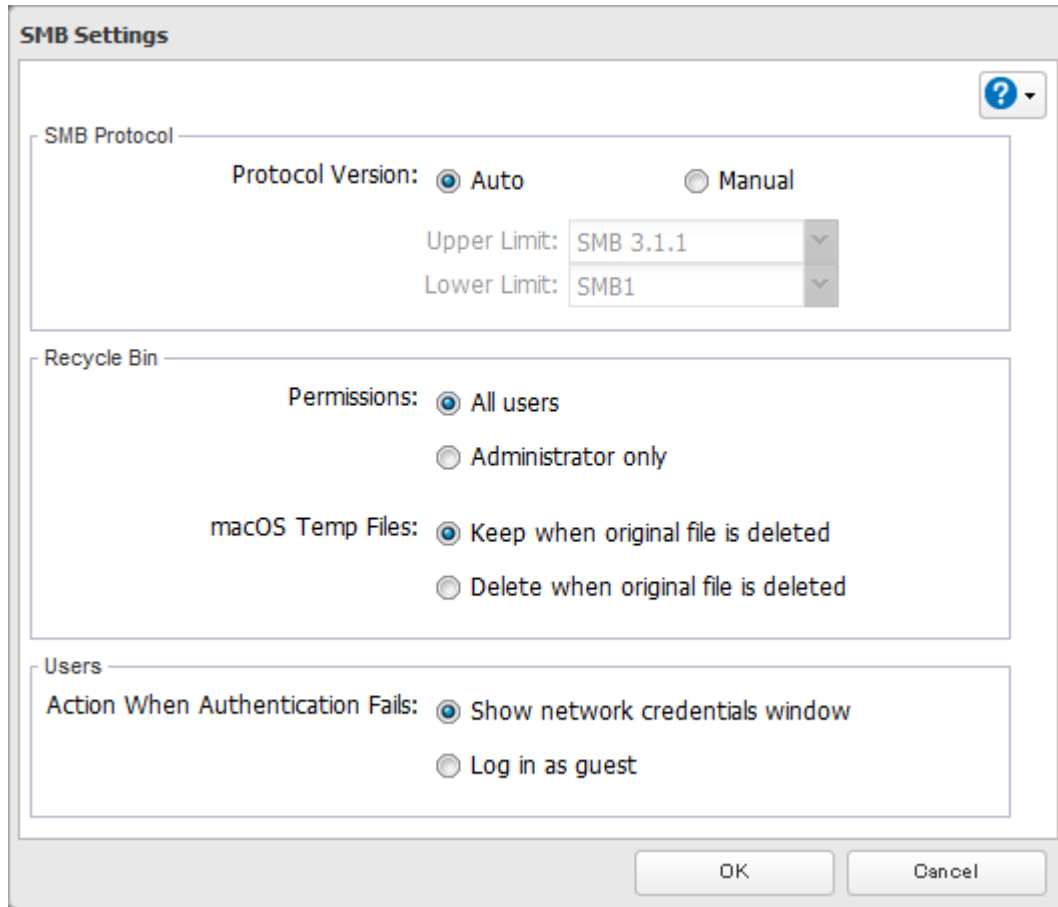

**5** Click *OK*.

The settings will be changed. The window to enter a username and password will be displayed next time you access a shared folder but fails.

# Chapter 3 RAID Modes and Drive Management

---

## Available RAID Modes

---

The LinkStation supports multiple types of RAID. The type of RAID arrays available for use depends on how many drives are installed on your LinkStation.

**Notes:**

- If you change the RAID mode, all data on the array is deleted. This is true for every procedure in this chapter. Always back up any important data before performing actions that affect your RAID array.
- Some arrays will allow you to change the RAID mode without losing data by adding drives. To change a RAID mode by adding drives to the existing array, refer to the [“Changing the RAID Mode using RMM”](#) section below.
- Drive capacity is displayed in Settings in actual gigabytes. The Properties window in Windows may show GiB instead, which will be a smaller number.
- If the LinkStation is restarted or shut down while changing the RAID mode, the message that appears on the Dashboard in Settings and NAS Navigator2 will change from I46 or I47 to I18.

### JBOD

This mode uses the drives inside the LinkStation as individual drives. The usable space is equal to the total capacity of both drives on the LinkStation. If any of the drives fail, then all data on that drive will be lost.

### RAID 1

Combines two drives into a mirrored array. The usable space is equal to the capacity of a single drive. Identical data is written to each drive. If a drive fails, data can be recovered by replacing the failed drive. As long as one drive in the array remains undamaged, all data in the array can be recovered.

### RAID 0

Combines two drives into a single array. The usable space is equal to the total capacity of both drives in the array. If a single drive in the array fails, then all data in the array will be lost.

The default RAID mode for LS720D LinkStation models is RAID 1.

---

## Working with RAID Arrays

---

To change RAID settings, navigate to *Storage > RAID* in Settings.

### Using JBOD

---

With JBOD, each drive on the LinkStation is addressed separately. To put drives in an array into JBOD, follow the procedure below.

- 1 From Settings, click *Storage*.



- 2 Click the settings icon (  ) to the right of "RAID".

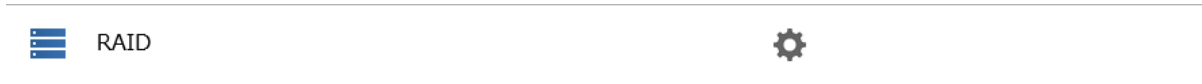

- 3 Click *Array 1*.

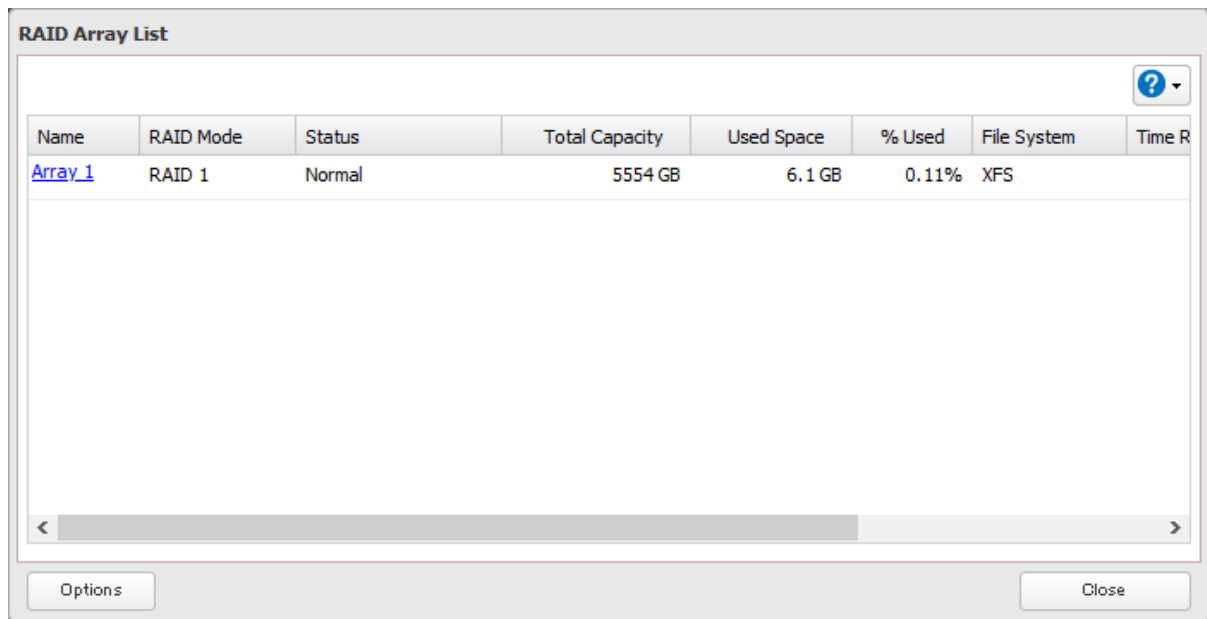

- 4 Click *Delete RAID Array*.

- 5 The "Confirm Operation" screen will open. Enter the confirmation number, then click *OK*.

- 6 Click *OK* when finished. Next, create a shared folder by referring to the ["Adding a Shared Folder"](#) section in chapter 2.

## Creating a RAID Array

Before creating a new RAID array, first put the drives into JBOD by referring to the ["Using JBOD"](#) section above. Then, follow the procedure below.

- 1 From Settings, click *Storage*.



- 2 Click the settings icon (  ) to the right of "RAID".

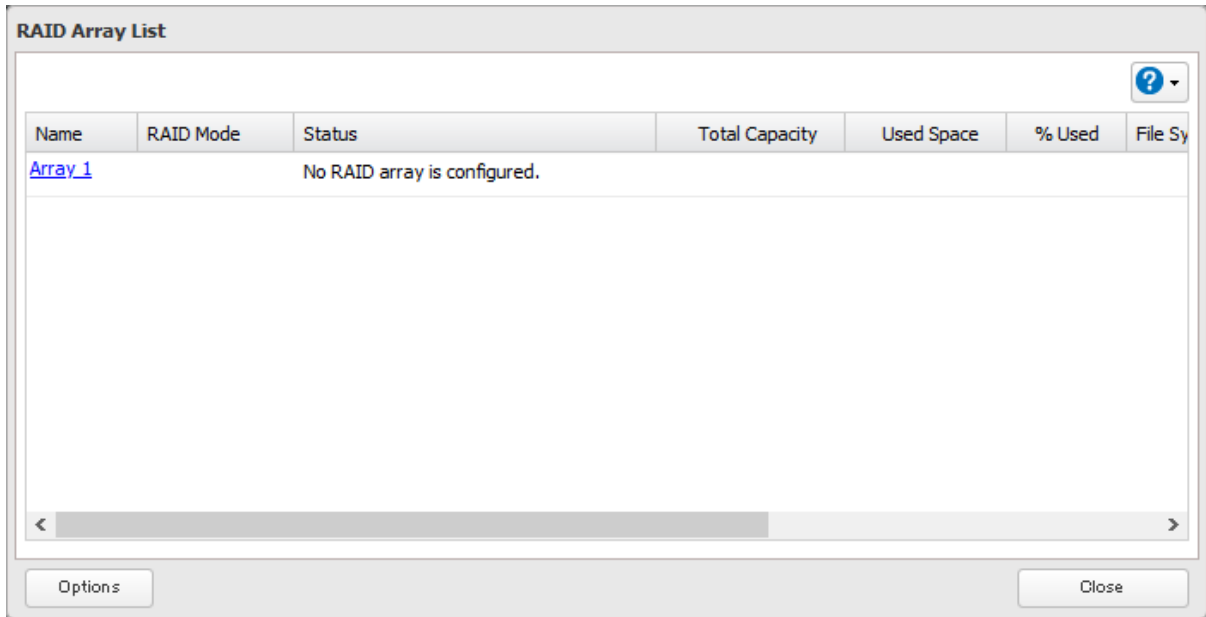
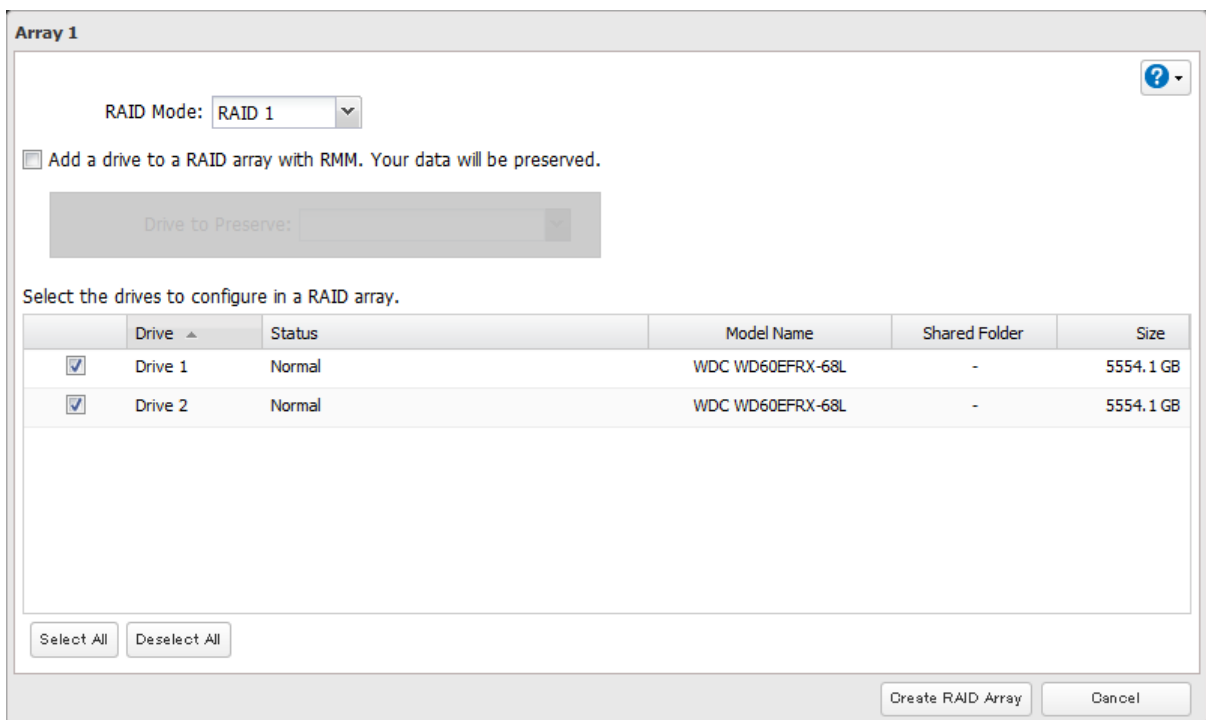

**3** Click *Array 1*.**4** Select a RAID mode and both drives 1 and 2 to be used, then click *Create RAID Array*.**5** Click *OK*.**6** The "Confirm Operation" screen will open. Enter the confirmation number, then click *OK*.**7** Click *OK* when finished. Next, create a shared folder by referring to the ["Adding a Shared Folder"](#) section in chapter 2.

## **Shutting Down the LinkStation Automatically If an Error Occurs**

This function will shut down the LinkStation automatically if an error occurs on a drive that is used in a RAID 1 array. To configure auto shutdown, follow the procedure below.

1 From Settings, click *Storage*.



2 Click the settings icon (  ) to the right of "RAID".



3 Click *Options*.

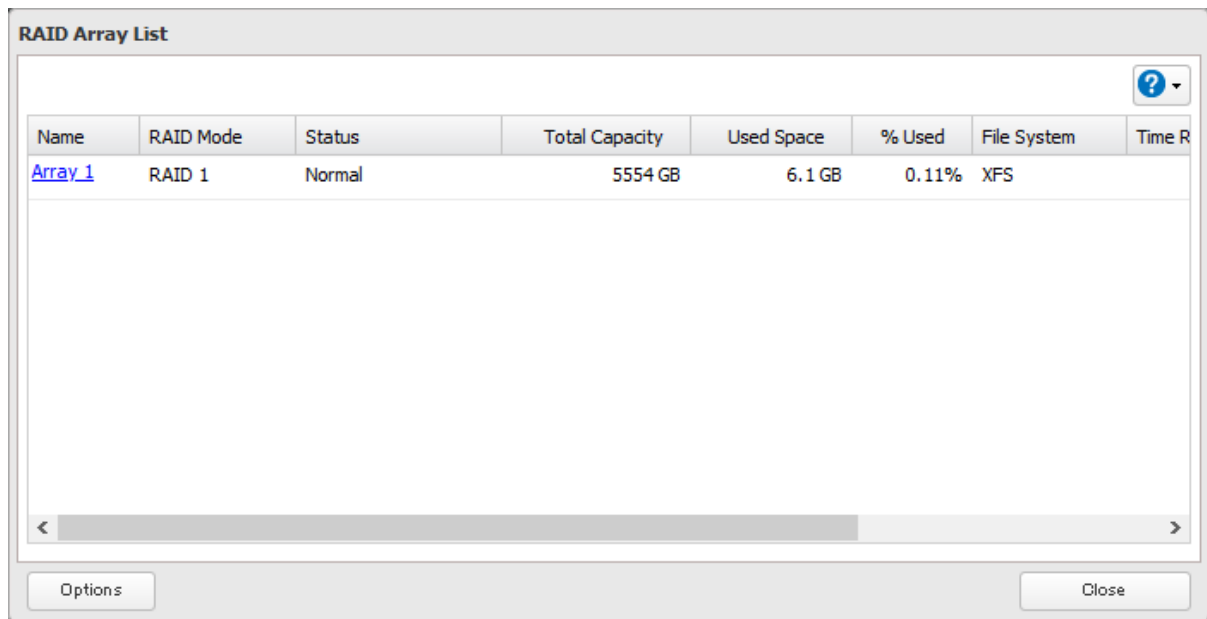

4 Click *Edit*.

5 Change the "Error Behavior" option to "Shut down" and click *OK*.

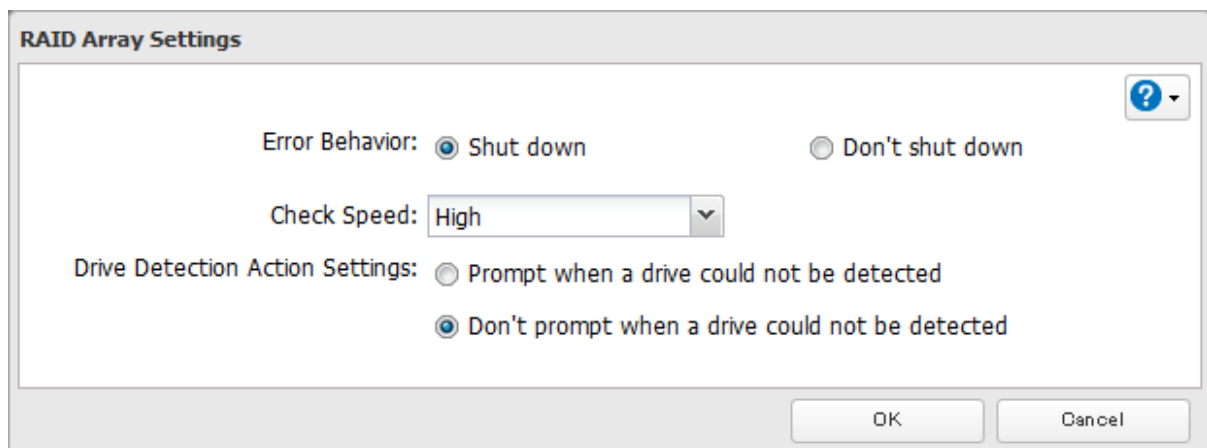

## Configuring Actions for If a Drive Used for the RAID Array Has Not Been Detected

You can configure actions to be taken by the LinkStation if a drive used for the RAID array cannot be mounted when booting.



## Displaying or Hiding the Confirmation Screen

Configure to display or hide the confirmation screen that showcases the actions for if a drive used for the RAID array cannot be mounted when booting. The confirmation screen is configured to appear by default. To hide the screen, follow the procedure below.

- 1 From Settings, click *Storage*.



- 2 Click the settings icon (  ) to the right of "RAID".



- 3 Click *Options*.

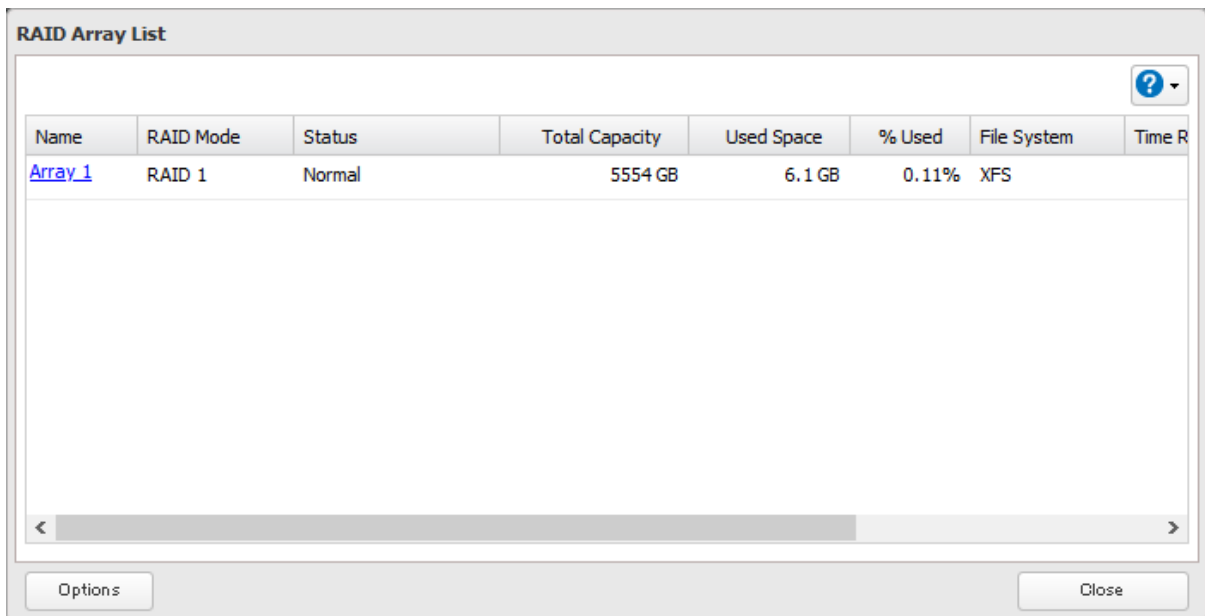

- 4 Click *Edit*.

- 5 Change the "Drive Detection Action Settings" option to "Don't prompt when a drive could not be detected" and click *OK*.

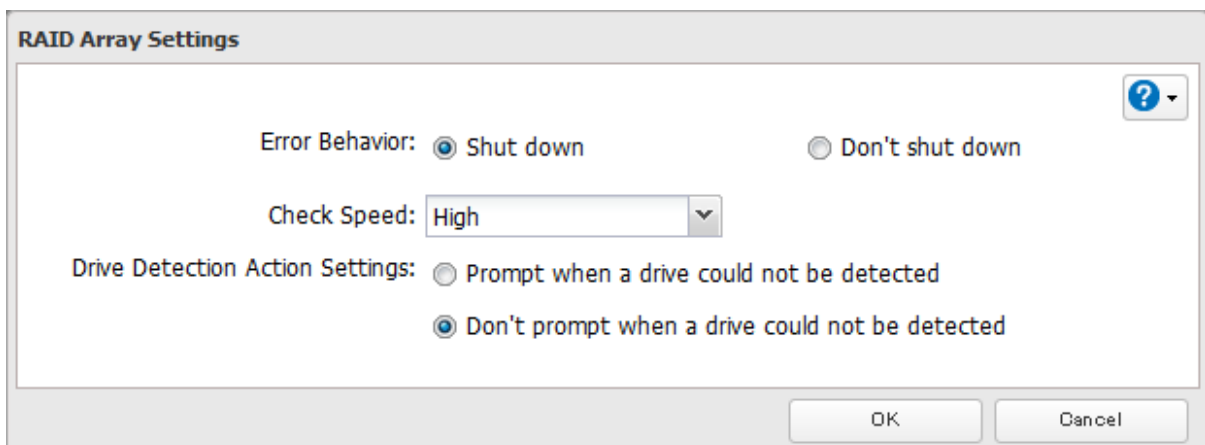

If the confirmation screen is not set to appear, an undetected drive will automatically be dismounted from the LinkStation. Subsequently, the LinkStation will enter degraded mode if RAID 1 has been configured and the RAID array will be corrupted if RAID 0 has been configured, resulting in data loss. It is recommended to proceed without changing settings that would prevent the confirmation screen from appearing.

### Selecting the Action on the Confirmation Screen

When the confirmation screen is displayed, the following screen will appear after logging in to Settings if the drive used for the RAID array could not be mounted. Select the action to run when the screen appears.

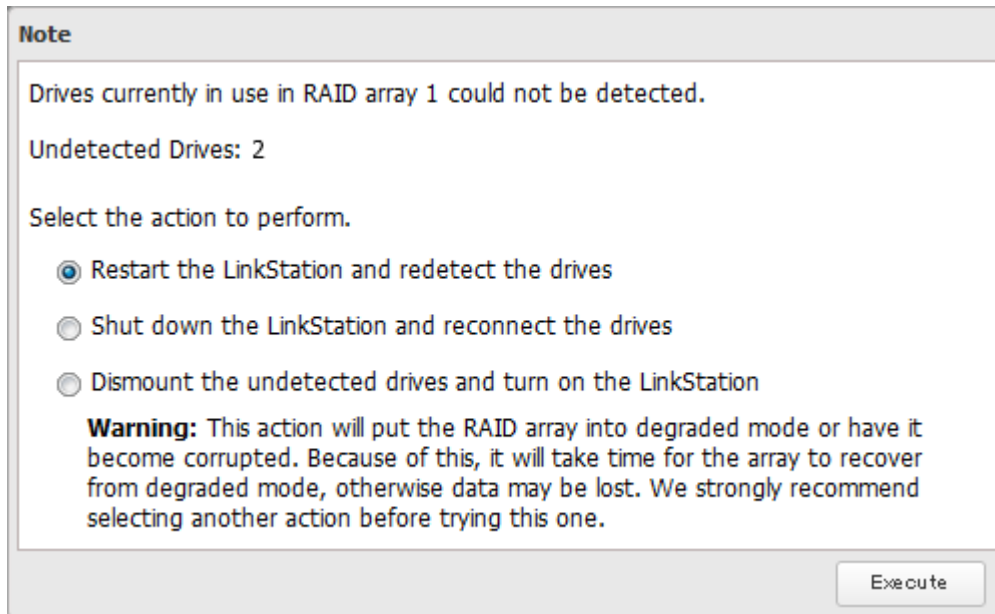

### Changing the RAID Mode using RMM

If the drives are currently in JBOD, you can use RMM (RAID Mode Manager) to create a RAID 1 array without erasing data on the drives.

- 1 From Settings, click *Storage*.



- 2 Click the settings icon (⚙️) to the right of "RAID".



**3** Click *Array 1*.

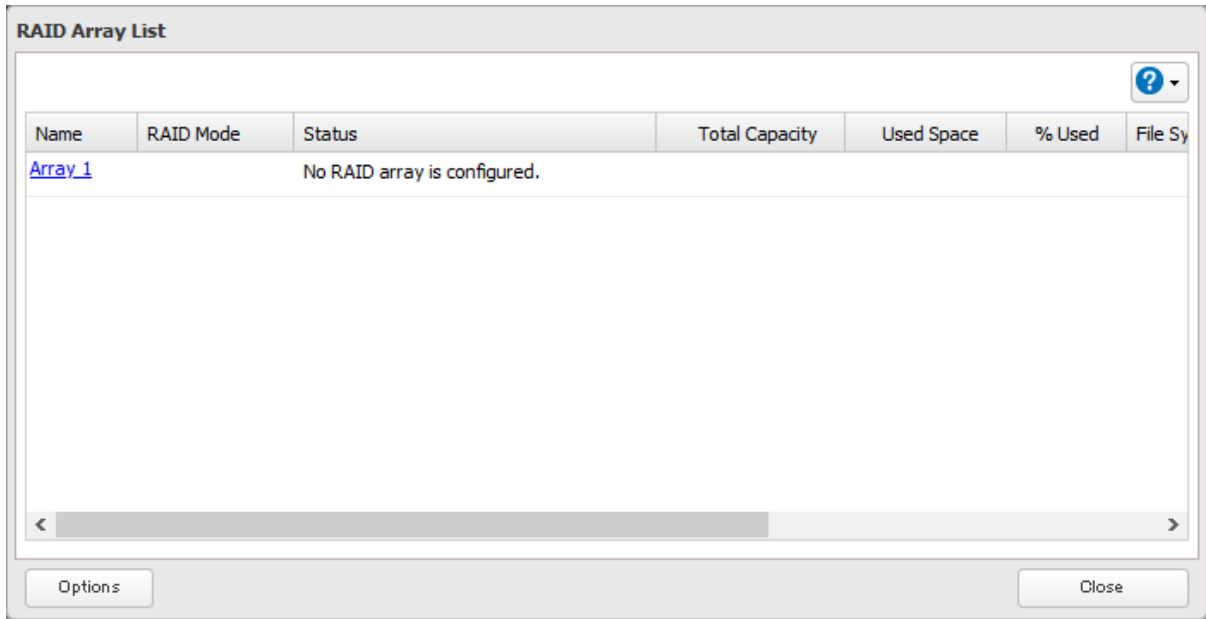

**4** Set the RAID mode to "RAID 1".

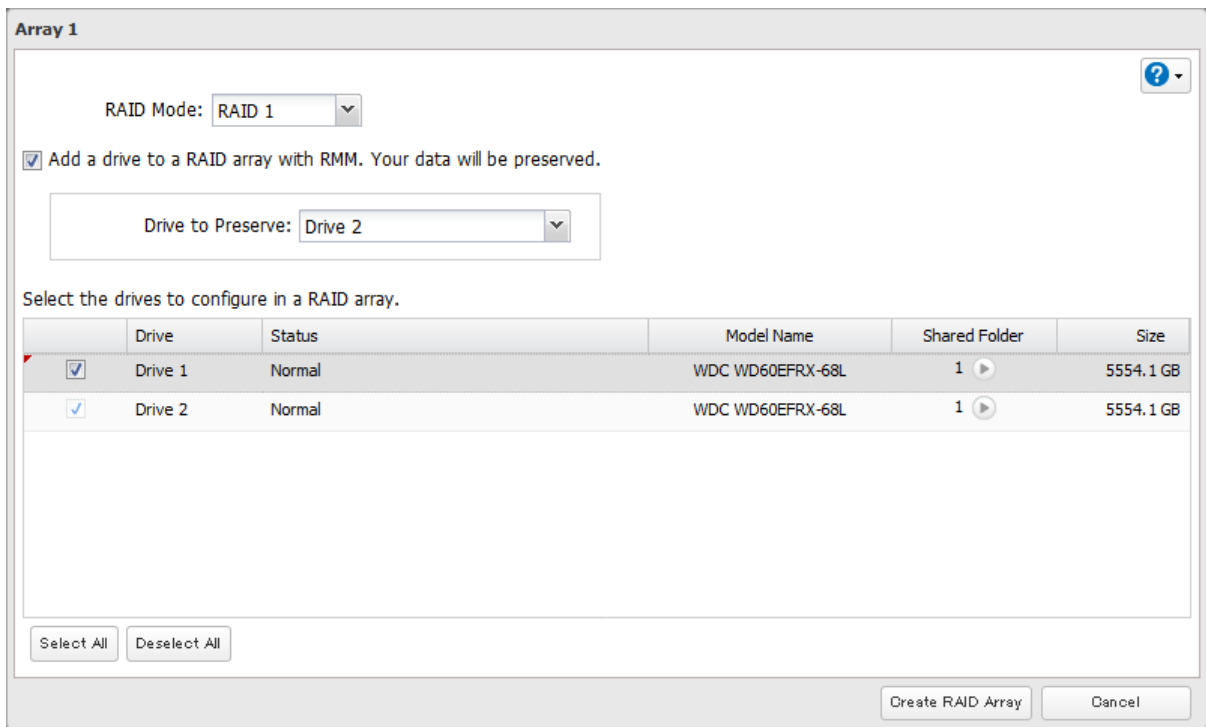

**5** Select the "Add a drive to a RAID array with RMM. Your data will be preserved." checkbox.

**6** Select the drive whose data will be saved from the drop-down list.

**7** Select the drive to add to the RAID array.

**8** Click *Create RAID Array*.

**9** The "Confirm Operation" screen will open. Enter the confirmation number, then click *OK*.

**10** Click *OK* when finished.

## RAID Scanning

A RAID scan checks your RAID array for bad sectors and if it finds any, it automatically repairs them. A RAID scan can only be run on a RAID 1 array. For best results, run a RAID scan regularly.

**1** From Settings, click *Storage*.



**2** Move the RAID scanning switch (  ) to the  position to enable RAID scanning.



**3** Click the settings icon (  ) to the right of "RAID Scanning".



**4** Click *Edit*.

**5** Select when to run the scan and click *OK*.

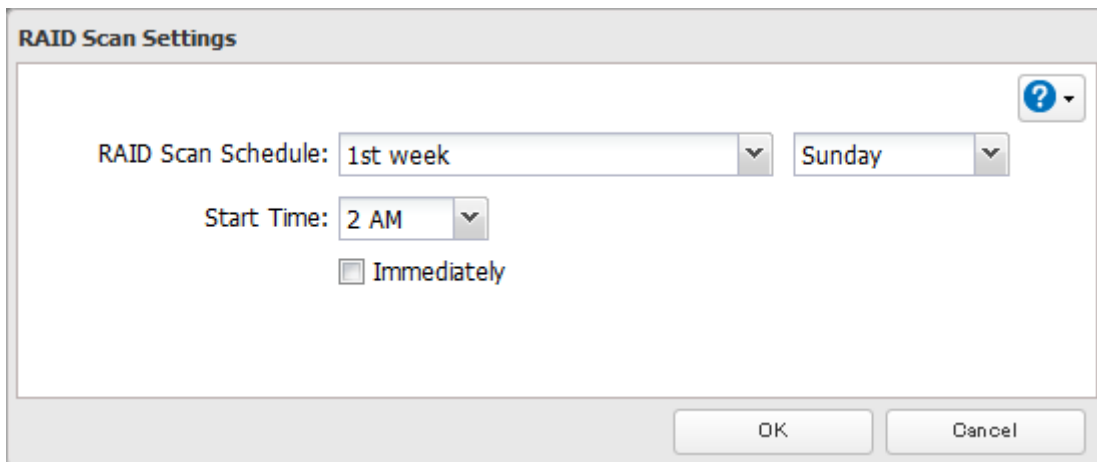

### Notes:

- Select the "Immediately" checkbox to run a RAID scan immediately.
- To stop a RAID scan, click *Cancel RAID Scan*.

## Adding an External Drive

### Connecting an External Drive

Your LinkStation features multiple USB ports, and you can connect an external drive to any of these ports. Once connected, it appears as a shared folder on the LinkStation. A formatted drive is detected automatically. Unformatted drives should be formatted in Settings.

After a USB drive is recognized, the LinkStation adds “usbdisk x” to the shared folder list, where “x” is the USB port to which the drive is connected.

## Compatibility

Supported file systems for external USB drives are below:

File Systems	Recommended Situation
XFS <sup>*4</sup>	Connecting to another Buffalo NAS device.
Ext3 <sup>*1</sup>	Connecting to another Buffalo NAS device. XFS is recommended because the more files stored in one folder, the slower the performance. The available capacity will be less than the area formatted to XFS.
NTFS <sup>*2</sup>	Connecting to Windows computers. The NTFS-formatted drive can use many more functions of the operating system than an exFAT drive.
HFS Plus <sup>*2, *3</sup>	Connecting to macOS computers. The HFS Plus-formatted drive can use many more functions of the operating system than an exFAT drive.
exFAT <sup>*1</sup>	Connecting to both Windows and macOS computers.
FAT32	Connecting to both Windows and macOS computers.

\*1 The available USB drive size is up to 16 TB.

\*2 This cannot be formatted from Settings.

\*3 This is read-only from the LinkStation. Files on the USB drive can be copied to the LinkStation.

\*4 To format using XFS on this LinkStation, the LinkStation should be updated to firmware version 1.02 or later. If the LinkStation is running a firmware version earlier than 1.02, the XFS-formatted USB drive cannot be shared with another Buffalo NAS device other than the following LinkStation models: LS710D, LS720D, and LS720DB.

Make sure only one device is connected to a USB port on the LinkStation. Note that only the first partition of a connected USB drive is mounted. Additional partitions are not recognized.

### Notes:

- When copying a file that is over 100 MB to a FAT32-formatted USB drive using File Explorer, an error message may appear. In such a case, use an FTP connection to copy the file.
- When copying files from a shared folder to a FAT32-formatted USB drive, the progress bar may not be displayed or the file copying may fail. Using a file system other than FAT32 is recommended for the USB drive.
- After connecting an RDX drive to the LinkStation, click *Redetect Drive* anytime.

## Dismounting Drives

If the LinkStation is powered on, dismount a USB drive before unplugging it. You may dismount external drives using the function button or from Settings. If the LinkStation is off, then a USB drive is already dismounted and may be unplugged safely.

**Note:** To dismount an RDX cartridge from an RDX dock, first perform the dismount process either using the function button or from Settings, then press the eject button on the dock to disconnect the cartridge.

## Using the Function Button

When you press the function button, the LinkStation will beep once. Press and hold down the button until the LinkStation beeps again and the function LED starts blinking white. When the LED stops blinking and returns to glowing, the dismount is finished. You may now unplug any USB drives safely.

## Using Settings

You can dismount a USB drive from a computer or a mobile device. Follow the appropriate procedure below to dismount a USB drive.

## Using a Computer

- 1 From Settings, click *Storage*.



- 2 Click the settings icon (⚙️) to the right of "USB Drives".



- 3 Select the drive to dismount and click *Dismount Drive*.

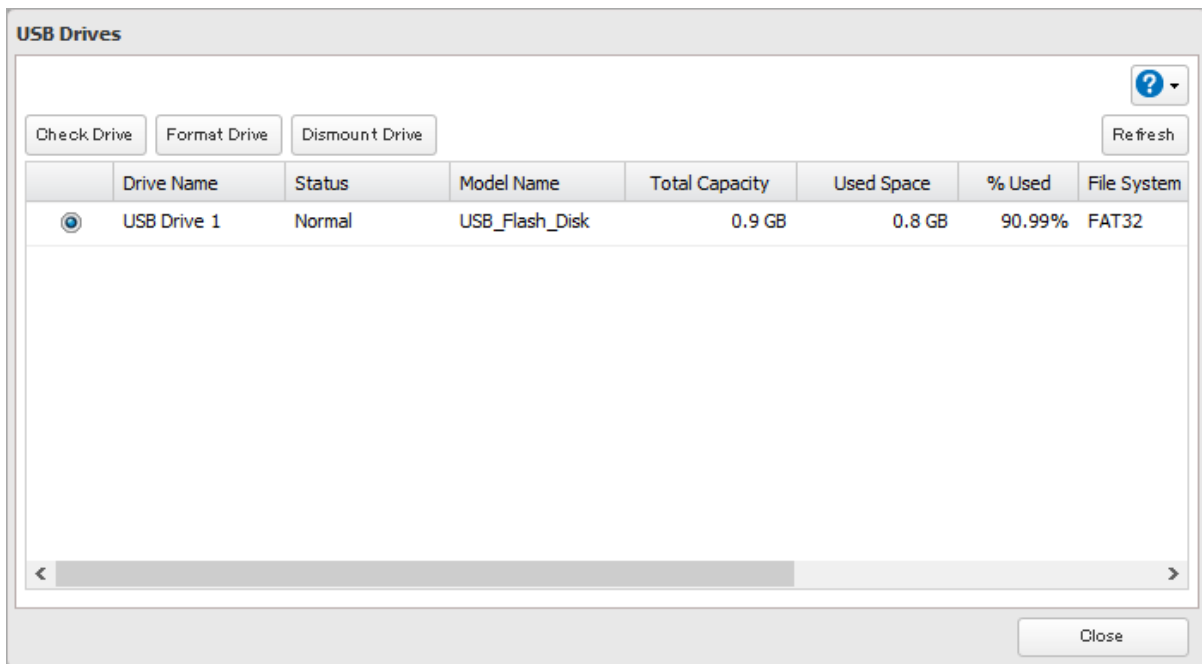

- 4 The "Confirm Operation" screen will open. Enter the confirmation number, then click *OK*.

- 5 When the dismounting process is finished, it is safe to unplug the drive. Disconnect the drive from the LinkStation.

## Using a Mobile Device

- 1 From Settings, tap *Direct Copy*.

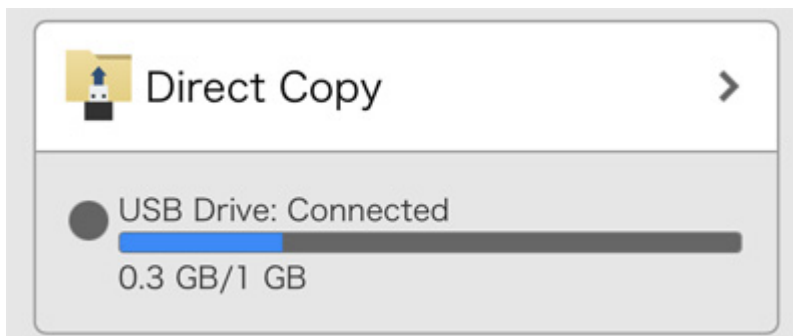

**2** Tap *Dismount*.



**3** When the dismounting process is finished, it is safe to unplug the drive. Disconnect the drive from the LinkStation.

**Note:** To remount the drive, unplug it and then plug it back in.

---

## Checking Drives

---

A drive check tests the data on a drive on the LinkStation or one that is connected via USB for integrity. Detected errors are fixed automatically. With large drives, a drive check may run for many hours. Shared folders cannot be accessed during a drive check. Do not turn off the LinkStation until the drive check is finished. Follow the procedure below to run a drive check.

**1** From Settings, click *Storage*.



- 2 Click the settings icon (  ) to the right of “Drives” to check an internal drive or “USB Drives” to check an external drive.

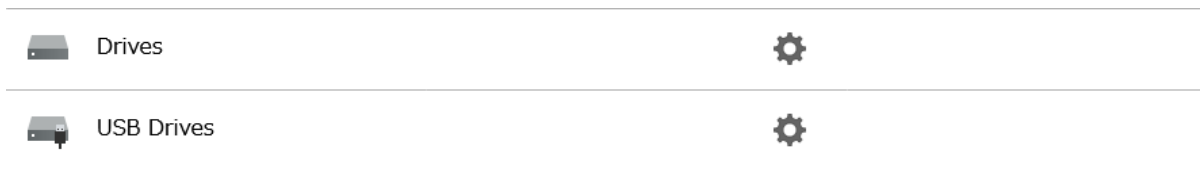

- 3 Select the drive or array to test, then click *Check Drive*.

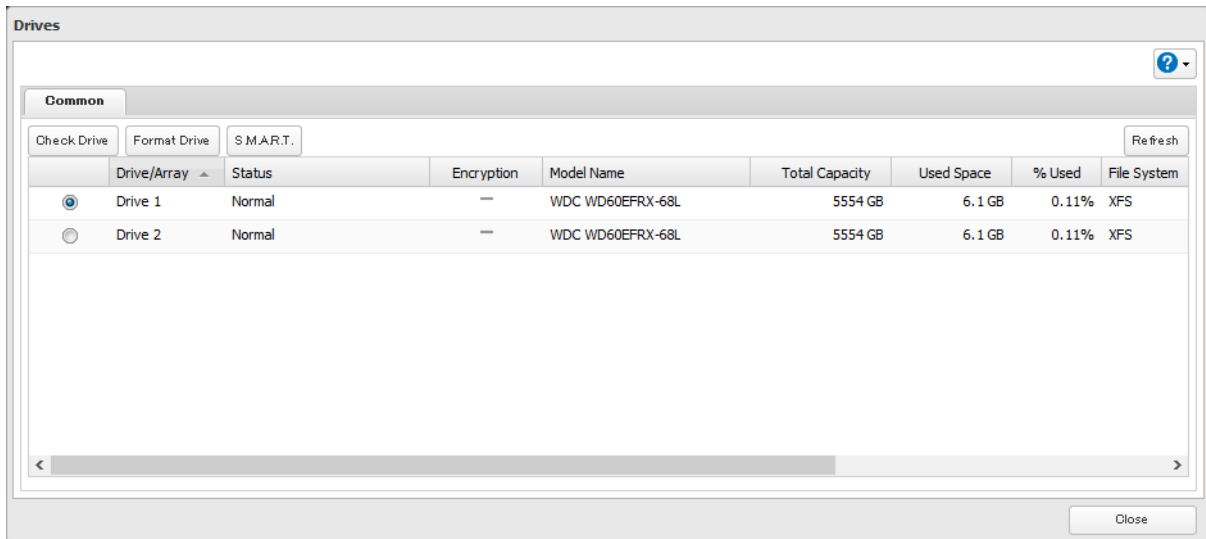

- 4 Click *Check*. You have the option of deleting information files from macOS during the check if desired.

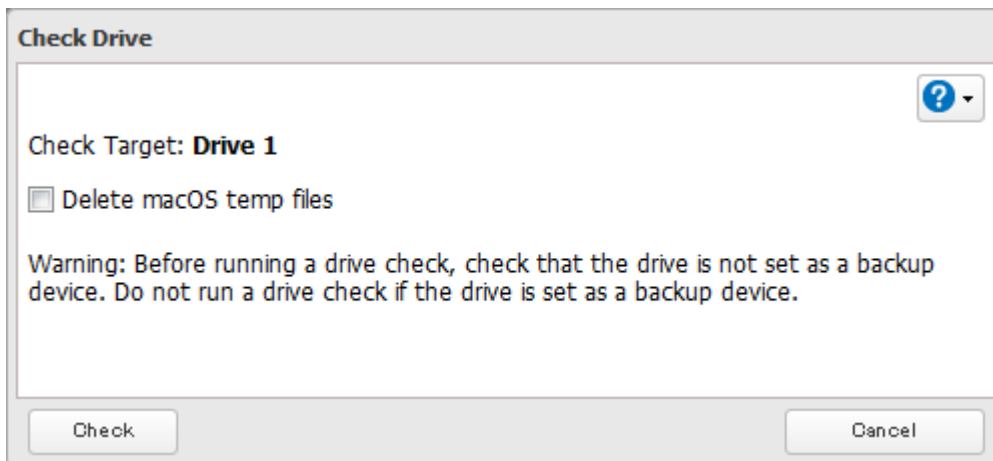

- 5 Either the I14 message for RAID arrays, the I21 message for drives, or the I27 message for USB drives will appear on the Dashboard in Settings and NAS Navigator2 until the checking process is finished. Click *OK* when finished.

## S.M.A.R.T.

S.M.A.R.T. (Self-Monitoring, Analysis, and Reporting Technology) monitors internal drives to detect and report various indicators of reliability, in the hope of anticipating failures. If S.M.A.R.T. informs you of impending drive failure, you may choose to replace the drive to avoid outages and possible data loss. Follow the procedure below to check S.M.A.R.T. information for the LinkStation's internal drives.



**Note:** S.M.A.R.T. information is only available for internal drives.

## Displaying S.M.A.R.T. Information

**1** From Settings, click *Storage*.



**2** Click the settings icon (  ) to the right of "Drives".

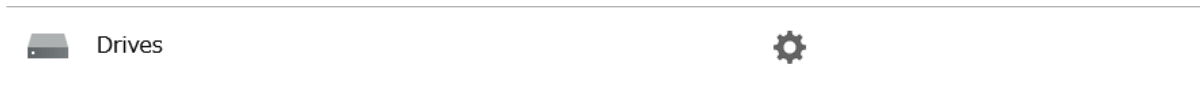

**3** Select a drive to check and click *S.M.A.R.T.*

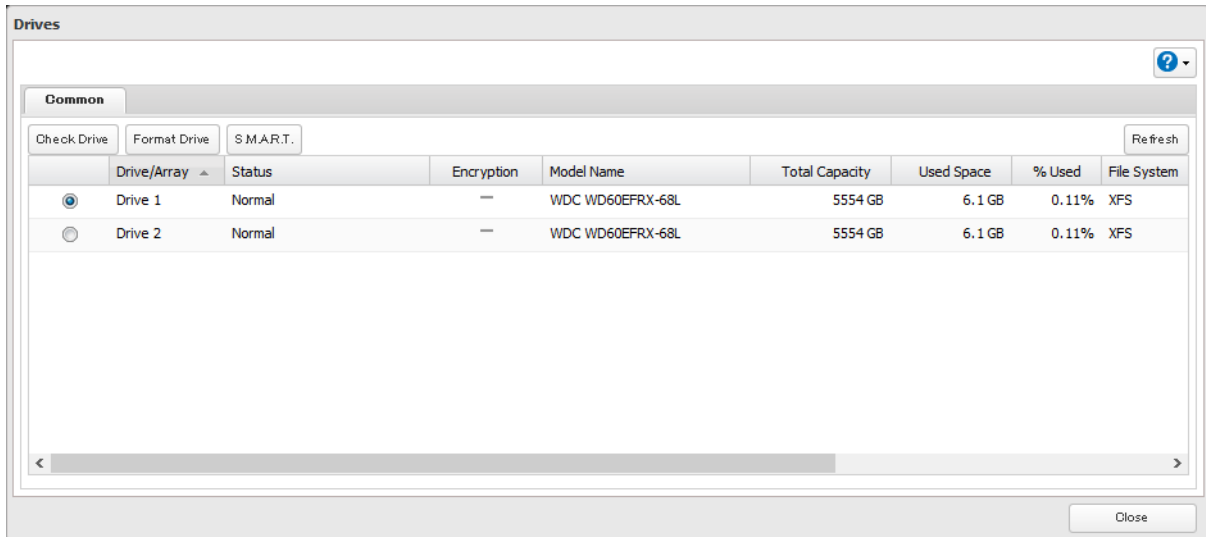

- 4** The S.M.A.R.T. information for the drive will be displayed. Different information may be displayed depending on the brand of drives on your LinkStation. Critical attributes are displayed in bold.

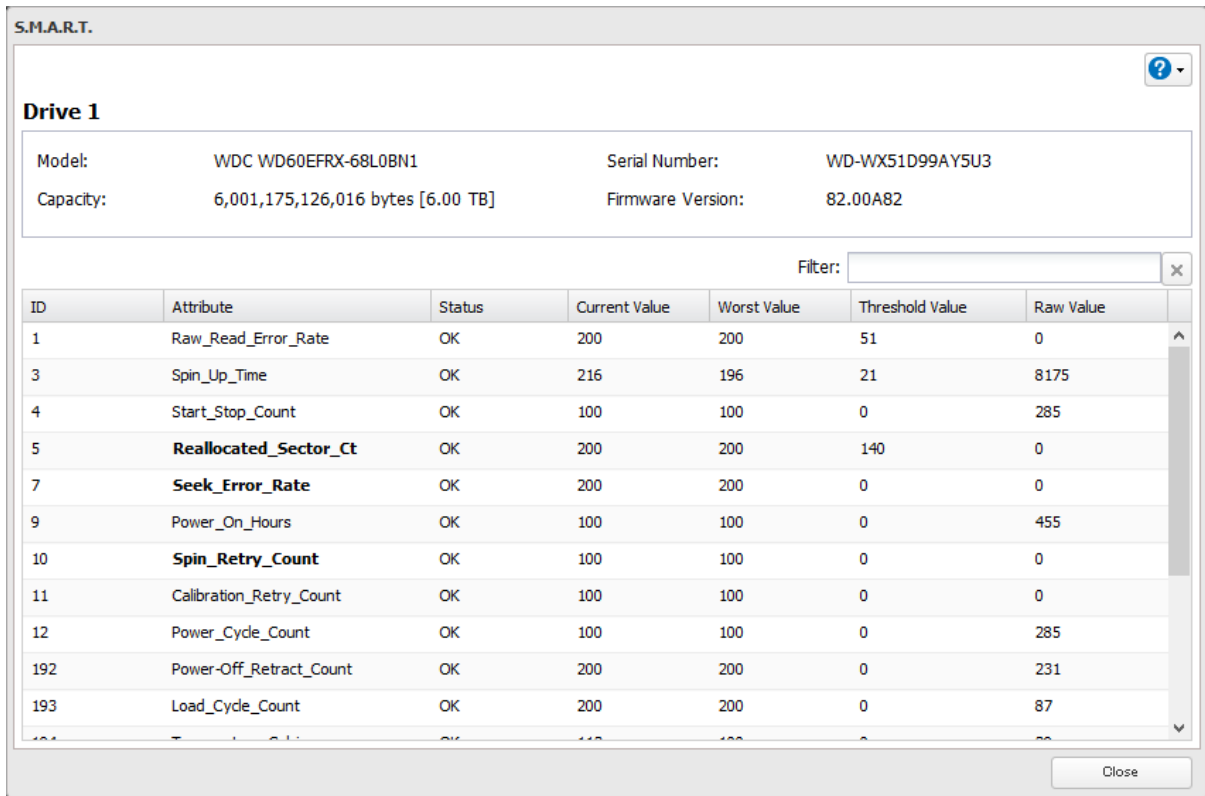

**S.M.A.R.T.**

**Drive 1**

Model: WDC WD60EFRX-68L0BN1      Serial Number: WD-WX51D99AY5U3  
 Capacity: 6,001,175,126,016 bytes [6.00 TB]      Firmware Version: 82.00A82

Filter:

ID	Attribute	Status	Current Value	Worst Value	Threshold Value	Raw Value
1	Raw_Read_Error_Rate	OK	200	200	51	0
3	Spin_Up_Time	OK	216	196	21	8175
4	Start_Stop_Count	OK	100	100	0	285
5	<b>Reallocated_Sector_Ct</b>	OK	200	200	140	0
7	<b>Seek_Error_Rate</b>	OK	200	200	0	0
9	Power_On_Hours	OK	100	100	0	455
10	<b>Spin_Retry_Count</b>	OK	100	100	0	0
11	Calibration_Retry_Count	OK	100	100	0	0
12	Power_Cycle_Count	OK	100	100	0	285
192	Power-Off_Retract_Count	OK	200	200	0	231
193	Load_Cycle_Count	OK	200	200	0	87

Close

## Checking the Drive Condition

Attributes with the worst value that is equal to or less than the threshold value may be significant. If an attribute reports a failure, or has had one in the past, it will be displayed in the status column. In such a case, replacing that drive is recommended.

## Formatting Drives

### Notes:

- Under some circumstances, data deleted when a drive is formatted can be recovered. To ensure that data is “gone forever”, a format might not be sufficient. Refer to the [“Erasing Data on the LinkStation Completely”](#) section below for more information.
- After a drive is formatted, the “% Used” and “Amount Used” in Settings will not be 0. This is because some drive space is used for the system area.

- 1** From Settings, click *Storage*.



- 2** Click the settings icon (  ) to the right of “Drives” to format an internal drive or “USB Drives” to format an external drive.



- 3** Select the drive or array to format, then click *Format Drive*.

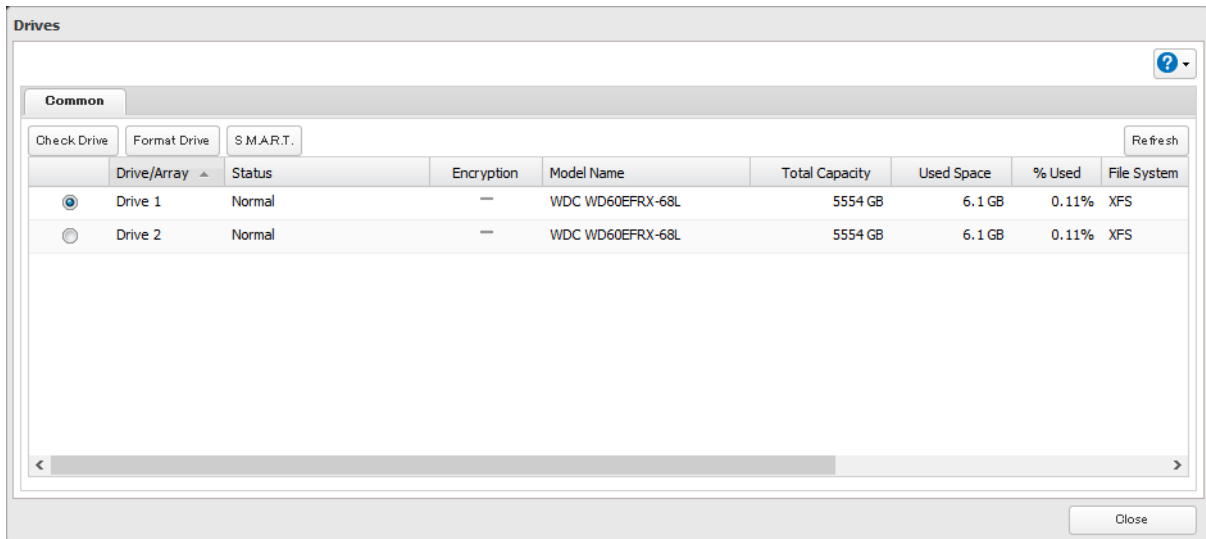

- 4** Select a format type, then click *Format*.

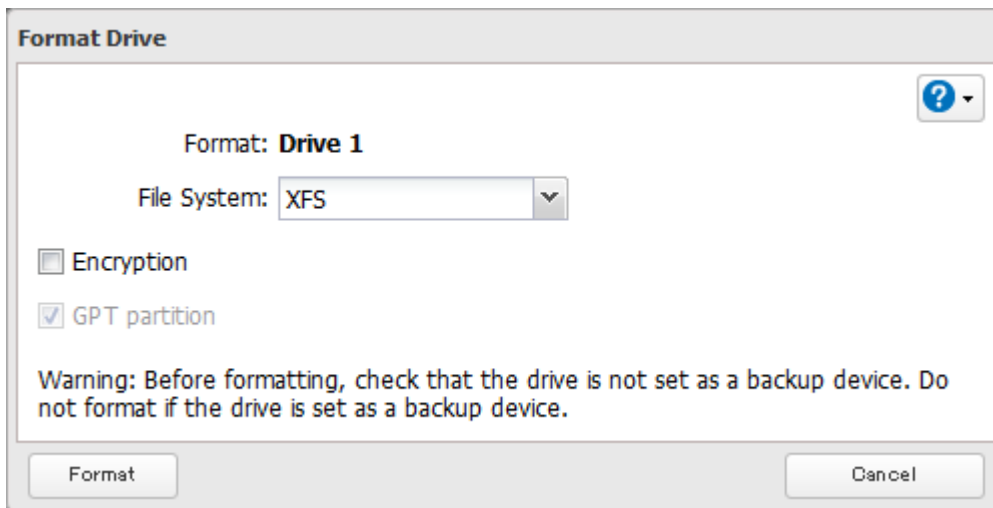

- 5** The “Confirm Operation” screen will open. Enter the confirmation number, then click *OK*.
- 6** Depending on the size and the formatted file system of your drive, the format may take several minutes or several hours to complete. Either the I13 message for RAID arrays, the I20 message for drives, or the I28 message for USB drives will appear on the Dashboard in Settings and NAS Navigator2 until the formatting process is finished. Click *OK* when finished.

**Notes:**

- Do not turn off or disconnect power to the LinkStation while formatting a drive.

- For drives that are 2.2 TB or larger, make sure that the “GPT partition” checkbox is selected.

## Encrypting Drives

Internal drives (and arrays) can be encrypted with 256-bit AES during formatting. Encrypted drives and arrays are then readable only from that specific LinkStation. To decrypt a drive or array, clear the “Encryption” checkbox and format it again.

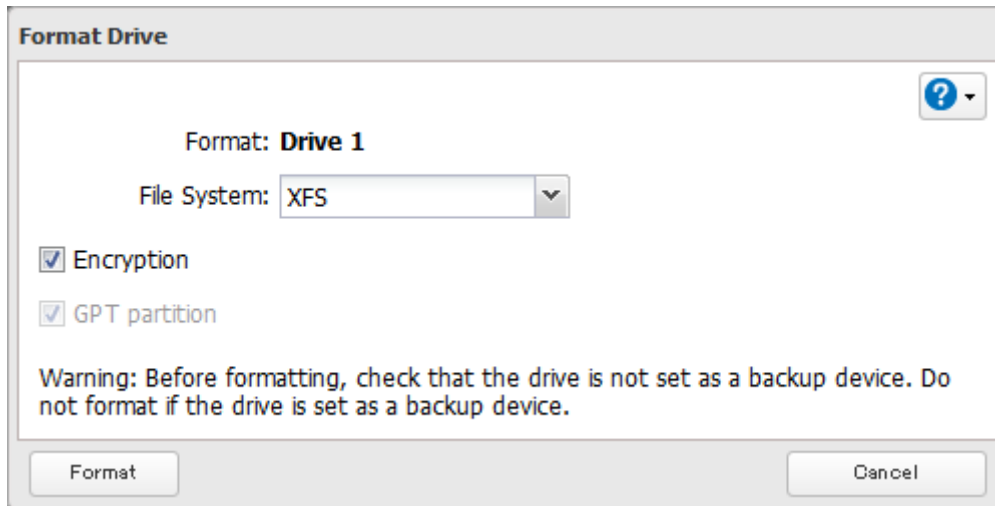

## Erasing Data on the LinkStation Completely

Under some circumstances, data from formatted drives can be recovered. The drive erasure process in this section does a much more thorough job of erasing data. This procedure is recommended for removing all data from a drive in a way that makes it nearly impossible to recover with current tools. The LinkStation will then be in the following state:

- Both drives in JBOD
- An empty shared folder on each drive
- All settings returned to their default values
- All logs deleted

Follow the procedure below to completely and permanently erase all data from your LinkStation.

- 1 From Settings, click *Management*.

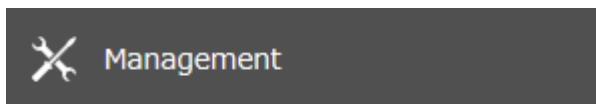

- 2 Click the settings icon (  ) to the right of “Restore/Erase”.

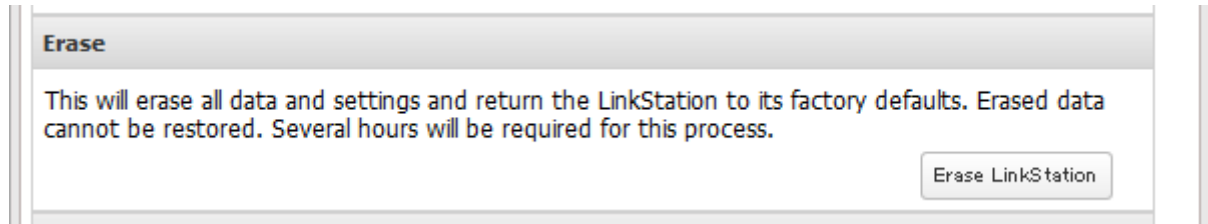

**3** Click *Erase LinkStation*.**4** The “Confirm Operation” screen will open. Enter the confirmation number, then click *OK*.**5** The complete format process will begin. After the complete format is finished, the LinkStation will shut down automatically. To power on the LinkStation, move the power switch to the “Off” position, then back to the “On” position.

---

## Quotas

---

You can set a quota for each user or group as well as a threshold alert where you will receive an email notification if the space used exceeds the configured threshold. To configure email notifications for the quota, refer to the [“Email Notification”](#) section in chapter 9.



**Notes:**

- When using quotas, disable the recycle bin or empty the trash folder often. The limited space includes the space used for trash.
- Quotas apply per drive or per array. If a quota is set to 1 GB, each array or drive can use a maximum of 1 GB.
- Quotas cannot be set for external drives connected to the LinkStation.
- If both user and group quotas are configured for a user and the group quota size is smaller than the user quota size, an error may occur if the space used exceeds the threshold for the group quota. The group quota size should be larger than the user quota size.
- When joined to a domain, only local users and groups will be able to set quotas. Domain users and groups will be able to configure access restrictions for shares but cannot set quotas.

## Quotas for Users

---

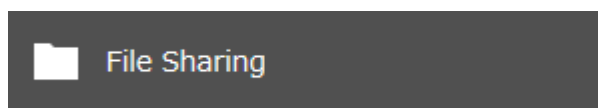
Follow this procedure to limit the shared folder space available for a user.

**1** From Settings, click *File Sharing*.**2** Click the settings icon (  ) to the right of “Users”.**3** Select the user that will be given a quota and click *Edit*. If you want to set a quota for a new user, create a user by referring to the [“Adding a User”](#) section in chapter 2.

- 4 Enable quotas, choose the alert and the maximum amount of space the user will be allowed to use, and click *OK*.

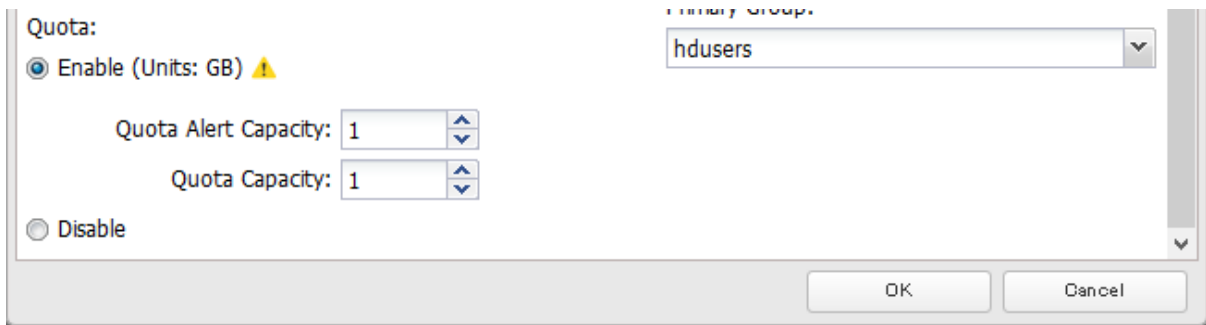

- 5 Click  at the top-right of Settings and choose *Restart*.

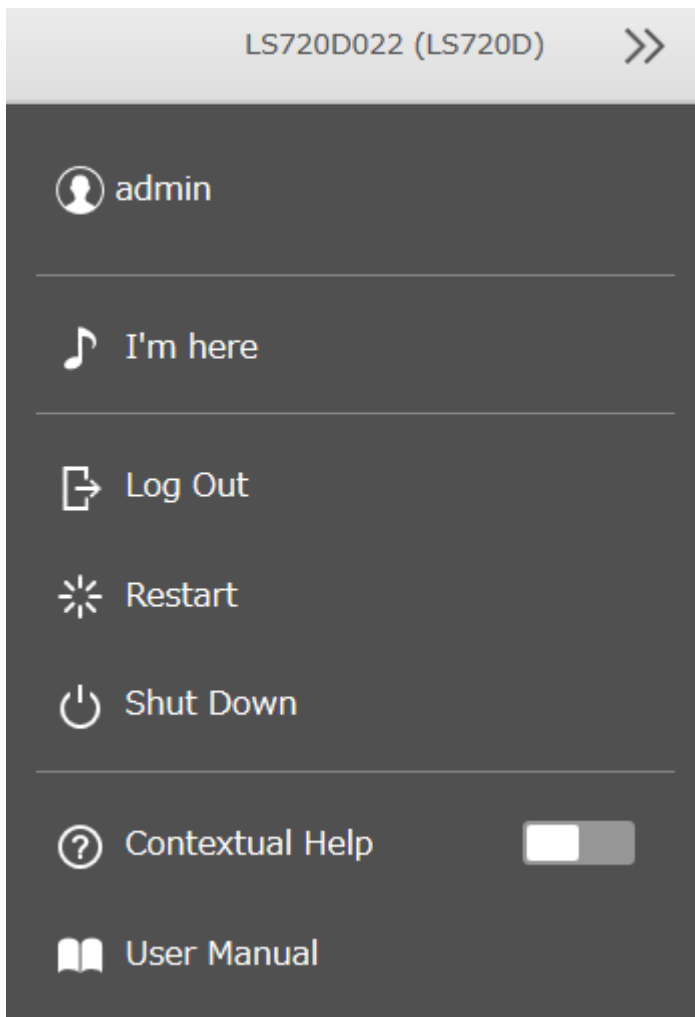

## Quotas for Groups

---

Follow the procedure below to limit the space for shared folders that each group can use.

- 1 From Settings, click *File Sharing*.

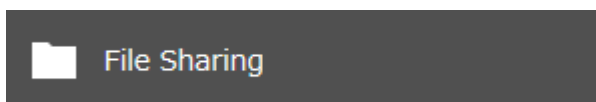

**2** Click the settings icon (  ) to the right of “Groups”.



**3** Select the group that will be given a quota and click *Edit*. If you want to set a quota for a new group, create a group by referring to the [“Adding a Group”](#) section in chapter 2.

**4** Enable quotas, choose the alert and the maximum amount of space the group will be allowed to use, and click *OK*.



**5** Click *Close*.

**6** Click the settings icon (  ) to the right of “Users”.



**7** Select the user that will inherit the group quota settings and click *Edit*. If you want to add a new user to a group with a quota, create a user by referring to the [“Adding a User”](#) section in chapter 2.

**8** Select the group’s checkbox to join and change the user’s primary group to the group with the quota, then click *OK*.

**9** Click *Close*.

**10** Click  at the top-right of Settings and choose *Restart*.

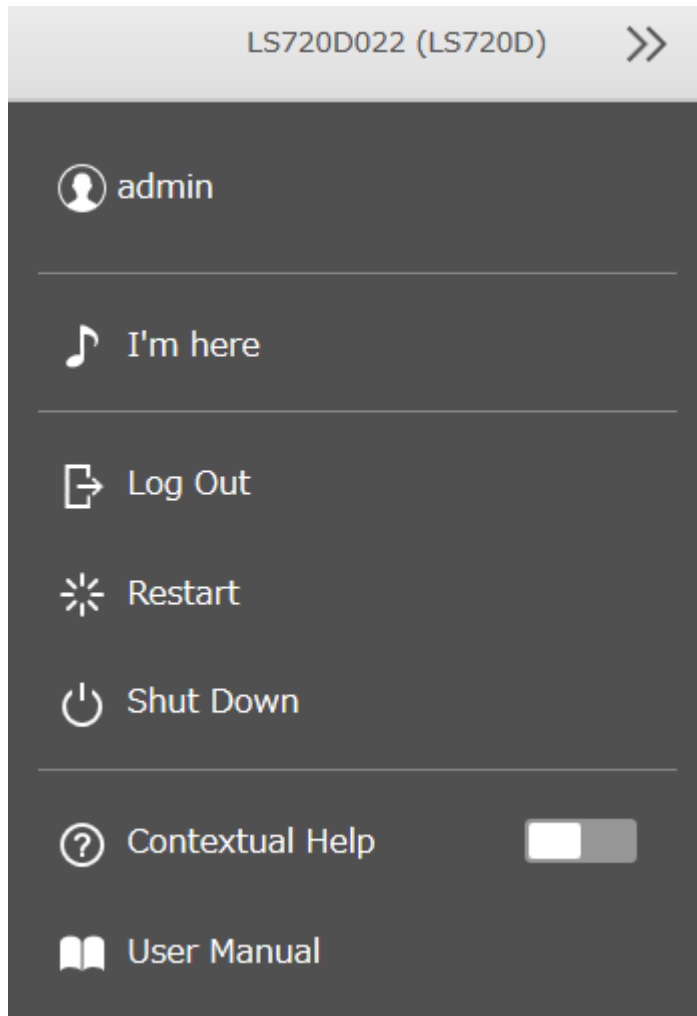

## Size Limits

If LVM is enabled, volumes can be created with maximum size limits.

### Notes:

- When creating an LVM volume, all data in the area you specified for the LVM volume will be erased. Before changing any settings, back up any important data.
- Do not use any of the following words for the name of a volume as these words are reserved for internal use by the LinkStation: array *x*, authtest, disk *x*, global, homes, info, lost+found, lp, mediacartridge *x*, msdfs\_root, mt-daapd, printers, ram, spool, usbdisk *x*. Any instances of “*x*” denote a number (for example: array1 or disk3)

**1** From Settings, click *Storage*.



**2** Click the settings icon (  ) to the right of “LVM”.





**3** Select the drive or array where the volume will be located and click *Enable LVM*.

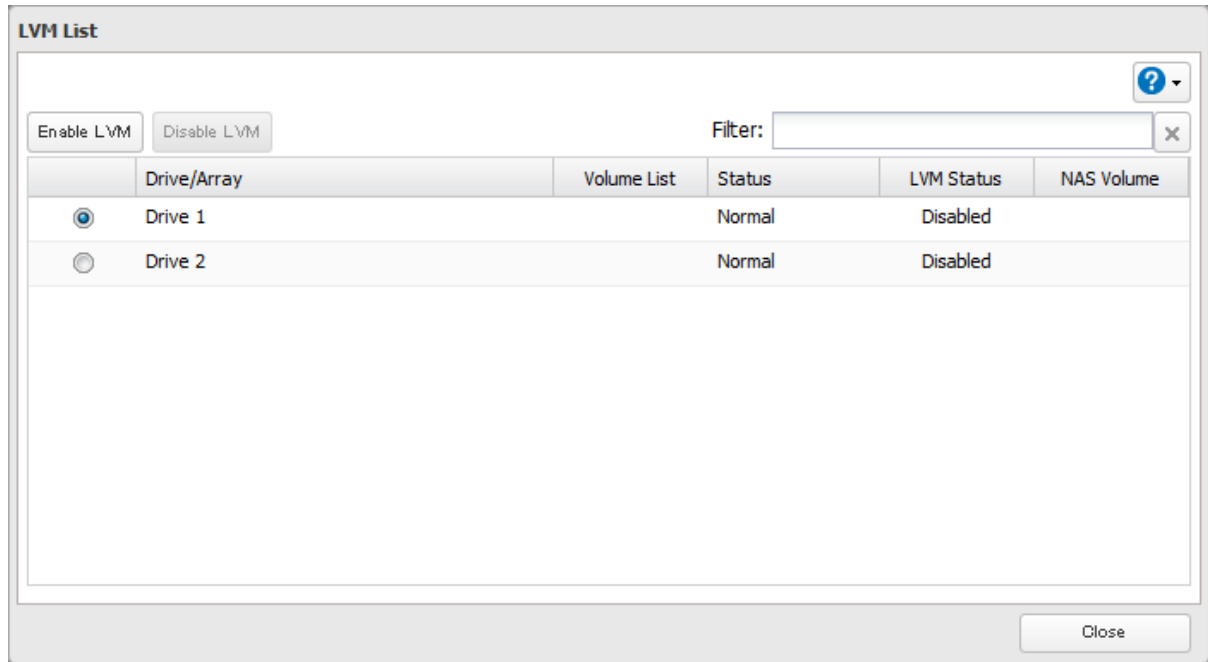

**4** The “Confirm Operation” screen will open. Enter the confirmation number, then click *OK*.

**5** Click *OK*.

**6** Click *Edit* under “NAS Volume”.

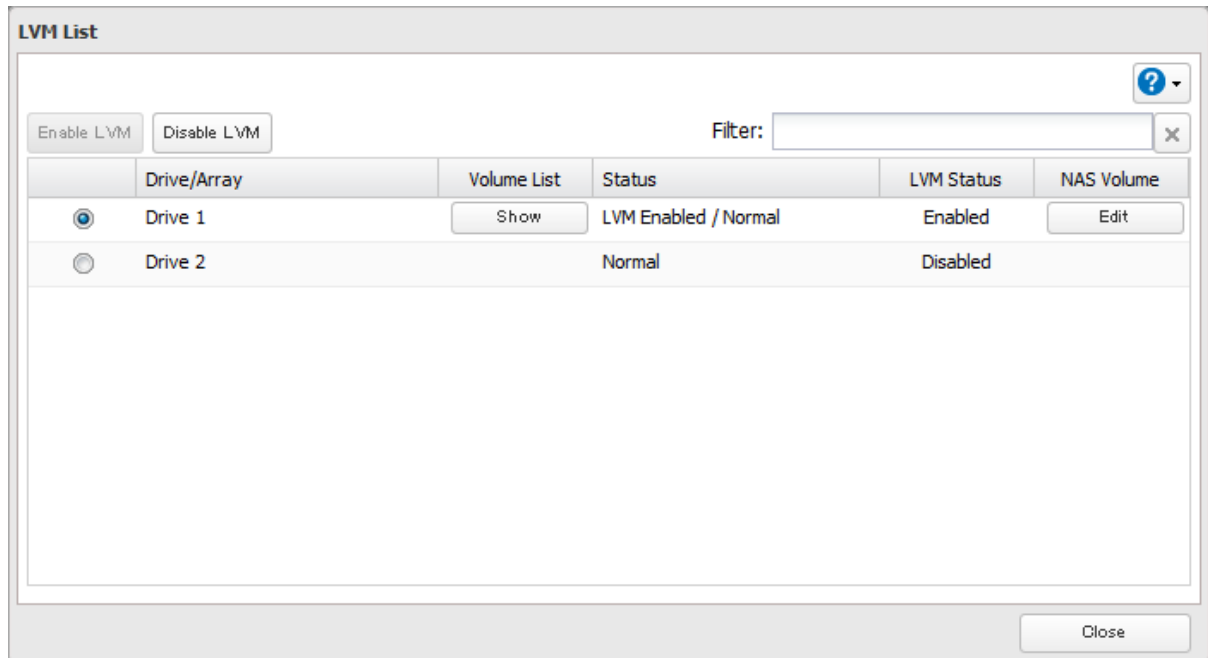

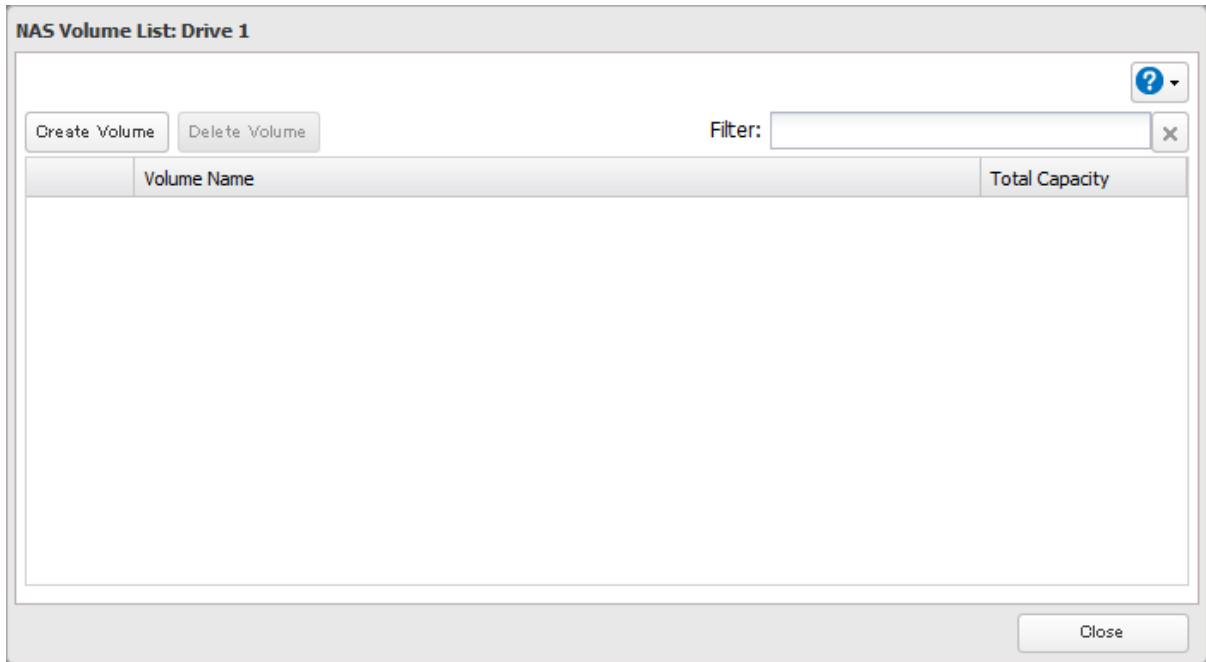
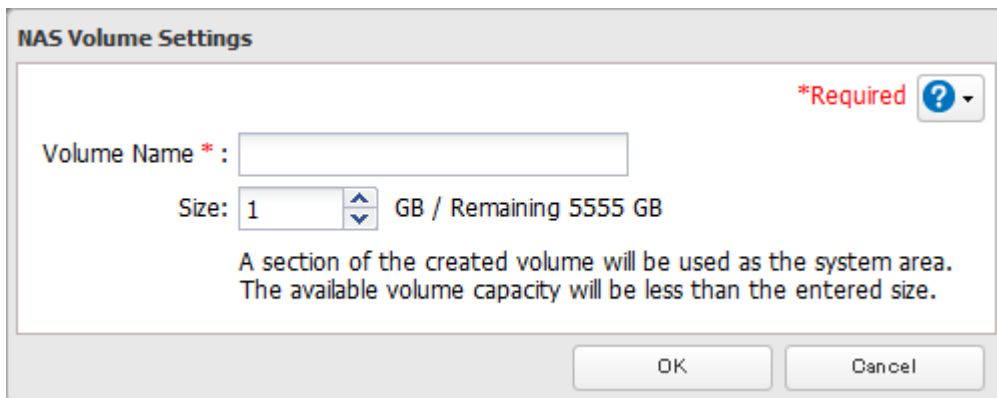
**7** Click *Create Volume*.**8** Configure the desired settings, then click *OK*.**9** Click *OK*.**10** Click *Close*, then click *Close* again.**11** Navigate to *File Sharing > Folder Setup*.**12** Click *Create Folder*.**13** Configure the settings.**14** Select the volume that you created for "Drive/Array" on the *Basic* tab and click *OK*.**Notes:**

- If you click *Show* under "Volume List", the volumes will be listed on the screen and you can see if these volumes are being used as NAS.

- If an LVM volume could not be mounted, try restarting the LinkStation. If an issue still exists, delete the LVM volume and recreate it. Deleting the LVM volume will erase all data on the volume.

# Chapter 4 Backup

---

## Backing Up Data on the LinkStation

---

You can back up the LinkStation folders to another shared folder on the same LinkStation, a connected USB drive, or a shared folder on another Buffalo NAS device, either on the same network or on another network.

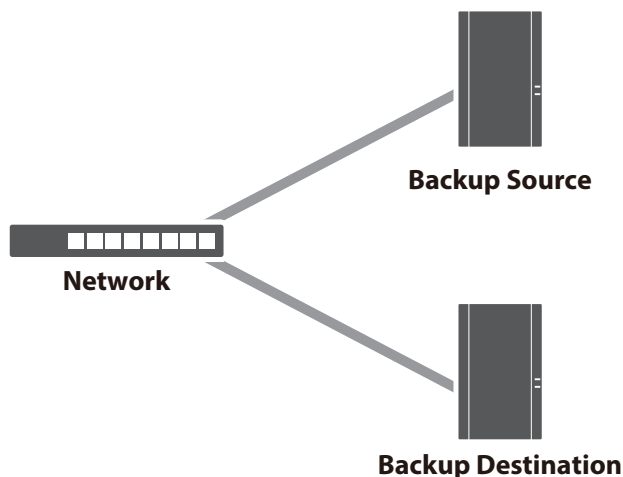

---

## Backup Modes

The following types of backup are available from this LinkStation. To restore data from backup, refer to the [“Restoring Backup Data”](#) section below.

### Full Backup

All files in the source will be backed up to the destination. You can specify how many backup versions to keep from 1–400, or select “Unlimited” to keep all backups until the drive is full. If you specify a number of backup versions, the backup destination folder should be on the same LinkStation or on an external USB drive attached to that LinkStation.

The backup data will be stored in the folder whose name will be the backup date and time.

- **Folders available as backup sources:**
  - Shared folder on the backup source LinkStation
  - USB drive connected to the backup source LinkStation\*
  - Shared folder on another Buffalo NAS device\*\*
- **Folders available as backup destinations:**
  - Shared folder on the backup source LinkStation\*\*
  - USB drive connected to the backup source LinkStation\*\*
  - Shared folder on another Buffalo NAS device\*\*

\*You can select up to the second level of folders. However, if the folder name of a second level folder contains symbols, that folder may not appear as the target folder.

\*\*The folder should have the “Backup” checkbox selected under “LAN Protocol Support” on the shared folder settings.

## Overwrite (Incremental)

The first backup job runs like a full backup. As each subsequent backup job runs, only files that have been changed since the last full backup will be backed up, but any files deleted from the backup source folder will also remain in the backup destination folder. The folder structure in the backup destination folder will be the same as the backup source folder.

- **Folders available as backup sources:**
  - Shared folder on the backup source LinkStation
  - USB drive connected to the backup source LinkStation\*
  - Shared folder on another Buffalo NAS device\*\*
- **Folders available as backup destinations:**
  - Shared folder on the backup source LinkStation\*\*
  - USB drive connected to the backup source LinkStation\*\*
  - Shared folder on another Buffalo NAS device\*\*

\*You can select up to the second level of folders. However, if the folder name of a second level folder contains symbols, that folder may not appear as the target folder.

\*\*The folder should have the “Backup” checkbox selected under “LAN Protocol Support” on the shared folder settings.

## Overwrite (Differential)

The first backup job runs like a full backup. As each subsequent backup job runs, only files that have been changed since the last full backup will be backed up, and any files deleted from the backup source folder will also be deleted from the backup destination folder. The backup destination folder will always remain the same size as the backup source folder, and the folder structure in the backup destination folder will be the same as the backup source folder.

- **Folders available as backup sources:**
  - Shared folder on the backup source LinkStation
  - USB drive connected to the backup source LinkStation\*
  - Shared folder on another Buffalo NAS device\*\*
- **Folders available as backup destinations:**
  - Shared folder on the backup source LinkStation\*\*
  - USB drive connected to the backup source LinkStation\*\*
  - Shared folder on another Buffalo NAS device\*\*

\*You can select up to the second level of folders. However, if the folder name of a second level folder contains symbols, that folder may not appear as the target folder.

\*\*The folder should have the “Backup” checkbox selected under “LAN Protocol Support” on the shared folder settings.

## Management Backup

Each time a backup is executed, management information is stored, and only files that have changed are backed up. Data is retrieved from the previous backup file for files that were not changed, which can help reduce the space used for backup and also for referencing status at a particular point in time (for data snapshot applications). You can specify how many backup versions to keep from 1–400, or select “Unlimited” to keep all backups until the drive is full. If using an external USB drive as the backup destination, do not use folders from drives formatted with FAT. The backup data will be stored in the folder whose name will be the backup date and time, and the destination folder will be set to read-only.

- **Folders available as backup sources:**
  - Shared folder on the backup source LinkStation
  - USB drive connected to the backup source LinkStation\*
  - Shared folder on another Buffalo NAS device\*\*
- **Folders available as backup destinations:**
  - Shared folder on the backup source LinkStation\*\*
  - USB drive connected to the backup source LinkStation\*\*,\*

\*You can select up to the second level of folders. However, if the folder name of a second level folder contains symbols, that folder may not appear as the target folder.

\*\*The folder should have the “Backup” checkbox selected under “LAN Protocol Support” on the shared folder settings.

\*\*\*The compatible file systems are ext3, XFS, and NTFS.

**Note:** For the destination folder, do not use a folder that has already been used as a target folder for another backup job. If you wish to use a folder that currently contains backup data as the destination folder for another backup job, format the folder first, or delete all data in the destination folder and change the folder attribute to read and write before configuring the folder as the destination folder.

## Preparing a Backup Destination

Configure a shared folder on a Buffalo NAS device or connected USB drive as a backup destination. The following procedure explains using another shared folder on the LinkStation as a backup destination. The procedure may vary depending on which Buffalo NAS device is selected as a destination. If using a USB drive as a backup destination, make sure its attribute is set to read and write. To change a read-only USB drive’s attribute to read and write, refer to the “[Read-Only Shares](#)” section in chapter 2.

If you would like to back up data from multiple backup sources, we recommend not using the same backup destination, as data in the backup destination may be overwritten by subsequent backup jobs. If you must back up data from multiple backup sources to the same backup destination, using management backup is recommended for precise version control.

- 1 From Settings, click *File Sharing*.

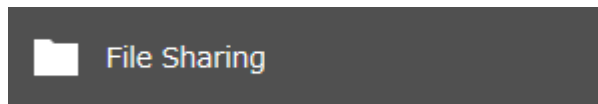

- 2 Click the settings icon (  ) to the right of “Folder Setup”.



- 3 Choose the folder to be set as a backup destination.

- 4 Under “LAN Protocol Support”, select the “Backup” checkbox on the *Basic* tab.

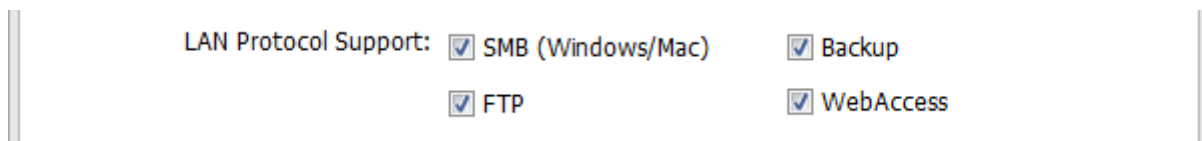

- 5 Click *OK* and proceed to the next step to create a backup device access key.

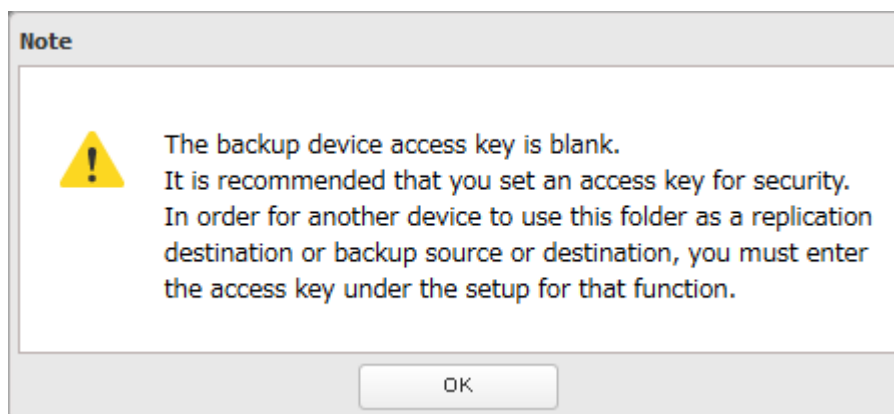

- 6** Enter the desired characters into the backup device access key field and click *OK*.

Backup Device Access Key:

**Note:** You may leave this field blank if you do not want a backup device access key, but for security reasons we highly recommend entering one for the shared folder. If a backup device access key is configured for the shared folder, that folder will not show up as a target for the backup source or destination when configuring a backup job on another Buffalo NAS device unless it's entered. You may create multiple folders using different backup device access keys for backup, but only one access key can be used on the LinkStation. Folders that are configured with a different access key cannot be used.

A backup destination has been created.

**Note:** If you want to back up to a Buffalo NAS device on another network, follow the procedure below to add the Buffalo NAS device so it can be used as a backup destination.

- (1) Create a new backup job by referring to the [“Configuring a Backup Job”](#) section below.
- (2) On the screen that allows you to select a shared folder, click *List of Servers*.
- (3) Click *Add*; enter the IP address or hostname of the destination Buffalo NAS device, then click *OK*.
- (4) Click *Close* when finished.
- (5) Click *Refresh* and make sure the desired Buffalo NAS device has been added to the list.

## Configuring a Backup Job

You can configure backup jobs by using another shared folder on the Buffalo NAS device or a USB drive connected to the LinkStation as a destination. You can also back up to a Buffalo NAS device on another network as long as the two networks are connected by a VPN or the route is configured properly.

- 1** From Settings, click *Backup*.



- 2** Click the settings icon (  ) to the right of “Backup”.



- 3 If you had configured a backup device access key for the backup source folder on another Buffalo NAS device or the backup destination folder, click *Set*. If you hadn't, skip to step 5.

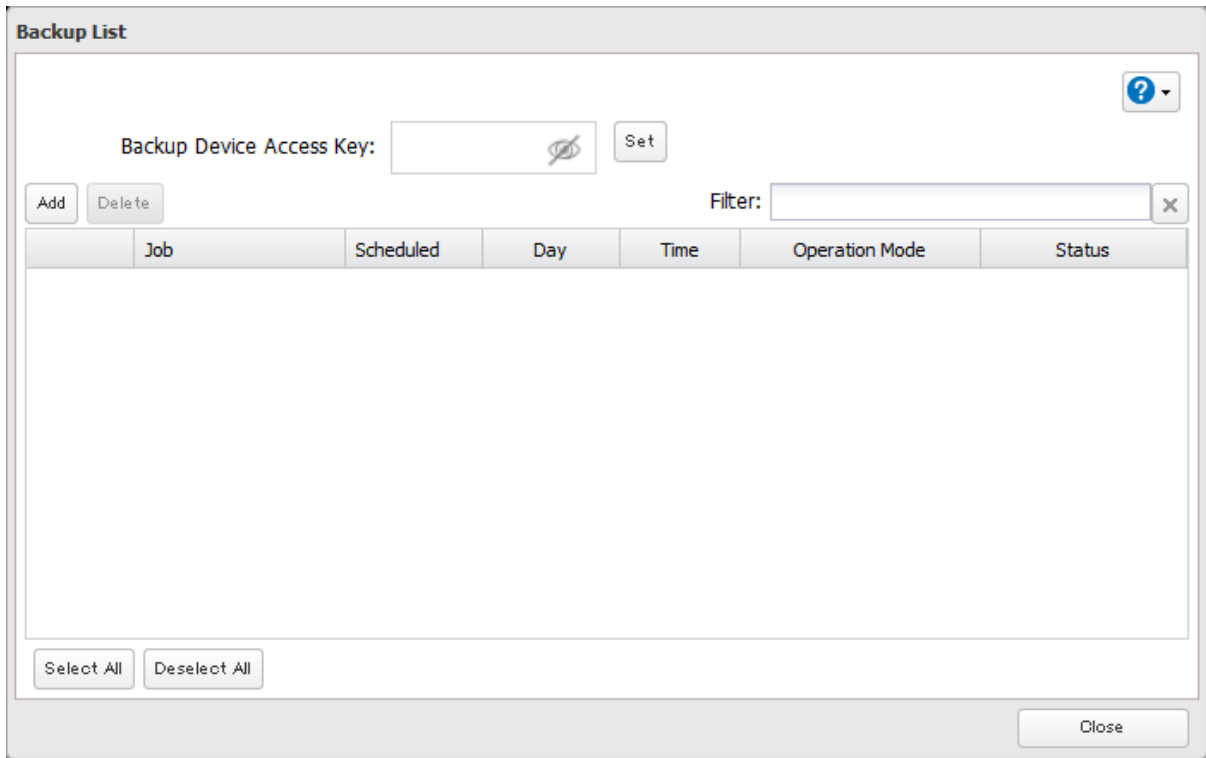

- 4 Enter the backup device access key and click *OK*.

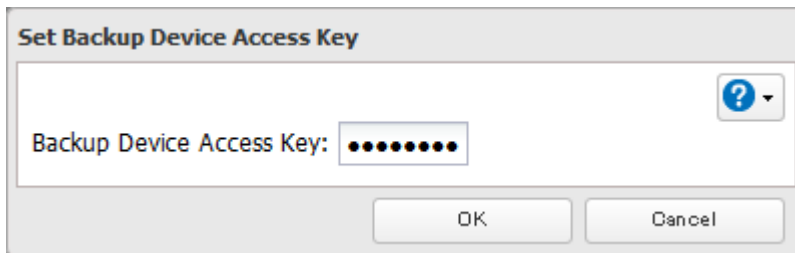



**5** Click *Add*.

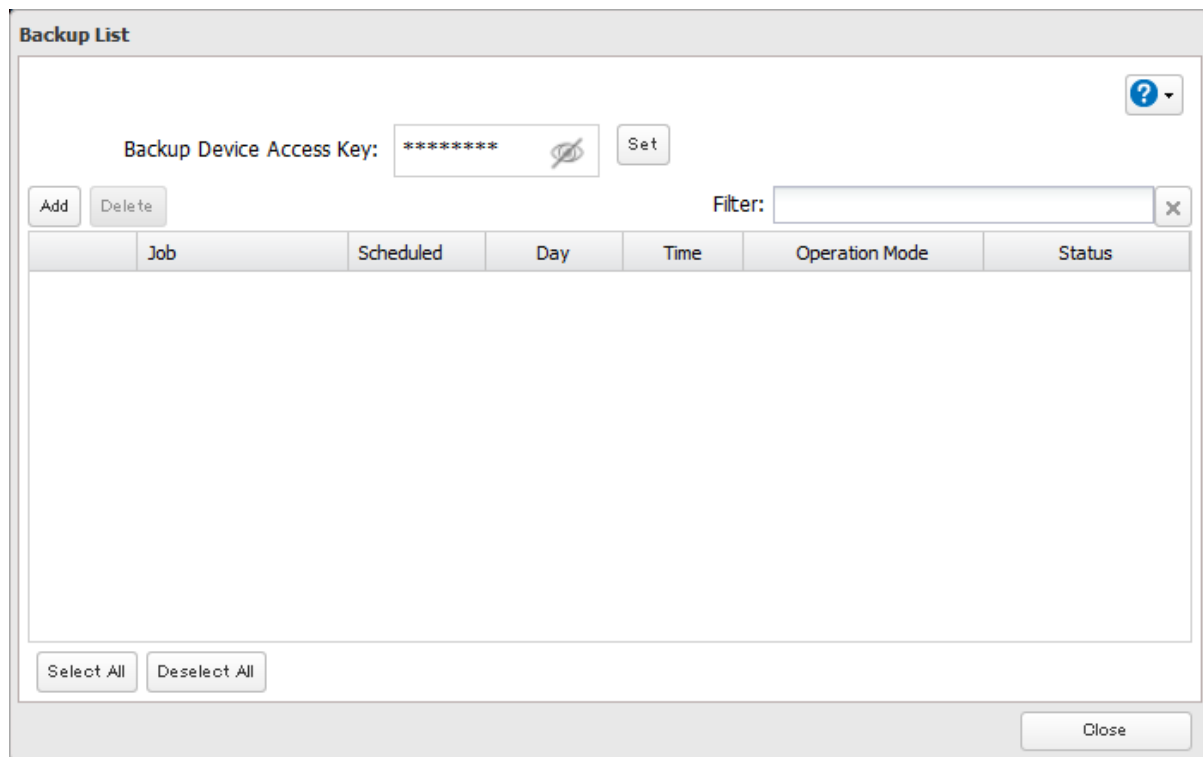

- 6** Select backup settings such as date and time to run, then select a backup mode for the “Operation Mode” drop-down list. Refer to the differences between the backup modes from the [“Backup Modes”](#) section above.

**Backup Job Settings**

\*Required ?

Name \* :

Schedule: Not scheduled Sunday 00 : 00

Operation Mode: Full backup

Versions: 10  Unlimited

Options

Create a subfolder for backup

Create backup log file

Save backup logs in the backup source folder

Select the folder to save backup logs

Backup Log Target Folder:

Encrypted data transfer

Compress and transfer

Ignore backup errors and continue backup job on schedule

Do not back up recycle bin

Overwrite unchanged files

Filter:

Backup Source Folder  Backup Destination Folder

- 7** Click *Add*.

**8** Select the shared folders that will be the backup source and destination.

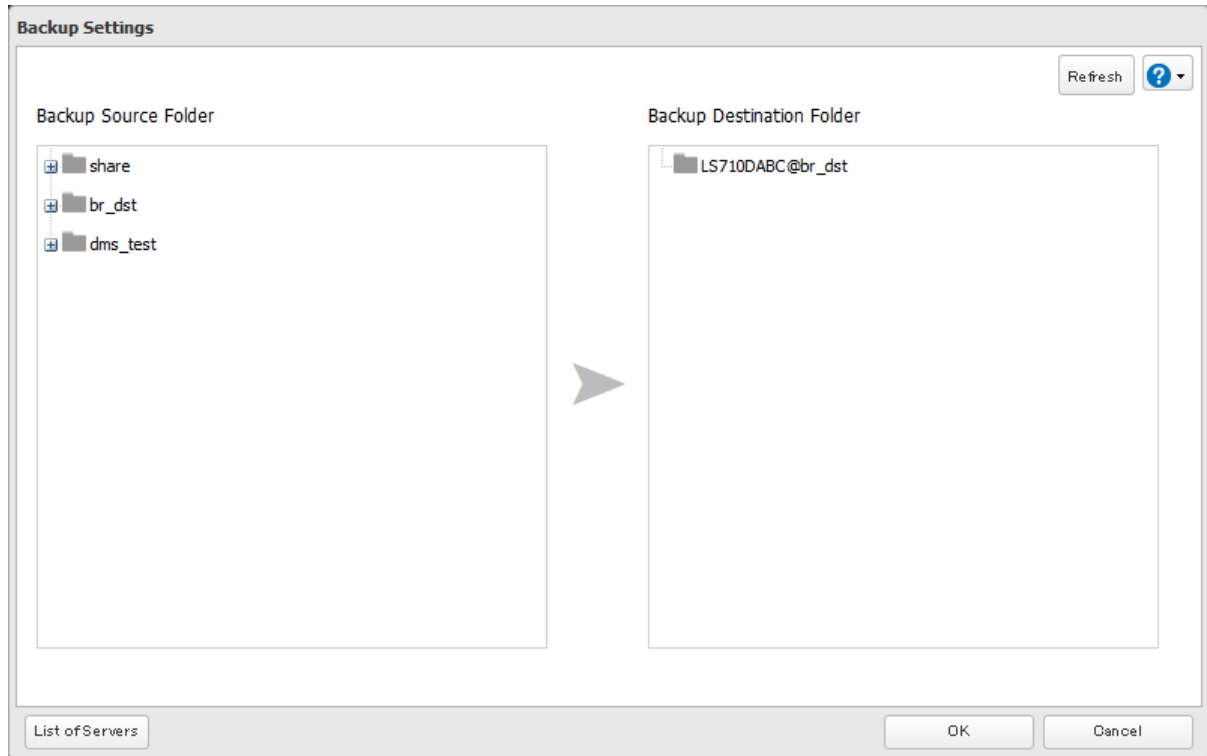

**9** Click *OK*, then click *OK* again. The backup job will be added to the backup jobs list.

#### Notes:

- Up to eight backup jobs can be configured at a time, and twenty-five backup source and destination folder pairs can be used in one backup job.
- During setup, you may choose to encrypt and/or compress backup data. Encrypted data will be transferred securely on the network. Compressed data will ease network loading and is recommended for slow or heavily-loaded network connections. Enabling either will increase the CPU load on the source LinkStation so that the transfer speed will become slower, and backup time will be slower than if they are disabled. Encrypted or compressed data will be decrypted or decompressed on the destination LinkStation.
- To back up data between Buffalo NAS devices on a network using jumbo frames, make sure that both devices are configured to use identical (or similar) MTU sizes. If MTU sizes are significantly different, the backup job may not be properly performed. In such a case, select the default MTU size (1,500 bytes) for both devices.
- You can also specify a hostname by a fully qualified domain name (FQDN).
- Windows-based TeraStations with multibyte characters in the hostname may not be detected as a backup destination, and folders in these devices cannot be used as backup destination folders.
- Backup data, such as ".DS\_Store" files, from macOS may include characters that cannot be read on FAT32-formatted drives in its filename. For best results, reformat the drive before using it as a backup destination.

## Restoring Backup Data

The procedure for restoring backup data varies depending on the backup mode. Refer to the following subsection corresponding to the backup mode you have used for backup. When restoring backup data, make sure you have enough available space on the LinkStation to accommodate the backup data, otherwise the restore process will fail.

### Full and Management Backups

Copy and paste the backed up files from the backup destination folder to a folder which you want to restore.

## Overwrite Backups (Incremental and Differential)

Files and folders have already been stored on the desired destination. You can access them by switching the operation to the backup destination LinkStation. Alternatively, you can restore any files or folders by creating a backup job and configuring the backup destination as a backup source and selecting the same backup mode for the “Operation Mode” drop-down list. Do not use the same folder as the backup destination to restore backup data from multiple backup sources, as this may cause the restored data to get overwritten.

## Backup Logs for If Backup Fails

If backup fails, the I54 message appears on the Dashboard in Settings and NAS Navigator2 and the following backup error codes may be displayed in the “Status” field. Read the description and try the respective corrective actions for each error to resolve it.

Code	Description	Corrective Action	Log Example
Code 3	The backup destination USB drive could not be found.	Check that the backup destination USB drive is connected to the LinkStation properly.	rsync error: errors selecting input/output files, dirs (code 3) at main.c(634) [Receiver=3.1.0]
			Can't write to backup destination(target disk is broken?).
Code 5	The backup destination shared folder could not be found.	Check that the Ethernet cable is securely connected and that the hub or other devices on the network are turned on.	rsync error: error starting client-server protocol (code 5) at main.c(1504)
Code 10	The Ethernet cable was disconnected from the backup source LinkStation when the backup job started.	Reconnect the Ethernet cable.	rsync error: error in socket IO (code 10) at clientserver.c(128) [sender=3.1.0pre1]
Code 11	The drive capacity of the backup destination LinkStation became full.	Delete unnecessary files and folders.	rsync error: error in file IO (code 11) at receiver.c(389) [receiver=3.1.0]
	Files larger than 4 GB were backed up to the FAT32-formatted USB drive.	Reduce the file size to 4 GB or less, or change the file system to one other than FAT32. Refer to the <a href="#">“Adding an External Drive”</a> section in chapter 3 for compatible file systems.	rsync: write failed on “filename”: File too large (27)
Code 12	Could not communicate between backup source and destination LinkStations.	Check that the Ethernet cable is securely connected and that the hub or other devices on the network are turned on.	rsync error: error in rsync protocol data stream (code 12) at io.c(515)
	The settings of the LinkStation were changed while the backup job was running.	Do not change the settings while the backup job is running. If changed, the connection will temporarily terminate and the backup job will fail.	

Code	Description	Corrective Action	Log Example
Code 14	There was insufficient memory on the LinkStation so the backup job did not run.	Reduce the number of backup destination files or disable any other functions running at the same time.	ERROR: out of memory in flist_expand
Code 22			rsync error: error in IPC code (code 14) at main.c(655) [receiver=2.6.8]
			rsync: fork failed in do_recv: Cannot allocate memory (12)
Code 20	The connection was disconnected while the backup job was running.	Do not change the settings while the backup job is running. If changed, the connection will temporarily terminate and the backup job will fail.	rsync error: received SIGINT, SIGTERM, or SIGHUP (code 20) at rsync.c(242)
Code 23	Invalid characters were used in the filename or folder name of the backup destinations.	Change the filename or folder name using compatible characters. Available characters are described in the <a href="#">"Adding a Shared Folder"</a> section in chapter 2.	rsync error: some files could not be transferred (code 23) at main.c(702)
	The backup destination files were updated while the backup job was running.	Do not overwrite the backup destination files while the backup job is running. If updated, the backup destination files will not be backed up and the backup job will fail.	
	The LinkStation backed up the data to the FAT32-formatted USB drive, then the capitalization of letters in the filenames or folder names on the backup source LinkStation was changed.	Do not change the capitalization of letters in the filenames and folder names on the backup source LinkStation if the backup destination USB drive is formatted to FAT32. Linux on the LinkStation is case-sensitive but FAT isn't, so files or folders with names that are identical save for the capitalization will not be identified and treated as the same file or folder. To back up properly, using XFS or ext3 is recommended.	
Code 24	The backup destination files were updated while the backup job was running.	Do not overwrite the backup destination files while the backup job is running. If updated, the backup destination files will not be backed up and the backup job will fail.	rsync warning: some files vanished before they could be transferred (code 24) at main.c
Code 30	The Ethernet cable was disconnected from the backup source or destination LinkStations while the backup job was running.	Reconnect the Ethernet cable.	rsync error: timeout in data send/receive (code 30) at io.c(195) [sender=3.1.0]
B14	Insufficient LinkStation memory.	Restart the LinkStation and try again.	-

Code	Description	Corrective Action	Log Example
B101	The backup destination LinkStation does not exist.	Check that the backup destination LinkStation is turned on, the Ethernet cables are securely connected, and the hostname of the backup destination LinkStation has not been changed.	-
B102		Check that the backup destination folders on the backup destination LinkStation are on the shared folder list and the backup destination folders are configured for backup in Settings.	-
B103	The backup source folders on the backup source LinkStation do not exist.	Check that the backup source folders on the backup source LinkStation are on the shared folder list.	-
B104	The backup destination folders on the backup destination LinkStation do not exist.	Check that the backup destination folders on the backup destination LinkStation are on the shared folder list.	-
B105	The drives were not recognized.	Check that the drives are recognized properly in Settings. If you configure the "usbdisk" folders for the backup source or destinations, check whether these folders are on the shared folder list.	-
B106	The file systems of the USB drive are not supported.	Check that the USB drive is formatted to the compatible file systems. If you configure the management backup in the backup job, FAT format cannot be used for the backup destination.	-
B107	The device files such as "/dev/null" etc. do not exist.	Restart the LinkStation and try again.	-

## Backing Up Your Mac with Time Machine

Time Machine is a backup program included with macOS. Configure your LinkStation as shown below to use Time Machine.

### 1. Configuring a Shared Folder as a Backup Destination

**1** From Settings, click *Backup*.



**2** Click the settings icon (⚙️) to the right of "Time Machine".



**3** Click *Edit*.

**4** Click *Browse*.

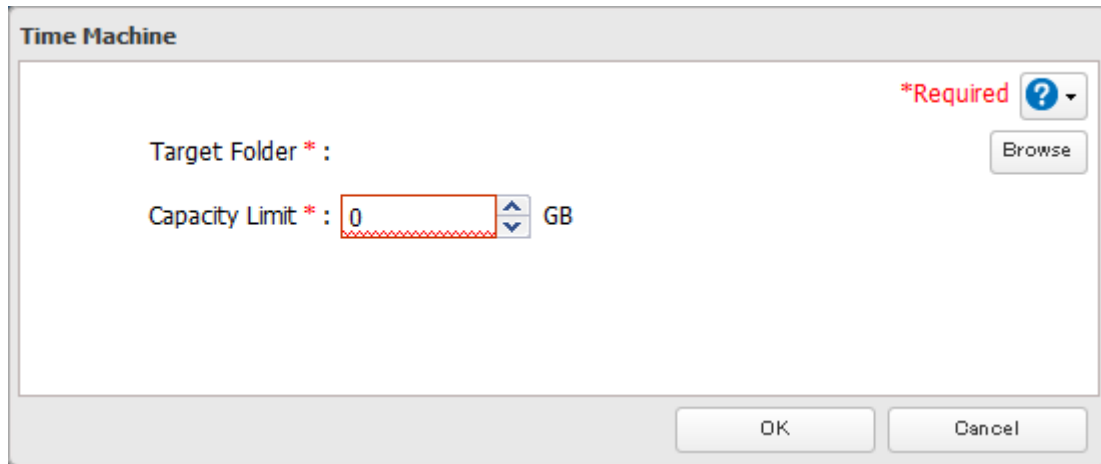

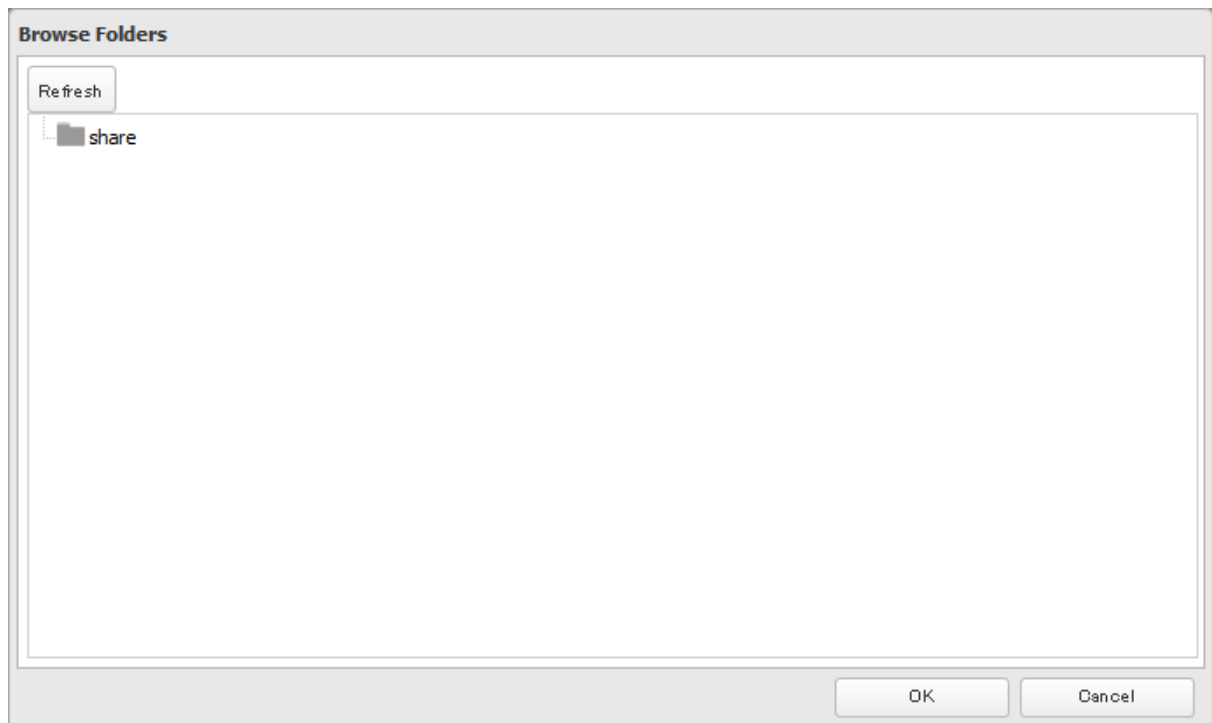

**5** Select the shared folder and click *OK*.

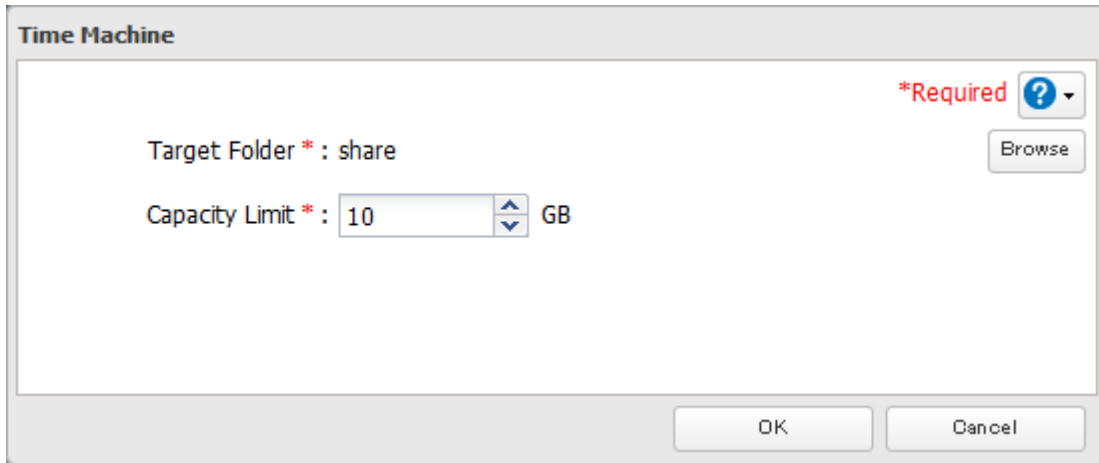

**6** Enter a limit size to save backup data from Time Machine and click *OK*.



**7** Click *OK*.

**8** Move the Time Machine switch (  ) to the  position to enable Time Machine.



## 2. Configuring Time Machine on macOS

**1** From the Apple menu, open *System Preferences*.



## 2 Click *Time Machine*.

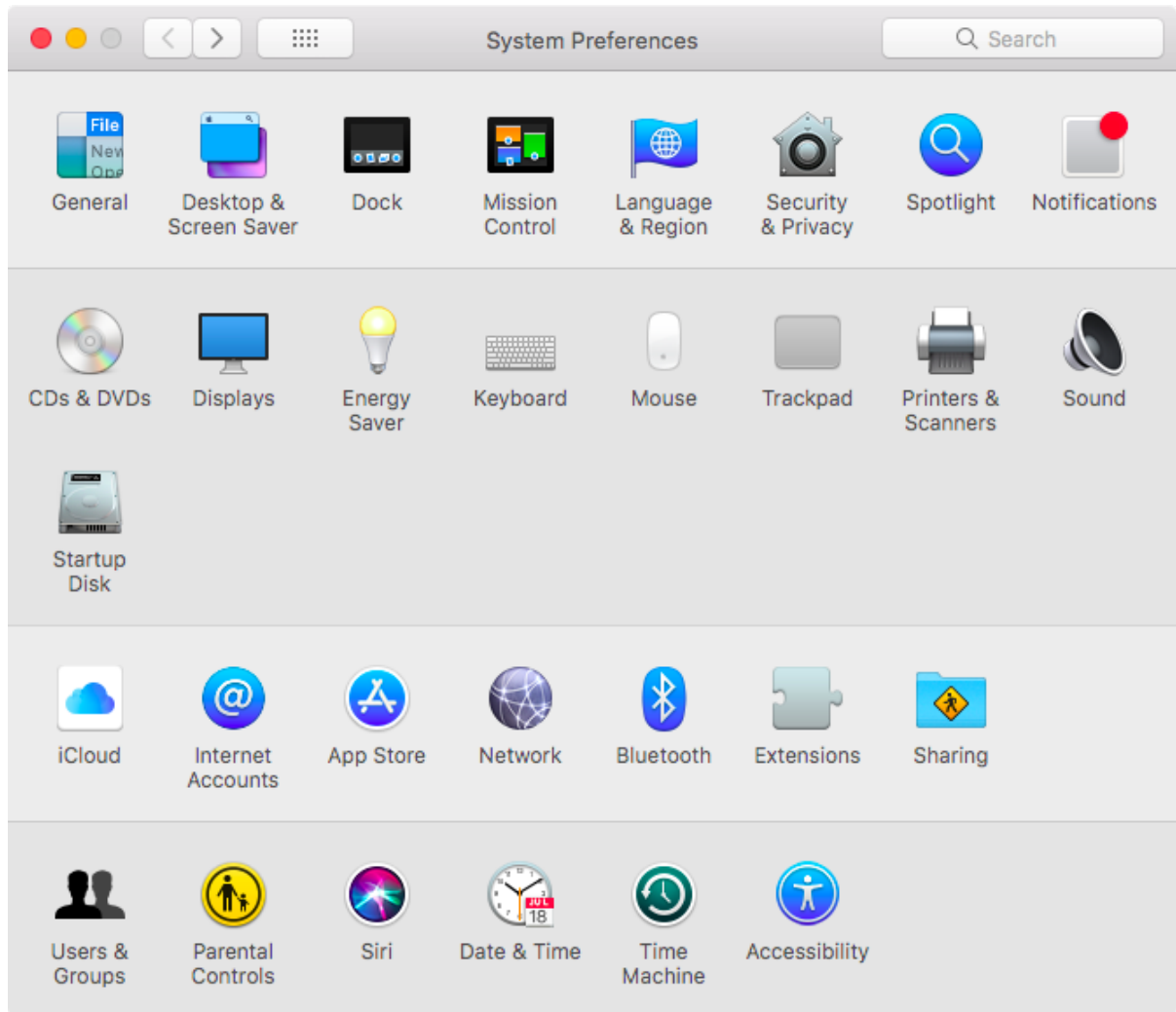

**3** Click *Select Backup Disk*.

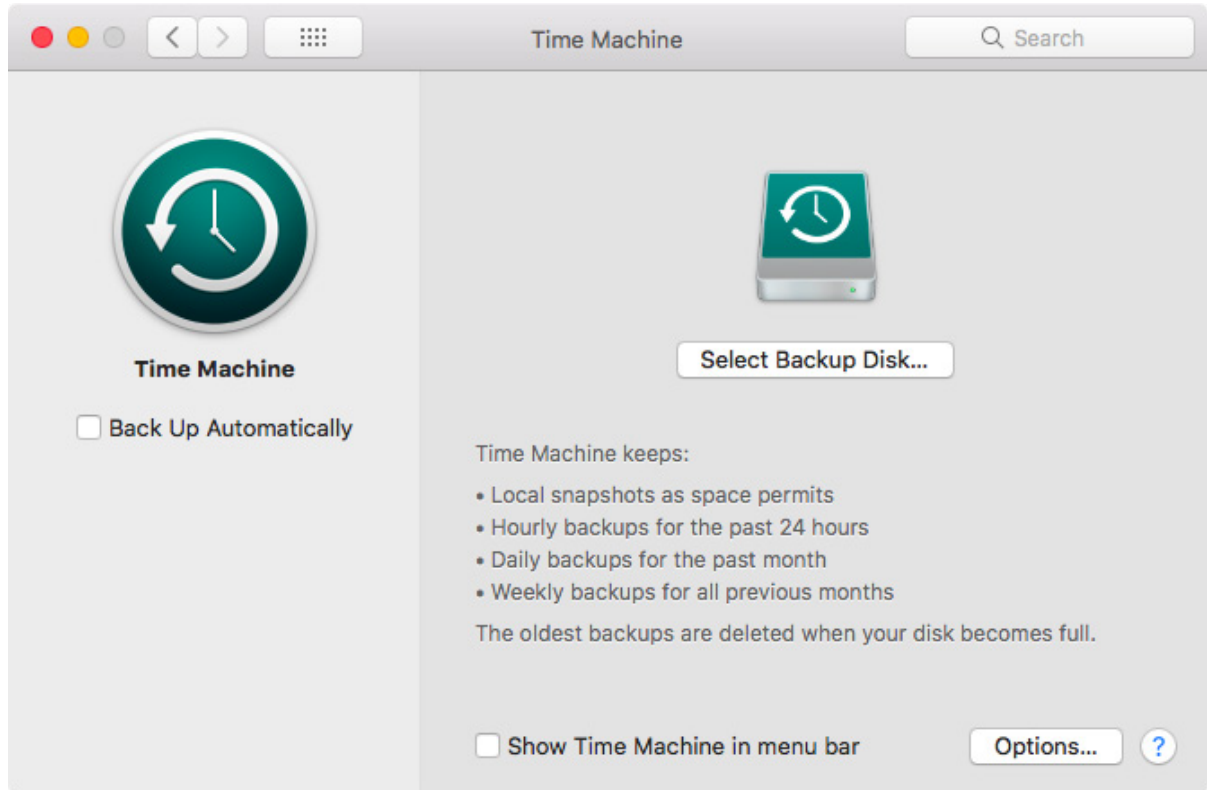

**4** Select the shared folder, then click *Use Disk*.

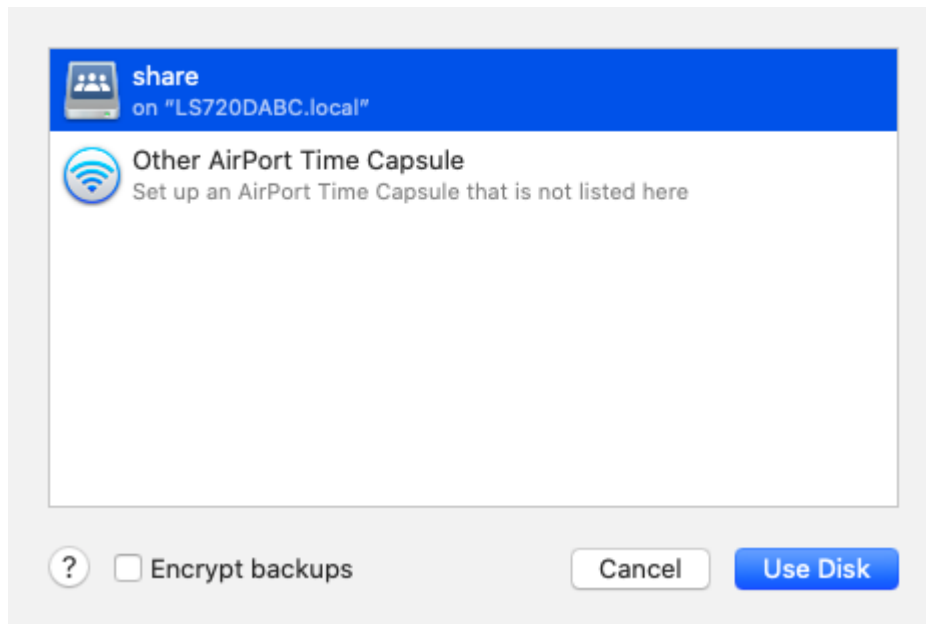

**5** Click *Connect*.

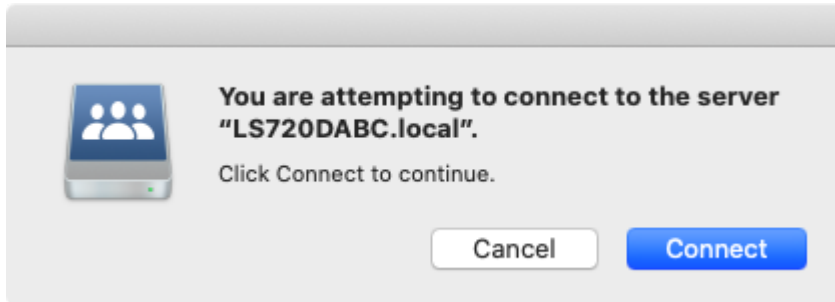

**6** Enter a username and password to be used for accessing the shared folder and click *Connect*.

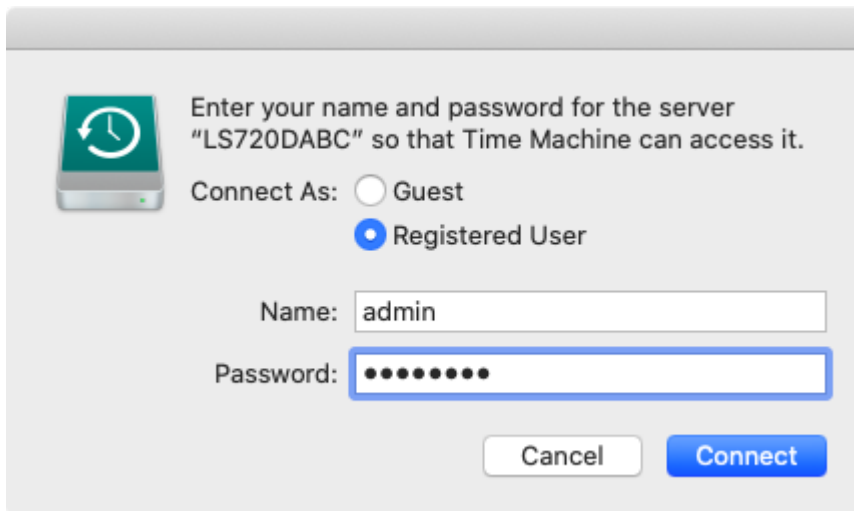

**Note:** If access restrictions are not configured on the destination share, log in using the administrator account. The default username and password for the administrator account are "admin" and "password". If access restrictions are configured, log in using an account with write privileges.

**7** Time Machine will count down from 120 seconds, then backup will begin.

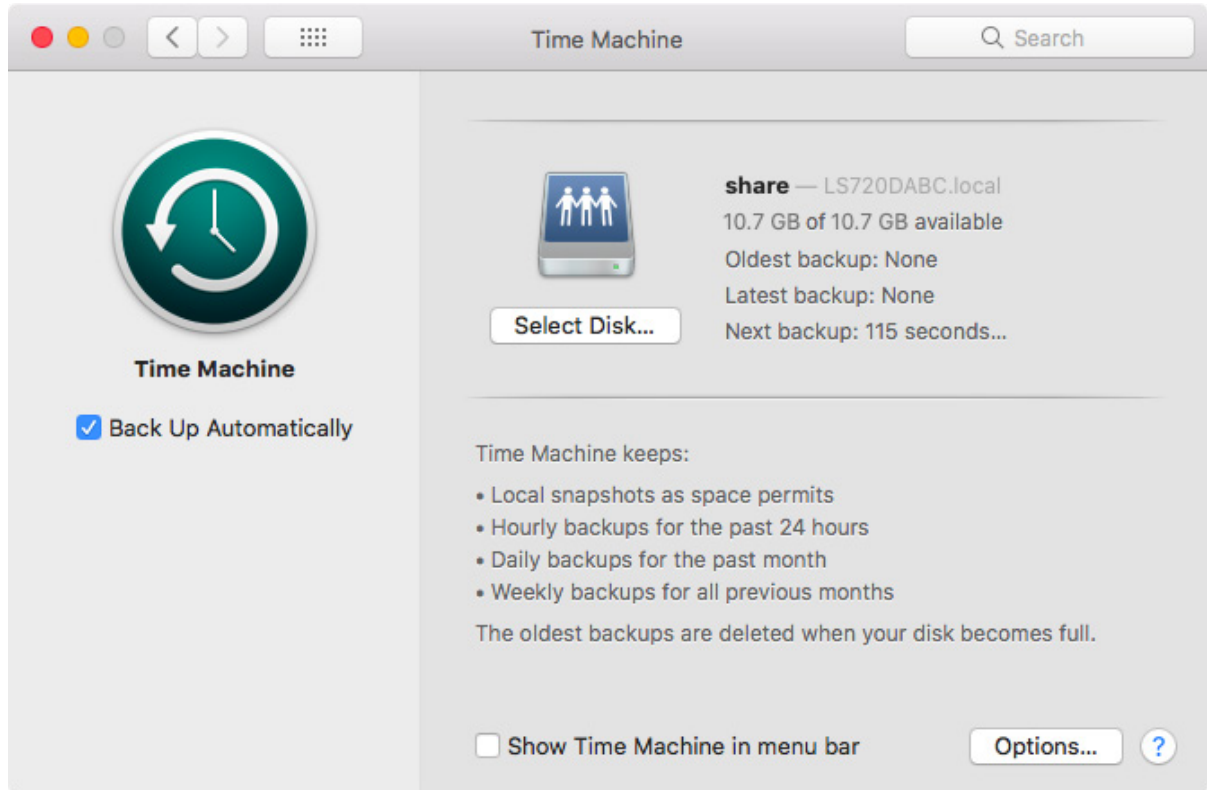

## Copying from a USB Device

Use Direct Copy to copy data from a USB device directly to the LinkStation. You can configure or start Direct Copy from a computer or a mobile device. Follow the appropriate procedure below to configure or start Direct Copy.

### Supported Devices:

- USB mass storage devices
- Card readers (except for card readers that can recognize two or more memory cards)
- Digital cameras and other PTP devices

## Configuring Direct Copy

### Using a Computer

**1** From Settings, click *Backup*.



**2** Click the settings icon (⚙️) to the right of "Direct Copy".



**3** Click *Edit*.

**4** Click *Browse*.

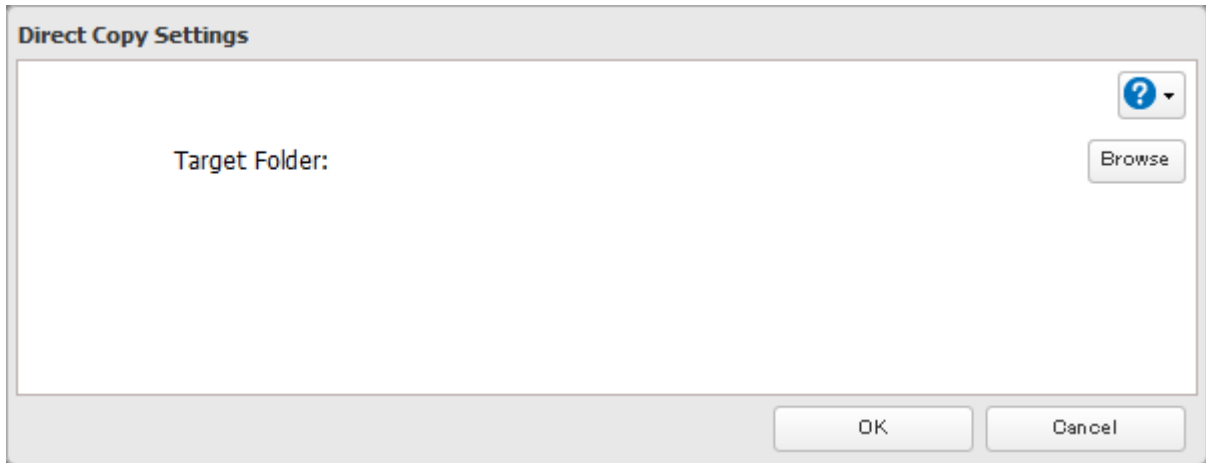

**5** Select the Direct Copy target folder and click *OK*.

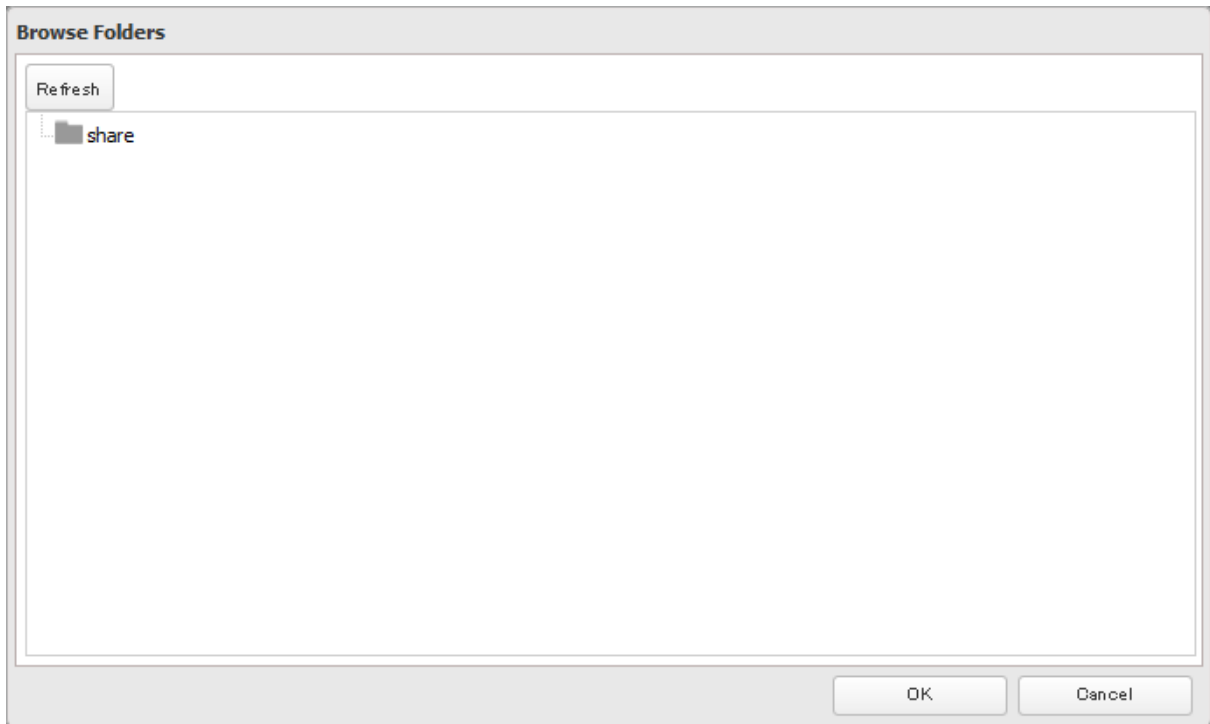

**6** Click *OK*, then click *OK* again.

**7** Move the Direct Copy switch (  ) to the  position to enable Direct Copy.



## Using a Mobile Device

- 1 From Settings, tap *Direct Copy*.

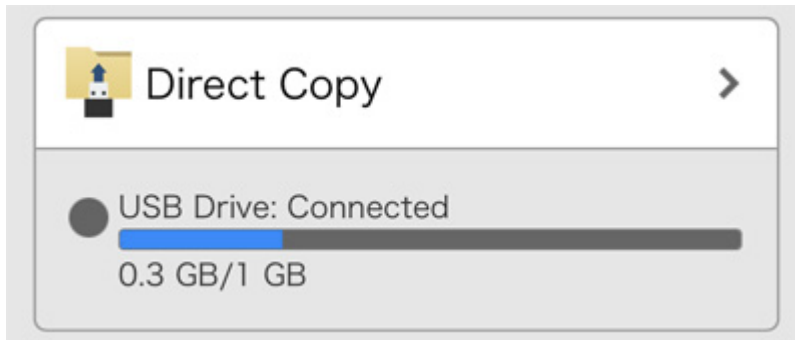

- 2 Move the Direct Copy switch (  ) to the  position to enable Direct Copy.



- 3 Select the Direct Copy target folder and tap *OK*.

## Starting Direct Copy

---

### Using the Function Button

- 1 Connect the USB device to the USB 3.2 Gen 1 port on the front. When it mounts (about 10 seconds), the function LED will light up.

**Notes:**

- Devices that don't cause the function LED to light up are not supported.
- When you connect PTP devices, the function LED may not light up. In such a case, disconnect the PTP device from the LinkStation, then reconnect it.

**2** You now have 60 seconds to press the function button once while the function LED is glowing.

**3** The function LED will blink as all the files on the USB device are copied to the Direct Copy folder on the LinkStation. When the copy operation is finished, the access LED of the USB device will stop blinking.

## Using a Mobile Device

**1** Connect the USB device to any USB port on the LinkStation.

**2** From Settings, tap *Direct Copy*.

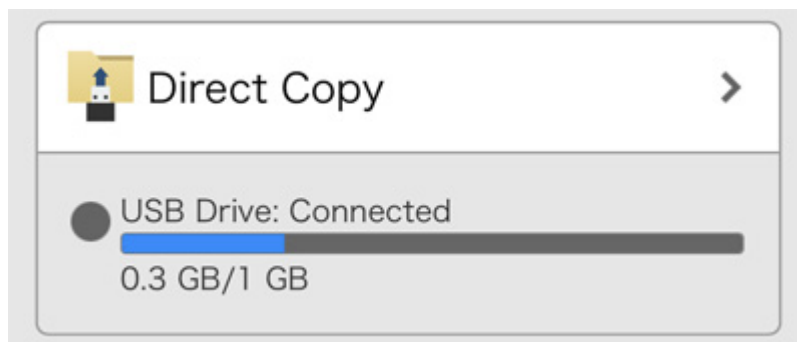

**3** Tap *Start Direct Copy*.

**4** The function LED will blink as all the files on the USB device will now be copied to the Direct Copy folder on the LinkStation. When the copy operation is finished, the access LED of the USB device will stop blinking.

**Notes:**

- While the function LED is blinking, press and hold the function button for three seconds to cancel the copy operation for Direct Copy. You can also cancel the copy operation from a mobile device by logging in to Settings and tapping *Cancel Direct Copy*.
- If files could not be copied using Direct Copy, connect the USB device to a computer on the network instead and use it to copy files into a shared folder on the LinkStation.



# Chapter 5 Cloud Services and Remote Access

## Synchronizing with Dropbox

The LinkStation supports synchronizing with Dropbox, the online cloud service. Once linked, you can share LinkStation files via Dropbox (or Dropbox files via LinkStation). To link your LinkStation with your Dropbox account, follow the procedure below.

**Note:** To use Dropbox Sync, you will need a Dropbox account and an available empty Dropbox folder. If you don't have a Dropbox account, or if you need to create a new empty Dropbox folder, refer to the Dropbox website.

### Configuring a New Job

- 1 From Settings, click *Cloud Storage*.

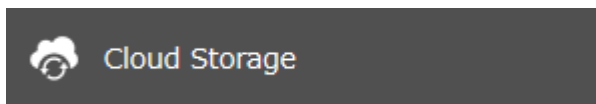

- 2 Move the Dropbox Sync switch (  ) to the  position to enable Dropbox Sync.



- 3 Click the settings icon (  ) to the right of "Dropbox Sync".

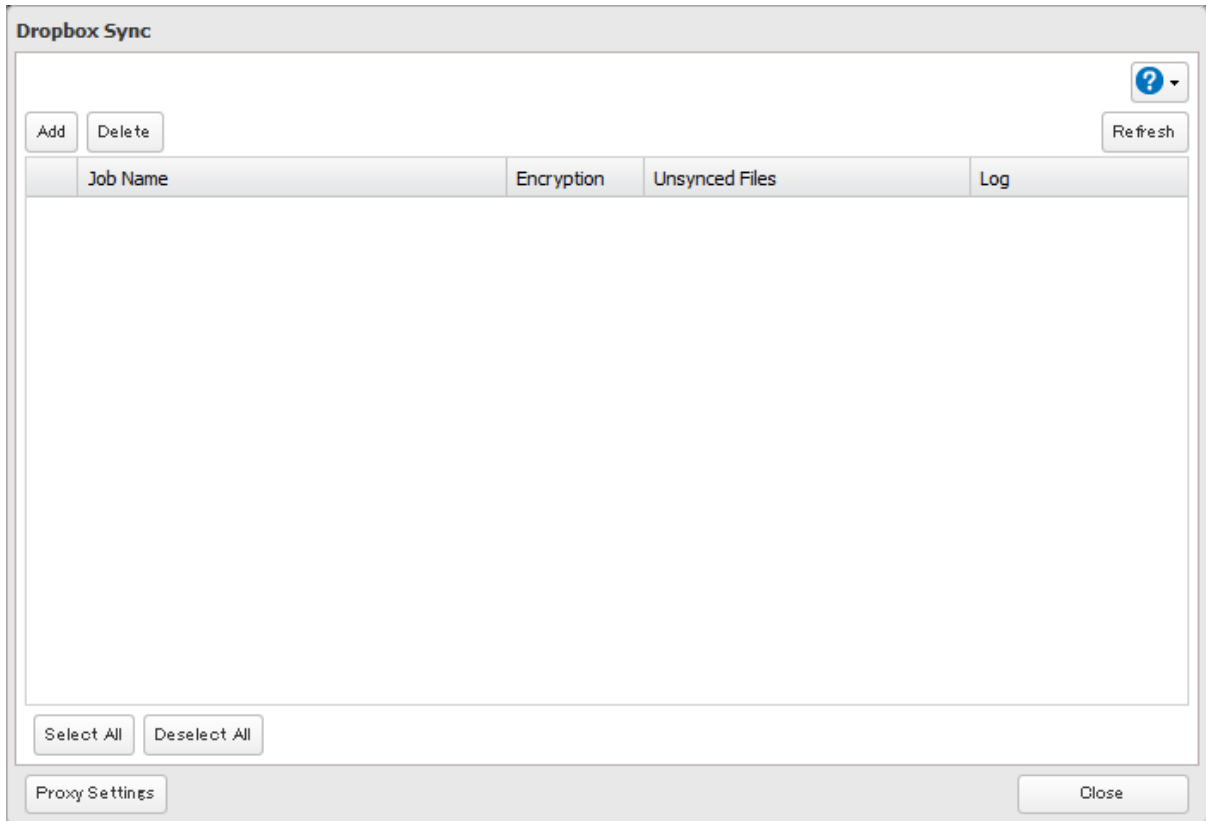
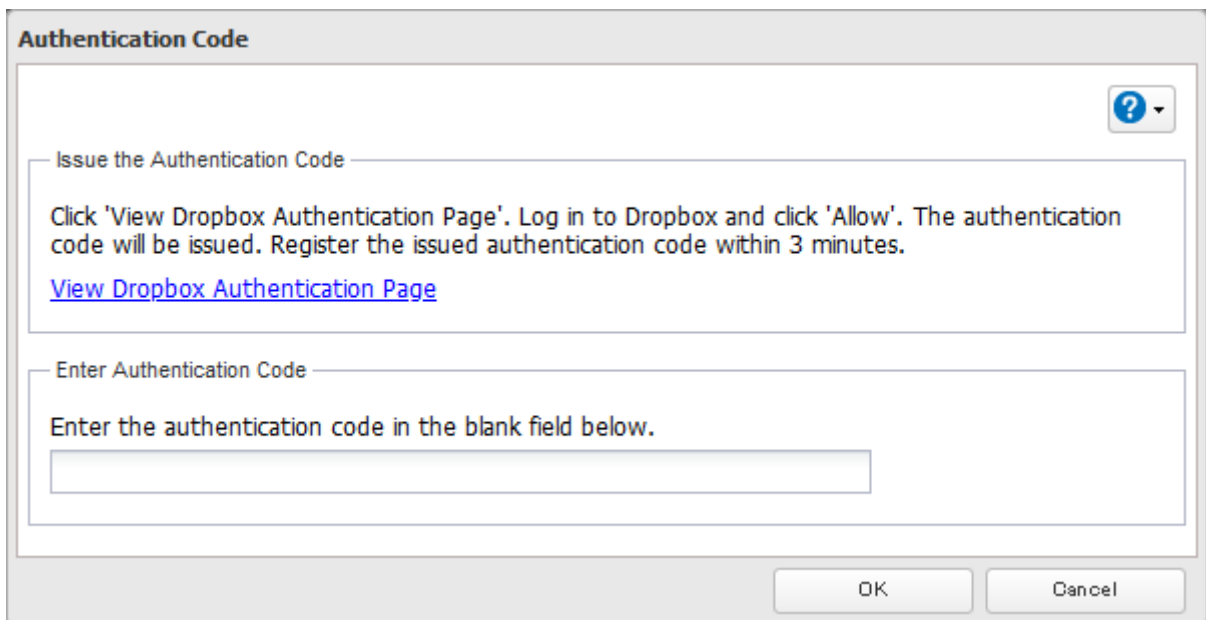

**4** Click *Add*.**5** Click *View Dropbox Authentication Page*.

**6** The authentication site that is offered by Dropbox will be displayed. Log in to the website with your Dropbox account, then click *Allow*.

**7** The authentication code will be displayed. Copy the authentication code and return to Settings. Authentication code reregistration should be finished within three minutes.

**8** Paste the authentication code and click *OK*.

**9** Enter the desired job name; select the LinkStation and Dropbox folders, and configure encryption. Click *OK*.  
 If you enable encryption, you will need to set an encryption password. The password cannot be changed once you configure it. Take note of the password and keep it secure. If you forget or lose the password, delete the old job first, then create a new job using the same Dropbox account.

**10** Click *OK*.**Notes:**

- Up to four Dropbox jobs can be configured at a time.
- When encryption is enabled, files uploaded to Dropbox not using Dropbox Sync will not be downloaded to the LinkStation even if the sync direction is configured to “Bidirectional” or “Download only”.
- Refer to the following website for synchronization restrictions between the LinkStation and Dropbox: <https://www.dropbox.com/help/145>

- Files that are 900 MB or larger cannot be downloaded using Dropbox Sync. However, even if the file size is smaller than 900 MB, downloading may fail when multiple processes are running at the same time.

## Changing Job Settings

Follow the procedure below to change any job settings you have already configured.

- From Settings, click *Cloud Storage*.

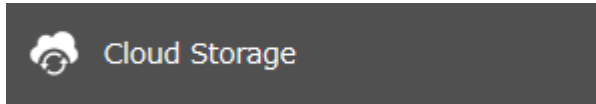

- Click the settings icon (⚙️) to the right of "Dropbox Sync".



- From the job list, click the job whose settings you want to change.

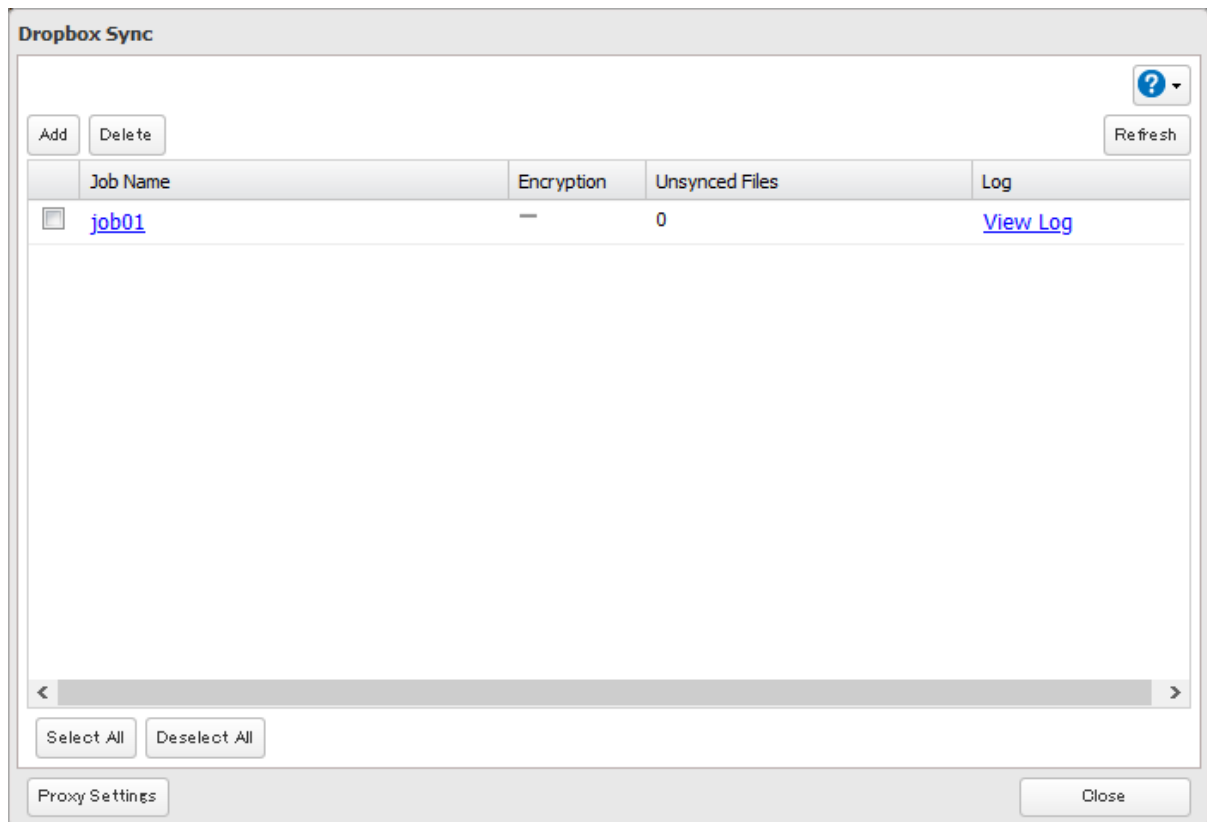

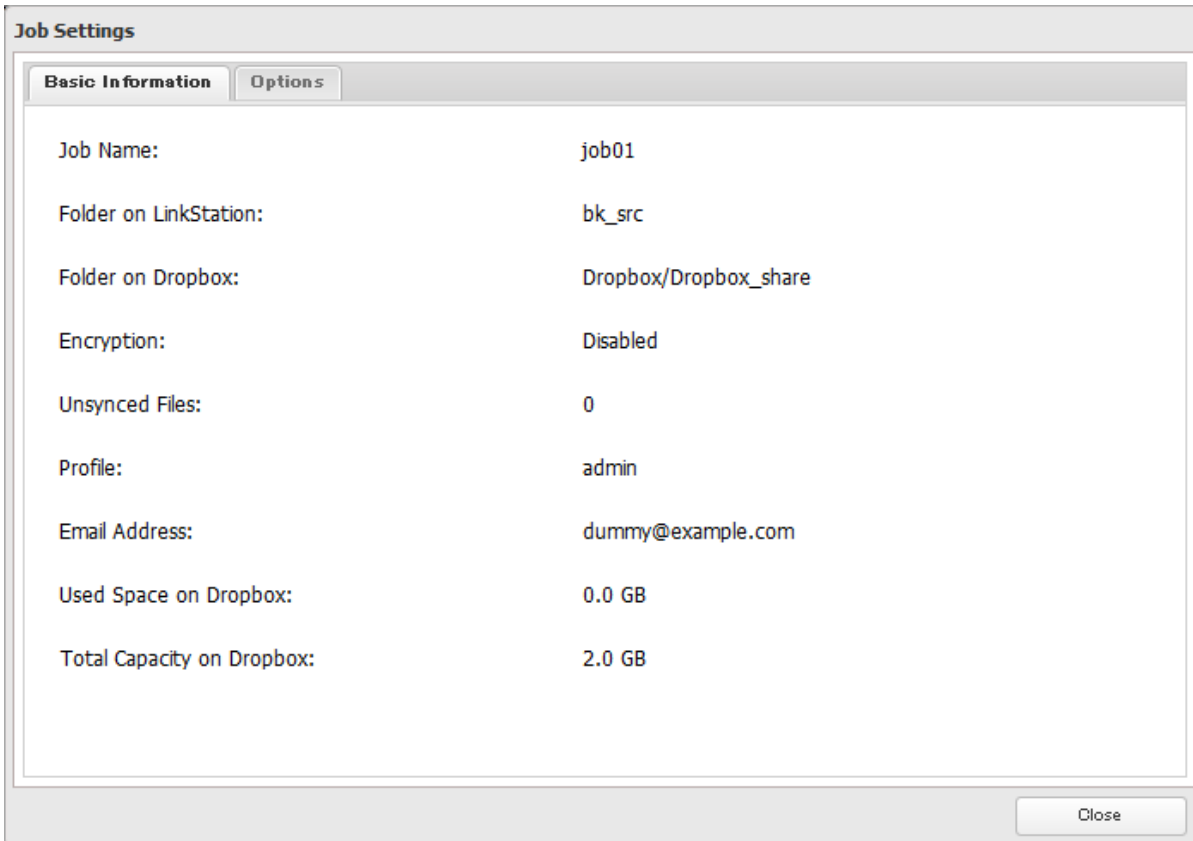
**4** Click the *Options* tab.

The screenshot shows a dialog box titled "Job Settings" with two tabs: "Basic Information" and "Options". The "Options" tab is selected. The dialog displays the following configuration details:

Job Name:	job01
Folder on LinkStation:	bk_src
Folder on Dropbox:	Dropbox/Dropbox_share
Encryption:	Disabled
Unsynced Files:	0
Profile:	admin
Email Address:	dummy@example.com
Used Space on Dropbox:	0.0 GB
Total Capacity on Dropbox:	2.0 GB

A "Close" button is located in the bottom right corner of the dialog box.

**5** Click *Edit*.

## 6 Configure the desired settings and click OK.

**Job Settings**

Sync Period: 5 minutes

Sync Direction: Bidirectional

Filter by File Size:  Enable  Disable

Maximum Size: 1 MB

Filtered Extensions:

Extensions

Add Delete

Filter Hidden Files:  Enable  Disable

OK Cancel

### Notes:

- When specific settings are changed, the changes will not be applied and the files on Dropbox may not be synchronized to the LinkStation. In such a case, delete the target files to be synchronized and upload them to Dropbox again or delete the job and recreate it again. The following are the specific circumstances for when files may not be synchronized:
  - Uploading or downloading fails.
  - File extensions are removed from filtering.
  - The sync direction is changed.
- If using Dropbox through a proxy server, click *Proxy Settings*. From the displayed page, you can select whether to use the configured settings or configure an identical proxy server. If using the identical proxy server, select “New settings” and enter the proxy server name, port number, username, and password. Consult your network administrator for detailed proxy server settings.
- Regardless of whether file filtering was configured, the following files will not be uploaded to Dropbox:
  - desktop.ini
  - thumbs.db
  - Files whose filename contains the symbols `/ \ > < : " | ? *`
  - Files whose filename ends with either a space or period
  - Files whose filename starts with either `~$` or `~.`
  - Files whose filename starts with `~` and have the file extension `.tmp`

## Using Microsoft Azure for Data Preservation

The LinkStation supports synchronizing with Microsoft Azure, the online cloud storage service. Once linked, you can back up data on the LinkStation to Azure Storage, or restore data from Azure Storage to the LinkStation. Microsoft Azure offers multiple types of storage and the LinkStation is compatible with blob storage. There are three types of blobs: block blobs, page blobs, and append blobs. The LinkStation only works with block blobs to store your data.

This feature is meant for situations such as disaster recovery and not a catch-all backup function. After linking the LinkStation and Microsoft Azure, data on the LinkStation will not be bidirectionally synchronized between the LinkStation and an Azure container.

### Notes:

- Depending on the services you have purchased, prices for operations and amount of data will vary. To avoid being charged unexpectedly expensive fees, we recommend staying aware of the price structure for data storage and operations and regularly checking how much have been charged.
- To access data that have been backed up to the container, use “Microsoft Azure Storage Explorer”.
- If using Azure Storage through a proxy server, click *Proxy Settings*. From the displayed page, you can select whether to use the configured settings or configure an identical proxy server. If using the identical proxy server, select “New settings” and enter the proxy server name, port number, username, and password. Consult your network administrator for detailed proxy server settings.

To link your LinkStation with a Microsoft Azure Storage account, follow the procedure below.

## Creating a New Backup Job

- 1 From the Azure portal, create your Azure Storage account and a container before proceeding with the procedure.
- 2 From Settings, click *Cloud Storage*.

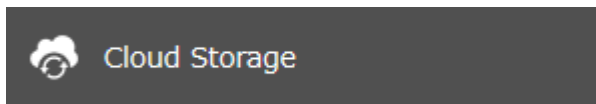

- 3 Move the Microsoft Azure Storage Sync switch (  ) to the  position to enable Microsoft Azure Storage Sync.



- 4 Click the settings icon (  ) to the right of “Microsoft Azure Storage Sync”.



**5** Click *Add*.

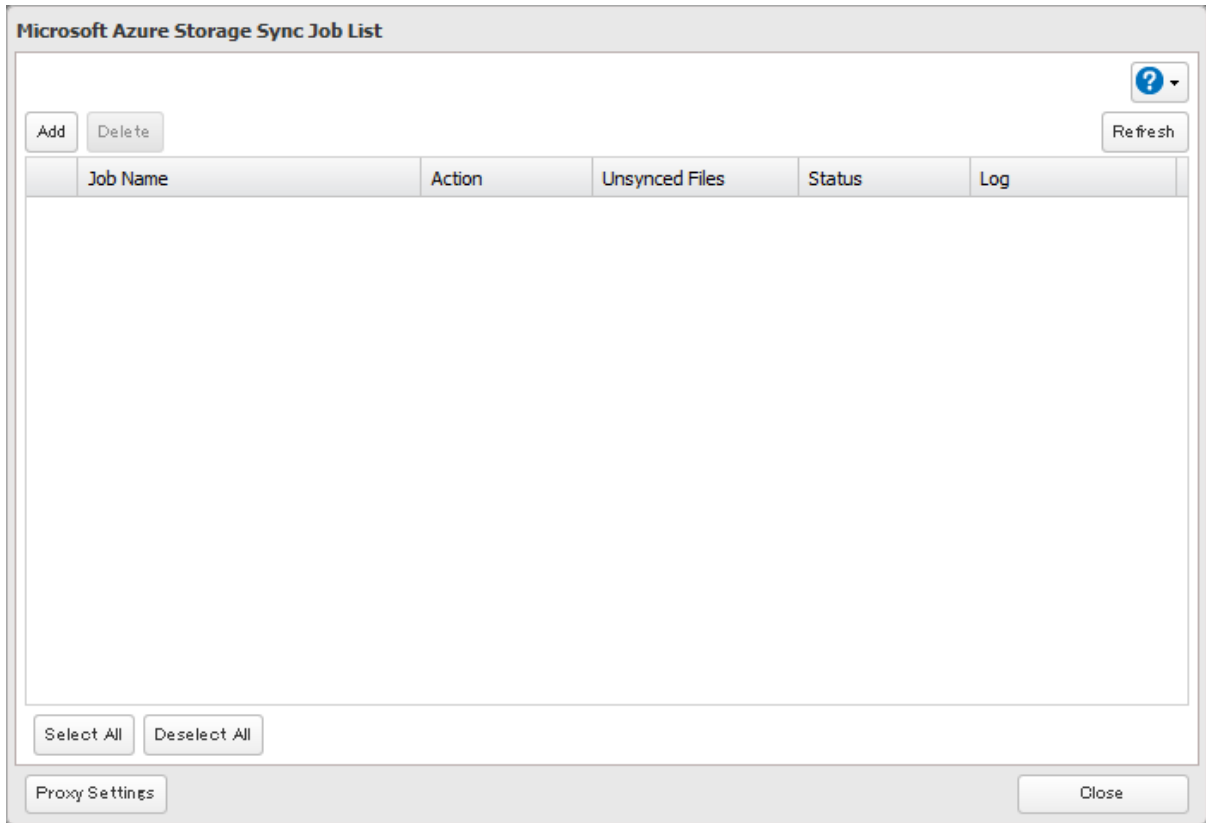

**6** The job setup wizard will open. Enter your Azure Storage account name and access key, then click *Next*.

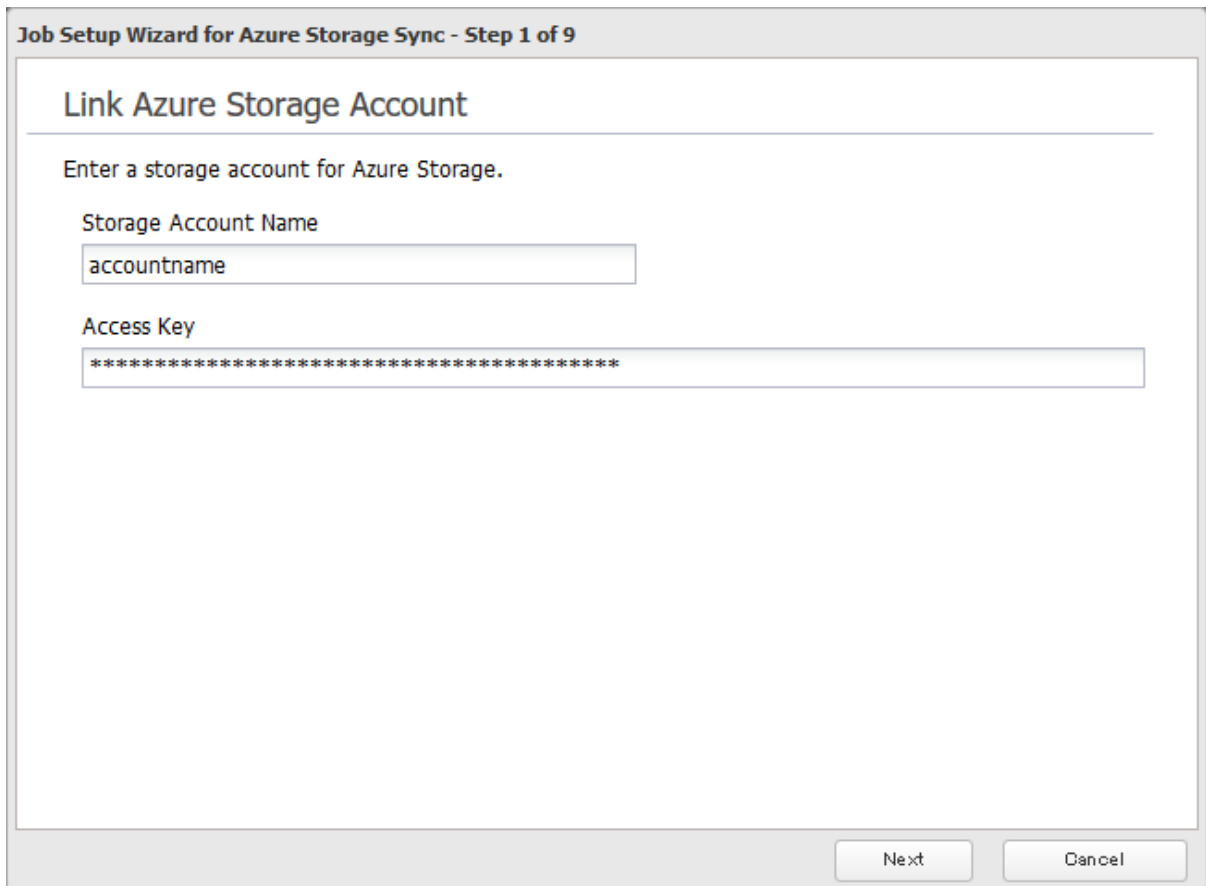



**7** Enter the desired job name and click *Next*.

**Job Setup Wizard for Azure Storage Sync - Step 2 of 9**

### Enter a Job Name

---

Enter a job name to create.

Job Name

**8** Select “Backup” and click *Next*.

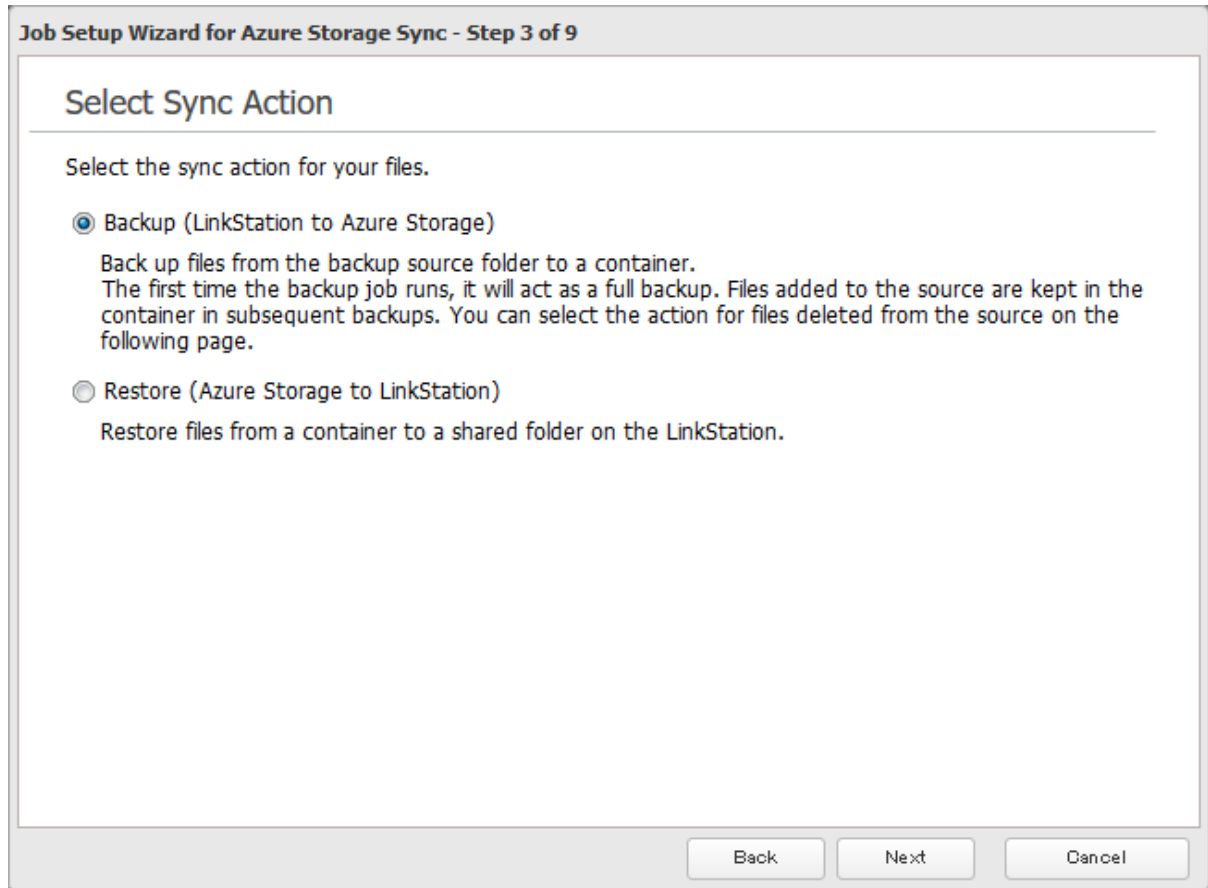

- 9 Select the desired shared folder on the LinkStation as the backup source folder and enter the container name for the backup destination, then click *Next*.

**Job Setup Wizard for Azure Storage Sync - Step 4 of 9**

### Configure Job Pairs

Select the shared folder that contains desired files for backup as the backup source and enter a container name.

Backup Source Folder  
bk\_src

Container Name  
test5

**10** Specify the sync period and click *Next*.

**Job Setup Wizard for Azure Storage Sync - Step 5 of 9**

### Configure Sync Period

Select the interval of time between each backup.

Backup Interval

5 minutes

Back Next Cancel

- 11** Select the desired action to take for files in the container that share the same name as files in the backup source after they are deleted, then click *Next*.

**Job Setup Wizard for Azure Storage Sync - Step 6 of 9**

### Configure File Sync Action

Select the action to take for files in the backup destination container after deleting files with the same name from the backup source folder.

- Delete from container  
Delete the files from the backup destination container.
- Keep in container  
Keep the files as is in the backup destination container.

Back Next Cancel

**12** Configure whether to filter the backup target files. The following screen is available to configure file filtering by file size and whether they're hidden. Configure the desired filtering settings and click *Next*.

**Job Setup Wizard for Azure Storage Sync - Step 7 of 9**

### Configure File Filters 1

Configure the requirements for filtering files. If any files in the backup source folder meet any of the following requirements, those files will not be backed up.

**Filter by File Size**

Enable  Disable

Maximum Size:  MB

**Filter Hidden Files**

Enable  Disable

Back Next Cancel

- 13** The following screen is available to configure file filtering by extensions. Configure the desired filtering settings and click *Next*.

**Job Setup Wizard for Azure Storage Sync - Step 8 of 9**

### Configure File Filters 2

Configure the requirements for filtering files. If any files in the backup source folder meet any of the following requirements, those files will not be backed up.

Filter by Extensions

Enable  Disable

Filtered Extensions

Extensions

Add

Delete

Back Next Cancel

- 14** Confirm that all settings are properly configured and click *OK*.

- 15** Click *OK* when finished.

**Notes:**

- Regardless of whether file filtering was configured, the following files will not be backed up to an Azure Storage container:
  - desktop.ini
  - thumbs.db
  - Files whose filename contains the symbols / \ > < : " | ? \*
  - Files whose filename ends with either a space or period
  - Files whose filename starts with either ~\$ or .~
  - Files whose filename starts with ~ and have the file extension .tmp
- Do not copy files that are 10 GB or larger, and do not copy 100,000 or more files to the backup source folder at once. If you do and backup fails, check the network environment speed and try again with fewer or smaller files.

## Creating a New Restore Job

- 1** From the Azure portal, create your Azure Storage account and a container before beginning the following procedure.

**2** From Settings, click *Cloud Storage*.

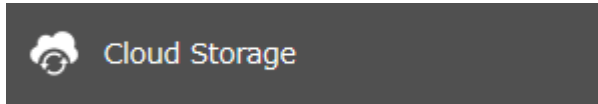

**3** Move the Microsoft Azure Storage Sync switch (  ) to the  position to enable Microsoft Azure Storage Sync.



**4** Click the settings icon (  ) to the right of "Microsoft Azure Storage Sync".

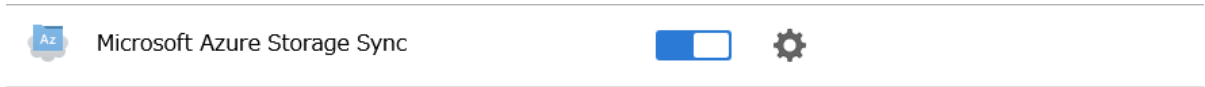

**5** Click *Add*.

The screenshot shows a window titled "Microsoft Azure Storage Sync Job List". At the top left are "Add" and "Delete" buttons. At the top right is a help icon (question mark in a circle) and a "Refresh" button. Below these is a table with the following columns: "Job Name", "Action", "Unsynced Files", "Status", and "Log". The table body is currently empty. At the bottom left are "Select All" and "Deselect All" buttons. At the bottom right is a "Close" button. A "Proxy Settings" button is located at the bottom left of the window frame.



**6** The job setup wizard will open. Enter your Azure Storage account name and access key, then click *Next*.

**Job Setup Wizard for Azure Storage Sync - Step 1 of 9**

### Link Azure Storage Account

Enter a storage account for Azure Storage.

Storage Account Name

Access Key

Next Cancel

**7** Enter the desired job name and click *Next*.

**Job Setup Wizard for Azure Storage Sync - Step 2 of 9**

### Enter a Job Name

---

Enter a job name to create.

Job Name

Back Next Cancel

**8** Select “Restore” and click *Next*.

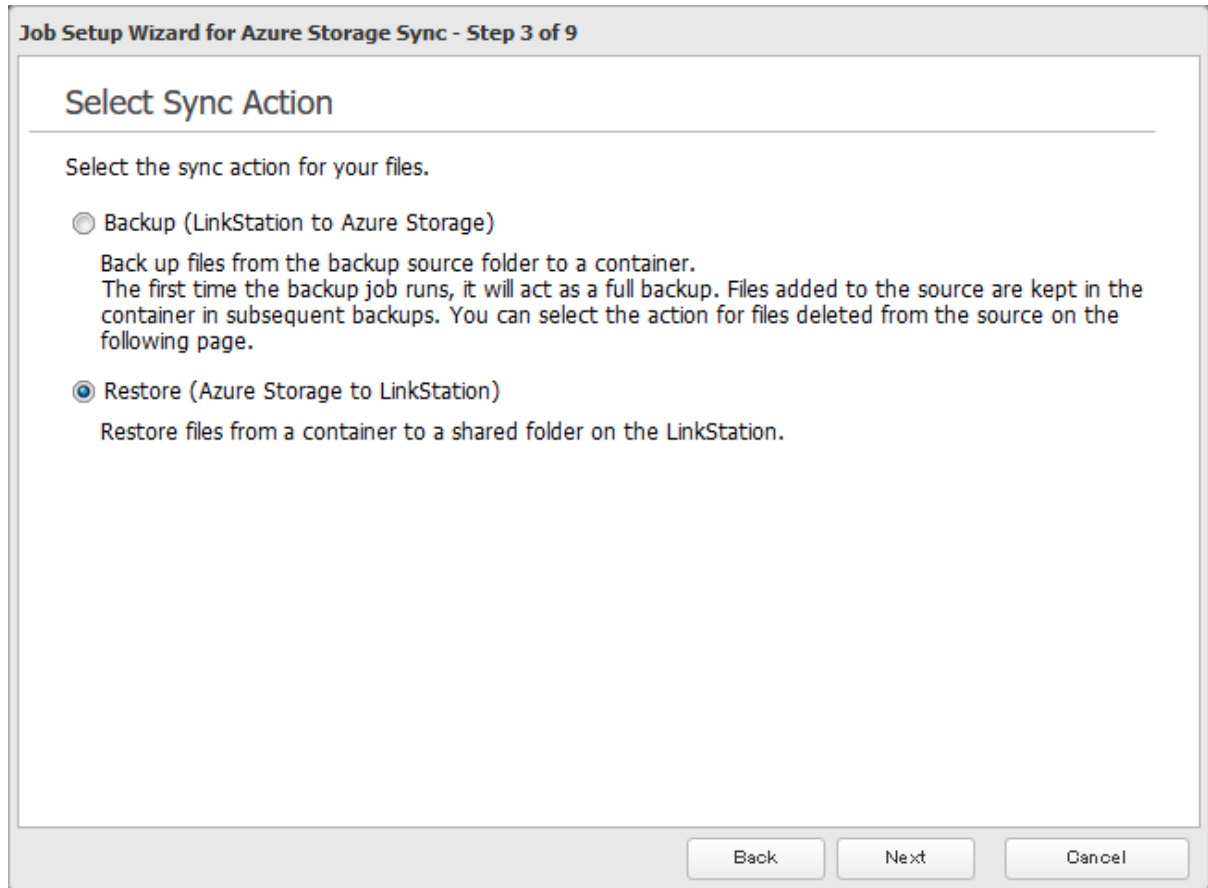

- 9 Enter the container name for the restore source and select the desired shared folder on the LinkStation as the restore destination, then click *Next*.

**Job Setup Wizard for Azure Storage Sync - Step 4 of 5**

### Configure Job Pairs

Enter a container name for the restore source and select a shared folder as the restore destination for restored files.

Container Name

Restore Destination Folder  
 ▼

Folder Level for Restored Files

First level  
 Files will be restored to the first level of the restored destination folder.

Second level  
 A folder will automatically be created in the restored destination folder and files will be restored to this folder. This folder name will be the date on which the job was created.

- 10 Select either to restore data into the first level folder (root folder) or the second level (subfolder) of the restore destination folder, then click *Next*.

- 11 Confirm that all settings are properly configured and click *OK*.

**Note:** When deleting a finished restore job, it can be converted to a backup job. If that restore job had been configured to restore to the second level of the shared folder, restored data will automatically be moved to the first level. If there are files with the same filename in the first level folder, those files will be overwritten.

## Changing Job Settings

Follow the procedure below to change any of the backup job settings you have already configured. Restore job settings cannot be changed.

- 1 From Settings, click *Cloud Storage*.

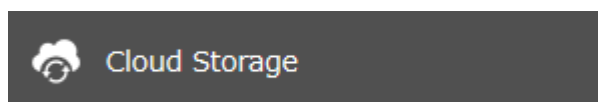

- 2 Click the settings icon (⚙️) to the right of "Microsoft Azure Storage Sync".



**3** From the job list, click the job whose settings you want to change.

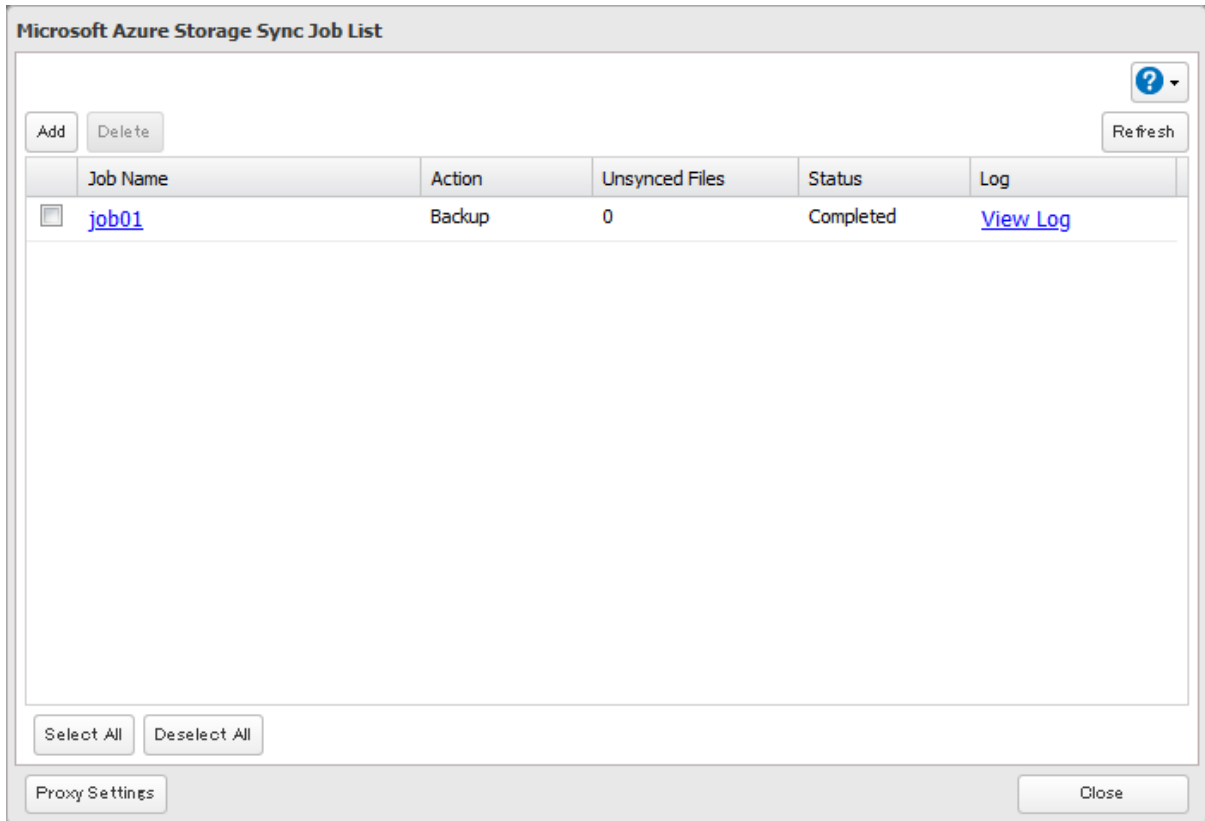

**4** Click the *Options* tab.

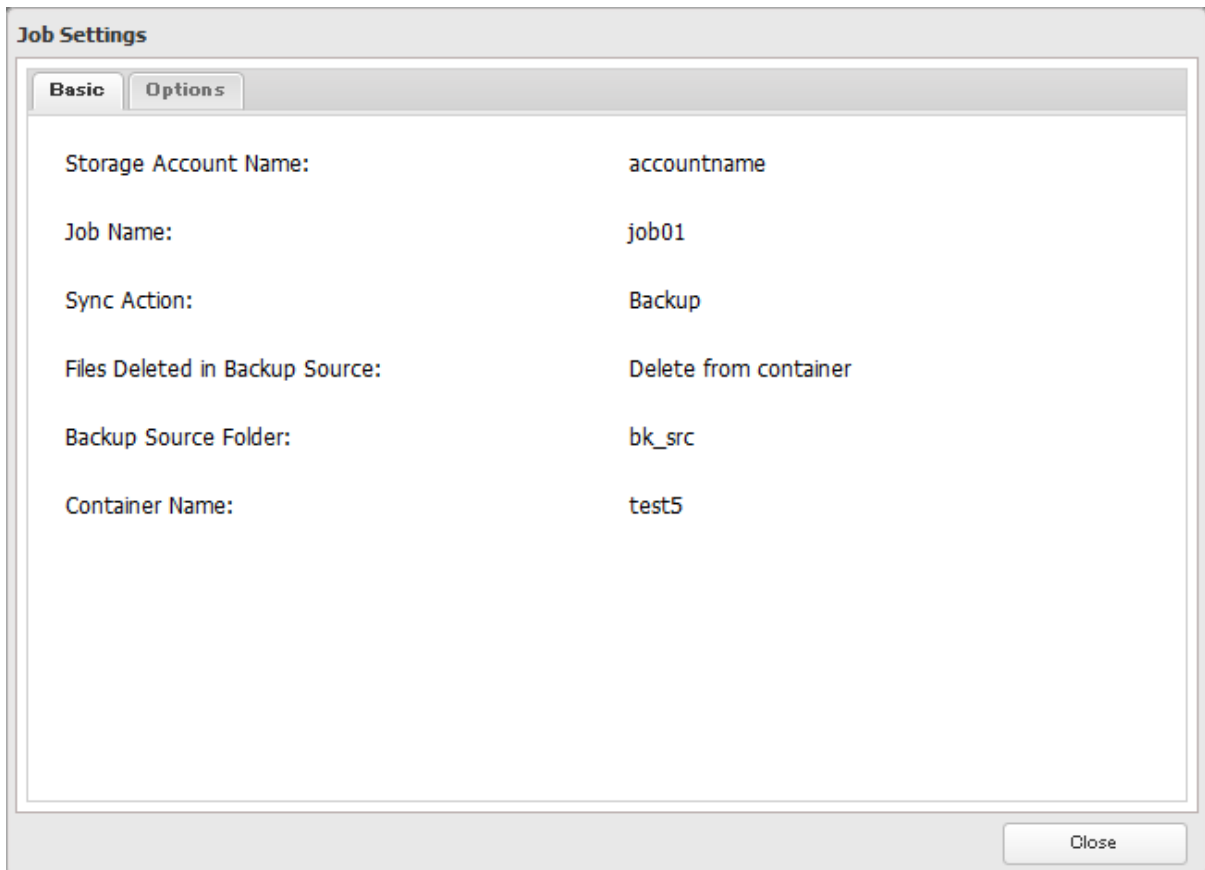

**5** Click *Edit*.

## 6 Configure the desired settings and click OK.

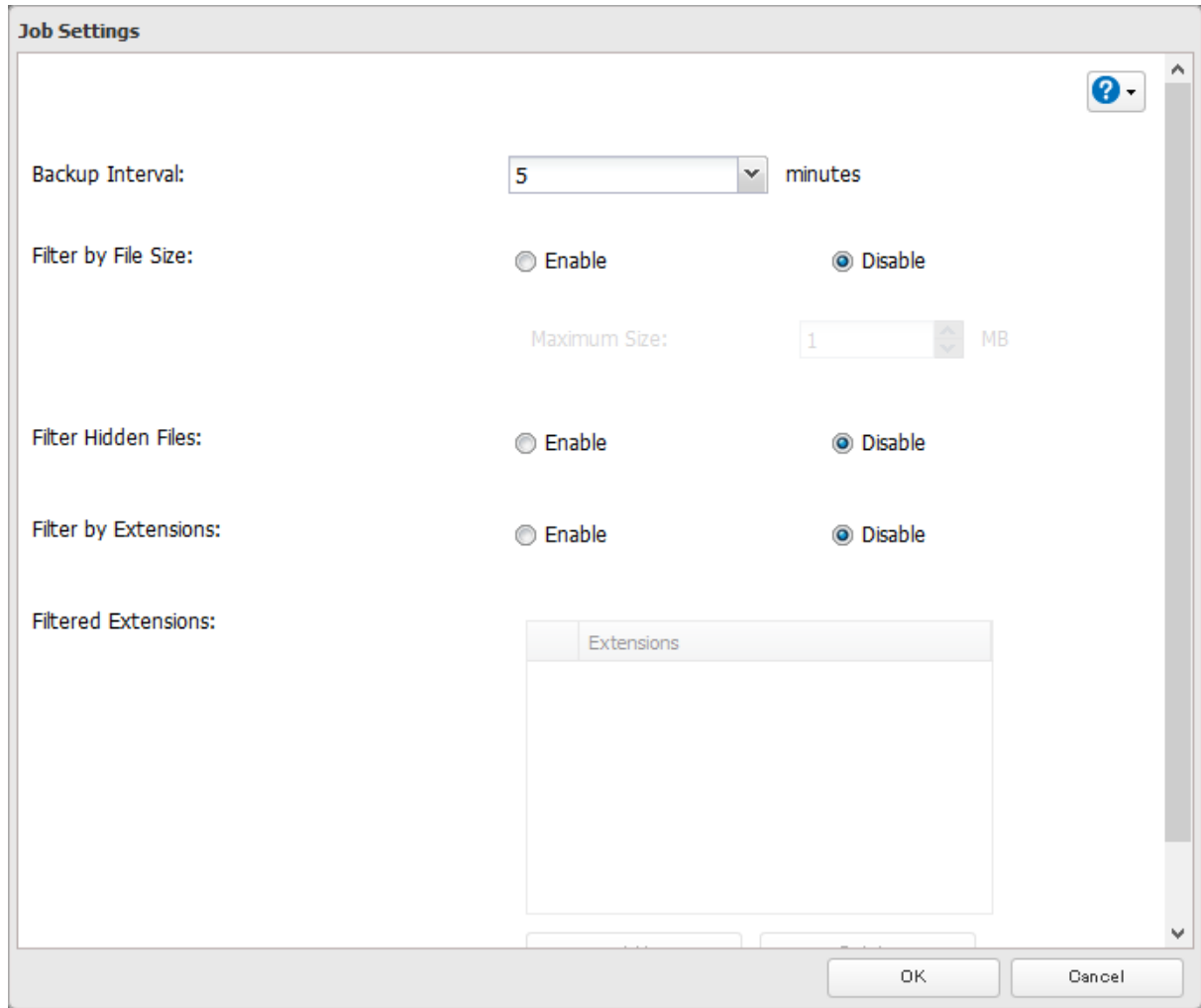

## Synchronizing with Microsoft OneDrive

The LinkStation supports synchronizing with Microsoft OneDrive, the online cloud storage. Once linked, you can share the LinkStation files via OneDrive (or OneDrive files via the LinkStation). To link your LinkStation with your Microsoft account, follow the procedure below.

**Note:** To use Microsoft OneDrive Sync, you need a Microsoft account and an available empty OneDrive folder. If you don't have a Microsoft account, or if you need to create a OneDrive folder, refer to the Microsoft website.

### Configuring a New Job

1 From Settings, click *Cloud Storage*.

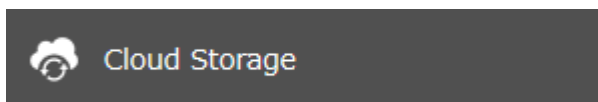

2 Move the OneDrive Sync switch (  ) to the  position to enable OneDrive Sync.



**3** Click the settings icon (  ) to the right of “Microsoft OneDrive Sync”.



**4** Click *Add*.

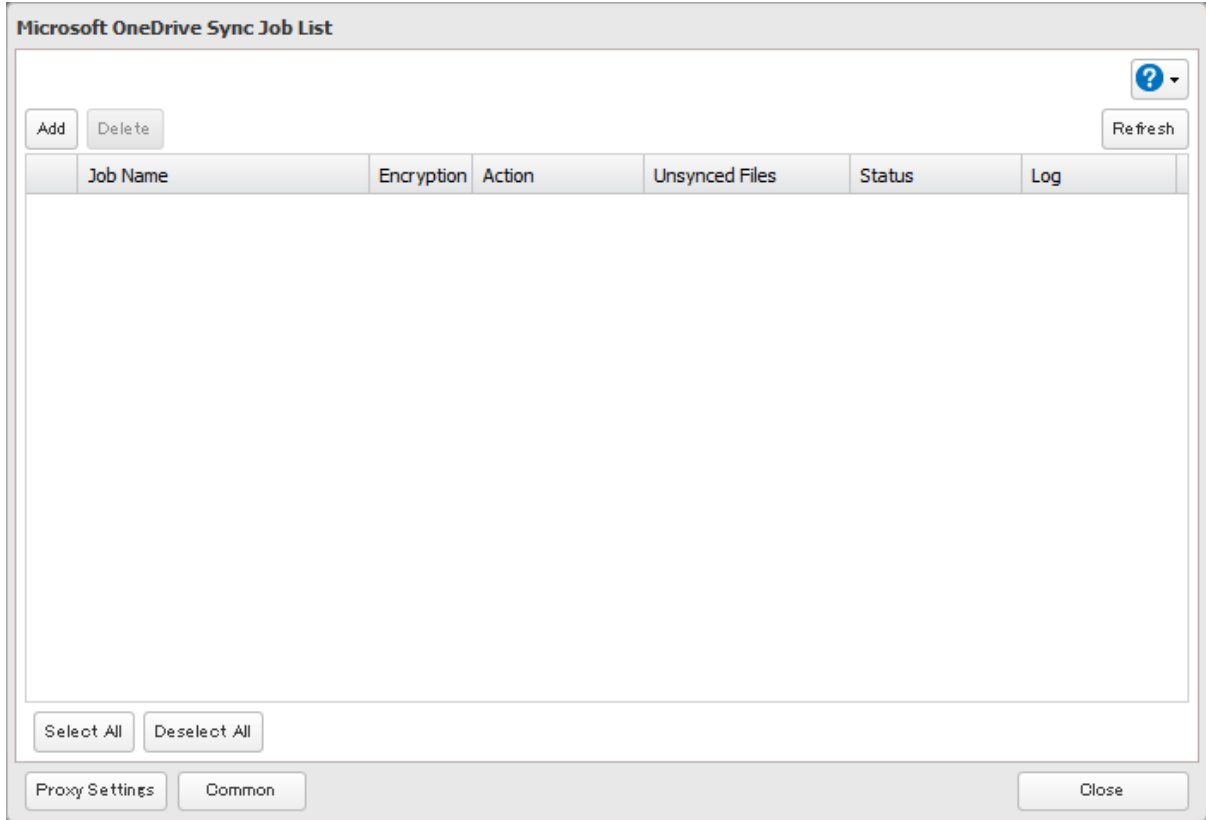

**5** The sign-in window will open. Enter the username and password of your Microsoft account, then sign in.

**6** Enter the desired job name and click *Next*.

**Job Setup Wizard for OneDrive Sync - Step 1 of 10**

### Enter a Job Name

---

Enter a job name to create.

 ?



- 7** Select the sync action and behavior for when files with the same name are already in the target folder. The behavior for when files with the same name already exist will work when the files that have the same name on both the LinkStation and OneDrive are changed. Click *Next* after configuring.

**Job Setup Wizard for OneDrive Sync - Step 2 of 10**

### Select Sync Action

Select the sync action for your files.

Bidirectional

Files with Same Names

- Keep files on OneDrive**  
If there is a file conflict when syncing, files on OneDrive will be saved over other versions.
- Keep files on the LinkStation**  
If there is a file conflict when syncing, files on the LinkStation will be saved over other versions.
- Keep files with newer modified date**  
If there is a file conflict when syncing, files with the newer modified date will be saved over other versions.

Back Next Cancel

- 8** Select the desired LinkStation and OneDrive folders. If you want to create an empty folder first, click *Browse* under “Folder on LinkStation”, then click *Create Folder* on the selecting folder window that appears. Click *Next* after selecting the folders.

**Job Setup Wizard for OneDrive Sync - Step 3 of 10**

### Configure Job Pairs

Select the folders on OneDrive and the LinkStation that files will be synced each other.

Folder on LinkStation	share	<input type="button" value="Browse"/>
Folder on OneDrive	OneDrive/Drive1	<input type="button" value="Browse"/>

**Notes:**

- The sixth level and deeper of shared and OneDrive folders cannot be selected.
- Do not use a shared folder configured as a Time Machine backup folder for OneDrive Sync.

**9** Specify the sync period and click *Next*.

**Job Setup Wizard for OneDrive Sync - Step 4 of 10**

### Configure Sync Period

Select the interval of time between each synchronization.

5 minutes

Back Next Cancel

- 10** Files will be uploaded during the start and end time of the period configured in step 9 above. If you want to always upload files during the configured sync period, select “Always sync within the sync period” for “Frequency”. Click *Next* after configuring.

**Job Setup Wizard for OneDrive Sync - Step 5 of 10**

### Configure Schedule

Configure a schedule for a job. If you select "Daily" for frequency, specify the start and end time. If you select "Weekly" for frequency, specify the day of the week and times.

Frequency  
Daily

Start Time  
01:00

End Time  
05:00

Day of Week  
 Sunday  Monday  Tuesday  Wednesday  Thursday  Friday  Saturday

Back Next Cancel

- 11 Select whether to encrypt the files using a password. When encryption is enabled, uploaded files will be archived in zip format and encrypted using the entered encryption password. Click *Next* after selecting.

**Job Setup Wizard for OneDrive Sync - Step 6 of 10**

### Configure Encryption

Enable encryption for the files when uploading to OneDrive.

Enable  Disable

Encryption Password

Setting an encryption password with 10 or more characters is recommended. The encryption password cannot be changed once it's configured. Make sure to manage the password carefully after it has been saved.

Back Next Cancel

**Note:** If the password contains spaces or backslashes (\), decrypting a file on a computer may fail.

- 12** Select whether to check for file consistency. If an inconsistency occurs with a file between the LinkStation and OneDrive, that file will be updated using the latest file version even if it hasn't been changed. Click *Next* after selecting.

**Job Setup Wizard for OneDrive Sync - Step 7 of 10**

### Configure Consistency Check

Enable a consistency check. Files will be compared to a hash value between files on the source and destination folders for uploading/downloading. If there are any inconsistencies between files, the system will try syncing again.

Enable  Disable

Back Next Cancel

- 13** Configure whether to filter the target files. The following screen is available to configure file filtering by file sizes and whether they're hidden. The file size filtering will work only for the upload process. The available maximum size is up to 15,360 MB (15 GB). "Hidden files" refer to files whose filename starts with a period. Configure the desired filtering settings and click Next.

**Job Setup Wizard for OneDrive Sync - Step 8 of 10**

### Configure File Filters 1

Configure the requirements for filtering files. If any files in the folder on either the LinkStation or OneDrive meet any of the following requirements, those files will not be synced.

**Filter by File Size**

Enable  Disable

Maximum Size:  MB

**Filter Hidden Files**

Enable  Disable

Back Next Cancel

- 14** The following screen is available to configure file filtering by extensions. Configure the desired filtering settings and click *Next*.

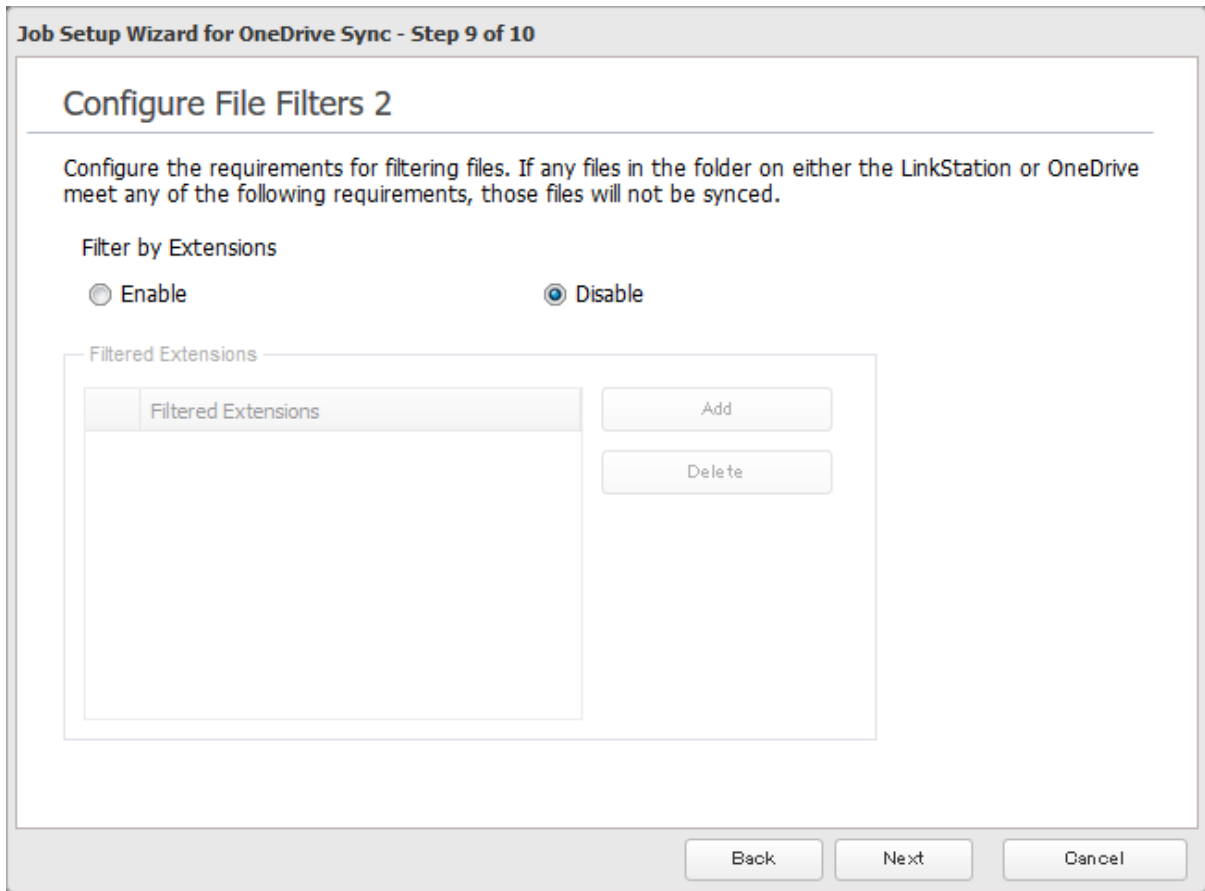

- 15** Confirm that all settings are properly configured and click *OK*.

- 16** Click *OK* when finished.

**Notes:**

- Files whose filename contains the symbols " # % & \* / : > < ? \ } { ~ may fail to be synchronized. This symbol limitation is based on "Normalization Form Canonical Composition (NFC)". If you copy files that contain any of these symbols to a LinkStation folder from macOS, the filenames may be converted to different ones that don't contain these symbols.
- Depending on your network environment, you may fail to download larger files. To prevent this issue, divide a larger file into smaller files or compress the files to a smaller size before uploading them to OneDrive.
- If a file's size is zero bytes, a sync error occurs and the file will not be synchronized. The I64 message will appear on the Dashboard in Settings and NAS Navigator2.

## Changing Job Settings

Follow the procedure below to change any job settings you have already configured.

- 1** From Settings, click *Cloud Storage*.

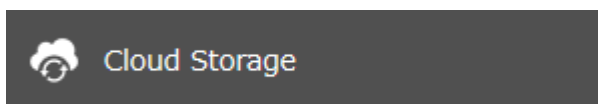



2 Click the settings icon (  ) to the right of “Microsoft OneDrive Sync”.



3 From the job list, click the job whose settings you want to change.

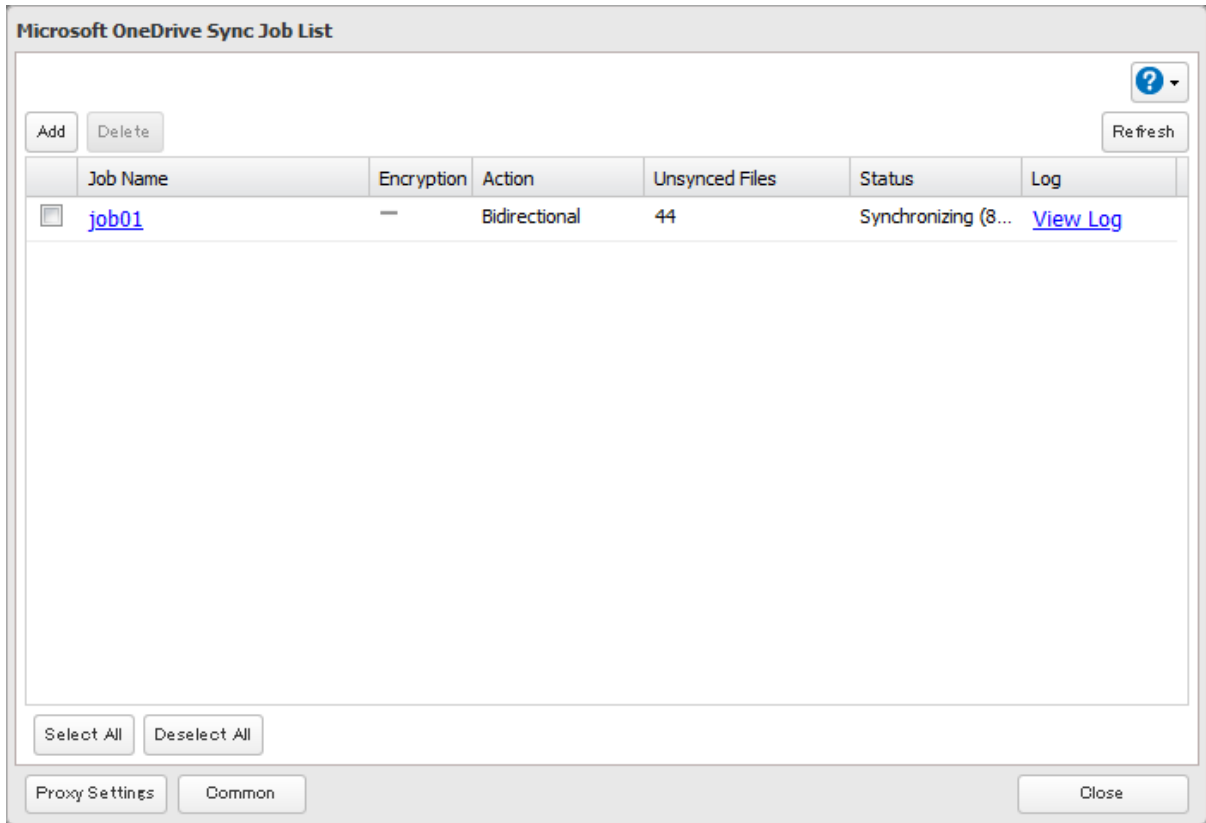

**4** Click the *Options* tab.

The screenshot shows a dialog box titled "Job Settings". It has two tabs: "Basic" and "Options". The "Options" tab is selected. The dialog displays the following information:

Job Name:	job01
Folder on LinkStation:	share
Folder on OneDrive:	OneDrive/Drive1/
Used Space on OneDrive:	3.5 GB
Total Capacity on OneDrive:	5.0 GB
Account Name:	admin

A "Close" button is located at the bottom right of the dialog box.

**5** Click *Edit*.

## 6 Configure the desired settings and click OK.

**Job Settings**

**Sync Settings** | Filter Settings

Sync Action: Bidirectional

Files with Same Names: Keep files on OneDrive

Sync Period: 5 minutes

Frequency: Daily

Start Time: 01:00

End Time: 05:00

Day of Week:  Sunday  Monday  Tuesday  Wednesday  
 Thursday  Friday  Saturday

Consistency Check:  Enable  Disable

OK Cancel

## Corrective Actions for in Case of Error

You may encounter error messages that contain the following error codes when creating OneDrive Sync jobs; the error log may contain the following error codes as well. If you encounter one of the following error codes, refer to the table below and try the respective corrective action. If the error code is not listed on the table, refer to the Microsoft website instead: <https://docs.microsoft.com/en-us/onedrive/developer/rest-api/concepts/errors?view=odsp-graph-online>.

Code	Description	Corrective Action
access_denied	Access denied for the requested information.	To link with OneDrive, please consent to the request from OneDrive.
server_error	The authentication server encountered a temporary error.	Please wait for about 10 minutes and try again.
temporarily_unavailable	The authentication server is too busy.	Please wait for about 10 minutes and try again.
authcode_notfound	The authentication server is too busy.	Please wait for about 10 minutes and try again.
auth_server_error	The authentication server encountered a temporary error.	The authentication server will recover within UTC 12:00 midnight–8:45 a.m. (Mon–Fri). Please wait until it recovers.
auth_server_maintenance	The authentication server is currently undergoing maintenance.	Maintenance will finish within UTC 12:00 midnight–8:45 a.m. (Mon–Fri). Please wait until maintenance finishes.

Code	Description	Corrective Action
activityLimitReached	There are too many requests so data could not be synchronized.	Check that the same Microsoft account is used on another Buffalo NAS device or Microsoft software. This error may be resolved by reducing the maximum number of threads per job on the window that appears by navigating to the job list and then clicking <i>Common</i> .
network_error	Could not register the authentication code.	Check that the network or proxy server settings are correct.
Unexpected error	Unknown error.	Please wait for about 10 minutes and try again.

## WebAccess

WebAccess is a software utility for accessing the files in the shared folder of your LinkStation from your computer or mobile devices through the Internet. **Be careful when configuring WebAccess. Certain settings can make the files in the shared folder available to anyone on the Internet, without any access restrictions.**

**Note:** WebAccess supports downloading up to 10,000 files at a time. Attempting to download 10,000 or more files at a time may result in unexpected behavior.

### Configuring WebAccess

You can configure WebAccess from a computer or a mobile device. Follow the appropriate procedure below to configure WebAccess.

#### Using a Computer

- 1 From Settings, click *File Sharing*.

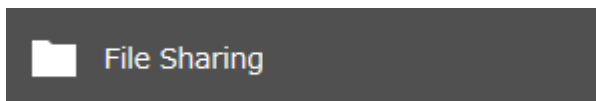

- 2 Click the settings icon (  ) to the right of "WebAccess".



- 3 Click *Edit*.

#### 4 Configure the desired settings, then click *OK*.

- To use SSL encryption for more secure data transfers, enable “HTTPS/SSL Encryption”.
- You may use the BuffaloNAS.com server as a DNS server, or disable it to use a different DNS server.
- Choose a “BuffaloNAS.com Name” and “BuffaloNAS.com Key” for your WebAccess account. Names and keys may contain between 3 and 20 alphanumeric characters, underscores (\_), and hyphens (-).
- If “Exclusive Session” is enabled, multiple users cannot be logged in to WebAccess at the same time. Only the last login will be active.
- Enter a time in minutes (1 to 120, or “Unlimited”) before inactive users are logged out of WebAccess.

#### 5 Move the WebAccess switch ( ) to the position to enable WebAccess.



#### 6 Click the settings icon ( ) to the right of “Folder Setup”.



#### 7 Select a shared folder to publish.

##### Notes:

- For best results, create a new dedicated share for WebAccess.
- When accessing shared folders through WebAccess from a remote location, a username and password may be required for certain operations. For best results, create a user account with permissions on the WebAccess share before using WebAccess.

**8** Under “LAN Protocol Support”, select the “WebAccess” checkbox on the *Basic* tab.

LAN Protocol Support:  SMB (Windows/Mac)  Backup  
 FTP  WebAccess

**9** Click the *Option 2* tab.

**10** Select the desired WebAccess security level for “WebAccess Permissions”.

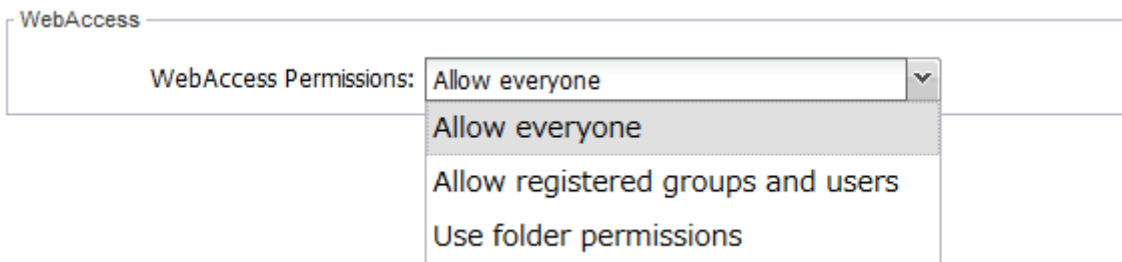

**Allow everyone:** Anyone can access (view) shared folders. (Access restrictions configured for shared folders will not work.)

**Allow registered groups and users:** All groups and users registered on the Buffalo NAS device can use WebAccess. (Access restrictions configured for shared folders will not work.)

**Use folder permissions:** Users and groups have the same access permissions with WebAccess that they do locally. If access restrictions are not set for the shared folder, then this option will not be shown.

**11** Click *OK*.

## Using a Mobile Device

**Note:** On your mobile device, download and install the “SmartPhone Navigator” and “WebAccess” apps from App Store (iOS or iPadOS devices) or Google Play (Android devices).

**1** Tap the SmartPhone Navigator icon (  ) on your mobile device.

**2** Select the NAS device from the NAS list to configure WebAccess.

**3** Tap *NAS Setup*.

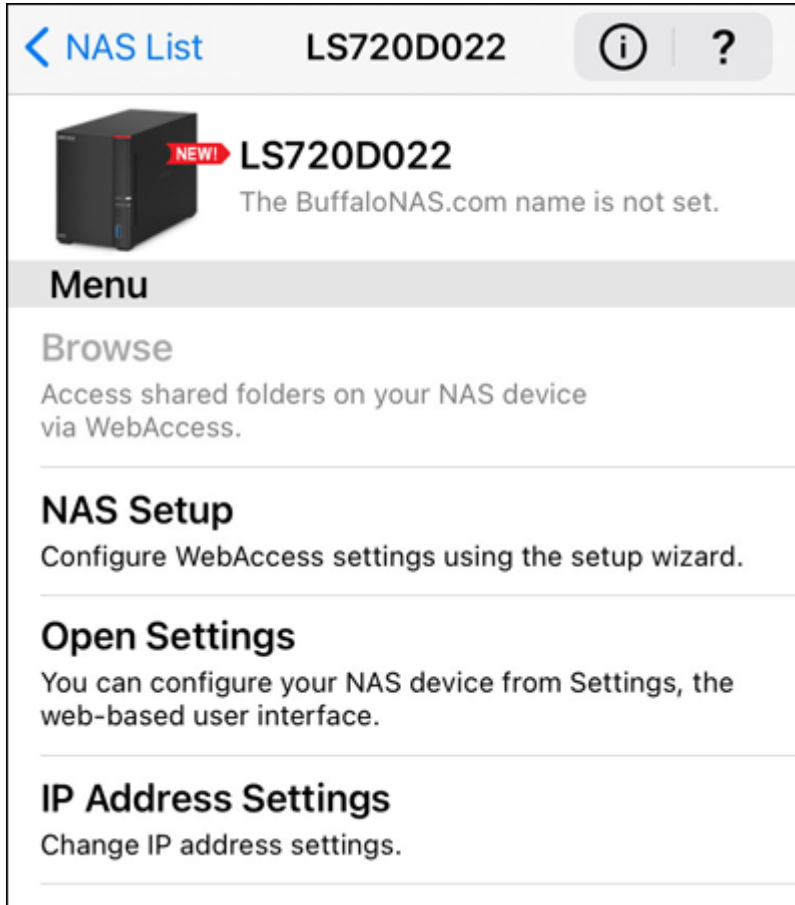

- 4 Enter a username and password (twice), then tap *Next*. If the user with the entered username doesn't already exist, a new user and a shared folder with the same name as the username will be created.

The screenshot shows a mobile application screen titled "NAS Setup". At the top left is a blue back arrow and the word "Back". The title "NAS Setup" is centered at the top. Below the title is a paragraph of instructions: "Enter a username and password. If the username and password don't already exist, a new user will be created. A shared folder with the same name as the user will be created." To the right of this text is a small grey circle with a white question mark. Below the text are three input fields: "Username", "Password", and "Password (Confirm)". At the bottom of the screen, separated by a wavy line, are two buttons: "Cancel" on the left and "Next" on the right.



- 5** Enter the desired BuffaloNAS.com name and tap *Set*.

Configure your BuffaloNAS.com name. You will use this name for opening the shared folder from an external network. The BuffaloNAS.com name may contain up to 20 alphanumeric characters.

If UPnP is not enabled on your network, setup will finish at the screen below and you will only be able to access your NAS device from the local network. To use WebAccess from outside your home, reconfigure WebAccess by referring to the [“Unable to Create a BuffaloNAS.com Name”](#) section below.

## Setup Complete

Configuration finished. You can now access your NAS using WebAccess.

**Note: You cannot access from an external network.**

Tap 'Open WebAccess' to access the NAS device using the WebAccess app.

---

[Finish](#) [Open WebAccess](#)

- 6 Tap *Finish* to exist the app. Alternatively, tap *Open WebAccess* to launch the WebAccess app and have a shortcut to your NAS device created.

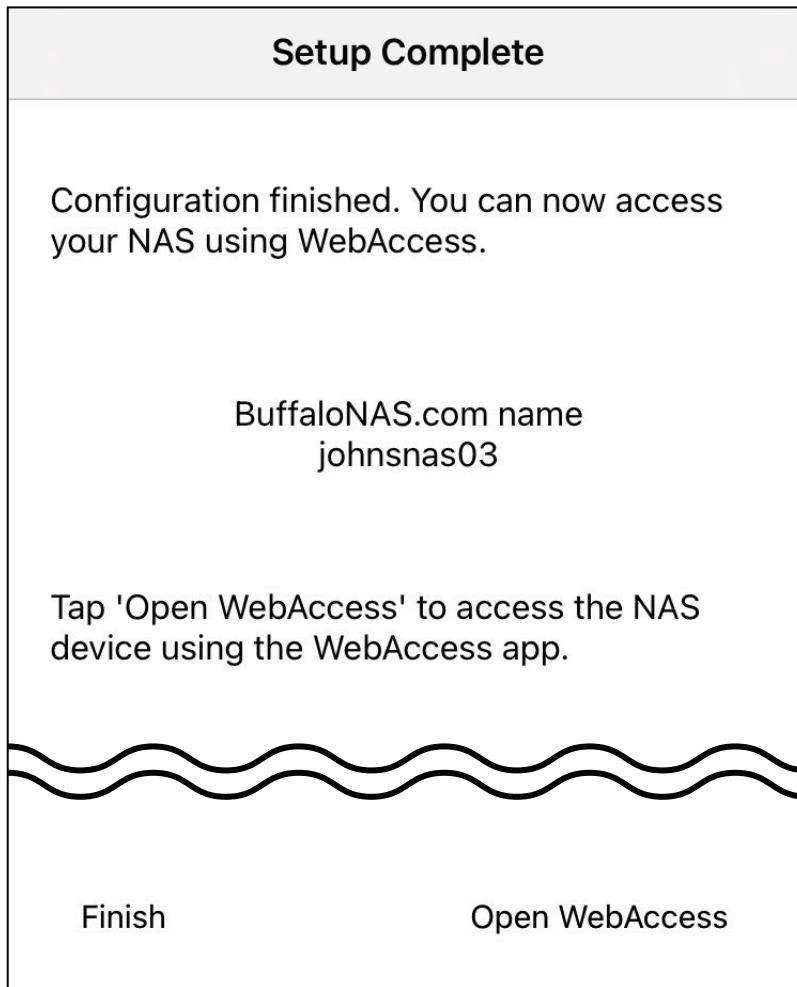

**Note:** Whether a user or group can access a folder through WebAccess depends on a combination of WebAccess settings and the shared folder's settings.

		Not logged in	Access restrictions for the logged-in users		
			No access	Read-only	Read and write
WebAccess permissions	Allow everyone	R	R/W	R/W	R/W
	Allow registered groups and users	-	R/W	R/W	R/W
	Use folder permissions	-	-	R	R/W

R/W: Read and write, R: Read-only, -: No access

## Accessing via WebAccess

There are many ways to access WebAccess folders depending on your device:

### For Mobile Devices

To access from a mobile device, install the "WebAccess" app by referring to the "[WebAccess](#)" section in chapter 1. Refer to the help guide for the app for more detailed information on using the app.

**For Computers**

Use a web browser on a computer; supported browsers include Microsoft Edge, Firefox, Google Chrome, Internet Explorer 9 or later, Safari 9 or later. Refer to the help guide at the BuffaloNAS.com website after connecting with your BuffaloNAS.com name for more detailed information.

**Unable to Create a BuffaloNAS.com Name**

If UPnP is disabled on your router, creating the BuffaloNAS.com name may fail. If this occurs, try the following procedure.

**Using a Computer**

- 1 From Settings, click *File Sharing*.

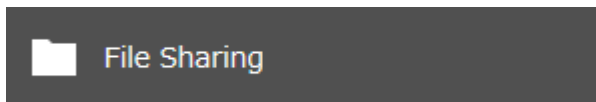

- 2 Click the settings icon (⚙️) to the right of "WebAccess".



- 3 Click *Edit*.

- 4 Enable "Access via BuffaloNAS.com Server" and the desired BuffaloNAS.com name and key.

**WebAccess Settings** \*Required ?

HTTPS/SSL Encryption:  Enable  Disable

Access via BuffaloNAS.com  Enable

Server:

BuffaloNAS.com Name \* :

BuffaloNAS.com Key \* :  Generate Random Key

Disable

Other DNS Service Hostname \* :

UPnP:  Enable  Disable

External Port \* :

NAS Internal Port \* :

Exclusive Session:  Enable  Disable

Session Timeout \* :  minutes  Unlimited

LAN Only OK Cancel

- 5 Disable "UPnP" and a router's port number into the "External Port" field, then click *OK*.

- 6 When configuring the required settings on the Buffalo NAS device is finished, next configure the router using the port number set at step 5 above.

## Using a Mobile Device

- 1 From Settings, tap *WebAccess*.

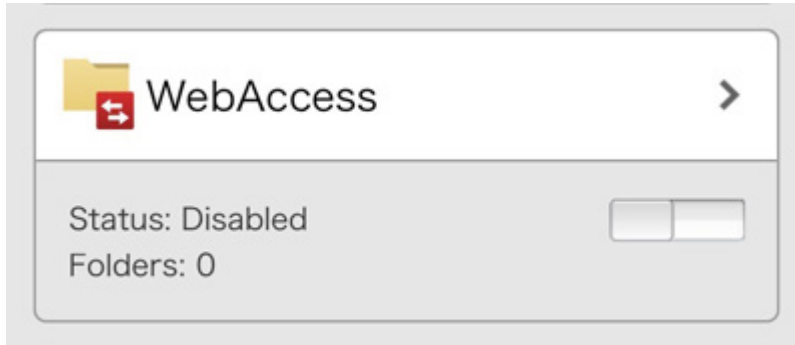

- 2 Select the desired WebAccess security level of shared folders and tap *OK*.

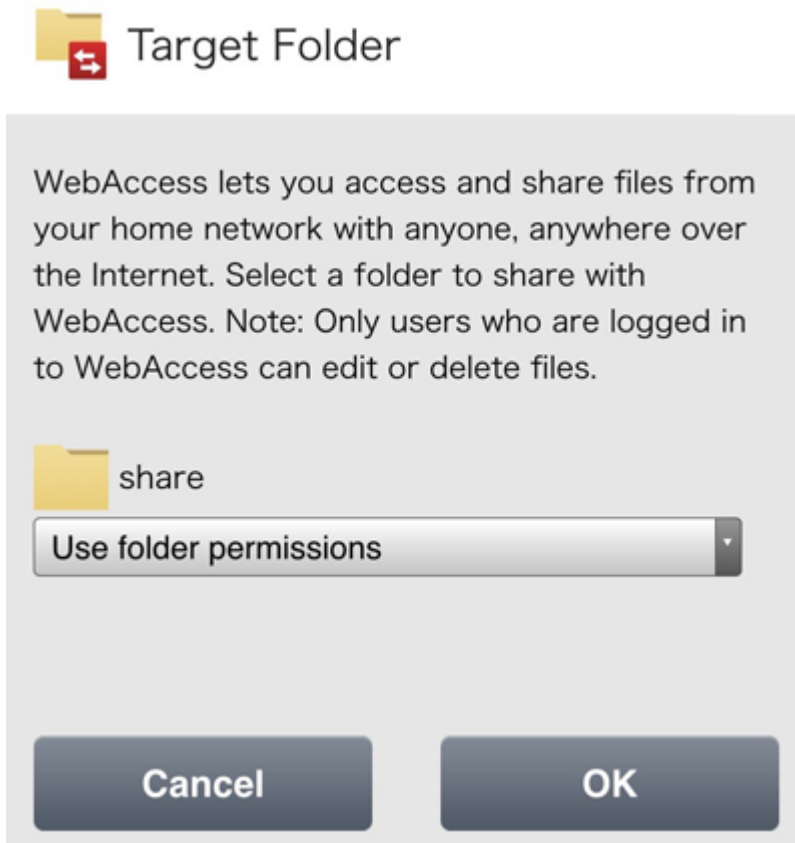

- 3 Tap *OK*.

- 4** Enter the desired BuffaloNAS.com name.

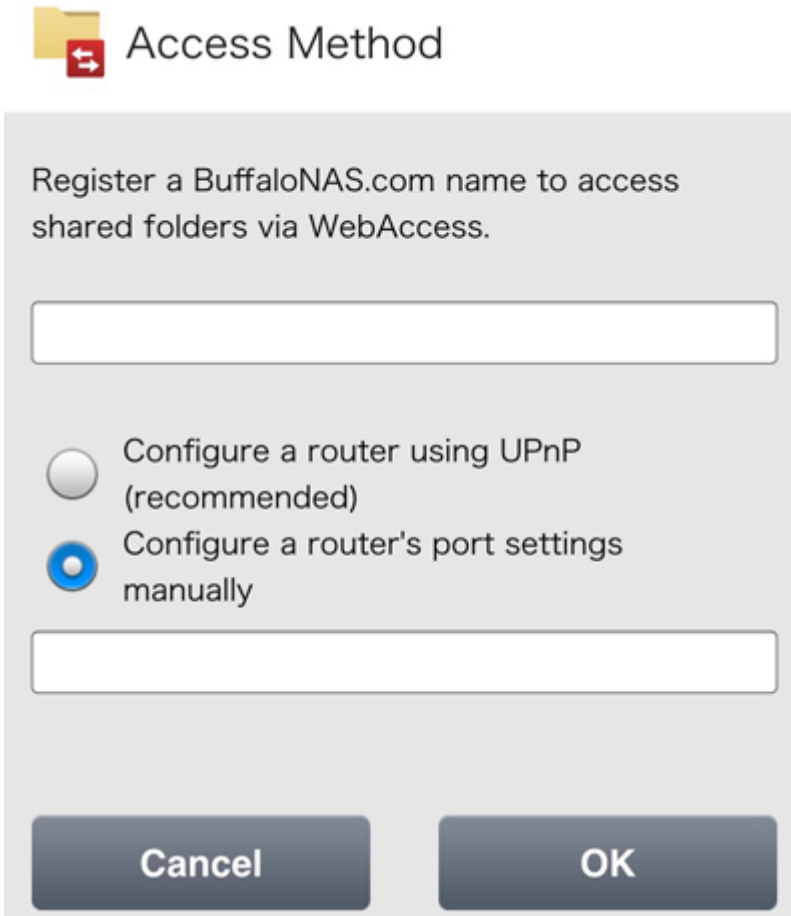

**Access Method**

Register a BuffaloNAS.com name to access shared folders via WebAccess.

Configure a router using UPnP (recommended)  
 Configure a router's port settings manually

Cancel OK

- 5** Select “Configure a router's port settings manually”, enter the router’s port number, and tap *OK*.
- 6** When configuring the required settings on the Buffalo NAS device is finished, next configure the router using the port number set at step 5 above.

---

## FTP

---

By default, the LinkStation’s shares are only accessible by users connected to the same network or router as the LinkStation. The optional FTP server allows users outside the local network to access the LinkStation.

**Note:** FTP is intended for users who already have FTP client software and have experience with it.

- 1** From Settings, click *File Sharing*.

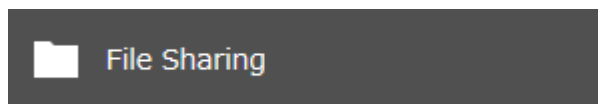

- 2** Move the FTP switch (  ) to the  position to enable FTP.



**3** Click the settings icon (  ) to the right of “Folder Setup”.



**4** Choose a folder to enable remote FTP access on.

**5** Under “LAN Protocol Support”, select the “FTP” checkbox on the *Basic* tab.

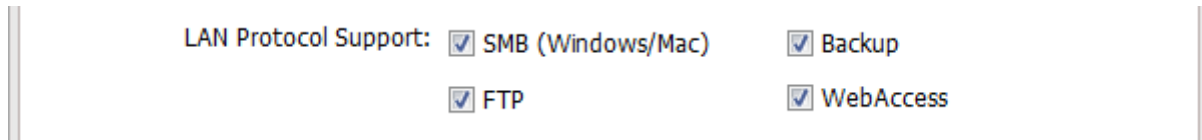

**6** Select read-only or read and write for the shared folder’s attribute on the *Option 2* tab and click *OK*.

### Accessing the LinkStation with an FTP Client

To access the LinkStation via FTP, configure your FTP client software with the following settings:

- Hostname: IP address of the LinkStation
- Username: the LinkStation’s username
- Password: the LinkStation’s password
- Port: 21

### Accessing the LinkStation with an Anonymous User

To allow anonymous access to your FTP share, disable access restrictions. Configure your FTP client software with the following settings for anonymous FTP access:

- Hostname: IP address of the LinkStation
- Username: “Anonymous”
- Password: any character string
- Port: 21

### Notes:

- If the LinkStation joins a domain, domain and anonymous users cannot remote access via FTP.
- Shared folders connected by FTP are available from the “/mnt” folder. The examples of default locations are:
  - /mnt/array1/share
  - /mnt/disk1/share
  - /mnt/usbdisk1
- For FTP connections, make sure that the total filename length including the folder path is 250 single-byte characters or fewer.

# Chapter 6 Multimedia

DLNA is a set of guidelines for sharing digital media. The LinkStation includes a DLNA server compliant with the DLNA guidelines. Videos, images, and music saved on the LinkStation can be played back on DLNA-compatible TVs, stereo equipment, game consoles, and other devices on the local network.

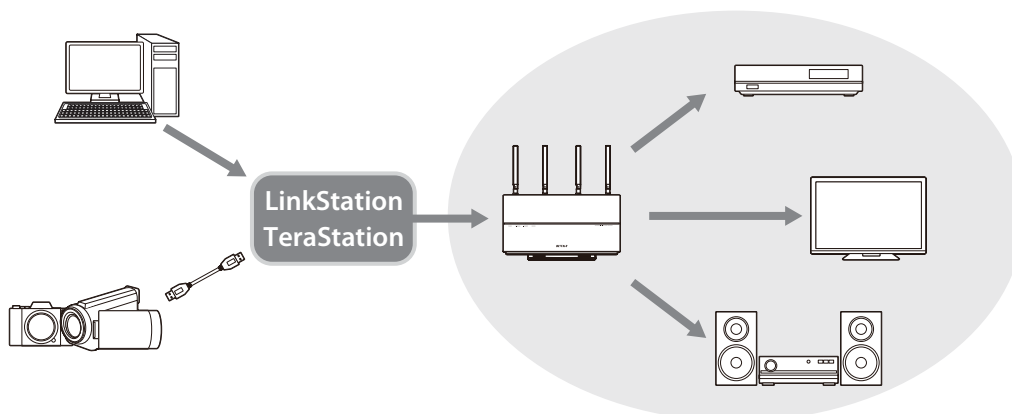

## Displaying for DLNA Clients

### Enabling DLNA

You can enable DLNA from a computer or a mobile device. Follow the appropriate procedure below to enable DLNA.

#### Using a Computer

- 1 From Settings, click *Applications*.

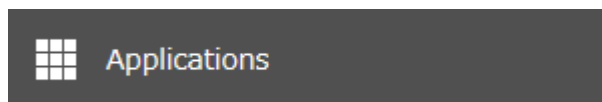

- 2 Move the DLNA switch (  ) to the  position to enable DLNA.



- 3 Click the settings icon (  ) to the right of "DLNA Server".





- 4 Select the display language for content management and click *OK*.

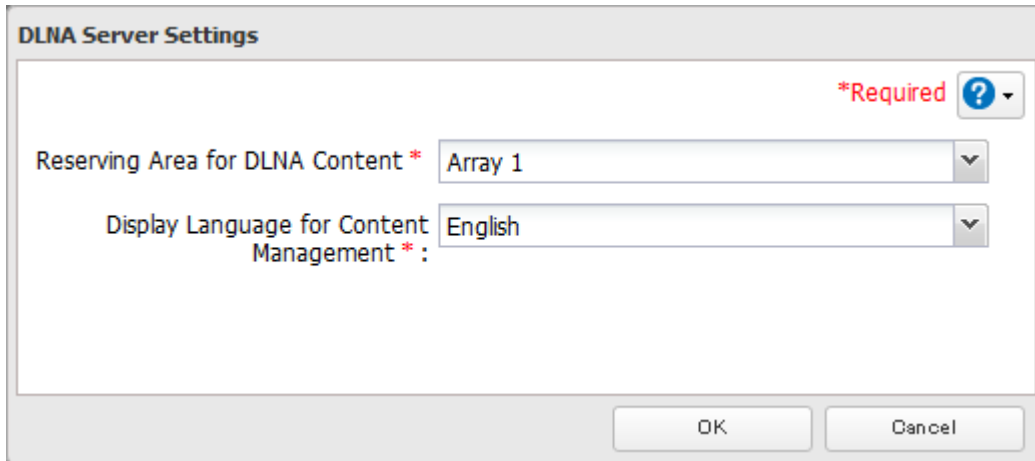

The image shows a dialog box titled "DLNA Server Settings". It contains two dropdown menus. The first is labeled "Reserving Area for DLNA Content \*" and is set to "Array 1". The second is labeled "Display Language for Content Management \*:" and is set to "English". A red asterisk and a question mark icon are visible in the top right corner, indicating required fields. At the bottom of the dialog are "OK" and "Cancel" buttons.

## Using a Mobile Device

- 1 From Settings, move the DLNA switch (  ) to the  position to enable DLNA.

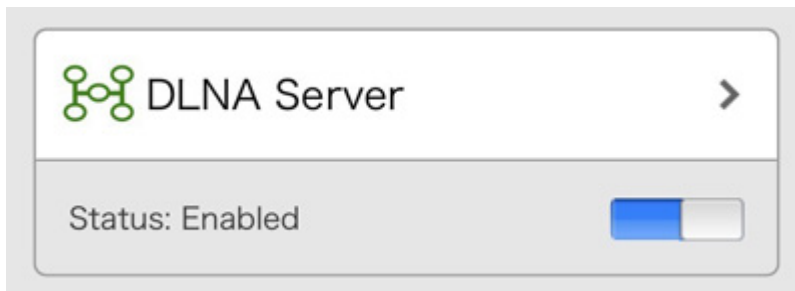

- 2 Tap *DLNA Server*.

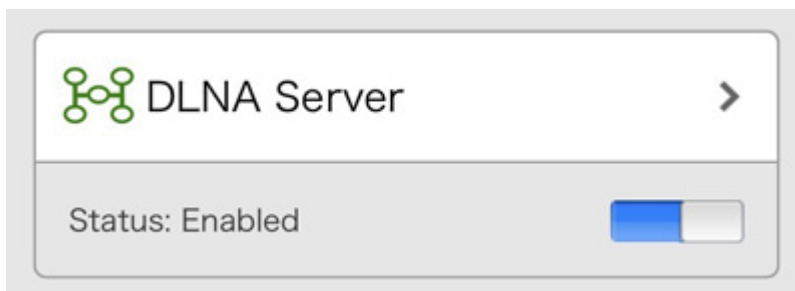

- 3 Select the display language for content management and tap *OK*.

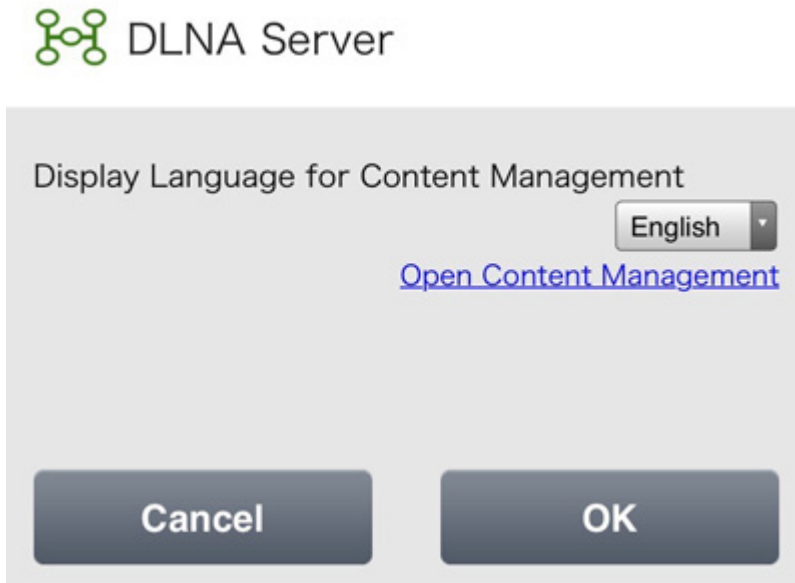

## Configuring Public Folders

- 1 From Settings, click *Applications*.

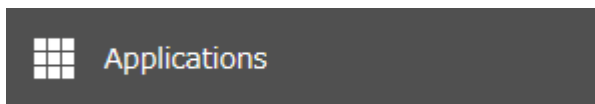

- 2 Click *Open Content Management*.



- 3 Navigate to *Basic Settings > Public Folder*.

- 4 Click *Add*.

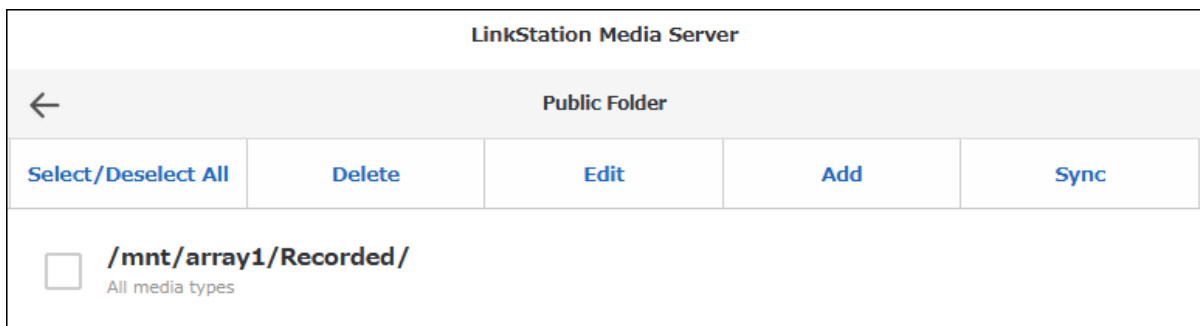

- 5 Select a shared folder to stream a file to a DLNA player and click *Next*.



- 6 Select the media type to store in the folder and click *Add*.

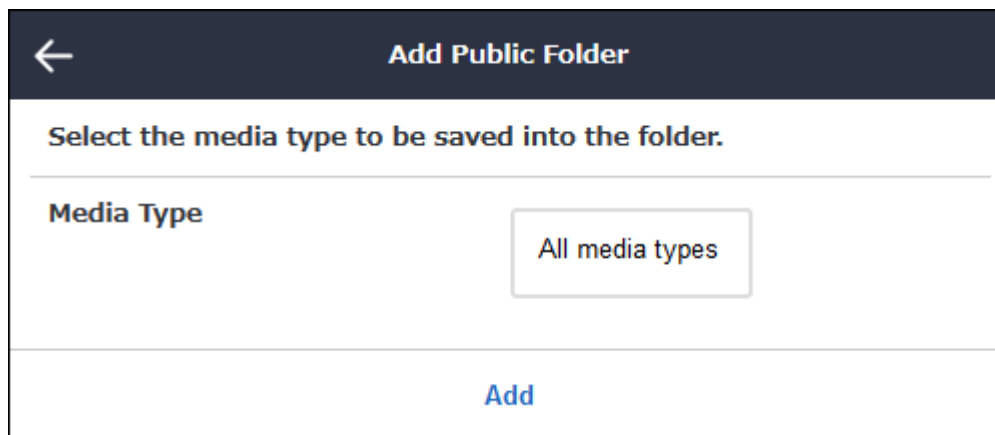

---

## File Playback

---

### Supported File Types

The LinkStation supports DLNA streaming of files with the extensions below.

Types	File Extensions
Video files	mpe, mpeg, mpg, m2p, tts, m2ts, mts, wmv
Audio files	mp3, wma, lpcm, pcm
Image files	jpg, jpeg

## Playing Files

To play back a file from a DLNA-compatible device:

- 1 Connect the DLNA-compatible device to the same network as the LinkStation and turn it on.
- 2 Select the LinkStation from the software of the DLNA-compatible device.
- 3 Select the file to be played back.

**Note:** For more information on playing files, refer to the DLNA-compatible devices' manuals.

## Changing Public File Type

You can set the file types to public for DLNA.

- 1 From Settings, click *Applications*.

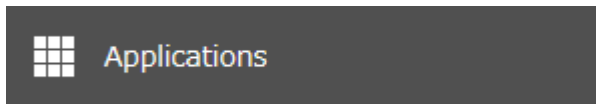

- 2 Click *Open Content Management*.

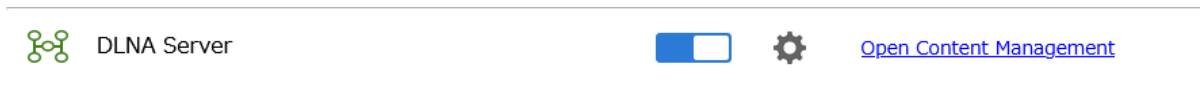

- 3 Navigate to *Basic Settings > Public File Type*.
- 4 The list of file types that can be stream to the DLNA player. This example shows the procedure for adding a new file type.  
Click *Add*.

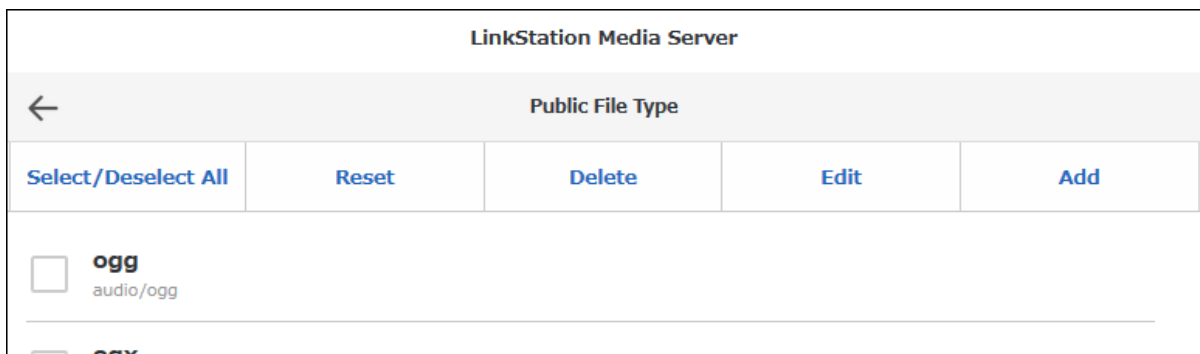

- 5** Enter an extension and media type (MIME type), then click *Add*.

**Add Public File Type**
✕

**Enter a file type to be set as public.**

---

**Extension**

---

**Media Type**

---

Close
Add

**Note:** If you want to restore the file type list to the factory default after changing the file types, click *Reset* on the page at step 4.

---

## Advanced Settings

---

### Changing Device Display Name

---

- 1** From Settings, click *Applications*.

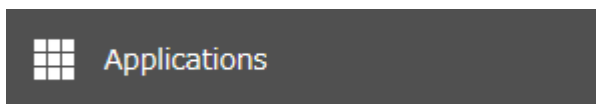

- 2** Click *Open Content Management*.



- 3** Navigate to *Basic Settings > Friendly Name*.

- 4** Change the friendly name to the desired name and click *Apply*.

**LinkStation Media Server**

← **Friendly Name**

[Reset](#) [Apply](#)

**Friendly Name**

LS720D022 [LinkStation Media Server]

## Restricting the Device Access

You can allow or deny the DLNA players on the network access to the LinkStation.

- 1** From Settings, click *Applications*.

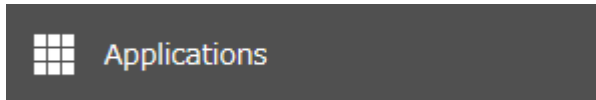

- 2** Click *Open Content Management*.



- 3** Navigate to *Basic Settings > Device Permissions > Access-Permitted Devices*.

- 4** Select the devices to be denied access and click *Deny*.

**LinkStation Media Server**

← **Access-Permitted Devices**

[Select/Deselect All](#) [Deny](#) [Delete](#)

**192.168.10.70**  
192.168.10.70 xx:xx:xx:xx:xx:xx

**192.168.10.69**

**Note:** If you want to return access-denied devices to access-permitted devices, navigate to *Device Permissions > Access-Denied Devices*, select the devices to have access restored, and click *Allow*.

By default, a newly-detected device will automatically be set as an access-permitted device. This setting can be changed by following the steps below.

- 5** From Settings, click *Applications*.

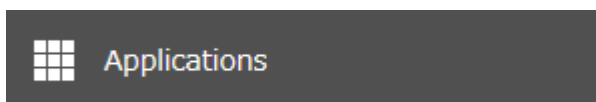

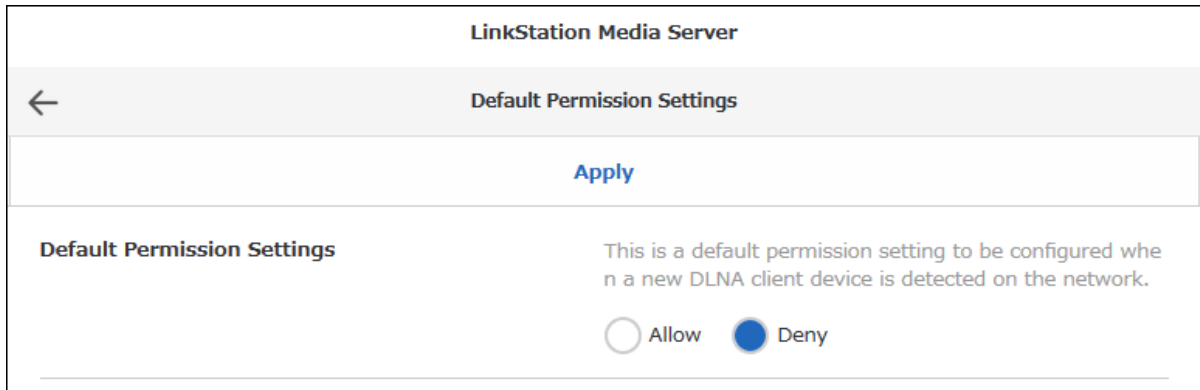
**6** Click *Open Content Management*.**7** Navigate to *Basic Settings > Device Permissions > Default Permission Settings*.**8** Set to “Deny” for “Default Permission Settings” and click *Apply*.

## Changing the Folder Display Language on DLNA Player

You can change the display language for folders on the LinkStation when accessing them from a DLNA player. It is set to English by default.

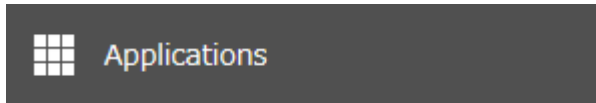
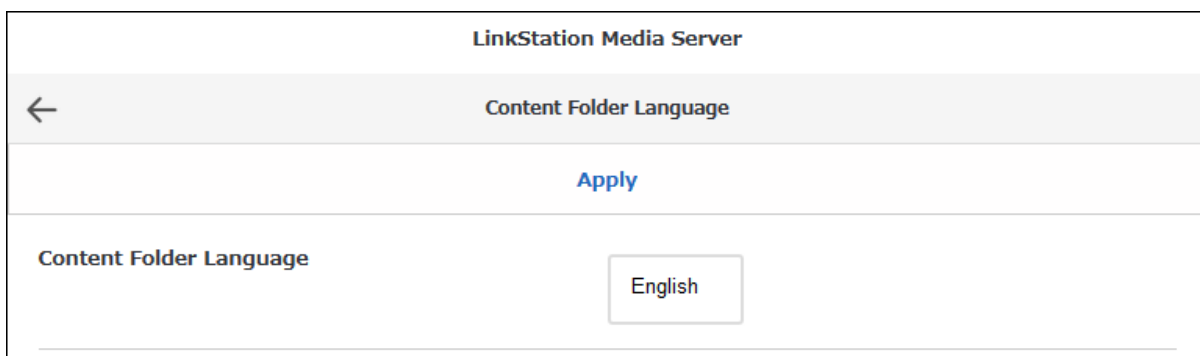
**1** From Settings, click *Applications*.**2** Click *Open Content Management*.**3** Navigate to *Basic Settings > Content Folder Language*.**4** Select the desired language from the drop-down list and click *Apply*.

## Managing Media Files and Folders

Content management can create a folder or rename a media file title.

**Note:** If your LinkStation unit is running firmware version 1.00, a folder named “dummy” will be displayed under content management as well as from DLNA devices. This folder is reserved for system use only. For safety, make sure your unit’s firmware is updated to the latest version.

### Creating Folders

- 1 From Settings, click *Applications*.

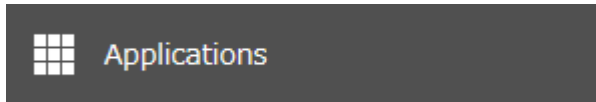

- 2 Click *Open Content Management*.



- 3 Navigate to *Content Management > Media Content*.

- 4 Click *Folders*.

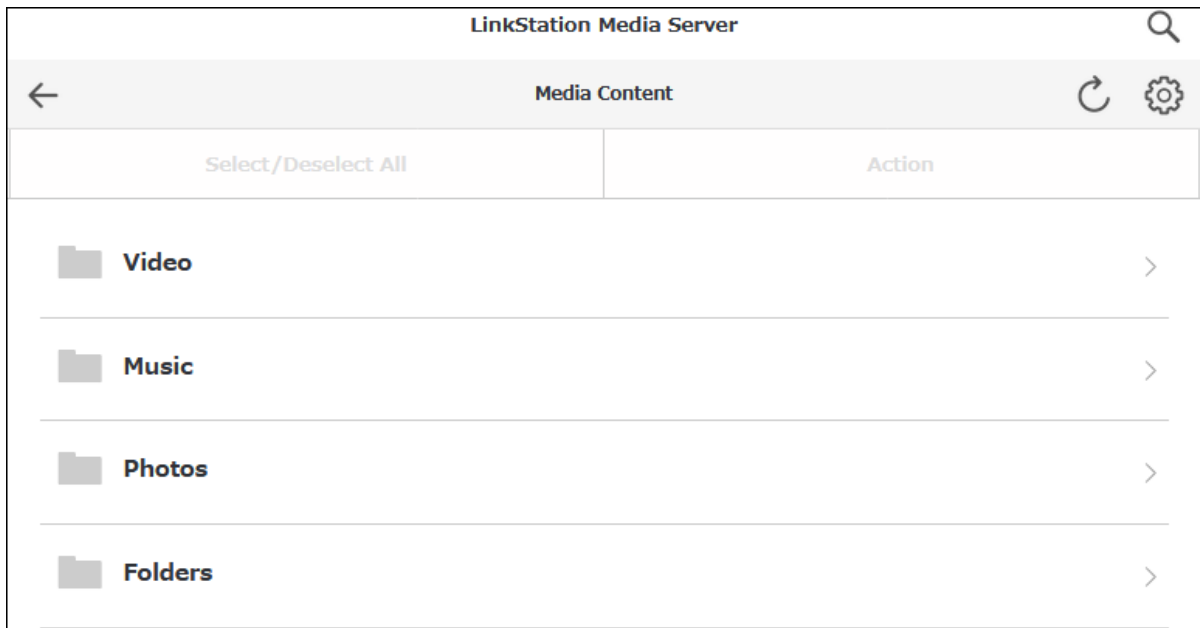

**Note:** The Media Content folders will be displayed in the language set under Content Folder Language.



**5** Select the location to create a new folder.

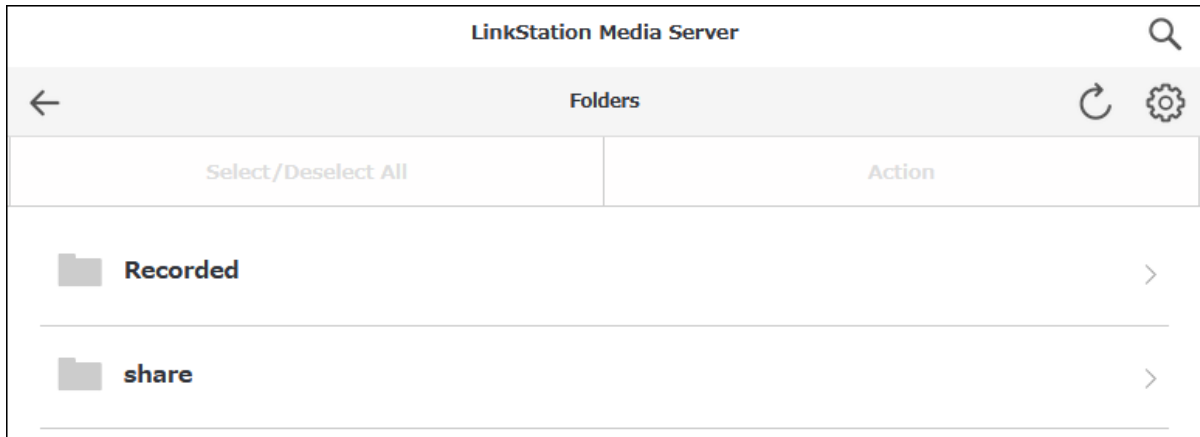

**6** Click *Action*.

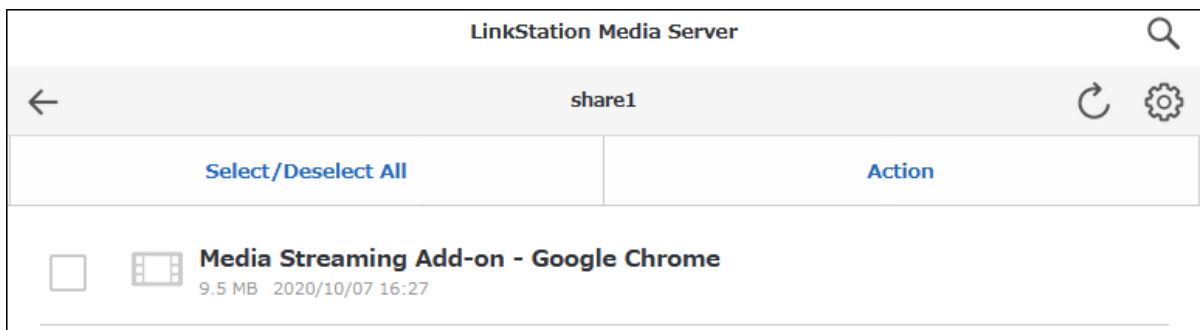

**7** Click *Create Folder*.

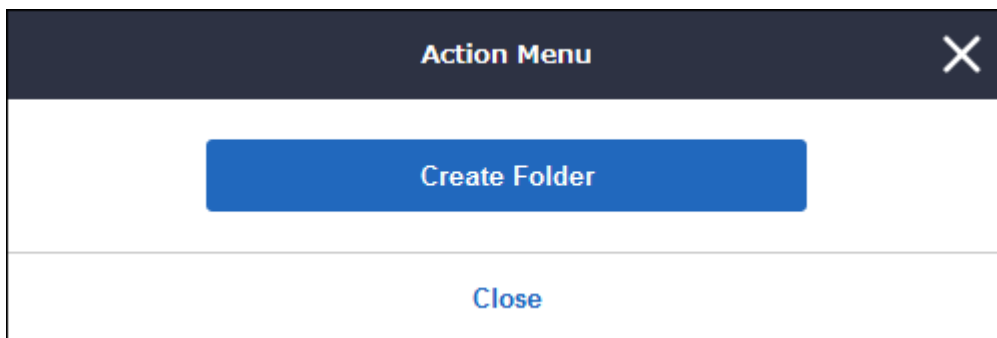

**8** Enter a desired folder name and click *Create*.

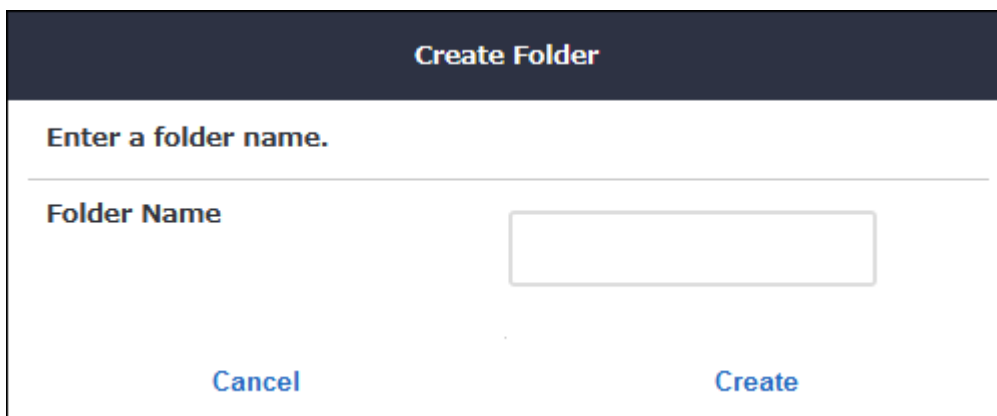

## Moving Files

- 1 From Settings, click *Applications*.

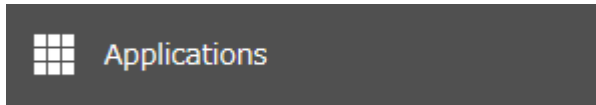

- 2 Click *Open Content Management*.



- 3 Navigate to *Content Management > Media Content*.

- 4 Click *Folders*.



**Note:** The Media Content folders will be displayed in the language set under Content Folder Language.

- 5 Select the location that contains the file you want to move.

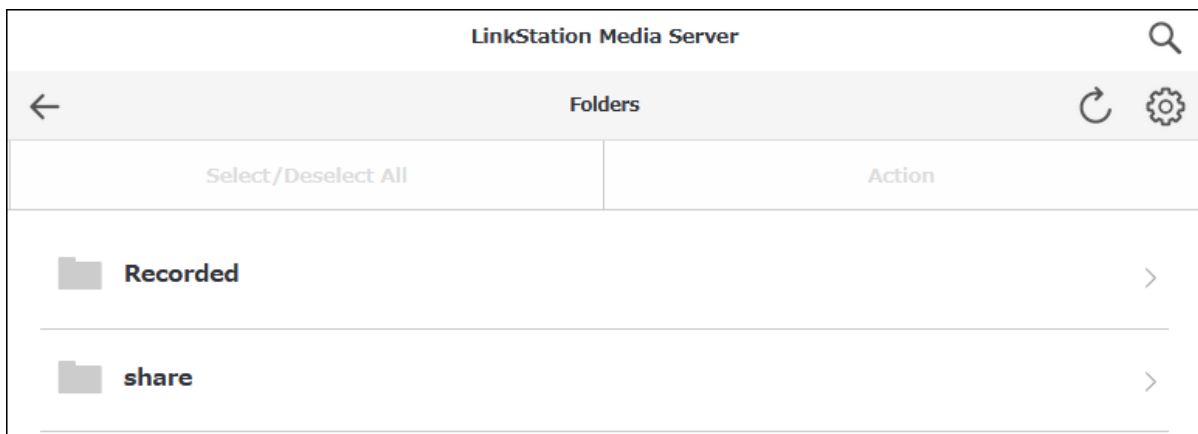

**6** Select a file to move and click *Action*.

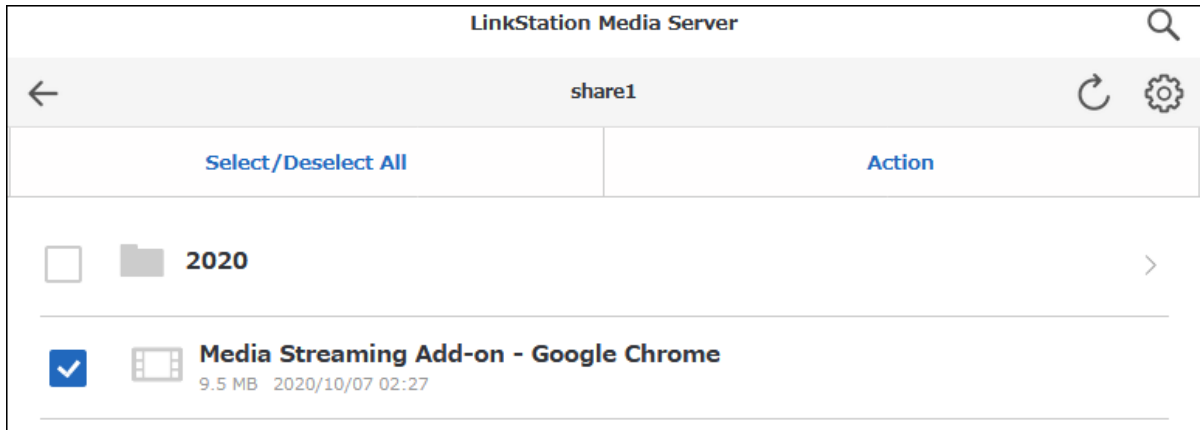

**7** Click *Move*.

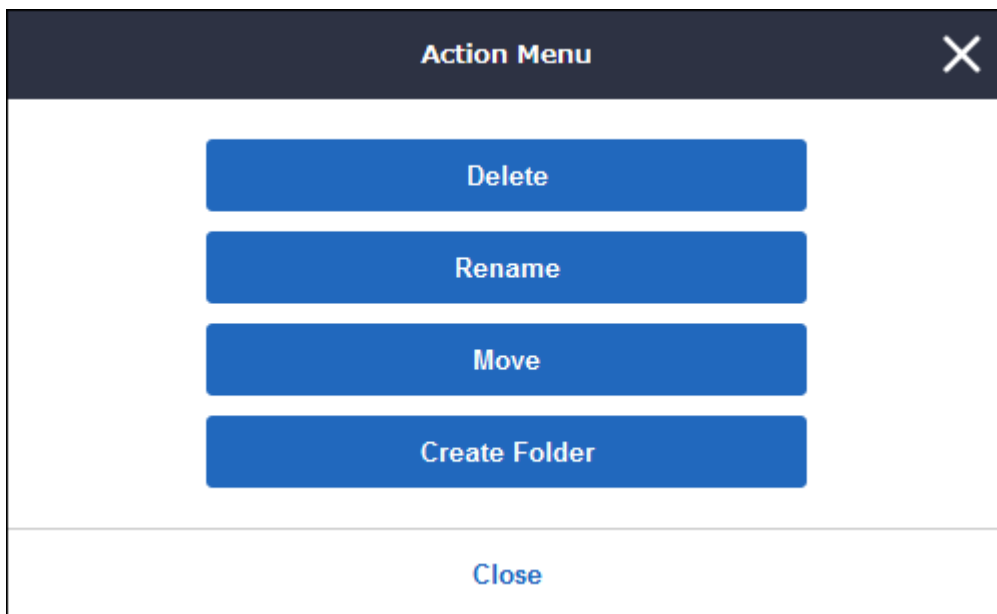

- 8 Select a folder that the file will be moved to and click *Move*.

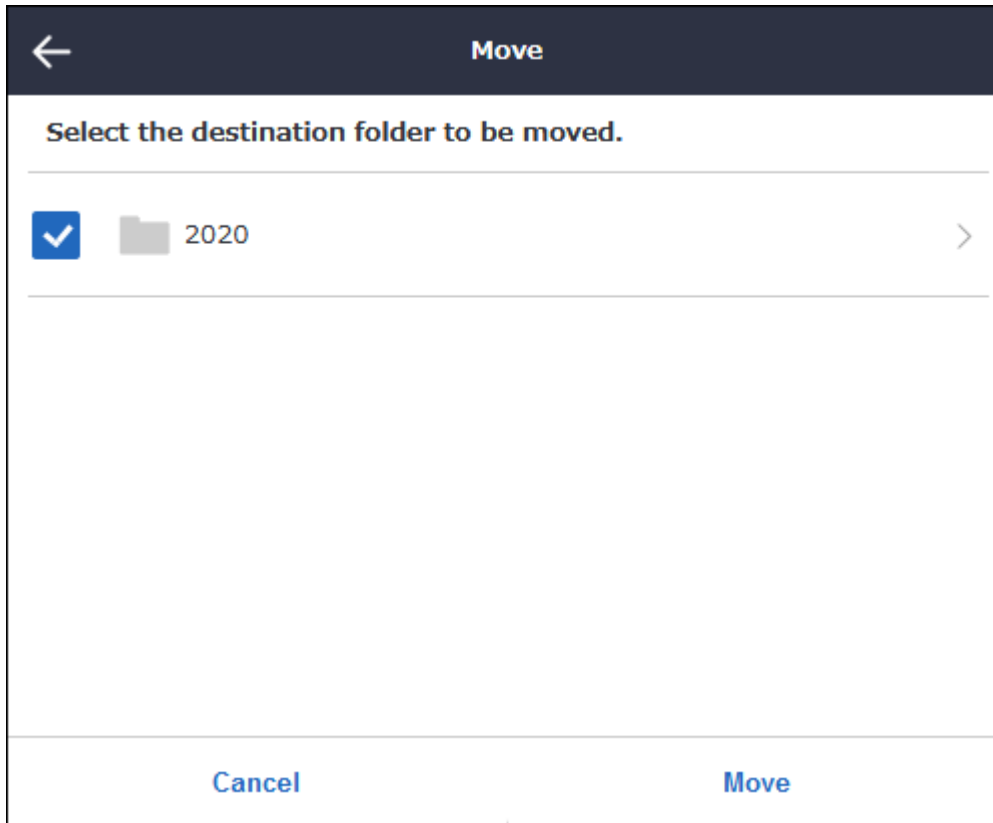

## Renaming Files or Folders

Media file titles or folder names can be renamed.

**Note:** If filenames are renamed, the changes will appear under “Title” in Properties. Names displayed when accessing from computers will not be affected.

- 1 From Settings, click *Applications*.

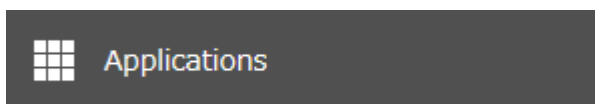

- 2 Click *Open Content Management*.



- 3 Navigate to *Content Management > Media Content*.

#### 4 Click *Folders*.

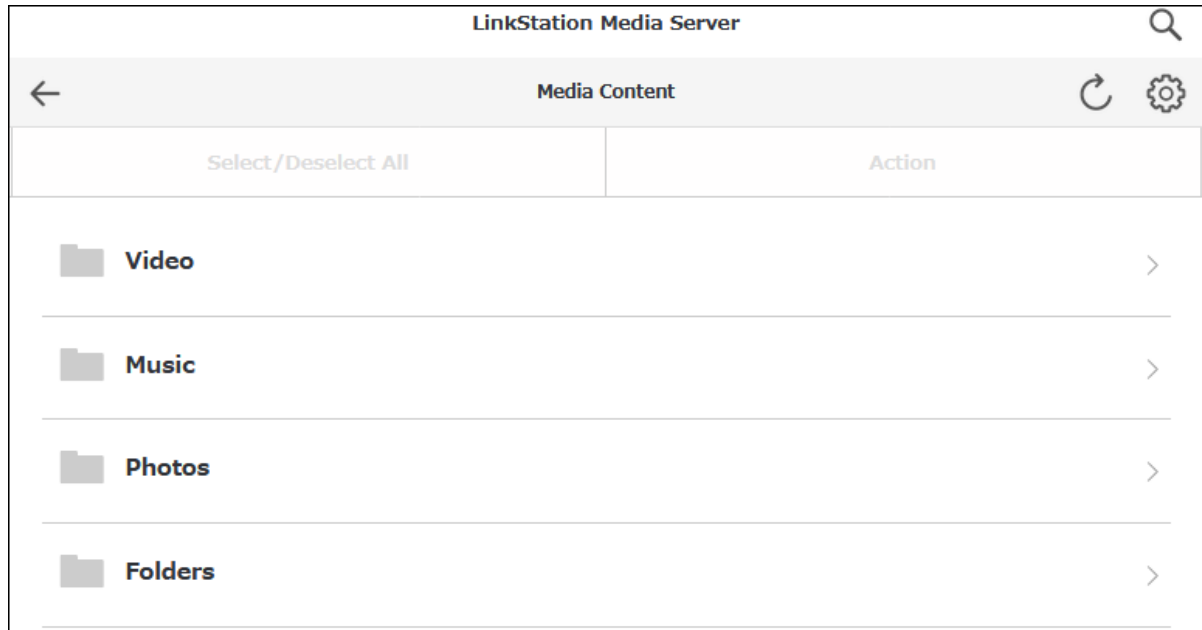

**Note:** The Media Content folders will be displayed in the language set under Content Folder Language.

#### 5 Select the location that contains the files or folders you want to rename.

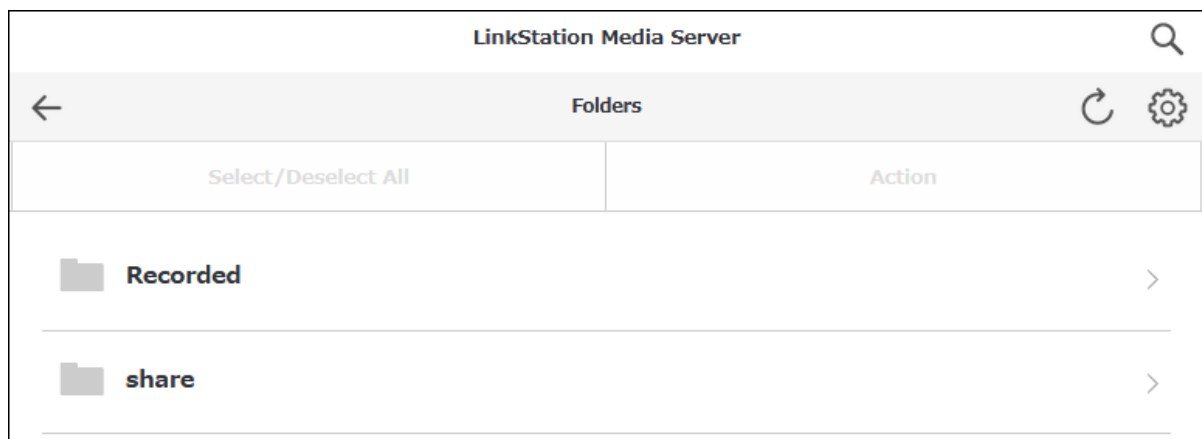

#### 6 Select a file or folder to rename and click *Action*.

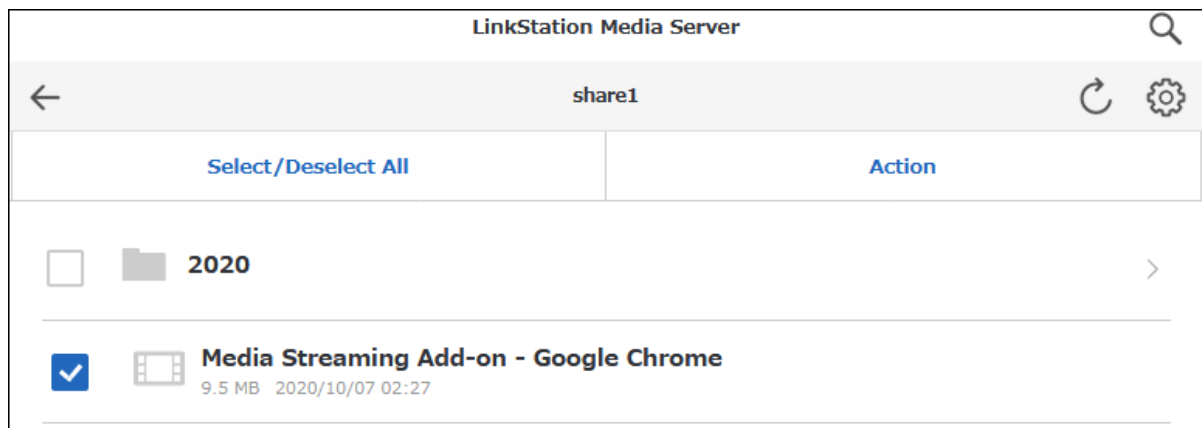

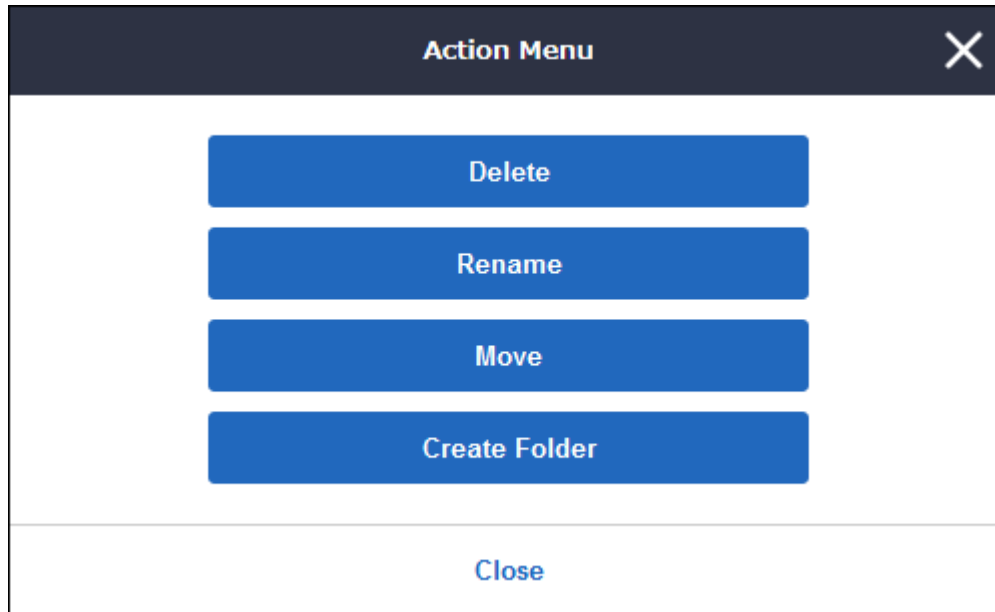
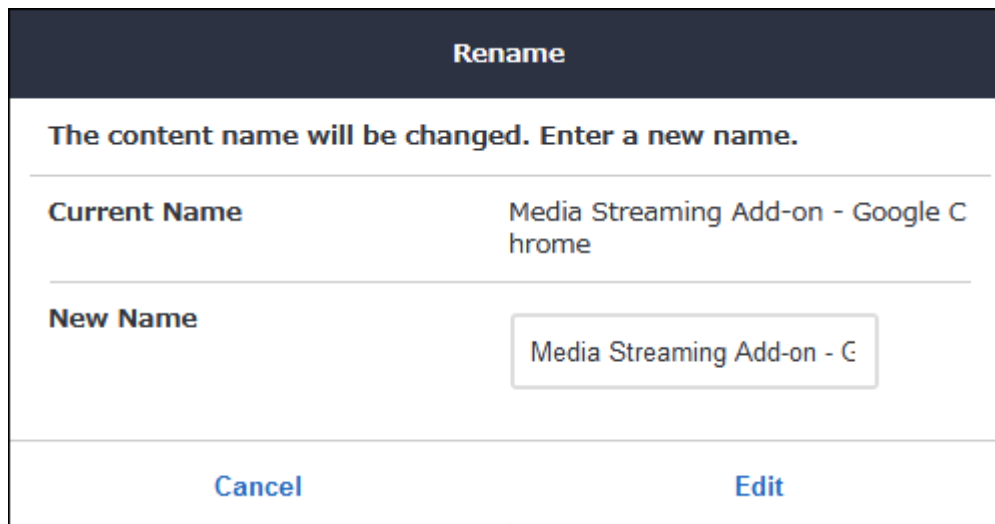
**7** Click *Rename*.**8** Enter a desired new name and click *Edit*.

## Deleting Files or Folders

---

Files and any folders created under content management can be deleted.

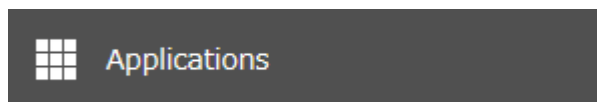
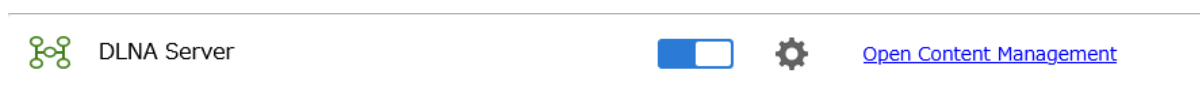
**1** From Settings, click *Applications*.**2** Click *Open Content Management*.**3** Navigate to *Content Management > Media Content*.

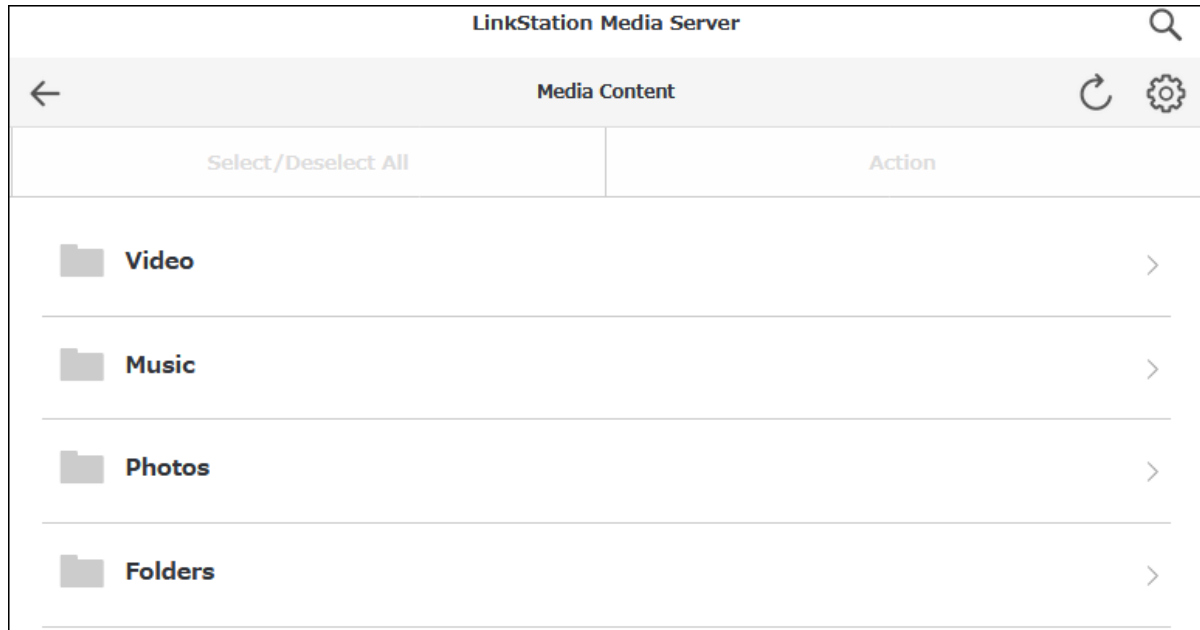
**4** Click *Folders*.

**Note:** The Media Content folders will be displayed in the language set under Content Folder Language.

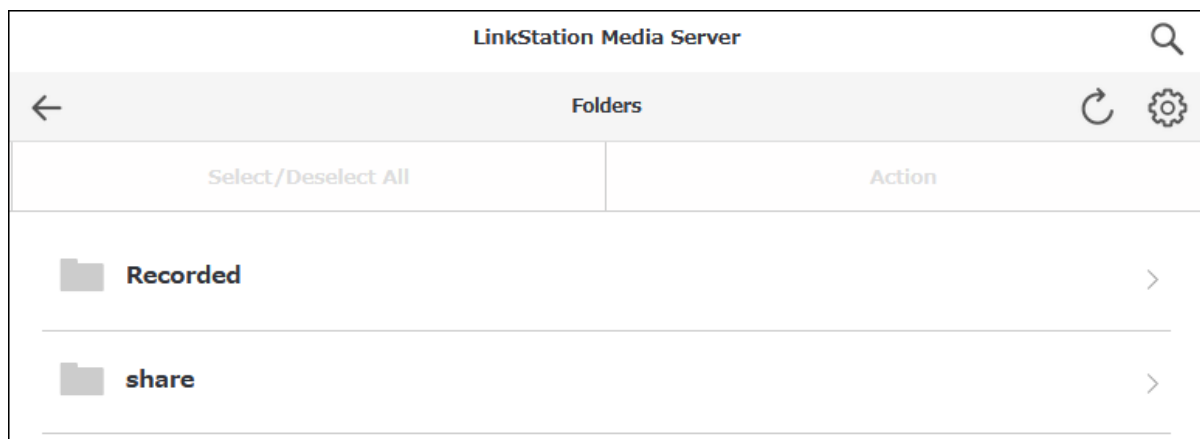
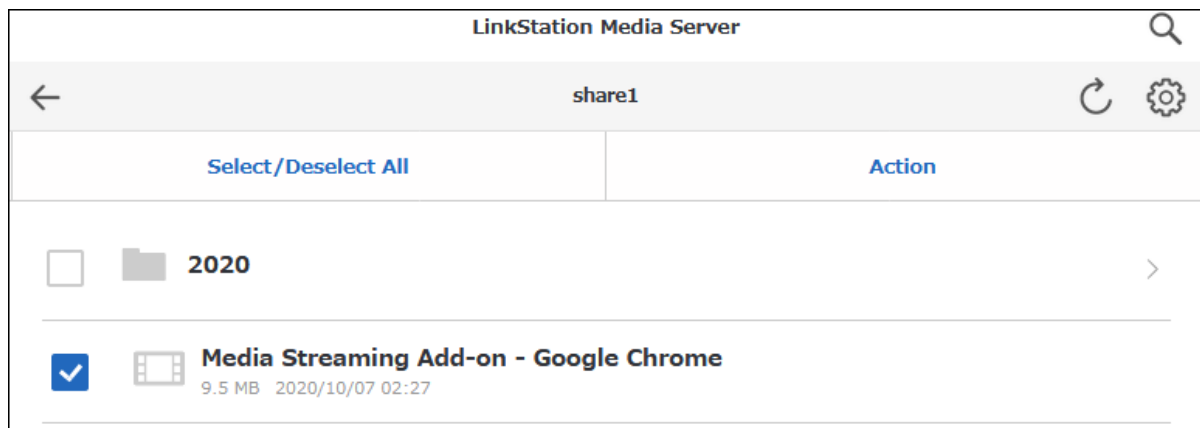
**5** Select the location that contains the files or folders you want to delete.**6** Select a file or folder to delete and click *Action*.

**7** Click *Delete*.

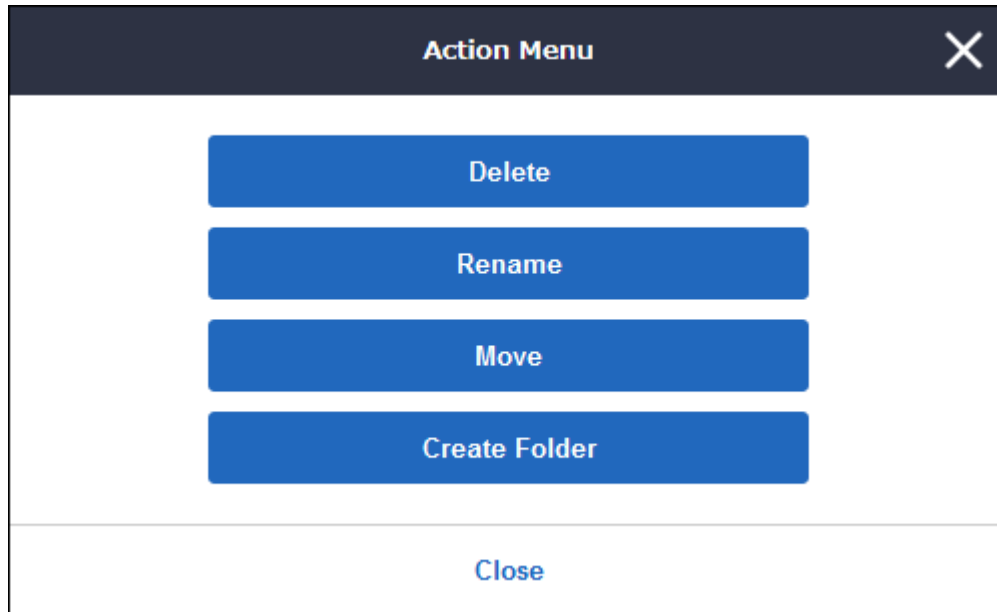

**8** Click *Delete* again.

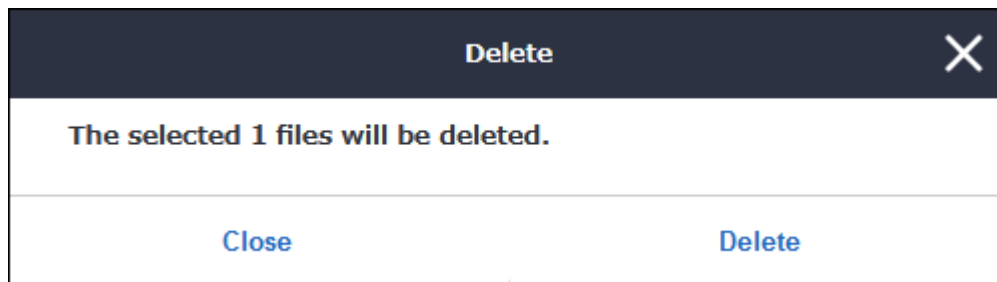



# Chapter 7 Settings Backup/Restoration

## Saving and Applying Settings

The LinkStation's settings can be saved to a USB memory device and applied to another Buffalo NAS device of the same series. Use this feature to back up or copy settings to a new Buffalo NAS device.

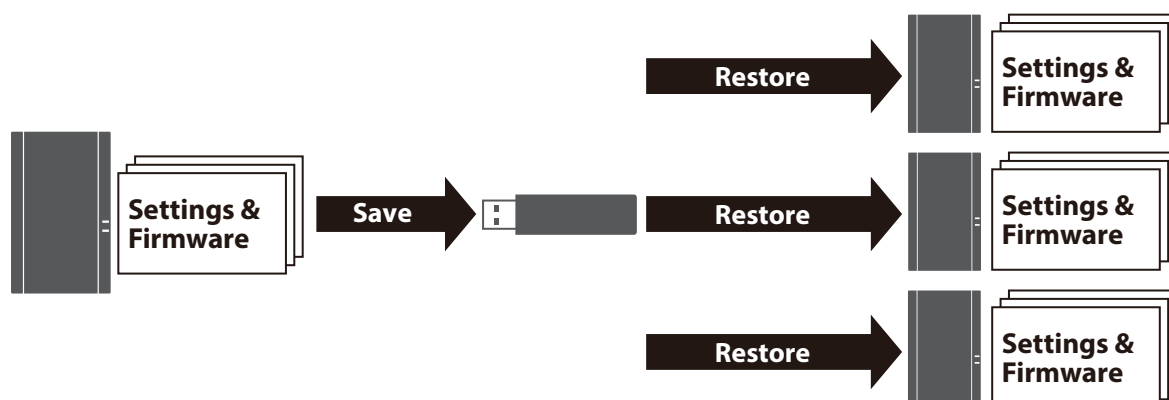

Write down the drive configuration (number of drives, RAID, LVM, etc.) of the Buffalo NAS device whose settings were saved. Make sure that any Buffalo NAS devices that you apply these settings to have the exact same drive configuration before you apply the settings. If the drive configuration is different, you may get unexpected results. Also, make sure the USB memory device to save settings to is compatible with USB 3.2 Gen 1/3.1 Gen 1/3.0 specifications.

The following settings are not saved or applied:

Category	Settings
File Sharing	All settings for USB drives
	Shared folders created on LVM volumes
Storage	All settings in "Drives"
	All settings in "LVM"
	USB drive information
Cloud Storage	Job settings of Dropbox Sync
	Job settings of Microsoft OneDrive Sync
Network	All settings except for Wake-on-LAN and MTU size settings in "IP Address"
Management	The LinkStation's hostname
	All settings in "Power Management"
	All settings in "SSL"
	Display language in Settings

## Saving Settings

- 1 Insert a 1 GB or larger USB memory device (not included) into a USB 3.2 Gen 1 port on the LinkStation.

**Note:** All data on the USB memory device will be erased!

**2** From Settings, click *Management*.

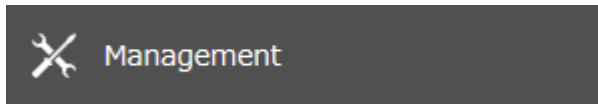

**3** Click the settings icon (  ) to the right of "Configuration Management".



**4** Select "Save current configuration to a USB drive".

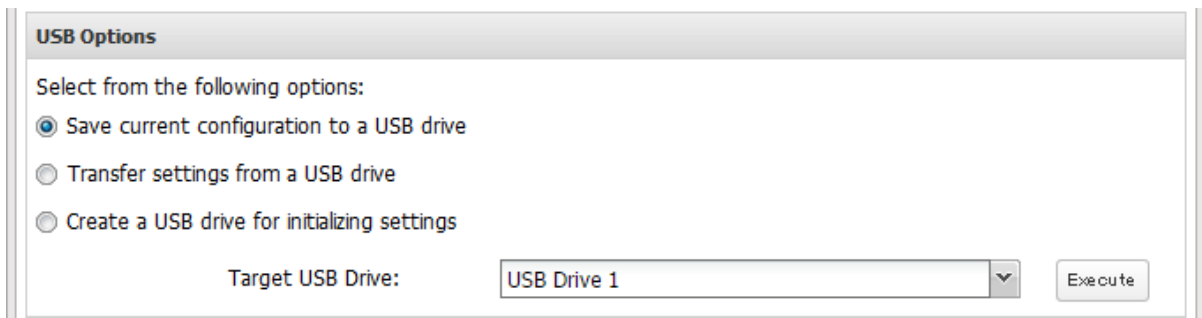

**5** From "Target USB Drive", select the USB memory device that is connected to the USB 3.2 Gen 1 port on the LinkStation, then click *Execute*.

**6** The "Confirm Operation" screen will open. Enter the confirmation number, then click *OK*.

**7** The settings will be saved. When saving settings is finished, click *OK*.

### Troubleshooting:

If the settings are not saved to the USB memory device successfully, you may receive an error message such as "The specified operation cannot be executed.". Verify:

- The USB memory device has a capacity of 1 GB or more.
- The USB memory device is not write-protected.

## Applying Settings

The saved settings can be applied to a different Buffalo NAS device of the same series. If applying settings to another Buffalo NAS device, the unit's current firmware version will be changed to the version used to save the settings.

**1** Insert the USB memory device with the saved settings into a USB 3.2 Gen 1 port on the LinkStation.

**2** From Settings, click *Management*.

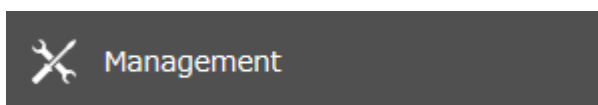

**3** Click the settings icon (  ) to the right of "Configuration Management".



**4** Select “Transfer settings from a USB drive”.

**5** From “Target USB Drive”, select the USB memory device that is connected to the USB 3.2 Gen 1 port on the LinkStation, then click *Execute*.**6** The “Confirm Operation” screen will open. Enter the confirmation number, then click *OK*.**7** The settings will be applied. When applying settings is finished, click *OK*.

---

## Transferring Another Buffalo NAS Device’s Settings

---

You can transfer saved settings from another series Buffalo NAS device to your LinkStation. The following settings can be transferred:

- Shared folders which are created from “File Sharing” > “Folder Setup”
- Access restrictions
- Users
- Groups

**Note:** This feature currently supports the following Buffalo NAS devices as of November 2020. The latest compatibility information will be on the [Buffalo website](#).

- TS-X series (TS-XL/R5, TS-WXL/R1, TS-WXL/1D, TS-RXL/R5, TS-XEL/R5 TeraStation models) running firmware version 1.58 or later
- TS5000 series (TS5200D, TS5200DN, TS5400D, TS5400DN, TS5400R, TS5400RN, TS5600D, TS5600DN, TS5800D, TS5800DN TeraStation models)
- TS4000 series (TS4200D, TS4400D, TS4400R, TS4800D TeraStation models)
- TS3000 series (TS3200D, TS3400D, TS3400R TeraStation models)
- TS5010 series (TS5210DN, TS5410DN, TS5410RN, TS5810DN, TS51210RH TeraStation models)
- TS3010 series (TS3210DN, TS3410DN, TS3410RN TeraStation models)
- TS6000 series (TS6200DN, TS6400DN, TS6400RN TeraStation models)
- TS3020 series (TS3220DN, TS3420DN, TS3420RN TeraStation models)
- LS700 series (LS710D, LS720D, LS720DB LinkStation models)

---

## Creating a Config File (.nas config)

---

### Procedure for TS-X Series Models

To transfer settings from TS-X series TeraStations, it will use the “NS-SHFT” software to create a config file. NS-SHFT can be downloaded from the [Buffalo website](#).

For the procedure on creating the config file, refer to the NS-SHFT user guide.

### Procedure for Buffalo NAS Devices Other Than TS-X Series Models

Follow the procedure below to create a config file on a Buffalo NAS device that is not part of TS-X series TeraStations.

- 1 Refer to the user manual of the Buffalo NAS device whose settings will be saved to a USB memory device.
- 2 Access the “usbdisk x” shared folder while connecting the USB memory device to the Buffalo NAS device whose settings were saved in the previous step. The “x” in the folder name represents the USB port number you connected the drive to.
- 3 Copy and paste the .nas\_config file to the desired location on your computer.

## Transferring Settings

Follow the procedure below to transfer settings from another series Buffalo NAS device.

- 1 Before transferring access restrictions with Active Directory domain users, make sure the migration target Buffalo NAS devices are joined to the same domain controller. To have the unit join the domain network, refer to the procedure on the [“Active Directory”](#) section in chapter 2.  
If you didn’t configure access restrictions with Active Directory domain users, skip to the next step.

- 2 From Settings, click *Management*.

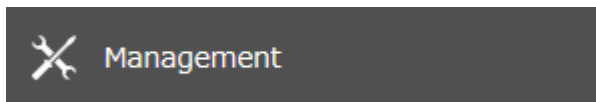

- 3 Click the settings icon (  ) to the right of “Configuration Management”.



- 4 Click *Browse* and choose the config file (.nas\_config) that was created with the migration source Buffalo NAS device. If the config file was created with a password, enter it into the “Password” field.

**Configuration Migration**

Migrate another LinkStation's users, groups, shared folders, and access restriction settings. Select the config file (.nas\_config) that was saved on the other LinkStation.  
 Note: If the migration source LinkStation is configured with Active Directory, this LinkStation should also have the same configuration, or else migration will not work.

For detailed information about compatible products for migration or the procedure to save the config file, refer to the [user manual](#).

Config File (.nas\_config):    
 Password:   
 (if needed)

- 5 Click *Import*.
- 6 The “Confirm Operation” screen will open. Enter the confirmation number, then click *OK*.
- 7 The settings will be transferred. When transferring settings is finished, click *OK*.

### Notes:

- If the migration target Buffalo NAS device contains shared folders, users, and groups that share the same name as the transferred settings, the existing settings will be overwritten. If the users and groups meet the following

conditions, the settings will not be transferred: users share the same name with groups already existing on the migration target Buffalo NAS device; groups share the same name with users on the migration target Buffalo NAS device.

- If the migration target Buffalo NAS devices have already added some shared folders, users, and groups, the transferred settings may exceed the maximum number of allowed shared folders, users, or groups. After migration finishes, open Settings and verify that all settings were properly transferred.

---

## Restoring Factory Defaults

---

The settings on the LinkStation can be restored to factory defaults using Settings or an USB memory device.

### Initializing from Settings

---

To initialize the LinkStation to its factory defaults from Settings, follow the procedure below.

**Note:** Initializing the LinkStation using Settings will not initialize the settings under content management.

- 1 From Settings, click *Management*.

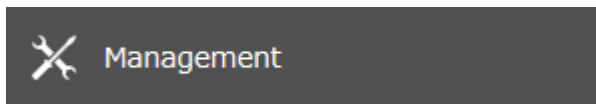

- 2 Click the settings icon (  ) to the right of "Restore/Erase".



- 3 Click *Initialize LinkStation*.

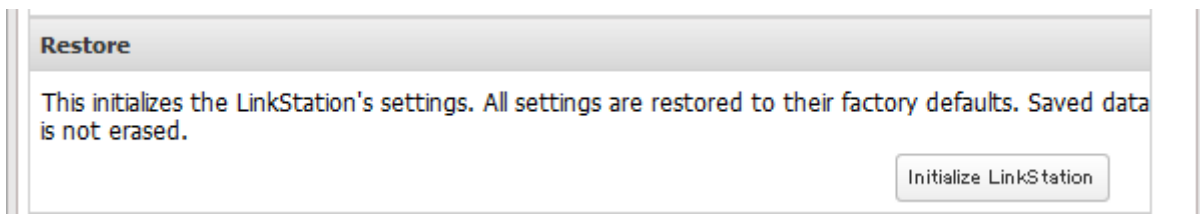

- 4 The "Confirm Operation" screen will open. Enter the confirmation number, then click *OK*.

- 5 The settings will be restored to its factory default settings. The I26 message will appear on NAS Navigator2 while settings are being restored. When it disappears, the initialization is finished.

---

### Initializing Using the USB Initialization Drive

---

A USB initialization drive will restore the settings on your LinkStation to their factory defaults. You can initialize them without logging in to Settings. Follow the procedure below to create a USB initialization drive.

**Notes:**

- You can use the USB initialization drive to initialize settings on the same LinkStation unit that created it.
- Normally, making and using a USB initialization drive will not affect data on the LinkStation. However, always back up your data regularly!
- This USB initialization drive can be used to recover the system if your LinkStation doesn't boot at all. In this case, if the data partition is damaged, then all your data will be deleted by the recovery process.
- The USB initialization drive should be a USB memory device that is compatible with USB 3.2 Gen 1/3.1 Gen 1/3.0 specifications.

## Creating a USB Initialization Drive

**1** Insert a 1 GB or larger USB memory device (not included) into a USB 3.2 Gen 1 port on the LinkStation.

**Note:** All data on the USB memory device will be erased!

**2** From Settings, click *Management*.

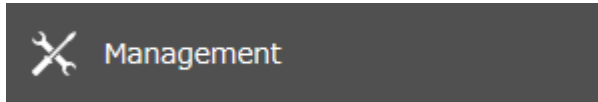

**3** Click the settings icon (  ) to the right of "Configuration Management".

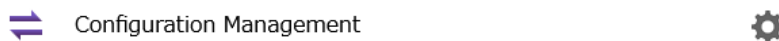

**4** Select "Create a USB drive for initializing settings".

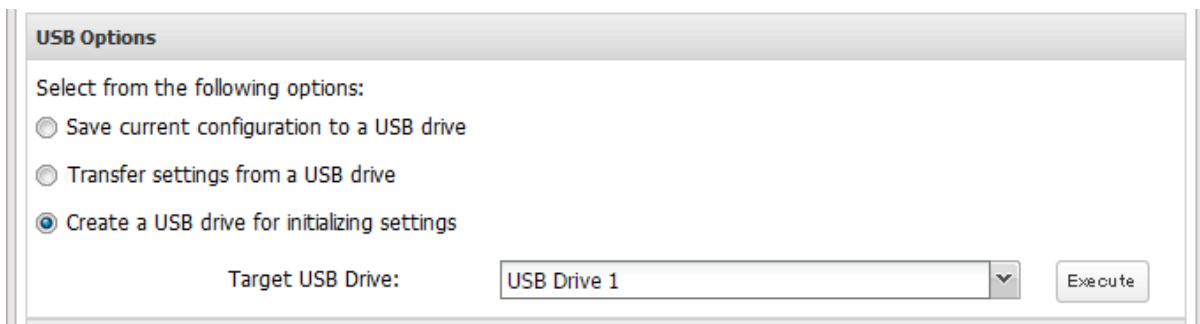

**5** From "Target USB Drive", select the USB memory device that is connected to the USB 3.2 Gen 1 port on the LinkStation, then click *Execute*.

**6** The "Confirm Operation" screen will open. Enter the confirmation number, then click *OK*.

**7** The LinkStation will create the USB initialization drive. This will take about one minute. When creating the USB initialization drive is finished, refresh the browser and log in to Settings again.

## Starting Initialization

To initialize the settings on your LinkStation with the USB memory device created above, follow the procedure below.

### Notes:

- If using the USB initialization drive to initialize, the unit's current firmware version will be changed to the version used to create the USB initialization drive.
- If initializing the settings using the USB initialization drive has failed, initialize them from Settings by referring to the ["Initializing from Settings"](#) section above.

**1** Move the power switch to the "Off" position to turn off the LinkStation.

**2** Insert the USB memory device into a USB 3.2 Gen 1 port on the LinkStation. Make sure that no other USB drives are currently connected to any USB ports on the LinkStation.

**3** Move the power switch to the "On" position to power on the LinkStation.

**4** When the I41 message appears on NAS Navigator2, press the function button.

**5** The LinkStation will initialize the settings. The I37 message will appear on NAS Navigator2 while settings are being initialized. When the initialization is finished, the LinkStation will restart automatically.

Dismount the USB memory device before unplugging it. Refer to the [“Dismounting Drives”](#) section in chapter 3 for the procedure on dismounting drives.

---

## Resetting the Administrator Password

---

If you forget the admin username or password and cannot log in to Settings, or incorrect network settings are configured and Settings becomes inaccessible, initialize these settings by holding down the init button (refer to the [“Diagrams”](#) section in chapter 1) for 10 seconds. This will typically reset the admin username and password, IP address settings other than Wake-on-LAN, and SSL to their factory default values. The I23 message will appear on NAS Navigator2 while settings are being initialized.

This button can be disabled in Settings; to do so, navigate to *Management > Restore/Erase > Edit* under “Init Button Settings”, then select “Keep current admin username and password” and click *OK*.

# Chapter 8 Network Settings

## Wake-on-LAN

The LinkStation supports Wake-on-LAN, which allows it to be turned on remotely. The LinkStation will be turned on automatically when receiving a Wake-on-LAN packet in the following situations: the LinkStation turns off but the power switch left in the "On" position, the LinkStation enters sleep mode.

- 1 From Settings, click *Network*.



- 2 Click the settings icon (  ) to the right of "IP Address".



- 3 Click *Edit*.

- 4 Enable "Wake-on-LAN", then click *OK*.

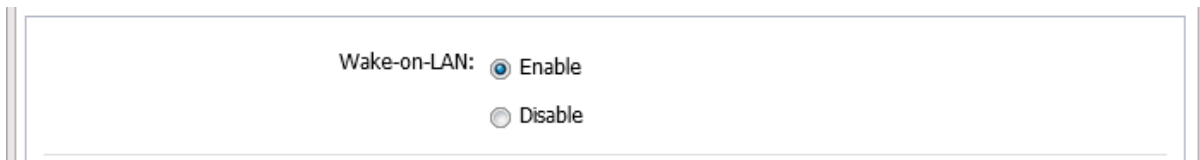

Wake-on-LAN is now enabled. As long as the LinkStation is connected to a power source and the network, you can turn it on remotely.

### Notes:

- After receiving the Wake-on-LAN packet, the LinkStation may take up to five minutes to be ready to use.
- To use Wake-on-LAN, you'll need Wake-on-LAN software that sends Wake-on-LAN packets. The LinkStation does not include Wake-on-LAN software.

## SNMP

If SNMP is enabled, you can browse your LinkStation from SNMP-compatible network management software.

- 1 From Settings, click *Network*.





- 2** Move the SNMP switch (  ) to the  position to enable SNMP.



- 3** Click the settings icon (  ) to the right of "SNMP".

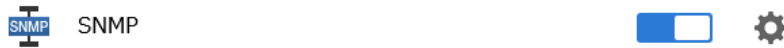

- 4** Click *Edit*.

- 5** Select whether to use SNMP version 2 or version 3.

**SNMP Settings** \*Required 

Use SNMPv2

SNMP Community Name \* :

Trap Notify:  Enable  
 Disable

Trap Settings

Trap Notify Community Name \* :

Trap Notify IP Address \* :

Use SNMPv3

Username \* :

Authentication and Privacy Protocol: SHA / AES

Authentication and Privacy Password \* :

Password (Confirm) \* :

- 6** Configure the desired settings, then click *OK*.

- 7** SNMP has been configured for the LinkStation. For further use, configure your SNMP-compatible network management software using the Buffalo-specific MIB (management information base) file. The MIB file is available from the [Buffalo website](#).

Depending on which SNMP client software you use, the procedure for configuring the software will differ. For more detailed information on configuring the client software, refer to its help or included manual.

## Proxy Server

If you place the LinkStation on a network that passes through a proxy server, configuring the proxy server settings is recommended. Unless you configure the proxy settings, firmware updates in Settings will not work. To configure the settings, follow the procedure below.

- 1 From Settings, click *Network*.



- 2 Click the settings icon (  ) to the right of "Proxy Server".





- 3 Enable "Proxy Server".

**Proxy Server Settings**

\*Required 

Proxy Server:  Enable  Disable

Address \* : http 

Port: 80  

Username:

Password:

- 4 Enter the proxy server IP address or hostname, port number, username and password, then click *OK*.

Once you configure the proxy server settings, you may use the settings for cloud storage services such as Dropbox, Microsoft Azure, and Microsoft OneDrive by selecting the "Configured settings" option on each settings page.

## Jumbo Frames

If your other network devices support jumbo frames, you may be able to improve network performance.

- 1 From Settings, click *Network*.











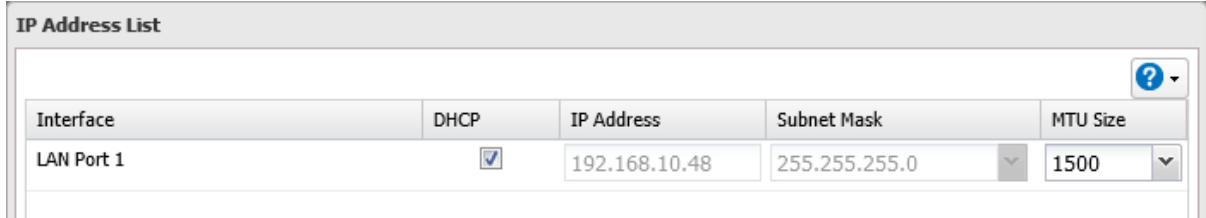







2 Click the settings icon (  ) to the right of "IP Address".



3 Click *Edit*.

4 Select or enter the desired MTU size and click *OK*.



Connection			Transmission	
				Transfer data using jumbo frames.
				Transfer data without using jumbo frames.
				Transfer data without using jumbo frames.
				No data can be transferred.

**Note:** Make sure the LinkStation's MTU size is smaller than the hub or router's. Larger MTU sizes may not transfer the data to the LinkStation correctly.

## Changing the IP Address

Normally, the LinkStation's IP address is set automatically by a DHCP server on your network. If you prefer, you can set it manually. An easy way to do this is to change it on NAS Navigator2. The procedure to change the IP address in Settings is below.

- 1 From Settings, click *Network*.



- 2 Click the settings icon (  ) to the right of "IP Address".



- 3 Click *Edit*.

- 4 Clear the "DHCP" checkbox and enter the desired IP address and its subnet mask.

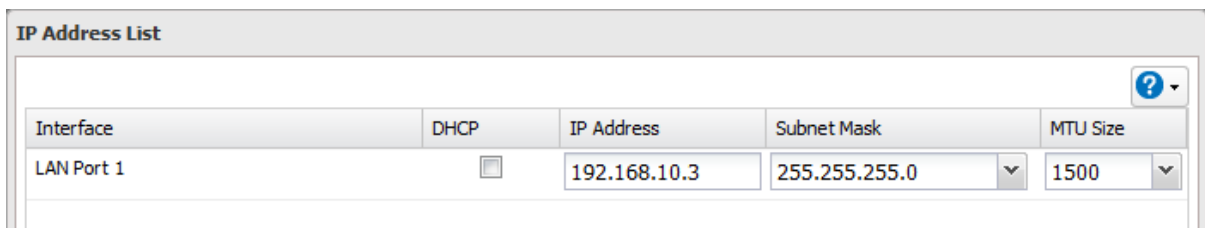

- 5 Select "User (static)" from the drop-down list for both the "Gateway Settings" and "DNS Settings" options, then enter the desired default gateway address and DNS server addresses.

Gateway Settings:	<input type="text" value="User (static)"/>
Default Gateway Address:	<input type="text" value="192.168.10.1"/>
DNS Settings:	<input type="text" value="User (static)"/>
Primary DNS Server:	<input type="text" value="192.168.10.1"/>
Secondary DNS Server:	<input type="text"/>
Services Restarted After:	<input type="text" value="1"/> <input type="text" value="seconds"/>

- 6 Click *OK*.

**Note:** Network services such as SMB will restart when the Ethernet cable is disconnected/reconnected or if a network issue occurs. You can specify the time to delay the restart at the "Services Restarted After" option.

## Mapping IP Address and Hostname

The LinkStation allows you to map an IP address and a hostname (FQDN) of another host you would like the LinkStation to communicate with, such as the domain controller. If you configure the mapping pair, the LinkStation can be accessed using the configured pair when name resolution is needed. Follow the procedure below to configure FQDN mapping.

**1** From Settings, click *Network*.



**2** Click the settings icon (⚙️) to the right of "IP Address".



**3** Click *FQDN Mapping*.

**IP Address List**

Interface	Type	DHCP	IP Address	Subnet Mask	MTU Size	More D
LAN Port 1	2.5GbE	✓	192.168.10.48	255.255.255.0	1500 bytes	▶

Wake-on-LAN: Enabled

Gateway Settings: Automatically assigned (LAN Port 1)

Default Gateway Address: 192.168.10.1

DNS Settings: Automatically assigned

Primary DNS Server: 192.168.10.1

Secondary DNS Server: Not assigned

Services Restarted After: 1 seconds

FQDN Mapping
Edit
Close

**4** Click *Add*.

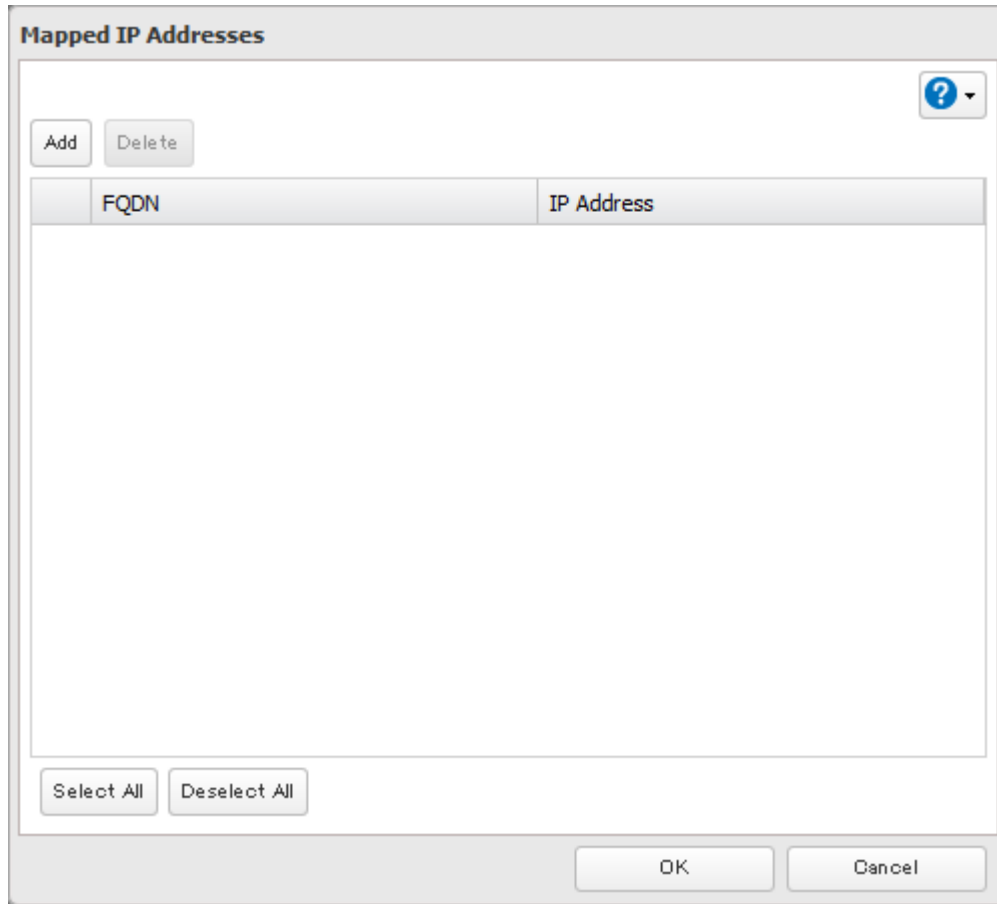

**5** Enter the hostname (FQDN) and the IP address that you want to map, then click *OK*.

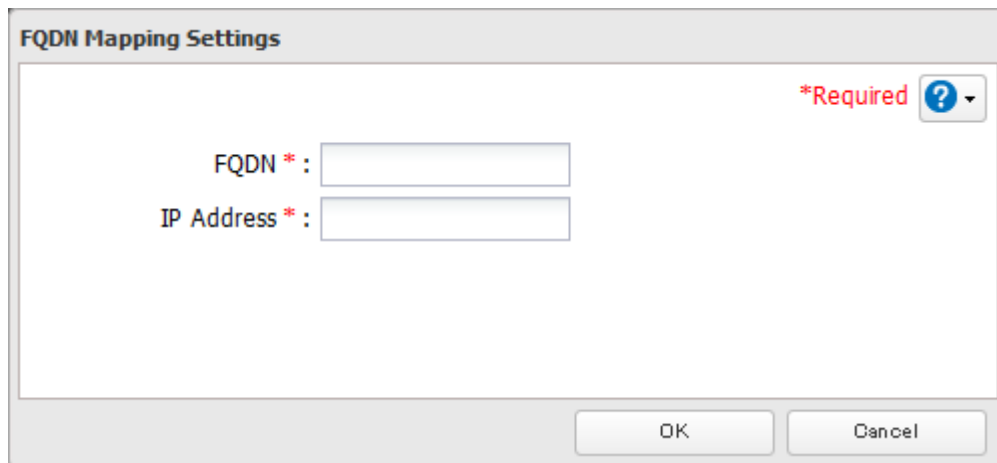

**6** Click *OK* again to apply settings.

# Chapter 9 Advanced Features



## Email Notification

Your LinkStation can send you email reports daily, or when settings are changed or an error occurs. You can configure the events that will trigger notifications from any of the following functions: quotas, drives (internal, external, or RAID array), fan, backup, system alert.

Refer to the contextual help in Settings for more detailed information such as when the notification email will be sent or the differences between the notification categories.

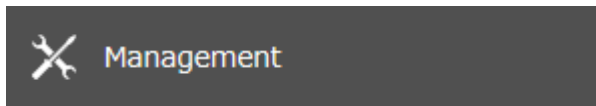
- 1 From Settings, click *Management*.



- 2 Move the email notification switch (  ) to the  position to enable email notification.

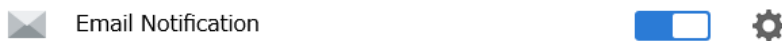

- 3 Click the settings icon (  ) to the right of "Email Notification".



- 4 Click *Edit*.

- 5** Enter your email server settings and the notification email's default subject, then configure recipients and the time when email reports will be sent. Click *OK* to save the configured settings and have a test email sent. If you select an authentication type other than "Disable" from the drop-down list, you can enter the sender email address and credentials of the email server.

**Email Notification** \*Required ?

SMTP Server Address \* :

SMTP Port \* :

Authentication Type:  ▼

Sender Address:

POP3 Server Address:

POP3 Port:

SSL/TLS:  ▼

Username:

Password:

Subject \* :

Add Delete Select from List

Recipients \* :

Name	Recipients	Class

Select All Deselect All

Send Daily Report at:  ▼

OK Cancel



- 6** To change the events of email reports, click *Advanced Report Settings*. On the displayed screen, select or clear the category's checkboxes.

Report Settings		<input checked="" type="checkbox"/> Daily Report	<input checked="" type="checkbox"/> Info	<input checked="" type="checkbox"/> Notice	<input checked="" type="checkbox"/> Error
Categories		<input checked="" type="checkbox"/>	<input checked="" type="checkbox"/>	<input checked="" type="checkbox"/>	<input checked="" type="checkbox"/>
Drive Quota	User			<input checked="" type="checkbox"/>	
	Group			<input checked="" type="checkbox"/>	
Storage	Internal Drive	<input checked="" type="checkbox"/>	<input checked="" type="checkbox"/>	<input checked="" type="checkbox"/>	<input checked="" type="checkbox"/>
	RAID Array	<input checked="" type="checkbox"/>	<input checked="" type="checkbox"/>	<input checked="" type="checkbox"/>	<input checked="" type="checkbox"/>
	USB Drive	<input checked="" type="checkbox"/>			<input checked="" type="checkbox"/>
Fan					<input checked="" type="checkbox"/>
Backup			<input checked="" type="checkbox"/>	<input checked="" type="checkbox"/>	
System Alert			<input checked="" type="checkbox"/>		

Email notification will be enabled.

### Email Notification Categories

Notification emails will be categorized into the following importance levels. You can configure them from the "Report Settings" page.

Levels	Details
Daily Report	Describes the status of the LinkStation in a daily report email.
Info	Sends a notification email if an event occurs. Info reports will contain just information such as capacity information, job starts/completes, etc.
Notice	Sends a notification email if a non-critical error occurs. Refer to the " <a href="#">Amber (Notices)</a> " section in chapter 11 for the list of events that will trigger this event notification. Notice reports will contain warnings such as something has failed, but the function or unit can continue operating as usual. It is recommended to perform the corrective action for the notice as soon as possible.
Error	Sends a notification email if a critical error occurs. Refer to the " <a href="#">Red (Errors)</a> " section in chapter 11 for the list of events that will trigger this event notification. Error reports will describe critical failures that prevented a function or unit from operating properly. It is recommended to perform the corrective action for the error immediately.

## Sleep Mode

To save energy, you can specify times to put the LinkStation into sleep (standby) mode, during which the drives and LEDs are turned off.

1 From Settings, click *Management*.

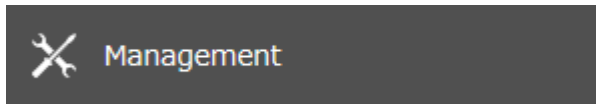

2 Click the settings icon (  ) to the right of "Sleep Timer".



3 Click *Edit*.

4 Specify the timer interval, wake-up time, and time to enter sleep mode, then click *OK*.

**Notes:**

- Up to three timers can be set.
- The time to enter sleep mode can be set from 12:00 a.m. to 3:45 a.m. of the next day. The time to wake from sleep mode can be set from 12:00 a.m. to 11:45 p.m. If the time to enter sleep mode is after 12:00 a.m., the wake-up time setting may be from 4:00 a.m. to 11:45 p.m.
- The time to enter sleep mode should not be set to the same time as or earlier than the start time.
- If sleep mode timer is scheduled to go off while checking or formatting a drive, or updating the firmware, the LinkStation will not enter sleep mode when the configured time is reached.
- While backups are configured or DLNA server is enabled, sleep timer settings cannot be changed.
- If you have configured this LinkStation as a backup destination for another Buffalo NAS device and it enters sleep mode, a backup job may fail because the LinkStation won't wake up from sleep mode.
- If scheduled times in the timer overlap, the operation is performed using the widest time interval.

- Examples of timer settings are shown below:
  - **Example 1:**  
 If running at a current time of 10:00 a.m. Wednesday  
 Timer 1: Daily 12:00–24:00  
 Timer 2: Not used  
 Timer 3: Not used  
 No operation is performed at 12:00 p.m. and the unit enters sleep mode at 12:00 a.m.
  - **Example 2:**  
 If running at a current time of 10:00 a.m. Wednesday  
 Timer 1: Daily 9:00–18:00  
 Timer 2: Wednesday 10:00–20:00  
 Timer 3: Not used  
 On days other than Wednesday, normal operation begins at 9:00 a.m. and the unit enters sleep mode at 6:00 p.m. On Wednesday, the unit enters sleep mode at 8:00 p.m.
  - **Example 3:**  
 If running at a current time of 10:00 a.m. Wednesday  
 Timer 1: Daily 9:00–18:00  
 Timer 2: Wednesday 10:00–1:00 a.m. of the next day  
 Timer 3: Not used  
 On days other than Wednesday, normal operation begins at 9:00 a.m. and the unit enters sleep mode at 6:00 p.m. On Wednesday, normal operation begins at 10:00 a.m. and the unit enters sleep mode at 1:00 a.m. of the next day.
  - **Example 4:**  
 If running at a current time of 10:00 a.m. Wednesday  
 Timer 1: Daily 9:00–18:00  
 Timer 2: Wednesday 7:30–22:00  
 Timer 3: Not used  
 On days other than Wednesday, normal operation begins at 9:00 a.m. and the unit enters sleep mode at 6:00 p.m. On Wednesday, normal operation begins at 7:30 a.m. and the unit enters sleep mode at 10:00 p.m.
- To wake the LinkStation from sleep mode before the wake-up time, press the function button.

---

## UPS (Uninterruptible Power Supply)

---

If a UPS (sold separately) is attached, the LinkStation can be automatically shut down to protect data in the event of a power outage.

**Note:** When the LinkStation restarts after an automatic shutdown such as from a power outage or power supply issue, verify that external power has been restored. If the LinkStation is turned on while it is still running on the UPS and external power has not been restored, the automatic shutdown will not be performed, even after the specified time elapses.

- 1** Plug the power cable of the UPS to a wall socket.
- 2** Connect the AC adapter of the LinkStation to the UPS.
- 3** Connect the UPS and the LinkStation using a USB cable.
- 4** Turn on the UPS, then the LinkStation.

5 From Settings, click *Management*.

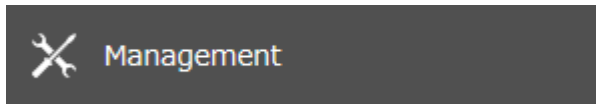

6 Click the settings icon (  ) to the right of “Power Management”.



7 Click *Edit*.

8 Configure the desired settings, then click *OK*.

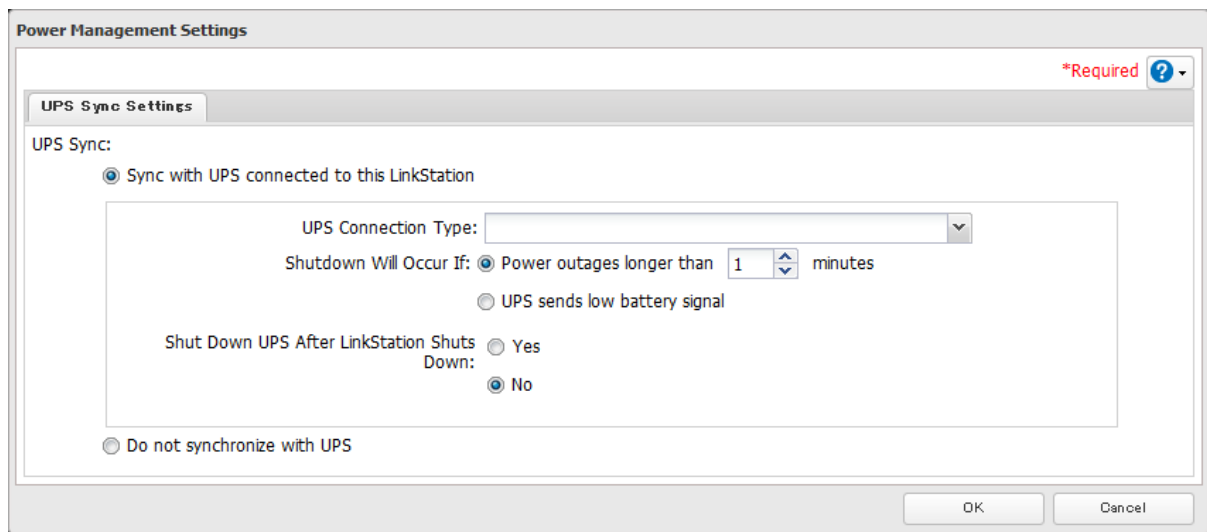

## Encrypting Data Transmission

### Encrypting Settings Data

All communication with Settings can use SSL encryption if you access the Settings page by changing “http://” to “https://” in the browser address bar or click *Secure Connection* from the login window. Once you are logged in using the HTTPS connection and wish to disable SSL encryption, click *Normal Connection* from the login window.

### SSL

SSL (Secure Socket Layer) is a protocol that uses a public key encryption system to establish secure communication channels between networked devices, allowing for encrypted Internet traffic and server identity verification. The SSL protocol uses a pair of keys – one private, one public – to authenticate and manage secure connections. SSL keys are used during setup screen operations.

### SSL Key Formats/Extensions

The SSL keys may include the following encoding formats and extensions:

#### SSL Certificate (server.crt)

The server.crt is the server public key, and is generated by the LinkStation. A computer that receives the server.crt uses it to encrypt data, and the LinkStation then uses the server.key file to decrypt the data.

In SSL, this key contains the server certificate, and depending on your computer environment, a check may be performed to determine the trustworthiness of the certificate. The server certificate included in the LinkStation's default settings was created by Buffalo, and in some cases, the security certificate warning message may appear in your browser or another security software. If this occurs, disregard the message and continue.

**Note:** Use TLS 1.2 SSL Certificate.

### SSL Private Key (server.key)

This file is the server private key, and it is usually not revealed. The server.key file is paired with the server.crt file to decrypt data encrypted by the SSL certificate.

**Note:** The passphrase for the private key must be removed before importing to the LinkStation.

## Updating SSL Key Files

To update a server certificate and a private key for SSL, follow this procedure.

- 1 From Settings, click *Management*.

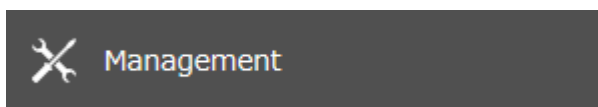

- 2 Click the settings icon (  ) to the right of "SSL".



- 3 Register "server.key" for "Secret Key" and "server.crt" for "Server Certificate (.crt)", then click *Import*.

 A dialog box titled "SSL Settings" with a question mark icon in the top right corner. It contains two input fields: "Secret Key:" and "Server Certificate (.crt):". Each field has a "Browse" button to its right. Below these fields is an "Import" button. At the bottom right of the dialog is a "Close" button.

### Notes:

- Place the SSL key files (server.key, server.crt) directly below the C root drive. The SSL key files may be unable to be updated if they are placed in folders or paths that contain multibyte characters.
- If Settings cannot be displayed after updating, initialize the LinkStation settings.
- Updating the firmware initializes an SSL key.

## Logs

### Displaying LinkStation's Logs

Follow the procedure to check the LinkStation's logs.

- 1 From Settings, click *Management*.

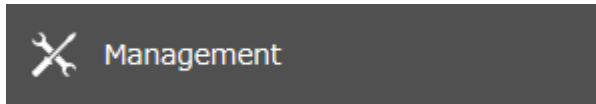

- 2 Click the settings icon (  ) to the right of "Logs".



- 3 Select a log to view.

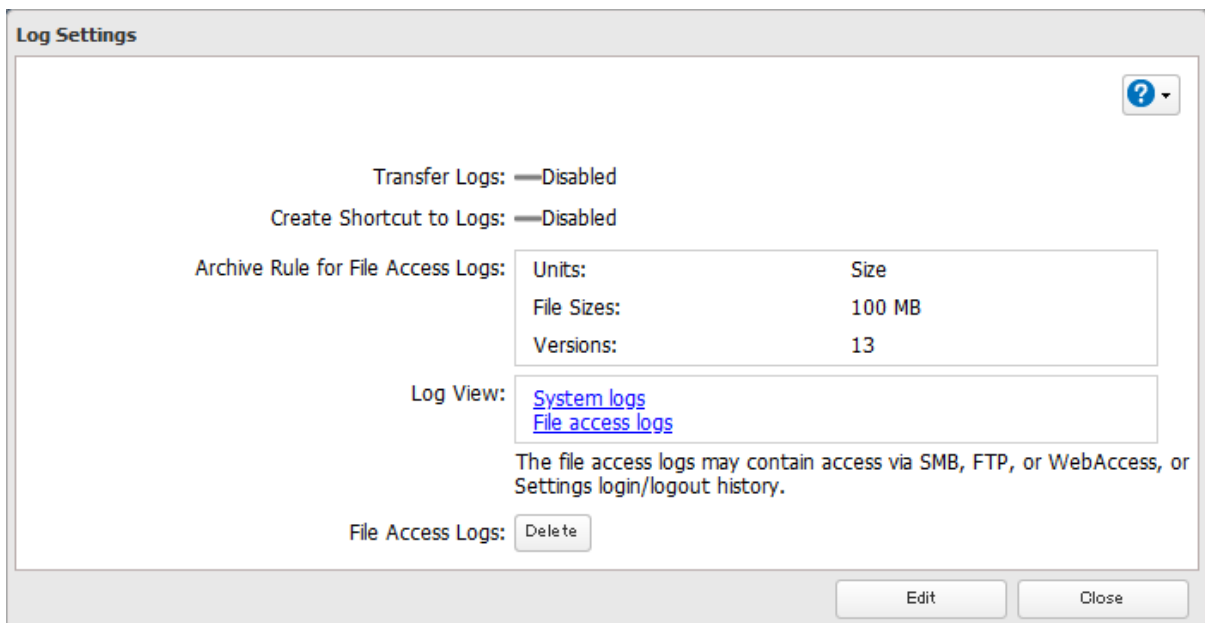

The file access log stores file access events that occurred on the internal drives. File access on USB drives are not logged.

**Note:** All logs are encoded in UTF-8 format. To make sure they display correctly, change the software encoding to "UTF-8".

### Transferring Logs to the Syslog Server

- 1 From Settings, click *Management*.

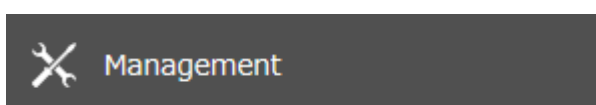

**2** Click the settings icon (  ) to the right of “Logs”.

 Logs



**3** Click *Edit*.

**4** Enable “Syslog Transfer”.

**Log Settings** \*Required 

Syslog Transfer:  Enable

Syslog Server IP Address \* :

Logs to Transfer:  System logs  File access logs

Disable

Create Shortcut to Logs:  Enable

Target Folder \* :

Disable

Archive Rule for File Access Logs:

Units:  Day  Week  Month  Size

File Sizes \* :    MB

Versions \* :

Archive Size: 1300 MB

**5** Enter the IP address of the syslog server where you want to transfer the logs to.

**6** Select the type of log that you want to transfer from “Logs to Transfer”.

**7** Click *OK*.

## Creating a Shortcut to the Logs in the Shared Folder

**1** From Settings, click *Management*.

 Management

**2** Click the settings icon (  ) to the right of “Logs”.

 Logs



**3** Click *Edit*.

**4** Enable “Create Shortcut to Logs”.

**Log Settings** \*Required ?

Syslog Transfer:  Enable  
 Syslog Server IP Address \* :   
 Logs to Transfer:  System logs  
 File access logs  
 Disable

Create Shortcut to Logs:  Enable  
 Target Folder \* :  Browse  
 Disable

Archive Rule for File Access Logs: Units:  Day  Week  Month  Size  
 File Sizes \* :  MB  
 Versions \* :   
 Archive Size: 1300 MB

**5** Click *Browse* and under “Target Folder”, select the shared folder where the created shortcut will lead. Click *OK*.

In the selected shared folder, a folder named “system\_log” will now contain the shortcuts to logs.

## Changing Archive Rules for File Access Logs

You can configure how many logs are kept or how long each log will be kept on the LinkStation.

**1** From Settings, click *Management*.

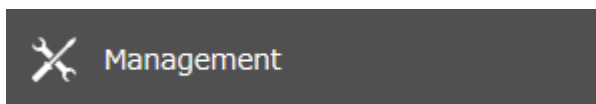

**2** Click the settings icon (  ) to the right of “Logs”.



**3** Click *Edit*.



- 4** Select the unit and version to save logs to the right of “Archive Rule for File Access Logs”. For example, if you select “Month” for the unit and enter “7” for the version, the file access logs for the next 7 months will be saved on the LinkStation.

Available duration and capacity to save logs will vary depending on the unit. The following values are available:

- Unit (Day): 1–367 for all versions
- Unit (Week): 1–53 for all versions
- Unit (Month): 1–13 for all versions
- Unit (Size): 1–100 for file sizes and 1–13 for all versions

**Log Settings** \*Required ?

**Syslog Transfer:**  Enable  
 Syslog Server IP Address \* :   
 Logs to Transfer:  System logs  File access logs  
 Disable

**Create Shortcut to Logs:**  Enable  
 Target Folder \* :    
 Disable

**Archive Rule for File Access Logs:** Units:  Day  Week  Month  Size  
 File Sizes \* :  MB  
 Versions \* :   
 Archive Size: 1300 MB

- 5** Click *OK*.

**Notes:**

- To delete the saved logs, click *Delete* at the window in step 3.
- If there is not enough space to save logs, the I70 message will appear on the Dashboard in Settings and NAS Navigator2. When it appears, delete unnecessary logs or move them to another device from the LinkStation. To access logs, go to the “system\_log” folder created in the shared folder that you have configured as the shortcut to the logs. If no free space is made available elsewhere, older logs will automatically be deleted.

## Updating the Firmware

If a new firmware version is available, a message is displayed when the LinkStation boots. You can update the firmware either manually or automatically.

**Notes:**

- If all drives and RAID arrays on the LinkStation have LVM enabled but no LVM volumes have been created, you will not be able to update the firmware from Settings.

- Settings will not be available while the firmware is updating. Don't try to access Settings from another computer or mobile device until the update is finished.

## Updating Manually

---

**1** From Settings, click *Management*.

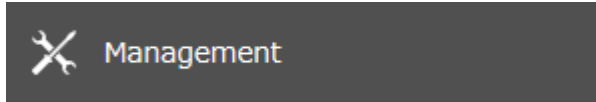

**2** Click the settings icon (  ) to the right of "Update".



**3** Click *Install Update*.

**4** The "Confirm Operation" screen will open. Enter the confirmation number, then click *OK*.

**5** When updating the firmware is finished, refresh the browser and log in to Settings again.

You can also download the latest firmware from the [Buffalo website](#).

## Updating Automatically

---

**1** From Settings, click *Management*.

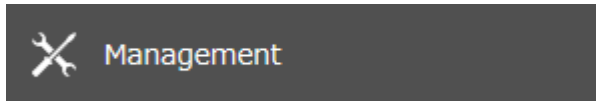

**2** Click the settings icon (  ) to the right of "Update".



**3** Click *Edit*.

- 4** Select “Update the firmware automatically” and click *OK*.

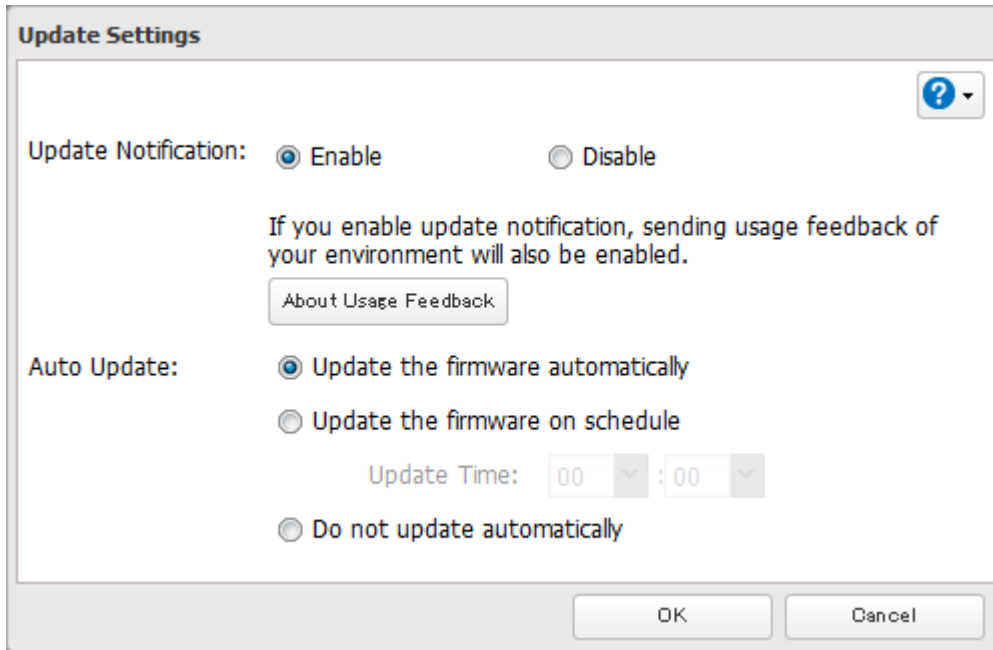

Alternatively, you may choose to schedule updates to occur during a specific time of day.

## Configuring Update Notification

Configure whether or not to receive a notification when a new firmware version becomes available.

- 1** From Settings, click *Management*.

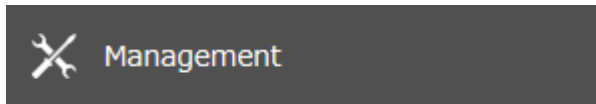

- 2** Click the settings icon (  ) to the right of “Update”.



- 3** Click *Edit*.

- 4** Select to enable or disable update notification and click *OK*.

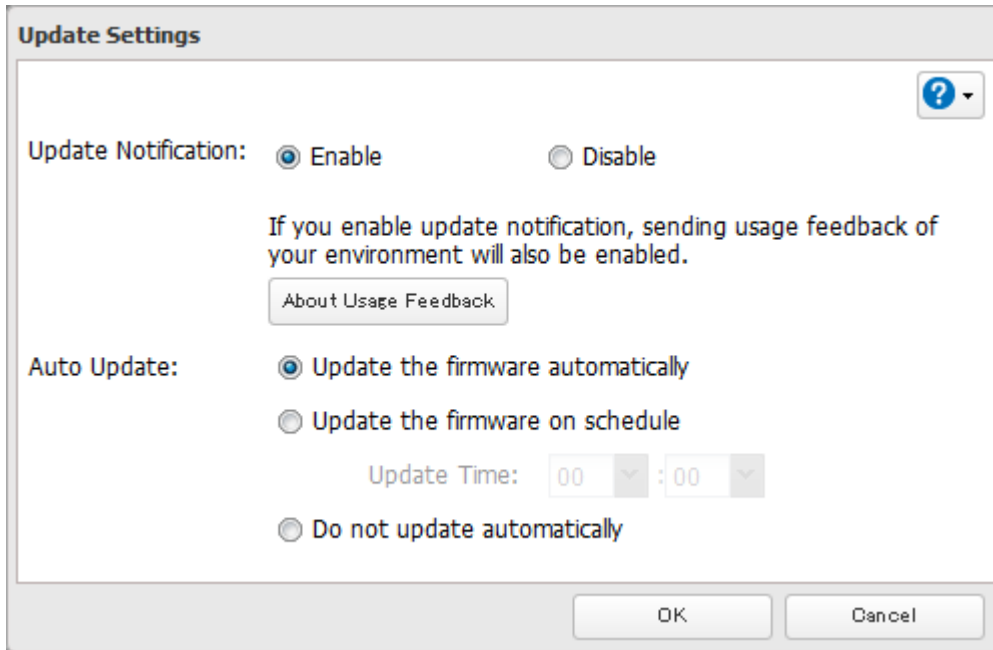

For further optimized firmware updates and product usability improvements, Buffalo may ask you to send your usage and environment information, such as the number of shared folders and client computers, and/or S.M.A.R.T. information. The collected information will only be used for improving future firmware stability and product development and no other purposes.

If update notification is enabled, it will also automatically enable sending usage feedback to Buffalo. If you don't want to send this information to us, disable update notification.

**Note:** If a backup job is running and the update time arrives, auto update will be skipped. After backup is finished, auto update will run at the next upcoming update time.

---

## Name, Date, Time, and Language

---

Configure the LinkStation's hostname, date, time, and language as shown below.

- 1** From Settings, click *Management*.

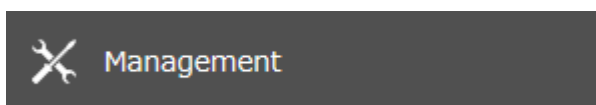

- 2** Click the settings icon (  ) to the right of "Name/Time/Language".



- 3** Click *Edit*.

**4** Click the *Name* tab, then configure the LinkStation's name and description.

The name will be used for identifying your LinkStation on the network. When your LinkStation is detected, the name will be used as the hostname. The hostname may contain up to 15 alphanumeric characters and hyphens (-). The first and last characters should not be a hyphen.

The screenshot shows the 'Name/Time/Language' configuration window with the 'Name' tab selected. The window title is 'Name/Time/Language' and it has a '\*Required' indicator and a help icon. Below the title bar are four tabs: 'Name', 'Time', 'Language', and 'Management Information'. The 'Name' tab is active, showing two text input fields: 'Name \* : LS720D022' and 'Description: LinkStation'. At the bottom right are 'OK' and 'Cancel' buttons.

**5** Click the *Time* tab. Enable the NTP server and select the "Use default NTP server" checkbox. If you disable the NTP function, click *Use Local Date/Time* to use your computer's time settings for the LinkStation.

The screenshot shows the 'Name/Time/Language' configuration window with the 'Time' tab selected. The window title is 'Name/Time/Language' and it has a '\*Required' indicator and a help icon. Below the title bar are four tabs: 'Name', 'Time', 'Language', and 'Management Information'. The 'Time' tab is active, showing the 'Date/Time Source:' section. There are two radio buttons: 'Enable' (selected) and 'Disable'. Under 'Enable', there is a text input field for 'NTP IP Address \* : ntp.jst.mfeed.ad.jp', a checked checkbox for 'Use default NTP server', and a dropdown menu for 'NTP Synchronization Frequency: Daily'. Under 'Disable', there is a greyed-out area with 'Date \* : 10/20/2020' and 'Time \* : 4 : 2 : 22' and a 'Use Local Date/Time' button. Below this is a 'Time Zone:' dropdown menu set to '(UTC-06:00) Central Time (US & Canada)'. At the bottom right are 'OK' and 'Cancel' buttons.

By default, the LinkStation adjusts its clock automatically by using a default NTP server. This NTP server belongs to Internet Multi Feed Inc. For more information, visit <http://www.jst.mfeed.ad.jp>.

To use a different NTP server, clear the "Use default NTP server" checkbox and enter a new NTP IP address or its hostname, then click *OK*. If an NTP server is specified by name instead of IP address, make sure that a DNS server is configured for the LinkStation.

**Note:** The internal clocks of the LinkStation and other devices on your network may run at slightly different speeds. Over a long period of time, your network devices may show somewhat different times, which can cause network problems. If clocks on your network vary by more than five minutes, unexpected behavior may occur. For best results, keep all clocks on your network devices set to the same time by adjusting them regularly, or use an NTP server to correct them all automatically.

- 6** Click the *Language* tab and select the language to be used.

The screenshot shows a dialog box titled "Name/Time/Language". It has four tabs: "Name", "Time", "Language", and "Management Information". The "Language" tab is active. In the top right corner, there is a red asterisk followed by the word "Required" and a blue question mark icon. Below the tabs, there are two dropdown menus: "Character Encoding" with "CP437" selected and "Display Language" with "English" selected. At the bottom right, there are "OK" and "Cancel" buttons.

**Note:** This tab changes the language used by the LinkStation for email notifications and other functions. To change the language displayed in Settings, go to Settings and click *Language* from the menu bar. Choose your desired language from the drop-down list.

- 7** Click the *Management Information* tab. Enter the desired location and administrator information.

The screenshot shows the same dialog box as above, but with the "Management Information" tab selected. The "Character Encoding" and "Display Language" dropdowns are no longer visible. Instead, there are two text input fields: "Location:" and "Administrator:". The "Required" indicator and "OK/Cancel" buttons remain the same.

- 8** When all settings are finished, click *OK*.

## Beep Alerts

You can set the LinkStation to beep if certain errors occur.

- 1** From Settings, click *Management*.

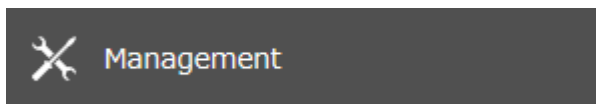

- 2** Click the settings icon (  ) to the right of "Notifications".



- 3** Click *Edit*.

- 4** Click the *Alert Sound* tab.

**5** Select the triggers to make the alert beep, then click *OK*.

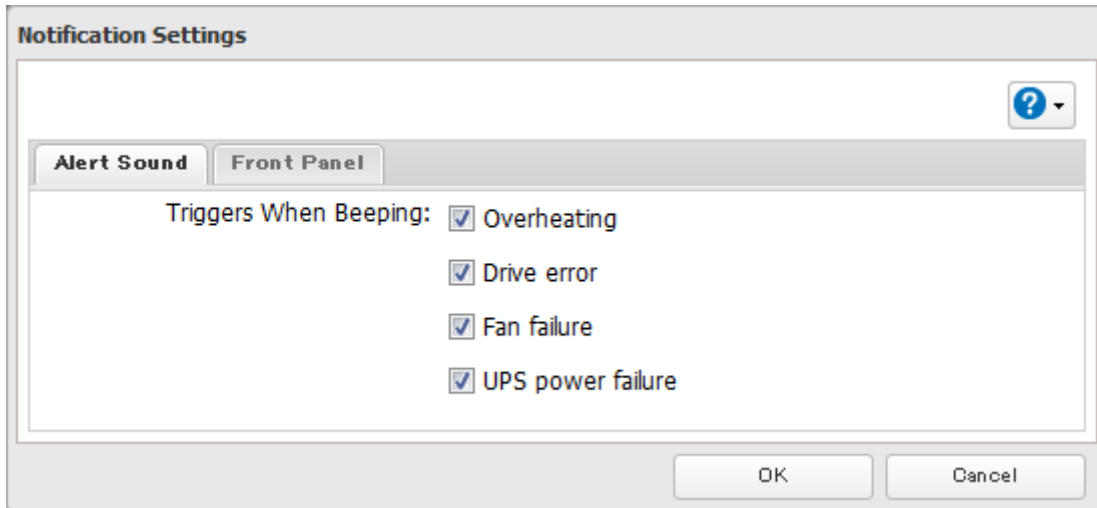

**6** Click *OK* when finished.

---

## LEDs

---

You may adjust the brightness of the LEDs on the LinkStation.

**1** From Settings, click *Management*.

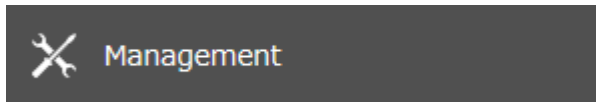

**2** Click the settings icon (⚙️) to the right of "Notifications".



**3** Click *Edit*.

**4** Click the *Front Panel* tab.

**5** Configure your settings, then click *OK*.

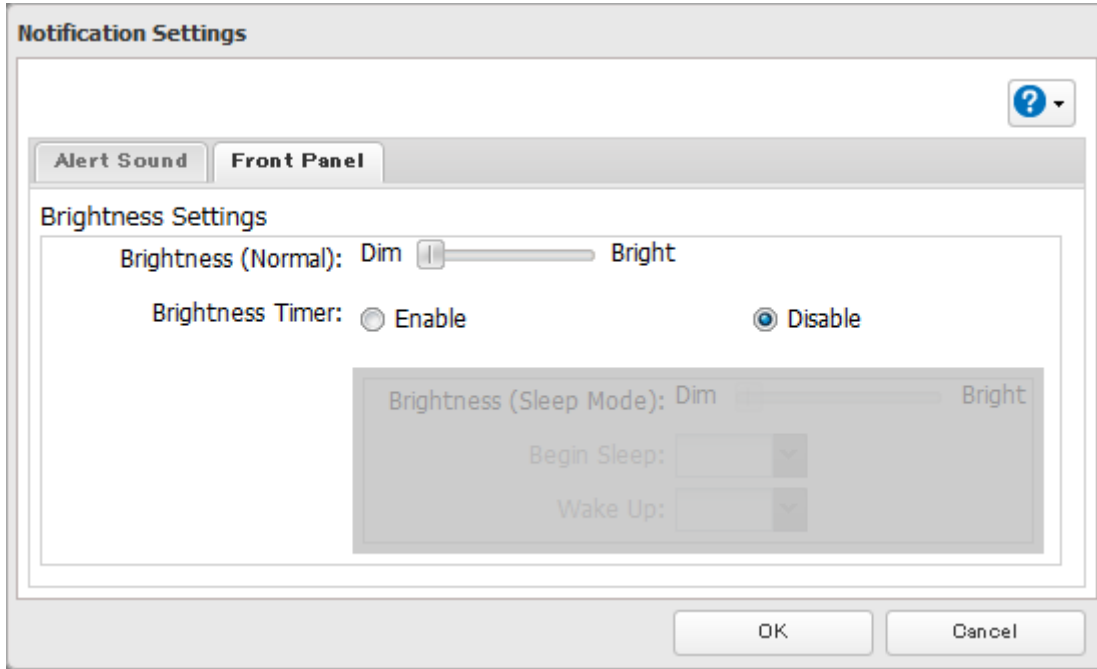

**6** Click *OK* when finished.



# Chapter 10 Drive Replacement and Troubleshooting

---

## Replacing a Defective Drive

---

Depending on the RAID mode you have configured, the procedure after replacing the defective drive may vary. Refer to the section of the configured RAID mode and follow the described procedure.

### Notes:

- Do not replace a running drive while the LinkStation is turned on. Power down the LinkStation before changing the drive. While the LinkStation is running, never unplug or remove drives without dismounting them first.
- For the replacement drive, use a Buffalo OP-HDBST series drive. The replacement drive should be the same capacity as the original drive.
- If sending a defective drive to Buffalo for replacement, please keep the cartridge as Buffalo will only replace the drive and not the cartridge.
- To avoid damaging the LinkStation with static electricity, ground yourself by touching something made of metal before handling any sensitive electronic parts.
- After a drive is replaced, it will take about 30 minutes before normal file reading and writing operations are restored. Settings may not be accessible during this period.
- Do not change the order of the drives on the LinkStation. For example, pulling out the drive in slot 1 and replacing it with the drive in slot 2 may cause data to be corrupted or lost.

## Drive Replacement for a RAID 1 Array

---

If a drive used in a RAID 1 array fails, you will need to recover the RAID array after replacing the defective drive with a new drive. You can recover the RAID array from a computer or a mobile device. Follow the appropriate procedure below to recover the RAID array.

**Note:** Make sure you do not format the replaced drive. If the replaced drive is formatted, the RAID array will not be recoverable.

### Using a Computer

- 1** Back up the saved data to another location before replacing the failed drive. If one or more drives fail during drive replacement, data can no longer be retrieved from the LinkStation.
- 2** Turn the LinkStation off and remove all cables.

**3** Slide the front panel left to remove it.

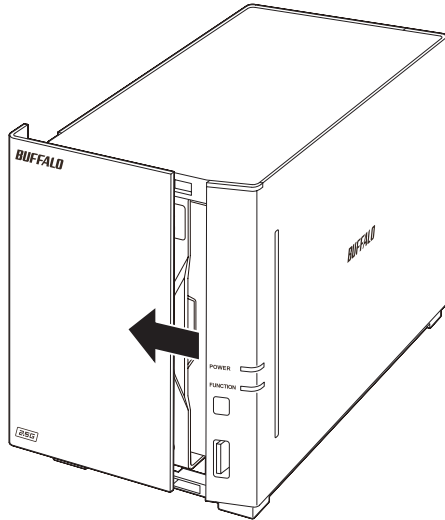

**4** Push the failed drive's cartridge up and remove it from the LinkStation.

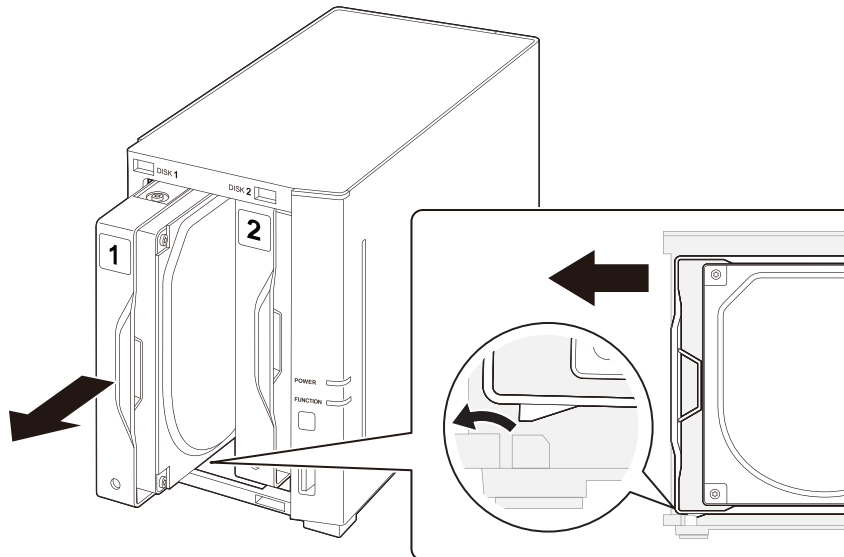

**Notes:**

- Do not press hard on the top of the LinkStation.
- Pull the drive straight out the front of the chassis.

**5** Unscrew the four screws and remove the drive from the cartridge.

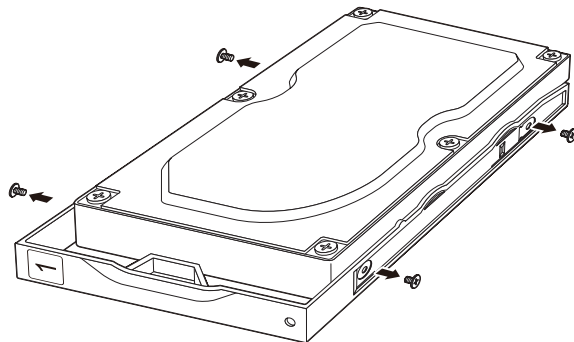

**6** Install a new drive (sold separately) into the cartridge.

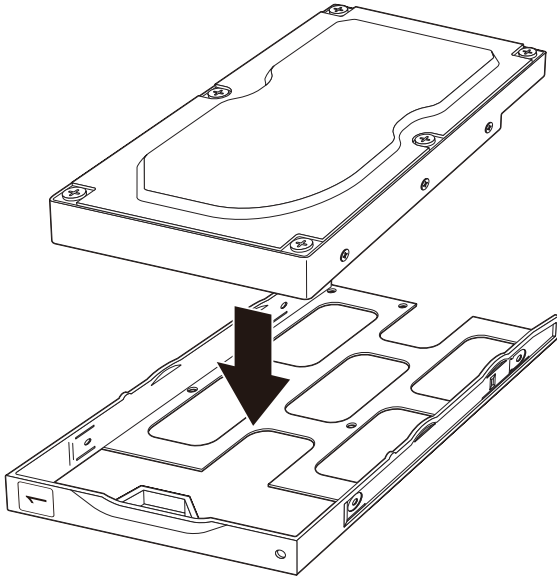

**7** Replace the four screws.

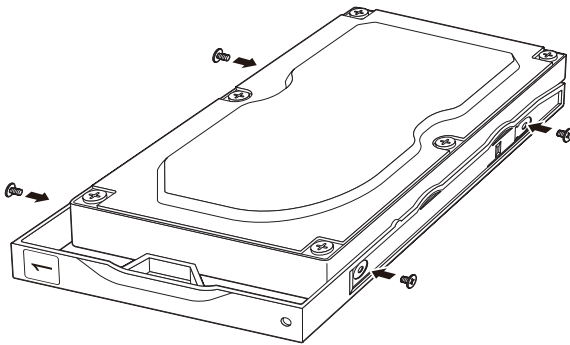

**8** Insert the new drive back into the empty slot.

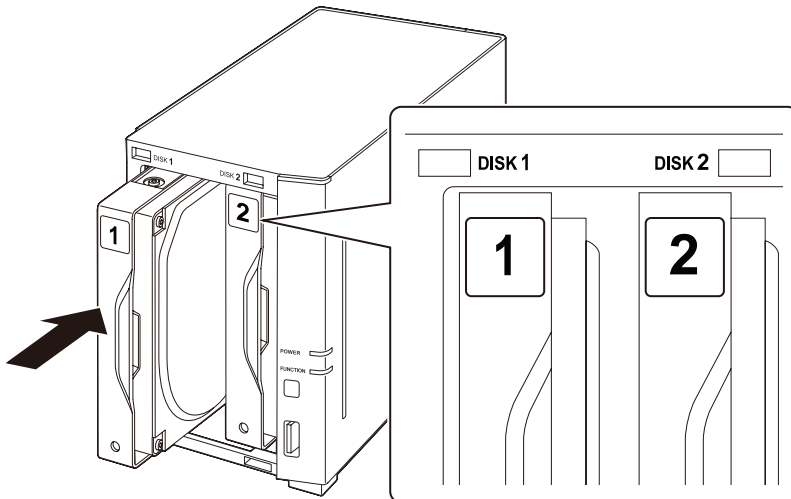

**9** Return the front panel and slide it right to close.

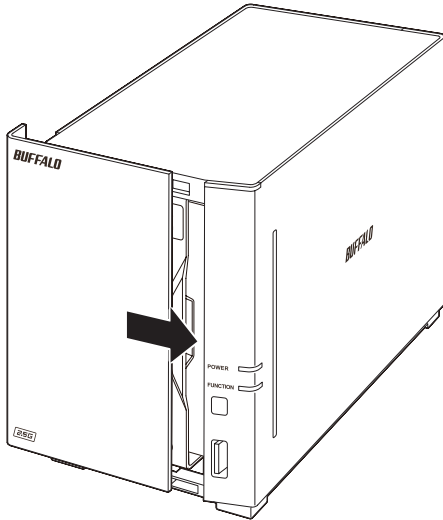

**10** Connect all cables, then turn on the LinkStation. When the replaced drive is detected, the power LED will glow amber.

**11** From Settings, click *Storage*.



**12** Click the settings icon (  ) to the right of "RAID".



**13** Click *Array 1*.

**14** Select the replaced drive and click *Recover RAID Array*.

**15** The "Confirm Operation" screen will open. Enter the confirmation number, then click *OK*.

The LinkStation will start recovering the RAID array. After a few minutes, the I18 message will be displayed until the array is recovered.

## Using a Mobile Device

**1** Back up the saved data to another location before replacing the failed drive. If one or more drives fail during drive replacement, data can no longer be retrieved from the LinkStation.

**2** Turn the LinkStation off and remove all cables.

**3** Slide the front panel left to remove it.

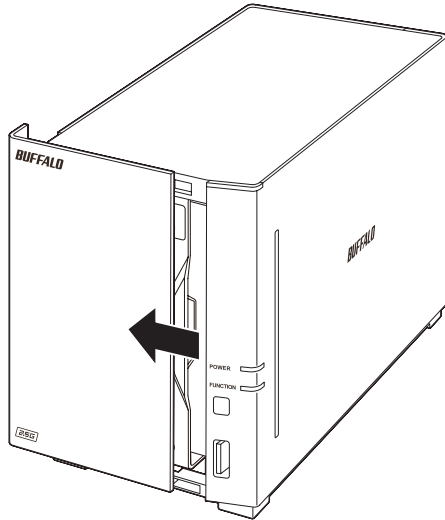

**4** Push the failed drive's cartridge up and remove it from the LinkStation.

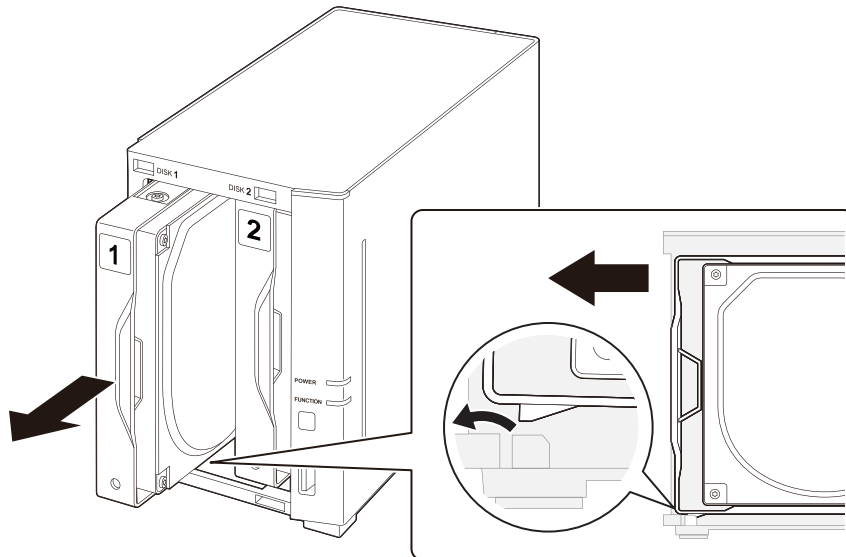

**Notes:**

- Do not press hard on the top of the LinkStation.
- Pull the drive straight out the front of the chassis.

**5** Unscrew the four screws and remove the drive from the cartridge.

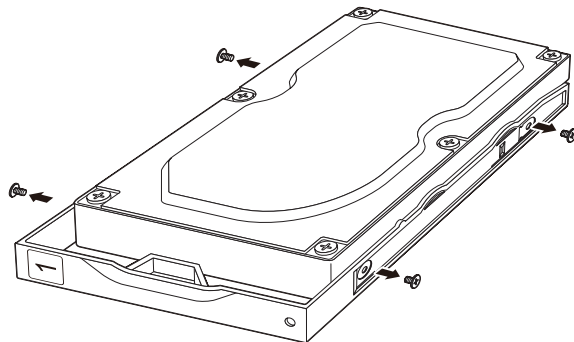

**6** Install a new drive (sold separately) into the cartridge.

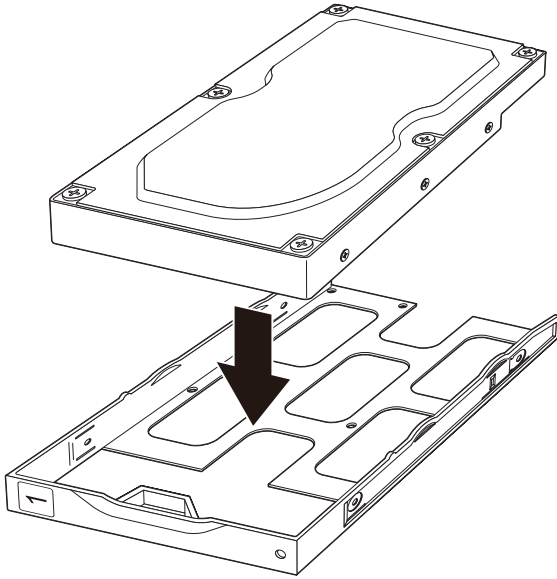

**7** Replace the four screws.

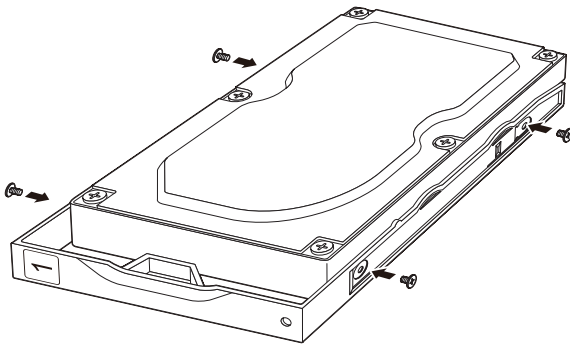

**8** Insert the new drive back into the empty slot.

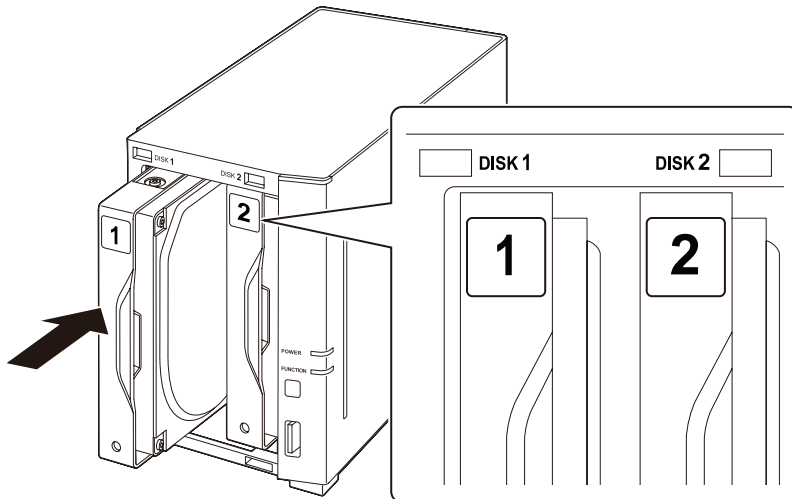

**9** Return the front panel and slide it right to close.

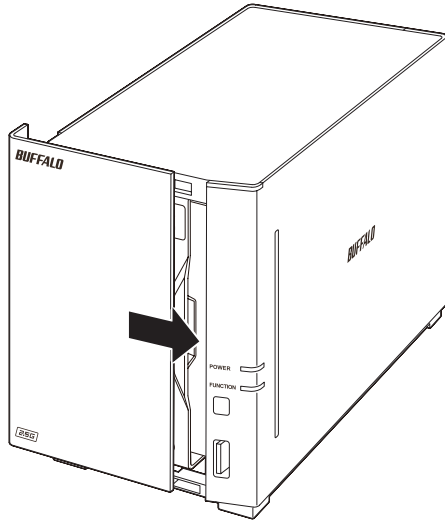

**10** Connect all cables, then turn on the LinkStation. When the replaced drive is detected, the power LED will glow amber.

**11** From Settings, tap the blinking yellow information icon (  ).

**12** Tap *Recover RAID Array*.

 View Status

**Note**

I12: The RAID array is in degraded mode.  
An error occurred on RAID array 1.

**Recover RAID Array**

**13** Tap *Recover RAID Array* again.

## Recover RAID Array

The defective drive has been replaced. Start RAID array recovery.

### RAID: RAID array 1 (RAID 1)

The defective drive has been replaced with a new drive.



Drive 1  
Normal



Drive 2  
New Drive

### Recover RAID Array 1

**Recover RAID Array**

**14** Tap *Yes*.

**15** The “Confirm Operation” screen will open. Enter the confirmation number, then tap *OK*.

The LinkStation will start recovering the RAID array.

## **Drive Replacement for a RAID 0 Array**

---

If a drive used in a RAID 0 array fails, you will need to delete the RAID array, format the replaced drive, then create a RAID 0 array again after replacing the defective drive with a new drive.

**Note:** If a drive malfunctions in a RAID 0 array, all data on the RAID array will be lost. All of the settings for the shared folders (such as access restrictions) are erased after replacing a drive in a RAID 0 array.

**1** Turn the LinkStation off and remove all cables.



**2** Slide the front panel left to remove it.

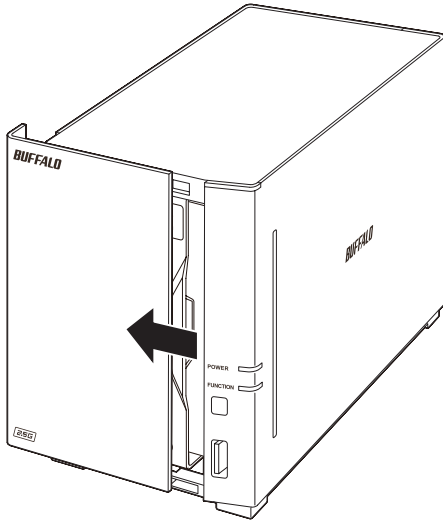

**3** Push the failed drive's cartridge up and remove it from the LinkStation.

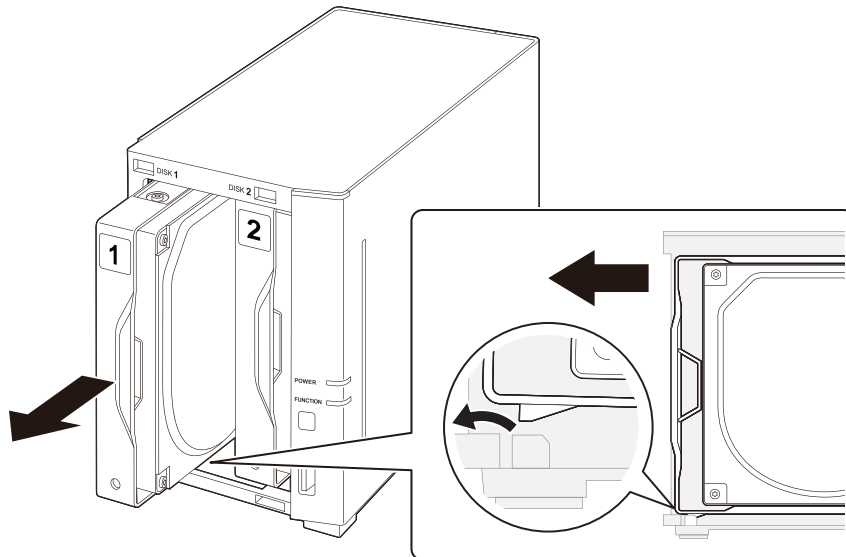

**Notes:**

- Do not press hard on the top of the LinkStation.
- Pull the drive straight out the front of the chassis.

**4** Unscrew the four screws and remove the drive from the cartridge.

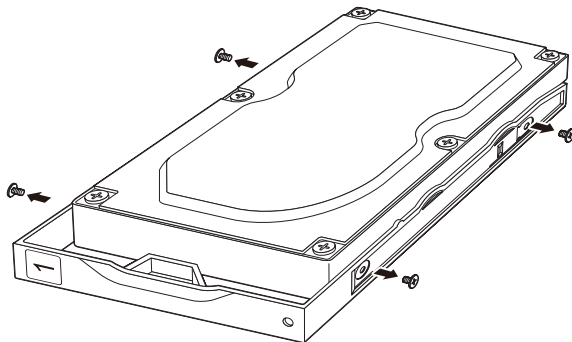

**5** Install a new drive (sold separately) into the cartridge.

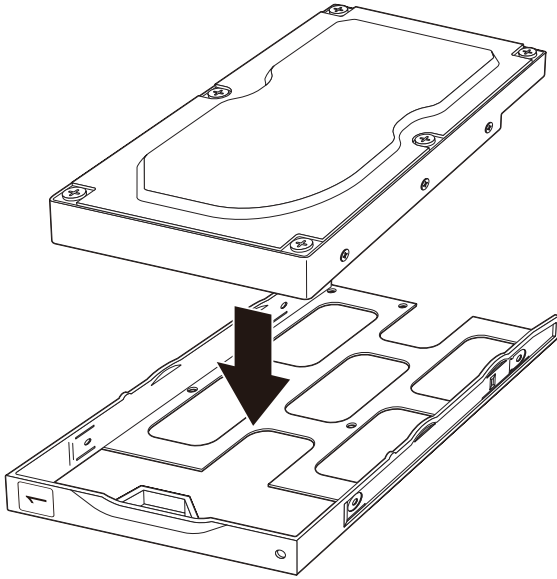

**6** Replace the four screws.

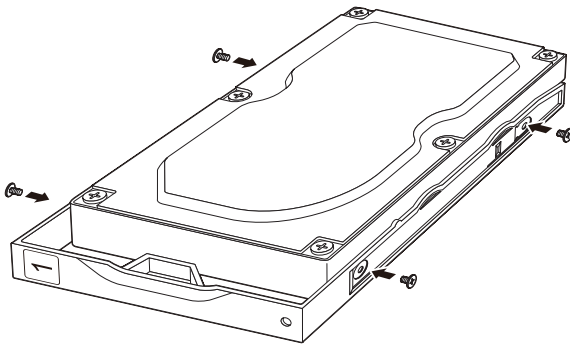

**7** Insert the new drive back into the empty slot.

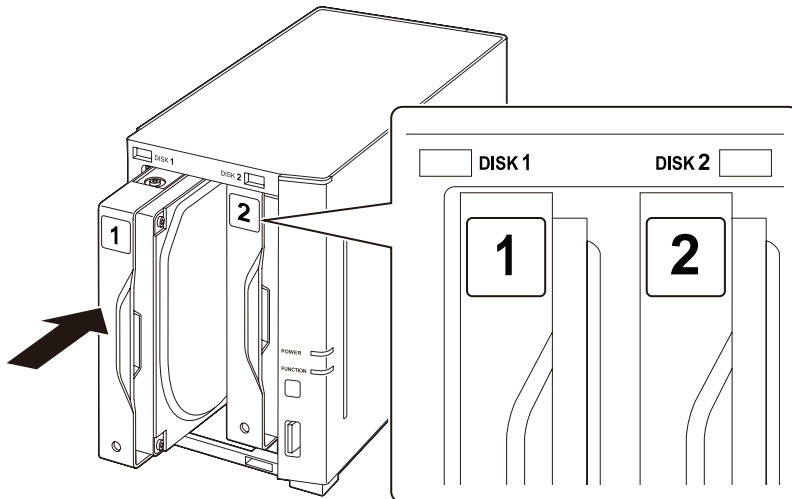

- 8 Return the front panel and slide it right to close.

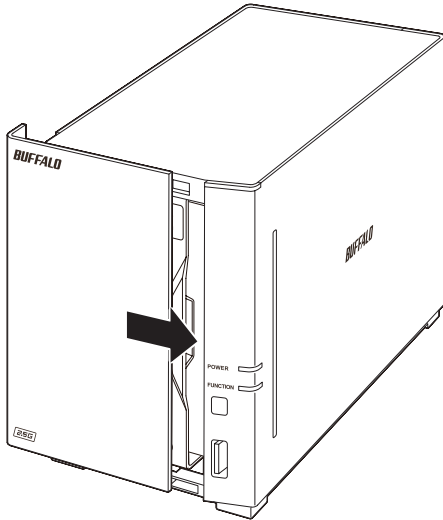

- 9 Connect all cables, then turn on the LinkStation.
- 10 Log in to Settings using NAS Navigator2.
- 11 When the following window appears after logging in, click *OK*.

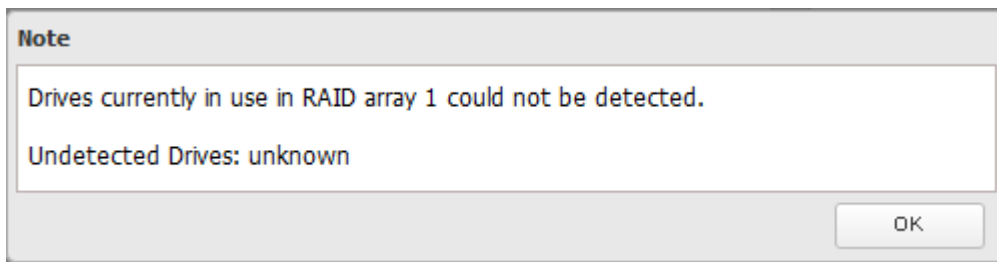

- 12 Delete the RAID array that held the failed drive by referring to the ["Using JBOD"](#) section in chapter 3.
  - 13 Format the replaced drive by referring to the ["Formatting Drives"](#) section in chapter 3.
  - 14 Create a new RAID 0 array by referring to the ["Creating a RAID Array"](#) section in chapter 3.
- The new RAID 0 array will be created. Next, create a shared folder by referring to the ["Adding a Shared Folder"](#) section in chapter 2.

## Drive Replacement for a JBOD

---

If a drive used in a JBOD fails, you will need to format the replaced drive after replacing the defective drive with a new drive.

**Note:** If a drive malfunctions in JBOD, all data on the drive will be lost.

- 1 Turn the LinkStation off and remove all cables.

**2** Slide the front panel left to remove it.

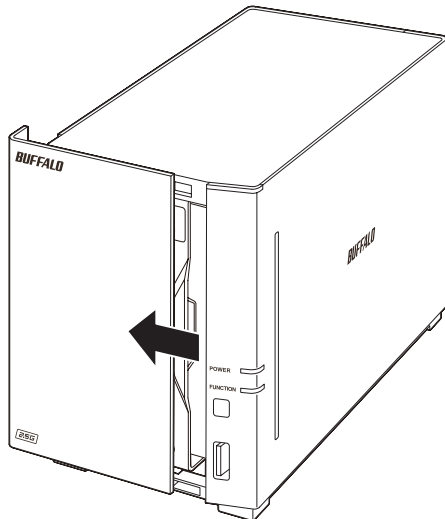

**3** Push the failed drive's cartridge up and remove it from the LinkStation.

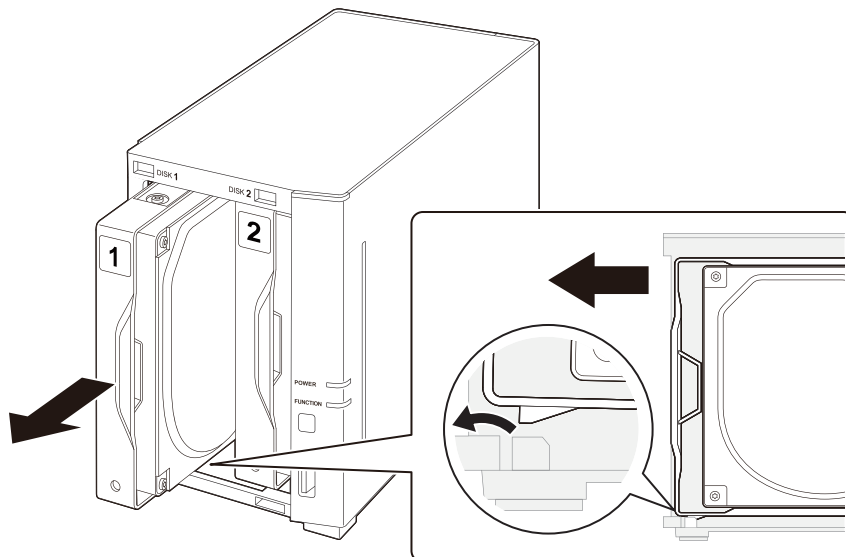

**Notes:**

- Do not press hard on the top of the LinkStation.
- Pull the drive straight out the front of the chassis.

**4** Unscrew the four screws and remove the drive from the cartridge.

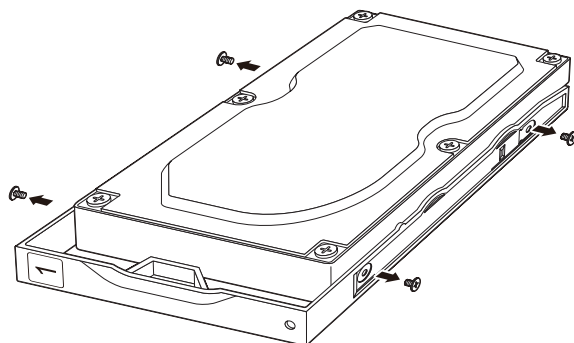

**5** Install a new drive (sold separately) into the cartridge.

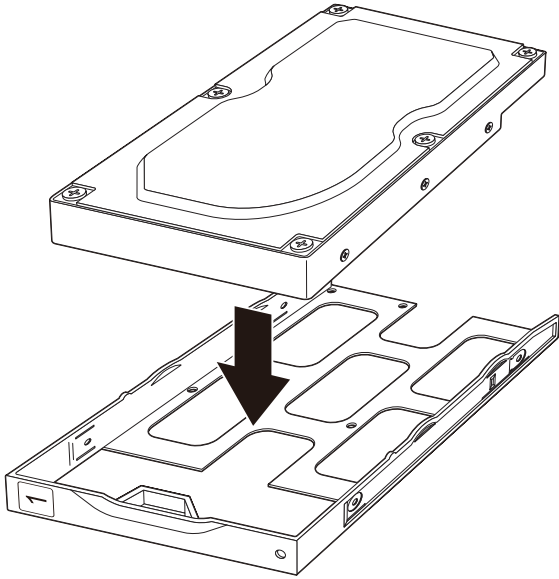

**6** Replace the four screws.

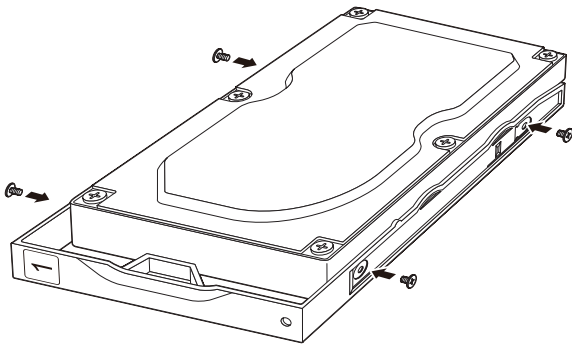

**7** Insert the new drive back into the empty slot.

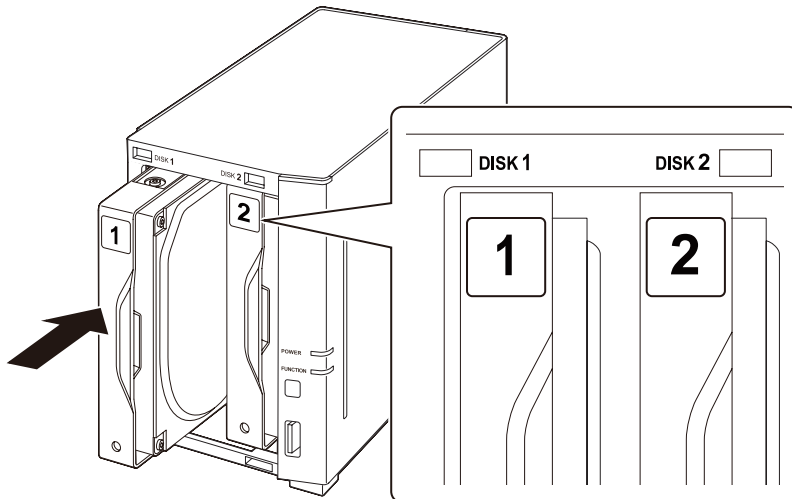

- 8** Return the front panel and slide it right to close.

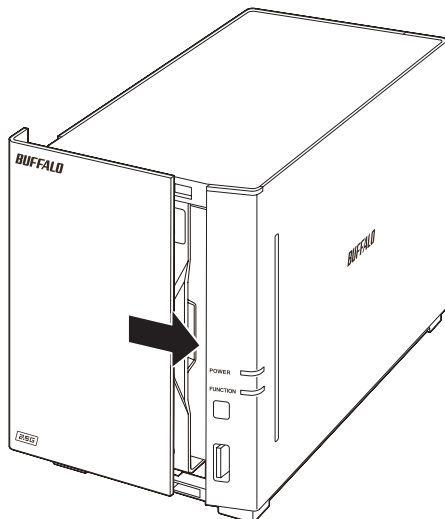

- 9** Connect all cables, then turn on the LinkStation. When the replaced drive is detected, the power LED will glow amber.

- 10** Format the replaced drive by referring to the [“Formatting Drives”](#) section in chapter 3.

The drive will be formatted. Next, create a shared folder by referring to the [“Adding a Shared Folder”](#) section in chapter 3.

## Replacing a Non-Malfunctioning Drive

This unit does not support hot-swapping. If you must change a drive that is not malfunctioning, **shut down the LinkStation before replacing the drive**. If you need to replace more than one drive all at once, replace the drives one at a time to preserve your data. When replacing the non-malfunctioning drive, the RAID array will function as below:

### Operating in RAID 1

The RAID array will enter degraded mode after replacing the drive. You will be unable to use the LinkStation until you recover the RAID array with a new drive.

### Operating in RAID 0

All data on the RAID array will be deleted after replacing the drive. You will be unable to use the LinkStation until you delete and create a new RAID array with a new drive.

### Operating in JBOD

All data on that drive will be deleted after replacing the drive. You will be unable to use the LinkStation until you format the new drive.

## Manually Recovering the Firmware

If an error occurs with the firmware, the LinkStation will generally try to repair it automatically. However, if the firmware cannot be automatically repaired by the system or the LinkStation enters emergency mode, you can try to manually repair the firmware by following the procedure below.

Before proceeding with manual firmware recovery, be aware that the manual firmware recovery process will erase data on the LinkStation. **Contact technical support immediately if firmware recovery is not successful.**

- 1** Move the power switch to the “Off” position to turn off the LinkStation.
- 2** Press and hold the function button while moving the power switch to the “On” position to power on the LinkStation.
- 3** When the I41 message appears on NAS Navigator2, press the function button to start firmware recovery.
- 4** The LinkStation will repair the firmware. The I37 message will appear on NAS Navigator2 while the firmware is being repaired. When firmware recovery is finished, the LinkStation will restart automatically.

**Note:** After firmware recovery, the firmware version will remain unchanged.

# Chapter 11 Appendix

## Power LED Operations

This section explains the details of power LED patterns when an event occurs. If there is a corresponding corrective action described for the code, try it first. If the LED still glowing due to an issue outlined below, contact Buffalo technical support for assistance.

### Red (Errors)

If a critical error occurs, the power LED will glow red. You can also confirm the current status from the Dashboard in Settings or by using NAS Navigator2. If NAS Navigator2 displays the error as an unknown error, check the Dashboard in Settings for the error details.

Code	Description	Corrective Action
Emergency Mode	The firmware is corrupted or a drive cannot be detected.	Check that the drive has been inserted properly. After that, refer to the <a href="#">“Manually Recovering the Firmware”</a> section in chapter 10 to recover the firmware.
E10	The LinkStation is running on the UPS battery due to a power outage.	Shut down the LinkStation safely and wait until the power outage ends. If certain settings are configured, the LinkStation may shut down automatically when the error is detected.
	If the setting to use the UPS connected to this LinkStation has been configured, the UPS cable may be disconnected.	Verify that the UPS cable or Ethernet cable is connected properly.
E11	An error occurred in the fan speed.	Check that no foreign objects or dust are clogging the fan. If any foreign objects or dust are found, use a pair of tweezers, an air duster, or other tools to remove them.
E12	A rise in the system temperature may have exceeded the allowable safety value.	Move the LinkStation to a cool location. Do not place objects in the area around the LinkStation.
E14	The RAID array cannot be mounted.	Run a drive check on the RAID array by referring to the <a href="#">“Checking Drives”</a> section in chapter 3.
E16	Unable to find the drive.	Make sure the drive has been inserted properly.
E22	Unable to mount the drive.	Format the drive by referring to the <a href="#">“Formatting Drives”</a> section in chapter 3. After formatting, if the error still appears after rebooting, replace the drive.
E30	An error occurred, so the drive was removed from the RAID array.	Replace the drive by referring to the <a href="#">“Replacing a Defective Drive”</a> section in chapter 10.
E41	The NVRAM inside the LinkStation failed.	Contact Buffalo technical support for assistance.



## Amber (Notices)

If a non-critical error occurs, the power LED will glow amber. You can also confirm the current status from the Dashboard in Settings or by using NAS Navigator2. If NAS Navigator2 displays the error as an unknown error, check the Dashboard in Settings for the error details.

You can click the “Clear” button to delete messages from the Dashboard.

Code	Description	Corrective Action
I10	A rise in the system temperature may have exceeded the allowable safety value.	Move the LinkStation to a cool location. Do not place objects in the area around the LinkStation.
I11	The drive has too many bad sectors.	Replace the drive by referring to the <a href="#">“Replacing a Defective Drive”</a> section in chapter 10.
I12	Operating in degraded mode.	Check if the E30 error is also displayed. If it is, refer to the corrective action for the E30 error.
I44	Initialization from the USB initialization drive was initiated, but the drive in slot 1 was not detected.	Make sure that the drive in slot 1 is present and fully inserted into its slot.
I45	Initialization failed.	-
I54	The backup job failed.	Refer to the <a href="#">“Backup Logs for If Backup Fails”</a> section in chapter 4 and try the respective corrective actions.
I55	Authentication during initialization of settings failed.	Settings can only be restored for the LinkStation whose settings were originally saved.
I64	Connecting to the cloud storage service failed.	Open Settings and check the status of the job that failed for the cloud service. Refer to the error log on the job list of the specific cloud storage service and check the cause of the error.
I70	There is not enough space to save file access logs.	Delete file access logs to free up space.

## Amber (Information Events)

After you change any settings, the power LED will glow amber. You can also confirm the current status from the Dashboard in Settings or by using NAS Navigator2. If NAS Navigator2 displays the status as an unknown error, check the Dashboard in Settings for the status details.

You can click the “Clear” button to delete messages from the Dashboard.

Code	Description	Corrective Action
I01	Checking the system area.	-
I13	Formatting the RAID array.	-
I14	Checking the RAID array.	-
I15	Examining the error status of the RAID array. <b>Note:</b> Transfer speeds are slower during the examination process.	-
I16	Creating the RAID array.	-
I17	Resynchronizing the RAID array. <b>Note:</b> Transfer speeds are slower during resynchronization.	-

Code	Description	Corrective Action
I18	Recovering the RAID array. <b>Note:</b> Transfer speeds are slower during the rebuilding process.	-
I19	Rewriting drives in the LinkStation with 0s.	-
I20	Formatting the drive.	-
I21	Checking the drive.	<ul style="list-style-type: none"> <li>• If the code appears while running a drive check, wait until the process finishes.</li> <li>• If the code appears right after the LinkStation boots up, restart the LinkStation after waiting 30 minutes. If the code appears again, try the appropriate corrective action below: <b>LS710D:</b> Contact Buffalo technical support for assistance. <b>LS720D:</b> Replace the drive by referring to the <a href="#">"Replacing a Defective Drive"</a> section in chapter 10.</li> </ul>
I25	Updating the LinkStation firmware.	Do not turn off the LinkStation's power.
I26	The initialization process has been started by using Settings and all settings are being initialized.	-
I27	Checking the USB drive.	-
I28	Formatting the USB drive.	-
I32	Appears after replacing the drive when the RAID array needs to be rebuilt in Settings or formatting is necessary.	From Settings, either recover the RAID array or format the drive.
I37	The initialization process has been started by using the USB initialization drive and settings are being initialized.	-
I38	Settings initialization is finished.	-
I40	Beginning settings initialization. All data on the drive in slot 1 will be deleted.	-
I41	Press the function button to start the settings initialization process.	-
I42	Preparing to start the settings initialization process.	-
I43	The LinkStation was started from the USB initialization drive, but the settings cannot be initialized from this USB initialization drive.	-
I46	Data migration or conversion (RAID migration) is in progress.	Do not turn off the LinkStation's power.
I47	Data migration or conversion (RAID migration) is in progress.	Do not turn off the LinkStation's power.
I52	A new firmware version has been released.	Update the firmware by referring to the <a href="#">"Updating the Firmware"</a> section in chapter 9.
I71	The space is occupied so older logs were removed.	Delete file access logs to free up space.

## Default Settings

Administrator's Name	admin	
Password	password	
Shared Folders	"share" for both Windows and macOS computers. <b>Note:</b> The recycle bin is enabled by default.	
IP Address	The LinkStation will get its IP address automatically from a DHCP server on the network. If no DHCP server is available, then an IP address will be assigned as follows: IP Address: 169.254.xxx.xxx ("xxx" is a number randomly assigned when booting the LinkStation.) Subnet Mask: 255.255.0.0	
Registered Groups	"hdusers", "admin", and "guest" You cannot edit or delete these default groups.	
Microsoft Network Group Settings	WORKGROUP	
MTU Size	1,500 bytes	
SMB	Enabled	
	SMB Protocol	Auto
	Recycle Bin	Permissions: All users macOS Temp Files: Keep when original file is deleted
	User Settings	Log in as guest
FTP	Disabled	
WebAccess	Disabled	
RAID Scanning	Disabled	
Dropbox Sync	Disabled	
Microsoft Azure Storage Sync	Disabled	
Microsoft OneDrive Sync	Disabled	
DLNA Server	Disabled	
SNMP	Disabled	
Time Machine	Disabled	
Direct Copy	Disabled	
Name/Time/Language	NTP	Enabled
Email Notification	Disabled	
Initialize	Init Button Settings	Restore admin username and password to factory defaults
RAID Mode	LS720D: RAID 1	

## Specifications

Check the [Buffalo website](#) for the latest product information and specifications.

LAN Interface	Standards Compliance	IEEE 802.3bz (2.5GBASE-T), IEEE 802.3ab (1000BASE-T), IEEE 802.3u (100BASE-TX), IEEE 802.3 (10BASE-T)
	Data Transfer Rates	2.5 Gbps, 10/100/1000 Mbps (auto sensing)
	Number of Ports	1
	Connector Type	RJ-45 8-pin (auto MDI-X)
	Supported Protocols	TCP/IP
	Network File Services	SMB/CIFS, FTP/FTPS, NFS, HTTP/HTTPS, SNMP
	MTU Sizes	1,500–9,219 bytes
USB Interface	Standards Compliance	USB 3.2 Gen 1/2.0
	Data Transfer Rates	USB 3.2 Gen 1: max. 5 Gbps USB 2.0: max. 480 Mbps
	Number of Ports	2 × USB 3.2 Gen 1, 1 × USB 2.0
	Connector Type	Type A
Internal Drive	Number of Drive Bays	LS710D: 1 LS720D: 2
	Drive Interface	SATA 6 Gbps
	Supported RAID	LS720D: 0, 1, JBOD (individual drives)
	Replacement Drive	LS720D: Buffalo OP-HDBST series drive <b>Note:</b> The replacement drive should be the same capacity as the original drive. The drives listed above are available from the <a href="#">Buffalo website</a> .
Others	Power Supply	AC 100–240 V, 50/60 Hz
	Power Consumption	LS710D (4 TB or smaller model): max. 24 W LS710D (8 TB model), LS720D (8 TB or smaller model): max. 36 W LS720D (16 TB): max. 48 W
	Dimensions (W × H × D, excluding protruding parts)	LS710D: 60 × 128 × 207 mm; 2.4 × 5.0 × 8.1 in. LS720D: 92 × 128 × 207 mm; 3.6 × 5.0 × 8.1 in.
	Weight	LS710D: approx. 1.3 kg; 2.9 lbs LS720D: approx. 2.4 kg; 5.3 lbs
	Operating Environment	Temperature: 5–40°C; 41–104°F Humidity: 20–80% non-condensing
	Compatible Devices	Windows PCs, Intel Mac computers, iOS devices, and Android devices with wired or wireless Ethernet connection.
	Supported OS	Windows 10, 8.1 Windows Server 2019, 2016, 2012 R2, 2012 Windows Server IoT 2019 for Storage, Windows Storage Server 2016, 2012 R2, 2012 macOS 10.15, 10.14, 10.13 iOS 10 or later Android 7.0 or later