



DLP® Projector

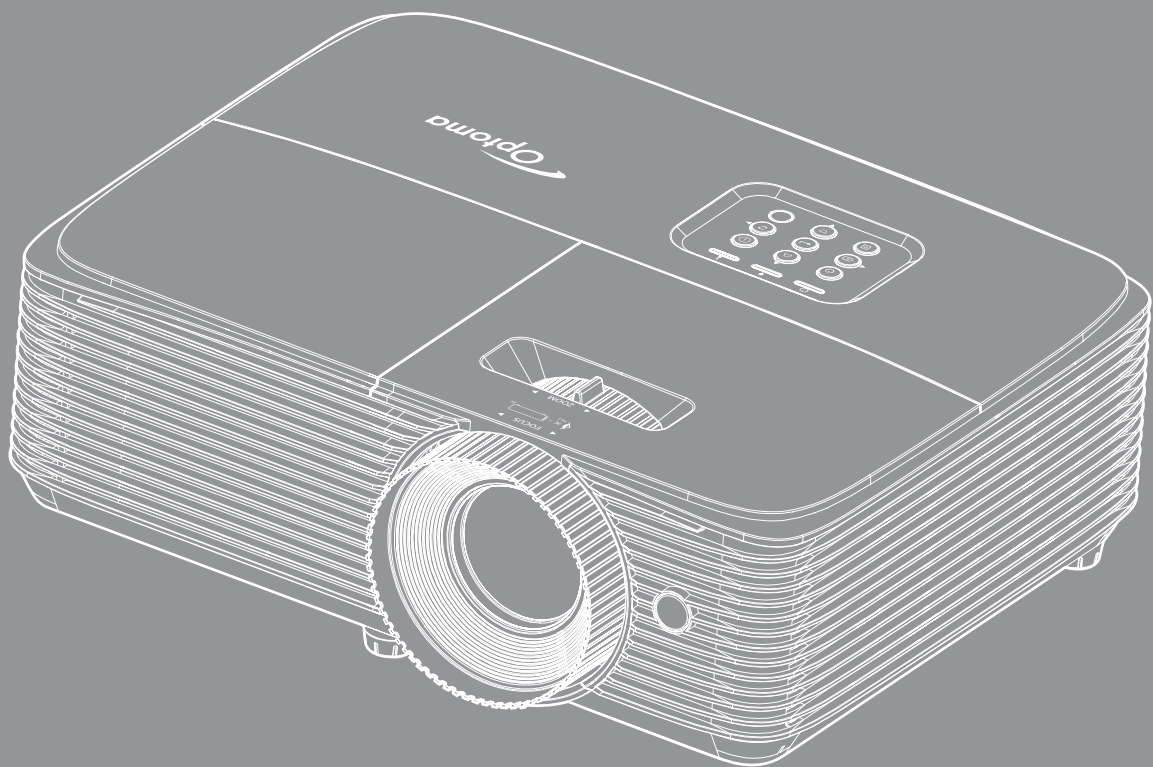

TABLE OF CONTENTS

SAFETY	4
<i>Important Safety Instruction</i>	4
<i>3D Safety Information</i>	5
<i>Copyright</i>	6
<i>Disclaimer</i>	6
<i>Trademark Recognition</i>	6
<i>FCC</i>	7
<i>Declaration of Conformity for EU countries</i>	7
<i>WEEE</i>	7
INTRODUCTION	8
<i>Package Overview</i>	8
<i>Standard accessories</i>	8
<i>Optional accessories</i>	8
<i>Product Overview</i>	9
<i>Connections</i>	10
<i>Keypad</i>	12
<i>Remote control 1</i>	13
<i>Remote control 2</i>	14
<i>Remote control 3</i>	15
<i>Remote control 4</i>	16
SETUP AND INSTALLATION	17
<i>Installing the projector</i>	17
<i>Adjusting the projector image</i>	23
USING THE PROJECTOR	26
<i>Powering on / off the projector</i>	26
<i>Selecting an input source</i>	27
<i>Menu navigation and features</i>	28
<i>OSD Menu tree (SVGA, XGA, and WXGA models)</i>	29
<i>Display image settings menu</i>	37
<i>Display 3D menu</i>	39
<i>Display aspect ratio menu</i>	40
<i>Display edge mask menu</i>	42
<i>Display zoom menu</i>	42
<i>Display image shift menu</i>	42
<i>Display keystone menu</i>	42
<i>Audio mute menu</i>	43
<i>Audio volume menu</i>	43
<i>Setup projection menu</i>	44
<i>Setup screen type menu</i>	44
<i>Setup lamp settings menu</i>	44

<i>Setup filter settings menu</i>	44
<i>Setup power settings menu</i>	44
<i>Setup security menu</i>	45
<i>Setup HDMI link settings menu</i>	46
<i>Setup test pattern menu</i>	46
<i>Setup remote settings menu</i>	46
<i>Setup projector ID menu</i>	47
<i>Setup options menu</i>	47
<i>Setup reset menu</i>	48
<i>Info menu</i>	48



MAINTENANCE..... 49

<i>Replacing the lamp</i>	49
<i>Installing and cleaning the dust filter</i>	51

ADDITIONAL INFORMATION..... 52

<i>Compatible resolutions</i>	52
<i>Image size and projection distance</i>	55
<i>Projector dimensions and ceiling mount installation</i>	57
<i>IR remote control 1 codes</i>	58
<i>IR remote control 2 codes</i>	60
<i>IR remote control 3 codes</i>	62
<i>IR remote control 4 codes</i>	64
<i>Troubleshooting</i>	66
<i>Warning indicators</i>	68
<i>Specifications</i>	70
<i>Optoma global offices</i>	71

SAFETY

	The lightning flash with arrow head within an equilateral triangle is intended to alert the user to the presence of uninsulated "dangerous voltage" within the product's enclosure that may be of sufficient magnitude to constitute a risk of electric shock to persons.
	The exclamation point within an equilateral triangle is intended to alert the user to the presence of important operating and maintenance (servicing) instructions in the literature accompanying the appliance.

Please follow all warnings, precautions and maintenance as recommended in this user's guide.

Important Safety Instruction



- Do not stare into the beam, RG2.
As with any bright source, do not stare into the direct beam, RG2 IEC 62471-5:2015.
- Do not block any ventilation openings. To ensure reliable operation of the projector and to protect from over heating, it is recommended to install the projector in a location that does not block ventilation. As an example, do not place the projector on a crowded coffee table, sofa, bed, etc. Do not put the projector in an enclosure such as a book case or a cabinet that restricts air flow.
- To reduce the risk of fire and/or electric shock, do not expose the projector to rain or moisture. Do not install near heat sources such as radiators, heaters, stoves or any other apparatus such as amplifiers that emits heat.
- Do not let objects or liquids enter the projector. They may touch dangerous voltage points and short out parts that could result in fire or electric shock.
- Do not use under the following conditions:
 - In extremely hot, cold or humid environments.
 - (i) Ensure that the ambient room temperature is within 5°C ~ 40°C
 - (ii) Relative humidity is 10% ~ 85%
 - In areas susceptible to excessive dust and dirt.
 - Near any appliance generating a strong magnetic field.
 - In direct sunlight.
- Do not use the projector in places where flammable gases or explosives gases may be present in the atmosphere. The lamp inside the projector becomes very hot during operation and the gases may ignite and result in a fire.
- Do not use the unit if it has been physically damaged or abused. Physical damage/abuse would be (but not limited to):
 - Unit has been dropped.
 - Power supply cord or plug has been damaged.
 - Liquid has been spilled on to the projector.
 - Projector has been exposed to rain or moisture.
 - Something has fallen in the projector or something is loose inside.
- Do not place the projector on an unstable surface. The projector may fall over resulting in injury or the projector may become damaged.
- Do not block the light coming out of the projector lens when in operation. The light will heat the object and could melt, cause burns or start a fire.

- Please do not open or disassemble the projector as this may cause electric shock.
- Do not attempt to service the unit yourself. Opening or removing covers may expose you to dangerous voltages or other hazards. Please call Optoma before you send the unit for repair.
- See projector enclosure for safety related markings.
- The unit should only be repaired by appropriate service personnel.
- Only use attachments/accessories specified by the manufacturer.
- Do not look into straight into the projector lens during operation. The bright light may harm your eyes.
- When replacing the lamp, please allow the unit to cool down. Follow instructions as described on pages 49-50.
- This projector will detect the life of the lamp itself. Please be sure to change the lamp when it shows warning messages.
- Reset the "Lamp Reset" function from the on-screen display "Setup lamp settings" menu after replacing the lamp module.
- When switching the projector off, please ensure the cooling cycle has been completed before disconnecting power. Allow 90 seconds for the projector to cool down.
- When the lamp is approaching to the end of its life time, the message "Lamp life exceeded." will show on the screen. Please contact your local reseller or service center to change the lamp as soon as possible.
- Turn off and unplug the power plug from the AC outlet before cleaning the product.
- Use a soft dry cloth with mild detergent to clean the display housing. Do not use abrasive cleaners, waxes or solvents to clean the unit.
- Disconnect the power plug from AC outlet if the product is not being used for a long period of time.

Note: *When the lamp reaches the end of its life, the projector will not turn back on until the lamp module has been replaced. To replace the lamp, follow the procedures listed under "Replacing the Lamp" section on pages 49-50.*

- *Do not setup the projector in places where it might be subjected to vibration or shock.*
- *Do not touch the lens with bare hands*
- *Remove battery/batteries from remote control before storage. If the battery/batteries are left in the remote for long periods, they may leak.*
- *Do not use or store the projector in places where smoke from oil or cigarettes may be present, as it can adversely affect the quality of the projector performance.*
- *Please follow the correct projector orientation installation as non standard installation may affect the projector performance.*
- *Use a power strip and or surge protector. As power outages and brown-outs can KILL devices.*

3D Safety Information

Please follow all warnings and precautions as recommended before you or your child use the 3D function.

Warning

Children and teenagers may be more susceptible to health issues associated with viewing in 3D and should be closely supervised when viewing these images.

Photosensitive Seizure Warning and Other Health Risks

- Some viewers may experience an epileptic seizure or stroke when exposed to certain flashing images or lights contained in certain Projector pictures or video games. If you suffer from, or have a family history of epilepsy or strokes, please consult with a medical specialist before using the 3D function.
- Even those without a personal or family history of epilepsy or stroke may have an undiagnosed condition that can cause photosensitive epileptic seizures.
- Pregnant women, the elderly, sufferers of serious medical conditions, those who are sleep deprived or under the influence of alcohol should avoid utilizing the unit's 3D functionality.

- If you experience any of the following symptoms, stop viewing 3D pictures immediately and consult a medical specialist: (1) altered vision; (2) light-headedness; (3) dizziness; (4) involuntary movements such as eye or muscle twitching; (5) confusion; (6) nausea; (7) loss of awareness; (8) convulsions; (9) cramps; and/ or (10) disorientation. Children and teenagers may be more likely than adults to experience these symptoms. Parents should monitor their children and ask whether they are experiencing these symptoms.
- Watching 3D projection may also cause motion sickness, perceptual after effects, disorientation, eye strain and decreased postural stability. It is recommended that users take frequent breaks to lessen the potential of these effects. If your eyes show signs of fatigue or dryness or if you have any of the above symptoms, immediately discontinue use of this device and do not resume using it for at least thirty minutes after the symptoms have subsided.
- Watching 3D projection while sitting too close to the screen for an extended period of time may damage your eyesight. The ideal viewing distance should be at least three times the screen height. It is recommended that the viewer's eyes are level with the screen.
- Watching 3D projection while wearing 3D glasses for an extended period of time may cause a headache or fatigue. If you experience a headache, fatigue or dizziness, stop viewing the 3D projection and rest.
- Do not use the 3D glasses for any other purpose than for watching 3D projection.
- Wearing the 3D glasses for any other purpose (as general spectacles, sunglasses, protective goggles, etc.) may be physically harmful to you and may weaken your eyesight.
- Viewing in 3D projection may cause disorientation for some viewers. Accordingly, DO NOT place your 3D PROJECTOR near open stairwells, cables, balconies, or other objects that can be tripped over, run into, knocked down, broken or fallen over.

Copyright

This publication, including all photographs, illustrations and software, is protected under international copyright laws, with all rights reserved. Neither this manual, nor any of the material contained herein, may be reproduced without written consent of the author.

© Copyright 2018

Disclaimer

The information in this document is subject to change without notice. The manufacturer makes no representations or warranties with respect to the contents hereof and specifically disclaims any implied warranties of merchantability or fitness for any particular purpose. The manufacturer reserves the right to revise this publication and to make changes from time to time in the content hereof without obligation of the manufacturer to notify any person of such revision or changes.

Trademark Recognition

Kensington is a U.S. registered trademark of ACCO Brand Corporation with issued registrations and pending applications in other countries throughout the world.

HDMI, the HDMI Logo, and High-Definition Multimedia Interface are trademarks or registered trademarks of HDMI Licensing LLC in the United States and other countries.

DLP®, DLP Link and the DLP logo are registered trademarks of Texas Instruments and BrilliantColor™ is a trademark of Texas Instruments.

All other product names used in this manual are the properties of their respective owners and are Acknowledged.

DARBEE is a trademark by Darbee Products, Inc.

FCC

This device has been tested and found to comply with the limits for a Class B digital device pursuant to Part 15 of the FCC rules. These limits are designed to provide reasonable protection against harmful interference in a residential installation. This device generates, uses and can radiate radio frequency energy and, if not installed and used in accordance with the instructions, may cause harmful interference to radio communications.

However, there is no guarantee that interference will not occur in a particular installation. If this device does cause harmful interference to radio or television reception, which can be determined by turning the device off and on is encouraged to try to correct the interference by one or more of the following measures:

- Reorient or relocate the receiving antenna.
- Increase the separation between the device and receiver.
- Connect the device into an outlet on a circuit different from that to which the receiver is connected.
- Consult the dealer or an experienced radio/television technician for help.

Notice: Shielded cables

All connections to other computing devices must be made using shielded cables to maintain compliance with FCC regulations.

Caution

Changes or modifications not expressly approved by the manufacturer could void the user's authority, which is granted by the Federal Communications Commission, to operate this projector.

Operation Conditions

This device complies with Part 15 of the FCC Rules. Operation is subject to the following two conditions:

1. This device may not cause harmful interference and
2. This device must accept any interference received, including interference that may cause undesired operation.

Notice: Canadian users

This Class B digital apparatus complies with Canadian ICES-003.

Remarque à l'intention des utilisateurs canadiens

Cet appareil numérique de la classe B est conforme à la norme NMB-003 du Canada.

Declaration of Conformity for EU countries

- EMC Directive 2014/30/EC (including amendments)
- Low Voltage Directive 2014/35/EC
- R & TTE Directive 1999/5/EC (if product has RF function)

WEEE



Disposal instructions

Do not throw this electronic device into the trash when discarding. To minimize pollution and ensure utmost protection of the global environment, please recycle it.

INTRODUCTION

Package Overview

Carefully unpack and verify that you have the items listed below under standard accessories. Some of the items under optional accessories may not be available depending on the model, specification and your region of purchase. Please check with your place of purchase. Some accessories may vary from region to region.

The warranty card is only supplied in some specific regions. Please consult your dealer for detailed information.

Standard accessories

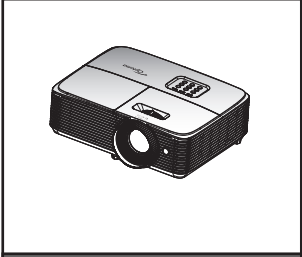
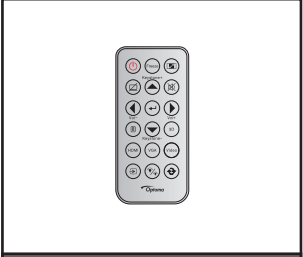
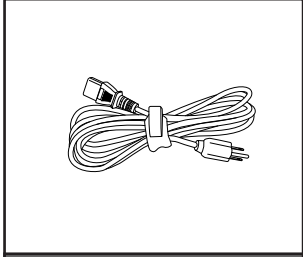
			<input type="checkbox"/> CD User Manual *(1) <input type="checkbox"/> Warranty Card *(2) <input checked="" type="checkbox"/> Basic User Manual
Projector	Remote control *(3)	Power lead	Documentation

Note:

- The remote control is shipped with the battery.
- *(1) For European User Manual please visit www.optomaeurope.com.
- *(2) For European warranty information please visit www.optomaeurope.com.
- *(3) The actual remote control may vary depending on the region.

Optional accessories

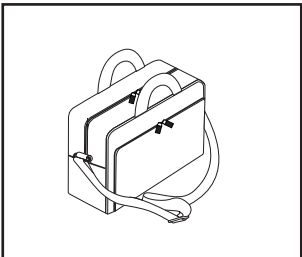
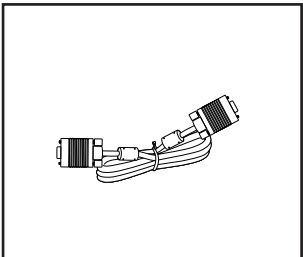
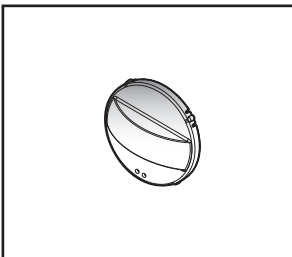
		
Carry bag	VGA cable	Lens cap

Note: Optional accessories vary depending on model, specification and region.

INTRODUCTION

Product Overview

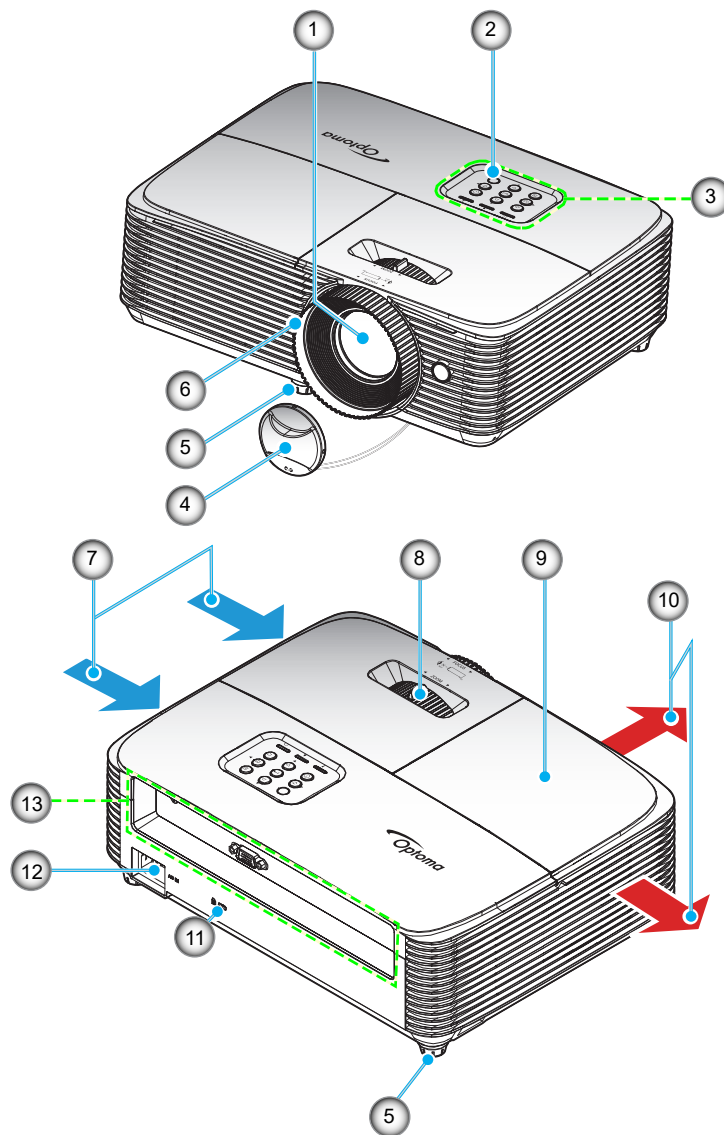

Note: Keep a minimum distance of 20 cm between the “inlet” and “outlet” labels.

No	Item	No	Item
1.	Lens	8.	Zoom Lever
2.	IR Receiver	9.	Lamp Cover
3.	Keypad	10.	Ventilation (outlet)
4.	Lens Cap	11.	Kensington™ Lock Port
5.	Tilt-Adjustment Foot	12.	Power Socket
6.	Focus Ring	13.	Input / Output
7.	Ventilation (inlet)		

INTRODUCTION

Connections

SVGA_XGA_WXGA (Type 1 (3 IO))

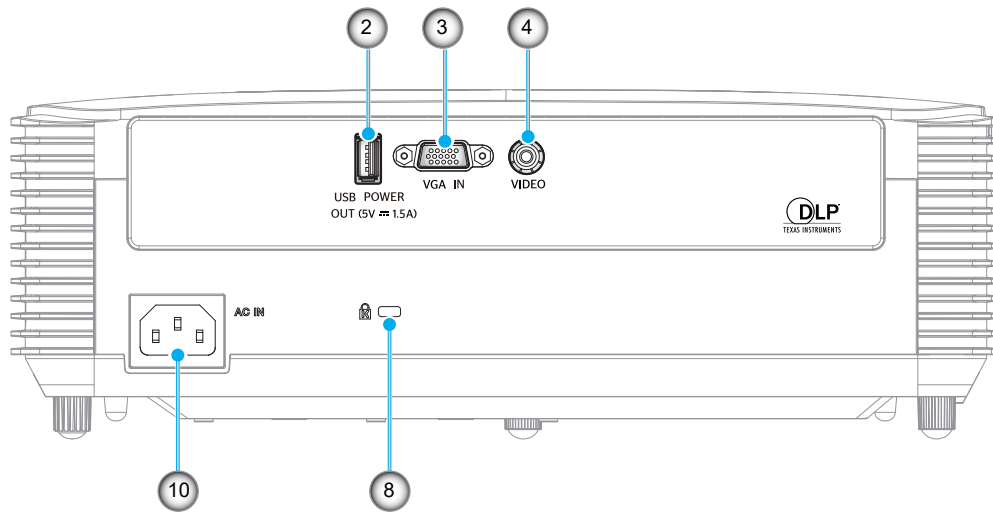

SVGA_XGA_WXGA (Type 2 (6 IO))

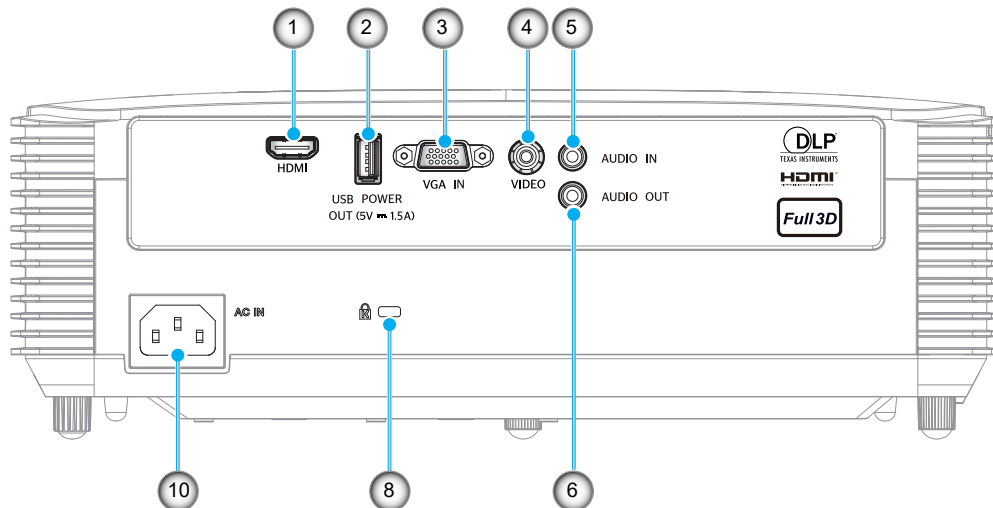

SVGA_XGA_WXGA (Type 3 (8 IO))

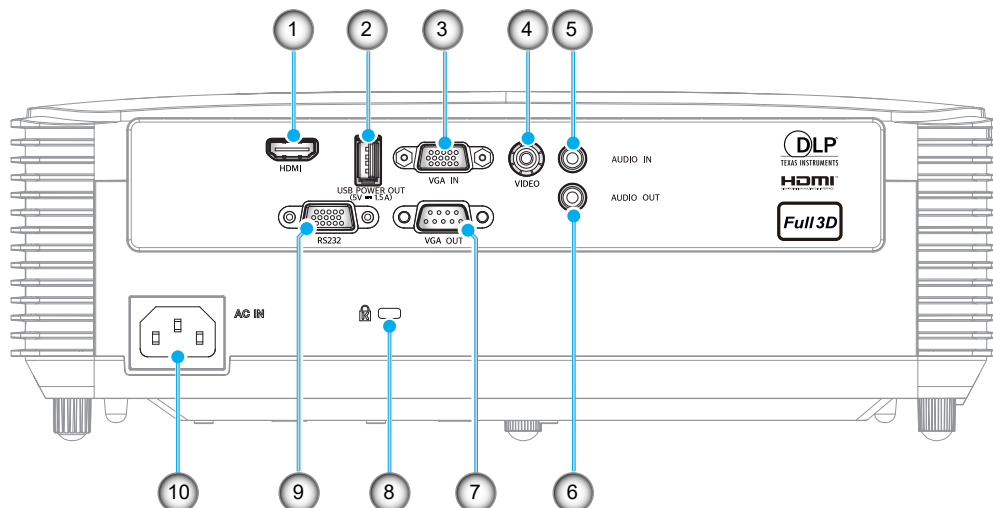

INTRODUCTION

No	Item	Type 1 (3 IO)	Type 2 (6 IO)	Type 3 (8 IO)
1.	HDMI Connector	N/A	√	√
2.	USB Power Out (5V $\overline{=}$ 1.5A) Connector / MOUSE / SERVICE Connector	√	√	√
3.	VGA IN Connector	√	√	√
4.	VIDEO Connector	√	√	√
5.	AUDIO IN Connector	N/A	√	√
6.	AUDIO OUT Connector	N/A	√	√
7.	VGA OUT Connector	N/A	N/A	√
8.	Kensington™ Lock Port	√	√	√
9.	RS232 Connector	N/A	N/A	√
10.	Power Socket	√	√	√

Note: “√” means the item is supported, “N/A” means the item is not available.

Note:

- Remote mouse requires special remote control.
- The I/Os depend on the projector you purchased, please check the physical product for reference.

INTRODUCTION

Keypad

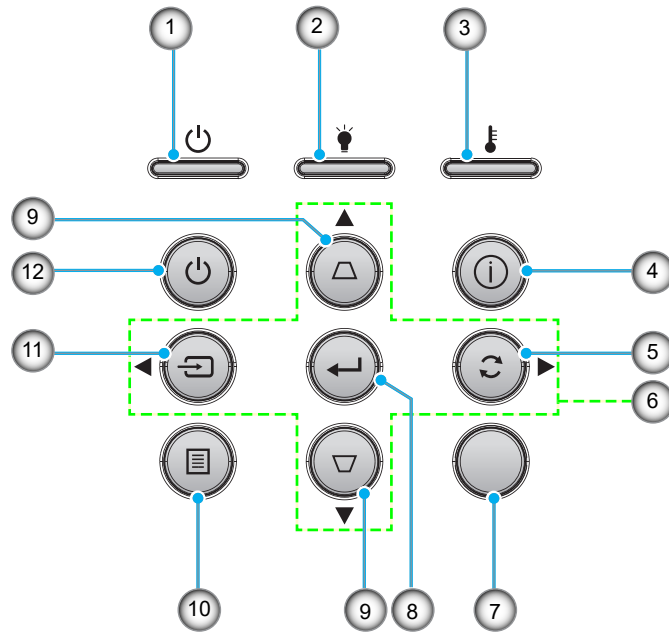

No	Item	No	Item
1.	On/Standby LED	7.	IR Receiver
2.	Lamp LED	8.	Enter
3.	Temp LED	9.	Keystone Correction
4.	Information	10.	Menu
5.	Re-Sync	11.	Source
6.	Four Directional Select Keys	12.	Power

INTRODUCTION

Remote control 1

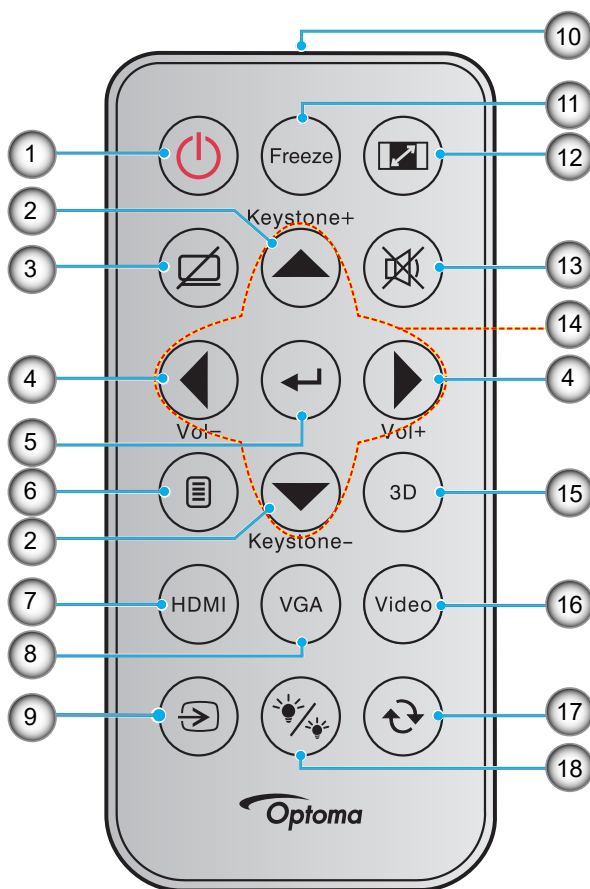

No	Item	No	Item
1.	Power On / Off	10.	IR LED Indicator
2.	Keystone + / -	11.	Freeze
3.	AV Mute	12.	Aspect Ratio
4.	Volume - / +	13.	Mute
5.	Enter	14.	Four Directional Select Keys
6.	Menu	15.	3D
7.	HDMI	16.	Video
8.	VGA	17.	Resync
9.	Source	18.	Brightness Mode

Note:

- The actual remote control may vary depending on the region.
- Some keys may have no function for models that do not support these features.
- Before using the remote control for the first time, remove the transparent insulation tape. See page 24 for battery installation.

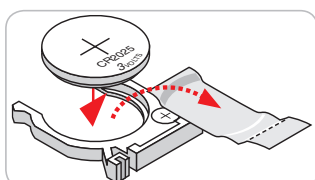

INTRODUCTION

Remote control 2

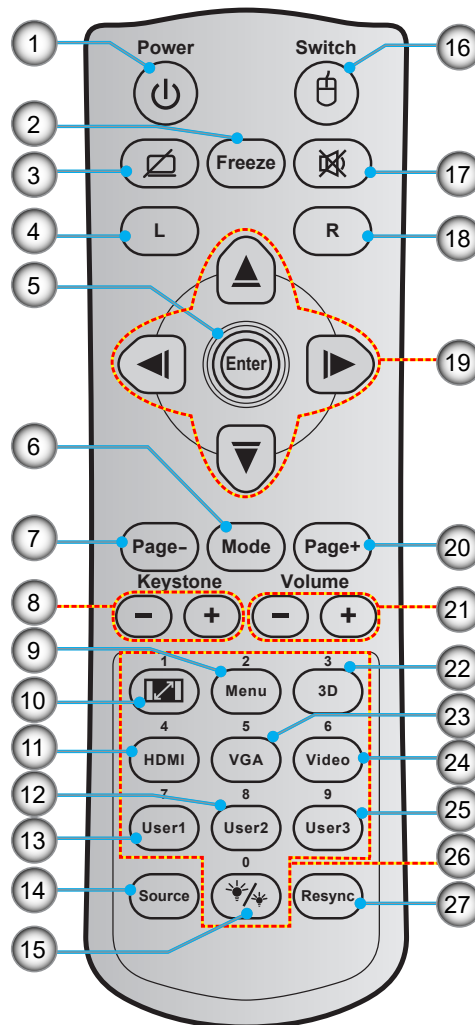

No	Item	No	Item
1.	Power On / Off	15.	Brightness Mode
2.	Freeze	16.	Mouse On / Off
3.	Display Blank / Audio Mute	17.	Mute
4.	Mouse Left Click	18.	Mouse Right Click
5.	Enter	19.	Four Directional Select Keys
6.	Mode	20.	Page +
7.	Page -	21.	Volume - / +
8.	Keystone - / +	22.	3D Menu On / Off
9.	Menu	23.	VGA
10.	Aspect Ratio	24.	Video
11.	HDMI	25.	User 3
12.	User 2	26.	Numeric Keypad (0-9)
13.	User 1	27.	Resync
14.	Source		

Note:

- The actual remote control may vary depending on the region.
- Some keys may have no function for models that do not support these features.

INTRODUCTION

Remote control 3

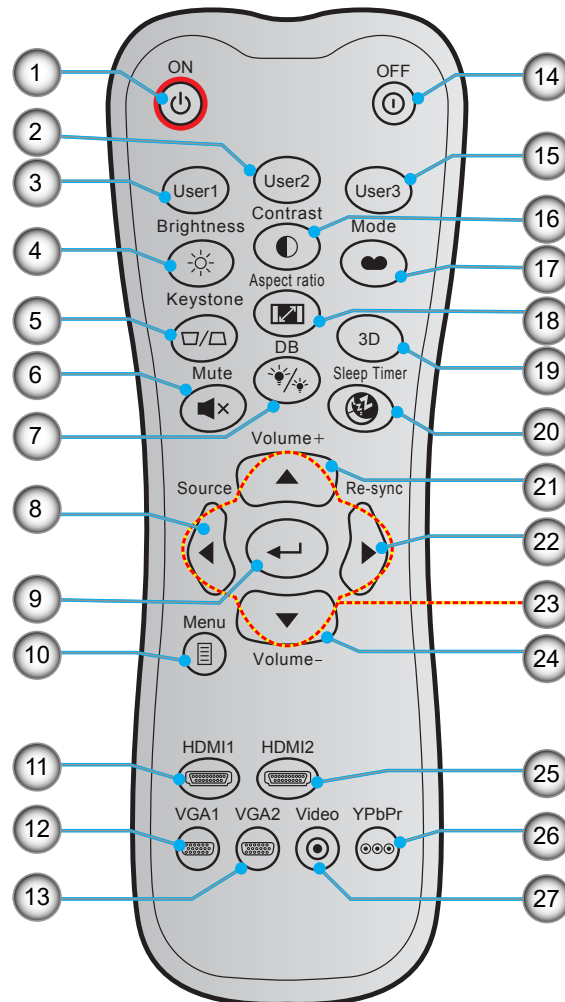

No	Item	No	Item
1.	Power On	15.	User 3
2.	User 2	16.	Contrast
3.	User 1	17.	Display Mode
4.	Brightness	18.	Aspect Ratio
5.	Keystone	19.	3D Menu On / Off
6.	Mute	20.	Sleep Timer
7.	DB (Dynamic Black)	21.	Volume +
8.	Source	22.	Re-Sync
9.	Enter	23.	Four Directional Select Keys
10.	Menu	24.	Volume -
11.	HDMI 1	25.	HDMI 2
12.	VGA 1 (not supported)	26.	YPbPr (not supported)
13.	VGA 2 (not supported)	27.	Video (not supported)
14.	Power Off		

Note:

- The actual remote control may vary depending on the region.
- Some keys may have no function for models that do not support these features.

INTRODUCTION

Remote control 4

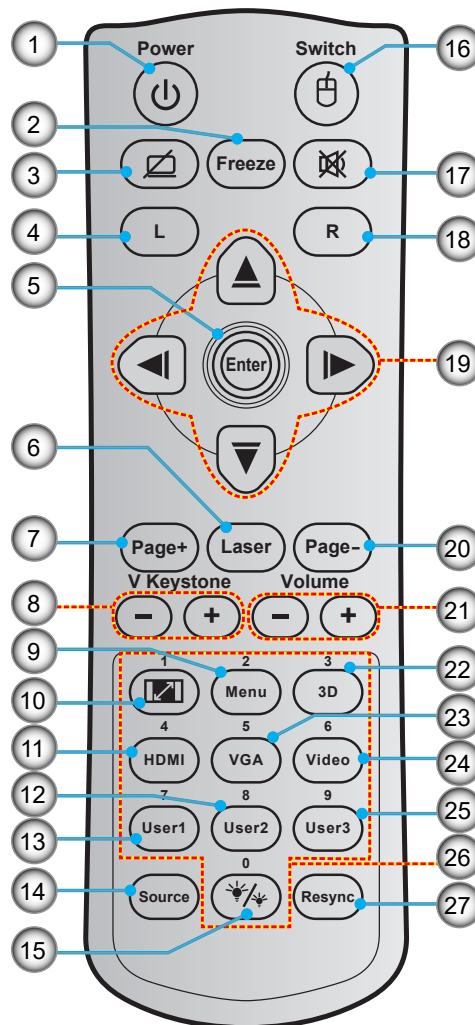

No	Item	No	Item
1.	Power On / Off	15.	Brightness Mode
2.	Freeze	16.	Mouse On / Off
3.	Display Blank / Audio Mute	17.	Mute
4.	Mouse Left Click	18.	Mouse Right Click
5.	Enter	19.	Four Directional Select Keys
6.	Laser	20.	Page -
7.	Page +	21.	Volume - / +
8.	V Keystone - / +	22.	3D Menu On / Off
9.	Menu	23.	VGA
10.	Aspect Ratio	24.	Video
11.	HDMI	25.	User 3
12.	User 2	26.	Numeric Keypad (0-9)
13.	User 1	27.	Resync
14.	Source		

Note:

- The actual remote control may vary depending on the region.
- Some keys may have no function for models that do not support these features.

SETUP AND INSTALLATION

Installing the projector

Your projector is designed to be installed in one of four possible positions.

Your room layout or personal preference will dictate which installation location you select. Take into consideration the size and position of your screen, the location of a suitable power outlet, as well as the location and distance between the projector and the rest of your equipment.

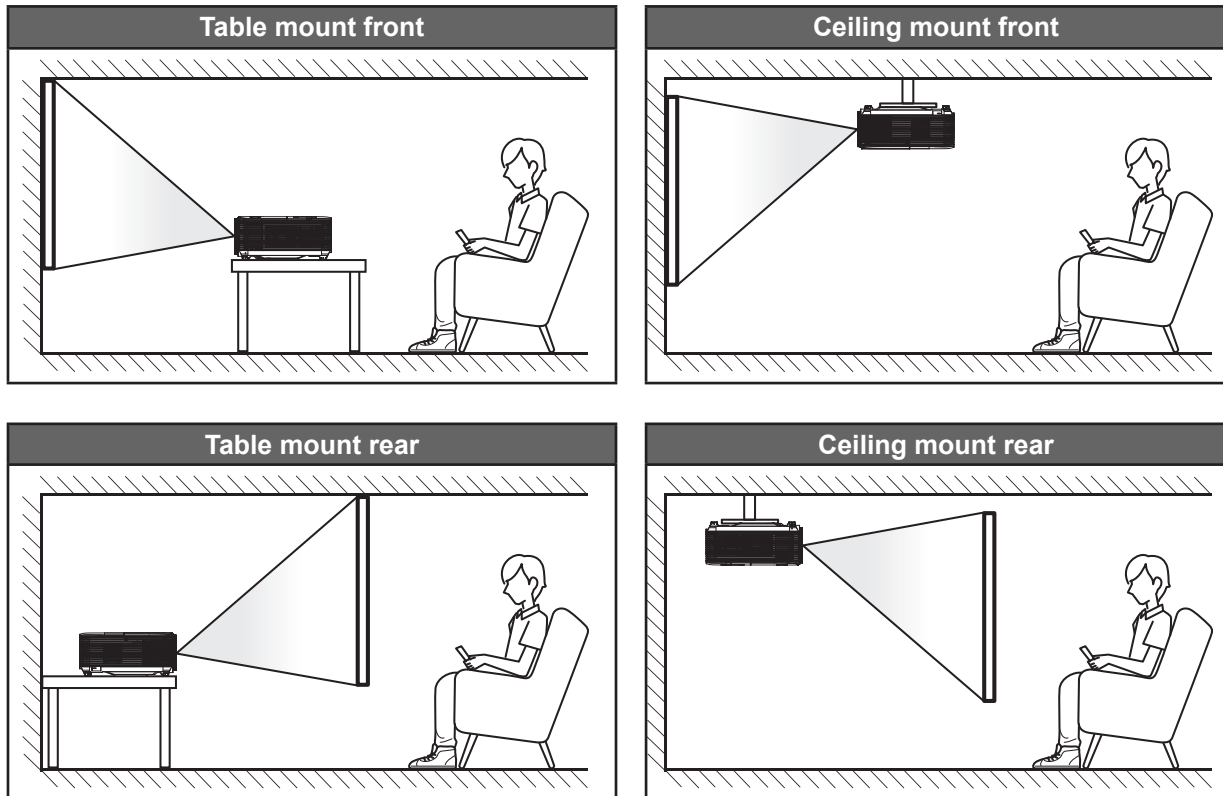

Projector should be placed flat on a surface and 90 degrees / perpendicular to the screen.

- How to determine projector location for a given screen size, please refer to distance table on pages 54-56.
- How to determine screen size for a given distance, please refer to distance table on pages 54-56.

Note: The further away the projector is placed from the screen the projected image size increases and vertical offset also increases proportionally.

IMPORTANT!

Do not operate the projector in any orientation other than table top or ceiling mount. The projector should be horizontal and not tilted either forwards/backwards or left/right. Any other orientation will invalidate the warranty and may shorten the lifetime of the projector lamp or the projector itself. For non standard installation advise please contact Optoma.

SETUP AND INSTALLATION

Projector installation notice (SVGA_XGA_WXGA)

- Place the projector in a horizontal position.

The tilt angle of the projector should not exceed 15 degrees, nor should the projector be installed in any way other than the desktop and ceiling mount, otherwise lamp life could decrease dramatically, and may lead to other **unpredictable damages**.



- Allow at least 30 cm clearance around the exhaust vent.

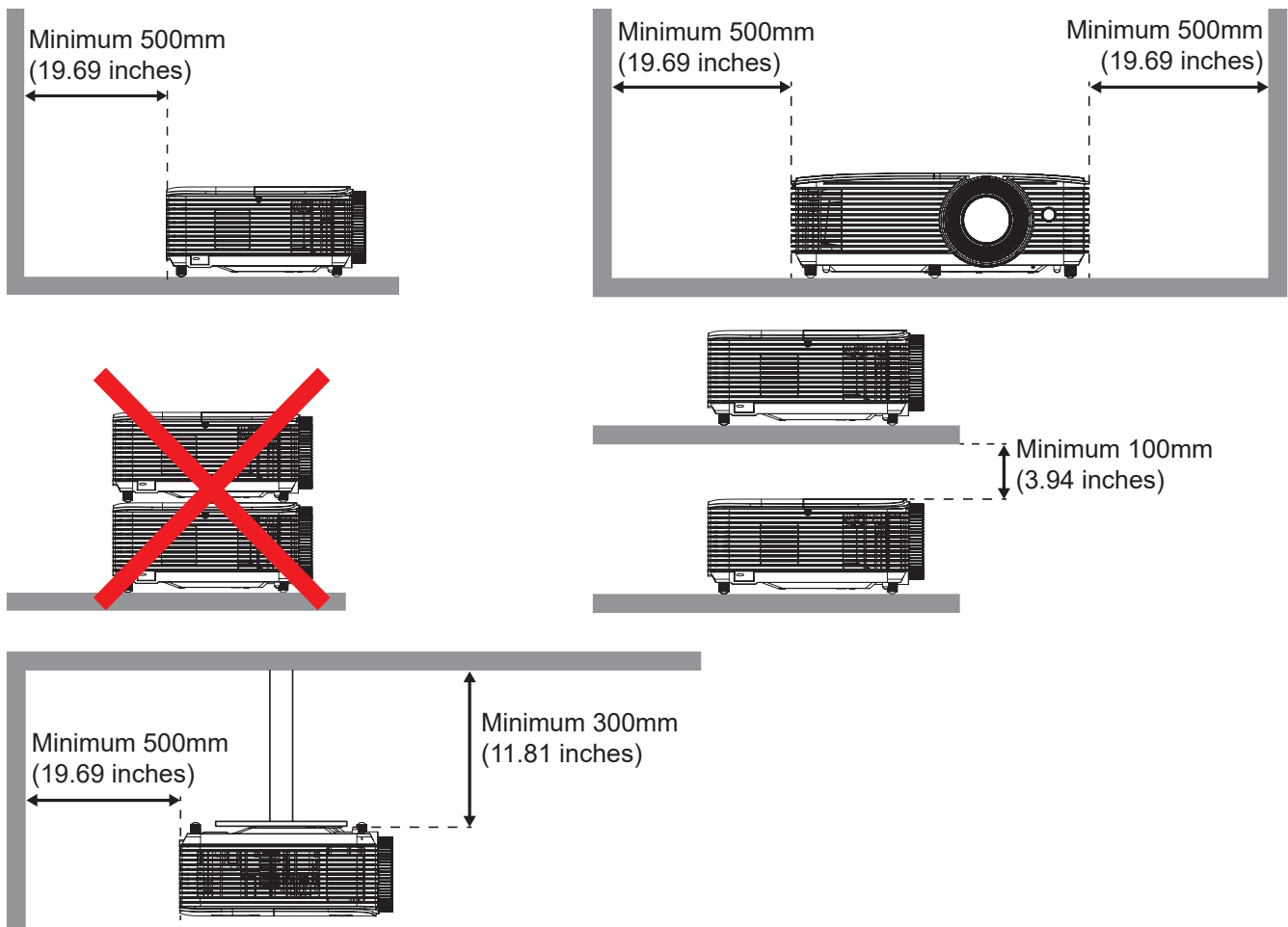

- Ensure that the intake vents do not recycle hot air from the exhaust vent.
- When operating the projector in an enclosed space, ensure that the surrounding air temperature within the enclosure does not exceed operation temperature while the projector is running, and the air intake and exhaust vents are unobstructed.
- All enclosures should pass a certified thermal evaluation to ensure that the projector does not recycle exhaust air, as this may cause the device to shutdown even if the enclosure temperature is within the acceptable operation temperature range.

SETUP AND INSTALLATION

SVGA_XGA_WXGA (Type 1 (3 IO))

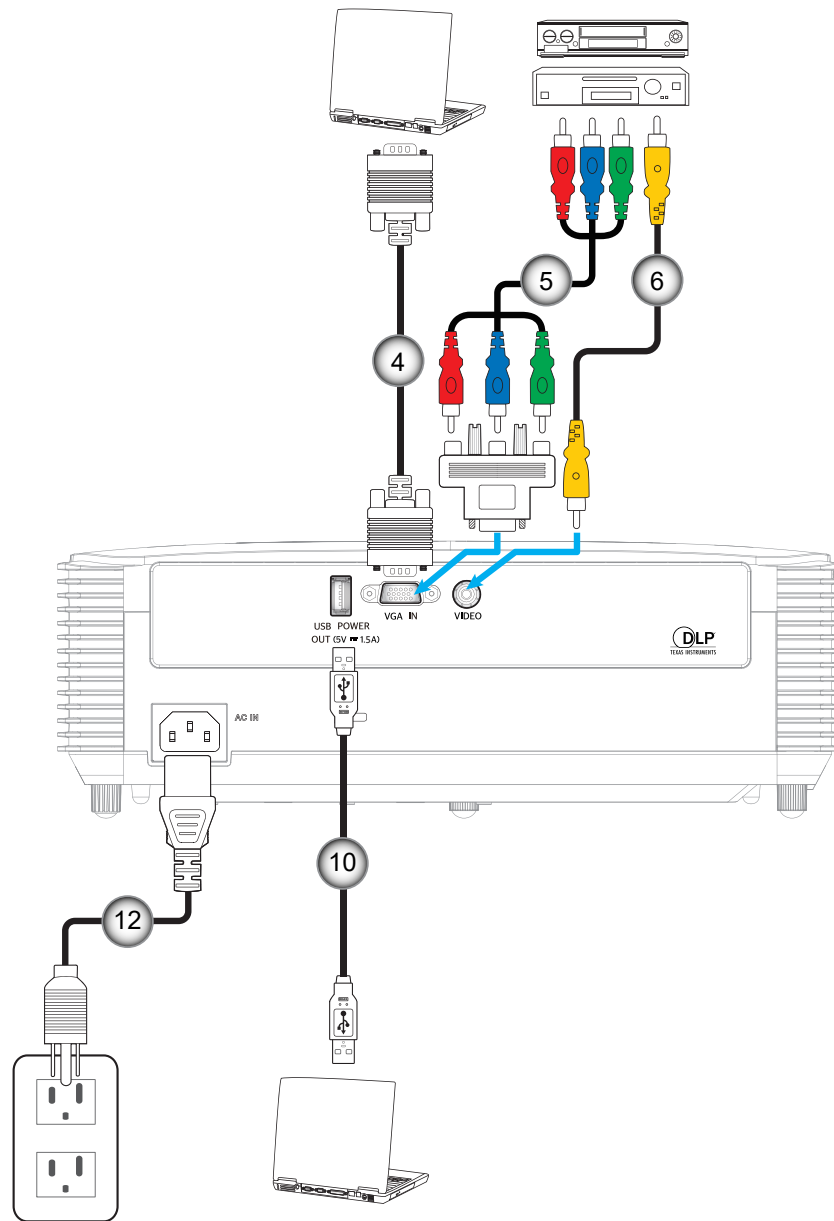

SETUP AND INSTALLATION

SVGA_XGA_WXGA (Type 2 (6 IO))

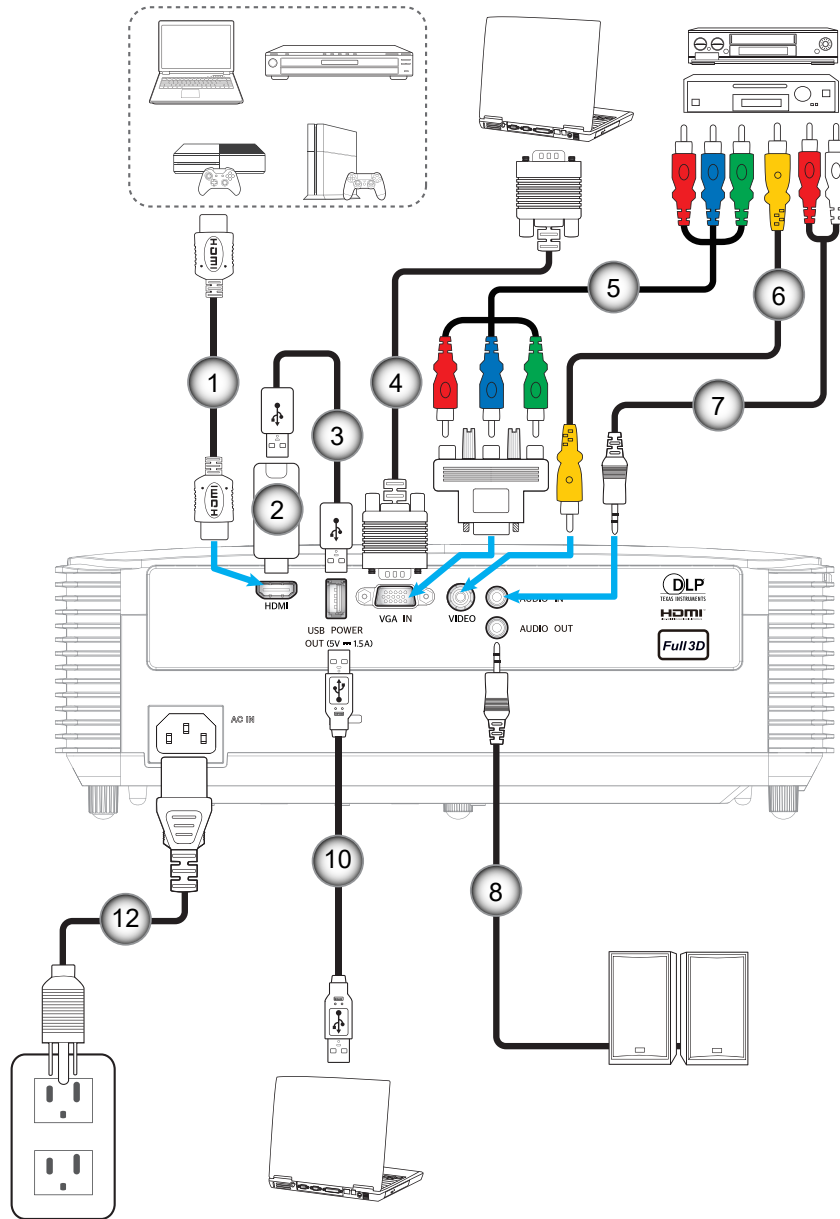

SETUP AND INSTALLATION

SVGA_XGA_WXGA (Type 3 (8 IO))

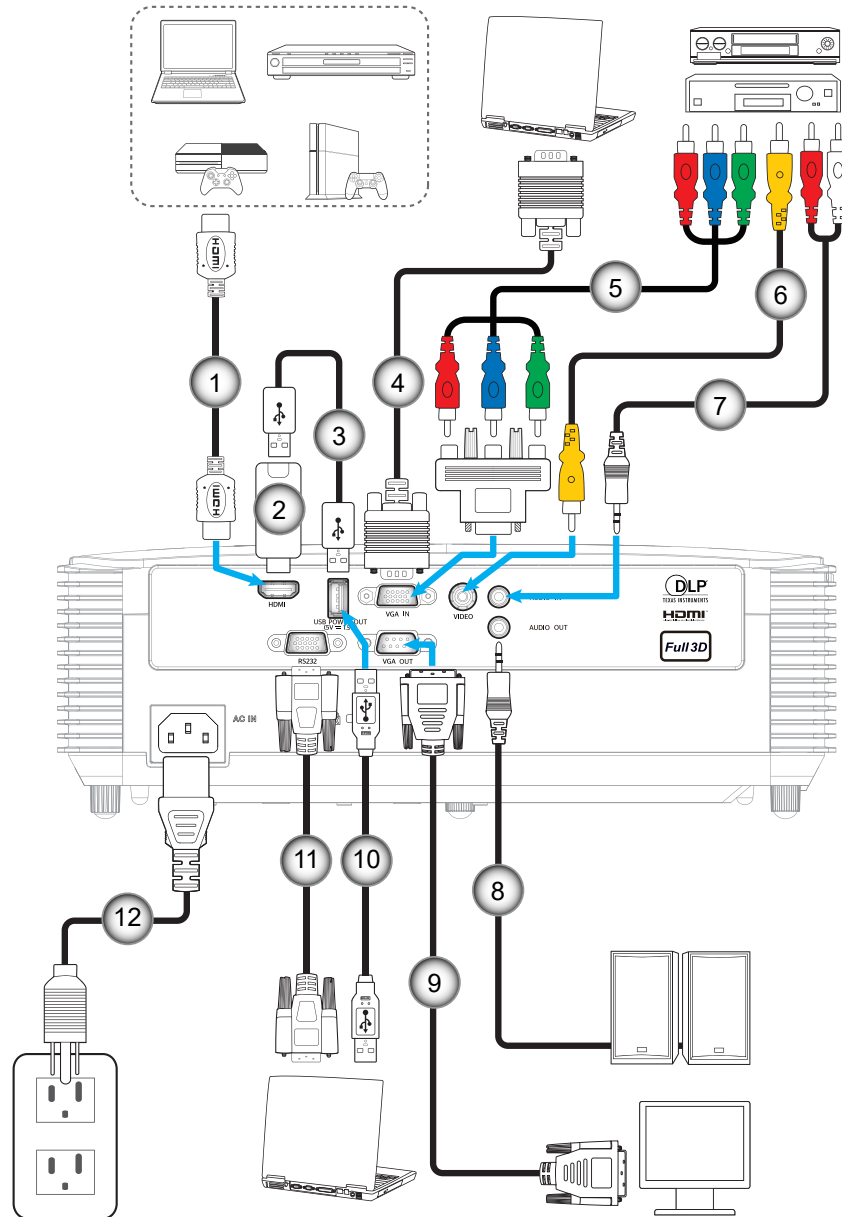

SETUP AND INSTALLATION

No	Item	Type 1 (3 IO)	Type 2 (6 IO)	Type 3 (8 IO)
1.	HDMI Cable	N/A	√	√
2.	HDMI Stick	N/A	√	√
3.	USB Power Cable	N/A	√	√
4.	VGA In Cable	√	√	√
5.	RCA Component Cable	√	√	√
6.	Video Cable	√	√	√
7.	Audio In Cable	N/A	√	√
8.	Audio Out Cable	N/A	√	√
9.	VGA out Cable	N/A	N/A	√
10.	USB Cable (mouse control)	√	√	√
11.	RS232 Cable	N/A	N/A	√
12.	Power Cord	√	√	√

Note: “√” means the item is supported, “N/A” means the item is not available.

SETUP AND INSTALLATION

Adjusting the projector image

Image height

The projector is equipped with elevator feet for adjusting the image height.

1. Locate the adjustable foot you wish to adjust on the underside of the projector.
2. Rotate the adjustable foot clockwise or counterclockwise to raise or lower the projector.

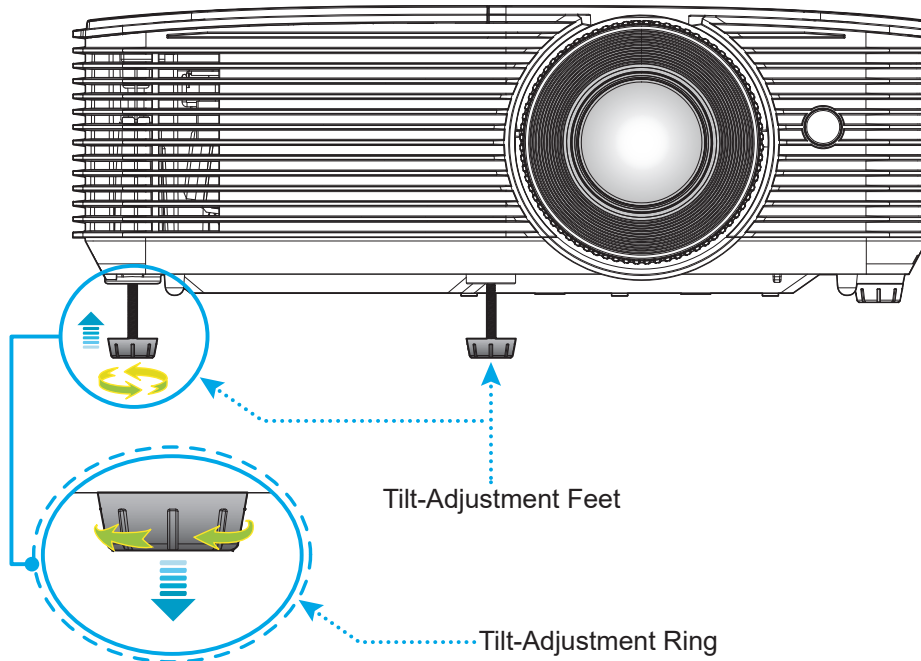

Zoom and focus

- To adjust the image size, turn the zoom lever clockwise or counterclockwise to increase or decrease the projected image size.
- To adjust the focus, turn the focus ring clockwise or counterclockwise until the image is sharp and legible.

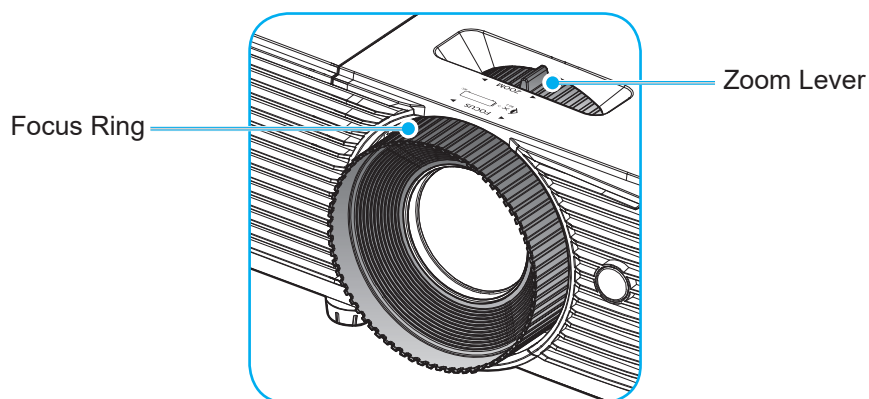

Note: The projector will focus at a distance of 1m to 12m (SVGA, XGA, and WXGA models).

SETUP AND INSTALLATION

Installing / replacing the batteries

1. Press firmly and slide the battery cover off.
2. Install new battery into the compartment. Remove the old battery and install new one (CR2025). Ensure that the side with a “+” is facing up.
3. Put the cover back.

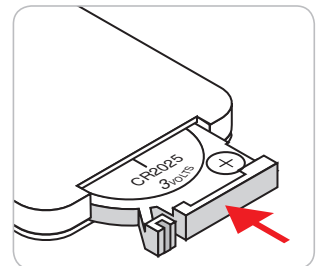
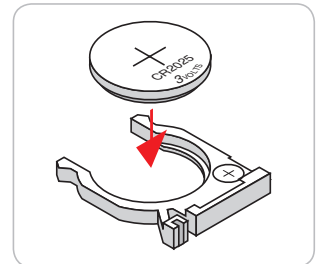
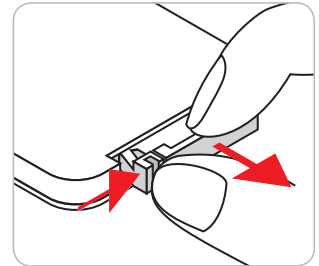

CAUTION: To ensure safe operation, please observe the following precautions:

- Use CR2025 type battery.
- Avoid contact with water or liquid.
- Do not expose the remote control to moisture or heat.
- Do not drop the remote control.
- If the battery has leaked in the remote control, carefully wipe the case clean and install new battery.
- Risk of an explosion if battery is replaced by an incorrect type.
- Dispose of used battery according to the instructions.

SETUP AND INSTALLATION

Effective range

Infra-Red (IR) remote control sensor is located on top of the projector. Ensure to hold the remote control at an angle within 30 degrees perpendicular to the projector's top IR remote control sensor to function correctly. The distance between the remote control and the sensor should not be longer than 6 meters (~ 20 feet).

Note: When pointing the remote control directly (0 degrees angle) on the IR sensor, the distance between the remote control and the sensor should not be longer than 8 meters (~ 26 feet).

- Make sure that there are no obstacles between the remote control and the IR sensor on the projector that might obstruct the infra-red beam.
- Make sure the IR transmitter of the remote control is not being shined by sunlight or fluorescent lamps directly.
- Please keep the remote controller away from fluorescent lamps for over 2 meters or the remote controller might become malfunction.
- If the remote control is close to Inverter-Type fluorescent lamps, it might become ineffective from time to time.
- If the remote control and the projector are within a very short distance, the remote control might become ineffective.
- When you aim at the screen, the effective distance is less than 6 meters from the remote control to the screen and reflecting the IR beams back to the projector. However, the effective range might change according to screens.

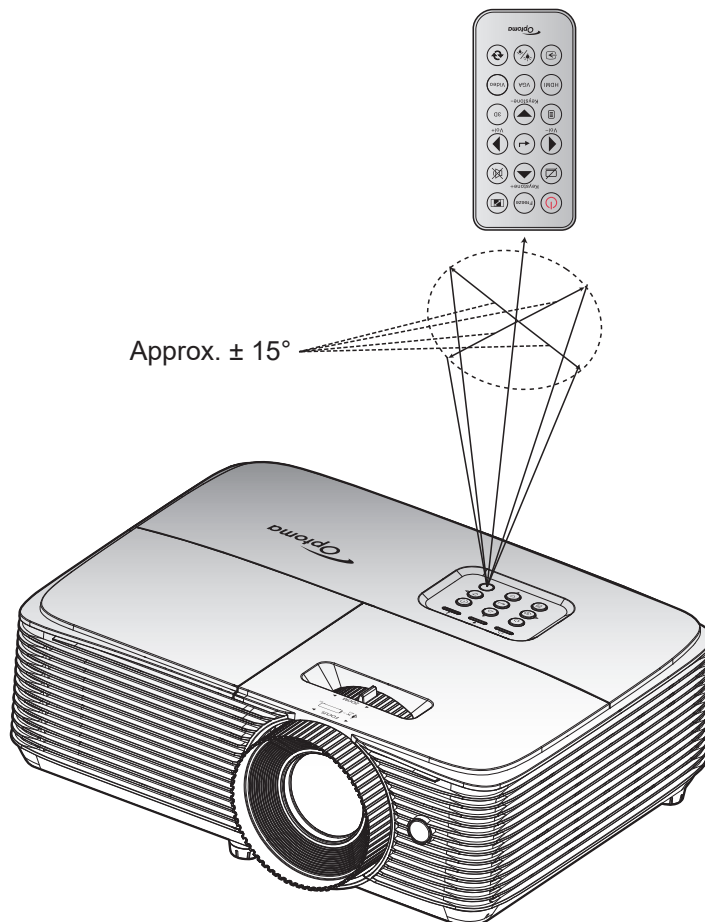

USING THE PROJECTOR

Powering on / off the projector

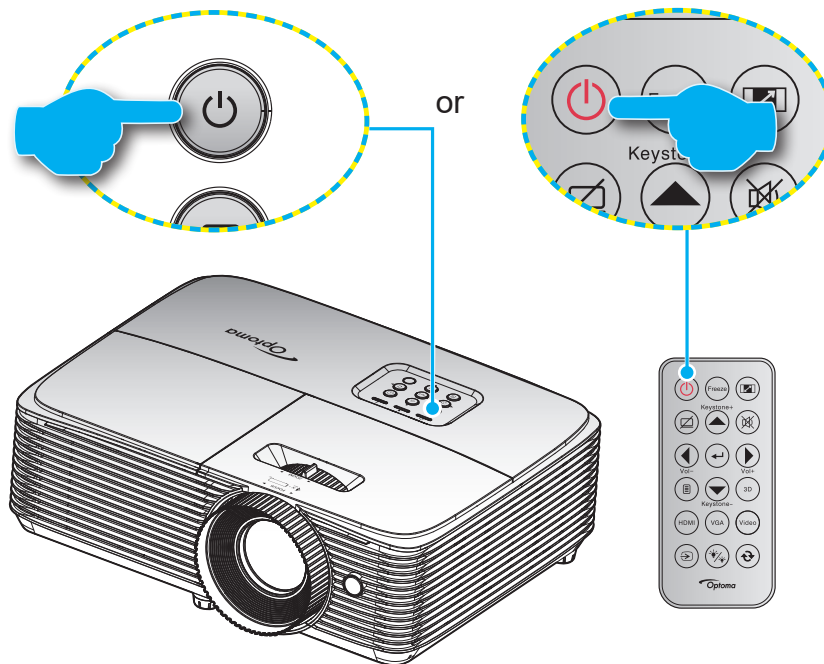

Powering on

1. Securely connect the power lead and signal/source cable. When connected, the On/Standby LED will turn red.
2. Turn on the projector by pressing the "⏻" either on the projector keypad or the remote control.
3. A start up screen will display in approximately 10 seconds and the On/Standby LED will be flashing green or flashing blue.

Note: The first time the projector is turned on, you will be prompted to select the preferred language, projection orientation, and other settings.

Powering off

1. Turn off the projector by pressing the "⏻" either on the projector keypad or the remote control.
2. The following message will be displayed:

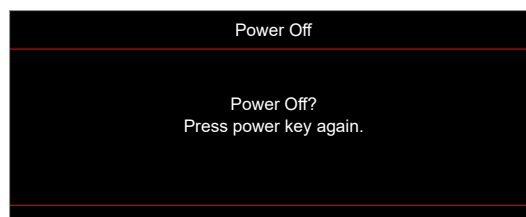

3. Press the "⏻" again to confirm, otherwise the message will disappear after 15 seconds. When you press the "⏻" button for the second time, the projector will shut down.
4. The cooling fans will continue to operate for about 10 seconds for the cooling cycle and the On/Standby LED will flash green or flash blue. When the On/Standby LED turns solid red, this indicates the projector has entered standby mode. If you wish to turn the projector back on, you must wait until the cooling cycle has finished and the projector has entered standby mode. When the projector is in standby mode, simply press the "⏻" button again to turn on the projector.
5. Disconnect the power lead from the electrical outlet and the projector.

Note: It is not recommended that the projector is turned on immediately, right after a power off procedure.

USING THE PROJECTOR

Selecting an input source



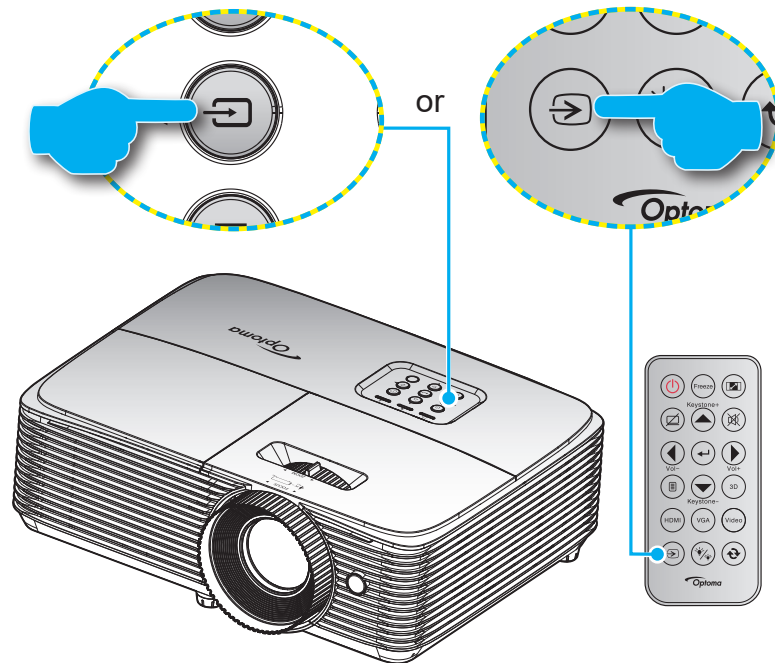











Turn on the connected source that you want to display on the screen, such as computer, notebook, video player, etc. The projector will automatically detect the source. If multiple sources are connected, push the source button on the projector keypad or the remote control to select the desired input.



USING THE PROJECTOR

Menu navigation and features

The projector has multilingual on-screen display menus that allow you to make image adjustments and change a variety of settings. The projector will automatically detect the source.

1. To open the OSD menu, press  on the remote control or the projector keyboard.
2. When OSD is displayed, use   keys to select any item in the main menu. While making a selection on a particular page, press  or  key to enter sub menu.
3. Use   keys to select the desired item in the sub menu and then press  or  key to view further settings. Adjust the settings by using   keys.
4. Select the next item to be adjusted in the sub menu and adjust as described above.
5. Press the  or  to confirm, and the screen will return to the main menu.
6. To exit, press the  or  again. The OSD menu will close and the projector will automatically save the new settings.

SVGA, XGA, and WXGA Models

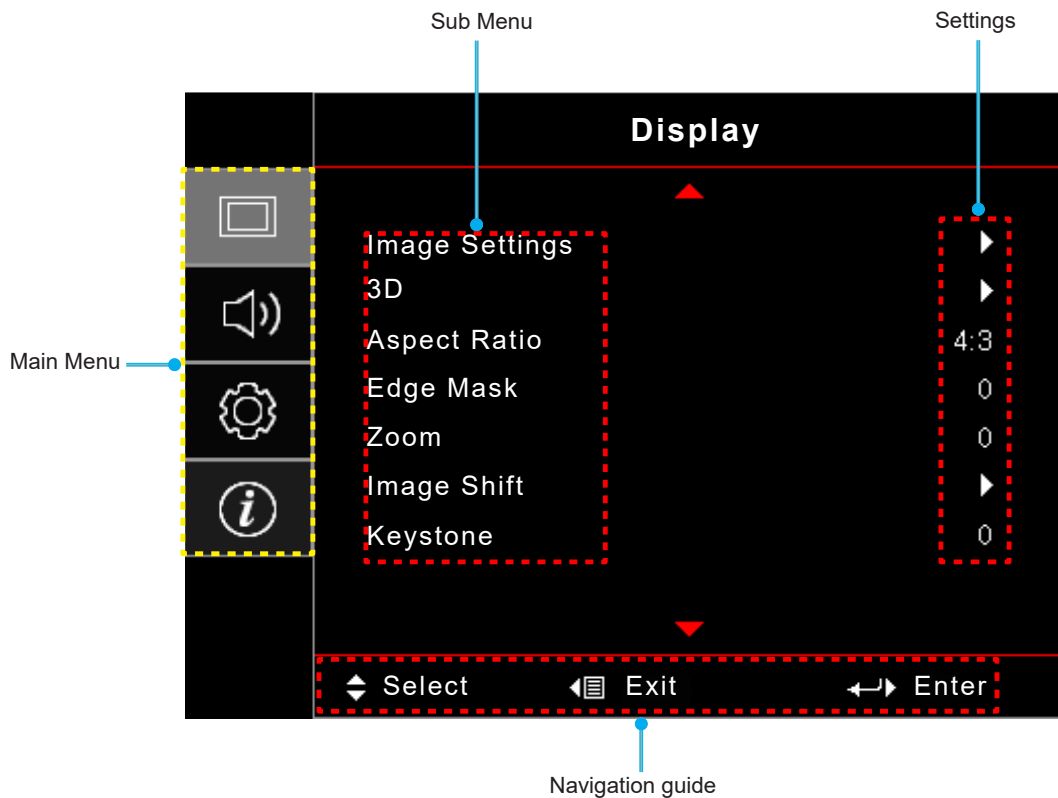

USING THE PROJECTOR







OSD Menu tree (SVGA, XGA, and WXGA models)

Main Menu	Sub Menu	Sub Menu 2	Sub Menu 3	Sub Menu 4	Values		
Display	Image Settings	Display Mode	[Data]		Presentation		
					Bright		
					Cinema		
					Game		
					sRGB		
					DICOM SIM.		
					User		
					3D		
		Wall Color			Off [Default]		
					Blackboard		
					Light Yellow		
					Light Green		
					Light Blue		
					Pink		
					Gray		
		Brightness			-50~50		
		Contrast			-50~50		
		Sharpness			1~15		
		Color			-50~50		
		Tint			-50~50		
		Gamma	Film				
			Video				
			Graphics				
			Standard(2.2)				
			1.8				
			2.0				
			2.4				
		Color Settings	BrilliantColor™			1~10	
			Color Temperature	[Data mode]		Warm	
						Medium	
						Cool	
			Color Matching			Color	R [Default]
							G
B							
C							
Y							
M							
W							
Hue		-50~50 [Default: 0]					
Saturation		-50~50 [Default: 0]					
Gain		-50~50 [Default: 0]					

USING THE PROJECTOR

Main Menu	Sub Menu	Sub Menu 2	Sub Menu 3	Sub Menu 4	Values
Display	Image Settings	Color Settings	Color Matching	Reset	Cancel [Default]
					Yes
				Exit	
			RGB Gain/Bias	Red Gain	-50~50
				Green Gain	-50~50
				Blue Gain	-50~50
				Red Bias	-50~50
				Green Bias	-50~50
				Blue Bias	-50~50
				Reset	Cancel [Default]
				Yes	
			Exit		
			Color Space [Not HDMI Input]		Auto [Default]
					RGB
					YUV
		Color Space [HDMI Input]		Auto [Default]	
				RGB(0~255)	
				RGB(16~235)	
			YUV		
		White Level	0~31 (depends on signal)		
		Black Level	-5~5 (depends on signal)		
		IRE		0	
				7.5	
		Signal	Automatic		Off
					On [Default]
			Frequency	-10~10 (depends on signal) [Default: 0]	
			Phase	0~31 (depends on signal) [Default: 0]	
			H. Position	-5~5 (depends on signal) [Default: 0]	
			V. Position	-5~5 (depends on signal) [Default: 0]	
		Exit			
		Brightness Mode		[Lamp Base - Data]	Bright
					Eco.
					Dynamic
	Eco+				
Reset					

USING THE PROJECTOR

Main Menu	Sub Menu	Sub Menu 2	Sub Menu 3	Sub Menu 4	Values	
Display	3D	3D Mode			Off	
					On [Default]	
					IR	
		3D->2D			3D [Default]	
					L	
					R	
		3D Format			Auto [Default]	
					SBS	
					Top and Bottom	
					Frame Sequential	
	3D sync invert			On		
				Off [Default]		
	Aspect Ratio				4:3	
					16:9	
					16:10 [WXGA model]	
					LBX [except SVGA and XGA models]	
					Native	
				Auto		
Edge Mask				0~10 [Default: 0]		
Zoom				-5~25 [Default: 0]		
Image shift	 H				-50~50 [Default: 0]	
	 V				-50~50 [Default: 0]	
Keystone				-40~40 [Default: 0]		
Audio	Mute				Off [Default]	
					On	
Volume					0-10 [Default: 5]	
Setup	Projection				Front  [Default]	
					Rear 	
					Ceiling-top 	
					Rear-top 	
	Screen Type	[WXGA model]				16:9
						16:10 [Default]
	Lamp Settings	Lamp Reminder				Off
						On [Default]
Lamp Reset						Cancel [Default]
					Yes	





USING THE PROJECTOR

Main Menu	Sub Menu	Sub Menu 2	Sub Menu 3	Sub Menu 4	Values
Setup	Filter Settings	Optional Filter Installed			Yes
					No
		Filter Usage Hours			(Read only)
		Filter Reminder			Off
					300hr
					500hr [Default]
					800hr
		Filter Reset			1000hr
					Cancel [Default]
	Power Settings	Direct Power On			Off [Default]
					On
		Signal Power On			Off [Default]
					On
		Auto Power Off (min)			0~180 (5 min increments) [Default: 20]
		Sleep Timer (min)			0~990 (30 min increments) [Default: 0]
			Always On		No [Default]
					Yes
		Quick Resume			Off [Default]
					On
		Power Mode (Standby)			Active
					Eco [Default]
		USB Power			Off
				On	
				Auto [Default]	
	Security	Security			Off
					On
		Security Timer		Month	
				Day	
				Hour	
	Change Password				
	HDMI Link Settings	HDMI Link			Off
					On
Inclusive of TV				No	
				Yes	
Power On Link				Mutual	
				PJ --> Device	
				Device --> PJ	
Power Off Link			Off		
			On		

USING THE PROJECTOR

Main Menu	Sub Menu	Sub Menu 2	Sub Menu 3	Sub Menu 4	Values		
Setup	Test Pattern				Green Grid		
					Magenta Grid		
					White Grid		
					White		
					Off		
	Remote Settings [depends on remote]	IR Function				On	
						Off	
		User 1					Test Pattern
							Brightness
							Contrast
							Sleep Timer [Default]
							Color Matching
							Color Temp
							Gamma
							Projection
							Lamp Settings
							Zoom
						Freeze	
		User 2					Test Pattern
							Brightness
							Contrast
							Sleep Timer
							Color Matching [Default]
							Color Temp
							Gamma
							Projection
							Lamp Settings
							Zoom
						Freeze	
		User 3					Test Pattern
							Brightness
							Contrast
							Sleep Timer
						Color Matching	
						Color Temp [Default]	
					Gamma		
					Projection		
					Lamp Settings		
					Zoom		
				Freeze			

USING THE PROJECTOR

Main Menu	Sub Menu	Sub Menu 2	Sub Menu 3	Sub Menu 4	Values	
Setup	Projector ID				0~99	
	Options	Language			English [Default]	
					Deutsch	
					Français	
					Italiano	
					Español	
					Português	
					Polski	
					Nederlands	
					Svenska	
					Norsk/Dansk	
					Suomi	
					ελληνικά	
					繁體中文	
					简体中文	
					日本語	
					한국어	
					Русский	
					Magyar	
					Čeština	
					عربي	
				ไทย		
				Türkçe		
				فارسی		
				Tiếng Việt		
				Bahasa Indonesia		
				Română		
				Slovenčina		
		Closed Captioning			CC1	
					CC2	
					Off [Default]	
		Menu Settings	Menu Location			Top left 
						Top right 
					Center  [Default]	
					Bottom left 	
					Bottom right 	
	Menu Timer				Off	
				5sec		
				10sec [Default]		
	Auto Source			Off [Default]		
				On		

USING THE PROJECTOR

Main Menu	Sub Menu	Sub Menu 2	Sub Menu 3	Sub Menu 4	Values	
Setup	Options	Input Source			HDMI	
					VGA	
					Video	
		Input Name	HDMI			Default [Default]
						Custom
			VGA			Default [Default]
						Custom
			Video			Default [Default]
						Custom
		High Altitude			Off [Default]	
					On	
		Display Mode Lock			Off [Default]	
					On	
		Keypad Lock			Off [Default]	
					On	
		Information Hide			Off [Default]	
					On	
		Logo			Default [Default]	
					Neutral	
		Background Color			None [Default: for Video/Pro-AV]	
					Blue [Default for Data model]	
					Red	
					Green	
					Grey	
					Logo	
		Reset OSD			Cancel [Default]	
					Yes	
Reset to Default			Cancel [Default]			
			Yes			

USING THE PROJECTOR

Main Menu	Sub Menu	Sub Menu 2	Sub Menu 3	Sub Menu 4	Values	
Information	Regulatory					
	Serial Number					
	Source					
	Resolution				00x00	
	Refresh Rate				0.00Hz	
	Display Mode					
	Power mode (Standby)					
	Lamp Hours	Bright				0 hr
		Eco				0 hr
		Dynamic				0 hr
		Eco+				0 hr
		Total				
	Projector ID				00~99	
	Filter Usage Hours					
	Brightness Mode					
FW Version	System					
	MCU					

Note:

- *The “Lamp Reset” in OSD will only reset both Lamp Hours in OSD and Lamp Hours in service mode. The Projection Hours in service mode will not be reset.*
- *Each display mode can be adjusted and saved the value.*
- *In 3D timing mode, the zoom/edge mask will be disabled to prevent from image break.*
- *The available menu options vary depending on the model type.*

USING THE PROJECTOR

Display menu

Display image settings menu

Display Mode (Data mode)

There are many factory presets optimized for various types of images.

- **Presentation:** This mode is suitable for showing PowerPoint presentations when the projector is connected to the PC.
- **Bright:** Maximum brightness from PC input.
- **Cinema:** Select this mode for home theater.
- **Game:** Select this mode to increase the brightness and response time level for enjoying video games.
- **sRGB:** Standardized accurate color.
- **DICOM SIM.:** This mode can project a monochrome medical image such as an X ray radiography, MRI, etc.
- **User:** Memorize user's settings.
- **3D:** To experience the 3D effect, you need to have 3D glasses. Make sure your PC/portable device has a 120 Hz signal output quad buffered graphics card and a 3D Player installed.

Wall Color

Use this function to obtain an optimized screen image according to the wall color. Select between off, blackboard, light yellow, light green, light blue, pink, and gray.

Brightness

Adjust the brightness of the image.

Contrast

The contrast controls the degree of difference between the lightest and darkest parts of the picture.

Sharpness

Adjust the sharpness of the image.

Color

Adjust a video image from black and white to fully saturated color.

Tint

Adjust the color balance of red and green.

Gamma

Set up gamma curve type. After the initial setup and fine tuning is completed, utilize the Gamma Adjustment steps to optimize your image output.

- **Film:** For home theater.
- **Video:** For video or TV source.
- **Graphics:** For PC / Photo source.
- **Standard(2.2):** For standardized setting.
- **1.8/ 2.0/ 2.4:** For specific PC / Photo source.

Color Settings

Configure the color settings.

- **BrilliantColor™:** This adjustable item utilizes a new color-processing algorithm and enhancements to enable higher brightness while providing true, more vibrant colors in picture.

USING THE PROJECTOR

- **Color Temperature (Data mode):** Select a color temperature from Warm, Medium, or Cool.
- **Color Matching:** Select the following options:
 - Color: Adjust the red (R), green (G), black (B), cyan (C), yellow (Y), magenta (M), and white (W) level of the image.
 - Hue: Adjust the color balance of red and green.
 - Saturation: Adjust a video image from black and white to fully saturated color.
 - Gain: Adjust the image brightness.
 - Reset: Return the factory default settings for color matching.
 - Exit: Exit the “Color Matching” menu.
- **RGB Gain/Bias:** This settings allows to configure the brightness (gain) and contrast (bias) of an image.
 - Reset: Return the factory default settings for RGB gain/bias.
 - Exit: Exit the “RGB Gain/Bias” menu.



- **Color Space (non-HDMI input only):** Select an appropriate color matrix type from the following: AUTO, RGB, or YUV.
- **Color Space (HDMI input only):** select an appropriate color matrix type from the following: Auto, RGB(0-255), RGB(16-235), and YUV.
- **White Level:** Allow user to adjust White Level when inputting Video signals.
Note: *White level can only be adjusted for Video input source.*
- **Black Level:** Allow user to adjust Black Level when inputting Video signals.
Note: *Black level can only be adjusted for Video input source.*
- **IRE:** Allow user to adjust IRE value when inputting Video signals.
Note:
 - *IRE is only available with NTSC video format.*
 - *IRE can only be adjusted for Video input sources.*

Signal

Adjust the signal options.

- **Automatic:** Configure automatically the signal (the frequency and phase items are grayed out). If automatic is disabled, the frequency and phase items will appear for tuning and saving the settings.
- **Frequency:** Change the display data frequency to match the frequency of your computer’s graphic card. Use this function only if the image appears to flicker vertically.
- **Phase:** Synchronize the signal timing of the display with the graphic card. If the image appears to be unstable or flickers, use this function to correct it.

USING THE PROJECTOR

- **H. Position:** Adjust the horizontal positioning of the image.
- **V. Position:** Adjust the vertical positioning of the image.
- **Exit:** Exit the “Signal” menu.

Note: Signal can only be adjusted for RGB/Component input sources.

Brightness Mode (Lamp base data)

Adjust the brightness mode settings for lamp-based projectors.

- **Bright:** Choose “Bright” to increase the brightness.
- **Eco.:** Choose “Eco.” to dim the projector lamp which will lower power consumption and extend the lamp life.
- **Dynamic:** Choose “Dynamic” to dim the lamp power which will be based on brightness level of the content and adjust lamp power consumption between 100% and 30% dynamically. The lamp life will be extended.
- **Eco+:** When Eco+ mode is activated, the brightness level of the content is automatically detected to significantly reduced lamp power consumption (up to 70%) during periods of inactivity.

Reset

Return the factory default settings for color settings.

Display 3D menu

3D Mode

Use this option to disable the 3D function or select the appropriate the 3D function.

- **Off:** Select “Off” to turn off 3D mode.
- **On:** Select to use optimized settings for DLP 3D Glasses.
- **IR:** Select “IR” to use optimized setting for IR 3D Glasses.

3D → 2D

Use this option to specify how the 3D content should appear on the screen.

- **3D:** Display 3D signal.
- **L (Left):** Display the left frame of 3D content.
- **R (Right):** Display the right frame of 3D content.

3D Format

Use this option to select the appropriate 3D format content.

- **Auto:** When a 3D identification signal is detected, the 3D format is selected automatically.
- **SBS:** Display 3D signal in “Side-by-Side” format.
- **Top and Bottom:** Display 3D signal in “Top and Bottom” format.
- **Frame Sequential:** Display 3D signal in “Frame Sequential” format.

3D Sync Invert

Use this option to enable/disable the 3D sync invert function.

USING THE PROJECTOR

Display aspect ratio menu

Aspect Ratio

Select the aspect ratio of the displayed image between the following options:

- **4:3:** This format is for 4:3 input sources.
- **16:9:** This format is for 16:9 input sources, like HDTV and DVD enhanced for Wide screen TV.
- **16:10 (WXGA only):** This format is for 16:10 input sources, like widescreen laptops.
- **LBX (except SVGA and XGA models):** This format is for non-16x9, letterbox source and if you use external 16x9 lens to display 2.35:1 aspect ratio in full resolution.
- **Native:** This format displays the original image without any scaling.
- **Auto:** Automatically selects the appropriate display format.

WXGA scaling table (screen type 16:10):

Note:

- Supported screen type 16:9 (1280x720), 16:10 (1280x800).
- When screen type is 16:9 there is no 16x10 format in this condition.
- When screen type is 16:10 there is no 16x9 format in this condition.
- If user change to auto, will auto change the display mode at same time.

16 : 10 screen	480i/p	576i/p	1080i/p	720p	PC
4x3	Scale to 1066x800.				
16x10	Scale to 1280x800.				
LBX	Scale to 1280x960, then get the central 1280x800 image to display.				
Native mode	1:1 mapping centered.		1:1 mapping display 1280x800.	1280x720 centered.	1:1 mapping centered.
Auto	-Input source will be fit into 1280x800 display area and be kept its original aspect ratio. -If source is 4:3, auto resize to 1066x800. -If source is 16:9 auto resize to 1280x720. -If source is 15:9 auto resize to 1280x768. -If source is 16:10 auto resize to 1280 x 800.				

WXGA auto mapping rule (screen type 16:10):

Auto	Input resolution		Auto/Scale	
	H-resolution	V-resolution	1280	800
4:3	640	480	1066	800
	800	600	1066	800
	1024	768	1066	800
	1280	1024	1066	800
	1400	1050	1066	800
	1600	1200	1066	800

USING THE PROJECTOR

Wide Laptop	1280	720	1280	720
	1280	768	1280	768
	1280	800	1280	800
SDTV	720	576	1280	720
	720	480	1280	720
HDTV	1280	720	1280	720
	1920	1080	1280	720

WXGA scaling table (screen type 16:9):

16 : 9 screen	480i/p	576i/p	1080i/p	720p	PC
4x3	Scale to 960x720.				
16x9	Scale to 1280x720.				
LBX	Scale to 1280x960, then get the central 1280x720 image to display.				
Native mode	1:1 mapping centered.		1:1 mapping display 1280x720.	1280x720 centered.	1:1 mapping centered.
Auto	-If this format is select, Screen type will auto become 16:9 (1280x720). -If source is 4:3, auto resize to 960x720. -If source is 16:9 auto resize to 1280x720. -If source is 15:9 auto resize to 1200x720. -If source is 16:10 auto resize to 1152x720.				

WXGA auto mapping rule (screen type 16:9):

Auto	Input resolution		Auto/Scale	
	H-resolution	V-resolution	1280	720
4:3	640	480	960	720
	800	600	960	720
	1024	768	960	720
	1280	1024	960	720
	1400	1050	960	720
	1600	1200	960	720
Wide Laptop	1280	720	1280	720
	1280	768	1200	720
	1280	800	1152	720
SDTV	720	576	1280	720
	720	480	1280	720
HDTV	1280	720	1280	720
	1920	1080	1280	720

SVGA and XGA scaling table:

Source	480i/p	576i/p	1080i/p	720p
4x3	Scale to 1024x768.			
16x9	Scale to 1024x576.			

USING THE PROJECTOR

Native mode	No scaling will be made; the resolution is dependent on which input source and is then displayed.
Auto	-If source is 4:3, auto resize to 1024x768. -If source is 16:9 auto resize to 1024x576. -If source is 15:9 auto resize to 1024x614. -If source is 16:10 auto resize to 1024x640.

SVGA and XGA auto mapping rule (screen type 16:9):

Auto	Input resolution		Auto/Scale	
	H-resolution	V-resolution	1024	768
4:3	640	480	1024	768
	800	600	1024	768
	1024	768	1024	768
	1600	1200	1024	768
Wide Laptop	1280	720	1024	576
	1280	768	1024	614
	1280	800	1024	640
SDTV	720	576	1024	576
	720	480	1024	576
HDTV	1280	720	1024	576
	1920	1080	1024	576

Display edge mask menu

Edge Mask

Use this function to remove the video encoding noise on the edge of video source.

Display zoom menu

Zoom

Use to reduce or magnify an image on the projection screen.

Display image shift menu

Image Shift

Adjust the projected image position horizontally (H) or vertically (V).

Display keystone menu

Keystone

Adjust the image distortion caused by tilting the projector.

USING THE PROJECTOR

Audio menu

Audio mute menu

Mute

Use this option to temporarily turn off the sound.

- **On:** Choose the “On” to turn mute on.
- **Off:** Choose the “Off” to turn mute off.

Note:

- *“Mute” function affects both internal and external speaker volume.*
- *When an external speaker is connected, the internal speaker is automatically muted.*

Audio volume menu

Volume

Adjust the audio volume level.

USING THE PROJECTOR

Setup menu

Setup projection menu

Projection

Select the preferred projection between front, rear, ceiling-top, and rear-top.

Setup screen type menu

Screen Type (for WXGA models only)

Choose the screen type from 16:9 and 16:10.

Setup lamp settings menu

Lamp Reminder

Choose this function to show or to hide the warning message when the changing lamp message is displayed. The message will appear 30 hours before suggested replacement of lamp.

Lamp Reset

Resets the lamp hour counter after replacing the lamp.

Setup filter settings menu

Optional Filter Installed

Set the warning message setting.

- **Yes:** Display warning message after 500 hours of use.

Note: "Filter Usage Hours / Filter Reminder / Filter Reset" will only appear when "Optional Filter Installed" is "Yes".

- **No:** Turn off warning message.

Filter Usage Hours

Display the filter time.

Filter Reminder

Choose this function to show or hide the warning message when the changing filter message is displayed. The available options include Off, 300hr, 500hr, 800hr, and 1000hr.

Filter Reset

Reset the dust filter counter after replacing or cleaning the dust filter.

Setup power settings menu

Direct Power On

Choose "On" to activate Direct Power mode. The projector will automatically power on when AC power is supplied, without pressing the "Power" key on the projector keypad or on the remote control.

Signal Power On

Choose "On" to activate Signal Power mode. The projector will automatically power on when a signal is detected, without pressing the "Power" key on the projector Keypad or on the remote control.

Note:

- *If the "Signal Power On" option is turned "On", the power consumption of the projector in standby mode will be over 3W.*
- *Due to the ErP directive, this feature is not available on models found in EMEA.*

USING THE PROJECTOR

Auto Power Off (min.)

Sets the countdown timer interval. The countdown timer will start, when there is no signal being sent to the projector. The projector will automatically power off when the countdown has finished (in minutes).

Sleep Timer (min.)

Configure the sleep timer.

- **Sleep Timer (min):** Sets the countdown timer interval. The countdown timer will start, with or without a signal being sent to the projector. The projector will automatically power off when the countdown has finished (in minutes).
Note: *The Sleep Timer is reset every time when the projector is powered off.*
- **Always On:** Check to set the sleep timer always on.

Quick Resume

Set the quick resume setting.

- **On:** If the projector is accidentally turned off, this feature allows the projector to be instantly powered on again, if selected within a period of 100 seconds.
- **Off:** The fan will start cooling the system after 10 seconds when user turns off the projector.

Power Mode (Standby)

Set the power mode setting.

- **Active:** Choose "Active" to return to normal standby.
- **Eco:** Choose "Eco." to save power dissipation further < 0.5W.

Note: *The fans will still run in active standby if "Signal Power On" is enabled.*

USB Power

Set the USB power settings.

- **On:** The projector is always powered on by a USB power source.
- **Off:** The USB Power function is off.
- **Auto:** The projector is automatically powered on by a USB power source.

Setup security menu

Security

Enable this function to prompt for a password before using the projector.

- **On:** Choose "On" to use security verification when the turning on the projector.
- **Off:** Choose "Off" to be able to switch on the projector without password verification.

Security Timer

Can be select the time (Month/Day/Hour) function to set the number of hours the projector can be used. Once this time has elapsed you will be requested to enter your password again.

Change Password

Use to set or modify the password that is prompted when turning the projector on.

USING THE PROJECTOR

Setup HDMI link settings menu

Note:

- When you connect HDMI CEC-compatible devices to the projector with HDMI cables, you can control them on the same power on or power off status using the HDMI Link control feature in the projector's OSD. This lets one device or multiple devices in a group power on or power off via HDMI Link Feature in a typical configuration, your DVD player may be connected to the projector through an amplifier or home theater system.

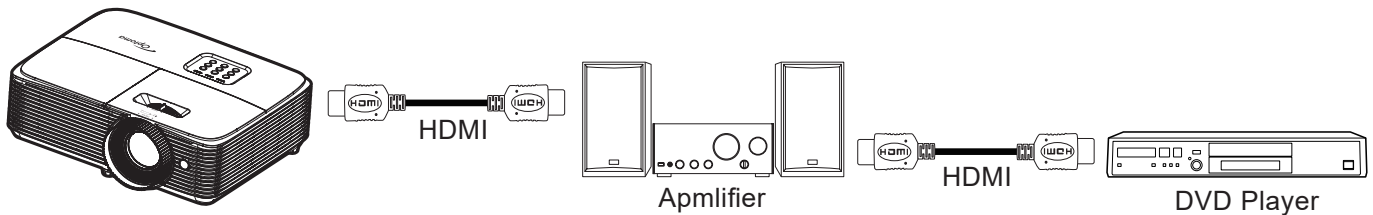

HDMI Link

Enable/disable the HDMI Link function. The inclusive TV, power on link, and power off link options will only be available if the setting is set to "On".

Inclusive of TV

Set to "Yes" if you prefer both TV and projector to be automatically turned off at the same time. To prevent both devices from being turned off at the same time, set the setting to "No".

Power On Link

CEC power on command.

- **Mutual:** Both projector and CEC device will be turned on simultaneously.
- **PJ -> Device:** The CEC device will be turned on only after the projector is switched on.
- **Device -> PJ:** The projector will be switched on only after the CEC device is turned on.

Power Off Link

Enable this function to let both HDMI Link and projector to be automatically turned off at the same time.

Setup test pattern menu

Test Pattern

Select the test pattern from green grid, magenta grid, white grid, white or disable this function (off).

Setup remote settings menu

IR Function

Set the IR function setting.

- **On:** Choose "On", the projector can be operated by the remote control from top IR receiver.
- **Off:** Choose "Off", the projector can't be operated by the remote control. By selecting "Off", you will be able to use the Keypad keys.

User1/ User2/ User3 (Type 1)

Assign the default function for User1, User2, or User3 between HDMI 2, test pattern, brightness, contrast, sleep timer, color matching, color temp, gamma, projection, lamp settings, zoom, and freeze.

USING THE PROJECTOR

User1/ User2/ User3 (Type 2)

Assign the default function for User1, User2, or User3 between HDMI 2, test pattern, brightness, contrast, sleep timer, color matching, color temp, gamma, projection, lamp settings, zoom, and freeze.

User1/ User2/ User3 (Type 3, Type 4, and Type 5)

Assign the default function for User1, User2, or User3 between test pattern, brightness, contrast, sleep timer, color matching, color temp, gamma, projection, lamp settings, zoom, and freeze.

Setup projector ID menu

Projector ID

ID definition can be set up by menu (range 0-99), and allow user control an individual projector by using RS232 command.

Setup options menu

Language

Select the multilingual OSD menu between English, German, French, Italian, Spanish, Portuguese, Polish, Dutch, Swedish, Norwegian/Danish, Finnish, Greek, traditional Chinese, simplified Chinese, Japanese, Korean, Russian, Hungarian, Czechoslovak, Arabic, Thai, Turkish, Farsi, Vietnamese, Indonesian, Romanian, and Slovakian.

Closed Captioning

Closed Captioning is a text version of the program sound or other information displayed on the screen. If the input signal contains closed captions, you can turn on the feature and watch the channels. The available options include "Off", "CC1", and "CC2".



Note: *Closed Captioning is only available for Video NTSC.*

Menu Settings

Set the menu location on the screen and configure menu timer settings.

- **Menu Location:** Select the menu location on the display screen.
- **Menu Timer:** Set the duration where the OSD menu stays visible on the screen.

Auto Source

If you set this option "On" and press the  button on the projector keypad or  button on the remote control then the next available input source is selected automatically. Set "Off" to disable auto source function.

Input Source (SVGA, XGA, and WXGA models)

Select the input source between HDMI, VGA, and Video.

Input Name (SVGA, XGA, and WXGA models)

Use to rename the input function for easier identification. The available options include HDMI, VGA, and Video.

High Altitude

When "On" is selected, the fans will spin faster. This feature is useful in high altitude areas where the air is thin.

Display Mode Lock

Choose "On" or "Off" to lock or unlock adjusting display mode settings.

Keypad Lock

When the keypad lock function is "On", the Keypad will be locked. However, the projector can be operated by the remote control. By selecting "Off", you will be able to reuse the Keypad.

USING THE PROJECTOR

Information Hide

Enable this function to hide the information message.

- **Off:** Choose “On” to hide the info message.
- **On:** Choose “Off” to show the “searching” message.

Logo

Use this function to set the desired startup screen. If changes are made, they will take effect the next time the projector is powered on.

- **Default:** The default startup screen.
- **Neutral:** Logo is not displayed on startup screen.

Background Color

Use this function to display a blue, red, green, grey color, none, or logo screen when no signal is available.

Note: *If the background color is set to “None”, then the background color is black.*

Setup reset menu

Reset OSD

Return the factory default settings for OSD menu settings.

Reset to Default

Return the factory default settings for Setup menu settings.

Info menu

Info menu

View the projector information as listed below:

- Regulatory
- Serial Number
- Source
- Resolution
- Refresh Rate
- Display Mode
- Power Mode (Standby)
- Lamp Hours
- Projector ID
- Filter Usage Hours
- Brightness Mode
- FW Version

MAINTENANCE

Replacing the lamp

The projector automatically detects the lamp life. When the lamp life is nearing the end of use, a warning message will appear on the screen.

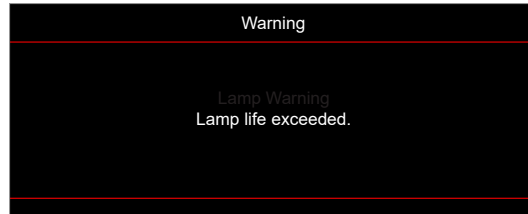

When you see this message, please contact your local reseller or service center to change the lamp as soon as possible. Make sure the projector has been cooled down for at least 30 minutes before changing the lamp.



Warning: If ceiling mounted, please use caution when opening the lamp access panel. It is recommended to wear safety glasses if changing the bulb when ceiling mounted. Caution must be used to prevent any loose parts from falling out of projector.



Warning: Lamp compartment is hot! Allow it to cool down before changing lamp!



Warning: To reduce the risk of personal injury, do not drop the lamp module or touch the lamp bulb. The bulb may shatter and cause injury if it is dropped.

MAINTENANCE

Replacing the lamp (continued)

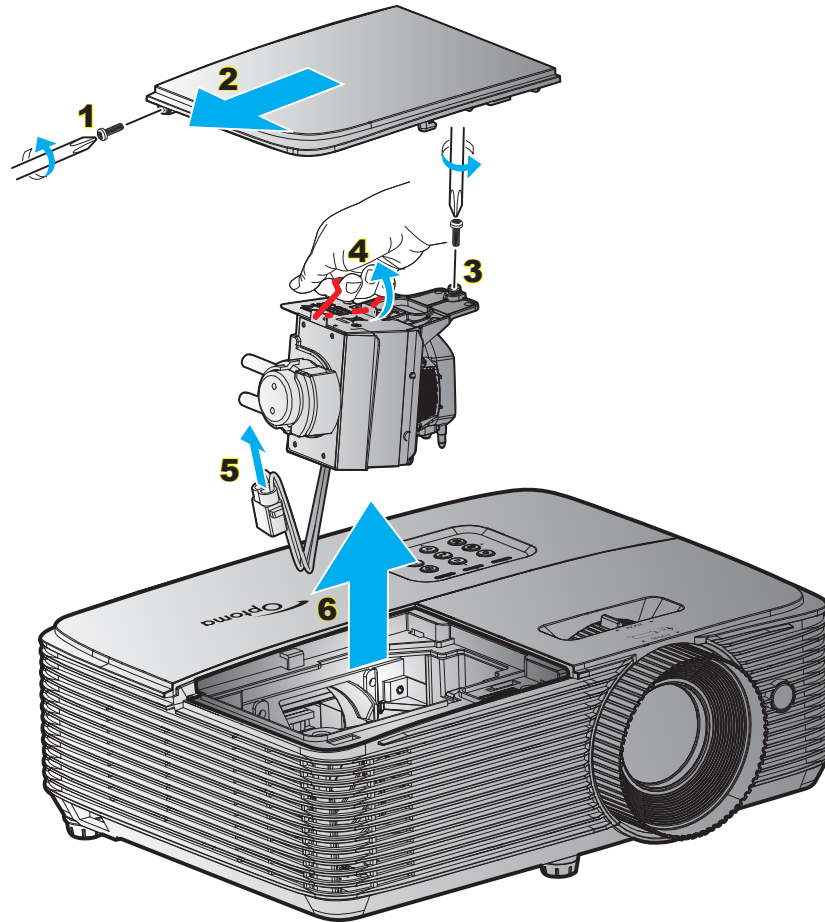

Procedure:

1. Switch off the power to the projector by pressing the "⏻" button on the remote control or the projector keypad.
2. Allow the projector to cool down for at least 30 minutes.
3. Disconnect the power cord.
4. Unscrew the screw on the cover. **1**
5. Remove the cover. **2**
6. Unscrew the screw on the lamp module. **3**
7. Lift up the lamp handle. **4**
8. Remove the lamp cord. **5**
9. Remove the lamp module carefully. **6**
10. To replace the lamp module, reverse the previous steps.
11. Turn on the projector and reset the lamp timer.
12. Lamp Reset: (i) Press "Menu" → (ii) Select "Setup" → (iii) Select "Lamp Settings" → (iv) Select "Lamp Reset" → (v) Select "Yes".

Note:

- *The screw on the lamp cover and the lamp cannot be removed.*
- *The projector cannot be turned on if the lamp cover has not been placed back on the projector.*
- *Do not touch the glass area of the lamp. Hand oil can cause the lamp shatter. Use a dry cloth to clean the lamp module if it was accidentally touched.*

MAINTENANCE

Installing and cleaning the dust filter

Installing the dust filter

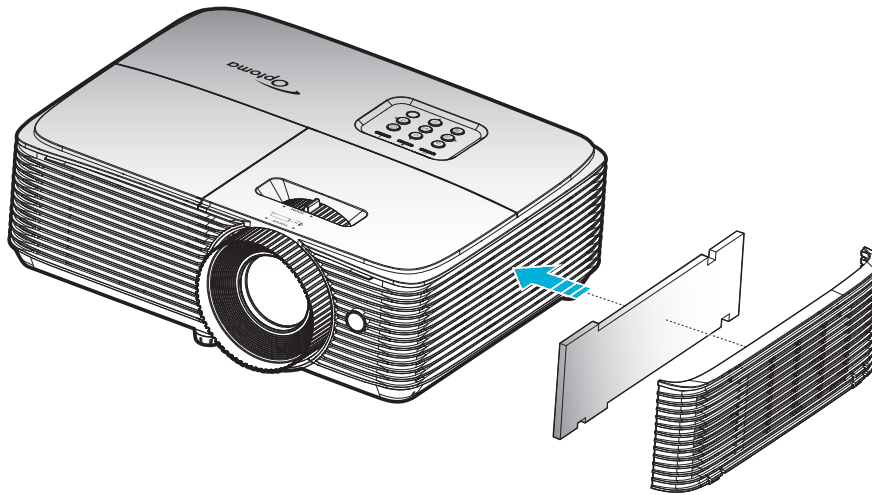

Note: Dust filters are only required/supplied in the selected regions with excessive dust.

Cleaning the dust filter

We recommend you to clean the dust filter every three months. Clean it more often if the projector is used in a dusty environment.

Procedure:

1. Switch off the power to the projector by pressing the "⏻" button on the remote control or the projector keypad.
2. Disconnect the power cord.
3. Remove the dust filter carefully. **1**
4. Clean or replace the dust filter. **2**
5. To install the dust filter, reverse the previous steps.

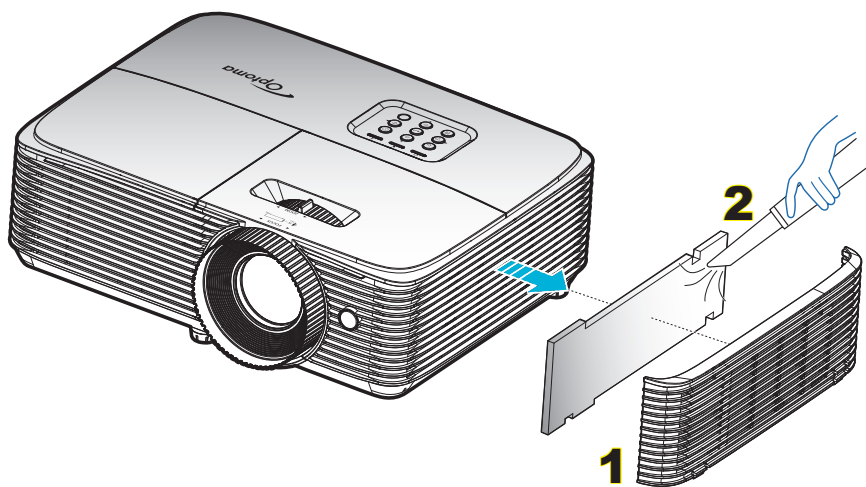

ADDITIONAL INFORMATION

Compatible resolutions

Digital compatibility

B0/Established Timing	B0/Standard Timing	B0/Detail Timing	B1/Video Mode	B1/Detail Timing
720x400 @ 70Hz	SVGA:	Native timing:	640x480p @ 60Hz	720x480p @ 60Hz
640x480 @ 60Hz	800x600 @ 120Hz			
640x480 @ 67Hz	1024x768 @ 120Hz	XGA: 1024x768 @ 60Hz	720x480p @ 60Hz	1280x720p @ 60Hz
640x480 @ 72Hz	1280x800 @ 60Hz	WXGA: 1280x800 @ 60Hz; 1280x720 @ 60Hz	1280x720p @ 60Hz	1366x768 @ 60Hz
640x480 @ 75Hz	1280x1024 @ 60Hz	1080P: 1920x1080 @ 60Hz	1920x1080i @ 60Hz	1920x1080i @ 50Hz
800x600 @ 56Hz	1680x1050 @ 60Hz	WUXGA: 1920x1200 @ 60Hz	720(1440)x480i @ 60Hz	1920x1080p @ 60Hz
800x600 @ 60Hz	1280x720 @ 60Hz		1920x1080p @ 60Hz	
800x600 @ 72Hz	1280x720 @ 120Hz		720x576p @ 50Hz	
800x600 @ 75Hz	1600x1200 @ 60Hz		1280x720p @ 50Hz	
832x624 @ 75Hz	XGA/WXGA:		1920x1080i @ 50Hz	
1024x768 @ 60Hz	1440x900 @ 60Hz		720(1440)x576i @ 50Hz	
1024x768 @ 70Hz	1024x768 @ 120Hz		1920x1080p @ 50Hz	
1024x768 @ 75Hz	1280x800 @ 60Hz		1920x1080p @ 24Hz	
1280x1024 @ 75Hz	1280x1024 @ 60Hz		1920x1080p @ 30Hz	
1152x870 @ 75Hz	1680x1050 @ 60Hz			
	1280x720 @ 60Hz			
	1280x720 @ 120Hz			
	1600x1200 @ 60Hz			
	1080P and WUXGA:			
	1280x720 @ 60Hz			
	1280x800 @ 60Hz			
	1280x1024 @ 60Hz			
	1400x1050 @ 60Hz			
	1600x1200 @ 60Hz			
	1280x768 @ 60Hz			
	1440x900 @ 60Hz			
	1280x720 @ 120Hz			
	1024x768 @ 120Hz			

ADDITIONAL INFORMATION

Analog compatibility

B0/Established Timing	B0/Standard Timing	B0/Detail Timing	B1/Video Mode	B1/Detail Timing
720x400 @ 70Hz	SVGA:	Native timing:		1366x768 @ 60Hz
640x480 @ 60Hz	800x600 @ 120Hz			
640x480 @ 67Hz	1024x768 @ 120Hz	XGA: 1024x768 @ 60Hz		
640x480 @ 72Hz	1280x800 @ 60Hz	WXGA: 1280x800 @ 60Hz; 1280x720 @ 60Hz		
640x480 @ 75Hz	1280x1024 @ 60Hz	1080P: 1920x1080 @ 60Hz		
800x600 @ 56Hz	1680x1050 @ 60Hz	WUXGA: 1920x1200 @ 60Hz		
800x600 @ 60Hz	1280x720 @ 60Hz			
800x600 @ 72Hz	1280x720 @ 120Hz			
800x600 @ 75Hz	1600x1200 @ 60Hz			
832x624 @ 75Hz	XGA/WXGA:			
1024x768 @ 60Hz	1440x900 @ 60Hz			
1024x768 @ 70Hz	1024x768 @ 120Hz			
1024x768 @ 75Hz	1280x800 @ 60Hz			
1280x1024 @ 75Hz	1280x1024 @ 60Hz			
1152x870 @ 75Hz	1680x1050 @ 60Hz			
	1280x720 @ 60Hz			
	1280x720 @ 120Hz			
	1600x1200 @ 60Hz			
	1080P and WUXGA:			
	1280x720 @ 60Hz			
	1280x800 @ 60Hz			
	1280x1024 @ 60Hz			
	1400x1050 @ 60Hz			
	1600x1200 @ 60Hz			
	1280x768 @ 60Hz			
	1440x900 @ 60Hz			
	1280x720 @ 120Hz			
	1024x768 @ 120Hz			

ADDITIONAL INFORMATION

True 3D video compatibility

Input resolution	HDMI 1.4a 3D Input	Input timing		
		1280x720P @ 50Hz	Top - and - Bottom	
		1280x720P @ 60Hz	Top - and - Bottom	
		1280x720P @ 50Hz	Frame packing	
		1280x720P @ 60Hz	Frame packing	
		1920x1080i @ 50 Hz	Side- by-Side (Half)	
		1920x1080i @ 60 Hz	Side- by-Side (Half)	
		1920x1080P @ 24 Hz	Top - and- Bottom	
		1920x1080P @ 24 Hz	Frame packing	
		HDMI 1.3	1920x1080i @ 50Hz	Side-by-Side(Half)
	1920x1080i @ 60Hz			
	1280x720P @ 50Hz			
	1280x720P @ 60Hz			
	800x600 @ 60Hz			
	1024x768 @ 60Hz			
	1280x800 @ 60Hz		Top-and-Bottom	TAB mode is on
	1920x1080i @ 50Hz			
	1920x1080i @ 60Hz			
	1280x720P @ 50Hz			
	1280x720P @ 60Hz			
800x600 @ 60Hz				
1024x768 @ 60Hz				
1280x800 @ 60Hz				
480i	HQFS	3D format is Frame sequential		

Note:

- If 3D input is 1080p@24hz, the DMD should replay with integral multiple with 3D mode.
- Support NVIDIA 3DTV Play if there is no patent fee from Optoma. 1080i@25hz and 720p@50hz will run in 100 hz; other 3D timing will run in 120hz.
- 1080p@24hz will run in 144Hz.

ADDITIONAL INFORMATION

Image size and projection distance

SVGA

Diagonal length (inch) Size of (16:9) Screen	Screen Size W x H				Projection Distance (D)				Offset (Hd)	
	(m)		(inch)		(m)		(feet)		(m)	(inch)
	Width	Height	Width	Height	Wide	Tele	Wide	Tele		
36	0.73	0.55	28.80	21.6	1.4	1.6	4.59	5.25	0.08	3.15
40	0.81	0.61	32.00	24	1.6	1.8	5.25	5.91	0.09	3.54
50	1.02	0.76	40.00	30	2.0	2.2	6.56	7.22	0.12	4.72
60	1.22	0.91	48.00	36	2.4	2.6	7.87	8.53	0.14	5.51
70	1.42	1.07	56.00	42	2.8	3.1	9.19	10.17	0.16	6.30
80	1.63	1.22	64.00	48	3.2	3.5	10.50	11.48	0.18	7.09
90	1.83	1.37	72.00	54	3.5	4.0	11.48	13.12	0.21	8.27
100	2.03	1.52	80.00	60	3.9	4.4	12.80	14.44	0.23	9.06
120	2.44	1.83	96.00	72	4.7	5.3	15.42	17.39	0.27	10.63
150	3.05	2.29	120.00	90	5.9	6.6	19.36	21.65	0.34	13.39
180	3.66	2.74	144.00	108	7.1	7.9	23.29	25.92	0.41	16.14
200	4.06	3.05	160.00	120	7.9	8.8	25.92	28.87	0.46	18.11
250	5.08	3.81	200.00	150	9.9	11.0	32.48	36.09	0.57	22.44
300	6.10	4.57	240.00	180	11.8	13.2	38.71	43.31	0.69	27.17

Note:

- Vertical Lens Shift values are always calculated from the Center of Projection Lens. Therefore the distance 5.2 cm (2.05 inch) from the Base to the Center of Projection Lens needs to be added to each Vertical Lens Shift value.
- Zoom ratio is 1.1x.

XGA

Diagonal length (inch) Size of (16:9) Screen	Screen Size W x H				Projection Distance (D)				Offset (Hd)	
	(m)		(inch)		(m)		(feet)		(m)	(inch)
	Width	Height	Width	Height	Wide	Tele	Wide	Tele		
36	0.73	0.55	28.80	21.6	1.4	1.6	4.59	5.25	0.08	3.15
40	0.81	0.61	32.00	24	1.6	1.8	5.25	5.91	0.09	3.54
50	1.02	0.76	40.00	30	2.0	2.2	6.56	7.22	0.12	4.72
60	1.22	0.91	48.00	36	2.4	2.6	7.87	8.53	0.14	5.51
70	1.42	1.07	56.00	42	2.8	3.1	9.19	10.17	0.16	6.30
80	1.63	1.22	64.00	48	3.2	3.5	10.50	11.48	0.18	7.09
90	1.83	1.37	72.00	54	3.5	4.0	11.48	13.12	0.21	8.27
100	2.03	1.52	80.00	60	3.9	4.4	12.80	14.44	0.23	9.06
120	2.44	1.83	96.00	72	4.7	5.3	15.42	17.39	0.27	10.63
150	3.05	2.29	120.00	90	5.9	6.6	19.36	21.65	0.34	13.39
180	3.66	2.74	144.00	108	7.1	7.9	23.29	25.92	0.41	16.14
200	4.06	3.05	160.00	120	7.9	8.8	25.92	28.87	0.46	18.11
250	5.08	3.81	200.00	150	9.9	11.0	32.48	36.09	0.57	22.44
300	6.10	4.57	240.00	180	11.8	13.2	38.71	43.31	0.69	27.17

ADDITIONAL INFORMATION

Note:

- Vertical Lens Shift values are always calculated from the Center of Projection Lens. Therefore the distance 5.2 cm (2.05 inch) from the Base to the Center of Projection Lens needs to be added to each Vertical Lens Shift value.
- Zoom ratio is 1.1x.

WXGA

Diagonal length (inch) Size of (16:9) Screen	Screen Size W x H				Projection Distance (D)				Offset (Hd)	
	(m)		(inch)		(m)		(feet)			
	Width	Height	Width	Height	Wide	Tele	Wide	Tele	(m)	(inch)
36	0.78	0.48	30.53	19.08	1.4	1.6	4.59	5.25	0.06	2.36
40	0.86	0.54	33.92	21.2	1.6	1.8	5.25	5.91	0.07	2.76
50	1.08	0.67	42.40	26.5	2.0	2.2	6.56	7.22	0.09	3.54
60	1.29	0.81	50.88	31.8	2.4	2.7	7.87	8.86	0.10	3.94
70	1.51	0.94	59.36	37.1	2.8	3.1	9.19	10.17	0.12	4.72
80	1.72	1.08	67.84	42.4	3.2	3.6	10.50	11.81	0.13	5.12
90	1.94	1.21	76.32	47.7	3.6	4.0	11.81	13.12	0.15	5.91
100	2.15	1.35	84.80	53	4.0	4.5	13.12	14.76	0.16	6.30
120	2.58	1.62	101.76	63.6	4.8	5.4	15.75	17.72	0.20	7.87
150	3.23	2.02	127.20	79.5	6.0	6.7	19.69	21.98	0.25	9.84
180	3.88	2.42	152.64	95.4	7.2	8.0	23.62	26.25	0.30	11.81
200	4.31	2.69	169.60	106	8.0	8.9	26.25	29.20	0.34	13.39
250	5.38	3.37	212.00	132.5	10.0	11.1	32.81	36.42	0.41	16.14
300	6.46	4.04	254.40	159	12.0	13.4	39.37	43.96	0.50	19.69

Note:

- Vertical Lens Shift values are always calculated from the Center of Projection Lens. Therefore the distance 5.2 cm (2.05 inch) from the Base to the Center of Projection Lens needs to be added to each Vertical Lens Shift value.
- Zoom ratio is 1.1x.

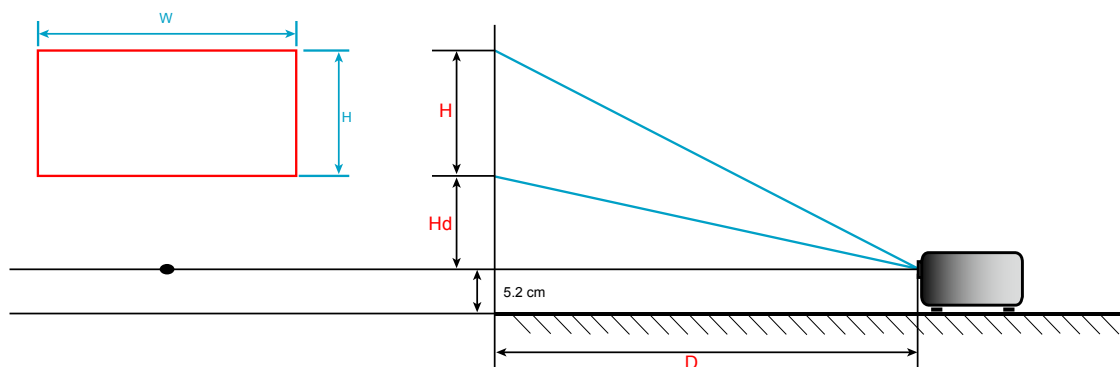

ADDITIONAL INFORMATION

Projector dimensions and ceiling mount installation

1. To prevent damage to your projector, please use the Optoma ceiling mount.
2. If you wish to use a third party ceiling mount kit, please ensure the screws used to attach a mount to the projector meet the following specifications:
 - Screw type: M4*3
 - Minimum screw length: 10mm

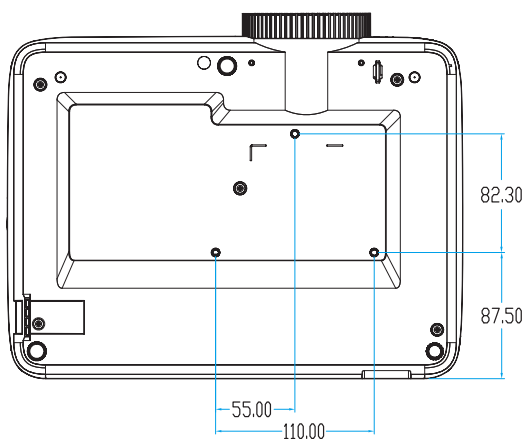
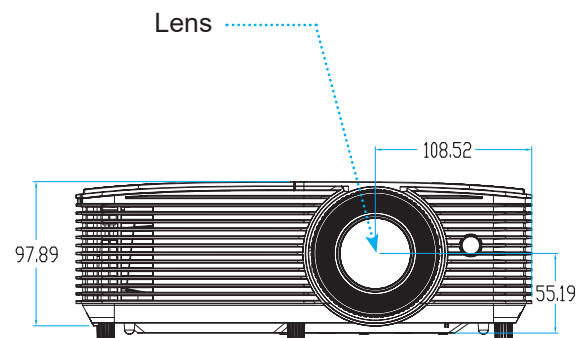
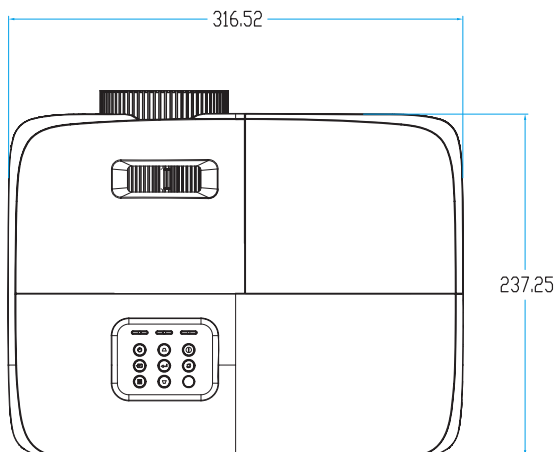

Unit: mm

Note: Please note that damage resulting from incorrect installation will void the warranty.



Warning:

- If you buy a ceiling mount from another company, please be sure to use the correct screw size. Screw size will vary depending on the thickness of the mounting plate.
- Be sure to keep at least 10 cm gap between the ceiling and the bottom of the projector.
- Avoid installing the projector near a heat source.







ADDITIONAL INFORMATION

IR remote control 1 codes



Key legend	Description	Key code
Power	Press to turn on / off the projector.	81
Freeze	Press to freeze the projector image.	8B
Aspect	Press to change aspect ratio of a displayed image.	98
AV mute	Press to turn off/ on projector built-in speaker	8A
Keystone+/up	<ul style="list-style-type: none"> Press to adjust image distortion caused by tilting the projector. Press to navigate up. 	C6
Mute	Press to momentarily turn off / on the audio.	92
Left/Vol-	<ul style="list-style-type: none"> Press to adjust to decrease the volume. Press to navigate left. 	C8
Enter	Confirm your item selection.	-C5 (for OSD) -CA (for emulation of USB mouse via USB)
Right/Vol+	<ul style="list-style-type: none"> Press to adjust to increase the volume. Press to navigate right. 	C9
Menu	Press to display or exit the on-screen display menus for projector.	88
Down/Keystone-	<ul style="list-style-type: none"> Press to adjust image distortion caused by tilting the projector. Press to navigate down. 	C7
3D	Press to manually select a 3D mode that matches your 3D content.	93

ADDITIONAL INFORMATION

Key legend		Description	Key code
HDMI		Press to choose HDMI source.	86
VGA		Press to choose VGA source.	8E
Video		Press to choose video source.	CE
Source		Press to select an input signal.	C3
Brightness mode		Press to automatically adjust the picture brightness to give an optimum contrast performance.	87
ReSync		Automatically synchronize the projector to the input source.	C4

ADDITIONAL INFORMATION

IR remote control 2 codes

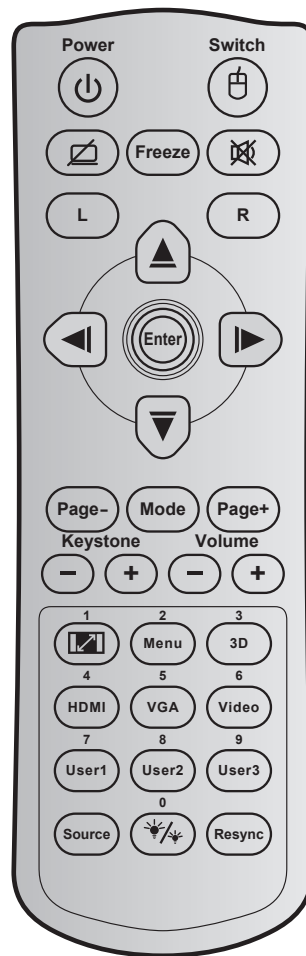

Key	Key code	Printing-key definition	Description
Power	81	Power on/off	Press to turn on / off the projector.
Switch	3E	Switch	Press to switch the USB mouse on / off.
Display blank / audio mute	8A		Press to hide / unhide the screen picture and turn off / on audio.
Freeze	8B	Freeze	Press to freeze the projector image.
Mute	92		Press to momentarily turn off / on the audio.
Mouse left click	CB	L	Use as mouse left click.
Mouse right click	CC	R	Use as mouse right click.
Four directional select keys	C6	Up arrow	Use ▲ ▼ ◀ ▶ to select items or make adjustments to your selection.
	C8	Left arrow	
	C9	Right arrow	
	C7	Down arrow	
Enter	C5	Enter	Confirm your item selection.
	CA	Enter	
Page -	C2	Page-	Press to page down.

ADDITIONAL INFORMATION

Key		Key code	Printing-key definition	Description
Mode		95	Mode	Press to switch Display mode on or off.
Page +		C1	Page+	Press to page up.
Keystone		85	Keystone+	Press to adjust image distortion caused by tilting the projector.
		84	Keystone-	
Volume		8C	Volume +	Press to adjust to increase / decrease the volume.
		8F	Volume -	
Aspect ratio / 1		98	/ 1	<ul style="list-style-type: none"> Press to change aspect ratio of a displayed image. Use as numeric keypad number "1".
Menu / 2		88	Menu/2	<ul style="list-style-type: none"> Press to display or exit the on-screen display menus for projector. Use as numeric keypad number "2".
3D / 3		93	3D/3	<ul style="list-style-type: none"> Press to manually select a 3D mode that matches your 3D content. Use as numeric keypad number "3".
HDMI / 4		86	HDMI/4	<ul style="list-style-type: none"> Press to choose HDMI source. Use as numeric keypad number "4".
VGA / 5		D0	VGA/5	<ul style="list-style-type: none"> Press to choose VGA source. Use as numeric keypad number "5".
Video / 6		D1	Video/6	<ul style="list-style-type: none"> Press to choose composite video source. Use as numeric keypad number "6".
User1 / 7; User2 / 8; User3 / 9		D2	User 1/7	<ul style="list-style-type: none"> User defined keys. Please see page 46 to setup. Use as numeric keypad numbers "7", "8", and "9" accordingly.
		D3	User 2/8	
		D4	User 3/9	
Source		C3	Source	Press to select an input signal.
Brightness mode / 0		96	/ 0	<ul style="list-style-type: none"> Press to automatically adjust the picture brightness to give an optimum contrast performance. Use as numeric keypad number "0".
Re-sync		C4	Re-Sync	Press to automatically synchronize the projector to the input source.





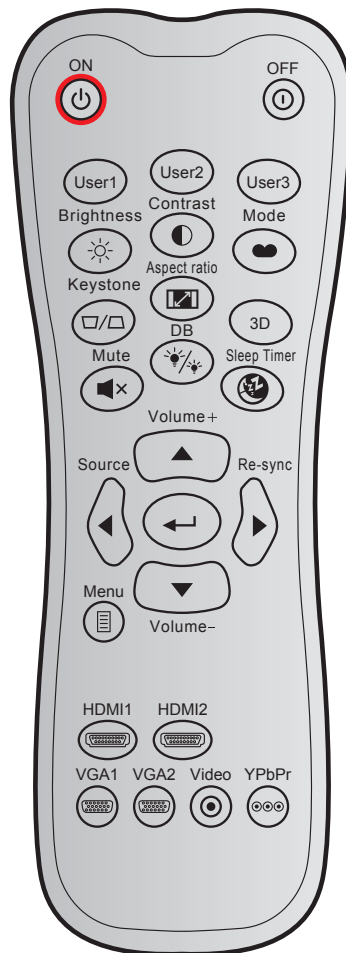









ADDITIONAL INFORMATION

IR remote control 3 codes



Key		Custom code		Data code	Printing-key definition	Description
		Byte 1	Byte 2	Byte 3		
Power on		32	CD	02	ON	Press to turn on the projector.
Power off		32	CD	2E	OFF	Press to turn off the projector.
User 1		32	CD	36	User1	User defined keys. Please see page 46 to setup.
User 2		32	CD	65	User2	
User 3		32	CD	66	User3	
Brightness		32	CD	41	Brightness	Adjust the brightness of the image.
Contrast		32	CD	42	Contrast	Control the degree of difference between the lightest and darkest parts of the picture.
Display mode		32	CD	05	Mode	Select a display mode for optimized settings for different applications. Please see page 37.
Keystone		32	CD	07	Keystone	Adjust image distortion caused by tilting the projector.
Aspect ratio		32	CD	64	Aspect ratio	Press to change aspect ratio of a displayed image.

ADDITIONAL INFORMATION

Key		Custom code		Data code	Printing-key definition	Description
		Byte 1	Byte 2	Byte 3		
3D		32	CD	89	3D	Manually select a 3D mode that matches your 3D content.
Volume +		32	CD	09	Volume +	Adjust to increase volume.
Four direction keys		32	CD	11	▲	Use ▲, ◀, ▶, or ▼ to select items or make adjustments to your selection.
		32	CD	10	◀	
		32	CD	12	▶	
		32	CD	14	▼	
Source		32	CD	18	Source	Press "Source" to select an input signal.
Enter key		32	CD	0F		Confirm your item selection.
Re-sync		32	CD	04	Re-sync	Automatically synchronizes the projector to the input source.
Volume -		32	CD	0C	Volume -	Adjust to decrease volume.
Menu		32	CD	0E	Menu	Display or exit the on-screen display menus for projector.
HDMI 1		32	CD	16	HDMI1	Press "HDMI1" to choose source from HDMI 1 / MHL connector.
HDMI 2		32	CD	30	HDMI2	Press "HDMI2" to choose source from HDMI 2 connector.
VGA 1		32	CD	1B	VGA1	No function
VGA 2		32	CD	1E	VGA2	No function
Video		32	CD	1C	Video	No function
YPbPr		32	CD	17	YPbPr	No function

ADDITIONAL INFORMATION

IR remote control 4 codes

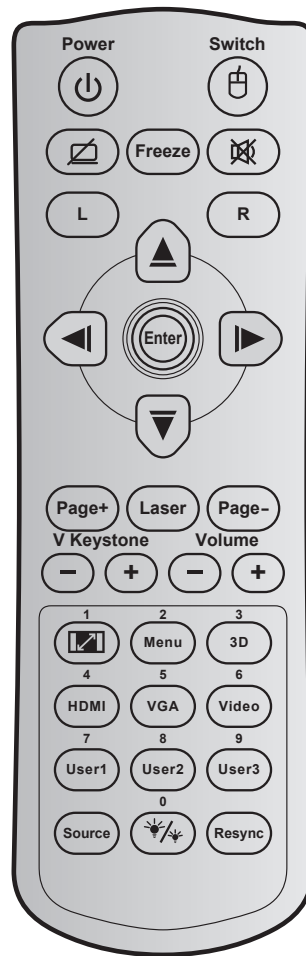

Key	Key code	Printing-key definition	Description
Power	81	Power on/off	Press to turn on / off the projector.
Switch	3E	Switch	Press to switch the USB mouse on / off.
Display blank / audio mute	8A		Press to hide / unhide the screen picture and turn off / on audio.
Freeze	8B	Freeze	Press to freeze the projector image.
Mute	92		Press to momentarily turn off / on the audio.
Mouse left click	CB	L	Use as mouse left click.
Mouse right click	CC	R	Use as mouse right click.
Four directional select keys	C6	Up arrow	Use ▲ ▼ ◀ ▶ to select items or make adjustments to your selection.
	C8	Left arrow	
	C9	Right arrow	
	C7	Down arrow	
Enter	C5	Enter	Confirm your item selection.
	CA	Enter	
Page -	C2	Page-	Press to page down.







Key		Key code	Printing-key definition	Description
Laser		N/A	Laser	Use as laser pointer.
Page +		C1	Page+	Press to page up.
V Keystone		85	Keystone+	Press to adjust image distortion caused by tilting the projector.
		84	Keystone-	
Volume		8C	Volume +	Press to adjust to increase / decrease the volume.
		8F	Volume -	
Aspect ratio / 1		98	/ 1	<ul style="list-style-type: none"> Press to change aspect ratio of a displayed image. Use as numeric keypad number "1".
Menu / 2		88	Menu/2	<ul style="list-style-type: none"> Press to display or exit the on-screen display menus for projector. Use as numeric keypad number "2".
3D / 3		93	3D/3	<ul style="list-style-type: none"> Press to manually select a 3D mode that matches your 3D content. Use as numeric keypad number "3".
HDMI / 4		86	HDMI/4	<ul style="list-style-type: none"> Press to choose HDMI source. Use as numeric keypad number "4".
VGA / 5		D0	VGA/5	<ul style="list-style-type: none"> Press to choose VGA source. Use as numeric keypad number "5".
Video / 6		D1	Video/6	<ul style="list-style-type: none"> Press to choose composite video source. Use as numeric keypad number "6".
User1 / 7; User2 / 8; User3 / 9		D2	User 1/7	<ul style="list-style-type: none"> User defined keys. Please see page 45 to setup. Use as numeric keypad numbers "7", "8", and "9" accordingly.
		D3	User 2/8	
		D4	User 3/9	
Source		C3	Source	Press to select an input signal.
Brightness mode / 0		96	/ 0	<ul style="list-style-type: none"> Press to automatically adjust the picture brightness to give an optimum contrast performance. Use as numeric keypad number "0".
Re-sync		C4	Re-Sync	Press to automatically synchronize the projector to the input source.

ADDITIONAL INFORMATION

Troubleshooting

If you experience a problem with your projector, please refer to the following information. If a problem persists, please contact your local reseller or service center.

Image problems

-  *No image appears on-screen*
- Ensure all the cables and power connections are correctly and securely connected as described in the "Installation" section.
 - Ensure the pins of connectors are not crooked or broken.
 - Check if the projection lamp has been securely installed. Please refer to the "Replacing the Lamp" section.
 - Ensure that the "AV Mute" feature is not turned on.
-  *Image is out of focus*
- Adjust the Focus Ring on the projector lens.
 - Make sure the projection screen is between the required distance from the projector. (Please refer to pages 54-56).
-  *The image is stretched when displaying 16:9 DVD title*
- When you play anamorphic DVD or 16:9 DVD, the projector will show the best image in 16: 9 format on projector side.
 - If you play the LBX format DVD title, please change the format as LBX in projector OSD.
 - If you play 4:3 format DVD title, please change the format as 4:3 in projector OSD.
 - Please setup the display format as 16:9 (wide) aspect ratio type on your DVD player.
-  *Image is too small or too large*
- Adjust the Zoom Lever on the top of the projector.
 - Move the projector closer to or further from the screen.
 - Press "Menu" on the projector panel, go to "Display > Aspect Ratio". Try the different settings.
-  *Image has slanted sides:*
- If possible, reposition the projector so that it is centered on the screen and below the bottom of the screen.
 - Use "Display > Keystone" from the OSD to make an adjustment.
-  *Image is reversed*
- Select "Setup > Projection" from the OSD and adjust the projection direction.
-  *Blurry double image*
- Press "3D" button and switch to "Off" to avoid normal 2D image is blurry double image.

ADDITIONAL INFORMATION

Two images, side-by-side format

- Press "3D" button and switch to "SBS" for input signal is HDMI 1.3 2D 1080i side-by-side.

Image does not display in 3D

- Check if the battery of 3D glasses is drained.
- Check if the 3D glasses is turned on.
- When the input signal is HDMI 1.3 2D (1080i side-by-side half), press "3D" button and switch to "SBS".

Other problems

The projector stops responding to all controls

- If possible, turn off the projector, then unplug the power cord and wait at least 20 seconds before reconnecting power.

Lamp burns out or makes a popping sound

- When the lamp reaches its end of life, it will burn out and may make a loud popping sound. If this happens, the projector will not turn on until the lamp module has been replaced. To replace the lamp, follow the procedures in the "Replacing the Lamp" section on pages 49-50.

Remote control problems

If the remote control does not work

- Check the operating angle of the remote control is pointed within $\pm 15^\circ$ to the IR receiver on the projector.
- Make sure there are not any obstructions between the remote control and the projector. Move to within 6 m (20 ft) of the projector.
- Make sure batteries are inserted correctly.
- Replace batteries if they are exhausted.

ADDITIONAL INFORMATION





Warning indicators

When the warning indicators (see below) light up or flash, the projector will automatically shutdown:

- "LAMP" LED indicator is lit red and if "On/Standby" indicator flashes red.
- "TEMP" LED indicator is lit red and if "On/Standby" indicator flashes red. This indicates the projector has overheated. Under normal conditions, the project can be switched back on.
- "TEMP" LED indicator flashes red and if "On/Standby" indicator flashes red.

Unplug the power cord from the projector, wait for 30 seconds and try again. If the warning indicator light up or flash, please contact your nearest service center for assistance.

LED lightning messages

Message	 Power LED	 Power LED	 Temp-LED	 Lamp-LED
	(Red)	(Green or Blue)	(Red)	(Red)
Standby state (Input power cord)	Steady light			
Power on (Warming)		Flashing (0.5 sec off / 0.5 sec on)		
Power on & Lamp lighting		Steady light		
Power off (Cooling)		Flashing (0.5 sec off / 0.5 sec light). Back to red steady light when cooling fan turns off.		
Quick Resume (100 secs)		Flashing (0.25 sec off / 0.25 sec on)		
Error (Lamp fail)	Flashing			Steady light
Error (Fan failure)	Flashing		Flashing	
Error (Over Temp)	Flashing		Steady light	

- Power off:

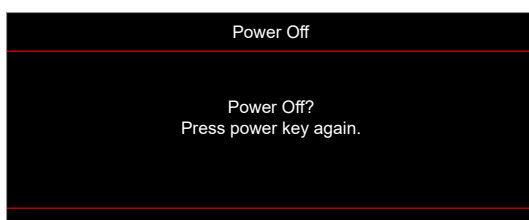

- Lamp warning:

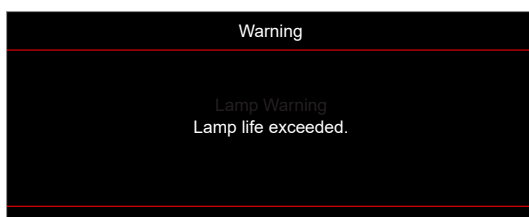

ADDITIONAL INFORMATION

- Temperature warning:

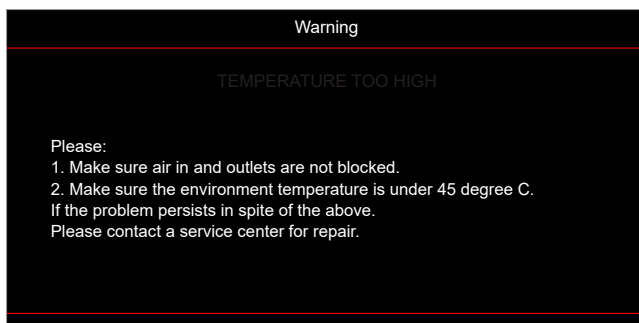

- Fan failed:

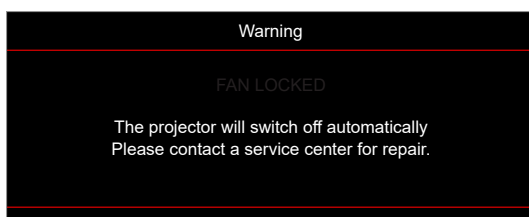

- Out of display range:

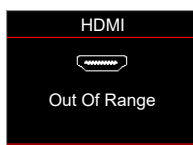

- Power down warning:

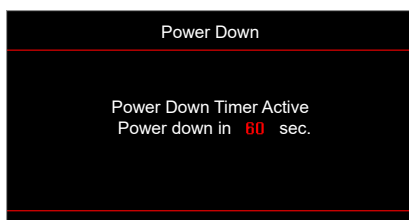

- Security timer alarm:



ADDITIONAL INFORMATION

Specifications

Optical	Description
Native resolution	SVGA / XGA / WXGA
Lens	Manual zoom and manual focus
Image size (diagonal)	27.78"~304.4"
Projection distance	1m ~ 12m (focus range)

Electrical	Description
Color reproduction	1073.4 Million color
Scan rate	- Horizontal scan rate: 15.375~91.146 KHz - Vertical scan rate: 50~ 85 Hz (120Hz for 3D feature projector)
Built-in speaker	Yes, 10W
USB power out	5V ~ 1.5A
Power requirement	100 - 240V AC 50/60Hz
Input current	2.8-1.0 A

Mechanical	Description
Installation orientation	Front, Rear, Ceiling - Top, Rear - Top
Dimensions	- 316 mm (W) x 243.5 mm (D) x 98 mm (H) (without feet) - 316 mm (W) x 243.5 mm (D) x 108.5 mm (H) (with feet)
Weight	2.9 kg
Environmental conditions	Operating in 5 ~ 40°C , 10% to 85% humidity (non-condensing)

Note: All specifications are subject to change without notice.



ADDITIONAL INFORMATION

Optoma global offices

For service or support, please contact your local office.



USA

3178 Laurelview Ct.
Fremont, CA 94538, USA
www.optomausa.com

 888-289-6786
 510-897-8601
 services@optoma.com



Canada

3178 Laurelview Ct.
Fremont, CA 94538, USA
www.optomausa.com

 888-289-6786
 510-897-8601
 services@optoma.com



Latin America

3178 Laurelview Ct.
Fremont, CA 94538, USA
www.optomausa.com

 888-289-6786
 510-897-8601
 services@optoma.com



Europe

Unit 1, Network 41, Bourne End Mills
Hemel Hempstead, Herts,
HP1 2UJ, United Kingdom
www.optoma.eu
Service Tel : +44 (0)1923 691865

 +44 (0) 1923 691 800
 +44 (0) 1923 691 888
 service@tsc-europe.com



Benelux BV

Randstad 22-123
1316 BW Almere
The Netherlands
www.optoma.nl

 +31 (0) 36 820 0252
 +31 (0) 36 548 9052



France

Bâtiment E
81-83 avenue Edouard Vaillant
92100 Boulogne Billancourt, France

 +33 1 41 46 12 20
 +33 1 41 46 94 35
 savoptoma@optoma.fr



Spain

C/ José Hierro,36 Of. 1C
28522 Rivas VaciaMadrid,
Spain

 +34 91 499 06 06
 +34 91 670 08 32



Deutschland

Wiesenstrasse 21 W
D40549 Düsseldorf,
Germany

 +49 (0) 211 506 6670
 +49 (0) 211 506 66799
 info@optoma.de

Scandinavia



Lerpeveien 25
3040 Drammen
Norway

 +47 32 98 89 90
 +47 32 98 89 99
 info@optoma.no

PO.BOX 9515
3038 Drammen
Norway

Korea

WOOMI TECH.CO.,LTD.
4F, Minu Bldg.33-14, Kangnam-Ku,
Seoul,135-815, KOREA
korea.optoma.com

 +82+2+34430004
 +82+2+34430005



Japan

東京都足立区綾瀬3-25-18
株式会社オーエス
コンタクトセンター:0120-380-495

 info@os-worldwide.com
www.os-worldwide.com



Taiwan

12F., No.213, Sec. 3, Beixin Rd.,
Xindian Dist., New Taipei City 231,
Taiwan, R.O.C.
www.optoma.com.tw

 +886-2-8911-8600
 +886-2-8911-6550
 services@optoma.com.tw
asia.optoma.com



Hong Kong

Unit A, 27/F Dragon Centre,
79 Wing Hong Street,
Cheung Sha Wan,
Kowloon, Hong Kong

 +852-2396-8968
 +852-2370-1222
www.optoma.com.hk

China

5F, No. 1205, Kaixuan Rd.,
Changning District
Shanghai, 200052, China

 +86-21-62947376
 +86-21-62947375
www.optoma.com.cn



P/N:36.7AZ01G002-A