



PL4901/PL5501/PL5502
LCD Monitor
User Manual



Disclaimer

BenQ Corporation makes no representations or warranties, either expressed or implied, with respect to the contents of this document. BenQ Corporation reserves the right to revise this publication and to make changes from time to time in the contents thereof without obligation to notify any person of such revision or changes.

Copyright

Copyright 2020 BenQ Corporation. All rights reserved. No part of this publication may be reproduced, transmitted, transcribed, stored in a retrieval system or translated into any language or computer language, in any form or by any means, electronic, mechanical, magnetic, optical, chemical, manual or otherwise, without the prior written permission of BenQ Corporation.

Product support

This document aims to provide the most updated and accurate information to customers, and thus all contents may be modified from time to time without prior notice. Please visit the website for the latest version of this document and other product information. Available files vary by model.

1. Make sure your computer is connected to the Internet.
2. Visit the local website from www.BenQ.com. The website layout and content may vary by region/country.
 - User manual and related document: www.BenQ.com > **BenQ DISPLAY** > **SUPPORT** > **Downloads** > model name > **User Manual**
 - (EU only) Dismantled information: Available on the user manual download page. This document is provided based on Regulation (EU) 2019/2021 to repair or recycle your product. Always contact the local customer service for servicing within the warranty period. If you wish to repair an out-of-warranty product, you are recommended to go to a qualified service personnel and obtain repair parts from BenQ to ensure compatibility. Do not disassemble the product unless you are aware of the consequences. If you cannot find the dismantled information on your product, contact the local customer service for assistance.

EPREL Registration Number:

PL4901: 370409

PL5501: 370822

PL5502: 370415

Table of Contents

Product support.....	3
Safety warnings and precautions.....	6
Important safety instructions.....	7
Notes on the LCD panel of this display	7
Safety notice for remote control	8
Battery safety notice	8
BenQ ecoFACTS	9
Package contents	10
Setting up the display.....	11
Installation Notes.....	11
Mounting on a wall	11
Ventilation Requirements for enclosure locating.....	12
Mounting in Portrait Position.....	13
Parts of the display and their functions.....	14
Input/output terminals	14
Remote control.....	15
Using the remote control	16
Connection	17
IR and display control daisy chain connection	17
External IR receiver.....	17
Configuration and calibration tool control.....	18
Video In connection	19
Connecting power	21
Basic operations.....	22
Turning the display on or off.....	22
Operations in the OSD menu.....	22
Software update procedure.....	23
OSD Setting	23
Color calibration & video wall setup software.....	26
Preparation.....	26

Operations- RS232.....	29
Operations- LAN.....	33
Troubleshooting.....	34
Product information.....	35
Specifications	35
USB device compatibility	36
Dimensions	37
Supported input signal resolution.....	40

Safety warnings and precautions



The lightning flash with arrowhead symbol, within an equilateral triangle, is intended to alert the user to the presence of uninsulated “dangerous voltage” within the product’s enclosure that may be of sufficient magnitude to constitute a risk of electric shock to persons.



The exclamation point within an equilateral triangle is intended to alert the user to the presence of important operating and maintenance (servicing) instructions in the literature accompanying the appliance.



THIS EQUIPMENT MUST BE GROUNDED

To ensure safe operation, the three-pin plug must be inserted only into a standard three-pin power outlet which is effectively grounded through normal household wiring. Extension cords used with the equipment must have three cores and be correctly wired to provide connection to the ground. Wrongly wired extension cords are a major cause of fatalities.

The fact that the equipment operates satisfactorily does not imply that the power outlet is grounded or that the installation is completely safe. For your safety, if you are in any doubt about the effective grounding of the power outlet, please consult a qualified electrician.

- The mains plug of the power supply cord shall remain readily operable. The AC receptacle (mains socket outlet) shall be installed near the equipment and shall be easily accessible. To completely disconnect this equipment from the AC mains, disconnect the power cord plug from the AC receptacle.
- Do not place this display on an uneven, sloping or unstable surface (such as a trolley) where it may fall and cause damage to itself or others.
- Do not place this display near water, like a spa or pool, or in a position which will allow the splashing or spraying of water onto the display, like in front of an open window where rain water may enter.
- Do not install this display in a confined space without proper ventilation and air circulation, such as in a closed cabinet. Allow proper space around the display for dissipating heat inside. Do not block any openings and vents on the display. Overheating may result in hazards and electric shock.
- Installation of this display should only be performed by a qualified technician. Failure to install this display properly may cause injuries and damages to the personnels and the display itself. Check the installation regularly and maintain the display periodically to ensure the best working condition.
- Use only the accessories approved or recommended by the manufacturer to mount this display. Using wrong or unsuitable accessories may cause the display to fall and result in serious personal injuries. Make sure that the surface and fixing points are strong enough to sustain the weight of the display.
- To reduce the risk of electric shock, do not remove covers. No user serviceable parts inside. Refer servicing to qualified service personnel.
- To prevent personal injuries, mounting the display or installing desktop stands is required before use.

Important safety instructions

1. Read these instructions.
2. Keep these instructions.
3. Heed all warnings.
4. Follow all instructions.
5. Do not use this apparatus near water.
6. Clean only with dry cloth.
7. Do not block any ventilation openings. Install in accordance with the manufacturer's instructions.
8. Do not install near any heat sources such as radiators, heat registers, stoves, or other apparatus (including amplifiers) that produce heat.
9. Do not defeat the safety purpose of the polarized or grounding-type plug. A polarized plug has two blades with one wider than the other. A grounding-type plug has two blades and a third grounding prong. The wide blade or the third prong are provided for your safety. If the provided plug does not fit into your outlet, consult an electrician for replacement of the obsolete outlet.
10. Protect the power cord from being walked on or pinched particularly at plugs, convenience receptacles, and the point where they exit from the apparatus.
11. Only use attachments/accessories specified by the manufacturer.
12. Use only with the cart, stand, tripod, bracket, or table specified by the manufacturer, or sold with the apparatus. When a cart is used, use caution when moving the cart/apparatus combination to avoid injury from tip-over.
13. Unplug this apparatus during lightning storms or when unused for long periods of time.
14. Refer all servicing to qualified service personnel. Servicing is required when the apparatus has been damaged in any way, such as power-supply cord or plug is damaged, liquid has been spilled or objects have fallen into the apparatus, the apparatus has been exposed to rain or moisture, does not operate normally, or has been dropped.



Notes on the LCD panel of this display

- The Liquid Crystal Display (LCD) panel of this display has a very thin protective layer of glass which is liable to marking or scratching, and cracking if struck or pressured. The liquid crystal substrate is also liable to damage under excessive force or extreme temperatures. Please handle with care.
- The response time and brightness of the LCD panel may vary with the ambient temperature.
- Avoid placing the display in direct sun or where direct sun or spot lighting will shine onto the LCD panel, as the heat may damage the panel and the external casing of the display, and the bright light will make viewing the display more difficult than necessary.
- The LCD panel consists of individual pixels to display images and is manufactured according to the design specifications. While 99.9% of these pixels work normally, 0.01% of the pixels may remain constantly lit (in red, blue or green) or unlit. This is a technical limitation of the LCD technology and is not a defect.

- LCD screens, like plasma (PDP) and conventional CRT (Cathode Ray Tube) screens, are also susceptible to 'screen burn-in' or 'image retention' which can be found on the screen as visible fixed lines and shades. To avoid such damage to the screen, avoid displaying still images (like On-Screen Display menus, fixed/inactive text or icons) for more than two hours. Change the aspect ratio from time to time. Fill the entire screen with the image and eliminate the black bars whenever possible. Avoid displaying images in 4:3 aspect ratio over a long period of time, otherwise there may be visible burn marks on the screen as two vertical lines.

Note: Under certain circumstances, condensation may occur on the inner side of the cover glass, it's a natural phenomenon and will not affect the operation of the display. This condensation will usually disappear after around 30 minutes of normal operation.

- If display of a still image is required, it is recommended to enable pixel shift under the General settings.

Safety notice for remote control

- Do not put the remote control in the direct heat, humidity, and avoid fire.
- Do not drop the remote control.
- Do not expose the remote control to water or moisture. Failure to do so could result in malfunction.
- Confirm there is no object between the remote control and the remote sensor of the product.
- When the remote control will not be used for an extended period, remove the batteries.

Battery safety notice

The use of the wrong type of batteries may cause chemical leaks or explosion. Please note the following:

- Always ensure that the batteries are inserted with the positive and negative terminals in the correct direction as shown in the battery compartment.
- Different types of batteries have different characteristics. Do not mix different types.
- Do not mix old and new batteries. Mixing old and new batteries will shorten battery life or cause chemical leaks from the old batteries.
- When batteries fail to function, replace them immediately.
- Chemicals which leak from batteries may cause skin irritation. If any chemical matter seeps out of the batteries, wipe it up immediately using a dry cloth, and replace the batteries as soon as possible.
- Due to varying storage conditions, the battery life for the batteries included with your product may be shortened. Replace them within 3 months or as soon as you can after initial use.
- There may be local restrictions on the disposal or recycling of batteries. Consult your local regulations or waste disposal provider.

BenQ ecoFACTS

BenQ has been dedicated to the design and development of greener product as part of its aspiration to realize the ideal of the “Bringing Enjoyment 'N Quality to Life” corporate vision with the ultimate goal to achieve a low-carbon society. Besides meeting international regulatory requirement and standards pertaining to environmental management, BenQ has spared no efforts in pushing our initiatives further to incorporate life cycle design in the aspects of material selection, manufacturing, packaging, transportation, using and disposal of the products. BenQ ecoFACTS label lists key eco-friendly design highlights of each product, hoping to ensure that consumers make informed green choices at purchase. Check out BenQ's CSR Website at <http://csr.BenQ.com/> for more details on BenQ's environmental commitments and achievements.



~ AC voltage

Package contents

Open the sales package and check the contents. If any item is missing or damaged, please contact your dealer immediately.



LCD display



Remote control

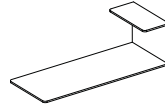

Gap inspection pad x 4



Quick start guide

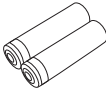

AAA battery x 2



Power cord x 1

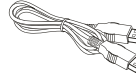

HDMI cable x 1



DVI cable x 1



DP cable x 1



Audio cable x 1



IR Extender cable x 1

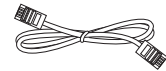

RS232/IR loop cable x 1



RS232 to USB cable x 1



RJ45 to RS232 cable x 1

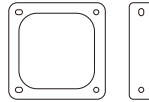

Alignment kit x 1



- The type of power cord supplied may differ from that illustrated depending on your region of purchase.
- Before discarding the package, check that you haven't left any accessories inside the box.
- Dispose of packaging materials wisely. You can recycle the cardboard carton. Consider storing the package (if possible) for future transport of the display.
- Do not leave plastic bags within reach of young children or babies.

Setting up the display

Installation Notes

- Due to the high power consumption, always use the plug exclusively designed for this product. If an extended line is required, please consult your service agent.
- The product should be installed on a flat surface to avoid tipping. The distance between the back of the product and the wall should be maintained for proper ventilation. Avoid installing the product in the kitchen, bathroom or any other places with high humidity so as not to shorten the service life of the electronic components.
- The product can normally operate only under 5000m in altitude. In installations at altitudes above 3000m, some abnormalities may be experienced.

Mounting on a wall

VESA Standard:

PL4901: 600 x 400 (4 - M6 x 40L)

PL5501: 600 x 400 (4 - M6 x 40L)

PL5502: 600 x 400 (4 - M6 x 40L)

To mount this display to a wall, you will have to obtain a standard wall-mounting kit (commercially available). We recommend using a mounting interface that complies with TUV-GS and/or ULI678 standard in North America.

1. Lay a protective sheet on a table, which was wrapped around the display when it was packaged, beneath the screen surface so as not to scratch the screen face.
2. Ensure you have all accessories for mounting this display (wall mount, ceiling mount, table stand, etc).
3. Follow the instructions that come with the base mounting kit. Failure to follow correct mounting procedures could result in damage to the equipment or injury to the user or installer. Product warranty does not cover damage caused by improper installation.
4. For the wall-mounting kit, use M6 mounting screws (having a length 10 mm longer than the thickness of the mounting bracket) and tighten them securely.

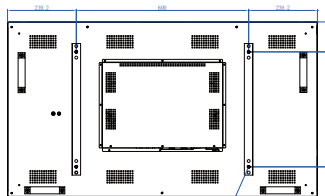

NOTE : UNIT:mm
 1. HOLE WIDTH (H/W) : 3.5/4.0/2.5/3.0
 2. WALL MOUNT SCREW THREAD DEPTH : 4-M6x40L

PL4901

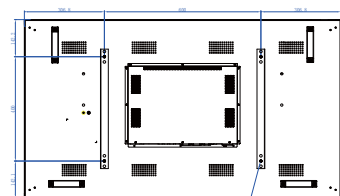

NOTE : UNIT:mm
 1. HOLE WIDTH (H/W) : 3.5/4.0/2.5/3.0
 2. WALL MOUNT SCREW THREAD DEPTH : 4-M6x40L

PL5501

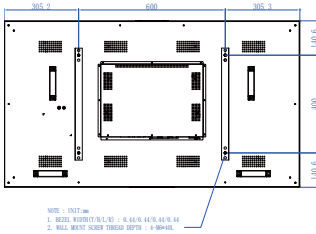

PL5502

5. Install the wall mounting bracket on the display and attach the display to the wall according to the mounting bracket's instructions. The length of the screw should exceed the thickness of the wall mounting bracket, please refer to below chart for each model. Make sure that all screws are tightened and secured properly. (Recommended torque: 16 (+2/-2) kgf/cm). The mounting means should be strong enough to bear the weight of the display.

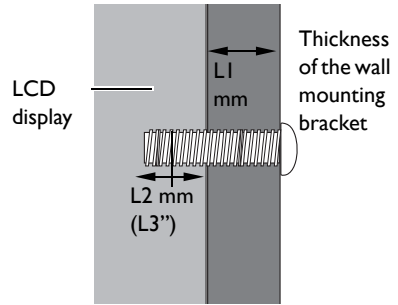

To prevent the display from falling:

- For wall or ceiling installation, we recommend installing the display with metal brackets which are commercially available. For detailed installation instructions, refer to the guide received with the respective bracket.
- To lessen the probability of injury and damage resulting from fall of the display in case of earthquake or other natural disaster, be sure to consult the bracket manufacturer for installation location.

Ventilation Requirements for enclosure locating

To allow heat to disperse, leave space between surrounding objects.

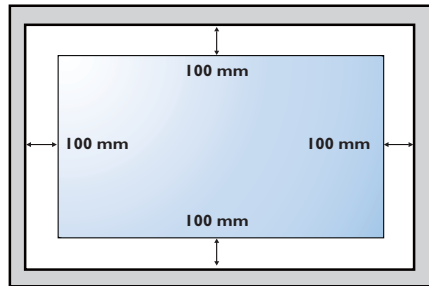

Mounting in Portrait Position

The display (PL4901/PL5501/PL5502) can be installed in portrait position and rotated 90 degrees anticlockwise.

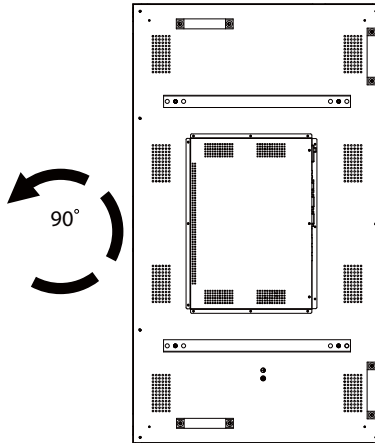

Parts of the display and their functions

Input/output terminals

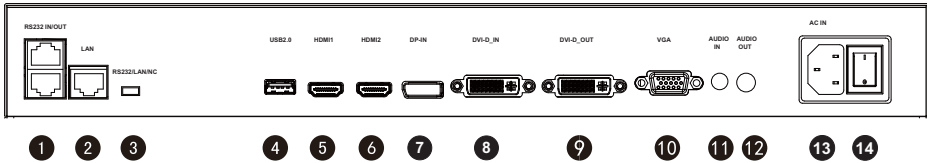

No.	Name	Description
1	RS232(IN/OUT)	Serial interface, used for mutual transfer of data between devices.
2	LAN	LAN command transfer only.
3	RS232/LAN/NC	Enable RS232(IN/OUT) or LAN port. NC to disable both RS232 and LAN port.
4	USB 2.0	Access multimedia files on USB drives directly.
5	HDMI1	Receive 4K2K 60Hz supported signals from an external device.
6	HDMI2	Receive 4K2K supported signals from an external device.
7	DP-IN	Connect a video source to a display device.
8	DVI-D-IN	DVI-D video input.
9	DVI-D-OUT	DVI-D video output.
10	VGA	Receive analog RGB signals from an external device (such as a computer).
11	AUDIO IN	Receives audio signals from an external device.
12	AUDIO OUT	Connects to an external audio device (such as a speaker, stereo system, or headphone) to output the audio that is supplied by the video source.
13	AC IN	AC power input from the wall outlet.
14	MAIN POWER SWITCH	Switch the main power on/off.

Remote control

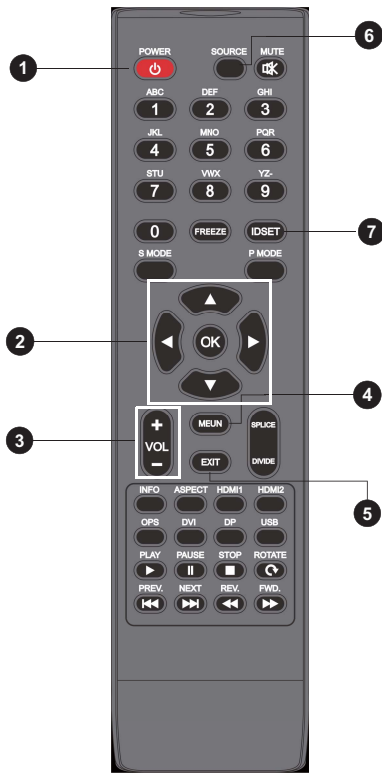

1 Power button

Turn the display on or off.

2 ▲/▼/◀/▶/OK

Scroll through settings and options in the OSD menu.

3 Volume VOL+/VOL-

Turn up/down the volume.

4 MENU

Open or close the OSD menu.

5 EXIT

Return key.

6 SOURCE

Switch input source.

7 ID Setting

Press and enter the corresponding code to control individual display in daisy chain.

Using the remote control

Installing remote control batteries

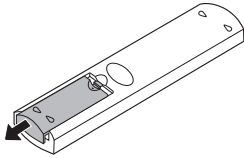

1. Open the remote control battery compartment cover.

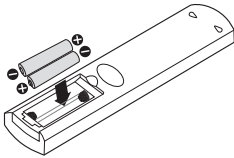

2. Insert the batteries ensuring that the positive and negative marked battery terminals match the (+) and (-) marks in the battery compartment.



Batteries must be purchased separately as they are not included in the display package.

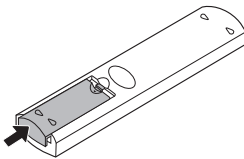

3. Refit the battery compartment cover.
-

Remote control usage tips

- Point and aim the top front of the remote control directly at the display's remote control sensor window when you press the buttons.
- Do not let the remote control become wet or place it in humid environments (like bathrooms).
- If the display's remote control sensor window is exposed to direct sunlight or strong light, the remote control may not operate properly. In this situation, change the light source, readjust the angle of the display or operate the remote control from a location closer to the display's remote control sensor window.

Connection

IR and display control daisy chain connection

Connect the LAN cable from the RS232 OUT of Display 1 to the RS232 IN of Display 2. It is for command sending and IR loop through.

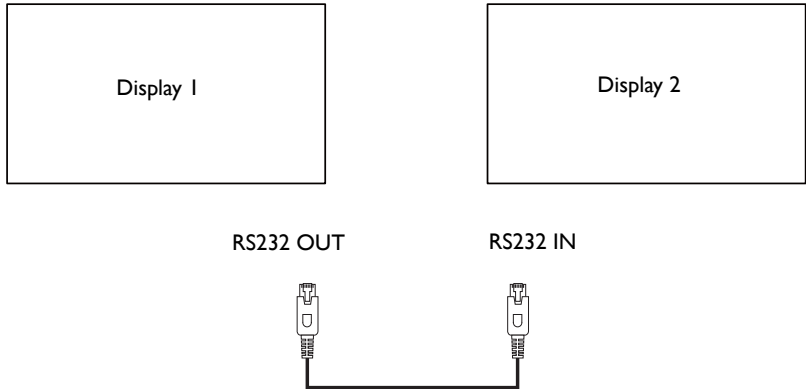

External IR receiver

Connect the IR receiver to the RS232 IN of the display for IR control.

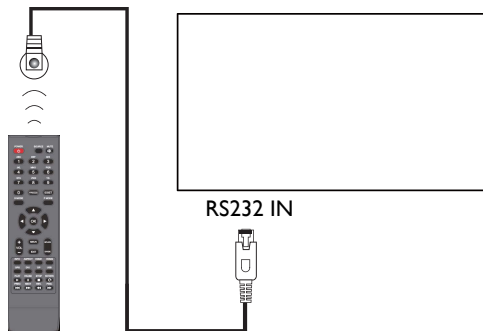

Configuration and calibration tool control

RS232

- Connect the RJ45 - RS232 cable to the RS232 - USB cable with computer for RS232 control.
- Make sure the dip switch is in RS232.

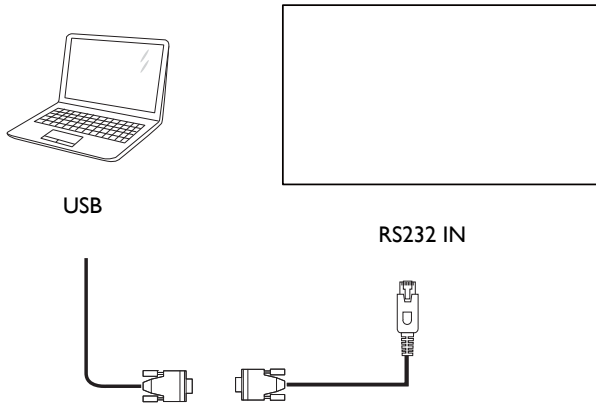

LAN

- Connect the LAN cable from the display LAN port to a router.
- Make sure the dip switch is in LAN.
- Connect the computer to the router via the LAN cable or wireless link.

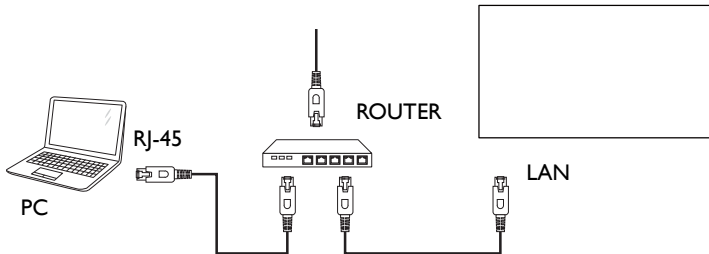

Video In connection

- Connect the DVI out of Display 1 to the DVI in of Display 2. DVI daisy chain supports up to 12 displays without splitter.

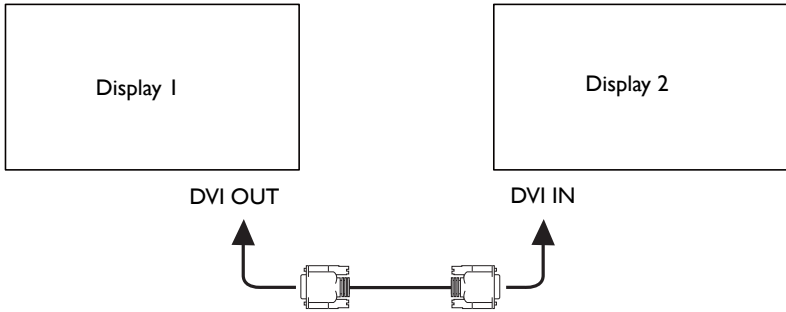

- DVI daisy chain supports DVI/HDMI 2/DP source in.

DVI IN

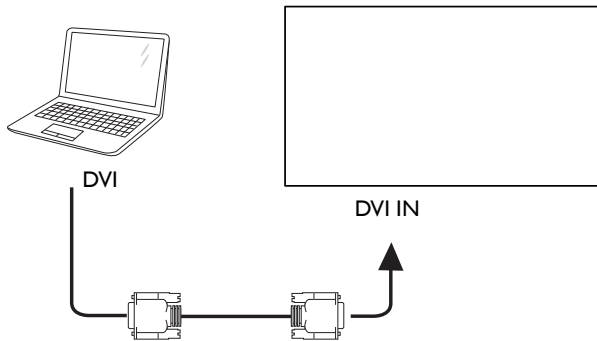

DP IN

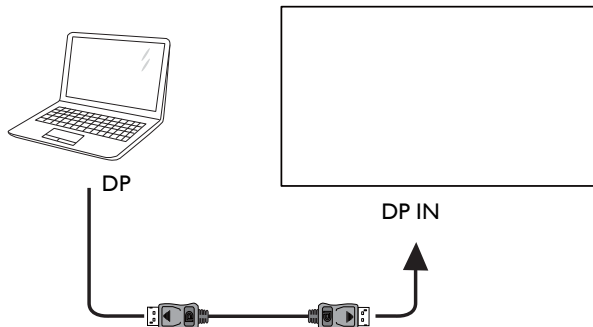

HDMI 2 IN



HDMI

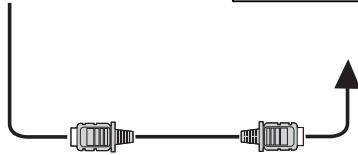

HDMI2 IN

HDMI 1 does not support DVI daisy chain.

Connecting the multimedia inputs

To view multimedia files on the USB flash drive, plug the USB flash drive in the **USB** port.

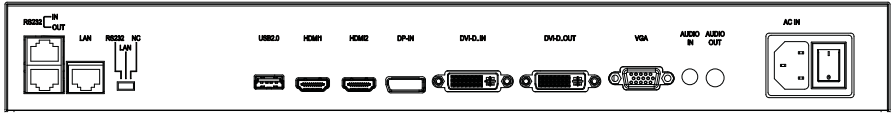

USB flash drive



USB 2.0 standard spec is 0.5A.

Connecting power

Plug one end of the power cord into the **Power** jack on the display and the other end into an appropriate power outlet (if the outlet is switched, turn on the switch).

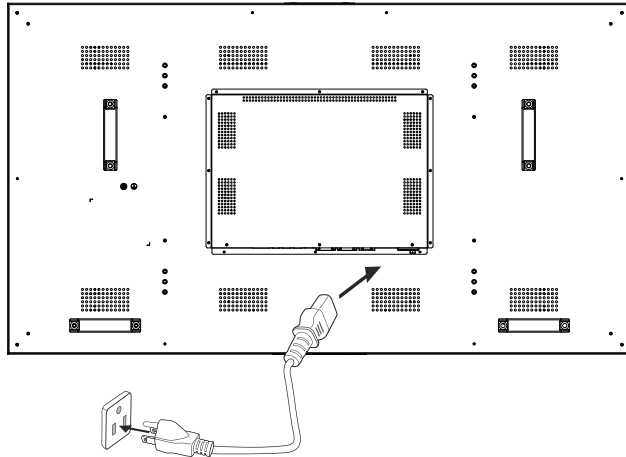

- The supplied power cord is suitable for use with 100-240V AC power only.
- The power cord and outlet illustrated may differ from the ones used in your region.
- Only use an appropriate power cord for your region. Never use a power cord which appears damaged or frayed, or change the plug type on the power cord.
- Be aware of the power loading when you use extension cords or multiple outlet power boards.
- There are no user serviceable parts in this display. Never unscrew or remove any covers. There are dangerous voltages inside the display. Turn off the power and unplug the power cord if you intend to move the display.

Basic operations

Turning the display on or off

1. Be sure to follow the instruction of [Connecting power on page 21](#).
2. Before turning on the display, make sure the Power switch is set to ON. The system will enter standby mode.

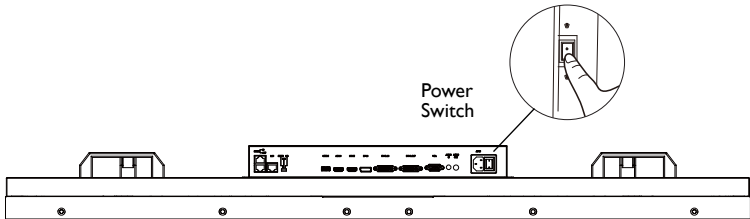

The display's standby mode still consumes power. To completely cut off power supply, set the Power switch to OFF (O) and then disconnect the power cord from the power outlet.

Operations in the OSD menu

Using the remote control

1. Press **MENU** to open the OSD menu.



2. Press **▲** and **▼** to select a feature and press **◀** or **▶** to adjust settings. Press **OK** to confirm changes.



3. Press **EXIT** to close the OSD menu.



Software update procedure

1. Save the updated file to the USB root folder.
2. Change the file name to "Merge.bin".
3. Insert the USB, and go to **OSD setting > Device setup**, click **Software update** to initiate update procedure.

OSD Setting

Picture

Menu	Description
Picture mode	<ul style="list-style-type: none"> • Press ◀ / ▶ on the remote control to select a picture mode. Options are Standard, Bright, Soft, and Custom. • Under Custom mode, press ◀ / ▶ on the remote control to adjust Contrast, Brightness, Hue, Sharpness, and Saturation.
Color temperature	<ul style="list-style-type: none"> • Press ◀ / ▶ on the remote control to select a preset color temperature for the image. Options are Standard, Warm, Cool or Custom. • Choose Custom to adjust RGB.
Aspect ratio	Press ◀ / ▶ on the remote control to select an aspect ratio. Options are 16:9 or 4:3 .
Backlight	Adjust brightness level from 0-100.
Color range	<ul style="list-style-type: none"> • Full stands for 0-255 RGB color. • Limit stands for 16-235 RGB color.
Anti-burn in	Switch on to display a defaulted photo every 6 hours and prevent burn-in from fixed picture content.
Gamma	Choose preferred Gamma value for the video wall. The value range is 2.0/2.2/2.4.

Sound

Menu	Description
Sound mode	<ul style="list-style-type: none"> • Choose a preset sound environment. Options are Standard, Music, Cinema, Sports, or Custom mode. • Under Custom mode, press ◀ / ▶ on the remote control to adjust sound related parameters.
Balance	Press ◀ / ▶ on the remote control to adjust Balance .
Surround sound	Enable/disable the surround sound.
Bass	Adjust the bass level from 0-100.
Treble	Adjust the treble level from 0-100.

Device Setup

Menu	Description
OSD language	English/French/Spanish/Portuguese/Italian/German/Russian/Chinese
Menu transparency	Adjust transparency level. Options are 0/25/50/75/100%.
Menu timeout	Adjust menu timeout period. Options are 5/15/30/45/60 seconds.
Software update	Click to initiate the update procedure.
Restore default settings	Set the video wall back to the default setting.
Restore default settings	Select black/blue back ground color for the display while there is no input source.
Power saving mode	<ul style="list-style-type: none"> • Low: Turn off backlight after 5 minutes. • High: Shut down the power after 5 minutes. • Off: Disable the power saving mode.
Power on mode	<ul style="list-style-type: none"> • On: Automatically power on after connecting to the outlet. • Off: Remain shut down after connecting to the outlet. • Last power status: Restore users to their previous operation status automatically after connecting to the outlet.
RS232ID	Check RS232 ID for control purpose.

Video wall

Menu	Description				
Wall settings	<ul style="list-style-type: none"> • Check the unit ID for the current position. Below is an example of 2 x 2 unit ID illustration. • Define the current position and total units of video wall. e.g. H-position: 1, V-position: 1, indicates the upper-left (unit ID 1) display. H total units: 2, V total units: 2, indicates a 2 x 2 video wall. H monitors <div style="display: flex; align-items: center; margin: 10px 0;"> <div style="margin-right: 10px;">V monitors</div> <table border="1" style="border-collapse: collapse; text-align: center; width: 150px; height: 100px;"> <tr> <td style="width: 50px; height: 50px;">1</td> <td style="width: 50px; height: 50px;">2</td> </tr> <tr> <td style="width: 50px; height: 50px;">3</td> <td style="width: 50px; height: 50px;">4</td> </tr> </table> <div style="margin-left: 10px;">Position</div> </div> <ul style="list-style-type: none"> • Enable/disable the video wall mode. On: switch display content to its corresponding position in video wall. Off: switch to single display. 	1	2	3	4
1	2				
3	4				

Bezel compensation	Select ON to initiate compensation.
Panel settings	Change power on logo procedure: 1. Save the picture to the USB root folder. The resolution must be 1920 × 1080, and the file must be under 100 KB. 2. Insert the USB, then click “Custom logo”.
Scene settings	<ul style="list-style-type: none">• Scene number: Switch between the selected scenes.• Empty/Save: Check if there is a saved or existed scene.• Apply Scene: Click to apply the current scene.

Time

Menu	Description
Time	Enter the corresponding time/date.

Color calibration & video wall setup software

The uniformity in image representation is a vital element in creating a video wall that consists of multiple displays. However, due to factors like component variation and aging, it is inevitable for each display to produce images with slight differences in color and luminance even when related settings are identical among all displays. The color calibration is designed to minimize such differences and enhance the image uniformity of all displays in a video wall application. It works by first measuring and comparing the color characteristics of each display, and then calibrating all displays with a common and optimal setting.

With the color calibration, you can also adjust color settings of each display easily on a host computer. Furthermore, with video wall control function, you can finish all setting on the laptop without switching back to the remote control.

Item		Hardware requirements
Color meter		X-Rite i1D3
System	CPU	Pentium 1GHz
	Storage	400 MB
	OS	Win 7 (32bit / 64bit), Win10 (32bit / 64bit)
	Interface	HDMI/DVI/DP (at least one of them supported)
		USB 2.0 (type A) x 2

Preparation

1. Install the configuration and calibration tool on the laptop.
2. Connect the color meter to the laptop.
3. Connect laptop to video walls (input source).
 - DVI daisy chain supports DVI/HDMI/DP source in.

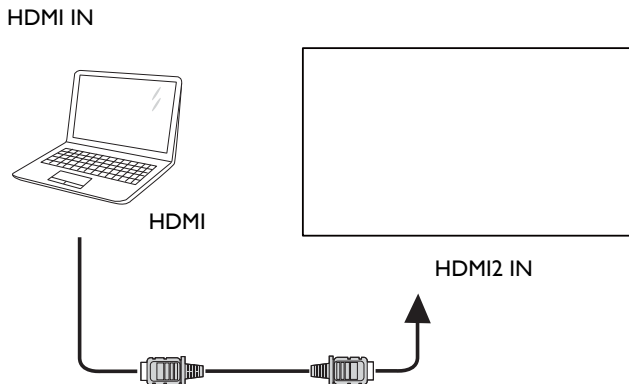

DVI IN

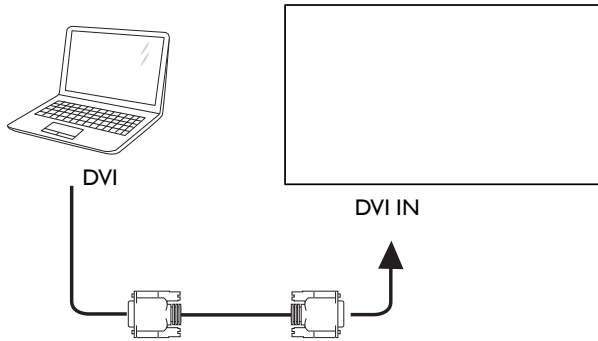

DP IN

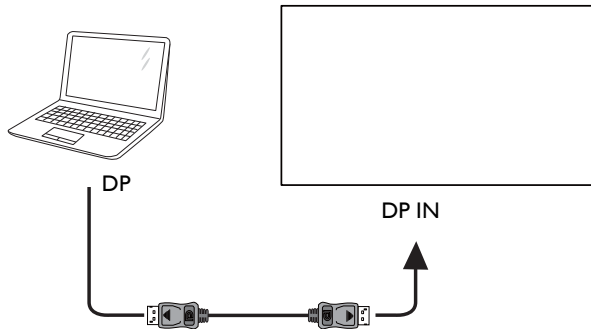

- Connect the DVI out of Display 1 to the DVI in of Display 2. DVI daisy chain supports up to 12 displays without splitter.

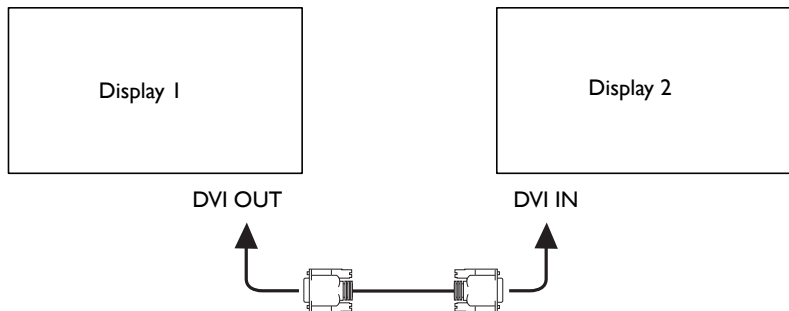

4. Connect laptop to video walls (RS232 link).

- Connect the laptop to the RS232 IN of the first display via RS232-USB cable and RJ45-RS232 cable.

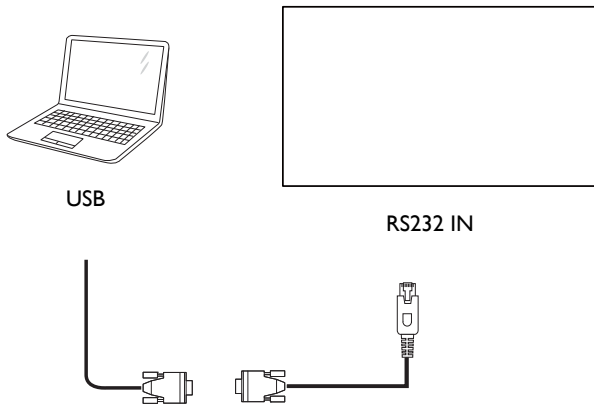

- Make sure the dip switch is in RS232.
- Connect the RS232 OUT of Display 1 to RS232 IN of Display 2 via LAN cable.

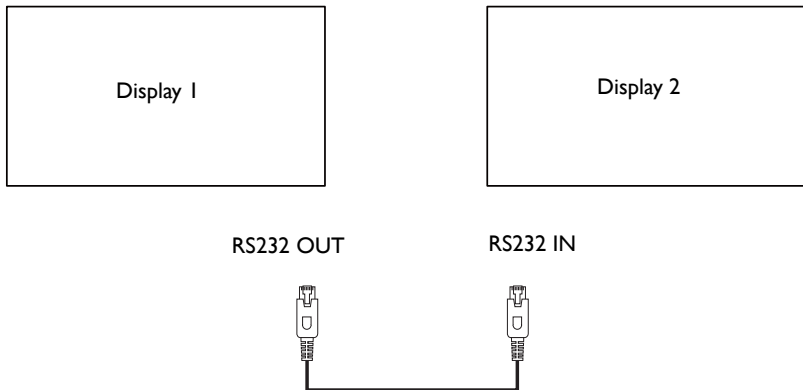

5. Launch the configuration and calibration tool and start color calibration/video wall setup.

Operations- RS232

Link Setup (communication setup)

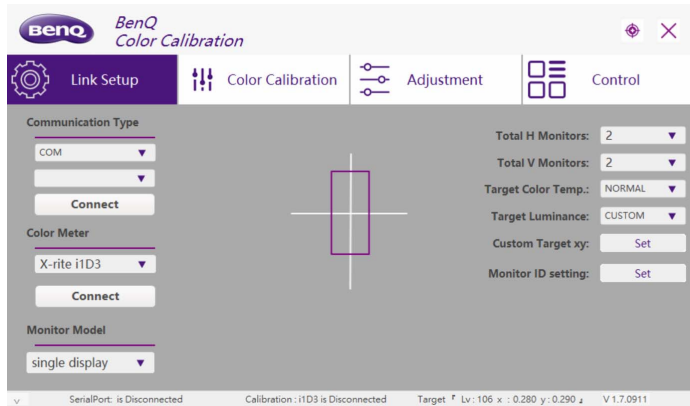

1. Select **COM**, choose the corresponding **COM Port**, then click **Connect**.
2. Plug in i1D3 color meter and click **Connect**.
3. Select single/multiple displays.
4. Enter total units of video wall.
5. Select **Target Color Temp./Target Luminance**; by selecting **CUSTOM**, luminance can be changed in **Custom Target xy**.
6. In **Custom target xy**, users can customize target color temperature. The x mark should be retained within the white rectangular box. Click **OK** to save.
7. In **Monitor ID setting**, follow the steps to match the Unit ID with display.

Color calibration (auto calibration)

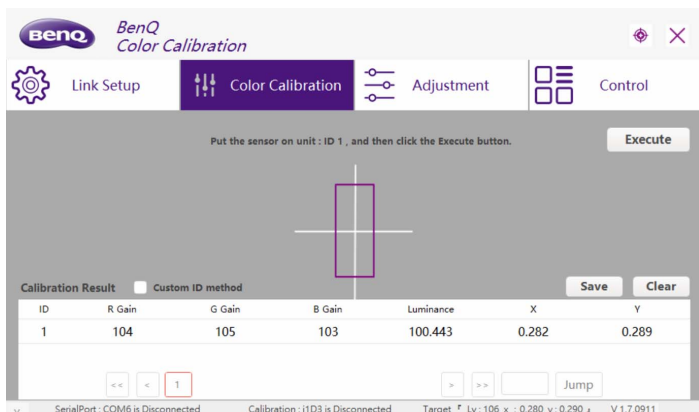

1. Open i1D3 lid, adhere the lens on the center of the monitor with correct Unit ID.
2. Click **Execute** to start calibration.
3. Follow the instructions in the prompt window to measure the second, third ...displays if needed.

- The calibrated parameters will be shown in the table. Click **Save** to store the calibrated parameters into the display.

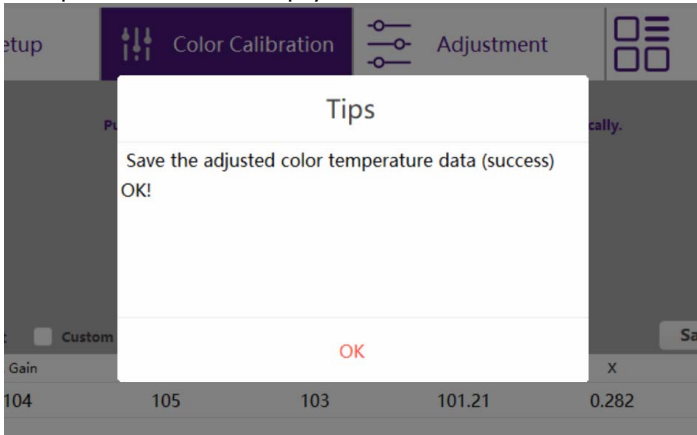

- Follow the instruction to perform calibration at the next display if needed.



If the program window has been moved, click on the bullseye button at the upper-right corner to automatically re-adjust the window back to center.

Adjustment (manual calibration)

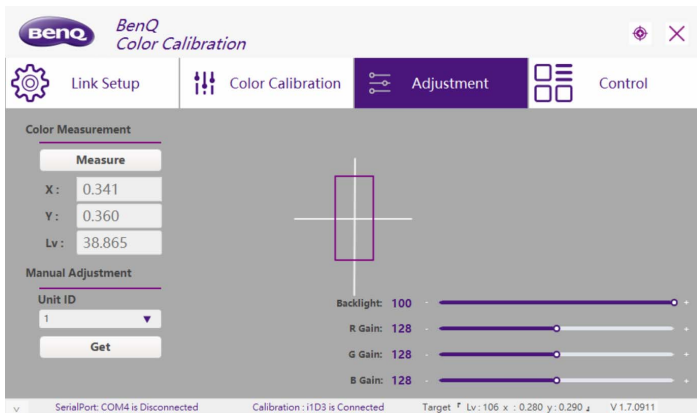

- Place the color meter on the center of the target display, and click **Measure**. Record the X/Y/Lv value as a standard.
- Move the color meter to the next display, select the corresponding “Unit ID” and click **Get**.
- Adjust the backlight and R/G/B gain to match the X/Y/Lv value that is recorded in step 1.
- Repeat the above steps to complete manual calibration.

Control (video wall configuration)

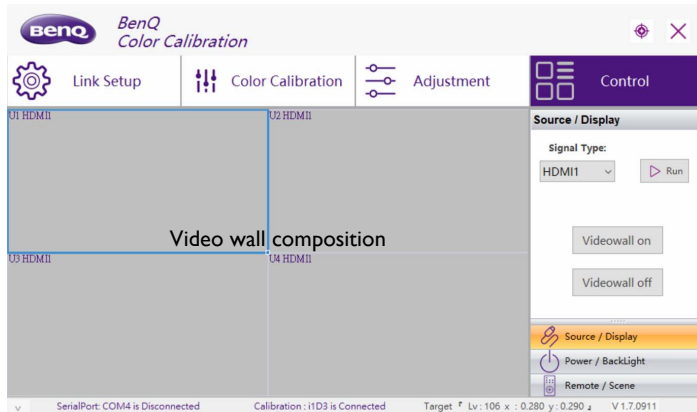

To initiate video wall, circle the target displays, and click **Videowall on**.

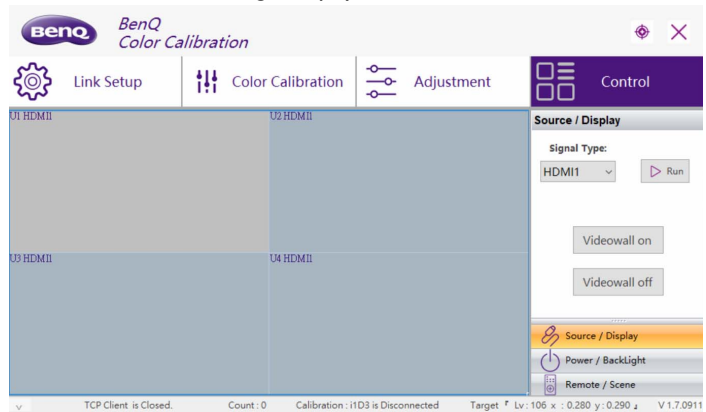

Name	Description
Source/Display	Switch input source, and enable/disable video wall tiling.
Power/Backlight	Turn ON/OFF the backlight and main power.

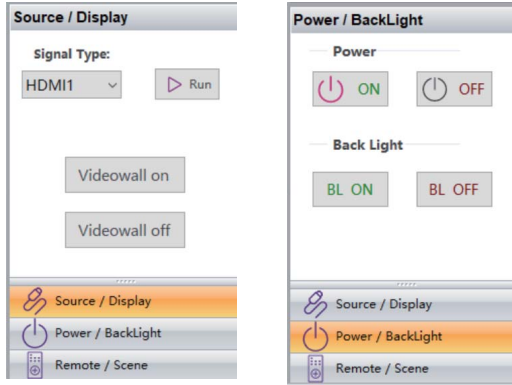

Name	Description
Remote/Scene	Edit/save video wall scene and call virtual remote control.

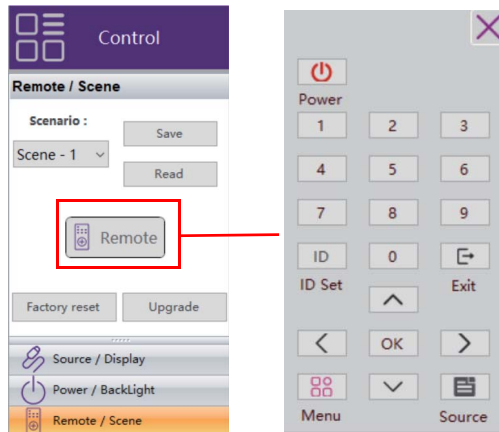

Operations- LAN Link Setup (communication setup)

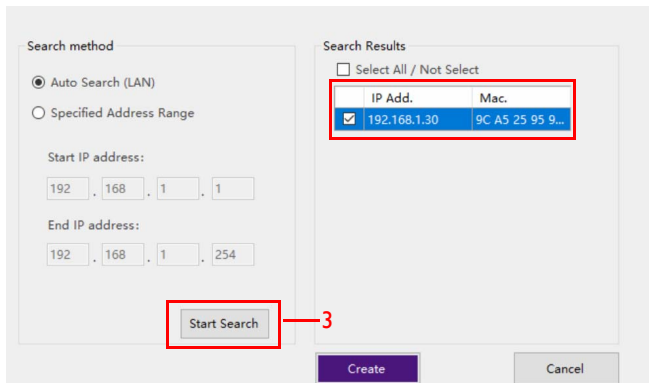
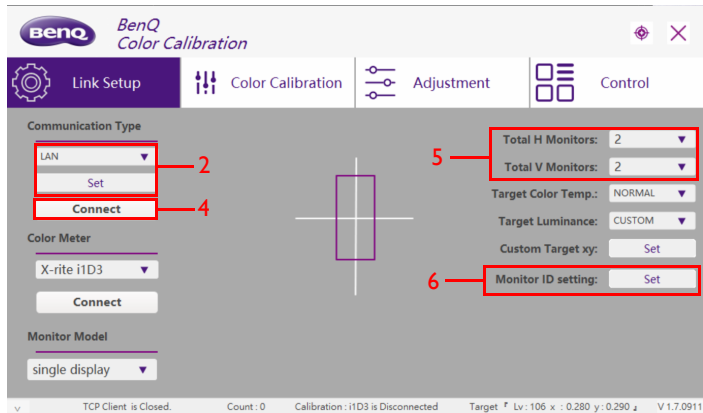

1. Follow the configuration and calibration tool control Connection. Refer to [LAN on page 18](#) for more information.
2. Select LAN, then click **Set**. A search window will pop out.
3. Click **Start Search** to scan display in the network. Check the box, and click **Create**.
4. Click **Connect** to start LAN connection.
5. Enter total units of video wall.
6. In **Monitor ID setting**, follow the steps to match the Unit ID with display.
7. Refer to [Control \(video wall configuration\) on page 31](#) to start video wall control and setup.

Troubleshooting

If you encounter problems during calibration, please refer to the following troubleshooting tips to try to solve the problems by yourself. If the problem persists, please contact BenQ Customer Support for help.

Problem	Solution
Cannot connect to the display(s)	Check the following: <ul style="list-style-type: none"> • Check the cable connection. Is the display correctly connected to the computer? • Check if the RS232 cable can be detected in Win "Device Manager". If not, install the driver for RS232 cable. • Is the display turned on? • Is the COM port setting in Settings?
Calibration incomplete	Check the display's ID setting. When calibrating multiple displays, each display must be given an unique ID for the Color Calibration to identify correctly.
Error or fail message appears	Please identify the following items <ul style="list-style-type: none"> • Identify correct connection between color meter and PC • Never connect multiple color meters simultaneously

Product information

Specifications

Item		Specifications
		PL4901/PL5501/PL5502
LCD panel	Backlight	D-LED
	Panel size	PL4901: 49", PL5501/PL5502: 55"
	Pixel pitch (mm)	PL4901: 0.5595(H) x 0.5595(V) PL5501/PL5502: 0.630(H) x 0.630(V)
	Frame Rate	60 Hz
	Native resolution (pixels)	FHD 1920 x 1080
	Active Area (mm)	PL4901: 1074.2×604.3 PL5501: 1209.4×680.4 PL5502: 1209.6×680.3
	Brightness (cd/m ²) (typical)	500 nits
	Contrast (typical)	1200:1
	Response time (ms) (typical)	8
	Panel Bit (8 or 10)	10 bit
	Aspect Ratio	16:9
Input	Video	VGA×1, DVI×1, HDMI 1(2.0)×1, HDMI 2(1.4)×1, DP×1
	Audio	Audio input×1 (3.5mm)
	USB (Type A)	×1 (2.0)
	Control	RS232×1, LAN×1 (command only)
Output	Video	DVI×1
	Audio	Audio output (L/R, RCA)×1
	External speaker out (L/R)	X
	Command/IR	RS232 out×1
Audio	Audio W (Amp)	8W×2
	Internal speaker	○
Power	Supply	100 - 240 V AC, 50/60 Hz
	Maximum (Watt)	PL4901: 160W, PL5501: 210W, PL5502: 245W
	Typical (Watt)	PL4901: 150W, PL5501: 195W, PL5502: 225W
	Consumption Standby	≤ 0.5W

Environment	Operating Temperature	0°C ~ 40°C
	Operating Humidity	20% ~ 80% RH Non-Condensing (without condensation)
	Storage Temperature	-20°C ~ 60°C
	Storage Humidity	10% ~ 90% RH Non-Condensing (without condensation)
	Display Orientation	Landscape / Portrait
Mechanical	Weight (without packing / with packing) (kg)	PL4901: 23.6/35.8 PL5501: 28.1/39.0, PL5502: 23.5/35.5
	Dimensions (W x H x D) (mm)	PL4901: 1078.4×608.5×117.4 PL5501: 1213.5×684.3×122.9 PL5502: 1210.5×681.2×121.1
	Bezel Dimension - T/B/L/ R (mm)	PL4901: 2.5/1.0/2.5/1.0 PL5501: 2.3/1.2/2.3/1.2 PL5502: 0.44/0.44/0.44/0.44
Feature	Image setting	○
	Source / Volume Control	○
	DVI Daisy Chain	Max 12 without splitter
	RS232 Control Daisy Chain	○
	ID Setting	○
	Sharpness enhancement	○
	Internal Temperature Sensor	○
	10-bit color processing	○
	Device Management Solution (DMS)	○
	HDMI-HDCP	1.4
	Color Calibration SW	○
	CEC Control	○
	FW Update	USB
RTC Function	○	



Specifications and functions are subject to change without notice.

USB device compatibility

	Format	Container	Resolution/Bitrate
Video	MPEG2/MPEG4/ H.264	mpg, avi, mp4, mkv, mov	1920x1080/Up to 10mbps
Image	PNG/JPEG/BMP	png, jpg, bmp	1920x1080
Audio	MP3	.mp3	Up to 48Khz and 320bps

Dimensions PL490I

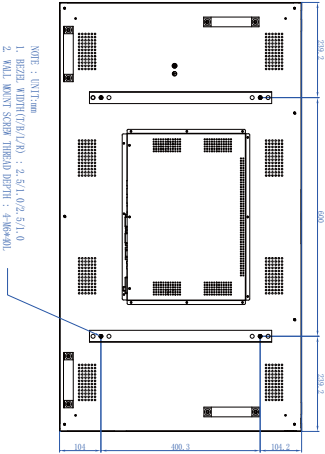
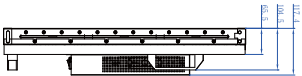
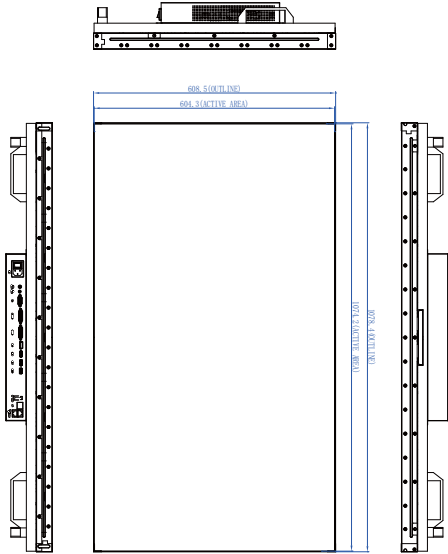

Unit: mm

PL5501

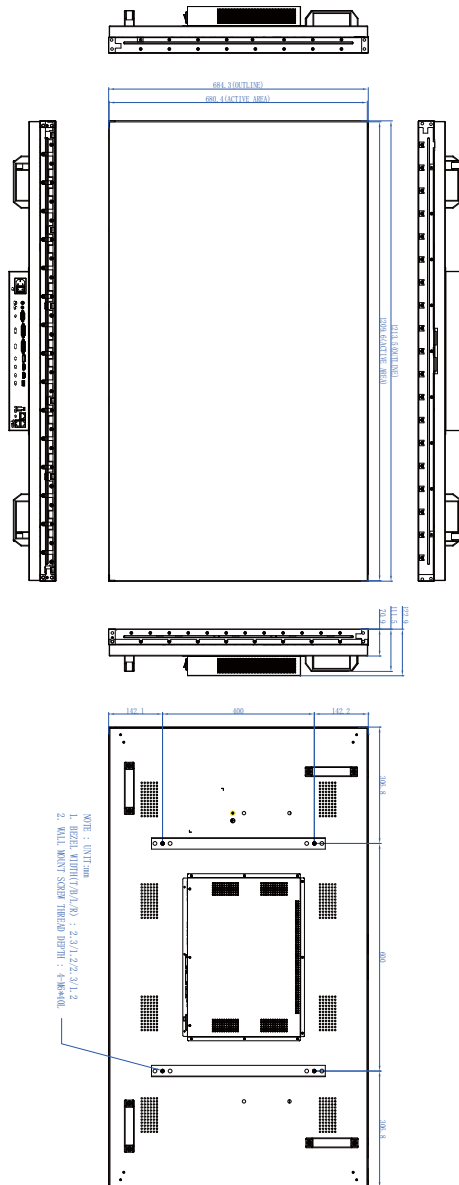

Unit: mm

PL5502

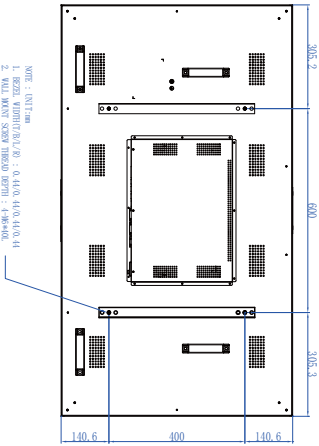
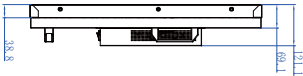
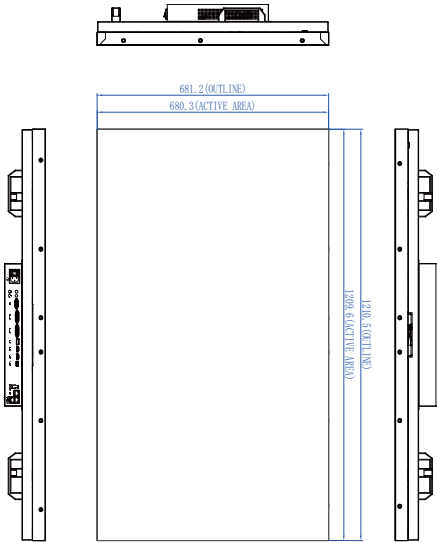

Unit: mm

Supported input signal resolution

Resolution	Input source			
	DVI	VGA	HDMI2.0	DP
640 x 480 @ 60Hz	○	○	○	○
720 x 400 @ 70Hz	○	○	○	○
800 x 600 @ 60Hz	○	○	○	○
1024 x 768 @ 60Hz	○	○	○	○
1280 x 720 @ 60Hz	○	○	○	○
1280 x 768 @ 60Hz				
1280 x 960 @ 60Hz				
1280 x 1024 @ 60Hz	○	○	○	○
1360 x 768 @ 60Hz	○	○	○	○
1366 x 768 @ 60Hz				
1440 x 900 @ 60Hz	○	○	○	○
1680 x 1050 @ 60Hz	○	○	○	○
1920 x 1080 @ 60Hz	○	○	○	○
3840 x 2160 @ 24Hz	○		○	○
3840 x 2160 @ 25Hz	○		○	○
3840 x 2160 @ 30Hz	○		○	○
3840 x 2160 @ 50Hz				
3840 x 2160 @ 60Hz			○ (HDMI1)	
480i (60Hz)			○	
480p (60Hz)			○	
576i (50Hz)			○	
576p (50Hz)			○	
720p (50Hz)			○	
720p (60Hz)			○	
1080i (50Hz)			○	
1080i (60Hz)			○	
1080p (50Hz)			○	



- : supported
- ◌: Blank: not supported