

# G435

SETUP GUIDE

設定指南

设置指南

설치 가이드





ENGLISH . . . . .	3
简体中文 . . . . .	12
繁體中文 . . . . .	21
한국어 . . . . .	30

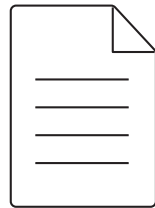
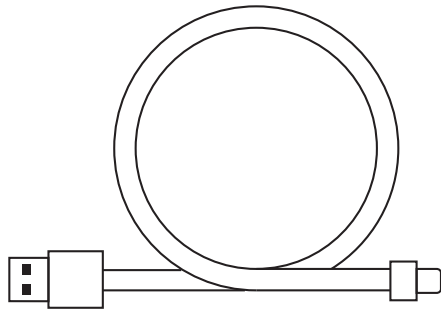
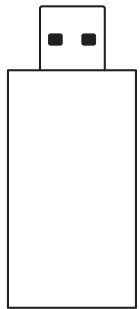

# LIGHTSPEED CONNECTION

Connect to your PC, Mac, PlayStation 5 or 4 with LIGHTSPEED Wireless Technology

– Insert receiver into the USB port of your device.

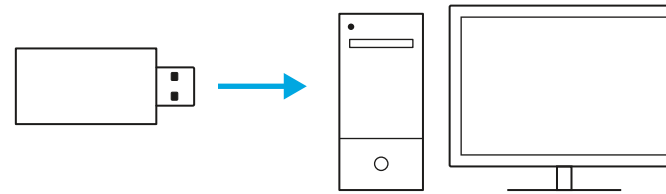

– Press the Power button for minimum 1.5 sec.

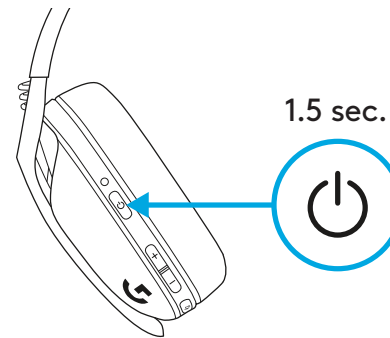

– The LED turns cyan once connected.

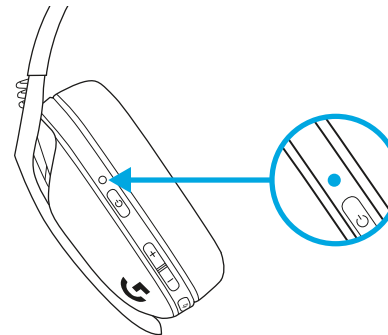

# BLUETOOTH CONNECTION

- Press 3 seconds or longer of the Power and Mute button.

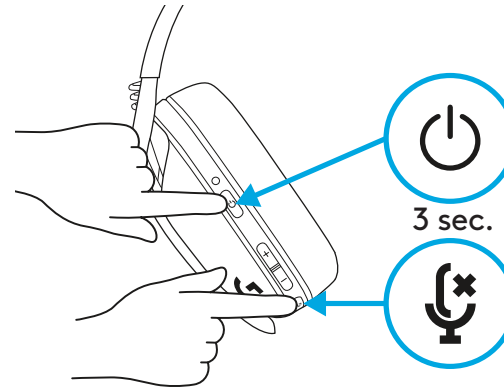

- LED will flash blue as it enters pairing mode.

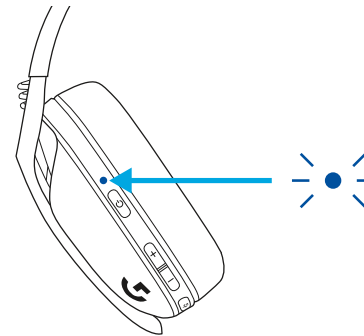

- Connect to your preferred device.

- G435 can connect to a single *bluetooth* device at a time.

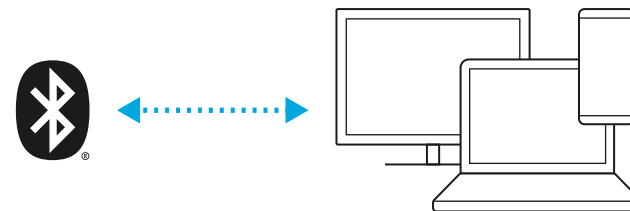

# SWITCH BETWEEN LIGHTSPEED AND BLUETOOTH

- Press 3 seconds or longer of the Mute button.

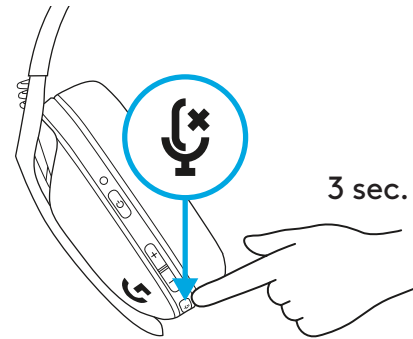

- Switch to LIGHTSPEED, LED will light cyan for 5 seconds.

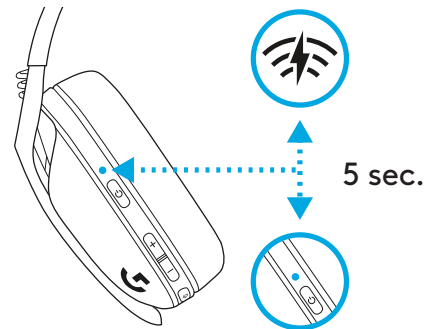

- Switch to Bluetooth, LED will light blue for 5 seconds.

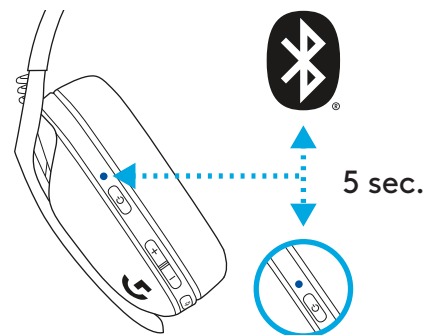

# POWER ON AND OFF

## Power ON

- Press the Power button for 1.5 seconds when the headset is OFF.

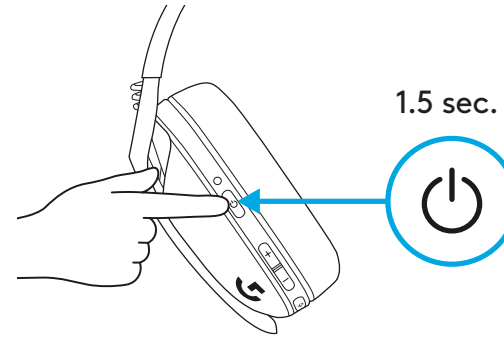

## Power OFF

- Press the Power button for 3 seconds when the headset is ON.

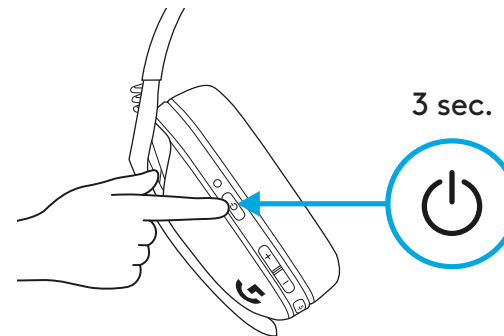

## Auto Shutoff

- After 30 minutes of inactivity.

# MUTE / UNMUTE AND MAX VOLUME

## MUTE / UNMUTE microphone

- Short press on the Mute button.

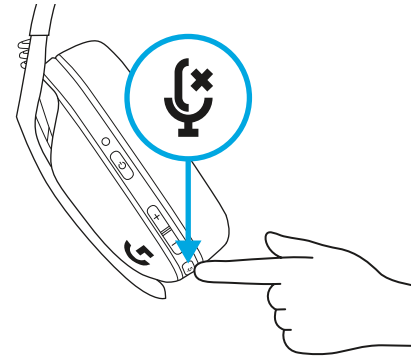

## Set Max Volume

- Set to 100 dB
  - Press 3 seconds or longer Mute button + Volume UP.
  - LED will flash orange 3 times.

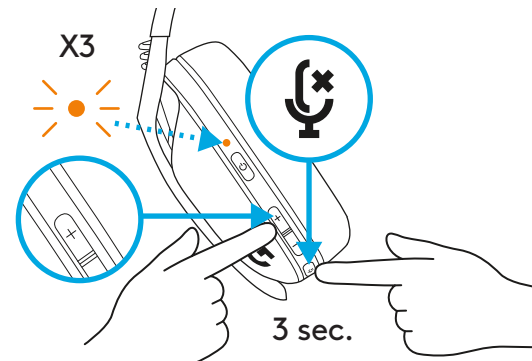

- Set to 85 dB
  - Press 3 seconds or longer Mute button + Volume DOWN.
  - LED will turn solid orange for 5 seconds.

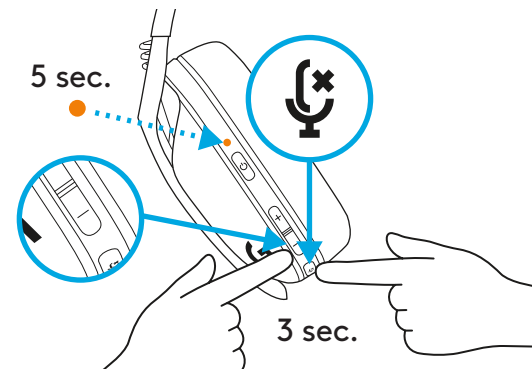

# BATTERY CHECK

- Single press Power button, when headset is ON
  - Battery 31% to 100% the LED will show **green** for 5 seconds.

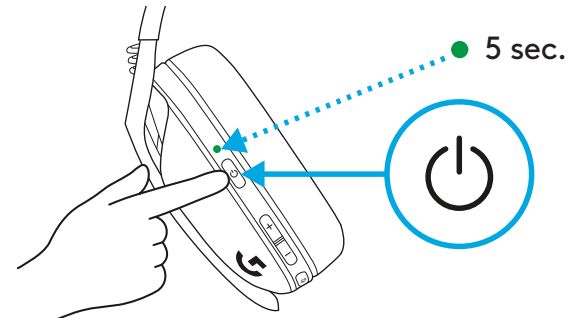

- Battery 15% to 30% the LED will show **red** for 5 seconds.

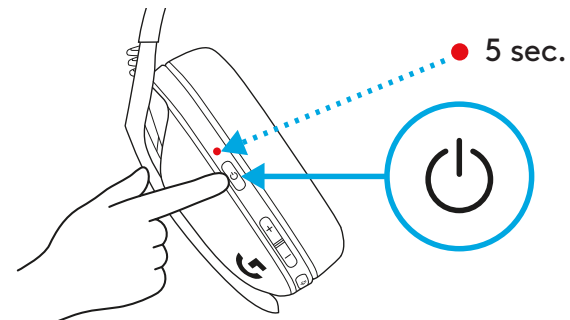

- Battery <15% the LED will flash **red** for 5 seconds.

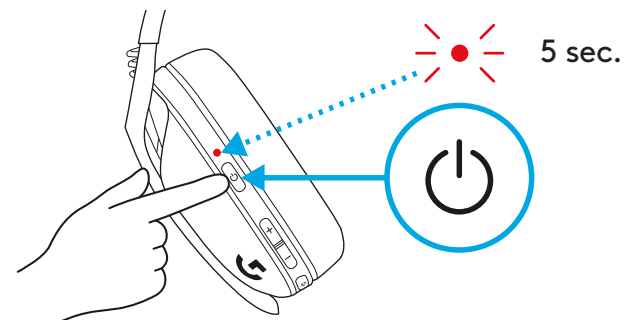



# SIDETONE

Sidetone lets you hear your voice while communicating with other people. It mirrors the experience of talking on a phone and allows you to adjust your speaking volume to a proper level.

- Enable Sidetone
  - Double press the Mute button and the LED will flash twice in **orange**.

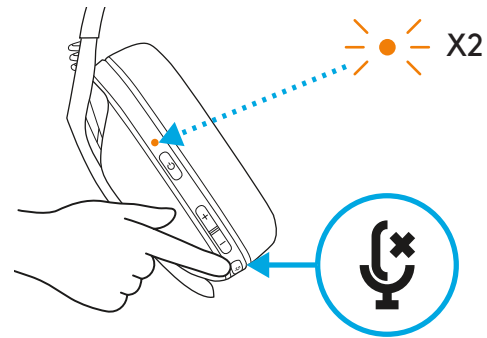

- Disable Sidetone
  - Double press the Mute button and the LED will flash once in **orange**.

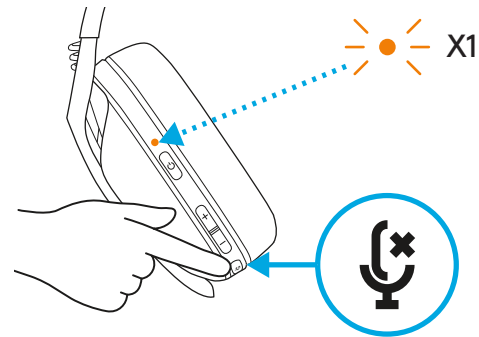

- Adjust Sidetone

- UP = Single press Mute button + Volume UP.

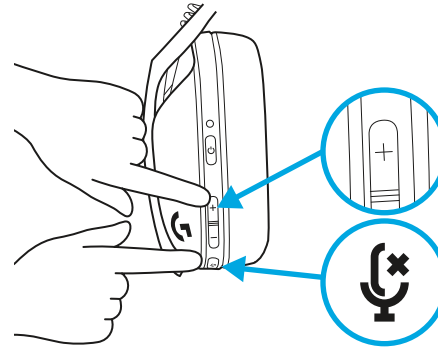

- DOWN = Single press Mute button + Volume DOWN.

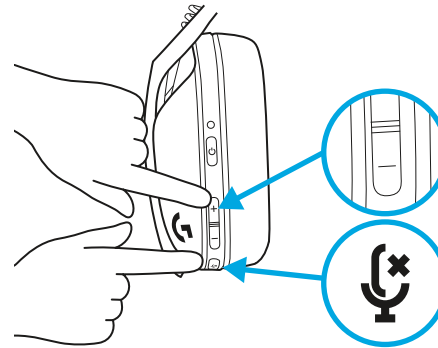

## SPARE PARTS

- Earpads
- Wireless USB Receiver
- Charging Cable

## RECYCLING

We encourage you to resell or donate working products. Otherwise, batteries, electronic and electrical equipment should not be disposed of with household waste. Wherever possible, they should be segregated and brought to an appropriate collection point to enable recycling and avoid potential impacts on the environment and human health. For more information, contact your local authorities or place of purchase, or visit [www.logitech.com/recycling](http://www.logitech.com/recycling)

## QUESTIONS?

[logitechG.com/support/G435](http://logitechG.com/support/G435)

## BATTERY REMOVAL

1

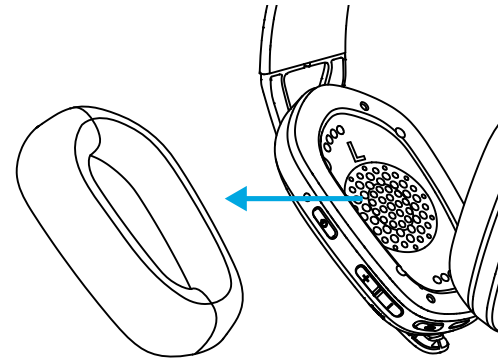

2

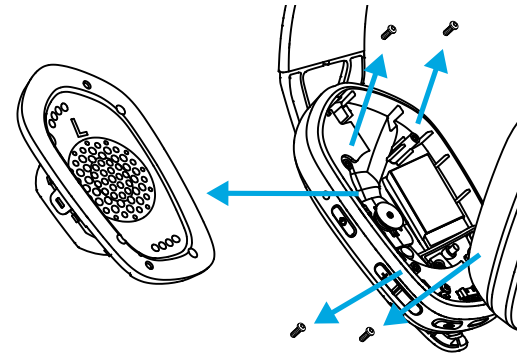

3

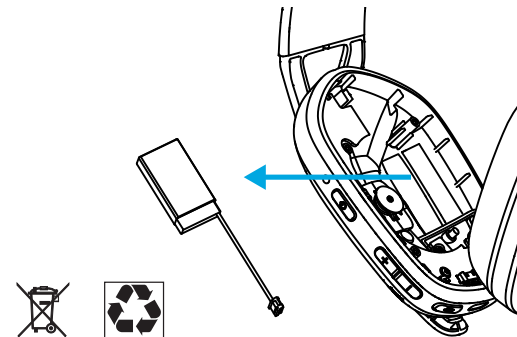

## LIGHTSPEED 连接

通过 LIGHTSPEED 无线技术连接您的 PC、Mac、PlayStation 5 或 4

- 将接收器插入设备的 USB 端口。

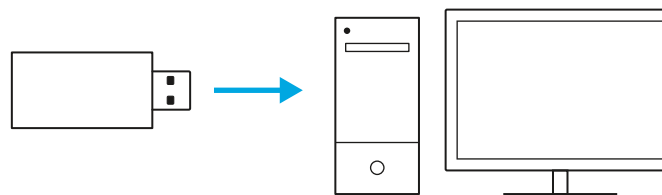

- 按下电源按钮至少 1.5 秒。

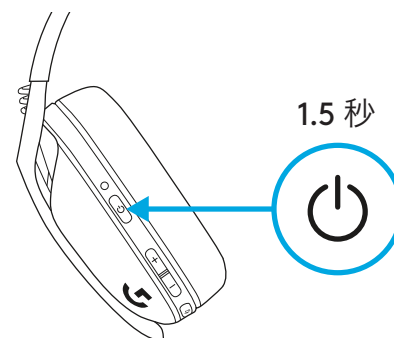

- 连接后, LED 会变为青色。

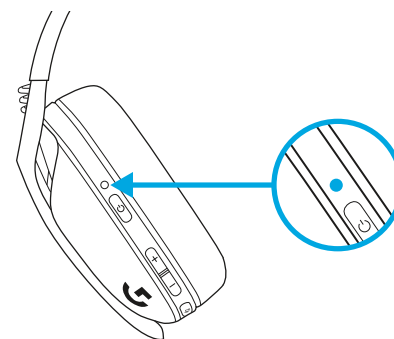

## 蓝牙连接

- 按下电源和静音按钮至少 3 秒。

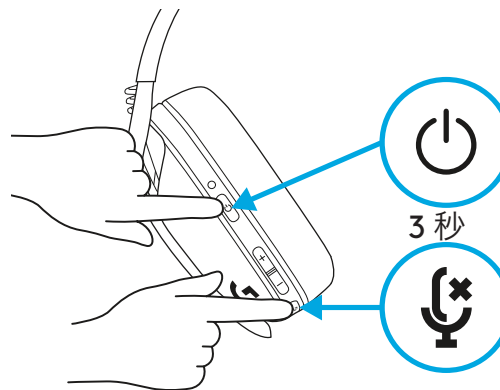

- 进入配对模式后, LED 会闪烁蓝色。

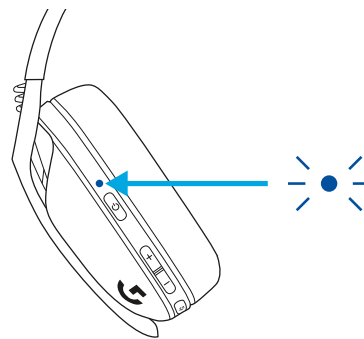

- 连接您的首选设备。

- G435 一次可以连接一个蓝牙设备。

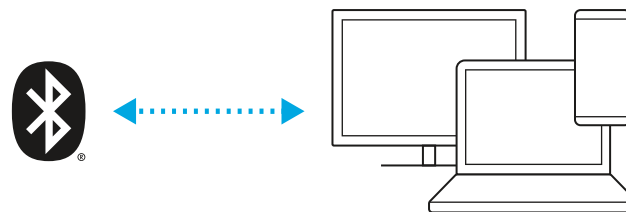

## 在 LIGHTSPEED 和蓝牙之间切换

- 按下静音按钮至少 3 秒。

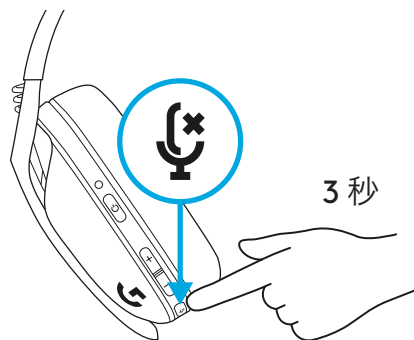

- 切换到 LIGHTSPEED, LED 将亮起青色 5 秒。

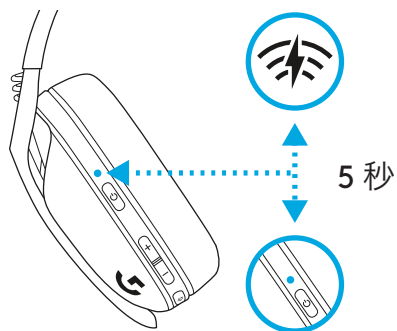

- 切换到蓝牙, LED 会亮起蓝色 5 秒。

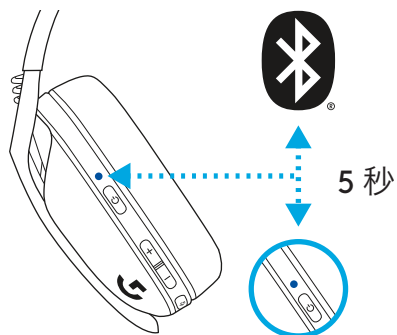

## 开启和关闭电源

### 开启电源

- 耳机麦克风关机状态下, 按住电源按钮 1.5 秒。

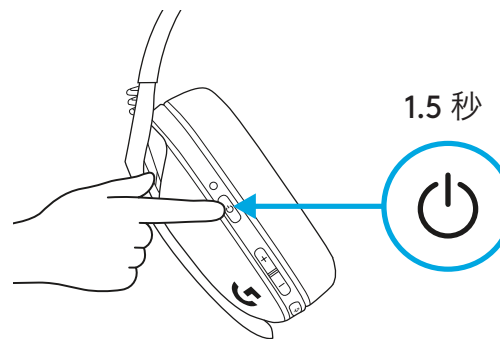

### 关闭电源

- 耳机麦克风开机状态下, 按住电源按钮 3 秒。

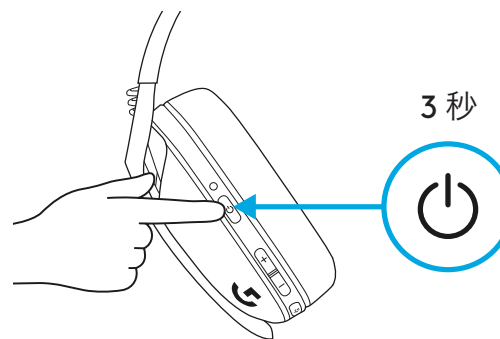

### 自动关机

- 闲置 30 分钟后。

## 静音/取消静音和最大音量

### 麦克风静音控制

- 短按静音按钮。

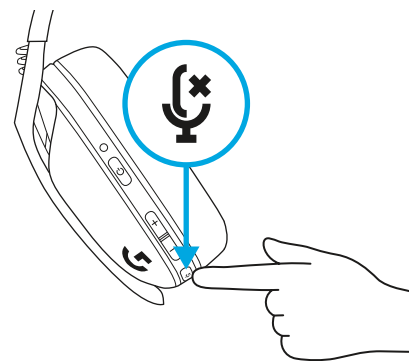

### 设置最大音量

- 设置为 100 dB
  - 按下静音按钮 + 音量上升按钮至少 3 秒。
  - LED 会闪烁橙色 3 次。

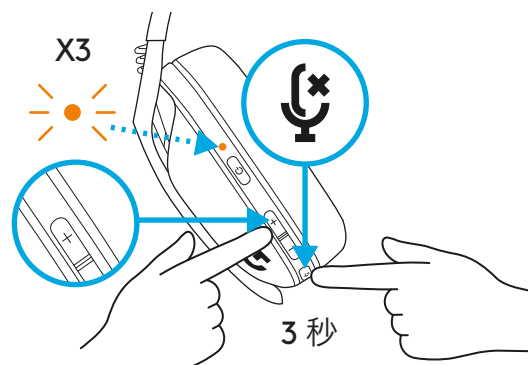

- 设置为 85 dB
  - 按下静音按钮 + 音量下降按钮至少 3 秒。
  - LED 将亮起橙色 5 秒。

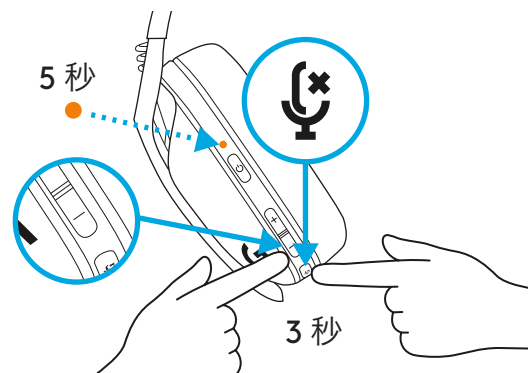



## 电量检查

- 耳机麦克风开机状态下, 按一下电源按钮
  - 电量为 31% 至 100% 时, LED 将亮起绿色 5 秒。

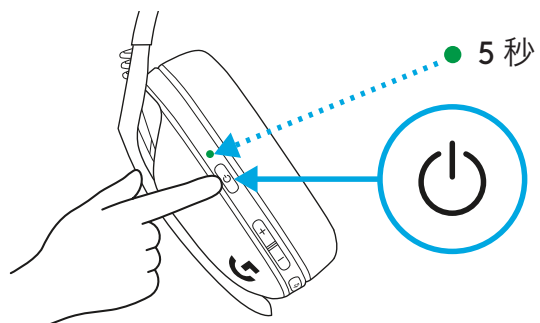

- 电量为 15% 至 30% 时, LED 将亮起红色 5 秒。

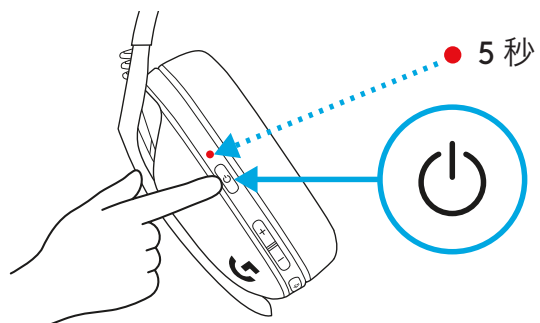

- 电量少于 15% 时, LED 将闪烁红色 5 秒。

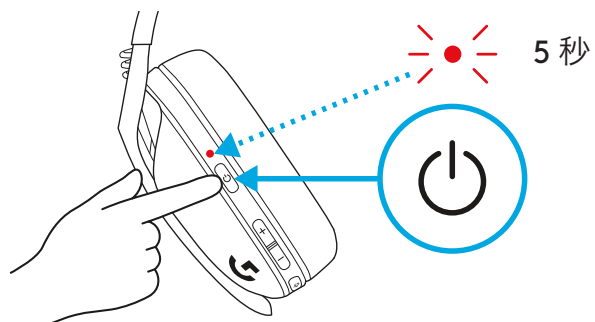

# 侧音

侧音功能让您在与他人交流时可以听到自己的声音。可以实现使用电话进行通话的体验, 并且可以将您的说话声音调节至适当的音量。

## - 启用侧音

- 按两次静音按钮, LED 将闪烁橙色两次。

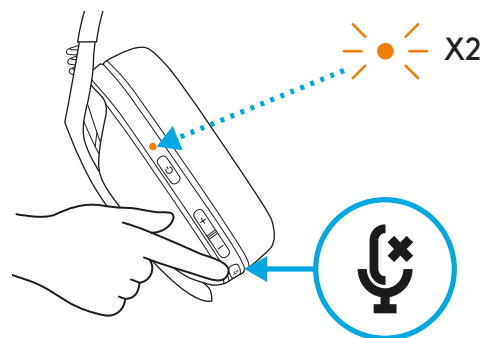

## - 禁用侧音

- 按两次静音按钮, LED 将闪烁橙色一次。

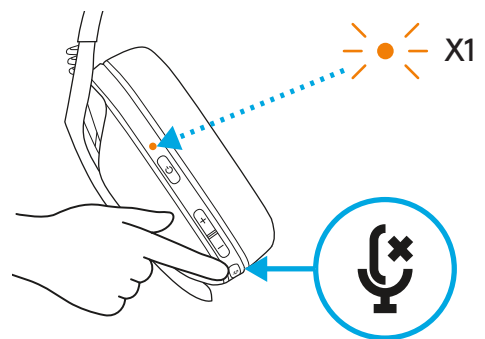

- 调节侧音

- 增加 = 按一下静音按钮 + 音量上升按钮。

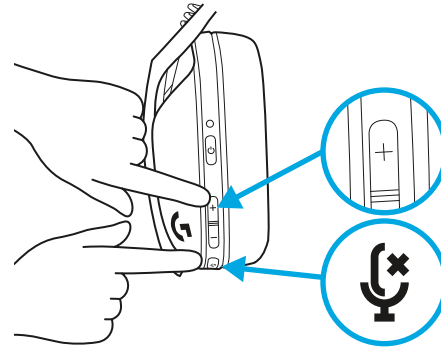

- 减少 = 按一下静音按钮 + 音量下降按钮。

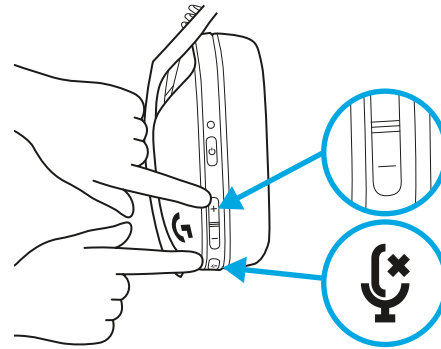

## 备件

- 耳垫
- 无线 USB 接收器
- 充电线缆

## 回收

我们鼓励您转售或捐赠仍可运行的产品。若非如此，电池、电子设备和电气设备不应与生活垃圾一同处理。只要情况允许，应将其隔离并带到适当的收集点，以便回收利用，并避免对环境和人类健康的潜在影响。了解更多信息，请联系当地主管部门或购买地点，或访问 [www.logitech.com/recycling](http://www.logitech.com/recycling)。

## 遇到问题？

[logitechG.com/support/G435](http://logitechG.com/support/G435)

## 电池移除

1

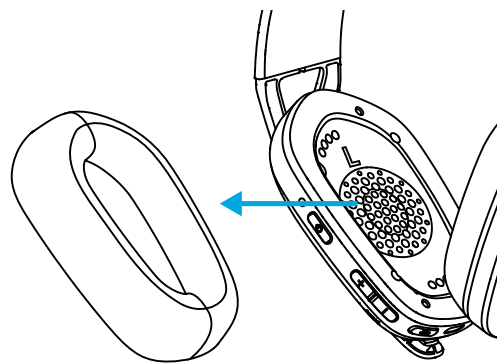

2

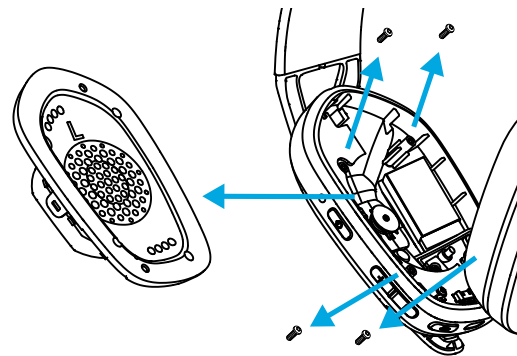

3

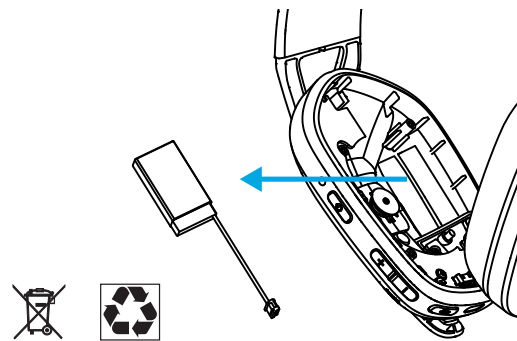

# LIGHTSPEED 連線

利用 LIGHTSPEED 無線技術，連線到您的 PC、Mac、PlayStation 5 或 4。

- 將接收器插入到您裝置的 USB 連接埠。

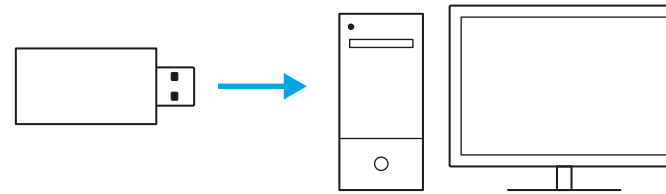

- 按住電源按鈕至少 1.5 秒鐘。

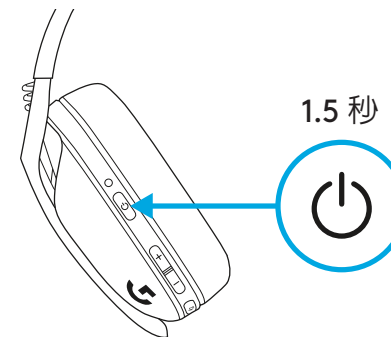

- 連線後，LED 指示燈會亮起青燈。

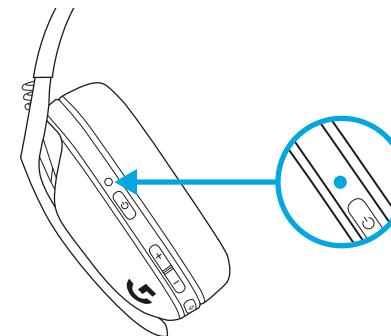

# 藍牙連線

- 按住電源按鈕與靜音按鈕 3 秒或更久時間。

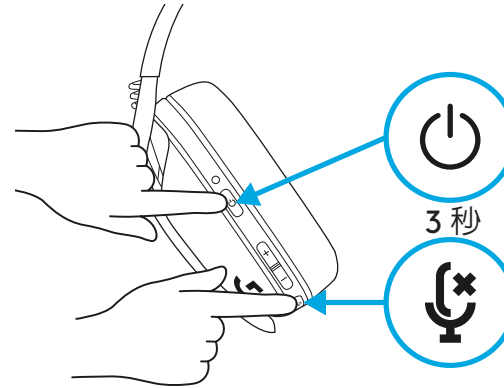

- 當裝置進入配對模式時，LED 指示燈會閃爍藍燈。

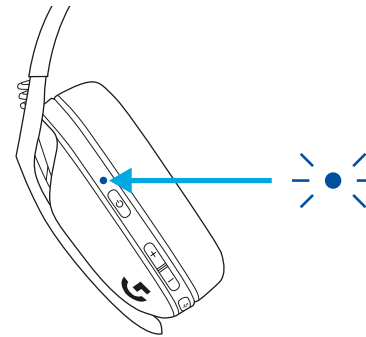

- 連線到您偏好的裝置。

- G435 一次可以連線到一個藍牙裝置。

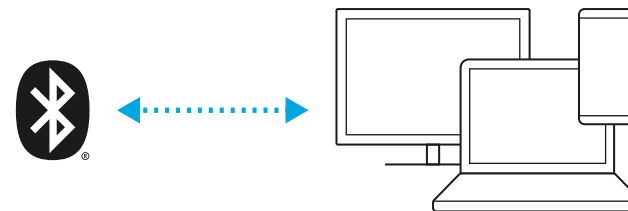

## 在 LIGHTSPEED 和藍牙間切換

- 按住靜音按鈕 3 秒或更久時間。

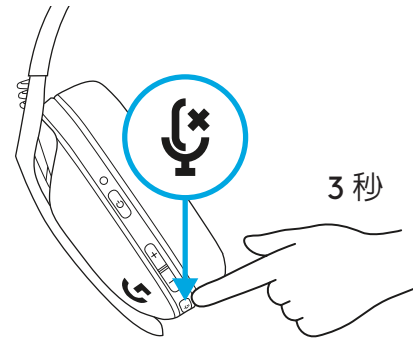

- 切換到 LIGHTSPEED，LED 指示燈會亮起青燈 5 秒。

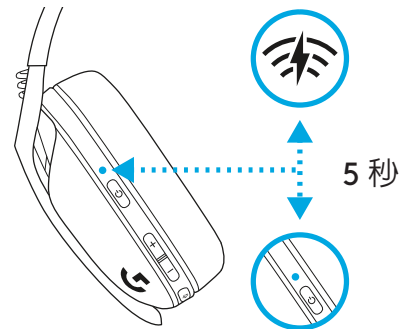

- 切換到藍牙，LED 指示燈會亮起藍燈 5 秒。

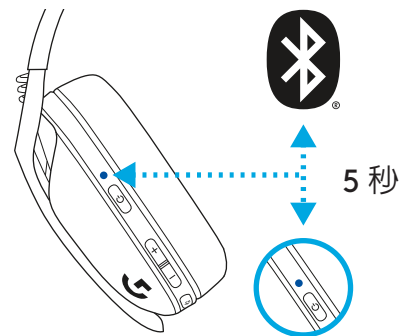

## 電源開啓與關閉

### 開啓電源

- 在耳機麥克風電源關閉時，按下電源按鈕 1.5 秒。

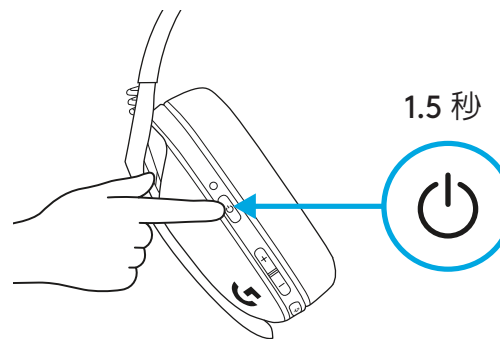

### 關閉電源

- 在耳機麥克風電源開啓時，按下電源按鈕 3 秒。

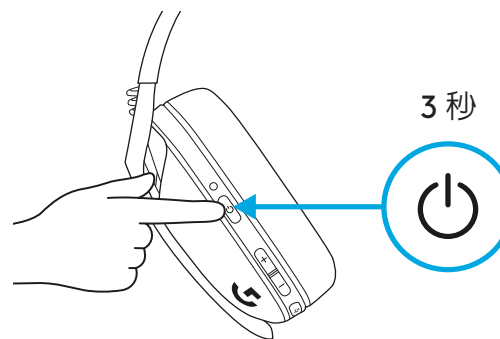

### 自動關機

- 30 分鐘沒有動作後。





## 電池檢查

- 當耳機麥克風電源開啓時，按一下電源按鈕
- 電池電量為 31% 到 100% 時，LED 指示燈會亮起綠燈 5 秒。

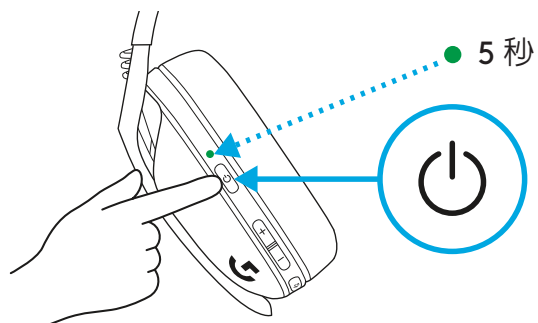

- 電池電量為 15% 到 30% 時，LED 指示燈會亮起紅燈 5 秒。

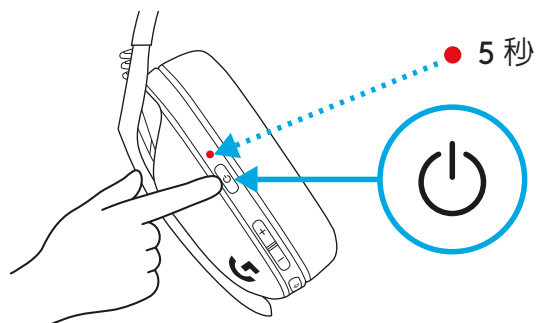

- 電池電量 <15% 時，LED 指示燈會閃爍紅燈 5 秒。

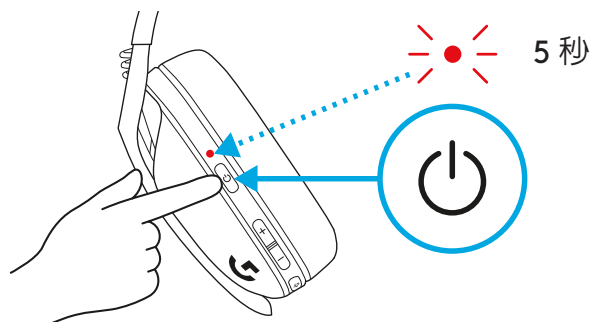

# 側音

側音讓您可以在與其他人通訊時聽到自己的聲音。其可反映通話體驗，讓您可將說話音量調整到適當音量。

## - 啓用側音

- 按兩下靜音按鈕，LED 指示燈會閃爍**橙燈**兩次。

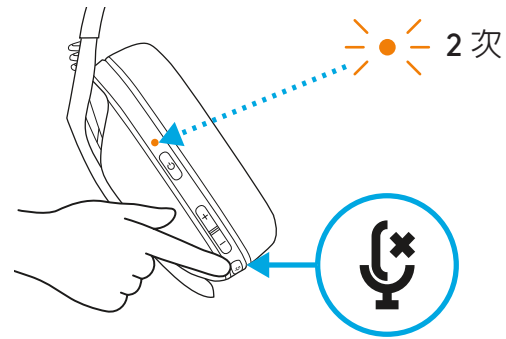

## - 停用側音

- 按兩下靜音按鈕，LED 指示燈會閃爍**橙燈**一次。

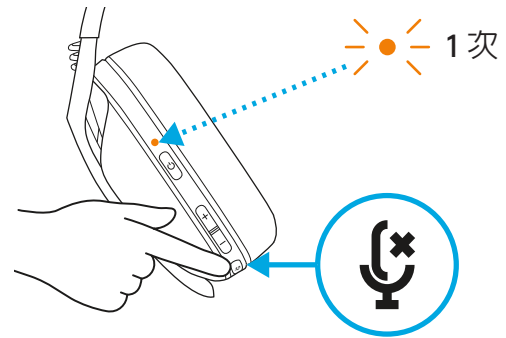

- 調整側音

- 增加 = 按一下靜音按鈕 + 音量增加。

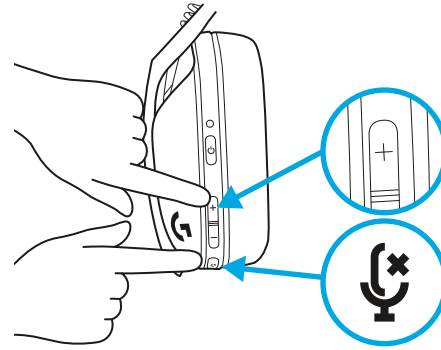

- 減少 = 按一下靜音按鈕 + 音量減少。

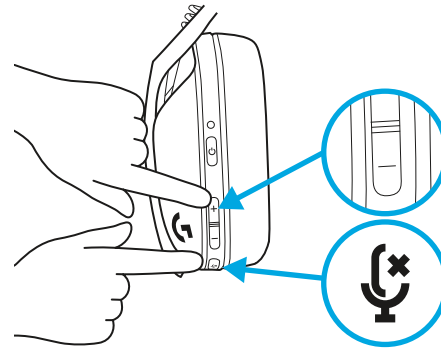

## 備用零件

- 耳墊
- 無線 USB 接收器
- 充電連接線

## 回收

我們鼓勵您轉售或捐贈可用的產品。否則，電池與電子廢棄物不應隨家庭廢棄物棄置。在可能時，應將其區分開並帶到適當的收集點以進行回收，避免可能對環境和人體健康造成潛在影響。如需詳細資訊，請聯繫您當地的機關或購買場所，或是造訪 [www.logitech.com/recycling](http://www.logitech.com/recycling)

## 有問題？

[logitechG.com/support/G435](http://logitechG.com/support/G435)

## 卸除電池

1

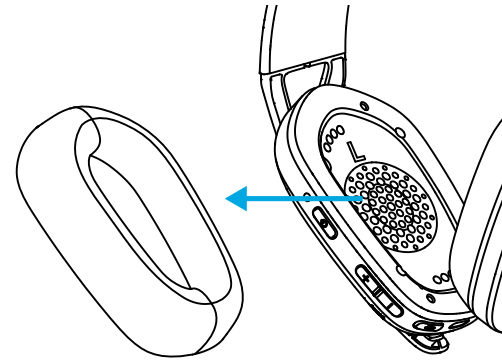

2

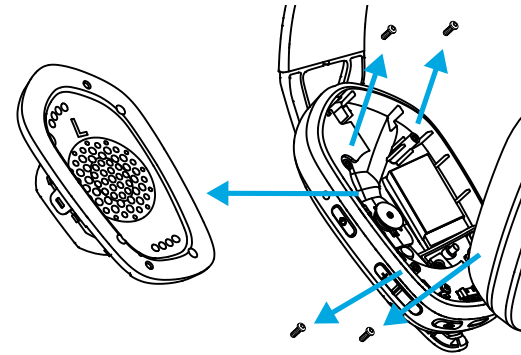

3

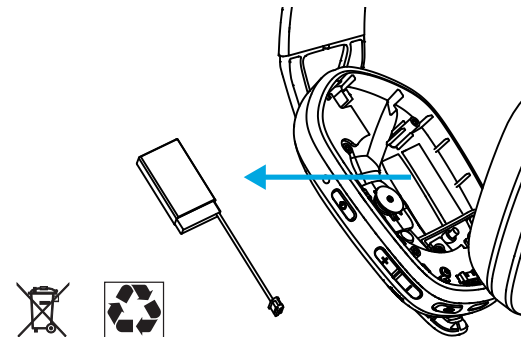

## LIGHTSPEED 연결

LIGHTSPEED 무선 기술로 PC, Mac, PlayStation 5 또는 4에 연결

- 장치의 USB 포트에 수신기를 삽입합니다.

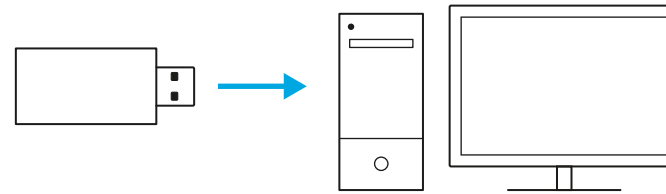

- 전원 버튼을 1.5초 이상 누릅니다.

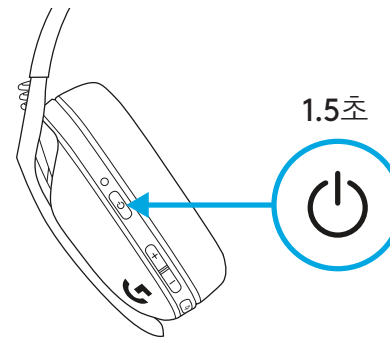

- 연결되면 LED가 **청록색**으로 바뀝니다.

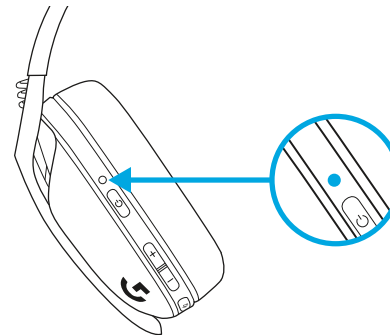

# BLUETOOTH 연결

- 전원 또는 음소거 버튼을 3초 이상 누릅니다.

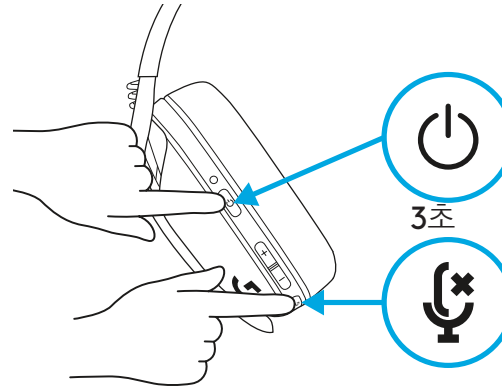

- 페어링 모드에 진입하면 LED가 파란색으로 깜박입니다.

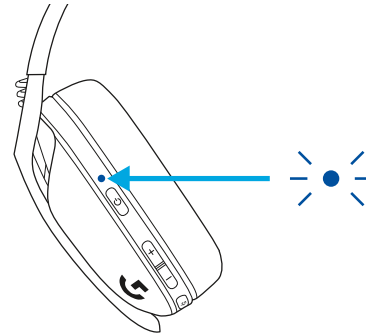

- 원하는 장치를 연결합니다.

- G435는 한 번에 하나의 BLUETOOTH 장치에 연결할 수 있습니다.

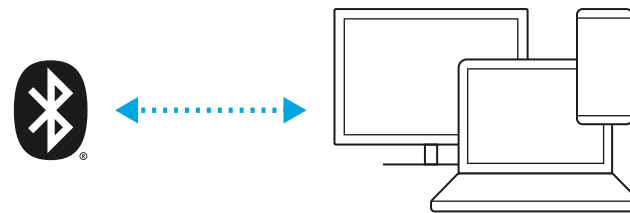

# LIGHTSPEED 및 *BLUETOOTH* 전환

- 음소거 버튼을 3초 이상 누릅니다.

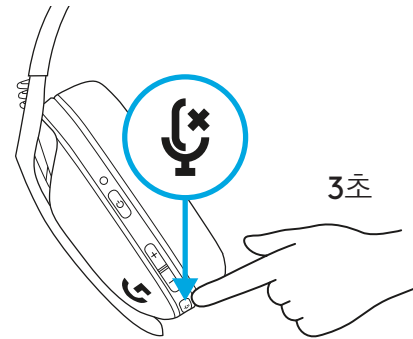

- LIGHTSPEED로 전환하면, 5초 동안 **청록색** LED가 켜집니다.

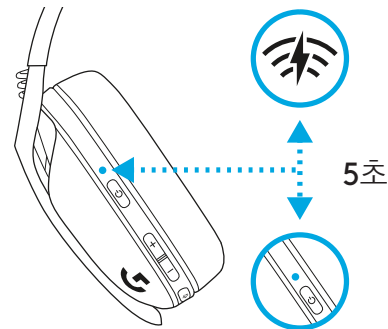

- *BLUETOOTH*로 전환하면, 5초 동안 **파란색** LED가 켜집니다.

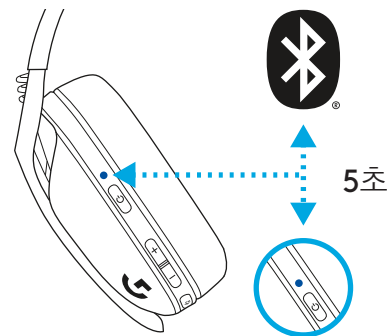



# 전원 켜기 및 끄기

## 전원 켜기

- 헤드셋이 꺼져 있을 때 전원 버튼을 1.5초 동안 누릅니다.

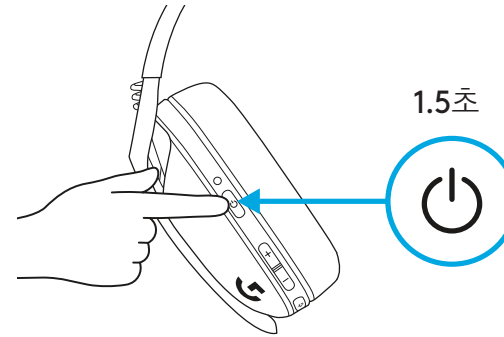

## 전원 끄기

- 헤드셋이 켜져 있을 때 전원 버튼을 3초 동안 누릅니다.

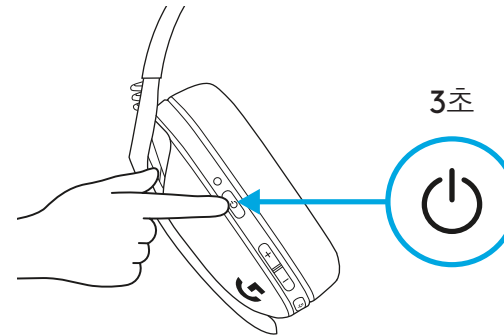

## 전원 종료

- 활동이 없는 시점에서 30분 후.

# 음소거 / 음소거 해제 및 최대 볼륨

## 마이크 음소거 / 음소거 해제

- 음소거 버튼을 짧게 누릅니다.

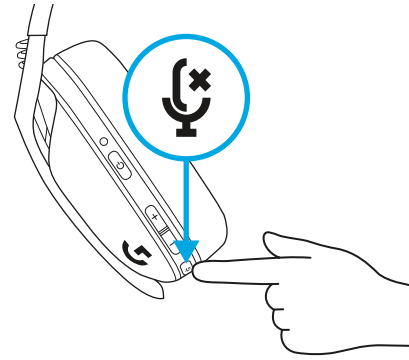

## 최대 볼륨 설정

- 100 dB로 설정
  - 음소거 버튼 + 볼륨 높이기 버튼을 3초 이상 누릅니다.
  - LED가 3번 주황색으로 깜박입니다.

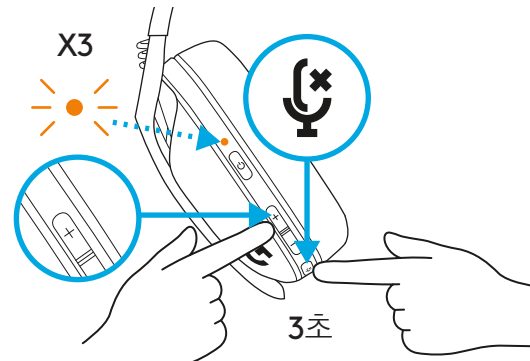

## - 85 dB로 설정

- 음소거 버튼 + 볼륨 낮추기 버튼을 3초 이상 누릅니다.
- LED가 5초 동안 주황색으로 켜집니다.

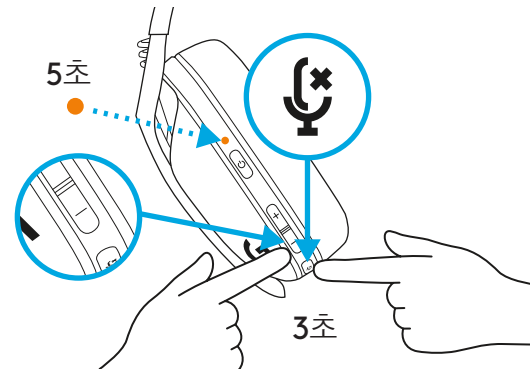

## 배터리 확인

- 헤드셋이 켜져 있을 때, 전원 버튼을 한 번 누릅니다.
- 배터리가 31%~100%인 경우, LED가 5초 동안 **초록색**으로 표시됩니다.

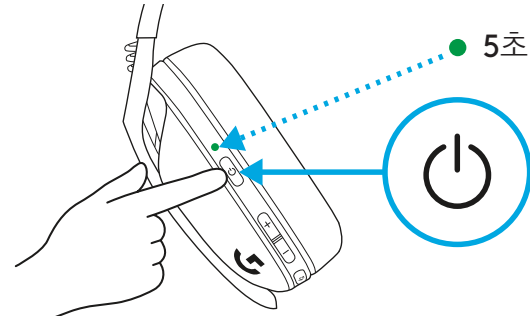

- 배터리가 15~30%인 경우, LED가 5초 동안 **빨간색**으로 표시됩니다.

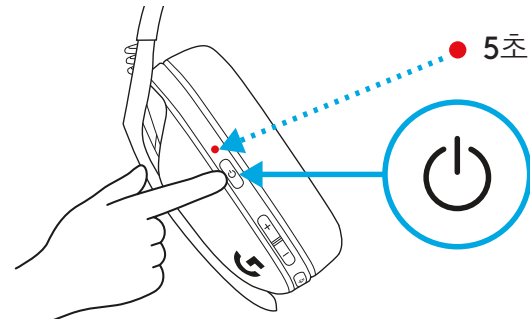

- 배터리가 15% 미만인 경우, LED가 5초 동안 **빨간색**으로 깜박입니다.

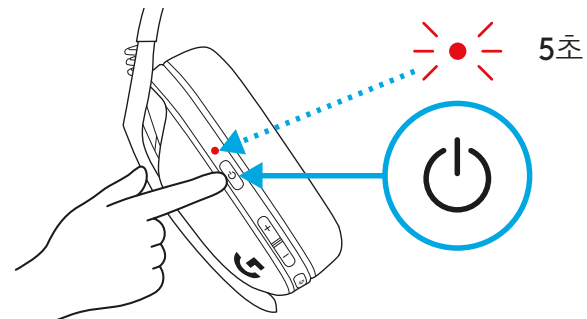

# 사이드톤

사이드톤은 다른 사람과 소통 시 내 목소리를 들려주는 기능입니다. 전화 통화 경험을 미러링하여 적절한 수준으로 목소리를 조절할 수 있게 해줍니다.

## - 사이드톤 활성화

- 음소거 버튼을 두 번 누르면 LED가 주황색으로 두 번 깜박입니다.

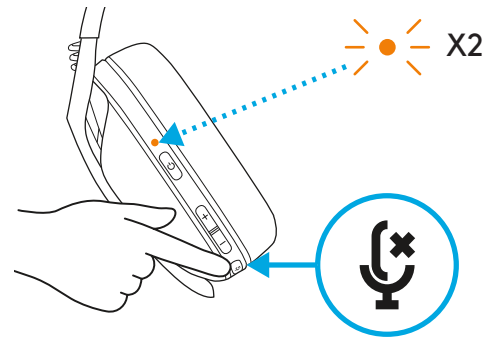

## - 사이드톤 비활성화

- 음소거 버튼을 두 번 누르면 LED가 주황색으로 한번 깜박입니다.

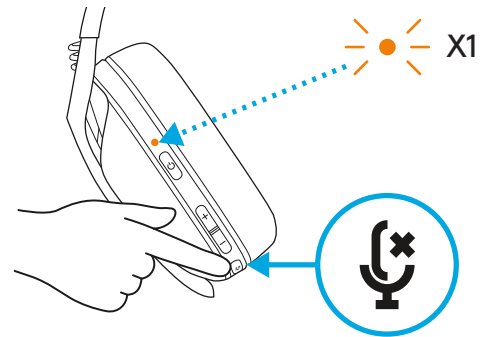

- 사이드톤 조절

- 높임 = 음소거 버튼 + 볼륨 높이기 버튼을 한 번 누릅니다.

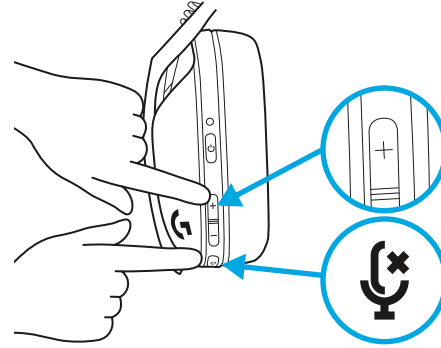

- 낮춤 = 음소거 버튼 + 볼륨 낮추기 버튼을 한 번 누릅니다.

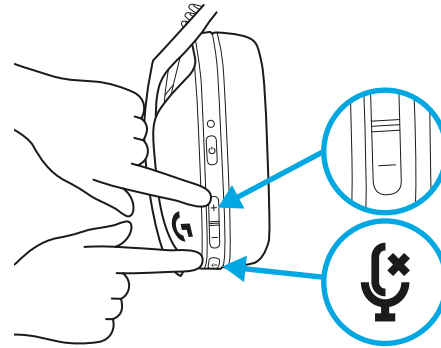

## 예비 부품

- 이어 패드
- 무선 USB 수신기
- 충전 케이블

## 재활용

작동하는 제품인 경우 재판매 또는 기부를 권장합니다.  
재판매나 기부를 하지 않는 경우, 배터리, 전자기기,  
전기장비는 생활 폐기물과 함께 처리하면 안 됩니다.  
가능하면 재활용과 환경 보호, 공중 보건을 위해  
분리하여 정해진 수거 장소에 버려야 합니다. 자세한  
사항은 지방 관헌이나 구매처에 문의하십시오.  
[www.logitech.com/recycling](http://www.logitech.com/recycling)에서도 확인할 수 있습니다.

## 질문이 있으십니까?

[logitechG.com/support/G435](http://logitechG.com/support/G435)

## 배터리 제거

1

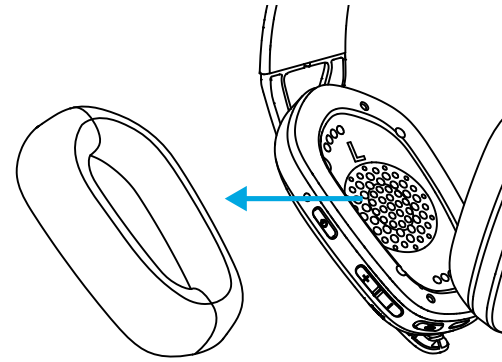

2

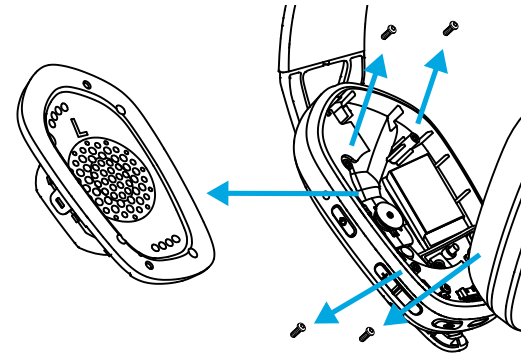

3

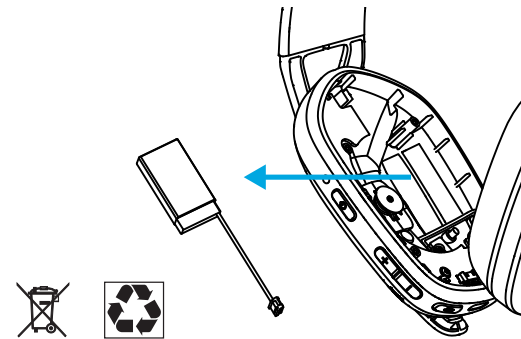



©2021 Logitech. Logitech, Logitech G, Logi, 罗技, 罗技G and their respective logos are trademarks or registered trademarks of Logitech Europe S.A. and/or its affiliates in the U.S. and other countries. All other trademarks are the property of their respective owners. Logitech assumes no responsibility for any errors that may appear in this manual. Information contained herein is subject to change without notice.

版权所有 © 2021 罗技。罗技、罗技 G、Logi、Logitech、Logitech G 及其各自标志为 罗技欧洲公司 和/或其在美国及其他国家/地区附属公司的商标，并或已注册。所有其它商标均是其各自所有者的财产。罗技对于本手册中可能出现的任何错误不承担任何责任。本手册中包含的信息如有更改，恕不事先通知。

WEB-621-002087.002