



# Hardware Reference Guide

© Copyright 2019 HP Development Company, L.P.

DisplayPort™ and the DisplayPort™ logo are trademarks owned by the Video Electronics Standards Association (VESA®) in the United States and other countries.

The information contained herein is subject to change without notice. The only warranties for HP products and services are set forth in the express warranty statements accompanying such products and services. Nothing herein should be construed as constituting an additional warranty. HP shall not be liable for technical or editorial errors or omissions contained herein.

First Edition: June 2019

Document Part Number: L63759-001





#### **Product Notice**

To access the latest user guides, go to <http://www.hp.com/support>, and follow the instructions to find your product. Then select **User Guides**.

For any further information or to request a full refund of the price of the computer, please contact your seller.

## About This Book

---

-  **WARNING!** Indicates a hazardous situation that, if not avoided, **could** result in serious injury or death.
  -  **CAUTION:** Indicates a hazardous situation that, if not avoided, **could** result in minor or moderate injury.
  -  **IMPORTANT:** Indicates information considered important but not hazard-related (for example, messages related to property damage). Warns the user that failure to follow a procedure exactly as described could result in loss of data or in damage to hardware or software. Also contains essential information to explain a concept or to complete a task.
  -  **NOTE:** Contains additional information to emphasize or supplement important points of the main text.
  -  **TIP:** Provides helpful hints for completing a task.
-



---

# Table of contents

<b>1 Product features</b>	<b>1</b>
Components	2
Certificates and labels location	3
<b>2 Setup</b>	<b>4</b>
Installing the stand or approved VESA 100 mounting bracket	4
Securing the thin client	6
Mounting and orienting the thin client	7
Supported orientation and placement	8
Unsupported placement	11
Connecting the power cord	12
Routine thin client care	12
<b>3 Hardware changes</b>	<b>13</b>
Warnings and cautions	13
Removing and replacing the access panel	13
Removing the access panel	13
Replacing the access panel	15
Locating internal components	16
Removing and replacing the M.2 flash storage module	17
Removing and replacing the battery	19
Replacing a low-profile PCI Express card	20
Installing additional SDRAM system memory	21
SODIMMs	21
DDR4-SDRAM SODIMMs	21
Populating SODIMM sockets	22
Installing SODIMMs	22
<b>4 Troubleshooting</b>	<b>25</b>
Computer Setup (F10) Utility, BIOS Settings	25
Computer Setup (F10) Utilities	25
Using Computer Setup (F10) Utilities	25
Computer Setup—File	26
Computer Setup—Storage	27
Computer Setup—Security	28
Computer Setup—Power	30

Computer Setup—Advanced .....	30
Changing BIOS Settings from the HP BIOS Configuration Utility (HPBCU) .....	31
Updating or restoring a BIOS .....	33
Diagnostics and troubleshooting .....	34
Lights .....	34
Wake-on LAN .....	35
Power-On Sequence .....	35
Resetting the Setup and Power-on passwords .....	36
Power-on diagnostic tests .....	36
Interpreting POST diagnostic front panel lights and audible codes .....	37
Troubleshooting .....	39
Basic troubleshooting .....	39
Diskless (No-Flash) thin client troubleshooting .....	40
Configuring a PXE server .....	41
Using HP ThinUpdate to restore the image .....	41
Device management .....	42
Power cord set requirements .....	42
Requirements for all countries .....	42
Requirements for specific countries and regions .....	43
Statement of Volatility .....	44
Specifications .....	46
<b>Appendix A Electrostatic discharge .....</b>	<b>47</b>
Preventing electrostatic damage .....	47
Grounding methods .....	47
<b>Appendix B Shipping information .....</b>	<b>48</b>
Shipping preparation .....	48
Important service repair information .....	48
<b>Appendix C Accessibility .....</b>	<b>49</b>
Supported assistive technologies .....	49
Contacting support .....	49
<b>Index .....</b>	<b>50</b>

---

# 1 Product features



This guide describes the features of the thin client. For more information about the hardware and software installed on this thin client, go to <http://www.hp.com/go/quickspecs> and search for this thin client.

Various options are available for your thin client. For more information about some of the available options, go to the HP website at <http://www.hp.com> and search for your specific thin client.

# Components

For more information, go to <http://www.hp.com/go/quickspecs> and search for your specific thin client to find the QuickSpecs.

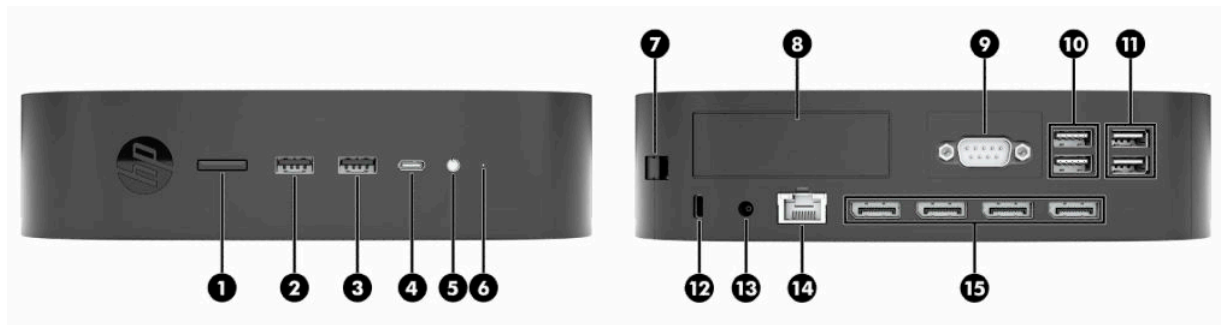

**Table 1-1 Components**

Component	Component
1 Power button	9 Optional port. If used, may provide dual coaxial cable connectors for external antenna or serial port (shown)
2 USB-A 3.1 Gen 1 port	10 USB-A 3.1 Gen 1 ports (2)
3 USB-A 3.1 Gen 2 port	11 USB-A 2.0 ports (2)
4 USB-C 3.1 Gen 2 downstream facing port (DFP)	12 Security cable slot
5 Headset jack	13 Power connector
6 Activity LED	14 RJ-45 (network) jack
7 Rear I/O panel latch	15 DisplayPort™ ports (4)
8 Low Profile PCIe Expansion Slot	



# Certificates and labels location

The certificates, regulatory labels, and serial number are located under the side cover. Have this serial number available when contacting HP customer service for assistance.

---

## **BURN HAZARD WARNING!**



To reduce the possibility of heat-related injuries, disconnect the power cord from the AC outlet and allow 15 minutes for the internal components to cool before you remove the access panel.

---

1. Lay the thin client down with the right side up and the front side with the HP logo facing you.
2. Insert a fingernail or blunt tool in the slot (1), and then lift the side cover (2) off the thin client.

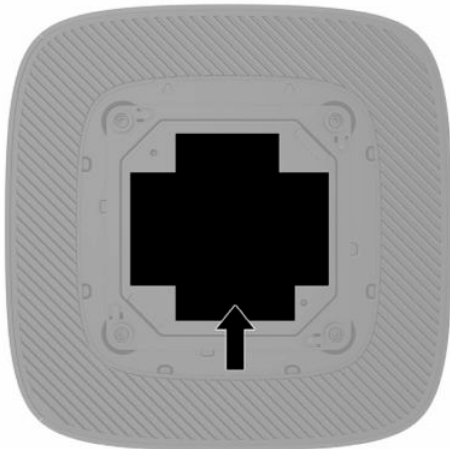
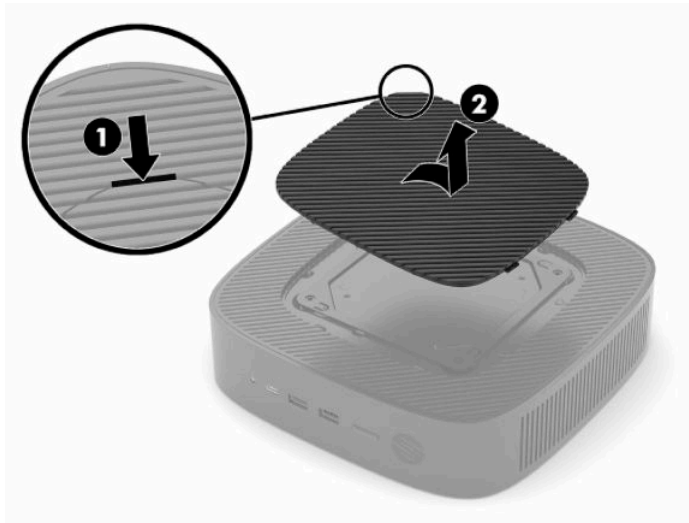

## 2 Setup

### Installing the stand or approved VESA 100 mounting bracket

 **IMPORTANT:** Unless the thin client is mounted with an approved VESA® 100 mounting bracket, it must be operated with the system stand attached to ensure proper airflow around the system.

You can use the thin client in either a vertical or horizontal orientation with the stand included with the thin client.

1. Remove or disengage any security devices that prohibit opening the thin client.
2. Remove all removable media, such as USB flash drives, from the thin client.
3. Turn off the thin client properly through the operating system, and then turn off any external devices.
4. If connected, disconnect the power cord from the AC outlet, and disconnect any external devices.

---

#### **BURN HAZARD WARNING!**



Regardless of the power-on state, voltage is always present on the system board as long as the system is plugged into an active AC outlet. You must disconnect the power cord to avoid damage to the internal components of the thin client.

---

5. Attach the stand to the thin client.
  - Attach the stand to the bottom of the thin client to use the thin client in the vertical orientation.
    - a. Turn the thin client upside down and locate the two screw holes in the grid on the bottom of the thin client.
    - b. Position the stand over the bottom of the thin client and line up the captive screws in the stand with the screw holes in the thin client.



- c. Tighten the captive screws securely.

- Attach the stand to the right side of the thin client to use it in the horizontal orientation.

---

**BURN HAZARD WARNING!**

---



To reduce the risk of personal injury or equipment damage from electric shock, hot surfaces, or fire, disconnect the power cord from the AC outlet and allow 15 minutes for the internal components to cool before you remove the access panel.

---

- a. Lay the thin client down with the right side up and the front side with the HP logo facing you.
- b. Insert a fingernail or blunt tool in the slot (1), and then lift the side cover (2) off the thin client.



**NOTE:** Retain the side cover for possible future use.

---

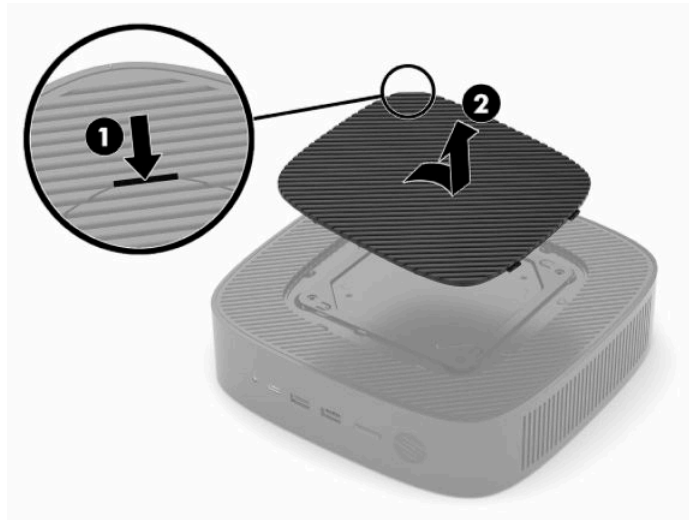

- c. Locate the two screw holes on the right side of the thin client.
- d. Position the stand over the side of the thin client and line up the captive screws in the stand with the screw holes in the thin client.



- e. Tighten the captive screws securely.



**NOTE:** Be sure that at least **10.2 cm (4 in)** of space on all sides of the thin client remain clear and free of obstructions.

---

## Securing the thin client

Thin clients are designed to accept a security cable. The security cable prevents unauthorized removal of the thin client. To order this option, go to the HP website at <http://www.hp.com> and search for your specific thin client.

1. Locate the security cable slot on the back panel.
2. Insert the security cable lock into the slot, and then use the key to lock it.



---

 **NOTE:** The security cable is designed to act as a deterrent, but it may not prevent the thin client from being mishandled or stolen.

---

## Mounting and orienting the thin client

This thin client incorporates four mounting points on the right side of the thin client. These mounting points follow the VESA (Video Electronics Standards Association) 100 standard, which provides industry-standard mounting interfaces for various mounting brackets and accessories. HP offers a number of mounting brackets that enable the thin client to be securely mounted in a variety of environments and orientations. Follow the manufacturer's instructions to install an approved mounting bracket.

 **NOTE:** The VESA 100 mounting holes are recessed 2 mm below the surface of the chassis side panel. Some models will include a 2 mm spacer to assist with the installation of a mounting bracket. If your model does not include the spacer, you should still be able to install your VESA 100 mounting bracket to the thin client.

If the system includes a 2 mm mounting bracket and is configured in the Horizontal orientation, the bracket may be stored on the inside of the VESA cover. Place the mounting bracket in the center of the VESA cover and twist it slightly to lock it into the VESA cover for storage.



## Supported orientation and placement

 **IMPORTANT:** You must adhere to the HP-supported orientation guidelines to ensure that your thin client functions properly.

Unless the thin client is mounted with an approved VESA 100 mounting bracket, you must operate it with the stand attached to ensure proper airflow around the system.

HP thin clients are uniquely designed to be set up and oriented in 6 different positions in order to support any possible deployment scenario.

1. **Vertical Plus** - this is the typical vertical deployment orientation with the system stand attached to the bottom of the thin client and the HP logo oriented right side up. Using a mounting bracket, the Vertical Plus orientation can also be used to mount the thin client to a vertical flat surface such as a wall.



2. **Vertical Minus** - this orientation would typically be used to mount the thin client to a vertical flat surface with the HP logo positioned at the bottom in an upside down orientation.



- Horizontal Plus** - this is the typical orientation for setting the thin client on a horizontal flat surface, i.e. a desktop, with the system stand attached to the side of the thin client.

 **NOTE:** Leave at least 2.54 cm (1 in) clearance if the thin client is placed under a monitor stand.



- Horizontal Minus** - this is the typical orientation used when mounting the thin client underneath a horizontal flat surface using a mounting bracket to attach the thin client to the under side of the flat surface, i.e. a desktop.



5. **Bezel Plus** - this orientation is used to mount the thin client on a vertical flat surface, i.e. a wall, so that the front input/output ports and system power button are facing up.

---

 **IMPORTANT:** The Bezel Plus orientation is not supported when the thin client is configured with a Fiber Optic NIC in the PCIe expansion slot.

---



6. **Bezel Minus** - in this orientation the thin client is mounted to a vertical flat surface so that the rear Input/Output ports are facing up.





## Unsupported placement

HP does not support the following placements for the thin client:

 **IMPORTANT:** Unsupported placement of thin clients could result in operation failure, damage to the devices, or both.

Thin clients require proper ventilation to maintain operating temperature. Do not block the vents.

The Bezel Plus orientation is not supported when the thin client is configured with a Fiber Optic NIC in the PCI Express expansion slot.

Do not put thin clients in drawers or other sealed enclosures. Do not place a monitor or other object on top of the thin client. Do not mount a thin client between the wall and a monitor unless using an approved dual VESA mounting adapter specifically designed for this mounting scenario. Thin clients require proper ventilation to maintain operating temperatures.

- In a desk drawer:

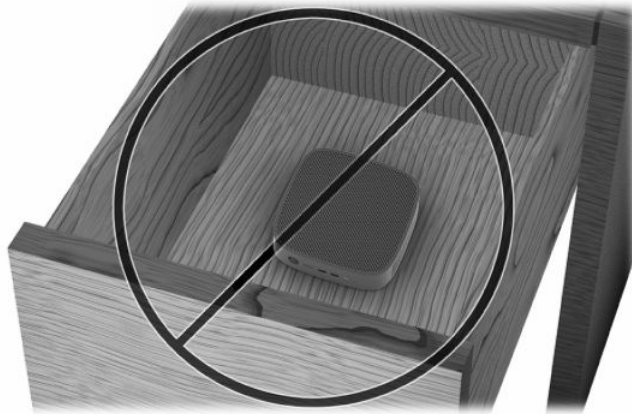

- With a monitor on the thin client:



## Connecting the power cord

1. Connect the power cord to the power adapter (1).
2. Connect the power cord to an AC outlet (2).
3. Connect the power adapter to the thin client (3).

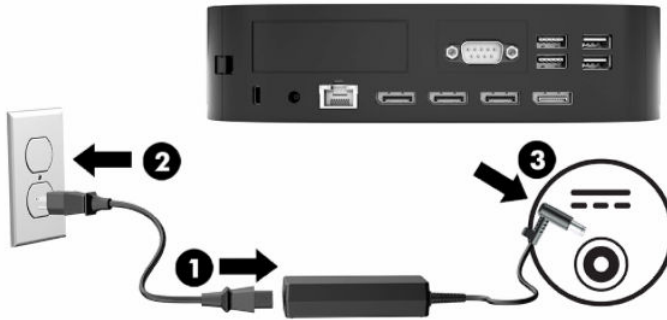

## Routine thin client care

Use the following information to properly care for your thin client:

- Never operate the thin client with the rear I/O panel removed.
- Keep the thin client away from excessive moisture, direct sunlight, and extreme heat and cold. For information about the recommended temperature and humidity ranges for the thin client, see [Specifications on page 46](#).
- Keep liquids away from the thin client and keyboard.
- Turn off the thin client and wipe the exterior with a soft, damp cloth as needed. Using cleaning products may discolor or damage the finish.

---

## 3 Hardware changes

### Warnings and cautions

Before performing upgrades, be sure to carefully read all of the applicable instructions, cautions, and warnings in this guide.

---

 **WARNING!** To reduce the risk of personal injury or equipment damage from electric shock, hot surfaces, or fire:

Disconnect the power cord from the AC outlet and allow the internal system components to cool before you touch them.

Do not connect telecommunications or telephone connectors to the network interface controller (NIC) receptacles.

Do not insert objects into or through the system vents.

Do not disable the power cord grounding plug. The grounding plug is an important safety feature.

Plug the power cord into a grounded (earthed) AC outlet that is easily accessible at all times.

To reduce the risk of serious injury, read the *Safety & Comfort Guide* provided with your user guides. It describes proper workstation setup, and proper posture, health, and work habits for computer users. The *Safety & Comfort Guide* also provides important electrical and mechanical safety information. The *Safety & Comfort Guide* is also available on the Web at <http://www.hp.com/ergo>.

 **WARNING!** Energized parts are inside the enclosure.

Disconnect power to the equipment before removing the access panel.

Replace and secure the access panel before re-energizing the equipment.

 **IMPORTANT:** Static electricity can damage the electrical components of the thin client or optional equipment. Before beginning these procedures, ensure that you are discharged of static electricity by briefly touching a grounded metal object. See [Preventing electrostatic damage on page 47](#) for more information.

When the thin client is plugged into an AC power source, voltage is always applied to the system board. You must disconnect the power cord from the power source before opening the thin client to prevent damage to internal components.

---

### Removing and replacing the access panel

#### Removing the access panel

---

 **WARNING!** To reduce the risk of personal injury or equipment damage from electric shock, hot surfaces, or fire, **always** operate the thin client with the access panel in place. In addition to enhancing safety, the access panel might provide important instructions and identification information, which can be lost if the access panel is not used. **Do not** use any access panel except the one that HP provides with this thin client.

Before removing the access panel, be sure that the thin client is turned off and the power cord is disconnected from the AC outlet.

If the thin client has been in operation prior to removing the access panel, the metal plate underneath the access panel can reach temperatures that may cause discomfort if directly touched. The thin client should be turned off and allowed 15 minutes to come to room temperature before removing the access panel.

---

To remove the access panel:

1. Remove or disengage any security devices that prohibit opening the thin client.
2. Remove all removable media, such as USB flash drives, from the thin client.
3. Turn off the thin client properly through the operating system, and then turn off any external devices.
4. Disconnect the power cord from the AC outlet, and disconnect any external devices.

 **IMPORTANT:** Regardless of the power-on state, voltage is always present on the system board as long as the system is plugged into an active AC outlet. You must disconnect the power cord to avoid damage to the internal components of the thin client.

5. Lay the thin client flat on a stable surface with the right side up.
6. Release the latch **(1)** on the left side of the rear I/O panel, rotate the I/O panel **(2)** to the right, and then lift it off the thin client.

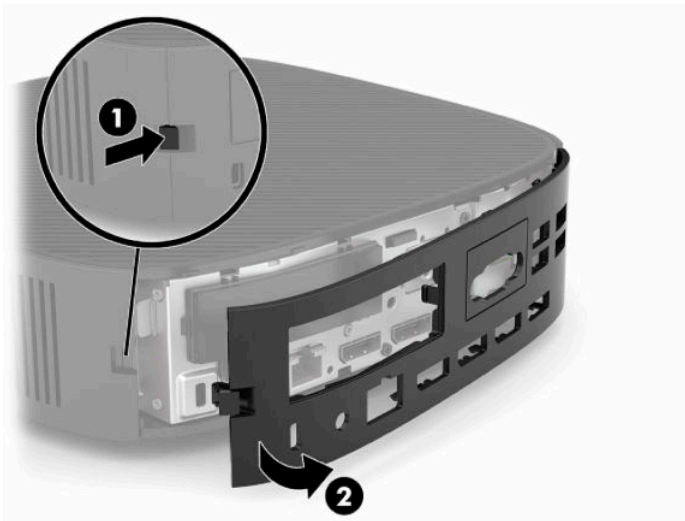

7. Press the access panel latch **(1)** to release the access panel.
8. Lift the access panel up from the rear of the system and then pull the access panel towards the rear of the system to remove it.

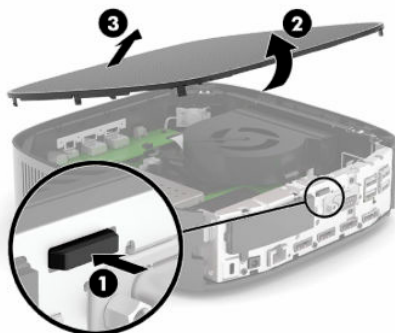

## Replacing the access panel

To replace the access panel:

1. Position the front of the access panel on the front of the chassis and press the rear edge down until it snaps into place.

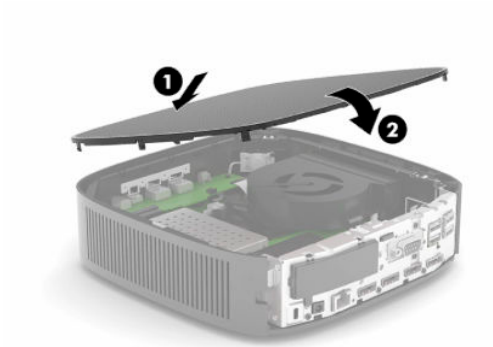

2. Insert the hooks on the right side of the rear I/O panel (1) into the right side of the back of the chassis, rotate the left side (2) to the chassis, and then press it to the chassis until it locks in place.

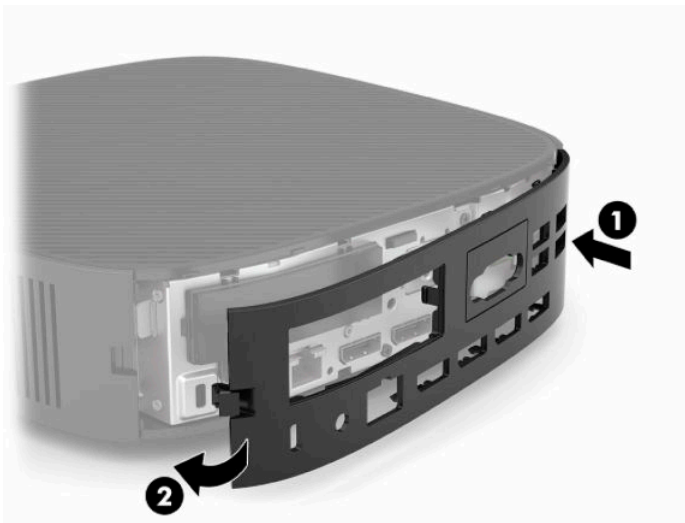

3. Replace the thin client stand.
4. Reconnect the power cord and turn on the thin client.
5. Lock any security devices that were disengaged when you removed the thin client access panel.

## Locating internal components

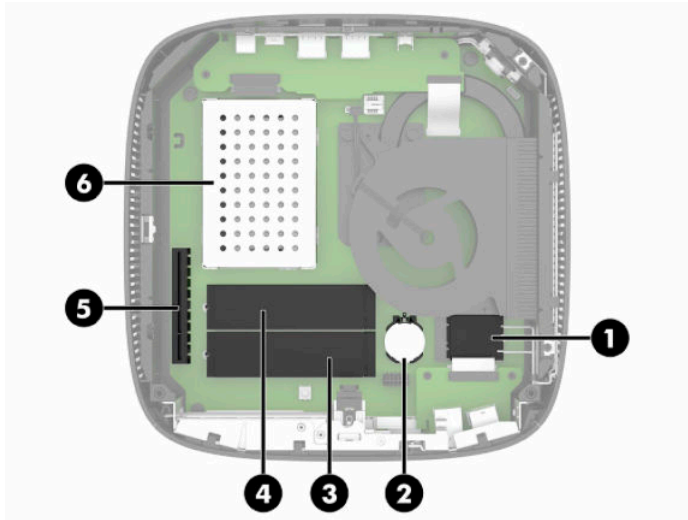

**Table 3-1** Internal components

Component	
1	WLAN card (select models)
2	Battery
3	M.2 SATA flash storage module
4	M.2 eMMC or NVMe flash storage module
5	Low profile PCI express riser card expansion slot
6	DDR4 SDRAM Memory (2 SODIMMs)

## Removing and replacing the M.2 flash storage module

 **IMPORTANT:** The thin client includes two M.2 flash storage slots. One slot supports eMMC and NVMe type flash modules. The second slot supports SATA type flash modules. When removing and replacing the M.2 flash modules, be sure and use the correct slot for the type of flash memory used or being replaced.

To remove the M.2 flash storage module:

1. Remove or disengage any security devices that prohibit opening the thin client.
2. Remove all removable media, such as USB flash drives, from the thin client.
3. Turn off the thin client properly through the operating system, and then turn off any external devices.
4. Disconnect the power cord from the AC outlet, and disconnect any external devices.

---

### **BURN HAZARD WARNING!**



Regardless of the power-on state, voltage is always present on the system board as long as the system is plugged into an active AC outlet. You must disconnect the power cord to avoid damage to the internal components of the thin client.

To reduce the possibility of heat-related injuries, disconnect the power cord from the AC outlet and allow 15 minutes for the internal components to cool before you remove the access panel.

- 
5. Remove the stand or VESA 100 mounting accessory from the thin client.
  6. Lay the thin client flat on a stable surface with the right side up.
  7. Remove the thin client access panel. See [Removing and replacing the access panel on page 13](#).
  8. Locate the M.2 socket for flash storage module on the system board.
  9. Loosen the screw securing the flash storage module until the end of the module can be raised.
  10. Pull the flash storage module out of the socket.

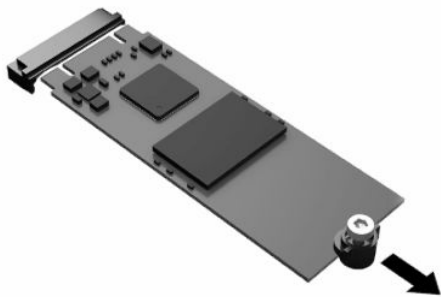

11. Pull the screw kit off of the flash storage module and attach it to the replacement flash storage module.

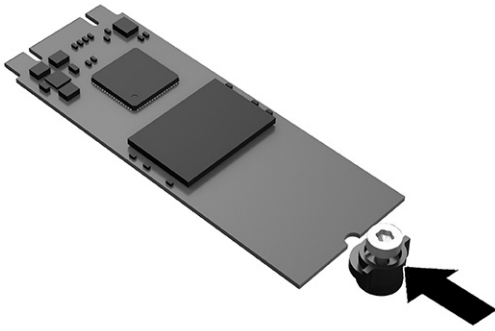

12. Slide the new flash storage module into the M.2 socket on the system board and press the module connectors firmly into the socket.

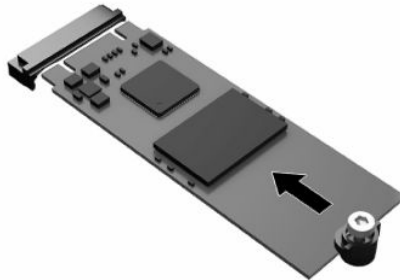

**NOTE:** A flash storage module can be installed in only one way.

13. Press the flash storage module down and use a screwdriver to tighten the screw and secure the module to the system board.

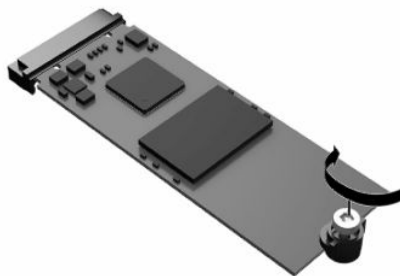

14. Replace and latch the access panel, and then reinstall the rear I/O panel. See [Removing and replacing the access panel on page 13](#).
15. Replace the thin client stand.



16. Reconnect the power cord and turn on the thin client.
17. Lock any security devices that were disengaged when the thin client access panel was removed.

## Removing and replacing the battery

To remove and replace the battery:

1. Remove or disengage any security devices that prohibit opening the thin client.
2. Remove all removable media, such as USB flash drives, from the thin client.
3. Turn off the thin client properly through the operating system, and then turn off any external devices.
4. Disconnect the power cord from the AC outlet, and disconnect any external devices.

---

### BURN HAZARD WARNING!



Regardless of the power-on state, voltage is always present on the system board as long as the system is plugged into an active AC outlet. You must disconnect the power cord to avoid damage to the internal components of the thin client.

To reduce the possibility of heat-related injuries, disconnect the power cord from the AC outlet and allow 15 minutes for the internal components to cool before you remove the access panel.

---

5. Remove the stand from the thin client.
6. Lay the thin client flat on a stable surface with the right side up.
7. Remove the thin client access panel. See [Removing and replacing the access panel on page 13](#).
8. Locate the battery on the system board.
9. To release the battery from its holder, squeeze the metal clamp **(1)** that extends above one edge of the battery. When the battery pops up, lift it out **(2)**.



10. To insert the new battery, slide one edge of the replacement battery under the holder's lip (1) with the positive side up. Push the other edge down until the clamp snaps over the other edge of the battery (2).



11. Replace and latch the access panel, and then reinstall the rear I/O panel. See [Removing and replacing the access panel on page 13](#).
12. Replace the thin client stand.
13. Reconnect the power cord and turn on the thin client.
14. Lock any security devices that were disengaged when the thin client access panel was removed.

HP encourages customers to recycle used electronic hardware, HP original print cartridges, and rechargeable batteries. For more information about recycling programs, go to <http://www.hp.com> and search for **recycle**.

---

**IMPORTANT**

Batteries, battery packs, and accumulators should not be disposed of together with the general household waste. To forward them to recycling or proper disposal, use the public collection system or return them to HP, an authorized HP partner, or their agents.

---

**IMPORTANT**

The Taiwan EPA requires dry battery manufacturing or importing firms, in accordance with Article 15 or the Waste Disposal Act, to indicate the recovery marks on the batteries used in sales, giveaways, or promotions. Contact a qualified Taiwanese recycler for proper battery disposal.

## Replacing a low-profile PCI Express card

An optional low-profile PCI-Express (PCIe) card may be installed in the thin client. A riser card is installed in this thin client by default.

To install a PCIe card:

1. Remove or disengage any security devices that prohibit opening the thin client.
2. Remove all removable media, such as USB flash drives, from the thin client.

3. Turn off the thin client properly through the operating system, and then turn off any external devices.
4. Disconnect the power cord from the AC outlet, and disconnect any external devices.

---

**BURN HAZARD WARNING!**

---



Regardless of the power-on state, voltage is always present on the system board as long as the system is plugged into an active AC outlet. You must disconnect the power cord to avoid damage to the internal components of the thin client.

To reduce the possibility of heat-related injuries, disconnect the power cord from the AC outlet and allow 15 minutes for the internal components to cool before you remove the access panel.

---

5. Remove the stand or VESA 100 mounting accessory from the thin client.
6. Lay the thin client flat on a stable surface with the right side up.
7. Remove the thin client access panel. See [Removing and replacing the access panel on page 13](#).
8. Locate the PCIe card on the system board.
9. Press the latch down and move it to the left to release the PCIe card.
10. If the PCIe card is full-length, pull back and hold the latch at the end of the PCIe slot to release the card.
11. Carefully pull the PCIe card out of the socket. You may need to pull one side and then the other to remove the card.
12. If the new PCIe card requires an opening in the chassis, push the expansion slot cover out of the rear I/O panel.
13. Align the PCIe card connectors with the slot in the riser card and the metal tab at the end of the card with the slot in the chassis. Press the PCIe card firmly into the slot in the riser card until it is securely seated and the tab is in the slot.
14. Press the latch down and move it to the right until it clicks into place to secure the PCIe card.
15. Replace and latch the access panel, and then reinstall the rear I/O panel. See [Removing and replacing the access panel on page 13](#).
16. Replace the thin client stand.
17. Reconnect the power cord and turn on the thin client.
18. Lock any security devices that were disengaged when the thin client access panel was removed.

## Installing additional SDRAM system memory

The system is capable of executing in dual channel mode when configured with two SODIMMs.

### SODIMMs

The memory sockets on the system board can be populated with up to two industry-standard SODIMMs. These memory sockets are populated with at least one preinstalled SODIMM. To achieve the maximum system performance, HP recommends that the thin client be configured for dual channel memory by populating both SODIMM slots with a SODIMM memory module.

### DDR4-SDRAM SODIMMs

For proper system operation, the SODIMMs must adhere to the following specifications:

- industry-standard 260-pin
- unbuffered non-ECC DDR4 SDRAM
- contain the mandatory Joint Electronic Device Engineering Council (JEDEC) specification

The thin client supports the following modules:

- 4 GB, 8 GB, and 16 GB non-ECC memory modules
- single-sided and double-sided SODIMMS



**NOTE:** The system does not operate properly when an unsupported SODIMM is installed.

Maximum memory speed (3200MHz) is only supported with single-rank SODIMMs.

## Populating SODIMM sockets

There are two SODIMM sockets on the system board. The sockets are labeled DIMM1 and DIMM2.

Item	Description	System Board Label
1	SODIMM1 socket	DIMM1
2	SODIMM2 socket	DIMM2

The system operates in dual-channel mode.

## Installing SODIMMs



**IMPORTANT:** You must disconnect the power cord and wait approximately 30 seconds for the power to drain before adding or removing memory modules. Regardless of the power state, voltage is always supplied to the memory modules as long as the thin client is plugged into an active AC outlet. Adding or removing memory modules while voltage is present can cause irreparable damage to the memory modules or system board.

The memory module sockets have gold-plated metal contacts. When upgrading the memory, it is important to use memory modules with gold-plated metal contacts to prevent corrosion or oxidation resulting from having incompatible metals in contact with each other.

Static electricity can damage the electronic components of the thin client or optional cards. Before beginning the following procedures, be sure that you are discharged of static electricity by briefly touching a grounded metal object. For more information, see [Electrostatic discharge on page 47](#).

When handling a memory module, be careful not to touch any of the contacts. Doing so can damage the module.

1. Remove or disengage any security devices that prohibit opening the thin client.
2. Remove all removable media, such as USB flash drives, from the thin client.
3. Turn off the thin client properly through the operating system, and then turn off any external devices.
4. Disconnect the power cord from the AC outlet, and disconnect any external devices.



**IMPORTANT:** You must disconnect the power cord and wait approximately 30 seconds for the power to drain before adding or removing memory modules. Regardless of the power-on state, voltage is always supplied to the memory modules as long as the thin client is plugged into an active AC outlet. Adding or removing memory modules while voltage is present may cause irreparable damage to the memory modules or system board.

---

**BURN HAZARD WARNING!**

---



To reduce the possibility of heat-related injuries, disconnect the power cord from the AC outlet and allow 15 minutes for the internal components to cool before you remove the access panel.

---

5. Remove the stand or VESA 100 mounting accessory from the thin client.
6. Lay the thin client flat on a stable surface with the right side up.
7. Remove the thin client access panel. See [Removing and replacing the access panel on page 13](#).

**⚠ WARNING!** To reduce risk of personal injury from hot surfaces, allow the internal system components to cool before you touch them.

---

8. Locate the memory compartment on the system board.
9. If a PCIe card is installed, remove it.
10. Lift the memory compartment cover out of the chassis.
11. To remove a SODIMM, press outward on the two latches on each side of the SODIMM **(1)**, rotate the SODIMM up, and then pull the SODIMM out of the socket **(2)**.



12. Slide the new SODIMM **(1)** into the socket at approximately a 30° angle, and then press the SODIMM down **(2)** so that the latches lock it in place.



**NOTE:** A memory module can be installed in only one way. Match the notch on the module with the tab on the memory socket.

---

13. Align the memory compartment cover with the two posts and the clips at the base of the compartment, and then set the memory compartment cover over the SODIMMs.



**TIP:** The small clips are pairs. When the compartment is properly placed, one of each pair will be inside the compartment and one will be outside.

---

14. Replace and latch the access panel, and then reinstall the rear I/O panel. See [Removing and replacing the access panel on page 13](#).
15. Replace the thin client stand or VESA 100 mounting accessory.
16. Reconnect the power cord and turn on the thin client.
17. Lock any security devices that were disengaged when the thin client access panel was removed.

The thin client automatically recognizes the additional memory when you turn on the thin client.

---

# 4 Troubleshooting

## Computer Setup (F10) Utility, BIOS Settings

### Computer Setup (F10) Utilities

Use Computer Setup (F10) Utility to do the following:

- Change factory default settings.
- Set the system date and time.
- Set, view, change, or verify the system configuration, including settings for processor, graphics, memory, audio, storage, communications, and input devices.
- Modify the boot order of bootable devices such as solid-state drives or USB flash drives.
- Select Post Messages Enabled or Disabled to change the display status of Power-On Self-Test (POST) messages. Post Messages Disabled suppresses most POST messages, such as memory count, product name, and other non-error text messages. If a POST error occurs, the error is displayed regardless of the mode selected. To manually switch to Post Messages Enabled during POST, press any key (except **F1** through **F12**).
- Enter the Asset Tag or property identification number assigned by the company to this computer.
- Enable the power-on password prompt during system restarts (warm boots) as well as during power-on.
- Establish a setup password that controls access to the Computer Setup (F10) Utility and the settings described in this section.
- Secure integrated I/O functionality, including the USB, audio, or embedded NIC, so that they cannot be used until they are unsecured.

### Using Computer Setup (F10) Utilities

Computer Setup can be accessed only by turning the computer on or restarting the system. To access the Computer Setup Utilities menu, complete the following steps:

1. Turn on or restart the computer.
2. Press either **esc** or **F10** while the “Press the ESC key for Startup Menu” message is displayed at the bottom of the screen.

Pressing **esc** displays a menu that allows you to access different options available at startup.

---

 **NOTE:** If you do not press **esc** or **F10** at the appropriate time, you must restart the computer and again press **esc** or **F10** when the monitor light turns green to access the utility.

 **NOTE:** You can select the language for most menus, settings, and messages using the Language Selection option using the **F8** key in Computer Setup.

---

3. If you pressed **esc**, press **F10** to enter Computer Setup.
4. A choice of five headings appears in the Computer Setup Utilities menu: File, Storage, Security, Power, and Advanced.

5. Use the arrow (left and right) keys to select the appropriate heading. Use the arrow (up and down) keys to select the option you want, then press **enter**. To return to the Computer Setup Utilities menu, press **esc**.
6. To apply and save changes, select **File > Save Changes and Exit**.
  - If you have made changes that you do not want applied, select **Ignore Changes and Exit**.
  - To reset to factory settings, select **Apply Defaults and Exit**. This option will restore the original factory system defaults.

 **IMPORTANT:** Do not turn the computer power off while the BIOS is saving the Computer Setup (F10) changes because the CMOS could become corrupted. It is safe to turn off the computer only after exiting the F10 Setup screen.

**Table 4-1 Computer Setup Utility menu options**

Heading	Table
File	<a href="#">Computer Setup—File on page 26</a>
Storage	<a href="#">Computer Setup—Storage on page 27</a>
Security	<a href="#">Computer Setup—Security on page 28</a>
Power	<a href="#">Computer Setup—Power on page 30</a>
Advanced	<a href="#">Computer Setup—Advanced on page 30</a>

## Computer Setup—File

 **NOTE:** Support for specific Computer Setup options may vary depending on the hardware configuration.

**Table 4-2 Computer Setup—File**

Option	Description
<b>System Information</b>	Lists: <ul style="list-style-type: none"> <li>• Product name</li> <li>• SKU number</li> <li>• System Board CT Number</li> <li>• Processor type</li> <li>• Processor speed</li> <li>• Processor stepping</li> <li>• Cache size (L1/L2)</li> <li>• Memory size</li> <li>• Integrated MAC</li> <li>• System BIOS</li> <li>• Chassis serial number</li> <li>• Asset tracking number</li> </ul>
<b>About</b>	Displays copyright notice.
<b>Flash System BIOS</b>	Allows you to flash system BIOS from a USB recovery key.



**Table 4-2 Computer Setup—File (continued)**

Option	Description
	<ul style="list-style-type: none"> <li>• Launch HpBiosUpdate</li> <li>• Update USB Type C PD FW</li> <li>• Update TPM FW</li> </ul>
<b>Set Time and Date</b>	Allows you to set system time and date.
<b>Default Setup</b>	Allows you to: <ul style="list-style-type: none"> <li>• Save Current Settings as Default</li> <li>• Restore Factory Settings as Default</li> </ul>
<b>Apply Defaults and Exit</b>	Loads the original factory system configuration settings for use by a subsequent Apply Defaults and Exit action.
<b>Ignore Changes and Exit</b>	Exits Computer Setup without applying or saving any changes.
<b>Save Changes and Exit</b>	Saves changes to system configuration or default settings and exits Computer Setup.

## Computer Setup—Storage

**Table 4-3 Computer Setup—Storage**

Option	Description
<b>Device Configuration</b>	Lists all installed BIOS-controlled storage devices. When a device is selected, detailed information and options are displayed. The following options may be presented:  <b>Hard Disk:</b> Size, model, firmware version, serial number.
<b>Storage Options</b>	<p><b>SATA Emulation</b></p> <p><b>IMPORTANT:</b> SATA emulation changes may prevent access to existing drive data and degrade or corrupt established volumes.</p> <p>Allows you to choose how the SATA controller and devices are accessed by the operating system. There are two supported options: IDE and AHCI (default).</p> <p>IDE—This is the most backwards-compatible setting of the three options. Operating systems usually do not require additional driver support in IDE mode.</p> <p>AHCI (default option)—Allows operating systems with AHCI device drivers loaded to take advantage of more advanced features of the SATA controller.</p> <p><b>External USB Storage Boot</b></p> <p>Allows you to set USB storage device default boot option in CSM or Legacy mode.</p>
<b>DPS Self-test</b>	Allows you to execute self-tests on ATA hard drives capable of performing the Drive Protection System (DPS) self-tests.  <b>NOTE:</b> This selection will only appear when at least one drive capable of performing the DPS self tests is attached to the system.
<b>Boot Order</b>	Allows you to: <ul style="list-style-type: none"> <li>• Specify the order in which EFI boot sources (such as a internal drive, USB hard drive, or USB optical drive) are checked for a bootable operating system image. Each device on the list may be individually excluded from or included for consideration as a bootable operating system source. EFI boot sources always have precedence over legacy boot sources.</li> </ul>

**Table 4-3 Computer Setup—Storage (continued)**

Option	Description
	<ul style="list-style-type: none"> <li>Specify the order in which legacy boot sources (such as a network interface card, internal drive, or USB optical drive) are checked for a bootable operating system image. Each device on the list may be individually excluded from or included for consideration as a bootable operating system source.</li> <li>Specify the order of attached hard drives. The first hard drive in the order will have priority in the boot sequence and will be recognized as drive C (if any devices are attached).</li> </ul> <p><b>NOTE:</b> You can use <b>F5</b> to disable individual boot items, as well as disable EFI boot and/or legacy boot. MS-DOS drive lettering assignments may not apply after a non-MS-DOS operating system has started.</p> <p><b>Shortcut to Temporarily Override Boot Order</b></p> <p>To boot <b>one time</b> from a device other than the default device specified in Boot Order, restart the computer and press <b>esc</b> (to access the boot menu) and then <b>F9</b> (Boot Order), or only <b>F9</b> (skipping the boot menu) when the monitor light turns green. After POST is completed, a list of bootable devices is displayed. Use the arrow keys to select the preferred bootable device and press <b>enter</b>. The computer then boots from the selected device this one time.</p>

## Computer Setup—Security



**NOTE:** Support for specific Computer Setup options may vary depending on the hardware configuration.

**Table 4-4 Computer Setup—Security**

Option	Description
<b>Setup Password</b>	<p>Allows you to set and enable a setup (administrator) password.</p> <p><b>NOTE:</b> If the setup password is set, it is required to change Computer Setup options, flash the ROM, and make changes to certain plug and play settings under Windows.</p>
<b>Power-On Password</b>	<p>Allows you to set and enable a power-on password. The power-on password prompt appears after a power cycle or reboot. If the user does not enter the correct power-on password, the thin client will not boot.</p>
<b>Password Options</b>  (This selection appears only if a power-on password or setup password is set.)	<p>Allows you to enable or disable:</p> <ul style="list-style-type: none"> <li>Stringent Password—When set, enables a mode in which there is no physical bypass of the password function. If enabled, removing the password jumper will be ignored.</li> <li>Password Prompt on F9 &amp; F12—Default is enabled.</li> <li>Setup Browse Mode—Allows viewing, but not changing, the F10 Setup Options without entering setup password. Default is enabled.</li> </ul>
<b>Device Security</b>	<p>Allows you to set Device Available/Device Hidden (default is Device Available) for:</p> <ul style="list-style-type: none"> <li>System audio</li> <li>Network controller</li> <li>M.2 Storage0</li> <li>M.2 Storage1</li> </ul>
<b>USB Security</b>	<p>Allows you to set Enabled or Disabled (default is enabled) for:</p> <ul style="list-style-type: none"> <li>Front USB Ports               <ul style="list-style-type: none"> <li>USB Port 1</li> <li>USB Port 2</li> <li>USB Port 3</li> </ul> </li> </ul>

**Table 4-4 Computer Setup—Security (continued)**

Option	Description
	<ul style="list-style-type: none"><li>• Rear USB Ports<ul style="list-style-type: none"><li>– USB Port 4</li><li>– USB Port 5</li><li>– USB Port 6</li><li>– USB Port 7</li></ul></li></ul>
<b>Slot Security</b>	Allows you to disable the PCI Express slots. Default is enabled. <ul style="list-style-type: none"><li>• Slot #—PCI Express x 8</li><li>• Slot #—M.2 PCIe x1</li></ul>
<b>Network Boot</b>	Enables/disables the computer's ability to boot from an operating system installed on a network server. (Feature available on NIC models only; the network controller must be either a PCI expansion card or embedded on the system board.) Default is enabled.
<b>System IDs</b>	Allows you to set: <ul style="list-style-type: none"><li>• Asset tag (18-byte identifier)—A property identification number assigned by the company to the computer.</li><li>• Ownership tag (80-byte identifier)</li></ul>
<b>System Security</b>	Provides these options: <ul style="list-style-type: none"><li>• Data Execution Prevention (enable or disable) - Helps prevent operating system security breaches. Default is enabled.</li><li>• Virtualization Technology (enable or disable)—Controls the virtualization features of the processor. Changing this setting requires turning the computer off and then back on. Default is disabled.</li><li>• TPM Device—Lets you set the Trusted Platform Module as available or hidden.</li><li>• TPM State—Select to enable the TPM.</li><li>• Clear TPM—Select to reset the TPM to an unowned state. After the TPM is cleared, it is also turned off. To temporarily suspend TPM operations, turn the TPM off instead of clearing it.</li></ul> <p><b>IMPORTANT:</b> Clearing the TPM resets it to factory defaults and turns it off. You will lose all created keys and data protected by those keys.</p>
<b>Secure Boot Configuration</b>	The options on this setup page are only for Windows 10 and other operating systems that support Secure Boot. Changing the default setting of the setup options on this page for operating system that do not support secure boot may prevent the system from booting successfully.  Legacy Support (enable or disable)—Enable or disable the legacy operating system support (Windows Embedded Standard 7 and HP Thin-Pro).  Secure Boot (enable or disable)—Only when the Legacy Support set to disable, this item can be set to enable. This item is for Secure Boot flow control. Secure boot is possible only if system run in user mode.  Key Management <ul style="list-style-type: none"><li>• Clear Secure Boot Keys (Clear or Don't Clear). Lets you clear the Secure Boot Key.</li><li>• Key ownership (HP keys or Customer keys). Lets you change the keys of different owners.</li></ul> Fast Boot (enable or disable)—Enable Fast Boot cause system boot by initializing a minimal set of devices which is required to launch active boot option. This option has no effect for BBS boot options.
<b>Memory Security</b>	AMD Transparent Secure Memory Encryption (enable or disable)—Allows you to turn on or turn off the AMD Transparent Secure Memory Encryption function.

## Computer Setup—Power



**NOTE:** Support for specific Computer Setup options may vary depending on the hardware configuration.

**Table 4-5 Computer Setup—Power**

Option	Description
<b>OS Power Management</b>	<p>Runtime Power Management (enable or disable)—Allows certain operating systems to reduce processor voltage and frequency when the current software load does not require the full capabilities of the processor. Default is enabled.</p> <p>Idle Power Savings (Extended/Normal)—Extended/Normal. Allows certain operating systems to decrease the processors power consumption when the processor is idle. Default is extended.</p>
<b>Hardware Power Management</b>	<p>S5 Maximum Power Savings—Turns off power to all nonessential hardware when system is off to meet EUP Lot 6 requirement of less than 0.5 Watt power usage. Default is disabled.</p>
<b>Thermal</b>	<p>Fan Idle Mode—Allows you to set default fan speed in idle mode.</p> <p>CPU Fan Speed (Read-Only)—Shows the CPU fan speed in RPM.</p> <p>Extend Operating Ambient Temp Mode—Allows you to configure the computer to operate in a high ambient temperature environment.</p> <p>High Temperature Support Status (Read-Only)—Indicates if the computer is able to operate in a high ambient temperature environment.</p>

## Computer Setup—Advanced



**NOTE:** Support for specific Computer Setup options may vary depending on the hardware configuration.

**Table 4-6 Computer Setup—Advanced**

Option	Heading
<b>Power-On Options</b>	<p>Allows you to set:</p> <ul style="list-style-type: none"><li>• POST messages (enable or disable)—Default is disabled.</li><li>• Press the ESC key for Startup Menu (Displayed/Hidden).</li><li>• After Power Loss (off/on/previous state)—Default is Power off. Set this option as follows:<ul style="list-style-type: none"><li>• Power off—Causes the computer to remain powered off when power is restored.</li><li>• Power on—Causes the computer to power on automatically as soon as power is restored.</li><li>• Previous state—Causes the computer to power on automatically as soon as power is restored, if it was on when power was lost.</li></ul></li></ul> <p><b>NOTE:</b> If you turn off power to the computer using the switch on a power strip, you will not be able to use the suspend/sleep feature or the Remote Management features. When Maximum Power Saving Mode is set to enabled, After Power Loss is automatically set to Off.</p> <ul style="list-style-type: none"><li>• POST Delay (in seconds)—Enabling this feature adds a user-specified delay to the POST process. This delay is sometimes needed for hard disks on some PCI cards that spin up so slowly that they are not ready to boot by the time POST is finished. The POST delay also gives you more time to select <b>F10</b> to enter Computer (F10) Setup. Default is None.</li><li>• Bypass F1 Prompt on Configuration Changes (enable or disable).</li><li>• Remote Wakeup Boot Source (Local Hard Drive/Remote Server). Allows you to set the source from which the computer gets its boot files when remotely awakened.</li></ul>
<b>BIOS Power-On</b>	<p>Allows you to set the computer to turn on automatically at a time you specify.</p>

**Table 4-6 Computer Setup—Advanced (continued)**

Option	Heading
<b>Onboard Devices</b>	Allows you to set resources for or disable legacy devices.
<b>Bus Options</b>	On some models, allows you to enable or disable: <ul style="list-style-type: none"> <li>• PCI SERR# Generation. Default is enabled.</li> <li>• PCI VGA Palette Snooping, which sets the VGA palette snooping bit in PCI configuration space; only needed when more than one graphics controller is installed. Default is disabled.</li> </ul>
<b>Device Options</b>	<ul style="list-style-type: none"> <li>• BIOS Primary Display—If a discrete graphics card is installed, allows you to select the video output device during Pre-OS time.</li> <li>• Integrated Graphics (Auto/Force)—Use this option to manage integrated (UMA) graphics memory allocation. The value you choose allocates memory permanently to graphics and is unavailable to the operating system. For example, if you set this value to 512 MB on a system with 2 GB of RAM, the system always allocates 512 MB for graphics and the other 1.5 GB for use by the BIOS and operating system. Default is Auto which sets UMA memory by the memory installed on the platform as follows: <ul style="list-style-type: none"> <li>– &lt; 4 GB: 256 MB</li> <li>– 4 GB - 6 GB: 512 MB</li> <li>– &gt; 6 GB: 1 GB</li> </ul> <p>If you select Force, the UMA Frame Buffer Size option displays, which lets you set the UMA memory size allocation between 256 MB and 1 GB.</p> </li> <li>• S5 Wake on LAN (enable or disable)</li> <li>• Num Lock State at Power-On (off/on). Default is off.</li> <li>• Internal Speaker (some models) (does not affect external speakers)—Default is enabled.</li> </ul>
<b>Option ROM Launch Policy</b>	Allows you to set: <ul style="list-style-type: none"> <li>• Onboard NIC PXE Option ROMs (enable or disable)</li> </ul>

## Changing BIOS Settings from the HP BIOS Configuration Utility (HPBCU)

You can change some BIOS settings locally within the operating system without having to go through the F10 utility. This table identifies the items that can be controlled with this method.

For more information about the HP BIOS Configuration Utility, see the *HP BIOS Configuration Utility (BCU) User Guide* at [www.hp.com](http://www.hp.com).

**Table 4-7 BIOS settings that can be changed in the operating system**

BIOS setting	Default value	Other values
Language	English	Francais, Espanol, Deutsch, Italiano, Dansk, Suomi, Nederlands, Norsk, Portugues, Svenska, Japanese
Set Time	00:00	00:00:23:59
Set Day	01/01/2011	01/01/2011 to current date
Default Setup	None	Save Current Settings as Default; Restore Factory Settings as Default
Apply Defaults and Exit	Disable	Enable
SATA Emulation	AHCI	IDE

**Table 4-7 BIOS settings that can be changed in the operating system (continued)**

<b>BIOS setting</b>	<b>Default value</b>	<b>Other values</b>
USB Storage Boot	Before SATA	After SATA
UEFI Boot Sources	Windows Boot Manager	USB Floppy/CD, USB hard drive
Legacy Boot Sources	USB floppy/CD	Hard drive
System Audio	Device available	Device hidden
Network Controller	Device available	Device hidden
M.2 Storage0	Device available	Device hidden
M.2 Storage1	Device available	Device hidden
Front USB Ports	Enable	Disable
USB Port 1, 2, 3	Enable	Disable
Rear USB Ports	Enable	Disable
USB Port 4, 5, 6, 7	Enable	Disable
M.2 PCIe x	Enable	Disable
Network Boot	Enable	Disable
Asset Tracking Number		
Ownership Tag		
BIOS Update	Disable	Auto, Force
BIOS Image File Name		
Update USB Type C PD FW	Disable	Enable
Update TPM FW	Disable	Enable
Data Execution Prevention	Enable	Disable
Virtualization Technology	Disable	Enable
TPM Device	Disable	Enable
TPM State	Enable	Disable
Clear TPM	Do not reset	Reset
Legacy Support	Enable	Disable (Note: The default value varies, depending on the OS)
Secure Boot	Disable	Enable (Note: The default value varies, depending on the OS)
Clear Secure Boot Keys	Don't Clear	Clear
Key Ownership	HP Keys	Custom Keys
Fast Boot	Disable	Enable (Note: The default value varies, depending on the OS)
Runtime Power Management	Enable	Disable
Idle Power Savings	Extended	Normal
S5 Maximum Power Savings	Disable	Enable
S5 Wake on LAN	Disable	Enable

**Table 4-7 BIOS settings that can be changed in the operating system (continued)**

BIOS setting	Default value	Other values
POST Messages	Disable	Enable
Press the ESC key for Startup Menu	Displayed	Hidden
After Power Loss	Off	On, Previous State
POST Delay (in seconds)	None	5, 10, 15, 20, 60
Bypass F1 Prompt on Configuration Changes	Disable	Enable
Remote Wakeup Boot Source	Local Hard Drive	Remote Server
Power on Sunday—Saturday	Disable	Enable
Power on Time (hh:mm)	00:00	00:00:23:59
Serial Port A	IO=3F8h; IRQ=4	Disable, IO=3F8h; IRQ=4, IO=3F8h; IRQ=3, IO=2F8h; IRQ=4, IO=2F8h; IRQ=3
PCI SERR# Generation	Enable	Disable
PCI VGA Palette Snooping	Disable	Enable
BIOS Primary Display	Onboard	PCIe Card
Integrated Graphics	Auto	Disable, Force
UMA Frame Buffer Size	512M	256M, 1G
Num Lock State at Power- On	Off	On
Internal Speaker	Enable	Disable
PXE Option ROMs	UEFI	Disable
PCIe Slot Option ROM Download	Enable	Do not launch
M.2 PCIe Slot Option ROM Download	Enable	Do not launch

## Updating or restoring a BIOS

### HP Device Manager

You can use HP Device Manager to update the BIOS of a thin client. You can use a prebuilt BIOS add-on or the standard BIOS upgrade package with an HP Device Manager File and Registry template. For more information about HP Device Manager File and Registry templates, review the *HP Device Manager User Guide* found at [www.hp.com/go/hpdm](http://www.hp.com/go/hpdm).

### Windows BIOS Flashing

You can use the BIOS Flash Update SoftPaq to restore or upgrade the system BIOS. Several methods for changing the BIOS firmware stored on your computer are available.

The BIOS executable is a utility designed to flash the System BIOS within a Microsoft Windows environment. To display the available options for this utility, launch the executable file under the Microsoft Windows environment.

You can run the BIOS executable with or without the USB storage device. If the system does not have a USB storage device installed, the BIOS update performs under the Microsoft Windows environment, and followed by system reboot.

### Linux BIOS Flashing

All BIOS flashing under ThinPro 6.x and later uses tool-less BIOS updates, in which the BIOS updates itself.

Use the following comments to flash a Linux® BIOS:

- `hptc-bios-flash ImageName`

Prepares the system to update the BIOS during the next restart. This command automatically copies the files into the correct location and prompts you to restart the thin client. This command requires that the tool-less update option in the BIOS settings is set to Auto. You can use `hpt-bios-cfg` to set the tool-less update option in the BIOS.

- `hptc-bios-flash -h`

Displays a list of options.

### BitLocker Drive Encryption/BIOS Measurements

If you have Windows BitLocker Drive Encryption (BDE) enabled on your system, HP recommends that you temporarily suspend BDE before updating the BIOS. You should also obtain your BDE recovery password or recovery PIN before suspending BDE. After you flash the BIOS, you can resume BDE.

To make a change to BDE, select **Start > Control Panel > BitLocker Drive Encryption**, click **Suspend Protection** or **Resume Protection** and then click **Yes**.

As a general rule, updating the BIOS modifies measurement values stored in the Platform Configuration Registers (PCRs) of the system's security module. Temporarily disable technologies that use these PCR values to ascertain platform health (BDE is one such example) before flashing the BIOS. After you update the BIOS, re-enable the functions and restart the system so that you can take new measurements.

### BootBlock Emergency Recovery Mode

In the event of a failed BIOS update (for example, if power is lost while updating), the System BIOS can become corrupted. BootBlock Emergency Recovery Mode detects this condition and automatically searches the root directory of the hard drive and any USB media sources for a compatible binary image. Copy the binary (.bin) file in the DOS Flash folder to the root of the storage device, and then power on the system. After the recovery process locates the binary image, it attempts the recovery process. The automatic recovery continues until it successfully restores or updates the BIOS. If the system has a BIOS Setup password, you might have to use the Startup Menu or Utilities submenu to flash the BIOS manually after providing the password. Sometimes there are restrictions on which BIOS versions may be installed on a platform. If the BIOS that was on the system had restrictions, then only allowable BIOS versions may be used for recovery.

## Diagnostics and troubleshooting

### Lights

**Table 4-8** Diagnostic and troubleshooting lights

Light	Status
Power light off	When the thin client is plugged into the wall socket and the power light is off, the thin client is powered off. However, the network can trigger a Wake On LAN event in order to perform management functions.
Power light on	Displays during boot sequence and while the thin client is on. During boot sequence, hardware initialization is processed and startup tests are performed on the following initializations:



**Table 4-8 Diagnostic and troubleshooting lights (continued)**

Light	Status
	<ul style="list-style-type: none"> <li>• Processor initialization</li> <li>• Memory detection and initialization</li> <li>• Video detection and initialization</li> </ul> <p><b>NOTE:</b> If one of the tests fails, the thin client stops, but the light stays on. If the video test fails, the thin client beeps. There are no messages sent to video for any of these failed tests.</p> <p><b>NOTE:</b> After the video subsystem initializes, anything that fails will have an error message.</p>
	<p><b>NOTE:</b> RJ-45 lights are located inside the network cable on the top-rear panel of the thin client. The lights are visible when the connector is installed. Blinking green indicates network activity, and amber indicates a 100 MB speed connection.</p>
Activity LED off	When the thin client is powered on and the flash activity light is off, then there is no access to the system flash.
Activity LED blinks white	Indicates the system is accessing the internal IDE flash.

## Wake-on LAN

Wake-on LAN (WOL) allows a computer to be turned on or resume from sleep or hibernation state by a network message. You can enable or disable WOL in Computer Setup using the **S5 Wake on LAN** setting.

To enable or disable WOL:

1. Turn on or restart the computer.
2. Press either **esc** or **F10** while the “Press the ESC key for Startup Menu” message is displayed at the bottom of the screen.

 **NOTE:** If you do not press **esc** or **F10** at the appropriate time, you must restart the computer and again press **esc** or **F10** when the monitor light turns green to access the utility.

3. If you pressed **esc**, press **F10** to enter Computer Setup.
4. Navigate to **Advanced > Device Options**.
5. Set **S5 Wake on LAN** to either enabled or disabled.
6. Press **F10** to accept any changes.
7. Select **File > Save Changes and Exit**.

 **IMPORTANT:** The **S5 Maximum Power Savings** setting can affect wake-on LAN. If you enable this setting, wake-on LAN is disabled. This setting is found in Computer Setup at **Power > Hardware Management**.

## Power-On Sequence

At power-on, the flash boot block code initializes the hardware to a known state, then performs basic power-on diagnostic tests to determine the integrity of the hardware. Initialization performs the following functions:

1. Initializes CPU and memory controller.
2. Initializes and configures all PCI devices.
3. Initializes video software.
4. Initializes the video to a known state.

5. Initializes USB devices to a known state.
6. Performs power-on diagnostics. For more information, see [Power-on diagnostic tests on page 36](#).
7. The thin client boots the operating system.

## Resetting the Setup and Power-on passwords

You can reset the Setup and Power-on passwords as follows:

1. Remove or disengage any security devices that prohibit opening the thin client.
2. Remove all removable media, such as USB flash drives, from the thin client.
3. Turn off the thin client properly through the operating system, and then turn off any external devices.
4. Disconnect the power cord from the AC outlet, and disconnect any external devices.

---

### BURN HAZARD WARNING!

---



Regardless of the power-on state, voltage is always present on the system board as long as the system is plugged into an active AC outlet. You must disconnect the power cord to avoid damage to the internal components of the thin client.

To reduce the possibility of heat-related injuries, disconnect the power cord from the AC outlet and allow 15 minutes for the internal components to cool before you remove the access panel.

---

5. Remove the stand or VESA 100 mounting accessory from the thin client.
6. Lay the thin client flat on a stable surface with the right side up.
7. Remove the thin client access panel. See [Removing and replacing the access panel on page 13](#).
8. Remove the password jumper from the system board header labeled PSWD/E49.
9. Replace the password jumper.
10. Replace and latch the access panel, and then reinstall the rear I/O panel. [Removing and replacing the access panel on page 13](#).
11. Replace the thin client stand.
12. Connect the computer to AC power, and then turn on the computer.
13. Lock any security devices that were disengaged when the thin client access panel was removed.
14. Replace and latch the access panel, and then reinstall the rear I/O panel. See [Removing and replacing the access panel on page 13](#).

## Power-on diagnostic tests

The Power-on diagnostics performs basic integrity tests of the hardware to determine its functionality and configuration. If a diagnostic test fails during hardware initialization the thin client simply stops. There are no messages sent to video.



**NOTE:** You can try to restart the thin client and run through the diagnostic tests a second time to confirm the first shutdown.

---

The following table lists the tests that are performed on the thin client.

**Table 4-10 Power-on diagnostic test**

Test	Description
Boot Block Checksum	Tests boot block code for proper checksum value
DRAM	Simple write/read pattern test of the first 640k of memory
Serial Port	Tests the serial port using simple port verification test to determine if ports are present
Timer	Tests timer interrupt by using polling method
RTC CMOS battery	Tests integrity of RTC CMOS battery
NAND flash device	Tests for proper NAND flash device ID present

## Interpreting POST diagnostic front panel lights and audible codes

This section covers the front panel light codes as well as the audible codes that may occur before or during POST that do not necessarily have an error code or text message associated with them.

### BURN HAZARD WARNING!



Regardless of the power-on state, voltage is always present on the system board as long as the system is plugged into an active AC outlet. You must disconnect the power cord to avoid damage to the internal components of the thin client.

To reduce the possibility of heat-related injuries, disconnect the power cord from the AC outlet and allow 15 minutes for the internal components to cool before you remove the access panel.



**NOTE:** Recommended actions in the following table are listed in the order in which they should be performed.

Not all diagnostic lights and audible codes are available on all models.

Beeps are broadcast through the chassis speaker. Blinks and beeps repeat for five cycles, after which only the blinks repeat.

**Table 4-12 Interpreting POST diagnostic front panel lights and audible codes**

Activity	Beeps	Possible Cause	Recommended Action
White power light is off.	None	Computer is off (S5).	None
White power light on.	None	Computer on.	None
White power light flashes every two seconds.	None	Computer in Suspend to RAM mode (some models only) or normal Suspend mode.	No action required. Press any key or move the mouse to wake the computer.
Red power light flashes two times, once every second, followed by a two-second pause.	2	Processor thermal protection activated:  The heat sink assembly is not properly attached to the processor.  OR	<b>IMPORTANT:</b> Internal components might be powered even when the computer is off. To prevent damage, disconnect the power cord before you remove a component.  <b>1.</b> Ensure that the computer air vents are not blocked and the processor cooling fan is plugged in and running.

**Table 4-12 Interpreting POST diagnostic front panel lights and audible codes (continued)**

Activity	Beeps	Possible Cause	Recommended Action
		The computer has vents blocked or is in a location where the ambient temperature is too high.	<ol style="list-style-type: none"> <li>Open the access panel, press power button, and verify that the processor fan is spinning. If the processor fan is not spinning, make sure the fan cable is plugged into the system board header. Ensure the fan is fully and properly seated or installed.</li> <li>If the fan is plugged in and seated properly but is not spinning, the problem might be in the processor fan. Contact HP for assistance.</li> <li>Verify that the fan assembly is properly attached. If problems persist, there might be a problem with the processor heatsink. Contact HP for assistance.</li> </ol>
Red power light flashes four times, once every second, followed by a two-second pause.	4	<p>Power failure (power supply is overloaded).</p> <p>OR</p> <p>The incorrect external power supply adapter is being used on the computer.</p>	<ol style="list-style-type: none"> <li>Check if a device is causing the problem by removing all attached devices. Turn the computer on. If the computer enters the POST, then turn the computer off and replace one device at a time and repeat this procedure until failure occurs. Replace the device that is causing the failure. Continue adding devices one at a time to ensure all devices are functioning properly.</li> <li>Replace the power supply.</li> <li>Replace the system board.</li> </ol>
Red power light flashes five times, once every second, followed by a two-second pause.	5	Prevideo memory error.	<p><b>IMPORTANT:</b> To avoid damage to the memory modules or the system board, unplug the power cord before attempting to reseal, install, or remove a memory module.</p> <ol style="list-style-type: none"> <li>Reseat memory modules.</li> <li>Replace memory modules one at a time to isolate the faulty module.</li> <li>Replace third-party memory with HP memory.</li> <li>Replace the system board.</li> </ol>
Red power light flashes six times, once every second, followed by a two-second pause.	6	Pre-video graphics error.	<p>For systems with a graphics card:</p> <ol style="list-style-type: none"> <li>Reseat the graphics card.</li> <li>Replace the graphics card.</li> <li>Replace the system board.</li> </ol> <p>For systems with integrated graphics, replace the system board.</p>
Red power light flashes eight times, once every second, followed by a two-second pause.	8	Invalid ROM based on bad checksum.	<ol style="list-style-type: none"> <li>Reflash the system ROM with the latest BIOS image using the BIOS Recovery procedure.</li> <li>Replace the system board.</li> </ol>
System does not power on and lights are not flashing.	None	System unable to power on.	<p>Press and hold the power button for less than four seconds. If the hard drive light turns white, the power button is working correctly. Try the following solutions:</p> <ol style="list-style-type: none"> <li>Remove the power cord from the computer.</li> </ol>

**Table 4-12 Interpreting POST diagnostic front panel lights and audible codes (continued)**

Activity	Beeps	Possible Cause	Recommended Action
			<ol style="list-style-type: none"> <li>Open the computer and press the yellow CMOS button on the system board for four seconds.</li> <li>Verify that the power cord is plugged into the power supply.</li> <li>Close the computer and reattach the power cord.</li> <li>Try to turn on the computer.</li> <li>Replace the computer.</li> </ol>

## Troubleshooting

### Basic troubleshooting

If the thin client is experiencing operating problems or will not power on, review the following items.

**Table 4-13 Basic troubleshooting issues and solutions**

Issue	Procedures
The thin client is experiencing operating problems.	Ensure that the following connectors are securely plugged into the thin client: Power connector, keyboard, mouse, network cable, display
The thin client does not turn on.	<ol style="list-style-type: none"> <li>Verify that the power supply is good by installing it on a known working thin client and testing it. If the power supply does not work on the test thin client, replace the power supply.</li> <li>If the thin client does not work properly with the replaced power supply, have the thin client serviced.</li> </ol>
The thin client turns on and displays a splash screen, but does not connect to the server.	<ol style="list-style-type: none"> <li>Verify that the network is operating and the network cable is working properly.</li> <li>Verify that the thin client is communicating with the server by having the system administrator ping the thin client from the server: <ul style="list-style-type: none"> <li>If the thin client pings back, then the signal was accepted and the thin client is working. This indicates a configuration issue.</li> <li>If the thin client does not ping back and the thin client does not connect to the server, re-image the thin client.</li> </ul> </li> </ol>
There is no link or activity on the network lights, or the lights do not blink green after you turn on the thin client. (The network lights are located inside the network cable on the top-rear panel of the thin client. Indicator lights are visible when the connector is installed.)	<ol style="list-style-type: none"> <li>Verify that the network is not down.</li> <li>Make sure the network cable is good by installing the network cable onto a known working device. If a network signal is detected, then the cable is good.</li> <li>Verify the power supply is good by replacing the power cable to the thin client with a known working power supply cable and testing it.</li> <li>If network lights still do not light and you know the power supply is good, then re-image the thin client.</li> <li>If network lights still do not light, run the IP configuration procedure.</li> <li>If network lights still do not light, have the thin client serviced.</li> </ol>
A newly connected unknown USB peripheral does not respond, or USB peripherals connected before the newly connected USB	An unknown USB peripheral may be connected and disconnected to a running platform as long as you do not reboot the system. If problems occur, disconnect the unknown USB peripheral and reboot the platform.

**Table 4-13 Basic troubleshooting issues and solutions (continued)**

Issue	Procedures
peripheral do not complete their device actions.	
Video does not show anything.	<ol style="list-style-type: none"> <li>1. Verify that the monitor brightness is set to a readable level.</li> <li>2. Verify that the monitor is good by connecting it to a known working computer and confirm that its front light turns green (assuming the monitor is Energy Star compliant). If the monitor is defective, replace it with a working monitor and repeat testing.</li> <li>3. Re-image the thin client, and turn on the monitor again.</li> <li>4. Test the thin client on a known working monitor. If the monitor does not display video, replace the thin client.</li> </ol>

## Diskless (No-Flash) thin client troubleshooting

This section is only for those thin clients that do not have ATA Flash capability. Because there is no ATA Flash in this model, the boot priority sequence is:

- USB device
  - PXE
1. When the thin client boots, the monitor should display the following information:

**Table 4-14 Diskless (no flash) model troubleshooting issues and solutions**

Item	Information	Action
MAC Address	NIC portion of the system board is OK	If no MAC Address, the system board is at fault. Contact the Call Center for service.
GUID	General system board information	If no GUID information, the system board is at fault and should be replaced.
Client ID	Information from server	If no Client ID information, there is no network connection. This problem could be a bad cable, the server is down, or a bad system board. Contact the Call Center for service for the bad system board.
MASK	Information from server	If no MASK information there is no network connection. This may be caused by a bad cable, the server is down, or a bad system board. Contact the Call Center for service for the bad system board.
DHCP IP	Information from server	If no DHCP IP information there is no network connection. This may be caused by a bad cable, the server is down, or a bad system board. Contact the Call Center for service for the bad system board.

If you are running in a Microsoft RIS PXE environment, go to step 2.

- If you are running in a Linux environment, go to step 3.
2. If you are running in a Microsoft RIS PXE environment, press the **F12** key to activate the network service boot as soon as the DHCP IP information appears on the screen.  
  
If the thin client does not boot to the network, the server is not configured to PXE.  
  
If you miss the F12 cue, the system will try to boot to the ATA flash that is not present. The message on the screen will read: **ERROR: Non-system disk or disk error. Replace and press any key when ready.**  
  
Pressing any key restarts the boot cycle.
  3. If you are running in a Linux environment, an error message will appear on the screen if there is no Client IP: **ERROR: Non-system disk or disk error. Replace and press any key when ready.**

## Configuring a PXE server

---

 **NOTE:** All PXE software is supported by authorized service providers on a warranty or service contract basis. Customers who call the HP Customer Service Center with PXE issues and questions should be referred to their PXE provider for assistance.

Additionally, refer to the following documents:

– For Windows Server 2008 R2: <http://technet.microsoft.com/en-us/library/7d837d88-6d8e-420c-b68f-a5b4baeb5248.aspx>

– For Windows Server 2012: <http://technet.microsoft.com/en-us/library/jj648426.aspx>

---

The following services must be running, and they may be running on different servers:

1. Domain Name Service (DNS)
2. Remote Installation Services (RIS)

---

 **NOTE:** Active Directory DHCP is not required, but is recommended.

---

## Using HP ThinUpdate to restore the image

HP ThinUpdate allows you to download images and add-ons from HP, capture an HP thin client image, and create bootable USB flash drives for image deployment.

HP ThinUpdate is preinstalled on some HP thin clients, and it is also available as an add-on at <http://www.hp.com/support>. Search for the thin client model, and see the **Drivers & software** section of the support page for that model.

- The Image Downloads feature lets you download an image from HP to either local storage or a USB flash drive. The USB flash drive option creates a bootable USB flash drive that can be used to deploy the image to other thin clients.
- The Image Capture feature lets you capture an image from an HP thin client and save it to a USB flash drive, which can be used to deploy the image to other thin clients.
- The Add-on Downloads feature lets you download add-ons from HP to either local storage or a USB flash drive.
- The USB Drive Management feature lets you do the following tasks:

- Create a bootable USB flash drive from an image file on local storage
- Copy an .ibr image file from a USB flash drive to local storage
- Restore a USB flash drive layout

You can use a bootable USB flash drive created with HP ThinUpdate to deploy an HP thin client image to another HP thin client of the same model with the same operating system.

### System requirements

To create a recovery device for the purpose of reflashing or restoring the software image on the flash, you need the following:

- One or more HP thin clients.
- USB flash drive in the following size or larger:
  - ThinPro: 8 GB
  - Windows 10 IoT (if using the USB format): 32 GB



**NOTE:** Optionally, you can use the tool on a Windows computer.

**This restore method will not work with all USB flash drives.** USB flash drives that do not show up as removable drive in Windows do not support this restore method. USB flash drives with multiple partitions generally do not support this restore method. The range of USB flash drives available on the market is constantly changing. Not all USB flash drives have been tested with the HP Thin Client Imaging Tool.

## Device management

The thin client includes a license for HP Device Manager and has a Device Manager agent preinstalled. HP Device Manager is a thin client optimized management tool used to manage the full life cycle of HP thin clients to include Discover, Asset Management, Deployment and Configuration. For more information on HP Device Manager, please visit [www.hp.com/go/hpdm](http://www.hp.com/go/hpdm).

If you wish to manage the thin client with other management tools such as Microsoft SCCM or LANDesk, go to [www.hp.com/go/clientmanagement](http://www.hp.com/go/clientmanagement) for more information.

## Power cord set requirements

The wide-range input feature of the computer permits it to operate from any line voltage from 100 to 120 V ac, or from 220 to 240 V ac.

The 3-conductor power cord set included with the computer meets the requirements for use in the country or region where the equipment is purchased.

Power cord sets for use in other countries or regions must meet the requirements of the country and region where the computer is used.

## Requirements for all countries

The following requirements are applicable to all countries and regions:

- The length of the power cord set must be at least **1.0 m** (3.3 ft) and no more than **2.0 m** (6.5 ft).
- All power cord sets must be approved by an acceptable accredited agency responsible for evaluation in the country or region where the power cord set will be used.



- The power cord sets must have a minimum current capacity of 10 A and a nominal voltage rating of 125 or 250 V ac, as required by the power system of each country or region.
- The appliance coupler must meet the mechanical configuration of an EN 60 320/IEC 320 Standard Sheet C13 connector for mating with the appliance inlet on the back of the computer.

## Requirements for specific countries and regions

**Table 4-15 Power cord requirements for specific countries and regions**

Country/region	Accredited agency	Applicable note number
Argentina	IRAM	1
Australia	SAA	1
Austria	OVE	1
Belgium	CEBEC	1
Brazil	ABNT	1
Canada	CSA	2
Chile	IMQ	1
Denmark	DEMKO	1
Finland	FIMKO	1
France	UTE	1
Germany	VDE	1
India	IS	1
Israel	SIR	1
Italy	INC	1
Japan	JIS	3
The Netherlands	KEMA	1
New Zealand	SANZ	1
Norway	NEMKO	1
The People's Republic of China	CCC	4
Saudi Arabia	SASO	7
Singapore	PSB	1
South Africa	SABS	1
South Korea	KTL	5
Sweden	SEMKO	1
Switzerland	SEV	1
Taiwan	BSMI	6
Thailand	TISI	1
The United Kingdom	ASTA	1

**Table 4-15 Power cord requirements for specific countries and regions (continued)**

Country/region	Accredited agency	Applicable note number
The United States	UL	2
<ol style="list-style-type: none"> <li>The flexible cord must be Type H05VV-F, 3-conductor, 0.75 mm<sup>2</sup> conductor size. Power cord set fittings (appliance coupler and wall plug) must bear the certification mark of the agency responsible for evaluation in the country or region where it will be used.</li> <li>The flexible cord must be Type SVT/SJT or equivalent, No. 18 AWG, 3-conductor. The wall plug must be a two-pole grounding type with a NEMA 5-15P (15 A, 125 V ac) or NEMA 6-15P (15 A, 250 V ac) configuration. CSA or C-UL mark. UL file number must be on each element.</li> <li>The appliance coupler, flexible cord, and wall plug must bear a “T” mark and registration number in accordance with the Japanese Dentori Law. The flexible cord must be Type VCTF, 3-conductor, 0.75 mm<sup>2</sup> or 1.25 mm<sup>2</sup> conductor size. The wall plug must be a two-pole grounding type with a Japanese Industrial Standard C8303 (7 A, 125 V ac) configuration.</li> <li>The flexible cord must be Type RVV, 3-conductor, 0.75 mm<sup>2</sup> conductor size. Power cord set fittings (appliance coupler and wall plug) must bear the CCC certification mark.</li> <li>The flexible cord must be Type H05VV-F 3-conductor, 0.75 mm<sup>2</sup> conductor size. KTL logo and individual approval number must be on each element. Corset approval number and logo must be printed on a flag label.</li> <li>The flexible cord must be Type HVCTF 3-conductor, 1.25 mm<sup>2</sup> conductor size. Power cord set fittings (appliance coupler, cable, and wall plug) must bear the BSMI certification mark.</li> <li>For 127 V ac, the flexible cord must be Type SVT or SJT 3-conductor, 18 AWG, with plug NEMA 5-15P (15 A, 125 V ac), with UL and CSA or C-UL marks. For 240 V ac, the flexible cord must be Type H05VV-F 3-conductor, 0.75 mm<sup>2</sup> or 1.00 mm<sup>2</sup> conductor size, with plug BS 1363/A with BSI or ASTA marks.</li> </ol>		

## Statement of Volatility

Thin client products typically have three types of memory devices: RAM, ROM, and flash memory devices. Data stored in the RAM memory device will be lost when the power is removed from the device. RAM devices could be powered by main, aux, or battery power, as described in the following list. Therefore, even when the thin client is not connected to an AC outlet, some of the RAM devices could be powered by battery power. Data stored in the ROM or flash memory devices will retain its data even if the power is removed to the device. Manufacturers of flash device usually specify a period of time (in the order of 10 years) for data retention.

Definition of power states:

**Main Power:** Power available when the thin client is turned on.

**Aux or Standby power:** Power available when the thin client is turned off when the power supply is connected to an active AC outlet.

**Battery Power:** Power from a coin battery present in the thin client systems.

The following table lists the available memory devices and their types per the models. Note that thin client systems do not use traditional hard drives with moving parts. Instead, they use flash memory devices with an IDE/ SATA front-end interface. Hence, the operating systems interface with these flash devices similar to a regular IDE/SATA hard drive. This IDE/SATA flash device contains the image of the operating system. The flash device can only be written by an administrator. A special software tool is required to format the flash devices and clear the data stored in them.

Use the following steps to update BIOS and to return the BIOS settings to factory default settings.

- Download the latest BIOS for your model off of the HP website.
- Follow the instructions on the website to flash the BIOS.
- Restart the system, and while the system starts (after the HP splash screen, if displayed), press the **F10** key to enter the BIOS setup screen.

4. If the Ownership Tag or Asset Tag is set, manually clear it under **Security > System IDs**.
5. Select **File > Save Changes and Exit**.
6. To clear the Setup or Power-On passwords, if set, and clear any other settings, turn off the computer and remove the power cord and the computer hood.
7. Locate the (black) two-pin password jumper on header E49 (labeled PSWD) and remove it.
8. Remove AC power, wait 10 sec until the power has drained out, and then press the Clear CMOS button. (This button is usually a yellow push button, labeled CMOS).
9. Replace the hood and power cord and turn the computer on. The passwords are now cleared and all other user-configurable, non-volatile memory settings are reset to their factory default values.
10. Re-enter the F10 setup utility.
11. Select **File > Default Setup > Restore Factory Settings as Default**. This action sets the default settings back to the factory defaults.
12. Select **File > Apply Defaults and Exit**.
13. Shut down the computer, remove power cord, and then place the (black) jumper back on header E49. Replace the computer hood and power cord.

**Table 4-16 Available memory devices and types**

Description	Location/Size	Power	Loss of data	Comments
System Boot ROM (BIOS)	SPI ROM (128 Mb) socketed, removable.			
System memory (RAM)	SODIMM socket. Removable (4 GB/8 GB/16 GB)	Main power	If main power is removed	Only S0/S3/S5/G3 ACPI states are supported
RTC (CMOS) RAM	RTC RAM is 256 byte RAM Memory in AMD embedded System on Chip (SoC).	Main/battery	If battery power is removed	
Keyboard/mouse (ROM)	2 KB embedded in the super I/O controller (SIO18)	Main		
Keyboard/mouse (RAM)	256 bytes embedded in the super I/O controller (SIO18)	Main	If main power is removed	
LOM EEPROM	Discrete 2 MB SPI ROM	Aux		One Time programmable memory (OTP)
TPM	7206 bytes	Main		

The information contained herein is subject to change without notice.

The only warranties for HP products and services are set forth in the express warranty statements accompanying such products and services. Nothing herein should be construed as constituting an additional warranty. HP shall not be liable for technical or editorial errors or omissions contained herein.

# Specifications

For the latest specifications or additional specifications on the thin client, go to <http://www.hp.com/go/quickspecs/> and search for your specific thin client to find the QuickSpecs.

**Table 4-17 Specifications**

	<b>Metric</b>	<b>U.S.</b>
<b>Dimensions (without stand)</b>		
Width	50 mm	1.97 in
Depth	210 mm	8.27 in
Height	210 mm	8.27 in
<b>Dimensions (with stand)</b>		
Width	152 mm	5.98 in
Depth	210 mm	8.27 in
Height	218 mm	8.58 in
<b>Weight (without stand)</b>	1271 g	2.8 lbs
<b>Weight (with stand)</b>	1323 g	2.9 lbs
<b>Operating temperature</b>	10°C to 40°C	50°F to 104°F
<b>Extended operating temperature</b>	10°C to 55°C	50°F to 131°F
To enable the extended operating temperature range, the system must be oriented vertically and the PCIe slot must be empty.		
Specifications are at sea level with altitude derating of 1° C/300m (1.8° F/1000ft) to a maximum of 3 Km (10,000 ft), with no direct, sustained sunlight. Upper limit may be limited by the type and number of options installed.		
<b>Relative Humidity (non-condensing)</b>		
Operating	10% to 90%	
Nonoperating	5% to 95%	
<b>Power Supply</b>		
Operating Voltage Range	100 VAC to 240 VAC	
Rated Line Frequency	50 Hz to 60 Hz	
<b>Power Output (maximum)</b>	90 W	
<b>Rated Output Current (maximum)</b>	4.62 W	
<b>Output Voltage</b>	+19.5 V dc	

---

# A Electrostatic discharge

A discharge of static electricity from a finger or other conductor can damage system boards or other static-sensitive devices. This type of damage can reduce the life expectancy of the device.

## Preventing electrostatic damage

To prevent electrostatic damage, observe the following precautions:

- Avoid hand contact by transporting and storing products in static-safe containers.
- Keep electrostatic-sensitive parts in their containers until they arrive at static-free workstations.
- Place parts on a grounded surface before removing them from their containers.
- Avoid touching pins, leads, or circuitry.
- Always be properly grounded when touching a static-sensitive component or assembly.

## Grounding methods

There are several methods for grounding. Use one or more of the following methods when handling or installing electrostatic-sensitive parts:

- Use a wrist strap connected by a ground cord to a grounded thin client chassis. Wrist straps are flexible straps of  $1\text{ M}\Omega \pm 10\%$  resistance in the ground cords. To provide proper grounding, wear the strap snug against the skin.
- Use heelstraps, toestraps, or bootstraps at standing workstations. Wear the straps on both feet when standing on conductive floors or dissipating floor mats.
- Use conductive field service tools.
- Use a portable field service kit with a folding static-dissipating work mat.

If you do not have any of the suggested equipment for proper grounding, contact an HP authorized dealer, reseller, or service provider.



**NOTE:** For more information about static electricity, contact an HP authorized dealer, reseller, or service provider.

---

---

# B Shipping information

## Shipping preparation

Follow these suggestions when preparing to ship the thin client:

1. Turn off the thin client and external devices.
2. Disconnect the power cord from the AC outlet, and then from the thin client.
3. Disconnect the system components and external devices from their power sources, and then from the thin client.
4. Pack the system components and external devices in their original packing boxes or similar packaging with sufficient packing material to protect them.



**NOTE:** For environmental nonoperating ranges, see [Specifications on page 46](#).

---

## Important service repair information

In all cases, remove and safeguard all external options before returning the thin client to HP for repair or exchange.

In countries that support customer mail-in repair by returning the same thin client to the customer, HP makes every effort to return the repaired thin client with the same internal memory and flash modules that were sent.

In countries that do not support customer mail-in repair by returning the same thin client to the customer, all internal options should be removed and safeguarded in addition to the external options. The thin client should be restored to the **original configuration** before returning it to HP for repair.

---

# C Accessibility

HP designs, produces, and markets products and services that can be used by everyone, including people with disabilities, either on a stand-alone basis or with appropriate assistive devices.

## Supported assistive technologies

HP products support a wide variety of operating system assistive technologies and can be configured to work with additional assistive technologies. Use the Search feature on your device to locate more information about assistive features.

---

 **NOTE:** For additional information about a particular assistive technology product, contact customer support for that product.

---

## Contacting support

We are constantly refining the accessibility of our products and services and welcome feedback from users. If you have an issue with a product or would like to tell us about accessibility features that have helped you, please contact us at (888) 259-5707, Monday through Friday, 6 a.m. to 9 p.m. Mountain Time. If you are deaf or hard-of-hearing and use TRS/VRS/WebCapTel, contact us if you require technical support or have accessibility questions by calling (877) 656-7058, Monday through Friday, 6 a.m. to 9 p.m. Mountain Time.

# Index

- A**
  - access panel
    - removing 13
    - replacing 15
  - accessibility 49
  - Advanced menu 30
  - audible codes 37
- B**
  - basic troubleshooting 39
  - battery, replacing 19
  - beep codes 37
  - BIOS
    - updating 33
  - BIOS Settings 25
- C**
  - cautions
    - attaching the stand 4
    - electric shock 13, 20, 22
    - installing SODIMMs 22
    - removing the battery 19
    - securing the power cable 12
    - static electricity 13
    - thin client orientation 8
    - thin client placement 11
    - ventilation 11
  - certificates location 3
  - changing BIOS settings 31
  - components 2
    - internal 16
  - Computer Setup (F10) Utility 25
  - Computer Setup — Advanced menu 30
  - Computer Setup — File menu 26
  - Computer Setup — Power menu 30
  - Computer Setup — Security menu 28
  - Computer Setup — Storage menu 27
  - configuring a PXE server 41
- D**
  - diagnostics and troubleshooting 34
  - dimensions 46
  - disabling/enabling Wake-on LAN (WOL) 35
  - diskless troubleshooting 40
- E**
  - electrostatic discharge 47
  - error
    - codes 37
- F**
  - File menu 26
  - flash memory, removing 48
  - flash storage module, replacing 17
  - flashing lights 37
- G**
  - grounding methods 47
- H**
  - hardware specifications 46
  - HP BIOS Configuration Utility (HPBCU) 31
  - HP ThinUpdate 41
  - humidity specifications 46
- I**
  - installation guidelines 13
  - installing
    - low-profile PCIe card 20
    - security cable 6
    - SODIMMs 21
    - system memory 21
  - internal components 16
- L**
  - labels location 3
  - lights 34
    - blinking power 37
  - low-profile PCIe card, installing 20
- M**
  - memory
    - installing system 21
    - socket population 22
    - specifications 21
- O**
  - options 1, 6
- P**
  - passwords 36
  - PCIe card, low-profile, installing 20
  - power cord
    - requirements for all countries 42
    - requirements for specific countries and regions 43
  - power cord connection 12
  - power cord set requirements 42
  - Power menu 30
  - power output specifications 46
  - power supply specifications 46
  - power-on diagnostic tests 36
  - power-on sequence 35
  - preventing electrostatic damage 47
  - PXE server 41
- R**
  - rated output current 46
  - recycling 20
  - relative humidity specifications 46
  - removing
    - access panel 13
    - battery 19
    - flash memory 48
    - solid state drive 48
    - SSD 48
  - replacing
    - access panel 15
    - battery 19
    - flash storage module 17
  - resetting passwords 36
  - routine care 12
- S**
  - security cable, installing 6
  - Security menu 28
  - serial number location 3
  - service repair 48
  - shipping preparation 48



- SODIMMs
  - installing 21
  - socket population 22
- solid state drive, removing 48
- specifications
  - dimensions 46
  - hardware 46
  - humidity 46
  - power output 46
  - power supply 46
  - rated output current 46
  - relative humidity 46
  - temperature 46
  - thin client 46
- specifications, memory 21
- SSD, removing 48
- stand, attaching 4
- Statement of Volatility 44
- Storage menu 27
- storage module, replacing flash 17
- support, contacting 49
- supported assistive technologies 49
- supported orientation 8
- supported placement 8

**T**

- temperature specifications 46
- tower stand 4
- troubleshooting 25, 39

**U**

- unsupported placement 11
- unsupported placements
  - in a drawer 11
  - under a monitor 11
- updating a BIOS 33
- using HP ThinUpdate to restore the image 41

**W**

- Wake-on LAN (WOL) 35
- warnings
  - burn 13, 23
  - electric shock 13, 19
  - grounding plug 13
  - NIC receptacles 13
- websites
  - HP 1