

**acer**



***Acer Chromebook 514***

# **USER'S MANUAL**

© 2021. All Rights Reserved.  
Acer Chromebook 514  
Covers: CB514-2H / CB514-2HT  
This revision: August 2021



### **Important**

**This manual contains proprietary information that is protected by copyright laws. The information contained in this manual is subject to change without notice. Images provided herein are for reference only and may contain information or features that do not apply to your computer. Acer Group shall not be liable for technical or editorial errors or omissions contained in this manual.**

## **Register your Acer product**

Go to [www.acer.com/register-product](http://www.acer.com/register-product), and sign in or sign up your Acer ID to register your product.

Once it is done, you can review it under “My Products” page.

Model number: \_\_\_\_\_

Serial number: \_\_\_\_\_

Date of purchase: \_\_\_\_\_

Place of purchase: \_\_\_\_\_

# TABLE OF CONTENTS

---

<b>Getting started</b>	<b>4</b>	<b>Your Acer Chromebook tour</b>	<b>6</b>
Turn on your Chromebook .....	4	Front view .....	6
Select your language settings .....	4	Keyboard view .....	7
Connect to a network .....	4	Function keys .....	8
Accept the Terms of Service .....	4	Common keyboard shortcuts .....	8
First-time sign-in .....	4	Touchpad .....	9
Create a new Google Account .....	4	Left view .....	10
Browse as a guest .....	4	USB Type-C information .....	10
Enterprise enrollment (optional) .....	5	Right view .....	11
Sign in to your Google Account .....	5	<b>Frequently asked questions</b>	<b>12</b>
		Get help or more information .....	13

# GETTING STARTED

---

## Turn on your Chromebook

On the Chromebook, press the power button. A "Welcome" screen will appear when the Chromebook first boots up.

## Select your language settings

Use the "Language" drop-down list to choose your default language setting. If there is more than one way to type in your language, you may be prompted to select a keyboard input method as well.

## Connect to a network

Select a network from the "Connect to network" list to connect to the Internet. If network access is protected, you will need an access password to connect to it.

## Accept the Terms of Service

Once connected to a network, accept the Terms of Service. Your Chromebook will then download any available system updates, so you automatically get the latest Chrome OS features.

## First-time sign-in

### Create a new Google Account

You can create a new Google Account if you don't already have one. Select **Create a Google Account** to set up a new account. A Google Account gives you access to useful web services developed by Google, such as Gmail, Google Drive, and Google Calendar.

### Browse as a guest

You can also use the Chromebook without a Google Account by selecting **Browse as a Guest**.

## Enterprise enrollment (optional)

You can enroll the Chromebook by selecting **Enterprise enrollment**.

## Sign in to your Google Account

If you already have a Google Account, enter your username and password in the sign-in box that appears and select the **Sign in** button. If your device is a Chromebook Enterprise, click **More options** and select **Enterprise enrollment**.

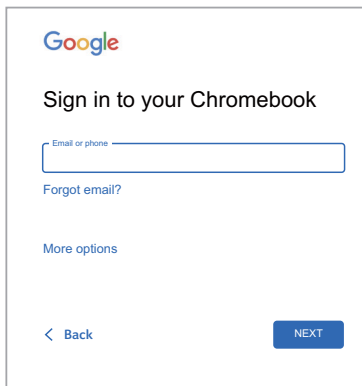

The screenshot shows the Google sign-in interface for a Chromebook. At the top is the Google logo. Below it is the text "Sign in to your Chromebook". There is a text input field with the placeholder text "Email or phone". Below the input field is a link for "Forgot email?". Further down is a link for "More options". At the bottom left is a "< Back" link, and at the bottom right is a blue "NEXT" button.



### Important

**Sign in with your primary Google Account. This account will be set as the owner and is the only account that will be able to change certain Chrome settings.**

# YOUR ACER CHROMEBOOK TOUR

## Front view

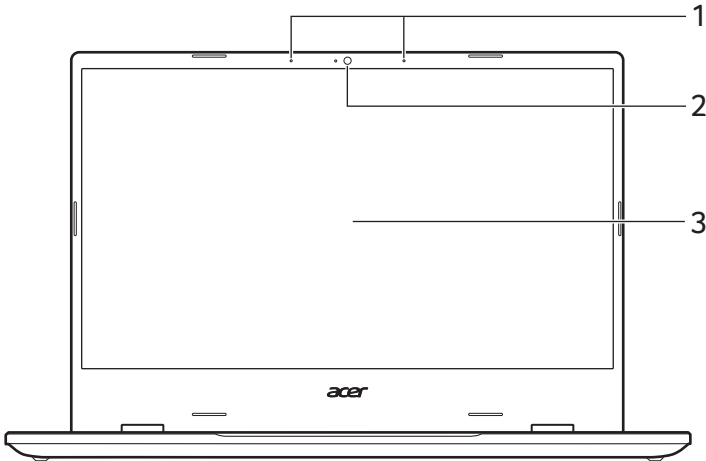

#	Icon	Item	Description
1		Microphone	Internal microphone for sound recording.
2		Webcam	Web camera for video communication. <i>A light next to the webcam indicates that the webcam is active.</i>
3		Screen	Displays computer output, supports touch or non-touch option.



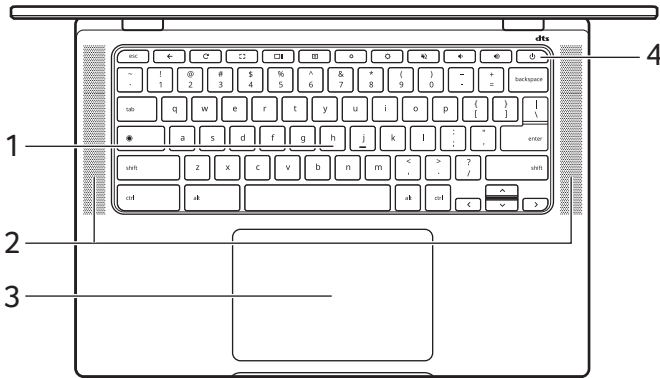







## Keyboard view



#	Icon	Item	Description
1		Keyboard	For entering data into your computer.
2		Speakers	Deliver stereo audio output.
3		Touchpad / click button	<p>Touch-sensitive pointing device which functions like a computer mouse.</p> <p><i>Pressing down anywhere on the pad functions like the left button of a mouse.</i></p> <p><i>Pressing down anywhere with two fingers functions like the right button of a mouse.</i></p>
4		Power button	Turns the computer on and off.



## Function keys

The Chromebook uses function keys or key combinations to access some hardware and software controls, such as screen brightness and volume. The dedicated function keys each have a specific function.

Icon	Function	Description
	Previous	Go to the previous page.
	Reload	Reload the current page.
	Full-screen	Open the page in full-screen mode.
	Next window	Switch to the next window.
	Screenshot	Takes screenshot.
	Brightness down	Decreases the screen brightness.
	Brightness up	Increases the screen brightness.
	Mute	Turns off audio output.
	Volume down	Decreases the volume.
	Volume up	Increases the volume.
	Launcher	Launch the Apps panel.

## Common keyboard shortcuts

You can use shortcuts to complete some tasks more quickly.

Keyboard shortcuts	Description
Ctrl + 	Takes screenshot.
Alt + 	Toggles caps lock.
Alt + 	Projects your screen.

**Note:** For a complete list of keyboard shortcuts, press **Ctrl + Alt + /**



## Touchpad

The built-in touchpad is a pointing device that senses movement on its surface. This means the cursor responds as you move your fingers across the surface of the touchpad.

Action	Gesture
Click	Press down on any part of the touchpad.
Two-finger tap (or alt-click)	Tapping the touchpad with two fingers or pressing (and holding) <b>Alt</b> on the keyboard and tapping the touchpad with one finger both equal a "right-click" on a computer mouse.
Two-finger swipe	Place two fingers on the touchpad and move them up and down to scroll vertically, left and right to scroll horizontally.
Drag and drop	Select the item you want to move with one finger. With a second finger, move the item. Release both fingers to drop the item. (This gesture works for files, not windows or icons.)

## Left view





#	Icon	Item	Description
1		USB Type-C port with DC-in	Connects to the provided USB Type-C power adapter and to USB devices with a USB Type-C connector. Supports DisplayPort™ over USB-C™.
2		USB 2.0 / 3.0 port	Connects to USB devices.
3		Headset/speaker jack	Connects to audio devices (e.g., speakers, headphones), or a headset with microphone.

## USB Type-C information

- USB 3.2 Gen 1 with transfer speeds up to 5 Gbps.
- Supports DisplayPort™ audio/video output.
- Delivers up to 3 A at 5 V DC for USB charging.
- DC-in: requires power adapter or power source providing 65 W at 9~20 V.  
For optimal performance, please use a certified Acer power adapter or USB Power Delivery device.





## Right view



#	Icon	Item	Description
1		Battery indicator	<p>Indicates the computer's battery status.</p> <p><b>Charging:</b> The light shows amber when the battery is charging.</p> <p><b>Fully charged:</b> The light shows blue when in AC mode.</p>
2		USB Type-C port with DC-in	<p>Connects to the provided USB Type-C power adapter and to USB devices with a USB Type-C connector.</p> <p>Supports DisplayPort™ over USB-C™.</p>

# FREQUENTLY ASKED QUESTIONS

---

Question	Answer
What software works on a Chromebook?	Chromebooks use apps from the Google Play Store and on the web, instead of traditional software applications. There are apps to be productive, get creative, enjoy movies and shows, play games and more.
How do I get more apps?	Download Chromebook apps from the Google Play Store app  . Find the app by clicking the Launcher icon  and searching “Play Store”.
Can I use Microsoft Office software?	Chromebooks work with Microsoft <sup>®</sup> Word, Excel <sup>®</sup> and PowerPoint <sup>®</sup> . You can download the apps from the Google Play Store or use them on the web. <i>*Additional functionality available with a Microsoft 365 subscription. Microsoft, Excel and PowerPoint are registered trademarks of Microsoft Corporation.</i>
Where can I find my files?	All your files are stored in the Files app  . Find the app by clicking the Launcher icon  and searching “Files”.
How do I transfer my local files?	Transfer your local files using a compatible storage device. Your Chromebook works with most external storage devices (e.g.: USB thumb drives, removable hard drives).
Why does my Chromebook need my Google Account information?	You’ll use your Google Account to sign in to your Chromebook. It is the same account you use for Google services such as Gmail and Drive. Your Chromebook uses your account information to automatically sign you into apps and services.

Question	Answer
How do I set this up for my child?	If you want to set up parental controls for your child, it's important that you sign in using your child's personal Google Account. If they don't already have one, you can create one during the sign-in process on your Chromebook. You will be able to add your child's school account after you complete device onboarding.

## Get help or more information

For information on:	Refer to:
Chromebook Help	Open the <b>Explore</b> app  on your Chromebook.
Chrome OS	<a href="https://google.com/support/chromebook/">google.com/support/chromebook/</a>