

Dell C2423H Dell C2723H Video Conferencing Monitor User's Guide

Model: C2423H/C2723H
Regulatory model: C2423Hb/C2723Hb



 **NOTE: A NOTE indicates important information that helps you make better use of your computer.**

 **CAUTION: A CAUTION indicates potential damage to hardware or loss of data if instructions are not followed.**

 **WARNING: A WARNING indicates a potential for property damage, personal injury, or death.**

Copyright © 2022 Dell Inc. or its subsidiaries. All rights reserved. Dell, EMC, and other trademarks are trademarks of Dell Inc. or its subsidiaries. Microsoft and Windows are either trademarks or registered trademarks of Microsoft Corporation in the United States and/or other countries. Other trademarks may be trademarks of their respective owners.

2022 - 02

Rev. A00

Contents

Safety Instructions	6
About Your Monitor	7
Product Features	9
Identifying Parts and Controls	11
Front View	11
Back View	12
Bottom View	13
Monitor Specifications	15
Resolution Specifications	16
Supported Video Modes	17
Preset Display Modes	17
Multi-Stream Transport (MST) Modes	18
Unified Communications (UC) Platform Compatibility List	18
Electrical Specifications	19
Webcam and Microphone Specifications	20
Speaker Specifications	20
Physical Characteristics	21
Monitor Environmental Characteristics	22
Pin Assignments	23
Universal Serial Bus (USB) Interface	26
USB Upstream Connector	26
USB Downstream Connector	27
USB Ports	27
Plug and Play Capability	28
LCD Monitor Quality and Pixel Policy	28
Ergonomics	28
Handling and Moving Your Display	30



Maintenance Guidelines	31
Cleaning Your Monitor	31
Setting Up the Monitor	33
Setting Up the Stand	33
Operating the Monitor Webcam	38
Organizing Your Cables	38
Securing Your Monitor Using Kensington Lock (optional)	39
Connecting Your Monitor	39
Connecting the HDMI Cable	40
Connecting the DisplayPort (DisplayPort to DisplayPort) Cable	40
Connecting the Monitor for DP Multi-Stream Transport (MST) Function	41
Using the Tilt, Swivel, and Vertical Extension	42
Tilt, Swivel	42
Vertical Extension	43
Rotating the Monitor	43
Rotate Clockwise	44
Rotate Counterclockwise	44
Adjusting the Rotation Display Settings of Your System	45
Removing the Monitor Stand	46
VESA Wall Mounting (optional)	46
Operating the Monitor	48
Power On the Monitor	48
Using the Joystick Control	48
Joystick Functions	49
Using the Main Menu	49
Using the Menu Launcher	49
Menu Launcher Details	50



Using the Navigation keys	51
Accessing the Menu System.....	51
OSD Messages	63
Initial Setup.....	63
OSD Warning Messages	63
Setting the Maximum Resolution.....	68
Setting Up Windows Hello	69
Setting Up the Monitor Webcam as Default Setting	73
Setting Up the Monitor Speaker as Default Setting	77
Troubleshooting	80
Self-test.....	80
Using the Joystick to Lock/Unlock Buttons.....	81
Locking the Power and Joystick Buttons	81
Updating Monitor Firmware	82
Common Problems	83
Product Specific Problems	86
Universal Serial Bus (USB) Specific Problems	94
Appendix	95
FCC Notices (U.S. only) and Other Regulatory Information.....	95
Contact Dell	95
EU Product Database for Energy Label and Product Information Sheet	95



Safety Instructions

⚠ WARNING: Use of controls, adjustments, or procedures other than those specified in this documentation may result in exposure to shock, electrical hazards, and/or mechanical hazards.

- Place the monitor on a solid surface and handle it carefully. The screen is fragile and can be damaged if dropped or hit sharply.
- Always be sure that your monitor is electrically rated to operate with the AC power available in your location.
- Keep the monitor in room temperature. Excessive cold or hot conditions can have an adverse effect on the liquid crystal of the display.
- Do not subject the monitor to severe vibration or high impact conditions. For example, do not place the monitor inside a car trunk.
- Unplug the monitor when it is going to be left unused for an extended period of time.
- To avoid electric shock, do not attempt to remove any cover or touch the inside of the monitor.

For information on safety instructions, see the *Safety, Environmental, and Regulatory Information* (SERI) document that is shipped with your monitor.





About Your Monitor

Package Contents



Your monitor ships with the components shown in the table below. If any component is missing, contact Dell technical support. For more information, see [Contact Dell](#).

 **NOTE: Some items may be optional and may not ship with your monitor. Some features may not be available in certain countries.**

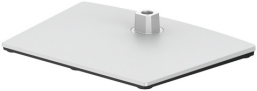
 **NOTE: If you are attaching a stand that you purchased from any other source, follow the set up instructions that were included with the stand.**

	Display
	Stand Riser
	Stand Base



	<p>Power Cable (varies by country)</p>
	<p>DisplayPort to DisplayPort cable Cable length: 1.80 M</p>
	<p>HDMI Cable Cable length: 1.80 M</p>
	<p>SuperSpeed USB 5 Gbps (USB 3.2 Gen1) Type-A to Type-B Upstream Cable (Enables the USB Ports on the Monitor) Cable length: 1.80 M</p>
	<ul style="list-style-type: none"> • Quick Setup Guide • Safety, Environmental, and Regulatory Information



Product Features

The **Dell C2423H/C2723H** monitor has an active matrix, Thin-Film Transistor (TFT), Liquid Crystal Display (LCD) and LED backlight. The monitor features include:

- **C2423H:** 60.47 cm (23.80 in.) viewable area (measured diagonally). 1920 x 1080 (16:9) resolution, plus full-screen support for lower resolutions.
- **C2723H:** 68.58 cm (27.00 in.) viewable area (measured diagonally). 1920 x 1080 (16:9) resolution, plus full-screen support for lower resolutions.
- Built-in speakers (2 x 5 W).
- Wide viewing angle to allow viewing from a sitting or standing position.
- Color gamut of sRGB 99%.
- Digital connectivity with DisplayPort and HDMI.
- Tilt, swivel, height, and rotate adjustment capabilities.
- Ultra-thin bezel minimizes the bezel gap in multi-monitor usage, enabling easier setup with an elegant viewing experience.
- Removable stand and Video Electronics Standards Association (VESA™) 100 mm mounting holes for flexible mounting solutions.
- Equipped with 1 USB Type-B (USB 3.2 Gen1) upstream port, 2 SuperSpeed USB 5 Gbps (USB 3.2 Gen1) Type-A downstream ports, and 2 SuperSpeed USB 5 Gbps (USB 3.2 Gen1) Type-A downstream charging ports (BC 1.2).
- Plug and play capability if supported by your system.
- On-Screen Display (OSD) adjustments for ease of set-up and screen optimization.
- Power and OSD buttons lock.
- Security lock slot.
- Stand lock.
- ≤ 0.3 W in Standby Mode.
- Certified for Windows Hello® (Face Authentication) and supports Microsoft Cortana®.
- The monitor uses Low Blue Light panel and is in compliance with TUV Rheinland (Hardware Solution) at factory reset/default setting mode.
- Decreases the level of hazard blue light emitted from the screen to make viewing more comfortable for your eyes.



- The monitor adopts Flicker-Free technology, which clears the eye visible flicker, brings comfort viewing experience and preventing users suffer from eye strain and fatigue.
- Optimize eye comfort with a flicker-free screen and low blue light feature.

 **WARNING: The possible long-term effects of blue light emission from the monitor may cause damage to the eyes, including eye fatigue, digital eye strain, and so on. ComfortView Plus feature is designed to reduce the amount of blue light emitted from the monitor to optimize eye comfort. The monitors use Low Blue Light panel and is in compliance with TUV Rheinland (Hardware Solution) at factory reset/default setting mode (Brightness: 75%, Contrast: 75%, Preset mode: Standard)**



Identifying Parts and Controls

Front View

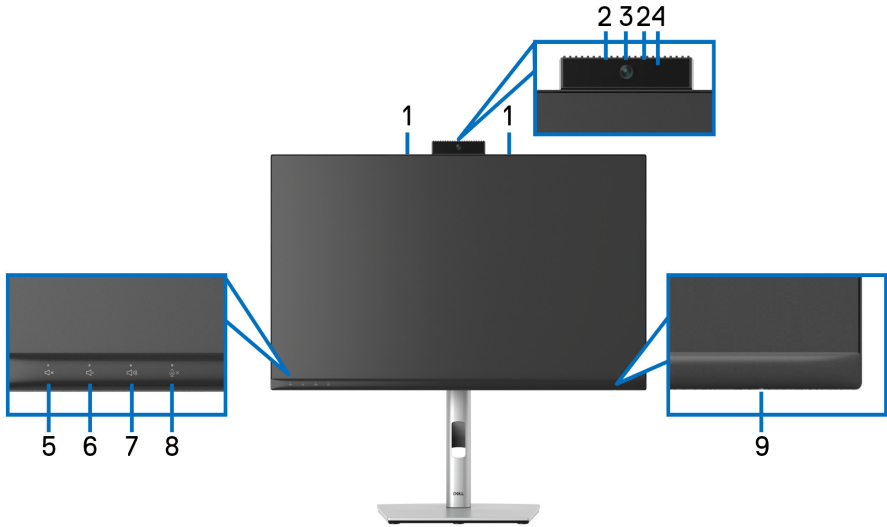

Front View with Monitor Stand

No.	Description	Use
1	Microphones	Monitor microphones (Mic).
2	IR LED	Indicator of infrared (IR).
3	Webcam lens	Transmits your image in a video conference.
4	Webcam LED indicator	Indicator of Webcam. It will light up in white when webcam is in use.
5	Speaker mute & LED	Press to mute and unmute speaker. LED will light up in static white when speaker is muted. LED will go dark when speaker is enabled/unmuted.
6	Volume down & LED	Short press for 2 unit volume decrement. Long press for continuous volume decrement.



7	Volume up & LED	Short press for 2 unit volume increment. Long press for continuous volume increment.
8	Microphone mute & LED	Press to mute and unmute microphone. LED will light up in static red when mic is muted. LED will go dark when mic is enabled/unmuted.
9	Power LED indicator	Solid white light indicates that the monitor is turned on and functioning normally. Breathing white light indicates that the monitor is in Standby Mode.

Back View



Back View with Monitor Stand

No.	Description	Use
1	VESA mounting holes (100 mm x 100 mm - behind the attached VESA Cover)	Wall mount monitor using VESA-compatible wall mount kit (100 mm x 100 mm).
2	Regulatory label	Lists the regulatory approvals.
3	Stand release button	Releases stand from the monitor.
4	Barcode, serial number, and Service Tag label	Contains monitor details and support information. Refer to this label if you need to contact Dell for technical support.
5	Power On/Off button	To turn the monitor on or off.



6	Joystick	Use to control the OSD menu. (For more Information, see Operating the Monitor)
7	Cable-management slot	Use to organize cables by inserting them through the slot.

Bottom View

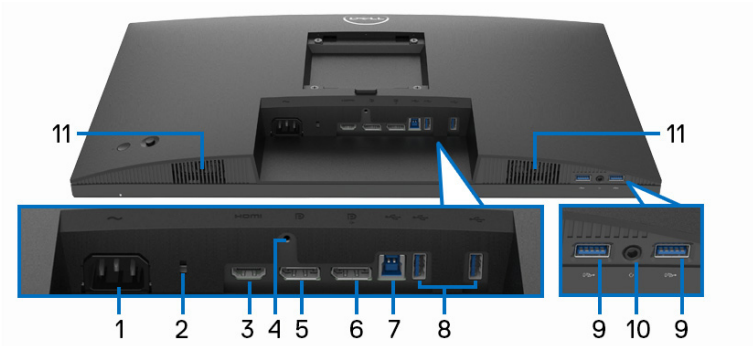

Bottom View without Monitor Stand

No.	Description	Use
1	Power connector	Connect the power cable (shipped with your monitor).
2	Security lock slot	Secures the monitor with security lock (security lock not included).
3	HDMI port	Connect your computer with the HDMI cable.
4	Stand lock feature	To lock the stand to the monitor using a M3 x 6 mm screw (screw not included).
5	DisplayPort	Connect your computer with the DisplayPort cable.



<p>6</p> 	<p>DisplayPort (out)</p>	<p>DisplayPort output for MST (multi-stream transport) capable monitor. To enable MST, see Connecting the Monitor for DP Multi-Stream Transport (MST) Function.</p> <p>NOTE: Remove the rubber plug when using DisplayPort out connector.</p>
<p>7</p>	<p>SuperSpeed USB 5 Gbps (USB 3.2 Gen1) Type-B upstream port</p>	<p>Connect the USB cable that comes with your monitor to the computer. Once this cable is connected, you can use the USB connectors on the monitor.</p>
<p>8</p>	<p>SuperSpeed USB 5 Gbps (USB 3.2 Gen1) Type-A downstream port (2)</p>	<p>Connect your USB device.*</p> <p>NOTE: To use this port, you must connect the USB upstream cable (shipped with your monitor) to the USB Type-B upstream port on the monitor and to your computer.</p>
<p>9</p>	<p>SuperSpeed USB 5 Gbps (USB 3.2 Gen1) Type-A downstream port with Power Charging (BC 1.2)</p>	<p>Connect your USB device* or charge your device</p> <p>NOTE: To use this port, you must connect the USB upstream cable (shipped with your monitor) to the USB Type-B upstream port on the monitor and to your computer.</p>
<p>10</p>	<p>Headphone jack</p>	<p>Connect headphones or headset to playback audio through HDMI or DisplayPort audio channels.</p> <p>CAUTION: Increasing the audio output beyond 50% on the volume control or equalizer may increase the output voltage on the headphones thereby increasing the sound pressure levels.</p>
<p>11</p>	<p>Built-in speakers</p>	<p>To output the sound from audio input.</p>

*To avoid signal interference, when a wireless USB device has been connected to a USB downstream port, it is NOT recommended to connect any other USB devices to the adjacent port(s).



Monitor Specifications

Model	C2423H	C2723H
Screen type	Active matrix - TFT LCD	
Panel technology	In-Plane Switching Technology	
Aspect ratio	16:9	
Viewable Image		
Diagonal	604.70 mm (23.80 in.)	685.80 mm (27.00 in.)
Width (active area)	527.04 mm (20.75 in.)	597.89 mm (23.54 in.)
Height (active area)	296.46 mm (11.67 in.)	336.31 mm (13.24 in.)
Total area	156246.28 mm ² (242.18 in. ²)	201076.38 mm ² (311.67 in. ²)
Pixel pitch	0.2745 mm x 0.2745 mm	0.3114 mm x 0.3114 mm
Pixel per inch (PPI)	92.53	81.59
Viewing angle	178° (vertical) typical 178° (horizontal) typical	
Luminance output	250 cd/m ² (typical)	300 cd/m ² (typical)
Contrast ratio	1000 to 1 (typical)	
Faceplate coating	Anti-Glare with 3H hardness	
Backlight	LED	
Response time	8 ms (Normal) 5 ms (Fast)	
Color depth	16.78 million colors	
Color gamut	sRGB 99%	
Built-in devices	1 x USB 3.2 Gen1 upstream port 4 x USB 3.2 Gen1 downstream ports	



Connectivity	<ul style="list-style-type: none"> • 1 x DisplayPort version 1.2* (HDCP 1.4) • 1 x HDMI port version 1.4 (HDCP 1.4) • 1 x DisplayPort (Out) with MST • 1 x USB Type-B (USB 3.2 Gen1) upstream port • 2 x SuperSpeed USB 5 Gbps (USB 3.2 Gen1) downstream ports • 2 x SuperSpeed USB 5 Gbps (USB 3.2 Gen1) downstream ports with BC1.2 charging capability at 2 A (maximum) • 1 x 3.5 mm headphone jack 	
Border width (edge of monitor to active area)	5.37 mm (Top)	5.99 mm (Top)
	5.38 mm (Left/Right)	6.01 mm (Left/Right)
	17.06 mm (Bottom)	17.06 mm (Bottom)
Adjustability		
Height adjustable stand	150 mm	
Tilt	-5° to 21°	
Swivel	-45° to 45°	
Pivot	-90° to 90°	
Dell Display Manager (DDM) compatibility	Easy Arrange and other key features	
Security	Security lock slot (cable lock sold separately)	

*DisplayPort 1.2/MST/DP audio is supported.

Resolution Specifications

Model	C2423H/C2723H
Horizontal scan range	30 kHz to 83 kHz (automatic)
Vertical scan range	56 Hz to 76 Hz (automatic)
Maximum preset resolution	1920 x 1080 at 60 Hz



Supported Video Modes

Model	C2423H/C2723H
Video display capabilities (HDMI & DisplayPort)	480p, 576p, 720p, 1080i*, 1080p

*Supported by HDMI input only.

Preset Display Modes

Display Mode	Horizontal Frequency (kHz)	Vertical Frequency (Hz)	Pixel Clock (MHz)	Sync Polarity (Horizontal /Vertical)
VESA, 720 x 400	31.47	70.08	28.32	-/+
VESA, 640 x 480	31.47	60.00	25.17	-/-
VESA, 640 x 480	37.50	75.00	31.50	-/-
VESA, 800 x 600	37.88	60.32	40.00	+/+
VESA, 800 x 600	46.88	75.00	49.50	+/+
VESA, 1024 x 768	48.36	60.00	65.00	-/-
VESA, 1024 x 768	60.02	75.03	78.75	+/+
VESA, 1152 x 864	67.50	75.00	108.00	+/+
VESA, 1280 x 1024	64.00	60.02	108.00	+/+
VESA, 1280 x 1024	80.00	75.02	135.00	+/+
VESA, 1600 x 900	60.00	60.00	108.00	+/+
VESA, 1920 x 1080	67.50	60.00	148.50	+/+

 **NOTE: The + or - sign in Sync polarity denotes that the video sync signal is triggered by either the positive edge or the negative edge, respectively.**



Multi-Stream Transport (MST) Modes

MST Source Monitor	Maximum Number of External Monitors that can be Supported
	1920 x 1080 at 60 Hz
1920 x 1080 at 60 Hz	• 3

Unified Communications (UC) Platform Compatibility List

The table below highlights the call functions that work on the Dell Video Conferencing Monitor – **C2423H** and **C2723H** when using the following UC platforms[#].

Buttons	Teams app	Zoom app	Other UC apps (Skype for Business, Google Hangouts, Blue Jeans, Cisco Webex, FaceTime, Slack, GoToMeeting)
Speaker Mute	√	√	√
Volume Down	√	√	√
Volume Up	√	√	√
Microphone Mute	√	√*	√*

√ Call function works with the UC platform.

* Mute function works by pressing the Mute button, but the Mute Icon on the UC platform is not sync (Icon shows unmute).

On Windows 10 64 Bit OS.



Electrical Specifications

Model	C2423H	C2723H
Video input signals	<ul style="list-style-type: none"> HDMI 1.4*/DisplayPort 1.2**, 600 mV for each differential line, 100 ohm input impedance per differential pair 	
AC input voltage/frequency/current	100 VAC to 240 VAC / 50 Hz or 60 Hz \pm 3 Hz / 1.5 A (typical)	
Inrush current	<ul style="list-style-type: none"> 120 V: 30 A (Max.) at 0°C (cold start) 240 V: 60 A (Max.) at 0°C (cold start) 	<ul style="list-style-type: none"> 120 V: 40 A (Max.) at 0°C (cold start) 240 V: 80 A (Max.) at 0°C (cold start)
Power consumption	<ul style="list-style-type: none"> 0.3 W (Off mode)¹ 0.3 W (Standby mode)¹ 12.6 W (On mode)¹ 82 W (Max.)² 11.51 W (P_{on})³ 36.88 kWh (TEC)³ 	<ul style="list-style-type: none"> 0.2 W (Off mode)¹ 0.3 W (Standby mode)¹ 13.2 W (On mode)¹ 85 W (Max.)² 11.80 W (P_{on})³ 37.72 kWh (TEC)³

*Not supporting the HDMI 1.4 optional specification, including HDMI Ethernet Channel (HEC), Audio Return Channel (ARC), standard for 3D format and resolutions, and standard for 4K digital cinema resolution.

**DisplayPort 1.2/MST/DP audio is supported.

¹ As defined in EU 2019/2021 and EU 2019/2013.

² Max brightness and contrast setting with maximum power loading on all USB ports.

³ P_{on}: Power consumption of On mode as defined in Energy Star 8.0 version.

TEC: Total energy consumption in kWh as defined in Energy Star 8.0 version.

This document is informational only and reflects laboratory performance. Your product may perform differently, depending on the software, components and peripherals you ordered and shall have no obligation to update such information.

Accordingly, the customer should not rely upon this information in making decisions about electrical tolerances or otherwise. No warranty as to accuracy or completeness is expressed or implied.





NOTE: This monitor is ENERGY STAR certified. This product qualifies for ENERGY STAR in the factory default settings which can be restored by “Factory Reset” function in the OSD menu. Changing the factory default settings or enabling other features may increase power consumption that could exceed the ENERGY STAR specified limit.



Webcam and Microphone Specifications

Model	C2423H/C2723H	
Lens	Field of view	88.9° for 2560 x 1920
	Focus mode	Fixed Focus
	Focus area	35 cm ~ 1.5 m
	Focusing distance (normal mode)	70 cm
Image Sensor	Active array size	5 mega-pixel
Video Specification	Video frame rate	1920 x 1080 (Full HD)- up to 30 frames per second
Audio Specification	Microphone type	Digital microphone x 2
Interface	USB 2.0 High Speed	
Power Supply	3.3 volts +/- 5% for USB and Microphone	
	5 volts +/- 5% for IR camera	

Speaker Specifications

Model	C2423H/C2723H	
Speaker rated power	2 x 5 W	
Frequency Response	200 Hz - 16 kHz	
Impedance	8 ohm	



Physical Characteristics

Model	C2423H	C2723H
Signal Cable Type	<ul style="list-style-type: none"> Digital: DisplayPort, 20 pins Digital: HDMI, 19 pins Universal Series Bus: USB Type-A to B 	
<p>NOTE: Dell monitors are designed to work optimally with the video cables that are shipped with your monitor. As Dell does not have control over the different cable suppliers in the market, the type of material, connector and process used to manufacture these cables, Dell does not guarantee video performance on cables that are not shipped with your Dell monitor.</p>		
Monitor Dimensions (with stand)		
Height (extended)	496.10 mm (19.53 in.)	534.15 mm (21.03 in.)
Height (compressed)	364.00 mm (14.33 in.)	384.15 mm (15.12 in.)
Width	537.80 mm (21.17 in.)	609.90 mm (24.01 in.)
Depth	179.57 mm (7.07 in.)	190.10 mm (7.48 in.)
Monitor Dimensions (without stand)		
Height	318.89 mm (12.55 in.)	359.37 mm (14.15 in.)
Width	537.80 mm (21.17 in.)	609.90 mm (24.01 in.)
Depth	57.85 mm (2.28 in.)	59.38 mm (2.34 in.)
Stand Dimensions		
Height (extended)	410.80 mm (16.17 in.)	428.30 mm (16.86 in.)
Height (compressed)	364.00 mm (14.33 in.)	381.50 mm (15.02 in.)
Width	245.00 mm (9.65 in.)	268.00 mm (10.55 in.)
Depth	179.57 mm (7.07 in.)	190.10 mm (7.48 in.)
Base	245.00 mm (9.65 in.) x 173.00 mm (6.81 in.)	268.00 mm (10.55 in.) x 185.00 mm (7.28 in.)
Monitor Weight		
Model	C2423H	C2723H
Weight with packaging	8.33 kg (18.36 lb)	10.01 kg (22.07 lb)
Weight with stand assembly and cables	6.02 kg (13.27 lb)	7.24 kg (15.96 lb)



Weight without stand assembly (For wall mount or VESA mount considerations - no cables)	3.83 kg (8.44 lb)	5.04 kg (11.11 lb)
Weight of stand assembly	1.76 kg (3.88 lb)	1.76 kg (3.88 lb)
Front frame gloss	2-4	

Monitor Environmental Characteristics

Model	C2423H	C2723H
Compliant Standards		
<ul style="list-style-type: none"> ENERGY STAR certified monitor EPEAT registered where applicable. EPEAT registration varies by country. See www.epeat.net for registration status by country. RoHS-compliant TCO Certified and TCO Certified Edge BFR/PVC free monitor (excluding external cables) Meets NFPA 99 leakage current requirements Arsenic-free glass and Mercury-free for the panel only 		
Temperature		
Operating	0°C to 40°C (32°F to 104°F)	
Non-operating	<ul style="list-style-type: none"> Storage: -20°C to 60°C (-4°F to 140°F) Shipping: -20°C to 60°C (-4°F to 140°F) 	
Humidity		
Operating	10% to 80% (non-condensing)	
Non-operating	<ul style="list-style-type: none"> Storage: 5% to 90% (non-condensing) Shipping: 5% to 90% (non-condensing) 	
Altitude		
Operating	5000 m (16404 ft) (maximum)	
Non-operating	12192 m (40000 ft) (maximum)	



Thermal Dissipation	<ul style="list-style-type: none"> • 279.78 BTU/hour (maximum) • 40.94 BTU/hour (typical) 	<ul style="list-style-type: none"> • 290.03 BTU/hour (maximum) • 45.04 BTU/hour (typical)
----------------------------	---	---

Pin Assignments

DP Port (in)

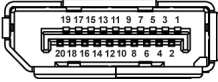

Pin Number	20-pin Side of the Connected Signal Cable
1	ML3 (n)
2	GND
3	ML3 (p)
4	ML2 (n)
5	GND
6	ML2 (p)
7	ML1 (n)
8	GND
9	ML1 (p)
10	ML0 (n)
11	GND
12	ML0 (p)
13	GND
14	GND
15	AUX (p)
16	GND
17	AUX (n)
18	Hot Plug Detect
19	Re-PWR
20	+3.3 V DP_PWR



DP Port (out)

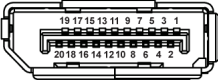

Pin Number	20-pin Side of the Connected Signal Cable
1	ML0 (p)
2	GND
3	ML0 (n)
4	ML1 (p)
5	GND
6	ML1 (n)
7	ML2 (p)
8	GND
9	ML2 (n)
10	ML3 (p)
11	GND
12	ML3 (n)
13	CONFIG1
14	CONFIG2
15	AUX CH (p)
16	GND
17	AUX CH (n)
18	Hot Plug Detect
19	Return
20	DP_PWR



HDMI Port

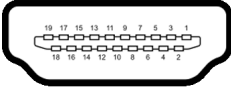

Pin Number	19-pin Side of the Connected Signal Cable
1	TMDS DATA 2+
2	TMDS DATA 2 SHIELD
3	TMDS DATA 2-
4	TMDS DATA 1+
5	TMDS DATA 1 SHIELD
6	TMDS DATA 1-
7	TMDS DATA 0+
8	TMDS DATA 0 SHIELD
9	TMDS DATA 0-
10	TMDS CLOCK+
11	TMDS CLOCK SHIELD
12	TMDS CLOCK-
13	CEC
14	Reserved (N.C. on device)
15	DDC CLOCK (SCL)
16	DDC DATA (SDA)
17	DDC/CEC Ground
18	+5 V POWER
19	HOT PLUG DETECT



Universal Serial Bus (USB) Interface

This section gives you information about the USB ports that are available on the monitor.

NOTE: This monitor is SuperSpeed USB 5 Gbps (USB 3.2 Gen1) and High-speed USB 2.0 compatible.

USB 3.2 Gen1

Transfer Speed	Data Rate	Power Supported
SuperSpeed	5 Gbps	4.5 W
High speed	480 Mbps	4.5 W
Full speed	12 Mbps	4.5 W

USB 2.0

Transfer Speed	Data Rate	Power Supported
High speed	480 Mbps	2.5 W
Full speed	12 Mbps	2.5 W
Low speed	1.5 Mbps	2.5 W

USB Upstream Connector

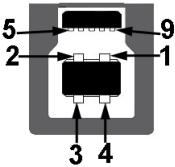

Pin Number	9-pin Side of the Connector
1	VCC
2	D-
3	D+
4	GND
5	SSTX-



6	SSTX+
7	GND
8	SSRX-
9	SSRX+

USB Downstream Connector



Pin Number	9-pin Side of the Connector
1	VCC
2	D-
3	D+
4	GND
5	SSRX-
6	SSRX+
7	GND
8	SSTX-
9	SSTX+

USB Ports

- 1 USB Type-B (USB 3.2 Gen1) upstream port - bottom
- 4 SuperSpeed USB 5 Gbps (USB 3.2 Gen1) Type-A downstream ports- 2 at bottom, 2 at rear
Power Charging Port - the ports with  battery icon supports fast current charging capability if the device is BC 1.2 compatible.

 **NOTE: SuperSpeed USB 5 Gbps (USB 3.2 Gen1) functionality requires a SuperSpeed USB 5 Gbps (USB 3.2 Gen1)-capable computer.**

 **NOTE: The USB ports on the monitor work only when the monitor is turned On or in Standby Mode. If you turn Off the monitor and then turn it On, the attached peripherals may take a few seconds to resume normal functionality.**



Plug and Play Capability

You can connect the monitor to any Plug and Play-compatible system. The monitor automatically provides the computer system with its Extended Display Identification Data (EDID) using Display Data Channel (DDC) protocols so that the system can configure itself and optimize the monitor settings. Most monitor installations are automatic; you can select different settings if desired. For more information about changing the monitor settings, see [Operating the Monitor](#).

LCD Monitor Quality and Pixel Policy

During the LCD Monitor manufacturing process, it is not uncommon for one or more pixels to become fixed in an unchanging state which are hard to see and do not affect the display quality or usability. For more information on Dell Monitor Quality and Pixel Policy, see <http://www.dell.com/pixelguidelines>.

Ergonomics

△ CAUTION: Improper or prolonged usage of keyboard may result in injury.

△ CAUTION: Viewing the monitor screen for extended periods of time may result in eye strain.

For comfort and efficiency, observe the following guidelines when setting up and using your computer workstation:

- Position your computer so that the monitor and keyboard are directly in front of you as you work. Special shelves are commercially available to help you correctly position your keyboard.
- To reduce the risk of eye strain and neck/arm/back/shoulder pain from using the monitor for long periods of time, we suggest you to:
 1. Set the distance of the screen between 20 to 28 in. (50 - 70 cm) from your eyes.
 2. Blink frequently to moisten your eyes or wet your eyes with water after prolonged usage of the monitor
 3. Take regular and frequent breaks for 20 minutes every two hours.
 4. Look away from your monitor and gaze at a distant object at 20 feet away for at least 20 seconds during the breaks.
 5. Perform stretches to relieve tension in the neck, arm, back, and shoulders during the breaks.
- Make sure that the monitor screen is at eye level or slightly lower when you are sitting in front of the monitor.



- Adjust the tilt of the monitor, its contrast, and brightness settings.
- Adjust the ambient lighting around you (such as overhead lights, desk lamps, and the curtains or blinds on nearby windows) to minimize reflections and glare on the monitor screen.
- Use a chair that provides good lower-back support.
- Keep your forearms horizontal with your wrists in a neutral, comfortable position while using the keyboard or mouse.
- Always leave space to rest your hands while using the keyboard or mouse.
- Let your upper arms rest naturally on both sides.
- Ensure that your feet are resting flat on the floor.
- When sitting, make sure that the weight of your legs is on your feet and not on the front portion of your seat. Adjust your chair's height or use a footrest if necessary to maintain a proper posture.
- Vary your work activities. Try to organize your work so that you do not have to sit and work for extended periods of time. Try to stand or get up and walk around at regular intervals.
- Keep the area under your desk clear of obstructions and cables or power cords that may interfere with comfortable seating or present a potential trip hazard.

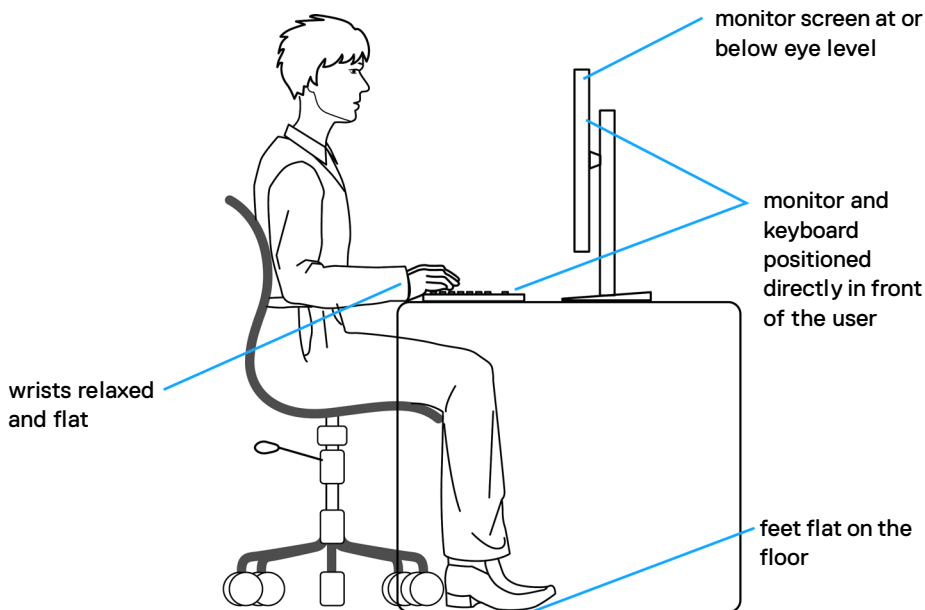

Handling and Moving Your Display

To ensure the monitor is handled safely when lifting or moving it, follow the guidelines mentioned below:

- Before moving or lifting the monitor, turn off your computer and the monitor.
- Disconnect all cables from the monitor.
- Place the monitor in the original box with the original packing materials.
- Hold the bottom edge and the side of the monitor firmly without applying excessive pressure when lifting or moving the monitor.

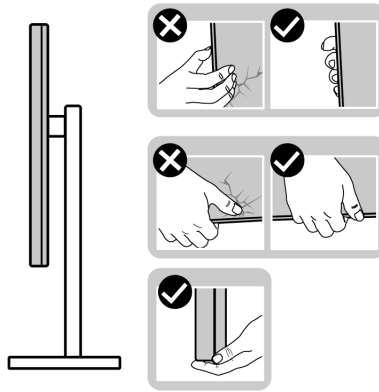

- When lifting or moving the monitor, ensure the screen is facing away from you and do not press on the display area to avoid any scratches or damage.

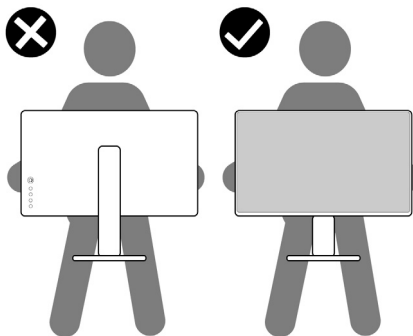

- When transporting the monitor, avoid any sudden shock or vibration to it.



- When lifting or moving the monitor, do not turn the monitor upside down while holding the stand base or stand riser. This may result in accidental damage to the monitor or cause personal injury.

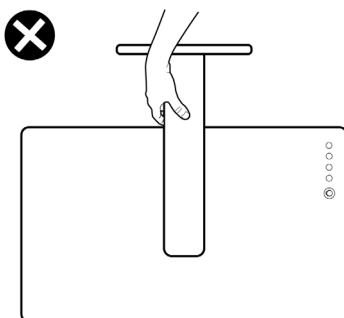

Maintenance Guidelines

Cleaning Your Monitor

Improper cleaning methods can result in physical damage to Dell monitors. Physical defects may affect the screen and body of the monitor.

⚠ CAUTION: Read and follow the [Safety Instructions](#) before cleaning the monitor.

⚠ WARNING: Before cleaning the monitor, unplug the monitor power cable from the electrical outlet.

For best practices, follow the instructions in the list below when unpacking, cleaning, or handling your monitor:

- To clean the Dell Monitor screen, lightly dampen a soft, clean cloth with water. If possible, use a special screen-cleaning tissue or solution suitable for the Dell Monitor screen.

⚠ CAUTION: Do not use detergents of any kind or other chemicals such as benzene, thinner, ammonia, abrasive cleaners, or compressed air.

- **Do not directly spray the cleaning solution or even water on the surface of the monitor.** Directly spraying liquid onto the panel will roll down to the bottom of the panel and corrode the electronics resulting in permanent damage. Instead, apply solution or water to soft cloth material.



 **NOTE: Using cleaner may cause changes in the appearance of the monitor, such as color fading, milky film on the monitor, deformation, uneven dark shade, and screen surface peeling.**



 **NOTE: Monitor damage due to improper cleaning methods and the use of benzene, thinner, ammonia, abrasive cleaners, alcohol, compressed air, detergent of any kind will lead to a Customer Induced Damage (CID). CID is not covered under the standard Dell warranty.**

- If you notice white powder when you unpack your monitor, wipe it off with a cloth.
- Handle your monitor with care as a darker-colored monitor may get scratched and show white scuff marks more than a lighter-colored monitor.
- To help maintain the best image quality on your monitor, use a dynamically changing screen saver and turn off your monitor when not in use.



Setting Up the Monitor

Setting Up the Stand

-  **NOTE:** The stand is not factory-installed.
-  **NOTE:** The following steps are specifically for setting up the stand that is shipped with your monitor. If you are attaching a stand that you purchased from any other source, follow the set up instructions that were included with the stand.

To set up the monitor stand:

1. Follow the instructions on the flaps of packaging box to remove the stand from the top cushion that secures it.
2. Remove the stand base and stand riser from the packaging cushion.

C2423H

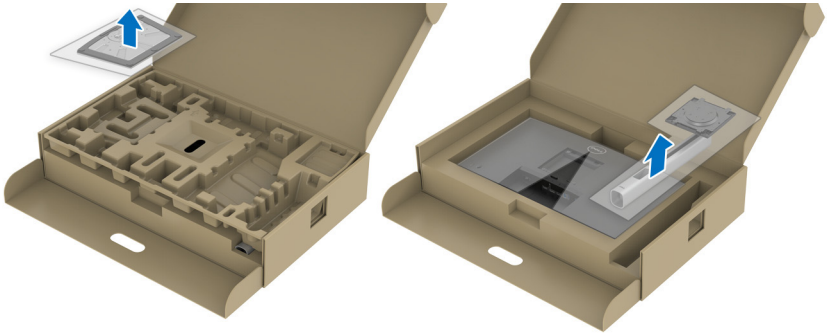

C2723H

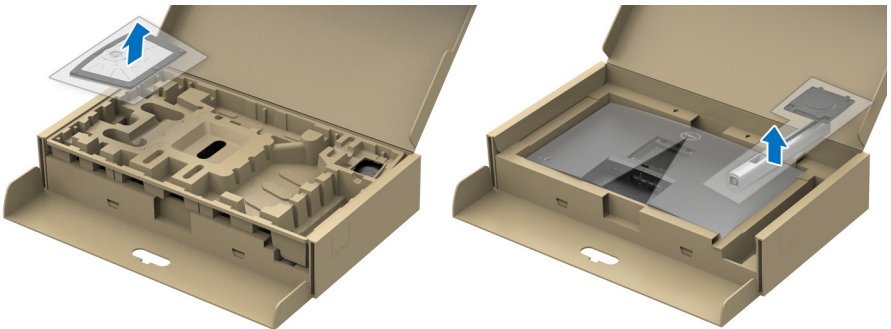

3. Align and place the stand riser on the stand base.
4. Open the screw handle at the bottom of the stand base and turn it clockwise to secure the stand assembly.
5. Close the screw handle.

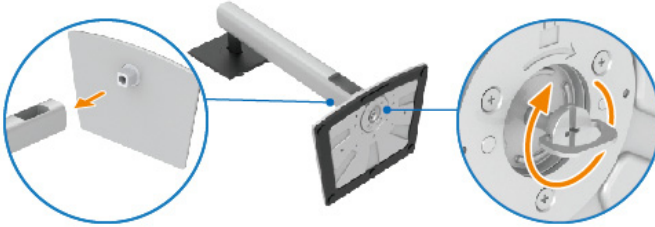

6. Open the protective cover to access the VESA slot on the display.

C2423H

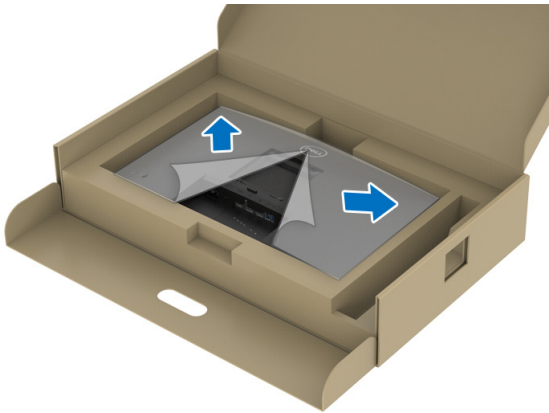

C2723H

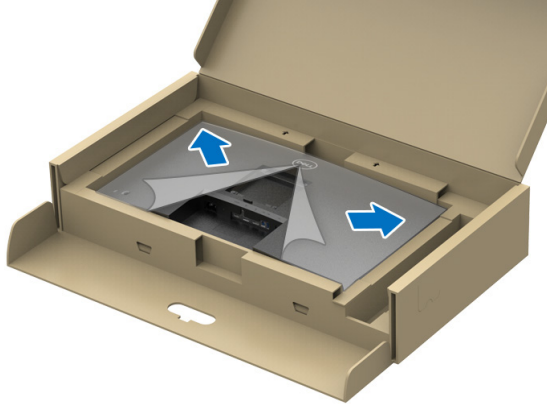

NOTE: Before attaching the stand assembly to the display, ensure that the front plate flap is opened to allow space for assembly.

7. Attach the stand assembly to the display.
 - a. Align and slide the tabs on the stand riser into the VESA slot.
 - b. Press the stand down till it snaps into place.

C2423H

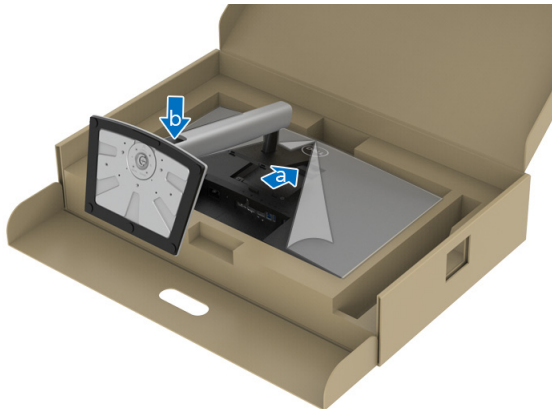

C2723H

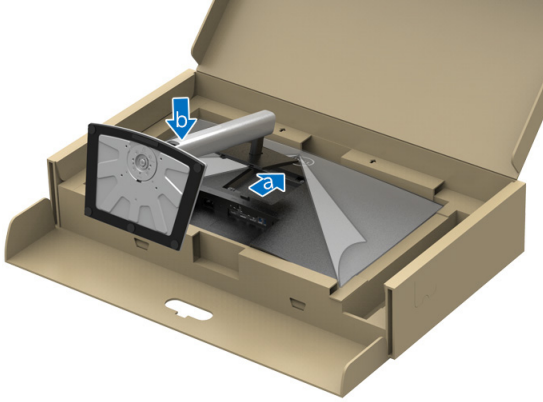

8. Hold the stand riser with both hands firmly and lift the monitor. Then place the monitor in an upright position on a flat surface.

NOTE: Hold the stand riser firmly when lifting the monitor to avoid any accidental damage.

C2423H

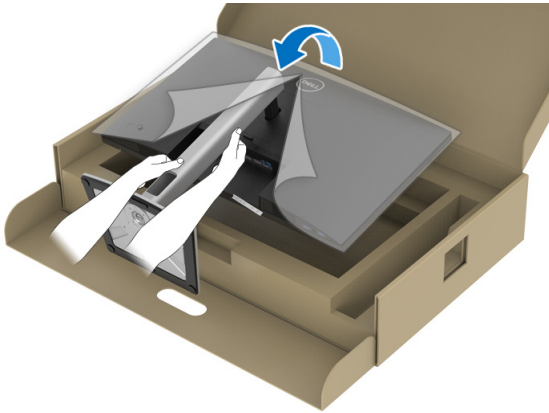

C2723H

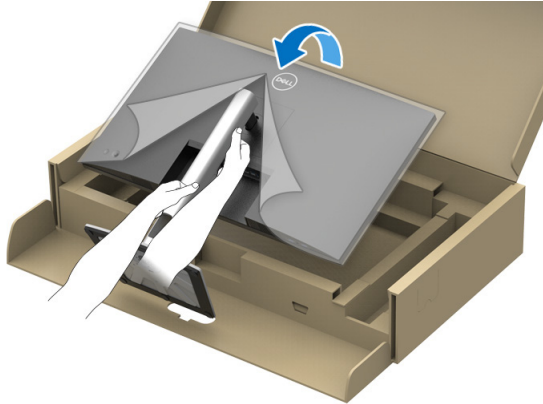

9. Lift the protective cover from the monitor.

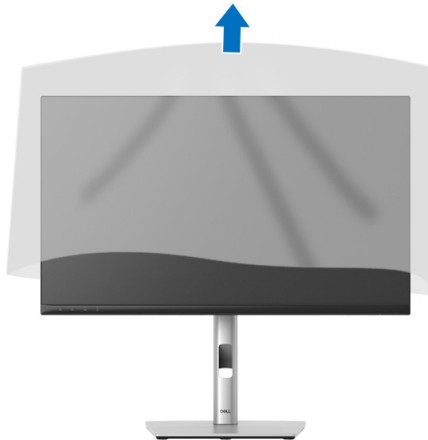

Operating the Monitor Webcam

When you want to use the monitor built-in webcam, press down on the webcam module and then release. The webcam module will pop up.

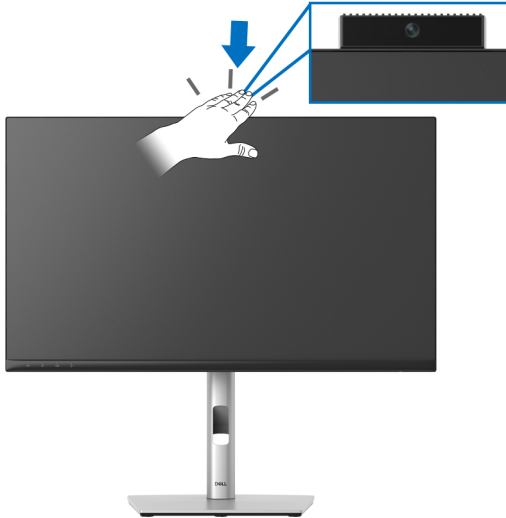

Organizing Your Cables



After attaching all necessary cables to your monitor and computer (See [Connecting Your Monitor](#) for cable attachment), organize all cables as shown above.

If your cable is not able to reach your PC, you may connect directly to the PC without routing through the slot on the monitor stand.



Securing Your Monitor Using Kensington Lock (optional)

The security-lock slot is located at the bottom of the monitor (see [Security lock slot](#)). Secure your monitor to a table using the Kensington security lock.

For more information on using the Kensington lock (sold separately), see the documentation that is shipped with the lock.

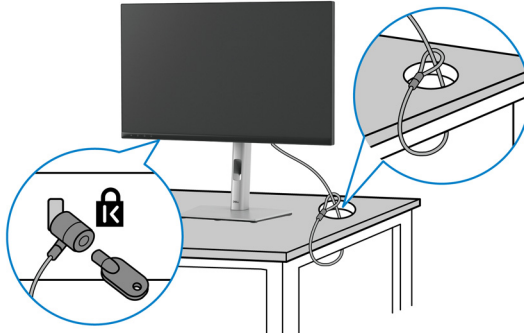

NOTE: The image is for the purpose of illustration only. The appearance of the lock may vary.

Connecting Your Monitor

WARNING: Before you begin any of the procedures in this section, follow the [Safety Instructions](#).

NOTE: Dell monitors are designed to work optimally with Dell supplied inbox cables. Dell does not guarantee the video quality and performance when using non-Dell cables.

NOTE: Route the cables through the cable-management slot before connecting them.

NOTE: Do not connect all cables to the computer at the same time.

NOTE: The graphics are used for the purpose of illustration only. Appearance of the computer may vary.

To connect your monitor to the computer:

1. Turn Off your computer and disconnect the power cable.
2. Connect the DisplayPort or HDMI cable from your monitor to the computer.



Connecting the HDMI Cable

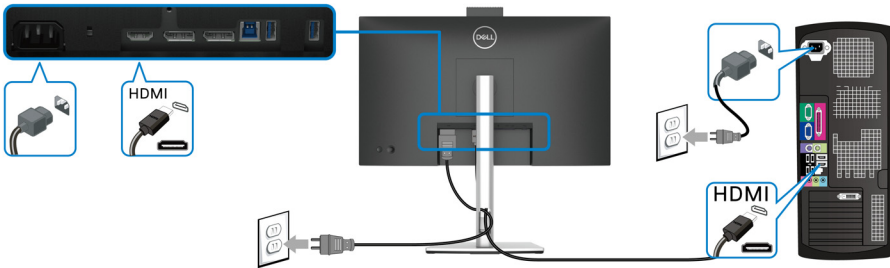

NOTE: The default out of factory setting is HDMI 1.4.

Connecting the DisplayPort (DisplayPort to DisplayPort) Cable

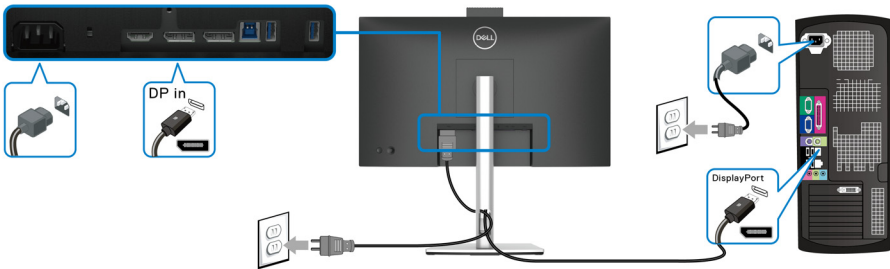

NOTE: The default out of factory setting is DP1.2. If the monitor fails to show any content after the DisplayPort cable is connected, follow the procedures below to change the settings to DP1.1:

- Press the joystick to open the Menu Launcher.
- Toggle the joystick to select Input Source.
- Toggle the joystick to highlight DP.
- Press and hold the joystick for approximately 10 seconds, and the DisplayPort configuration message appears.
- Toggle the joystick to select **Yes** and then press the joystick to save the changes.



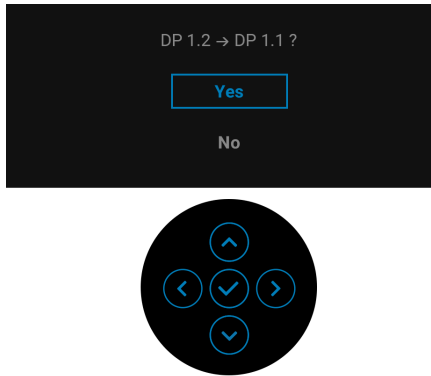

Repeat the above steps to change the DisplayPort format settings if necessary.

Connecting the Monitor for DP Multi-Stream Transport (MST) Function

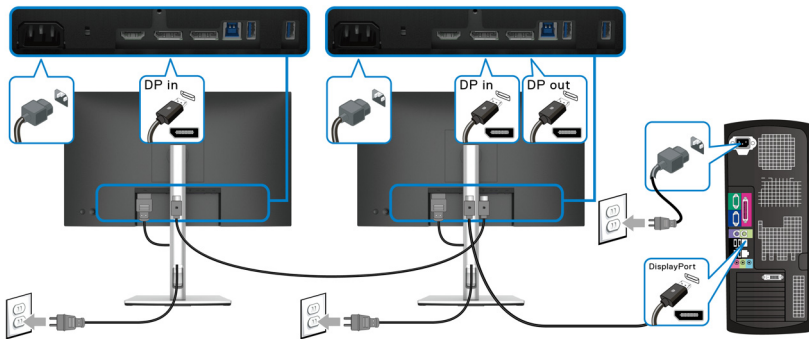

NOTE: This monitor supports the DP MST feature. To make use of this feature, your PC Graphics Card must be certified to at least DP1.2 with MST option.

NOTE: Remove the rubber plug when using DP out connector.

CAUTION: The graphics are used for the purpose of illustration only. Appearance of the computer may vary.

If your monitor displays an image, installation is complete. If it does not display an image, see [Common Problems](#).



Using the Tilt, Swivel, and Vertical Extension

NOTE: The following instructions are applicable only for attaching the stand that was shipped with your monitor. If you are attaching a stand that you purchased from any other source, follow the set up instructions that were included with the stand.

Tilt, Swivel

With the stand attached to the monitor, you can tilt and swivel the monitor for the most comfortable viewing angle.

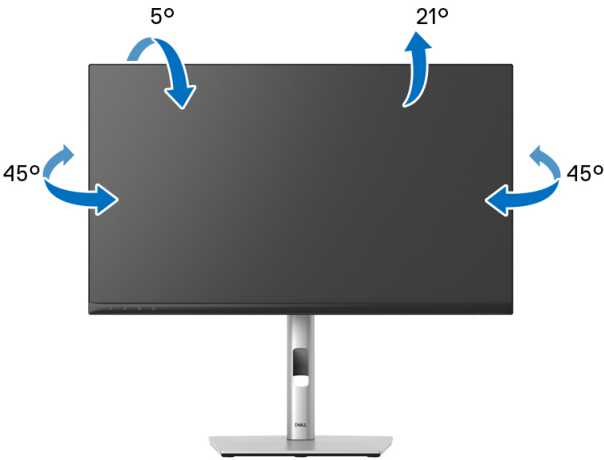

NOTE: The stand is not installed at the factory when shipped.



Vertical Extension

 **NOTE:** The stand extends vertically up to 150 mm. The figure below illustrates how to extend the stand vertically.

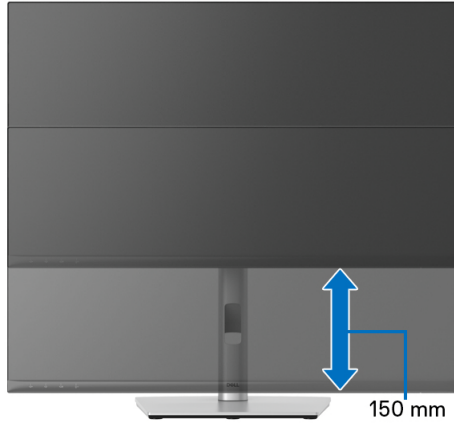

Rotating the Monitor

Before you rotate the monitor, your monitor should be fully vertically extended ([Vertical Extension](#)) and fully tilted up to avoid hitting the bottom edge of the monitor.

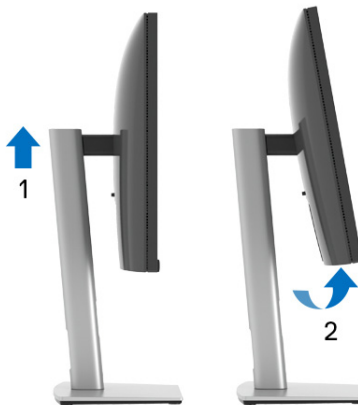



Rotate Clockwise



Rotate Counterclockwise



-  **NOTE:** To use the Display Rotation function (Landscape versus Portrait view) with your Dell computer, you require an updated graphics driver that is not included with this monitor. To download the graphics driver, go to www.dell.com/support and see the Download section for Video Drivers for latest driver updates.
-  **NOTE:** When in the Portrait View Mode, you may experience performance degradation in graphic-intensive applications (3D Gaming and etc.).



Adjusting the Rotation Display Settings of Your System

After you have rotated your monitor, you need to complete the procedure below to adjust the Rotation Display Settings of your system.

 **NOTE: If you are using the monitor with a non-Dell computer, you need to go the graphics driver website or your computer manufacturer website for information on rotating the 'contents' on your display.**

To adjust the Rotation Display Settings:



1. Right-click on the desktop and click **Properties**.
2. Select the **Settings** tab and click **Advanced**.
3. If you have an ATI graphics card, select the **Rotation** tab and set the preferred rotation.
4. If you have an nVidia graphics card, click the **nVidia** tab, in the left-hand column select **NVRotate**, and then select the preferred rotation.
5. If you have an Intel[®] graphics card, select the **Intel** graphics tab, click **Graphic Properties**, select the **Rotation** tab, and then set the preferred rotation.

 **NOTE: If you do not see the rotation option or it is not working correctly, go to www.dell.com/support and download the latest driver for your graphics card.**

 **NOTE: You can also refer to the [Rotation](#) function on your OSD to rotate your display.**



Removing the Monitor Stand

-  **NOTE:** To prevent scratches on the LCD screen when removing the stand, ensure that the monitor is placed on a soft, clean surface.
-  **NOTE:** The following instructions are applicable only for attaching the stand that was shipped with your monitor. If you are attaching a stand that you purchased from any other source, follow the set up instructions that were included with the stand.



To remove the stand:

1. Place the monitor on a soft cloth or cushion.
2. Press and hold the stand release button.
3. Lift the stand up and away from the monitor.

VESA Wall Mounting (optional)



(Screw dimension: M4 x 10 mm).

Refer to the instructions that come with the VESA-compatible wall mounting kit.

1. Place the monitor panel on a soft cloth or cushion on a stable flat table.
2. Remove the stand. (See [Removing the Monitor Stand](#))



3. Use a Phillips crosshead screwdriver to remove the four screws securing the plastic cover.
4. Attach the mounting bracket from the wall mounting kit to the monitor.
5. Mount the monitor on the wall. For more information, see the documentation that shipped with the wall mounting kit.



NOTE: For use only with UL or CSA or GS-listed wall mount bracket with minimum weight or load bearing capacity of 15.32 kg (C2423H)/ 20.16 kg (C2723H).



Operating the Monitor

Power On the Monitor

Press the Power Button to turn On the monitor.

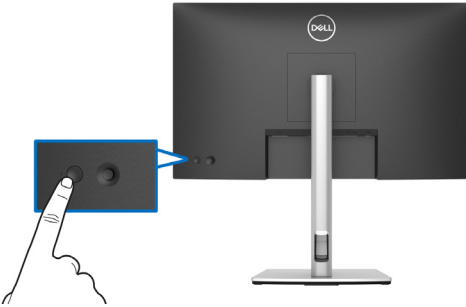

Using the Joystick Control

To modify the OSD adjustments using the joystick control on the rear end of the monitor, do the following:

1. Press the joystick button to launch the OSD Menu Launcher.
2. Move the joystick **up/down/left/right** to toggle between the OSD menu options.

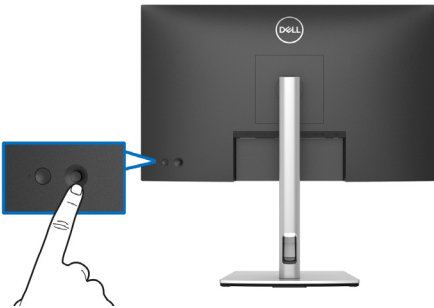

Joystick Functions

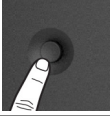
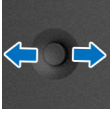
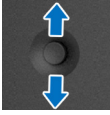
Function	Description
	Press joystick to open the OSD Menu Launcher.
	<ul style="list-style-type: none">For right and left navigation.Move right to enter the submenu.Move left to exit from the submenu.
	<ul style="list-style-type: none">For up and down navigation.Toggle between the menu items.Increases (up) or decreases (down) the parameters of the selected menu item.

Using the Main Menu

Using the Menu Launcher

Press the joystick to open the OSD Menu Launcher.

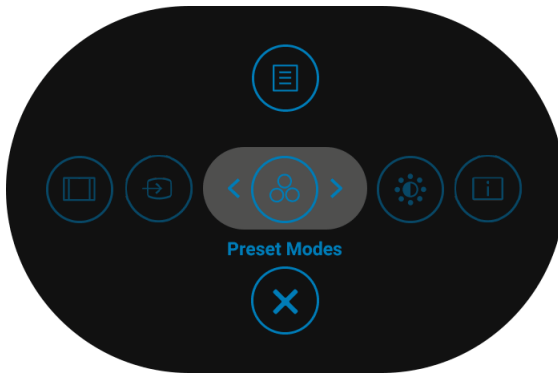

Menu Launcher



The following table describes the Menu Launcher functions:

Menu Launcher Details

Menu Launcher Icon	Description
 Main Menu	Opens the On-Screen Display (OSD). See Accessing the Menu System .
 Aspect Ratio (Shortcut Key 1)	Adjusts the aspect ratio of your screen.
 Input Source (Shortcut Key 2)	<ul style="list-style-type: none">• Sets the Input Source.• Select Auto from Input Source menu to scan for available input sources.
 Preset Modes (Shortcut Key 3)	Allows you to choose from a list of preset color modes.
 Brightness/Contrast (Shortcut Key 4)	Select this icon to adjust the brightness and contrast level.
 Display Info (Shortcut Key 5)	Displays the monitor's current status.
 Exit	Exits from the OSD main menu.

 **NOTE:** You can set your preferred **Shortcut Key**. See [Personalize](#) for details.



Using the Navigation keys

When the OSD main menu is active, move the joystick to configure the settings, following the navigation keys displayed below the OSD.

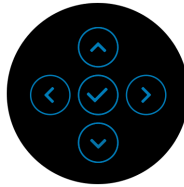

After you change the settings, press the joystick to save the changes before proceeding to another menu or exit the OSD menu.

NOTE: To exit the current menu item and return to the previous menu, move the joystick to the left until you exit.

Accessing the Menu System

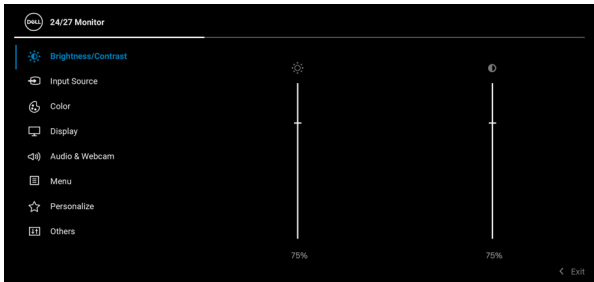
Icon	Menu and Submenus	Description
	Brightness/Contrast	Activates Brightness/Contrast adjustment.
		
	Brightness	Adjusts the luminance of the backlight. Toggle the joystick up to increase the brightness and toggle the joystick down to decrease the brightness (Range: 0 - 100).



Contrast

Adjusts the **Brightness** first, and then adjust the **Contrast** only if further adjustment is necessary.

Toggle the joystick **up** to increase the contrast and toggle the joystick **down** to decrease the contrast (Range: 0 - 100).

The **Contrast** function adjusts the degree of difference between darkness and lightness on the monitor screen.



Input Source

Selects between the different video signals that may be connected to your monitor.

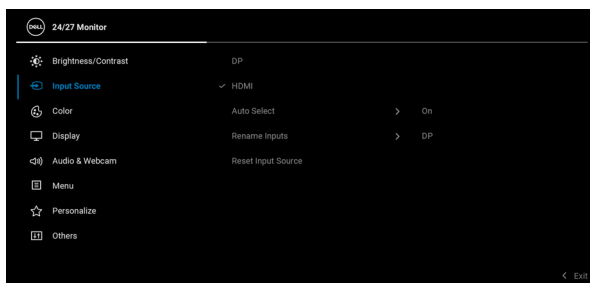

DP

Select the **DP** input when you are using the DisplayPort (DP) connector. Press the joystick to confirm the selection.

HDMI

Select the **HDMI** input when you are using the HDMI connector. Press the joystick to confirm the selection.

Auto Select

Allows you to scan for available input sources. The default is **On**.

Rename Inputs

Allows you to select the input name for the selected input source. The options are **PC**, **PC 1**, **PC 2**, **Laptop**, **Laptop 1**, and **Laptop 2**.

NOTE: Input names in warning messages and Display Info will not be changed.



Reset Input Source

Press the joystick to reset all settings under the **Input Source** menu to the factory preset values.



Color

Adjusts the color setting mode.

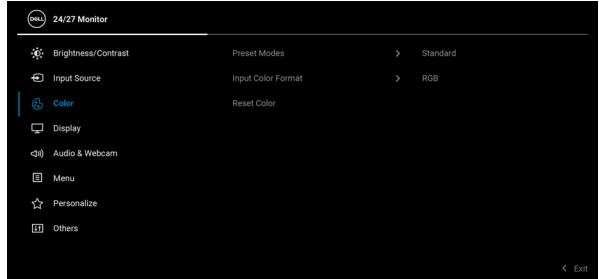

Preset Modes

Allows you to choose from a list of preset color modes.



- **Standard:** Default Color setting. This monitor uses a low blue light panel, and is certified by TÜV to reduce blue light output and create a more relaxing and less stimulating image while reading content on the screen.
-



-
- **Movie:** Ideal for movies.
 - **Game:** Ideal for most gaming applications.
 - **Warm:** Presents colors at lower color temperatures. The screen appears warmer with a red/yellow tint.
 - **Cool:** Presents colors at higher color temperatures. The screen appears cooler with a blue tint.
 - **Custom Color:** Allows you to manually adjust the color settings.

Toggle the joystick **up** or **down** to adjust the RGB color values and create your own preset color mode.

Input Color Format

Allows you to set the video input mode to:

- **RGB:** Select this option if your monitor is connected to a computer or a media player that supports RGB output.
- **YCbCr:** Select this option if your media player supports only YCbCr output.

Press the joystick to confirm the selection.

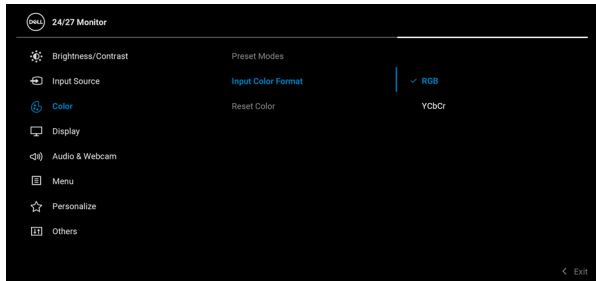

Hue

Shifts the color of the video image to green or purple. This is used to adjust the desired flesh tone color. Toggle the joystick **up** or **down** to adjust the hue from '0' to '100'.

NOTE: Hue adjustment is available only when you select **Movie** or **Game** preset mode.

Saturation

Adjusts the color saturation of the video image. Toggle the joystick **up** or **down** to adjust the saturation from '0' to '100'.

NOTE: Saturation adjustment is available only when you select **Movie** or **Game** preset mode.

Reset Color

Press the joystick to reset all settings under the **Color** menu to the factory preset values.



Display

Use the **Display** menu to adjust images.



Aspect Ratio

Adjusts the image ratio to **16:9**, **4:3**, or **5:4**.

Sharpness

This feature can make the image look sharper or softer.

Toggle the joystick **up** or **down** to adjust the sharpness from '0' to '100'.

Response Time

Allows you to set the **Response Time** to **Normal** or **Fast**.



MST

DP Multi Stream Transport, select **On** to enable MST (DP Out), select **Off** to disable the MST function. See [Connecting the Monitor for DP Multi-Stream Transport \(MST\) Function](#) for details.

NOTE: When DP upstream cable and DP downstream cable are connected, the OSD will set **MST** to **On** automatically. This action will only be done once after **Factory Reset** or **Display Reset**.

Reset Display

Press the joystick to reset all settings under the **Display** menu to the factory preset values.



Audio & Webcam

Allows you to adjust audio and webcam settings.

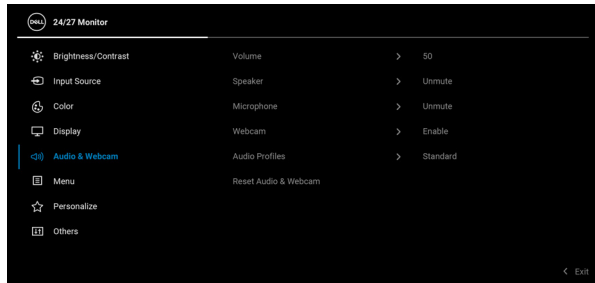

NOTE: For Webcam and Microphone to work, connect the USB upstream cable from the PC to the monitor.

Volume

Allows you to increase the speaker volume.

Move the joystick up and down to adjust the volume from '0' to '100'.

Speaker

Select to **Mute** or **Unmute** the Speaker.

Microphone

Select to **Mute** or **Unmute** the Microphone.

Webcam

Select to **Enable** or **Disable** the Webcam.

Audio Profiles

Allows you to choose from a list of preset audio profiles.

Standard: Default audio setting.



- **Voice:** Load profile ideal for meetings.
- **Movie:** Load profile ideal for movies.
- **Game:** Load profile ideal for gaming.
- **Music:** Load profile ideal for listening to music.

Reset Audio & Webcam

Press the joystick to reset all settings under the **Audio & Webcam** menu to the factory preset values.



Menu

Select this option to adjust the settings of the OSD, such as, the languages of the OSD, the amount of time the menu remains on screen, and so on.

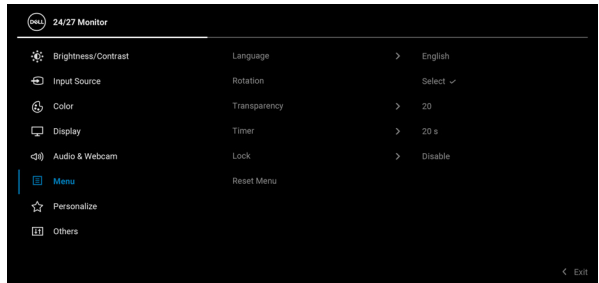

Language

Sets the OSD display to one of the eight languages (English, Spanish, French, German, Brazilian Portuguese, Russian, Simplified Chinese, or Japanese).

Rotation

Press the joystick to rotate the OSD and the screen by 0/90/180/270 degrees.

You can adjust the menu according to your display rotation.

Transparency

Select this option to change the menu transparency by toggling the joystick **up** or **down** (Range: 0 - 100).

Timer

Sets the length of time the OSD will remain active after the last time you pressed a button.

Toggle the joystick **up** or **down** to adjust the slider in 1 second increments, from 5 to 60 seconds.



Lock

With the control buttons on the monitor locked, you can prevent people from accessing the controls. It also prevents accidental activation in multiple monitors side-by-side setup.

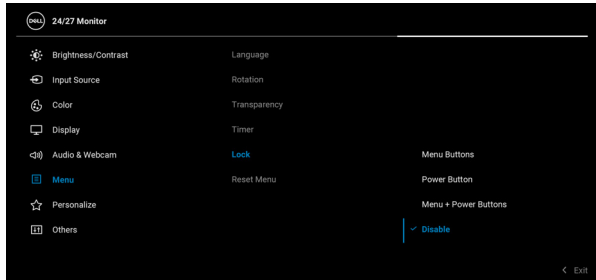

- **Menu Buttons:** All joystick functions are locked and not accessible by the user.
- **Power Button:** Only the **Power Button** is locked and not accessible by the user.
- **Menu + Power Buttons:** Both the joystick & the **Power Button** are locked and not accessible by the user.

The default setting is **Disable**.

Alternative Lock Method [for Menu/function buttons]: You can also press and hold the joystick to the **up** or **down** or **left** or **right** for 4 seconds to set the lock options.

NOTE: To unlock the button(s), press and hold the joystick to the **up** or **down** or **left** or **right** for 4 seconds.

Reset Menu

Press the joystick to reset all settings under the **Menu** menu to the factory preset values.





Personalize

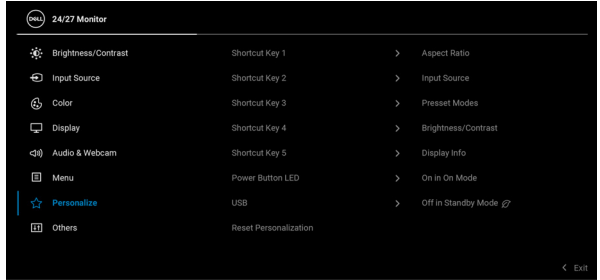

Shortcut Key 1	Allows you to choose a feature from Preset Modes , Brightness/Contrast , Input Source , Aspect Ratio , Volume , Speaker , Microphone , Webcam , Rotation , or Display Info and set it as a shortcut key.
Shortcut Key 2	
Shortcut Key 3	
Shortcut Key 4	
Shortcut Key 5	
Power Button LED	Allows you to set the power LED indicator on or off to save energy.
USB	Allows you to enable or disable USB Type-A Downstream Ports charging function during monitor standby mode.
Reset Personalization	Press the joystick to reset all settings under the Personalize menu to the factory preset values.





Others

Select this option to adjust the OSD settings, such as **DDC/CI**, **LCD Conditioning**, and so on.

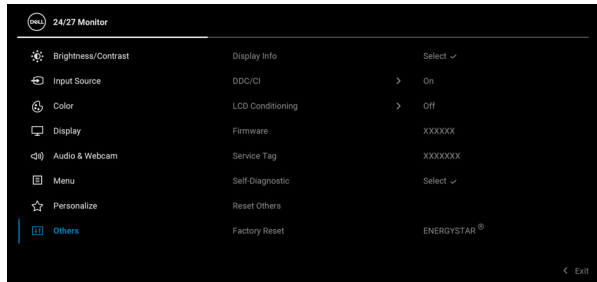

Display Info

Press the joystick to display the monitor's current settings.

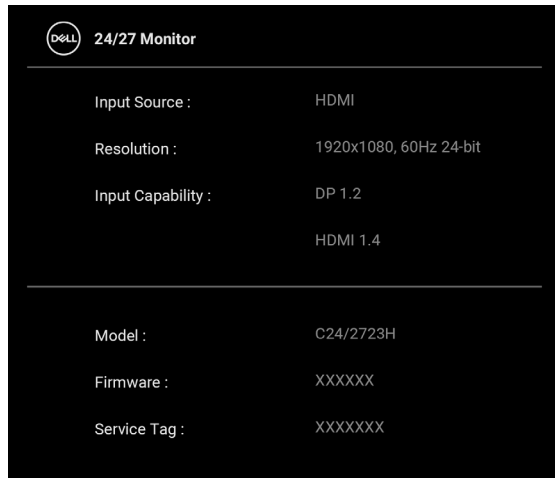

DDC/CI

DDC/CI (Display Data Channel/Command Interface) allows your monitor parameters (brightness, color balance, and etc.) to be adjustable via the software on your computer. You can disable this feature by selecting **Off**. Enable this feature for best user experience and optimum performance of your monitor.

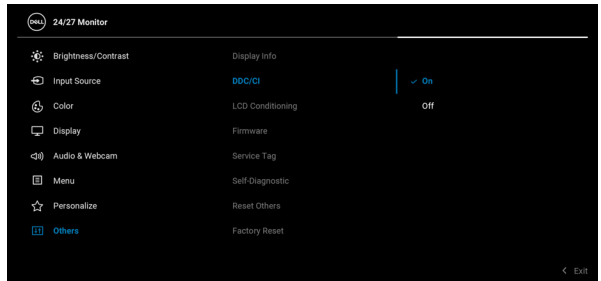

LCD Conditioning

Helps reduce minor cases of image retention. Depending on the degree of image retention, the program may take some time to run. You can enable this feature by selecting **On**.

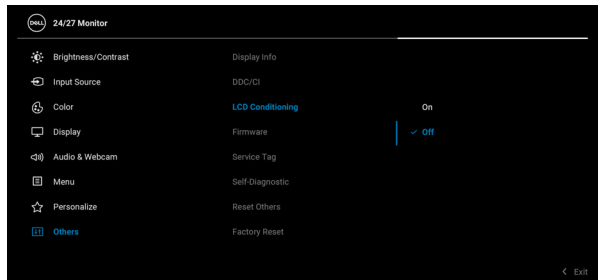

Firmware

Displays the firmware version of your monitor.



Service Tag

Displays the service tag of your monitor. This string is required when you look for phone support, check your warranty status, update drivers on Dell's website, etc.

Self-Diagnostic

Press the joystick to initiate the self-diagnostic process.

1. When initiated, a gray screen appears.
2. Carefully inspect the screen for abnormalities.
3. Press the joystick. The color of the screen changes to red.
4. Inspect the display for any abnormalities.
5. Repeat steps 3 and 4 to inspect the display in green, blue, black, white and text screens.

The test is complete when the text screen appears. To exit, press the joystick again.

Reset Others

Press the joystick to reset all settings under the **Others** menu to the factory preset values.

Factory Reset

Restore all preset values to the factory default settings. These are also the settings for ENERGY STAR® tests.

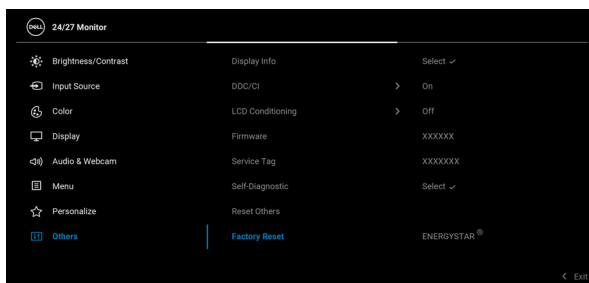

OSD Messages

Initial Setup

When **Factory Reset** is selected, the following message appears:



When **Yes** is selected, the following message appears.

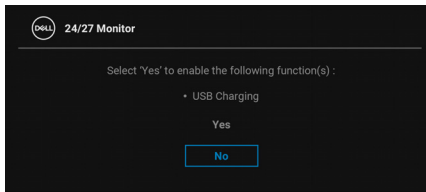

OSD Warning Messages

When the monitor does not support a particular resolution mode, you will see the following message:

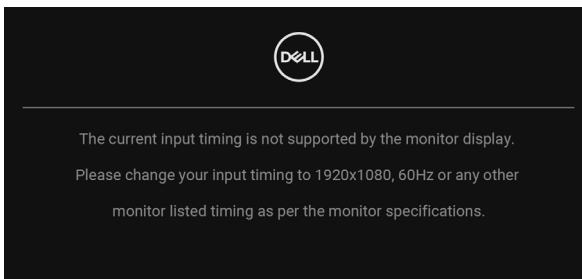

This means that the monitor cannot synchronize with the signal that it is receiving from the computer. See [Monitor Specifications](#) for the Horizontal and Vertical frequency ranges addressable by this monitor. Recommended mode is 1920 x 1080.

 **NOTE: The message may be slightly different according to the connected input signal.**

You will see the following message before the **DDC/CI** function is disabled:

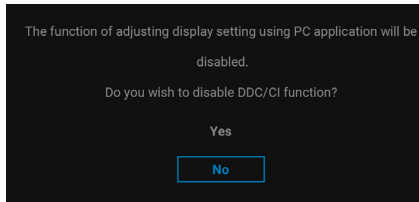

When you adjust the **Brightness** level for the first time, the following message appears:

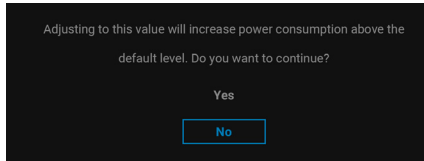

 **NOTE: If Yes is selected, the message will not appear next time you intend to change the Brightness setting.**

When you change the default setting of power saving features for the first time, such as **USB**, the following message appears:



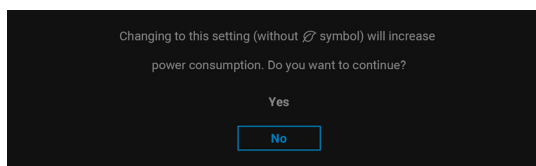

NOTE: If you select **Yes** for any one of the features mentioned above, the message will not appear next time you intend to change the settings of these features. When you perform a factory reset, the message will appear again.

You will see the following message before the **Lock** function is activated:

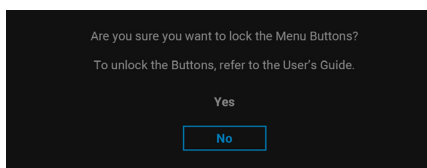

NOTE: The message may be slightly different according to the selected settings.

When the monitor goes into Standby mode, the following message appears:

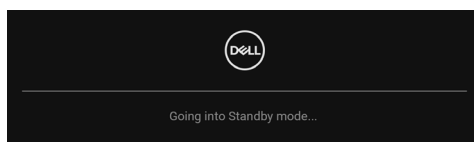

Activate the computer and wake up the monitor to gain access to the [OSD](#).

NOTE: The message may be slightly different according to the connected input signal.



The OSD functions only in the normal operation mode. If you press any button other than the **Power Button** during the Standby mode, the following message will appear depending on the selected input:

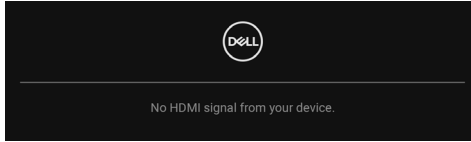

NOTE: The message may be slightly different according to the connected input signal.

Activate the computer and the monitor to gain access to the **OSD**.

NOTE: The message may be slightly different according to the connected input signal.

If either DisplayPort or HDMI input is selected and the corresponding cable is not connected, a dialog box as shown below appears.

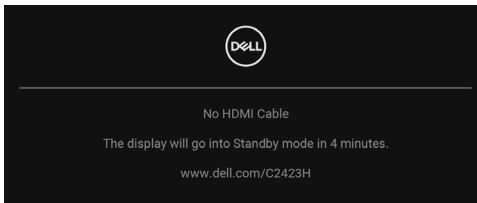

OR

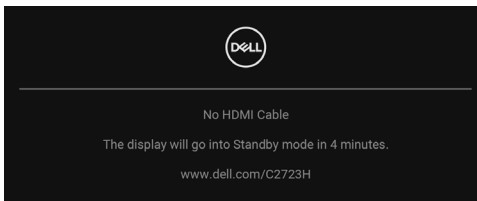

NOTE: The message may be slightly different according to the connected input signal.



When **Disable** is selected for the Webcam, the following message appears:

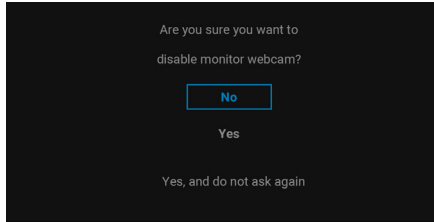

When the Webcam is disabled and the webcam module **pop up**, the following message appears:

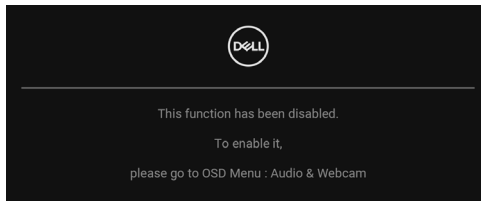

 **NOTE: For Webcam and Microphone to work, connect the USB upstream cable from the PC to the monitor.**

See [Troubleshooting](#) for more information.



Setting the Maximum Resolution

To set the maximum resolution for the monitor:

In Windows[®] 7, Windows[®] 8, and Windows[®] 8.1:

1. For Windows[®] 8 and Windows[®] 8.1 only, select the Desktop tile to switch to classic desktop.
2. Right-click on the desktop and click **Screen Resolution**.
3. Click the dropdown list of the **Screen Resolution** and select **1920 x 1080**.
4. Click **OK**.

In Windows[®] 10:

1. Right-click on the desktop and click **Display settings**.
2. Click **Advanced display settings**.
3. Click the dropdown list of **Resolution** and select **1920 x 1080**.
4. Click **Apply**.

If you do not see **1920 x 1080** as an option, you may need to update your graphics driver. Depending on your computer, complete one of the following procedures:

If you have a Dell desktop or portable computer:

- Go to <http://www.dell.com/support>, enter your service tag, and download the latest driver for your graphics card.

If you are using a non-Dell computer (portable or desktop):

- Go to the support site for your computer and download the latest graphic drivers.
- Go to your graphics card website and download the latest graphic drivers.

 **NOTE: The following OSD settings will be synchronized: Brightness, Contrast, Preset Modes, Color Temp., Custom Color (RGB Gain), Hue (Movie, Game mode), Saturation (Movie, Game mode), Response Time, and Sharpness.**



Setting Up Windows Hello

In Windows® 10:

Click Windows Start menu, click **Settings**.

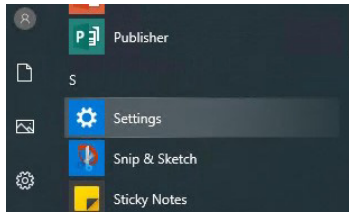

Click **Accounts**.

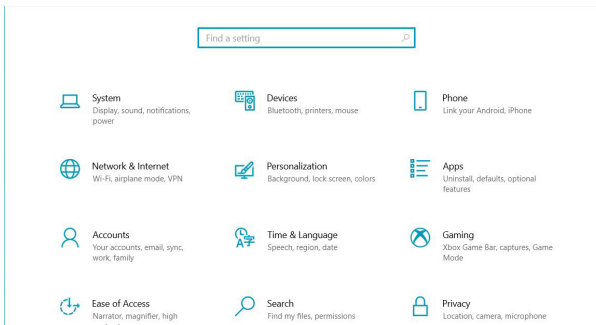

Click **Sign-in options**. You must set up a PIN before you can enroll in Windows Hello.

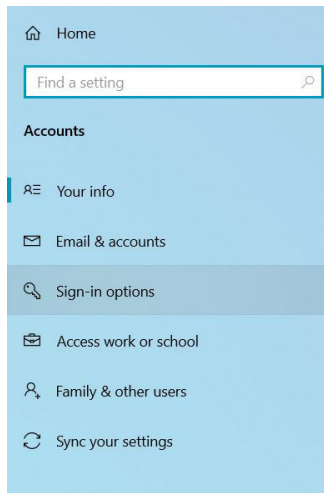

Click **Add** under **PIN** and enter to **Set up a PIN**. Enter New PIN and Confirm PIN, and then click **OK**.



Once you have done that, the options to set up Windows Hello will unlock. Click **Set up** under **Windows Hello**, enter to **Windows Hello setup**.

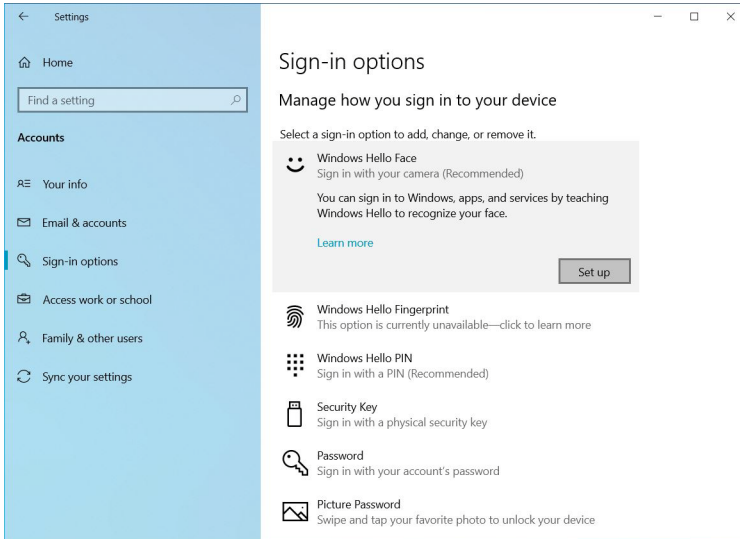

The following message is displayed, click **Get started**.

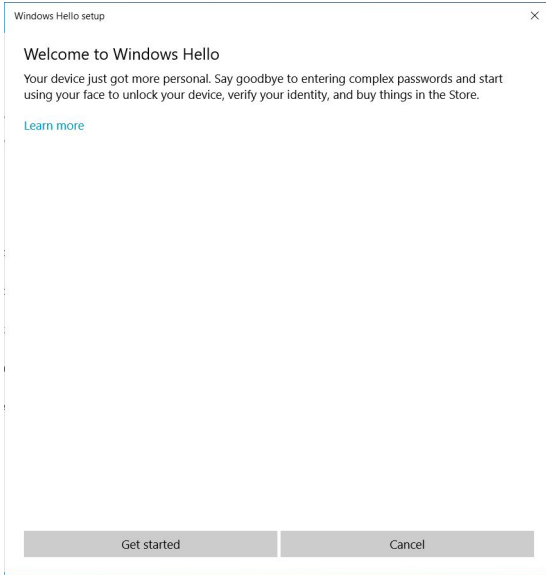

Keep looking directly at your screen and position yourself so that your face is in the center of the frame that appears on screen. The webcam will then register your face.

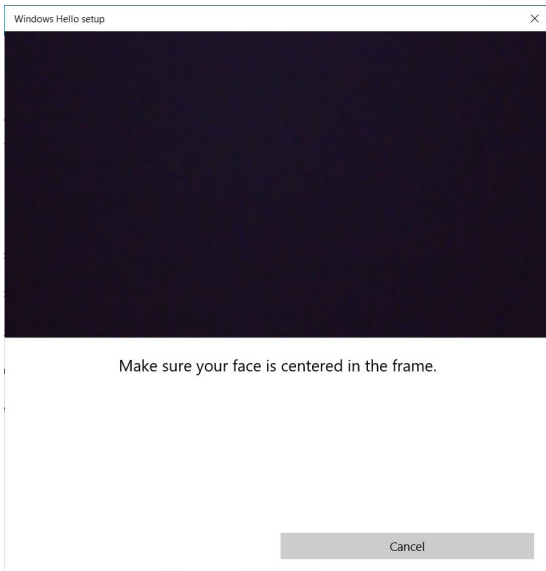

When the following message is displayed, click **Close** to exit **Windows Hello setup**.

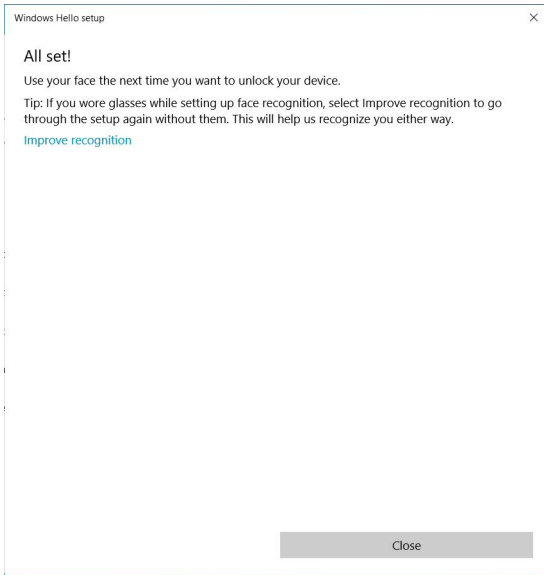

Once you have set up, you have another option to improve the recognition. Click **Improve recognition** if necessary.



Setting Up the Monitor Webcam as Default Setting

When using a notebook with built-in webcam to connect this monitor, in the device manager interface, you can find the notebook built-in webcam and the monitor webcam. Normally, they are in enable status, and the default setting is using notebook built-in webcam.

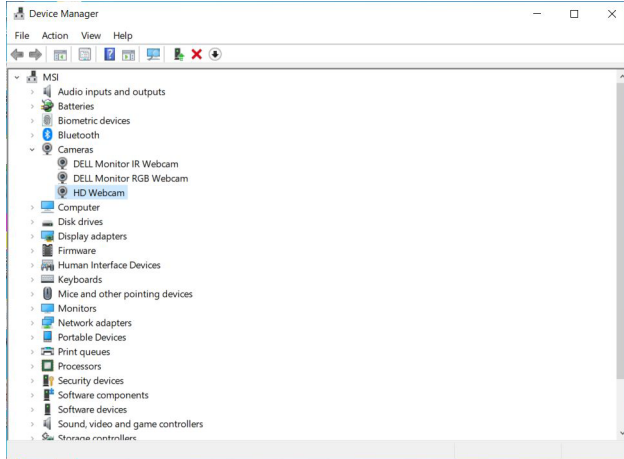

If you want to set up the monitor webcam as default setting, you need to disable the notebook built-in webcam. To identify the notebook built-in webcam and disable it, please follow below instruction:

Right-click **DELL Monitor IR Webcam**, and click **Properties** to open the **DELL Monitor IR Webcam Properties**.

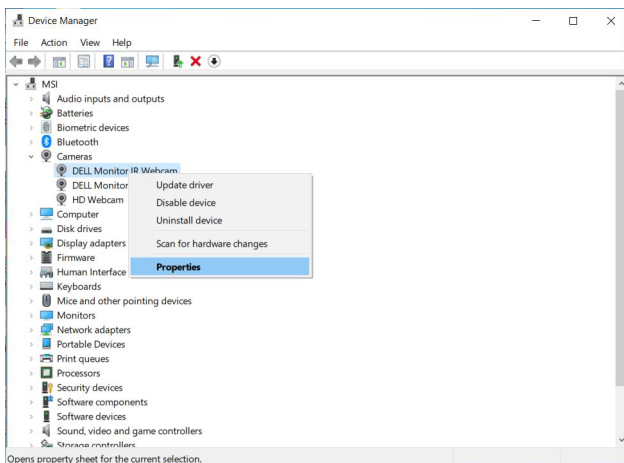

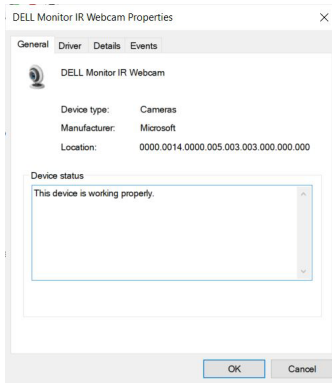

Click **Details > Property** and select **Hardware Ids**.

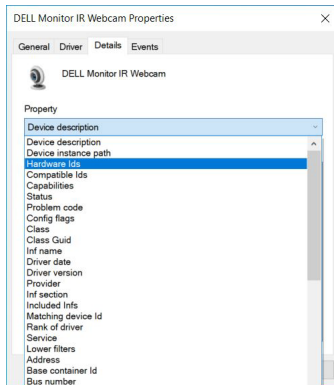

The **Value** will show the detail hardware ids of this **DELL Monitor IR Webcam**. The hardware ids of the notebook built-in webcam and the monitor webcam are different. For C2423H/C2723H, the monitor webcam hardware ids will show as below:

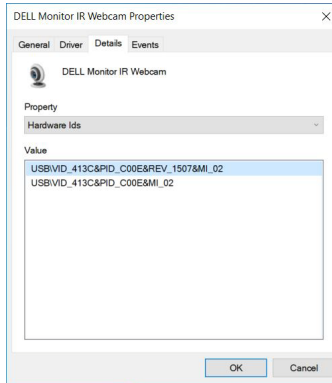

Right-click the **PC/Notebook** webcam, which has different hardware ids, and then click **Disable**.

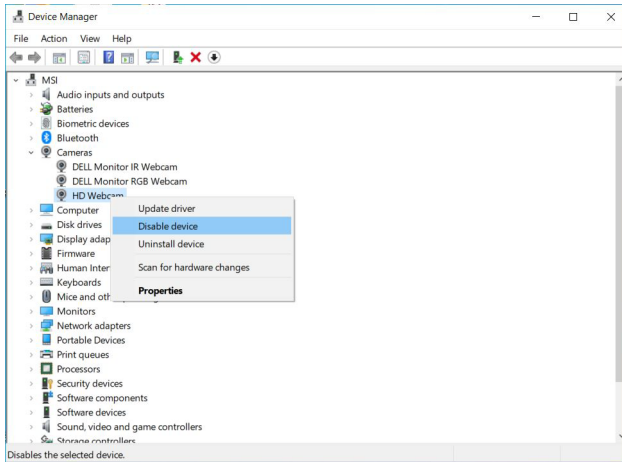

The following message is displayed:



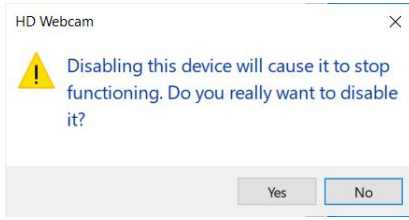

Click **Yes**. The notebook webcam is now disabled and the monitor webcam will be used as the default setting. Restart the notebook.

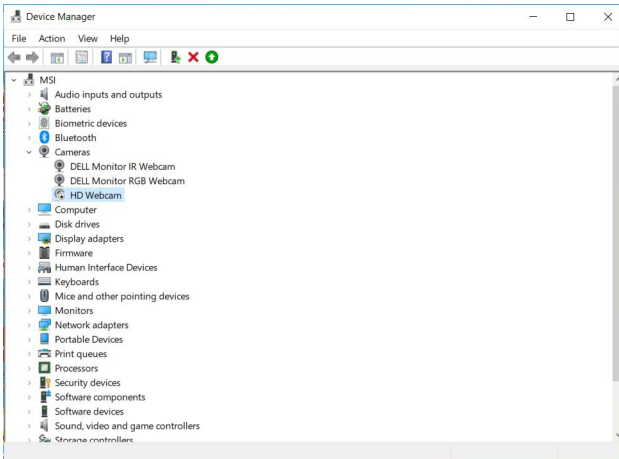

Setting Up the Monitor Speaker as Default Setting

When your computer connects multiple speakers, if you want to setup the monitor speaker as default setting, please follow below instructions:

Right-click **Volume** in the Windows task bar notification area.

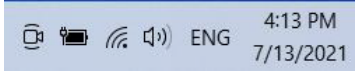

Click **Sounds** to enter to **Sound** setting interface.

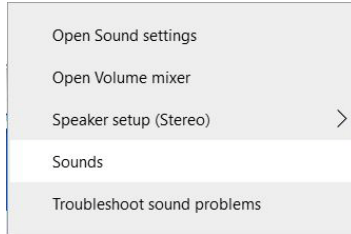

If only the HDMI or DP cable is connected from your monitor to the computer, only one speaker named **DELL C2423H/C2723H** from the monitor will show in the **Sound** setting interface.

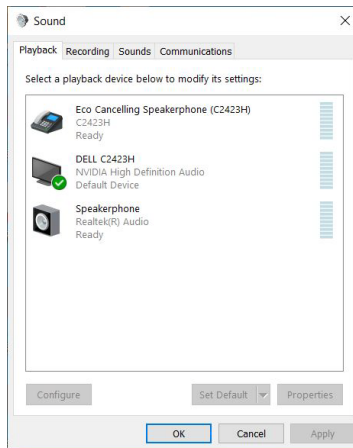

Click **DELL C2423H/C2723H**, and then click **Set Default**, the monitor speaker will be used as the default setting.

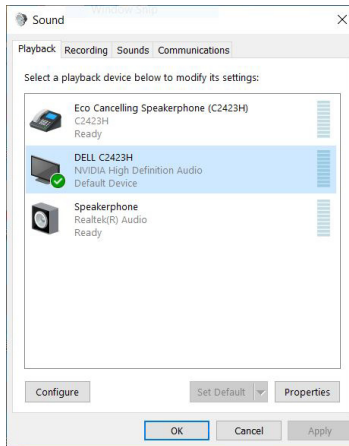

Click **OK** to exit the **Sound** setting.

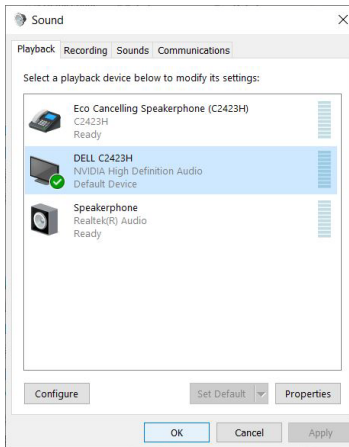

If the USB cable and the HDMI or DP cable are connected from the monitor to the computer, two audio paths named **DELL C2423H/C2723H** and **Echo Cancelling Speakerphone (C2423H/C2723H)** from the monitor will show in the **Sound** setting interface. The **DELL C2423H/C2723H** monitor would show options for two audio paths supported in the monitor.



- **Echo Cancelling Speakerphone (C2423H/C2723H)** audio path is where audio streams through USB. This is through USB-A to USB-B cable. As the microphone path streams from monitor back to PC through USB, this selection is required for VoIP/UC conference applications. Audio Recording and Playback will work under this selection.
- **DELL C2423H/C2723H** audio path is where audio streams through HDMI/DP. Under this selection, there will not be microphone support. This selection is suitable for Audio Playback only.

Audio Playback performance would be the same for either audio path selection. Under normal Playback with USB-A to USB-B and/or for UC conference applications, default selecting the **Echo Cancelling Speakerphone (C2423H/C2723H)** audio path is recommended.

 **NOTE: If you select DELL C2423H/C2723H audio path, please ensure that the Echo Cancelling Speakerphone (C2423H/C2723H) volume is set to medium or high. Else, the DELL C2423H/C2723H maximum volume may sound soft because it is limited by the Echo Cancelling Speakerphone (C2423H/C2723H) volume. For example, when the Echo Cancelling Speakerphone (C2423H/C2723H) volume is at 50%, and the DELL C2423H/C2723H volume is set to 100%, the DELL C2423H/C2723H will have the same sound level as the former.**

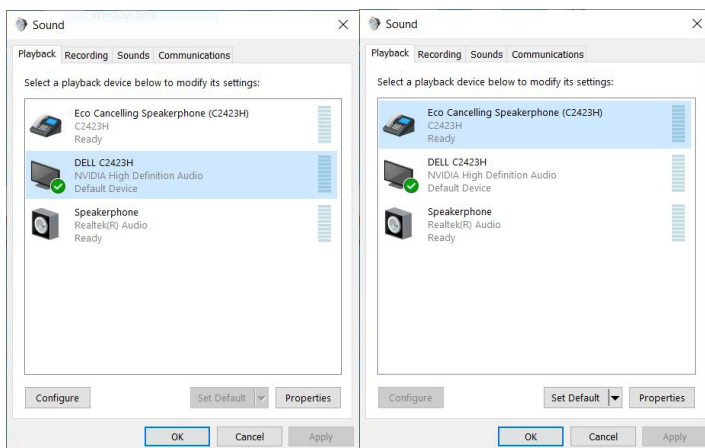

Troubleshooting

 **WARNING:** Before you begin any of the procedures in this section, follow the [Safety Instructions](#).

Self-test

Your monitor provides a self-test feature that allows you to check whether your monitor is functioning properly. If your monitor and computer are properly connected but the monitor screen remains dark, run the monitor self-test by performing the following steps:

1. Turn off both your computer and the monitor.
2. Unplug the video cable from the back of the computer.
3. Turn on the monitor.

The floating dialog box should appear on-screen (against a black background), if the monitor cannot sense a video signal and is working correctly. While in self-test mode, the power LED remains white. Also, depending upon the selected input, one of the dialogs shown below will continuously scroll through the screen.

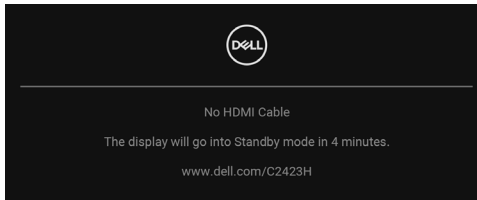

OR

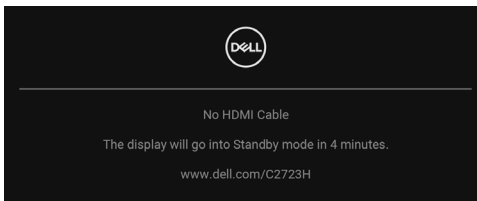

 **NOTE:** The message may be slightly different according to the connected input signal.

4. This box also appears during normal system operation, if the video cable becomes disconnected or damaged.
5. Turn Off your monitor and reconnect the video cable; then turn On both your computer and the monitor.



If your monitor screen remains blank after you use the previous procedure, check your video controller and computer, because your monitor is functioning properly.

Using the Joystick to Lock/Unlock Buttons

Locking the Power and Joystick Buttons

You can lock the joystick and Power buttons to prevent access to the OSD menu and/or power off the monitor.

To lock the buttons:

1. Toggle and hold the joystick to the **up** or **down** or **left** or **right** for about 4 seconds until a pop menu appears.

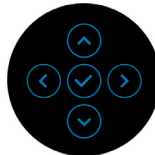
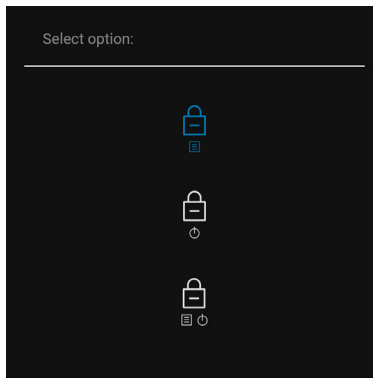

2. Select one of the following options:
 - **Menu Buttons:** All joystick functions are locked and not accessible by the user.
 - **Power Buttons:** Only the **Power Button** is locked and not accessible by the user.
 - **Menu + Power Buttons:** Both the joystick & the **Power Button** are locked and not accessible by the user.



To unlock the button(s), press and hold the joystick to the **up** or **down** or **left** or **right** for 4 seconds. Select the **Unlock** icon to unlock the button(s).

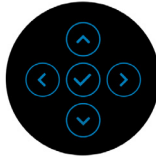
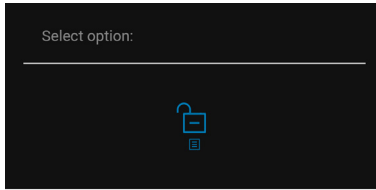

Updating Monitor Firmware

You may verify your current firmware revision in [Firmware](#). If this is not available, go to the Dell download support site for the latest application installer (**Monitor Firmware Update Utility.exe**) and refer to the Firmware Update Instruction User's Guide: www.dell.com/C2423H, www.dell.com/C2723H.



Common Problems

The following table contains general information about common monitor problems you might encounter and the possible solutions:

Common Symptoms	What You Experience	Possible Solutions
No Video/Power LED off	No picture	<ul style="list-style-type: none">• Ensure that the video cable connecting the monitor and the computer is properly connected and secure.• Verify that the power outlet is functioning properly using any other electrical equipment.• Ensure that the Power Button is pressed fully.• Ensure that the correct input source is selected in the Input Source menu.
No Video/Power LED on	No picture or no brightness	<ul style="list-style-type: none">• Increase brightness & contrast controls via OSD.• Perform monitor self-test feature check.• Check for bent or broken pins in the video cable connector.• Run the built-in diagnostics.• Ensure that the correct input source is selected in the Input Source menu.
Poor Focus	Picture is fuzzy, blurry, or ghosting	<ul style="list-style-type: none">• Eliminate video extension cables.• Reset the monitor to factory settings.• Change the video resolution to the correct aspect ratio.
Shaky/Jittery Video	Wavy picture or fine movement	<ul style="list-style-type: none">• Reset the monitor to factory settings.• Check environmental factors.• Relocate the monitor and test in another room.



Missing Pixels	LCD screen has spots	<ul style="list-style-type: none"> • Cycle power On-Off. • Pixel that is permanently Off is a natural defect that can occur in LCD technology. • For more information on Dell Monitor Quality and Pixel Policy, see Dell Support site at: http://www.dell.com/pixelguidelines.
Stuck-on Pixels	LCD screen has bright spots	<ul style="list-style-type: none"> • Cycle power On-Off. • Pixel that is permanently off is a natural defect that can occur in LCD technology. • For more information on Dell Monitor Quality and Pixel Policy, see Dell Support site at: http://www.dell.com/pixelguidelines.
Brightness Problems	Picture too dim or too bright	<ul style="list-style-type: none"> • Reset the monitor to factory settings. • Adjust brightness & contrast controls via OSD.
Geometric Distortion	Screen not centered correctly	<ul style="list-style-type: none"> • Reset the monitor to factory settings.
Horizontal/Vertical Lines	Screen has one or more lines	<ul style="list-style-type: none"> • Reset the monitor to factory settings. • Perform monitor self-test feature check and determine if these lines are also in self-test mode. • Check for bent or broken pins in the video cable connector. • Run the built-in diagnostics.



Synchronization Problems	Screen is scrambled or appears torn	<ul style="list-style-type: none"> • Reset the monitor to factory settings. • Perform monitor self-test feature check to determine if the scrambled screen appears in self-test mode. • Check for bent or broken pins in the video cable connector. • Restart the computer in the safe mode.
Safety Related Issues	Visible signs of smoke or sparks	<ul style="list-style-type: none"> • Do not perform any troubleshooting steps. • Contact Dell immediately.
Intermittent Problems	Monitor malfunctions on & off	<ul style="list-style-type: none"> • Ensure that the video cable connecting the monitor to the computer is connected properly and is secure. • Reset the monitor to factory settings. • Perform monitor self-test feature check to determine if the intermittent problem occurs in self-test mode.
Missing Color	Picture missing color	<ul style="list-style-type: none"> • Perform monitor self-test feature check. • Ensure that the video cable connecting the monitor to the computer is connected properly and is secure. • Check for bent or broken pins in the video cable connector.
Wrong Color	Picture color not good	<ul style="list-style-type: none"> • Try different Preset Modes in Color settings OSD. Adjust the R/G/B value in Custom Color in Color settings OSD. • Change the Input Color Format to RGB or YCbCr/YPbPr in the Color settings OSD. • Run the built-in diagnostics.



Image retention from a static image left on the monitor for a long period of time	Faint shadow from the static image displayed appears on the screen	<ul style="list-style-type: none"> Set the screen to turn off after a few minutes of screen idle time. These can be adjusted in Windows Power Options or Mac Energy Saver setting. Alternatively, use a dynamically changing screensaver.
Webcam/Mic does not work	<ul style="list-style-type: none"> USB cable not plug in or not select the correct USB source Not set the monitor webcam/mic as the default device 	<ul style="list-style-type: none"> Plug in the USB Cable (Type-A to Type-B). Select the monitor Webcam/Mic as the default in the PC side.

Product Specific Problems

Common Symptoms	What You Experience	Possible Solutions
Screen image is too small	Image is centered on screen, but does not fill entire viewing area	<ul style="list-style-type: none"> Check the Aspect Ratio setting in the Display menu OSD. Reset the monitor to factory settings.
Cannot adjust the monitor with the joystick control on the rear of the monitor	OSD does not appear on the screen	<ul style="list-style-type: none"> Turn Off the monitor, unplug the power cord, plug it back, and then turn On the monitor. Check whether the OSD menu is locked. If yes, toggle and hold the joystick to any direction for 4 seconds to unlock (for more information, see Lock).



No Input Signal when user controls are pressed	No picture, the LED light is white	<ul style="list-style-type: none"> • Check the signal source. Ensure the computer is not in the standby mode by moving the mouse or pressing any key on the keyboard. • Check whether the signal cable is plugged in properly. Re-plug the signal cable if necessary. • Reset the computer or video player.
The picture does not fill the entire screen	The picture cannot fill the height or width of the screen	<ul style="list-style-type: none"> • Due to different video formats (aspect ratio) of DVDs, the monitor may display in full screen. • Run the built-in diagnostics.
No video at HDMI/ DisplayPort port	When connected to some dongle/ docking device at the port, there is no video when unplugging/plugging the Thunderbolt cable from the notebook	Unplug the HDMI/DisplayPort cable from dongle/docking device, then plug the docking Thunderbolt cable to the notebook. Plug the HDMI/DisplayPort cable 7 seconds later.
Monitor buttons (Speaker mute/ Volume down/ Volume up/ Microphone mute) not working with Microsoft Teams® App	Monitor buttons (Speaker mute/ Volume down/ Volume up/ Microphone mute) not working on Microsoft Teams® App with Chrome OS / Ubuntu	<p>Use Microsoft Teams® App to perform the below tasks:</p> <ul style="list-style-type: none"> • Call Icon to accept / hang up call • Volume down / Volume up adjustment • Mic mute / unmute • Camera on / off
Video recording not working	Video recording App not working with Win 7	<ul style="list-style-type: none"> • Windows 7 not supported • Switch to Windows 10



Headset with Mic (3.5 mm combo jack) not working with monitor mute / unmute button	Headset with Mic (3.5 mm combo jack) has no response when pressing the monitor mute / unmute button while using UC App	Use UC App Mic icon to mute / unmute
When press either Volume down / Volume up or Mute button, LED not blink	When press either Volume down / Volume up or Mute button, LED not blink when connected to HDMI or DP only	Connect USB upstream (USB A to B) cable
Camera or Mic not working	Camera or Mic not working when connected to HDMI or DP only	Connect USB upstream (USB A to B) cable
Microphone not working or not detected	Microphone not working or not detected on the Voice recorder App with Intel Gen 11th CPU (Tiger Lake) platform	<ul style="list-style-type: none"> • Disable Intel Smart Sound Technology for USB Audio driver in the Device Manager and re-boot the PC • Alternatively, download the latest Audio Driver version for your computer or notebook • Unplug the 2-ring headphone from the headphone jack. Plug in a 3-ring headphone, or use the built-in microphone • Unplug the 2-ring microphone from the headphone jack as this is not supported. Use the built-in microphone instead



No sound can be heard from recorded video	No sound can be heard from recorded video with Intel Gen 11th CPU (Tiger Lake) platform	<ul style="list-style-type: none"> • Disable Intel Smart Sound Technology for USB Audio driver in the Device Manager and re-boot the PC • Alternatively, download the latest Audio Driver version for your computer or notebook
When pressing either Volume down / Volume up, OSD volume bar response is lagging/delayed	When pressing either Volume down / Volume up, OSD volume bar response is lagging/delayed with monitor connected to Intel Gen 11th CPU (Tiger Lake) platform	<ul style="list-style-type: none"> • Disable Intel Smart Sound Technology for USB Audio driver in the Device Manager and re-boot the PC • Alternatively, download the latest Audio Driver version for your computer or notebook
No sound coming from the speakers	No sound coming from the speakers when play audio/video on your system	<ul style="list-style-type: none"> • Ensure that you have set the default playback device as Echo Cancelling Speakerphone (C2423H/C2723H) or DELL C2423H/C2723H on your system. • Turn Off the monitor, unplug the monitor power cord, replug it, and then turn On the monitor. • Reset the monitor to Factory Settings.



Speaker volume is low / sounds soft	Speaker volume is low / sounds soft when speaker option is DELL C2423H/C2723H in Sound setting interface	<ul style="list-style-type: none"> • Increase the speaker volume of DELL C2423H/C2723H to maximum in the Sound setting interface. • Press the Volume Up button to increase the speaker volume of DELL C2423H/C2723H. • If you select DELL C2423H/C2723H audio path, please ensure that the Echo Cancelling Speakerphone (C2423H/C2723H) volume is set to medium or high. Else, the DELL C2423H/C2723H maximum volume may sound soft because it is limited by the Echo Cancelling Speakerphone (C2423H/C2723H) volume. For example, when the Echo Cancelling Speakerphone (C2423H/C2723H) volume is at 50%, and the DELL C2423H/C2723H volume is set to 100%, the DELL C2423H/C2723H will have the same sound level as the former.
Webcam is not detected	Webcam is not detected in the Windows Device Manager	<ul style="list-style-type: none"> • Ensure that the USB upstream cable is connected between the monitor and the computer or notebook. • Reconnect the USB upstream cable to the computer or notebook.
Webcam cannot connect / Webcam disconnected	Could not detect Monitor camera / Could not switch back to the PC camera	<ul style="list-style-type: none"> • Reset the monitor to Factory Settings. • Turn Off the monitor, unplug the monitor power cord, replug it, and then turn On the monitor. • Select the Monitor camera again in the Camera / Video setting of your UC conference application.



Microphone is muted	Microphone is muted in the Windows Device Manager	<ul style="list-style-type: none"> • Ensure that the USB upstream cable is connected between the monitor and the computer or notebook. • Reconnect the USB upstream cable to the computer or notebook. • Ensure that the microphone is enabled / unmuted on the monitor. If the microphone mute LED is lighting up in static red (indicates microphone muted), press the microphone button to unmute the microphone. • Ensure that the monitor's microphone is selected and enabled / unmuted on the setting in the UC application.
Microphone volume is low / sounds soft	Microphone volume is low / sounds soft to the other participant when in audio / video call	<ul style="list-style-type: none"> • Ensure that the Mute button's LED is dark (Indicates microphone unmuted). • Adjust the distance between the user and the microphone. The user should avoid sitting too far away from the microphone. The most optimum distance between the user and the microphone is 70 cm. • Ensure that the monitor's microphone is selected and enabled / unmuted on the setting in the UC application. • Increase the microphone volume in the Sound setting interface at the PC side / in the UC application.



Front buttons do not work	No response on the UC application when pressing the buttons located on the front bezel	<ul style="list-style-type: none"> · Ensure that the USB upstream cable is connected from the PC to the monitor. · For some UC platforms / applications, the Mute function works by pressing the Mute button, but the Mute Icon on the UC platform is not sync (Icon shows unmute). For more information, see Unified Communications (UC) Platform Compatibility List.
Webcam image looks over-exposed	Webcam image shows over-exposed background	<ul style="list-style-type: none"> · Adjust the environment lighting condition. Ensure the monitor is setup at a well lighted environment, preferably under ceiling lights. The user should avoid a dim / dark background. The user should avoid directly facing a window with bright sunlight.
Webcam image looks grainy / dark	Webcam image appears grainy / dark	Adjust the environment lighting condition. Ensure the monitor is setup at a well lighted environment, preferably under ceiling lights. The user should avoid a dim environment.
Webcam image looks blurry	Webcam image appears blurry / not clear	<ul style="list-style-type: none"> · Peel off the transparent protective film which originally stucked on the front of the webcam. · If the protective film is already peeled off, use a clean and slightly damp cloth to wipe the surface of the front webcam. · Adjust the distance between the user and the camera. The user should avoid sitting too far away from the camera. The most optimum distance between the user and the camera is 70 cm.



Time lag between video and audio when playing XBOX	When playing XBOX, the show out time between video and audio has 3 ~ 5 second difference while turning On monitor power or unplugging/plugging HDMI cable.	<ul style="list-style-type: none"> • The monitor codec IC initialization time requires approximately 3 ~ 5 seconds. This is normal behavior. • Wait for 3 ~ 5 seconds after turning On monitor power or plugging-in the HDMI cable before playing video on XBOX.
Volume value or speaker status is not updated in OSD	When increasing / decreasing OSD volume value or mute / unmute speaker, the adjusted value is not updated in OSD and front panel button.	<ul style="list-style-type: none"> • Switch audio device configuration of Windows to Echo Cancelling Speakerphone (C2423H/C2723H). See Setting Up the Monitor Speaker as Default Setting. • Clear all grayed-out device in your computer's Device Manager.
The Mute button is not working	Press on the Mute button does not mute and unmute microphone when using Microsoft Teams	<ul style="list-style-type: none"> • Ensure that the USB upstream cable is connected from the PC to the monitor. • Ensure that the Teams account is provisioned / setup as 'Teams Only' mode. The tenant administrator should enable the account to 'Teams Only' mode.
Webcam no image	Webcam no image when using Skype for Business (SfB)	Select 'DELL Monitor RGB Webcam' as the camera in Skype Video Device setting.
Webcam being occupied	Webcam being occupied and cannot be used	Avoid running multiple conference softwares at the same time. While you are using 'conference software A', close the other 'conference software B'.



Universal Serial Bus (USB) Specific Problems

Common Symptoms	What You Experience	Possible Solutions
USB interface is not working	USB peripherals are not working	<ul style="list-style-type: none">• Check that your monitor is turned On.• Reconnect the upstream cable to your computer.• Reconnect the USB peripherals (downstream connector).• Switch Off and then turn On the monitor again.• Reboot the computer.• Some USB devices like external portable HDD require higher electric current; connect the device directly to the computer system.
SuperSpeed USB 5 Gbps (USB 3.2 Gen1) interface is slow	SuperSpeed USB 5 Gbps (USB 3.2 Gen1) peripherals working slowly or not working at all	<ul style="list-style-type: none">• Check that your computer is SuperSpeed USB 5 Gbps (USB 3.2 Gen1)-capable.• Some computers have USB 3.2, USB 2.0 and USB 1.1 ports. Ensure that the correct USB port is used.• Reconnect the upstream cable to your computer.• Reconnect the USB peripherals (downstream connector).• Reboot the computer.
Wireless USB peripherals stop working when a USB 3.2 device is plugged in	Wireless USB peripherals responding slowly or only working as the distance between itself and its receiver decreases	<ul style="list-style-type: none">• Increase the distance between the USB 3.2 peripherals and the wireless USB receiver.• Position your wireless USB receiver as close as possible to the wireless USB peripherals.• Use a USB-extender cable to position the wireless USB receiver as far away as possible from the USB 3.2 port.



Appendix

FCC Notices (U.S. only) and Other Regulatory Information

For FCC notices and other regulatory information, see the regulatory compliance website located at www.dell.com/regulatory_compliance.

Contact Dell

For customers in the United States, call 800-WWW-DELL (800-999-3355).

 **NOTE: If you do not have an active Internet connection, you can find contact information on your purchase invoice, packing slip, bill, or Dell product catalog.**

Dell provides several online and telephone-based support and service options. Availability varies by country and product, and some services may not be available in your area.

- Online technical assistance — www.dell.com/support/monitors
- Contacting Dell — www.dell.com/contactdell

EU Product Database for Energy Label and Product Information Sheet

C2423H: <https://eprel.ec.europa.eu/qr/854715>

C2723H: <https://eprel.ec.europa.eu/qr/1006737>

