

CP1500PFCRM2U
USER MANUAL

FEATURES

- 1 . LCD module display
- 2 . Power On Indicator
- 3 . Power Switch
- 4 . Down/Display button
- 5 . Up/Mute button
- 6 . Enter/Setup Button
- 7 . Circuit Breaker
- 8 . Expansion Slot
- 9 . Communication Protection Ports RJ45
- 10 . Battery and Surge Protected Outlets
- 11 . Wiring Fault Indicator (Red)
- 12 . Dry contact
- 13 . USB Port to PC
- 14 . Widely Spaced Outlets Designed for AC Adapters

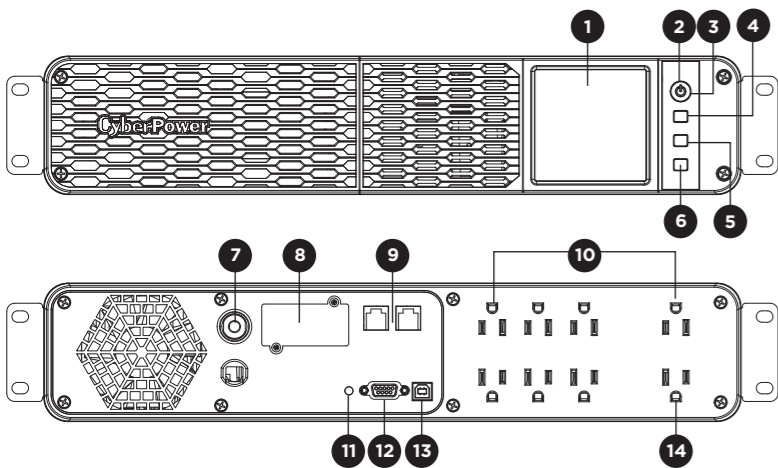

PRODUCT REGISTRATION

Thank you for purchasing a CyberPower product. Please take a few minutes to register your product at: cyberpowersystems.com/registration. Registration certifies your product's warranty, confirms your ownership in the event of a product loss or theft and entitles you to free technical support. Register your product now to receive the benefits of CyberPower ownership.

IMPORTANT SAFETY WARNINGS (SAVE THESE INSTRUCTIONS)

When using electrical appliances, basic safety precautions should always be followed to reduce the risk of fire, electric shock, and/or injury to persons including the following. This Manual Contains Important Instructions that should be followed during installation and maintenance of the UPS and batteries.

CAUTION! To prevent the risk of fire or electric shock, install in a temperature and humidity controlled indoor area free of conductive contaminants. (Please see specifications for acceptable temperature and humidity range).

CAUTION! To reduce the risk of electric shock, do not remove the cover except to service the battery. Turn off and unplug the unit before servicing the batteries. There are no user serviceable parts inside except for the battery.

CAUTION! Hazardous live parts inside can be energized by the battery even when the AC input power is disconnected.

CAUTION! The UPS must be connected to an AC power outlet with fuse or circuit breaker protection. Do not plug into an outlet that is not grounded. If you need to de-energize this equipment, turn off and unplug the unit.

CAUTION! To avoid electric shock, turn off the unit and unplug it from the AC power source before servicing the battery. **CAUTION!** Not for use in a computer room as defined in the Standard for the Protection of Electronic Computer/Data Processing Equipment, ANSI/NFPA 75.

CAUTION! To reduce the risk of fire, connect only to a circuit provided with 20 amperes maximum branch circuit over current protection in accordance with the National Electric Code, ANSI/NFPA 70.

DO NOT USE FOR MEDICAL OR LIFE SUPPORT EQUIPMENT! CyberPower Systems does not sell products for life support or medical applications. **DO NOT** use in any circumstance that would affect the operation and safety of life support equipment, medical applications, or patient care.

DO NOT USE WITH OR NEAR AQUARIUMS! To reduce the risk of fire or electric shock, do not use with or near an aquarium. Condensation from the aquarium can cause the unit to short out.

DO NOT USE THE UPS ON ANY TRANSPORTATION! To reduce the risk of fire or electric shock, do not use the unit on any transportation such as airplanes or ships. The effect of shock or vibration caused during transit and the damp environment can cause the unit to short out.

INSTALLING YOUR UPS SYSTEM

UNPACKING
Inspect the UPS upon receipt. The box should contain the following:
(a) UPS
(b) User's manual
(c) USB A+B type cable
(d) Function Setup Guide
(e) M5 truss head screw x4pcs

"PowerPanel" Business software is available on our website. Please visit cyberpowersystems.com and go to the Software Section for free download.

SUPPORTS ACTIVE PFC POWER SUPPLIES
This CyberPower UPS system delivers sine wave output, which is ideal for seamless operation of computers using high efficiency switching power supplies with Active Power Factor Correction (Active PFC), home entertainment systems, and other sensitive electronics.

OVERVIEW
The CP1500PFCRM2U provides complete power protection from utility power that is not always consistent. The CP1500PFCRM2U features 1500 Joules of surge protection. The unit provides long lasting battery backup during power outages with maintenance free batteries. The CP1500PFCRM2U ensures consistent power to your electronic devices and includes software that will automatically save your open files and shutdown your computer system during a utility power loss.

AUTOMATIC VOLTAGE REGULATOR
The CP1500PFCRM2U stabilizes inconsistent utility power voltage to nominal levels that are safe for equipment. Inconsistent incoming utility power may be damaging to important data files and hardware, but with Automatic Voltage Regulation (AVR), damaging voltage levels are corrected to safe levels. AVR automatically increases low utility power to a consistent and safe 110/120 volts.

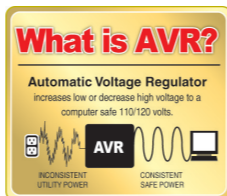

DETERMINE THE POWER REQUIREMENTS OF YOUR EQUIPMENT
1. Ensure that the equipment plugged into the outlet does not exceed the UPS's rated capacity (1500VA/1000W for CP1500PFCRM2U). If the rated capacity of the unit is exceeded, an overload condition may occur and cause the UPS to shut down or the circuit breaker to trip.
2. There are many factors that can affect the amount of power that your electronic devices will require. It is suggested that the load placed on the battery outlets not exceed 80% of the unit's capacity.

INSTALLING YOUR UPS SYSTEM - Continued
HARDWARE INSTALLATION GUIDE

1. Your new UPS may be used immediately upon receipt. However, after receiving a new UPS, to ensure the battery's maximum charge capacity, it is recommended that you charge the battery for at least 8 hours. Your UPS is equipped with an auto-charge feature. When the UPS is plugged into an AC outlet, the battery will automatically charge whether the UPS is turned on or off.
Note: This UPS is designed with a safety feature to keep the system from being turned on during shipment. The first time you turn the UPS on, you will need to have it connected to AC power or it will not power up.
With the UPS unit turned off and unplugged, connect your computer, monitor, and any other peripherals requiring battery backup into the battery power supplied outlets. **DO NOT plug a laser printer, paper shredder, copier, space heater, vacuum, sump pump or other large electrical devices into the "Battery and Surge Protected Outlets". The power demands of these devices may overload and damage the UPS.**
2. Plug the UPS into a 2 pole, 3 wire grounded receptacle (wall outlet). Make sure the wall branch outlet is protected by a fuse or circuit breaker and does not service equipment with large electrical demands (e.g. air conditioner, copier, etc...). The warranty prohibits the use of extension cords, outlet strips, and surge strips.
3. Press the power switch to turn the unit on. The Power On indicator light will illuminate and the unit will "beep". If an overload is detected, an audible alarm will sound and the unit will emit one long beep. To correct this, turn the UPS off and unplug at least one piece of equipment from the battery power supplied outlets. Make sure the circuit breaker is depressed and then turn the UPS on.
4. To maintain optimal battery charge, leave the UPS plugged into an AC outlet at all times.
5. To store the UPS for an extended period, cover it and store with the battery fully charged. While in storage, recharge the battery every three months to ensure battery life.
6. To ensure the wall outlet and UPS are located near the equipment being attached for proper accessibility.

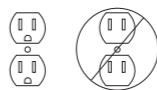

BASIC OPERATION

1. **LCD module display**
High resolution and intelligent LCD display shows all the UPS information using icons and messages. For more information, please review the "Definitions for Illuminated LCD indicators" section.
2. **Power On Indicator**
This LED is illuminated when the utility power is normal and the UPS outlets are providing power, free of surges and spikes.
3. **Power Switch**
Master on/off switch for equipment connected to the battery power supplied outlets.
4. **Down/Display button**
The button can be used to select the LCD display contents including Input Voltage, Output Voltage, and Estimated Run Time. Short press the button to scroll down the function menu. Pressing the button for 2 seconds will keep the LCD display always on or turn the LCD display off while in AC/Utility power mode. For more information about the Down/Display Button, please refer to the Function Setup Guide.
5. **Up/Mute button**
Short press the button to scroll up the function menu. Holding the button for more than 2 seconds will silence the alarm. For more information about the Up/Mute Button, please refer to the Function Setup Guide.
6. **Enter/Setup Button**
Press the button for 2 seconds to enter the setup menu and then select the functions for configuration. For more information about the Enter/Setup Button, please refer to the Function Setup Guide.
7. **Circuit Breaker**
Located on the back of the UPS, the circuit breaker serves to provide overload and fault protection. Under normal operating conditions, the circuit breaker is depressed.
8. **Expansion Slot**
Remove the cover panel to install an optional RMCARD to remotely monitor and manage the UPS over a network. Other options include cloud monitoring via a mobile app and web-based app (RCCARD or RWCCARD).
9. **Communication Protection Ports RJ45**
Communication protection ports, bi-directional, will protect a 10/100/1000 Ethernet connection. (RJ45).
10. **Battery and Surge Protected Outlets**
The unit has eight battery powered/ surge suppression outlets for connected equipment to ensure temporary uninterrupted operation of your equipment during a power failure. **(DO NOT plug a laser printer, paper shredder, copier, space heater, vacuum cleaner, sump pump or other large electrical devices into the "Battery and Surge Protected Outlets". The power demands of these devices may overload and damage the unit.)**
11. **Wiring Fault Indicator (Red)**
This LED indicator will illuminate to warn the user that a wiring problem exists, such as bad ground, missed ground or reversed wiring. If this is illuminated, disconnect all electrical equipment from the outlet and have an electrician check to ensure the outlet is properly wired. The unit will not provide surge protection without being plugged into a grounded and properly wired wall outlet.
12. **Dry contact**
This port produces information for equipment that can read dry contact signals.
13. **USB Port to PC**
This port allows connection and communication from the USB port on the computer to the UPS unit. The UPS communicates its status to the PowerPanel® Business software.
14. **Widely Spaced Outlets Designed for AC Adapters**
The unit has two outlets spaced to allow AC power adapter blocks to be plugged into the UPS without blocking adjacent outlets.

RACK INSTALLATION (OPTION)

1. Remove all equipment connected to the product.
2. Make sure the product is turned off and disconnected from AC power source.
3. Use the supplied truss head screws to secure the UPS to your existing rack system.

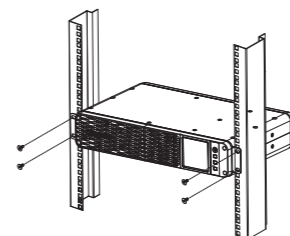

REPLACING THE BATTERY

Replacement of batteries located in an **OPERATOR ACCESS AREA**.
1. When replacing batteries, replace with the same number of the following battery: CyberPower / RB1290X2D
2. **CAUTION!** Risk of Energy Hazard, 24 V, maximum 9 Ampere-hour battery. Before replacing batteries, remove conductive jewelry such as chains, wrist watches, and rings. High energy conducted through these materials could cause severe burns.
3. **CAUTION!** Do not dispose of batteries in a fire. The batteries may explode.
4. **CAUTION!** Do not open or mutilate batteries. Released material is harmful to the skin and eyes. It may be toxic.
5. **CAUTION:** A battery can present a risk of electrical shock and high short circuit current. The following precautions should be observed when working on batteries:
1) Remove watches rings, or other metal objects.
2) Use tools with insulated handles.
CAUTION - RISK OF EXPLOSION IF BATTERY IS REPLACED BY AN INCORRECT TYPE. DISPOSE OF USED BATTERIES ACCORDING TO LOCAL REGULATIONS.

BATTERY REPLACEMENT PROCEDURE:

1. Loosen the screws on the faceplate.
2. Slide the side front panel.
3. Remove front panel completely off the unit.
4. Disconnect the black and red cable.
5. Replace the new battery pack. Assemble the screws, covers, cable and front panel in the reverse sequence of above steps.
Recharge the units for 8-16 hours to ensure the UPS performs expected runtime.

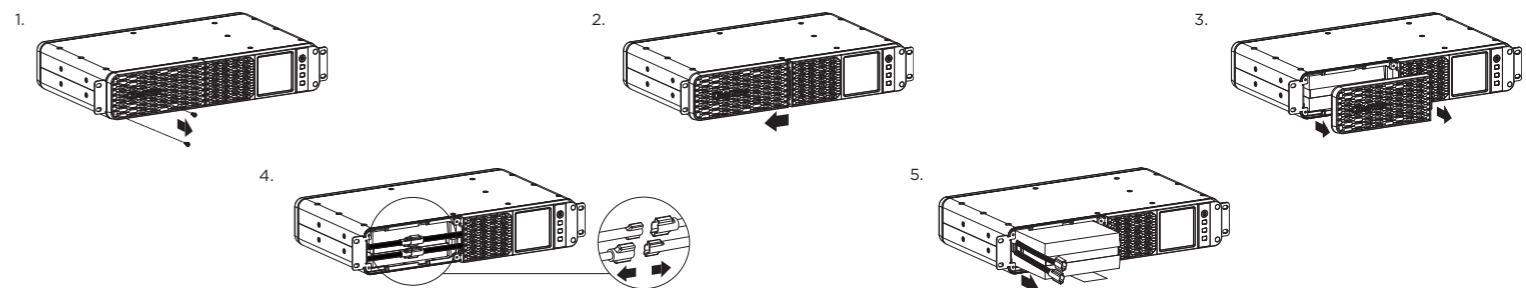

REMINDER: Batteries are considered **HAZARDOUS WASTE** and must be disposed of properly. Most retailers that sell lead-acid batteries collect used batteries for recycling, as required by local regulations

DEFINITIONS FOR ILLUMINATED LCD INDICATORS

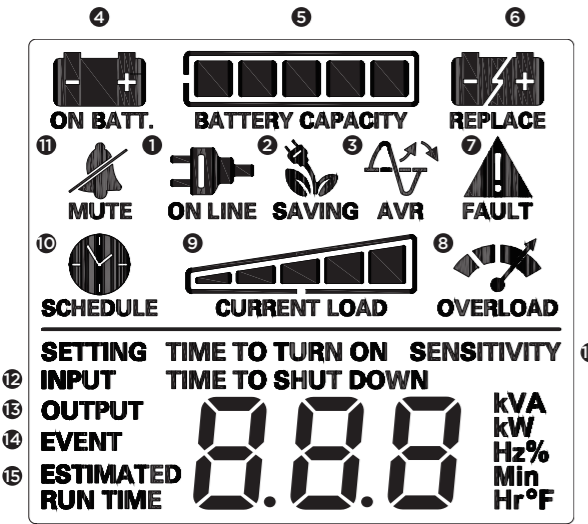

- ONLINE:** The UPS is supplying utility power to connected equipment.
- ENERGY-SAVING:** The UPS is in energy-saving bypass mode. See "CyberPower Green Power UPSTM Technology" section for more information.
- AVR (Automatic Voltage Regulation):** The UPS is automatically correcting low AC line voltage without using battery power. This is a normal, automatic operation of your UPS, and no action is required on your part.
- ON BATTERY:** During a severe/extended saq or power outage, this icon appears and an alarm sounds (two short beeps followed by a pause) to indicate the UPS is operating from its internal batteries. During a prolonged saq or power outage, the alarm will beep rapidly every 1/2 second to indicate the UPS's batteries are nearly out of power. You should save files and turn off your equipment immediately or allow the software to shut the system down.
- BATTERY CAPACITY:** This meter displays the approximate charge level (in 20% increments) of the UPS's internal battery. During a power outage or severe/extended saq, the UPS switches to battery power, the BATTERY icon appears, and the charge level decreases.

- REPLACE BATTERY:** This icon illuminates when the batteries are not properly connected or the batteries are worn out.
- FAULT:** This icon appears if there is a problem with the UPS. Press the POWER button to turn the UPS off.
 - E02: Charger Fault-No Charge** (Contact CyberPower Systems for support.)
 - E11: Battery Overvoltage** (Contact CyberPower Systems for support.)
 - E21: Output Short** (Check the status of equipment connected to the UPS and then turn on the UPS again.)
 - E22: Overload** (Unplug at least one piece of equipment from battery outlets and turn the UPS on again.)
- OVER LOAD:** This icon appears and an alarm sounds to indicate the battery-supplied outlets are overloaded. To clear the overload, unplug some of your equipment from the battery-supplied outlets until the icon turns off and the alarm stops.
- CURRENT LOAD:** This meter displays the approximate output load level (in 20% increments) of the UPS battery outlets.
- SCHEDULE:** Users can setup the schedule to turn on and shut down the computer and UPS through PowerPanel® Business software. The LCD display will show how much time is left before the UPS will turn back on or shut down.
- MUTE:** This icon appears whenever the UPS is in silent mode. However, when there is a problem with the UPS, the alarm will still beep even in silent mode.
- INPUT METER:** This meter measures the AC voltage that the UPS system is receiving from the utility wall outlet. The INPUT voltage meter can be used as a diagnostic tool to identify poor-quality input power.
- OUTPUT METER:** This meter measure, in real time, the AC voltage that the UPS system is providing to the computer, such as normal AC line mode, AVR mode, and battery backup mode. (Note: The OUTPUT meter shows the status of the battery backup outlets in terms of load, frequency, and voltage.)
- EVENT:** This meter records the number of power outages.
- ESTIMATED RUNTIME:** This displays the estimated runtime of the UPS with current battery capacity and load.
- SENSITIVITY SETUP:** This meter is also used to setup the UPS sensitivity when you are in the programming mode. If the connected equipment can tolerate more power events (example: unstable power often associated with stormy weather), select Low Sensitivity and the UPS will go to Battery Mode less often. If the connected equipment is more sensitive to power events, select High Sensitivity and the UPS will go to Battery Mode more often.

For more information about functions setup, please refer to the Function Setup Guide.

TROUBLESHOOTING

| Problem | Possible Cause | Solution |
|---|---|---|
| Circuit breaker button is projecting from the back of the unit. | Circuit breaker has tripped due to an overload. | Turn the UPS off and unplug at least one piece of equipment. Wait 10 seconds, reset the circuit breaker by depressing the button, and then turn the UPS on. |
| The UPS does not perform expected runtime. | Battery not fully charged. | Recharge the battery by leaving the UPS plugged in. |
| | Battery is worn out. | Please contact CyberPower Systems about replacement batteries. |
| The UPS will not turn on. | The on/off switch is designed to prevent damage from rapidly turning it off and on. | Turn the UPS off. Wait 10 seconds and then turn the UPS on. |
| | The unit is not connected to an AC outlet. | The unit must be connected to a 120V 60Hz outlet. |
| | The battery is worn out. | Please contact CyberPower Systems. |
| | Mechanical problem. | Please contact CyberPower Systems. |
| PowerPanel® Business software is inactive (all icons are gray). | The USB/serial cable is not connected. | Connect the USB/serial cable to the UPS unit and an open USB/serial port on the back of the computer. |
| | The USB/serial cable is connected to the wrong port. | Check the back of the computer for an additional USB port. Move the cable to this port. |
| | The unit is not providing battery power. | Shutdown your computer and turn the UPS off. Wait 10 seconds and turn the UPS back on. This should reset the unit. |

Additional troubleshooting information can be found under "Support" at www.cyberpowersystems.com

TECHNICAL SPECIFICATIONS

| Model | CP1500PFCRM2U |
|-------------------------------|--|
| Capacity | 1500VA/1000W |
| Nominal Input Voltage | 120V |
| Input Frequency | 60 Hz ± 3 Hz |
| On-Battery Output Voltage | 120Vac ± 5% |
| On-Battery Output Wave Form | Sinewave |
| Operating Temperature | + 32°F to 104° F / 0° C to 40° C |
| Operating Relative Humidity | 0 to 95% non-condensing |
| Size (W x H x D) | 17.05" x 10.5" x 3.39" (433 x 266 x 86 mm) |
| Net Weight | 32lbs / 14.5kg |
| Battery Type | CyberPower / RB1290X2D |
| Typical Battery Recharge Time | 8 hours to 90% capacity from total discharge |
| Typical Battery Life | 3 to 6 years, depending on number of discharge/recharge cycles |
| Recommended Battery | Sealed Maintenance Free Lead Acid Battery |
| Safety Approvals | UL1778(UPS), CSA C22.2 No. 107, FCC/DoC Class B |

SYSTEM FUNCTIONAL BLOCK DIAGRAM

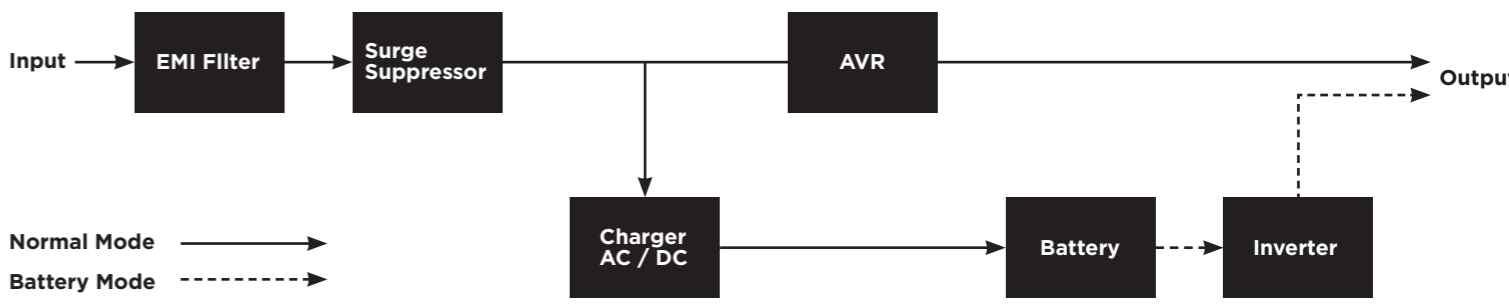

CYBERPOWER GREENPOWER UPS™ TECHNOLOGY

Advanced Energy-Saving Patented Bypass Technology
 CyberPower's patented GreenPower UPS™ with Bypass Technology reduces UPS energy costs by up to 75% compared to conventional UPS models. Even when utility power is normal, conventional UPS models constantly pass power through a transformer. By contrast, under normal conditions the advanced circuitry of a GreenPower UPS™ bypasses the transformer. As a result, the power efficiency is significantly increased while decreasing waste heat, using less energy, and reducing energy costs. When an abnormal power condition occurs, the GreenPower UPS™ automatically runs power through its transformer to regulate voltage and provide "safe" power. Since utility power is normal over 88% of the time, the GreenPower UPS™ operates primarily in its efficient bypass mode.



The GreenPower UPS™ is also manufactured in accordance with the Restriction on Hazardous Substances (RoHS) directive making it one of the most environmentally-friendly on the market today.

FCC COMPLIANCE STATEMENT

This device complies with part 15 of the FCC rules. Operation is subject to the following two conditions: (1) this device may not cause harmful interference, and (2) this device must accept any interference received, including interference that may cause undesired operation.



Note: This equipment has been tested and found to comply with the limits for a Class B digital device, pursuant to part 15 of the FCC Rules. These limits are designed to provide reasonable protection against harmful interference in a residential installation. This equipment generates, uses, and can radiate radio frequency energy and, if not installed and used in accordance with the instructions, may cause harmful interference to radio communications. However, there is no guarantee that interference will not occur in a particular installation. If this equipment does cause harmful interference to radio or television reception, which can be determined by turning the equipment off and on, the user is encouraged to try to correct the interference by one or more of the following measures:

- Reorient or relocate the receiving antenna.
- Increase the separation between the equipment and receiver.
- Connect the equipment to an outlet on a circuit different from that to which the receiver is connected.
- Consult the dealer or an experienced radio/TV technician for help.

Warning: Changes or modifications not expressly approved by the party responsible for compliance could void the user's authority to operate the equipment.

Canadian Compliance Statement
 CAN ICES-3 (B)/NMB-3(B)

LIMITED WARRANTY AND CONNECTED EQUIPMENT GUARANTEE

Please visit www.CyberPowerSystems.com for a copy of the Limited Warranty and Connected Equipment Guarantee.

Where Can I Get More Information?
 The application of the United Nations Convention of Contracts for the International Sale of Goods is expressly excluded. CyberPower is the warrantor under this Limited Warranty.

For further information please feel free to contact CyberPower at: Cyber Power Systems (USA), Inc. 4241 12th Ave E., STE 400, Shakopee, MN 55379; Call us at **(877) 297-6937**; or submit a web ticket online at cyberpowersystems.com/support.

WARNING: This product can expose you to chemicals including bisphenol A (BPA) and styrene, which is known to the State of California to cause reproductive harm and cancer. For more information, go to www.P65Warnings.ca.gov.

CyberPowerSystems.com

© 2022 Cyber Power Systems (USA), Inc. PowerPanel® Business is a trademark of Cyber Power Systems (USA) Inc.

CyberPower and the CyberPower logo are trademarks of Cyber Power Systems, Inc., and/or affiliates, which are registered in many countries and regions. All other trademarks are the property of their respective owners.

Copyright © 2022 Cyber Power Systems, Inc. All rights reserved.