



PX3-3000/4000/5000 Series

User Guide

Xerus™ Firmware v3.6.0

Copyright © 2020 Raritan, Inc.
PX3-1H-v3.6.0-E
March 2020
255-80-0035-00

Safety Guidelines

WARNING! Read and understand all sections in this guide before installing or operating this product.

WARNING! Connect this product to an AC power source whose voltage is within the range specified on the product's nameplate. Operating this product outside the nameplate voltage range may result in electric shock, fire, personal injury and death.

WARNING! Connect this product to an AC power source that is current limited by a suitably rated fuse or circuit breaker in accordance with national and local electrical codes. Operating this product without proper current limiting may result in electric shock, fire, personal injury and death.

WARNING! Connect this product to a protective earth ground. Never use a "ground lift adaptor" between the product's plug and the wall receptacle. Failure to connect to a protective earth ground may result in electric shock, fire, personal injury and death.

WARNING! This product contains no user serviceable parts. Do not open, alter or disassemble this product. All servicing must be performed by qualified personnel. Disconnect power before servicing this product. Failure to comply with this warning may result in electric shock, personal injury and death.

WARNING! Use this product in a dry location. Failure to use this product in a dry location may result in electric shock, personal injury and death.

WARNING! Do not rely on this product's receptacle lamps, receptacle relay switches or any other receptacle power on/off indicator to determine whether power is being supplied to a receptacle. Unplug a device connected to this product before performing repair, maintenance or service on the device. Failure to unplug a device before servicing it may result in electric shock, fire, personal injury and death.

WARNING! Only use this product to power information technology equipment that has a UL/IEC 60950-1 or equivalent rating. Attempting to power non-rated devices may result in electric shock, fire, personal injury and death.

WARNING! Do not use a Raritan product containing outlet relays to power large inductive loads such as motors or compressors. Attempting to power a large inductive load may result in damage to the relay.

WARNING! Do not use this product to power critical patient care equipment, fire or smoke alarm systems. Use of this product to power such equipment may result in personal injury and death.

WARNING! If this product is a model that requires assembly of its line cord or plug, all such assembly must be performed by a licensed electrician and the line cord or plugs used must be suitably rated based on the product's nameplate ratings and national and local electrical codes. Assembly by unlicensed electricians or failure to use suitably rated line cords or plugs may result in electric shock, fire, personal injury or death.

WARNING! This product contains a chemical known to the State of California to cause cancer, birth defects, or other reproductive harm.

Safety Instructions

1. Installation of this product should only be performed by a person who has knowledge and experience with electric power.
2. Make sure the line cord is disconnected from power before physically mounting or moving the location of this product.
3. This product is designed to be used within an electronic equipment rack. The metal case of this product is electrically bonded to the line cord ground wire. A threaded grounding point on the case may be used as an additional means of protectively grounding this product and the rack.
4. Examine the branch circuit receptacle that will supply electric power to this product. Make sure the receptacle's power lines, neutral and protective earth ground pins are wired correctly and are the correct voltage and phase. Make sure the branch circuit receptacle is protected by a suitably rated fuse or circuit breaker.
5. If the product is a model that contains receptacles that can be switched on/off, electric power may still be present at a receptacle even when it is switched off.

Tip 1: The outlet (socket) shall be installed near the equipment and shall be easily accessible.

*Tip 2: For detailed information on any Raritan PDU's overcurrent protectors' design, refer to that model's product specification on Raritan website's **PDU Product Selector page***
<https://www.raritan.com/product-selector>.

This document contains proprietary information that is protected by copyright. All rights reserved. No part of this document may be photocopied, reproduced, or translated into another language without express prior written consent of Raritan, Inc.

© Copyright 2020 Raritan, Inc. All third-party software and hardware mentioned in this document are registered trademarks or trademarks of and are the property of their respective holders.

FreeType Project Copyright Notice

Portions of this software are copyright © 2015 The FreeType Project (www.freetype.org). All rights reserved.

FCC Information

This equipment has been tested and found to comply with the limits for a Class A digital device, pursuant to Part 15 of the FCC Rules. These limits are designed to provide reasonable protection against harmful interference in a commercial installation. This equipment generates, uses, and can radiate radio frequency energy and if not installed and used in accordance with the instructions, may cause harmful interference to radio communications. Operation of this equipment in a residential environment may cause harmful interference.

VCCI Information (Japan)

この装置は、クラスA情報技術装置です。この装置を家庭環境で使用すると電波妨害を引き起こすことがあります。この場合には使用者が適切な対策を講ずるよう要求されることがあります。 VCCI-A

Raritan is not responsible for damage to this product resulting from accident, disaster, misuse, abuse, non-Raritan modification of the product, or other events outside of Raritan's reasonable control or not arising under normal operating conditions.

If a power cable is included with this product, it must be used exclusively for this product.



Warning

This is a class A product. In a domestic environment this product may cause radio interference in which case the user may be required to take adequate measures.

CAUTION:

To reduce the risk of shock — Use indoors only in a dry location. No user serviceable parts inside. Refer servicing to qualified personnel. For use with IT equipment only. Disconnect power before servicing.



SecureLock™

Contents

Safety Guidelines	ii
<hr/>	
Safety Instructions	iii
<hr/>	
Applicable Models	xix
<hr/>	
What's New in the PX3 User Guide	xxi
<hr/>	
Chapter 1 Introduction	1
<hr/>	
Product Models	1
Package Contents	1
Zero U Products.....	2
1U Products.....	2
2U Products.....	2
APIPA and Link-Local Addressing.....	2
Before You Begin	3
Unpacking the Product and Components	3
Preparing the Installation Site.....	4
Checking the Branch Circuit Rating	4
Filling Out the Equipment Setup Worksheet	4
<hr/>	
Chapter 2 Rackmount, Inlet and Outlet Connections	5
<hr/>	
Circuit Breaker Orientation Limitation	5
Rack-Mounting the PDU	5
Rackmount Safety Guidelines	5
Mounting Zero U Models Using L-Brackets.....	6
Mounting Zero U Models Using Button Mount	7
Mounting Zero U Models Using Claw-Foot Brackets	8
Mounting Zero U Models Using Two Rear Buttons.....	10
Mounting 1U or 2U Models	11
Connecting a PX3 Locking Line Cord.....	13
Disconnecting a PX3 Locking Line Cord	14
Installing Cable Retention Clips on the Inlet (Optional)	15
Installing Cable Retention Clips on Outlets (Optional)	16
Locking Outlets and Cords.....	17
SecureLock™ Outlets and Cords.....	17
Button-Type Locking Outlets.....	19

Chapter 3 Initial Installation and Configuration 20

Connecting the PDU to a Power Source	20
Connecting the PX3 to Your Network.....	21
USB Wireless LAN Adapters	22
Supported Wireless LAN Configuration	22
Dual Ethernet Connection.....	23
Configuring the PX3.....	23
Connecting a Mobile Device to PX3	24
Connecting the PX3 to a Computer.....	30
Bulk Configuration Methods	32
Cascading Multiple PX3 Devices for Sharing Ethernet Connectivity	33
Best Practices for Cascading.....	34
Cascading All Devices via USB	35
Extended Cascading with PX3 Devices	37
Restrictions of Port-Forwarding Connections	40
Power-Sharing Restrictions and Connection	42
Making a Power-Sharing Connection	43
Power-Sharing Configurations and Restrictions.....	44
Supported Sensor Configurations for Power Sharing	45

Chapter 4 Connecting External Equipment (Optional) 47

Connecting Raritan Environmental Sensor Packages	47
Identifying the Sensor Port	48
DX2 Sensor Packages.....	48
DX Sensor Packages.....	50
DPX3 Sensor Packages	51
DPX2 Sensor Packages	53
DPX Sensor Packages	56
Using an Optional DPX3-ENVHUB4 Sensor Hub.....	61
Mixing Diverse Sensor Types.....	62
Connecting Asset Management Strips	67
Combining Regular Asset Strips	68
Introduction to Asset Tags	70
Connecting Regular Asset Strips to PX3	70
Connecting Blade Extension Strips.....	72
Connecting Composite Asset Strips (AMS-Mx-Z)	74

Connecting a Logitech Webcam	77
Connecting a GSM Modem	78
Connecting an Analog Modem	78
Connecting an External Beeper	79
Connecting a Schroff LHX/SHX Heat Exchanger	79
Connecting a Modbus RTU Device or Bus	80

Chapter 5 PDU Linking 81

FAQs	82
PDU Linking in the Web GUI	84
Designating the Master Unit	85
Adding a Link Unit	86
Master Units Manage Link Units	89
Releasing a Link Unit	90
Switching to a Different PDU	91
Re-linking a Link Unit.....	92
Viewing Link Unit Information	94
Outlet Groups.....	102
Pairwise Outlet Groups	107
OCPs Page	109
Peripherals Page.....	109
Feature Ports Page	110
Displays for Master and Link Units	110
PDU Linking in the CLI.....	112
PDU Linking CLI Commands	113

Chapter 6 Introduction to PDU Components 114

Panel Components	114
Inlet	115
Outlets.....	116
Connection Ports.....	117
Dot-Matrix LCD Display	119
Reset Button.....	162
Circuit Breakers	162
Resetting the Button-Type Circuit Breaker	163
Resetting the Handle-Type Circuit Breaker	163
Fuse	164
Fuse Replacement on Zero U Models	164
Fuse Replacement on 1U Models	166

Beeper	167
Replaceable Controller	168
Threaded Grounding Point	169

Chapter 7 Using the Web Interface 170

Supported Web Browsers	170
Login, Logout and Password Change	170
Login	171
Changing Your Password	173
Remembering User Names and Passwords	174
Logout	174
Web Interface Overview	175
Menu	178
Quick Access to a Specific Page	181
Sorting a List	182
Dashboard	183
Dashboard - Inlet I1	185
Dashboard - OCP	187
Dashboard - Alerted Sensors	188
Dashboard - Inlet History	190
Dashboard - Alarms	192
PDU	194
Internal Beeper State	197
PX3 Latching Relay Behavior	198
Options for Outlet State on Startup	198
Initialization Delay Use Cases	199
Inrush Current and Inrush Guard Delay	199
Time Units	200
Setting Thresholds for Total Active Energy or Power	200
+12V Power Supply Sensor	201
Inlet	202
Configuring a Multi-Inlet Model	205
Outlets	206
Available Data of the Outlets Overview Page	210
Bulk Configuration for Outlet Thresholds	211
Setting Outlet Power-On Sequence and Delay	212
Setting Non-Critical Outlets	213
Load Shedding Mode	215
Individual Outlet Pages	218
Outlet Groups	226
Creating an Outlet Group	227
Outlet Group Power Control	228
Resetting a Group's Active Energy	232
Modifying an Outlet Group	233
Deleting an Outlet Group	236
Viewing More Information	238

Contents

OCPs	240
Individual OCP Pages	242
Possible OCP-Tripped Root Cause	247
Peripherals	249
Yellow- or Red-Highlighted Sensors	255
Managed vs Unmanaged Sensors/Actuators	257
Sensor/Actuator States	258
Finding the Sensor's Serial Number	259
Identifying the Sensor Position and Channel	260
How the Automatic Management Function Works	262
Managing One Sensor or Actuator	262
Individual Sensor/Actuator Pages	264
Z Coordinate Format	269
Feature Port	270
Asset Strip	272
External Beeper	280
Schroff LHX/SHX	281
Power CIM	286
User Management	287
Creating Users	288
Editing or Deleting Users	292
Creating Roles	293
Editing or Deleting Roles	295
Setting Your Preferred Measurement Units	296
Setting Default Measurement Units	297
Device Settings	299
Configuring Network Settings	301
Configuring Network Services	326
Configuring Security Settings	337
Setting the Date and Time	360
Event Rules and Actions	364
Setting Data Logging	427
Configuring Data Push Settings	428
Monitoring Server Accessibility	437
Front Panel Settings	445
Configuring the Serial Port	446
Lua Scripts	447
Miscellaneous	453
Maintenance	455
Device Information	457
Viewing Connected Users	462
Viewing or Clearing the Local Event Log	464
Updating the PX3 Firmware	465
Viewing Firmware Update History	469
Bulk Configuration	470
Backup and Restore of Device Settings	477
Network Diagnostics	479
Downloading Diagnostic Information	480
Hardware Issue Detection	480

Rebooting the PX3.....	482
Resetting All Settings to Factory Defaults	482
Retrieving Software Packages Information	483
Webcam Management.....	484
Configuring Webcams and Viewing Live Images	486
Sending Links to Snapshots or Videos	489
Viewing and Managing Locally-Saved Snapshots.....	491
Changing Storage Settings.....	493
SmartLock and Card Reader	497
SmartLock.....	499
Card Readers	504

Chapter 8 Using SNMP 506

Enabling and Configuring SNMP.....	506
SNMPv2c Notifications.....	507
SNMPv3 Notifications	508
Downloading SNMP MIB	511
SNMP Gets and Sets	512
The PX3 MIB	512
Retrieving Energy Usage	514
A Note about Enabling Thresholds.....	514

Chapter 9 Using the Command Line Interface 515

About the Interface	515
Logging in to CLI	516
With HyperTerminal.....	516
With SSH or Telnet	517
With an Analog Modem	518
Different CLI Modes and Prompts.....	518
Closing a Local Connection.....	519
The ? Command for Showing Available Commands.....	519
Querying Available Parameters for a Command	520
Showing Information	521
Network Configuration.....	521
PDU Configuration	525
Outlet Information	526
Outlet Group Information	527
Inlet Information	528
Overcurrent Protector Information	529
Date and Time Settings	530
Default Measurement Units.....	530
Environmental Sensor Information	531
Environmental Sensor Package Information.....	532
Actuator Information	533
Outlet Sensor Threshold Information	534

Outlet Pole Sensor Threshold Information	535
Outlet Group Threshold Information	536
Inlet Sensor Threshold Information	537
Inlet Pole Sensor Threshold Information	539
Overcurrent Protector Sensor Threshold Information	541
Environmental Sensor Threshold Information	542
Environmental Sensor Default Thresholds	543
Security Settings	544
Authentication Settings	545
Existing User Profiles	546
Existing Roles	547
Load Shedding Settings	547
Serial Port Settings	547
EnergyWise Settings	548
Asset Strip Settings	548
Rack Unit Settings of an Asset Strip	549
Event Log	550
Network Connections Diagnostic Log	551
Server Reachability Information	551
Command History	552
Reliability Data	553
Reliability Error Log	553
Reliability Hardware Failures	553
Examples	553
Clearing Information	556
Clearing Event Log	556
Clearing Diagnostic Log for Network Connections	557
Configuring the PX3 Device and Network	557
Entering Configuration Mode	557
Quitting Configuration Mode	558
PDU Configuration Commands	558
Network Configuration Commands	566
Time Configuration Commands	596
Checking the Accessibility of NTP Servers	601
Security Configuration Commands	601
Outlet Configuration Commands	622
Outlet Group Configuration Commands	624
Inlet Configuration Commands	626
Overcurrent Protector Configuration Commands	628
User Configuration Commands	628
Role Configuration Commands	640
Authentication Commands	644
Environmental Sensor Configuration Commands	656
Configuring Environmental Sensors' Default Thresholds	660
Sensor Threshold Configuration Commands	662
Actuator Configuration Commands	676
Server Reachability Configuration Commands	677
EnergyWise Configuration Commands	680
Asset Management Commands	682

Serial Port Configuration Commands.....	689
Multi-Command Syntax	691
Load Shedding Configuration Commands	693
Enabling or Disabling Load Shedding	693
Power Control Operations.....	694
Turning On the Outlet(s)	694
Turning Off the Outlet(s).....	695
Power Cycling the Outlet(s)	696
Canceling the Power-On Process	697
Example - Power Cycling Specific Outlets	697
Actuator Control Operations	698
Switching On an Actuator	698
Switching Off an Actuator	699
Example - Turning On a Specific Actuator	699
Unblocking a User	699
Resetting the PX3	700
Restarting the PDU.....	700
Resetting Active Energy Readings	700
Resetting to Factory Defaults.....	701
Network Troubleshooting	701
Entering Diagnostic Mode.....	702
Quitting Diagnostic Mode	702
Diagnostic Commands.....	702
Retrieving Previous Commands	704
Automatically Completing a Command.....	705
Logging out of CLI	705

Chapter 10 Using SCP Commands 707

Firmware Update via SCP	707
Bulk Configuration via SCP	708
Backup and Restore via SCP	709
Downloading Diagnostic Data via SCP	710
Uploading or Downloading Raw Configuration Data	712
Keys that Cannot Be Uploaded	715

Chapter 11 In-Line Monitors 717

Overview	717
Safety Instructions.....	717
Flexible Cord Installation Instructions.....	718
Flexible Cord Selection	718
Plug Selection	719
Receptacle Selection	719
Derating a Raritan Product.....	719
Wiring of 3-Phase In-Line Monitors	720
In-Line Monitor Unused Channels.....	720

Step by Step Flexible Cord Installation.....	720
In-Line Monitor's Web Interface	725
Dashboard Page	726
Inlets/Outlets Page.....	731
Appendix A Specifications	733
<hr/>	
Maximum Ambient Operating Temperature	733
Serial RS-232 "RJ-45" Port Pinouts	733
Sensor RJ-45 Port Pinouts	733
Feature RJ-45 Port Pinouts	734
Expansion RJ-45 Port Pinouts	735
Appendix B Equipment Setup Worksheet	736
<hr/>	
Appendix C Configuration or Firmware Upgrade with a USB Drive	740
<hr/>	
Device Configuration/Upgrade Procedure	740
System and USB Requirements	741
Configuration Files.....	742
fwupdate.cfg	743
config.txt	747
devices.csv	750
Configuration Files for PDU Linking.....	750
Creating Configuration Files via Mass Deployment Utility.....	751
Data Encryption in 'config.txt'	752
Firmware Upgrade via USB.....	753
Appendix D Bulk Configuration or Firmware Upgrade via DHCP/TFTP	755
<hr/>	
Bulk Configuration/Upgrade Procedure	756
TFTP Requirements	757
DHCP IPv4 Configuration in Windows	757
DHCP IPv6 Configuration in Windows	767
DHCP IPv4 Configuration in Linux.....	774
DHCP IPv6 Configuration in Linux.....	776
Appendix E Raw Configuration Upload and Download	778
<hr/>	
Downloading Raw Configuration.....	778
Download via Web Browsers	778
Download via Curl	779
Uploading Raw Configuration	780
Upload via Curl	781
Curl Upload Return Codes.....	782

Appendix F Resetting to Factory Defaults 784

Using the Reset Button.....	784
Using the CLI Command	785

Appendix G PX3 Models with Residual Current Monitoring 786

RCM Current Sensor	786
RCM State Sensor	787
Compliance with IEC 62020	788
RCM Self-Test	789
Web Interface Operations for RCM.....	790
Checking RCM State and Current	790
Setting RCM Current Thresholds.....	792
Scheduling RCM Self-Test.....	793
Disabling or Enabling Front Panel RCM Self-Test	794
Setting RCM DC Current Thresholds	794
Front Panel Operations for RCM	796
LCD Message for RCM Critical State.....	796
Checking RCM States and Current	797
Running RCM Self-Test.....	798
RCM SNMP Operations	799
RCM Trap.....	799
RCM Residual Current and State Objects.....	800
Setting RCM Thresholds	800
Running RCM Self-Test.....	800
CLI Operations for RCM.....	800
Showing Residual Current Monitoring Information	801
Setting RCM Current Thresholds.....	801
Setting Front Panel RCM Self-Test	803
Running RCM Self-Test.....	803
Degaussing RCM Type B Sensors.....	803

Appendix H Old Generations of PX3 Models 804

PX3 'Phase II' Front Panel Display.....	804
PX3 'Phase I' Front Panel Display.....	805
Overview of the LCD Display	805
Control Buttons	806
Operating the LCD Display	807

Serial RS-232 "DB9" Port Pinouts	822
Appendix I LDAP Configuration Illustration	823
<hr/>	
Step A. Determine User Accounts and Roles.....	823
Step B. Configure User Groups on the AD Server	824
Step C. Configure LDAP Authentication on the PX3	825
Step D. Configure Roles on the PX3.....	828
Appendix J Updating the LDAP Schema	831
<hr/>	
Returning User Group Information	831
From LDAP/LDAPS	831
From Microsoft Active Directory.....	831
Setting the Registry to Permit Write Operations to the Schema	832
Creating a New Attribute	832
Adding Attributes to the Class.....	833
Updating the Schema Cache	835
Editing rciusergroup Attributes for User Members.....	835
Appendix K RADIUS Configuration Illustration	838
<hr/>	
Standard Attributes	838
NPS Standard Attribute Illustration.....	838
FreeRADIUS Standard Attribute Illustration.....	856
Vendor-Specific Attributes	857
NPS VSA Illustration	857
FreeRADIUS VSA Illustration	869
AD-Related Configuration	870
Appendix L Additional PX3 Information	874
<hr/>	
RJ45-to-DB9 Cable Requirements for Modem Connections	874
Reserving IP Addresses in DHCP Servers	875
Reserving IP in Windows	876
Reserving IP in Linux.....	877
Sensor Threshold Settings	879
Thresholds and Sensor States	879
"To Assert" and Assertion Timeout.....	882
"To De-assert" and Deassertion Hysteresis.....	884

Default Voltage and Current Thresholds	887
Altitude Correction Factors	889
Unbalanced Current Calculation	889
Data for BTU Calculation	890
Ways to Probe Existing User Profiles.....	891
Raritan Training Website.....	891
Role of a DNS Server.....	892
Cascading Troubleshooting	892
Possible Root Causes.....	892
Slave Device Events in the Log	895
The Ping Tool.....	896
Installing the USB-to-Serial Driver (Optional).....	897
Initial Network Configuration via CLI.....	898
Device-Specific Settings.....	905
TLS Certificate Chain.....	906
What is a Certificate Chain	906
Illustration - GMAIL SMTP Certificate Chain	909
Browsing through the Online Help	912

Appendix M Integration 914

Dominion KX II / III Configuration.....	914
Configuring Rack PDU Targets.....	914
Turning Outlets On/Off and Cycling Power	918
Dominion KSX II, SX or SX II Configuration	919
Dominion KSX II	919
Dominion SX and SX II	920
Power IQ Configuration	924
dcTrack	925
dcTrack Overview.....	925
Asset Management Strips and dcTrack	926

Appendix N Third Party Licenses 927

Licenses - Bind9 927
Licenses - Clish..... 937
Licenses - Dropbear 945
Licenses - FreeType 948
Licenses - IW..... 950
Licenses - JSON-C..... 951
Licenses - LIBTIRPC 952
Licenses - LIBXML2 952
Licenses - Mbus 953
Licenses - Net-SNMP 953
Licenses - Open LDAP 962
Licenses - OpenSSL 964
Licenses - Wireless-RegDB..... 967
Licenses - WPA Supplicant and Hostapd 967

Index 969

Applicable Models

This User Guide is applicable to the following PDU Generation.











- PX3 with iX7™ PDU Generation (3000/4000/5000 series)

Any PX Generations can be associated with existing metering families called “Series”, from 1000 series to 5000 series.

For example, PX2-4000 and PX3-4000 series are all inlet metered and outlet metered PDUs, but have different controller generations.



*Note: For information on other PX2, PX3, PXC or PXO models, refer to respective Online Help or User Guide on the Raritan website's **Support page** (<http://www.raritan.com/support/>).*

▶ PX models comparison in brief:

Features	Inlet power measurement	Outlet power measurement	Outlet switching	Load shedding
1000 Series				
2000 Series				
3000 Series (Inline meters)				
4000 Series				
5000 Series				

Important: PDUs with similar model names but of different product families may vary in their designs. For example, PX2-5660V and PX3-5660V do NOT share the same outlet sequence and technical designs. For details on a model's technical design, refer to their product specifications on Raritan website's *PDU Product Selector page* <https://www.raritan.com/product-selector>.

▶ Comparison between PX2, PX3, PXC and PXO series:

Product models	PX2	PX3	PXC / PXO
Front panel display	LED display	Dot-matrix LCD display	Dot-matrix LCD display
Outlet latching relays		 *	
Number of LAN ports	1	2	2
Maximum LAN rate	100 Mbps **	1,000 Mbps	100 Mbps
Replaceable controller		 ***	
Number of USB-A ports	1	2	1
Maximum USB rate	12 Mbps	480 Mbps	480 Mbps
RS-232 port (CONSOLE/MODEM)	Male DB9 Connector	RJ-45 Connector	RJ-45 Connector
Expansion ports		 ****	
SENSOR port type	RJ-12	RJ-45	RJ-45

* Only PX3 models with outlet switching have outlet latching relays.

** A few customized PX2 models also support the Ethernet speed up to 1000 Mbps.

*** Only PX3 "Zero U" models have the replaceable controller.

**** PX3 Expansion port is designed for power sharing of controllers.

Note: PX3 in this table only refers to PX3 PDUs with "iX7" controller.

What's New in the PX3 User Guide

Important: If your PX3 is running any firmware version older than 3.3.0, you must upgrade it to 3.3.x or 3.4.x before upgrading it to 3.5.0 or later. See *Updating the PX3 Firmware* (on page 465).

▶ **New Features and Updates:**

PDU Linking (on page 81)

Please see the Release Notes for a more detailed explanation of the changes applied to this version of PX3.

Chapter 1 Introduction

In this User Guide, PX3 refers to PX3 with "iX7" controller (that is, PX3-iX7) unless otherwise specified.

Raritan's PX3 is an intelligent power distribution unit (PDU) that allows you to reboot remote servers and other network devices and/or to monitor power in the data center.

The intended use of PX3 is distribution of power to information technology equipment such as computers and communication equipment where such equipment is typically mounted in an equipment rack located in an information technology equipment room.

Raritan offers different types of PX3 models -- some are outlet-switching capable, and some are not. With the outlet-switching function, you can recover systems remotely in the event of system failure and/or system lockup, eliminate the need to perform manual intervention or dispatch field personnel, reduce downtime and mean time to repair, and increase productivity.

In This Chapter

Product Models	1
Package Contents	1
APIPA and Link-Local Addressing	2
Before You Begin	3

Product Models

PX3 comes in several models that are built to stock and can be obtained almost immediately. Raritan also offers custom models that are built to order and can only be obtained on request.

Download the PX3 Data Sheet from Raritan's website, visit the **Product Selector page** (<http://www.findmypdu.com/>) on Raritan's website, or contact your local reseller for a list of available models.

Package Contents

The following sub-topics describe the equipment and other material included in the product package.

Zero U Products

- One PX3
- Screws, brackets and/or buttons for Zero U
- Cable retention clips for the inlet (for some models only)
- Cable retention clips for outlets (for some models only)

1U Products

- One PX3
- 1U bracket pack and screws
- Cable retention clips for the inlet (for some models only)

2U Products

- One PX3
- 2U bracket pack and screws
- Cable retention clips for the inlet (for some models only)

APIPA and Link-Local Addressing

PX3 supports Automatic Private Internet Protocol Addressing (APIPA).

With APIPA, your PX3 automatically configures a link-local IP address and a link-local host name when it cannot obtain a valid IP address from any DHCP server in the TCP/IP network.

Only IT devices connected to *the same subnet* can access the PX3 using the link-local address/host name. Those in a different subnet cannot access it.

*Exception: PX3 in the Port Forwarding mode does not support APIPA. See **Setting the Cascading Mode** (on page 318).*

Once the PX3 can get a DHCP-assigned IP address, it stops using APIPA and the link-local address is replaced by the DHCP-assigned address.

▶ **Scenarios where APIPA applies:**

- DHCP is enabled on the PX3, but no IP address is assigned to the PX3. This may be caused by the absence or malfunction of DHCP servers in the network.

*Note: Configuration by connecting the PX3 to a computer using a network cable is an application of this scenario. See **Connecting the PX3 to a Computer** (on page 30).*

- The PX3 previously obtained an IP address from the DHCP server, but the lease of this IP address has expired, and the lease cannot be renewed, or no new IP address is available.
- ▶ **Link-local addressing:**
- *IPv4 address:*
Factory default is to enable IPv4 only. The link-local IPv4 address is *169.254.x.x/16*, which ranges between 169.254.1.0 and 169.254.254.255.
 - *IPv6 address:*
A link-local IPv6 address is available only after IPv6 is enabled on the PX3. See **Configuring Network Settings** (on page 301).
 - *Host name - pdu.local:*
You can type *https://pdu.local* to access the PX3 instead of typing the link-local IP address.
- ▶ **Retrieval of the link-local address:**
- See **Device Info** (on page 152).

Before You Begin

Before beginning the installation, perform the following activities:

- Unpack the product and components
- Prepare the installation site
- Check the branch circuit rating
- Fill out the equipment setup worksheet

Unpacking the Product and Components

1. Remove the PX3 and other equipment from the box in which they were shipped. See **Package Contents** (on page 1) for a complete list of the contents of the box.
2. Compare the serial number of the equipment with the number on the packing slip located on the outside of the box and make sure they match.
3. Inspect the equipment carefully. If any of the equipment is damaged or missing, contact Raritan Technical Support Department for assistance.
4. Verify that all circuit breakers on the PX3 are set to ON. If not, turn them ON.

Or make sure that all fuses are inserted and seated properly. If there are any fuse covers, ensure that they are closed.

Note: Not all models have overcurrent protectors.

Preparing the Installation Site

1. Make sure the installation area is clean and free of extreme temperatures and humidity.

*Note: If necessary, contact Raritan Technical Support for the maximum operating temperature for your model. See **Maximum Ambient Operating Temperature** (on page 733).*

2. Allow sufficient space around the PX3 for cabling and outlet connections.
3. Review **Safety Instructions** (on page iii) listed in this User Guide.

Checking the Branch Circuit Rating

The rating of the branch circuit supplying power to the PDU shall be in accordance with national and local electrical codes.

Filling Out the Equipment Setup Worksheet

An Equipment Setup Worksheet is provided in this User Guide. See **Equipment Setup Worksheet** (on page 736). Use this worksheet to record the model, serial number, and use of each IT device connected to the PDU.

As you add and remove devices, keep the worksheet up-to-date.

Chapter 2 Rackmount, Inlet and Outlet Connections

In This Chapter

Circuit Breaker Orientation Limitation	5
Rack-Mounting the PDU	5
Connecting a PX3 Locking Line Cord	13
Installing Cable Retention Clips on the Inlet (Optional)	15
Installing Cable Retention Clips on Outlets (Optional)	16
Locking Outlets and Cords	17

Circuit Breaker Orientation Limitation

Usually a PDU can be mounted in any orientation. However, when mounting a PDU with circuit breakers, you must obey these rules:

- Circuit breakers CANNOT face down. For example, do not horizontally mount a Zero U PDU with circuit breakers on the ceiling.
- If a rack is subject to shock in environments such as boats or airplanes, the PDU CANNOT be mounted upside down. If installed upside down, shock stress reduces the trip point by 10%.

Note: If normally the line cord is down, upside down means the line cord is up.

Rack-Mounting the PDU

This chapter describes how to rack mount a PX3. Only the most common rackmount method is displayed. Follow the procedure suitable for your model.

Rackmount Safety Guidelines

In Raritan products which require rack mounting, follow these precautions:

- Operation temperature in a closed rack environment may be greater than room temperature. Do not exceed the rated maximum ambient temperature of the Power Distribution Units. See **Specifications** (on page 733) in the User Guide.
- Ensure sufficient airflow through the rack environment.
- Mount equipment in the rack carefully to avoid uneven mechanical loading.
- Connect equipment to the supply circuit carefully to avoid overloading circuits.
- Ground all equipment properly, especially supply connections, to the branch circuit.

Mounting Zero U Models Using L-Brackets

If your PDU has circuit breakers implemented, read **Circuit Breaker Orientation Limitation** (on page 5) before mounting it.

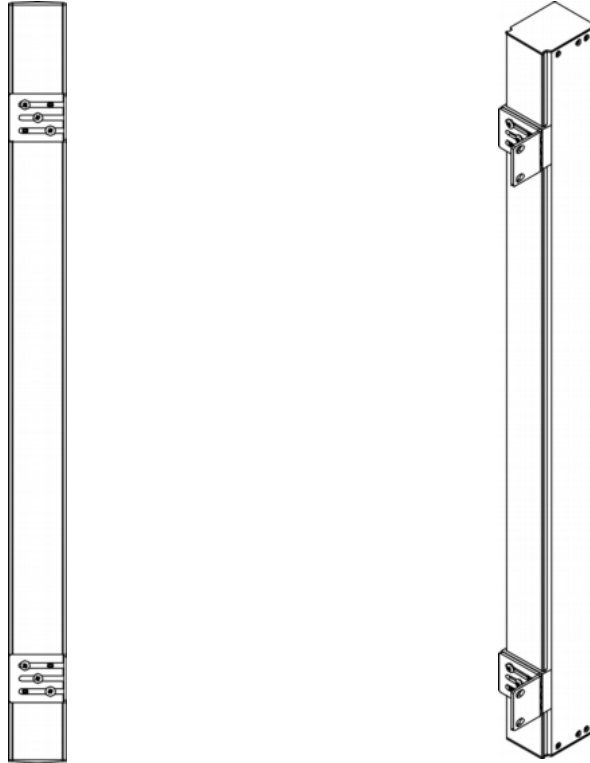

► **To mount Zero U models using L-brackets:**

1. Align the baseplates on the rear of the PX3 device.
2. Secure the baseplates in place. Use the included L-shaped hex key to loosen the hex socket screws until the baseplate is "slightly" fastened.

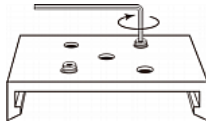

3. Align the L-brackets with the baseplates so that the five screw-holes on the baseplates line up through the L-bracket's slots. The rackmount side of brackets should face either the left or right side of the PX3 device.
4. Fasten the brackets in place with at least three screws (one through each slot). Use additional screws as desired.

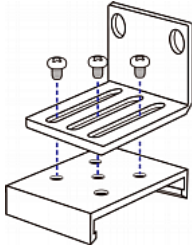

- Using rack screws, fasten the PX3 device to the rack through the L-brackets.

Mounting Zero U Models Using Button Mount

If your PDU has circuit breakers implemented, read **Circuit Breaker Orientation Limitation** (on page 5) before mounting it.

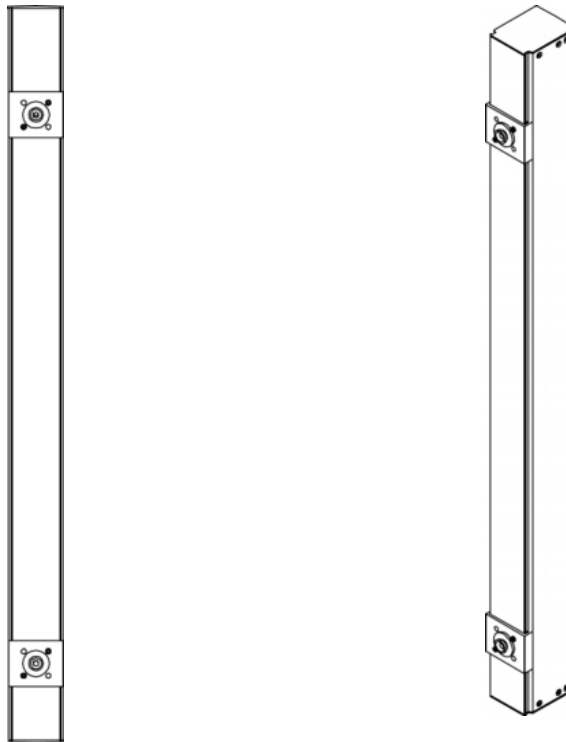

► **To mount Zero-U models using button mount:**

- Align the baseplates on the rear of the PX3 device. Leave at least 24 inches between the baseplates for stability.
- Make the baseplates grasp the device lightly. Use the included L-shaped hex key to loosen the hex socket screws until the baseplate is "slightly" fastened.
- Screw each mounting button in the center of each baseplate. The recommended torque for the button is 1.96 N·m (20 kgf·cm).

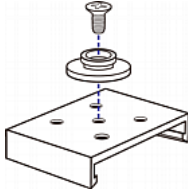

4. Align the large mounting buttons with the mounting holes in the cabinet, fixing one in place and adjusting the other.
5. Loosen the hex socket screws until the mounting buttons are secured in their position.
6. Ensure that both buttons can engage their mounting holes simultaneously.
7. Press the PX3 device forward, pushing the mounting buttons through the mounting holes, then letting the device drop about 5/8". This secures the PX3 device in place and completes the installation.

Mounting Zero U Models Using Claw-Foot Brackets

If your PDU has circuit breakers implemented, read ***Circuit Breaker Orientation Limitation*** (on page 5) before mounting it.

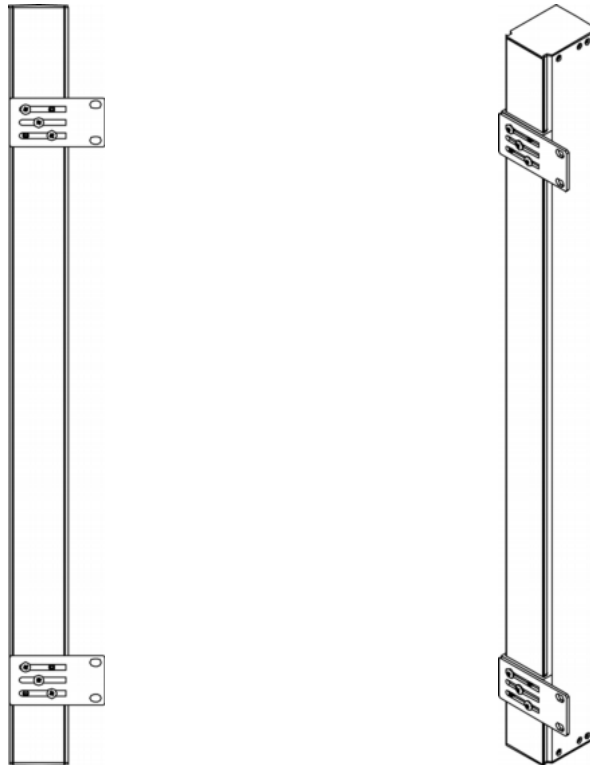

► **To mount Zero U models using claw-foot brackets:**

1. Align the baseplates on the rear of the PX3 device.

2. Secure the baseplates in place. Use the included L-shaped hex key to loosen the hex socket screws until the baseplate is "slightly" fastened.
3. Align the claw-foot brackets with the baseplates so that the five screw-holes on the baseplates line up through the bracket's slots. The rackmount side of brackets should face either the left or right side of the PX3 device.
4. Fasten the brackets in place with at least three screws (one through each slot). Use additional screws as desired.

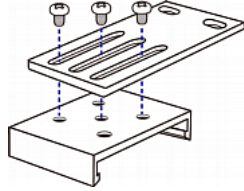

5. Using rack screws, fasten the PX3 device to the rack through the claw-foot brackets.

Mounting Zero U Models Using Two Rear Buttons

The following describes how to mount a PX3 using two buttons only. If your PDU has circuit breakers implemented, read **Circuit Breaker Orientation Limitation** (on page 5) before mounting it.

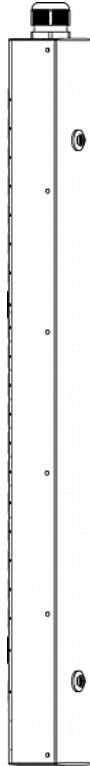

► **To mount Zero U models using two buttons:**

1. Turn to the rear of the PX3.
2. Locate two screw holes on the rear panel: one near the bottom and the other near the top (the side of cable gland).
3. Screw a button in the screw hole near the bottom. The recommended torque for the button is 1.96 N·m (20 kgf·cm).

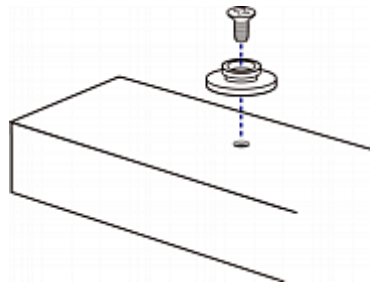

4. Screw a button in the screw hole near the top. The recommended torque for the button is 1.96 N·m (20 kgf·cm).
5. Ensure that the two buttons can engage their mounting holes in the rack or cabinet simultaneously.
6. Press the PX3 device forward, pushing the mounting buttons through the mounting holes, then letting the device drop slightly. This secures the PX3 device in place and completes the installation.

Mounting 1U or 2U Models

Using the appropriate brackets and tools, fasten the 1U or 2U device to the rack or cabinet.

► **To mount the PX3 device:**

1. Attach a rackmount bracket to both sides of the PX3 with the provided screws.

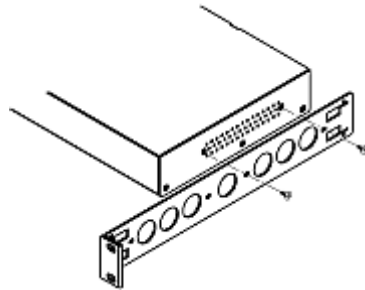

2. Insert the cable-support bar into rackmount brackets.

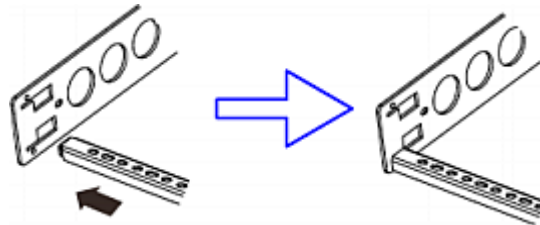

3. Secure with the provided end cap screws.

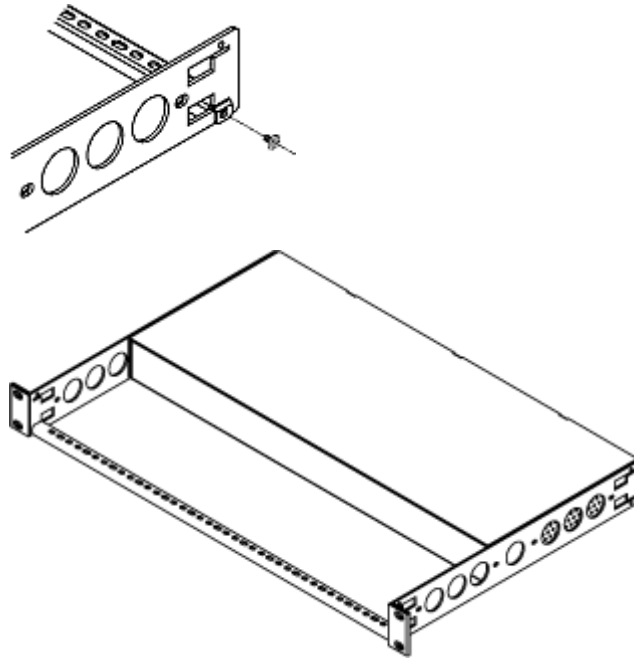

4. Fasten the rackmount brackets' ears to the rack using your own fasteners.

Connecting a PX3 Locking Line Cord

The PX3 is shipped with either of the following locking line cords.

- A line cord with locking clips: A locking inlet on the PDU is required for this cord.
- A line cord with slide release buttons: This line cord automatically locks after being connected to the inlet. A locking inlet is not required for this cord.

A locking inlet and/or locking line cord ensure that the line cord is securely fastened to the inlet.

► To connect a cord with locking clips:

Make sure the line cord's locking clips fit into the locking holes at two sides of the inlet when plugging the cord's connector into the PDU's locking inlet.

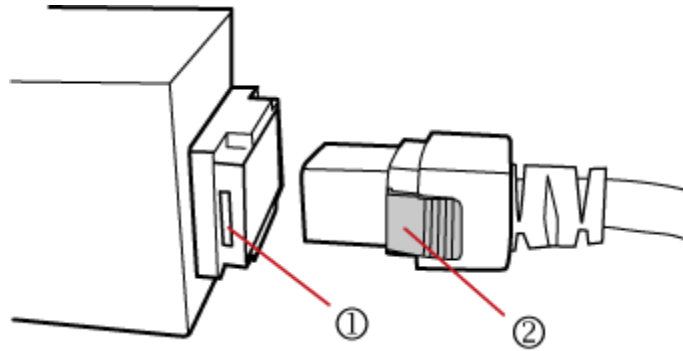

Number	Item
1	Locking holes on the inlet
2	Locking clips of the line cord

► To connect a cord with slide release buttons:

Simply plug the cord's connector into the PDU's inlet.

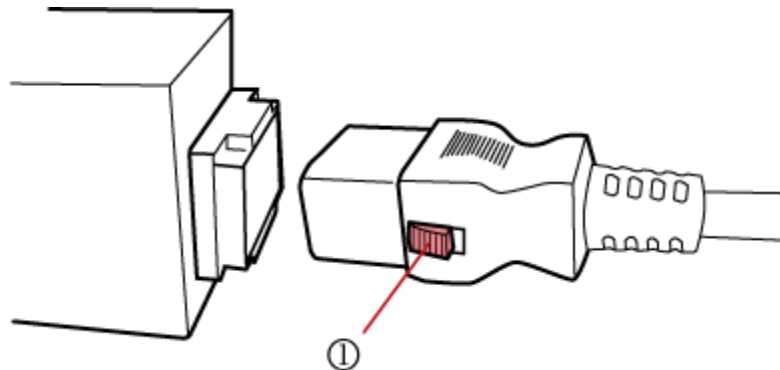

Number	Item
1	Slide release buttons

For information on removing the locking line cord, see **Disconnecting a PX3 Locking Line Cord** (on page 14).

Disconnecting a PX3 Locking Line Cord

The ways to disconnect a locking line cord vary according to the cord type.

► **To disconnect a line cord with locking clips:**

Press both locking clips of the line cord while unplugging the cord.

Tip: You can slightly move the line cord's plug horizontally while pulling it out to facilitate the disconnection process.

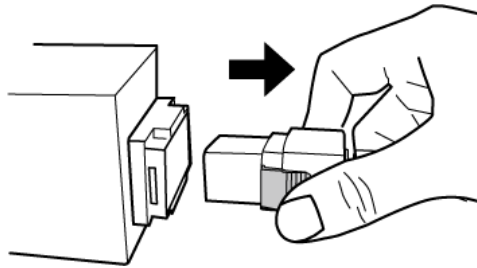

► **To disconnect a line cord with slide release buttons:**

Push both slide release buttons toward the cord while unplugging this cord.

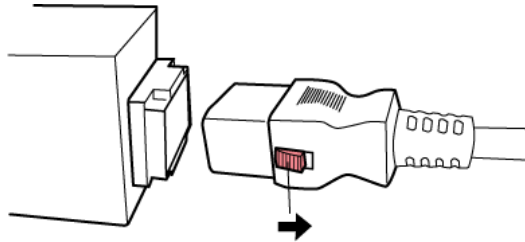

Installing Cable Retention Clips on the Inlet (Optional)

If your PX3 device is designed to use a cable retention clip, install the clip before connecting a power cord. A cable retention clip prevents the connected power cord from coming loose or falling off.

The use of cable retention clips is highly recommended for regions with high seismic activities, and environments where shocks and vibrations are expected.



► **To install and use a cable retention clip on the inlet:**

1. Locate two tiny holes adjacent to the inlet.
2. Install the cable retention clip by inserting two ends of the clip into the tiny holes.

Zero U models

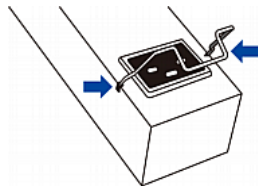

1U/2U models

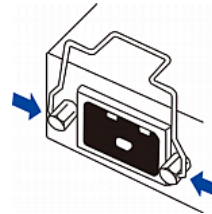

3. Connect the power cord to the inlet, and press the clip toward the power cord until it holds the cord firmly.

Zero U models

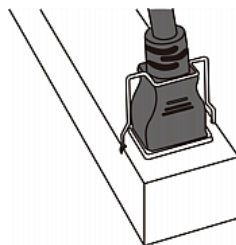

1U/2U models

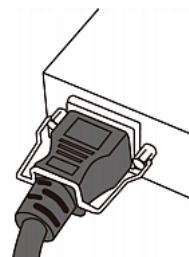

Installing Cable Retention Clips on Outlets (Optional)

If your PX3 device is designed to use a cable retention clip, install the clip before connecting a power cord. A cable retention clip prevents the connected power cord from coming loose or falling off.

The use of cable retention clips is highly recommended for regions with high seismic activities, and environments where shocks and vibrations are expected.

These optional clips come in various sizes to accommodate diverse power cords used on IT equipment, which are connected to C13 or C19 outlets. You can request a cable retention kit containing different sizes of clips from your reseller. Make sure you use a clip that fits the power cord snugly to facilitate the installation or removal operation (for servicing).



*Note: Some NEMA sockets on PSE-certified PDUs for Japan have integral locking capability and do not need cable retention clips. See **Locking Outlets and Cords** (on page 17).*

► **To install and use a cable retention clip on the outlet:**

1. Locate two tiny holes at two sides of an outlet.
2. Install the cable retention clip by inserting two ends of the clip into the tiny holes.

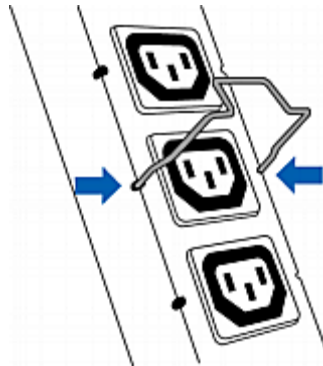

3. Plug the power cord into the outlet, and press the clip toward the power cord until it holds the cord firmly. The clip's central part holding the plug should face downwards toward the ground, like an inverted "U". This allows gravity to keep the clip in place.

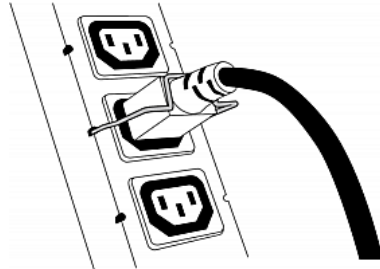

4. Repeat the same steps to install clips and power cords on the other outlets.

Locking Outlets and Cords

In addition to the cable retention clips, Raritan also provides other approaches to secure the connection of the power cords from your IT equipment to the Raritan PDUs, including:

- SecureLock™ outlets and cords
- Button-type locking outlets

Note that NOT all Raritan PDUs are implemented with any of the above locking outlets.

SecureLock™ Outlets and Cords

SecureLock™ is an innovative mechanism designed by Raritan, which securely holds C14 or C20 plugs that are plugged into Raritan PDUs in place. This method requires the following two components:

- Raritan PDU with SecureLock™ outlets, which have a latch slot inside either side of the outlet.
- SecureLock™ cords, which is a power cord with a locking latch on each side of its plug. The following diagram illustrates such a plug.

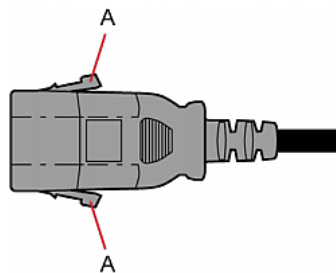

Item	Description
A	Latches on the SecureLock™ cord's plug

Only specific PDUs are implemented with the SecureLock™ mechanism. If your PDU does not have this design, do NOT use the SecureLock™ cords with it.

Tip: The SecureLock™ outlets can accept regular power cords for power distribution but the SecureLock™ mechanism does not take effect.

► **To lock a power cord using the SecureLock™ mechanism:**

1. Verify that the SecureLock™ cord you purchased meets your needs.
 - The cords' female socket matches the power socket type (C14 or C20) on your IT equipment.
 - The cord's male plug matches the outlet type (C13 or C19) on your PDU.
2. Connect the SecureLock™ cord between the IT equipment and your PDU.
 - Plug the female socket end of the cord into the power socket of the desired IT equipment.
 - Plug the male plug end of the cord into the appropriate SecureLock™ outlet on the PDU. Push the plug toward the outlet until you hear the click, which indicates the plug's latches are snapped into the latch slots of the outlet.

► **To remove a SecureLock™ power cord from the PDU:**

1. Press and hold down the two latches on the cord's plug as illustrated in the diagram below.

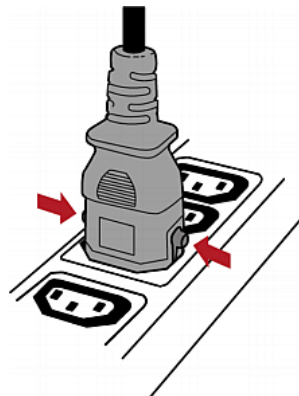

2. Unplug the cord now.

Button-Type Locking Outlets

Such outlets do not require any special power cords to achieve the locking purpose. All you need to do is simply plug a regular power cord into the locking outlet and the outlet automatically locks the cord.

► **To remove a power cord from the locking outlet:**

1. Press and hold down the tiny button adjacent to the outlet. Depending on the outlet type, the button location differs.

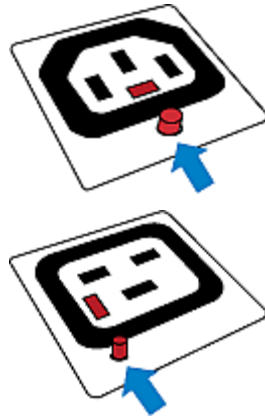

2. Unplug the power cord now.

Chapter 3 Initial Installation and Configuration

This chapter explains how to install your PX3 and configure it for network connectivity.

In This Chapter

Connecting the PDU to a Power Source	20
Connecting the PX3 to Your Network	21
Configuring the PX3	23
Bulk Configuration Methods.....	32
Cascading Multiple PX3 Devices for Sharing Ethernet Connectivity.....	33
Power-Sharing Restrictions and Connection	42

Connecting the PDU to a Power Source

1. Verify that all circuit breakers on the PX3 are set to ON. If not, turn them ON.

Or make sure that all fuses are inserted and seated properly. If there are any fuse covers, ensure that they are closed.

Note: Not all models have overcurrent protectors.

2. Connect each PX3 to an appropriately rated branch circuit. Refer to the label or nameplate affixed to your PX3 for appropriate input ratings or range of ratings.

Note: When a PX3 powers up, it proceeds with the power-on self test and software loading for a few moments. At this time, the outlet LEDs cycle through different colors. Note that outlet LEDs are only available on some PDU models.

3. When the software has completed loading, the outlet LEDs show a steady color and the front panel display illuminates.

Connecting the PX3 to Your Network

To remotely administer the PX3, you must connect the PX3 to your local area network (LAN). PX3 can be connected to a wired or wireless network.

*Note: If your PX3 will work as a master device in the bridging mode, you must make a wired connection. See **Cascading Multiple PX3 Devices for Sharing Ethernet Connectivity** (on page 33).*

Ethernet port of PX3 must be enabled for the described connection to work properly, which has been enabled per default. See **Wired Network Settings** (on page 302).

► **To make a wired connection:**

1. Connect a standard network patch cable to either or both Ethernet ports on the PX3.
 - The two Ethernet ports must be connected to different subnets. See **Dual Ethernet Connection** (on page 23).
 - The "green" Ethernet port labeled "ETH①10/100/1000" supports up to 1000 Mbps so it is highly recommended for network connection.
2. Connect the other end of the cable to your LAN.

Below illustrates the ETHERNET ports on PX3 Zero U models. Note that the port locations on your models may differ.

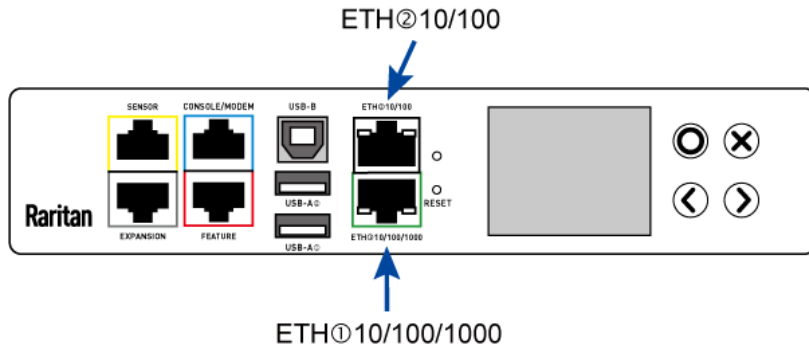

Warning: Accidentally plugging an RS-232 RJ-45 connector into the Ethernet port can cause permanent damage(s) to the Ethernet hardware.

► **To make a wireless connection:**

Do one of the following:

- Plug a supported USB wireless LAN adapter into the USB-A port on your PX3.

- Connect a USB hub to the USB-A port on the PX3. Then plug the supported USB wireless LAN adapter into the appropriate USB port on the hub.

See **USB Wireless LAN Adapters** (on page 22) for a list of supported wireless LAN adapters.

USB Wireless LAN Adapters

The PX3 supports the following USB Wi-Fi LAN adapters.

Wi-Fi LAN adapters	Supported 802.11 protocols
SparkLAN WUBR-508N	A/B/G/N
Proxim Orinoco 8494	A/B/G
Zyxel NWD271N	B/G
Edimax EW-7722UnD	A/B/G/N
TP-Link TL-WDN3200 v1	A/B/G/N
Raritan USB WIFI	A/B/G/N

Supported Wireless LAN Configuration

If wireless networking is preferred, ensure that the wireless LAN configuration of your PX3 matches the access point. The following is the wireless LAN configuration that the PX3 supports.

- Network type: 802.11 A/B/G/N
- Protocol: WPA2 (RSN)
- Key management: WPA-PSK, or WPA-EAP with PEAP and MSCHAPv2 authentication
- Encryption: CCMP (AES)

Tip: Supported 802.11 network protocols vary according to the wireless LAN adapter being used with the PX3. See *USB Wireless LAN Adapters* (on page 22).

Note: You must configure PX3 to enable its wireless LAN interface. See the topic titled *Configuring Network Settings* (on page 301) in the User Guide.

Dual Ethernet Connection

One PX3 device has two Ethernet (LAN) ports:

- ETH①10/100/1000 (marked in *green*) supports up to 1000 Mbps. This is "ETH1".
- ETH②10/100 (marked in *white*) supports up to 100 Mbps. This is "ETH2".

For more information on the two ports, see **Connection Ports** (on page 117, "**Connection Port Functions**" on page 117).

You can connect both ports to *different* subnets (networks) and therefore obtain two IP addresses for wired networking. It is strongly recommended that you DO NOT connect both ports to the same subnet to avoid potential issues. Contact your IT department if you are not sure whether the two Ethernet ports are connecting to the same or different subnets.

*Exception: A USB-cascading chain must connect to "only one" network. Do NOT connect both Ethernet ports of any PX3 master or slave device to the LAN. See **Cascading Multiple PX3 Devices for Sharing Ethernet Connectivity** (on page 33).*

▶ **Check list when connecting both ports to the networks:**

- Both Ethernet interfaces are connecting to different subnets.
- Both Ethernet interfaces have been enabled. By default both are enabled. See **Device Info** (on page 152) and **Ethernet Interface Settings** (on page 305).
- Both Ethernet interfaces are configured with proper IPv4 and/or IPv6 settings. See **Wired Network Settings** (on page 302).
 - It is NOT required that the two Ethernet interfaces share similar network settings. For example, you can enable IPv4 settings in one interface but enable IPv6 settings in the other, or apply static IP to one but DHCP IP to the other.
- The cascading mode is disabled. By default it is disabled. See **Setting the Cascading Mode** (on page 318).

Configuring the PX3

You can initially configure the PX3 via one of the following:

- A TCP/IP network that supports DHCP
- A mobile device with PDView installed
- A computer physically connected to the PX3

▶ **Configuration via a DHCP-enabled network:**

1. Connect the PX3 to a DHCP IPv4 network. See **Connecting the PX3 to Your Network** (on page 21).

2. Retrieve the DHCP-assigned IPv4 address. Use the front panel LCD display to retrieve it. See **Device Info** (on page 152).
3. Launch a web browser to configure the PX3. See **Login** (on page 171).

▶ **Configuration via a connected mobile device:**

1. Download the PDView app to your mobile device. See **Connecting a Mobile Device to PX3** (on page 24).
2. Connect the mobile device to PX3 via USB.
3. Launch PDView to configure the PX3.

▶ **Configuration via a connected computer:**

1. Connect the PX3 to a computer. See **Connecting the PX3 to a Computer** (on page 30).
2. Use the connected computer to configure the PX3 via the command line or web interface.
 - Command line interface: See **Initial Network Configuration via CLI** (on page 898).
 - Web interface: Launch the web browser on the computer, and type the link-local IP address or *pdu.local* to access the PX3. See **Login** (on page 171).

For link-local IP address retrieval, see **Device Info** (on page 152).

*Tip: To configure a number of PX3 devices quickly, see **Bulk Configuration Methods** (on page 32).*

Connecting a Mobile Device to PX3

Raritan's PDView is a free app that turns your iOS or Android mobile device into a local display for PX3.

PDView is especially helpful when your PX3 is not connected to the network but you need to check the PX3 status, retrieve its information, or change its settings.

▶ **Requirements for using PDView:**

- PX3 is running any post-3.0.0 firmware version.
- If using an Android device, it must support USB "On-The-Go" (OTG).
- An appropriate USB cable is required. For information, refer to Step B below.

▶ **Step A: Download and install PDView**

1. Visit either Apple App or Google Play Store.

- <https://itunes.apple.com/app/raritan-pdview/id780382738>



- <https://play.google.com/store/apps/details?id=com.raritan.android.pdview>



2. Install PDView.



► **Step B: Connect the mobile device to PX3**

1. Get an appropriate USB cable for your mobile device.
 - *iOS:* Use the regular USB cable shipped with your iOS mobile device.
 - *Android:* Use an **USB OTG** adapter cable.
2. Connect the mobile device to the appropriate USB port on the PX3.
 - *iOS:* USB-A port.
 - *Android:* USB-B port

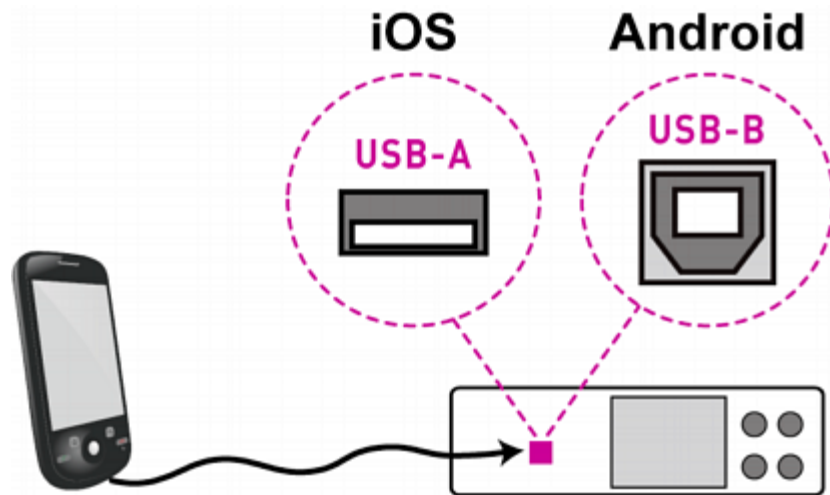

► **Step C: Launch PDView to access the PX3**

1. Launch the PDView app from your mobile device. Below illustrate iPad's PDView screens.

- a. The "Disconnected" message displays first when PDView has not detected the PX3 yet.

A diagram in PDView indicates the appropriate USB port your mobile device should connect according to your mobile operating system.

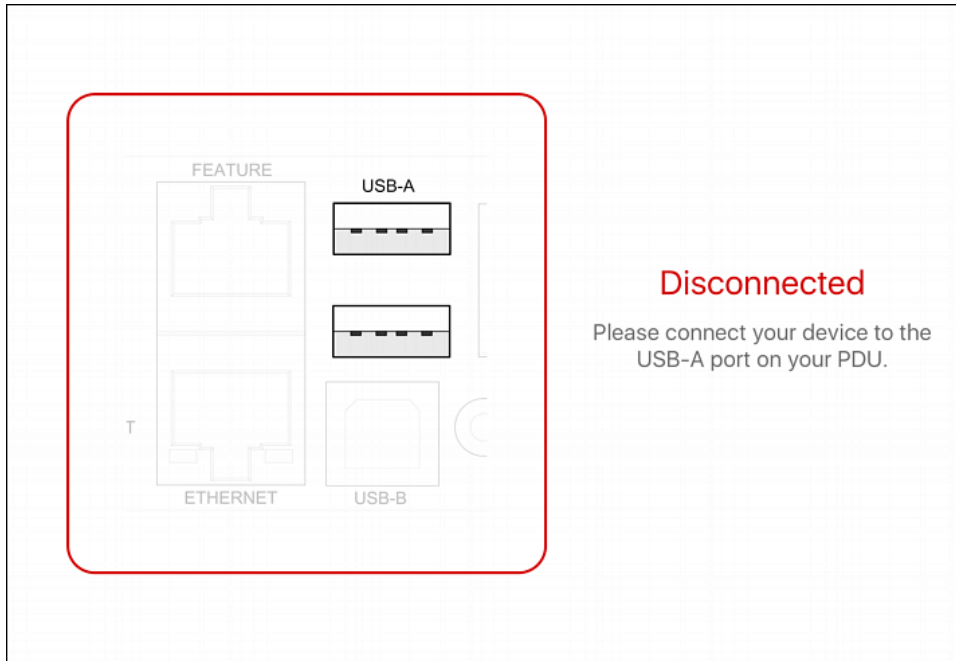

Note: PDView also shows the 'Disconnected' status during the firmware upgrade. If so, wait until the firmware upgrade finishes.

- b. The PDView shows the "Connected" message when it detects the connected PX3.

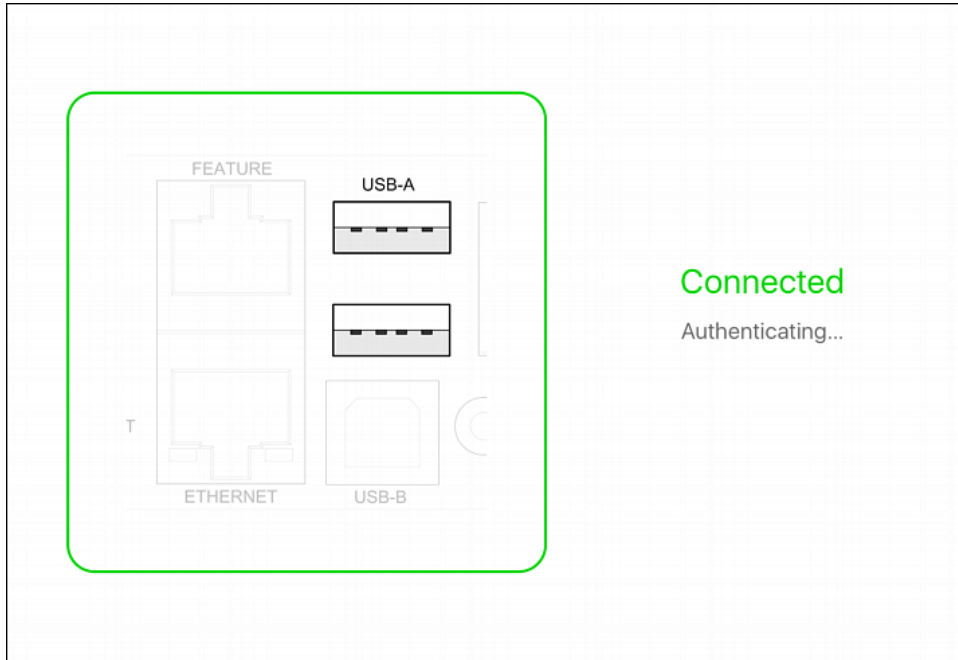

2. If the factory-default user credentials "admin/raritan" remain unchanged, PDView automatically logs in to the web interface of PX3. If they have been changed, the login screen displays instead and you must enter appropriate user credentials for login.
3. The web interface opens. Now you can view or modify the data of PX3.
 - The web interface prompts you to change the password if this is the first time you log in.

*Tip: You can store the updated "admin" or other user credentials in PDView so that automatic login always functions properly upon detection of the PX3. See **Saving User Credentials for PDView's Automatic Login** (on page 28).*

Saving User Credentials for PDView's Automatic Login

When PDView detects PX3 for the "first" time, it automatically attempts to log in with the factory-default user credentials -- *admin* (user name) and *raritan* (password).

If you have modified the factory-default user credentials, PDView's automatic login fails and the login screen displays for you to manually enter user credentials.

To make automatic login work again, you can save the modified admin credentials or any custom user credentials in PDView. A maximum of 5 user credentials can be saved, and PDView will try these credentials one by one until the login succeeds.

The following procedure illustrates iPad only, but the procedure applies to any iOS or Android mobile devices.

► **To save user credentials in PDView:**

1. Make sure your mobile device is NOT connected to the PX3 so that PDView does NOT perform the automatic login feature after it is launched.
2. Launch PDView on your mobile device.



3. Tap the top-right icon  (iOS) or  (Android).

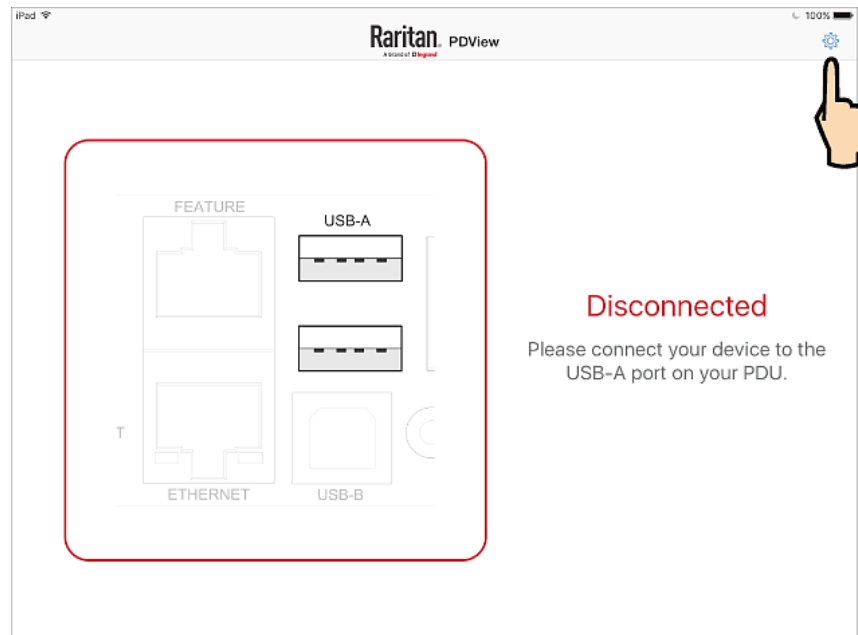

4. The user credentials setup page opens.

- Per default, three administrator user credentials are pre-configured for three companies' products:
 - *Raritan*
 - *Legrand*
 - *ServerTech (Server Technology)*

The screenshot shows the 'Settings' screen in the Raritan PDView application. At the top, there is a navigation bar with a back arrow, the text 'Raritan PDView', the title 'Settings', and a 'Save' button. Below the navigation bar, the section 'Default Username/Password Credentials:' is displayed. It contains five rows of input fields for usernames and passwords. The first three rows are pre-filled with 'admin' and specific standard passwords (Raritan, Legrand, and ServerTech). The last two rows are empty. At the bottom left, there is a 'Privacy Policy' link.

Username	Password
admin	Raritan standard password
admin	Legrand standard password
admin	ServerTech standard password

5. Modify existing user credentials or type new ones, and tap Save.
 - The pre-configured admin credentials can be removed or overwritten to meet your needs.

Connecting the PX3 to a Computer

The PX3 can be connected to a computer for configuration via one of the following ports.

- Ethernet ports
- USB-B port
- RS-232 serial port (RJ-45)

Note that the port locations on your models may differ.

- **Zero U models:**

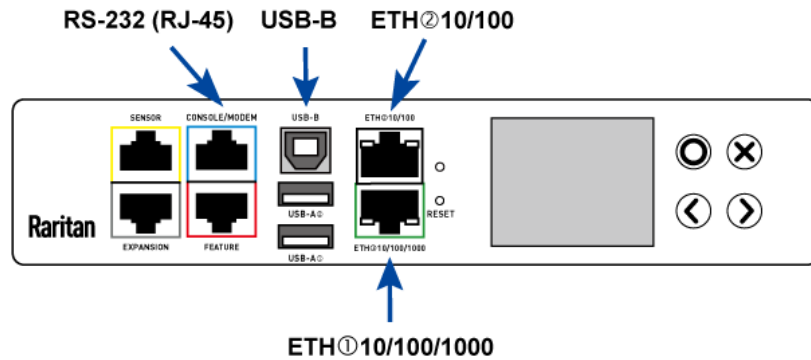

To use the command line interface (CLI) for configuration, establish an RS-232 or USB connection.

To use a web browser for configuration, make a network connection to the computer. The PX3 is automatically configured with the following link-local addressing in any network without DHCP available:

- `https://169.254.x.x` (where x is a number)
- `https://pdu.local`

See **APIPA and Link-Local Addressing** (on page 2).

Establish one of the following connections to a computer. Ethernet port of PX3 must be enabled for the described connection to work properly, which has been enabled per default.

► **Direct network connection:**

1. Connect one end of a standard network patch cable to either Ethernet port of the PX3.
2. Connect the other end to a computer's Ethernet port.
3. On the connected computer, launch a web browser to access the PX3, using either link-local addressing: `pdu.local` or `169.254.x.x`. See **Login** (on page 171).

▶ **USB connection:**

1. A USB-to-serial driver is required in Windows*. Install this driver before connecting the USB cable. See **Installing the USB-to-Serial Driver (Optional)** (on page 897).
2. Connect a USB cable between a computer's USB-A port and the USB-B port of PX3.
3. Perform **Initial Network Configuration via CLI** (on page 898).

Note: Not all serial-to-USB converters work properly with the PX3 so Raritan does not introduce the use of such converters.

▶ **Serial connection for "RJ-45" RS-232 connector:**

1. Connect the RJ-45 end of the RJ45-to-DB9 adapter cable to the RJ-45 port labeled CONSOLE / MODEM on PX3.
 - See **RJ45-to-DB9 Cable Requirements for Computer Connections** (on page 31).
2. Connect the DB9 end to your computer's RS-232 port (COM).
3. Perform **Initial Network Configuration via CLI** (on page 898).

RJ45-to-DB9 Cable Requirements for Computer Connections

An RJ45-to-DB9 adapter/cable is required for connecting the **PX3** to a computer, if the use of a USB cable is not wanted.

A third party RJ45-to-DB9 adapter/cable needs to meet the following requirements.

- RJ-45 to "DB9 female"
- RX/TX and according control pins are CROSSED

The widespread blue Cisco RJ-45 to DB9 adapter cable is highly recommended, which has the following pin assignments:

DB9 pin signal	DB9 pin No.	RJ-45 pin No.	RJ-45 pin signal
CTS	8	1	RTS
DSR	6	2	DTR
RxD	2	3	TxD
GND	5	4	GND
GND	5	5	GND
TxD	3	6	RxD
DTR	4	7	DSR
RTS	7	8	CTS

DB9 pin signal	DB9 pin No.	RJ-45 pin No.	RJ-45 pin signal
DCD	1 (Not connected)		N/A
RI	9 (Not connected)		

*Note: The blue Cisco RJ-45 to DB9 adapter cable CANNOT be used for connecting a modem. See **RJ45-to-DB9 Cable Requirements for Modem Connections** (on page 874).*

Bulk Configuration Methods

If you have to set up multiple PX3 devices, you can use one of the following configuration methods to save your time.

▶ A bulk configuration file downloaded from PX3:

- *Requirement:* All PX3 devices to configure are of the same model and firmware.
- *Procedure:* First finish configuring one PX3. Then download the bulk configuration file from it and copy this file to all of the other PX3 devices. See **Bulk Configuration** (on page 470).

▶ A TFTP server:

- *Requirement:* DHCP is enabled in your network and a TFTP server is available.
- *Procedure:* Prepare special configuration files, which must include *fwupdate.cfg*, and copy them to the root directory of the TFTP server. Re-boot all PX3 devices after connecting them to the network. See **Bulk Configuration or Firmware Upgrade via DHCP/TFTP** (on page 755).

▶ Curl command:

- *Requirement:* Two files are required -- one is a configuration file in TXT and the other is a devices list file in CSV. See **config.txt** (on page 747) and **devices.csv** (on page 750).
- *Procedure:* Upload both files to all of PX3 devices one by one, using the appropriate curl command. See **Upload via Curl** (on page 781).

▶ SCP or PSCP command:

- *Requirement:* Two files are required -- one is a configuration file in TXT and the other is a devices list file in CSV.
- *Procedure:* Upload both files to all of PX3 devices one by one, using the appropriate SCP or PSCP command. See **Uploading or Downloading Raw Configuration Data** (on page 712).

▶ **A USB flash drive:**

- *Requirement:* A FAT32- or superfloppy-formatted USB flash drive containing two special configuration files and one devices list file is required.
- *Procedure:* Plug this USB drive into the PX3. When a happy smiley is shown on the front panel display, press and hold one of the control buttons on the front panel until the display turns blank.

See **Configuration or Firmware Upgrade with a USB Drive** (on page 740).

Cascading Multiple PX3 Devices for Sharing Ethernet Connectivity

Important: To upgrade an existing Raritan USB-cascading chain from any pre-3.3.10 firmware version to version 3.3.10 or later, follow the *Upgrade Sequence in an Existing Cascading Chain* (on page 467).

You can have multiple PX3 devices share one Ethernet connection by cascading them via one of the interfaces below:

- USB interface
- Ethernet interface

The first one in the cascade is the master device and all the other devices follow it in the cascade. Only the master device is physically connected to the LAN -- wired or wireless.

Each device in the cascade is accessible over the network, with Bridging or Port-Forwarding cascading mode activated on the master device. See **Setting the Cascading Mode** (on page 318).

- **Bridging:** Each device in the cascading chain is accessed with a different IP address.
- **Port Forwarding:** Each device in the cascading chain is accessed with the same IP address(es) but with a different port number assigned.

▶ **Basic cascading restrictions:**

- All devices in the chain must run "compatible" firmware versions.
 - Firmware version 3.3.10 or later is NOT compatible with pre-3.3.10 firmware versions in terms of the cascading feature so all Raritan devices in the cascading chain must run version 3.3.10 or later.
- The cascading mode of all devices in the chain must be the same.
- In the Bridging mode, the master device can have "only one" connection to the network. DO NOT connect both Ethernet ports to the network(s) unless your network has the R/STP protocol enabled.

Note: The Port Forwarding mode does NOT have this restriction. In this mode, you can enable two wired and one wireless network connections.

- Do NOT connect cascaded devices other than master to the LAN or WLAN.
- (WIFI only) You must use Raritan's USB WIFI wireless LAN adapter instead of other WIFI adapters for wireless network connection.

▶ **Troubleshooting:**

When a networking issue occurs, check the cascading connection and/or software settings of all devices in the chain. See **Cascading Troubleshooting** (on page 892).

Best Practices for Cascading

▶ **One Ethernet connection per cabinet is better:**

One Ethernet connection per cabinet is better than one Ethernet connection across cabinets because of these advantages:

- Easier to manage or maintain one cabinet when all of the cabling and connections are located in the same cabinet.
- Reduces the cross-cabinet cabling.

▶ **When to establish a chain comprising 16 devices:**

A chain consisting of 16 devices saves the most Ethernet connections and costs, and it is recommended only when:

- External Ethernet ports are expensive or limited.
- Available IP addresses are limited.

▶ **Ethernet cascading is recommended for Raritan's PX3-iX7, PX3TS-iX7, PXC, PXO, SRC and Legrand PDUs:**

If the products you purchase are Raritan's PX3-iX7 PDUs, PX3TS-iX7 transfer switches, PXC PDUs, PXO PDUs, SRC, or Legrand PDUs, cascading them via Ethernet is better than via USB because the Ethernet interface offers the following benefits.

- Longer cabling distance
- Lower latency
- Connection more reliable with RJ-45 connectors

See Extended Cascading (for PX3 PDUs Only).

Note: Raritan's iX7-based BCM2 series products, including BCM2-iX7, PMC-iX7 and PMMC, do not support such cascading because they have only "one" Ethernet port.

For more information on cascading configurations and restrictions, refer to the *Cascading Guide* on the Raritan **Support page** (<http://www.raritan.com/support/>).

Cascading All Devices via USB

You must set the cascading mode before establishing the chain. See **Setting the Cascading Mode** (on page 318).

Any certified USB 2.0 cable up to 5 meters (16 feet) long can be used.

Both cascading modes support a maximum of 16 devices in a chain.

The following diagram illustrates PX3 devices cascaded via USB.

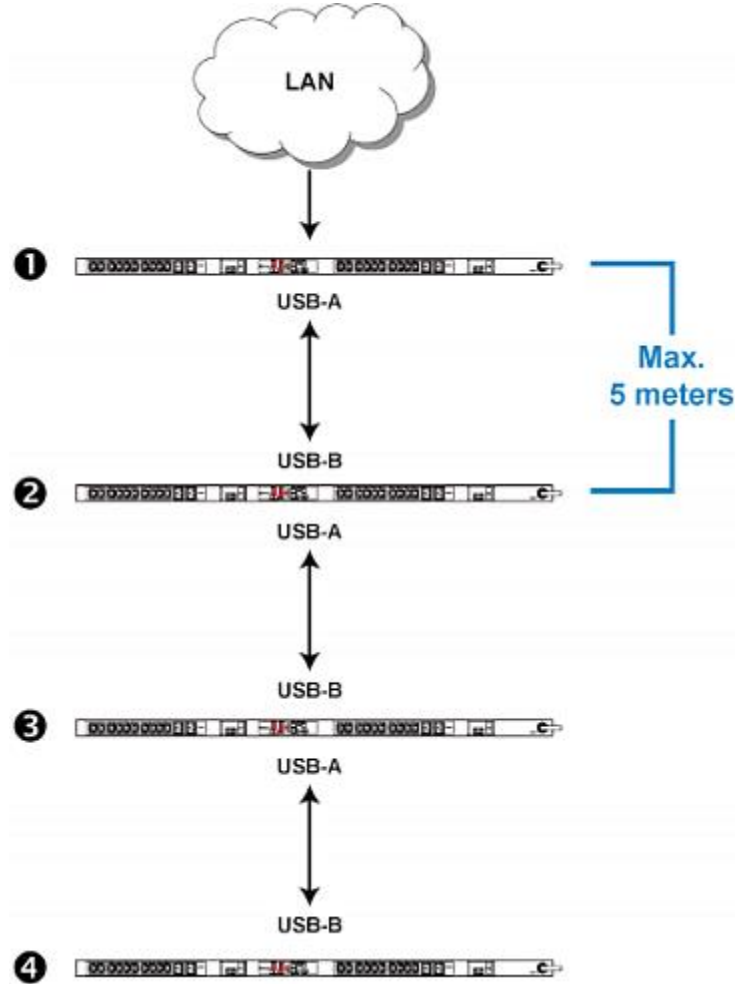

Number	Device role
1	Master device
2	Slave 1
3	Slave 2
4	Slave 3

► **To cascade PX3 devices via USB:**

1. Make sure all Raritan devices are running firmware version 3.3.10 or later.
 2. Choose the appropriate one as the master device.
 - When the Port Forwarding mode over "wireless LAN" is intended, the master device must be a Raritan product with two USB-A ports, such as PX3, Smart Rack Controller, EMX2-888, PX3TS or BCM2.
 3. Log in to all devices one by one and select the same cascading mode.
 - **Bridging mode:**
Set the cascading mode of all devices to Bridging.
 - **Port Forwarding mode:**
Set the cascading mode of all devices to Port Forwarding. Make sure the cascading role and downstream interface are also set correctly.
- See **Setting the Cascading Mode** (on page 318).
4. Connect the master device to the LAN, using a method below.
 - **Bridging mode:**
Use a standard network patch cable (CAT5e or higher).
 - **Port Forwarding mode:**
Use a standard network patch cable and/or a Raritan USB WIFI wireless LAN adapter. For information on the Raritan USB WIFI adapter, see **USB Wireless LAN Adapters** (on page 22).
 5. Connect the USB-A port of the master device to the USB-B port of an additional PX3 via a USB cable. This additional device is Slave 1.
 6. Connect Slave 1's USB-A port to the USB-B port of an additional PX3 via another USB cable. The second additional device is Slave 2.
 7. Repeat the same step to connect more slave devices. You can cascade up to 15 slave devices.
 8. (Optional) Configure or change the network settings of the master and/or slave devices as needed. See **Configuring Network Settings** (on page 301).
 - **Bridging mode:** Each cascaded device has its own network settings. For example, you can have some devices use DHCP-assigned IP addresses and the others use static IP addresses.
 - **Port Forwarding mode:** Only the master device's network settings should be configured.

► **A tip for USB cascading:**

The "USB-cascading" chain can be a combination of diverse Raritan products that support the USB-cascading feature, including PX3, PXC, Smart Rack Controller, transfer switch, PX2, BCM and EMX.

Extended Cascading with PX3 Devices

PX3 supports cascading via either Ethernet or USB ports. This is because they have "two" Ethernet ports.

You can use either Ethernet port on the PX3 PDU for cascading.

You must set the cascading mode before establishing the chain. See **Setting the Cascading Mode** (on page 318).

Both cascading modes support a maximum of 16 devices in a chain.

When establishing a Port-Forwarding chain, make sure you follow the guidelines described in the section titled **Restrictions of Port-Forwarding Connections** (on page 40).

You can mix Ethernet and USB cascading in the PX3 PDU chain if preferred. The following diagram illustrates such a chain.

The distance between two Ethernet-cascaded devices can be up to 100 meters, while the distance between two USB-cascaded devices supports up to 5 meters only.

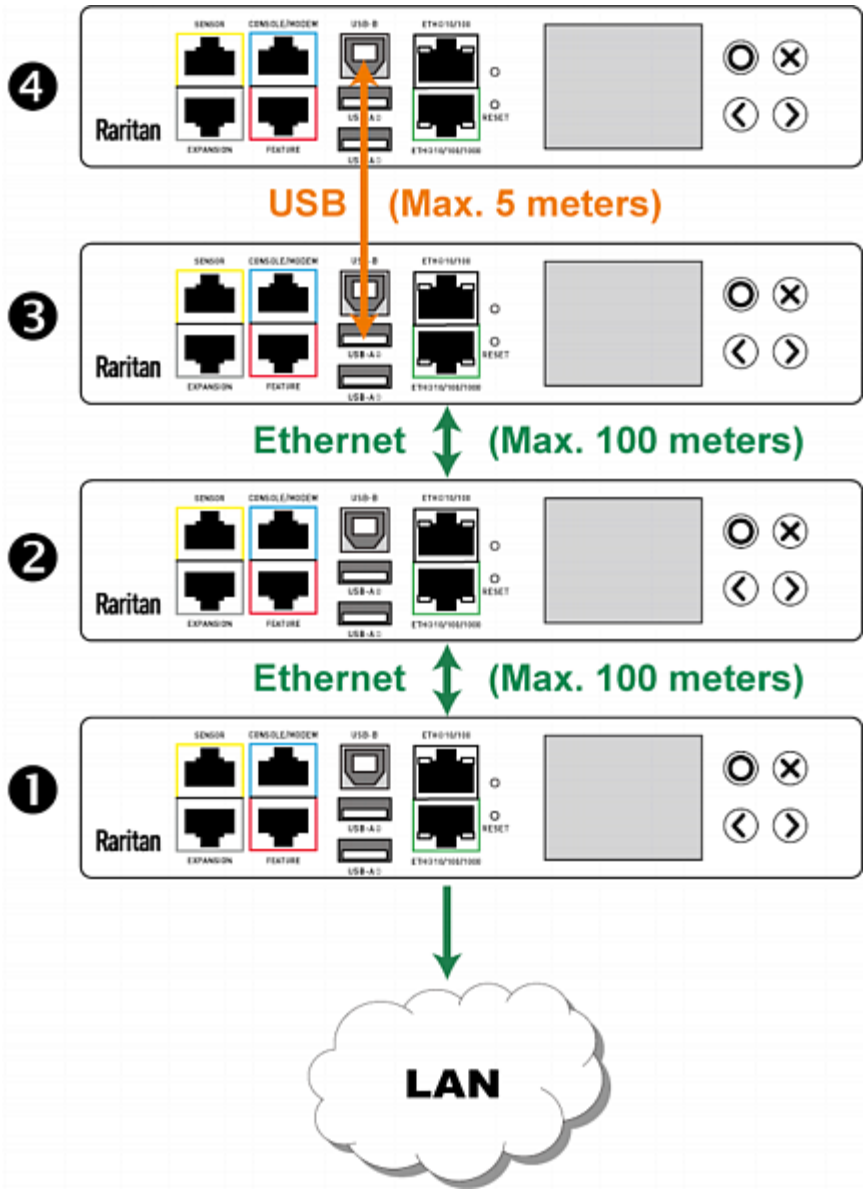

Number	Device role
①	Master device
②	Slave 1
③	Slave 2
④	Slave 3

For instructions on USB cascading, see ***Cascading All Devices via USB*** (on page 35).

▶ **Suggestions for extended cascading:**

- Ethernet cascading is recommended because of the longer distance, lower latency and more reliable connection it supports.
- The "green" ETH1 port (ETH①10/100/1000) on a Raritan master device is recommended for network connection because it supports up to 1000 Mbps.

▶ **To cascade PX3 PDUs via Ethernet ports:**

1. Make sure all Raritan devices are running firmware version 3.3.10 or later.
 2. Choose one PX3 as the master device.
 3. Log in to all devices one by one and select the same cascading mode.
 - **Bridging mode:**
Set the cascading mode of all devices to Bridging.
 - **Port Forwarding mode:**
Set the cascading mode of all devices to Port Forwarding. Make sure the cascading role and downstream interface are also set correctly.
- See ***Setting the Cascading Mode*** (on page 318).
4. Connect the master device to the LAN, using a method below.
 - **Bridging mode:**
Use a standard network patch cable (CAT5e or higher).
 - **Port Forwarding mode:**
Use a standard network patch cable and/or a Raritan USB WIFI wireless LAN adapter. For information on the Raritan USB WIFI adapter, see ***USB Wireless LAN Adapters*** (on page 22).
 5. Connect the available Ethernet port of the master device to either Ethernet port of another PX3 via a standard network patch cable. This additional PX3 device is Slave 1.
 6. Connect Slave 1's available Ethernet port to either Ethernet port of another PX3 via a standard network patch cable. The second additional device is Slave 2.
 7. Repeat the same step to connect more PX3 PDUs. You can cascade up to 15 slave devices.
 8. (Optional) Configure or change the network settings of the master and/or slave devices as needed. See ***Configuring Network Settings*** (on page 301).
 - **Bridging mode:** Each cascaded device has its own network settings. For example, you can have some devices use DHCP-assigned IP addresses and the others use static IP addresses.
 - **Port Forwarding mode:** Only the master device's network settings should be configured.

► **Recommendations for cascade loops:**

You can connect both the first and the last PDU to your network (cascade loop) under the following conditions:

- a. The remaining network **MUST** use R/STP to avoid network loops.

AND

Both the first and the last PDUs **MUST** either attach to the same switch or, if they are attached to two separate switches, you must configure both ports of these switches so that the STP costs are high. This prevents the STP protocol from sending unrelated traffic through the PDU cascade, which can cause bottlenecks that lead to connectivity issues in the whole network.

Restrictions of Port-Forwarding Connections

The following guidelines must be obeyed for establishing a cascading chain in the **Port Forwarding** mode.

- Each cascaded device, except for the master device, must have only one upstream device.
- Each cascaded device, except for the last slave device, must have only one downstream device.
- Use only one cable to cascade two devices. That is, **NO** simultaneous connection of USB and Ethernet cables between two cascaded devices.

The following diagrams illustrate cascading connections that are **NOT** supported.

► **UNSUPPORTED connections:**

- One cascaded device has two upstream devices via Ethernet cables.

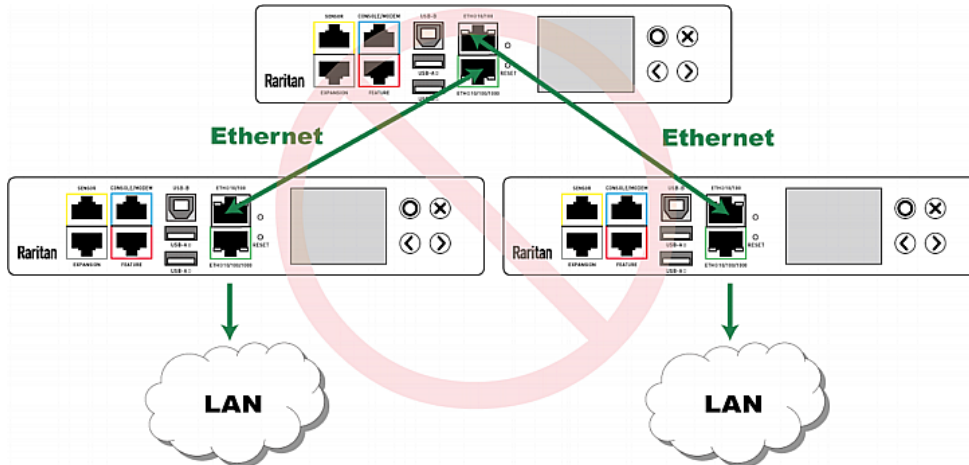

- One cascaded device has two upstream devices via Ethernet and USB cables.

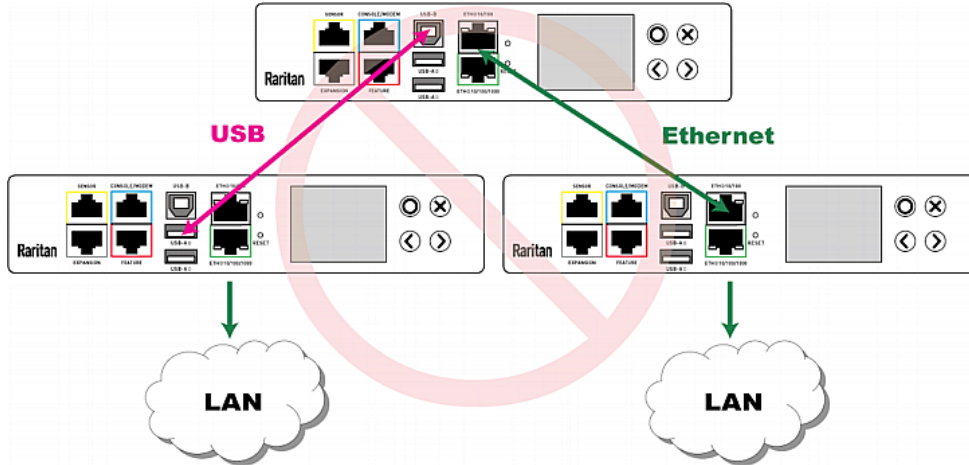

- One cascaded device has two downstream devices.

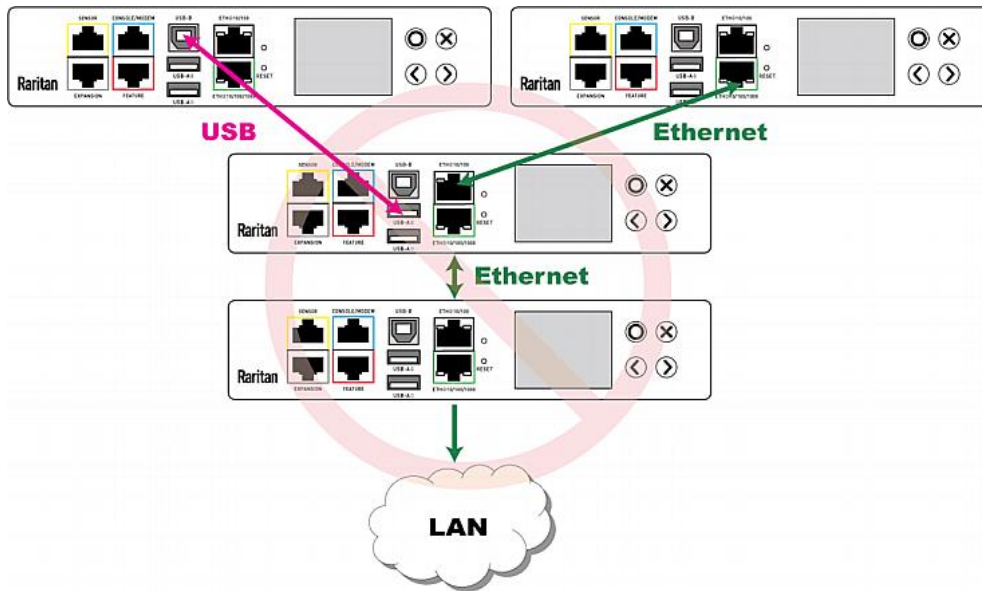

- One device is connected to another device via two cascading cables - USB and Ethernet cables.

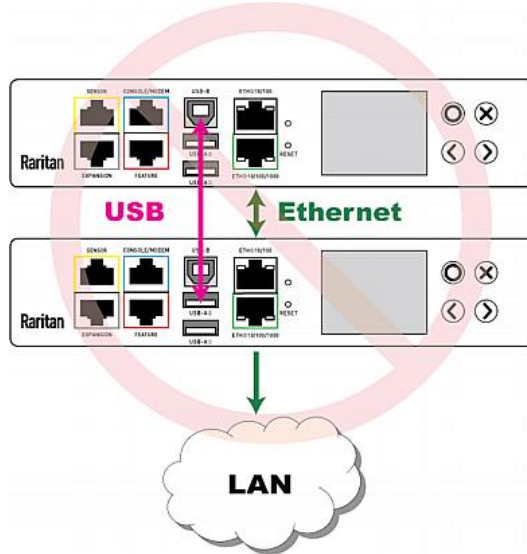

Power-Sharing Restrictions and Connection

Two PX3 devices can share power supply to their controllers via EXPANSION ports, so that when either PX3 controller fails to receive DC 12V power from its inlet(s), it continues to receive backup power from another PX3 device which functions properly and therefore remains to be accessible to users.

For documentation purpose, the term "power-sharing mode" is used to describe the status when the 12V power supply from the inlet to a PX3 controller fails, causing that controller to receive power from another PX3 device.

Before making a power-sharing connection, first read **Power-Sharing Configurations and Restrictions** (on page 44), and remove unsupported equipment from **BOTH** PX3 PDUs.

After a PDU enters the power-sharing mode, some of its data/operations remain to be available while other data/operations are no longer available.

▶ **Unavailable data or operations on the PDU that enters the power-sharing mode:**

- All outlets lose power, and enter the "disabled" state.
 - No outlet switching can be performed if the PX3 is an outlet-switching capable PDU.

- All internal sensors become "unavailable", including sensors of inlets, outlets, and OCPs.

Exception: Only active energy data remains available.

- Communications with relay/meter boards are lost. Therefore, firmware upgrade may fail due to this reason.

▶ **Available data or operations on the PDU that enters the power-sharing mode:**

- Change software settings, such as customizing names, modifying network settings, configuring thresholds, and so on.

Note: Outlet switching is not available because all outlets lose power.

- Monitor the status of connected Raritan environmental sensor packages, or configure/control their settings.
- Operate the front panel display.

▶ **Events that occur when entering the power-sharing mode:**

- The 12V power supply sensor enters the fault state. See **+12V Power Supply Sensor** (on page 201).

*Tip: You can set an event rule for sending a notification when this sensor enters the fault state. See **Event Rules and Actions** (on page 364).*

- The above event is logged in the internal event log. See **Default Log Messages** (on page 370).

▶ **To find whether a PX3 has entered the power-sharing mode:**

- Check the state of its +12V power supply sensor.

Tip: For SNMP, the sensor type for this +12V power supply is `i1smplsStatus (46)`.

Making a Power-Sharing Connection

Make sure **BOTH** PX3 devices comply with the configuration limitations when establishing a power-sharing connection. See **Power-Sharing Configurations and Restrictions** (on page 44).

The supported maximum power-sharing distance is 2 meters.

▶ **Make a power-sharing connection:**

1. Get a standard network patch cable (Cat5e/6), which can be up to 2 meters long.
 - Do NOT use a crossover cable.
2. Connect one end to a PX3 device's EXPANSION port, and the other end to another one's EXPANSION port.
 - Note that the EXPANSION port location on your PX3 may differ from the following images.

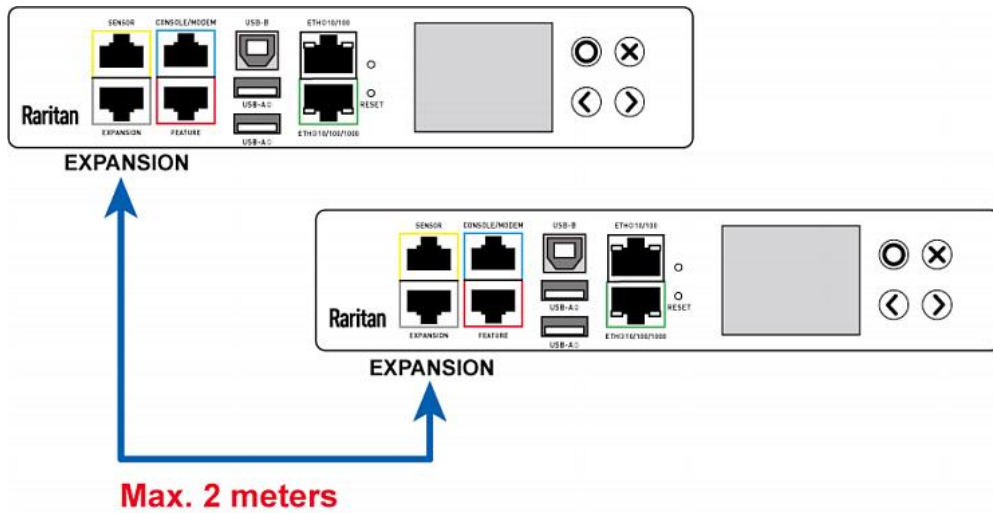

Power-Sharing Configurations and Restrictions

When either PX3 PDU enters the power-sharing mode, BOTH PDUs involved in the power-sharing connection support "less" external equipment than usual. It is strongly recommended to remove specific equipment from both PX3 PDUs when making a power-sharing connection.

► Configuration limitations on "both" PDUs:

- NO USB wireless LAN adapter is connected.
That is, you have to connect both PDUs to a "wired" network if LAN access is wanted.
- No asset management strips can be connected simultaneously.
- The maximum number of DX environmental sensor packages or door handles that can be connected decreases. For details, see **Supported Sensor Configurations for Power Sharing** (on page 45).
- After either PDU enters the power-sharing mode, you must NOT physically remove or add any environmental sensor packages to BOTH PDUs.

Supported Sensor Configurations for Power Sharing

All information and restrictions described in this section apply to BOTH PDUs involved in the power-sharing configuration, unless otherwise specified.

- There are *no* limitations for connecting Raritan's DPX or DPX2 environmental sensor packages to an iX7™ PDU in the power-sharing mode. See **DPX Sensor Packages** (on page 56) or **DPX2 Sensor Packages** (on page 53).
- The maximum number of supported DPX3 environmental sensor packages remains unchanged -- that is, 12 DPX3 packages. See **DPX3 Sensor Packages** (on page 51).
- The maximum number of supported DX environmental sensor packages also remains unchanged as long as the DPX3-ENVHUB4 sensor hub is *not* used -- that is, 12 DX sensor packages. See **DX Sensor Packages** (on page 50).
- The maximum number of supported DX2 environmental sensor packages remains unchanged -- that is, 12 DX2 packages. See **DX2 Sensor Packages** (on page 48).

However, there are DX restrictions when DPX3-ENVHUB4 is used, and there are also door handles-related restrictions.

▶ **DX sensor restrictions while DPX3-ENVHUB4 is involved:**

- A maximum of one DPX3-ENVHUB4 and a maximum of 10 DX sensor packages are supported.

▶ **Door handle connection restrictions (via DX2-DH2C2 or DX-PD2C5):**

- (Restriction only for DX2-DH2C2 manufactured before 2019) DO NOT connect any "SouthCo H3-EM series" door handle(s) because of insufficient power supply in the power-sharing mode.

Note: The latest generation of DX2-DH2C2 does NOT have this restriction and can have SouthCo H3-EM series connected in the power-sharing mode.

- A maximum of 2 door handles connected to a maximum of one DX2-DH2C2 or one DX-PD2C5 package are supported.
- All of the 2 door handles must be controlled by the same PDU so that you can have "only one" handle opened at a time to avoid critical power consumption. That is, ALL door handles must be connected to only one PDU in the power-sharing connection, NOT both PDUs.

*Note: It is strongly suggested to check and make sure the upper limit of "powered cry contact actuators" is set to 1 when making a power-sharing connection. See **Peripherals** (on page 249).*

▶ **Other sensor restrictions when door handles are present:**

First make sure the connection of door handles complies with the above restrictions.

The following restrictions apply only to the PDU that has all the door handles connected.

- When there are 2 door handles connected to the PDU (via DX2-DH2C2 or DX-PD2C5), up to 10 sensor packages of DPX/DPX2/DPX3/DX2 or up to 2 additional DX sensor packages can be additionally connected. Raritan's sensor hubs must NOT be used.
- When there is only 1 handle connected, up to 12 sensor packages of DPX/DPX2/DPX3/DX2 or up to 3 DX sensor packages can be additionally connected. Raritan's sensor hubs must NOT be used.

▶ **NO physical changes made to the number of connected sensor packages:**

- After either PDU enters the power-sharing mode, you must NOT physically remove or add any environmental sensor packages to BOTH PDUs.

Warning: The in-rush current of a newly added sensor package may cause both PDUs to reboot.

For information on Raritan's sensor packages or hubs, see **Connecting Raritan Environmental Sensor Packages** (on page 47).

Chapter 4 Connecting External Equipment (Optional)

More features are available if you connect Raritan's or third-party external equipment to your PX3.

In This Chapter

Connecting Raritan Environmental Sensor Packages	47
Connecting Asset Management Strips.....	67
Connecting a Logitech Webcam	77
Connecting a GSM Modem.....	78
Connecting an Analog Modem	78
Connecting an External Beeper	79
Connecting a Schroff LHX/SHX Heat Exchanger.....	79
Connecting a Modbus RTU Device or Bus.....	80

Connecting Raritan Environmental Sensor Packages

PX3 supports all types of Raritan environmental sensor packages, including DPX, DPX2, DPX3, DX and DX2 sensor packages. DPX series is the first generation while DX2 series is the latest generation.

For detailed information on each sensor package, refer to the Environmental Sensors and Actuators Guide (or Online Help) on Raritan website's **Support page** (<http://www.raritan.com/support/>).

An environmental sensor package may comprise sensors only or a combination of sensors and actuators.

PX3 can manage a maximum of 32 sensors and/or actuators. The supported maximum cabling distance is 98 feet (30 meters), except for DPX sensor packages.

For information on connecting different types of sensor packages, see:

- **DX2 Sensor Packages** (on page 48)
- **DX Sensor Packages** (on page 50)
- **DPX3 Sensor Packages** (on page 51)
- **DPX2 Sensor Packages** (on page 53)
- **DPX Sensor Packages** (on page 56)

Identifying the Sensor Port

Warning: If you purchase Raritan's environmental sensor packages, make sure you connect them to the correct port on the PX3, or damages may be caused to PX3 and/or connected sensor packages.

► **How to identify the SENSOR port:**

- The correct port is labeled SENSOR.
- The SENSOR port is marked with YELLOW color, as shown below.



DX2 Sensor Packages

You can cascade up to 12 DX2 sensor packages.

When cascading DX2, remember that the PX3 only supports a maximum of 32 sensors and/or actuators.

If there are more than 32 sensors and/or actuators connected, every sensor and/or actuator after the 32nd one is NOT managed by the PX3.

*Tip: To manage the last several sensors/actuators after 32nd function, you can release some "managed" sensors or actuators, and then manually bring the last several sensors/actuators into management. See **Peripherals** (on page 249).*

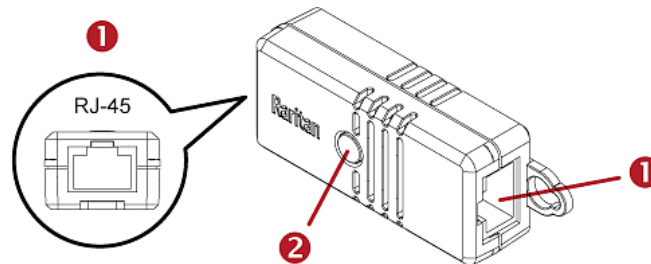

Numbers	Components
1	RJ-45 ports, each of which is located on either end of a DX2 sensor package.
2	LED, which indicates the sensor package's status

► **Connect DX2 to the PX3:**

1. Connect a standard network patch cable (CAT5e or higher) to either RJ-45 port on a DX2 sensor package.
2. If you want to cascade DX2 packages, get an additional standard network patch cable (CAT5e or higher) and then:
 - a. Plug one end of the cable into the remaining RJ-45 port on the prior DX2 package.
 - b. Plug the other end into either RJ-45 port on an additional DX2 package.

Repeat the same steps to cascade more DX2 packages.

Exception: You CANNOT cascade DX2-DH2C2 packages. A PX3 supports only one DX2-DH2C2.

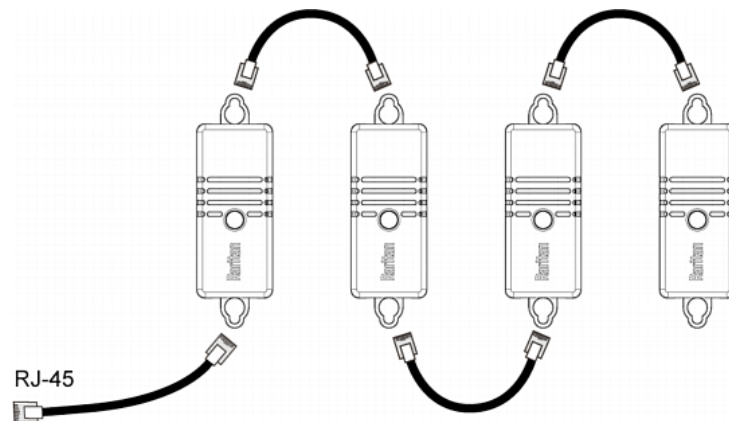

3. Connect the first DX2 sensor package to the PX3 by plugging its cable's connector into the RJ-45 SENSOR port of the PX3.
4. If needed, connect a DPX2 sensor package to the end of the DX2 chain. See **Connecting a DPX2 Sensor Package to DX2, DX or DPX3** (on page 55).

Warning: DX2-DH2C2 and asset management strip(s) are mutually exclusive so do NOT connect both of them to the PX3 simultaneously.

DX Sensor Packages

Most DX sensor packages contain terminals for connecting detectors or actuators. For information on connecting actuators or detectors to DX terminals, refer to the Environmental Sensors and Actuators Guide (or Online Help) on Raritan website's **Support page** (<http://www.raritan.com/support/>).

You can cascade up to 12 DX sensor packages.

When cascading DX, remember that the PX3 only supports a maximum of 32 sensors and/or actuators.

If there are more than 32 sensors and/or actuators connected, every sensor and/or actuator after the 32nd one is NOT managed by the PX3.

For example, if you cascade 12 DX packages, and each package contains 3 functions (a function is a sensor or actuator), the PX3 does NOT manage the last 4 functions because the total 36 ($12 \times 3 = 36$) exceeds 32 by 4.

*Tip: To manage the last several sensors/actuators after 32nd function, you can release some "managed" sensors or actuators, and then manually bring the last several sensors/actuators into management. See **Peripherals** (on page 249).*

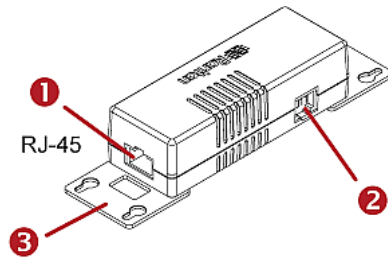

Numbers	Components
①	RJ-45 ports, each of which is located on either end of a DX sensor package.
②	RJ-12 port, which is reserved for future use and now blocked.
③	Removable rackmount brackets.

▶ Connect DX to the PX3:

1. Connect a standard network patch cable (CAT5e or higher) to either RJ-45 port on a DX sensor package.
2. If you want to cascade DX packages, get an additional standard network patch cable (CAT5e or higher) and then:
 - a. Plug one end of the cable into the remaining RJ-45 port on the prior DX package.
 - b. Plug the other end into either RJ-45 port on an additional DX package.
 Repeat the same steps to cascade more DX packages.

Exception: You CANNOT cascade DX-PD2C5 sensor packages. One PX3 supports only one DX-PD2C5.

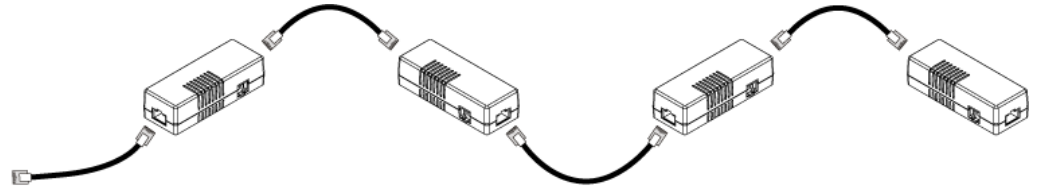

RJ-45

3. Connect the first DX sensor package to the PX3 by plugging its cable's connector into the RJ-45 SENSOR port of the PX3.
4. If needed, connect a DPX2 sensor package to the end of the DX chain. See **Connecting a DPX2 Sensor Package to DX2, DX or DPX3** (on page 55).

Warning: DX-PD2C5 or DX2-DH2C2, and asset management strip(s) are mutually exclusive so do NOT connect both of them to the PDU simultaneously.

DPX3 Sensor Packages

A DPX3 sensor package features the following:

- Its connection interface is RJ-45.
- You can cascade a maximum of 12 DPX3 sensor packages.

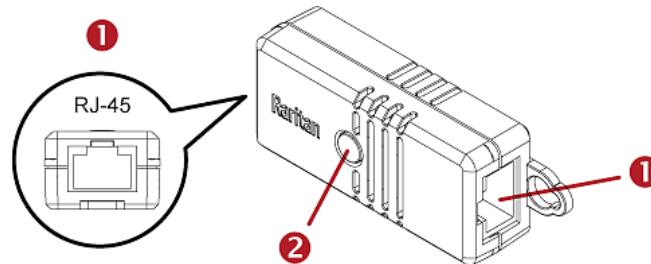

Numbers	Components
1	RJ-45 ports, each of which is located on either end of a DPX3 sensor package.
2	LED for indicating the sensor status.

► **To connect DPX3 to the PX3:**

1. Connect a standard network patch cable (CAT5e or higher) to either RJ-45 port on the DPX3 sensor package.
2. If you want to cascade DPX3 sensor packages, get an additional standard network patch cable (CAT5e or higher) and then:

- a. Plug one end of the cable into the remaining RJ-45 port on the prior DPX3.
 - b. Plug the other end into either RJ-45 port on an additional DPX3.
- Repeat the same steps to cascade more DPX3 sensor packages.

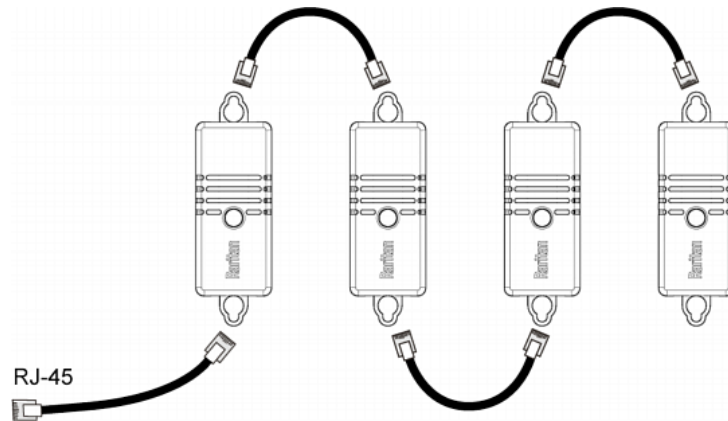

3. Connect the first DPX3 sensor package to the PX3 by plugging its cable's connector into the RJ-45 SENSOR port of the PX3.
4. If needed, connect a DPX2 sensor package to the end of the DPX3 chain. See **Connecting a DPX2 Sensor Package to DX2, DX or DPX3** (on page 55).

DPX2 Sensor Packages

A DPX2 sensor cable is shipped with a DPX2 sensor package. This cable is made up of one RJ-12 connector and one to three head connectors. You have to connect DPX2 sensor packages to the sensor cable.

For more information on DPX2 sensor packages, access the Environmental Sensors and Actuators Guide (or Online Help) on Raritan website's **Support page** (<http://www.raritan.com/support/>).

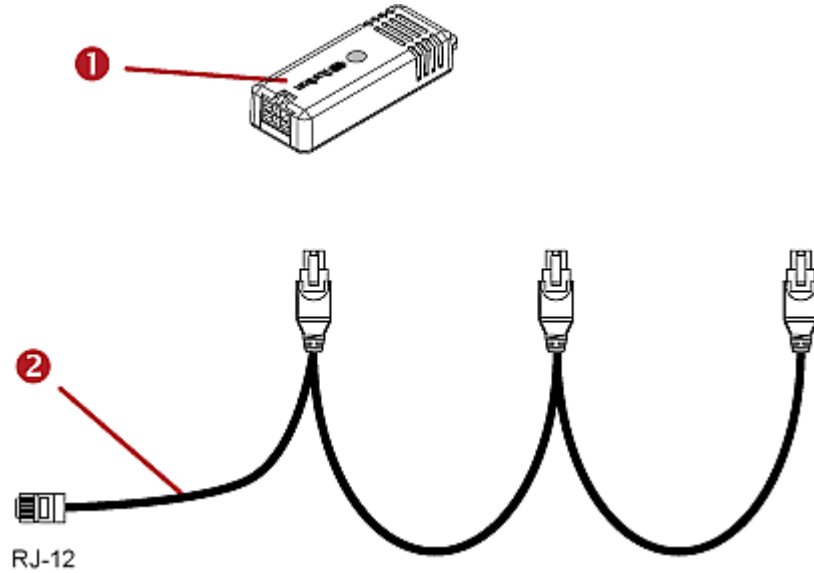

Item	
①	DPX2 sensor package
②	DPX2 sensor cable with one RJ-12 connector and three head connectors

The following procedure illustrates a DPX2 sensor cable with three head connectors. Your sensor cable may have fewer head connectors.

Warning: If there are free head connectors between a DPX2 sensor cable's RJ-12 connector and the final attached DPX2 sensor package, the sensor packages following the free head connector(s) on the same cable do NOT work properly. Therefore, always occupy all head connectors prior to the final sensor package with a DPX2 sensor package.

► **To connect DPX2 to the PX3:**

1. Connect a DPX2 sensor package to the first head connector of the DPX2 sensor cable.

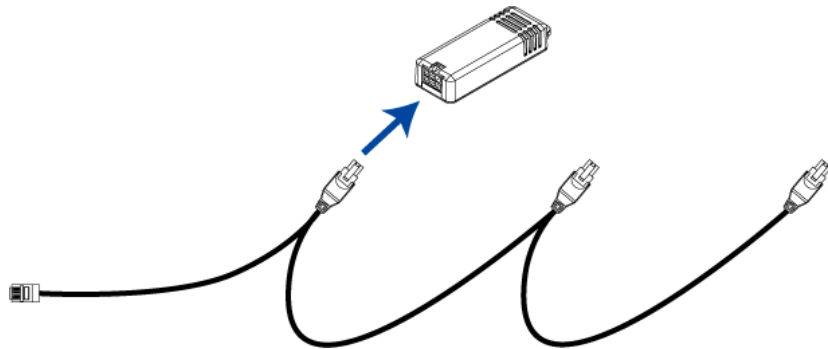

2. Connect remaining DPX2 sensor packages to the second and then the third head connector.

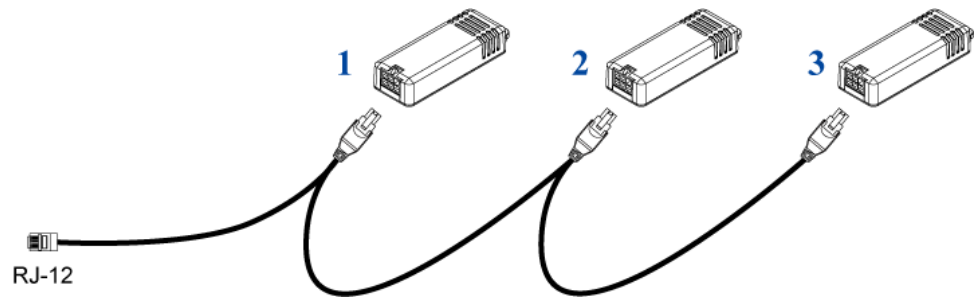

Tip: If the number of sensors you are connecting is less than the number of head connectors on your sensor cable, connect them to the first one or first two head connectors to ensure that there are NO free head connectors prior to the final DPX2 sensor package attached.

3. Use an RJ-12 to RJ-45 adapter to connect the DPX2 sensor package(s) to the PX3.
 - a. Connect the adapter's RJ-12 connector to the DPX2 sensor cable.
 - b. Connect the adapter's RJ-45 connector to the RJ-45 SENSOR port of the PX3.

OR you can directly connect the DPX2 sensor package to a DX sensor chain without using any RJ-12 to RJ-45 adapter. See **Connecting a DPX2 Sensor Package to DX2, DX or DPX3** (on page 55).

Connecting a DPX2 Sensor Package to DX2, DX or DPX3

You can connect one DPX2 sensor package to the "end" of a DX2, DX or DPX3 sensor chain. It is strongly recommended to use an RJ-12 to RJ-45 adapter for connecting DPX2 to the final DX2, DX or DPX3 in the chain.

The maximum number of DX2, DX or DPX3 sensor packages in the chain must be less than 12 when a DPX2 sensor package is involved.

The following diagrams illustrate DX sensor chain only, but the same principles also apply to DX2 and DPX3 sensor chains if connecting DPX2 to the end of DX2 or DPX3 sensor chains.

- ▶ **When connecting a DPX2 sensor package containing "three" DPX2 sensors:**

A maximum of nine DX sensor packages can be cascaded because $12-3=9$.

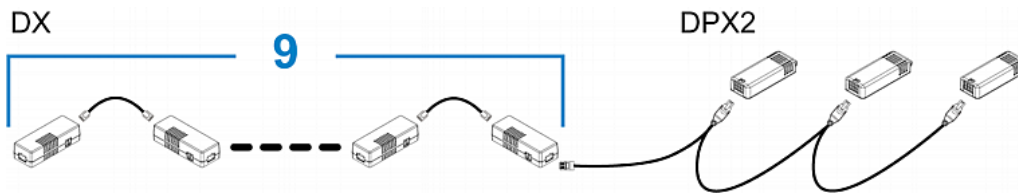

- ▶ **When connecting a DPX2 sensor package containing "two" DPX2 sensors:**

A maximum of ten DX sensor packages can be cascaded because $12-2=10$.

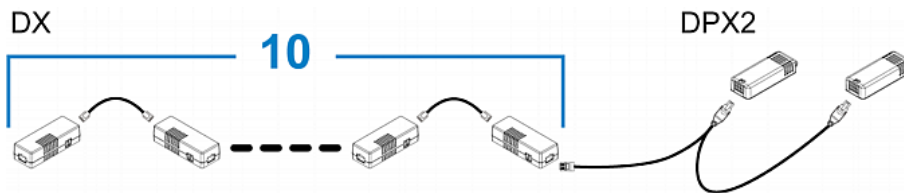

- ▶ **When connecting a DPX2 sensor package containing "one" DPX2 sensor:**

A maximum of eleven DX sensor packages can be cascaded because $12-1=11$.

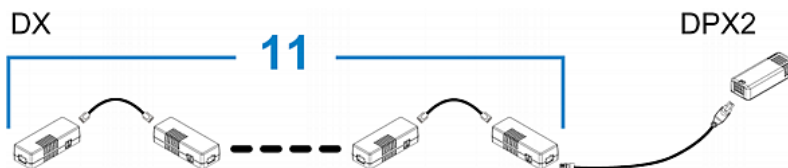

DPX Sensor Packages

Most DPX sensor packages come with a factory-installed sensor cable, whose sensor connector is RJ-12.

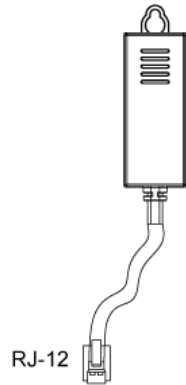

For the cabling length restrictions, see **Supported Maximum DPX Sensor Distances** (on page 60).

Warning: For proper operation, wait for 15-30 seconds between each connection operation or each disconnection operation of environmental sensor packages.

▶ **To directly connect a DPX with a factory-installed sensor cable:**

An RJ-12 to RJ-45 adapter is required to connect a DPX sensor package to PX3.

- a. Connect the adapter's RJ-12 connector to the DPX sensor cable.
- b. Connect the adapter's RJ-45 connector to the RJ-45 SENSOR port of the PX3.

▶ **To directly connect a differential air pressure sensor:**

1. Connect a Raritan-provided phone cable to the IN port of a differential air pressure sensor.
2. Get an RJ-12 to RJ-45 adapter. Connect the adapter's RJ-12 connector to the other end of the phone cable.
3. Connect this adapter's RJ-45 connector to the RJ-45 SENSOR port on the PX3.

4. If intended, connect one DPX sensor package to the OUT port of the differential air pressure sensor. It can be any DPX sensor package, such as a DPX-T3H1.

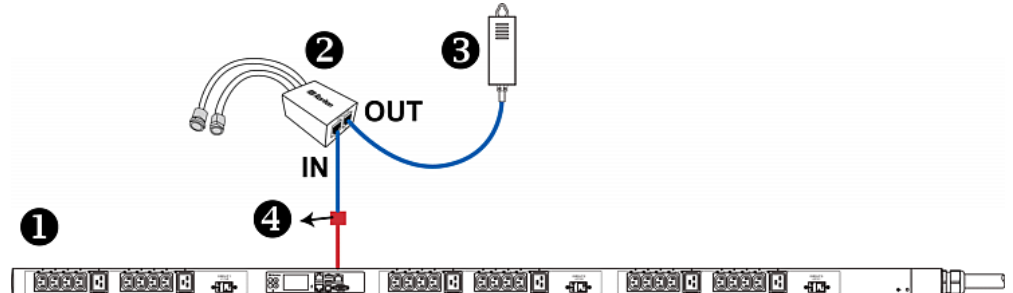

①	The PX3
②	Raritan differential air pressure sensors
③	One DPX sensor package (optional)
④	RJ-12 to RJ-45 adapter

Using an Optional DPX-ENVHUB4 Sensor Hub

Optionally, you can connect a Raritan *DPX-ENVHUB4* sensor hub to the PX3. This allows you to connect up to four DPX sensor packages to the PX3 via the hub.

This sensor hub supports DPX sensor packages only. Do NOT connect DPX2, DPX3, DX or DX2 sensor packages to it.

DPX-ENVHUB4 sensor hubs CANNOT be cascaded. You can connect only one hub to each SENSOR port on the PX3.

*Tip: The Raritan sensor hub that supports ALL types of Raritan environmental sensor packages is DPX3-ENVHUB4. See **Using an Optional DPX3-ENVHUB4 Sensor Hub** (on page 61).*

► To connect DPX sensor packages via the DPX-ENVHUB4 hub:

1. Connect the DPX-ENVHUB4 sensor hub to the PX3.
 - a. Plug one end of the Raritan-provided phone cable (4-wire, 6-pin, RJ-12) into the IN port (Port 1) of the hub.
 - b. Get an RJ-12 to RJ-45 adapter. Connect this adapter's RJ-12 connector to the other end of the phone cable.
 - c. Connect this adapter's RJ-45 connector to the PDU's RJ-45 SENSOR port.
2. Connect DPX sensor packages to any of the four OUT ports on the hub.

This diagram illustrates a configuration with a sensor hub connected.

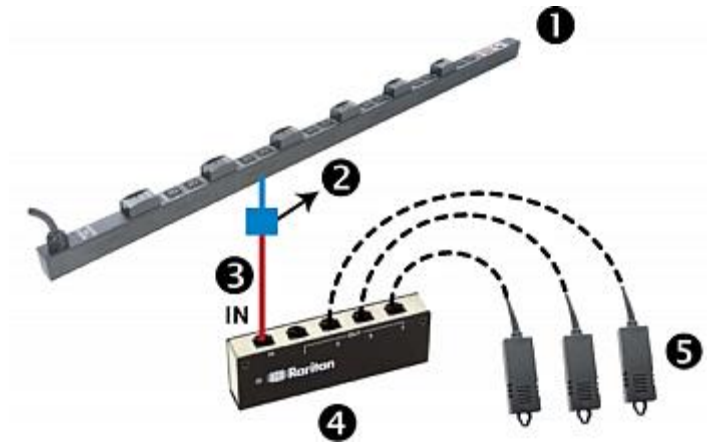

①	PX3
②	RJ-12 to RJ-45 adapter
③	Raritan-provided phone cable
④	DPX-ENVHUB4 sensor hub
⑤	DPX sensor packages

Using an Optional DPX-ENVHUB2 cable

A Raritan *DPX-ENVHUB2* cable doubles the number of connected environmental sensors per SENSOR port.

This cable supports DPX sensor packages only. Do NOT connect DPX2, DPX3, DX or DX2 sensor packages to it.

► To connect DPX sensor packages via the DPX-ENVHUB2 cable:

1. Use an RJ-12 to RJ-45 adapter to connect the DPX-ENVHUB2 cable to PX3.
 - a. Connect the adapter's RJ-12 connector to the cable.
 - b. Connect the adapter's RJ-45 connector to the RJ-45 SENSOR port on the PX3.

2. The cable has two RJ-12 sensor ports. Connect DPX sensor packages to the cable's sensor ports.

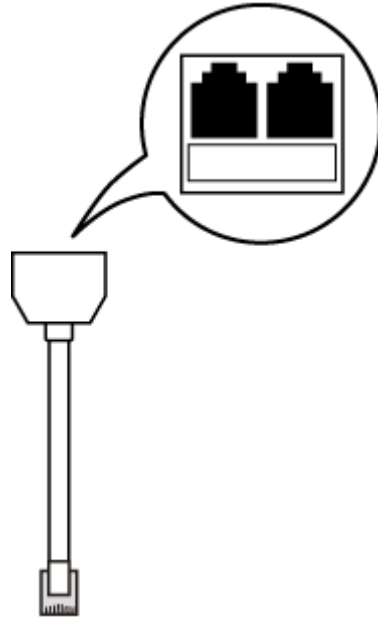

3. Repeat the above steps if there are additional SENSOR ports on your PX3.

Supported Maximum DPX Sensor Distances

When connecting the following DPX sensor packages to the PX3, you must follow two restrictions.

- DPX-CC2-TR
- DPX-T1
- DPX-T3H1
- DPX-AF1
- DPX-T1DP1

▶ **Sensor connection restrictions:**

- Connect a DPX sensor package to the PX3 using the sensor cable pre-installed (or provided) by Raritan. You **MUST NOT** extend or modify the sensor cable's length by using any tool other than the Raritan's sensor hubs.
- If using a DPX-ENVHUB4 sensor hub, the cabling distance between the PX3 and the sensor hub is up to 33' (10 m).

▶ **Maximum distance illustration:**

The following illustrates the maximum distance when connecting DPX sensor packages with a maximum 16' (5 m) sensor cable to the PX3 via a sensor hub.

- The sum of a DPX-T3H1 sensor cable's length is 16 feet (5 meters).

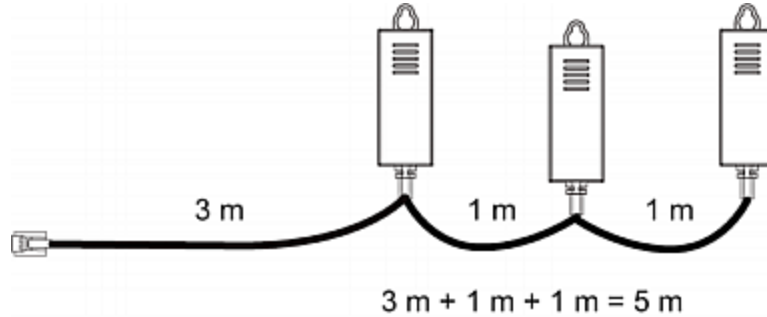

- The total cabling length between the PX3 and one DPX-T3H1 is 49' (15 m) as illustrated below.

Note that the length 16 feet (5 meters) is the length of each DPX-T3H1 sensor cable, which is defined in the above diagram.

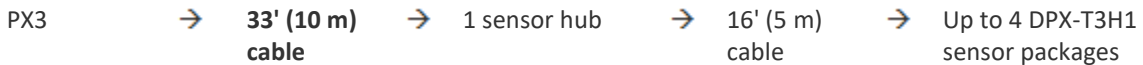

Using an Optional DPX3-ENVHUB4 Sensor Hub

A Raritan DPX3-ENVHUB4 sensor hub is physically and functionally similar to the DPX-ENVHUB4 sensor hub, which increases the number of sensor ports for the PX3, except for the following differences:

- All ports on the DPX3-ENVHUB4 sensor hub are RJ-45 instead of RJ-12 as the DPX-ENVHUB4 sensor hub.
- The DPX3-ENVHUB4 sensor hub supports all Raritan environmental sensor packages, including DPX, DPX2, DPX3, DX and DX2 sensor packages.

To connect diverse types of sensor packages to this sensor hub, you must follow the combinations shown in the section titled **Mixing Diverse Sensor Types** (on page 62).

► To connect Raritan sensor packages via the DPX3-ENVHUB4 hub:

1. Connect the DPX3-ENVHUB4 sensor hub to the PX3 using a standard network patch cable (CAT5e or higher).
 - a. Plug one end of the cable into the IN port (Port 1) of the hub.
 - b. Plug the other end of the cable into the RJ-45 SENSOR port of the PX3.
2. Connect the Raritan sensor packages to any of the four OUT ports on the hub.
 - An RJ-12 to RJ-45 adapter is required for connecting a DPX or DPX2 sensor package to the hub.

This diagram illustrates a configuration with a sensor hub connected.

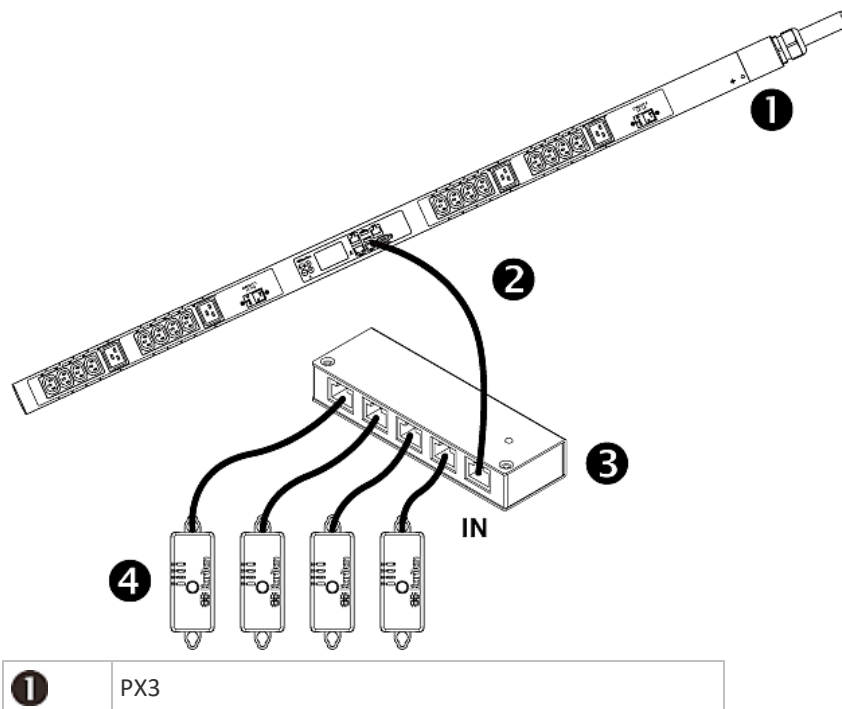

②	A standard network cable
③	DPX3-ENVHUB4 sensor hub
④	Any Raritan sensor packages

Mixing Diverse Sensor Types

You can mix diverse sensor packages on one PX3 according to the following sensor combination principles. In some scenarios, the DPX3-ENVHUB4 sensor hub is required.

When mixing different sensor types, remember that the PX3 only supports a maximum of 32 sensors/actuators.

PX3 does NOT support any other sensor-mixing combinations than those described in this section.

In most illustrations below, any DX or DPX3 sensor package can be replaced with a DX2 sensor package.

For those illustrations where DX, DPX3 and DX2 are interchangeable, they are all marked with the following oval image.



Important: Unlike DX or DPX3 series, DX2 CANNOT be connected with DPX sensor package(s).

▶ **1 DX + 1 DPX:**

- It is strongly recommended to use an RJ-12 to RJ-45 adapter to connect the DPX sensor package to the DX sensor package.

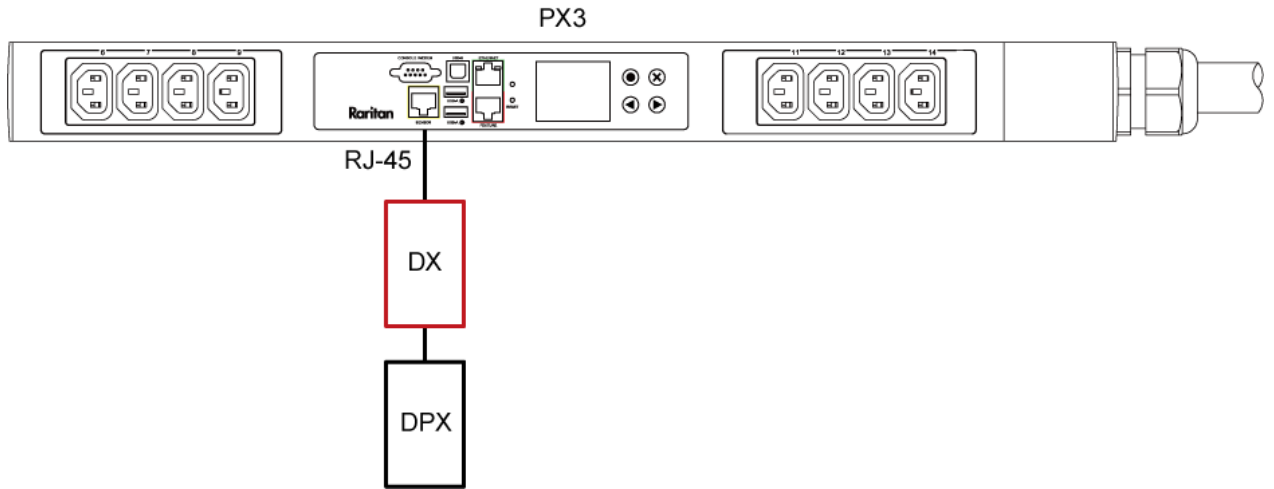

▶ **Diverse combinations via the DPX3-ENVHUB4 sensor hub:**

- You must use the **DPX3-ENVHUB4** sensor hub instead of the old DPX-ENVHUB4 sensor hub. Each port on the hub supports any of the following:
 - One individual DX2 sensor package
 - A chain of DX2 sensor packages
 - One individual DX sensor package
 - A chain of DX sensor packages
 - One individual DPX3 sensor package
 - A chain of DPX3 sensor packages
 - One individual DPX2 sensor package
 - One individual DPX sensor package

- An RJ-12 to RJ-45 adapter is recommended to connect a DPX or DPX2 sensor package to DPX3-ENVHUB4.
- In the following diagrams, the sensor package in "green" can be replaced by a DPX2 sensor package. The sensor package in "blue" can be one DPX2, DPX3, DX or DX2 sensor package.

This section only illustrates the following three combinations, but actually there are tens of different combinations by using the DPX3-ENVHUB4 sensor hub.

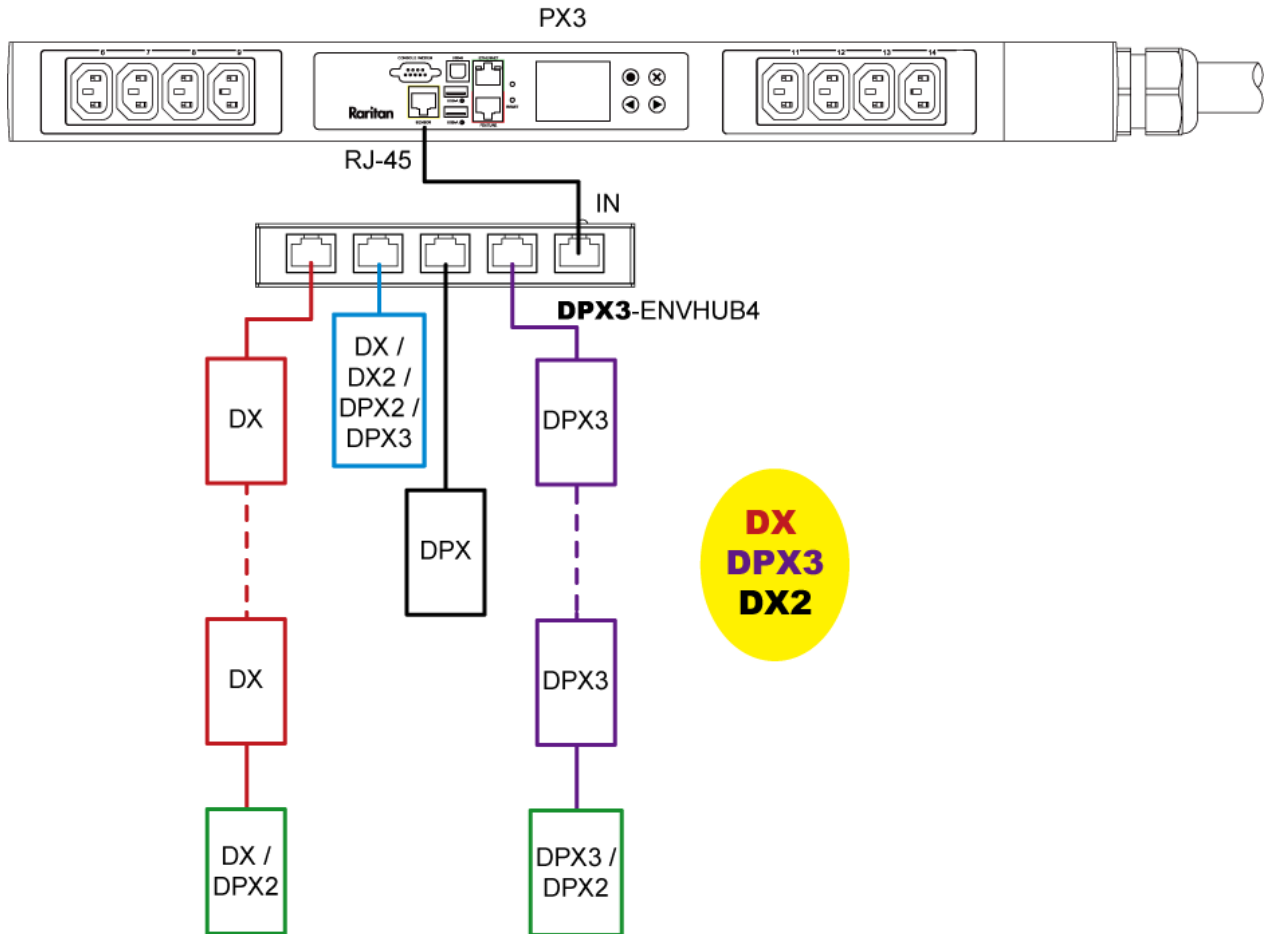

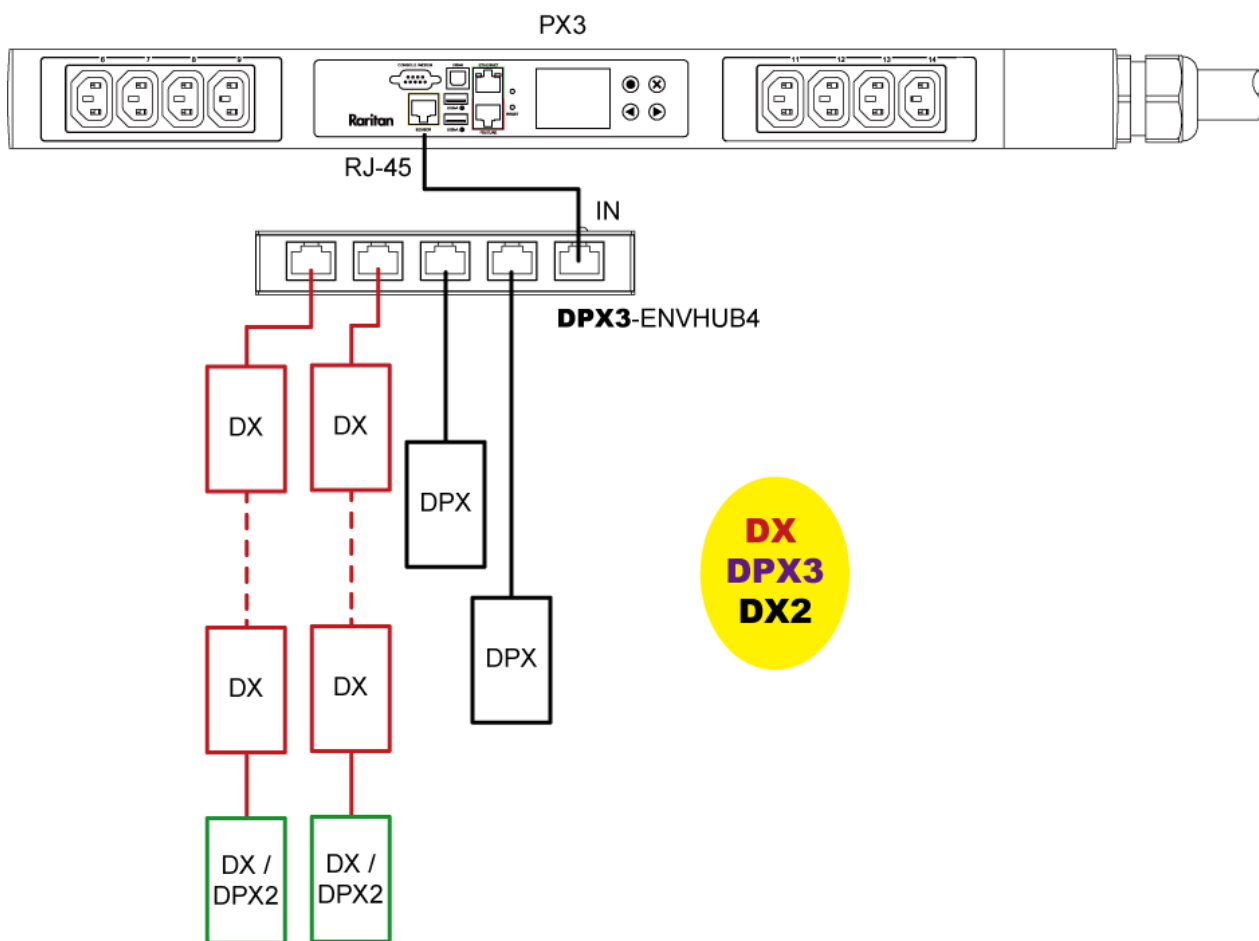

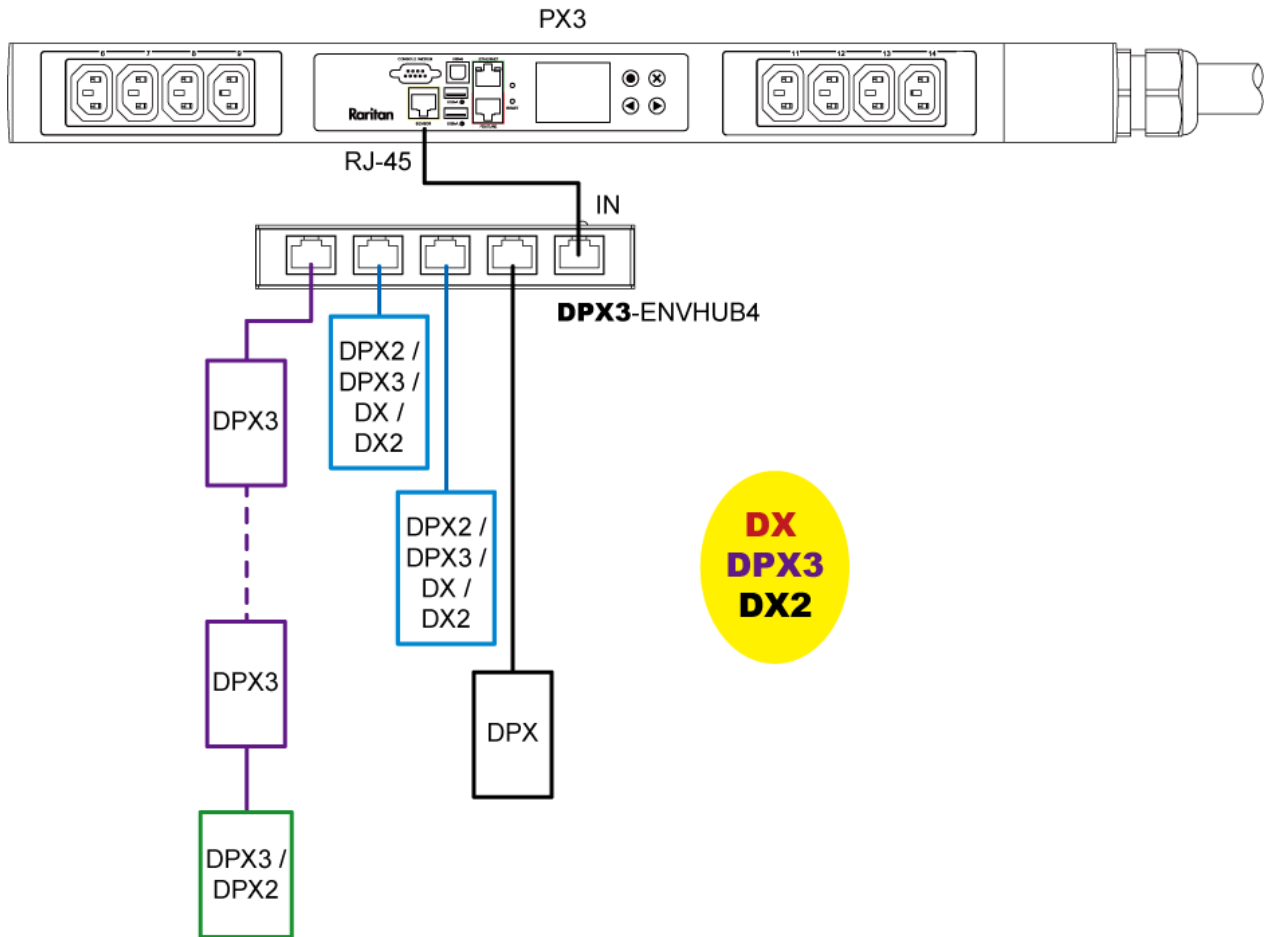

► **Mix DX2, DX and DPX3 in a sensor chain:**

Any DX or DX2 sensor package in a chain can be replaced by a DPX3 sensor package, or vice versa. The total number of sensor packages in this chain cannot exceed 12.

For example, the following diagram shows a sensor chain comprising DX2, DX and DPX3 sensor packages.

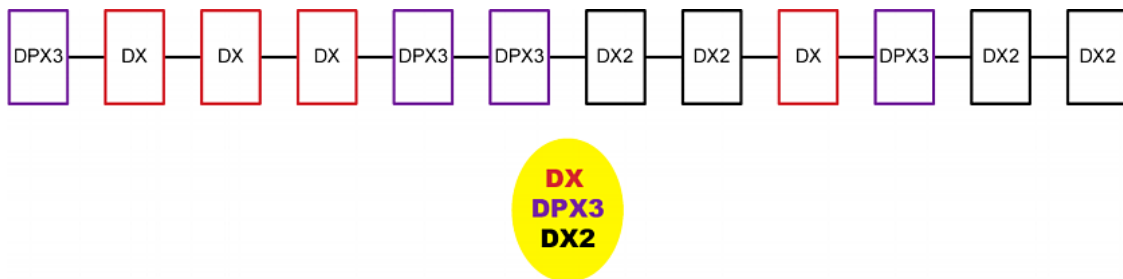

You can add a DPX2 sensor package to the end of such a sensor-mixing chain if needed. See **Connecting a DPX2 Sensor Package to DX2, DX or DPX3** (on page 55).

Connecting Asset Management Strips

You can remotely track the locations of up to 64 IT devices in the rack by connecting asset management strips (asset strips) to the PX3 after IT devices are tagged electronically.

To use the asset management feature, you need the following items:

- *Raritan asset strips*: An asset strip transmits the asset management tag's ID and positioning information to the PX3.
- *Raritan asset tags*: An asset management tag (asset tag) is adhered to an IT device. The asset tag uses an electronic ID to identify and locate the IT device.

Warning: DX-PD2C5 or DX2-DH2C2, and asset management strip(s) are mutually exclusive so do NOT connect both of them to the PDU simultaneously.

Combining Regular Asset Strips

Each tag port on the regular asset strips corresponds to a rack unit and can be used to locate IT devices in a specific rack (or cabinet).

For each rack, you can attach asset strips up to 64U long, consisting of one MASTER and multiple SLAVE asset strips.

The difference between the master and slave asset strips is that the master asset strip has an RJ-45 connector while the slave does not.

The following diagram illustrates some asset strips. Note that Raritan provides more types of asset strips than the diagram.

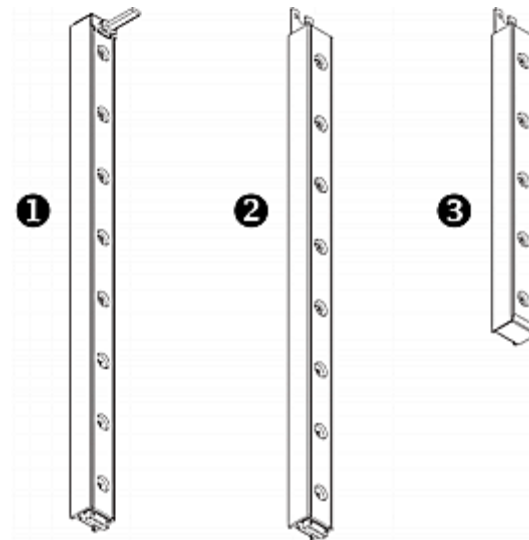

①	8U MASTER asset strip with 8 tag ports
②	8U SLAVE asset strip with 8 tag ports
③	5U "ending" SLAVE asset strip with 5 tag ports

Note: Unlike general slave asset strips, which have one DIN connector respectively on either end, the ending slave asset strip has one DIN connector on only one end. An ending asset strip is installed at the end of the asset strip assembly.

► To assemble asset strips:

1. Connect a MASTER asset strip to an 8U SLAVE asset strip.
 - Plug the white male DIN connector of the slave strip into the white female DIN connector of the master strip.

- Make sure that the U-shaped sheet metal adjacent to the male DIN connector is inserted into the rear slot of the master strip. Screw up the U-shaped sheet metal to reinforce the connection.

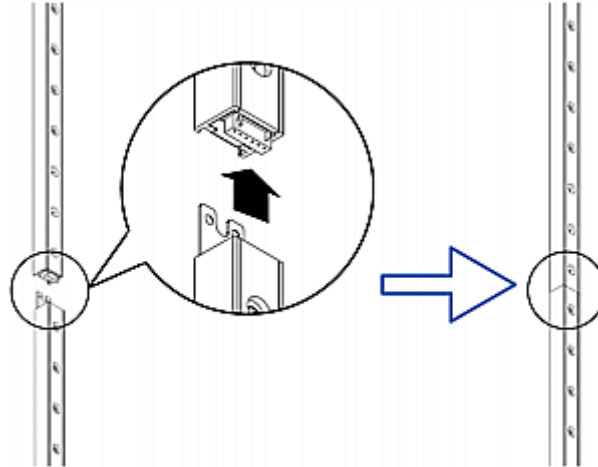

2. Connect another 8U slave strip to the one being attached to the master strip in the same manner as Step 1.
3. Repeat the above step to connect more slave strips. The length of the asset strip assembly can be up to 64U.
 - The final slave strip can be 8U or 5U, depending on the actual height of your rack.
 - Connect the "ending" asset strip as the final one in the assembly.
4. Vertically attach the asset strip assembly to the rack, next to the IT equipment, making each tag port horizontally align with a rack unit.
5. The asset strips are automatically attracted to the rack because of magnetic stripes on the back.

Note: The asset strip is implemented with a tilt sensor so it can be mounted upside down.

Introduction to Asset Tags

You need both asset strips and asset tags for tracking IT devices.

Asset tags provide an ID number for each IT device. The asset tags are adhered to an IT device at one end and plugged in to an asset strip at the other.

The asset strip is connected to the PX3, and the asset tag transmits the ID and positioning information to the asset strip.

The following diagram illustrates an asset tag. Note that there are two types of asset tags: non-programmable and programmable tags. The only difference is that programmable asset tags allow you to customize each tag's ID or barcode number while non-programmable ones have factory default ID or barcode numbers, which you cannot change.



A	Barcode (ID number), which is available on either end of the "non-programmable" asset tag
B	Tag connector
C	Adhesive area with the tape

Note: The barcode of each "non-programmable" asset tag is unique and is displayed in the PX3 device's web interface for identification.

Connecting Regular Asset Strips to PX3

The cabling distance between an asset strip assembly and the PX3 can be up to 10 meters.

► **To connect regular asset strips to the PX3 device:**

1. Affix the adhesive end of an asset tag to each IT device through the tag's tape.
2. Plug the connector of each asset tag into the corresponding tag port on the asset strip.
3. Connect the asset strip assembly to the PX3 device, using a network patch cable (CAT5e or higher).
 - Connect one end of the cable to the RJ-45 connector on the MASTER asset strip.
 - Connect the other end of the cable to the FEATURE port on the PX3 device.

The PX3 device supplies power to the connected asset strip assembly. All LEDs on the asset strip assembly may cycle through different colors during the power-on process if the asset strip's firmware is being upgraded by the PX3. After the power-on or firmware upgrade process completes, the LEDs show solid colors. Note that the LED color of the tag ports with asset tags connected will be different from the LED color of the tag ports without asset tags connected.

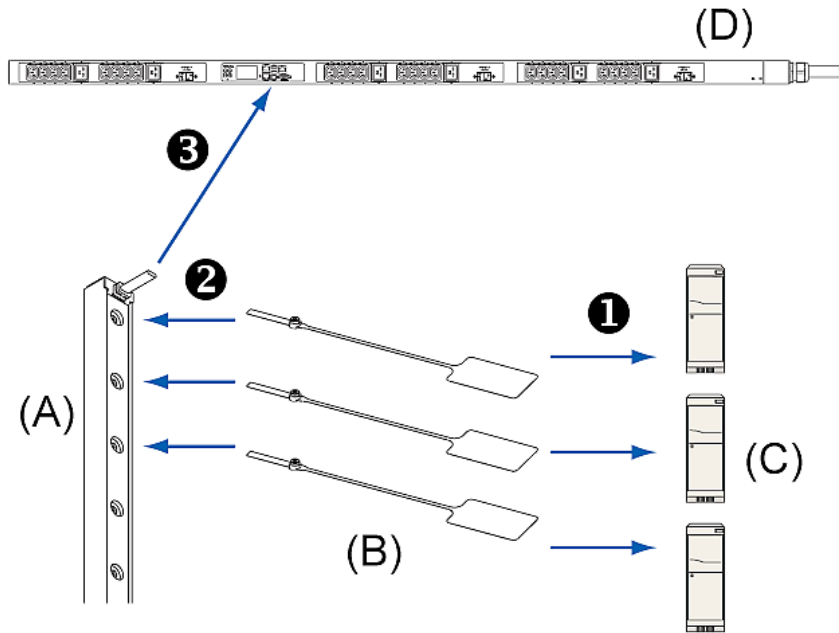

(A)	MASTER asset strip
(B)	Asset tags
(C)	IT devices
(D)	PX3

Connecting Blade Extension Strips

For blade servers, which are contained in a single chassis, you can use a blade extension strip to track individual blade servers.

Raritan's blade extension strip functions similar to a Raritan asset strip but requires a tag connector cable for connecting it to a tag port on the regular or composite asset strip. A blade extension strip contains 4 to 16 tag ports.

The following diagrams illustrate a tag connector cable and a blade extension strip with 16 tag ports.

Tag connector cable

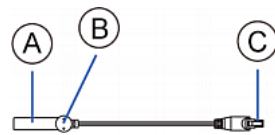

A	Barcode (ID number) for the tag connector cable
B	Tag connector
C	Cable connector for connecting the blade extension strip

Note: A tag connector cable has a unique barcode, which is displayed in the PX3 device's web interface for identifying each blade extension strip where it is connected.

Blade extension strip with 16 tag ports

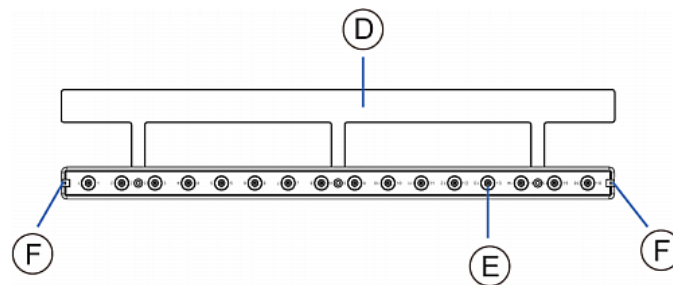

D	Mylar section with the adhesive tape
E	Tag ports
F	Cable socket(s) for connecting the tag connector cable

Note: Each tag port on the blade extension strip is labeled a number, which is displayed as the slot number in the PX3 device's web interface.

► **To install a blade extension strip:**

1. Connect the tag connector cable to the blade extension strip.
 - Plug the cable's connector into the socket at either end of the blade extension strip.

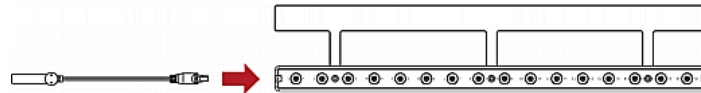

2. Move the blade extension strip toward the bottom of the blade chassis until its mylar section is fully under the chassis, and verify that the blade extension strip does not fall off easily. If necessary, you may use the adhesive tape in the back of the mylar section to help fix the strip in place.

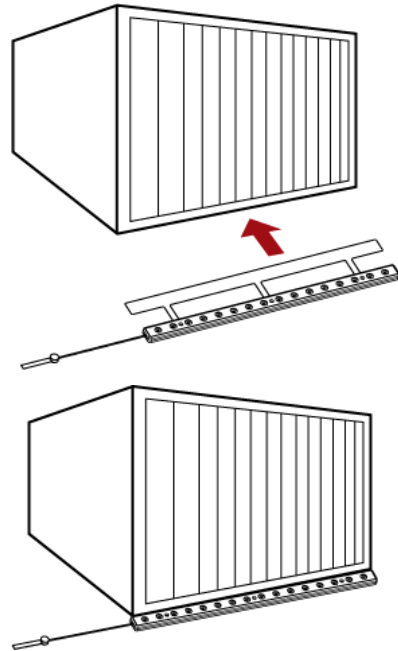

3. Connect one end of an asset tag to a blade server and the other end to the blade extension strip.
 - a. Affix the adhesive part of the asset tag to one side of a blade server through the tag's tape.

- b. Plug the tag connector of the asset tag into a tag port on the blade extension strip.

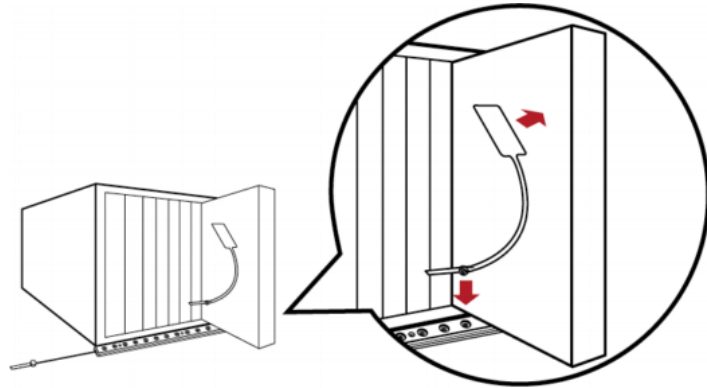

4. Repeat the above step until all blade servers in the chassis are connected to the blade extension strip via asset tags.
5. Plug the tag connector of the blade extension strip into the closest tag port of the regular or composite asset strip on the rack.

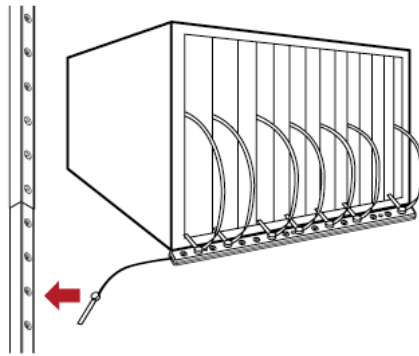

6. Repeat the above steps to connect additional blade extension strips. Up to 128 asset tags on blade extension strips are supported per FEATURE port.

Note: If you need to temporarily disconnect the blade extension strip from the asset strip, wait at least 1 second before re-connecting it back, or the PX3 device may not detect it.

Connecting Composite Asset Strips (AMS-Mx-Z)

A composite asset strip is named AMS-Mx-Z, where x is a number, such as AMS-M2-Z or AMS-M3-Z. It is a type of asset strip that functions the same as regular MASTER asset strips except for the following differences:

- It has two RJ-45 connectors.
- Multiple composite asset strips can be daisy chained.
- It contains less tag ports than regular asset strips.

For example, AMS-M2-Z contains two tag ports, and AMS-M3-Z contains three tag ports only.

The composite asset strip is especially useful for tracking large devices such as SAN boxes in the cabinet.

The following diagram illustrates AMS-M3-Z.

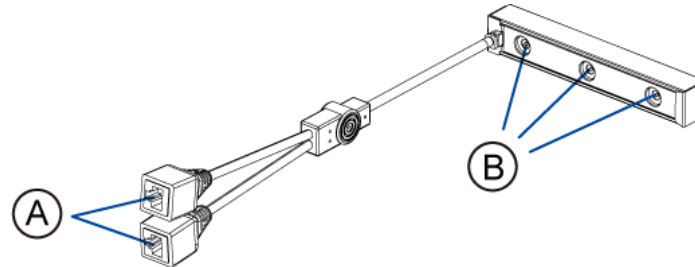

A	Two RJ-45 connectors
B	Tag ports

Important: DO NOT hot swap or hot plug any AMS-Mx-Z in a composite asset strip chain after connecting the chain to the PX3 device. Doing so may cause the device's FEATURE port to malfunction.

► **To connect composite asset strips to the PX3 device:**

If there are only 2 or 3 IT devices to track, you can connect only one AMS-M2-Z or AMS-M3-Z to the PX3 device. In this case, go to step 2. If there are more than 2 or 3 IT devices, you need to daisy chain multiple composite asset strips and start from step 1.

1. (Optional) Daisy chain multiple composite asset strips.
 - a. Get a standard network patch cable that is within 2 meters.
 - b. Connect one end of the network cable to the RJ-45 connector labeled "Output" on the first composite asset strip.
 - c. Connect the other end of the cable to the RJ-45 connector labeled "Input" on the secondary composite asset strip.
 - d. Repeat the same steps to connect more composite asset strips. See ***Daisy-Chain Limitations of Composite Asset Strips*** (on page 76) for the maximum number of composite asset strips supported per chain.

Note: Different types of composite asset strips can be mixed in a chain.

2. Connect the composite asset strip(s) to the PX3 device via a standard network patch cable (CAT5e or higher).
 - a. Connect one end of the cable to the RJ-45 port labeled "Input" on the composite asset strip.
 - For a composite asset strip chain, connect the cable to the "Input" port of the first asset strip.
 - b. Connect the other end of the cable to the FEATURE port on the PX3 device.

3. Affix an asset tag to the IT device. Then connect this asset tag to the composite asset strip by plugging the tag connector into the tag port on the composite asset strip. For details, see **Connecting Regular Asset Strips to PX3** (on page 70).
4. (Optional) For a chain, it is highly recommended using the cable ties to help hold the weight of all connecting cables.

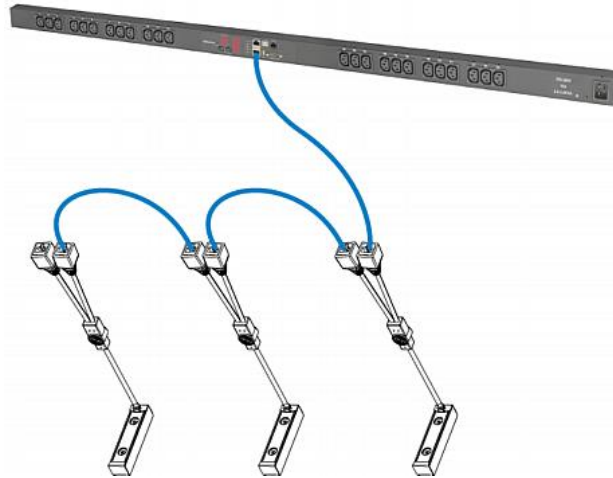

5. Repeat Step 3 to connect IT devices to the other composite asset strips in the chain.

Daisy-Chain Limitations of Composite Asset Strips

There are some limitations when daisy chaining composite asset strips "AMS-Mx-Z," where x is a number.

- The maximum cable length between composite asset strips is 2 meters, but the total cable length cannot exceed 10 meters.
- The maximum number of composite asset strips that can be daisy chained depends on the Raritan product you purchased.
- It is NOT supported to hot swap or hot plug any AMS-Mx-Z in a composite asset strip chain that has been connected to Raritan's PDU, SRC, or PMC. Therefore, first disconnect the chain from the device when you need to swap or add any AMS-Mx-Z to the chain.

Raritan devices	Maximum strips per chain
EMX2-111, PX2 PDUs, BCM1 (NOT BCM2 series)	Up to 4 composite asset strips are supported.
Smart Rack Controller, EMX2-888, PX3 PDUs,	Up to 6 composite asset strips are supported.

Raritan devices	Maximum strips per chain
PX3TS transfer switches	
PMC (BCM2 series)	

Note: In case you hot swap or hot plug any AMS-Mx-Z in a chain, causing the FEATURE port of the PX3 to malfunction, you can power cycle or reset the PX3 to restore the FEATURE port.

Connecting a Logitech Webcam

Connect webcams to PX3 in order to view videos or snapshots of the webcam's surrounding area.

The following USB Video Class (UVC) compliant webcam is supported:

- Logitech® HD pro C920
- Logitech® Webcam® Pro 9000, Model 960-000048

Other UVC-compliant webcams may also work. However, Raritan has neither tested them nor claimed that they will work properly.

Tip: You can easily find a list of UVC-compliant webcams on the Internet.

The PX3 supports up to two webcams. After connecting a webcam, you can retrieve visual information from anywhere through the PX3 web interface.

For more information on the Logitech webcam, refer to the user documentation accompanying it.

▶ To connect a webcam:

1. Connect the webcam to the USB-A port on the PX3. The PX3 automatically detects the webcam.
2. Position the webcam properly.

Important: If a USB hub is used to connect the webcam, make sure it is a "powered" hub.

Snapshots or videos captured by the webcam are immediately displayed in the PX3 web interface after the connection is complete. See **Configuring Webcams and Viewing Live Images** (on page 486).

Connecting a GSM Modem

The following Cinterion® GSM modems can be connected to the PX3 in order to send SMS messages containing event information.

- MC52iT
- MC55iT
- EHS6T

See **Available Actions** (on page 384) for more information on SMS messages.

Note: PX3 cannot receive SMS messages.

▶ **To connect the GSM modem:**

1. Connect the GSM modem to the serial port labeled CONSOLE / MODEM on the PX3.
 - A third party RJ-45 to "DB9 male" adapter/cable is required for this connection. See **RJ45-to-DB9 Cable Requirements for Modem Connections** (on page 874).
2. Configure the GSM modem as needed. See the supporting GSM modem help for information on configuring the GSM modem.
3. Configure the GSM modem settings in the PX3 to specify the modem's SIM PIN number and the recipient phone number. See **Configuring the Serial Port** (on page 446).

Connecting an Analog Modem

The PX3 supports remote dial-in communications to access the CLI through an analog modem. This dial-in feature provides an additional alternative to access the PX3 when the LAN access is not available. To dial in to the PX3, the remote computer must have a modem connected and dial the correct phone number.

Below are the analog modems that the PX3 supports for sure:

- NETCOMM IG6000 Industrial Grade SmartModem
- US Robotics 56K modem

The PX3 may also support other analog modems which Raritan did not test.

Note that the PX3 does NOT support dial-out or dial-back operations via the modem.

▶ **To connect an analog modem:**

1. Plug a telephone cord into the phone jack of the supported modem.
2. Plug the modem's RS-232 cable into the serial port labeled CONSOLE / MODEM on the PX3.

- A third party RJ-45 to "DB9 male" adapter/cable is required for this connection. See ***RJ45-to-DB9 Cable Requirements for Modem Connections*** (on page 874).

You need to enable the modem dial-in support to take advantage of this feature, see ***Configuring the Serial Port*** (on page 446).

Connecting an External Beeper

The PX3 supports the use of an external beeper for audio alarms.

External beepers that are supported include but may not be limited to the following:

- Mallory Sonalert MODEL SNP2R

After having an external beeper connected, you can create event rules for the PX3 to switch on or off the external beeper when specific events occur. See ***Event Rules and Actions*** (on page 364).

▶ **To connect an external beeper:**

1. Connect a standard network patch cable to the FEATURE port of the PX3.
2. Plug the other end of the cable into the external beeper's RJ-45 socket.

The beeper can be located at a distance up to 330 feet (100 m) away from the PX3.

Connecting a Schroff LHX/SHX Heat Exchanger

To remotely monitor and administer the Schroff® LHX-20, LHX-40 and SHX-30 heat exchangers through the PX3 device, you must establish a connection between the heat exchanger and the PX3 device.

For more information on the LHX/SHX heat exchanger, refer to the user documentation accompanying that product.

To establish a connection between the PX3 and LHX/SHX heat exchanger, an RJ-45 to RS-232 adapter cable provided by Schroff is required.

▶ **To connect an LHX or SHX heat exchanger:**

1. Plug the RS-232 DB9 end of the adapter cable into the RS-232 port on the Schroff LHX/SHX heat exchanger.
2. Plug the RJ-45 end of the cable into the port labeled FEATURE on your PX3 device.

To enable the support of the LHX/SHX heat exchanger, see ***Miscellaneous*** (on page 453).

Connecting a Modbus RTU Device or Bus

If connecting the Modbus RTU devices to PX3 and enabling the Modbus Gateway feature, the Modbus TCP clients on your network will be able to communicate with those Modbus RTU devices attached to PX3.

▶ **To use the Modbus Gateway feature:**

1. Connect a Modbus RTU device, or a Modbus bus with multiple RTU devices, to the PX3 via two adapters described below.
 - a. Connect an isolated RS485-to-RS232 adapter to the Modbus RTU device or Modbus bus.
 - b. Connect an RS232-to-USB adapter (using FTDI's FT232 chip) to the RS485-to-RS232 adapter.
 - c. Connect the RS232-to-USB adapter to the USB-A port on the PX3.
2. On the PX3, enable and properly configure the Modbus Gateway feature. See ***Changing Modbus Settings*** (on page 333).

▶ **Communications between Modbus TCP and RTU devices:**

- The PX3 acts only as a message gateway for the Modbus TCP client. Messages from the Modbus TCP client(s) are passed through the PX3 to the connected Modbus RTU devices or Modbus bus.
- The Modbus RTU devices on the bus are identified with their Modbus RTU addresses using the Modbus unit identifier addresses in the Modbus TCP protocol.

If the Modbus TCP client does not support unit identifier addressing, refer to ***Changing Modbus Settings*** (on page 333).

- The PX3 supports communications to multiple Modbus RTU devices. Note that the connected Modbus RTU devices are invisible to the PX3.

Chapter 5 PDU Linking

The PDU Linking feature allows the linking configuration of a single master PDU unit to multiple link units for faster and more efficient power management. Only one master unit is connected to the network in PDU Linking, which allows a cost-efficient PDU operation and networking infrastructure.

The master PDU is the first PDU in the chain with up to seven link units connected in sequence in the chain. The master PDU has full knowledge of the location of the connected link units in the chain, as well as the power and environmental information of all link units.

When you create a master and link configuration in a chain, you log in to the master unit with visibility to control both the master unit and the connected link units from within the GUI, SNMP, and CLI.

The PDU Linking feature also allows the Raritan cascading technology, which enables multiple PDUs to share network connectivity by cascading them through the USB or Ethernet interface.

The administrator privilege is required for all management actions (adding, configuring, releasing) of the PDU Linking feature. Each PDU in the chain can be monitored and managed from anywhere by the network protocols HTTP(S), SNMP, SSH, Telnet, and Modbus.

All units in the linked chain should be the same model PDU. All units must run the same firmware version, which can be upgraded respectively for each unit in the chain.

In This Chapter

FAQs.....	82
PDU Linking in the Web GUI	84
Displays for Master and Link Units	110
PDU Linking in the CLI	112

FAQs

▶ What's the difference between a "master unit" and a "link unit"?

Master and link units are the same model PDUs that are equal to each other, and each has its own IP address. You designate a PDU as the master unit by logging into the unit and then adding a link unit. The first unit becomes the master, and when the first link unit is added, the master unit is automatically assigned PDU ID "1", which is reserved to identify a master unit only, and the ID "1" cannot be edited. A connection between the master and the link unit has now occurred and the chain is formed.

As you continue to add link units to the chain as desired (up to seven link units), you select Link ID "2" through "8" for the Link ID numbers. (PDU ID "1" was reserved for the master). Note that the Link ID "2-8" is the sequential number of each link unit that you select as you add the unit to the chain, and once selected, the Link ID cannot be edited.

When the chain is established with a single master unit, and one or more link units, communication occurs with the master unit through its IP address. The master unit, in turn, communicates to the other link units in the chain through their individual IP addresses, which optimizes power monitoring and PDU management.

▶ Which Raritan PDUs can be linked?

With network connectivity, PDU Linking supports these Raritan products when formed in a linked chain: PX3 with iX7 main controller and PX3TS with iX7 main controller. All devices in the chain should be the same models.

▶ Can master units be linked together?

No. Once a unit is designated as the master unit in a chain, it cannot be linked to a master unit in another chain. A master unit can only be linked to one or more link units in a chain.

▶ How many units can be linked?

Including the master, a full chain can include a total of eight units. The first unit added is designated as the master unit with the ID "1". Each unit you then add to the chain is designated as a link unit, beginning with ID "2" and ending with ID "8".

▶ What is re-linking?

Re-linking is a required function when a link unit no longer recognizes or responds to the master unit, most likely caused if the link unit was reset to factory defaults. The status of the disassociated link unit will be displayed as "Access Denied". Selecting the link unit when in this status displays the Re-link button that allows reconnection of the link unit in the chain for regaining device control.

Note: Re-linking uses the same Link Unit ID and hostname, but you will need to reauthenticate with your login credentials.

▶ **What user privileges are required for managing the PDU Linking configuration?**

Administrative privileges are required for both the master unit and link unit. To add a link, your administrative login account is required, but after that you only log in to the master to manage the chain, as all link units in the chain are visible in the user interface from the master unit view.

▶ **What happens if the connection is lost between the master and link units?**

If the network connection is lost, these link unit functions will still work:

1. energy accumulation
2. local display (regular metering values and alerts of raised thresholds)
3. maintained outlet states

and these link unit functions will stop working:

1. event log entries are lost
2. event engine rules/alarms
3. remote access to the link unit
4. synchronization of master settings and time when not using NTP

▶ **Which system areas of the master and link units are automatically synchronized?**

The master PDU periodically checks link unit reachability. You can define rules to be alerted when communication with a link unit fails, such as a system alarm. Some link unit settings are automatically synchronized with the master:

1. Peripheral device settings
2. Front panel privileges and default view
3. USB host port lockdown
4. Time and date settings
5. General data logging settings

▶ **How are firmware updates handled?**

Uploaded firmware images in the GUI are automatically distributed to all link units at the same time. Starting a firmware update requires the same image to be uploaded to all units.

▶ **Does PDU Linking support mass deployment of PDUs?**

Yes, mass deployment has been extended to support a setup for the PDU Linking feature (multi-IP or single-IP) via the Raritan Mass Deployment Utility, which provides the Excel spreadsheet process used for PDU bulk configuration. For information about using the utility, see **Configuration or Firmware Upgrade with a USB Drive** (on page 740).

▶ **Which network setup modes are supported by PDU Linking?**

For the underlying network, the PDU Linking feature can use the typical network setup modes:

Independent PDU Setup: All PDUs have their own regular IP address. They don't need to be in a physical chain to be logically chained. You communicate only to the master using its normal IP address. Configure networking of the units, and then add link units using the Web GUI, CLI, or USB.

Bridged Setup: Same as Independent PDU Setup, but the PDUs are physically connected as a chain, either by ethernet or USB. The configuration steps are the same as with Independent PDU Setup.

Port Forwarding Cascade: The PDUs are physically connected as a chain (either by Ethernet or USB). Only the first master PDU is connected to your network with the IP address you assigned. The other PDUs will get automatically-assigned private IP addresses which are not visible; you can configure both PDUs at one time with a USB stick, or configure the network first and then add link units.

Note: When referring to "cascading", or the physical chaining of units, although the mixing of connection types (Ethernet and USB) is not recommended in the cascade, the mixing is possible with these restrictions: In Port Forwarding mode, you must build a single, linear chain where each unit has exactly one upstream device and optionally one downstream device. In Bridging mode, you must not build any loops; in other words, multiple paths between two units.

PDU Linking in the Web GUI

The following topics describe how to configure and use PDU Linking using the web interface.

Designating the Master Unit

Log in to the PDU you want to designate as the master unit. When you add the first link unit, a chain is established between the master and the new link, and the master becomes ID "1".

To view and manage a link chain, log in to the master unit, as displayed on the PDU page:

The screenshot shows the Raritan PDU management interface. The left sidebar contains navigation options: Dashboard, PDU, Inlets, Outlets, Outlet Groups, OCPs, Peripherals, Feature Ports, User Management, Device Settings, and Maintenance. The main content area is titled "My PDU (1)" and is divided into three sections:

- Details:** A table showing key information about the master PDU, highlighted with a red border.

Firmware version	3.6.0.5-46238
Model	PX3-5660V
Serial number	1BZB284980
MAC address	02:0d:9c:75:d9:03
Rating	190-208V, 24A, 7.9-8.6kVA, 50/60Hz
Data log	Export as CSV
- Link PDUs:** A table showing the first link unit in the chain.

#	Host	Model	Status	Firmware
2	192.168.6.29	PX3-5660V	OK	3.6.0.5-46238

 Below the table are buttons for "Add Link PDU" and "Release Link PDU".
- Settings:** A table of configuration options for the PDU.

Name	My PDU	Edit Settings
Relay behavior on power loss	Non-latching	
Outlet state on device startup	last known	
Outlet initialization delay on device startup	3 s	
Power off period during power cycle	10 s	
Inrush guard delay	200 ms	
Reset all energy counters	Reset	
Internal Beeper	Off	^

The PDU page displays the following information about the master PDU:

1. Firmware version
2. Model
3. Serial number
4. MAC address
5. Rating

The ID of the master unit is automatically assigned the ID "1", as shown in the example as "My PDU (1)". The ID cannot be edited.

Adding a Link Unit

A link unit (up to seven units) can be added to a single master unit.

On the PDU page, the master unit is displayed as highlighted in the following screen example in red. Note the following section "Link PDUs", designed for the PDU Linking feature, where multiple PDUs added to the chain are displayed as the link units. The Add Link PDU button, highlighted in green in the screen example, also displays in the Link PDUs section.

The screenshot displays the Raritan PDU management interface. The left sidebar contains navigation options: Dashboard, PDU, Inlet, Outlets, Outlet Groups, OCPs, Peripherals, Asset Strip, User Management, Device Settings, and Maintenance. The main content area is titled "My PDU" and includes the Raritan logo, language selection (EN), user role (Administrator), and a Logout button.

The "PDU" section is divided into three main areas:

- Details:** A table showing unit information, highlighted with a red border.

Firmware version	3.6.0.5-46238
Model	PX3-5660V
Serial number	1BZB284980
MAC address	02:0d:9c:75:d9:03
Rating	190-208V, 24A, 7.9-8.6kVA, 50/60Hz
Data log	Export as CSV
- Link PDUs:** A table with columns for #, Host, Model, Status, and Firmware. It currently shows "No link PDUs configured." and includes an "Add Link PDU" button highlighted with a green border, along with a "Release Link PDU" button.
- Settings:** A configuration section with an "Edit Settings" link. It includes fields for Name (My PDU), Relay behavior on power loss (Non-latching), Outlet state on device startup (last known), Outlet initialization delay on device startup (3 s), Power off period during power cycle (10 s), Inrush guard delay (200 ms), and a "Reset all energy counters" button. An "Internal Beeper" section at the bottom shows the State set to "Off".

The left sidebar also displays device information: Model PX3-5660V, Firmware Version 3.6.0.5-46238, Last Login 1/8/2020, 12:22:04 AM UTC-0800, and Device Time 1/8/2020, 7:13:11 AM UTC-0800. Help links for Online Documentation and Raritan Support are also present.

► **To add a link unit:**

Log in to the master PDU as shown displayed above in the PDU page.

Click Add Link PDU. The following add box displays:

The screenshot shows the Raritan PDU management interface. A modal dialog box titled "Add Link PDU" is open, allowing the user to configure a new link unit. The dialog box contains the following fields:

- Link ID:** A dropdown menu with the value "2" selected.
- IP address/hostname:** A text input field containing "192.168.6.29".
- Administrator login:** A text input field containing "admin".
- Password:** A password input field with masked characters "*****".

At the bottom of the dialog box are "Cancel" and "Add" buttons. Below the dialog box, the "Link PDUs" section shows a table with columns for #, Host, Model, Status, and Firmware. The table is currently empty, with the message "No link PDUs configured." and buttons for "Add Link PDU" and "Release Link PDU". Below this is the "Settings" section, which includes various configuration options for the PDU, such as Name, Relay behavior on power loss, Outlet state on device startup, Outlet initialization delay on device startup, Power off period during power cycle, Inrush guard delay, and Reset all energy counters.

1. The Link ID is populated as the next available ID number (2-8), assigned sequentially as each link unit is added to the chain to identify the link unit in the user interfaces. Note: From the drop-down, you can manually select the desired Link ID to order the link units in the chain as desired. Once associated with a link unit, the Link ID cannot be edited.
2. Provide the IP address of the link unit.
3. Provide the login credentials for the link unit. Note: If the link unit has factory settings, you will be prompted to set the new password.
4. Click Add.

The new link unit is added on the PDU page with the master unit, in a list in the Link PDUs section. All link units added to the chain in this way are now managed by the single master unit.

The screenshot shows the Raritan PX3-5660V PDU management interface. The left sidebar contains navigation options: Dashboard, PDU, Inlets, Outlets, Outlet Groups, OCPs, Peripherals, Feature Ports, User Management, Device Settings, and Maintenance. The main content area is titled 'My PDU (1)' and is divided into several sections:

- Details:** A table showing device information:

Firmware version	3.6.0.5-46238
Model	PX3-5660V
Serial number	1B2B284980
MAC address	02:0d:9c:75:d9:03
Rating	190-208V, 24A, 7.9-8.6kVA, 50/60Hz
Data log	Export as CSV
- Link PDUs:** A table listing linked units:

# ▲	Host	Model	Status	Firmware
2	192.168.6.29	PX3-5660V	OK	3.6.0.5-46238

 Below the table are buttons for 'Add Link PDU' and 'Release Link PDU'.
- Settings:** A table of configuration options:

Name	My PDU	Edit Settings
Relay behavior on power loss	Non-latching	
Outlet state on device startup	last known	
Outlet initialization delay on device startup	3 s	
Power off period during power cycle	10 s	
Inrush guard delay	200 ms	
Reset all energy counters	Reset	
- Internal Beeper:** A table showing the beeper state:

State	Off
-------	-----

The PDU page displays the following information about the link unit:

- Link ID
- Host/IP address
- Communication status
- Firmware version

About the Link ID

The PDU ID "1" is automated and reserved internally for the master unit. The master unit's PDU ID "1" cannot be edited.

The Link ID "2-8" is available for you to select as the ID for each of the link units you add to chain. From the Link ID drop-down, you can select the desired Link ID to manage the link units in the chain. Once selected, the Link ID cannot be edited.

Add Link PDU

Link ID	2
IP address/hostname	
Administrator login	
Password	

2
4
5
6
7
8

Master Units Manage Link Units

The master unit manages the following functions for the entire chain of linked units:

- User management and authentication – configured only on the master.
- Date and time – the master synchronizes its date and time settings to link units. If NTP is not used, then the synchronization interval is every 10 minutes.
- Device settings – only the master device settings are configurable, except for Network Settings. Some settings will be synced to link units. The serial port is configurable for the master only; link units use the console.
- Data model settings – such as outlet names, thresholds, peripherals, etc., are configured on the master and stored on link units.
- Lua scripts – Communication with link units in a Lua script is possible.

Releasing a Link Unit

Releasing a link unit means the unit is separated from the chain and the unit then becomes standalone. The master unit no longer has access to the released link unit.

Note: If a release action is attempted on a link unit when the unit is an unreachable state, a warning message displays, and the master will not recognize the link unit. A factory reset will be required on the link unit.

The screenshot displays the Raritan web interface for a PDU. The left sidebar contains navigation options: Dashboard, PDU, Inlets, Outlets, Outlet Groups, OCPs, Peripherals, Feature Ports, User Management, Device Settings, and Maintenance. The main content area is titled 'My PDU (1)' and includes several sections:

- Details:** A table showing device information:

Firmware version	3.6.0.5-46238
Model	PX3-5660V
Serial number	1BZB284980
MAC address	02:0d:9c:75:d9:03
Rating	190-208V, 24A, 7.9-8.6kVA, 50/60Hz
Data log	Export as CSV
- Link PDUs:** A table listing linked PDUs:

# ▲	Host	Model	Status	Firmware
2	192.168.6.29	PX3-5660V	OK	3.6.0.5-46238

 Below the table are buttons for 'Add Link PDU' and 'Release Link PDU'.
- Settings:** A table of configuration options:

Name	My PDU	Edit Settings
Relay behavior on power loss	Non-latching	
Outlet state on device startup	last known	
Outlet initialization delay on device startup	3 s	
Power off period during power cycle	10 s	
Inrush guard delay	200 ms	
Reset all energy counters	Reset	
- Internal Beeper:** A table showing the beeper state:

State	Off
-------	-----

The left sidebar also displays device information: Model PX3-5660V, Firmware Version 3.6.0.5-46238, and system status like Last Login and Device Time.

► **To release a link unit:**

From the PDU page, in the Link PDUs section, click a link unit to select it.

Click Release Link PDU.

A confirmation prompts to cancel or release:

Release Link PDU

ⓘ Are you sure you want to release link PDU 192.168.6.29 (2)?

Cancel

Release

If released, the link unit is removed from the PDU page.

Switching to a Different PDU

Switching PDUs is a control function noted by the Switch control in the in the upper left corner of the PDU, Outlet, Outlet Groups, OCPs, and Feature Ports pages, called out in the following screen example.

Displayed data in the GUI defaults to the master unit. The Switch control allows you to switch quickly from a master page to a link unit page, and back again to the master.

The screenshot shows the Raritan My PDU interface. On the left is a navigation sidebar with options: Dashboard, PDU, Inlets, Outlets, Outlet Groups, OCPs, Peripherals, Feature Ports, User Management, and Device Settings. The main content area is titled 'My PDU' and includes a dropdown menu for switching between PDU units. The dropdown is currently open, showing 'My PDU (1)' (selected) and 'My PDU (2)'. Below the dropdown is a table of device details for the selected unit (My PDU (2)).

Firmware version	3.6.0.5-46238
Model	PX3-5660V
Serial number	1BZB284980
MAC address	02:0d:9c:75:d9:03
Rating	190-208V, 24A, 7.9-8.6kVA, 50/60Hz
Data log	Export as CSV

Below the device details is a 'Link PDUs' section with a table:

# ▲	Host	Model	Status	Firmware
2	192.168.6.29	PX3-5660V	OK	3.6.0.5-46238

At the bottom of the Link PDUs section are two buttons: 'Add Link PDU' and 'Release Link PDU'.

► **To switch to a different PDU:**

1. Click the Switch  control.
2. Select one of the link PDUs from the drop-down list. Link number "2-8" appears in parentheses.
3. The page displays data for the selected link PDU.

- To return to the PDU page for the master, select the master PDU. Master number "1" appears in parentheses.

Note: The Switch control is only available when there is at least one link unit in the chain; otherwise, the page defaults to displaying only the data of the master PDU.

Re-linking a Link Unit

In PDU Linking, Re-link is a required function when a link unit no longer recognizes or responds to the master unit, most likely caused when the link unit has been reset to factory defaults. Resetting to factory defaults causes the linked unit in the chain to be unreachable, and it would have to be removed from the chain manually.

If reset to factory defaults, the status of the disassociated link unit will be displayed on the PDU page as "Access Denied", shown below.

The screenshot shows the Raritan PDU management interface. The left sidebar contains navigation options: Dashboard, PDU, Inlet, Outlets, Outlet Groups, OCPs, Peripherals, Asset Strip, User Management, Device Settings, and Maintenance. The main content area is titled 'My PDU' and displays details for a PDU with the following information:

Details	
Firmware version	3.6.0.5-46238
Model	PX3-5660V
Serial number	1B2B284980
MAC address	02:0d:9c:75:d9:03
Rating	190-208V, 24A, 7.9-8.6kVA, 50/60Hz
Data log	Export as CSV

Below the details is a 'Link PDUs' table:

#	▲	Host	Model	Status	Firmware
2		192.168.6.29	<unknown>	Access Denied	<unknown>

Buttons for 'Add Link PDU', 'Release Link PDU', and 'Re-link' are visible below the table. The 'Re-link' button is highlighted with a red box. Below the table is a 'Settings' section with various configuration options like Name, Relay behavior on power loss, Outlet state on device startup, etc. An 'Internal Beeper' section is also visible at the bottom.

► **To re-link a link unit:**

- When you select the link unit in the "Access Denied" status, the Re-link button displays, as noted above.
- To reconnect the link unit in the chain, and to regain full control of the unit, click Re-link.

- Although re-linking uses the same Link Unit ID and hostname of the unreachable unit, you will need to reauthenticate with your login credentials shown below.
- Click the Re-link button.

Re-authenticate Link PDU

Link ID	2
IP address/hostname	192.168.6.29
Administrator login	<input type="text" value="admin"/>
Password	<input type="password" value="*****"/>

- The status of the link unit changes to "OK".

The screenshot shows the Raritan My PDU web interface. The left sidebar contains navigation options: Dashboard, PDU, Inlets, Outlets, Outlet Groups, OCPs, Peripherals, Feature Ports, User Management, Device Settings, and Maintenance. The main content area displays details for 'My PDU (1)'. The 'Link PDU' table is highlighted with a green border, showing the following data:

#	Host	Model	Status	Firmware
2	192.168.6.29	PX3-5660V	OK	3.6.0.5-46238

Below the table are buttons for 'Add Link PDU' and 'Release Link PDU'. The 'Settings' section includes fields for Name, Relay behavior on power loss, Outlet state on device startup, Outlet initialization delay on device startup, Power off period during power cycle, Inrush guard delay, and Internal Beeper.

Viewing Link Unit Information

When a link unit is added to the chain, the master unit view (through the GUI) allows full access to the operational data of the link unit. For example, using the navigation tabs of the GUI, link unit data is displayed in several pages: the Dashboard, PDUs, Inlets, Outlets, Outlet Groups, Peripherals, and Feature Ports.

► Dashboard

The Dashboard shows inlets, OCPs, alerted sensors, and inlet history for the entire linked chain.

In this example, data for the single inlet of the master "My PDU (1)" Inlet I1, and the inlet of the link unit "My PDU (2)" Inlet I1, are displayed together. The OCPs for the units are also available together on the Dashboard page.

Peripheral sensors are not shown on the dashboard by default. Only sensors (both PDU or peripheral) in warned or critical state are displayed in the Alerted Sensors section.



My PDU

EN | Administrator | Logout

Dashboard

PDU

Inlets

Outlets

Outlet Groups

OCPs

Peripherals

Feature Ports

User Management

Device Settings

Maintenance

Model
PX3-5660V

Firmware Version
3.6.0.5-46238

Help
[Online Documentation](#)
[Raritan Support](#)

Last Login
1/8/2020, 12:22:04 AM UTC-0800

Device Time
1/8/2020, 7:30:22 AM UTC-0800

My PDU (1) Inlet I1

0.0 W 0.0 VA	L1 0.0 A / 24A	L2 0.0 A / 24A	L3 0.0 A / 24A
Active Energy: 0 Wh Power Factor: 1.00 Line Frequency: 50.0 Hz Unbalanced Current: 0 %	L1-L2: 199 V L1-N: 115 V	L2-L3: 199 V L2-N: 115 V	L3-L1: 199 V L3-N: 115 V

My PDU (2) Inlet I1

0.0 W 0.0 VA	L1 0.0 A / 24A	L2 0.0 A / 24A	L3 0.0 A / 24A
Active Energy: 0 Wh Power Factor: 1.00 Line Frequency: 50.0 Hz Unbalanced Current: 0 %	L1-L2: 199 V L1-N: 115 V	L2-L3: 199 V L2-N: 115 V	L3-L1: 199 V L3-N: 115 V

Overcurrent Protectors

Name	PDU	Status	Current Drawn	Protected Outlets	Lines
Overcurrent Protector C1	My PDU (1)	closed	0.000 A / 20 A	1-10	L1-L2
Overcurrent Protector C2	My PDU (1)	closed	0.000 A / 20 A	11-20	L2-L3
Overcurrent Protector C3	My PDU (1)	closed	0.000 A / 20 A	21-30	L3-L1
Overcurrent Protector C1	My PDU (2)	closed	0.000 A / 20 A	1-10	L1-L2
Overcurrent Protector C2	My PDU (2)	closed	0.000 A / 20 A	11-20	L2-L3
Overcurrent Protector C3	My PDU (2)	closed	0.000 A / 20 A	21-30	L3-L1

Alerted Sensors

No Alerted Sensors

Alarms

No Alarms

▶ PDU Page

The PDU page displays the details and settings for the selected unit (master or link). The Link PDUs section is only shown when the master unit is selected.

The screenshot displays the Raritan web interface for a PDU. The left sidebar contains navigation options: Dashboard, PDU, Inlets, Outlets, Outlet Groups, OCPs, Peripherals, Feature Ports, User Management, Device Settings, and Maintenance. The main content area is titled "My PDU (1)" and is divided into three sections:

- Details:** A table showing unit information: Firmware version (3.6.0.5-46238), Model (PX3-5660V), Serial number (1B2B284980), MAC address (02:0d:9c:75:d9:03), Rating (190-208V, 24A, 7.9-8.6kVA, 50/60Hz), and Data log (with an "Export as CSV" button).
- Link PDUs:** A table with columns for #, Host, Model, Status, and Firmware. It lists one linked PDU with Host 192.168.8.29, Model PX3-5660V, Status OK, and Firmware 3.6.0.5-46238. Below the table are "Add Link PDU" and "Release Link PDU" buttons.
- Settings:** A configuration page for "My PDU" with an "Edit Settings" link. It includes fields for Name, Relay behavior on power loss (Non-latching), Outlet state on device startup (last known), Outlet initialization delay on device startup (3 s), Power off period during power cycle (10 s), Inrush guard delay (200 ms), and a "Reset all energy counters" button. An "Internal Beeper" section shows the State as "Off".

► **Inlets Page**

On the Inlets page, the master unit and link units are displayed together on the same page.

In this example, data for the single inlet of the master "My PDU (1)" Inlet I1, and the inlet of the link unit "My PDU (2)" Inlet I1, are shown together on the Inlets page.

The screenshot shows the Raritan web interface. The top navigation bar includes the Raritan logo, the text "My PDU", and user information "EN | Administrator | Logout". A sidebar on the left contains navigation links: Dashboard, PDU, Inlets (highlighted), Outlets, Outlet Groups, OCPs, Peripherals, Feature Ports, User Management, Device Settings, and Maintenance. The main content area is divided into two sections for "My PDU (1) Inlet I1" and "My PDU (2) Inlet I1". Each section displays a table of power metrics and phase readings.

Unit	Power (W)	Power (VA)	L1	L2	L3
My PDU (1) Inlet I1	0.0	0.0	0.0 A / 24 A	0.0 A / 24 A	0.0 A / 24 A
My PDU (2) Inlet I1	0.0	0.0	0.0 A / 24 A	0.0 A / 24 A	0.0 A / 24 A

Additional data shown in the interface includes Active Energy (0 Wh), Power Factor (1.00), Line Frequency (50.0 Hz), and Unbalanced Current (0 %). Voltage readings for each phase are also provided: L1-L2: 199 V, L1-N: 115 V, L2-L3: 199 V, L2-N: 115 V, L3-L1: 199 V, L3-N: 115 V.

▶ Outlets Page

The Outlets page defaults to display only the outlets of the master unit, in this example 30 outlets.

The screenshot shows the Raritan My PDU interface. The main content area displays a table titled "My PDU (1) Outlets" with 30 rows. Each row represents an outlet, numbered 1 through 30. The columns are: #, Name, Status, RMS Current, Active Power, and Power Factor. All outlets are currently "on" and show 0.000 A RMS Current, 0 W Active Power, and 1.00 Power Factor. The interface includes a sidebar with navigation options like Dashboard, PDU, Inlets, Outlets, Outlet Groups, OCPs, Peripherals, Feature Ports, User Management, Device Settings, and Maintenance. It also displays device information such as Model (PX3-5660V), Firmware Version (3.6.0.5-46238), Last Login (1/8/2020, 1:18:58 PM UTC-0800), and Device Time (1/9/2020, 6:24:21 AM UTC-0800).

#	Name	Status	RMS Current	Active Power	Power Factor
1	Outlet 1	on	0.000 A	0 W	1.00
2	Outlet 2	on	0.000 A	0 W	1.00
3	Outlet 3	on	0.000 A	0 W	1.00
4	Outlet 4	on	0.000 A	0 W	1.00
5	Outlet 5	on	0.000 A	0 W	1.00
6	Outlet 6	on	0.000 A	0 W	1.00
7	Outlet 7	on	0.000 A	0 W	1.00
8	Outlet 8	on	0.000 A	0 W	1.00
9	Outlet 9	on	0.000 A	0 W	1.00
10	Outlet 10	on	0.000 A	0 W	1.00
11	Outlet 11	on	0.000 A	0 W	1.00
12	Outlet 12	on	0.000 A	0 W	1.00
13	Outlet 13	on	0.000 A	0 W	1.00
14	Outlet 14	on	0.000 A	0 W	1.00
15	Outlet 15	on	0.000 A	0 W	1.00
16	Outlet 16	on	0.000 A	0 W	1.00
17	Outlet 17	on	0.000 A	0 W	1.00
18	Outlet 18	on	0.000 A	0 W	1.00
19	Outlet 19	on	0.000 A	0 W	1.00
20	Outlet 20	on	0.000 A	0 W	1.00
21	Outlet 21	on	0.000 A	0 W	1.00
22	Outlet 22	on	0.000 A	0 W	1.00
23	Outlet 23	on	0.000 A	0 W	1.00
24	Outlet 24	on	0.000 A	0 W	1.00
25	Outlet 25	on	0.000 A	0 W	1.00
26	Outlet 26	on	0.000 A	0 W	1.00
27	Outlet 27	on	0.000 A	0 W	1.00
28	Outlet 28	on	0.000 A	0 W	1.00
29	Outlet 29	on	0.000 A	0 W	1.00
30	Outlet 30	on	0.000 A	0 W	1.00

► **Viewing Outlets for Link Units**

On the Outlets page, you can switch from the master to the link.

1. From the Outlets page drop-down, select the link unit "My PDU (2)". Note: To view outlets for a specific link unit, the link unit must be selected by name.

The screenshot shows the Raritan PDU management interface. The top navigation bar includes the Raritan logo, the page title "My PDU", and user information (EN, Administrator, Logout). A left sidebar contains navigation options: Dashboard, PDU, Inlets, Outlets (selected), Outlet Groups, OCPs, Peripherals, Feature Ports, User Management, Device Settings, and Maintenance. The main content area displays a dropdown menu for "My PDU (1) Outlets" with "My PDU (2)" selected. Below the dropdown is a table of outlets with columns for Outlet ID, Name, Status, RMS Current, Active Power, Power Factor, and Non-Critical.

Outlet ID	Outlet Name	Status	RMS Current	Active Power	Power Factor	Non-Critical
1	Outlet 1	on	0.000 A	0 W	1.00	false
2	Outlet 2	on	0.000 A	0 W	1.00	false
3	Outlet 3	on	0.000 A	0 W	1.00	false
4	Outlet 4	on	0.000 A	0 W	1.00	false
5	Outlet 5	on	0.000 A	0 W	1.00	false
6	Outlet 6	on	0.000 A	0 W	1.00	false
7	Outlet 7	on	0.000 A	0 W	1.00	false
8	Outlet 8	on	0.000 A	0 W	1.00	false
9	Outlet 9	on	0.000 A	0 W	1.00	false
10	Outlet 10	on	0.000 A	0 W	1.00	false
11	Outlet 11	on	0.000 A	0 W	1.00	false
12	Outlet 12	on	0.000 A	0 W	1.00	false
13	Outlet 13	on	0.000 A	0 W	1.00	false

#	Name	Status	RMS Current	Active Power	Power Factor	Non-Critical
1	Outlet 1	off	0.000 A	0 W	1.00	false
2	Outlet 2	off	0.000 A	0 W	1.00	false
3	Outlet 3	off	0.000 A	0 W	1.00	false
4	Outlet 4	on	0.000 A	0 W	1.00	false
5	Outlet 5	on	0.000 A	0 W	1.00	false
6	Outlet 6	on	0.000 A	0 W	1.00	false
7	Outlet 7	on	0.000 A	0 W	1.00	false
8	Outlet 8	on	0.000 A	0 W	1.00	false
9	Outlet 9	on	0.000 A	0 W	1.00	false
10	Outlet 10	on	0.000 A	0 W	1.00	false
11	Outlet 11	on	0.000 A	0 W	1.00	false
12	Outlet 12	on	0.000 A	0 W	1.00	false
13	Outlet 13	on	0.000 A	0 W	1.00	false
14	Outlet 14	on	0.000 A	0 W	1.00	false
15	Outlet 15	on	0.000 A	0 W	1.00	false
16	Outlet 16	on	0.000 A	0 W	1.00	false
17	Outlet 17	on	0.000 A	0 W	1.00	false
18	Outlet 18	on	0.000 A	0 W	1.00	false
19	Outlet 19	on	0.000 A	0 W	1.00	false
20	Outlet 20	on	0.000 A	0 W	1.00	false
21	Outlet 21	on	0.000 A	0 W	1.00	false
22	Outlet 22	on	0.000 A	0 W	1.00	false
23	Outlet 23	on	0.000 A	0 W	1.00	false
24	Outlet 24	on	0.000 A	0 W	1.00	false
25	Outlet 25	on	0.000 A	0 W	1.00	false
26	Outlet 26	on	0.000 A	0 W	1.00	false
27	Outlet 27	on	0.000 A	0 W	1.00	false
28	Outlet 28	on	0.000 A	0 W	1.00	false
29	Outlet 29	on	0.000 A	0 W	1.00	false
30	Outlet 30	on	0.000 A	0 W	1.00	false

2. You can switch back to the master unit by selecting "My PDU (1)".

Note: The Switch control is only available when there is at least one link unit in the chain; otherwise, the page defaults to displaying only the outlets of the master.

- From the Outlets page (either master or link), select an outlet in the list to view operational details for the specific outlet and to configure outlet settings.

The screenshot displays the Raritan PX3-5660V PDU web interface. The top navigation bar shows the Raritan logo, the page title 'My PDU', and user information including 'Administrator' and 'Logout'. The left sidebar contains a navigation menu with options like Dashboard, PDU, Inlets, Outlets (selected), Outlet Groups, OCPs, Peripherals, Feature Ports, User Management, Device Settings, and Maintenance. The main content area is titled 'My PDU (2) Outlet 5' and features three tabs: Details, Sensors, and Settings. The Details tab is active, showing a table of outlet information. The Sensors tab shows a table of real-time sensor data. The Settings tab allows for configuration of outlet parameters. At the bottom, the Outlet History tab shows a grid for recording power usage.

Details	
Label	5
Outlet status	On
Receptacle type	IEC 60320 C13
Lines	L1-L2
Inlet	My PDU (2) Inlet I1
Overcurrent protector	Overcurrent Protector C1

Sensors		
Sensor	Value	State
RMS Current	0.000 A	normal
RMS Voltage	199 V	normal
Line Frequency	50.0 Hz	normal
Active Power	0 W	normal
Active Energy	0 Wh	normal
Apparent Power	0 VA	normal
Power Factor	1.00	normal

Settings	
Name	Edit Settings
State on device startup	PDU defined (last known)
Power off period during power cycle	PDU defined (10 seconds)
Non-critical	False
Reset energy counter	<input type="button" value="Reset"/>

Outlet History	
0.8 W	
0.6 W	
0.4 W	

Outlet Groups

An outlet group is a named collection of selected outlets. When user-defined, an outlet group can contain outlets from different PDUs, including both master and link units.

Outlet groups support fast and efficient outlet control actions (On, Off, Power Cycle) across multiple PDUs, and with PDU Linking, member outlets for the master and its link units can be collected in the same outlet group.

Outlet groups are managed by the master unit, and multiple outlet groups can be controlled simultaneously. Summary and power energy readings are available per outlet group.

The Outlet Groups page displays current user-defined outlet groups along with name, outlet state, active power reading, and the page also shows the outlet labels that were selected for the group. Note in the Outlets column in this example that outlets from both master and link units display together within a named group. This is an example of outlet "pairwise", a function described in more detail later in this next section.

Note: Outlet groups can contain multiple pairs of outlets; the next screen example shows only two outlet pairs in the sample groups.

Click the control arrow  to toggle the outlet group list in ascending or descending order by group number.

Raritan
A brand of **Legrand**

My PDU EN ▼ | Administrator | Logout

Dashboard | PDU | Inlets | Outlets | **Outlet Groups** | OCPs | Peripherals | Feature Ports | User Management > | Device Settings > | Maintenance >

Model: PX3-5660V
Firmware Version: 3.6.0.5-46238
Help: [Online Documentation](#), [Raritan Support](#)
Last Login: 1/8/2020, 12:22:04 AM UTC-0800
Device Time: 1/8/2020, 7:43:42 AM UTC-0800

Outlet Groups + Add group

# ▲	Name	Outlet State	Active Power	Outlets
1	Test	3 on	0 W	PDU 1: 9 and 12 PDU 2: 12
2	Outlet pair 1	2 on	0 W	PDU 1: 1 PDU 2: 1
3	Outlet pair 2	2 on	0 W	PDU 1: 2 PDU 2: 2
4	Outlet pair 3	2 on	0 W	PDU 1: 3 PDU 2: 3
5	Outlet pair 4	2 on	0 W	PDU 1: 4 PDU 2: 4
6	Outlet pair 5	2 on	0 W	PDU 1: 5 PDU 2: 5
7	Outlet pair 6	2 on	0 W	PDU 1: 6 PDU 2: 6
8	Outlet pair 7	2 on	0 W	PDU 1: 7 PDU 2: 7
9	Outlet pair 8	2 on	0 W	PDU 1: 8 PDU 2: 8
10	Outlet pair 9	2 on	0 W	PDU 1: 9 PDU 2: 9
11	Outlet pair 10	2 on	0 W	PDU 1: 10 PDU 2: 10

▶ **Viewing Outlet Group Details**

Click an outlet group name in the list to display operations details for the outlet group. From this page, you can issue the outlet control actions On, Off, and Cycle (power cycling to restore the outlet) for all member outlets in the outlet group. The page also allows editing of the outlet group members and its outlet settings.

The screenshot displays the Raritan My PDU interface for 'Outlet Group 1 - Test'. The interface is divided into a sidebar and a main content area.

Sidebar (Left):

- Dashboard
- PDU
- Inlets
- Outlets
- Outlet Groups
- OCPs
- Peripherals
- Feature Ports
- User Management
- Device Settings
- Maintenance
- Model: PX3-5660V
- Firmware Version: 3.6.0.5-46238
- Help: Online Documentation, Raritan Support
- Last Login: 1/9/2020, 6:15:11 AM UTC-0800
- Device Time: 1/9/2020, 8:11:08 AM UTC-0800

Main Content Area (Right):

Outlet Group 1 - Test [On] [Off] [Cycle] [Settings]

Outlets Table:

#	PDU	Outlet	Status	Active Power
1	My PDU (1)	Outlet 9	on	0 W
2	My PDU (1)	Outlet 12	on	0 W
3	My PDU (2)	Outlet 12	on	0 W

Sensors Table:

Sensor	Value	State
Active Power	0 W	normal
Active Energy	0 Wh	normal

Settings: Name: Test [Edit Settings]

Reset energy counter [Reset]

Sensor History: Graph showing Active Power (0.0 W) over time from 6:17 AM to 8:11 AM.

Thresholds: [Expandable section]

▶ **To add an outlet group:**

1. On the Outlet Groups page, click **+ Add group**. The New Outlet Group page displays, defaulting to the outlets in the master unit.

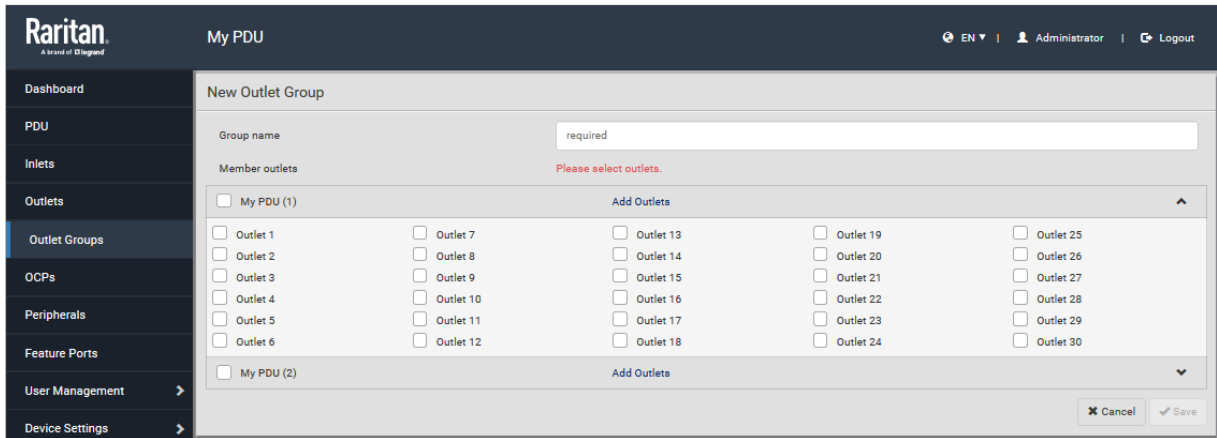

2. Type a name for the new outlet group.
3. Select individual member outlets for the master as shown in the default page, or to select all outlets for the master, select My PDU (1).
4. To select individual member outlets for the link unit My PDU (2), click Add Outlets. To select all outlets for the link unit, select My PDU (2). Note: Link units have to be selected by name to display their outlets.
5. Click Save.

The following example shows the outlet group named "TEST 1" with all outlet members selected for the master unit and outlet members 1-6 selected for the link unit.

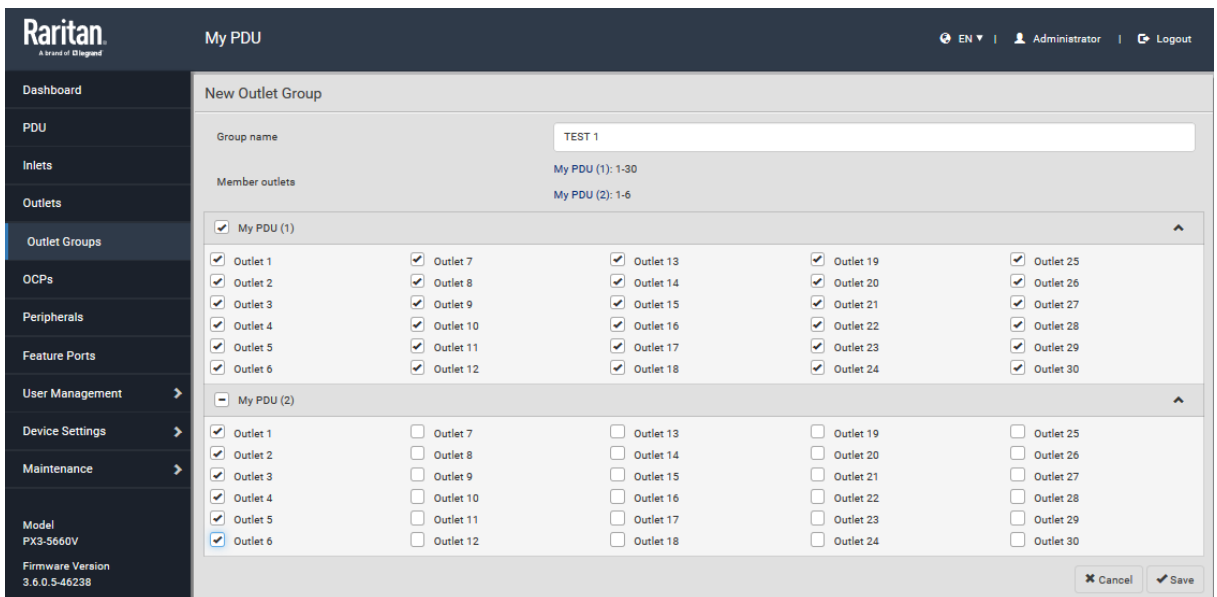

Controlling Outlets in Groups

1. From the Outlet Groups page, select an outlet group by name.
2. Click the desired control: On, Off, or Cycle. This example shows three outlets in status On. When Off is clicked, a prompt appears to confirm applying the action to all outlets in the group.
3. Click the Switch button.

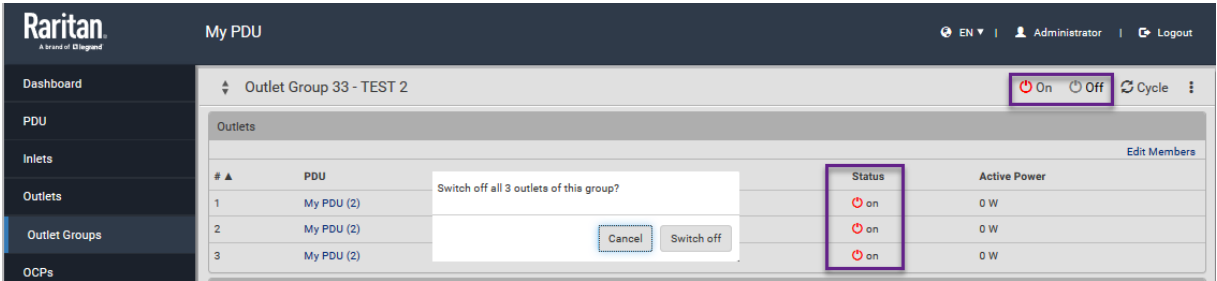

4. The status of the outlets in the group appears on the Outlets Group page as Off.



Pairwise Outlet Groups

The PDU Linking feature offers the "pairwise" functionality for outlet grouping. Pairwise lets you create auto-named pairs of outlet groups that span multiple PDUs (master and link units) using the same outlet label. Pairwise simplifies outlet switching up or down a server by automatically creating multiple outlet groups, each containing one pair of outlets between PDUs that can be controlled as a pair-related outlet group.

Example: Chain with master and a single link unit

PDU 1 (Master Unit)	Server Load	PDU 2 (Link Unit)
Outlet 1	Server 1	Outlet 1
Outlet 2	Server 2	Outlet 2
Outlet 3	Server 3	Outlet 3
...
Outlet 20	Server 20	Outlet 20

Using the above example, to power up or down a server, you would typically switch one outlet of PDU 1 and one outlet of PDU 2. With pairwise, you can auto-create an outlet group named "Outlet pair 3", and the new group will automatically contain Outlet 3 from PDU 1 (master) and Outlet 3 from PDU 2 (link). Powering up or down the server only requires switching the "Outlet pair 3" outlet group, allowing for improved accuracy and speed over outlet control.

Automatically Create Pairwise Outlet Groups

1. From the Outlet Groups page, from the drop-down menu  select Automatic Creation.

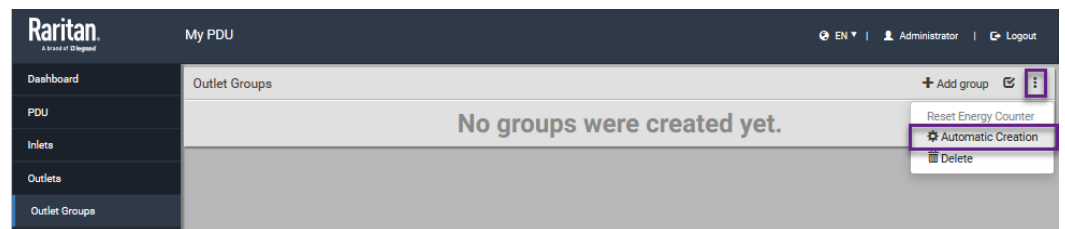

2. Confirm the pairwise creation.

Pairwise Outlet Group Creation

Create outlet groups that contain pairs of outlets with the same label.

Pairwise outlet groups will be created for My PDU (1) and My PDU (2).

3. Pairwise outlet groups are created and named automatically for all outlets on the master and link unit, such as "Outlet pair 1", "Outlet pair 2", "Outlet pair 3", etc.

<input type="checkbox"/>	#	Name	Outlet State	Active Power	Outlets
<input type="checkbox"/>	1	Outlet pair 1	2 on	0 W	PDU 1:1 PDU 2:1
<input type="checkbox"/>	2	Outlet pair 2	2 on	0 W	PDU 1:2 PDU 2:2
<input type="checkbox"/>	3	Outlet pair 3	2 on	0 W	PDU 1:3 PDU 2:3
<input type="checkbox"/>	4	Outlet pair 4	2 on	0 W	PDU 1:4 PDU 2:4
<input type="checkbox"/>	5	Outlet pair 5	2 on	0 W	PDU 1:5 PDU 2:5
<input type="checkbox"/>	6	Outlet pair 6	2 on	0 W	PDU 1:6 PDU 2:6
<input type="checkbox"/>	7	Outlet pair 7	2 on	0 W	PDU 1:7 PDU 2:7
<input type="checkbox"/>	8	Outlet pair 8	2 on	0 W	PDU 1:8 PDU 2:8
<input type="checkbox"/>	9	Outlet pair 9	2 on	0 W	PDU 1:9 PDU 2:9
<input type="checkbox"/>	10	Outlet pair 10	2 on	0 W	PDU 1:10 PDU 2:10
<input type="checkbox"/>	11	Outlet pair 11	2 on	0 W	PDU 1:11 PDU 2:11
<input type="checkbox"/>	12	Outlet pair 12	2 on	0 W	PDU 1:12 PDU 2:12
<input type="checkbox"/>	13	Outlet pair 13	2 on	0 W	PDU 1:13 PDU 2:13
<input type="checkbox"/>	14	Outlet pair 14	2 on	0 W	PDU 1:14 PDU 2:14
<input type="checkbox"/>	15	Outlet pair 15	2 on	0 W	PDU 1:15 PDU 2:15

OCPs Page

Overcurrent protectors from both master and link PDUs are displayed together on the same OCPs page. If sensors are present on the units, sensor data for both master and link units will also appear on the page.

The screenshot shows the 'My PDU' interface with the 'Overcurrent Protectors' page selected. The table lists six protectors, with the first three associated with 'My PDU (1)' and the last three with 'My PDU (2)'. Each entry includes its ID, name, status (all 'closed'), current drawn (0.000 A / 20 A), protected outlets, and lines.

#	Name	PDU	Status	Current Drawn	Protected Outlets	Lines
1	Overcurrent Protector C1	My PDU (1)	closed	0.000 A / 20 A	1-10	L1-L2
2	Overcurrent Protector C2	My PDU (1)	closed	0.000 A / 20 A	11-20	L2-L3
3	Overcurrent Protector C3	My PDU (1)	closed	0.000 A / 20 A	21-30	L3-L1
4	Overcurrent Protector C1	My PDU (2)	closed	0.000 A / 20 A	1-10	L1-L2
5	Overcurrent Protector C2	My PDU (2)	closed	0.000 A / 20 A	11-20	L2-L3
6	Overcurrent Protector C3	My PDU (2)	closed	0.000 A / 20 A	21-30	L3-L1

Peripherals Page

The Peripherals Page shows peripheral devices connected to the master or link unit.

The screenshot shows the 'My PDU (1) Peripheral Devices' page. The table lists 26 devices with columns for ID, Name, Reading, State, Type, Serial Number, Position, and Actuator. A green box highlights rows 5 through 9, which are On/Off devices.

#	Name	Reading	State	Type	Serial Number	Position	Actuator
1	Temperature 1	24.0 °C	normal	Temperature	QMSemu0004	Port 1, Chain position 4	
2	Relative Humidity 1	42 %	normal	Humidity	QMSemu0004	Port 1, Chain position 4	
3	Temperature 2	24.0 °C	normal	Temperature	QMTemu0005	Port 1, Chain position 5	
4	Hall Effect 1		normal	Magnetic Contact	QLLemu0001	Port 1, Chain position 1	
5	On/Off 1		normal	Contact Closure	QLLemu0001	Port 1, Chain position 1, Channel 1	
6	On/Off 2		normal	Contact Closure	QLLemu0001	Port 1, Chain position 1, Channel 2	
7	On/Off 3		normal	Contact Closure	QLLemu0001	Port 1, Chain position 1, Channel 3	
8	On/Off 4		normal	Contact Closure	QLLemu0001	Port 1, Chain position 1, Channel 4	
9	On/Off 5		normal	Contact Closure	QLLemu0001	Port 1, Chain position 1, Channel 5	
10	Dry Contact 1		off	Dry Contact	QLLemu0001	Port 1, Chain position 1, Channel 1	✓
11	Dry Contact 2		off	Dry Contact	QLLemu0001	Port 1, Chain position 1, Channel 2	✓
12	On/Off 6		normal	Contact Closure	QU7emu0003	Port 1, Chain position 3, Channel 1	
13	On/Off 7		normal	Contact Closure	QU7emu0003	Port 1, Chain position 3, Channel 2	
14	On/Off 8		normal	Contact Closure	QU7emu0003	Port 1, Chain position 3, Channel 3	
15	On/Off 9		normal	Contact Closure	QU7emu0003	Port 1, Chain position 3, Channel 4	
16	On/Off 10		normal	Contact Closure	QU7emu0003	Port 1, Chain position 3, Channel 5	
17	Powered Dry Contact 1		off	Powered Dry Contact	QU7emu0003	Port 1, Chain position 3, Channel 1	✓
18	Powered Dry Contact 2		off	Powered Dry Contact	QU7emu0003	Port 1, Chain position 3, Channel 2	✓
19	Hall Effect 2		normal	Magnetic Contact	QLLemu0002	Port 1, Chain position 2	
20	On/Off 11		normal	Contact Closure	QLLemu0002	Port 1, Chain position 2, Channel 1	
21	On/Off 12		normal	Contact Closure	QLLemu0002	Port 1, Chain position 2, Channel 2	
22	On/Off 13		normal	Contact Closure	QLLemu0002	Port 1, Chain position 2, Channel 3	
23	On/Off 14		normal	Contact Closure	QLLemu0002	Port 1, Chain position 2, Channel 4	
24	On/Off 15		normal	Contact Closure	QLLemu0002	Port 1, Chain position 2, Channel 5	
25	Dry Contact 3		off	Dry Contact	QLLemu0002	Port 1, Chain position 2, Channel 1	✓
26	Dry Contact 4		off	Dry Contact	QLLemu0002	Port 1, Chain position 2, Channel 2	✓
			unmanaged	Absolute Humidity	QMSemu0004	Port 1, Chain position 4	

Feature Ports Page

The Feature Ports Page can display device Asset Strip information and the Switch PDU control is available for the data from both the master and link units.

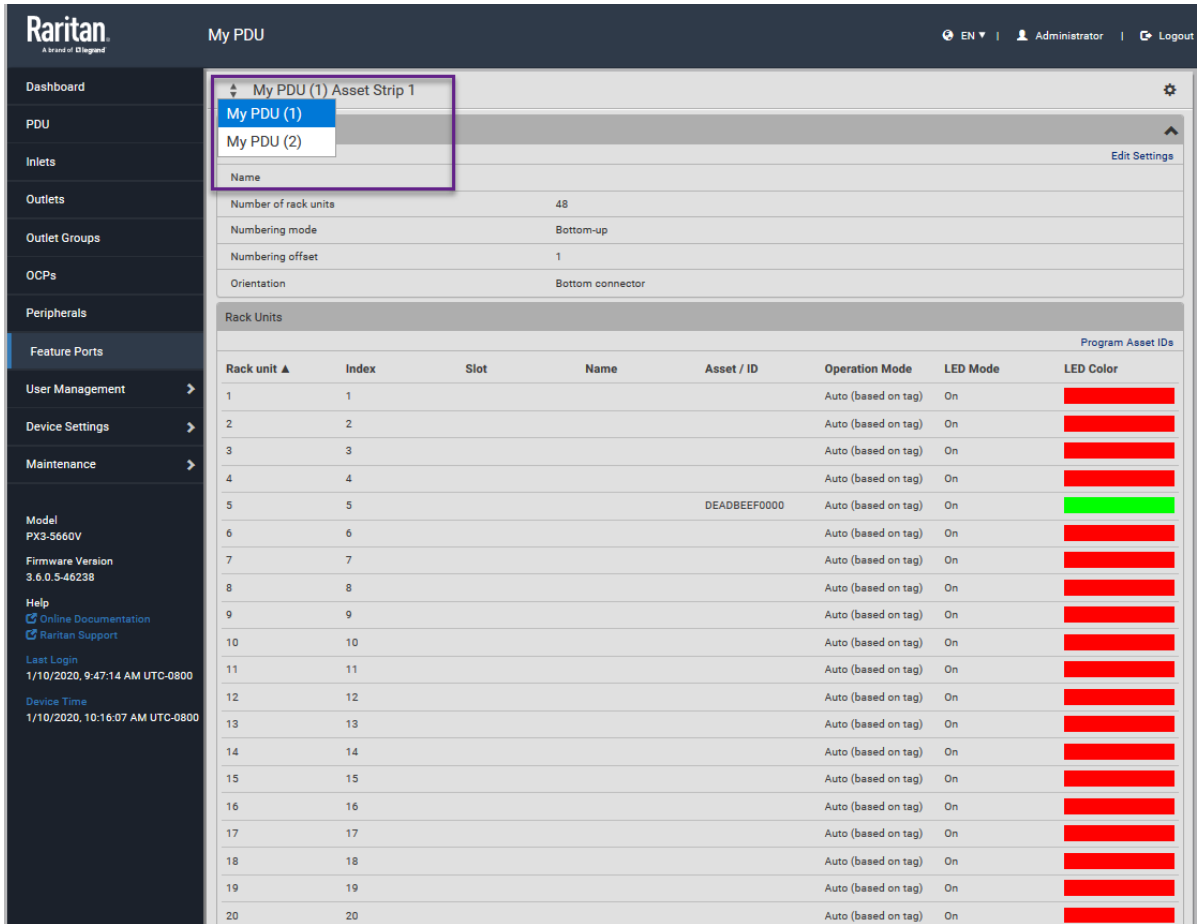

Displays for Master and Link Units

Each unit in a PDU Linking chain displays its own PDU data (inlets, outlets, sensors, alerts, etc.)

► **Master unit:**

From the following example of the master unit display, navigate the options for displaying Link PDU identification and status, and to confirm the master unit that is controlling the link unit in the chain.

1. Can show alarms, which may be triggered by link units.

2. PDU information shows a list of link units with host name/IP address, model, device name, serial number, firmware version, and communication status.

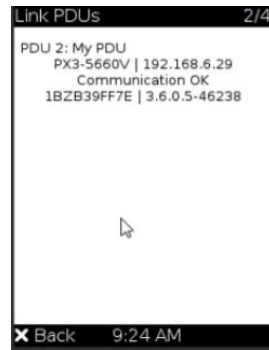

▶ **Link units:**

1. No display of alarms (no event engine on link units)
2. PDU information shows the master IP address

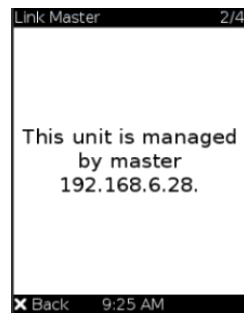

PDU Linking in the CLI

For each PDU in a chain, you can list the PDUs, switch a PDU, add a new link PDU, and release a link PDU. You can then use all regular PDU-related commands as usual to access and control individual units, as with any standalone PDU.

The CLI is disabled on link units. Access to the link unit via the CLI is available only through the master CLI.

If any link units are configured, the CLI prompt includes the currently selected PDU and Link ID, such as My Pdu (1) or My Pdu (2).

Some commands are not available for link units:

- Authentication settings
- EnergyWise settings
- Security settings (login, role-based access control, user blocking, and strong passwords.)
- Server monitor
- User management

PDU Linking CLI Commands

▶ PDU List

Displays the following information for each unit:

- Link ID
- Communication status (for link unit only)
- Device name
- Model name
- Serial number
- Firmware version

pdu list

▶ Switch PDU

Switch between the master and link units. The Link ID must be PDU 1 (master) or PDUs 2-8 (link units).

pdu [id]

▶ Add a New Link PDU

Add a link unit to a master unit. Only available when PDU 1 (master) is selected. The command can be used to re-establish a connection to an existing link unit if the Link ID and host match exactly. The command requires admin privileges and prompts for the user's password.

pdu link [id] [host] [login]

- id: New link ID (PDUs 2-8)
- host: Host name or IP address
- login: Name of user with admin privileges

▶ Release a Link PDU

Release a link unit from a chain until the unit becomes standalone. The master unit does not have access to a released link unit. The command is only available when PDU 1 (master) is selected. The command requires admin privileges, and prompts for confirmation unless the "/y" is specified.

pdu release [id] {/y}

- id: Link ID of the unit to be released (PDUs 2-8).

Chapter 6 Introduction to PDU Components

This chapter explains how to use the PX3 device, including:

- Introduction to the LEDs and ports on the PDU
- Operation of the front panel display
- The overcurrent protector's behavior
- The internal beeper's behavior
- The reset button

In This Chapter

Panel Components	114
Circuit Breakers	162
Fuse	164
Beeper	167
Replaceable Controller	168
Threaded Grounding Point	169

Panel Components

PX3 comes in Zero U, 1U, and 2U sizes. All types of models come with the following components on the outer panels.

- Inlet
- Outlets
- Connection ports
- Dot-matrix LCD display
- Reset button

Connection ports, the LCD display and reset button are located on a replaceable controller of the PX3 model. See **Replaceable Controller** (on page 168).

Inlet

Most of PX3 PDUs are shipped with a locking line cord, which is ready to be plugged into the PDU's inlet and an appropriate receptacle for electricity reception. Such devices cannot be rewired by the user.

A locking line cord helps secure the cord connection. For details, see **Connecting a PX3 Locking Line Cord** (on page 13).

Connect each PX3 to an appropriately rated branch circuit. Refer to the label or nameplate affixed to your PX3 for appropriate input ratings or range of ratings.

There is no power switch on the PX3. To power cycle the PDU, unplug it from the branch circuit, wait 10 seconds and then plug it back in.

Besides, a PX3 "Zero U" model supports a relocatable inlet. See **Zero U Models' Relocatable Inlet** (on page 115).

Zero U Models' Relocatable Inlet

You can easily change the inlet's location from the side to the top or from the top to the side on a Zero U model.

► To change a PX3 inlet's position:

1. Power OFF the PDU.
2. Remove the screws at two sides of the inlet to uninstall the inlet module.
3. Re-install the inlet module in a manner that the inlet is located at the desired position.

Inlet on the side

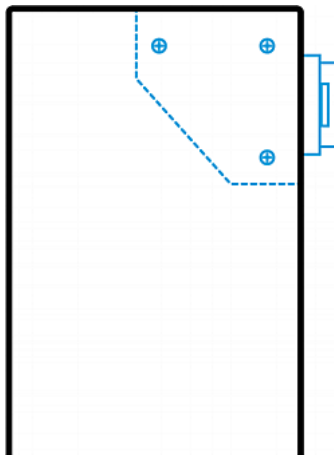

Inlet on the top

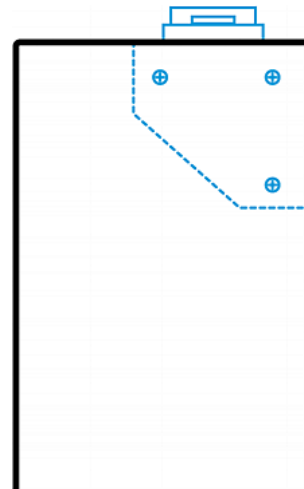

Outlets

The total number of outlets varies from model to model.

PX3-3000 Series

These models are NOT outlet-switching capable so all outlets are always in the ON state.

Outlet LEDs are not available.

PX3-4000 Series

These models are NOT outlet-switching capable so all outlets are always in the ON state.

A small LED adjacent to each outlet indicates the outlet state. Outlet LEDs always light red, indicating that the outlet power is ON.

PX3-5000 Series

These models are outlet-switching capable. A small LED adjacent to each outlet indicates the outlet or PDU state. The PDU is shipped from the factory with all outlets turned ON.

The table below explains how to interpret different outlet LED states.

LED state	Outlet status	What it means
Not lit	Powered OFF	The outlet is turned off and no power is available. OR the control circuitry's power supply is broken.
Red	ON and LIVE	LIVE power. The outlet is on and power is available.
Red flashing	ON and LIVE	The current flowing through the outlet is greater than the upper warning (non-critical) threshold.
Green	OFF and LIVE	The outlet is turned off and power is available when the outlet is turned on.
Green flashing	OFF and NOT LIVE	The outlet is turned off and power is not available. For example, a circuit breaker has tripped or a phase fails on a three-phase model.
Red and Green flashing alternatively	ON and NOT LIVE	The outlet is turned on but power is not available. For example, a circuit breaker has tripped or a phase fails on a three-phase model.
Cycling through Red, Green and Yellow	n/a	The PX3 device has just been plugged in and its management software is loading. LED color cycling does not interrupt power to outlets. It is an indication of firmware loading.

Note: When a PX3 powers up, it proceeds with the power-on self test and software loading for a few moments. At this time, the outlet LEDs cycle through different colors. When the software has completed loading, the outlet LEDs show a steady color and the front panel display illuminates.

Connection Ports

Depending on the model you purchased, the total number of ports available varies.

Zero U Connection Ports

A PX3 has 9 connection ports. Depending on the model you purchased, port locations on your models may be different from the following image.

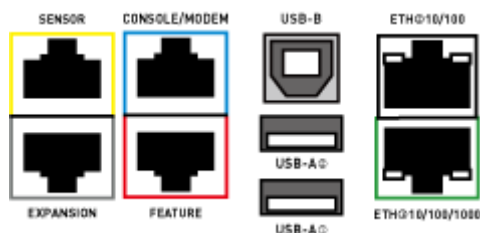

- CONSOLE/MODEM port x 1 (blue)
- Sensor port x 1 (yellow)
- USB-A port x 2
- USB-B port x 1
- Feature port x 1 (red)
- Ethernet port x 2 (green and white)

Note: ETH1 supports up to 1000 Mbps. This is "ETH1". ETH2 supports up to 100 Mbps. This is "ETH2".

- Expansion port x 1 (gray)

1U and 2U Port Locations

The difference between Zero U, 1U and 2U models is that Zero U models have all the connection ports located on the front panel while most of the 1U and 2U models have the ports located respectively on the front and back panels.

Connection Port Functions

The table below explains the function of each port.

Port	Used for...
USB-B	<ul style="list-style-type: none"> • Cascading PX3 devices for sharing a network connection. See Cascading All Devices via USB (on page 35). • Establishing a USB connection between a computer and the PX3 for: <ul style="list-style-type: none"> ▪ Using the command line interface. ▪ Performing the disaster recovery. Contact Raritan Technical Support for instructions. • Connecting to an Android mobile device for viewing or configuring the PX3. <ul style="list-style-type: none"> ▪ See Connecting a Mobile Device to PX3 (on page 24).
USB-A	<p>This is a "host" port, which is powered, per USB 2.0 specifications.</p> <ul style="list-style-type: none"> • Connecting to an iOS mobile device for viewing or configuring the PX3. See Connecting a Mobile Device to PX3 (on page 24). • Connecting a USB device, such as a Logitech® webcam or wireless LAN adapter. • Cascading PX3 devices for sharing a network connection.
FEATURE	<p>Connection to one of the following devices:</p> <ul style="list-style-type: none"> ▪ A Raritan access product, such as Dominion KX III KVM switch, with the use of a power CIM. ▪ A Schroff® LHX-20, SHX-30 or LHX-40 device, using an RJ-45 to RS-232 cable provided by Schroff. ▪ An external beeper with the RJ-45 socket. ▪ A Raritan asset management strip, which allows you to track the locations of IT devices on the rack. <p>See Connecting External Equipment (Optional) (on page 47).</p> <p style="background-color: #f0f0f0; padding: 5px;">Warning: This is not an RS-232 port so do NOT plug in an RS-232 device, or damages can be caused to the device.</p>
CONSOLE/ MODEM (RJ-45)	<p>Establishing a serial connection between the PX3 and a computer or modem. You need a third-party RJ-45 to DB9 adapter/cable for the connection(s). Note that the RJ-45 to DB9 adapter/cable for connecting a computer is different from the one for connecting a modem. For details, refer to:</p> <ul style="list-style-type: none"> ▪ RJ45-to-DB9 Cable Requirements for Computer Connections (on page 31) ▪ RJ45-to-DB9 Cable Requirements for Modem Connections (on page 874)
SENSOR (RJ-45)	<p>Connection to one of the following devices:</p> <ul style="list-style-type: none"> ▪ Raritan's environmental sensor package(s). ▪ Raritan's sensor hub, which expands the number of a sensor port to four ports.

Port	Used for...
ETH①10/100/1000, ETH②10/100	<p>PX3 has two Ethernet ports.</p> <ul style="list-style-type: none"> ▪ ETH①10/100/1000 (marked in <i>green</i>) supports up to 1000 Mbps. This is "ETH1". ▪ ETH②10/100 (marked in <i>white</i>) supports up to 100 Mbps. This is "ETH2". <p>Connecting the PX3 to your company's network via a standard network patch cable (Cat5e/6). This connection is necessary to administer or access the PX3 remotely.</p> <p>There are two small LEDs adjacent to the port:</p> <ul style="list-style-type: none"> ▪ Green indicates a physical link and activity. ▪ Yellow indicates communications at 10/100 BaseT speeds. <p>Note that the yellow LED of the ETH②10/100 port has NO function so it will not be lit regardless of the communication status.</p> <p>You can use either Ethernet port for network connection or cascading. See Extended Cascading with PX3 Devices (on page 37).</p> <hr/> <p><i>Note: Network connection to this port is not required if wireless connection is preferred, or if the PX3 is a slave device in the cascading configuration.</i></p>
EXPANSION	<p>Connecting to the EXPANSION port of another PX3 so that the power supply to either PX3 controller will continue whenever power failure occurs on the inlet of one PX3 PDU.</p> <ul style="list-style-type: none"> ▪ See Power-Sharing Restrictions and Connection (on page 42).

Dot-Matrix LCD Display

The following diagram shows the dot-matrix LCD display panel on Zero U models.



You can use the LCD display to view the PDU information and even switch an outlet. It consists of:

- A dot-matrix LCD display
- Four control buttons

Zero U models automatically adjust the orientation of the content shown on the dot-matrix LCD display after detecting the direction in which the PDU is installed. 1U and 2U models do NOT adjust the content's orientation.

If the orientation of your Zero U model's LCD content does not meet your need, you can manually change it and stick to the orientation. See **Manually Changing PX3's Zero U LCD Orientation** (on page 157).

Note 1: All dot-matrix LCD display diagrams illustrated in the User Guide are for Zero U models. Your dot-matrix LCD may look slightly different if it is on a 1U/2U model.

*Note 2: For information on LCD displays of old PX3 models, see **Old Generations of PX3 Models** (on page 804).*

Automatic and Manual Modes

After powering on or resetting the PX3, the front panel LCD display first shows some dots, then Raritan logo and finally enters the automatic mode.

▶ Automatic mode without alerts available:



In this mode, the LCD display cycles through the inlet information as long as there are no alerts.

If overcurrent protectors are available on your PX3, the display cycles between both the inlet and overcurrent protector information.

*Note: You can make a PX3 with overcurrent protectors show the inlet information only in the automatic mode. See **Front Panel Settings** (on page 445).*

▶ Manual mode:

To view more information or control outlets if your PX3 is outlet-switching capable, enter the manual mode.

Press  or  to enter the manual mode, where the Main Menu is first displayed. See **Main Menu** (on page 124).

To return to the automatic mode, press  once or multiple times.

▶ When an alert exists:





- In the automatic mode, when an alert occurs, the LCD display stops cycling through information, and warns you by showing the alerts notice in a yellow or red background. See **Alerts Notice in a Yellow or Red Screen** (on page 158).

To enter the manual mode, press .

- In the manual mode, both the top and bottom bars will turn yellow or red to indicate the presence of any alert. See **Operating the Dot-Matrix LCD Display** (on page 123).

Control Buttons

Use the control buttons to navigate to the menu in the manual mode.

Button	Function
	Up
	Down
	OK
	Back -- OR -- Switch between automatic and manual modes

Operating the Dot-Matrix LCD Display

Enter manual mode when you want to operate the dot-matrix LCD display. You can use the dot-matrix LCD display to:

- Show information of the PX3, built-in components, or connected peripheral devices
- Control actuators if any
- Control outlets if your model supports outlet-switching

▶ **Color changes of the display's top and bottom bars:**

- In the manual mode, both the top and bottom bars will turn yellow or red to indicate the presence of any alert. For color definitions, see **Yellow- or Red-Highlighted Sensors** (on page 255).

Screen with yellow bars	Screen with red bars
All alerts enter the warning level only.	Partial or all alerts enter the critical level.

- Both bars turn black when there are NO alerts.

Screen with black bars

Main Menu

The Main Menu contains 8 to 10 menu commands, depending on the model. Control buttons that can be used and the system time are shown at the bottom of the LCD display.

The currently-selected item's number and total of menu items are indicated in the top-right corner of the display.

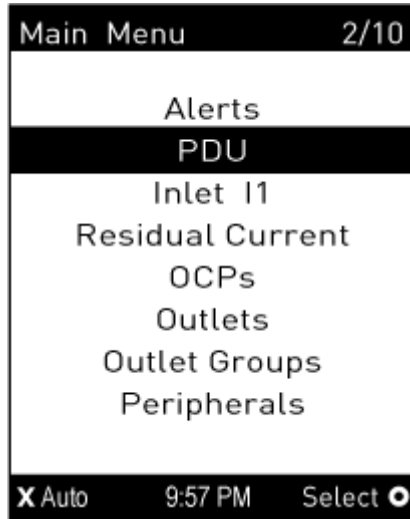

If any alerts exist, the top and bottom bars on the LCD display change the color from black to yellow or red. See **Operating the Dot-Matrix LCD Display** (on page 123).

Menu command	Function
Alerts	Indicates all alerted sensors, if any. See Alerts (on page 126).
PDU	Shows the internal beeper's state, and, if it is on, the reason for turning on. If your PDU has multiple inlets, this menu item also shows the total active power and total active energy. See PDU (on page 128).
Inlet I1	Shows the inlet I1's information. See Inlet (on page 132).
Residual Current	Available only on PX3 models supporting residual current monitoring. See Front Panel Operations for RCM (on page 796).
OCPs	Shows a list of overcurrent protector information. See OCPs (on page 133). Only the models with overcurrent protectors have this menu item.
Outlets	Shows each outlet's information. If your PDU supports outlet-switching, you can turn on, off or power cycle an outlet. See Outlets (on page 134).
Outlet Groups	Show each outlet group's information. If your PX3 supports outlet-switching, you can turn on, off or power cycle an outlet group. See Outlet Groups (on page 140).
Peripherals	Shows the information of connected Raritan environmental sensors or actuators, such as the temperature sensor. You can turn on or off a connected actuator with this command. See Peripherals (on page 145).
Assets	Shows the asset management information if Raritan asset management equipment is connected to your PX3. See Assets (on page 149).
Device Info	Shows the device information, such as IP and MAC address. See Device Info (on page 152).

Note: To return to the automatic mode, press . See **Automatic and Manual Modes** (on page 121).

Alerts



The "Alerts" menu command shows a list of the following alerted sensors, including both internal and external sensors.

- Any numeric sensor that enters the warning or critical range if the thresholds have been enabled
- State sensors that enter the alarmed state
- Any tripped circuit breakers or blown fuses

*Tip: The same information is available in the web interface's Dashboard. See **Dashboard - Alerted Sensors** (on page 188).*

If there are no alerted sensors, the LCD display shows the message "No Alerts."

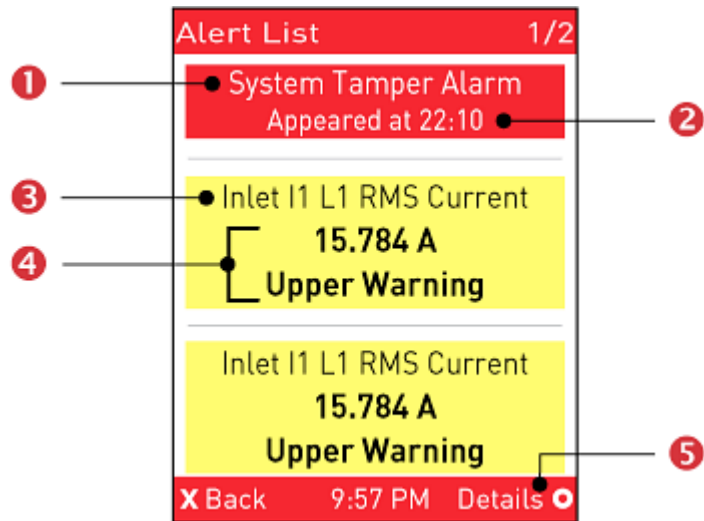

► **To view alerted sensors:**

1. Press  or  to select "Alerts" in the Main Menu, and press .
2. Alerted sensors, if any, are highlighted in either red or yellow. For color definitions, see **Yellow- or Red-Highlighted Sensors** (on page 255).
 - The top and bottom bars on the LCD display may be yellow or red, depending on the type(s) of available alerts. See **Operating the Dot-Matrix LCD Display** (on page 123).







Number	Description
1	Alarm names.

Number	Description
2	<p>The time the alarm occurred.</p> <p>If the alarm occurred at least two times, then more information is shown.</p> <ul style="list-style-type: none"> ▪ Number of alarms ▪ The first occurrence time ▪ The last occurrence time
3	Alerted sensor names.
4	<p>Sensor readings and/or states.</p> <p>A numeric sensor shows both the reading and state. A state sensor or actuator shows the state only.</p> <p>Available states are listed below. For further information, see Sensor/Actuator States (on page 258).</p> <ul style="list-style-type: none"> ▪ Alarmed ▪ Lower Critical = below lower critical ▪ Lower Warning = below lower warning ▪ Upper Warning = above upper warning ▪ Upper Critical = above upper critical ▪ Open (only available for Raritan PDUs with overcurrent protectors)
5	<p>The 'Details' command appears for alarms only.</p> <ul style="list-style-type: none"> ▪ If your Alert List comprises alerted sensors only, then 'Details' is not shown.

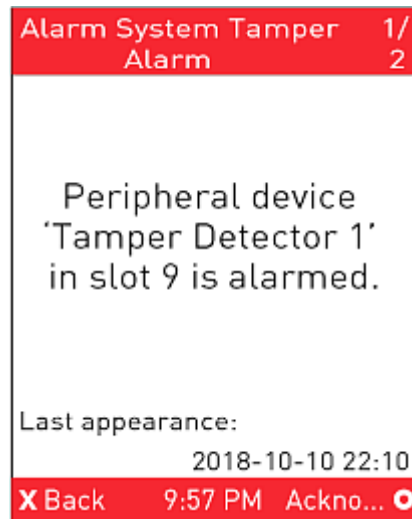
3. Press  or  to view additional pages. When there are multiple pages, page numbers appear in the top-right corner of the display.
4. (Optional) If there are alarms in the Alert List, you can perform the following operations.

- a. Press  to view detailed information of the alarm.



- b. (Optional) If the alarm occurred more than one time, the numbers of current page and total pages are shown in the top-right corner, similar to the above diagram. Press  or  to view the information of other occurrences.
- c. To acknowledge all alarms now, press .



PDU

Depending on the model you purchased, the "PDU" menu command may show one or all of the following data.

- Internal beeper states -- Active or Off
- Total active power of the PX3 -- available on multi-inlet models and in-line monitors only
- Total active energy of the PX3 -- available on multi-inlet models and in-line monitors only
- Energy pulse output settings -- available on PX3-4000 and PX3-5000 series only
- 12V power supply status

*Tip: The internal beeper state information is also available in the PX3 web interface. See **PDU** (on page 194).*

▶ To view or configure PDU information:

1. Press  or  to select "PDU" in the Main Menu, and press .
2. The internal beeper state is shown: Active or Off.



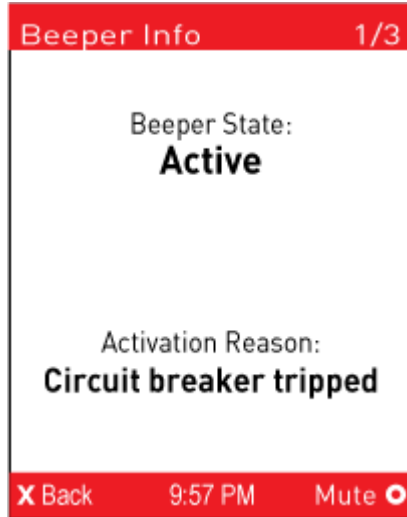

- In the Active state, the reason of turning on the beeper is indicated, and the top/bottom bars turn red.
- To mute the beep sound immediately, press . See **Muting the Internal Beeper** (on page 131).

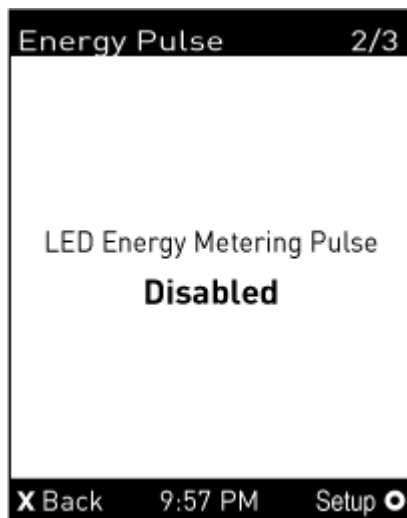

3. If your PX3 is a PX3-4000 or PX3-5000 model, it supports the active energy pulse output. Press  to enter the Energy Pulse page. By default the energy pulsing is turned off. DO NOT enable this feature unless you have to use it.

Note: This feature, once enabled, blink all outlet LEDs proportional to the energy consumption. It can be used as a simple interface in certification labs where they use an optical sensor to count the number of pulses and compare it to the energy reading of a reference meter.



- a. To change the energy pulse settings, press .
- b. Press  or  to select an option.
- c. Press  to confirm the selection, or  to cancel.

Note: All outlet LEDs on the PX3 turn OFF after enabling the energy pulsing. You still can turn on or off outlets during the pulsing period though outlet LEDs do not change their status.

4. Press  to show the status of the 12V power supply to the controller. For details on this sensor, see **+12V Power Supply Sensor** (on page 201).

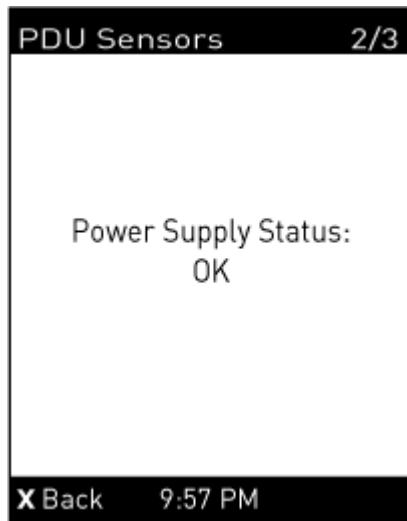

5. If your PX3 has more than one inlet, press  to show the information of total active power (W) and total active energy (Wh).

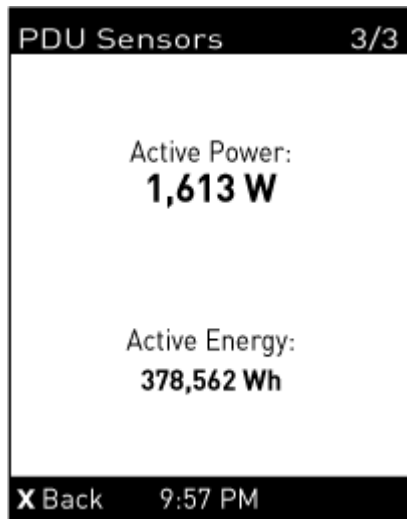

6. To return to the Main Menu, press .

Muting the Internal Beeper

After enabling the internal beeper's mute control function, you can choose to mute the beeper via the front panel whenever the beeper sounds for an alarm. By default, the beeper's mute control feature via front panel is enabled.

*Tip: To disable this feature, see **Front Panel Settings** (on page 445).*

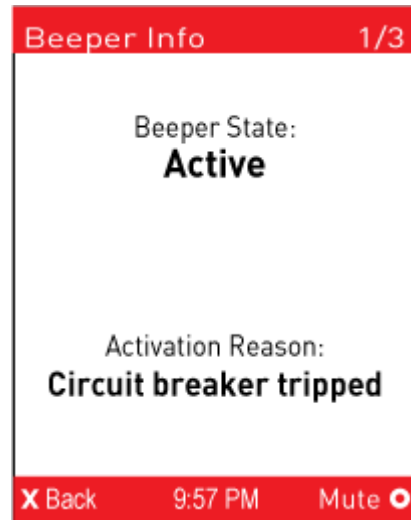

► To mute the internal beeper during an alarm:

1. Press  or  to select "PDU" in the Main Menu, and press .



2. Press . A confirmation message appears.



3. Press  to select Yes and then press .
4. The beeper stops beeping, and the Beeper State shows "Active (Muted)".

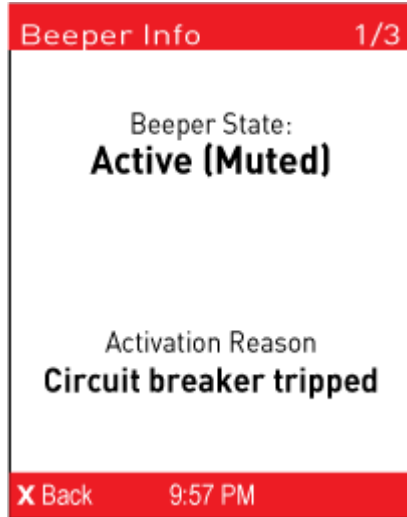



Note that the alarmed state remains unchanged yet for the moment.



Inlet

An inlet's information is divided into two pages. Page numbers are indicated in the top-right corner of the LCD display.

► To show the inlet information:

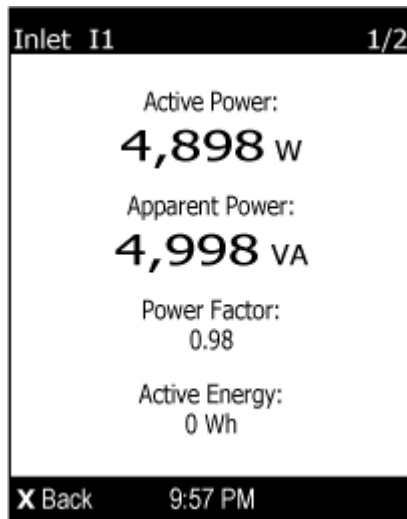
1. Press  or  to select "Inlet I1" in the Main Menu, and press .
2. The first page shows the inlet's active power (W), apparent power (VA), power factor (PF), and active energy (Wh).



3. To go to other page(s), press  or .
- For a single-phase model, the second page shows the inlet's voltage (V), frequency (Hz) and current (A).

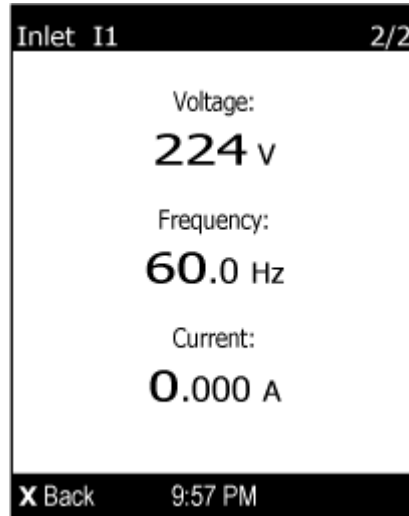

- For a three-phase model, the next several pages respectively show unbalanced current's percentage, line frequency, and the current and voltage values of each line.
4. To return to the Main Menu, press .

OCPs

If your model has more overcurrent protectors (OCPs) than the LCD display can show at a time, a page number appears in the top-right corner of the display. Otherwise, no page numbers are available.



▶ To show the overcurrent protector information:

1. Press  or  to select "OCPs" in the Main Menu, and press .

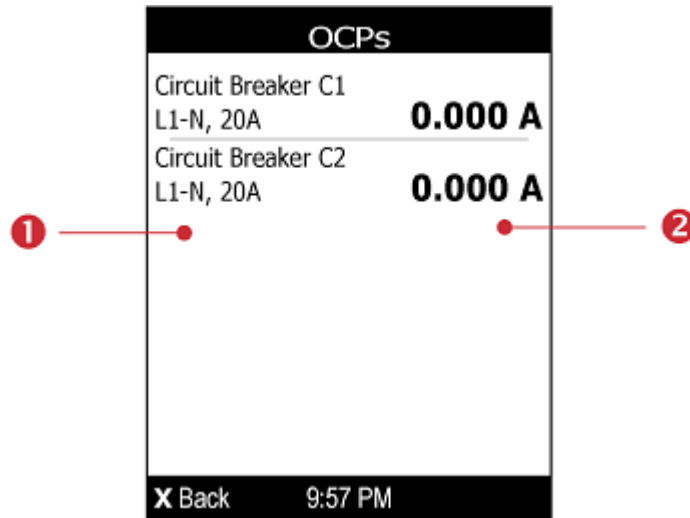
- The LCD display shows a list of overcurrent protectors similar to the following diagram.



Number	Description
①	Overcurrent protector names. Associated lines and rated current are displayed below each overcurrent protector's name.
②	Current reading of the corresponding overcurrent protector.

- If the desired overcurrent protector is not visible, press  or  to scroll up or down.

Note: If any circuit breaker trips, the list of overcurrent protectors looks slightly different from the above diagram. The tripped one will show "open" instead of a current reading.

Outlets

With the front panel display, you can do the following for outlets:



- Show each outlet's information.
- Turn on, off or power cycle an individual outlet if your PX3 is outlet-switching capable. To do this, you must first enable the front panel outlet control function. See **Front Panel Settings** (on page 445).

Showing an Outlet's Information

Multiple outlet information can be displayed on the LCD display.

Control buttons that can be used and the system time are shown at the bottom of the LCD display.





► To show an outlet's information:

1. Press  or  to select "Outlets" in the Main Menu, and press .
2. The LCD display shows a list of outlets with their receptacle types, current values (A), and power states which are indicated by the colors of circles.

The currently-selected outlet number and total of outlets are indicated in the top-right corner of the display.



- A red circle indicates that this outlet is powered on.
 - A green circle indicates that this outlet is powered off.
- If so, the word "Off" replaces the current value.

Outlets		1/8
Outlet 1 NEMA 5-20R	0.000 A	●
Outlet 2 NEMA 5-20R	0.000 A	●
Outlet 3 NEMA 5-20R	0.332 A	●
Outlet 4 NEMA 5-20R	0.000 A	●
X Back		9:57 PM Details 

3. Press  or  to select an outlet, and press .
 - If the desired outlet is not visible, press  or  to scroll up or down.
4. The LCD display shows the selected outlet's power state, active power (W), apparent power (VA), power factor (PF) and active energy (Wh).

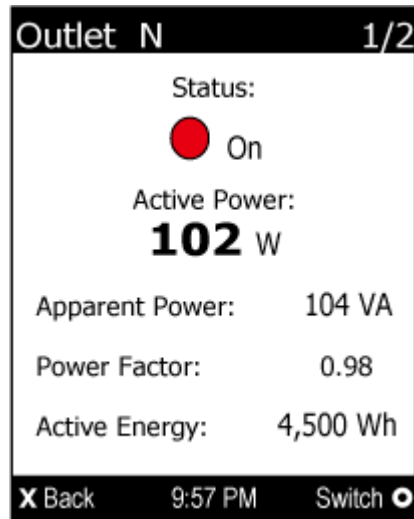
Note: In the following diagrams, N represents the selected outlet's number.



5. To go to the next page which shows the outlet's voltage (V), frequency (Hz) and current (A), press  or .

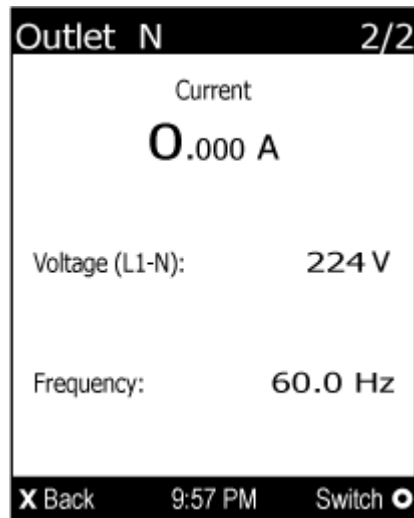

6. To return to the Main Menu, press  several times until the Main Menu is shown.

Power Control

This section applies to outlet-switching capable models only.



The front panel outlet control must be enabled for performing this power control function. The default is to disable this function. See **Front Panel Settings** (on page 445).

Available options for power control vary, based on the power state of the selected outlet.

- For an outlet which has been turned on, the 'Switch On' option is unavailable.
- For an outlet which has been turned off, the 'Switch Off' option is unavailable.

Control buttons that can be used and the system time are shown at the bottom of the LCD display.

▶ To power on, off or cycle an outlet using the LCD display:



1. Press  or  to select "Outlets" in the Main Menu, and press .
2. The LCD display shows a list of outlets with their receptacle types, current values (A), and power states which are indicated by the colors of circles.

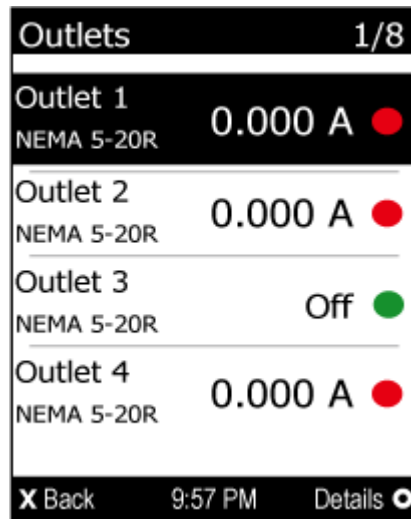

The currently-selected outlet number and total of outlets are indicated in the top-right corner of the display.

- A red circle indicates that this outlet is powered on.
- A green circle indicates that this outlet is powered off.

If so, the word "Off" replaces the current value.





3. Press  or  to select an outlet, and press .

If the desired outlet is not visible, press  or  to scroll up or down.

4. The LCD display shows the selected outlet's information. For details, see ***Showing an Outlet's Information*** (on page 135).

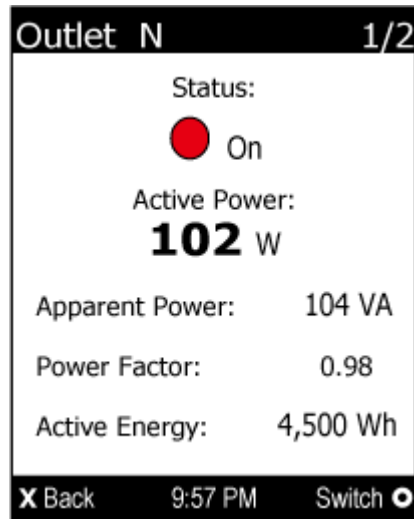
Note: In the following diagrams, N represents the selected outlet's number.







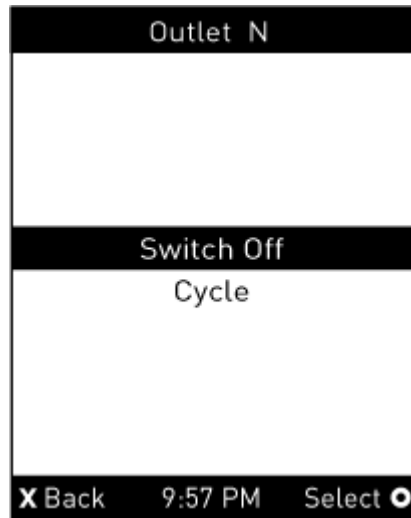

5. Press  to go to the power control page. A submenu similar to the following diagram appears.

Note: The submenu is not available when the front panel outlet control is disabled. If so, a message "Front-panel outlet control is disabled" is displayed.

- When the selected outlet has been turned off, 'Switch On' replaces the option of 'Switch Off'.



6. Press  or  to select the desired option, and press .
 - Switch Off: Turn off the outlet.
 - Switch On: Turn on the outlet.
 - Cycle: Power cycle the outlet. The outlet is turned off and then on.
7. A confirmation message appears. Press  or  to select Yes or No, and then press .
 - Yes: Confirm the operation.
 - No: Abort the operation.
8. Verify that the selected outlet is switched on or off, depending on the option you selected in the above step.
 - Check the outlet state shown on the LCD display -- red or green circles.
 - Check the outlet LED. A green LED indicates that the outlet is turned off, and a red LED indicates that the outlet is turned on.
9. To return to the Main Menu, press  several times until the Main Menu is shown.

Outlet Groups

You can do the following on the front panel display:

- Show each outlet group's information, including each member outlet of a group.
- Turn on, off or power cycle an individual outlet group if your PX3 is outlet-switching capable. To do this, you must first enable the front panel outlet control function. See **Front Panel Settings** (on page 445).



Showing an Outlet Group's Information

Only PDUs with outlet-switching and/or outlet-metering feature show this menu item.

If any outlet group has been created, the front panel then shows a list of these groups and their status. See **Creating an Outlet Group** (on page 227).



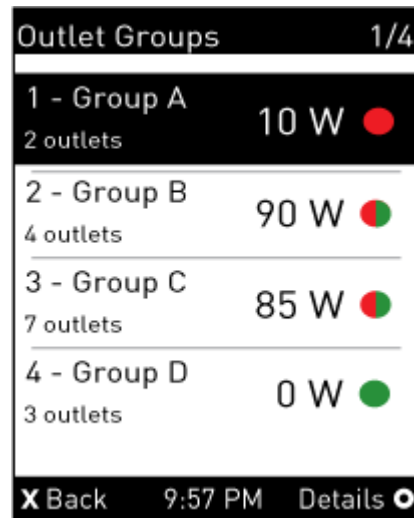

Control buttons that can be used and the system time are shown at the bottom of the LCD display.

► To show an outlet group's information:

1. Press  or  to select "Outlet Groups" in the Main Menu, and press .
2. The LCD display shows a list of outlet groups with the information below:
 - The total number of outlets in the group
 - Power states which are indicated by the colors of circles
 - Each group's active power value





The currently-selected outlet group's number and total of outlet groups are indicated in the top-right corner of the display, such as "1/4" in the above diagram.

- A red circle indicates that all outlets of the group are powered on.
 - A green circle indicates that all outlets of the group are powered off.
 - A half-red half-green circle indicates some outlets are powered on while the others of the group are powered off.
3. Press  or  to select an outlet group, and press .
 - If the desired outlet group is not visible, press  or  to scroll up or down.
 4. The LCD display shows the selected outlet group's power state, active power (W), and active energy (Wh).

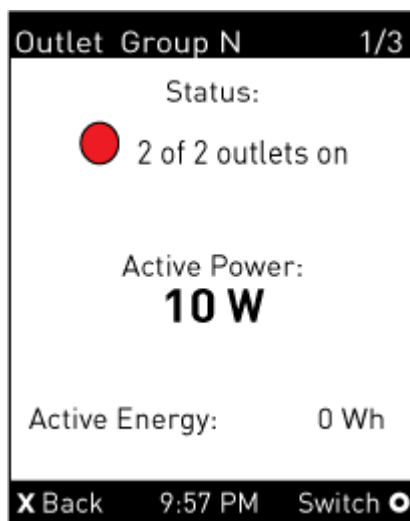
Note: In the following diagrams, N represents the selected outlet group's index number. The rightmost number in the title bar represents this group's total pages.



- To check the status of each member outlet of the group, press  or .

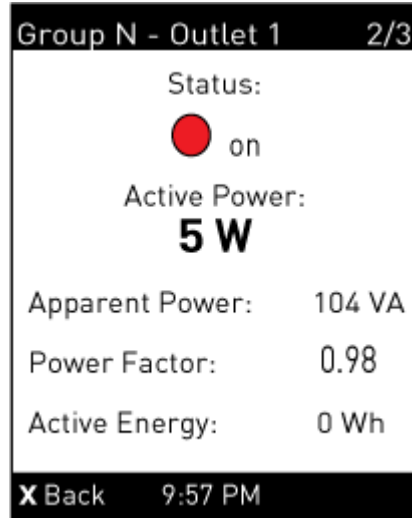

- To return to the Main Menu, press  several times until the Main Menu is shown.



Group's Power Control

This section applies to outlet-switching capable models only.

The front panel outlet control must be enabled for performing this power control function. The default is to disable this function. See **Front Panel Settings** (on page 445).

Control buttons that can be used and the system time are shown at the bottom of the LCD display.

► To power on, off or cycle an outlet group using the LCD display:



- Press  or  to select "Outlet Groups" in the Main Menu, and press .

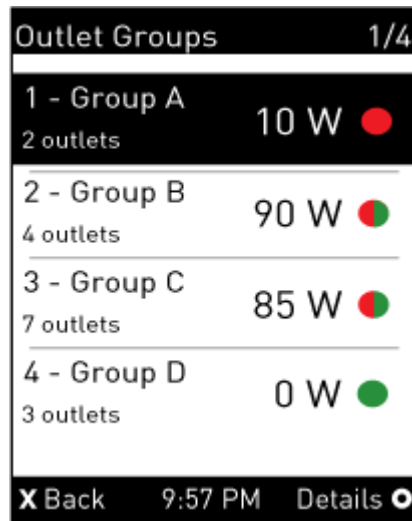

- The LCD display shows a list of outlet groups.



The currently-selected outlet group's number and total of outlet groups are indicated in the top-right corner of the display, such as "1/4" in the above diagram.

- A red circle indicates that all outlets of the group are powered on.
- A green circle indicates that all outlets of the group are powered off.
- A half-red half-green circle indicates some outlets are powered on while the others of the group are powered off.

2. Press  or  to select an outlet group, and press .

If the desired outlet group is not visible, press  or  to scroll up or down.

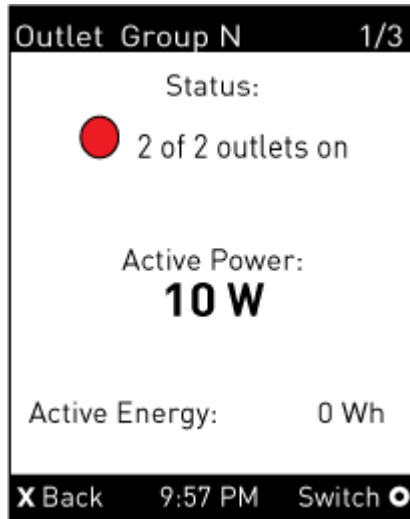

Note: In the following diagrams, N represents the selected outlet group's index number. The rightmost number in the title bar represents this group's total pages.





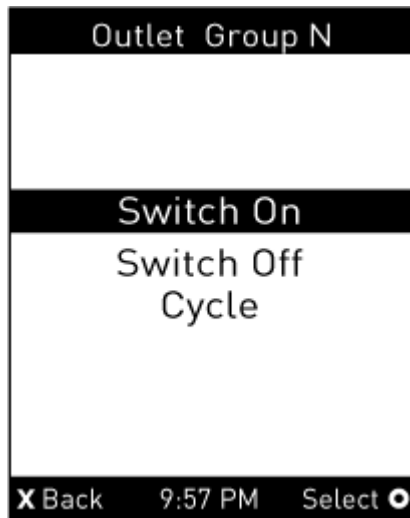

3. Press  to go to the power control page. A submenu similar to the following diagram appears.

Note: The submenu is not available when the front panel outlet control is disabled. If so, a message "Front-panel outlet control is disabled" is displayed.



4. Press  or  to select the desired option, and press .

 - Switch On: Turn on the outlet group.
 - Switch Off: Turn off the outlet group.





- Cycle: Power cycle the outlet group.
5. A confirmation message appears. Press  or  to select Yes or No, and then press .
 - Yes: Confirm the operation.
 - No: Abort the operation.
 6. Verify that the selected outlet group is switched on or off, depending on the option you selected in the above step.
 - Check the outlet group state shown on the LCD display -- red or green circles.
 - Check each member outlet's LED of the group. A green LED indicates that the outlet is turned off, and a red LED indicates that the outlet is turned on.
 7. To return to the Main Menu, press  several times until the Main Menu is shown.

Peripherals

If there are no Raritan environmental sensor packages connected to your PX3, the LCD display shows the message "No managed devices" for the "Peripherals" menu command.

If you have enabled the front panel actuator control function, you can switch on or off a connected actuator using the LCD display. See **Miscellaneous** (on page 453).



► To show environmental sensor or actuator information:

1. Press  or  to select "Peripherals" in the Main Menu, and press .
2. The display shows a list of environmental sensors/actuators.
 - If the desired sensor or actuator is not visible, press  or  to scroll up or down.
 - When the list exceeds one page, the currently-selected sensor/actuator's ID number and total of managed sensors/actuators are indicated in the top-right corner of the display.
 - If any sensor enters the warning, critical, or alarmed state, like 'Tamper Detector 1' shown below, it is highlighted in yellow or red. For color definitions, see **Yellow- or Red-Highlighted Sensors** (on page 255).

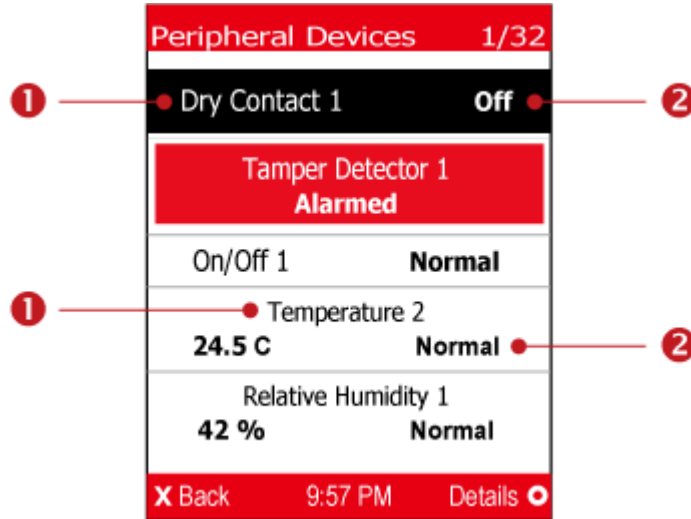
The top and bottom bars also turn yellow or red. See *Operating the Dot-Matrix LCD Display* (on page 123).



Number	Description
1	Sensor or actuator names.
2	<p>Sensor or actuator states as listed below. For further information, see <i>Sensor/Actuator States</i> (on page 258).</p> <ul style="list-style-type: none"> ▪ <i>n/a</i> = unavailable ▪ <i>Normal</i> ▪ <i>Alarmed</i> ▪ <i>Lower Critical</i> = below lower critical ▪ <i>Lower Warning</i> = below lower warning ▪ <i>Upper Warning</i> = above upper warning ▪ <i>Upper Critical</i> = above upper critical ▪ <i>On</i> ▪ <i>Off</i> ▪ <i>Open</i> ▪ <i>Closed</i> <p>A numeric sensor shows both the reading and state. A state sensor or actuator shows the state only.</p>

3. To view an environmental sensor or actuator's detailed information, press  or  to select that sensor or actuator, and press . A screen similar to the following is shown.

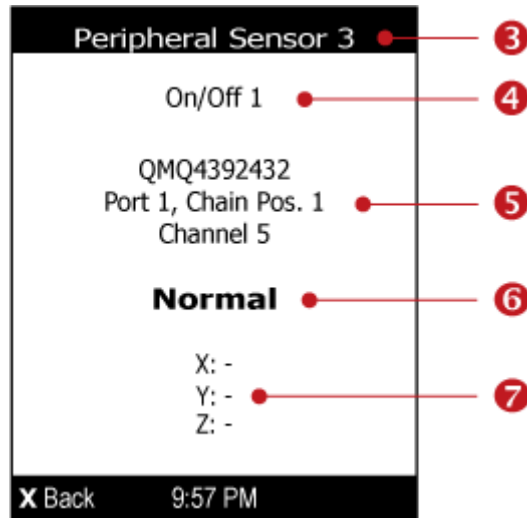



Number	Description
3	The ID number assigned to this sensor or actuator. <ul style="list-style-type: none"> ▪ A sensor shows "Peripheral Sensor x" (x is the ID number) ▪ An actuator shows "Peripheral Actuator x"
4	Sensor or actuator name.
5	The following information is listed. <ul style="list-style-type: none"> ▪ Serial number ▪ Chain position, which involves the following information: <ul style="list-style-type: none"> ▪ <i>Port <N></i>: <N> is the number of the sensor port where this sensor or actuator is connected. This number is always 1 for PX3. ▪ <i>Chain Pos. <n></i>: <n> is the sensor or actuator's position in a sensor daisy chain. <hr/> <i>Note: Only Raritan's DX, DX2, DPX2 and DPX3 series provide the chain position information.</i> <hr/> ▪ If this sensor or actuator is on a sensor package with multiple channels, such as DX2-DH2C2, its channel number is indicated as "Channel x", where x is a number.
6	Depending on the sensor type, any of the following information is displayed: <ul style="list-style-type: none"> ▪ State of a state sensor: <i>Normal, Alarmed, Open</i> or <i>Closed</i>. ▪ State of an actuator: <i>On</i> or <i>Off</i>. ▪ Reading of a numeric sensor.

Number	Description
7	X, Y, and Z coordinates which you specify for this sensor or actuator. See <i>Individual Sensor/Actuator Pages</i> (on page 264).

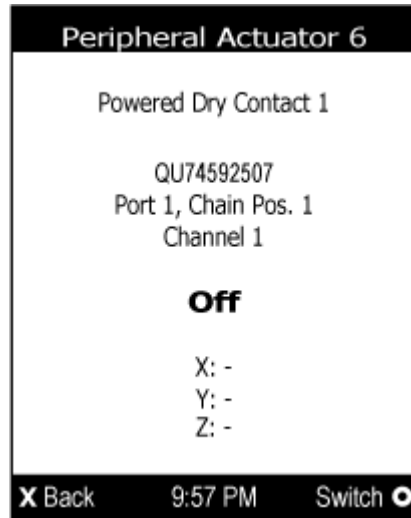

► **To switch on or off an actuator:**

1. Follow the above steps 1 to 3 to select an actuator.



2. Press  to turn on or off the actuator. A confirmation message similar to the following is shown.





3. Press  or  to select Yes or No, and then press .
4. Verify that the actuator status shown on the LCD display has been changed.

Assets

If there are no Raritan asset management strips connected, the LCD display shows the message "No asset strips connected" for the "Assets" menu command.

After connecting asset strips, only the information of the rack units where asset tags have been detected is shown on the LCD display.

▶ To show asset strip information:

1. Press  or  to select "Assets" in the Main Menu, and press .
2. The display shows the available asset strip, and indicates how many rack units and tags are detected on this strip.
 - The number of tags includes both the tags attached to the asset strip and those attached to the blade extension strip, if any.







3. Press  to show this asset strip's details, including:
 - State - strip status.
 - Main Tags - number of the tags attached to the asset strip.
In the following diagram, this number is 30.
 - Blade Tags - number of the tags attached to the blade extension strip(s), if any.
In the following diagram, this number is 2.

Note: The 'Blade Tags' information appears only when there are tags detected on the connected blade extension strip.

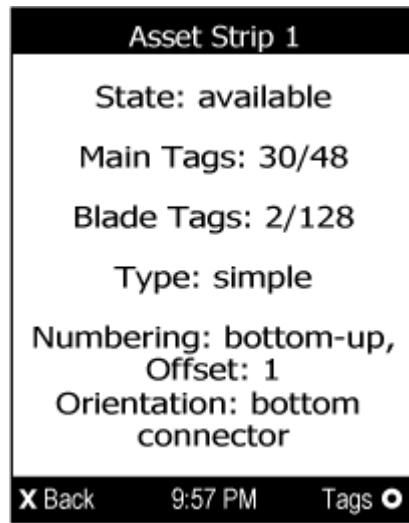
- Type - the asset strip type.
- Numbering - the numbering mode. See **Asset Strip** (on page 272).
- Offset - the starting number of the rack unit numbering.

- Orientation - the strip's orientation.



4. Press  again to show a list of available tags and their information.
 - When the list exceeds one page, the currently-selected main tag and total of available main tags are indicated in the top-right corner of the display.
 - If the desired tag is not visible, press  or  to scroll up or down.

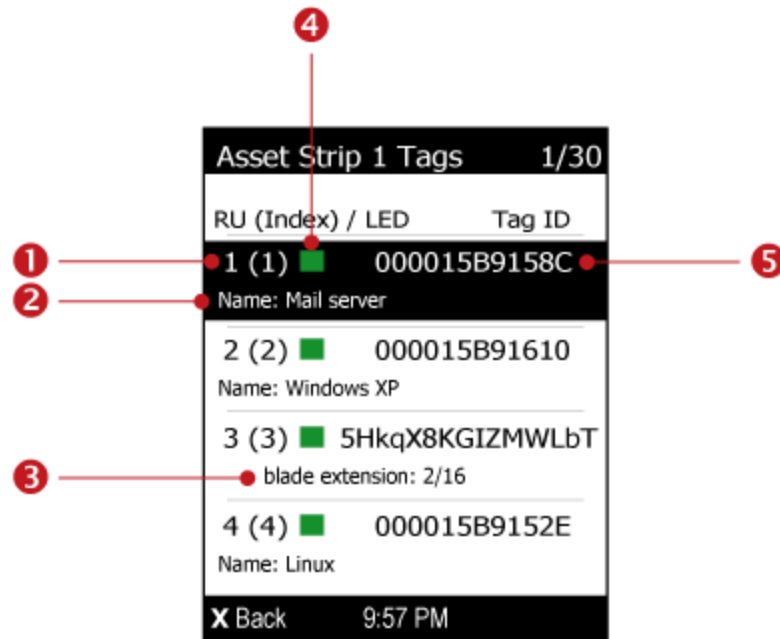

Number	Description
1	Two numbers are displayed for each tag. <ul style="list-style-type: none"> ▪ Rack unit number: The number assigned to this tag based on the selected numbering mode. See Asset Strip (on page 272). ▪ The index number in parentheses: The physical port number printed on the asset strip.
2	The asset tag's name if you have specified. This field does not show up when no name is available.
3	If the connected tag is the blade extension strip, it shows 'blade extension' and indicates how many tags and slots are available on this extension strip.
4	A color box, which represents the current LED color of the tag port where this asset tag is connected. The default is green. <ul style="list-style-type: none"> ▪ You can customize the color. See Asset Strip (on page 272).
5	The connected asset tag's ID number (barcode).

5. If any blade extension strip is connected to this asset strip, select it and press  to view a list of available tags and asset IDs on this extension strip.





Number	Description
6	The information of the selected blade extension strip, including: <ul style="list-style-type: none"> ▪ Rack unit number ▪ Index number in parentheses ▪ Current LED color of the tag port where it is connected ▪ Extension strip's ID number (barcode)

Number	Description
7	The slot number of each asset tag
8	The connected asset tag's ID number (barcode).

Device Info

The display shows the device's information, network and IPv4/IPv6 settings through various pages. Page numbers are indicated in the top-right corner of the LCD display.

▶ **To show the device information:**

1. Press  or  to select "Device Info" in the Main Menu, and press .
2. Device information similar to the following diagram displays.

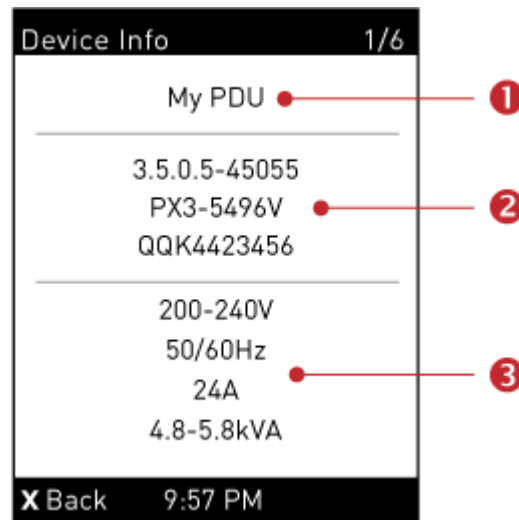

Number	Description
1	Device name.
2	Firmware version, model name and serial number.
3	Device ratings, including rated voltage, frequency, current and power.

3. Press  to show the Network Common page.

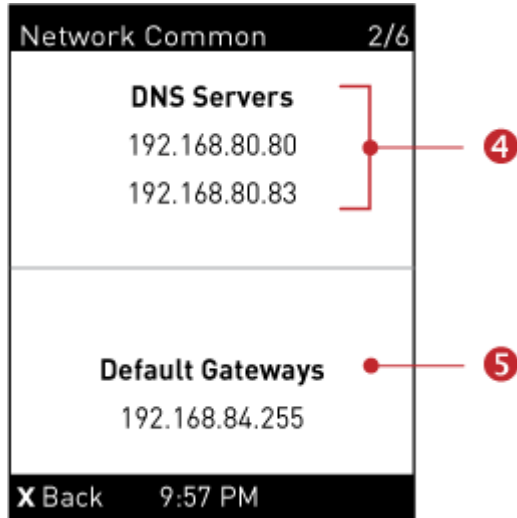

Number	Description
4	DNS servers.
5	Default gateways.

4. Press  to show the Network Cascading page.

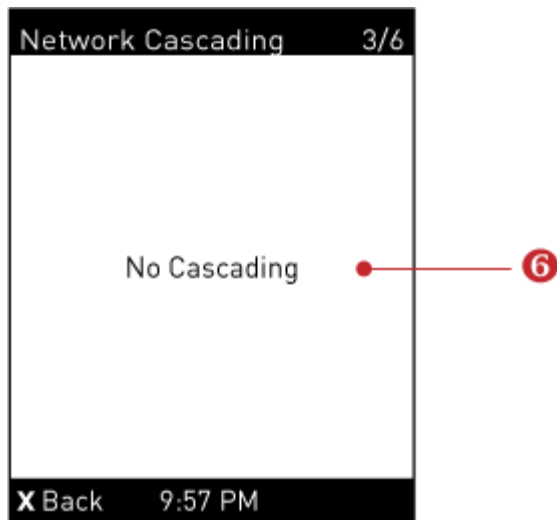

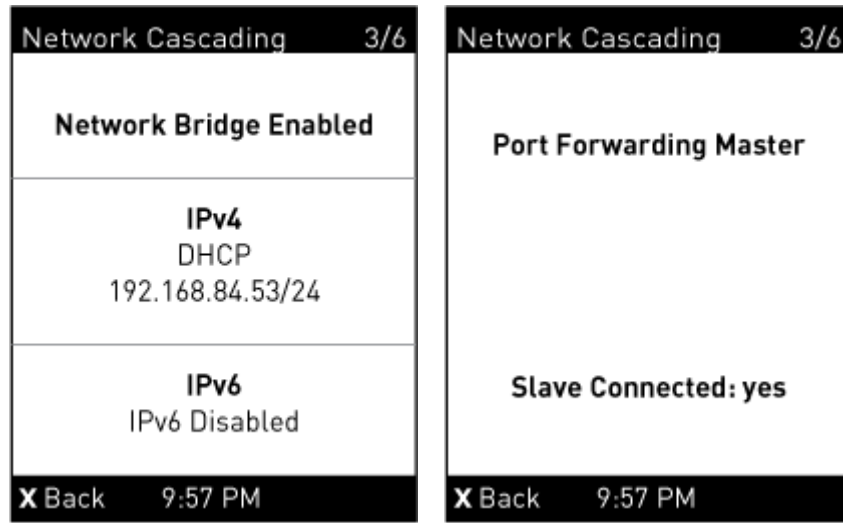

Number	Description
6	<p>Cascading status, which can be one of the following:</p> <ul style="list-style-type: none"> ▪ No Cascading: This device's cascading mode is set to None. See Setting the Cascading Mode (on page 318). ▪ Network Bridge Enabled: This device's cascading mode is set to Bridging. Its IP address is also displayed on this page. ▪ Port Forwarding Master: This device's cascading mode is set to Port Forwarding, and it is a master device. <ul style="list-style-type: none"> ▪ Slave Connected: Indicates whether the presence of a slave device is detected - <i>yes</i> or <i>no</i>. ▪ Port Forwarding Slave: This device's cascading mode is set to Port Forwarding, and it is a slave device. <ul style="list-style-type: none"> ▪ Slave Connected: Indicates whether the presence of a slave device is detected - <i>yes</i> or <i>no</i>. ▪ Cascade Position: Indicates the position of a slave device in the Port Forwarding mode. 1 represents Slave 1, 2 represents Slave 2, and so on. ▪ A port forwarding slave device will also display the master device's IP address on this page.

5. Press  to show the Ethernet pages.

A PX3 has two Ethernet pages -- ETH1 and ETH2.

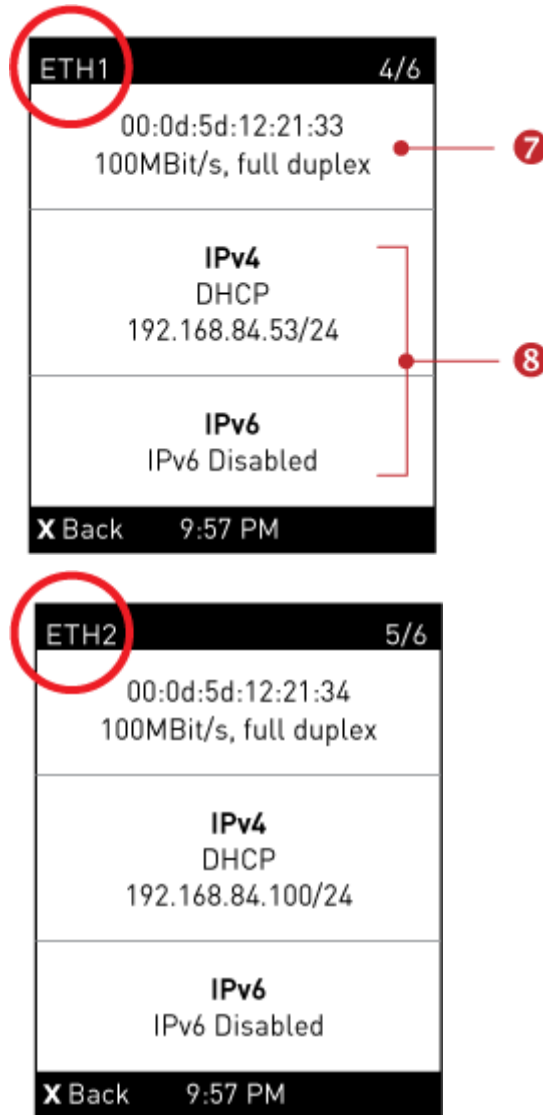

Number	Description
7	Ethernet interface information, including: <ul style="list-style-type: none"> ▪ MAC address. ▪ Speed. ▪ Full or half duplex.

Number	Description
8	<p>IPv4/IPv6 network information, including:</p> <ul style="list-style-type: none">▪ Network configuration: DHCP (or Automatic), or Static. Static represents Static IP.▪ IP address.▪ Prefix length, such as "/24". <hr/> <p><i>Note: If you disable any Ethernet interface, a message 'Interface Disabled' is shown. See Ethernet Interface Settings (on page 305).</i></p>

If you do not enable IPv4/IPv6 settings, an 'IPv4 (or IPv6) Disabled' message is displayed.

6. Press  to show the WIRELESS page.

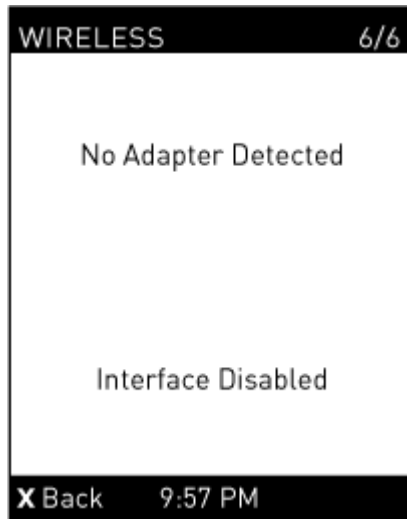

-- OR --

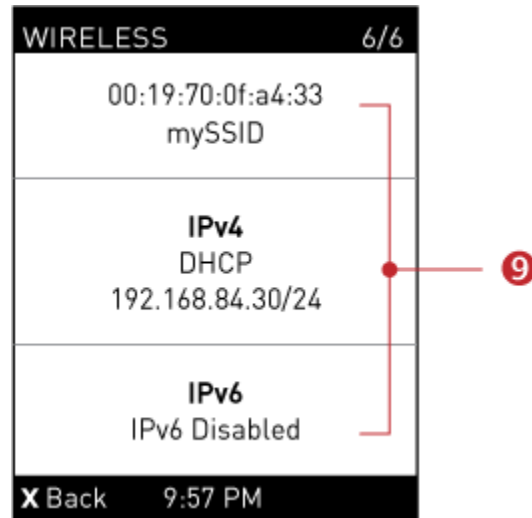

Number	Description
9	<p>If NO supported WLAN adapter is plugged or detected, the message "No Adapter Detected" is shown.</p> <p>If a supported WLAN adapter is detected and configured properly, wireless network information is shown instead, including:</p> <ul style="list-style-type: none"> ▪ MAC address ▪ SSID ▪ IPv4/IPv6 network information -- for detailed explanation, refer to number 8

7. To return to the Main Menu, press

Manually Changing PX3's Zero U LCD Orientation

A Zero U model has a tilt sensor that can detect the orientation of its physical device to automatically adjust its LCD content's orientation.

If the LCD's orientation does not meet your need, you can manually configure it.

The factory default is automatic orientation.

► To set up the LCD orientation:

1. Press or simultaneously until you see the LCD shows "Fixed Orientation".
2. If the current LCD orientation does not meet your need, repeat the above step until the orientation you preferred is displayed.
 - If you want to return to the factory default, also repeat step 1 until the LCD shows "Automatic Orientation".

Alerts Notice in a Yellow or Red Screen

In the automatic mode, if an alert occurs, the LCD display automatically shows a yellow or red screen which indicates the total number of alerted sensors and information of the latest transitions.

- When all alerted sensors enter the warning levels, the screen's background turns yellow.
- When at least one of the alerted sensors enters the critical level or there is any "alarm", the screen's background turns red.

For color definitions, see **Yellow- or Red-Highlighted Sensors** (on page 255).

The following illustrates the alerts notices in red.

▶ **When there are only alerted sensors -- NO ALARMS are present:**

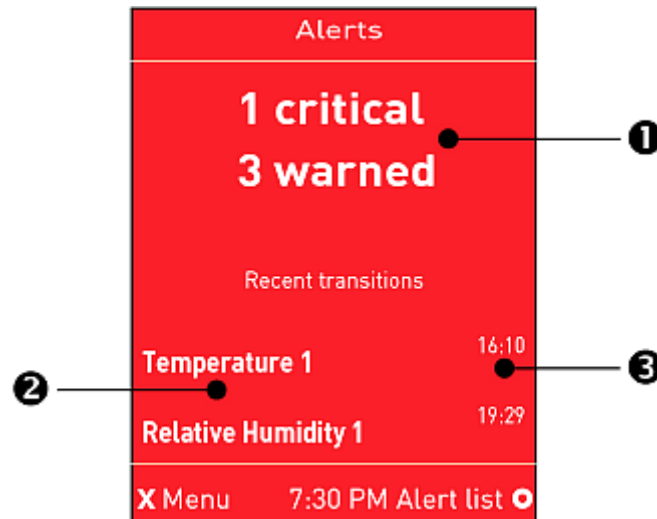



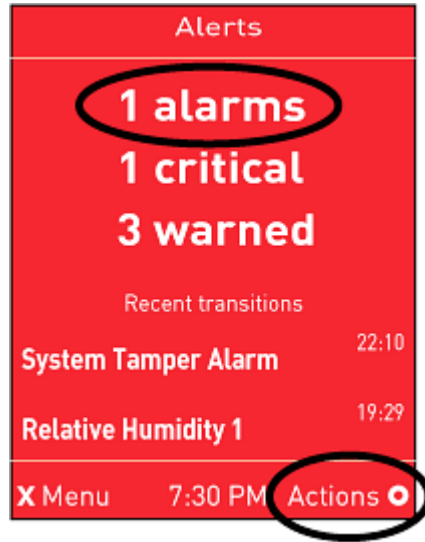

Number	Description
1	The total of alerted sensors in critical and warning levels.
2	A list of final alerted sensors that changed their readings or states.
3	The final time that each alerted sensor changed its readings or states.

► **When there is any alarm present:**



The LCD display looks similar to the above diagram except that it shows the alarm(s) and the available command in the bottom-right corner is 'Actions' instead of 'Alert list'.

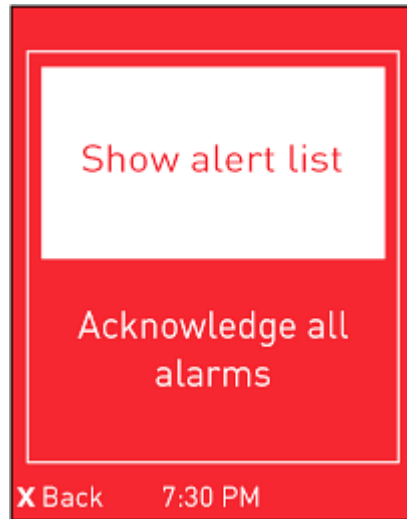

► **Available operations:**

- For the notice listing alerted sensors only, press  to view a list of all alerted sensors. See **Alerts** (on page 126).
- For the notice where at least an alarm is present, press . Then do the following:
 - a. Two options display. Press  or  to select either option, and press .



- *Show alert list*: This option lists all of alerted sensors and alarms. You still can choose to acknowledge alarms after viewing the list. See **Alerts** (on page 126).
 - *Acknowledge all alarms*: This option immediately acknowledges all existing alarms, without showing the list of alarms.
- b. (Optional) If 'Acknowledge all alarms' is selected in the above step, a confirmation prompt similar to the diagram below appears. Press  or  to confirm or abort the operation, and press .

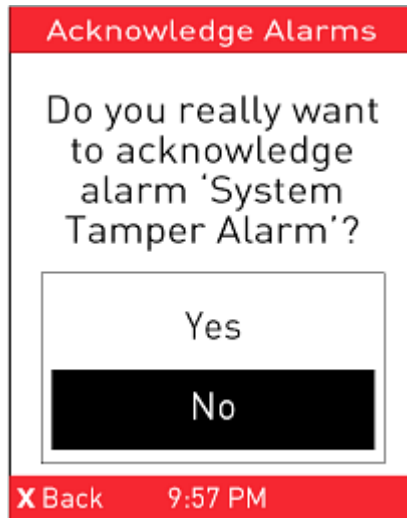

Showing the Firmware Upgrade Progress

When upgrading the PX3, the firmware upgrade progress will be displayed as a percentage on the LCD display, similar to the following diagram.



In the end, a message appears, indicating whether the firmware upgrade succeeds or fails.

Reset Button

The reset button is located inside the small hole labeled RESET near the display panel.

Pressing this reset button restarts the PX3 software without any loss of power to outlets.

The PX3 can be reset to its factory default values using this button when a serial connection is available. See **Resetting to Factory Defaults** (on page 784).

The following images illustrate the locations of the reset button on Zero U models. Port locations may differ on your models.

► **PX3 Zero U diagram:**

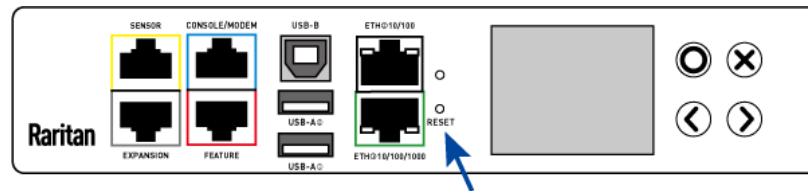

Circuit Breakers

PX3 models rated over 20A (North American) or 16A (international) contain overcurrent protectors for outlets, which are usually branch circuit breakers. These circuit breakers automatically trip (disconnect power) when the current flowing through the circuit breaker exceeds its rating.

If a circuit breaker switches off power, the LCD display shows `open`. To find which circuit breaker is open (trips), select Alerts or OCPs in the Main Menu. See **Operating the Dot-Matrix LCD Display** (on page 123).

When a circuit breaker trips, power flow ceases to all outlets connected to it. You must manually reset the circuit breaker so that affected outlets can resume normal operation.

Depending on the model you purchased, the circuit breaker may use a button- or handle-reset mechanism.

Resetting the Button-Type Circuit Breaker

Your button-type circuit breakers may look slightly different from the images shown in this section, but the reset procedure remains the same.

► **To reset the button-type breakers:**

1. Locate the breaker whose ON button is up, indicating that the breaker has tripped.

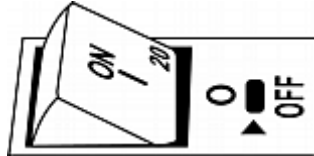

2. Examine your PX3 and the connected equipment to remove or resolve the cause that results in the overload or short circuit. **This step is required, or you cannot proceed with the next step.**
3. Press the ON button until it is completely down.



Resetting the Handle-Type Circuit Breaker

Your handle-type circuit breakers may look slightly different from the images shown in this section, but the reset procedure remains the same.

► **To reset the handle-type breakers:**

1. Lift the hinged cover over the breaker.
2. Check if the colorful rectangle or triangle below the operating handle is GREEN, indicating that the breaker has tripped.

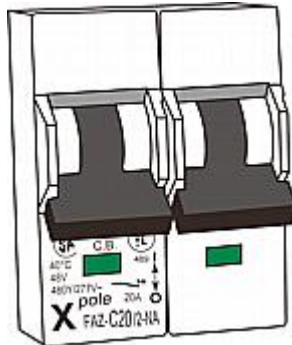

3. Examine your PX3 and the connected equipment to remove or resolve the cause that results in the overload or short circuit. **This step is required, or you cannot proceed with the next step.**
4. Pull up the operating handle until the colorful rectangle or triangle turns RED.

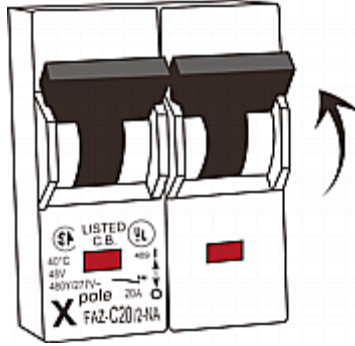

Fuse

Some PX3 devices may be implemented with fuses instead of circuit breakers. A fuse blows to protect associated outlets if it detects the overload.

If your PDU uses fuses, you must replace it with a new one when it blows or malfunctions. The rating and type of the new fuse must be the same as the original one.



Use of inappropriately rated fuse results in damage to the PDU and connected equipment, electric shock, fire, personal injury or death.

Depending on the design of your PDU, the fuse replacement methods differ.

Fuse Replacement on Zero U Models

This section only applies to a Zero U PDU with "replaceable" fuses.

► **To replace a fuse on Zero U models:**

1. Lift the hinged cover over the fuse.



2. Verify the new fuse's rating against the rating specified in the fuse holder's cover.



3. Push the cover of the fuse holder to expose the fuse.



4. Take the fuse out of the holder.



5. Insert a new fuse into the holder. There is no orientation limit for fuse insertion.
6. Close the fuse holder and the hinged cover in a reverse order.

Fuse Replacement on 1U Models

On the 1U model, a fuse is installed in a fuse knob, which fits into the PDU's fuse carrier.



Number	Description
1	Fuse carrier
2	Fuse knob where a fuse is installed

► **To replace a fuse on 1U PDUs:**

1. Disconnect the PDU's power cord from the power source.
2. Remove the desired fuse from the PDU's fuse carrier using a flat screwdriver.
 - a. Rotate the fuse knob counterclockwise until its slot is inclined to 45 degrees.

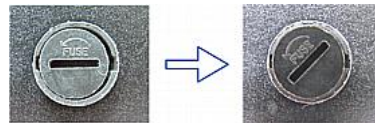

- b. Take this knob out of the fuse carrier.
3. Remove the original fuse from this knob, and insert either end of a new one into the knob. Make sure the new fuse's rating is the same as the original one.



Number	Description
1	Fuse knob

Number	Description
2	Fuse

4. Install this knob along with the new fuse into the fuse carrier using a flat screwdriver.
 - a. Have this knob's slot inclined 45 degrees when inserting the knob into the fuse carrier.



- b. Gently push this knob into the fuse carrier and then rotate it clockwise until its slot is horizontal.
5. Verify whether this knob's head is aligned with the fuse carrier. If its head is higher or lower than the fuse carrier, re-install it.

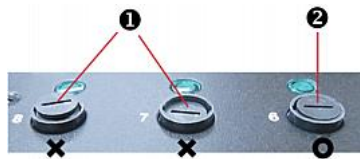

Number	Description
1	INAPPROPRIATE installations
2	Appropriate installation

6. Connect the PDU's power cord to the power source and verify that the corresponding fuse LED is lit, indicating that the fuse works properly.

Beeper

The PX3 includes an internal beeper to issue an audible alarm for an overcurrent protector which is open.

- The beeper sounds an alarm within 3 seconds of a circuit breaker trip.
- The beeper stops as soon as all circuit breakers have been reset.

You can also set the internal beeper to sound for specific events. See **Event Rules and Actions** (on page 364).

*Tip: To remotely check this beeper's state via the web interface, see **PDU** (on page 194).*

Replaceable Controller

A PX3 *Zero U* model provides flexibility for replacement of its controller. The controller, which contains the dot-matrix LCD display and connection ports, is usually located in the middle of the PDU.

If the controller is broken, you can simply send the controller back to Raritan for repair, or purchase a new controller from Raritan.

1U / 2U PDUs and all of PX3-3000 series do NOT support this feature.

► **To request a new controller:**

Contact tech@raritan.com to request a new PX3 controller.

Include these details with your request:

- The serial number of the PDU
- The serial number of the controller board
- The full model number of the PDU
- The firmware version that the PDU is running (if known).

► **To replace a controller:**

1. PDU is NOT required to be powered off.
2. Loosen the screws at two sides of the PX3 controller, and lift it up.

Note: Loosen the screws instead of removing them.

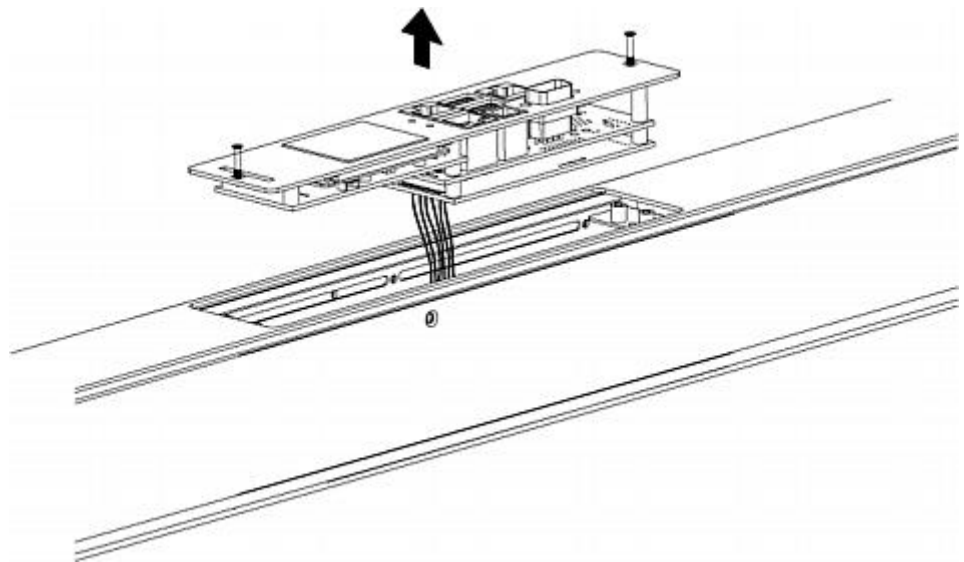

- 3. Disconnect the PDU's controller cable from the controller.

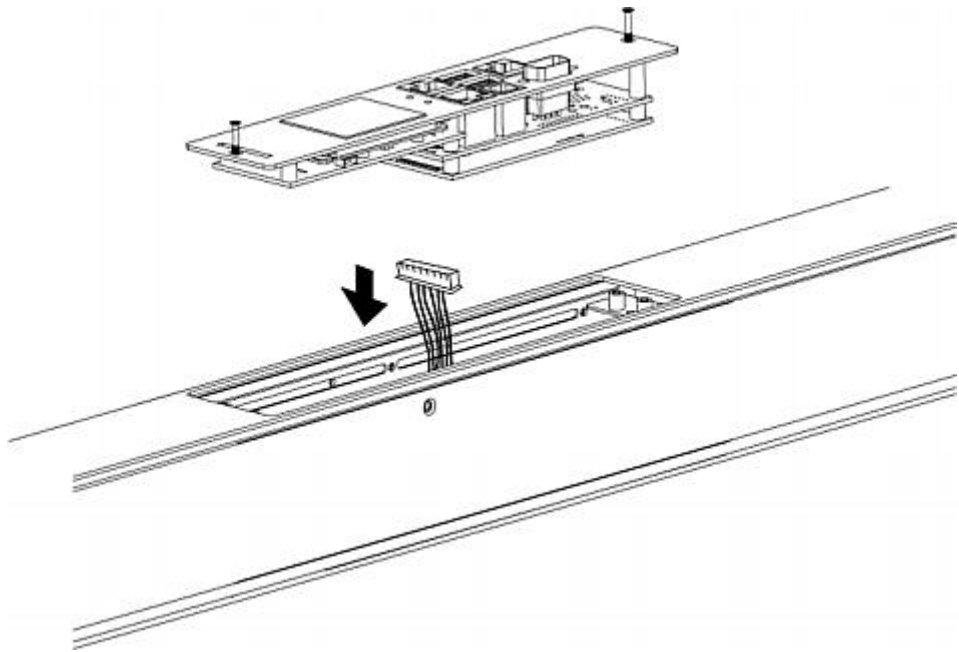

- 4. Get a new PX3 controller and install it back into the PDU in the reverse order.

Threaded Grounding Point

If the PX3 model you purchased is designed to have a threaded grounding point, you can identify it via the grounding symbol as shown below:



Wire this point to an electrical system in order to protectively ground the PX3.

Chapter 7 Using the Web Interface

This chapter explains how to use the web interface to administer the PX3.

In This Chapter

Supported Web Browsers.....	170
Login, Logout and Password Change	170
Web Interface Overview	175
Dashboard	183
PDU	194
Inlet.....	202
Outlets	206
Outlet Groups	226
OCPs.....	240
Peripherals.....	249
Feature Port.....	270
User Management	287
Device Settings	299
Maintenance.....	455
Webcam Management	484
SmartLock and Card Reader	497

Supported Web Browsers

- Internet Explorer® 11
- Firefox® 52 and later
- Safari® (Mac)
- Google® Chrome® 52 and later
- Android 4.2 and later
- iOS 7.0 and later

Login, Logout and Password Change

The first time you log in to the PX3, use the factory default "admin" user credentials. For details, refer to the Quick Setup Guide accompanying the product.

After login, you can create user accounts for other users. See **Creating Users** (on page 288).

Login

You must enable JavaScript in the web browser for proper operation.

► **To log in to the web interface:**

1. Open a browser and type the IP address of your PX3.
 - If the link-local addressing has been enabled, you can type *pdu.local* instead of an IP address. See **APIPA and Link-Local Addressing** (on page 2).

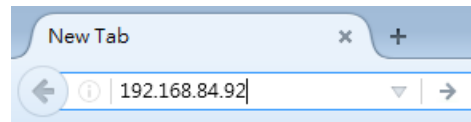

*Tip: You can also enter the desired page's URL so that you can immediately go to that page after login. See **Quick Access to a Specific Page** (on page 181).*

2. If any security alert message appears, accept it.
3. The login screen displays. Type your user name and password. User credentials are case sensitive.

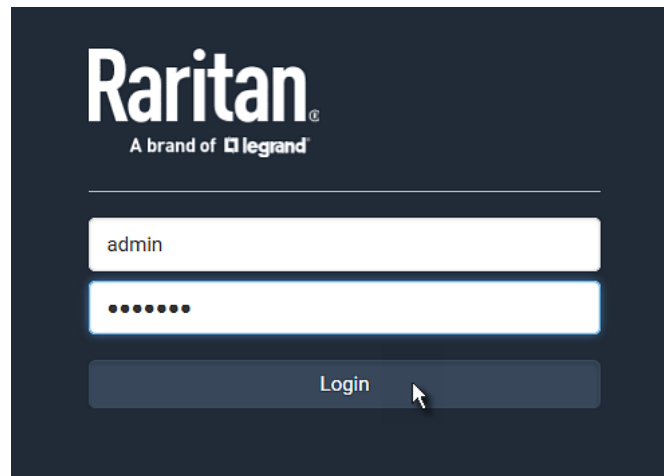

4. (Optional) If a security agreement is displayed, accept it. Otherwise, you cannot log in.

*Note: To configure the security agreement, see **Enabling the Restricted Service Agreement** (on page 358).*

5. Click Login or press Enter. The web interface of PX3 opens.

Depending on your hardware configuration, your web interface shown onscreen may look slightly different from the image below.

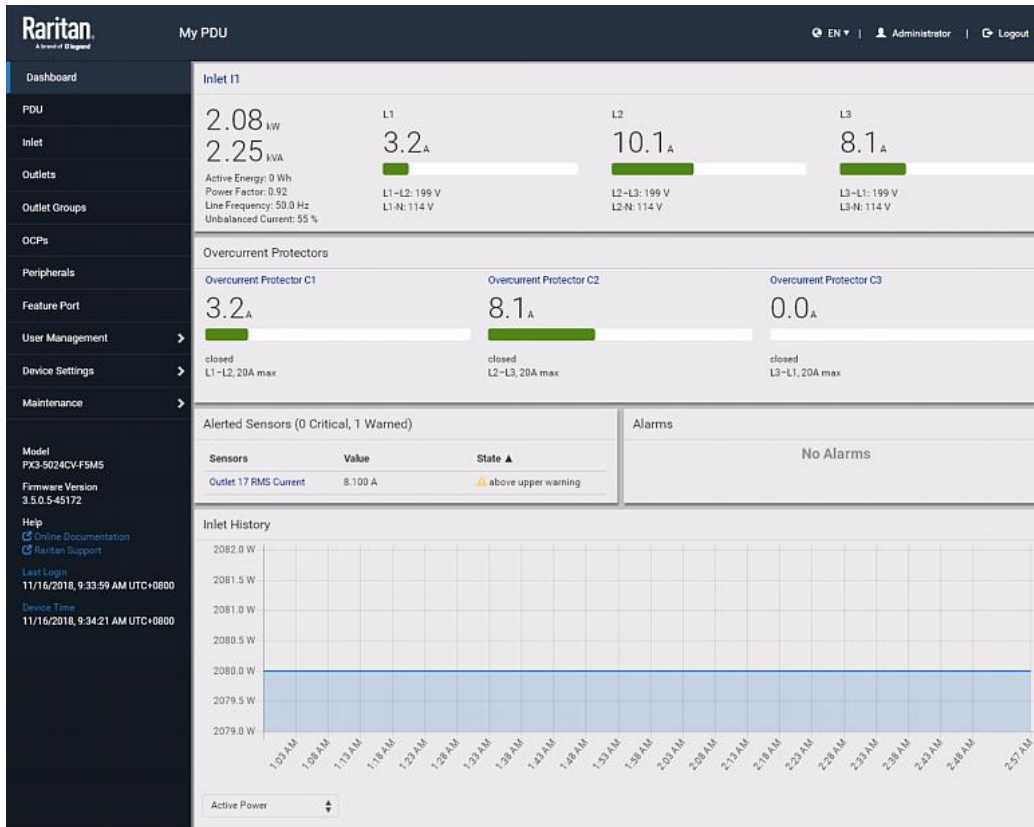

*Note: The address to access a slave device in the Port Forwarding mode via non-standard ports is a combination of a protocol (http:// or https://), an IP address and a port number. See **Port Forwarding Examples** (on page 323).*

Changing Your Password

You need appropriate permissions to change your password. Refer to the following for details.

To change other users' passwords, Administrator Privileges are required instead. See **Editing or Deleting Users** (on page 292).

► **Password change request on first login:**

On *first login*, if you have both the Change Local User Management and Change Security Settings permissions, you can choose to either change your password or ignore it.

- *Not Now* ignores the request for this time only.
- *Do not ask again* ignores the request permanently. If you select this checkbox, then click *Not Now*.
- Or enter the new password and click Ok.

Password change recommended for user 'admin'

Password

Confirm password

Do not ask again.

Users without permissions listed must change password.

*Note: This password change request also appears if the 'force password change' is enabled in the user account setting. See **Creating Users** (on page 288).*

► **To change your password via the Change Password command:**

You must have the Change Own Password permission to change your own password. See **Creating Roles** (on page 293).

1. Choose User Management > Change Password.
2. First type the current password, and then the new password twice. Passwords are case sensitive.

- A password comprises 4 to 64 characters.

Change Password - admin

Old Password	required
New password	required
Confirm password	required

Save

Remembering User Names and Passwords

PX3 supports the password manager of common web browsers, including:

- Microsoft Internet Explorer®
- Mozilla Firefox®
- Google Chrome®

You can save the login name and password when these browsers ask whether to remember them.

For information on how to activate a web browser's password manager, see the user documentation accompanying your browser.

PX3 does NOT support other browser password managers.

Logout

After finishing your tasks, you should log out to prevent others from accessing the PX3 web interface.

▶ **To log out without closing the web browser:**

- Click "Logout" on the top-right corner.
- OR --
- Close the tab of PX3 while there are other tabs available in the browser.

▶ **To log out by closing the web browser:**

- Click  on the top-right corner of the window.
- OR --
- Choose File > Close, or File > Exit.

Web Interface Overview

The web interface consists of four areas as shown below.

▶ **Operation:**

1. Click any menu or submenu item in the area of **1**.
2. That item's data/setup page is then opened in the area of **2**.
3. Now you can view or configure settings on the opened page.



- To return to the main menu and the Dashboard page, click on the top-left corner.

Number	Web interface element
1	Menu (on page 178)
2	Data/setup page of the selected menu item.
3	<ul style="list-style-type: none"> Left side: <ul style="list-style-type: none"> - PX3 device name.

Number	Web interface element
	<p data-bbox="451 348 1105 380"><i>Note: To customize the device name, see PDU (on page 194).</i></p> <ul style="list-style-type: none"> <li data-bbox="407 401 1243 548"> ▪ Right side: <ul style="list-style-type: none"> <li data-bbox="451 443 1227 474">- Displayed language, which is English (EN) by default. You can change it. <li data-bbox="451 485 1243 516">- Your login name, which you can click to view your user account settings. <li data-bbox="451 527 626 548">- Logout button.
4	<p data-bbox="407 569 643 600">From top to bottom --</p> <ul style="list-style-type: none"> <li data-bbox="407 611 618 642">▪ Your PX3 model. <li data-bbox="407 653 724 684">▪ Current firmware version. <li data-bbox="407 695 1040 758"> ▪ Online Documentation: link to the online help of PX3. <ul style="list-style-type: none"> <li data-bbox="451 726 1040 758">- See <i>Browsing through the Online Help</i> (on page 912). <li data-bbox="407 768 1089 800">▪ Raritan Support: link to Raritan Technical Support webpage. <li data-bbox="407 810 951 873"> ▪ Date and time of your user account's last login. <ul style="list-style-type: none"> <li data-bbox="451 842 919 873">- Click Last Login to view your login history. <li data-bbox="407 884 1325 989"> ▪ PX3 system time, which is converted to the time zone of your computer or mobile device. <ul style="list-style-type: none"> <li data-bbox="451 957 1032 989">- Click Device Time to open the Date/Time setup page.

Menu

Depending on your model and hardware configuration, your PX3 may show all or some menu items shown below.

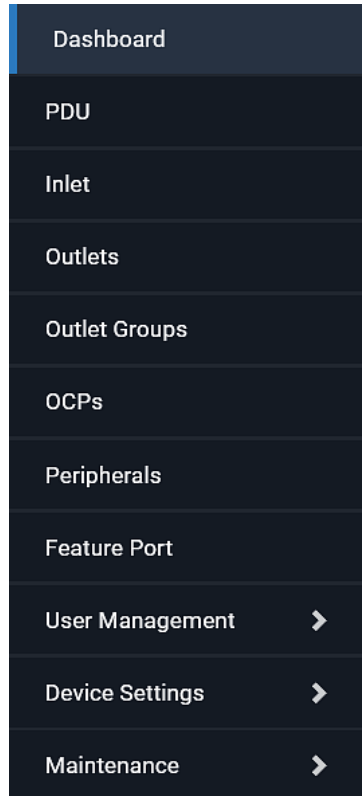

Menu	Information shown
Dashboard	Summary of the PX3 status, including a list of alerted sensors and alarms, if any. See Dashboard (on page 183).
PDU	Device data and settings, such as the device name and MAC address. See PDU (on page 194).
Inlet	Inlet status and settings, such as inlet thresholds. See Inlet (on page 202).
Outlets	Outlet status, settings and outlet control if your model is outlet-switching capable. See Outlets (on page 206).

Menu	Information shown
Outlet Groups	<p>Only PDUs with outlet-switching and/or outlet-metering feature show this menu item.</p> <p>You can create one or multiple groups comprising one or multiple outlets of the same PX3.</p> <p>Functions which you can perform on an outlet group vary depending on the model you purchased.</p> <p>See Outlet Groups (on page 226).</p>
OCPs	<p>The OCPs menu item displays only when there are overcurrent protectors implemented on your model.</p> <p>OCP status and settings, such as OCP thresholds.</p> <p>See OCPs (on page 240).</p>
Peripherals	<p>Status and settings of Raritan environmental sensor packages, if connected.</p> <p>See Peripherals (on page 249).</p>
<p>Feature Port</p> <p>The name 'Feature Port(s)' will be replaced with one of the device names listed to the right</p>	<p>Status and settings of the device connected to the Feature port(s), which can be one of the following.</p> <ul style="list-style-type: none"> ▪ Asset Strip ▪ External Beeper ▪ LHX 20 ▪ SHX 30 ▪ LHX 40 ▪ Power CIM <p>See Feature Port (on page 270).</p>
Webcams	<p>The 'Webcams' menu item appears when there is any webcam(s) connected to the PX3, or when there are snapshots saved onto the PX3 already.</p> <p>Webcam live snapshots/video and webcam settings.</p> <p>See Webcam Management (on page 484).</p>

Menu	Information shown
SmartLock -- <i>and/or</i> -- Card Readers	<p data-bbox="505 369 1349 491"> Either or both menu items appear only when you connect Raritan's SmartLock kit to this product. For details, refer to the user documentation accompanying the SmartLock kit or download it from Raritan's Support page (http://www.raritan.com/support/). </p> <ul data-bbox="488 527 1386 653" style="list-style-type: none"> ▪ SmartLock: Configures and controls the door handles connected to this product via DX2-DH2C2. Note that this page is not available if connecting the door handles to other Raritan sensors than DX2-DH2C2. ▪ Card Readers: Lists the card readers connected to PX3 directly or indirectly. <p data-bbox="488 667 997 695"> See SmartLock and Card Reader (on page 497). </p>
User Management	<p data-bbox="488 720 1273 747"> Data and settings of user accounts and groups, such as password change. </p> <p data-bbox="488 762 899 789"> See User Management (on page 287). </p>
Device Settings	<p data-bbox="488 808 1365 869"> Device-related settings, including network, security, system time, event rules and more. </p> <p data-bbox="488 884 862 911"> See Device Settings (on page 299). </p>
Maintenance	<p data-bbox="488 930 1386 991"> Device information and maintenance commands, such as firmware upgrade, device backup and reset. </p> <p data-bbox="488 1005 841 1033"> See Maintenance (on page 455). </p>

If a menu item contains the submenu, the submenu is shown after clicking that item.

► **To return to the previous menu list, do any below:**

- Click the topmost link with the symbol <. For example, click

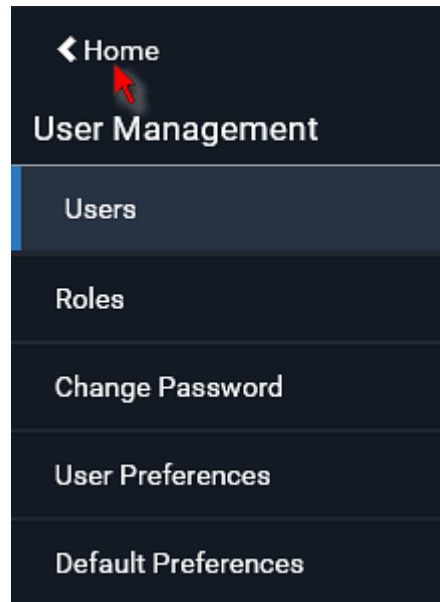
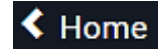

- Click  on the top-left corner to return to the main menu.

Quick Access to a Specific Page

If you often visit a specific page in the PX3 web interface, you can note down its URL or bookmark it with your web browser. Next time, you just enter its URL in the address bar of the browser prior to login. After login, the PX3 immediately shows the wanted page rather than the Dashboard page.

Besides, you can also send the URL to other users so that they immediately see that page after login, using their own user credentials.

► **URL examples:**

In the following examples, it is assumed that the IP address of PX3 is 192.168.84.118.

Page	URL
Peripherals	https://192.168.84.118/#/peripherals
Event Log	https://192.168.84.118/#/maintenance/eventLog/0

Sorting a List

If any list displays an arrow (▲ or ▼) in one of its column headers, you are allowed to resort the list by clicking any column header. The list will be resorted in the ascending or descending order based on the selected column.

► **Illustration -- Event Log:**

1. By default, the Event Log is sorted in the descending order based on the ID column. Therefore, the arrow ▼ is displayed adjacent to the ID header.
2. To have it resorted in the ascending order based on the same column, click the ID header.

ID ▼	Timestamp	Event Class
665	7/24/2017, 3:14:43 AM Eastern Daylight Time	User Activity
664	7/24/2017, 2:42:35 AM Eastern Daylight Time	Sensor
663	7/24/2017, 2:42:35 AM Eastern Daylight Time	Sensor
662	7/24/2017, 2:42:35 AM Eastern Daylight Time	Sensor

3. The arrow turns to ▲, indicating the list is sorted in the "ascending" order.



4. To resort the list based on a different column, click a different column header. In this example, the 'Event Class' column is clicked.

ID ▲	Timestamp	Event Class	Event
------	-----------	-------------	-------

5. The arrow ▲ now appears adjacent to the selected column 'Event Class,' indicating the list is sorted in the ascending order based on that column.

ID	Timestamp	Event Class ▲	Event
----	-----------	---------------	-------

Dashboard

The Dashboard page contains four to five sections, depending on your model.

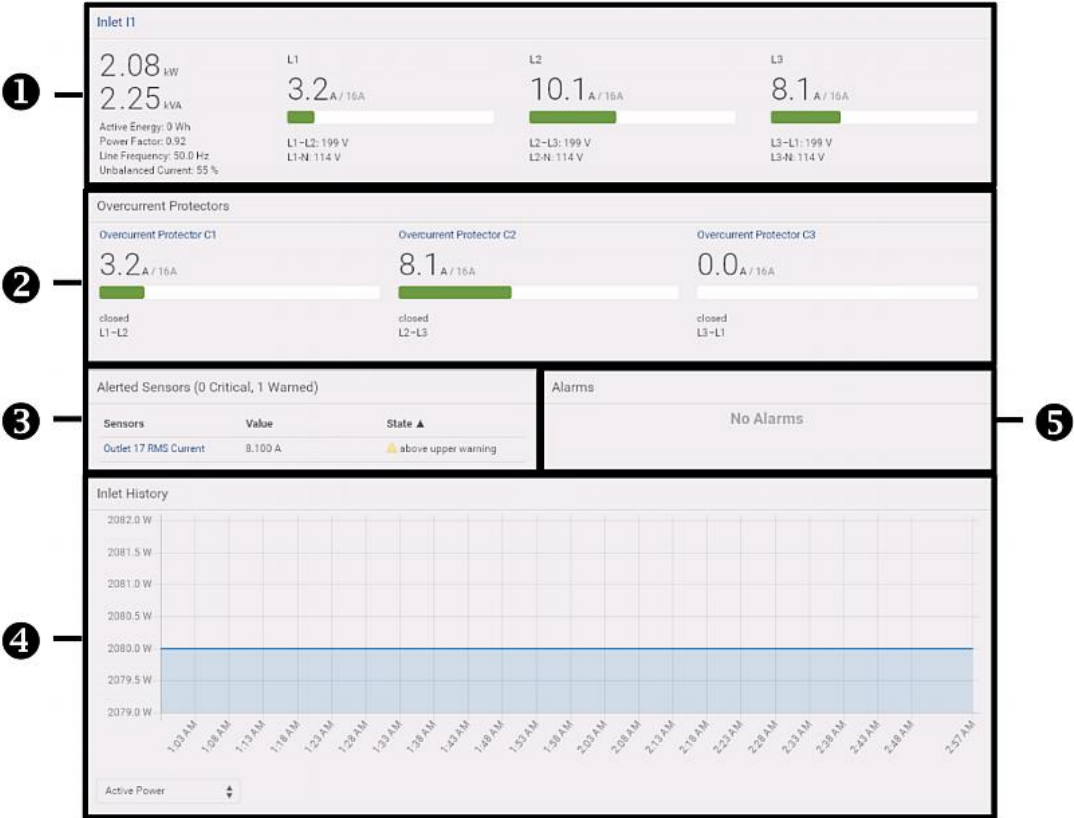

Number	Section	Information shown
1	Inlet I1	<ul style="list-style-type: none"> Overview of inlet power data A current bar per phase, which changes colors to indicate the RMS current state <ul style="list-style-type: none"> - green: normal - yellow: warning - red: critical <p>See Dashboard - Inlet I1 (on page 185).</p>
2	Overcurrent Protectors	<p>This section is available only when your PX3 contains overcurrent protectors (OCPs).</p> <ul style="list-style-type: none"> Overview of each OCP's status A current bar per OCP, which changes colors to indicate the RMS current state <ul style="list-style-type: none"> - green: normal - yellow: warning - red: critical <p>See Dashboard - OCP (on page 187).</p>
3	Alerted Sensors	<ul style="list-style-type: none"> When no sensors enter the alarmed state, this section shows the message "No Alerted Sensors." When any sensor enters the alarmed state, this section lists all of them. <p>See Dashboard - Alerted Sensors (on page 188).</p>
4	Inlet History	<p>The chart of the inlet's active power history is displayed by default. You can make it show a different data type.</p> <p>See Dashboard - Inlet History (on page 190).</p>
5	Alarms	<p>This section can show data only after you have set event rules requiring users to take the acknowledgment action.</p> <ul style="list-style-type: none"> When there are no unacknowledged events, this section shows the message "No Alarms." When there are unacknowledged events, this section lists all of them. <p>See Dashboard - Alarms (on page 192).</p>

► **The Hardware Failures section:**

If PX3 detects any internal hardware issues, a section labeled "Hardware Failures" will appear on the Dashboard page, listing all of current hardware issues.

Hardware Failures		
Failure Message	Last Asserted ▲	Number of Occurrences
I2C bus 0 is stuck.	1/1/2018, 1:18:24 AM UTC+0100	17

This section does NOT display as long as there are no hardware failures present. See **Hardware Issue Detection** (on page 480).

Dashboard - Inlet I1

The number of phases shown in the Inlet section is model dependent.

▶ [Link to the Inlet page:](#)

To view more information or configure the inlet(s), click this section's title 'Inlet I1' to go to the Inlet page. See **Inlet** (on page 202).

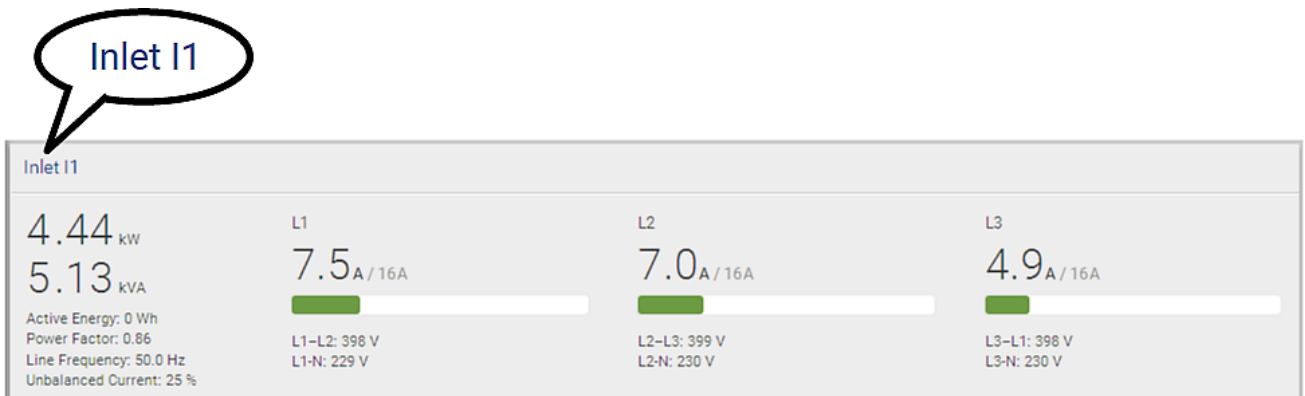

▶ [Left side - generic inlet power data:](#)

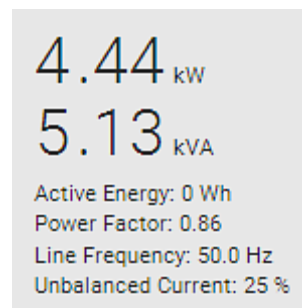

The left side lists all or some of the following data. Available data is model dependent.

- **Active power (kW or W)**
- **Apparent power (kVA or VA)**
- Active energy (kWh or Wh)
- Power factor
- Line frequency (Hz)
- Unbalanced current (%) - *model dependent*

▶ **Right side - inlet's current and voltage:**

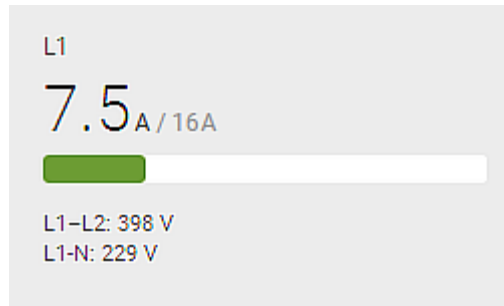



The right side shows the current and voltage data per phase. For a single-phase device, it shows only one line, but for a three-phase device, it shows three lines (L1, L2 and L3).

Inlet data from top to bottom includes:

- RMS current (A) and rated current
 - The smaller, gray text adjacent to RMS current is the rated current.
- A bar showing the RMS current level
- RMS voltage (V)

The RMS current bars automatically change colors to indicate the current status if the thresholds have been enabled. To configure thresholds, see **Inlet** (on page 202).

Status	Bar colors
normal	
above upper warning	
above upper critical	

Note: The "below lower warning" and "below lower critical" states also show yellow and red colors respectively. However, it is not meaningful to enable the two thresholds for current levels.

Dashboard - OCP

Availability and total number of OCPs depend on the models.

► **Each OCP's link:**

To view more information or configure individual OCPs, click the desired OCP's index number, which is C1, C2 and the like, to go to its setup page.

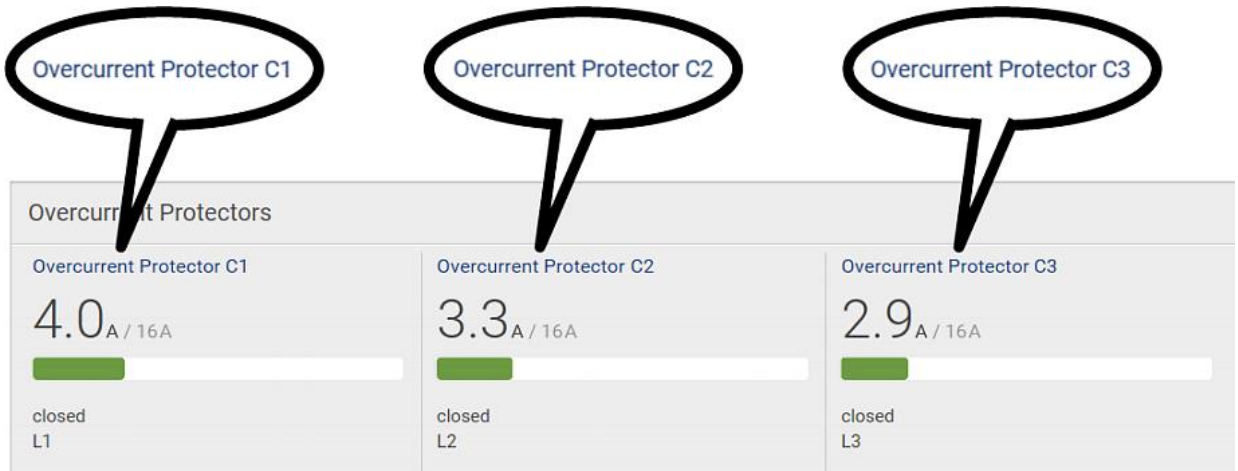



► **Each OCP's power data:**

OCP data from top to bottom includes:

- RMS current (A), and rated current
 - Smaller gray text adjacent to RMS current is each OCP's rated current, such as "16A" shown in the above diagram.

- A bar showing OCP current levels
- OCP status -- open or closed
- Associated line pair

The RMS current bars automatically change colors to indicate the current status if OCP thresholds have been enabled. To configure thresholds, see **OCPs** (on page 240).

Status	Bar colors
normal	
above upper warning	
above upper critical	



Note: The "below lower warning" and "below lower critical" states also show yellow and red colors respectively. However, it is not meaningful to enable the two thresholds for current levels.

Dashboard - Alerted Sensors

When any internal sensors or environmental sensor packages connected to the PX3 enter an abnormal state, the Alerted Sensors section in the Dashboard show them for alerting users. This section also lists tripped circuit breakers or blown fuses, if available.

To view detailed information or configure each alerted sensor, you can click each sensor's name to go to individual sensor pages. See **Individual Sensor/Actuator Pages** (on page 264).

If wanted, you can resort the list by clicking the desired column header. See **Sorting a List** (on page 182).

Alerted Sensors (1 Critical, 1 Warned)		
Sensors	Value	State ▲
Temperature 3	20.7 °C	 above upper critical
Temperature 1	19.8 °C	 above upper warning

► **Summary in the section title:**



Information in parentheses adjacent to the title is the total number of alerted sensors.

For example:

- **1 Critical:** 1 sensor enters the critical or alarmed state.
 - Numeric sensors enter the critical state.
 - State sensors enter the alarmed state.
- **1 Warned:** 1 'numeric' sensor enters the warning state.

► **List of alerted sensors:**

Two icons are used to indicate various sensor states.

Icons	Sensor states
	Numeric sensors: <ul style="list-style-type: none"> ▪ above upper warning ▪ below lower warning
	Numeric sensors: <ul style="list-style-type: none"> ▪ above upper critical ▪ below lower critical State sensors: <ul style="list-style-type: none"> ▪ alarmed state

For details, see **Sensor/Actuator States** (on page 258).

Dashboard - Inlet History

- The Inlet History graph displays the history of the sensor values. Select a different data type by clicking the selector  below the diagram.

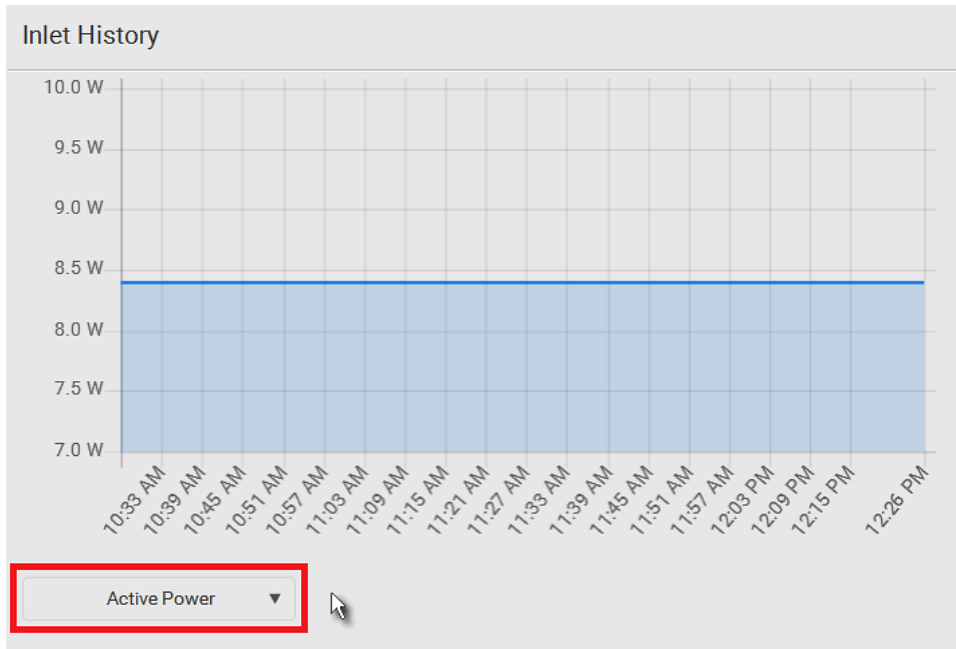
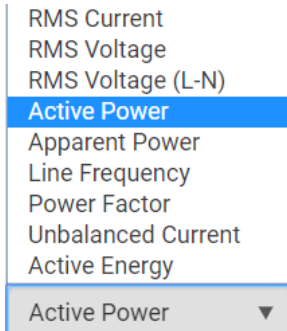

- To retrieve the exact data at a particular time, hover your mouse over the data line in the chart. Both the time and data are displayed as illustrated below.

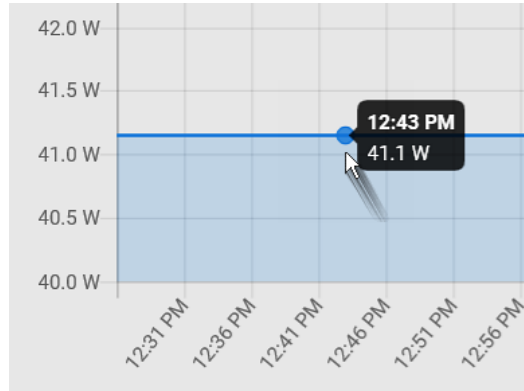

► **Inlet selection on multi-inlet models:**

If your PDU is a multi-inlet model, you can have one or multiple inlets show their power charts by selecting the checkbox(es) of the desired inlet(s).

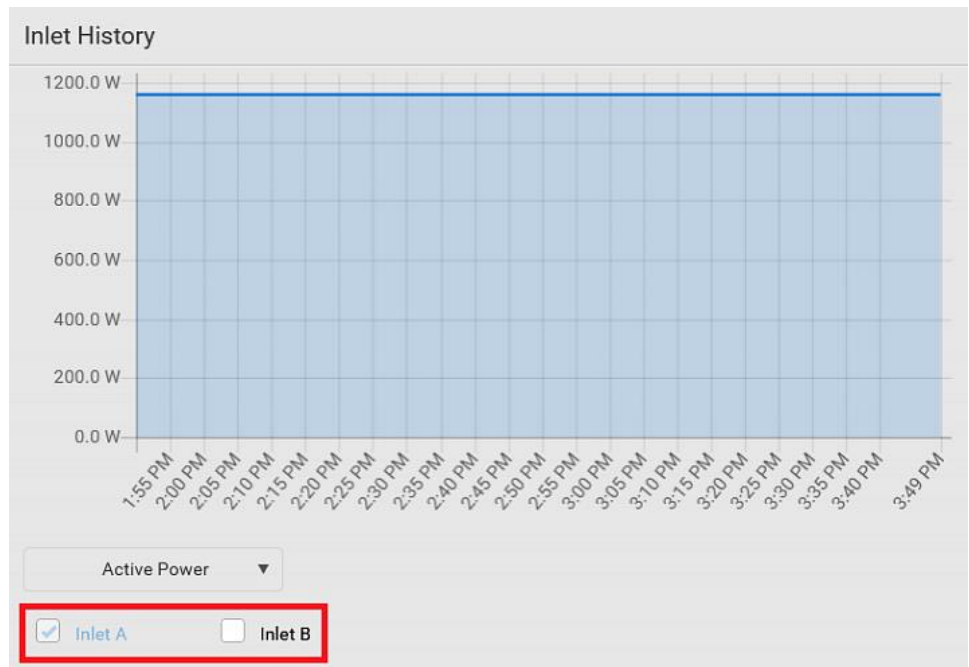

- When multiple inlets are displayed in the chart, their colors differ. You can identify each inlet's data according to the colors of the selected inlet checkboxes.



- When both inlets are shown in the chart, simply hover your mouse over either inlet's data line. Both inlets' values display simultaneously, marked with corresponding colors.

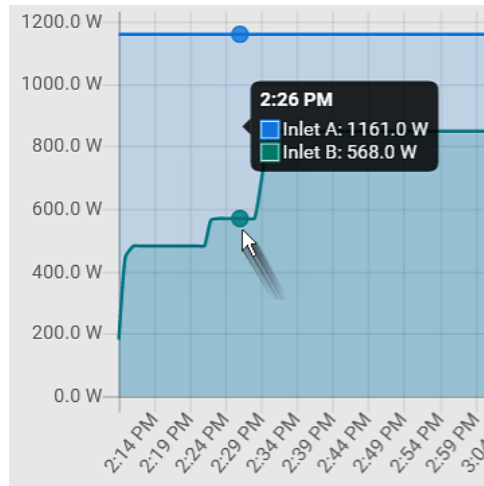

Dashboard - Alarms

If configuring any event rules which require users to take the acknowledgment action, the Alarms section will list any event which no one acknowledges yet since event occurrence.

*Note: For information on event rules, see **Event Rules and Actions** (on page 364).*

Only users with the 'Acknowledge Alarms' permission can manually acknowledge an alarm.

► **To acknowledge an alarm:**

- Click Acknowledge, and that alarm then disappears from the Alarms section.

Alarms

Name: System Tamper Alarm
Reason: Peripheral device 'Tamper Detector 1' in slot 11 is alarmed.
First Appearance: 7/4/2017, 7:55:44 AM Eastern Daylight Time
Last Appearance: 7/4/2017, 7:58:20 AM Eastern Daylight Time
Count: 3
More Alerts: [1 more reasons](#) ▼

[Acknowledge](#)

This table explains each column of the alarms list.

Field	Description
Name	Custom name of the Alarm action.
Reason	The first event that triggers the alert.
First Appearance	Date and time when the event indicated in the Reason column occurred for the first time.
Last Appearance	Date and time when the event indicated in the Reason column occurred for the last time.
Count	Number of times the event indicated in the Reason column has occurred.
More Alerts	<p>This field appears only when there are more than one types of events triggering this alert.</p> <p>If there are other types of events (that is, other reasons) triggering the same alert, the total number of additional reasons is displayed. You can click it to view a list of all events.</p>

The date and time shown on the PX3 web interface are automatically converted to your computer's time zone. To avoid time confusion, it is suggested to apply the same time zone settings as those of PX3 to your computer or mobile device.

*Tip: You can also acknowledge all alarms by operating the LCD display. Refer to **Alerts Notice in a Yellow or Red Screen** (on page 158).*

PDU

The PX3 device's generic information and PDU settings are available on the PDU page.

To open the PDU page, click 'PDU' in the **Menu** (on page 178).

▶ **Device information shown:**

- Firmware version
- Serial number
- MAC address
- Rating
- **Internal Beeper State** (on page 197)
- Status of **+12V Power Supply Sensor** (on page 201)

▶ **To configure global settings:**

1. Click Edit Settings.

Settings		Edit Settings
Name	My PDU	
Relay behavior on power loss	Non-latching	
Outlet state on device startup	last known	
Outlet initialization delay on device startup	3 s	
Power off period during power cycle	10 s	
Inrush guard delay	200 ms	
Reset all energy counters	<input type="button" value="Reset"/>	

2. Now you can configure the fields.

- Click to select an option.
- Adjust the numeric values.
- For time-related fields, if you do not prefer the option selection using , you can type a value manually which must include a time unit, such as '50 s'. See **Time Units** (on page 200).

*In the following table, those fields marked with * are available on an outlet-switching capable model only.*

Field	Function	Note
Name	Customizes the device name.	

Field	Function	Note
*Relay behavior on power loss	<p>Selects an operating mode to determine the latching relay behavior when PDU power is lost.</p> <ul style="list-style-type: none"> ▪ <i>Options: Non-latching and Latching</i> ▪ <i>Non-latching has all relays open at the power loss while latching has all relays remain unchanged at the power loss.</i> 	See PX3 Latching Relay Behavior (on page 198).
*Outlet state on device startup (for non-latching mode only)	<p>Determines the initial power state of ALL outlets after the PX3 powers up.</p> <ul style="list-style-type: none"> ▪ <i>Options: on, off, and last known</i> <p>See Options for Outlet State on Startup (on page 198).</p>	<ul style="list-style-type: none"> ▪ After removing power from the PDU, you must wait for a minimum of 10 seconds before powering it up again. Otherwise, the default outlet state settings may not work properly. ▪ You can override the global outlet state setting on a per-outlet basis so specific outlets behave differently on startup. See Individual Outlet Pages (on page 218). ▪ This setting works only when 'Relay behavior on power loss' is set to <i>Non-latching</i>. This is because all relays keep their states unchanged in the latching mode regardless of the power supply status.
*Outlet initialization delay on device startup (for non-latching mode only)	<p>Determines how long the PX3 waits before providing power to all outlets during power cycling or after recovering from a temporary power loss.</p> <ul style="list-style-type: none"> ▪ <i>Range: 1 second to 1 hour</i> 	<ul style="list-style-type: none"> ▪ See Initialization Delay Use Cases (on page 199). ▪ This setting works only when 'Relay behavior on power loss' is set to <i>Non-latching</i>. This is because all relays keep their states unchanged in the latching mode regardless of the power supply status.
*Power off period during power cycle	<p>Determines the power-off period after the outlet is switched OFF during a power cycle.</p> <ul style="list-style-type: none"> ▪ <i>Range: 1 second to 1 hour</i> 	<ul style="list-style-type: none"> ▪ Power cycling the outlet(s) turns the outlet(s) off and then back on. ▪ You can override this global power cycle setting on a per-outlet basis so specific outlets' power-off period is different. See Individual Outlet Pages (on page 218).

Field	Function	Note
*Inrush guard delay	Prevents a circuit breaker trip due to inrush current when many devices connected to the PDU are turned on. <ul style="list-style-type: none"> ▪ <i>Range: 100 milliseconds to 10 seconds</i> 	See <i>Inrush Current and Inrush Guard Delay</i> (on page 199).

3. Click Save.

► **To reset ALL active energy counters:**

An active energy reading is a value of total accumulated energy, which is never reset, even if the power fails or the PX3 is rebooted. However, you can manually reset this reading to restart the energy accumulation process.

Only users with the "Admin" role assigned can reset active energy readings.

*Note: This reset button does not reset the active energy values of outlet groups. See **Outlet Groups** (on page 226).*

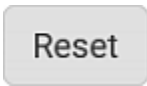

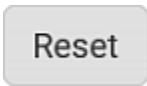
1. Click .
 2. Click Reset on the confirmation message.
 - All active energy readings on this PX3 are reset to zero.
-

*Tip: You can choose to reset the active energy reading of an individual inlet or outlet. See **Inlet** (on page 202) or **Individual Outlet Pages** (on page 218).*

► **To view total active energy and power on multi-inlet models:**

If your PX3 is a multi-inlet model or an in-line monitor, a "Power" section for showing the data of total active energy and total active power is available on the PDU page.

For a regular PX3 model with multiple inlets:

- Total active energy = sum of all inlets' active energy values
- Total active power = sum of all inlets' active power values

For an in-line monitor with multiple inlets/outlets:

- Total active energy = sum of all outlets' active energy values
- Total active power = sum of all outlets' active power values

Sensor	Value	State
Active Power	16 W	normal
Active Energy	100243 Wh	normal

► **To configure the thresholds of total active energy and power:**

For a multi-inlet model or an in-line monitor, a "Thresholds" section is also available on the PDU page. See **Setting Thresholds for Total Active Energy or Power** (on page 200).



Internal Beeper State

The PDU page indicates the internal beeper state.

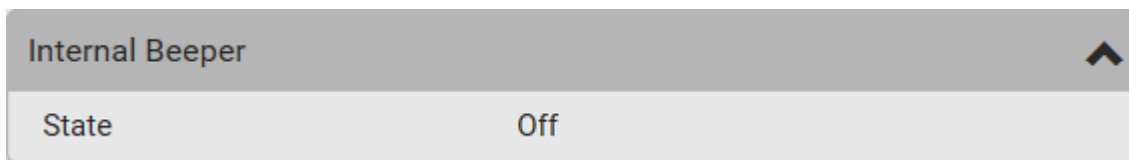

► **Available beeper states:**

States	Description
Off	The beeper is turned off.
Active	<p>The beeper is turned on.</p> <p>"Activation Reason" is displayed, indicating why the beeper sounds an alarm.</p> <p>For example, if the beeper is turned on because of a specific event rule "XXX," the activation reason looks like:</p> <pre>Event Action triggered by rule: XXX</pre>

► **Scenarios when the beeper sounds an alarm:**

- Any overcurrent protector on the PX3, including fuses and circuit breakers, has tripped or blown. See **Beeper** (on page 167).
- You have set an event rule that turns on the internal beeper when a specific event occurs, and that event occurs now. See **Event Rules and Actions** (on page 364).
- On the PX3 supporting residual current monitoring (RCM), the beeper also sounds when an RCM alarm is detected.

Note that only the RCM sensor will cause the PDU to beep while RCM "DC" sensor does not cause the PDU to beep regardless of its sensor state.

For details, see **PX3 Models with Residual Current Monitoring** (on page 786).

*Tip: To check the internal beeper state via CLI, see **PDU Configuration** (on page 525).*

PX3 Latching Relay Behavior

PX3 incorporates latching relays in models with outlet switching. Unlike non-latching relays, latching relays do NOT require power to keep their contacts closed.

PX3 outlet switching can be configured to operate as a true latching relay or to simulate a non-latching relay. The operating mode determines the latching relay behavior when PDU power is lost. Regardless of which mode is selected, power is not required to keep relay contacts closed.

▶ **Non-Latching Mode:**

- Relay always opens when power is lost. This insures all relays are open when power is applied to the PDU.
- Always select this mode if the combined in-rush current of the devices connected to the PDU trip circuit breakers when power is applied to the PDU.
- This is the factory default operating mode.

▶ **Latching Mode:**

- Relay does not open when power is lost.
- This is the preferred operating mode ONLY if you are sure in-rush current does not trip circuit breakers when power is applied to the PDU.
- Power to the outlet is not disrupted if a PDU internal failure occurs.
- In Latching mode, the following features are disabled.
 - PDU-level outlet state on startup: See **PDU** (on page 194).
 - Outlet-level outlet state on startup: See **Individual Outlet Pages** (on page 218).
 - PDU-level outlet initialization delay on startup: See **PDU** (on page 194).

Options for Outlet State on Startup

The following are available options for initial power states of outlets after powering up the PX3 device.

Option	Function
on	Turns on the outlet(s).
off	Turns off the outlet(s).
last known	Restores the outlet(s) to the previous power state(s) before the PX3 was powered off.

If you are configuring an individual outlet on **Individual Outlet Pages** (on page 218), there is one more outlet state option.

Additional option	Function
PDU defined (xxx)	<p>Follows the global outlet state setting, which is set on PDU (on page 194).</p> <p>The value xxx in parentheses is the currently-selected global option - <i>on</i>, <i>off</i>, or <i>last known</i>.</p>

Initialization Delay Use Cases

Apply the initialization delay in either of the following scenarios.

- When power may not initially be stable after being restored
- When UPS batteries may be charging

Tip: When there are a large number of outlets, set the value to a smaller number to avoid a long wait before all outlets are available.

Inrush Current and Inrush Guard Delay

▶ **Inrush current:**

When electrical devices are turned on, they can initially draw a very large current known as inrush current. Inrush current typically lasts for 20-40 milliseconds.

▶ **Inrush guard delay:**

The inrush guard delay feature helps prevent a circuit breaker trip due to the combined inrush current of many devices turned on at the same time.

For example, if the inrush guard delay is set to 100 milliseconds and two or more outlets are turned on at the same time, the PDU will sequentially turn the outlets on with a 100 millisecond delay occurring between each one.

Time Units

If you choose to type a new value in the time-related fields, such as the "Idle timeout period" field, you must add a time unit after the numeric value. For example, you can type '15 s' for 15 seconds.

Note that different fields have different range of valid values.

► **Time units:**

Unit	Time
ms	millisecond(s)
s	second(s)
min	minute(s)
h	hour(s)
d	day(s)

Setting Thresholds for Total Active Energy or Power

This section applies only to multi-inlet models, including in-line monitors.

Thresholds for total active energy and total active power are disabled by default. You can enable and set them so that you are alerted when the total active energy or total active power hits a certain level.

For a regular PX3 model with multiple inlets:

- Total active energy = sum of all inlets' active energy values
- Total active power = sum of all inlets' active power values

For an in-line monitor with multiple inlets/outlets:

- Total active energy = sum of all outlets' active energy values
- Total active power = sum of all outlets' active power values

► **To configure thresholds for total active energy and/or power:**

1. Click PDU.
 - On the PDU page, you can also view the total active power and total active energy. See **PDU** (on page 194).
2. Click the Thresholds title bar at the bottom of the page to display thresholds.



3. Click the desired sensor (required), and then click Edit Thresholds.

Thresholds				
Edit Thresholds				
Sensor ▲	Lower Critical	Lower Warning	Upper Warning	Upper Critical
Active Energy	---	---	---	---
Active Power	---	---	---	---

4. Make changes as needed.
 - To enable any threshold, select the corresponding checkbox.
 - Type a new value in the accompanying text box.

Lower Critical	<input type="checkbox"/>	0	W
Lower Warning	<input type="checkbox"/>	0	W
Upper Warning	<input type="checkbox"/>	0	W
Upper Critical	<input type="checkbox"/>	0	W
Deassertion Hysteresis		0	W
Assertion Timeout		0	Samples

For concepts of thresholds, deassertion hysteresis and assertion timeout, see **Sensor Threshold Settings** (on page 879).

5. Click Save.

+12V Power Supply Sensor

The PX3's controller receives DC 12V power from its inlet. A sensor monitors the power supply status and indicates it on the PDU page.

Sensors		
Sensor	Value	State
+12V Supply 1 Status		OK

State	Description
OK	The PX3 controller is receiving power from its own inlet.
fault	The PX3 controller cannot receive power from its own inlet because of a power failure on the inlet or a broken 12V power supply. Instead it is receiving power from another PX3 PDU. See Power-Sharing Restrictions and Connection (on page 42). After entering the fault state, this sensor is listed in the Alerted Sensors section of the Dashboard. See Dashboard (on page 183).
unavailable	The communication with the 12V power supply sensor is lost.

► **Alternatives for checking the 12V power supply status:**

- Dot-matrix LCD panel. See **PDU** (on page 128).
- CLI command: `show pdu details`. See **Using the Command Line Interface** (on page 515).

Inlet

You can view all inlet information, configure inlet-related settings, or reset the inlet active energy on the Inlet page. To open this page, click 'Inlet' in the **Menu** (on page 178).

Inlet thresholds, once enabled, help you identify whether the inlet enters the warning or critical level. In addition, you can have PX3 automatically generate alert notifications for any warning or critical status. See **Event Rules and Actions** (on page 364).

*Note: If your PX3 is a multi-inlet model, see **Configuring a Multi-Inlet Model** (on page 205).*

► **Generic inlet information shown:**

- Inlet power overview, which is the same as **Dashboard - Inlet I1** (on page 185).
- A list of inlet sensors with more details. Number of available inlet sensors depends on the model.
 - Sensors show both readings and states.
 - Sensors in warning or critical states are highlighted in yellow or red.
 See **Yellow- or Red-Highlighted Sensors** (on page 255).

- Inlet's power chart, which is the same as **Dashboard - Inlet History** (on page 190)

► **To customize the inlet's name:**

1. Click Edit Settings.

Settings	
	Edit Settings
Label	I1
Name	
Reset energy counter	<input type="button" value="Reset"/>

2. Type a name for the inlet.
 - For example, you can name it to identify the power source.
3. Click Save.
4. The inlet's custom name is displayed on the Inlet or Dashboard page, followed by its label in parentheses.

► **To reset the inlet's active energy counter:**

Only users with the "Admin" role assigned can reset active energy readings. The energy reset feature per inlet is especially useful when your PX3 has more than one inlet.



1. Click .
2. Click Reset on the confirmation message.
This inlet's active energy reading is then reset to zero.

*Tip: To reset ALL active energy counters on the PX3, see **PDU** (on page 194).*

► **To configure inlet thresholds:**

Per default, there are pre-defined RMS voltage and current threshold values in related fields. See **Default Voltage and Current Thresholds** (on page 887). You can modify them to meet your needs.

1. Click the Thresholds title bar at the bottom of the page to display inlet thresholds.



2. Click the desired sensor (required), and then click Edit Thresholds.

Thresholds				
Edit Thresholds				
Sensor ▲	Lower Critical	Lower Warning	Upper Warning	Upper Critical
Active Energy	---	---	---	---
Active Power	---	---	---	---
Apparent Power	---	---	---	---
Line Frequency	57 Hz	59 Hz	61 Hz	63 Hz
Power Factor	---	---	---	---
RMS Current	---	---	5 A	10 A
RMS Voltage	160 V	180 V	240 V	250 V

3. Make changes as needed.
 - To enable any threshold, select the corresponding checkbox.
 - Type a new value in the accompanying text box.

Lower critical	<input checked="" type="checkbox"/>	<input type="text" value="94"/>	V
Lower warning	<input checked="" type="checkbox"/>	<input type="text" value="97"/>	V
Upper warning	<input checked="" type="checkbox"/>	<input type="text" value="247"/>	V
Upper critical	<input checked="" type="checkbox"/>	<input type="text" value="254"/>	V
Deassertion hysteresis		<input type="text" value="2"/>	V
Assertion timeout		<input type="text" value="0"/>	Samples

For concepts of thresholds, deassertion hysteresis and assertion timeout, see **Sensor Threshold Settings** (on page 879).

4. Click Save.

► **To configure residual current thresholds:**

If your model supports residual current monitoring, a section titled "Residual Current Monitor" is displayed on the Inlet page. See **Web Interface Operations for RCM** (on page 790).

Configuring a Multi-Inlet Model

If the PX3 has more than one inlet, the Inlets page lists all inlets.

► **To view or configure each inlet:**

1. Click 'Show Details' of the desired inlet.

The screenshot displays two inlet data cards. The top card is for 'Inlet A' and the bottom card is for 'Inlet B'. Each card shows power consumption (kW and kVA), current (A / 16A) with a progress bar, and other metrics like Active Energy, Power Factor, and Line Frequency. A red box highlights the 'Show Details' button on the right side of each card.

Inlet	Power (kW)	Power (kVA)	Current (A / 16A)	Active Energy (kWh)	Power Factor	Line Frequency (Hz)	RMS Voltage (V)
Inlet A	1.16	1.46	8.8	184.84	0.80	50.0	220
Inlet B	850.0	1.06	5.7	123.62	0.80	50.0	220

2. Now you can configure the selected inlet, such as enabling thresholds or resetting its energy. See **Inlet** (on page 202).
 - To disable the inlet, see the following instructions.

► **To disable one or multiple inlets:**

1. On the individual inlet's data page, click Edit Settings.

The screenshot shows the 'Settings' page for an inlet. It includes a title bar with an up arrow, an 'Edit Settings' button, and several configuration fields: Label (A), Name, Status (Enabled), and a 'Reset Active Energy' button with a 'Reset Energy' button next to it. A red mouse cursor is pointing at the 'Edit Settings' button.

Field	Value
Label	A
Name	
Status	Enabled
Reset Active Energy	Reset Energy

2. Select the "Disable this inlet" checkbox.

3. Click Save.
4. The inlet status now shows "Disabled."

Settings	
	Edit Settings
Label	A
Name	
Status	Disabled
Reset Active Energy	<input type="button" value="Reset Energy"/>

5. To disable additional inlets, repeat the above steps.
 - If disabling an inlet will result in all inlets being disabled, a confirmation dialog appears, indicating that all inlets will be disabled. Then click Yes to confirm this operation or No to abort it.

After disabling any inlet, the following information or features associated with the disabled one are no longer available:

- Sensor readings, states, warnings, alarms or event notifications associated with the disabled inlet.
- Sensor readings, states, warnings, alarms or event notifications for all outlets and overcurrent protectors associated with the disabled inlet.
- The outlet-switching capability, if available, for all outlets associated with the disabled inlet.

Exception: All active energy sensors continue to accumulate data regardless of whether any inlet has been disabled.

Warning: A disabled inlet, if remaining connected to a power source, continues to receive power from the connected power source and supplies power to the associated outlets and overcurrent protectors.

Outlets

The Outlets page shows a list of all outlets and the overview of outlet status and data. To open this page, click 'Outlets' in the **Menu** (on page 178).















On this page, you can:

- **View all outlets' status.**

If any outlet sensor enters the alarmed state, it is highlighted in yellow or red. See **Yellow- or Red-Highlighted Sensors** (on page 255).

- Perform actions on all or multiple outlets simultaneously with setup/power-control commands on the top-right corner.

Note that only outlet-switching capable models show the power-control buttons, and you must have the Switch Outlet permission to perform outlet-switching operations.

Outlets						 On  Off  Cycle  
# ▲	Name	Status	RMS Current	Active Power	Power Factor	
1	Outlet 1	 on	0.211 A	41 W	0.98	
2	Outlet 2	 on	0.793 A	155 W	0.98	
3	Outlet 3	 on	0.274 A	53 W	0.98	
4	Outlet 4	 on	0.236 A	46 W	0.98	
5	Outlet 5	 on	0.673 A	131 W	0.98	
6	Outlet 6	 on	0.782 A	153 W	0.98	
7	Outlet 7	 on	0.547 A	107 W	0.98	
8	Outlet 8	 on	0.305 A	59 W	0.98	

- Go to an individual outlet's data/setup page by clicking an outlet's name. See *Individual Outlet Pages* (on page 218).

Outlets	
# ▲	Name
1	Outlet 1
2	Outlet 2
3	Outlet 3
4	Outlet 4

If wanted, you can resort the list by clicking the desired column header. See **Sorting a List** (on page 182).

▶ **To show or hide specific columns on the outlets overview page:**

1. Click  to show a list of outlet data types.
2. Select those you want to show, and deselect those you want to hide. See **Available Data of the Outlets Overview Page** (on page 210).

▶ **To configure global outlet settings or perform the load-shedding command:**

1. Click  to show a list of commands.
2. Select the desired command.

Note that only outlet-switching capable models have the commands marked with * in the table.

Command	Refer to
Threshold Bulk Setup	Bulk Configuration for Outlet Thresholds (on page 211)
*Sequence Setup	Setting Outlet Power-On Sequence and Delay (on page 212)
*Load Shedding Setup	Setting Non-Critical Outlets (on page 213)
*Activate Load Shedding -- OR -- Deactivate Load Shedding	Load Shedding Mode (on page 215)

▶ **To power control or reset the active energy readings of multiple outlets:**

You can switch any outlet regardless of its current power state. That is, you can turn on any outlet that is already turned on, or turn off any outlet that is already turned off.

1. Click  to make checkboxes appear in front of outlets.



Tip: To perform the desired action on only one outlet, you can simply click that outlet without making the checkboxes appear.

2. Select multiple outlets.

- To select ALL outlets, select the topmost checkbox in the header row.

<input checked="" type="checkbox"/>	# ▲	Name
<input type="checkbox"/>	1	Outlet 1
<input type="checkbox"/>	2	Outlet 2
<input type="checkbox"/>	3	Outlet 3

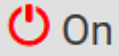
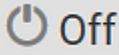
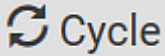
3. Click or select the desired button or command.

Button/command	Action
 On	Power ON.
 Off	Power OFF.
 Cycle	Power cycle. <ul style="list-style-type: none"> ▪ Power cycling the outlet(s) turns the outlet(s) off and then back on.
 > Reset Energy Counter	Resets active energy readings of selected outlets. <ul style="list-style-type: none"> ▪ Only users with the "Admin" role assigned can reset active energy readings.

Confirm the operation when prompted.

*Tip: To reset ALL active energy counters on the PX3, see **PDU** (on page 194). You can also power control an outlet or reset its active energy from **Individual Outlet Pages** (on page 218).*

4. When performing any outlet-switching operation, a 'Sequence running' message similar to the following displays before the outlet-switching process finishes.
 - It indicates how many selected outlets are NOT switched on/off or cycled yet.

- If needed, click  to stop the outlet-switching operation.

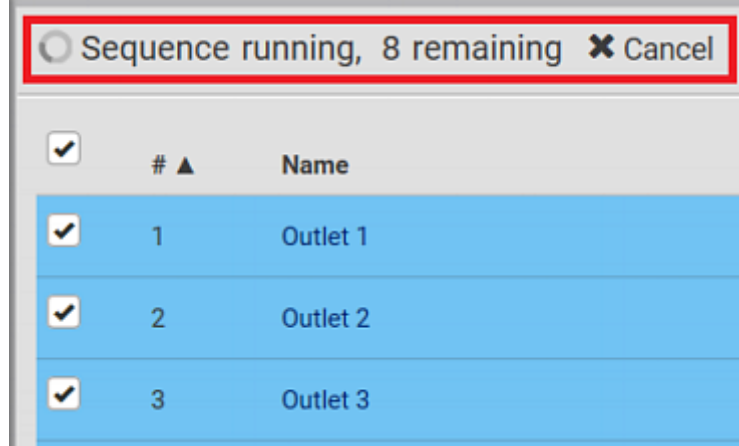



Available Data of the Outlets Overview Page

All or some of the following outlet data is displayed on the outlets overview page based on your model and selection. To show or hide specific data, click



. See **Outlets** (on page 206).

- Outlet status, which is marked with either icon below. This information is available on outlet-switching capable models only.

Icon	Outlet status
	Outlet turned on
	Outlet turned off

- RMS current (A)
- Active power (W)
- Power factor
- Non-critical setting for indicating whether the outlet is a non-critical outlet. This information is available on outlet-switching capable models only.

Non-critical setting	Description
true	The outlet is a non-critical outlet, which will be turned OFF in the load shedding mode. See Load Shedding Mode (on page 215).
false	The outlet is a critical outlet, which will remain unchanged in the load shedding mode.

- Sequence order
- Sequence delay (seconds)

*Note: To set critical and non-critical outlets, or set sequence-related settings, see **Outlets** (on page 206).*

Bulk Configuration for Outlet Thresholds

Outlet thresholds, if enabled, help you identify whether any outlet enters the warning or critical level. See **Yellow- or Red-Highlighted Sensors** (on page 255). In addition, you can have PX3 automatically generate alert notifications for any warning or critical status. See **Event Rules and Actions** (on page 364).

Thresholds of multiple or all outlets can be configured simultaneously on the Outlets page.

Per default, there are pre-defined RMS voltage and current threshold values in related fields. See **Default Voltage and Current Thresholds** (on page 887).

► To configure thresholds-related settings for multiple outlets:

1. On the Outlets page, click  > Threshold Bulk Setup.
2. In the "Show Outlet Sensors of Type" field, select a sensor type.
3. Select one or multiple outlets.
 - To select ALL outlets, select the topmost checkbox in the header row.

<input checked="" type="checkbox"/>	# ▲	Name
<input type="checkbox"/>	1	Outlet 1
<input type="checkbox"/>	2	Outlet 2
<input type="checkbox"/>	3	Outlet 3

4. Click Edit Thresholds.
5. Make changes as needed.
 - To enable any threshold, select the corresponding checkbox.

- Type a new value in the accompanying text box.

Lower critical	<input checked="" type="checkbox"/>	94	V
Lower warning	<input checked="" type="checkbox"/>	97	V
Upper warning	<input checked="" type="checkbox"/>	247	V
Upper critical	<input checked="" type="checkbox"/>	254	V
Deassertion hysteresis		2	V
Assertion timeout		0	Samples

For concepts of thresholds, deassertion hysteresis and assertion timeout, see **Sensor Threshold Settings** (on page 879).

6. Click Save.

Setting Outlet Power-On Sequence and Delay





By default, outlets are sequentially powered on in the ascending order from outlet 1 to the final when turning ON or power cycling all outlets on the PX3. You can change the order in which the outlets power ON. This is useful when there is a specific order in which some IT equipment should be powered up first.

In addition, you can make a delay occur between two outlets that are turned on consecutively. For example, if the power-on sequence is Outlet 1 through Outlet 8, and you want the PX3 to wait for 5 seconds before turning on Outlet 4, after Outlet 3 is turned on, assign a delay of 5 seconds to Outlet 3.

► **To set the outlet power-on sequence:**

1. On the Outlets page, click  > Sequence Setup.
2. Select one or multiple outlets by clicking them one by one in the 'Outlet' column.
3. Click the arrow buttons to change the outlet positions.

Button	Function
	Top

Button	Function
	Up
	Down
	Bottom
	Restores to the default sequence

Next time when power cycling the PX3, it will turn on all outlets based on the new outlet order.

The new order also applies when performing the power-on or power-cycling operation on partial outlets.

► **To set a power-on delay for any outlet:**

1. On the same outlets list, click the 'Delay' column of the outlet that requires a wait after it is turned on.
2. Type a new value in seconds.
3. Click Save.

PX3 will insert a power-on delay between the configured outlet and the one following it during the power-on process.

Setting Non-Critical Outlets

Outlets that are turned off when load shedding is activated are called non-critical outlets. Outlets that are not affected by load shedding are called critical outlets. See **Load Shedding Mode** (on page 215).

Per default, all outlets are configured as critical.

► **To determine critical and non-critical outlets:**

1. On the Outlets page, click  > Load Shedding Setup.
2. To set non-critical outlets, select the checkboxes of those you want.

- To select ALL outlets, select the topmost checkbox in the header row.

Load Shedding	
<input checked="" type="checkbox"/> Non Critical	Outlets ▲
<input type="checkbox"/>	Outlet 1
<input type="checkbox"/>	Outlet 2
<input type="checkbox"/>	Outlet 3

3. To turn non-critical outlets into critical ones, deselect their checkboxes.
 - To deselect ALL outlets, deselect the topmost checkbox in the header row.
4. Click Save.

*Tip: You can also set up non-critical outlet setting by configuring outlets one by one. See **Individual Outlet Pages** (on page 218).*

Load Shedding Mode

When a UPS supplying power to PX3 switches into battery backup operation, it may be desirable to switch off non-critical outlets to conserve UPS battery life. This feature is known as load shedding.

Outlets that are turned off when load shedding is activated are called non-critical outlets. Outlets that are not affected by load shedding are called critical outlets. By default, all outlets are critical. To set non-critical ones, see **Setting Non-Critical Outlets** (on page 213).

When load shedding is activated, the PX3 turns off all non-critical outlets. When load shedding is deactivated, the PX3 turns back on all non-critical outlets that were ON before entering the load shedding mode.

Exception: If you once manually perform switch-off operation on any non-critical outlets during the load shedding mode, those outlets will NOT be turned back on when exiting the load shedding mode.

Activation of load shedding can be accomplished using the web interface, SNMP or CLI, or triggered by the contact closure sensors.

*Tip: It is better to check non-critical outlets prior to manually entering the load shedding mode. The non-critical information can be retrieved from the Outlets page. See **Outlets** (on page 206) or **Available Data of the Outlets Overview Page** (on page 210).*

You must have the following two permissions to perform the load shedding commands.

- 'Change Pdu, Inlet, Outlet & Overcurrent Protector Configuration'
- 'Switch Outlet' permission for all **non-critical** outlets



▶ To enter the load shedding mode:

1. On the Outlets page, click  > Activate Load Shedding.

Note: In case PX3 prevents you from performing this command, check your permissions, especially whether you have the Switch Outlet permission for ALL non-critical outlets.

2. Click Activate on the confirmation message.

In the load shedding mode:

- You CANNOT power on any "non-critical" outlets.
- The lock icon  appears for "non-critical" outlets that WILL be automatically powered on when deactivating the load shedding mode.
- The off icon  appears for outlets, critical or non-critical, that WILL NOT be automatically powered on when deactivating the load shedding mode.

*Tip: The above two icons are switched if you manually perform any power operations on non-critical outlets during the load shedding mode. See **Off and Lock Icons for Outlets** (on page 217).*

- The message "Load shedding active" appears next to the 'Outlets' title.
- The Non Critical column, if not shown prior to the load shedding mode, automatically displays on the Outlets page.

# ▲	Name	Status	Non-Critical	
Outlets Load shedding active 🔌 On 🔌 Off 🔄 Cycle 📧 ⋮				
1	Outlet 1	🔒 off	true	
2	Outlet 2	🔒 off	true	
3	Outlet 3	🔌 on	false	
4	Outlet 4	🔌 on	false	
5	Outlet 5	🔌 off	false	
6	Outlet 6	🔌 on	false	

*Tip: To make the Non-Critical column appear when the load shedding mode is not activated yet. See **Outlets** (on page 206) or **Available Data of the Outlets Overview Page** (on page 210).*

▶ **To exit from the load shedding mode:**

1. On the Outlets page, click ⋮ > Deactivate Load Shedding.
2. Click Deactivate on the confirmation message.



Now you can turn on/off any outlets.

▶ **TIP -- automatic load shedding via contact closure sensors:**

If you have connected a Raritan contact closure sensor to PX3, you can set up an event rule in a manner that this sensor's status change automatically activates or deactivates the load shedding mode. For an example, see **Sample Environmental-Sensor-Level Event Rule** (on page 423).

Off and Lock Icons for Outlets

This section further explains the following two icons for outlets, which display in the load shedding mode.

- Lock icon : It means the outlet WILL be automatically powered on after deactivating the load shedding mode.
- Off icon : It means the outlet will remain powered OFF when deactivating the load shedding mode.

▶ Which outlets show the lock icon :

- **Non-critical** outlets that were powered ON prior to the load shedding mode
- **Non-critical** outlets that you manually switch on during the load shedding mode

Note: The switching-on operation does not power on the selected non-critical outlets while the load shedding mode is active, but will cause those outlets to be automatically turned on after disabling the load shedding mode.

▶ Which outlets show the Off icon :

- Any outlets, **critical or non-critical**, that were powered OFF prior to the load shedding mode
- Any outlets, **critical or non-critical**, that you manually switch off during the load shedding mode

Individual Outlet Pages

An outlet's data/setup page is opened after clicking the outlet's name on the Outlets overview page. See **Outlets** (on page 206).

Outlets	
# ▲	Name
1	Outlet 1
2	Outlet 2
3	Outlet 3
4	Outlet 4

The individual outlet's page shows this outlet's detailed information. See **Detailed Information on Outlet Pages** (on page 224).

In addition, you can perform the following operations on this outlet page. Note that only outlet-switching capable models show the power-control buttons, and you must have the Switch Outlet permission to perform outlet-switching operations.

► **To power control this outlet:**

1. Click one of the power-control buttons.

⌵ Outlet 1

🔴 On
⏻ Off
🔄 Cycle

Details	
Label	1
Outlet status	🔴 on
Receptacle type	IEC 60320 C13
Lines	L1-NEUTRAL
Inlet	Inlet I1
Overcurrent protector	Overcurrent Protector C1

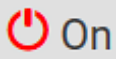
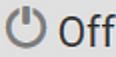
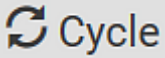
Button/command	Action
 On	Power ON.
 Off	Power OFF.
 Cycle	Power cycle. <ul style="list-style-type: none"> Power cycling the outlet(s) turns the outlet(s) off and then back on.

2. Confirm it on the confirmation message.

*Tip: To switch an outlet using the front panel display, see **Power Control** (on page 137).*

► **To configure this outlet:**

1. Click Edit Settings.

Settings	
	Edit Settings
Name	
State on device startup	PDU defined (last known)
Power off period during power cycle	PDU defined (10 seconds)
Non-critical	False
Reset energy counter	<input type="button" value="Reset"/>

2. Configure available fields. Note that the fields marked with * are only available on outlet-switching capable models.

Field	Description
Name	Type an outlet name up to 64 characters long.
*State on device startup	Click this field to select this outlet's initial power state after PX3 powers up. <ul style="list-style-type: none"> Options: <i>on</i>, <i>off</i>, <i>last known</i> and <i>PDU defined</i>. See Options for Outlet State on Startup (on page 198). Note that any option other than "PDU defined" will override the global outlet state setting on this particular outlet.

Field	Description
*Power off period during power cycle	Select an option to determine how long this outlet is turned off before turning back on. <ul style="list-style-type: none"> Options: <i>PDU defined</i> or customized time. See Power-Off Period Options for Individual Outlets (on page 225). Note that any time setting other than "PDU defined" will override the global power-off period setting on this particular outlet.
*Non-critical	Select this checkbox only when you want this outlet to turn off in the load shedding mode. See Load Shedding Mode (on page 215).

- Click Save.
- The outlet's custom name, if available, is displayed in the outlets list, following by its label in parentheses.

*Note for 'State on device startup': This setting works only when 'Relay behavior on power loss' is set to Non-latching. This is because all relays keep their states unchanged in the latching mode regardless of the power supply status. See **PDU** (on page 194).*

► **To reset this outlet's active energy reading:**

Only users with the "Admin" role assigned can reset active energy readings.

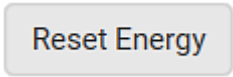

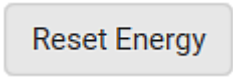
- Click .
- Click Reset on the confirmation message.

*Tip: To reset ALL active energy counters on the PX3, see **PDU** (on page 194).*

► **To view this outlet's power chart:**

By default this outlet's active power data within the past tens of minutes is shown in the power chart.

You can click the selector  below the chart to show a different data type for this outlet, including:

- RMS current
- RMS voltage
- Active power
- Apparent power

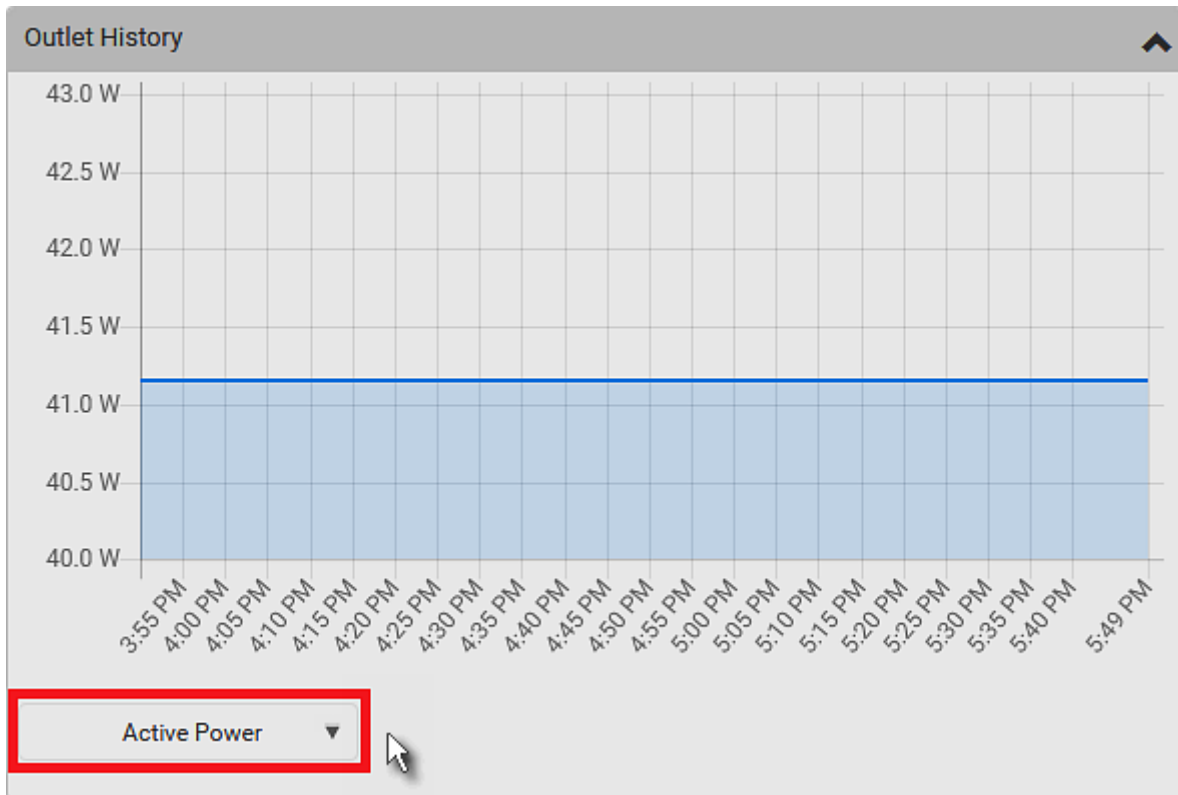

- To retrieve the exact data at a particular time, hover your mouse over the data line in the chart. Both the time and data are displayed as illustrated below.

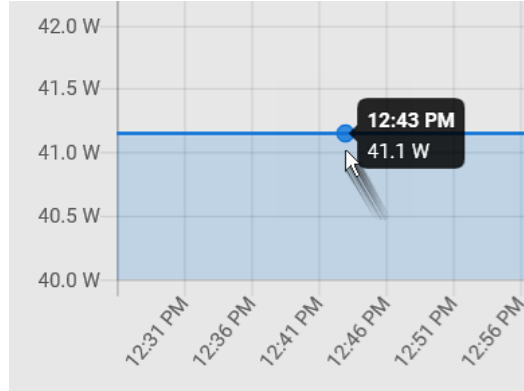

► **To configure this outlet's threshold settings:**

Per default, there are pre-defined RMS voltage and current threshold values in related fields. See **Default Voltage and Current Thresholds** (on page 887). You can modify the defaults as needed.

*Note: The threshold values set for an individual outlet will override the bulk threshold values, if any, stored on that particular outlet. See **Bulk Configuration for Outlet Thresholds** (on page 211).*

1. If the outlet's threshold data is invisible, click the Thresholds title bar to display it.



2. Click the desired sensor (required), and then click Edit Thresholds.

Thresholds				
Sensor ▲	Lower Critical	Lower Warning	Upper Warning	Upper Critical
Active Energy	---	---	---	---
Active Power	---	---	---	---
Apparent Power	---	---	---	---
Line Frequency	---	---	---	---
Power Factor	---	---	---	---
RMS Current	---	---	10.4 A	12.8 A
RMS Voltage	---	---	---	---

3. Make changes as needed.

- To enable any threshold, select the corresponding checkbox.
- Type a new value in the accompanying text box.

Lower critical	<input checked="" type="checkbox"/>	<input type="text" value="94"/>	<input type="text" value="V"/>
Lower warning	<input checked="" type="checkbox"/>	<input type="text" value="97"/>	<input type="text" value="V"/>
Upper warning	<input checked="" type="checkbox"/>	<input type="text" value="247"/>	<input type="text" value="V"/>
Upper critical	<input checked="" type="checkbox"/>	<input type="text" value="254"/>	<input type="text" value="V"/>
Deassertion hysteresis		<input type="text" value="2"/>	<input type="text" value="V"/>
Assertion timeout		<input type="text" value="0"/>	<input type="text" value="Samples"/>

For concepts of thresholds, deassertion hysteresis and assertion timeout, see **Sensor Threshold Settings** (on page 879).

4. Click Save.

► **Other operations:**

- You can go to another outlet's data/setup page by clicking the outlet selector  on the top-left corner.
- You can go to the associated Inlet's or overcurrent protector's data pages by clicking the Inlet or Overcurrent Protector links in the Details section.



◅ Outlet 1

⏻ On
 ⏻ Off
↻ Cycle

Details	
Label	1
Outlet status	⏻ on
Receptacle type	IEC 60320 C13
Lines	L1-NEUTRAL
Inlet	Inlet I1
Overcurrent protector	Overcurrent Protector C1

Detailed Information on Outlet Pages

Each outlet's data page has the Details section for showing general outlet information and Sensors section for showing the outlet sensor status.

► **Details section:**

Field	Description
Label	The physical outlet number
Outlet status	<div style="background-color: #f2f2f2; padding: 5px; margin-bottom: 5px;">This information is only available on outlet-switching capable models.</div> On or Off
Receptacle type	This outlet's receptacle type
Lines	Lines associated with this outlet

Field	Description
Inlet	<p>This information is useful when there are multiple inlets on your PDU.</p> <p>Inlet associated with this outlet</p>
Overcurrent protector	<p>This information is available only when your PX3 has overcurrent protectors.</p> <p>Overcurrent protector associated with this outlet</p>

► **Sensors section:**

- RMS current (A)
- RMS voltage (V)
- Active power (W)
- Active energy (Wh)
- Apparent power (VA)
- Power factor
- Line frequency (Hz) -- *model dependent*

If any outlet sensor enters the alarmed state, it is highlighted in yellow or red. See **Yellow- or Red-Highlighted Sensors** (on page 255).

Power-Off Period Options for Individual Outlets

There are two options for setting the power-off period during the power cycle on each individual outlet's page. See **Individual Outlet Pages** (on page 218).

Option	Function
PDU defined (xxx)	Follows the global power-off period setting, which is set on PDU (on page 194). The value xxx in parentheses is the current global value.
Customized time	<p>If selecting this option, do either of the following:</p> <ul style="list-style-type: none"> ▪ Click  to select an existing time option. ▪ Type a new value <i>with an appropriate time unit added</i>. See Time Units (on page 200).

Outlet Groups

Only PDUs with outlet-switching and/or outlet-metering feature show this menu item.

Choose Outlet Groups in the **Menu** (on page 178). The following Outlet Groups page opens.

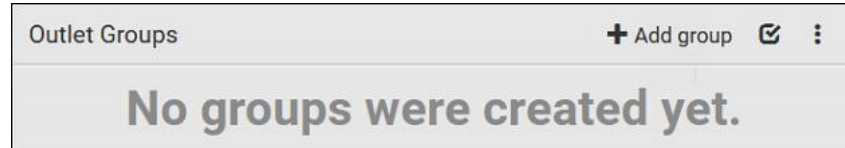

▶ **Required permissions:**

You must have one of the permissions below to be able to operate all or some of the outlet group features.

- Administrator Privileges -- *all operations*
- Change Pdu, Inlet, Outlet & Overcurrent Protector Configuration -- *creating, editing and deleting outlet groups*
- Switch Outlet Group -- *powering on, off or cycle outlet groups*

▶ **Outlet group operations:**

You can group one or multiple outlets on this page using . See **Creating an Outlet Group** (on page 227).

The Outlet Groups page will list all outlet groups you create.

The screenshot shows a header bar with the text 'Outlet Groups' on the left, and '+ Add group', a checkmark icon, and a vertical ellipsis icon on the right. Below the header is a table with the following data:

# ▲	Name	Outlet State	Active Power	Outlets
1	Outlet group 1	2 on	0 W	1-2
2	Outlet group 2	1 on , 2 off	0 W	1 and 3-4
3	Outlet group 3	1 on , 3 off	0 W	1, 3 and 5-6

Then you can perform one of the following actions on one or multiple outlet groups:

- Power on, off or cycle the selected group(s). See **Outlet Group Power Control** (on page 228).
- Observe the power status of each outlet group and/or power status of each member outlet.
- Re-name a group or change its member outlets. See **Modifying an Outlet Group** (on page 233).
- Observe or monitor the following group sensors.
 - A group's active power: sum of all member outlets' active power values.
 - A group's active energy: sum of **increments** of all member outlets' active energy values. The initial value is zero when a group is created. Removal of any member outlet will NOT cause its group's active energy value to decrease.

Note: A group's active energy is NOT the sum of all member outlets' active energy values.

- Reset the active energy values of the selected group(s). See **Resetting a Group's Active Energy** (on page 232).
- Enable and set up the thresholds of a group's sensor(s) so that the PDU can display an alarm when a threshold is reached or crossed. See **Modifying an Outlet Group** (on page 233).

Creating an Outlet Group

You can create an outlet group if you often have to perform the same action on the same outlets at a regular interval.

For example, create an outlet group when you need to:

- Power cycle specific outlets every week.
- Sum up and track specific outlets' active power values every month.
- Sum up the increased values of specific outlet's active energy values every month.

Note that an outlet can be the member outlet of one or multiple groups.

To create an outlet group, you must have either permission below.

- Administrator Privileges
- Change Pdu, Inlet, Outlet & Overcurrent Protector Configuration

▶ To create an outlet group:

1. Click  .

2. Type the group name.

3. Select the outlets you want in the Available field.
 - To select all outlets of the PDU, click Select All.
4. To delete any selected outlet(s), click an outlet's  in the Selected field.
 - To remove all selected outlets, click Deselect All.
5. Click Save.

Tip: PX3 allows you to assign the same name to diverse outlet groups. If this really occurs, you still can identify different groups through their unique index numbers.

Outlet Group Power Control

You must have either permission below to power control any outlet groups.

- Administrator Privileges
- Switch Outlet Group

You can switch one or multiple outlet groups at a time on the Outlet Groups page.

To switch one single outlet group only, there are two methods -- either the Outlet Groups page or individual group page.

► **To switch one or multiple groups on the Outlet Groups page:**

This method allows you to switch more than one outlet group simultaneously.

1. Click  to make checkboxes appear in front of outlet groups.

Tip: To perform the desired action on only one outlet group, you can simply click that group without making the checkboxes appear.

2. Select multiple outlet groups.

- To select ALL outlet groups, select the topmost checkbox in the header row.

<input checked="" type="checkbox"/>	# ▲	Name
<input type="checkbox"/>	1	Outlet group 1
<input type="checkbox"/>	2	Outlet group 2
<input type="checkbox"/>	3	Outlet group 3

3. Click the desired button.

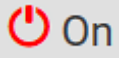
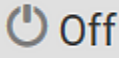
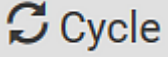
Button/command	Action
 On	Power ON.
 Off	Power OFF.
 Cycle	Power cycle. <ul style="list-style-type: none"> ▪ Power cycling the outlet(s) turns the outlet(s) off and then back on.

Confirm the operation when prompted.

4. Verify that the outlet-switching result on the Outlet State column of the Outlet Groups page.
 - For example, if a group's Outlet State reads "1 on, 2 off", it means there are 3 outlets in total -- one of the outlets is turned ON, and two of the outlets are turned OFF.

- For detailed information about which outlets are turned on and which are turned off, you can open that outlet group's page by clicking on its name.

Outlet Groups		
# ▲	Name	Outlet State
1	Outlet group 1	2 on
2	Outlet group 2	1 on , 2 off
3	Outlet group 3	1 on , 3 off

► To switch one group on a specific outlet group's page:

This method allows you to switch ONLY one outlet group at a time.

1. Open a specific outlet group's page by clicking on its name.

Outlet Groups	
# ▲	Name
1	Outlet group 1
2	Outlet group 2
3	Outlet group 3

2. Click the desired power control button on the top-right corner.

- Confirm the operation when prompted.

# ▲	Outlet	Status	Active Power
1	Outlet 1	on	0 W
2	Outlet 2	on	0 W

If Switchable Outlet Groups are Limited

For the Switch Outlet Group permission, if you assign a role to any user, which permits the user to switch only "specific" outlet groups instead of all outlet groups, the following switching issue may appear.

► Issue:

- When an outlet group that the user originally can switch is deleted, and then re-created with the same group name, the user will not be able to switch the "new" outlet group with the same group name.

► Solution:

1. Edit the role assigned to the user. See **Editing or Deleting Roles** (on page 295).
2. Find the Switch Outlet Group permission, and re-select that newly-created outlet group in its outlet group list.

Note: The above issue does not occur for any role which has "All Outlet Groups" selected for its Switch Outlet Group permission.

Resetting a Group's Active Energy

An outlet group's active energy is the sum of **increments** of all member outlets' active energy values. For detailed information, see **Outlet Groups** (on page 226).

Note: A group's active energy is NOT the sum of all member outlets' active energy values.

A group's active energy decreases to zero when it is reset.

- You can reset the active energy sensor(s) of one or multiple outlet groups at a time on the Outlet Groups page.
- To reset a single outlet group's active energy sensor, there are two methods -- either Outlet Groups page or individual group page.
- Resetting an outlet group's active energy has NO impact on any member outlet's active energy so all member outlets' active energy values remain unchanged.

It requires the Administrator Privileges to reset any outlet group's active energy.

► **To reset the active energy of one or multiple groups on the Outlet Groups page:**

This method allows you to reset the active energy of more than one outlet group simultaneously.

1. Click  to make checkboxes appear in front of outlet groups.

Tip: To perform the desired action on only one outlet group, you can simply click that group without making the checkboxes appear.

2. Select multiple outlet groups.
 - To select ALL outlet groups, select the topmost checkbox in the header row.

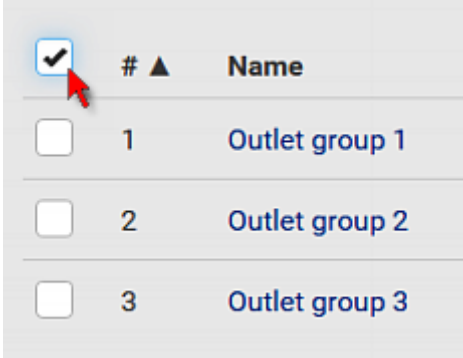

<input checked="" type="checkbox"/>	# ▲	Name
<input type="checkbox"/>	1	Outlet group 1
<input type="checkbox"/>	2	Outlet group 2
<input type="checkbox"/>	3	Outlet group 3

3. Click  > Reset Energy Counter.

- Confirm the operation when prompted.

► **To reset one group's active energy on a specific outlet group's page:**

This method allows you to reset the active energy of ONLY one outlet group at a time.

1. Open a specific outlet group's page by clicking on its name.

Outlet Groups	
# ▲	Name
1	Outlet group 1
2	Outlet group 2
3	Outlet group 3

2. Click Reset in the Settings section.
 - Confirm the operation when prompted.

Settings	
Edit Settings	
Name	outlet group 1
Reset energy counter	<input type="button" value="Reset"/>

*Note: The energy reset feature on the PDU page resets active energy of "outlets" and/or "inlet(s)" only. It does NOT reset outlet groups' active energy values. See **PDU** (on page 194).*

Modifying an Outlet Group

To modify an outlet group, you must have either permission below.

- Administrator Privileges
- Change Pdu, Inlet, Outlet & Overcurrent Protector Configuration

You can do the following on an individual outlet group's page:

- Change its member outlets
- Modify its group name
- Observe its group sensors' values and states
 - Active power: sum of all member outlets' active power values.

- Active energy: sum of **increments** of all member outlets' active energy values.

For detailed information on the two group sensors, see **Outlet Groups** (on page 226).



- View the group's active power chart
- Configure the thresholds of its group sensors

To open any outlet group's page, click on its name on the Outlet Groups page.

Outlet Groups	
# ▲	Name
1	Outlet group 1
2	Outlet group 2
3	Outlet group 3

► **To modify the member outlets:**

1. Click Edit Members.

Outlets			
# ▲	Outlet	Status	Active Power
			Edit Members
1	Outlet 1	 on	0 W
2	Outlet 2	 on	0 W

2. Add or remove outlets of this group.
 - To select any outlet(s), select them one by one from the Available list.
 - To select all available outlets, click Select All.
 - To remove any outlet(s) from the Selected field, click that outlet's .

- To remove all outlets, click Deselect All.

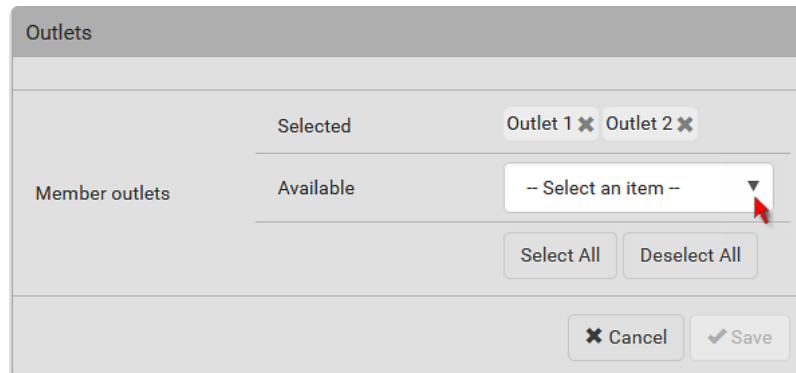

3. Click Save.

► **To change the group name:**

1. Click Edit Settings.



2. Type a new name.
3. Click Save.

Tip: PX3 allows you to assign the same name to diverse outlet groups. If this really occurs, you still can identify different groups through their unique index numbers.

► **To configure the thresholds of group sensors:**

1. Click the Thresholds title bar at the bottom of the page to display thresholds.



2. **Click the desired sensor** (required), and then click Edit Thresholds.

Thresholds				
Edit Thresholds				
Sensor ▲	Lower Critical	Lower Warning	Upper Warning	Upper Critical
Active Energy	---	---	---	---
Active Power	---	---	---	---

3. Make changes as needed.
 - To enable any threshold, select the corresponding checkbox.
 - Type a new value in the accompanying text box.For concepts of thresholds, deassertion hysteresis and assertion timeout, see **Sensor Threshold Settings** (on page 879).
4. Click Save.

Deleting an Outlet Group

To delete an outlet group, you must have either permission below.

- Administrator Privileges
- Change Pdu, Inlet, Outlet & Overcurrent Protector Configuration

You can delete one or multiple outlet groups at a time.

To delete a single outlet group only, there are two methods -- either Outlet Groups page or individual group page.

► **To delete one or multiple groups on the Outlet Groups page:**

This method allows you to delete more than one outlet group.



1. Click  to make checkboxes appear in front of outlet groups.

Tip: To perform the desired action on only one outlet group, you can simply click that group without making the checkboxes appear.

2. Select multiple outlet groups.
3. To select ALL outlet groups, select the topmost checkbox in the header row.



<input checked="" type="checkbox"/>	# ▲	Name
<input type="checkbox"/>	1	Outlet group 1
<input type="checkbox"/>	2	Outlet group 2
<input type="checkbox"/>	3	Outlet group 3



4. Click  >  **Delete**.
 - Confirm the operation when prompted.

► **To delete a group on a specific outlet group's page:**

This method allows you to delete ONLY one outlet group at a time.

1. Open a specific outlet group's page by clicking on its name.

Outlet Groups	
# ▲	Name
1	Outlet group 1
2	Outlet group 2
3	Outlet group 3

2. Click  >  Delete.
 - Confirm the operation when prompted.

Viewing More Information

On the individual outlet group page, you can view more information by doing the following.

► **To observe an outlet group's active power chart:**

- The chart of an outlet group's active power history will be shown for you to have an overview of its overall changes in the past tens of minutes.

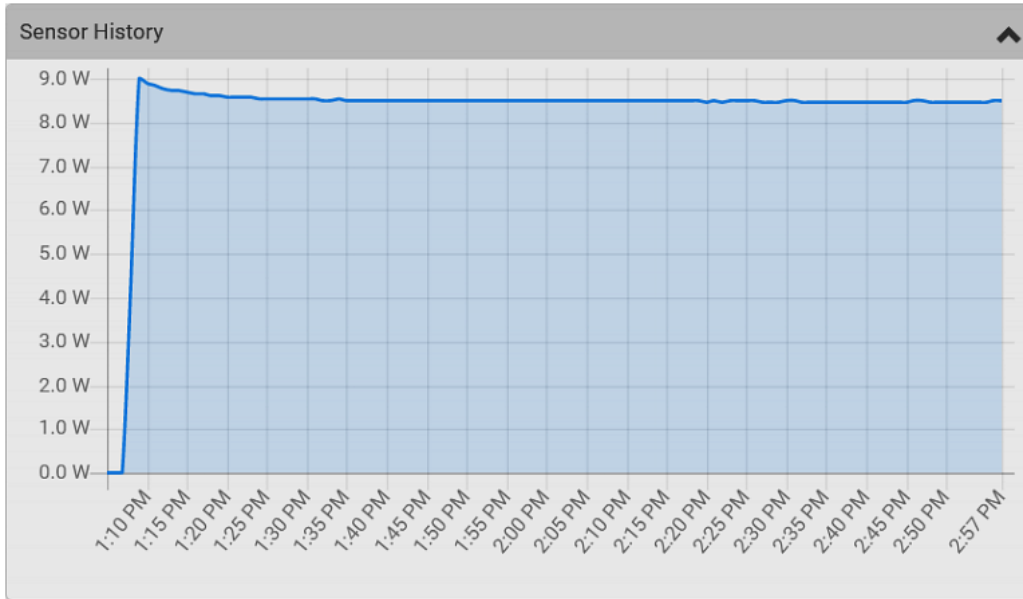

- To retrieve the exact data at a particular time, hover your mouse over the data line in the chart. Both the time and data are displayed as illustrated below.

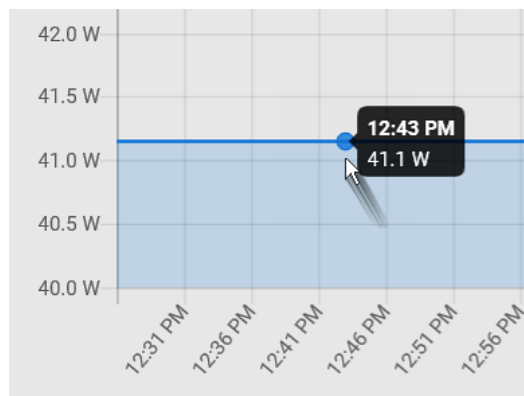

► **To visit a member outlet's page from the current page:**

- On an outlet group's individual page, you can go to a member outlet's page easily. Just click the outlet links in the Outlets section.

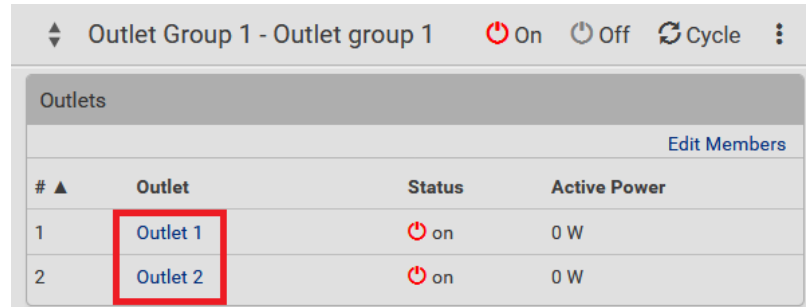

# ▲	Outlet	Status	Active Power
1	Outlet 1	🔴 on	0 W
2	Outlet 2	🔴 on	0 W

► **To visit a different outlet group's page from the current page:**

- On an outlet group's individual page, you can go to another outlet group's page easily. Just click the outlet selector  on the top-left corner.

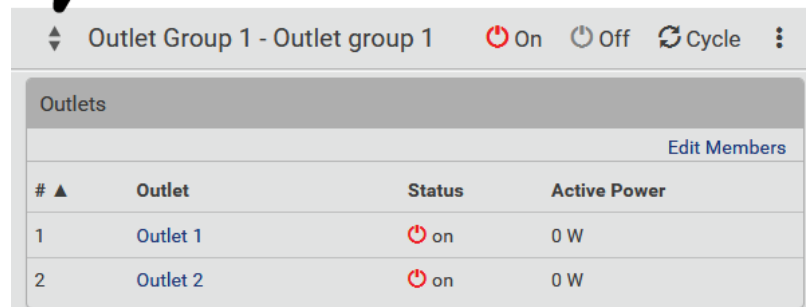
# ▲	Outlet	Status	Active Power
1	Outlet 1	🔴 on	0 W
2	Outlet 2	🔴 on	0 W

OCPs

The OCPs page is available only when your PX3 has overcurrent protectors, such as circuit breakers.

The OCPs page lists all overcurrent protectors as well as their status. If any OCP trips or its current level enters the alarmed state, it is highlighted in red or yellow. See **Yellow- or Red-Highlighted Sensors** (on page 255).

To open the OCPs page, click 'OCPs' in the **Menu** (on page 178).

You can go to each OCP's data/setup page by clicking its name on this page.





Overcurrent Protectors						
# ▲	Name	Status	Current Drawn	Protected Outlets	Lines	
1	Overcurrent Protector C1	closed	4.390 A / 16 A	<div style="width: 27%; background-color: green;"></div>	1-10	L1-L2
2	Overcurrent Protector C2	closed	5.619 A / 16 A	<div style="width: 35%; background-color: green;"></div>	11-20	L2-L3
3	Overcurrent Protector C3	closed	5.396 A / 16 A	<div style="width: 33%; background-color: green;"></div>	21-30	L3-L1

If wanted, you can resort the list by clicking the desired column header. See **Sorting a List** (on page 182).

► Overcurrent protector overview:

- OCP status - open (tripped) or closed
- Current drawn, rated current and current bar
 - The smaller, gray text adjacent to "current drawn" is the rated current of each OCP.
 - The RMS current bars change colors to indicate the status if the OCP thresholds have been configured and enabled.

Status	Bar colors
normal	
above upper warning	
above upper critical	

Note: The "below lower warning" and "below lower critical" states also show yellow and red colors respectively. However, it is not meaningful to enable the two thresholds for current levels.

- Protected outlets, which are indicated with outlet numbers
- Associated lines

► **To configure current thresholds for multiple overcurrent protectors:**

OCP thresholds, when enabled, help you identify the OCP whose RMS current enters the warning or critical level with the yellow or red color. In addition, you can have PX3 automatically generate alert notifications for any warning or critical status. See **Event Rules and Actions** (on page 364).

*Note: By default, upper thresholds of an OCP's RMS current have been configured. See **Default Voltage and Current Thresholds** (on page 887). You can modify them as needed.*

1. Click  > Threshold Bulk Setup.
2. Select one or multiple OCPs.
 - To select all OCPs, simply click the topmost checkbox in the header row.

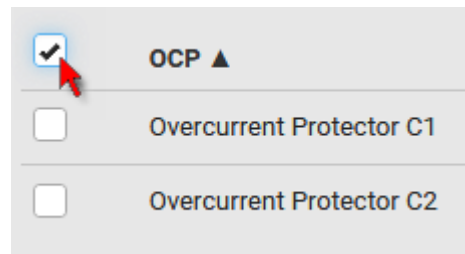

3. Click Edit Thresholds.
4. Make changes as needed.
 - To enable any threshold, select the corresponding checkbox.

- Type a new value in the accompanying text box.

Lower critical	<input type="checkbox"/>	0	A
Lower warning	<input type="checkbox"/>	0	A
Upper warning	<input checked="" type="checkbox"/>	10.4	A
Upper critical	<input checked="" type="checkbox"/>	12.8	A
Deassertion hysteresis		1	A
Assertion timeout		0	Samples

For concepts of thresholds, deassertion hysteresis and assertion timeout, see **Sensor Threshold Settings** (on page 879).

5. Click Save.

Individual OCP Pages

An OCP's data/setup page is opened after clicking any OCP's name on the OCPs or Dashboard page. See **OCPs** (on page 240) or **Dashboard** (on page 183).

► General OCP information:

Field	Description
Label	This OCP's physical number.
Status	open or closed. <ul style="list-style-type: none"> ▪ When an OCP trips (open), if your PX3 is an outlet-metered model that supports "outlet peak current" sensors, a message will show up, indicating which outlet is likely to trigger the OCP-tripped event. For details, see Possible OCP-Tripped Root Cause (on page 247).
Type	This OCP's type.
Rating	This OCP's rated current.

Field	Description
Lines	Lines associated with this OCP.
Protected outlets	Outlets associated with this OCP.
Inlet	Inlet associated with this OCP. This information is useful only when your PDU has multiple inlets.
RMS current	This OCP's current state and readings, including current drawn and current remaining.

► **To customize this OCP's name:**

1. Click Edit Settings.
2. Type a name.
3. Click Save.

► **To view this OCP's RMS current chart:**

This OCP's data chart is shown in the Overcurrent Protector History section.

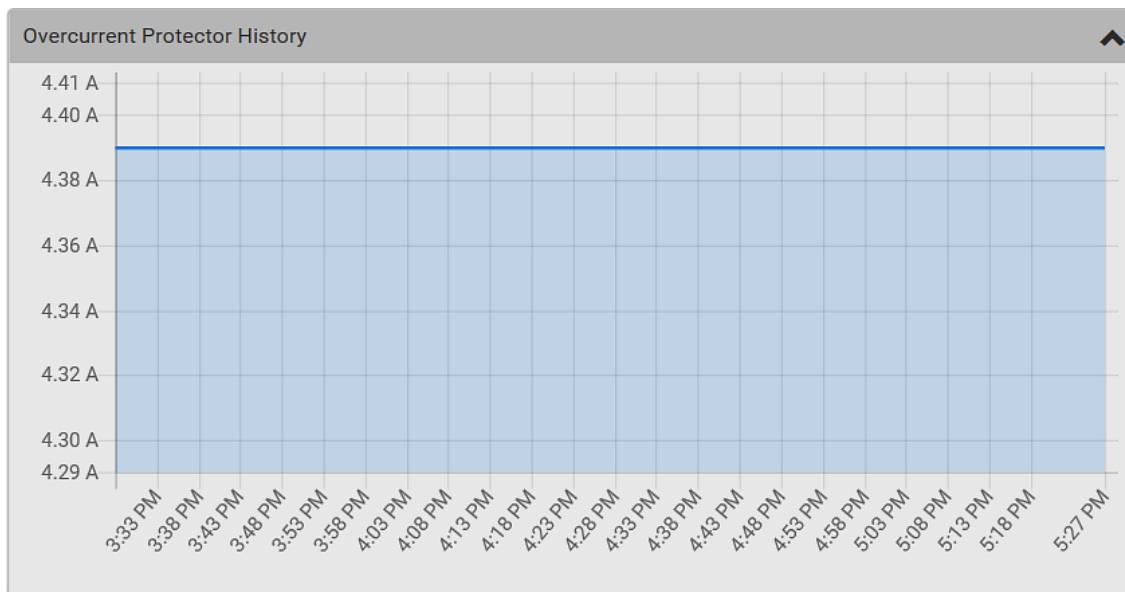

- To retrieve the exact data at a particular time, hover your mouse over the data line in the chart. Both the time and data are displayed as illustrated below.

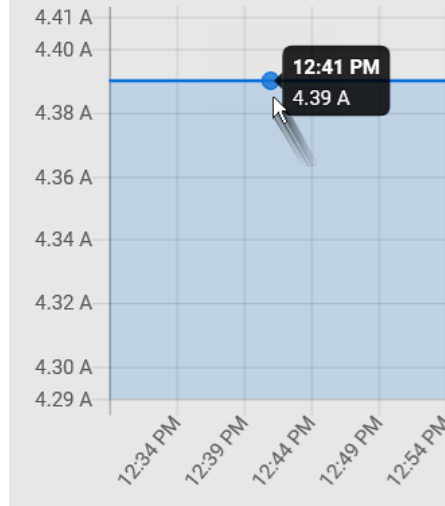

► **To configure this OCP's threshold settings:**

By default, upper thresholds of an OCP's RMS current have been configured. See **Default Voltage and Current Thresholds** (on page 887). You can modify them as needed.

*Note: The threshold values set for an individual OCP will override the bulk threshold values stored on that particular OCP. To configure thresholds for multiple OCPs at a time, see **OCPs** (on page 240).*

1. Click the Thresholds title bar at the bottom of the page to display the threshold data.



2. Click the RMS current sensor (required), and then click Edit Thresholds.

Sensor ▲	Lower Critical	Lower Warning	Upper Warning	Upper Critical
RMS Current	—	—	10.4 A	12.8 A

3. Make changes as needed.
 - To enable any threshold, select the corresponding checkbox.

- Type a new value in the accompanying text box.

Lower critical	<input type="checkbox"/>	0	A
Lower warning	<input type="checkbox"/>	0	A
Upper warning	<input checked="" type="checkbox"/>	10.4	A
Upper critical	<input checked="" type="checkbox"/>	12.8	A
Deassertion hysteresis		1	A
Assertion timeout		0	Samples

For concepts of thresholds, deassertion hysteresis and assertion timeout, see **Sensor Threshold Settings** (on page 879).

4. Click Save.

▶ **Other operations:**

- You can go to another OCP's data/setup page by clicking the OCP selector  on the top-left corner.
- You can go to the associated Inlet's data page by clicking the Inlet link in the Details section.



Overcurrent Protector C1	
Details	
Label	C1
Status	closed
Type	1-pole circuit breaker
Rating	16 A
Lines	L1
Protected outlets	1-6
Inlet	Inlet 1

Possible OCP-Tripped Root Cause

This feature applies to PX3-5000 and PX3-4000 models only.

Outlet-metered models that support "outlet peak current" sensors can detect which outlet is LIKELY to cause the associated OCP to trip, and indicate it on several user interfaces, including the web interface, front panel display, and command line interface (CLI).

Note that those models without "outlet peak current" sensors *do not* support this feature.

► **Web interface:**

- On the page of a tripped OCP, the Status field indicates the outlet number that may cause the OCP-tripped event.

Overcurrent Protector C1	
Details	
Label	C1
Status	 ⚠ open Likely caused by Outlet 8
Type	2-Pole Circuit Breaker
Rating	20 A
Lines	L1-L2
Protected Outlets	1-12
Inlet	Inlet I1

► **Front panel display:**

The 'Likely trip cause' message will be displayed for an "open" OCP, indicating which outlet may cause the OCP-tripped event. See **OCPs** (on page 133).

OCPs	
Circuit Breaker C1 L1-L2, 20A	Open
Likely trip cause:	Outlet 8
Circuit Breaker C2 L1-L2, 20A	0.000 A



► **CLI:**

- Perform the `show ocp` command in the CLI. If any OCP has tripped, then the outlet that may cause this event is shown in parentheses in the State field of the tripped OCP. See **Overcurrent Protector Information** (on page 529).

Peripherals

If there are Raritan environmental sensor packages connected to the PX3, they are listed on the Peripherals page. See **Connecting Raritan Environmental Sensor Packages** (on page 47).

An environmental sensor package comprises one or some of the following sensors/actuators:

- **Numeric sensors:** Detectors that show both readings and states, such as temperature sensors.
- **State sensors:** Detectors that show states only, such as contact closure sensors.
- **Actuators:** An actuator controls a system or mechanism so it shows states only.

PX3 communicates with *managed* sensors/actuators only and retrieves their data. It does not communicate with unmanaged ones. See **Managed vs Unmanaged Sensors/Actuators** (on page 257).

When the number of "managed" sensors/actuators has not reached the maximum, PX3 automatically brings newly-detected sensors/actuators under management by default.

One PX3 can manage a maximum of 32 sensors/actuators.

Note: To disable the automatic management function, refer to the final table in this section. You need to manually manage a sensor/actuator only when it is not under management.

When any sensor/actuator is no longer needed, you can unmanage/release it. Open the Peripheral Devices page by clicking Peripherals in the **Menu** (on page 178). Then you can:

- **Perform actions on multiple sensors/actuators by using the control/action icons on the top-right corner.**

Peripheral Devices							
# ▲	Name	Reading	State	Type	Serial Number	Position	Actuator
1	Temperature 1	24.0 °C	normal	Temperature	QMTemu0005	Port 1, Chain Position 5	
2	Temperature 2	24.0 °C	normal	Temperature	QMSemu0004	Port 1, Chain Position 4	
3	Relative Humidity 1	42 %	normal	Humidity	QMSemu0004	Port 1, Chain Position 4	
4	On/Off 1		normal	Contact Closure	QU7emu0003	Port 1, Chain Position 3, Channel 1	
5	On/Off 2		normal	Contact Closure	QU7emu0003	Port 1, Chain Position 3, Channel 2	

- Go to an individual sensor's or actuator's data/setup page by clicking its name.

Peripheral Devices	
# ▲	Name
1	Temperature 1
2	Temperature 2
3	Relative Humidity 1
4	On/Off 1

If wanted, you can resort the list by clicking the desired column header. See **Sorting a List** (on page 182).

► **Sensor/actuator overview on this page:**

If any sensor enters an alarmed state, it is highlighted in yellow or red. See **Yellow- or Red-Highlighted Sensors** (on page 255). An actuator is never highlighted.

Column	Description
Name	By default the PX3 assigns a name comprising the following two elements to a newly-managed sensor/actuator. <ul style="list-style-type: none"> ▪ Sensor/actuator type, such as "Temperature" or "Dry Contact." ▪ Sequential number of the same sensor/actuator type, like 1, 2, 3 and so on. You can customize the name. See Individual Sensor/Actuator Pages (on page 264).
Reading	Only managed 'numeric' sensors show this data, such as temperature and humidity sensors.
State	The data is available for all sensors and actuators. See Sensor/Actuator States (on page 258).
Type	Sensor or actuator type.
Serial Number	This is the serial number printed on the sensor package's label. It helps to identify your Raritan sensors/actuators. See Finding the Sensor's Serial Number (on page 259).

Column	Description
Position	The data indicates where this sensor or actuator is located in the sensor chain. See Identifying the Sensor Position and Channel (on page 260).
Actuator	Indicates whether this sensor package is an actuator or not. If yes, the symbol  is shown.

► **To release or manage sensors/actuators:**

When the total of managed sensors/actuators reaches the maximum value, you cannot manage additional ones. The only way to manage any sensor/actuator is to release or replace the managed ones. To replace a managed sensor/actuator, see **Managing One Sensor or Actuator** (on page 262). To release any one, follow this procedure.

1. Click  to make checkboxes appear in front of sensors/actuators.

Tip: To perform the desired action on only one sensor/actuator, simply click that sensor/actuator without making the checkboxes appear.

2. Select multiple sensors/actuators.
 - To release sensors/actuators, you must select "managed" ones only. See **Sensor/Actuator States** (on page 258).
 - To manage sensors/actuators, you must select "unmanaged" ones only.
 - To select ALL sensors/actuators, select the topmost checkbox in the header row.

Peripheral Devices		
<input checked="" type="checkbox"/>	# ▲	Name
<input type="checkbox"/>	1	Temperature 1
<input type="checkbox"/>	2	Temperature 2
<input type="checkbox"/>	3	Relative Humidity 1

3. To release selected ones, click  > Release.

To manage them, click  > Manage.

- The management action triggers a "Manage Peripheral Device" dialog. Simply click Manage if you are managing *multiple* sensors/actuators.

Manage Peripheral Device



Automatically assign a sensor number
 Manually select a sensor number

Sensor 1 (unused) ▼

Cancel
Manage

- If you are managing only *one* sensor/actuator, you can choose to assign an ID number by selecting "Manually select a sensor number." See **Managing One Sensor or Actuator** (on page 262).
4. Now released sensors/actuators become "unmanaged." Managed ones show one of the managed states.

► **To configure sensor/actuator-related settings:**

1. Click  > Peripheral Device Setup.
2. Now you can configure the fields.
 - Click  to select an option.
 - Adjust the numeric values.
 - Select or deselect the checkbox.

Field	Function	Note
Peripheral device Z coordinate format	Determines how to describe the vertical locations (Z coordinates) of Raritan environmental sensor packages. <ul style="list-style-type: none"> ▪ <i>Options: Rack units and Free-form</i> See Z Coordinate Format (on page 269).	To specify the location of any sensor/actuators in the data center, see Individual Sensor/Actuator Pages (on page 264).
Peripheral device auto management	Enables or disables the automatic management feature for Raritan environmental sensor packages. <ul style="list-style-type: none"> ▪ <i>The default is to enable it.</i> 	See How the Automatic Management Function Works (on page 262).

Field	Function	Note
Altitude	<p>Specifies the altitude of PX3 above sea level when a Raritan's differential air pressure sensor is attached.</p> <ul style="list-style-type: none"> Range: -425 to 3000 meters (-1394 to 9842 feet) Note that it can be a negative value down to -425 meters (-1394 feet) because some locations are below the sea level. 	<ul style="list-style-type: none"> The device's altitude is associated with the altitude correction factor. See Altitude Correction Factors (on page 889). The default altitude measurement unit is meter. See Setting Default Measurement Units (on page 297). You can have the measurement unit vary between meter and foot according to user credentials. See Setting Your Preferred Measurement Units (on page 296).
Active powered dry contact limit	<p>Determines the maximum number of "active" powered dry contact actuators that is permitted concurrently.</p> <ul style="list-style-type: none"> Range: 0 to 24 Default: 1 	<ul style="list-style-type: none"> An "active" actuator is the one that is turned ON, or, if with a door handle connected, is OPENED. This setting only applies to "powered dry contact" (PD) actuators rather than normal "dry contact" actuators. You need either 'Change Peripheral Device Configuration' privilege or 'Administrator Privileges' to change its upper limit. To turn on/off the connected actuators, see Peripherals (on page 249).

- Click Save.
- To return to the sensor list on the Peripheral Devices page, click "Peripheral Devices" on the top.

◀ [Peripheral Devices](#) | Setup

▶ **To configure default threshold settings:**

Note that any changes made to default threshold settings not only re-determine the initial threshold values that will apply to newly-added sensors but also the threshold values of the already-managed sensors where default thresholds are being applied. See **Individual Sensor/Actuator Pages** (on page 264).

- Click  > Default Threshold Setup.

2. Click the desired sensor type (required), and then click Edit Thresholds.

Peripheral Device Default Thresholds				
	Edit Thresholds			
Sensor Type ▲	Lower Critical	Lower Warning	Upper Warning	Upper Critical
Absolute Humidity	2 g/m³	4 g/m³	20 g/m³	22 g/m³
Air Flow	0.4 m/s	0.8 m/s	2.6 m/s	3.2 m/s
Air Pressure	—	—	80 Pa	100 Pa
Relative Humidity	10 %	15 %	85 %	90 %
Temperature	10 °C	15 °C	30 °C	35 °C
Vibration	---	---	0.05 g	0.1 g

3. Make changes as needed.
 - To enable any threshold, select the corresponding checkbox.
 - Type a new value in the accompanying text box.

Lower critical	<input checked="" type="checkbox"/>	10	°C
Lower warning	<input checked="" type="checkbox"/>	15	°C
Upper warning	<input checked="" type="checkbox"/>	30	°C
Upper critical	<input checked="" type="checkbox"/>	35	°C
Deassertion hysteresis		1	°C
Assertion timeout		0	Samples

For concepts of thresholds, deassertion hysteresis and assertion timeout, see **Sensor Threshold Settings** (on page 879).

4. Click Save.

*Tip: To customize the threshold settings on a per-sensor basis, go to **Individual Sensor/Actuator Pages** (on page 264).*

► **To turn on or off any actuator(s):**

1. Select one or multiple actuators which are *in the same status* - on or off.
2. To select multiple actuators, click  to make checkboxes appear and then select desired actuators.
3. Click the desired button.

 **On** : Turn ON.

 **Off** : Turn OFF.

*Note: Per default you can turn on as many dry contact actuators as you want, but only one "powered dry contact" actuator can be turned on at the same time. To change this limitation of "powered dry contact" actuators, modify the active powered dry contact setting. See **Peripherals** (on page 249).*

- Confirm the operation when prompted.

If you select a DX2-DH2C2 door handle lock, then the Open and Close buttons appear. For detailed operations, see **Door Handle Status and Control** (on page 502).

*Tip: If intending to control the actuator via the front panel, see **Front Panel Settings** (on page 445).*

Yellow- or Red-Highlighted Sensors

The PX3 highlights those sensors that enter the abnormal state with a yellow or red color. Note that numeric sensors can change colors only after you have enabled their thresholds.





Tip: When an actuator is turned ON, it is also highlighted in red for drawing attention.

For concepts of thresholds, deassertion hysteresis and assertion timeout, see **Sensor Threshold Settings** (on page 879).

# ▲	Name	Reading	State	Type	Serial Number	Position	Actuator
1	Temperature 1	25.0 °C	above upper critical	Temperature	AEH2A51454	Port 1	
2	Absolute Humidity 1	10.8 g/m ³	normal	Absolute Humidity	AEI1750551	Port 4	
3	Absolute Humidity 2	11.0 g/m ³	above upper warning	Absolute Humidity	AEI2850240	Port 4	
4	Temperature 2	25.8 °C	above upper critical	Temperature	AEI2A50775	Port 1	
5	Relative Humidity 1	44 %	normal	Humidity	AEI2A50775	Port 1	

In the following table, "R" represents any numeric sensor's reading. The symbol <= means "smaller than" or "equal to."

Sensor status	Color	States shown in the interface	Description
Unknown		unavailable	Sensor state or readings cannot be detected.

Sensor status	Color	States shown in the interface	Description
		unmanaged	Sensors are not being managed. See Managed vs Unmanaged Sensors/Actuators (on page 257).
Normal		normal	<ul style="list-style-type: none"> ▪ Numeric or state sensors are within the normal range. -- OR -- ▪ No thresholds have been enabled for numeric sensors.
Warning		above upper warning	Upper Warning threshold < "R" <= Upper Critical threshold
		below lower warning	Lower Critical threshold <= "R" < Lower Warning threshold
Critical		above upper critical	Upper Critical threshold < "R"
		below lower critical	"R" < Lower Critical threshold
Alarmed		alarmed	State sensors enter the abnormal state.
OCP alarm		Open	<ul style="list-style-type: none"> ▪ Circuit breaker trips. -- OR -- ▪ Fuse blown.

If you have connected a Schroff® LHX/SHX heat exchanger, when any sensor implemented on that device fails, it is also highlighted in red.

Managed vs Unmanaged Sensors/Actuators

To manually manage or unmanage/release a sensor or actuator, see *Peripherals* (on page 249).

▶ Managed sensors/actuators:

- PX3 communicates with managed sensors/actuators and retrieves their data.
- Managed sensors/actuators are always listed on the Peripheral Devices page no matter they are physically connected or not.
- They have an ID number as illustrated below.

Peripheral Devices	
# ▲	Name
1	On/Off 1
2	On/Off 2
3	Temperature 1
4	Absolute Humidity 1
5	Relative Humidity 1

- They show one of the managed states. See *Sensor/Actuator States* (on page 258).
- For managed 'numeric' sensors, their readings are retrieved and displayed. If any numeric sensor is disconnected or its reading cannot be retrieved, it shows "unavailable" for its reading.

▶ Unmanaged sensors/actuators:

- PX3 does NOT communicate with unmanaged sensors/actuators so their data is not retrieved.
- Unmanaged sensors/actuators are listed only when they are physically connected to PX3.

They disappear when they are no longer connected.

- They do *not* have an ID number.
- They show the "unmanaged" state.

Sensor/Actuator States

An environmental sensor or actuator shows its real-time state after being managed.

Available sensor states depend on the sensor type -- numeric or state sensors. For example, a contact closure sensor is a state sensor so it switches between three states only -- *unavailable*, *alarmed* and *normal*.

Sensors will be highlighted in yellow or red when they enter abnormal states. See **Yellow- or Red-Highlighted Sensors** (on page 255).

An actuator's state is marked in red when it is turned on.

► Managed sensor states:

In the following table, "R" represents any numeric sensor's reading. The symbol \leq means "smaller than" or "equal to."

State	Description
normal	<ul style="list-style-type: none"> For numeric sensors, it means the readings are within the normal range. For state sensors, it means they enter the normal state.
below lower critical	"R" < Lower Critical threshold
below lower warning	Lower Critical threshold \leq "R" < Lower Warning threshold
above upper warning	Upper Warning threshold < "R" \leq Upper Critical threshold
above upper critical	Upper Critical threshold < "R"
alarmed	The state sensor enters the abnormal state.
unavailable	<ul style="list-style-type: none"> Communication with the managed sensor is lost. -- OR -- DX2, DX, DPX2 or DPX3 sensor packages are upgrading their sensor firmware.

Note that for a contact closure sensor, the normal state depends on the normal setting you have configured. Refer to the Environmental Sensors and Actuators Guide (or Online Help) for detailed information, which is available on Raritan's **Support page** (<http://www.raritan.com/support/>).

► **Managed actuator states:**

State	Description
on	The actuator is turned on.
off	The actuator is turned off.
unavailable	<ul style="list-style-type: none"> ▪ Communication with the managed actuator is lost. -- OR -- ▪ DX2 or DX sensor packages are upgrading their sensor firmware.

► **Unmanaged sensor/actuator states:**

State	Description
unmanaged	Sensors or actuators are physically connected to the PX3 but not managed yet.

*Note: Unmanaged sensors or actuators will disappear from the web interface after they are no longer physically connected to the PX3. To manage a sensor/actuator, go to **Peripherals** (on page 249).*

Finding the Sensor's Serial Number

A DPX environmental sensor package includes a serial number tag on the sensor cable.



A DX2, DX, DPX2 or DPX3 sensor package has a serial number tag attached to its rear side.



The serial number for each sensor or actuator appears listed in the web interface after each sensor or actuator is detected by the PX3. Match the serial number from the tag to those listed in the sensor table.

Peripheral Devices On Off							
# ▲	Name	Reading	State	Type	Serial Number	Position	Actuator
1	On/Off 1		normal	Contact Closure	QLLemu0001	Port 1, Chain Position 1, Channel 1	
2	On/Off 2		normal	Contact Closure	QLLemu0001	Port 1, Chain Position 1, Channel 3	
3	Temperature 1	24.0 °C	normal	Temperature	QMTemu0005	Port 1, Chain Position 5	
4	Absolute Humidity 1	9.2 g/m ³	normal	Absolute Humidity	QMSemu0004	Port 1, Chain Position 4	
5	Relative Humidity 1	42 %	normal	Humidity	QMSemu0004	Port 1, Chain Position 4	

Identifying the Sensor Position and Channel

Raritan has developed five types of environmental sensor packages - DPX, DPX2, DPX3, DX and DX2 series. Only DPX2, DPX3, DX and DX2 sensor packages can be daisy chained.

PX3 can indicate where each sensor or actuator is connected on the Peripheral Devices page.

Peripheral Devices On Off							
# ▲	Name	Reading	State	Type	Serial Number	Position	Actuator
1	On/Off 1		normal	Contact Closure	QLLemu0001	Port 1, Chain Position 1, Channel 1	
2	On/Off 2		normal	Contact Closure	QLLemu0001	Port 1, Chain Position 1, Channel 3	
3	Temperature 1	24.0 °C	normal	Temperature	QMTemu0005	Port 1, Chain Position 5	
4	Absolute Humidity 1	9.2 g/m ³	normal	Absolute Humidity	QMSemu0004	Port 1, Chain Position 4	
5	Relative Humidity 1	42 %	normal	Humidity	QMSemu0004	Port 1, Chain Position 4	

- DPX series shows the sensor port number only.
For example, *Port 1*.
- DPX2, DPX3, DX and DX2 series show both the sensor port number and its position in a sensor chain.
For example, *Port 1, Chain Position 2*.

- If a Raritan DPX3-ENVHUB4 sensor hub is involved, the hub port information is also indicated for DX2, DX, DPX2 and DPX3 series, but NOT indicated for DPX series.

For example, *Hub Port 3*.

- If a sensor/actuator contains channels, such as a contact closure sensor or dry contact actuator, the channel information is included in the position information.

For example, *Channel 1*.

► **Sensor/actuator position examples:**

Example	Physical position
Port 1	Connected to the sensor port #1.
Port 1, Channel 2	<ul style="list-style-type: none"> ▪ Connected to the sensor port #1. ▪ The sensor/actuator is the 2nd channel of the sensor package.
Port 1, Chain Position 4	<ul style="list-style-type: none"> ▪ Connected to the sensor port #1. ▪ The sensor/actuator is located in the 4th sensor package of the sensor chain.
Port 1, Chain Position 3, Channel 2	<ul style="list-style-type: none"> ▪ Connected to the sensor port #1. ▪ The sensor/actuator is located in the 3rd sensor package of the sensor chain. ▪ It is the 2nd channel of the sensor package.
Port 1, Chain Position 1, Hub Port 2, Chain Position 3	<ul style="list-style-type: none"> ▪ Connected to the sensor port #1. ▪ Connected to the 2nd port of the DPX3-ENVHUB4 sensor hub, which shows the following two pieces of information: <ul style="list-style-type: none"> ▪ The hub's position in the sensor chain -- "Chain Position 1" ▪ The hub port where this particular sensor package is connected -- "Hub Port 2" ▪ The sensor/actuator is located in the 3rd sensor package of the sensor chain connected to the hub's port 2.

How the Automatic Management Function Works

This setting is configured on **Peripherals** (on page 249).

▶ **After enabling the automatic management function:**

When the total number of managed sensors and actuators has not reached the upper limit yet, PX3 automatically brings newly-connected environmental sensors and actuators under management after detecting them.

PX3 can manage up to 32 sensors/actuators.

▶ **After disabling the automatic management function:**

PX3 no longer automatically manages any newly-added environmental sensors and actuators, and therefore neither ID numbers are assigned nor sensor readings or states are available for newly-added ones.

You must manually manage new sensors/actuators. See **Peripherals** (on page 249).

Managing One Sensor or Actuator

If you are managing only one sensor or actuator, you can assign the desired ID number to it. Note that you cannot assign ID numbers when managing multiple sensors/actuators at a time.

*Tip: When the total of managed sensors/actuators reaches the maximum value, you cannot manage additional ones. The only way to manage any sensor/actuator is to release or replace the managed ones. To replace a managed one, assign an ID number to it by following the procedure below. To release any one, see **Peripherals** (on page 249).*

▶ **To manage only one sensor/actuator:**

1. From the list of "unmanaged" sensors/actuators, click the one you want to manage.

2. The Manage Peripheral Device dialog appears.

- To let PX3 randomly assign an ID number to it, select "Automatically assign a sensor number."
This method does not release any managed sensor or actuator.
- To assign a desired ID number, select "Manually select a sensor number." Then click  to select an ID number.
This method may release a managed sensor/actuator if the number you selected has been assigned to a specific sensor/actuator.

Tip: The information in parentheses following each ID number indicates whether the number has been assigned to a sensor or actuator. If it has been assigned to a sensor or actuator, it shows the sensor package's serial number. Otherwise, it shows the word "unused."

3. Click Manage.

► **Special note for a Raritan humidity sensor:**

A Raritan humidity sensor is able to provide two measurements - relative and absolute humidity values.

- A relative humidity value is measured in percentage (%).
- An absolute humidity value is measured in grams per cubic meter (g/m³).

However, only relative humidity sensors are "automatically" managed if the automatic management function is enabled. You must "manually" manage absolute humidity sensors as needed.

Note that relative and absolute values of the same humidity sensor do NOT share the same ID number though they share the same serial number and position.

# ▲	Name	Reading	State	Type	Serial Number	Position
1	On/Off 1		normal	Contact Closure	QLLemu0001	Port 1, Chain Position 1, Channel 1
2	On/Off 2		normal	Contact Closure	QLLemu0001	Port 1, Chain Position 1, Channel 3
3	Relative Humidity 1	42 %	normal	Humidity	QMSemu0004	Port 1, Chain Position 4
4	Absolute Humidity 1	9.2 g/m³	normal	Absolute Humidity	QMSemu0004	Port 1, Chain Position 4
5	Temperature 1	24.0 °C	normal	Temperature	QMSemu0004	Port 1, Chain Position 4

Individual Sensor/Actuator Pages

A sensor's or actuator's data/setup page is opened after clicking any sensor or actuator name on the Peripheral Devices page. See **Peripherals** (on page 249).

Note that only a numeric sensor has threshold settings, while a state sensor or actuator has no thresholds.

Threshold settings, if enabled, help you identify whether any numeric sensor enters the warning or critical level. See **Yellow- or Red-Highlighted Sensors** (on page 255). In addition, you can have PX3 automatically generate alert notifications for any warning or critical status. See **Event Rules and Actions** (on page 364).

► **To configure a numeric sensor's threshold settings:**

1. Click Edit Thresholds.

Sensor	
	Edit Thresholds
Reading	22.8 °C
State	normal
Last time changed	3/14/2019, 7:03:27 AM UTC+0800

Tip: The date and time shown on the PX3 web interface are automatically converted to your computer's time zone. To avoid time confusion, it is suggested to apply the same time zone settings as those of PX3 to your computer or mobile device.

2. Select or deselect 'Use default thresholds' according to your needs.

Sensor

[Edit Thresholds](#)

Use default thresholds	<input checked="" type="checkbox"/>		
Lower critical	<input checked="" type="checkbox"/>	10	°C
Lower warning	<input checked="" type="checkbox"/>	15	°C
Upper warning	<input checked="" type="checkbox"/>	30	°C
Upper critical	<input checked="" type="checkbox"/>	35	°C
Deassertion hysteresis		1	°C
Assertion timeout		0	Samples

- To have this sensor follow the default threshold settings configured for its own sensor type, select the 'Use default thresholds' checkbox. The default threshold settings are configured on the page of **Peripherals** (on page 249).
- To customize the threshold settings for this particular sensor, deselect the 'Use default thresholds' checkbox, and then modify the threshold fields below it.

*Note: For concepts of thresholds, deassertion hysteresis and assertion timeout, see **Sensor Threshold Settings** (on page 879).*

3. Click Save.

► **To set up a sensor's or actuator's physical location and additional settings:**

1. Click Edit Settings.

Settings	
	Edit Settings
Name	Temperature 1
Description	
Location (X)	
Location (Y)	
Location (Z: Rack Units)	

2. Make changes to available fields, and then click Save.

Fields	Description
Name	A name for the sensor or actuator.
Description	Any descriptive text you want.
Location (X, Y and Z)	Describe the sensor's or actuator's location in the data center by typing alphanumeric values for the X, Y and Z coordinates. See Sensor/Actuator Location Example (on page 270). If the term "Rack Units" appears in parentheses in the Z location, you must type an integer number. The Z coordinate's format is determined on the page of Peripherals (on page 249).
Alarmed to Normal Delay	This field is available for the DX-PIR presence detector only. It determines the wait time before the PX3 announces that the presence detector is back to normal after it already returns to normal. Adjust the value in seconds.
Binary Sensor Subtype	This field is available for any Raritan contact closure sensor except for DX2-DH2C2's contact closure sensors. Determine the sensor type of your contact closure detector. <ul style="list-style-type: none"> ▪ <i>Contact Closure</i> detects the door lock or door open/closed status. ▪ <i>Smoke Detection</i> detects the appearance of smoke. ▪ <i>Water Detection</i> detects the appearance of water on the floor. ▪ <i>Vibration</i> detects the vibration of the floor.

Fields	Description
Sensor Polarity	<p>This field is available for DX2-CC2 contact closure sensors only.</p> <p>Determine the normal state of your DX2-CC2.</p> <ul style="list-style-type: none"> ▪ <i>Normal Open</i>: The open status of the connected detector/switch is considered normal. An alarm is triggered when the detector/switch turns closed. ▪ <i>Normal Closed</i>: The closed status of the connected detector/switch is considered normal. An alarm is triggered when the detector/switch turns opened.

► **To view a numeric sensor's chart**

This sensor's data within the past tens of minutes is shown in the chart. Note that only a numeric sensor has this diagram. State sensors and actuators do not have such data.



- To retrieve the exact data at a particular time, hover your mouse over the data line in the chart. Both the time and data are displayed as illustrated below.

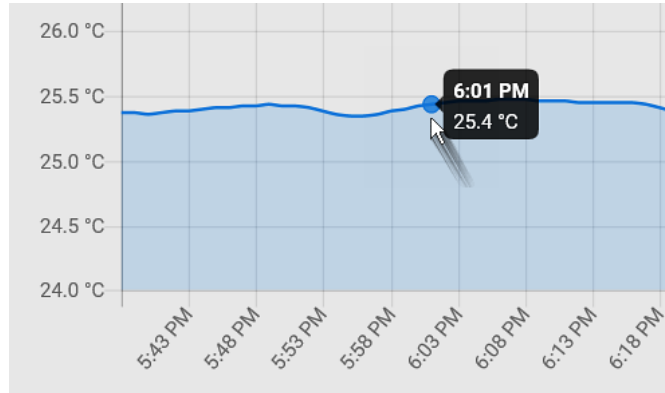

► **To turn on or off an actuator:**

1. Click the desired control button.

⌵ Dry Contact 1

⏻ On ⏻ Off

Details

Peripheral Device ID	7
Position	Port 1, Chain Position 1
Serial Number	QLLemu0001
Type	Contact Closure (On/Off)

⏻ On : Turn ON.

⏻ Off : Turn OFF.

2. Confirm the operation on the confirmation message. An actuator's state is marked in red when it is turned on.

*Note: Per default you can turn on as many dry contact actuators as you want, but only one "powered dry contact" actuator can be turned on at the same time. To change this limitation of "powered dry contact" actuators, modify the active powered dry contact setting. See **Peripherals** (on page 249).*

► **Other operations:**

You can go to another sensor's or actuator's data/setup page by clicking the

selector  on the top-left corner.



Temperature 1

Details	
Peripheral device ID	1
Position	Port 1
Serial number	AEH9C50070
Type	Temperature

Z Coordinate Format

Z coordinates refer to vertical locations of Raritan's environmental sensor packages. You can use either the number of rack units or a descriptive text to describe Z coordinates.

For a Z coordinate example, see **Sensor/Actuator Location Example** (on page 270).

► **To configure Z coordinates:**

1. Determine the Z coordinate format on **Peripherals** (on page 249). Available Z coordinate formats include:

Format	Description
Rack units	The height of the Z coordinate is measured in standard rack units. When this is selected, you can type a numeric value in the rack unit to describe the Z coordinate of any environmental sensors or actuators.

Format	Description
Free-form	Any alphanumeric string can be used for specifying the Z coordinate. The value comprises 0 to 24 characters.

2. Configure Z coordinates on the **Individual Sensor/Actuator Pages** (on page 264).

Sensor/Actuator Location Example

Use the X, Y and Z coordinates to describe each sensor's or actuator's physical location in the data center. See **Individual Sensor/Actuator Pages** (on page 264).

The X, Y and Z values act as additional attributes and are not tied to any specific measurement scheme. Therefore, you can use non-measurement values.

▶ **Example:**

X = Brown Cabinet Row

Y = Third Rack

Z = Top of Cabinet

▶ **Values of the X, Y and Z coordinates:**

- X and Y: They can be any alphanumeric values comprising 0 to 24 characters.
- Z: When the Z coordinate format is set to *Rack units*, it can be any number ranging from 0 to 60. When its format is set to *Free-form*, it can be any alphanumeric value comprising 0 to 24 characters. See **Peripherals** (on page 249).

Feature Port

The FEATURE port supports connection to the following devices.

Device	Description
Asset Strip	Raritan asset strips
External Beeper	An external beeper with the RJ-45 socket.
LHX 20	Schroff® LHX-20 heat exchanger.
SHX 30	Schroff® SHX-30 heat exchanger.
LHX 40	Schroff® LHX-40 heat exchanger.

Device	Description
Power CIM	This type represents one of the following Raritan products: <ul style="list-style-type: none"> Raritan power CIM, D2CIM-PWR. This CIM is used to connect the PX3 to the Raritan digital KVM switch -- Dominion KX II / III. Dominion KSX II Dominion SX or SX II

When the PX3 detects the connection of any listed device, it replaces 'Feature Port' in the menu with that device's name and shows that device's data/settings instead. See **Asset Strip** (on page 272), **External Beeper** (on page 280), **Schroff LHX/SHX** (on page 281) and **Power CIM** (on page 286).

When no devices are detected, the PX3 displays the name 'Feature Port' and the Feature Port page shows the message "No device is currently connected."

Open the Feature Port page by clicking it in the **Menu** (on page 178). From this page, you can enable or disable this port's detection capability, or force it to show a specific device's data/settings even though no device is detected.

*Note: You must enable the LHX/SHX support for the PX3 to detect the presence of a supported Schroff® LHX/SHX heat exchanger. See **Miscellaneous** (on page 453).*

► **To configure the feature port:**

1. Click  on the top-right corner. The Feature Port Setup dialog appears.

Feature Port Setup

Port: 1
Device Type: Asset Strip
Detection Mode:

Auto ▼

2. Click the Detection Mode field, and select one mode.

Mode	Description
Auto	Enable the port to automatically detect the device connection.
Disabled	Disable the port's detection capability.

Mode	Description
Asset Strip, Raritan asset strips, LHX 20, SHX 30, LHX 40, Power CIM	Force the PX3 to show the selected device's data/setup page regardless of the physical connection status.

*Note: 'LHX 20', 'SHX 30', and 'LHX 40' are not available when the support of LHX/SHX heat exchangers is disabled. See **Miscellaneous** (on page 453).*

Asset Strip

After connecting and detecting Raritan asset management strips (asset strips), the PX3 shows 'Asset Strip' in place of 'Feature Port' in the menu.

*Note: For connection instructions, see **Connecting Asset Management Strips** (on page 67).*

To open the Asset Strip page, click it in the **Menu** (on page 178). On this page, you can configure the rack units of asset strips and asset tags. A rack unit refers to a tag port on the asset strips. The "Change Asset Strip Configuration" permission is required.

For the functionality of this icon  on the top-right corner, see **Feature Port** (on page 270).

► **To configure asset strip and rack unit settings:**

1. Click Edit Settings.

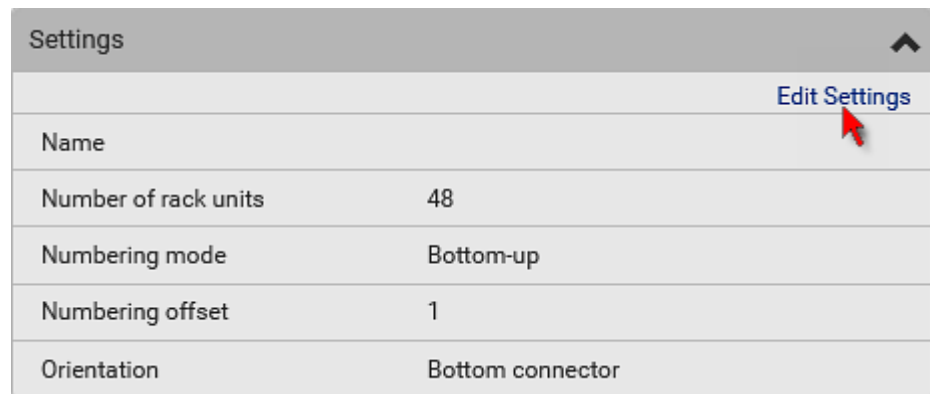

2. Make changes to the settings by directly typing a new value, or clicking that field to select a different option.

Field	Description
Name	Name for this asset strip assembly.
Number of rack units	<p>Total of available tag ports on this asset strip assembly, ranging between 8 and 64.</p> <ul style="list-style-type: none"> For the current generation of asset strips, which show the suffix "G3" on its hardware label, the PX3 automatically detects the number of its tag ports (rack units), and you <i>cannot</i> change this value. For old "non-G3" asset strips, there is no automatic detection for them so you must manually adjust this value.
Numbering mode	<p>The rack unit numbering method in a rack/cabinet.</p> <ul style="list-style-type: none"> <i>Top-Down</i>: The numbering starts from the highest rack unit of a rack/cabinet. <i>Bottom-Up</i>: The numbering starts from the lowest rack unit of a rack/cabinet.
Numbering offset	<p>The start number in the rack unit numbering.</p> <p>For example, if this value is set to 3, then the first number is 3, the second number is 4, and so on.</p>
Orientation	<p>The asset strip's orientation by indicating the location of its RJ-45 connector.</p> <ul style="list-style-type: none"> <i>Top Connector</i>: The RJ-45 connector is located on the top. <i>Bottom Connector</i>: The RJ-45 connector is located on the bottom. <p>Asset strips can detect their strip orientation and show it in this field.</p> <p>You need to adjust this value only when your asset strips are the oldest ones without tilt sensors implemented.</p>
Color with connected tag	<p>Click this field to determine the LED color denoting the presence of an asset tag.</p> <ul style="list-style-type: none"> Default is green.
Color without connected tag	<p>Click this field to determine the LED color denoting the absence of an asset tag.</p> <ul style="list-style-type: none"> Default is red.

For color settings, there are two ways to set the color.

- Click a color in the color palette.

- Type the hexadecimal RGB value of the color, such as #00FF00.

3. Click Ok. The rack unit numbering and LED color settings are immediately updated on the Rack Units list illustrated below.
 - The 'Index' number is the physical tag port number printed on the asset strip, which is not configurable. However, its order will change to reflect the latest rack unit numbering.

Rack Units							Program Asset IDs
Rack unit ▲	Index	Slot	Name	Asset / ID	Operation Mode	LED Mode	LED Color
1	1			000015B914BB	Auto	On	
2	2			000015B9152E	Auto	On	
3	3			000015B9158C	Auto	On	
4	4				Auto	On	
5	5			000015B91600	Auto	On	
6	6			000015B91546	Auto	On	

- A blade extension strip and a *programmable* tag are marked with the word 'programmable' in the Asset/ID column. You can customize their Asset IDs. For instructions, refer to this section's last procedure below.
- If wanted, you can resort the list by clicking the desired column header. See **Sorting a List** (on page 182).

► **To customize a single rack unit's settings:**

You can make a specific rack unit's LED behave differently from the others on the asset strip, including the LED light and color.

1. Click the desired rack unit on the Rack Units list. The setup dialog for the selected one appears.

Setup of Rack Unit 3

Name

Operation Mode

LED Mode

LED Color

2. Make changes to the information by typing a new value or clicking that field to select a different option.

Field	Description
Name	Name for this rack unit. For example, you can name it based on the associated IT device.
Operation Mode	Determine whether this rack unit's LED behavior automatically changes according to the presence and absence of the asset tag. <ul style="list-style-type: none"> ▪ <i>Auto</i>: The LED behavior varies, based on the asset tag's presence. ▪ <i>Manual Override</i>: This option differentiates this rack unit's LED behavior.





Field	Description
LED Mode	<p>This field is configurable only after the Operation Mode is set to Manual Override.</p> <p>Determine how the LED light behaves for this particular rack unit.</p> <ul style="list-style-type: none"> ▪ <i>On</i>: The LED stays lit. ▪ <i>Off</i>: The LED stays off. ▪ <i>Slow blinking</i>: The LED blinks slowly. ▪ <i>Fast blinking</i>: The LED blinks quickly.
LED Color	<p>This field is configurable only after the Operation Mode is set to Manual Override.</p> <p>Determine what LED color is shown for this rack unit if the LED is lit.</p>

► **To expand a blade extension strip:**

A blade extension strip, like an asset strip, has multiple tag ports. An extension strip is marked with a grayer color on the Asset Strip page, and its tag ports list is collapsed by default.

Note: If you need to temporarily disconnect the blade extension strip from the asset strip, wait at least 1 second before re-connecting it back, or the PX3 device may not detect it.

1. Locate the rack unit (tag port) where the blade extension strip is connected. Click its slot number, whose format is similar to **1-N** , where N is the total number of its tag ports.

Rack Units							
							Program Asset IDs
Rack unit ▲	Index	Slot	Name	Asset / ID	Operation Mode	LED Mode	LED Color
1	1			000015B914BB	Auto	On	
2	2	1-16 		0000ABC12345 (programmable)	Auto	On	
3	3			000015B9152E	Auto	On	
4	4				Auto	On	

2. All tag ports of the blade extension strip are listed below it. Their port numbers are displayed in the Slot column.

Rack Units							
							Program Asset IDs
Rack unit ▲	Index	Slot	Name	Asset / ID	Operation Mode	LED Mode	LED Color
1	1			000015B914BB	Auto	On	
2	2	1-16 ▼		0000ABC12345 (programmable)	Auto	On	
	Extension	1		000015B9160A			
	Extension	2		000015B91610			
	Extension	3		000015B91622			
	Extension	4		000015B9158C			
	Extension	5		000015B91600			
	Extension	6		000015B91546			
	Extension	7					
	Extension	8					
	Extension	9					
	Extension	10					
	Extension	11					
	Extension	12					
	Extension	13					
	Extension	14					
	Extension	15					
	Extension	16					
3	3			000015B9152E	Auto	On	







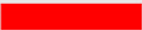

- To hide the blade extension slots list, click **1-N ▼**.

► **To customize asset IDs on programmable asset tags:**

You can customize asset IDs only when the asset tags are "programmable" ones. Non-programmable tags do not support this feature. In addition, you can also customize the ID of a blade extension strip.

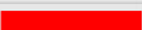
If a barcode reader is intended, connect it to the computer you use to access the PX3.

1. Click Program Asset IDs.

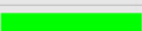
Rack Units							
							Program Asset IDs
Rack unit ▲	Index	Slot	Name	Asset / ID	Operation Mode	LED Mode	LED Color
1	16				Auto	On	
2	15				Auto	On	
3	14				Auto	On	
4	13				Auto	On	
5	12				Auto	On	
6	11				Auto	On	
7	10			(programmable)	Auto	On	
8	9			(programmable)	Auto	On	
9	8			(programmable)	Auto	On	
10	7			00001492BD47	Auto	On	
11	6			00001492CB50	Auto	On	

2. In the Asset/ID column, enter the customized asset IDs by typing values or scanning the barcode.
 - When using a barcode reader, first click the desired rack unit, and then scan the asset tag. Repeat this step for all desired rack units.

- An asset ID contains up to 12 characters that comprise only numbers and/or UPPER CASE alphabets. Lower case alphabets are NOT accepted.

Rack Units				
				Rack Units
Rack unit ▲	Index	Slot	Name	Asset / ID
1	16			Tag ID
2	15			Tag ID
3	14			Tag ID
4	13			Tag ID
5	12			Tag ID
6	11			Tag ID
7	10			WINDOWS
8	9			LINUX
9	8			ROUTER X
10	7			00001492BD47

3. Verify the correctness of customized asset IDs and modify as needed.
4. Click Apply at the bottom of the page to save changes.
 - Or click Cancel to abort changes.

Tip: Another way to abort changes is to click Rack Units. Refer to the diagram below.

Rack Units				
				Rack Units
Rack unit ▲	Index	Slot	Name	Asset / ID
1	16			Tag ID
2	15			Tag ID

Asset Strip Automatic Firmware Upgrade

After connecting the asset strip to the PX3, it automatically checks its own firmware version against the version of the asset strip firmware stored in the PX3 firmware. If two versions are different, the asset strip automatically starts downloading the new firmware from the PX3 to upgrade its own firmware.

During the firmware upgrade, the following events take place:

- The asset strip is completely lit up, with the blinking LEDs cycling through diverse colors.
- A firmware upgrade process is indicated in the PX3 web interface.
- An SNMP trap is sent to indicate the firmware upgrade event.

External Beeper

After connecting and detecting a supported external beeper, the PX3 shows 'External Beeper' in place of 'Feature Port' in the menu.

*Note: For connection instructions, see **Connecting an External Beeper** (on page 79).*

To open the External Beeper page, click it in the **Menu** (on page 178). This page shows an external beeper's status, including:

- Number of the FEATURE port where this external beeper is connected
- Its device type
- Its connection status
- The beeper's state - off or active

For the functionality of this icon  on the top-right corner, see **Feature Port** (on page 270).

Schroff LHX/SHX

You must enable the LHX/SHX support for the PX3 to detect the presence of a supported Schroff® LHX/SHX heat exchanger. See **Miscellaneous** (on page 453).

After enabling the LHX/SHX support and connecting a supported Schroff® LHX/SHX heat exchanger to the PX3, the PX3 shows the connected device type in place of 'Feature Port' in the menu -- LHX 20, LHX 40 or SHX 30.

*Note: For connection instructions, see **Connecting a Schroff LHX/SHX Heat Exchanger** (on page 79).*

To open the LHX/SHX page, click 'LHX 20', 'LHX 40' or 'SHX 30' in the **Menu** (on page 178). Then you can monitor and administer the connected LHX/SHX device with the following.

- Name the heat exchanger
- Monitor LHX/SHX built-in sensors and device states
- Configure the air outlet temperature setpoint
- Configure the default fan speed
- Configure the air temperature/fan speed thresholds (for alert generation)
- Request maximum cooling using the fan speed and opening the cold water valve
- Acknowledge alerts or errors remotely, such as failed LHX/SHX sensors or emergency cooling activation
- Accumulative operating hours
- Indicate the number of power supplies present and whether a condenser pump is present

Available information/operation is model dependent. For example, only LHX devices can show sensor alerts. See your LHX/SHX user documentation for details.



Important: The LHX/SHX settings are stored on the port where the LHX/SHX device is connected, and are lost if that device is re-connected to a different PX3 port.

For the functionality of this icon  on the top-right corner, see **Feature Port** (on page 270).

► **To view the LHX/SHX device state:**

The Operation State field indicates whether the device is operating fine, and the Switch State field indicates its power status.



If the device does not operate properly, such as some sensor failure, it shows "critical" and the symbol .

Operational State	critical 
Switch State	 On

► **To turn on or off the LHX/SHX device:**



1. Click the desired power-control button on the top-right corner.

LHX 40 (1)

 On
 Off

Information

Schroff[®]

Model	LHX 40
Firmware Version	0x3d
Operational State	critical 
Switch State	 On

 On : Power ON.

 Off : Power OFF.

2. Confirm the operation on the confirmation message.

► **To configure LHX/SHX settings:**

1. Click Edit Settings.

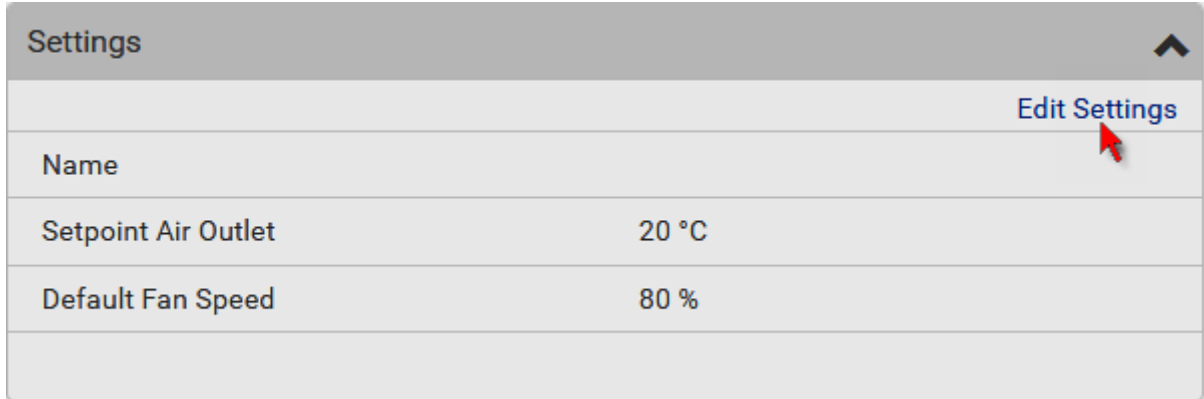

Settings	
	Edit Settings
Name	
Setpoint Air Outlet	20 °C
Default Fan Speed	80 %

2. Configure the settings as needed.
 - Provide a customized name.
 - Specify the desired air outlet setpoint temperature.
 - Specify the default fan speed.
3. Click Save.

► **To view all sensor data and configure thresholds:**

1. Locate the Sensors section, which lists all air outlet/inlet temperatures and fan speeds, and indicates the door closed/open status of the LHX/SHX device.
2. To set the thresholds for any temperature or fan speed sensor implemented on the LHX/SHX device:
 - a. Click the desired sensor.

- b. Click Edit Thresholds.

Sensors		
		Edit Thresholds
Name	Reading	Status
Temperature Air Outlet (F1)	19.9 °C	normal
Temperature Air Outlet (F2)	19.9 °C	normal
Temperature Air Inlet (F3)	25.9 °C	normal
Temperature Air Inlet (F4)	25.9 °C	normal
Temperature Water Inlet (F6)	26.6 °C	normal
Fan Speed (M1)	2844 rpm	normal
Fan Speed (M2)	3035 rpm	normal
Fan Speed (M3)	2837 rpm	normal
Fan Speed (M4)	3008 rpm	normal
Fan Speed (M5)	2682 rpm	normal
Fan Speed (M6)	2855 rpm	normal
Fan Speed (M7)	2907 rpm	normal
Door Contact	0	closed

- c. Enable and set the desired thresholds and deassertion hysteresis.
Note that assertion timeout is NOT available on LHX/SHX.
- d. Click Save.
3. After thresholds are enabled, sensors may be highlighted in yellow or red if they enter the warning or critical range. See **Yellow- or Red-Highlighted Sensors** (on page 255).

*Tip: You can also create event rules to notify you of the warning or critical levels. See **Event Rules and Actions** (on page 364).*

► **To view sensor alerts and LHX event log:**

Remote alert acknowledgment is supported by the LHX-20 and LHX-40. The SHX-30 does not support this feature.

1. Locate the Alert States section.

- If any LHX sensors fail, they are indicated. Click Acknowledge to acknowledge the sensor failure.

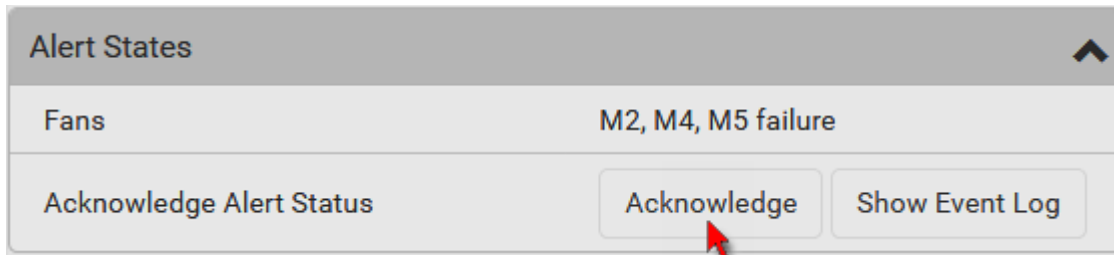

- To view the history of LHX events, click Show Event Log to go to the Event Log page.

► **Operation time statistics:**

This section indicates the accumulative operation hours of the LHX/SHX device and its fans since the device is connected to the PX3 and turned on.

Available time units in the statistics --

- h: hour(s)
- d: day(s)

Statistics	
Operating Hours (Varistar LHX)	7 h
Operating Hours (Fan 1)	6 h
Operating Hours (Fan 2)	6 h
Operating Hours (Fan 3)	6 h
Operating Hours (Fan 4)	3 h
Operating Hours (Fan 5)	3 h
Operating Hours (Fan 6)	0 h
Operating Hours (Fan 7)	0 h

► **Request maximum cooling:**

Only SHX 30 supports this feature. See **SHX Request Maximum Cooling** (on page 286).

SHX Request Maximum Cooling

The PX3 allows you to remotely activate the Schroff SHX 30's maximum cooling feature. Both LHX 20 and LHX 40 do not support remote activation of maximum cooling.

The Request Maximum Cooling feature is available only after the PX3 detects SHX 30. For additional information on the SHX 30 maximum cooling feature, refer to the SHX 30 documentation.

▶ **To perform maximum cooling:**

- Go to the SHX page, and click Request Maximum Cooling.
Then the SHX 30 enters into emergency cooling mode and runs at its maximum cooling level of 100% in order to cool the device.
When maximum cooling is requested for an SHX 30, the message "Maximum cooling requested" is displayed.

▶ **To stop maximum cooling:**

- Click Cancel Maximum Cooling.

Power CIM

After connecting and detecting a Raritan power CIM, the PX3 shows 'Power CIM' in place of 'Feature Port' in the menu. See ***Dominion KX II / III Configuration*** (on page 914) or ***Dominion KSX II, SX or SX II Configuration*** (on page 919).

Open the Power CIM page by clicking it in the **Menu** (on page 178). This page shows the CIM's status, including:

- Number of the FEATURE port where this CIM is connected
- Its device type
- Its connection status

For the functionality of this icon  on the top-right corner, see **Feature Port** (on page 270).

User Management

User Management menu deals with user accounts, permissions, and preferred measurement units on a per-user basis.

PX3 is shipped with one built-in administrator account: **admin**, which is ideal for initial login and system administration. You cannot delete 'admin' or change its permissions, but you can and **should** change its password.

A "role" determines the tasks/actions a user is permitted to perform on the PX3 so you must assign one or multiple roles to each user.

Click 'User Management' in the **Menu** (on page 178), and the following submenu displays.

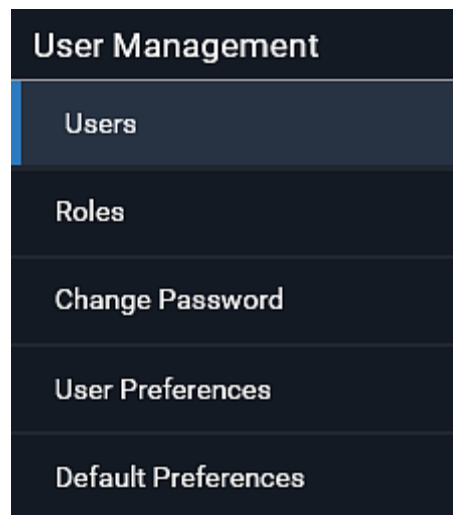



Submenu command	Refer to...
Users	<i>Creating Users</i> (on page 288)
Roles	<i>Creating Roles</i> (on page 293)
Change Password	<i>Changing Your Password</i> (on page 173)
User Preferences	<i>Setting Your Preferred Measurement Units</i> (on page 296)
Default Preferences	<i>Setting Default Measurement Units</i> (on page 297)

Creating Users

All users must have a user account, containing the login name and password. Multiple users can log in simultaneously using the same login name.

To add users, choose User Management > Users > .

Users  			
Enabled ▲	User Name	Full Name	Roles
	admin	Administrator	Admin

▶ User information:

Field/setting	Description
User name	The name the user enters to log in to the PX3. <ul style="list-style-type: none"> 4 to 32 characters Case sensitive Colon character and spaces are NOT permitted.
Full name	The user's first and last names.
Password, Confirm password	<ul style="list-style-type: none"> 4 to 64 characters Case sensitive Spaces are permitted.
Telephone number	The user's telephone number
Email address	The user's email address <ul style="list-style-type: none"> Up to 128 characters Case sensitive
Enable	When selected, the user can log in to the PX3.
Force password change on next login	When selected, a password change request automatically appears the next time the user logs in. For details, see Changing Your Password (on page 173).

▶ SSH:

You need to enter the SSH public key only if the public key authentication for SSH is enabled. See **Changing SSH Settings** (on page 332).

1. Open the SSH public key with a text editor.

- Copy and paste all content in the text editor into the SSH Public Key field.

► **SNMPv3:**

The SNMPv3 access permission is disabled by default.

Field/setting	Description
Enable SNMPv3	Select this checkbox when intending to permit the SNMPv3 access by this user. <hr/> <i>Note: The SNMPv3 protocol must be enabled for SNMPv3 access. See Configuring SNMP Settings (on page 329).</i> <hr/>
Security level	Click the field to select a preferred security level from the list: <ul style="list-style-type: none"> None: No authentication and no privacy. This is the default. Authentication: Authentication and no privacy. Authentication & Privacy: Authentication and privacy.

- **Authentication Password:** This section is configurable only when 'Authentication' or 'Authentication & Privacy' is selected.

Field/setting	Description
Same as user password	Select this checkbox if the authentication password is identical to the user's password. To specify a different authentication password, disable the checkbox.
Password, Confirm password	Type the authentication password if the 'Same as User Password' checkbox is deselected. The password must consist of 8 to 32 ASCII printable characters.

- **Privacy Password:** This section is configurable only when 'Authentication & Privacy' is selected.

Field/setting	Description
Same as authentication password	Select this checkbox if the privacy password is identical to the authentication password. To specify a different privacy password, disable the checkbox.

Field/setting	Description
Password, Confirm password	Type the privacy password if the 'Same as Authentication Password' checkbox is deselected. The password must consist of 8 to 32 ASCII printable characters.

- **Protocol:** This section is configurable only when 'Authentication' or 'Authentication & Privacy' is selected.

Field/setting	Description
Authentication	Click this field to select the desired authentication protocol. Two protocols are available: <ul style="list-style-type: none"> ▪ MD5 ▪ SHA-1 (default)
Privacy	Click this field to select the desired privacy protocol. Two protocols are available: <ul style="list-style-type: none"> ▪ DES (default) ▪ AES-128

► **Preferences:**

This section determines the measurement units displayed in the web interface and command line interface for this user.

Field	Description
Temperature unit	Preferred units for temperatures -- °C (Celsius) or °F (Fahrenheit).
Length unit	Preferred units for length or height -- Meter or Feet.
Pressure unit	Preferred units for pressure -- Pascal or Psi. <ul style="list-style-type: none"> ▪ Pascal = one newton per square meter ▪ Psi = pounds per square inch

*Note: Users can change the measurement units at any time by setting their own preferences. See **Setting Your Preferred Measurement Units** (on page 296).*

► **Roles:**

Select one or multiple roles to determine the user's permissions.

To select all roles, select the topmost checkbox in the header row. However, a user can have a maximum of 32 roles only.

If the built-in roles do not satisfy your needs, add new roles by clicking



. This newly-created role will be then automatically assigned to the user account currently being created. See **Creating Roles** (on page 293).

Built-in role	Description
Admin	Provide full permissions.
Operator	Provide frequently-used permissions, including: <ul style="list-style-type: none"> • Acknowledge Alarms • Change Own Password • Change Pdu, Inlet, Outlet & Overcurrent Protector Configuration • Switch Outlet (if your PX3 is outlet-switching capable) • Switch Outlet Group (if your PX3 is outlet-switching capable) • View Event Settings • View Local Event Log

Note: With multiple roles selected, a user has the union of all roles' permissions.

Editing or Deleting Users

To edit or delete users, choose User Management > Users to open the Users page, which lists all users.

Users ✉ 👤 +			
Enabled	User Name ▲	Full Name	Roles
✓	admin	Administrator	Admin
✗	John		Operator
✓	Mary		Operator
✓	Teresa		Operator

In the Enabled column:

- ✓: The user is enabled.
- ✗: The user is disabled.

If wanted, you can resort the list by clicking the desired column header. See **Sorting a List** (on page 182).

▶ To edit or delete a user account:

1. On the Users page, click the desired user. The Edit User page for that user opens.
2. Make changes as needed.
 - For information on each field, see **Creating Users** (on page 288).
 - To change the password, type a new password in the Password and Confirm Password fields. If the password field is left blank, the password remains unchanged.
 - To delete this user, click , and confirm the operation.

Edit User - John

User

User name	<input type="text" value="John"/>
Full name	<input type="text"/>
Password	<input type="password"/>

3. Click Save.

► **To delete multiple user accounts:**

1. On the Users page, click  to make checkboxes appear in front of user names.

Tip: To delete only one user, you can simply click that user without making the checkboxes appear. Refer to the above procedure.

2. Select one or multiple users.
 - To select all roles, except for the admin user, select the topmost checkbox in the header row.
3. Click .

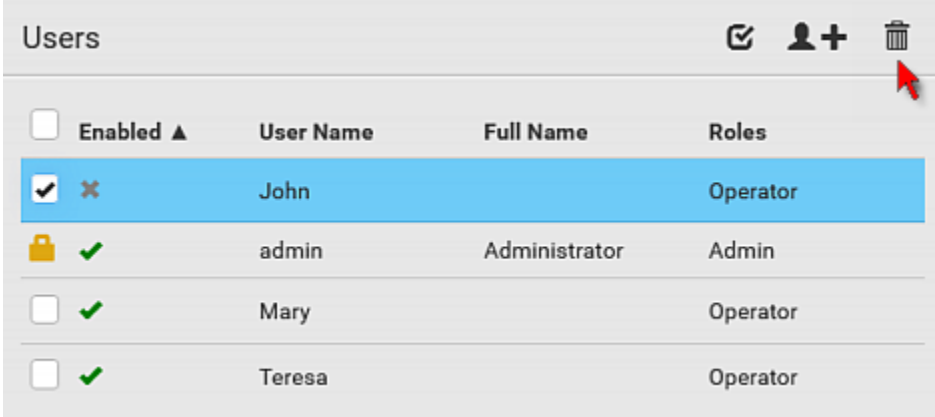

<input type="checkbox"/> Enabled ▲	User Name	Full Name	Roles
<input checked="" type="checkbox"/> ✕	John		Operator
 <input checked="" type="checkbox"/>	admin	Administrator	Admin
<input type="checkbox"/> <input checked="" type="checkbox"/>	Mary		Operator
<input type="checkbox"/> <input checked="" type="checkbox"/>	Teresa		Operator

4. Click Delete on the confirmation message.

Creating Roles

A role is a combination of permissions. Each user must have at least one role. The PX3 provides two built-in roles.



Built-in role	Description
Admin	Provide full permissions.

Built-in role	Description
Operator	Provide frequently-used permissions, including: <ul style="list-style-type: none"> • Acknowledge Alarms • Change Own Password • Change Pdu, Inlet, Outlet & Overcurrent Protector Configuration • Switch Outlet (if your PX3 is outlet-switching capable) • Switch Outlet Group (if your PX3 is outlet-switching capable) • View Event Settings • View Local Event Log

If the two do not satisfy your needs, add new roles. PX3 supports up to 64 roles.

► **To create a role:**

1. Choose User Management > Roles > .

Roles			
Role Name ▲	Description		
Admin	System defined administrator role including all privileges.		
Operator	Predefined operator role.		

2. Assign a role name.
 - 1 to 32 characters long
 - Case sensitive
 - Spaces are permitted
3. Type a description for the role in the Description field.
4. Select the desired privilege(s).
 - The 'Administrator Privileges' includes all privileges.
 - The 'Unrestricted View Privileges' includes all 'View' privileges.
5. If any privilege requires the argument setting, the symbol  displays in the rightmost edge of that privilege's row. To select such a privilege:
 - a. Click on that privilege's row to display a list of available arguments for that privilege.
 - b. Select the desired arguments.

- To select all arguments, simply select the checkbox labeled 'All XXX'.

Tip: The other way to select all arguments is to select that privilege's checkbox while the arguments list is not expanded yet.

For example, on an outlet-switching capable model, you can specify the outlets that users can switch on/off as shown below. To select all outlets, select the 'All Outlets' checkbox instead.

Switch Outlet		2-4 and 7	⌵
<input type="checkbox"/>	All Outlets	<input type="checkbox"/>	Outlet 5
<input type="checkbox"/>	Outlet 1	<input type="checkbox"/>	Outlet 6
<input checked="" type="checkbox"/>	Outlet 2	<input checked="" type="checkbox"/>	Outlet 7
<input checked="" type="checkbox"/>	Outlet 3	<input type="checkbox"/>	Outlet 8
<input checked="" type="checkbox"/>	Outlet 4		

6. Click Save.

Now you can assign the role to any user. See **Creating Users** (on page 288) or **Editing or Deleting Users** (on page 292).

Editing or Deleting Roles

Choose User Management > Roles to open the Roles page, which lists all roles.

If wanted, you can resort the list by clicking the desired column header. See **Sorting a List** (on page 182).

Roles		✍️	👤+
Role Name ▲	Description		
Admin	System defined administrator role including all privileges.	🔒	
Manager	Able to change all settings except for security settings		
Operator	Predefined operator role.		

The Admin role is not user-configurable so the lock icon 🔒 displays, indicating that you are not allowed to configure it.

▶ To edit a role:

1. On the Roles page, click the desired role. The Edit Role page opens.
2. Make changes as needed.
 - The role name cannot be changed.

- To delete this role, click , and confirm the operation.

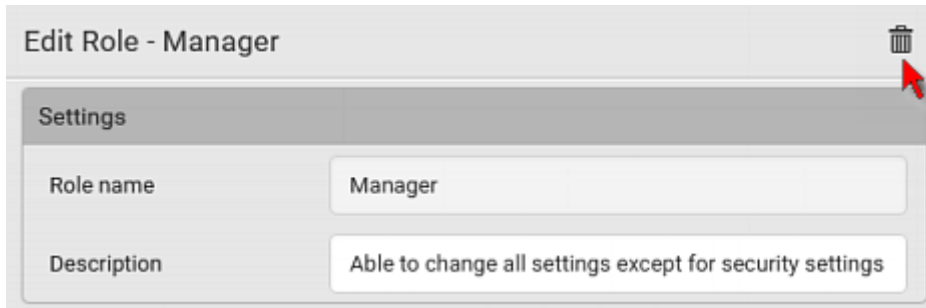

3. Click Save.

► **To delete any roles:**

1. On the Roles page, click  to make checkboxes appear in front of roles.

Tip: To delete only one role, you can simply click that role without making the checkboxes appear. Refer to the above procedure.

2. Select one or multiple roles.
 - To select all roles, except for the Admin role, select the topmost checkbox in the header row.
3. Click  on the top-right corner.
4. Click Delete on the confirmation message.

Setting Your Preferred Measurement Units

You can change the measurement units shown in the PX3 user interface according to your own preferences regardless of the permissions you have.

*Tip: Preferences can also be changed by administrators for specific users on the Edit User page. See **Editing or Deleting Users** (on page 292).*

Measurement unit changes only apply to the web interface and command line interface.

Setting your own preferences does not change the default measurement units. See **Setting Default Measurement Units** (on page 297).

► **To select the measurement units you prefer:**

1. Choose User Management > User Preferences.
2. Make changes as needed.

Field	Description
Temperature unit	Preferred units for temperatures -- °C (Celsius) or °F (Fahrenheit).

Field	Description
Length unit	Preferred units for length or height -- Meter or Feet.
Pressure unit	Preferred units for pressure -- Pascal or Psi. <ul style="list-style-type: none"> ▪ Pascal = one newton per square meter ▪ Psi = pounds per square inch

3. Click Save.

Setting Default Measurement Units

Default measurement units are applied to all PX3 user interfaces across all users, including users accessing the PX3 via external authentication servers.

For a list of affected user interfaces, see ***User Interfaces Showing Default Units*** (on page 298). The front panel display also shows the default measurement units.

*Note: The preferred measurement units set by any individual user or by the administrator on a per-user basis will override the default units in the web interface and command line interface. See **Setting Your Preferred Measurement Units** (on page 296) or **Creating Users** (on page 288).*

► **To set up default user preferences:**

1. Click User Management > Default Preferences.
2. Make changes as needed.

Field	Description
Temperature unit	Preferred units for temperatures -- °C (Celsius) or °F (Fahrenheit).
Length unit	Preferred units for length or height -- Meter or Feet.
Pressure unit	Preferred units for pressure -- Pascal or Psi. <ul style="list-style-type: none"> ▪ Pascal = one newton per square meter ▪ Psi = pounds per square inch

3. Click Save.

User Interfaces Showing Default Units

Default measurement units will apply to the following user interfaces or data:

- Web interface for "newly-created" local users when they have not configured their own preferred measurement units. See **Creating Users** (on page 288).
- Web interface for users who are authenticated via LDAP/Radius servers.
- The sensor report triggered by the "Send Sensor Report" action. See **Send Sensor Report** (on page 396).
- Front panel LCD display.

Device Settings

Click 'Device Settings' in the **Menu** (on page 178), and the following submenu displays.

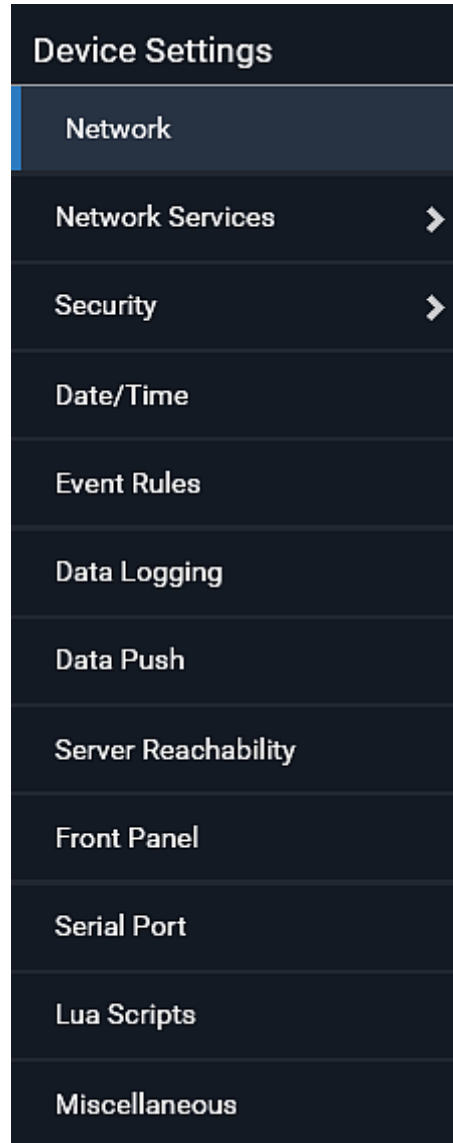

Menu command	Submenu command	Refer to...
Network		<i>Configuring Network Settings</i> (on page 301)
Network Services	HTTP	<i>Changing HTTP(S) Settings</i> (on page 327)
	SNMP	<i>Configuring SNMP Settings</i> (on page 329)

Menu command	Submenu command	Refer to...
	SMTP Server	Configuring SMTP Settings (on page 331)
	SSH	Changing SSH Settings (on page 332)
	Telnet	Changing Telnet Settings (on page 333)
	Modbus	Changing Modbus Settings (on page 333)
	Server Advertising	Enabling Service Advertising (on page 336)
Security	IP Access Control	Creating IP Access Control Rules (on page 338)
	Role Based Access Control	Creating Role Based Access Control Rules (on page 342)
	TLS Certificate	Setting Up a TLS Certificate (on page 344)
	Authentication	Setting Up External Authentication (on page 349)
	Login Settings	Configuring Login Settings (on page 356)
	Password Policy	Configuring Password Policy (on page 357)
	Service Agreement	Enabling the Restricted Service Agreement (on page 358)
Date/Time		Setting the Date and Time (on page 360)
Event Rules		Event Rules and Actions (on page 364)
Data Logging		Setting Data Logging (on page 427)
Data Push		Configuring Data Push Settings (on page 428)
Server Reachability		Monitoring Server Accessibility (on page 437)
Front Panel		Front Panel Settings (on page 445)
Serial Port		Configuring the Serial Port (on page 446)
Lua Scripts		Lua Scripts (on page 447)
Miscellaneous		Miscellaneous (on page 453)

Configuring Network Settings

Configure wired, wireless, and Internet protocol-related settings on the Network page after **Connecting the PX3 to Your Network** (on page 21).

You can enable both the wired and wireless networking on PX3 so that it has multiple IP addresses -- wired and wireless IP. For example, you can obtain one IPv4 and/or IPv6 address by enabling one Ethernet interface, and obtain one more IPv4 and/or IPv6 address by enabling/configuring the wireless interface. This also applies when PX3 enters the port forwarding mode so that PX3 has more than one IPv4 or IPv6 address in the port forwarding mode.

However, PX3 in the BRIDGING mode obtains "only one" IP address for wired networking. Wireless networking is NOT supported in this mode.

Important: In the bridging mode, only the IP parameters of the BRIDGE interface function. The IP parameters of ETH1/ETH2 and WIRELESS interfaces do NOT function.

► **To set up the network settings:**

1. Choose Device Settings > Network.
2. To use DHCP-assigned DNS servers and gateway instead of static ones, go to step 3. To manually specify DNS servers and default gateway, configure the Common Network Settings section. See **Common Network Settings** (on page 304).
 - Static routes and cascading mode are also in this section. You need to configure them only when there are such local requirements. See **Setting the Cascading Mode** (on page 318) and **Static Route Examples** (on page 314).
3. To configure IPv4/IPv6 settings for a *wired* network, click the ETH1/ETH2 or BRIDGE section. See **Wired Network Settings** (on page 302).
 - If the device's cascading mode is set to 'Bridging', the BRIDGE section appears. Then you must click the BRIDGE section for IPv4/IPv6 settings.
4. To configure IPv4/IPv6 settings for a *wireless* network, click the WIRELESS section. See **Wireless Network Settings** (on page 308).
 - You must connect a USB wireless LAN adapter to the PX3 for wireless networking.

Note: If the device's cascading mode is set to 'Bridging' or its role is set to 'Slave' in the port forwarding mode, the wireless settings will be disabled.

5. To configure the ETH1/ETH2 interface settings, see **Ethernet Interface Settings** (on page 305).
6. Click Save.

▶ **After enabling either or both Internet protocols:**

After enabling IPv4 and/or IPv6, all but not limited to the following protocols will be compliant with the selected Internet protocol(s):

- LDAP
- NTP
- SMTP
- SSH
- Telnet
- FTP
- SSL/TLS
- SNMP
- SysLog

Note: PX3 disables TLS 1.0 and 1.1 by default. It enables only TLS 1.2 and 1.3.

Wired Network Settings

On the Network page, click the ETH1/ETH2 section to configure IPv4/IPv6 settings.

If the device's cascading mode is set to 'Bridging', the BRIDGE section appears. Then you must click the BRIDGE section for IPv4/IPv6 settings. See **Setting the Cascading Mode** (on page 318).

▶ **Enable Interface:**

Make sure the Ethernet interface is enabled, or all networking through this interface fails. This setting is available in the ETH1/ETH2 section, but not available in the BRIDGE section.

Enable interface

▶ **IPv4 settings:**

Field/setting	Description
Enable IPv4	Enable or disable the IPv4 protocol.
IP auto configuration	Select the method to configure IPv4 settings. <ul style="list-style-type: none"> ▪ <i>DHCP</i>: Auto-configure IPv4 settings via DHCP servers. ▪ <i>Static</i>: Manually configure the IPv4 settings.
Preferred hostname	Enter the hostname you prefer for IPv4 connectivity

- **DHCP settings:** Optionally specify the preferred hostname, which must meet the following requirements:
 - Consists of alphanumeric characters and/or hyphens
 - Cannot begin or end with a hyphen
 - Cannot contain more than 63 characters
 - Cannot contain punctuation marks, spaces, and other symbols
- **Static settings:** Assign a static IPv4 address, which follows this syntax "IP address/prefix length".
Example: *192.168.84.99/24*

▶ **IPv6 settings:**

Field/setting	Description
Enable IPv6	Enable or disable the IPv6 protocol.
IP auto configuration	Select the method to configure IPv6 settings. <ul style="list-style-type: none"> ▪ <i>Automatic:</i> Auto-configure IPv6 settings via DHCPv6. ▪ <i>Static:</i> Manually configure the IPv6 settings.
Preferred hostname	<ul style="list-style-type: none"> ▪ Enter the hostname you prefer for IPv6 connectivity

- **Automatic settings:** Optionally specify the preferred hostname, which must meet the above requirements.
- **Static settings:** Assign a static IPv6 address, which follows this syntax "IP address/prefix length".
Example: *fd07:2fa:6cff:1111::0/128*

- ▶ (Optional) To view the diagnostic log for EAP authentication:
 - Click Show EAP Authentication Log. See *Diagnostic Log for Network Connections* (on page 313).

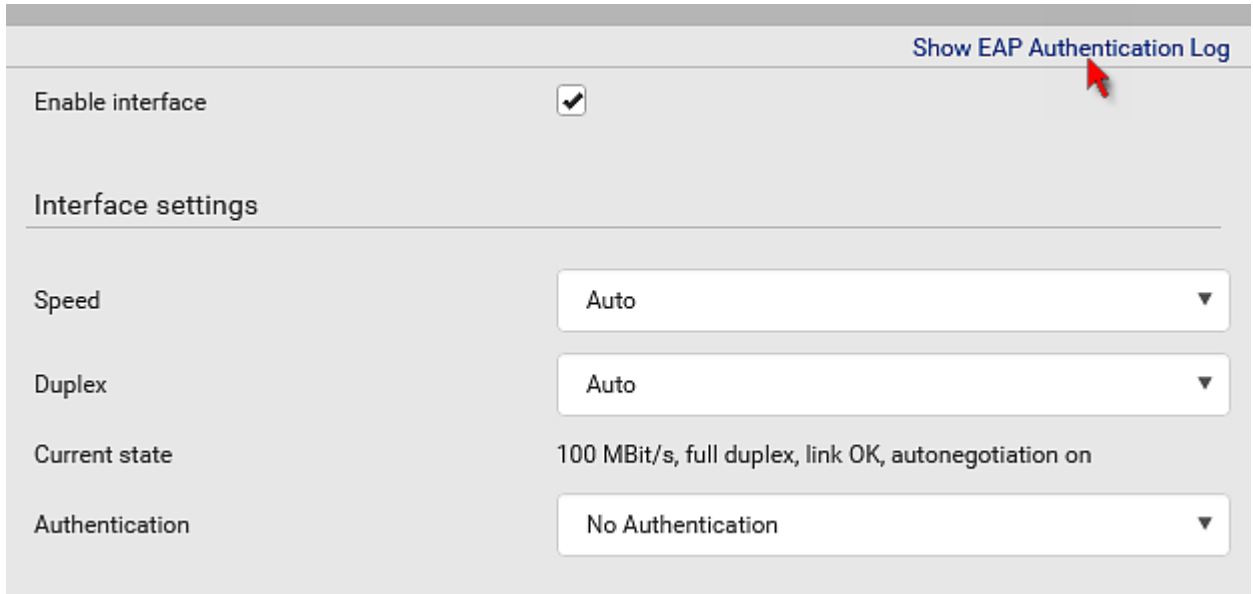

Common Network Settings

Common Network Settings are OPTIONAL, not required. Therefore, leave them unchanged if there are no specific local networking requirements.

Field	Description
Cascading mode	Leave it to the default "None" unless you are establishing a cascading chain. For more information, refer to: <ul style="list-style-type: none"> ▪ Cascading Multiple PX3 Devices for Sharing Ethernet Connectivity (on page 33) ▪ Setting the Cascading Mode (on page 318)
DNS resolver preference	Determine which IP address is used when the DNS resolver returns both IPv4 and IPv6 addresses. <ul style="list-style-type: none"> ▪ IPv4 address: Use the IPv4 addresses. ▪ IPv6 address: Use the IPv6 addresses.
DNS suffixes (optional)	Specify a DNS suffix name if needed.

Field	Description
First/Second/Third DNS server	<p>Manually specify static DNS server(s).</p> <ul style="list-style-type: none"> If any static DNS server is specified in these fields, it will override the DHCP-assigned DNS server. If DHCP (or Automatic) is selected for IPv4/IPv6 settings, and there are NO static DNS servers specified, the PX3 will use DHCP-assigned DNS servers.
IPv4/IPv6 routes	<p>You need to configure these settings only when your local network contains two subnets, and you want PX3 to communicate with the other subnet.</p> <p>If so, make sure IP forwarding has been enabled in your network, and then you can click 'Add Route' to add static routes.</p> <p>See Static Route Examples (on page 314).</p>

Ethernet Interface Settings

By default both ETH1 and ETH2 interfaces on PX3 are enabled.

▶ Enable Interface:

Make sure the Ethernet interface is enabled, or all networking through this interface fails. This setting is available in the ETH1/ETH2 section, but not available in the BRIDGE section.

Enable interface

▶ Other Ethernet settings:

Field	Description
Speed	<p>Select a LAN speed.</p> <ul style="list-style-type: none"> <i>Auto</i>: System determines the optimum LAN speed through auto-negotiation. <i>10 MBit/s</i>: Speed is always 10 Mbps. <i>100 MBit/s</i>: Speed is always 100 Mbps. <i>1 GBit/s</i>: Speed is always 1 Gbps (1000 Mbps).
Duplex	<p>Select a duplex mode.</p> <ul style="list-style-type: none"> <i>Auto</i>: The PX3 selects the optimum transmission mode through auto-negotiation. <i>Full</i>: Data is transmitted in both directions

Field	Description
	<p>simultaneously.</p> <ul style="list-style-type: none"> • <i>Half</i>: Data is transmitted in one direction (to or from the PX3) at a time.
Current state	Show the LAN's current status, including the current speed and duplex mode.
Authentication	<p>Select an authentication method.</p> <ul style="list-style-type: none"> ▪ <i>No Authentication</i>: No authentication data is required. ▪ <i>EAP</i>: Use Protected Extensible Authentication Protocol. Enter required authentication data in the fields that appear.
Outer authentication	<p>This field appears when 'EAP' is selected.</p> <p>There are two authentication methods for EAP.</p> <ul style="list-style-type: none"> ▪ <i>PEAP</i>: A TLS tunnel is established, and an inner authentication method can be specified for this tunnel. ▪ <i>TLS</i>: Authentication between the client and authentication server is performed using TLS certificates.
Inner authentication	<p>This field appears when both 'EAP' and 'PEAP' are selected.</p> <ul style="list-style-type: none"> ▪ <i>MS-CHAPv2</i>: Authentication based on the given password using MS-CHAPv2 protocol. ▪ <i>TLS</i>: Authentication between the client and authentication server is performed using TLS certificates.
Identity	<p>This field appears when 'EAP' is selected.</p> <p>Type your user name.</p>
Password	<p>This field appears only when 'EAP', 'PEAP' and 'MS-CHAPv2' are all selected.</p> <p>Type your password.</p>

Field	Description
Client certificate, Client private key, Client private key password	<p>This field appears when 'EAP', 'PEAP' and 'TLS' are all selected.</p> <p>PEM encoded X.509 certificate and PEM encoded private key are required for certification-based authentication methods. Private key password is optional.</p> <ul style="list-style-type: none"> ▪ PX3 supports private keys of PKCS#1 and PKCS#8 formats. ▪ Client Private Key Password should be entered only when your private key is encrypted with a password. ▪ To view the uploaded certificate, click Show Client Certificate. ▪ To remove the uploaded certificate and private key, click 'Clear Key/Certificate selection'.
CA certificate	<p>This field appears when 'EAP' is selected.</p> <p>A third-party CA certificate may or may not be needed. If needed, follow the steps below.</p>
RADIUS authentication server name	<p>This field appears when 'EAP' is selected.</p> <p>Type the name of the RADIUS server if it is present in the TLS certificate.</p> <ul style="list-style-type: none"> ▪ The name must match the fully qualified domain name (FQDN) of the host shown in the certificate.

Note: Auto-negotiation is disabled after setting both the speed and duplex settings of the PX3 to NON-Auto values, which may result in a duplex mismatch.

- **Available settings for the CA Certificate:**

If the required certificate file is a chain of certificates, and you are not sure about the requirements of a certificate chain, see **TLS Certificate Chain** (on page 906).

Field/setting	Description
Enable verification of TLS certificate chain	<p>Select this checkbox for the PX3 to verify the validity of the TLS certificate that will be installed.</p> <ul style="list-style-type: none"> ▪ For example, the PX3 will check the certificate's validity period against the system time.

Field/setting	Description
	<p>Click this button to import a certificate file. Then you can:</p> <ul style="list-style-type: none"> Click Show to view the certificate's content. Click Remove to delete the installed certificate if it is inappropriate.
Allow expired and not yet valid certificates	<ul style="list-style-type: none"> Select this checkbox to make the authentication succeed regardless of the certificate's validity period. After deselecting this checkbox, the authentication fails whenever any certificate in the selected certificate chain is outdated or not valid yet.
Allow connection if system clock is incorrect	<p>When this checkbox is deselected, and if the system time is incorrect, the installed TLS certificate is considered not valid yet and will cause the wireless network connection to fail.</p> <p>When this checkbox is selected, it will make the wireless network connection successful when the PX3 system time is earlier than the firmware build before synchronizing with any NTP server.</p> <ul style="list-style-type: none"> The incorrect system time issue may occur when the PX3 has once been powered off for a long time.

Wireless Network Settings

If the device's cascading mode is set to 'Bridging' or its role is set to 'Slave' in the port forwarding mode, the wireless settings will be disabled. See **Setting the Cascading Mode** (on page 318).

By default the wireless interface is disabled. You should enable it if wireless networking is wanted.

On the Network page, click the WIRELESS section to configure wireless and IPv4/IPv6 settings.

▶ Interface Settings:

Field/setting	Description
Enable interface	<p>Enable or disable the wireless interface.</p> <p>When disabled, the wireless networking fails.</p>
Hardware state	<p>Check this field to ensure that the PX3 has detected a wireless USB LAN adapter. If not, verify whether the</p>

Field/setting	Description
	USB LAN adapter is firmly connected or whether it is supported.
SSID	Type the name of the wireless access point (AP).
Force AP BSSID	If the BSSID is available, select this checkbox.
BSSID	Type the MAC address of an access point.
Enable High Throughput (802.11n)	Enable or disable 802.11n protocol.
Authentication	Select an authentication method. <ul style="list-style-type: none"> ▪ <i>No Authentication</i>: No authentication data is required. ▪ <i>PSK</i>: A Pre-Shared Key is required. ▪ <i>EAP</i>: Use Protected Extensible Authentication Protocol. Enter required authentication data in the fields that appear.
Pre-Shared Key	This field appears only when PSK is selected. Type the PSK string.
Outer authentication	This field appears when 'EAP' is selected. There are two authentication methods for EAP. <ul style="list-style-type: none"> ▪ <i>PEAP</i>: A TLS tunnel is established, and an inner authentication method can be specified for this tunnel. ▪ <i>TLS</i>: Authentication between the client and authentication server is performed using TLS certificates.
Inner authentication	This field appears when both 'EAP' and 'PEAP' are selected. <ul style="list-style-type: none"> ▪ <i>MS-CHAPv2</i>: Authentication based on the given password using MS-CHAPv2 protocol. ▪ <i>TLS</i>: Authentication between the client and authentication server is performed using TLS certificates.

Field/setting	Description
Identity	<p>This field appears when 'EAP' is selected.</p> <p>Type your user name.</p>
Password	<p>This field appears only when 'EAP', 'PEAP' and 'MS-CHAPv2' are all selected.</p> <p>Type your password.</p>
Client certificate, Client private key, Client private key password	<p>This field appears when 'EAP', 'PEAP' and 'TLS' are all selected.</p> <p>PEM encoded X.509 certificate and PEM encoded private key are required for certification-based authentication methods. Private key password is optional.</p> <ul style="list-style-type: none"> ▪ PX3 supports private keys of PKCS#1 and PKCS#8 formats. ▪ Client Private Key Password should be entered only when your private key is encrypted with a password. ▪ To view the uploaded certificate, click Show Client Certificate. ▪ To remove the uploaded certificate and private key, click 'Clear Key/Certificate selection'.
CA certificate	<p>This field appears when 'EAP' is selected.</p> <p>A third-party CA certificate may or may not be needed. If needed, follow the steps below.</p>
RADIUS authentication server name	<p>This field appears when 'EAP' is selected.</p> <p>Type the name of the RADIUS server if it is present in the TLS certificate.</p> <ul style="list-style-type: none"> ▪ The name must match the fully qualified domain name (FQDN) of the host shown in the certificate.

- **Available settings for the CA Certificate:**

If the required certificate file is a chain of certificates, and you are not sure about the requirements of a certificate chain, see **TLS Certificate Chain** (on page 906).

Field/setting	Description
Enable verification of TLS certificate chain	Select this checkbox for the PX3 to verify the validity of the TLS certificate that will be installed. <ul style="list-style-type: none"> ▪ For example, the PX3 will check the certificate's validity period against the system time.
	Click this button to import a certificate file. Then you can: <ul style="list-style-type: none"> ▪ Click Show to view the certificate's content. ▪ Click Remove to delete the installed certificate if it is inappropriate.
Allow expired and not yet valid certificates	<ul style="list-style-type: none"> ▪ Select this checkbox to make the authentication succeed regardless of the certificate's validity period. ▪ After deselecting this checkbox, the authentication fails whenever any certificate in the selected certificate chain is outdated or not valid yet.
Allow connection if system clock is incorrect	<p>When this checkbox is deselected, and if the system time is incorrect, the installed TLS certificate is considered not valid yet and will cause the wireless network connection to fail.</p> <p>When this checkbox is selected, it will make the wireless network connection successful when the PX3 system time is earlier than the firmware build before synchronizing with any NTP server.</p> <ul style="list-style-type: none"> ▪ The incorrect system time issue may occur when the PX3 has once been powered off for a long time.

► **IPv4 settings:**

Field/setting	Description
Enable IPv4	Enable or disable the IPv4 protocol.
IP auto configuration	Select the method to configure IPv4 settings. <ul style="list-style-type: none"> ▪ <i>DHCP</i>: Auto-configure IPv4 settings via DHCP servers. ▪ <i>Static</i>: Manually configure the IPv4 settings.
Preferred hostname	Enter the hostname you prefer for IPv4 connectivity

- **DHCP settings:** Optionally specify the preferred hostname, which must meet the following requirements:
 - Consists of alphanumeric characters and/or hyphens
 - Cannot begin or end with a hyphen
 - Cannot contain more than 63 characters
 - Cannot contain punctuation marks, spaces, and other symbols
- **Static settings:** Assign a static IPv4 address, which follows this syntax "IP address/prefix length".
Example: *192.168.84.99/24*

▶ **IPv6 settings:**

Field/setting	Description
Enable IPv6	Enable or disable the IPv6 protocol.
IP auto configuration	Select the method to configure IPv6 settings. <ul style="list-style-type: none"> ▪ <i>Automatic:</i> Auto-configure IPv6 settings via DHCPv6. ▪ <i>Static:</i> Manually configure the IPv6 settings.
Preferred hostname	<ul style="list-style-type: none"> ▪ Enter the hostname you prefer for IPv6 connectivity

- **Automatic settings:** Optionally specify the preferred hostname, which must meet the above requirements.
- **Static settings:** Assign a static IPv6 address, which follows this syntax "IP address/prefix length".
Example: *fd07:2fa:6cff:1111::0/128*

▶ **(Optional) To view the wireless LAN diagnostic log:**

- Click Show WLAN Diagnostic Log. See **Diagnostic Log for Network Connections** (on page 313).

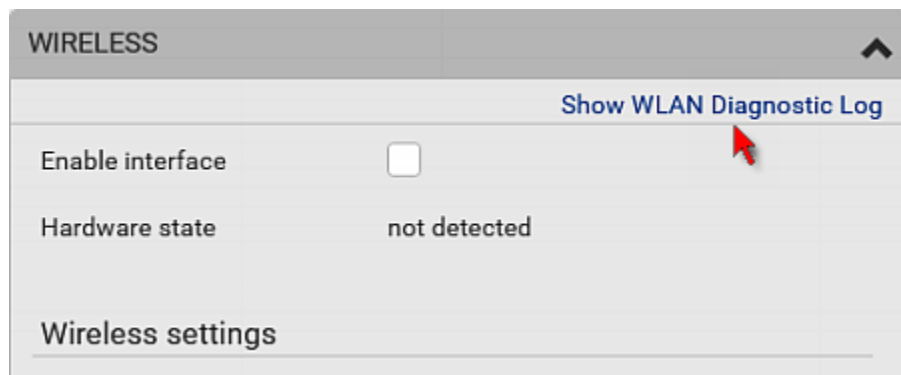

Diagnostic Log for Network Connections



PX3 provides a diagnostic log for inspecting connection errors that occurred during the EAP authentication or the wireless network connection. The information is useful for technical support.

Note that the diagnostic log shows data only after connection errors are detected.

Each entry in the log consists of:

- ID number
- Date and time
- Description



► To view the log:

1. Access the diagnostic log with either method below.
 - Choose Device Settings > Network > ETH1/ETH2 > Show EAP Authentication Log. See **Configuring Network Settings** (on page 301).
 - Choose Device Settings > Network > WIRELESS > Show WLAN Diagnostic Log.
2. The log is refreshed automatically at a regular interval of five seconds. To avoid any new events' interruption during data browsing, you can suspend the automatic update by clicking  **Pause**.
 - To restore automatic update, click  **Resume**. Those new events that have not been listed yet due to suspension will be displayed in the log now.
3. To go to other pages of the log, click the pagination bar at the bottom of the page.
 - When there are more than 5 pages and the page numbers listed does not show the desired one, click  to have the bar show the next or previous five page numbers, if available.



4. If wanted, you can resort the list by clicking the desired column header. See **Sorting a List** (on page 182).

► To clear the diagnostic log:

1. On the top-right corner of the log, click  >  **Clear Log**.
2. Click Clear Log on the confirmation message.

Static Route Examples

This section describes two static route examples: IPv4 and IPv6. Both examples assume that two network interface controllers (NIC) have been installed in one network server, leading to two available subnets, and IP forwarding has been enabled. All of the NICs and PX3 devices in the examples use static IP addresses.

Most of local multiple networks are not directly reachable and require the use of a gateway. Therefore, we will select Gateway in the following examples. If your local multiple networks are directly reachable, you should select Interface rather than Gateway.

*Note: If Interface is selected, you should select an interface name instead of entering an IP address. See **Interface Names** (on page 317).*

▶ IPv4 example:

- Your PX3: *192.168.100.64*
- Two NICs: *192.168.200.75* and *192.168.100.88*
- Two networks: *192.168.200.0* and *192.168.100.0*
- Prefix length: 24

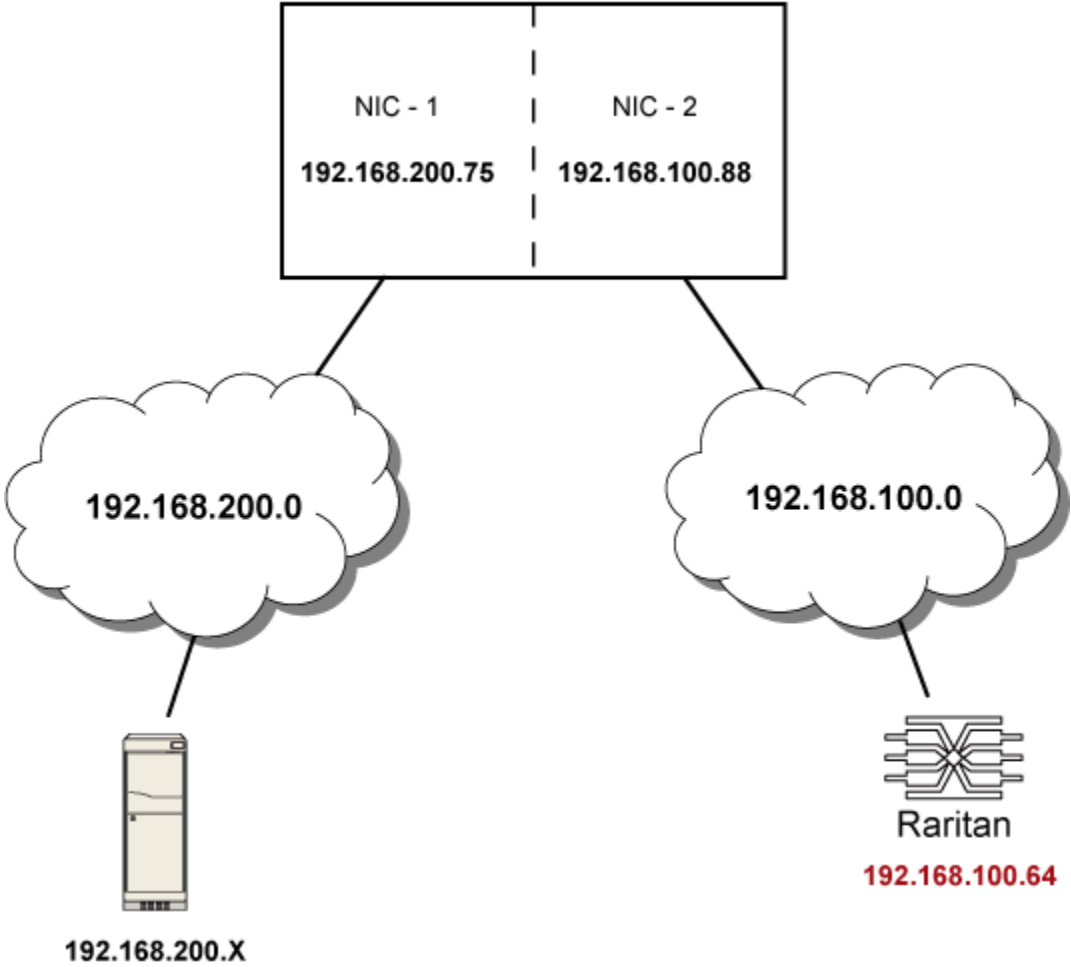



In this example, NIC-2 (192.168.100.88) is the next hop router for your PX3 to communicate with any device in the other subnet 192.168.200.0.

In the IPv4 "Static Routes" section, you should enter the data as shown below. Note that the address in the first field must be of the Classless Inter-Domain Routing (CIDR) notation.

1	192.168.200.0/24	Gateway	192.168.100.88	↑	↓	🗑️
---	------------------	---------	----------------	---	---	----

Tip: If you have configured multiple static routes, you can click on any route and

then make changes, use  or  to re-sort the priority, or click

 to delete it.

▶ **IPv6 example:**

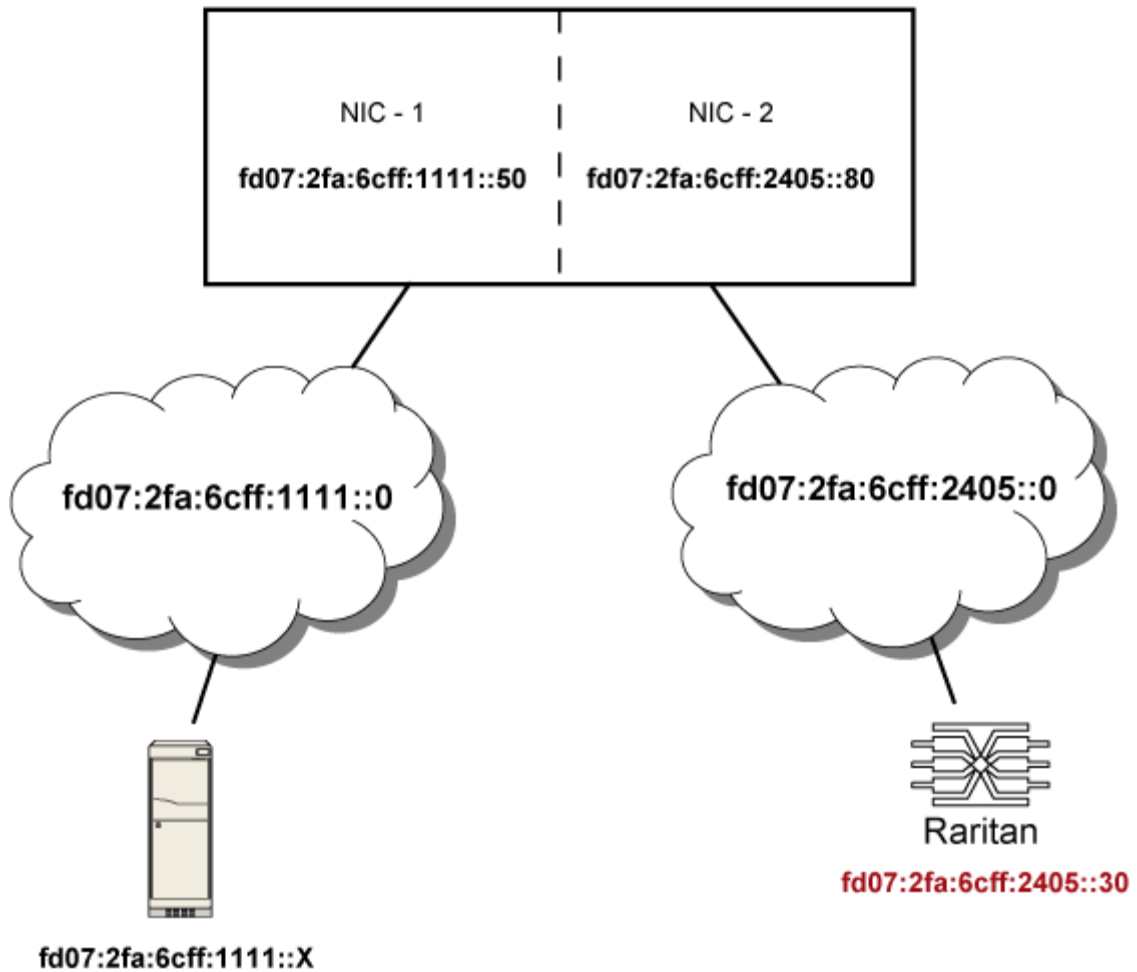

- Your PX3: `fd07:2fa:6cff:2405::30`
- Two NICs: `fd07:2fa:6cff:1111::50` and `fd07:2fa:6cff:2405::80`
- Two networks: `fd07:2fa:6cff:1111::0` and `fd07:2fa:6cff:2405::0`
- Prefix length: 64



In this example, NIC-2 (fd07:2fa:6cff:2405::80) is the next hop router for your PX3 to communicate with any device in the other subnet fd07:2fa:6cff:1111::0.

In the IPv6 "Static Routes" section, you should enter the data as shown below. Note that the address in the first field must be of the Classless Inter-Domain Routing (CIDR) notation.

Tip: If you have configured multiple static routes, you can click on any route and

then make changes, use  or  to re-sort the priority, or click  to delete it.

Interface Names

When your local multiple networks are "directly reachable", you should select Interface for static routes. Then choose the interface where another network is connected.

▶ Interface list:

Interface name	Description
BRIDGE	When another wired network is connected to the Ethernet port of your PX3, and your PX3 has been set to the bridging mode, select this interface name instead of the Ethernet interface.
ETH1	When another wired network is connected to the ETH1 port of your PX3, select this interface name.
ETH2	When another wired network is connected to the ETH2 port of your PX3, select this interface name.
WIRELESS	When another wireless network is connected to your PX3, select this interface name.

Setting the Cascading Mode

A maximum of 16 PX3 devices can be cascaded to share one Ethernet connection. See **Cascading Multiple PX3 Devices for Sharing Ethernet Connectivity** (on page 33).

The cascading mode configured on the master device determines the Ethernet sharing method, which is either network bridging or port forwarding. See **Overview of the Cascading Modes** (on page 320).

The cascading mode of all devices in the chain must be the same.

Only a user with the Change Network Settings permission can configure the cascading mode.

*Note: PX3 in the Port Forwarding mode does not support APIPA. See **APIPA and Link-Local Addressing** (on page 2).*

► **To configure the cascading mode:**

1. Connect the device you will cascade to the LAN and find its IP address, or connect it to a computer.
 - For computer connection instructions, see **Connecting the PX3 to a Computer** (on page 30).
 - To find the IP address, see **Device Info** (on page 152).
2. Log in to its web interface. See **Login** (on page 171).
3. Choose Device Settings > Network.
4. Select the preferred mode in the Cascading Mode field.

Mode	Description
None	No cascading mode is enabled. This is the default.
Bridging	Each device in the cascading chain is accessed with a different IP address.
Port Forwarding	Each device in the cascading chain is accessed with the same IP address(es) but with a different port number assigned. For details on port numbers, see Port Number Syntax (on page 321).

Tip: If selecting Port Forwarding, the Device Information page will show a list of port numbers for all cascaded devices. Simply choose Maintenance > Device Information > Port Forwarding.

5. For the Port Forwarding mode, one to two more fields have to be configured.

Note that if either setting below is incorrectly configured, a networking issue occurs.

Field	Description
Port forwarding role (available on all cascaded devices)	<i>Master or Slave.</i> This is to determine which device is the master and which ones are slave devices.
Downstream interface (available on the master device only)	<i>USB or ETH1/ETH2.</i> This is to determine which port on the master device is connected to Slave 1. If ETH1 or ETH2 is selected as the downstream interface, make sure the selected Ethernet interface is enabled.

6. (Optional) Configure the network settings by clicking the BRIDGE, ETH1/ETH2, or WIRELESS section on the same page.
 - In the Bridging mode, each cascaded device can have different network settings. You may need to configure each device's network settings in the BRIDGE section.
 - In the Port Forwarding mode, all cascaded devices share the master device's network settings. You only need to configure the master device's network settings in the ETH1/ETH2 and/or WIRELESS section.

See **Wired Network Settings** (on page 302) or **Wireless Network Settings** (on page 308)

Tip: You can enable/configure multiple network interfaces in the Port Forwarding mode so that the cascading chain has multiple IP addresses.

7. Click Save.

For information on accessing each cascaded device in the Port Forwarding mode, see **Port Forwarding Examples** (on page 323).

► **Recommendations for cascade loops:**

You can connect both the first and the last PDU to your network (cascade loop) under the following conditions:

- a. The remaining network MUST use R/STP to avoid network loops.
AND

Both the first and the last PDUs MUST either attach to the same switch or, if they are attached to two separate switches, you must configure both ports of these switches so that the STP costs are high. This prevents the STP protocol from sending unrelated traffic through the PDU cascade, which can cause bottlenecks that lead to connectivity issues in the whole network.

► **Online cascading information:**

For more information on cascading configurations and restrictions, refer to the *Cascading Guide* on the Raritan **Support page** (<http://www.raritan.com/support/>).

Overview of the Cascading Modes

You must apply a cascading mode to the cascading chain. See **Setting the Cascading Mode** (on page 318).

There are two cascading modes: Bridging and Port Forwarding.

In the following illustration, it is assumed that users enable the DHCP networking for the cascading chain comprising four devices. In the diagrams, "M" is the master device and "S" is a slave device.

► **Illustration:**

- "Bridging" mode:

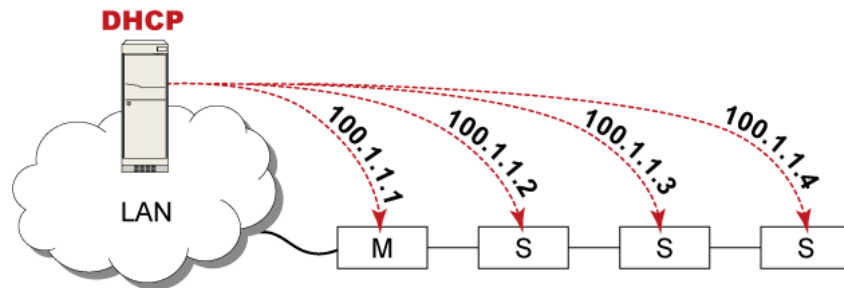

In this mode, the DHCP server communicates with every cascaded device respectively and assigns four *different* IP addresses. Each device has its own IP address.

The way to remotely access each cascaded device is completely the same as accessing a standalone device in the network.

- "Port Forwarding" mode:

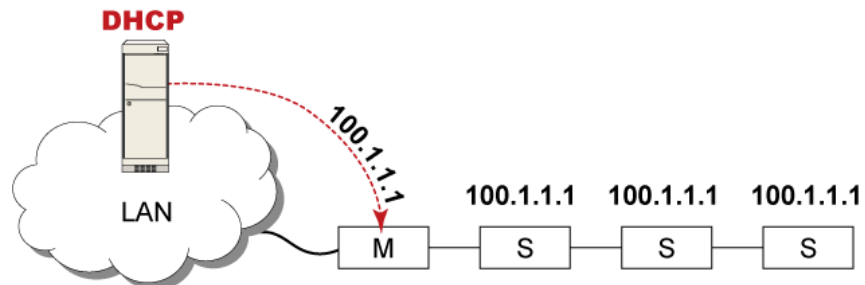

In this mode, the DHCP server communicates with the master device alone and assigns one IP address to the master device. All slave devices share the same IP address as the master device.

You must specify a 5XXXX port number (where X is a number) when remotely accessing any slave device with the shared IP address. See **Port Number Syntax** (on page 321).

► **Comparison between cascading modes:**

- The Bridging mode supports the wired network only, while the Port Forwarding mode supports both wired and wireless networks.
- Both cascading modes support a maximum of 16 devices in a chain.
- Both cascading modes support both DHCP and static IP addressing.
- In the Bridging mode, each cascaded device has a unique IP address. In the Port Forwarding mode, all cascaded devices share the same IP address(es) as the master device.
- In the Bridging mode, each cascaded device has only one IP address. In the Port Forwarding mode, each cascaded device can have multiple IP addresses as long as the master device has multiple network interfaces enabled/configured properly.

For example:

- When the master device has two Ethernet ports (ETH1/ETH2), you can enable ETH1, ETH2 and WIRELESS interfaces so that the Port-Forwarding chain has two wired IP addresses and one wireless IP address.

Port Number Syntax

In the Port Forwarding mode, all devices in the cascading chain share the same IP address(es). To access any cascaded device, you must assign an appropriate port number to it.

- Master device: The port number is either 5NNXX or the standard TCP/UDP port.
- Slave device: The port number is 5NNXX.

► **5NNXX port number syntax:**

- NN is a two-digit number representing the network protocol as shown below:

Protocols	NN
HTTPS	00
HTTP	01
SSH	02
TELNET	03
SNMP	05
MODBUS	06

- XX is a two-digit number representing the device position as shown below.

Position	XX	Position	XX
Master device	00	Slave 8	08
Slave 1	01	Slave 9	09
Slave 2	02	Slave 10	10
Slave 3	03	Slave 11	11
Slave 4	04	Slave 12	12
Slave 5	05	Slave 13	13
Slave 6	06	Slave 14	14
Slave 7	07	Slave 15	15

For example, to access the Slave 4 device via Modbus/TCP, the port number is 50604. See **Port Forwarding Examples** (on page 323) for further illustrations.

Tip: The full list of each cascaded device's port numbers can be retrieved from the web interface. Choose Maintenance > Device Information > Port Forwarding.

► **Standard TCP/UDP ports:**

The master device can be also accessed through standard TCP/UDP ports as listed in the following table.

Protocols	Port Numbers
HTTPS	443
HTTP	80
SSH	22
TELNET	23
SNMP	161
MODBUS	502

In the Port Forwarding mode, the cascaded device does NOT allow you to modify the standard TCP/UDP port configuration, including HTTP, HTTPS, SSH, Telnet and Modbus/TCP.

Port Forwarding Examples

To access a cascaded device in the Port Forwarding mode, assign a port number to the IP address.

- Master device: Assign proper 5NNXX port numbers or standard TCP/UDP ports. See **Port Number Syntax** (on page 321) for details.
- Slave device: Assign proper 5NNXX port numbers.

Assumption: *The Port Forwarding mode is applied to a cascading chain comprising three devices. The IP address is 192.168.84.77.*

► **Master device:**

Position code for the master device is '00' so each port number is 5NN00 as listed below.

Protocols	Port numbers
HTTPS	50000
HTTP	50100
SSH	50200
TELNET	50300
SNMP	50500
MODBUS	50600

Examples using "5NN00" ports:

- To access the master device via HTTPS, the IP address is:
https://192.168.84.77:50000/
- To access the master device via HTTP, the IP address is:
http://192.168.84.77:50100/
- To access the master device via SSH, the command is:
ssh -p 50200 192.168.84.77

Examples using standard TCP/UDP ports:

- To access the master device via HTTPS, the IP address is:
https://192.168.84.77:443/
- To access the master device via HTTP, the IP address is:
http://192.168.84.77:80/
- To access the master device via SSH, the command is:
ssh -p 22 192.168.84.77

► **Slave 1 device:**

Position code for Slave 1 is '01' so each port number is 5NN01 as shown below.

Protocols	Port numbers
HTTPS	50001
HTTP	50101
SSH	50201
TELNET	50301
SNMP	50501
MODBUS	50601

Examples:

- To access Slave 1 via HTTPS, the IP address is:
https://192.168.84.77:50001/
- To access Slave 1 via HTTP, the IP address is:
http://192.168.84.77:50101/
- To access Slave 1 via SSH, the command is:
ssh -p 50201 192.168.84.77

► **Slave 2 device:**

Position code for Slave 2 is '02' so each port number is 5NN02 as shown below.

Protocols	Port numbers
HTTPS	50002
HTTP	50102
SSH	50202
TELNET	50302
SNMP	50502
MODBUS	50602

Examples:

- To access Slave 2 via HTTPS, the IP address is:
https://192.168.84.77:50002/
- To access Slave 2 via HTTP, the IP address is:
http://192.168.84.77:50102/
- To access Slave 2 via SSH, the command is:
ssh -p 50202 192.168.84.77

Adding, Removing or Swapping Cascaded Devices

Change a device's cascading mode first before adding that device to a cascading chain, or before disconnecting that device from the chain.

If you only want to change the cascading mode of an existing chain, or swap the master and slave device, always start from the slave device.

*Note: If the following procedures are not followed, a networking issue occurs. When a networking issue occurs, check the cascading connection and/or software settings of all devices in the chain. See **Cascading Troubleshooting** (on page 892).*

▶ **To add a device to an existing chain:**

1. Connect the device you will cascade to the LAN and find its IP address, or connect it to a computer.
2. Log in to this device and set its cascading mode to be the same as the existing chain's cascading mode. See **Setting the Cascading Mode** (on page 318).
3. (Optional) If this device will function as a slave device, disconnect it from the LAN after configuring the cascading mode.
4. Connect this device to the chain, using either a USB or Ethernet cable.

▶ **To remove a device from the chain:**

1. Log in to the desired cascaded device, and change its cascading mode to None.

Exception: If you are going to connect the removed device to another cascading chain, set its cascading mode to be the same as the mode of another chain.

2. Now disconnect it from the cascading chain.

▶ **To swap the master and slave device:**

- In the Bridging mode, you can swap the master and slave devices by simply disconnecting ALL cascading cables from them, and then reconnecting cascading cables. No changes to software settings are required.
- In the Port Forwarding mode, you must follow the procedure below:
 - a. Access the slave device that will replace the master device, and set its role to 'Master', and correctly set the downstream interface.
 - b. Access the master device, set its role to 'Slave'.
 - c. Swap the master and slave device now.

- You must disconnect the LAN cable and ALL cascading cables connected to the two devices first before swapping them, and then reconnecting all cables.

► **To change the cascading mode applied to a chain:**

1. Access the last slave device, and change its cascading mode.
 - If the new cascading mode is 'Port Forwarding', you must also set its role to 'Slave'.
2. Access the second to last, third to last and so on until the first slave device to change their cascading modes one by one.
3. Access the master device, and change its cascading mode.
 - If the new cascading mode is 'Port Forwarding', you must also set its role to 'Master', and correctly select the downstream interface.

The following diagram indicates the correct sequence. 'N' is the final one.

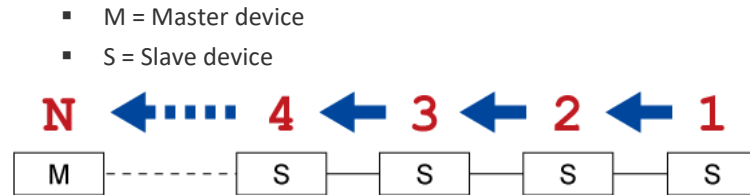

Configuring Network Services

PX3 supports the following network communication services.

Network Services
HTTP
SNMP
SMTP Server
SSH
Telnet
Modbus
Service Advertising

HTTPS and HTTP enable the access to the web interface. Telnet and SSH enable the access to the command line interface. See **Using the Command Line Interface** (on page 515).

By default, SSH is enabled, Telnet is disabled, and all TCP ports for supported services are set to standard ports. You can change default settings if necessary.

Note: Telnet access is disabled by default because it communicates openly and is thus insecure.

Submenu command	Refer to
HTTP	Changing HTTP(S) Settings (on page 327)
SNMP	Configuring SNMP Settings (on page 329)
SMTP Server	Configuring SMTP Settings (on page 331)
SSH	Changing SSH Settings (on page 332)
Telnet	Changing Telnet Settings (on page 333)
Modbus	Changing Modbus Settings (on page 333)
Server Advertising	Enabling Service Advertising (on page 336)

Important: Raritan uses TLS instead of SSL 3.0 due to published security vulnerabilities in SSL 3.0. Make sure your network infrastructure, such as LDAP and mail services, uses TLS rather than SSL 3.0.

Changing HTTP(S) Settings

HTTPS uses Transport Layer Security (TLS) technology to encrypt all traffic to and from the PX3 so it is a more secure protocol than HTTP. PX3 disables TLS 1.0 and 1.1 by default. It enables only TLS 1.2 and 1.3.

By default, any access to the PX3 via HTTP is automatically redirected to HTTPS. You can disable this redirection if needed.

► To change HTTP or HTTPS port settings:

1. Choose Device Settings > Network Services > HTTP.
2. Enable either or both protocols by selecting the corresponding 'Enable' checkbox.
3. To use a different port for HTTP or HTTPS, type a new port number.

Warning: Different network services cannot share the same TCP port.

4. To redirect the HTTP access to the PX3 to HTTPS, select the "Redirect HTTP connections to HTTPS."
 - The redirection checkbox is configurable only when both HTTP and HTTPS have been enabled.

▶ **Special note for AES ciphers:**

The PX3 device's TLS-based protocols support AES 128- and 256-bit ciphers. The exact cipher to use is negotiated between PX3 and the client (such as a web browser), which is impacted by the cipher priority of PX3 and the client's cipher availability/settings.

Tip: To force PX3 to use a specific AES cipher, refer to your client's user documentation for information on configuring AES settings. For example, you can enable a cipher and disable the other in the Firefox via the "about:config" command.

Configuring SNMP Settings

You can enable or disable SNMP communication between an SNMP manager and the PX3. Enabling SNMP communication allows the manager to retrieve and even control the power status of each outlet.

Besides, you may need to configure the SNMP destination(s) if the built-in "System SNMP Notification Rule" is enabled and the SNMP destination has not been set yet. See **Event Rules and Actions** (on page 364).

► To configure SNMP communication:

1. Choose Device Settings > Network Services > SNMP.

SNMP

SNMP Agent

Enable SNMP v1 / v2c

Read community string

Write community string

Enable SNMP v3

MIB-II System Group

sysContact

sysName

sysLocation

SNMP Notifications

Enable SNMP notifications

Notification type

Timeout s

Number of retries

#	Host	Port	Community
1	<input type="text"/>	<input type="text" value="162"/>	<input type="text"/>
2	<input type="text"/>	<input type="text" value="162"/>	<input type="text"/>
3	<input type="text"/>	<input type="text" value="162"/>	<input type="text"/>

Download MIBs

2. Enable or disable "SNMP v1 / v2c" and/or "SNMP v3" by clicking the corresponding checkbox.
 - The SNMP v1/v2c read-only access is enabled by default. The default 'Read community string' is "public."
 - To enable read-write access, type the 'Write community string.' Usually the string is "private."
3. Enter the MIB-II system group information, if applicable.
 - sysContact - the contact person in charge of the system
 - sysName - the name assigned to the system
 - sysLocation - the location of the system
4. To configure SNMP notifications:
 - a. Select the 'Enable SNMP notifications' checkbox.
 - b. Select a notification type -- SNMPv2c trap, SNMPv2c inform, SNMPv3 trap, and SNMPv3 inform.
 - c. Specify the SNMP notification destinations and enter necessary information. For details, refer to:
 - **SNMPv2c Notifications** (on page 507)
 - **SNMPv3 Notifications** (on page 508)

*Note: Any changes made to the 'SNMP Notifications' section on the SNMP page will update the settings of the System SNMP Notification Action, and vice versa. See **Available Actions** (on page 384). To add more than three SNMP destinations, you can create new SNMP notification actions. See **Send an SNMP Notification** (on page 401).*

5. You must download the SNMP MIB for your PX3 to use with your SNMP manager.
 - a. Click the Download MIBs title bar to show the download links.



- b. Click the PDU2-MIB download link. See **Downloading SNMP MIB** (on page 511).
6. Click Save.

Configuring SMTP Settings

The PX3 can be configured to send alerts or event messages to a specific administrator by email. See **Event Rules and Actions** (on page 364).

To send emails, you have to configure the SMTP settings and enter an IP address for your SMTP server and a sender's email address.

If any email messages fail to be sent successfully, the failure event and reason are available in the event log. See **Viewing or Clearing the Local Event Log** (on page 464).

► **To set SMTP server settings:**

1. Choose Device Settings > Network Services > SMTP Server.
2. Enter the information needed.

Field	Description
IP address/host name	Type the name or IP address of the mail server.
Port	Type the port number. <ul style="list-style-type: none"> ▪ Default is 25
Sender email address	Type an email address for the sender.
Number of sending retries	Type the number of email retries. <ul style="list-style-type: none"> ▪ Default is 2 retries
Time between sending retries	Type the interval between email retries in minutes. <ul style="list-style-type: none"> ▪ Default is 2 minutes.
Server requires authentication	Select this checkbox if your SMTP server requires password authentication.
User name, Password	Type a user name and password for authentication after selecting the above checkbox. <ul style="list-style-type: none"> ▪ The length of user name and password ranges between 4 and 64. Case sensitive. ▪ Spaces are not allowed for the user name, but allowed for the password.
Enable SMTP over TLS (StartTLS)	If your SMTP server supports the Transport Layer Security (TLS), select this checkbox.

▪ **Settings for the CA Certificate:**

If the required certificate file is a chain of certificates, and you are not sure about the requirements of a certificate chain, see **TLS Certificate Chain** (on page 906).

Field/setting	Description
	<p>Click this button to import a certificate file. Then you can:</p> <ul style="list-style-type: none"> Click Show to view the certificate's content. Click Remove to delete the installed certificate if it is inappropriate.
Allow expired and not yet valid certificates	<ul style="list-style-type: none"> Select this checkbox to make the authentication succeed regardless of the certificate's validity period. After deselecting this checkbox, the authentication fails whenever any certificate in the selected certificate chain is outdated or not valid yet.

3. Now that you have set the SMTP settings, you can test it to ensure it works properly.
 - a. Type the recipient's email address in the 'Recipient email addresses' field. Use a comma to separate multiple email addresses.
 - b. Click Send Test Email.
 - c. Check if the recipient(s) receives the email successfully.
4. Click Save.

► **Special note for AES ciphers:**

The PX3 device's TLS-based protocols support AES 128- and 256-bit ciphers. The exact cipher to use is negotiated between PX3 and the client (such as a web browser), which is impacted by the cipher priority of PX3 and the client's cipher availability/settings.

Tip: To force PX3 to use a specific AES cipher, refer to your client's user documentation for information on configuring AES settings.

Changing SSH Settings

You can enable or disable the SSH access to the command line interface, change the TCP port, or set a password or public key for login over the SSH connection.

► **To change SSH settings:**

1. Choose Device Settings > Network Services > SSH.
2. To enable or disable the SSH access, select or deselect the checkbox.
3. To use a different port, type a port number.
4. Select one of the authentication methods.
 - *Password authentication only:* Enables the password-based login only.

- *Public key authentication only:* Enables the public key-based login only.
 - *Password and public key authentication:* Enables both the password- and public key-based login. This is the default.
5. Click Save.

If the public key authentication is selected, you must enter a valid SSH public key for each user profile to log in over the SSH connection. See **Creating Users** (on page 288).

Changing Telnet Settings

You can enable or disable the Telnet access to the command line interface, or change the TCP port.

▶ To change Telnet settings:

1. Choose Device Settings > Network Services > Telnet.
2. To enable the Telnet access, select the checkbox.
3. To use a different port, type a new port number.
4. Click Save.

Changing Modbus Settings

The PX3 supports both the Modbus/TCP and Modbus Gateway features. Enable either or both Modbus features according to your needs.

▶ Modbus/TCP Access:

You can enable or disable the Modbus/TCP access to PX3, set it to the read-only mode, or change the TCP port.

1. Choose Device Settings > Network Services > Modbus.
2. To enable the Modbus/TCP access, select the "Enable Modbus/TCP access" checkbox.
3. To use a different port, type a new port number.
4. To enable the Modbus read-only mode, select the checkbox of the "Enable read-only mode" field. To enable the read-write mode, deselect it.

► **Modbus Gateway:**

If connecting the Modbus RTU devices to PX3 and enabling the Modbus Gateway feature, the Modbus TCP clients on your network will be able to communicate with those Modbus RTU devices attached to PX3. See **Connecting a Modbus RTU Device or Bus** (on page 80).

1. To allow the Modbus TCP clients on the network to communicate with the Modbus RTU devices connected to the PX3, select the 'Enable Modbus gateway' checkbox.

Modbus Gateway	
Enable Modbus gateway	<input checked="" type="checkbox"/>
TCP port	<input type="text" value="503"/>
Parity	<input type="text" value="Even"/>
Line speed	<input type="text" value="19200"/>
Default address	<input type="text" value="1"/>

2. Now configure the fields shown.

Field	Description
TCP port	<p>Use the default port 503, or assign a different port. Valid range is 1 to 65535.</p> <hr/> <p><i>Note: Port 502 is the default Modbus/TCP port for PX3, so you cannot use that port for the Modbus Gateway.</i></p>
Parity, Line speed	<p>Use the default values, or update if the Modbus RTU devices are using different communication parameters.</p>
Default address	<p>If the Modbus TCP client does not support Modbus RTU unit identifier addressing, enter a Default Address.</p> <p>If you must provide a unit identifier address:</p> <ul style="list-style-type: none"> ▪ Only one Modbus RTU device is supported. ▪ The unit identifier address you provide is applied to the Modbus RTU device connected to PX3. <p>Note that each Modbus RTU device's unit identifier address must be unique.</p> <hr/> <p><i>Warning: If the connected Modbus RTU device's address does not match the address entered in this field, communications between the Modbus TCP clients and Modbus RTU device fail.</i></p>

Enabling Service Advertising

The PX3 advertises all enabled services that are reachable using the IP network. This feature uses DNS-SD (Domain Name System-Service Discovery) and MDNS (Multicast DNS). The advertised services are discovered by clients that have implemented DNS-SD and MDNS.

The advertised services include the following:

- HTTP
- HTTPS
- Telnet
- SSH
- Modbus
- json-rpc
- SNMP

By default, this feature is enabled.

Enabling this feature also enables Link-Local Multicast Name Resolution (LLMNR) and/or MDNS, which are required for resolving APIPA host names. See **APIPA and Link-Local Addressing** (on page 2).

The service advertisement feature supports both IPv4 and IPv6 protocols.

If you have set a preferred host name for IPv4 and/or IPv6, that host name can be used as the zero configuration .local host name, that is, `<preferred_host_name>.local`, where `<preferred_host_name>` is the preferred host name you have specified for PX3. The IPv4 host name is the first priority. If an IPv4 host name is not available, then use the IPv6 host name.

*Note: For information on configuring IPv4 and/or IPv6 network settings, see **Wired Network Settings** (on page 302).*

► **To enable or disable service advertising:**

1. Choose Device Settings > Network Services > Service Advertising.
2. To enable the service advertising, select either or both checkboxes.
 - To advertise via MDNS, select the Multicast DNS checkbox.
 - To advertise via LLMNR, select the Link-Local Multicast Name Resolution checkbox.
3. Click Save.

Configuring Security Settings

The PX3 provides tools to control access. You can enable the internal firewall, create firewall rules, and set login limitations. In addition, you can create and install the certificate or set up external authentication servers for access control. This product supports SHA-2 TLS certificates.

*Tip: To force all HTTP accesses to the PX3 to be redirected to HTTPS, see **Changing HTTP(S) Settings** (on page 327).*

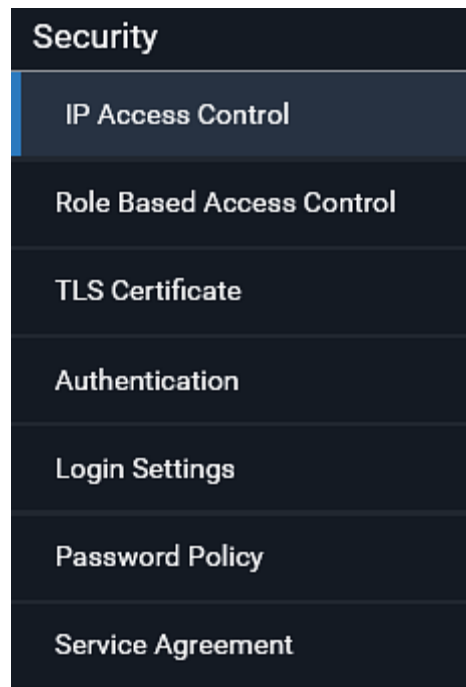

Submenu command	Refer to
IP Access Control	<i>Creating IP Access Control Rules</i> (on page 338)
Role Based Access Control	<i>Creating Role Based Access Control Rules</i> (on page 342)
TLS Certificate	<i>Setting Up a TLS Certificate</i> (on page 344)
Authentication	<i>Setting Up External Authentication</i> (on page 349)
Login Settings	<i>Configuring Login Settings</i> (on page 356)
Password Policy	<i>Configuring Password Policy</i> (on page 357)
Service Agreement	<i>Enabling the Restricted Service Agreement</i> (on page 358)

Creating IP Access Control Rules

IP access control rules (firewall rules) determine whether to accept or discard traffic to/from the PX3, based on the IP address of the host sending or receiving the traffic. When creating rules, keep these principles in mind:

- **Rule order is important.**

When traffic reaches or is sent from the PX3, the rules are executed in numerical order. Only the first rule that matches the IP address determines whether the traffic is accepted or discarded. Any subsequent rules matching the IP address are ignored.

- **Prefix length is required.**

When typing the IP address, you must specify it in the CIDR notation. That is, BOTH the address and the prefix length are included. For example, to specify a single address with the 24-bit prefix length, use this format:

x.x.x.x/24

/24 = the prefix length.

Note: Valid IPv4 addresses range from 0.0.0.0 through 255.255.255.255.

► **To configure IPv4 access control rules:**

1. Choose Device Settings > Security > IP Access Control.
2. Select the 'Enable IPv4 access control' checkbox to enable IPv4 access control rules.
3. Determine the IPv4 default policy.
 - *Accept*: Accepts traffic from all IPv4 addresses.
 - *Drop*: Discards traffic from all IPv4 addresses, without sending any failure notification to the source host.
 - *Reject*: Discards traffic from all IPv4 addresses, and an ICMP message is sent to the source host for failure notification.
4. Go to the Inbound Rules section or the Outbound Rules section according to your needs.
 - Inbound rules control the data sent to the PX3.
 - Outbound rules control the data sent from the PX3.
5. Create rules. Refer to the tables below for different operations.

ADD a rule to the end of the list



- Click Append.
- Type an IP address and subnet mask in the IP/Mask field.
- Select an option in the Policy field.
 - *Accept*: Accepts traffic from/to the specified IP address(es).
 - *Drop*: Discards traffic from/to the specified IP address(es), without sending any failure notification to the source or destination host.
 - *Reject*: Discards traffic from/to the specified IP address(es), and an ICMP message is sent to the source or destination host for failure notification.

INSERT a rule between two rules

- Select the rule above which you want to insert a new rule. For example, to insert a rule between rules #3 and #4, select #4.
- Click *Insert Above*.
- Type an IP address and subnet mask in the IP/Mask field.
- Select *Accept*, *Drop* or *Reject* in the Policy field. Refer to the above table for details.

The system automatically numbers the rule.

6. When finished, the rules are listed.

- You can select any existing rule and then click  or  to change its priority.

IPv4

Enable IPv4 access control

Inbound Rules

Default policy Accept ▼

#	IP/Mask	Policy	
1	192.168.8.8/32	Drop	
2	192.168.255.33/24	Accept	
3	192.210.15.30/32	Reject	

Append Insert Above

Outbound Rules

Default policy Accept ▼

#	IP/Mask	Policy	
1	192.23.89.100/24	Drop	

Append Insert Above

Save

7. Click Save. The rules are applied.



► **To configure IPv6 access control rules:**

1. On the same page, select the 'Enable IPv6 access control' checkbox to enable IPv6 access control rules.
2. Follow the same procedure as the above IPv4 rule setup to create IPv6 rules.
3. **Make sure you click the Save button in the IPv6 section**, or the changes made to IPv6 rules are not saved.

Editing or Deleting IP Access Control Rules

When an existing IP access control rule requires updates of IP address range and/or policy, modify them accordingly. Or you can delete any unnecessary rules.

► **To modify or delete a rule:**

1. Choose Device Settings > Security > IP Access Control.
2. Go to the IPv4 or IPv6 section.
3. Select the desired rule in the list.
 - Ensure the IPv4 or IPv6 checkbox has been selected, or you may not edit or delete any rule.
4. Perform the desired action.
 - Make changes to the selected rule, and then click Save. For information on each field, see **Creating IP Access Control Rules** (on page 338).
 - Click  to remove it.
 - To resort its order, click  or .
5. Click Save.
 - IPv4 rules: **Make sure you click the Save button in the IPv4 section**, or the changes made to IPv4 rules are not saved.
 - IPv6 rules: **Make sure you click the Save button in the IPv6 section**, or the changes made to IPv6 rules are not saved.

Creating Role Based Access Control Rules

Role-based access control rules are similar to IP access control rules, except that they are applied to members of a specific role. This enables you to grant system permissions to a specific role, based on their IP addresses.

Same as IP access control rules, the order of role-based access control rules is important, since the rules are executed in numerical order.

► **To create IPv4 role-based access control rules:**

1. Choose Device Settings > Security > Role Based Access Control.
2. Select the 'Enable role based access control for IPv4' checkbox to enable IPv4 access control rules.
3. Determine the IPv4 default policy.
 - *Accept*: Accepts traffic when no matching rules are present.
 - *Deny*: Rejects any user's login attempt when no matching rules are present.
4. Create rules. Refer to the tables below for different operations.

ADD a rule to the end of the list



- Click Append.
- Type a starting IP address in the Start IP field.
- Type an ending IP address in the End IP field.
- Select a role in the Role field. This rule applies to members of this role only.
- Select an option in the Policy field.
 - *Accept*: Accepts traffic from the specified IP address range when the user is a member of the specified role.
 - *Deny*: Rejects the login attempt of a user from the specified IP address range when that user is a member of the specified role.

INSERT a rule between two rules

- Select the rule above which you want to insert a new rule. For example, to insert a rule between rules #3 and #4, select #4.
- Click Insert Above.
- Type a starting IP address in the Start IP field.
- Type an ending IP address in the End IP field.
- Select a role in the Role field. This rule applies to members of this role only.
- Select *Accept* or *Deny* in the Policy field. Refer to the above table for details.

The system automatically numbers the rule.

5. When finished, the rules are listed on this page.

- You can select any existing rule and then click  or  to change its priority.

IPv4

Enable role based access control for IPv4

Default policy Accept ▼

#	Start IP	End IP	Role	Policy
1	192.168.255.0	192.168.255.255	Operator	Deny
2	192.168.90.16	192.168.90.55	Admin	Accept

Append
Insert Above

✔ Save

6. Click Save. The rules are applied.

► **To configure IPv6 access control rules:**



- On the same page, select the 'Enable role based access control for IPv6' checkbox to enable IPv6 access control rules.
- Follow the same procedure as the above IPv4 rule setup to create IPv6 rules.
- Make sure you click the Save button in the IPv6 section**, or the changes made to IPv6 rules are not saved.

Editing or Deleting Role Based Access Control Rules

You can modify existing rules to update their roles/IP addresses, or delete them when they are no longer needed.

► **To modify a role-based access control rule:**

- Choose Device Settings > Security > Role Based Access Control.
- Go to the IPv4 or IPv6 section.
- Select the desired rule in the list.
 - Ensure the IPv4 or IPv6 checkbox has been selected, or you may not edit or delete any rule.
- Perform the desired action.

- Make changes to the selected rule, and then click Save. For information on each field, see **Creating Role Based Access Control Rules** (on page 342).
 - Click  to remove it.
 - To resort its order, click  or .
5. Click Save.
- IPv4 rules: **Make sure you click the Save button in the IPv4 section**, or the changes made to IPv4 rules are not saved.
 - IPv6 rules: **Make sure you click the Save button in the IPv6 section**, or the changes made to IPv6 rules are not saved.

Setting Up a TLS Certificate

Important: Raritan uses TLS instead of SSL 3.0 due to published security vulnerabilities in SSL 3.0. Make sure your network infrastructure, such as LDAP and mail services, uses TLS rather than SSL 3.0.

Having an X.509 digital certificate ensures that both parties in a TLS connection are who they say they are.

Besides, you can create or apply for a multi-domain certificate with subject alternative names.

▶ **To obtain a CA-signed certificate:**

1. Create a Certificate Signing Request (CSR) on the PX3. See **Creating a CSR** (on page 345).
2. Submit it to a certificate authority (CA). After the CA processes the information in the CSR, it provides you with a certificate.
3. Import the CA-signed certificate onto the PX3. See **Installing a CA-Signed Certificate** (on page 346).

Note: If you are using a certificate that is part of a chain of certificates, each part of the chain is signed during the validation process.

▶ **A CSR is not required in either scenario below:**

- Make the PX3 create a *self-signed* certificate. See **Creating a Self-Signed Certificate** (on page 347).
- Appropriate, valid certificate and key files are already available, and you only need to import them. See **Installing or Downloading Existing Certificate and Key** (on page 348).

Creating a CSR

Follow this procedure to create the CSR for your PX3.

Note that you must enter information in the fields showing the message 'required.'

required

► **To create a CSR:**

1. Choose Device Settings > Security > TLS Certificate.
2. Provide the information requested.
 - **Subject:**

Field	Description
Country	The country where your company is located. Use the standard ISO country code, which comprises two uppercase letters. For a list of ISO codes, google ISO 3166 country codes.
State or province	The full name of the state or province where your company is located.
Locality	The city where your company is located.
Organization	The registered name of your company.
Organizational unit	The name of your department.
Common name	The fully qualified domain name (FQDN) of your PX3.
Email address	An email address where you or another administrative user can be reached.

Warning: If you generate a CSR without values entered in the required fields, you cannot obtain third-party certificates.

▪ **Subject Alternative Names:**

If you want a certificate to secure multiple hosts across different domains or subdomains, you can add additional DNS host names or IP addresses of the wanted hosts to this CSR so that a single certificate will be valid for all of them.

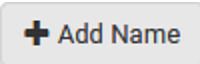
 + Add Name

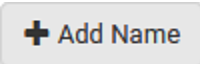
Click  when there are more than one additional hosts to add.

- Examples of subject alternative names: *support.raritan.com*, *help.raritan.com*, *help.raritan.net*, and *192.168.77.50*.

▪ **Key Creation Parameters:**

Field	Do this
Key length	Select an available key length (bits). A larger key length enhances the security, but slows down the response of PX3. <ul style="list-style-type: none"> Only 2048 is available now.
Self-sign	For requesting a certificate signed by the CA, ensure this checkbox is NOT selected.
Challenge, Confirm challenge	Type a password. The password is used to protect the certificate or CSR. This information is optional. The value should be 4 to 64 characters long. Case sensitive.

- Click Create New TLS Key to create both the CSR and private key. This may take several minutes to complete.
- Click Download Certificate Signing Request to download the CSR to your computer.
 - You are prompted to open or save the file. Click Save to save it onto your computer.
 - Submit it to a CA to obtain the digital certificate.
 - If the CSR contains incorrect data, click Delete Certificate Signing Request to remove it, and then repeat the above steps to re-create it.
- To store the newly-created private key on your computer, click Download Key in the **New TLS Certificate** section.

Note: The Download Key button in the Active TLS Certificate section is for downloading the private key of the currently-installed certificate rather than the newly-created one.

- You are prompted to open or save the file. Click Save to save it onto your computer.
- After getting the CA-signed certificate, install it. See **Installing a CA-Signed Certificate** (on page 346).

Installing a CA-Signed Certificate

To get a certificate from a certificate authority (CA), first create a CSR and send it to the CA. See **Creating a CSR** (on page 345).

After receiving the CA-signed certificate, install it onto the PX3.

► **To install the CA-signed certificate:**

- Choose Device Settings > Security > TLS Certificate.
- Click  to navigate to the CA-signed certificate file.
- Click Upload to install it.

- To verify whether the certificate has been installed successfully, check the data shown in the Active TLS Certificate section.

Creating a Self-Signed Certificate

When appropriate certificate and key files for PX3 are unavailable, the alternative, other than submitting a CSR to the CA, is to generate a self-signed certificate.

Note that you must enter information in the fields showing the message 'required.'

required

► **To create and install a self-signed certificate:**

- Choose Device Settings > Security > TLS Certificate.
- Enter information.

Field	Description
Country	The country where your company is located. Use the standard ISO country code, which comprises two uppercase letters. For a list of ISO codes, google ISO 3166 country codes.
State or province	The full name of the state or province where your company is located.
Locality	The city where your company is located.
Organization	The registered name of your company.
Organizational unit	The name of your department.
Common name	The fully qualified domain name (FQDN) of your PX3.
Email address	An email address where you or another administrative user can be reached.
Key length	Select an available key length (bits). A larger key length enhances the security, but slows down the response of PX3. <ul style="list-style-type: none"> Only 2048 is available now.
Self-sign	Ensure this checkbox is selected, which indicates that you are creating a self-signed certificate.
Validity in days	This field appears after the Self-sign checkbox is selected. Type the number of days for which the self-signed certificate will be valid.

A password is not required for a self-signed certificate so the Challenge and Confirm Challenge fields disappear.

- Click Create New TLS Key to create both the self-signed certificate and private key. This may take several minutes to complete.
- Once complete, do the following:

- a. Double check the data shown in the New TLS Certificate section.
- b. If correct, click "Install Key and Certificate" to install the self-signed certificate and private key.

Tip: To verify whether the certificate has been installed successfully, check the data shown in the Active TLS Certificate section.

If incorrect, click "Delete Key and Certificate" to remove the self-signed certificate and private key, and then repeat the above steps to re-create them.

5. (Optional) To download the self-signed certificate and/or private key, click Download Certificate or Download Key in the New TLS Certificate section.
 - You are prompted to open or save the file. Click Save to save it onto your computer.

Note: The Download Key button in the Active TLS Certificate section is for downloading the private key of the currently-installed certificate rather than the newly-created one.

Installing or Downloading Existing Certificate and Key

You can download the already-installed certificate and private key from any PX3 for backup or file transfer. For example, you can install the files onto a replacement PX3, add the certificate to your browser and so on.

If valid certificate and private key files are already available, you can install them on the PX3 without going through the process of creating a CSR or a self-signed certificate.

Note: If you are using a certificate that is part of a chain of certificates, each part of the chain is signed during the validation process.

▶ To download active key and certificate files from PX3:

1. Choose Device Settings > Security > TLS Certificate.
2. In the *Active TLS Certificate* section, click Download Key and Download Certificate respectively.

Note: The Download Key button in the New TLS Certificate section, if present, is for downloading the newly-created private key rather than the one of the currently-installed certificate.

3. You are prompted to open or save the file. Click Save to save it onto your computer.

▶ To install available key and certificate files onto PX3:

1. Choose Device Settings > Security > TLS Certificate.
2. Select the "Upload key and certificate" checkbox at the bottom of the page.
3. The 'Key File' and 'Certificate file' buttons appear. Click each button to select the key and/or certificate file.

4. Click Upload. The selected files are installed.
5. To verify whether the certificate has been installed successfully, check the data shown in the Active TLS Certificate section.

Setting Up External Authentication

Important: Raritan uses TLS instead of SSL 3.0 due to published security vulnerabilities in SSL 3.0. Make sure your network infrastructure, such as LDAP and mail services, uses TLS rather than SSL 3.0.

For security purposes, users attempting to log in to PX3 must be authenticated. PX3 supports the following authentication mechanisms:

- Local user database on the PX3
- Lightweight Directory Access Protocol (LDAP)
- Remote Access Dial-In User Service (Radius) protocol

By default, PX3 is configured for local authentication. If you use this method, you only need to create user accounts. See **Creating Users** (on page 288).

If you prefer external authentication, you must provide PX3 with information about the external Authentication and Authorization (AA) server.

If both local and external authentication is needed, create user accounts on the PX3 in addition to providing the external AA server data.

When configured for external authentication, all PX3 users must have an account on the external AA server. Local-authentication-only users will have no access to the PX3 except for the admin, who always can access the PX3.

If the external authentication fails, an "Authentication failed" message is displayed. Details regarding the authentication failure are available in the event log. See **Viewing or Clearing the Local Event Log** (on page 464).

Note that only users who have both the "Change Authentication Settings" and "Change Security Settings" permissions can configure or modify the authentication settings.

► To enable external authentication:

1. Collect external AA server information. See **Gathering LDAP/Radius Information** (on page 350).
2. Enter required data for external AA server(s) on the PX3. See **Adding LDAP/LDAPS Servers** (on page 351) or **Adding Radius Servers** (on page 354).
 - For illustrations, see **LDAP Configuration Illustration** (on page 823) or **RADIUS Configuration Illustration** (on page 838).
3. If both the external and local authentication is needed, or you have to return to the local authentication only, see **Managing External Authentication Settings** (on page 355).

► **Special note about the AES cipher:**

The PX3 device's TLS-based protocols support AES 128- and 256-bit ciphers. The exact cipher to use is negotiated between PX3 and the client (such as a web browser), which is impacted by the cipher priority of PX3 and the client's cipher availability/settings.

Tip: To force PX3 to use a specific AES cipher, refer to your client's user documentation for information on configuring AES settings.

Gathering LDAP/RADIUS Information

It requires knowledge of your AA server settings to configure the PX3 for external authentication. If you are not familiar with these settings, consult your AA server administrator for help.

► **Information needed for LDAP authentication:**

- The IP address or hostname of the LDAP server
- Whether the Secure LDAP protocol (LDAP over TLS) is being used
 - If Secure LDAP is in use, consult your LDAP administrator for the CA certificate file.
- The network port used by the LDAP server
- The type of the LDAP server, usually one of the following options:
 - *OpenLDAP*
 - If using an OpenLDAP server, consult the LDAP administrator for the Bind Distinguished Name (DN) and password.
 - *Microsoft Active Directory® (AD)*
 - If using a Microsoft Active Directory server, consult your AD administrator for the name of the Active Directory Domain.
- Bind Distinguished Name (DN) and password (if anonymous bind is NOT used)
- The Base DN of the server (used for searching for users)
- The login name attribute (or AuthorizationString)
- The user entry object class
- The user search subfilter (or BaseSearch)

► **Information needed for RADIUS authentication:**

- The IP address or host name of the RADIUS server
- Authentication protocol used by the RADIUS server
- Shared secret for a secure communication
- UDP authentication port and accounting port used by the RADIUS server

Adding LDAP/LDAPS Servers

To use LDAP authentication, enable it and enter the information you have gathered.

Note that you must enter information in the fields showing the message 'required.'

required

► **To add LDAP/LDAPS servers:**

1. Choose Device Settings > Security > Authentication.
2. Click New in the LDAP Servers section.
3. Enter information.

Field/setting	Description
IP address / hostname	The IP address or hostname of your LDAP/LDAPS server. <ul style="list-style-type: none"> ▪ Without the encryption enabled, you can type either the domain name or IP address in this field, but you must type the fully qualified domain name if the encryption is enabled.
Copy settings from existing LDAP server	This checkbox appears only when there are existing AA server settings on the PX3. To duplicate any existing AA server's settings, refer to the duplicating procedure below.
Type of LDAP server	Choose one of the following options: <ul style="list-style-type: none"> ▪ OpenLDAP ▪ Microsoft Active Directory. Active Directory is an implementation of LDAP/LDAPS directory services by Microsoft for use in Windows environments.
Security	Determine whether you would like to use Transport Layer Security (TLS) encryption, which allows the PX3 to communicate securely with the LDAPS server. <p>Three options are available:</p> <ul style="list-style-type: none"> ▪ StartTLS ▪ TLS ▪ None
Port (None/StartTLS)	<ul style="list-style-type: none"> ▪ The default Port is 389. Either use the standard LDAP TCP port or specify another port.
Port (TLS)	Configurable only when "TLS" is selected in the Security field. The default is 636. Either use the default port or specify another one.

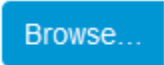
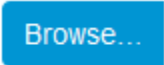
Field/setting	Description
Enable verification of LDAP server certificate	Select this checkbox if it is required to validate the LDAP server's certificate by the PX3 prior to the connection. If the certificate validation fails, the connection is refused.
CA certificate	Consult your AA server administrator to get the CA certificate file for the LDAPS server.  Click  to select and install the certificate file. <ul style="list-style-type: none"> Click Show to view the installed certificate's content. Click Remove to delete the installed certificate if it is inappropriate. <hr/> <p><i>Note: If the required certificate file is a chain of certificates, and you are not sure about the requirements of a certificate chain, see TLS Certificate Chain (on page 906).</i></p>
Allow expired and not yet valid certificates	<ul style="list-style-type: none"> Select this checkbox to make the authentication succeed regardless of the certificate's validity period. After deselecting this checkbox, the authentication fails whenever any certificate in the selected certificate chain is outdated or not valid yet.
Anonymous bind	Use this checkbox to enable or disable anonymous bind. <ul style="list-style-type: none"> To use anonymous bind, select this checkbox. When a Bind DN and password are required to bind to the external LDAP/LDAPS server, deselect this checkbox.
Bind DN	Required after deselecting the Anonymous Bind checkbox. Distinguished Name (DN) of the user who is permitted to search the LDAP directory in the defined search base.
Bind password, Confirm bind password	Required after deselecting the Anonymous Bind checkbox. Enter the Bind password.
Base DN for search	Distinguished Name (DN) of the search base, which is the starting point of the LDAP search. <ul style="list-style-type: none"> Example: <code>ou=dev,dc=example,dc=com</code>
Login Name Attribute	The attribute of the LDAP user class which denotes the login name. <ul style="list-style-type: none"> Usually it is the <code>uid</code>.

Field/setting	Description
User entry object class	The object class for user entries. <ul style="list-style-type: none"> Usually it is <code>inetOrgPerson</code>.
User search subfilter	Search criteria for finding LDAP user objects within the directory tree.
Active Directory domain	The name of the Active Directory Domain. <ul style="list-style-type: none"> Example: <code>testradius.com</code>

- To verify if the authentication configuration is set correctly, click Test Connection to check whether the PX3 can connect to the new server successfully.

*Tip: You can also test the connection on the Authentication page after finishing adding servers. See **Managing External Authentication Settings** (on page 355).*

- Click Add Server. The new LDAP server is listed on the Authentication page.
- To add more servers, repeat the same steps.
- In the Authentication Type field, select LDAP.** Otherwise, the LDAP authentication does not work.
- Click Save. The LDAP authentication is now in place.

► **To duplicate LDAP/LDAPS server settings:**

If you have added any LDAP/LDAPS server to the PX3, and the server you will add shares identical settings with an existing one, the most convenient way is to duplicate that LDAP/LDAPS server's data and then revise the IP address/host name.

- Repeat Steps 1 to 2 in the above procedure.
- Select the "Copy settings from existing LDAP server" checkbox.
- Click the "Select LDAP Server" field to select the LDAP/LDAPS server whose settings you want to copy.
- Modify the IP Address/Hostname field.
- Click Add Server.

Note: If the PX3 clock and the LDAP server clock are out of sync, the installed TLS certificates, if any, may be considered expired. To ensure proper synchronization, administrators should configure the PX3 and the LDAP server to use the same NTP server(s).

Adding Radius Servers

To use Radius authentication, enable it and enter the information you have gathered.

Note that you must enter information in the fields showing the message 'required.'



► **To add Radius servers:**

1. Choose Device Settings > Security > Authentication.
2. Click New in the Radius Servers section.
3. Enter information.

Field/setting	Description
IP address / hostname	The IP address or hostname of your Radius server.
Type of RADIUS authentication	<p>Select an authentication protocol.</p> <ul style="list-style-type: none"> ▪ PAP (Password Authentication Protocol) ▪ CHAP (Challenge Handshake Authentication Protocol) ▪ MS-CHAPv2 (Microsoft Challenge Handshake Authentication Protocol) <p>CHAP is generally considered more secure because the user name and password are encrypted, while in PAP they are transmitted in the clear.</p> <p>MS-CHAPv2 provides stronger security than the above two. Selecting this option will support both MS-CHAPv1 and MS-CHAPv2.</p>
Authentication port, Accounting port	<p>The defaults are standard ports -- 1812 and 1813.</p> <p>To use non-standard ports, type a new port number.</p>
Timeout	<p>This sets the maximum amount of time to establish contact with the Radius server before timing out.</p> <p>Type the timeout period in seconds.</p>
Retries	Type the number of retries.
Shared secret, Confirm shared secret	The shared secret is necessary to protect communication with the Radius server.

- To verify if the authentication configuration is set correctly, click Test Connection to check whether the PX3 can connect to the new server successfully.

*Tip: You can also test the connection on the Authentication page after finishing adding servers. See **Managing External Authentication Settings** (on page 355).*

- Click Add Server. The new Radius server is listed on the Authentication page.
- To add more servers, repeat the same steps.
- In the Authentication Type field, select Radius.** Otherwise, the Radius authentication does not work.
- Click Save. Radius authentication is now in place.

Managing External Authentication Settings



Choose Device Settings > Security > Authentication to open the Authentication page, where you can:

- Enable both the external and local authentication
- Edit or delete a server
- Resort the access order of servers
- Test the connection to a server
- Disable external authentication without removing servers

▶ To test, edit or delete a server, or resort the server list:

- Select a server in the list.

Access Order	IP Address / Hostname	Security	Port	LDAP Server Type
1	192.168.91.100	None	389	OpenLDAP
2	192.168.1.33	StartTLS	389	OpenLDAP
3	192.168.8.95	None	389	Microsoft Active Directory

- Perform the desired action.
 - Click Edit to edit its settings, and click Modify Server to save changes. For information on each field, see **Adding LDAP/LDAPS Servers** (on page 351) or **Adding Radius Servers** (on page 354).
 - Click Delete to delete the server, and then confirm the operation.
 - Click Test Connection to verify the connection to the selected server. User credentials may be required.
 - Click  or  to change the server order, which determines the access priority, and click Save Order to save the new sequence.

Note: Whenever PX3 is successfully connected to one external authentication server, it STOPS trying access to remaining servers in the authentication list regardless of the user authentication result.

▶ **To enable both external and local authentication:**

1. In the 'Authentication type' field, select the external authentication you want -- LDAP or RADIUS.
2. Select the following checkbox. Then the PX3 always tries external authentication first. Whenever the external authentication fails, the PX3 switches to local authentication.

Use local authentication if remote authentication is not available

3. Click Save.

▶ **To disable external authentication:**

1. In the 'Authentication type' field, select Local.
2. Click Save.

Configuring Login Settings

Choose Device Settings > Security > Login Settings to open the Login Settings page, where you can:

- Configure the user blocking feature.

Note: The user blocking function applies only to local authentication instead of external authentication through AA servers.

- Determine the timeout period for any inactive user.
- Prevent simultaneous logins using the same login name.

▶ **To configure user blocking:**

1. To enable the user blocking feature, select the 'Block user on login failure' checkbox.
2. In the 'Block timeout' field, type a value or click  to select a time option. This setting determines how long the user is blocked.
 - If you type a value, the value must be followed by a time unit, such as '4 min.' See **Time Units** (on page 200).
3. In the 'Maximum number of failed logins' field, type a number. This is the maximum number of login failure the user is permitted before the user is blocked from accessing the PX3.
4. Click Save.

*Tip: If any user blocking event occurs, you can unblock that user manually by using the "unblock" CLI command over a local connection. See **Unblocking a User** (on page 699).*

► **To set limitations for login timeout and use of identical login names:**

1. In the "Idle timeout period" field, type a value or click  to select a time option. This setting determines how long users are permitted to stay idle before being forced to log out.
 - If you type a value, the value must be followed by a time unit, such as '4 min.' See **Time Units** (on page 200).
 - Keep the idle timeout to 20 minutes or less if possible. This reduces the number of idle sessions connected, and the number of simultaneous commands sent to the PX3.
2. Select the 'Prevent concurrent login with same username' checkbox if intending to prevent multiple persons from using the same login name simultaneously.
3. Click Save.

Configuring Password Policy

Choose Device Settings > Security > Password Policy to open the Password Policy page, where you can:

- Force users to use strong passwords.
- Force users to change passwords at a regular interval -- that is, password aging.

Use of strong passwords makes it more difficult for intruders to crack user passwords and access the PX3.

► **To configure password aging:**

1. Select the 'Enabled' checkbox of Password Aging.
2. In the 'Password aging interval' field, type a value or click  to select a time option. This setting determines how often users are requested to change their passwords.
 - If you type a value, the value must be followed by a time unit, such as '10 d.' See **Time Units** (on page 200).
3. Click Save.

► **To force users to create strong passwords:**

1. Select the 'Enabled' checkbox of Strong Passwords to activate the strong password feature. The following are the default settings:

Minimum length	= 8 characters
Maximum length	= 32 characters
At least one lowercase character	= Required
At least one uppercase character	= Required
At least one numeric character	= Required
At least one special character	= Required
Number of forbidden previous passwords	= 5

Note: The maximum password length accepted by PX3 is 64 characters.

2. Make changes to the default settings as needed.
3. Click Save.

Enabling the Restricted Service Agreement

The restricted service agreement feature, if enabled, forces users to read a security agreement when they log in to the PX3.

Users must accept the agreement, or they cannot log in.

An event notifying you if a user has accepted or declined the agreement can be generated. See **Default Log Messages** (on page 370)

▶ To enable the service agreement:

1. Click Device Settings > Security > Service Agreement.
2. Select the 'Enforce restricted service agreement' checkbox.
3. Edit or paste the content as needed.
 - A maximum of 10,000 characters can be entered.
4. Click Save.

► **Login manner after enabling the service agreement:**

After the Restricted Service Agreement feature is enabled, the agreement's content is displayed on the login screen.

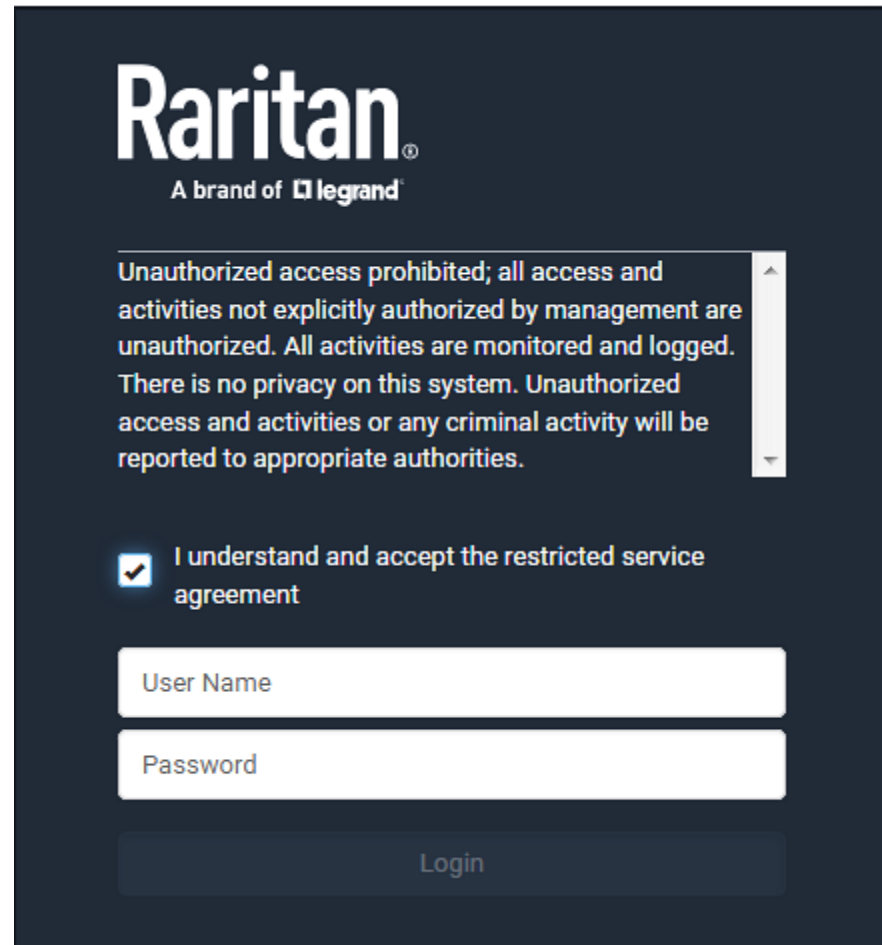

The screenshot shows the Raritan login page. At the top, the Raritan logo is displayed with the tagline "A brand of legrand". Below the logo, a scrollable text box contains the following text: "Unauthorized access prohibited; all access and activities not explicitly authorized by management are unauthorized. All activities are monitored and logged. There is no privacy on this system. Unauthorized access and activities or any criminal activity will be reported to appropriate authorities." Below the text box, there is a checked checkbox with the label "I understand and accept the restricted service agreement". Underneath the checkbox are two input fields: "User Name" and "Password". At the bottom of the form is a "Login" button.

Do either of the following, or the login fails:

- In the web interface, select the checkbox labeled "I understand and accept the restricted service agreement."

Tip: To select the agreement checkbox using the keyboard, first press Tab to go to the checkbox and then Enter.

- In the CLI, type `y` when the confirmation message "I understand and accept the restricted service agreement" is displayed.

Setting the Date and Time

Set the internal clock on the PX3 manually, or link to a Network Time Protocol (NTP) server.

Note: If you are using Sunbird's Power IQ to manage the PX3, you must configure Power IQ and the PX3 to have the same date/time or NTP settings.

► **To set the date and time:**

1. Choose Device Settings > Date/Time.
2. Click the 'Time zone' field to select your time zone from the list.
3. If the daylight saving time applies to your time zone, verify the 'Automatic daylight saving time adjustment' checkbox is selected.
 - If the daylight saving time rules are not available for the selected time zone, the checkbox is not configurable.
4. Select the method for setting the date and time.

Customize the date and time

- Select 'User specified time'.



- Type values in the Date field using the yyyy-mm-dd format, or click  to select a date. For details, see **Calendar** (on page 362).

- Determine the time format you want by clicking 12H or 24H button.
 - **12H** represents the 12-hour format.
 - **24H** represents the 24-hour format.



- If selecting 12-hour format, then determine the current period by clicking the AM or PM button.



- Type values in the Time field using the hh:mm:ss format, or click   to adjust values.
 - When 12H is being applied, the hour cannot exceed the maximum number 12. If exceeding 12, the time change cannot be saved.

Use the NTP server

- Select "Synchronize with NTP server."
- There are two ways to assign the NTP servers:
 - To use the DHCP-assigned NTP servers, DO NOT enter any NTP servers for the First and Second time server.
DHCP-assigned NTP servers are available only when either IPv4 or IPv6 DHCP is enabled.
 - To use the manually-specified NTP servers, specify the primary NTP server in the "First time server" field. A secondary NTP server is optional.
Click Check NTP Servers to verify the validity and accessibility of the manually-specified NTP servers.

5. Click Save.

PX3 follows the NTP server sanity check per the IETF RFC. If your PX3 has problems synchronizing with a Windows NTP server, see **Windows NTP Server Synchronization Solution** (on page 363).

Calendar



The calendar icon in the Date field is a convenient tool to select a custom date. Click it and a calendar similar to the following appears.

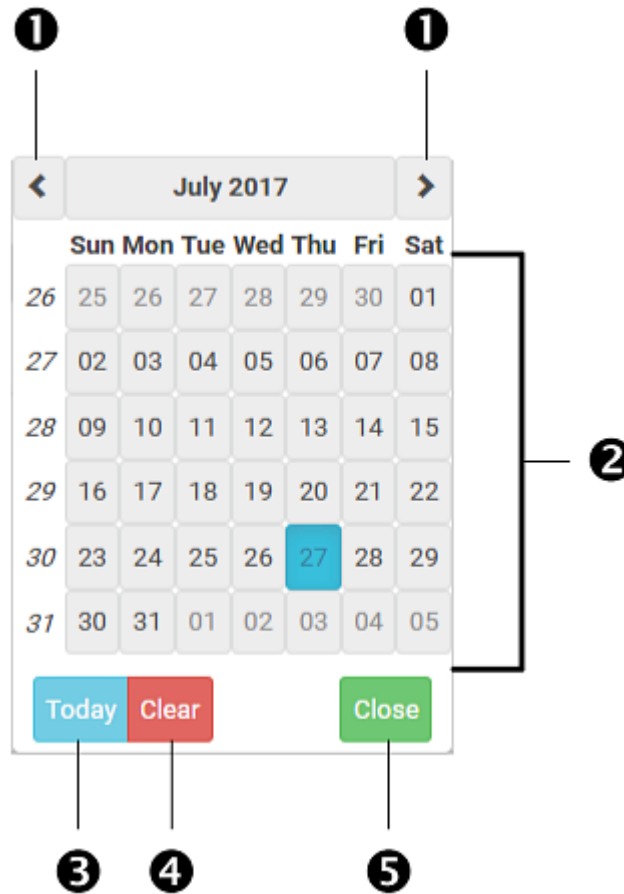

Number	Item	Description
1	arrows	Switch between months.
2	dates (01-31)	All dates of the selected month. To select a date, simply click it.
3	Today	Select today's date.
4	Clear	Clear the entry, if any, in the Date field.
5	Close	Close the calendar.

Windows NTP Server Synchronization Solution

The NTP client on the PX3 follows the NTP RFC so the PX3 rejects any NTP servers whose root dispersion is more than one second. An NTP server with a dispersion of more than one second is considered an inaccurate NTP server by the PX3.

Note: For information on NTP RFC, visit <http://tools.ietf.org/html/rfc4330> - <http://tools.ietf.org/html/rfc4330> to refer to section 5.

Windows NTP servers may have a root dispersion of more than one second, and therefore cannot synchronize with the PX3. When the NTP synchronization issue occurs, change the dispersion settings to resolve it.

► **To change the Windows NTP's root dispersion settings:**

1. Access the registry settings associated with the root dispersion on the Windows NTP server.

HKEY_LOCAL_MACHINE\SYSTEM\CurrentControlSet\Services\W32Time\Config

2. *AnnounceFlags* must be set to 0x05 or 0x06.
 - 0x05 = 0x01 (Always time server) and 0x04 (Always reliable time server)
 - 0x06 = 0x02 (Automatic time server) and 0x04 (Always reliable time server)

Note: Do NOT use 0x08 (Automatic reliable time server) because its dispersion starts at a high value and then gradually decreases to one second or lower.

3. *LocalClockDispersion* must be set to 0.

Event Rules and Actions

A benefit of the product's intelligence is its ability to notify you of or react to a change in conditions. This event notification or reaction is an "event rule."

An event rule consists of two parts:

- **Event:** This is the situation where the PX3 or a device connected to it meets a certain condition. For example, the inlet's voltage reaches the warning level.
- **Action:** This is the response to the event. For example, the PX3 notifies the system administrator of the event via email.

If you want the PX3 to perform one action at a regular interval instead of waiting until an event occurs, you can schedule that action. For example, you can make the PX3 email the temperature report every hour.

Note that you need the Administrator Privileges to configure event rules.

► To create an event rule:

1. Choose Device Settings > Event Rules.
2. If the needed action is not available yet, create it by clicking  **New Action**.
 - a. Assign a name to this action.
 - b. Select the desired action and configure it as needed.
 - c. Click Create.

For details, see **Available Actions** (on page 384).

3. Click  **New Rule** to create a new rule.
 - a. Assign a name to this rule.
 - b. Make sure the Enabled checkbox is selected, or the new event rule does not work.
 - c. In the Event field, select the event to which you want the PX3 to react.
 - d. In the 'Available actions' field, select the desired action(s) to respond to the selected event.
 - e. Click Create.

For details, see **Built-in Rules and Rule Configuration** (on page 365).

► To create a scheduled action:

1. If the needed action is not available yet, create it by clicking  **New Action**. See above.

Note: When creating scheduled actions, available actions are less than usual because it is meaningless to schedule certain actions like "Alarm," "Log event message," "Send email," "Syslog message" and the like.

2. Click  **New Scheduled Action** to schedule the desired action.

- a. Assign a name to this scheduled action.
- b. Make sure the Enabled checkbox is selected, or the PX3 does not perform this scheduled action.
- c. Set the interval time, which ranges from every minute to yearly.
- d. In the 'Available actions' field, select the desired action(s).
- e. Click Create.

For details, see **Scheduling an Action** (on page 406).

Built-in Rules and Rule Configuration

PX3 is shipped with four built-in event rules, which cannot be deleted. If the built-in event rules do not satisfy your needs, create new rules.

▶ Built-in rules:

- *System Event Log Rule:*

This causes ANY event occurred to the PX3 to be recorded in the internal log. It is enabled by default.

*Note: For the default log messages generated for each event, see **Default Log Messages** (on page 370).*

- *System SNMP Notification Rule:*

This causes SNMP traps or informs to be sent to specified IP addresses or hosts when ANY event occurs to the PX3. It is disabled by default.

- *System Tamper Detection Alarmed:*

This causes the PX3 to send alarm notifications if a DX tamper sensor has been connected and the PX3 detects that the tamper sensor enters the alarmed state. It is enabled by default.

- *System Tamper Detection Unavailable:*

This causes the PX3 to send alarm notifications if a DX tamper sensor was once connected or remains connected but then the PX3 does not detect the presence of the tamper sensor. It is enabled by default.

▶ Event rule configuration illustration:

1. Choose Device Settings > Event Rules > **+ New Rule**.
2. Click the Event field to select an event type.
 - <Any sub-event> means all events shown on the list.

- <Any Numeric Sensor> means all numeric sensors of the PX3, including internal and environmental sensors. <Any Numeric Sensor> is especially useful if you want to receive the notifications when any numeric sensor's readings pass through a specific threshold.

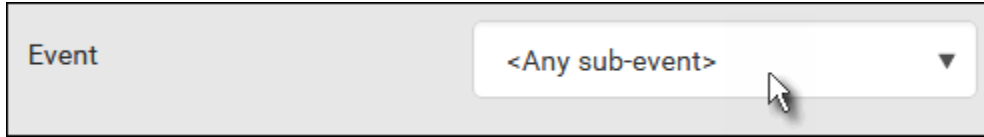

The screenshot shows a grey rectangular box with the word "Event" on the left. To its right is a white dropdown menu with a downward arrow on the right side. The text inside the dropdown menu is "<Any sub-event>". A mouse cursor is pointing at the dropdown arrow.

3. In this example, the Peripheral Device Slot is selected, which is related to the environmental sensor packages. Then a sensor ID field for this event type appears. Click this additional field to specify which sensor should be the subject of this event.

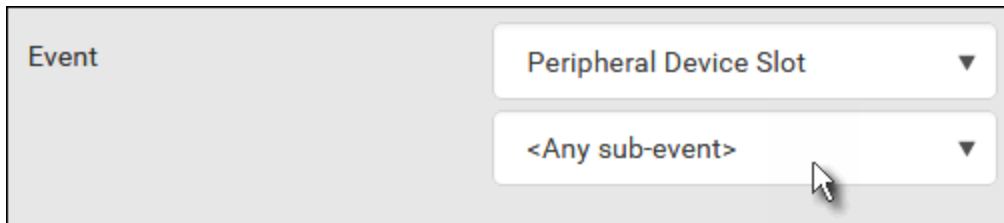

The screenshot shows a grey rectangular box with the word "Event" on the left. To its right are two stacked white dropdown menus. The top dropdown menu has "Peripheral Device Slot" selected and a downward arrow on the right. The bottom dropdown menu has "<Any sub-event>" selected and a downward arrow on the right. A mouse cursor is pointing at the bottom dropdown arrow.

4. In this example, sensor ID 3 (Slot 3) is selected, which is a temperature sensor. Then a new field for this sensor appears. Click this field to specify the type of event(s) you want.

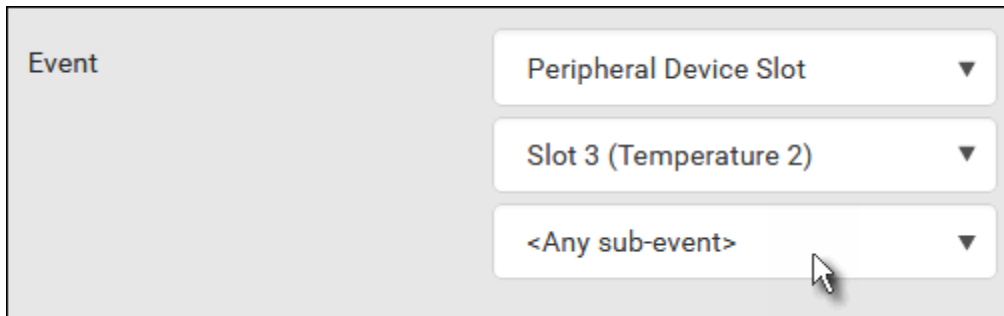

The screenshot shows a grey rectangular box with the word "Event" on the left. To its right are three stacked white dropdown menus. The top dropdown menu has "Peripheral Device Slot" selected and a downward arrow on the right. The middle dropdown menu has "Slot 3 (Temperature 2)" selected and a downward arrow on the right. The bottom dropdown menu has "<Any sub-event>" selected and a downward arrow on the right. A mouse cursor is pointing at the bottom dropdown arrow.

5. In this example, Numeric Sensor is selected because we want to select numeric-sensor-related event(s). Then a field for numeric-sensor-related events appears. Click this field to select one of the numeric-sensor-related events from the list.

The screenshot shows a configuration panel with a label 'Event' on the left. On the right, there are four stacked dropdown menus. The first menu is set to 'Peripheral Device Slot', the second to 'Slot 3 (Temperature 2)', and the third to 'Numeric Sensor'. The fourth menu is currently set to '<Any sub-event>' and a mouse cursor is hovering over it, indicating it is about to be clicked to reveal a list of sub-events.

6. In this example, 'Above upper critical threshold' is selected because we want the PX3 to react only when the selected temperature sensor's reading enters the upper critical range. A "Trigger condition" field appears, requiring you to define the "exact" condition related to the "upper critical" event.

The screenshot shows the same configuration panel as in step 5, but now the fourth dropdown menu is set to 'Above upper critical threshold'. Below this menu, a 'Trigger condition' section is visible. It contains three radio buttons: 'Asserted', 'Deasserted', and 'Both'. The 'Both' radio button is selected, and a mouse cursor is hovering over it.

7. Select the desired radio button to finish the event configuration. Refer to the following table for different types of radio buttons.
 - If needed, you may refer to event rule examples in the section titled **Sample Event Rules** (on page 419).
8. To select any action(s), select them one by one from the 'Available actions' list.
 - To select all available actions, click Select All.

9. To remove any action(s) from the 'Selected actions' field, click that action's .
 - To remove all actions, click Deselect All.

▶ **Radio buttons for different events:**

According to the event you select, the "Trigger condition" field containing three radio buttons may or may not appear.

Event types	Radio buttons
Numeric sensor threshold-crossing events, or the occurrence of the selected event -- true or false	Available radio buttons include "Asserted," "Deasserted" and "Both." <ul style="list-style-type: none"> ▪ Asserted: PX3 takes the action only when the selected event occurs. That is, the status of the event transits from FALSE to TRUE. ▪ Deasserted: PX3 takes the action only when the selected event disappears or stops. That is, the status of the selected event transits from TRUE to FALSE. ▪ Both: PX3 takes the action both when the event occurs (asserts) and when the event stops/disappears (deasserts).
State sensor state change	Available radio buttons include "Alarmed/Open/On," "No longer alarmed/Closed/Off" and "Both." <ul style="list-style-type: none"> ▪ Alarmed/Open/On: PX3 takes the action only when the chosen sensor enters the alarmed, open or on state. ▪ No longer alarmed/Closed/Off: PX3 takes the action only when the chosen sensor returns to the normal, closed, or off state. ▪ Both: PX3 takes the action whenever the chosen sensor switches its state.
Sensor availability	Available radio buttons include "Unavailable," "Available" and "Both." <ul style="list-style-type: none"> ▪ Unavailable: PX3 takes the action only when the chosen sensor is NOT detected and becomes unavailable. ▪ Available: PX3 takes the action only when the chosen sensor is detected and becomes available. ▪ Both: PX3 takes the action both when the chosen sensor becomes unavailable or available.

Event types	Radio buttons
Network interface link state	<ul style="list-style-type: none"> ▪ Link state is up: PX3 takes the action only when the network link state changes from down to up. ▪ Link state is down: PX3 takes the action only when the network link state changes from up to down. ▪ Both: PX3 takes the action whenever the network link state changes.
Function enabled or disabled	<ul style="list-style-type: none"> ▪ Enabled: PX3 takes the action only when the chosen function is enabled. ▪ Disabled: PX3 takes the action only when the chosen function is disabled. ▪ Both: PX3 takes the action when the chosen function is either enabled or disabled.
Restricted service agreement	<ul style="list-style-type: none"> ▪ Accepted: PX3 takes the action only when the specified user accepts the restricted service agreement. ▪ Declined: PX3 takes the action only when the specified user rejects the restricted service agreement. ▪ Both: PX3 takes the action both when the specified user accepts or rejects the restricted service agreement.
Server monitoring event	<ul style="list-style-type: none"> ▪ Monitoring started: PX3 takes the action only when the monitoring of any specified server starts. ▪ Monitoring stopped: PX3 takes the action only when the monitoring of any specified server stops. ▪ Both: PX3 takes the action when the monitoring of any specified server starts or stops.
Server reachability	<ul style="list-style-type: none"> ▪ Unreachable: PX3 takes the action only when any specified server becomes inaccessible. ▪ Reachable: PX3 takes the action only when any specified server becomes accessible. ▪ Both: PX3 takes the action when any specified server becomes either inaccessible or accessible.

Event types	Radio buttons
Device connection or disconnection, such as a USB-cascaded slave device	<ul style="list-style-type: none"> ▪ Connected: PX3 takes the action only when the selected device is physically connected to it. ▪ Disconnected: PX3 takes the action only when the selected device is physically disconnected from it. ▪ Both: PX3 takes the action both when the selected device is physically connected to it and when it is disconnected.
+12V Supply 1 Status	<p>Available radio buttons include "Fault," "OK" and "Both."</p> <ul style="list-style-type: none"> ▪ Fault: PX3 takes the action only when the selected 12V power supply to the controller enters the fault state. ▪ OK: PX3 takes the action only when when the selected 12V power supply to the controller enters the OK state. ▪ Both: PX3 takes the action whenever the selected 12 power supply's status changes.

Default Log Messages

These default log messages are recorded internally and emailed to specified recipients when PX3 events occur (are TRUE) or, in some cases, stop or become unavailable (are FALSE). See **Send Email** (on page 394) to configure email messages.

Event/context	Default message when the event = TRUE	Default message when the event = FALSE
Asset Management > State	State of asset strip [AMSNUMBER] ('[AMSNAME]') changed to '[AMSSTATE]'.	
Asset Management > Rack Unit > * > Tag Connected	Asset tag with ID '[AMSTAGID]' connected at rack unit [AMSRACKUNITPOSITION], slot [AMSBLADESLOTPOSITION] of asset strip [AMSNUMBER] ('[AMSNAME]').	Asset tag with ID '[AMSTAGID]' disconnected at rack unit [AMSRACKUNITPOSITION], slot [AMSBLADESLOTPOSITION] of asset strip [AMSNUMBER] ('[AMSNAME]').
Asset Management > Rack Unit > * > Blade Extension Connected	Blade extension with ID '[AMSTAGID]' connected at rack unit [AMSRACKUNITPOSITION] of asset strip [AMSNUMBER] ('[AMSNAME]').	Blade extension with ID '[AMSTAGID]' disconnected at rack unit [AMSRACKUNITPOSITION] of asset strip [AMSNUMBER] ('[AMSNAME]').

Event/context	Default message when the event = TRUE	Default message when the event = FALSE
Asset Management > Firmware Update	Firmware update for asset strip [AMSNUMBER] ('[AMSNAME]'): status changed to '[AMSSTATE]'.	
Asset Management > Device Config Changed	Config parameter '[CONFIGPARAM]' of asset strip [AMSNUMBER] ('[AMSNAME]') changed to '[CONFIGVALUE]' by user '[USERNAME]'.	
Asset Management > Rack Unit Config Changed	Config of rack unit [AMSRACKUNITPOSITION] of asset strip [AMSNUMBER] ('[AMSNAME]') changed by user '[USERNAME]' to: Name '[AMSRACKUNITNAME]', LED Operation Mode '[AMSLEDDOPMODE]', LED Color '[AMSLEDCOLOR]', LED Mode '[AMSLEDMODE]'	
Asset Management > Blade Extension Overflow	Blade extension overflow occurred on strip [AMSNUMBER] ('[AMSNAME]').	Blade extension overflow cleared for strip [AMSNUMBER] ('[AMSNAME]').
Asset Management > Composite Asset Strip Composition Changed	Composition changed on composite asset strip [AMSNUMBER] ('[AMSNAME]').	
Card Reader Management > Card Reader > * > Card inserted	Card of type '[SMARTCARDTYPE]' with ID '[SMARTCARDID]' inserted at Card Reader '[CARDREADERID]'.	
Card Reader Management > Card Reader > * > Card removed	Card of type '[SMARTCARDTYPE]' with ID '[SMARTCARDID]' removed at Card Reader '[CARDREADERID]'.	
Card Reader Management > Card Reader attached	Card Reader with id '[CARDREADERID]' disconnected.	
Card Reader Management > Card Reader detached	Card of type '[SMARTCARDTYPE]' with ID '[SMARTCARDID]' inserted.	
Device > System started	System started.	
Device > System reset	System reset performed by user '[USERNAME]' from host '[USERIP]'.	
Device > Firmware validation failed	Firmware validation failed by user '[USERNAME]' from host '[USERIP]'.	
Device > Firmware update started	Firmware upgrade started from version '[OLDVERSION]' to version '[VERSION]' by user '[USERNAME]' from host '[USERIP]'.	

Event/context	Default message when the event = TRUE	Default message when the event = FALSE
Device > Firmware update completed	Firmware upgraded successfully from version '[OLDVERSION]' to version '[VERSION]' by user '[USERNAME]' from host '[USERIP]'.	
Device > Firmware update failed	Firmware upgrade failed from version '[OLDVERSION]' to version '[VERSION]' by user '[USERNAME]' from host '[USERIP]'.	
Device > Hardware failure present	Failure '[FAILURETYPESTR]' asserted for component '[COMPONENTID]'.	Failure '[FAILURETYPESTR]' deasserted for component '[COMPONENTID]'.
Device > Device identification changed	Config parameter '[CONFIGPARAM]' changed to '[CONFIGVALUE]' by user '[USERNAME]' from host '[USERIP]'.	
Device > Device settings saved	Device settings saved by user '[USERNAME]' from host '[USERIP]'.	
Device > Device settings restored	Device settings restored from host '[USERIP]'.	
Device > Data push failed	Data push to URL [DATAPUSH_URL] failed. [ERRORDESC].	
Device > Event log cleared	Event log cleared by user '[USERNAME]' from host '[USERIP]'.	
Device > Bulk configuration saved	Bulk configuration saved by user '[USERNAME]' from host '[USERIP]'.	
Device > Bulk configuration copied	Bulk configuration copied by user '[USERNAME]' from host '[USERIP]'.	
Device > Network interface link state is up	The [IFNAME] network interface link is now up.	The [IFNAME] network interface link is now down.
Device > Peripheral Device Firmware Update	Firmware update for peripheral device [EXTSENSORSERIAL] from [OLDVERSION] to [VERSION] [SENSORSTATENAME].	
Device > Sending SMTP message failed	Sending SMTP message to '[SMTPRECIPIENTS]' using server '[SMTPSERVER]' failed. [ERRORDESC].	
Device > Sending SNMP inform failed or no response	Sending SNMP inform to manager [SNMPMANAGER]:[SNMPMANAGERPORT] failed or no response. [ERRORDESC].	

Event/context	Default message when the event = TRUE	Default message when the event = FALSE
Device > Sending Syslog message failed	Sending Syslog message to server [SYSLOGSERVER]:[SYSLOGPORT] ([SYSLOGTRANSPORTPROTO]) failed. [ERRORDESC].	
Device > Sending SMS message failed	Sending SMS message to '[PHONENUMBER]' failed.	
Device > An LDAP error occurred	An LDAP error occurred: [ERRORDESC].	
Device > A Radius error occurred	A Radius error occurred: [ERRORDESC].	
Device > Raw configuration downloaded	Raw configuration downloaded by user '[USERNAME]' from host '[USERIP]'.	
Device > Raw configuration updated	Raw configuration updated by user '[USERNAME]' from host '[USERIP]'.	
Device > Unknown peripheral device attached	An unknown peripheral device with rom code '[ROMCODE]' was attached at position '[PERIPHDEVPOSITION]'.	
Device > Slave connected	Slave connected.	Slave disconnected.
Device > WLAN authentication over TLS with incorrect system clock	Established connection to wireless network '[SSID]' via Access Point with BSSID '[BSSID]' using '[AUTHPROTO]' authentication with incorrect system clock.	
Device > Features > Schroff LHX / SHX Support	Schroff LHX / SHX support enabled.	Schroff LHX / SHX support disabled.
Energywise > Enabled	User '[USERNAME]' from host '[USERIP]' enabled EnergyWise.	User '[USERNAME]' from host '[USERIP]' disabled EnergyWise.
Peripheral Device Slot > * > Numeric Sensor > Unavailable	Peripheral device '[EXTSENSORNAME]' in slot '[EXTSENSORSLOT]' unavailable.	Peripheral device '[EXTSENSORNAME]' in slot '[EXTSENSORSLOT]' available.
Peripheral Device Slot > * > Numeric Sensor > Above upper critical threshold	Peripheral device '[EXTSENSORNAME]' in slot [EXTSENSORSLOT] asserted 'above upper critical' at [SENSORREADING] [SENSORREADINGUNIT].	Peripheral device '[EXTSENSORNAME]' in slot [EXTSENSORSLOT] deasserted 'above upper critical' at [SENSORREADING] [SENSORREADINGUNIT].
Peripheral Device Slot > * > Numeric Sensor > Above upper warning threshold	Peripheral device '[EXTSENSORNAME]' in slot [EXTSENSORSLOT] asserted 'above upper warning' at [SENSORREADING] [SENSORREADINGUNIT].	Peripheral device '[EXTSENSORNAME]' in slot [EXTSENSORSLOT] deasserted 'above upper warning' at [SENSORREADING] [SENSORREADINGUNIT].

Event/context	Default message when the event = TRUE	Default message when the event = FALSE
Peripheral Device Slot > * > Numeric Sensor > Below lower warning threshold	Peripheral device '[EXTSENSORNAME]' in slot [EXTSENSORSLOT] asserted 'below lower warning' at [SENSORREADING] [SENSORREADINGUNIT].	Peripheral device '[EXTSENSORNAME]' in slot [EXTSENSORSLOT] deasserted 'below lower warning' at [SENSORREADING] [SENSORREADINGUNIT].
Peripheral Device Slot > * > Numeric Sensor > Below lower critical threshold	Peripheral device '[EXTSENSORNAME]' in slot [EXTSENSORSLOT] asserted 'below lower critical' at [SENSORREADING] [SENSORREADINGUNIT].	Peripheral device '[EXTSENSORNAME]' in slot [EXTSENSORSLOT] deasserted 'below lower critical' at [SENSORREADING] [SENSORREADINGUNIT].
Peripheral Device Slot > * > State Sensor/Actuator > Unavailable	Peripheral device '[EXTSENSORNAME]' in slot '[EXTSENSORSLOT]' unavailable.	Peripheral device '[EXTSENSORNAME]' in slot '[EXTSENSORSLOT]' available.
Peripheral Device Slot > * > State Sensor/Actuator > Alarmed/Open/On	Peripheral device '[EXTSENSORNAME]' in slot [EXTSENSORSLOT] is [SENSORSTATENAME].	Peripheral device '[EXTSENSORNAME]' in slot [EXTSENSORSLOT] is [SENSORSTATENAME].
Peripheral Device Slot > * > State Sensor/Actuator > Switched by user	Peripheral device '[EXTSENSORNAME]' in slot [EXTSENSORSLOT] has been switched to [SENSORSTATENAME] by user '[USERNAME]' from host.	
Inlet > * > Enabled	Inlet '[INLET]' has been enabled by user '[USERNAME]' from host '[USERIP]'.	Inlet '[INLET]' has been disabled by user '[USERNAME]' from host '[USERIP]'.
Inlet > * > Sensor > * > Unavailable	Sensor '[INLETSENSOR]' on inlet '[INLET]' unavailable.	Sensor '[INLETSENSOR]' on inlet '[INLET]' available.
Inlet > * > Sensor > * > Above upper critical threshold	Sensor '[INLETSENSOR]' on inlet '[INLET]' asserted 'above upper critical' at [SENSORREADING] [SENSORREADINGUNIT].	Sensor '[INLETSENSOR]' on inlet '[INLET]' deasserted 'above upper critical' at [SENSORREADING] [SENSORREADINGUNIT].
Inlet > * > Sensor > * > Above upper warning threshold	Sensor '[INLETSENSOR]' on inlet '[INLET]' asserted 'above upper warning' at [SENSORREADING] [SENSORREADINGUNIT].	Sensor '[INLETSENSOR]' on inlet '[INLET]' deasserted 'above upper warning' at [SENSORREADING] [SENSORREADINGUNIT].
Inlet > * > Sensor > * > Below lower warning threshold	Sensor '[INLETSENSOR]' on inlet '[INLET]' asserted 'below lower warning' at [SENSORREADING] [SENSORREADINGUNIT].	Sensor '[INLETSENSOR]' on inlet '[INLET]' deasserted 'below lower warning' at [SENSORREADING] [SENSORREADINGUNIT].
Inlet > * > Sensor > * > Below lower critical threshold	Sensor '[INLETSENSOR]' on inlet '[INLET]' asserted 'below lower critical' at [SENSORREADING] [SENSORREADINGUNIT].	Sensor '[INLETSENSOR]' on inlet '[INLET]' deasserted 'below lower critical' at [SENSORREADING] [SENSORREADINGUNIT].

Event/context	Default message when the event = TRUE	Default message when the event = FALSE
	[SENSORREADINGUNIT].	[SENSORREADINGUNIT].
Inlet > * > Sensor > * > Reset	Sensor '[INLETSSENSOR]' on inlet '[INLET]' has been reset by user '[USERNAME]' from host '[USERIP]'.	
Inlet > * > Sensor > * > Normal	Sensor '[INLETSSENSOR]' on inlet '[INLET]' entered normal state.	Sensor '[INLETSSENSOR]' on inlet '[INLET]' exited normal state.
Inlet > * > Sensor > * > Failed	Sensor '[INLETSSENSOR]' on inlet '[INLET]' entered failed state.	Sensor '[INLETSSENSOR]' on inlet '[INLET]' entered normal state.
Inlet > * > Sensor > * > OK	Sensor '[INLETSSENSOR]' on inlet '[INLET]' entered OK state.	Sensor '[INLETSSENSOR]' on inlet '[INLET]' exited OK state.
Inlet > * > Sensor > * > Warning	Sensor '[INLETSSENSOR]' on inlet '[INLET]' entered warning state.	Sensor '[INLETSSENSOR]' on inlet '[INLET]' exited warning state.
Inlet > * > Sensor > * > Critical	Sensor '[INLETSSENSOR]' on inlet '[INLET]' entered critical state.	Sensor '[INLETSSENSOR]' on inlet '[INLET]' exited critical state.
Inlet > * > Sensor > * > Self-Test	Sensor '[INLETSSENSOR]' on inlet '[INLET]' started self test.	Sensor '[INLETSSENSOR]' on inlet '[INLET]' finished self test.
Inlet > Pole > * > Sensor > Unavailable	Sensor '[PDUPOLESENSOR]' on pole '[INLETPOLE]' of inlet '[INLET]' unavailable.	Sensor '[PDUPOLESENSOR]' on pole '[INLETPOLE]' of inlet '[INLET]' available.
Inlet > Pole > * > Sensor > Above upper critical threshold	Sensor '[PDUPOLESENSOR]' on pole '[INLETPOLE]' of inlet '[INLET]' asserted 'above upper critical' at [SENSORREADING] [SENSORREADINGUNIT].	Sensor '[PDUPOLESENSOR]' on pole '[INLETPOLE]' of inlet '[INLET]' deasserted 'above upper critical' at [SENSORREADING] [SENSORREADINGUNIT].
Inlet > Pole > * > Sensor > Above upper warning threshold	Sensor '[PDUPOLESENSOR]' on pole '[INLETPOLE]' of inlet '[INLET]' asserted 'above upper warning' at [SENSORREADING] [SENSORREADINGUNIT].	Sensor '[PDUPOLESENSOR]' on pole '[INLETPOLE]' of inlet '[INLET]' deasserted 'above upper warning' at [SENSORREADING] [SENSORREADINGUNIT].
Inlet > Pole > * > Sensor > Below lower warning threshold	Sensor '[PDUPOLESENSOR]' on pole '[INLETPOLE]' of inlet '[INLET]' asserted 'below lower warning' at [SENSORREADING] [SENSORREADINGUNIT].	Sensor '[PDUPOLESENSOR]' on pole '[INLETPOLE]' of inlet '[INLET]' deasserted 'below lower warning' at [SENSORREADING] [SENSORREADINGUNIT].

Event/context	Default message when the event = TRUE	Default message when the event = FALSE
Inlet > Pole > * > Sensor > Below lower critical threshold	Sensor '[PDUPOLESENSOR]' on pole '[INLETPOLE]' of inlet '[INLET]' asserted 'below lower critical' at [SENSORREADING] [SENSORREADINGUNIT].	Sensor '[PDUPOLESENSOR]' on pole '[INLETPOLE]' of inlet '[INLET]' deasserted 'below lower critical' at [SENSORREADING] [SENSORREADINGUNIT].
Inlet > Pole > * > Sensor > Normal	Sensor '[PDUPOLESENSOR]' on pole '[INLETPOLE]' of inlet '[INLET]' entered normal state.	Sensor '[PDUPOLESENSOR]' on pole '[INLETPOLE]' of inlet '[INLET]' exited normal state.
Inlet > Pole > * > Sensor > Failed	Sensor '[PDUPOLESENSOR]' on pole '[INLETPOLE]' of inlet '[INLET]' entered failed state.	Sensor '[PDUPOLESENSOR]' on pole '[INLETPOLE]' of inlet '[INLET]' exited failed state.
Inlet > Pole > * > Sensor > Warning	Sensor '[PDUPOLESENSOR]' on pole '[INLETPOLE]' of inlet '[INLET]' entered warning state.	Sensor '[PDUPOLESENSOR]' on pole '[INLETPOLE]' of inlet '[INLET]' exited warning state.
Inlet > Pole > * > Sensor > Critical	Sensor '[PDUPOLESENSOR]' on pole '[INLETPOLE]' of inlet '[INLET]' entered critical state.	Sensor '[PDUPOLESENSOR]' on pole '[INLETPOLE]' of inlet '[INLET]' exited critical state.
Inlet > Pole > * > Sensor > Self-Test	Sensor '[PDUPOLESENSOR]' on pole '[INLETPOLE]' of inlet '[INLET]' started self test.	Sensor '[PDUPOLESENSOR]' on pole '[INLETPOLE]' of inlet '[INLET]' finished self test.
Modem > Dial-in link established	An incoming call from caller '[CALLERID]' was received.	The incoming call from caller '[CALLERID]' was disconnected: [CALLENDREASON].
Modem > Modem attached	A [MODEMTYPE] modem was attached.	
Modem > Modem detached	A [MODEMTYPE] modem was removed.	
Outlet > * > Power control > Powered on	Outlet '[OUTLET]' has been powered on by user '[USERNAME]' from host '[USERIP]'.	
Outlet > * > Power control > Powered off	Outlet '[OUTLET]' has been powered off by user '[USERNAME]' from host '[USERIP]'.	
Outlet > * > Power control > Power cycled	Outlet '[OUTLET]' power cycle initiated by user '[USERNAME]' from host '[USERIP]'.	
Outlet > * > Sensor > * > Unavailable	Sensor '[OUTLETSENSOR]' on outlet '[OUTLET]' unavailable.	Sensor '[OUTLETSENSOR]' on outlet '[OUTLET]' available.

Event/context	Default message when the event = TRUE	Default message when the event = FALSE
Outlet > * > Sensor > * > Above upper critical threshold	Sensor '[OUTLETSENSOR]' on outlet '[OUTLET]' asserted 'above upper critical' at [SENSORREADING] [SENSORREADINGUNIT].	Sensor '[OUTLETSENSOR]' on outlet '[OUTLET]' deasserted 'above upper critical' at [SENSORREADING] [SENSORREADINGUNIT].
Outlet > * > Sensor > * > Above upper warning threshold	Sensor '[OUTLETSENSOR]' on outlet '[OUTLET]' asserted 'above upper warning' at [SENSORREADING] [SENSORREADINGUNIT].	Sensor '[OUTLETSENSOR]' on outlet '[OUTLET]' deasserted 'above upper warning' at [SENSORREADING] [SENSORREADINGUNIT].
Outlet > * > Sensor > * > Below lower warning threshold	Sensor '[OUTLETSENSOR]' on outlet '[OUTLET]' asserted 'below lower warning' at [SENSORREADING] [SENSORREADINGUNIT].	Sensor '[OUTLETSENSOR]' on outlet '[OUTLET]' deasserted 'below lower warning' at [SENSORREADING] [SENSORREADINGUNIT].
Outlet > * > Sensor > * > Below lower critical threshold	Sensor '[OUTLETSENSOR]' on outlet '[OUTLET]' asserted 'below lower critical' at [SENSORREADING] [SENSORREADINGUNIT].	Sensor '[OUTLETSENSOR]' on outlet '[OUTLET]' deasserted 'below lower critical' at [SENSORREADING] [SENSORREADINGUNIT].
Outlet > * > Sensor > Active Energy > Reset	Sensor '[OUTLETSENSOR]' on outlet '[OUTLET]' has been reset by user '[USERNAME]' from host '[USERIP]'.	
Outlet > * > Sensor > Outlet State > On/Off	Outlet '[OUTLET]' state changed to on.	Outlet '[OUTLET]' state changed to off.
Outlet > * > Pole > * > Sensor > Unavailable	Sensor '[POLESENSOR]' on pole '[OUTLETPOLE]' of outlet '[OUTLET]' unavailable.	Sensor '[POLESENSOR]' on pole '[OUTLETPOLE]' of outlet '[OUTLET]' available.
Outlet > * > Pole > * > Sensor > Above upper critical threshold	Sensor '[PDUPOLESENSOR]' on pole '[OUTLETPOLE]' of outlet '[OUTLET]' asserted 'above upper critical' at [SENSORREADING] [SENSORREADINGUNIT].	Sensor '[PDUPOLESENSOR]' on pole '[OUTLETPOLE]' of outlet '[OUTLET]' asserted 'above upper critical' at [SENSORREADING] [SENSORREADINGUNIT].
Outlet > * > Pole > * > Sensor > Above upper warning threshold	Sensor '[PDUPOLESENSOR]' on pole '[OUTLETPOLE]' of outlet '[OUTLET]' asserted 'above upper warning' at [SENSORREADING] [SENSORREADINGUNIT].	Sensor '[PDUPOLESENSOR]' on pole '[OUTLETPOLE]' of outlet '[OUTLET]' deasserted 'above upper warning' at [SENSORREADING] [SENSORREADINGUNIT].
Outlet > * > Pole > * > Sensor > Below lower warning threshold	Sensor '[PDUPOLESENSOR]' on pole '[OUTLETPOLE]' of outlet '[OUTLET]' asserted 'below lower warning' at [SENSORREADING] [SENSORREADINGUNIT].	Sensor '[PDUPOLESENSOR]' on pole '[OUTLETPOLE]' of outlet '[OUTLET]' deasserted 'below lower warning' at [SENSORREADING] [SENSORREADINGUNIT].

Event/context	Default message when the event = TRUE	Default message when the event = FALSE
Outlet > * > Pole > * > Sensor > Below lower critical threshold	Sensor '[PDUPOLESENSOR]' on pole '[OUTLETPOLE]' of outlet '[OUTLET]' asserted 'below lower critical' at [SENSORREADING] [SENSORREADINGUNIT].	Sensor '[PDUPOLESENSOR]' on pole '[OUTLETPOLE]' of outlet '[OUTLET]' deasserted 'below lower critical' at [SENSORREADING] [SENSORREADINGUNIT].
Outlet Grouping > Outlet Group > * > Outlet Group Modified	Outlet group '[OUTLETGROUPID]' was modified.	
Outlet Grouping > Outlet Group > * > Power control > Power cycled	Outlet group '[OUTLETGROUPID]' power cycle initiated by user '[USERNAME]' from host '[USERIP]'.	
Outlet Grouping > Outlet Group > * > Power control > Powered off	Outlet group '[OUTLETGROUPID]' has been powered off by user '[USERNAME]' from host '[USERIP]'.	
Outlet Grouping > Outlet Group > * > Power control > Powered on	Outlet group '[OUTLETGROUPID]' has been powered on by user '[USERNAME]' from host '[USERIP]'.	
Outlet Grouping > Outlet Group > * > Sensor > Above upper critical threshold	Sensor '[OUTLETGROUPSENSOR]' on outlet group '[OUTLETGROUPID]' asserted 'above upper critical' at [SENSORREADING] [SENSORREADINGUNIT].	Sensor '[OUTLETGROUPSENSOR]' on outlet group '[OUTLETGROUPID]' deasserted 'above upper critical' at [SENSORREADING] [SENSORREADINGUNIT].
Outlet Grouping > Outlet Group > * > Sensor > Above upper warning threshold	Sensor '[OUTLETGROUPSENSOR]' on outlet group '[OUTLETGROUPID]' asserted 'above upper warning' at [SENSORREADING] [SENSORREADINGUNIT].	Sensor '[OUTLETGROUPSENSOR]' on outlet group '[OUTLETGROUPID]' deasserted 'above upper warning' at [SENSORREADING] [SENSORREADINGUNIT].
Outlet Grouping > Outlet Group > * > Sensor > Below lower critical threshold	Sensor '[OUTLETGROUPSENSOR]' on outlet group '[OUTLETGROUPID]' asserted 'below lower critical' at [SENSORREADING] [SENSORREADINGUNIT].	Sensor '[OUTLETGROUPSENSOR]' on outlet group '[OUTLETGROUPID]' deasserted 'below lower critical' at [SENSORREADING] [SENSORREADINGUNIT].
Outlet Grouping > Outlet Group > * > Sensor > Below lower warning threshold	Sensor '[OUTLETGROUPSENSOR]' on outlet group '[OUTLETGROUPID]' asserted 'below lower warning' at [SENSORREADING] [SENSORREADINGUNIT].	Sensor '[OUTLETGROUPSENSOR]' on outlet group '[OUTLETGROUPID]' deasserted 'below lower warning' at [SENSORREADING] [SENSORREADINGUNIT].
Outlet Grouping > Outlet Group > * > Sensor > Unavailable	Sensor '[OUTLETGROUPSENSOR]' of outlet group '[OUTLETGROUPID]' unavailable.	Sensor '[OUTLETGROUPSENSOR]' on outlet group '[OUTLETGROUPID]' available.

Event/context	Default message when the event = TRUE	Default message when the event = FALSE
Outlet Grouping > Outlet Group > * > Sensor > Reset	Sensor '[OUTLETGROUPSENSOR]' on outlet group '[OUTLETGROUPID]' has been reset by user '[USERNAME]' from host '[USERIP]'.	
Outlet Grouping > Outlet Group Created	Outlet group '[OUTLETGROUPID]' was created.	
Outlet Grouping > Outlet Group Deleted	Outlet group '[OUTLETGROUPID]' was deleted.	
Overcurrent Protector > * > Sensor > * > Unavailable	Sensor '[OCPSENSOR]' on overcurrent protector '[OCP]' unavailable.	Sensor '[OCPSENSOR]' on overcurrent protector '[OCP]' available.
Overcurrent Protector > * > Sensor > * > Above upper critical threshold	Sensor '[OCPSENSOR]' on overcurrent protector '[OCP]' asserted 'above upper critical' at [SENSORREADING] [SENSORREADINGUNIT].	Sensor '[OCPSENSOR]' on overcurrent protector '[OCP]' deasserted 'above upper critical' at [SENSORREADING] [SENSORREADINGUNIT].
Overcurrent Protector > * > Sensor > * > Above upper warning threshold	Sensor '[OCPSENSOR]' on overcurrent protector '[OCP]' asserted 'above upper warning' at [SENSORREADING] [SENSORREADINGUNIT].	Sensor '[OCPSENSOR]' on overcurrent protector '[OCP]' deasserted 'above upper warning' at [SENSORREADING] [SENSORREADINGUNIT].
Overcurrent Protector > * > Sensor > * > Below lower warning threshold	Sensor '[OCPSENSOR]' on overcurrent protector '[OCP]' asserted 'below lower warning' at [SENSORREADING] [SENSORREADINGUNIT].	Sensor '[OCPSENSOR]' on overcurrent protector '[OCP]' deasserted 'below lower warning' at [SENSORREADING] [SENSORREADINGUNIT].
Overcurrent Protector > * > Sensor > * > Below lower critical threshold	Sensor '[OCPSENSOR]' on overcurrent protector '[OCP]' asserted 'below lower critical' at [SENSORREADING] [SENSORREADINGUNIT].	Sensor '[OCPSENSOR]' on overcurrent protector '[OCP]' deasserted 'below lower critical' at [SENSORREADING] [SENSORREADINGUNIT].
Overcurrent Protector > * > Sensor > Trip > Open/Close	Sensor '[OCPSENSOR]' on overcurrent protector '[OCP]' is open.	Sensor '[OCPSENSOR]' on overcurrent protector '[OCP]' is closed.
Pdu > Controller > * > Communication failed	Communication with controller '[CONTROLLER]' (board ID [BOARDID]) failed.	Communication with controller '[CONTROLLER]' (board ID [BOARDID]) restored.
Pdu > Controller > * > Firmware update	Controller '[CONTROLLER]' with board ID [BOARDID] has started firmware update	Controller '[CONTROLLER]' with board ID [BOARDID] has completed firmware update
Pdu > Controller > * > Incompatible	Controller '[CONTROLLER]' with board ID [BOARDID] is incompatible.	Controller '[CONTROLLER]' with board ID [BOARDID] is no longer incompatible.

Event/context	Default message when the event = TRUE	Default message when the event = FALSE
Pdu > Controller > * > OK	Controller '[CONTROLLER]' with board ID [BOARDID] is OK.	Controller '[CONTROLLER]' with board ID [BOARDID] is no longer OK.
Pdu > Load Shedding > Started	PX placed in Load Shedding Mode by user '[USERNAME]' from host '[USERIP]'.	PX removed from Load Shedding Mode by user '[USERNAME]' from host '[USERIP]'.
Pdu > Sensor > +12V Supply 1 Status > Fault	Global sensor '[PDUSENSOR]' entered fault state.	Pdu > Sensor > +12V Supply 1 Status > Fault
Pdu > Sensor > +12V Supply 1 Status > Unavailable	Global sensor 'powerSupplyStatus 1' unavailable.	Global sensor 'powerSupplyStatus 1' available.
Server Monitoring > * > Error	Error monitoring server '[MONITOREDHOST]': [ERRORDESC]	
Server Monitoring > * > Monitored	Server '[MONITOREDHOST]' is now being monitored.	Server '[MONITOREDHOST]' is no longer being monitored.
Server Monitoring > [MONITOREDHOST] > Power control completed	Power control operation for '[MONITOREDHOST]' finished with result: [SERVERPOWERRESULT]	
Server Monitoring > [MONITOREDHOST] > Power control initiated	User '[USERNAME]' initiated a power control operation for '[MONITOREDHOST]': [SERVERPOWEROPERATION]	
Server Monitoring > * > Unreachable	Server '[MONITOREDHOST]' is unreachable.	Server '[MONITOREDHOST]' is reachable.
Server Monitoring > * > Unrecoverable	Connection to server '[MONITOREDHOST]' could not be restored.	
User Activity > * > User logon state	User '[USERNAME]' from host '[USERIP]' logged in.	User '[USERNAME]' from host '[USERIP]' logged out.
User Activity > * > Authentication failure	Authentication failed for user '[USERNAME]' from host '[USERIP]'.	
User Activity > * > User accepted the Restricted Service Agreement	User '[USERNAME]' from host '[USERIP]' accepted the Restricted Service Agreement.	User '[USERNAME]' from host '[USERIP]' declined the Restricted Service Agreement.
User Activity > * > User blocked	User '[USERNAME]' from host '[USERIP]' was blocked.	
User Activity > * > Session timeout	Session of user '[USERNAME]' from host '[USERIP]' timed out.	
User Administration > User added	User '[UMTARGETUSER]' added by user	

Event/context	Default message when the event = TRUE	Default message when the event = FALSE
	'[USERNAME]' from host '[USERIP]'.	
User Administration > User modified	User '[UMTARGETUSER]' modified by user '[USERNAME]' from host '[USERIP]'.	
User Administration > User deleted	User '[UMTARGETUSER]' deleted by user '[USERNAME]' from host '[USERIP]'.	
User Administration > Password changed	Password of user '[UMTARGETUSER]' changed by user '[USERNAME]' from host '[USERIP]'.	
User Administration > Password settings changed	Password settings changed by user '[USERNAME]' from host '[USERIP]'.	
User Administration > Role added	Role '[UMTARGETROLE]' added by user '[USERNAME]' from host '[USERIP]'.	
User Administration > Role modified	Role '[UMTARGETROLE]' modified by user '[USERNAME]' from host '[USERIP]'.	
User Administration > Role deleted	Role '[UMTARGETROLE]' deleted by user '[USERNAME]' from host '[USERIP]'.	
Webcam Management > Image upload started	A snapshot upload of webcam '[WEBCAMNAME]' to folder '[PATH]' was started.	
Webcam Management > Webcam attached	Webcam '[WEBCAMNAME]' ('[WEBCAMUVCID]') added to port '[WEBCAMUSBPORT]'.	
Webcam Management > Webcam detached	Webcam '[WEBCAMNAME]' ('[WEBCAMUVCID]') removed from port '[WEBCAMUSBPORT]'.	
Webcam Management > Webcam settings changed	Webcam '[WEBCAMNAME]' settings changed by user '[USERNAME]'.	
LHX/SHX > Connected	LHX has been connected to [PORTTYPE] port [PORTID].	LHX has been disconnected from [PORTTYPE] port [PORTID].
LHX/SHX > Operational State	LHX connected to [PORTTYPE] port [PORTID] has been switched on.	LHX connected to [PORTTYPE] port [PORTID] has been switched off.
LHX/SHX > Sensor > Unavailable	Sensor '[LHXSENSORID]' on LHX at [PORTTYPE] port '[PORTID]' unavailable.	Sensor '[LHXSENSORID]' on LHX at [PORTTYPE] port '[PORTID]' available.

Event/context	Default message when the event = TRUE	Default message when the event = FALSE
LHX/SHX > Sensor > Above upper critical threshold	Sensor '[LHXSENSORID]' on LHX at [PORTTYPE] port '[PORTID]' asserted 'above upper critical' at [SENSORREADING] [SENSORREADINGUNIT].	Sensor '[LHXSENSORID]' on LHX at [PORTTYPE] port '[PORTID]' deasserted 'above upper critical' at [SENSORREADING] [SENSORREADINGUNIT].
LHX/SHX > Sensor > Above upper warning threshold	Sensor '[LHXSENSORID]' on LHX at [PORTTYPE] port '[PORTID]' asserted 'above upper warning' at [SENSORREADING] [SENSORREADINGUNIT].	Sensor '[LHXSENSORID]' on LHX at [PORTTYPE] port '[PORTID]' deasserted 'above upper warning' at [SENSORREADING] [SENSORREADINGUNIT].
LHX/SHX > Sensor > Below lower warning threshold	Sensor '[LHXSENSORID]' on LHX at [PORTTYPE] port '[PORTID]' asserted 'below lower warning' at [SENSORREADING] [SENSORREADINGUNIT].	Sensor '[LHXSENSORID]' on LHX at [PORTTYPE] port '[PORTID]' deasserted 'below lower warning' at [SENSORREADING] [SENSORREADINGUNIT].
LHX/SHX > Sensor > Below lower critical threshold	Sensor '[LHXSENSORID]' on LHX at [PORTTYPE] port '[PORTID]' asserted 'below lower critical' at [SENSORREADING] [SENSORREADINGUNIT].	Sensor '[LHXSENSORID]' on LHX at [PORTTYPE] port '[PORTID]' deasserted 'below lower critical' at [SENSORREADING] [SENSORREADINGUNIT].
LHX/SHX > Base Electronics Failure	The base electronics on LHX at [PORTTYPE] port '[PORTID]' failed.	The base electronics on LHX at [PORTTYPE] port '[PORTID]' is back to normal.
LHX/SHX > Condenser Pump Failure	The condenser pump on LHX at [PORTTYPE] port '[PORTID]' failed.	The condenser pump on LHX at [PORTTYPE] port '[PORTID]' is back to normal.
LHX/SHX > Emergency Cooling	Emergency cooling on LHX at [PORTTYPE] port '[PORTID]' was activated.	Emergency cooling on LHX at [PORTTYPE] port '[PORTID]' was deactivated.
LHX/SHX > Maximum cooling request	Maximum cooling was requested for LHX at [PORTTYPE] port '[PORTID]'.	Maximum cooling is not any more requested for LHX at [PORTTYPE] port '[PORTID]'.
LHX/SHX > Parameter Data Loss	Data loss in parameter memory was detected on LHX at [PORTTYPE] port '[PORTID]'.	
LHX/SHX > ST-Bus Communication Error	An ST-Bus communication error was detected on LHX at [PORTTYPE] port '[PORTID]'.	

Event/context	Default message when the event = TRUE	Default message when the event = FALSE
LHX/SHX > Collective fault	A collective fault occurred on LHX at [PORTTYPE] port '[PORTID]'.	
LHX/SHX > Door Contact	The door of LHX at [PORTTYPE] port '[PORTID]' was opened.	The door of LHX at [PORTTYPE] port '[PORTID]' was closed.
LHX/SHX > Sensor Failure	A sensor failure (broken or short circuit) occurred on LHX at [PORTTYPE] port '[PORTID]' at sensor '[LHXSENSORID]'.	
LHX/SHX > Fan Failure	A fan motor failure occurred on LHX at [PORTTYPE] port '[PORTID]' at fan '[LHXFANID]'.	
LHX/SHX > Power Supply Failure	A power supply failure occurred on LHX at [PORTTYPE] port '[PORTID]' at power supply '[LHXPOWERSUPPLYID]'.	
LHX/SHX > Threshold Air Inlet	The air inlet temperature threshold on LHX at [PORTTYPE] port '[PORTID]' was crossed.	The air inlet temperature on LHX at [PORTTYPE] port '[PORTID]' is within thresholds.
LHX/SHX > Threshold Air Outlet	The air outlet temperature threshold on LHX at [PORTTYPE] port '[PORTID]' was crossed.	The air outlet temperature on LHX at [PORTTYPE] port '[PORTID]' is within thresholds.
LHX/SHX > Threshold Water Inlet	The water inlet temperature threshold on LHX at [PORTTYPE] port '[PORTID]' was crossed.	The water inlet temperature on LHX at [PORTTYPE] port '[PORTID]' is within thresholds.
LHX/SHX > Threshold Water Outlet	The water outlet temperature threshold on LHX at [PORTTYPE] port '[PORTID]' was crossed.	The water outlet temperature on LHX at [PORTTYPE] port '[PORTID]' is within thresholds.
LHX/SHX > Voltage Low	The supply voltage on LHX at [PORTTYPE] port '[PORTID]' is low.	The supply voltage on LHX at [PORTTYPE] port '[PORTID]' is back to normal.
LHX/SHX > Threshold Humidity	The humidity threshold on LHX at [PORTTYPE] port '[PORTID]' was crossed.	The humidity on LHX at [PORTTYPE] port '[PORTID]' is within thresholds.
LHX/SHX > External Water Cooling Failure	An external water cooling failure occurred on LHX at [PORTTYPE] port '[PORTID]'.	
LHX/SHX > Water Leak	Water leakage was detected on LHX at [PORTTYPE] port '[PORTID]'.	

The asterisk symbol (*) represents anything you select for the 'trigger' events.

Available Actions

The PX3 comes with three built-in actions, which cannot be deleted. You can create additional actions for responding to different events.

► **To test an action:**

- Click the Test button next to the Action. The action is triggered and you can verify it.

Actions		+ New Action
Name ▲	Type	
System Event Log Action	Log event message	▶ Test
System SNMP Notification Action	Send SNMP notification	▶ Test
System Tamper Alarm	Alarm	▶ Test

► **Built-in actions:**

- *System Event Log Action:*
This action records the selected event in the internal log when the event occurs.
- *System SNMP Notification Action:*
This action sends SNMP notifications to one or multiple IP addresses after the selected event occurs.

*Note: No IP addresses are specified for this notification action by default so you must enter IP addresses before applying this action to any event rule. See **Editing or Deleting a Rule/Action** (on page 419). Any changes made to the 'SNMP Notifications' section on the SNMP page will update the settings of the System SNMP Notification Action, and vice versa. See **Configuring SNMP Settings** (on page 329).*

- *System Tamper Alarm:*
This action causes the PX3 to show the alarm for the Raritan tamper sensor, if any, on the Dashboard page until a person acknowledges it. By default, this action has been assigned to the built-in tamper detection event rules. For information on acknowledging an alarm, see **Dashboard - Alarms** (on page 192).

► **Actions you can create:**

1. Choose Device Settings > Event Rules > **+ New Action**.
2. Click the Action field to select an action type from the list.

Action

-- Select an action type ▾

3. Below is the list of available actions.

Note: The "Change load shedding state", "Power control server", "Switch outlets" and "Switch outlet group" options are only available for outlet-switching capable models.

Action	Function
Alarm	Requires the user to acknowledge the alert after it is generated. If needed, you can have the alert notifications regularly generated until a person takes the acknowledgment action. See Alarm (on page 387).
Change load shedding state	Enters or quits the load shedding mode. See Change Load Shedding State (on page 388).
Execute an action group	Creates a group of actions comprising existing actions. See Action Group (on page 388).
External beeper	Enables or disables the connected external beeper, or causes it to enter an alarm cycle. See External Beeper (on page 389).
Internal beeper	Turns on or off the internal beeper. See Internal Beeper (on page 389).
Log event message	Records the selected events in the internal log. See Log an Event Message (on page 389).
Power control server	Two operations are available. <ul style="list-style-type: none"> ▪ Shuts down a monitored server and then powers off the outlet(s) associated with that server. ▪ Powers up the outlet(s) associated with a monitored server. See Shut down a Server and Control its Power (on page 390).
Push out sensor readings	Sends internal sensor log, environmental sensor log or asset management strip data to a remote server using HTTP POST requests. See Push Out Sensor Readings (on page 391).
Record snapshots to webcam storage	Makes a connected webcam start or stop taking snapshots. See Record Snapshots to Webcam Storage (on page 391).

Action	Function
Request LHX/SHX maximum cooling	Applies the maximum cooling to the LHX/SHX device. See Request LHX/SHX Maximum Cooling (on page 393). This option is available only when the Schroff LHX/SHX support has been enabled.
Send email	Emails a textual message. See Send Email (on page 394).
Send sensor report	Reports the readings or status of the selected sensors, including internal or external sensors. See Send Sensor Report (on page 396).
Send SMS message	Sends a message to a mobile phone. See Send SMS Message (on page 398).
Send snapshots via email	Emails the snapshots captured by a connected Logitech® webcam (if available). See Send Snapshots via Email (on page 399).
Send SNMP notification	Sends SNMP traps or informs to one or multiple SNMP destinations. See Send an SNMP Notification (on page 401).
Start/stop Lua script	If you are a developer who can create a Lua script, you can upload it to the PX3, and have the PX3 automatically perform or stop the script in response to an event. See Start or Stop a Lua Script (on page 402).
Switch LHX/SHX	Switches on or off the LHX/SHX device. See Switch LHX/SHX (on page 403). This option is available only when the Schroff LHX/SHX support has been enabled.
Switch outlets	Switches on, off or cycles the power to the specified outlet(s). See Switch Outlets (on page 404).
Switch outlet group	Switches on, off or cycles the power to all outlets of the specified outlet group. See Switch Outlet Group (on page 403).
Switch peripheral actuator	Switches on or off the mechanism or system connected to the specified actuator. See Switch Peripheral Actuator (on page 404).
Syslog message	Makes the PX3 automatically forward event messages to the specified syslog server. See Syslog Message (on page 405).

4. Enter the information as needed and click Create.
5. Then you can assign the newly-created action to an event rule or schedule it. See **Event Rules and Actions** (on page 364).

Alarm

The Alarm is an action that requires users to acknowledge an alert. This helps ensure that the user is aware of the alert.

If the Alarm action has been included in a specific event rule and no one acknowledges that alert after it occurs, the PX3 resends or regenerates an alert notification regularly until the alert is acknowledged or the maximum number of alert notifications is sent.

For information on acknowledging an alert, see **Dashboard** (on page 183).

▶ Operation:

1. Choose Device Settings > Event Rules > .
2. Select Alarm from the Action list.
3. In the Alarm Notifications list box, specify one or multiple ways to issue the alert notifications. Available methods vary, depending on how many notification-based actions have been created. Notification-based action types include:
 - External beeper
 - Syslog message
 - Send email
 - Send SMS message
 - Internal beeper

If no appropriate actions are available, create them first.

 - a. To select any methods, select them one by one in the Available field.
To add all available methods, simply click Select All.
 - b. To delete any methods, click a method's  in the Selected field.
To remove all methods, simply click Deselect All.
4. To enable the notification-resending feature, select the 'Enable re-scheduling of alarm notifications' checkbox.
5. In the 'Re-scheduling period' field, specify the time interval (in minutes) at which the alert notification is resent or regenerated regularly.
6. In the 'Re-scheduling limit' field, specify the maximum number of times the alert notification is resent. Values range from 1 to infinite.
7. **(Optional)** You can instruct the PX3 to send the acknowledgment notification after the alarm is acknowledged in the 'Acknowledgment notifications' field. Available methods are identical to those for generating alarm notifications.



- a. In the Available field, select desired methods one by one, or click Select All. See step 3 for details.
- b. In the Selected field, click any method's  to remove unnecessary ones, or click Deselect All.

Action Group

You can create an action group that performs up to 32 actions. After creating such an action group, you can easily assign this set of actions to any event rule rather than selecting all needed actions one by one per rule.

If the needed action is not available yet, create it first. See **Available Actions** (on page 384).

▶ Operation:

1. Choose Device Settings > Event Rules > .
2. Select 'Execute an action group' from the Action list.
3. To select any action(s), select them one by one from the 'Available actions' list.
 - To select all available actions, click Select All.
4. To remove any action(s) from the 'Selected actions' field, click that action's .

 - To remove all actions, click Deselect All.

Change Load Shedding State

The "Change load shedding state" action is available only when your PX3 is able to control outlet power. Use this action to activate or deactivate the load shedding mode for responding to a specific event. For additional information, see **Load Shedding Mode** (on page 215).

▶ Operation:

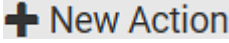
1. Choose Device Settings > Event Rules > .
2. Select 'Change load shedding state' from the Action list.
3. In the Operation field, select either one below:
 - Start load shedding: Enters the load shedding mode when the specified event occurs.
 - Stop load shedding: Quits the load shedding mode when the specified event occurs.

External Beeper

If an external beeper is connected to the PX3, the PX3 can change the beeper's behavior or status to respond to a certain event.

► **To control the connected external beeper:**

1. Choose Device Settings > Event Rules > **+ New Action**.
2. Select 'External beeper' from the Action list.
3. In the 'Beeper port' field, select the port where the external beeper is connected. This port is the FEATURE port.
4. In the 'Beeper action' field, select an action for the external beeper to carry out.
 - Alarm: Causes the external beeper to sound an alarm cycle every 20 seconds - stays on for 0.7 seconds and then off for 19.3 seconds.
 - On: Turns on the external beeper so that it buzzes continuously.
 - Off: Turns off the external beeper so that it stops buzzing.

Warning: If you create an event rule for the external beeper but disconnect it when an event causes it to beep, the beeper no longer beeps after it is re-connected even though the event triggering the beeping action remains asserted.

Internal Beeper

You can have the built-in beeper of the PX3 turned on or off when a certain event occurs.

► **Operation:**

1. Choose Device Settings > Event Rules > **+ New Action**.
2. Select 'Internal beeper' from the Action list.
3. Select an option from the Operation field.
 - Turn beeper on: Turns on the internal beeper to make it buzz.
 - Turn beeper off: Turns off the internal beeper to make it stop buzzing.

Log an Event Message

The option 'Log event message' records the selected events in the internal log.

The default log message generated for each type of event is available in the section titled **Default Log Messages** (on page 370).

Shut down a Server and Control its Power

The "Power control server" action is available only when your PX3 is outlet-switching capable.

You can configure the PX3 to shut down a specific server and then turn off its outlet(s), or turn on that server's outlet(s) after a certain event occurs.

The only restriction is a server must be one of the servers being monitored by your PX3 and the same PX3 supplies power to it. To have any server monitored, see **Monitoring Server Accessibility** (on page 437).

*Tip: If the server has multiple power cords, make sure all of its power cords are connected to the same PX3 and you have created an outlet group for controlling all outlets simultaneously. See **Outlet Groups** (on page 226).*

▶ Operation:

1. Choose Device Settings > Event Rules > **+ New Action**.
2. Select 'Power control server' from the Action list.
3. In the Operation field, select an action for the server.
 - Power up: Turns on the outlet or outlet group associated with the selected server.
 - Graceful shutdown: Shuts down the selected server first and then turn off its associated outlet or outlet group.
4. Select the server you want in the Server field.
 - If PX3 cannot power control any server, a message 'Power control not configured' is shown in the end of the server's host name or IP address.

Push Out Sensor Readings

You can configure the PX3 to push sensor log to a remote server after a certain event occurs, including logs of internal sensors, environmental sensors and actuators.

If you have connected Raritan's asset strips to the PX3, you can also configure the PX3 to push the data to a server.

Before creating this action, make sure that you have properly defined the destination servers and the data to be sent on the Data Push page. See **Configuring Data Push Settings** (on page 428).

*Tip: To send the data at a regular interval, schedule this action. See **Scheduling an Action** (on page 406). Note that the "Asset management log" is generated only when there are changes made to any asset strips or asset tags, such as connection or disconnection events.*

▶ Operation:

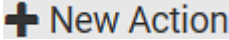
1. Choose Device Settings > Event Rules > .
2. Select 'Push out sensor readings' from the Action list.
3. Select a server or host which receives the data in the Destination field.
 - If the desired destination is not available yet, go to the Data Push page to specify it.

Record Snapshots to Webcam Storage

This option allows you to define an action that starts or stops a specific webcam from taking snapshots.

Per default the snapshots are stored on the PX3. See **Viewing and Managing Locally-Saved Snapshots** (on page 491).

It is recommended to specify a remote server to store as many snapshots as possible. See **Changing Storage Settings** (on page 493).

▶ Operation:

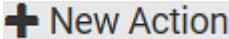
1. Choose Device Settings > Event Rules > .
2. Select 'Record snapshots to webcam storage' from the Action list.
3. Select a webcam in the Webcam field.
4. Select the action to perform - 'Start recording' or 'Stop recording.'
 - If 'Start recording' is selected, adjust the values of the following:
 - Number of snapshots - the number of snapshots to be taken when the event occurs.

The maximum amount of snapshots that can be stored on the PX3 is 10. If you set it for a number greater than 10 and the storage location is on the PX3, after the 10th snapshot is taken and stored, the oldest snapshots are overwritten. Storing snapshots on a remote server does not have such a limitation.

- Time before first snapshot - the amount of time in seconds between when the event is triggered and the webcam begins taking snapshots.
- Time between snapshots - the amount of time in seconds between when each snapshot is taken.
- Folder - names of the folders that will be automatically created to store webcam snapshots after the recording action is triggered by the rule you will configure.

Note that the Folder field is available only when the selected webcam has been configured to store its snapshots on an "FTP" server. See **Changing Storage Settings** (on page 493).

Folder name options	Definition
Serial number / Webcam name	Two folders will be created. <ul style="list-style-type: none"> ▪ The parent folder's name is the serial number of PX3. ▪ The subfolder's name is the selected webcam's name.
Serial number / Webcam name / Rule name	Three folders will be created. <ul style="list-style-type: none"> ▪ Definitions of the parent folder and first subfolder are the same as the first row. ▪ The final subfolder's name is the name of event rule that triggers this recording action.
Serial number / Webcam name / Timestamp	Three folders will be created. <ul style="list-style-type: none"> ▪ Definitions of the parent folder and first subfolder are the same as the first row. ▪ The final subfolder's name is the time when the recording event occurs, which is the accumulated time in seconds since 1970/1/1.
Serial number / Webcam name / Rule name / Timestamp	Four folders will be created. <ul style="list-style-type: none"> ▪ Definitions of the parent folder and first subfolder are the same as the first row. ▪ The second subfolder's name is the name of event rule that triggers this recording action. ▪ The final subfolder's name is the time when the recording event occurs, which is the accumulated time in seconds since 1970/1/1.

Folder name options	Definition
Serial number / Webcam name / Formatted timestamp	<p>Three folders will be created.</p> <ul style="list-style-type: none"> ▪ Definitions of the parent folder and first subfolder are the same as the first row. ▪ The final subfolder's name is the time when the recording event occurs, which is a format comprising year, month, date, hour, minute, second and timezone.
Serial number / Webcam name / Rule name / Formatted timestamp	<p>Four folders will be created.</p> <ul style="list-style-type: none"> ▪ Definitions of the parent folder and first subfolder are the same as the first row. ▪ The second subfolder's name is the name of event rule that triggers this recording action. ▪ The final subfolder's name is the time when the recording event occurs, which is a format comprising year, month, date, hour, minute, second and timezone.

No matter which timestamp you choose, the timestamp is based on the time you have configured on the PX3. See **Setting the Date and Time** (on page 360).

To find the serial number of your PX3, see **Device Information** (on page 457). To change the webcam's name, see **Configuring Webcams and Viewing Live Images** (on page 486).

Tip: If you choose "Timestamp" as the final subfolder's name and do not understand the occurrence time indicated by the timestamp, you can always easily convert it to a readable formatted time by googling Unix timestamp converter.

Request LHX/SHX Maximum Cooling

If Schroff LHX/SHX Support is enabled, the LHX/SHX-related actions will be available. See **Miscellaneous** (on page 453).

The 'Request LHX/SHX maximum cooling' action applies the maximum cooling to the SHX-30 device only. The LHX-20 and LHX-40 devices do not support this feature.

In the maximum cooling mode, an SHX-30 device runs at 100% fan speed and the cold water valve is open 100%.

▶ Operation:

1. Choose Device Settings > Event Rules >  **New Action**.
2. Select 'Request LHX/SHX maximum cooling' from the Action list.
3. In the Available LHX/SHX field, select the desired SHX-30 device one by one, or click Select All.

4. To remove any SHX-30 device from the Selected LHX/SHX field, click that device's  or click Deselect All.

Send Email

You can configure emails to be sent when an event occurs and can customize the message.

Messages consist of a combination of free text and PX3 placeholders. The placeholders represent information which is pulled from the PX3 and inserted into the message.

For example:

```
[USERNAME] logged into the device on [TIMESTAMP]
```

translates to

```
Mary logged into the device on 2012-January-30 21:00
```

For a list and definition of available variables, see **Placeholders for Custom Messages** (on page 415).

▶ Operation:

1. Choose Device Settings > Event Rules > .
2. Select 'Send email' from the Action list.
3. In the 'Recipient email addresses' field, specify the email address(es) of the recipient(s). Use a comma to separate multiple email addresses.
4. By default, the SMTP server specified on the SMTP Server page will be the SMTP server for performing this action.

To use a different SMTP server, select the 'Use custom settings' radio button. The fields for customized SMTP settings appear. For information on each field, see **Configuring SMTP Settings** (on page 331).

Default messages are sent based on the event. For a list of default log messages and events that trigger them, see **Default Log Messages** (on page 370).

5. If needed, you can customize the subject and messages sent via this email.
 - Select the 'Custom subject' checkbox, and enter the text you prefer as this email's subject.
 - Select the 'Use custom log message' checkbox, and then create a custom message up to 1024 characters in the provided field.

When clicking anywhere inside the text box, the Event Context Information displays, showing a list of placeholders and their definitions. Just scroll down to select the desired placeholder. For details, see **Placeholders for Custom Messages** (on page 415).

Use custom log message

Event Context Information

In your custom message, you may use placeholders for certain event contexts. For example, a message displaying the username and host the user connected from might read like:

User [USERNAME] from [USERIP] caused an event.

search

Placeholder ▲	Description
[AMSBLADESLOTPOSITION]	The (horizontal) slot position inside a blade extension
[AMSLEDCOLOR]	The RGB LED color
[AMSLEDMODE]	The LED indication mode
[AMSLEDOPMODE]	The LED operating mode

1024 characters remaining.

- To start a new line in the text box, press Enter.

Note: In case you need to type any square brackets "[" and "]" in the custom message for non-placeholder words, always add a backslash in front of the square bracket. That is, \[or \]. Otherwise, the message sent will not display the square brackets.

Send Sensor Report

You may set the PX3 so that it automatically reports the latest readings or states of one or multiple sensors by sending a message or email or simply recording the report in a log. These sensors can be either internal or environmental sensors listed below.



- Inlet sensors, including RMS current, RMS voltage, active power, apparent power, power factor and active energy.
- Outlet sensors, including RMS current, RMS voltage, active power, apparent power, power factor, active energy and outlet state (for outlet-switching capable PDUs only).
- Overcurrent protector sensors, including RMS current and tripping state.
- Peripheral device sensors, which can be any Raritan environmental sensor packages connected to the PX3, such as temperature or humidity sensors.

An example of this action is available in the section titled **Send Sensor Report Example** (on page 409).

▶ Operation:

1. Choose Device Settings > Event Rules > .
2. Select 'Send sensor report' from the Action list.
3. In the 'Destination actions' section, select the method(s) to report sensor readings or states. The number of available methods varies, depending on how many messaging actions have been created.

The messaging action types include:

- Log event message
 - Syslog message
 - Send email
 - Send SMS message
4. If no messaging actions are available, create them now. See **Available Actions** (on page 384).
 - a. To select any methods, select them one by one in the Available field. To add all available methods, simply click Select All.
 - b. To delete any methods, click a method's  in the Selected field. To remove all methods, simply click Deselect All.
 5. In the 'Available sensors' field, select the desired target's sensor.
 - a. Click the first  to select a target component from the list.

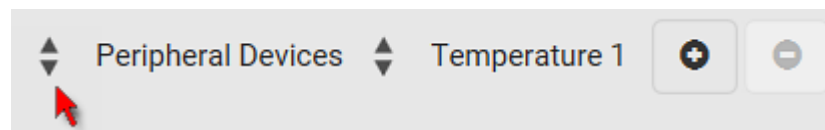

- b. Click the second  to select the specific sensor for the target from the list.



- c. Click  to add the selected sensor to the Report Sensors list box.

For example, to monitor the current reading of the Inlet 1, select Inlet 1 from the left field, and then select RMS Current from the right field.

6. To report additional sensors simultaneously, repeat the above step to add more sensors.
- To remove any sensor from the 'Report sensors' list box, select it and click . To make multiple selections, press Ctrl+click or Shift+click to highlight multiple ones.

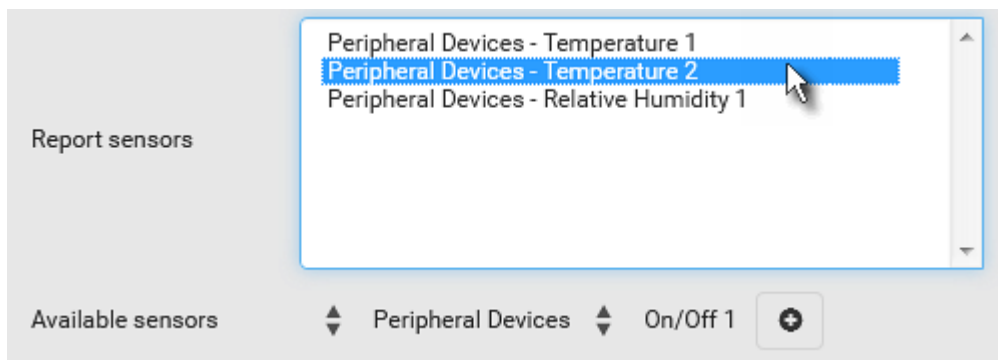

7. To immediately send out the sensor report, click Send Report Now.

*Tip: When intending to send a sensor report using custom messages, use the placeholder [SENSORREPORT] to report sensor readings. See **Placeholders for Custom Messages** (on page 415).*

Send SMS Message

You can configure SMS messages to be sent when an event occurs and can customize the message.

Only the 7-bit ASCII charset is supported for SMS messages. Messages consist of a combination of free text and PX3 placeholders. The placeholders represent information which is pulled from the PX3 and inserted into the message.

A supported modem, such as the Cinterion® GSM MC52i modem, must be plugged into the PX3 in order to send SMS messages. See **Connecting a GSM Modem** (on page 78).

Note: The PX3 cannot receive SMS messages.

For example:

```
[USERNAME] logged into the device on [TIMESTAMP]
```

translates to

```
Mary logged into the device on 2012-January-30 21:00
```

For a list and definition of available variables, see **Placeholders for Custom Messages** (on page 415).

▶ Operation:

1. Choose Device Settings > Event Rules > **+ New Action**.
2. Select 'Send SMS message' from the Action list.
3. In the 'Recipient phone number' field, specify the phone number of the recipient.
4. Select the 'Use custom log message' checkbox, and then create a custom message in the provided text box.

- When clicking anywhere inside the text box, the Event Context Information displays, showing a list of placeholders and their definitions. Just scroll down to select the desired placeholder. For details, see **Placeholders for Custom Messages** (on page 415).

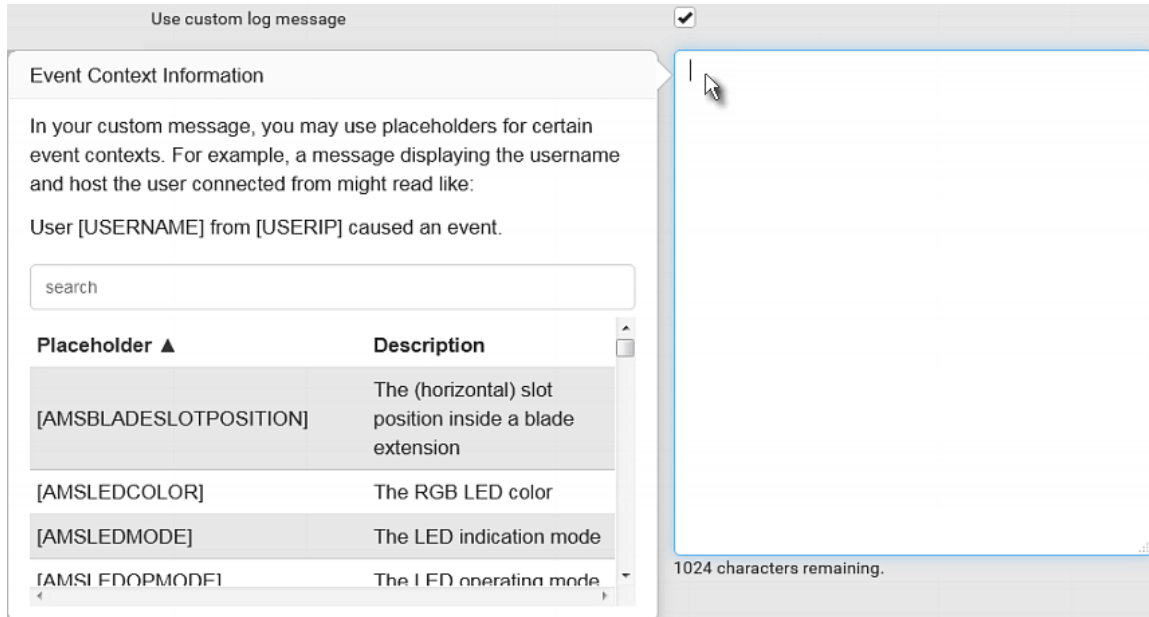

- To start a new line in the text box, press Enter.

Note: In case you need to type any square brackets "[" and "]" in the custom message for non-placeholder words, always add a backslash in front of the square bracket. That is, \[or \]. Otherwise, the message sent will not display the square brackets.

Send Snapshots via Email

This option notifies one or multiple persons for the selected events by emailing snapshots or videos captured by a connected Logitech® webcam.

▶ Operation:

1. Choose Device Settings > Event Rules > **+ New Action**.
2. Select 'Send snapshots via email' from the Action list.
3. In the 'Recipient email addresses' field, specify the email address(es) of the recipient(s). Use a comma to separate multiple email addresses.
4. By default, the SMTP server specified on the SMTP Server page will be the SMTP server for performing this action.

To use a different SMTP server, select the 'Use custom SMTP server' checkbox. The fields for customized SMTP settings appear. For information on each field, see **Configuring SMTP Settings** (on page 331).

5. Select the webcam that is capturing the images you want sent in the email.
6. Adjust the values of the following:
 - Number of snapshots - the number of snapshots to be taken when the event occurs. For example, you can specify 10 images be taken once the event triggers the action.
 - Snapshots per mail - the number of snapshots to be sent at one time in the email.
 - Time before first snapshot - the amount of time in seconds between when the event is triggered and the webcam begins taking snapshots.
 - Time between snapshots - the amount of time in seconds between when each snapshot is taken.
7. If needed, you can customize the subject and messages sent via this email.
 - Select the 'Custom subject' checkbox, and enter the text you prefer as this email's subject.
 - Select the 'Use custom log message' checkbox, and then create a custom message up to 1024 characters in the provided field.

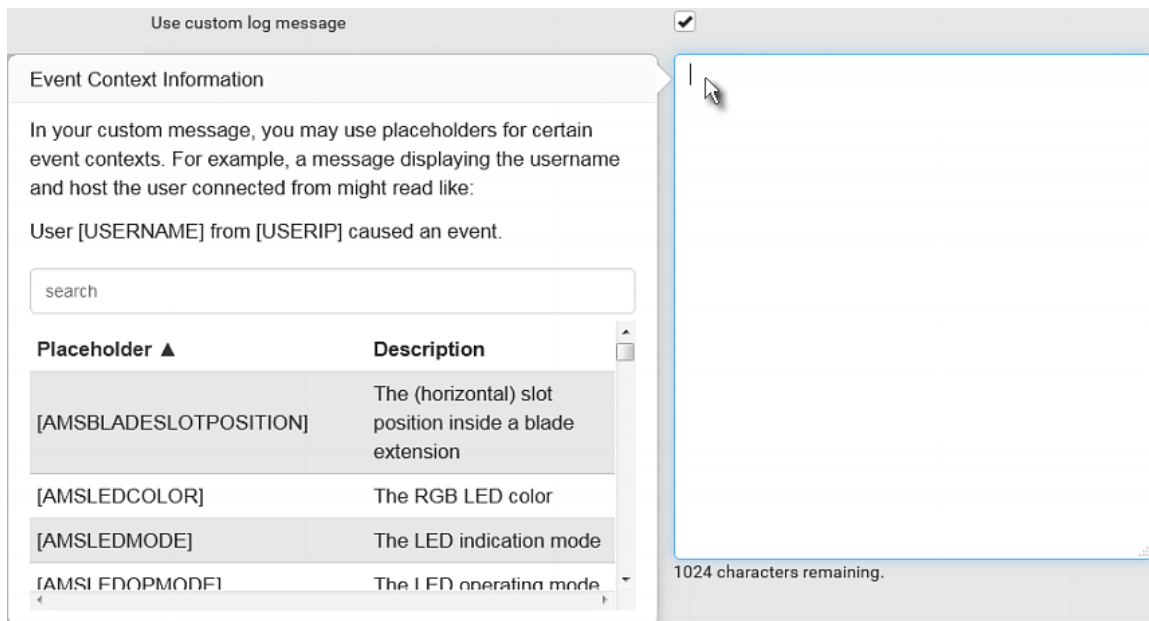

- To start a new line in the text box, press Enter.

Note: In case you need to type any square brackets "[" and "]" in the custom message for non-placeholder words, always add a backslash in front of the square bracket. That is, \[or \]. Otherwise, the message sent will not display the square brackets.

Send an SNMP Notification

This option sends an SNMP notification to one or multiple SNMP destinations.

▶ **Operation:**

1. Choose Device Settings > Event Rules > **+ New Action**.
2. Select 'Send SNMP notification' from the Action list.
3. Select the type of SNMP notification. See either procedure below according to your selection.

▶ **To send SNMP v2c notifications:**

1. In the 'Notification type' field, select 'SNMPv2c trap' or 'SNMPv2c inform.'
2. For SNMP INFORM communications, leave the resend settings at their default or do the following:
 - a. In the Timeout field, specify the interval of time, in seconds, after which a new inform communication is resent if the first is not received. For example, resend a new inform communication once every 3 seconds.
 - b. In the 'Number of retries' field, specify the number of times you want to re-send the inform communication if it fails. For example, inform communications are re-sent up to 5 times when the initial communication fails.
3. In the Host fields, enter the IP address of the device(s) you want to access. This is the address to which notifications are sent by the SNMP system agent.
4. In the Port fields, enter the port number used to access the device(s).
5. In the Community fields, enter the SNMP community string to access the device(s). The community is the group representing the PX3 and all SNMP management stations.

Tip: An SNMP v2c notification action permits only a maximum of three SNMP destinations. To assign more than three SNMP destinations to a specific rule, first create several SNMP v2c notification actions, each of which contains completely different SNMP destinations, and then add all of these SNMP v2c notification actions to the same rule.

▶ **To send SNMP v3 notifications:**

1. In the 'Notification type' field, select 'SNMPv3 trap' or 'SNMPv3 inform.'
2. For SNMP TRAPS, the engine ID is prepopulated.
3. For SNMP INFORM communications, leave the resend settings at their default or do the following:
 - a. In the Timeout field, specify the interval of time, in seconds, after which a new inform communication is resent if the first is not received. For example, resend a new inform communication once every 3 seconds.

- b. In the 'Number of retries' field, specify the number of times you want to re-send the inform communication if it fails. For example, inform communications are re-sent up to 5 times when the initial communication fails.
4. For both SNMP TRAPS and INFORMS, enter the following as needed and then click OK to apply the settings:
 - a. Host name
 - b. Port number
 - c. User ID for accessing the host -- make sure the User ID has the SNMPv3 permission.
 - d. Select the host security level

Security level	Description
"noAuthNoPriv"	Select this if no authorization or privacy protocols are needed.
"authNoPriv"	Select this if authorization is required but no privacy protocols are required. <ul style="list-style-type: none"> • Select the authentication protocol - MD5 or SHA • Enter the authentication passphrase and then confirm the authentication passphrase
"authPriv"	Select this if authentication and privacy protocols are required. <ul style="list-style-type: none"> • Select the authentication protocol - MD5 or SHA • Enter the authentication passphrase and confirm the authentication passphrase • Select the Privacy Protocol - DES or AES • Enter the privacy passphrase and then confirm the privacy passphrase

Start or Stop a Lua Script

If you have created or loaded a Lua script file into the PX3, you can have that script automatically run or stop in response to a specific event.

For instructions on creating or loading a Lua script into this product, see **Lua Scripts** (on page 447).

► **To automatically start or stop a Lua script:**

1. Choose Device Settings > Event Rules > **+ New Action**.
2. Select 'Start/stop Lua script' from the Action list.
3. In the Operation field, select 'Start script' or 'Stop script.'

4. In the Script field, select the script that you want it to be started or stopped when an event occurs.
 - No script is available if you have not created or loaded it into the PX3.
5. To apply different arguments than the default, do the following. Note that the newly-added arguments will override this script's default arguments.

 + Add argument

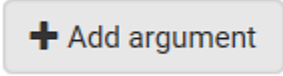
- a. Click .
- b. Type the key and value.
- c. Repeat the same steps to enter more arguments as needed.

- To remove any existing argument, click  adjacent to it.

Switch LHX/SHX

If Schroff LHX/SHX Support is enabled, the LHX/SHX-related actions will be available. See **Miscellaneous** (on page 453).

Use this action to switch the LHX/SHX on or off when, for example, temperature thresholds are reached.

▶ Operation:

1. Choose Device Settings > Event Rules > .
2. Select 'Switch LHX/SHX' from the Action list.
3. In the Operation field, select 'Turn LHX/SHX on' or 'Turn LHX/SHX off.'
4. In the Available LHX/SHX field, select the LHX/SHX device to be turned on or off. To select all available LHX/SHX devices, click Select All.

To remove any LHX/SHX device from the Selected LHX/SHX field, click that device's . To remove all devices, click Deselect All.

Switch Outlet Group

The "Switch outlet group" action is available only when your PX3 is outlet-switching capable. This action turns on, off or power cycles a specific outlet group.

▶ Operation:



1. Choose Device Settings > Event Rules > .
2. Select 'Switch outlet group' from the Action list.
3. To specify the outlet group where this action will be applied, select it from the 'Group to switch' list.
4. In the Operation field, select an operation for the selected outlet group.
 - Turn on all outlets in group: Turns on the selected outlet group.

- Turn off all outlets in group: Turns off the selected outlet group.
- Cycle all outlets in group: Cycles power to the selected outlet group.

Switch Outlets

The "Switch outlets" action is available only when your PX3 is outlet-switching capable. This action turns on, off or power cycles a specific outlet.

▶ **Operation:**

1. Choose Device Settings > Event Rules >  **New Action**.
2. Select 'Switch outlets' from the Action list.
3. In the Operation field, select an operation for the selected outlet(s).
 - Turn outlet on: Turns on the selected outlet(s).
 - Turn outlet off: Turns off the selected outlet(s).
 - Cycle outlet: Cycles power to the selected outlet(s).
4. To specify the outlet(s) where this action will be applied, select them one by one from the 'Available outlets' list.
 - To add all outlets, click Select All.
5. To remove any outlets from the 'Selected outlets' field, click that outlet's .
 - To remove all outlets, click Deselect All.
6. If 'Turn outlet on' or 'Cycle outlet' is selected in step 3, you can choose to select the 'Use sequence order and delays' checkbox so that all selected outlets will follow the power-on sequence defined on the page of **Outlets** (on page 206).

Switch Peripheral Actuator

If you have any actuator connected to the PX3, you can set up the PX3 so it automatically turns on or off the system controlled by the actuator when a specific event occurs.

*Note: For information on connecting actuators, see **DX2 Sensor Packages** (on page 48).*

▶ **Operation:**

1. Choose Device Settings > Event Rules >  **New Action**.
2. Select 'Switch peripheral actuator' from the Action list.
3. In the Operation field, select an operation for the selected actuator(s).
 - Turn on: Turns on the selected actuator(s).
 - Turn off: Turns off the selected actuator(s).

4. To select the actuator(s) where this action will be applied, select them one by one from the 'Available actuators' list.
 - To add all actuators, click Select All.
5. To remove any selected actuator from the 'Selected actuators' field, click that actuator's .
 - To remove all actuators, click Deselect All.

Syslog Message

Use this action to automatically forward event messages to the specified syslog server. Determine the syslog transmission mechanism you prefer when setting it up - UDP, TCP or TLS over TCP.

PX3 may or may not detect the syslog message transmission failure. If yes, it will log this syslog failure as well as the failure reason in the event log. See **Viewing or Clearing the Local Event Log** (on page 464).

▶ **Operation:**

1. Choose Device Settings > Event Rules >  **New Action**.
2. Select 'Syslog message' from the Action list.
3. In the 'Syslog server' field, specify the IP address to which the syslog is forwarded.
4. In the 'Transport protocol' field, select one of the syslog protocols: TCP, UDP or TCP+TLS. The default is UDP.

Transport protocols	Next steps
UDP	<ul style="list-style-type: none"> ▪ In the 'UDP port' field, type an appropriate port number. Default is 514. ▪ Select the 'Legacy BSD syslog protocol' checkbox if applicable.
TCP	NO TLS certificate is required. Type an appropriate port number in the 'TCP port' field.

Transport protocols	Next steps
TCP+TLS	<p>A TLS certificate is required. Do the following:</p> <ol style="list-style-type: none"> Type an appropriate port number in the 'TCP port' field. Default is 6514. In the 'CA certificate' field, click  to select a TLS certificate. After importing the certificate, you may: <ul style="list-style-type: none"> Click Show to view its contents. Click Remove to delete it if it is inappropriate. Determine whether to select the 'Allow expired and not yet valid certificates' checkbox. <ul style="list-style-type: none"> To always send the event message to the specified syslog server as long as a TLS certificate is available, select this checkbox. To prevent the event message from being sent to the specified syslog server when any TLS certificate in the selected certificate chain is outdated or not valid yet, deselect this checkbox.

*Note: If the required certificate file is a chain of certificates, and you are not sure about the requirements of a certificate chain, see **TLS Certificate Chain** (on page 906).*

Scheduling an Action

An action can be regularly performed at a preset time interval instead of being triggered by a specific event. For example, you can make the PX3 report the reading or state of a specific sensor regularly by scheduling the "Send sensor report" action.



When scheduling an action, make sure you have a minimum of 1-minute buffer between this action's creation and first execution time. Otherwise, the scheduled action will NOT be performed at the specified time when the buffer time is too short. For example, if you want an action to be performed at 11:00 am, you should finish scheduling it at 10:59 am or earlier.

If the needed action is not available yet, create it first. See **Available Actions** (on page 384).

▶ Operation:

- Choose Device Settings > Event Rules >  **New Scheduled Action**.
- To select any action(s), select them one by one from the 'Available actions' list.
 - To select all available actions, click Select All.

3. To remove any action(s) from the 'Selected actions' field, click that action's .
 - To remove all actions, click Deselect All.
4. Select the desired frequency in the 'Execution time' field, and then specify the time interval or a specific date and time in the field(s) that appear.

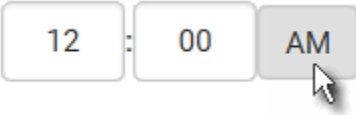
Execution time	Frequency settings
Minutes	<p>Click the Frequency field to select an option.</p> <p>The frequency ranges from every minute, every 5 minutes, every 10 minutes and so on until every 30 minutes.</p>
Hourly	<p>Type a value in the Minute field, which is set to either of the following:</p> <ul style="list-style-type: none"> The Minute field is set to 0 (zero). Then the action is performed at 1:00 am, 2:00 am, 3:00 am and so on. The Minute field is set to a non-zero value. For example, if it is set to 30, then the action is performed at 1:30 am, 2:30 am, 3:30 am and so on.
Daily	<p>Type values or click  .</p> <p>The time is measured in 12-hour format so you must correctly specify AM or PM by clicking the AM/PM button.</p> <div style="text-align: center;">  </div> <p>For example, if you specify 01:30PM, the action is performed at 13:30 pm every day.</p>
Weekly	<p>Both the day and time must be specified for the weekly option.</p> <ul style="list-style-type: none"> Days range from Sunday to Saturday. The time is measured in 12-hour format so you must correctly specify AM or PM by clicking the AM/PM button.
Monthly	<p>Both the date and time must be specified for the monthly option.</p> <ul style="list-style-type: none"> The dates range from 1 to 31. The time is measured in 12-hour format so you must correctly specify AM or PM by clicking the AM/PM button. <p>Note that NOT every month has the date 31, and February in particular does not have the date 30 and probably even 29. Check the calendar when selecting 29, 30 or 31.</p>
Yearly	<p>This option requires three settings:</p> <ul style="list-style-type: none"> Month - January through December. Day of month - 1 to 31. Time - the value is measured in 12-hour format so you must correctly specify AM or PM by clicking the AM/PM button.

An example of the scheduled action is available in the section titled **Send Sensor Report Example** (on page 409).

Send Sensor Report Example

To create a scheduled action for emailing a temperature sensor report hourly, it requires:

- A 'Send email' action
- A 'Send sensor report' action
- A timer - that is, the scheduled action

▶ **Steps:**

1. Click  **New Action** to create a 'Send email' action that sends an email to the desired recipient(s). For details, see ***Send Email*** (on page 394).
 - In this example, this action is named *Email a Sensor Report*.

- If wanted, you can customize the subject and content of this email in this action.

New Action

Action name	<input type="text" value="Email a Sensor Report"/>
Action	<input type="text" value="Send email"/>
Recipient email addresses	<input type="text" value="IT-manager@raritan.com"/>
SMTP server	<input checked="" type="radio"/> Use default settings Server name: 192.168.5.50 Sender email address: manager@raritan.com Settings can be changed in SMTP Server settings. <input type="radio"/> Use custom settings
Custom subject	<input checked="" type="checkbox"/> <input type="text" value="Sensor Report: [EXTSENSOR] - [EXTSENSORNAME]"/>
Use custom log message	<input checked="" type="checkbox"/>
Custom log message	<div style="border: 1px solid #ccc; padding: 5px;"><p>The following is the complete sensor report –</p><p><u>[SENSORREPORT]</u></p></div> <p>962 characters remaining.</p>
<input type="button" value="✕ Cancel"/> <input type="button" value="✓ Create"/>	

2. Click **+ New Action** to create a 'Send sensor report' action that includes the 'Email a Sensor Report' action as its destination action. For details, see ***Send Sensor Report*** (on page 396).
 - In this example, this action is named *Send Temperature Sensor Readings*.

- You can specify more than one temperature sensor as needed in this action.

New Action

Action name

Action

Destination actions

Selected

Available

Email a Sensor Report ✕

Peripheral Devices - Temperature 1

Peripheral Devices - Temperature 2

Report sensors

Available sensors

Peripheral Devices

Relative Humidity 1

+

-

Note: Reported sensor units can be changed in the [Default Preferences](#).

3. Click **+ New Scheduled Action** to create a timer for performing the 'Send Temperature Sensor Readings' action hourly. For details, see **Scheduling an Action** (on page 406).

- In this example, the timer is named *Hourly Temperature Sensor Reports*.
- To perform the specified action at 12:30 pm, 01:30 pm, 02:30 pm, and so on, select Hourly, and set the Minute to 30.

New Scheduled Action

Timer name	<input type="text" value="Hourly Temperature Sensor Reports"/>
Enabled	<input checked="" type="checkbox"/>
Execution time	<input type="text" value="Hourly"/>
Minute	<input type="text" value="30"/>
Selected actions	<input type="text" value="Send Temperature Sensor Readings"/>
Available actions	<input type="text" value="-- Select an item --"/>

Then the PX3 will send out an email containing the specified temperature sensor readings hourly every day.

Whenever you want the PX3 to stop sending the temperature report, deselect the Enabled checkbox in the timer.

Placeholders for Custom Messages

Actions of "Send email" and "Send SMS message" allow you to customize event messages. See **Send Email** (on page 394) or **Send SMS Message** (on page 398). In addition, you can add custom text message to the "Send snapshots via email" action. See **Send Snapshots via Email** (on page 399).

When clicking anywhere inside the text box, the Event Context Information displays, showing a list of placeholders and their definitions. Simply drag the scroll bar and then click the desired placeholder to insert it into the custom message. Or you can type a keyword in the "search" box to quickly find the desired placeholder.

Note that available placeholders are model dependent.

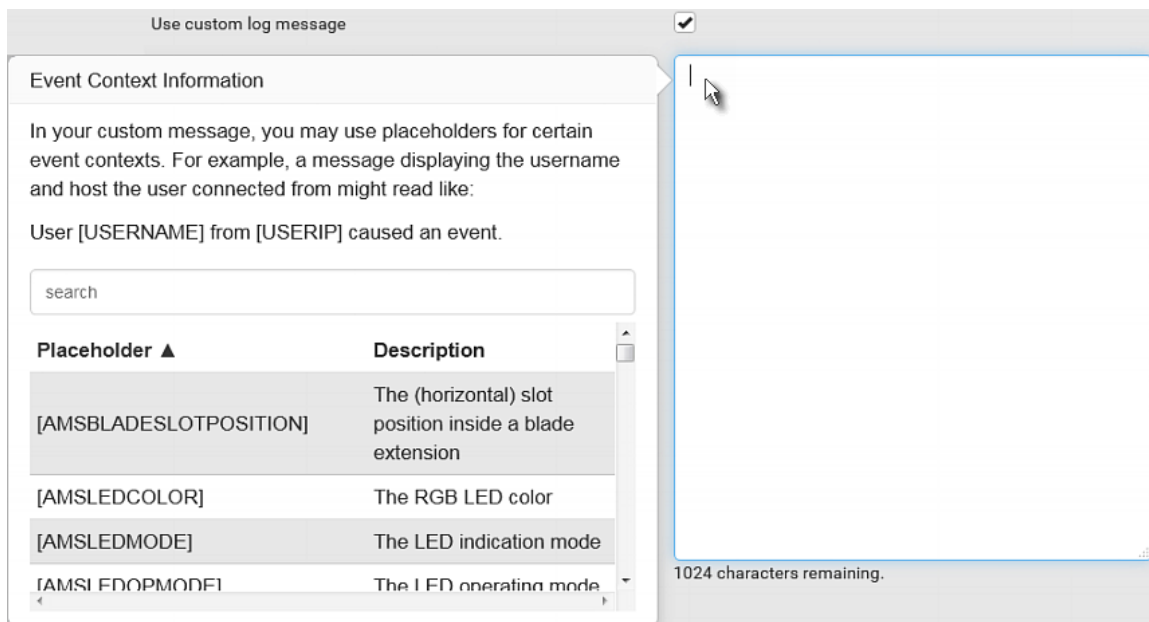

If wanted, you can resort the list by clicking the desired column header. See **Sorting a List** (on page 182).

To make the Event Context Information disappear, click anywhere inside the browser's window.

The following are placeholders that can be used in custom messages.

Placeholder	Definition
[AMSBLADESLOTPOSITION]	The (horizontal) slot position inside a blade extension
[AMSLEDCOLOR]	The RGB LED color
[AMSLEDMODE]	The LED indication mode
[AMSLEDOPMODE]	The LED operating mode

Placeholder	Definition
[AMSNAME]	The name of an asset strip
[AMSNUMBER]	The numeric ID of an asset strip
[AMSRACKUNITPOSITION]	The (vertical) rack unit position
[AMSSTATE]	The human-readable state of an asset strip
[AMSTAGID]	The asset tag ID
[CARDREADERCHANNEL]	The channel number of a card reader
[CARDREADERID]	The id of a card reader
[CARDREADERMANUFACTURER]	The manufacturer of a card reader
[CARDREADERPRODUCT]	The product name of a card reader
[CARDREADERSERIALNUMBER]	The serial number of a card reader
[COMPONENTID]	The ID of a hardware component
[CONFIGPARAM]	The name of a configuration parameter
[CONFIGVALUE]	The new value of a parameter
[DATETIME]	The human readable timestamp of the event occurrence
[DEVICEIP]	The IP address of the device the event occurred on
[DEVICENAME]	The name of the device the event occurred on
[DEVICSERIAL]	The unit serial number of the device the event occurred on
[ERRORDESC]	The error message
[EVENTRULENAME]	The name of the matching event rule
[EXTSENSOR]	The peripheral device identifier
[EXTSENSORNAME]	The name of a peripheral device
[EXTSENSORSLOT]	The ID of a peripheral device slot
[FAILURETYPE]	The numeric hardware failure type
[FAILURETYPESTR]	The textual hardware failure type
[IFNAME]	The human readable name of a network interface
[INLET]	The inlet label
[INLETPOLE]	The inlet power line identifier
[INLETSENSOR]	The inlet sensor name
[ISASSERTED]	Boolean flag whether an event condition became true (1) or false (0)

Placeholder	Definition
[LDAPERRORDESC]	The LDAP error occurred
[LHXFANID]	The ID of a fan connected to an LHX/SHX
[LHXPOWERSUPPLYID]	The ID of an LHX/SHX power supply
[LHXSENSORID]	The ID of an LHX/SHX sensor probe
[LOGMESSAGE]	The original log message
[MONITOREDHOST]	The name or IP address of a monitored host
[NETAUTHRESULTSTR]	The network authentication result string ('succeeded' or 'failed')
[OCP]	The overcurrent protector label
[OCPSENSOR]	The overcurrent protector sensor name
[OCPTRIPCAUSELABEL]	The label of the outlet that likely caused the OCP trip
[OLDVERSION]	The firmware version the device is being upgraded from
[OUTLET]	The outlet label
[OUTLETGROUPID]	The outlet group ID
[OUTLETGROUPNAME]	The outlet group name
[OUTLETGROUPSENSOR]	The outlet group sensor name
[OUTLETNAME]	The outlet name <i>Note: If any outlet does not have a name, neither an outlet name nor an outlet number will be shown in the custom message for it. Therefore, it is recommended to check the availability of all outlet names if intending to use this placeholder.</i>
[OUTLETPOLE]	The outlet power line identifier
[OUTLETSENSOR]	The outlet sensor name
[PDUPOLESENSOR]	The sensor name for a certain power line
[PDUSENSOR]	The PDU sensor name
[PERIPHDEVPOSITION]	The position of an attached peripheral device
[PHONENUMBER]	The destination phone number of an outgoing SMS message
[PORTID]	The label of the external port the event-triggering device is connected to

Placeholder	Definition
[PORTTYPE]	The type of the external port (e.g. 'feature' or 'auxiliary') the event-triggering device is connected to
[RADIUSERRORDESC]	The Radius error message
[ROMCODE]	The romcode of an attached peripheral device
[SENSORREADING]	The value of a sensor reading
[SENSORREADINGUNIT]	The unit of a sensor reading
[SENSORREPORT]	The formatted sensor report contents
[SENSORSTATENAME]	The human readable state of a sensor
[SENSORTHRESHOLDNAME]	The name of the threshold being crossed
[SENSORTHRESHOLDVALUE]	The value of the threshold being crossed
[SERVERPOWEROPERATION]	The power control operation that was initiated on a server (on/off)
[SERVERPOWERRESULT]	The result of a power control operation
[SMARTCARDID]	The id of a smart card
[SMARTCARDTYPE]	The type of a smart card
[SMTPRECIPIENTS]	The list of recipients of an outgoing mail
[SMTPSERVER]	The name or IP address of an SMTP server
[SYSCONTACT]	SNMP MIB-II sysContact field
[SYSLOCATION]	SNMP MIB-II sysLocation field
[SYSNAME]	SNMP MIB-II sysName field
[TIMEREVENTID]	The id of a timer event
[TIMESTAMP]	The timestamp of the event occurrence
[UMTARGETROLE]	The target role of a user management operation
[UMTARGETUSER]	The target user of a user management operation
[USERIP]	The IP address a user connected from
[USERNAME]	The user who performed an operation
[VERSION]	The firmware version the device is upgrading to

Note: In case you need to type any square brackets "[" and "]" in the custom message for non-placeholder words, always add a backslash in front of the square bracket. That is, \[or \]. Otherwise, the message sent will not display the square brackets.

Editing or Deleting a Rule/Action

You can change the settings of an event rule, action or scheduled action, or delete them.

*Exception: Some settings of the built-in event rules or actions are not user-configurable. You cannot delete built-in rules and actions. See **Built-in Rules and Rule Configuration** (on page 365) or **Available Actions** (on page 384).*

► **To edit or delete an event rule, action or scheduled action:**

1. Choose Device Settings > Event Rules.
2. Click the desired one in the list of rules, actions or scheduled actions. Its setup page opens.
3. Perform the desired action.
 - To modify settings, make necessary changes and then click Save.
 - To delete it, click  **Delete** on the top-right corner. Then click Delete on the confirmation message.

Sample Event Rules

Sample PDU-Level Event Rule

In this example, we want the PX3 to record the firmware upgrade failure in the internal log when it happens.

The event rule involves:

- Event: Device > Firmware update failed
- Action: System Event Log Action

► **To create this PDU-level event rule:**

1. For an event at the PDU level, select "Device" in the Event field.
2. Select "Firmware update failed" so that the PX3 responds to the event related to firmware upgrade failure.

3. To make PX3 record the firmware update failure event in the internal log, select "System Event Log Action" in the 'Available actions' field.

The screenshot shows a configuration form for an event rule. It is divided into several sections:

- Event:** Contains two dropdown menus. The first is labeled 'Device' and has a red '1' next to it. The second is labeled 'Firmware update failed' and has a red '2' next to it.
- Selected actions:** Contains a list of actions. One action, 'System Event Log Action', is selected and has a red '3' next to it. There is a small 'x' icon to the right of the action name.
- Available actions:** Contains a dropdown menu with the text '-- Select an item --' and a downward arrow.
- Buttons:** There are four buttons at the bottom: 'Select All', 'Deselect All', 'Cancel' (with an 'x' icon), and 'Create' (with a checkmark icon).

Sample Outlet-Level Event Rule

In this example, we want the PX3 to send SNMP notifications to the SNMP manager for any sensor change event of outlet 3.

The event rule involves:

- Event: Outlet > Outlet 3 > Sensor > Any sub-event
- Action: System SNMP Notification Action

▶ To create this outlet-level event rule:

1. For an event at the outlet level, select "Outlet" in the Event field.
2. Select "Outlet 3" because that is the desired outlet.
3. Select "Sensor" to refer to sensor-related events.
4. Select "Any sub-event" to include all events related to all sensors of this outlet and all thresholds, such as current, voltage, upper critical threshold, upper warning threshold, lower critical threshold, lower warning threshold, and so on.
5. To make PX3 send SNMP notifications, select "System SNMP Notification Action" in the 'Available actions' field.

*Note: The SNMP notifications may be SNMP v2c or SNMP v3 traps/informs, depending on the settings for the System SNMP Notification Action. See **Enabling and Configuring SNMP** (on page 506).*

The screenshot shows a configuration panel for SNMP notifications. It is divided into several sections:

- Event:** A list of four dropdown menus. The first is 'Outlet' (marked with a red '1'), the second is 'Outlet 3' (marked with a red '2'), the third is 'Sensor' (marked with a red '3'), and the fourth is '<Any sub-event>' (marked with a red '4').
- Selected actions:** A single dropdown menu showing 'System SNMP Notification Action' (marked with a red '5') and a close button (X).
- Available actions:** A dropdown menu with the text '-- Select an item --'.
- Buttons:** At the bottom, there are four buttons: 'Select All', 'Deselect All', 'Cancel' (with an X icon), and 'Create' (with a checkmark icon).

Then the SNMP notifications are sent when:

- Any numeric sensor's reading enters the warning or critical range.
- Any sensor reading or state returns to normal.
- Any sensor becomes unavailable.
- The active energy sensor is reset.
- Any state sensor changes its state.

For example, when the outlet 3's voltage exceeds the upper warning threshold, the SNMP notifications are sent, and when the voltage drops below the upper warning threshold, the SNMP notifications are sent again.

Sample Inlet-Level Event Rule

In this example, we want the PX3 to send SNMP notifications to the SNMP manager for any sensor change event of the Inlet I1.

The event rule involves:

- Event: Inlet > Sensor > Any sub-event
- Action: System SNMP Notification Action

► **To create the above event rule:**

1. For an event at the inlet level, select "Inlet" in the Event field.
2. Select "Sensor" to refer to sensor-related events.
3. Select "Any sub-event" to include all events related to all sensors of this inlet and all thresholds, such as current, voltage, upper critical threshold, upper warning threshold, lower critical threshold, lower warning threshold, and so on.
4. To make the PX3 send SNMP notifications, select "System SNMP Notification Action" in the 'Available actions' box.

*Note: The SNMP notifications may be SNMP v2c or SNMP v3 traps/informs, depending on the settings for the System SNMP Notification Action. See **Enabling and Configuring SNMP** (on page 506).*

The screenshot shows a configuration interface for an event rule. On the left, there are labels for 'Event', 'Selected actions', and 'Available actions'. The 'Event' section contains three stacked dropdown menus. The first is labeled 'Inlet' with a red '1' to its right. The second is labeled 'Sensor' with a red '2' to its right. The third is labeled '<Any sub-event>' with a red '3' to its right. The 'Selected actions' section shows a single action 'System SNMP Notification Action' with a red '4' to its left and a close icon to its right. The 'Available actions' section has a dropdown menu with the text '-- Select an item --'. Below these sections are two buttons: 'Select All' and 'Deselect All'. At the bottom right are two buttons: 'Cancel' with a close icon and 'Create' with a checkmark icon.

Then the SNMP notifications are sent when:

- Any numeric sensor's reading enters the warning or critical range.
- Any sensor reading or state returns to normal.
- Any sensor becomes unavailable.

- The active energy sensor is reset.

For example, when the Inlet I1's voltage exceeds the upper warning threshold, the SNMP notifications are sent, and when the voltage drops below the upper warning threshold, the SNMP notifications are sent again.

Sample Environmental-Sensor-Level Event Rule

This section applies to outlet-switching capable models only.

In this example, we want PX3 to activate the load shedding function when a contact closure sensor enters the alarmed state. This event rule requires creating a new action before creating the rule.

▶ **Step 1: create a new action for activating the load shedding**

1. Choose Device Settings > Event Rules > **+ New Action**.
2. In this illustration, assign the name "Activate Load Shedding" to the new action.
3. In the Action field, select "Change load shedding state."
4. In the Operation field, select "Start load shedding."

New Action

Action name	<input style="width: 80%;" type="text" value="Activate Load Shedding"/> 2
Action	<input style="width: 80%;" type="text" value="Change load shedding state"/> 3 ▼
Operation	<input style="width: 80%;" type="text" value="Start load shedding"/> 4 ▼

5. Click Create to finish the creation.

After the new action is created, follow the procedure below to create an event rule that triggers the load shedding mode when the contact closure sensor enters the alarmed state. This event rule involves the following:

- Event: Peripheral Device Slot > Slot 1 > State Sensor/Actuator > Alarmed/Open/On
- Trigger condition: Alarmed
- Action: Activate Load Shedding

▶ **Step 2: create the contact closure-triggered load shedding event rule**

1. Click **+ New Rule** on the Event Rules page.
2. In this illustration, assign the name "Contact Closure Triggered Load Shedding" to the new rule.
3. In the Event field, select "Peripheral Device Slot" to indicate we are specifying an event related to the environmental sensor package.
4. Select the ID number of the desired contact closure sensor. In this illustration, the ID number of the desired contact closure sensor is 1, so select Slot 1.

*Note: ID numbers of all sensors/actuators are available on the Peripherals page. See **Peripherals** (on page 249).*

5. Select "State Sensor/Actuator" because the contact closure sensor is a state sensor.
6. Select "Alarmed" since we want the PX3 to respond when the selected contact closure sensor changes its state related to the "alarmed" state.
7. In the 'Trigger condition' field, select the Alarmed/Open/On radio button so that the action is taken only when the contact closure sensor enters the alarmed state.

8. Select "Activate Load Shedding" from the 'Available actions' list.

Event		Peripheral Device Slot	3	▼
		Slot 1 (On/Off 1)	4	▼
		State Sensor / Actuator	5	▼
		Alarmed / Open / On	6	▼
Trigger condition	7	<input checked="" type="radio"/> Alarmed / open / on		
		<input type="radio"/> No longer alarmed / closed / off		
		<input type="radio"/> Both		
Selected actions	8	Activate Load Shedding ✕		
Available actions		-- Select an item --		▼
		Select All	Deselect All	
		✕Cancel	✓Create	

A Note about Infinite Loop

You should avoid building an infinite loop when creating event rules.

The infinite loop refers to a condition where the PX3 keeps busy because the action or one of the actions taken for a certain event triggers an identical or similar event which will result in an action triggering one more event.

Example 1

This example illustrates an event rule which continuously causes the PX3 to send out email messages.

Event selected	Action included
Device > Sending SMTP message failed	Send email

Example 2

This example illustrates an event rule which continuously causes the PX3 to send out SMTP messages when one of the selected events listed on the Device menu occurs. Note that <Any sub-event> under the Device menu includes the event "Sending SMTP message failed."

Event selected	Action included
Device > Any sub-event	Send email

Example 3

This example illustrates a situation where two event rules combined regarding the outlet state changes causes the PX3 to continuously power cycle outlets 1 and 2 in turn.

Event selected	Action included
Outlet > Outlet 1 > Sensor > Outlet State > On/Off > Both (trigger condition)	Cycle Outlet 2 (Switch outlets --> Cycle Outlet --> Outlet 2)
Outlet > Outlet 2 > Sensor > Outlet State > On/Off > Both (trigger condition)	Cycle Outlet 1 (Switch outlets --> Cycle Outlet --> Outlet 1)

A Note about Untriggered Rules

In some cases, a measurement exceeds a threshold causing the PX3 to generate an alert. The measurement then returns to a value within the threshold, but the PX3 does not generate an alert message for the Deassertion event. Such scenarios can occur due to the hysteresis tracking the PX3 uses. See **"To De-assert" and Deassertion Hysteresis** (on page 884).

Setting Data Logging

The PX3 can store 120 measurements for each sensor in a memory buffer. This memory buffer is known as the data log. Sensor readings in the data log can be retrieved using SNMP.

You can configure how often measurements are written into the data log using the Measurements Per Log Entry field. Since the PX3 internal sensors are measured every second, specifying a value of 60, for example, would cause measurements to be written to the data log once every minute. Since there are 120 measurements of storage per sensor, specifying a value of 60 means the log can store the last two hours of measurements before the oldest one in the log gets overwritten.

Whenever measurements are written to the log, three values for each sensor are written: the average, minimum and maximum values. For example, if measurements are written every minute, the average of all measurements that occurred during the preceding 60 seconds along with the minimum and maximum measurement values are written to the log.

*Note: The PX3 device's SNMP agent must be enabled for this feature to work. See **Enabling and Configuring SNMP** (on page 506). In addition, using an NTP time server ensures accurately time-stamped measurements.*

By default, data logging is enabled. You must have the "Administrator Privileges" or "Change Pdu, Inlet, Outlet & Overcurrent Protector Configuration" permissions to change the setting.

► **To configure the data logging feature:**

1. Choose Device Settings > Data Logging.
2. To enable the data logging feature, select the "Enable" checkbox in the General Settings section.
3. Type a number in the Measurements Per Log Entry field. Valid range is from 1 to 600. The default is 60.
4. Verify that all sensor logging is enabled. If not, click Enable All at the bottom of the page to have all sensors selected.
 - You can also click the topmost checkbox labeled "Logging Enabled" in the header row of each section to select all sensors of the same type.
 - If any section's number of sensors exceeds 35, the remaining sensors are listed on next page(s). If so, a pagination bar similar to the following diagram displays in this section, which you can click any button to switch between pages.



5. Click Save. This button is located at the bottom of the page.

Important: Although it is possible to selectively enable/disable logging for individual sensors on the PX3, it is NOT recommended to do so.

Configuring Data Push Settings

You can push the sensor or asset strip data to a remote server for data synchronization. The destination and authentication for data push have to be configured properly on the PX3.



The data will be sent in JSON format using HTTP POST requests. For more information on its format, see **Data Push Format** (on page 429).

For instructions on connecting asset strips, see **Connecting Asset Management Strips** (on page 67).

After configuring the destination and authentication settings, do either or both of the following:

- To perform the data push after the occurrence of a certain event, create the data push action and assign it to an event rule.
- To push the data at a regular interval, schedule the data push action. See **Event Rules and Actions** (on page 364).

► To configure data push settings:

1. Choose Device Settings > Data Push.
2. To specify a destination, click  **New Destination**.
3. Do the following to set up the URL field.
 - a. Click  to select *http* or *https*.
 - b. Type the URL or host name in the accompanying text box.
4. If selecting *https*, a CA certificate is required for making the connection.

- Click  to install it. Then you can:
- Click Show to view the certificate's content.
 - Click Remove to delete the installed certificate if it is inappropriate.

*Note: If the required certificate file is a chain of certificates, and you are not sure about the requirements of a certificate chain, see **TLS Certificate Chain** (on page 906).*

5. If the destination server requires authentication, select the 'Use authentication' checkbox, and enter the following data.
 - User name comprising up to 64 characters
 - Password comprising up to 128 characters
6. In the 'Entry type' field, determine the data that will be transmitted.
 - *Asset management tag list*: Transmit the information of the specified asset strip(s), including the general status of the specified strip(s) and a list of asset tags. The asset tags list also includes the tags on blade extension strips, if any.

- *Asset management tag log*: Transmit the log of all asset strips, which is generated when there are changes made to asset tags and asset strips, including asset tag connection or disconnection events.
 - *Sensor log*: Transmit the record of all logged sensors, including their sensor readings and/or status. Logged sensors refer to all internal and/or environmental sensors/actuators that you have selected on the Data Logging page. See **Setting Data Logging** (on page 427).
7. If 'Asset management tag list' is selected in the above step, specify the asset strip(s) whose information to send. For PX3 with only one FEATURE port, only one asset strip is available.
 - To specify the asset strip(s), select them one by one from the Available AMS Ports list. Or click Select All to add all.
 - To remove the asset strip(s), click that asset strip's  in the Selected AMS Ports field. Or click Deselect All to remove all.
 8. Click Create.
 9. Repeat the same steps for additional destinations. Up to 64 destinations are supported.

► **To immediately push out the data:**

1. On the Data Push page, choose the one whose data you want to push out.



2. Click its

► **To modify or delete data push settings:**

1. On the Data Push page, click the one you want in the list.
2. Perform either action below.
 - To modify settings, make necessary changes and then click Save.
 - To delete it, click , and then confirm it on the confirmation message.

Data Push Format

Each push message contains exactly one JSON object. The data format is formally defined in IDL files, sharing several definitions from the JSON-RPC data model.

IDL files are available by launching **JSON-RPC online help** (<https://help.raritan.com/json-rpc/pdu/v3.6.0/namespacedatapush.html>).

To have an overview of the data format, see the following topic.

- **Sensor Log** (on page 430)
- **Asset Management Tag List** (on page 433)
- **Asset Management Tag Log** (on page 436)

Sensor Log

The root object of the message is a `SensorLogPushMessage` structure. It comprises a list of sensor descriptors and a list of log rows.

▶ **Sensor descriptors:**

The sensor descriptor vector contains static information of all logged sensors, including:

- The electrical component a sensor is associated with. For example, an inlet pole or an overcurrent protector.
- The sensor's type. For example, RMS current or active energy.
- Unit and range of the sensor's readings.

See **Sensor Descriptors for Inlet Active Power** (on page 431)

▶ **Log rows:**

Each log row consists of a time stamp (accumulated seconds since 1/1/1970) and a list of log records -- one for each logged sensor.

The length and order of the record list is the same as the sensor descriptor vector.

See **Log Rows** (on page 432).

Sensor Descriptors for Inlet Active Power

The following illustrates a descriptor for an inlet active power sensor.

The `metadata` field is relevant only to numeric sensors so the `readingtype` field is displayed twice in the illustration.

Note that a Raritan-provided explanation, which is the comment beginning with `//` in each line, is added to the following illustration for you to understand it better.

```
{
  "device": {
    "type": 0,           // Inlet sensor (see DeviceType enumeration)
    "label": "I1",     // Inlet label: I1
    "line": 0          // Power line; not applicable for inlet sensors
  },
  "id": "activePower", // Sensor identification
  "readingtype": 0,    // Reading type: numeric
  "metadata": {
    "type": {
      "readingtype": 0, // Reading type: numeric
      "type": 5,        // Sensor type: Active power
      "unit": 3         // Reading unit: Watt
    },
    "decdigits": 0,    // No decimal digits
    "accuracy": 1.0,   // Accuracy: 1 percent
    "resolution": 1.0, // Reading resolution: 1 W
    "tolerance": 1.5,  // Reading tolerance: +/- 1.5 W
    "range": {
      "lower": 0.0,    // Minimum reading: 0 W
      "upper": 30000.0 // Maximum reading: 30 kW
    }
  }
}
```

Log Rows

The following illustrates log rows with only one sensor record shown.

The actual length and order of log rows will be the same as those of sensors descriptors.

Note that a Raritan-provided explanation, which is the comment beginning with // in each line, is added to the following illustration for you to understand it better.

```
{
  "timestamp": 1334052852,          // Time stamp (seconds since 1/1/1970)
  "records": [
    {
      "available": true,           // This record is available
      "takenValidSamples": 60,     // Number of valid samples in this log period
      "state": 5,                 // Sensor was in normal range
      "minValue": 5800.0,         // Minimum sensor value: 5.8 kW
      "avgValue": 5900.0,         // Average sensor value: 5.9 kW
      "maxValue": 6100.0         // Maximum sensor value: 6.1 kW
    },
    {
      // [...] record for next sensor
    }
  ]
}
```

Asset Management Tag List

The root object of the asset management tag list message is an `AssetStripsMessage` structure. It contains current data about all connected asset management strips and tags, which is similar to the illustration below.

```

{
  "assetStrips": [
    {
      "stripInfo": {
        "bladeOverflow": false,
        "bladeTagCount": 0,
        "cascadeState": 0,
        "componentCount": 1,
        "mainTagCount": 2,
        "maxBladeTagCount": 128,
        "maxMainTagCount": 64,
        "rackUnitCount": 48
      },
      "deviceInfo": {
        "appVersion": 24,
        "bootVersion": 6,
        "deviceId": 48,
        "hardwareId": 2,
        "isCascadable": false,
        "orientationSensAvailable": true,
        "protocolVersion": 257,
        "rackUnitCountConfigurable": true
      },
      "settings": {
        "rackUnitCount": 48,
        "name": "Asset Strip 1",
        "scanMode": 0,
        "defaultColorConnected": { "r": 0, "g": 255, "b": 0 },
        "defaultColorDisconnected": { "r": 255, "g": 0, "b": 0 },
        "numberingMode": 1,
        "numberingOffset": 1,
        "orientation": 0
      }
    },
  ],
}

```

(Continued)

```
"tags": [  
  {  
    "rackUnitNumber": 4,  
    "slotNumber": 0,  
    "familyDesc": "Unknown",  
    "rawId": "DEADBEEF0000",  
    "programmable": 0  
  },  
  {  
    "rackUnitNumber": 5,  
    "slotNumber": 0,  
    "familyDesc": "Unknown",  
    "rawId": "DEADBEEF0500",  
    "programmable": 0  
  }  
]  
}  
]
```

Asset Management Tag Log

The root object of the asset management log message is an `AssetLogPushMessage` structure. It contains a list of tag or strip events since the last successful push.

Note that a Raritan-provided explanation, which is the comment beginning with `//` in each line, is added to the following illustration for you to understand it better.

```
{
  "records": [
    {
      "timestamp": 1334052852, // Time stamp (seconds since 1/1/1970)
      "type": 1, // 0: empty, 1: tag connected, 2: tag disconnected,
                // 3: asset strip state changed
      "assetStripNumber": 0, // Asset strip number
      "rackUnitNumber" : 10, // Rack unit number
      "rackUnitPosition" : 12, // Rack unit position
      "slotNumber", // Blade extension slot number
      "tagId", // The ID of the asset management tag
      "state": 5, // Sensor was in normal range
      "parentBladeId", // ID of the parent blade extension tag
      "state": 0 // 0: disconnected, 1: firmware update,
                // 2: unsupported, 3: available
    },
    {
      // [...] next record
    }
  ]
}
```

Monitoring Server Accessibility

You can monitor whether specific IT devices are alive by having the PX3 continuously ping them. An IT device's successful response to the ping commands indicates that the IT device is still alive and can be remotely accessed.

This function is especially useful when you are not located in an area with Internet connectivity.

PX3 can monitor any IT device, such as database servers, remote authentication servers, power distribution units (PDUs), and so on. It supports monitoring a maximum of 64 IT devices.

To perform this feature, you need the Administrator Privileges.

The default ping settings may not be suitable for monitoring devices that require high connection reliability so it is strongly recommended that you should adjust the ping settings for optimal results.

In addition, if your PX3 is outlet switching capable, you can even connect a monitored IT device to one or multiple outlets of PX3 and then have PX3 perform the following two actions as needed, in addition to monitoring its status:

- First shut down the monitored IT device.
- After the IT device is shut down, power off the outlet(s) where that device is connected.

Important: Not every IT device can be shut down by PX3 so it is suggested to verify whether the device can be shut down using a shutdown command. For example, PX3 cannot shut down a PDU with a shutdown command.

*Tip: To make the PX3 automatically log, send notifications or perform other actions for any server monitoring events, you can create event rules. See **Event Rules and Actions** (on page 364). An example is available in **Example: Ping Monitoring and SNMP Notifications** (on page 443).*

► **To add IT equipment for ping monitoring:**

1. Choose Device Settings > Server Reachability.
2. Click  **Monitor New Server**.
3. By default, the "Enable ping monitoring for this server" checkbox is selected. If not, select it to enable this feature.
4. Configure the following.

Field	Description
IP address/hostname	IP address or host name of the IT equipment which you want to monitor.

Field	Description
Number of successful pings to enable feature	The number of successful pings required to declare that the monitored equipment is "Reachable." Valid range is 0 to 200.
Wait time after successful ping	The wait time before sending the next ping if the previous ping was successfully responded. Valid range is 5 to 600 (seconds).
Wait time after unsuccessful ping	The wait time before sending the next ping if the previous ping was not responded. Valid range is 3 to 600 (seconds).
Number of consecutive unsuccessful pings for failure	The number of consecutive pings without any response before the monitored equipment is declared "Unreachable." Valid range is 1 to 100.
Wait time before resuming pinging after failure	The wait time before the PX3 resumes pinging after the monitored equipment is declared "Unreachable." Valid range is 1 to 1200 (seconds).
Number of consecutive failures before disabling feature (0 = unlimited)	The number of times the monitored equipment is declared "Unreachable" consecutively before the PX3 disables the ping monitoring feature for it and shows "Waiting for reliable connection." Valid range is 0 to 100.

5. On a PDU with outlet switching capability, there is one more checkbox available -- *Power control enabled*.
To be able to shut down and power control the monitored IT device via the Server Reachability page, enable this checkbox and configure related settings, which are explained in the following table.
6. Click Create.
7. To add more IT devices, repeat the same steps.

► **To configure the shutdown and power control settings:**

Restriction: To make the power control feature work properly, the power cord(s) of the monitored IT device must be connected to the "same" PDU which is monitoring the IT device.



Field	Description
Shutdown command	<p>This is the command which is sent to the monitored IT device via SSH for shutting it down after you press the Shutdown button on PX3.</p> <ul style="list-style-type: none"> ▪ <i>GNU/Linux:</i> This option sends the GNU/Linux shutdown command. ▪ <i>Windows:</i> This option sends the Windows shutdown command. ▪ <i>Custom:</i> If the monitored device's system is neither GNU/Linux nor Windows, choose this option to specify a proper shutdown command, which can comprise a maximum of 1024 ASCII characters.
User name, Password	<p>Specify user credentials for logging in to the monitored device via SSH.</p> <ul style="list-style-type: none"> ▪ <i>User name:</i> The name comprises up to 128 non-empty ASCII characters. ▪ <i>Password:</i> The password comprises up to 128 ASCII characters.
SSH port	<p>The monitored device's SSH port.</p> <ul style="list-style-type: none"> ▪ Default is 22.
Power target to switch	<p>Select the outlet or outlet group that is powering the monitored device.</p>

Field	Description
Method of checking successful shutdown	<p>This field determines when PX3 will power off the outlet(s) that supplies power to the monitored device, after PX3 issues the shutdown command to that device.</p> <ul style="list-style-type: none"> ▪ <i>Timer:</i> ▪ PX3 will power off the selected outlet or outlet group after the time specified in the 'Timer delay' field expires.<i>Active power drop:</i> PX3 will power off the selected outlet(s) after the active power value of the selected outlet or outlet group drops below the value specified in the 'Active power threshold' field. <hr/> <p><i>Note: Number of available methods is model dependent. The 'Active power drop' method is available only on models with outlet metering capability.</i></p>
Timer delay	<p>This field appears for the 'Timer' method.</p> <p>Valid values range between 5 and 10,000 seconds.</p>
Active power threshold	<p>The field appears for the 'Active power drop' method.</p> <p>Valid values range between 0 and 21,000 W.</p>
Timeout for shutdown check	<p>This field appears for the 'Active power drop' method.</p> <p>Valid values range between 5 and 10,000 seconds.</p> <p>The power-off operation is performed only when the active power value of the selected outlet or outlet group drops below the 'Active power threshold' within the period of time specified in this field.</p> <p>If the active power value drops below the 'Active power threshold' after the specified time expires, the power-off operation will NOT be performed.</p>

Server Status Checking or Power Control

It is model dependent whether your PX3 supports the shutdown and power control features via the Server Reachability page.

After adding IT equipment for monitoring, all IT devices are listed on the Server Reachability page.

Server Reachability				
		 Power Up	 Shutdown	 Monitor New Server
IP Address/Hostname ▲	Ping Enabled	Status	Power Control	
100.192.3.55	yes	Waiting for reliable connection	(disabled)	
150.33.84.99	yes	Waiting for reliable connection	Server power is off	
www.legrand.com	yes	Reachable	Server power is on	
www.raritan.com	yes	Reachable	Server power is on	

In the beginning, the status of the added IT equipment shows "Waiting for reliable connection," which means the requested number of consecutive successful or unsuccessful pings has not reached before PX3 can declare that the monitored device is reachable or unreachable.

► **To check the server monitoring states and results:**

1. The column labeled "Ping Enabled" indicates whether the monitoring for the corresponding IT device is activated or not.
2. The column labeled "Status" indicates the accessibility of monitored equipment.

Status	Description
Reachable	The monitored equipment is accessible.
Unreachable	The monitored equipment is inaccessible.
Waiting for reliable connection	The connection between the PX3 device and the monitored equipment is not reliably established yet.

3. If your PX3 supports outlet switching, one more column displays -- *Power Control*.

Power control status	Description
(disabled)	Power control is not enabled for the monitored equipment.

Power control status	Description
Server power is on	The outlet or outlet group associated with the monitored equipment is being powered on. <ul style="list-style-type: none"> In the scenario where an 'outlet group' is associated with the equipment, the message 'Server power is on' is shown as long as one of the outlets in the outlet group remains powered on.
Server power is off	The outlet or all outlets of the outlet group associated with the monitored equipment are being powered off.
Server is shutting down	PX3 has sent the shutdown command to the monitored equipment, but the shutdown operation has not completed or succeeded yet.
Power state unknown	PX3 cannot determine the power state of the outlet(s) associated with the monitored device. For example, maybe the outlet group associated with the monitored device has been deleted.

► **To shut down a monitored device:**

1. Select the IT device that you want to shut down.
2. Click  **Shutdown**.
3. Confirm the operation when prompted.
4. Observe the Power Control status of the monitored device to make sure the shutdown operation succeeds.

► **To power on a monitored device:**

1. Select the IT device that you want to turn on.
2. Click  **Power Up**.
3. Confirm the operation when prompted.
4. Observe the Power Control status of the monitored device to make sure the power-on operation succeeds.

Editing or Deleting Ping Monitoring Settings

You can edit the ping monitoring settings of any IT device or simply delete it if no longer needed.

► **To modify or delete any monitored IT device:**

1. Choose Device Settings > Server Reachability.
2. Click the desired one in the list.
3. Perform the desired action.

- To modify settings, make necessary changes and then click Save. For information on each field, see **Monitoring Server Accessibility** (on page 437).
- To delete it, click  **Delete** on the top-right corner.

Example: Ping Monitoring and SNMP Notifications

In this illustration, it is assumed that a significant PDU (IP address: 192.168.84.95) shall be monitored by your PX3 to make sure that PDU is properly operating all the time, and the PX3 must send out SNMP notifications (trap or inform) if that PDU is declared unreachable due to power or network failure. The prerequisite for this example is that the power sources are different between your PX3 and the monitored PDU.

This requires the following two steps.

► Step 1: Set up the ping monitoring for the target PDU

1. Choose Device Settings > Server Reachability.
2. Click  **Monitor New Server**.
3. Ensure the "Enable ping monitoring for this server" checkbox is selected.
4. Enter the data shown below.
 - Enter the server's data.

Field	Data entered
IP address/hostname	192.168.84.95

- To make the PX3 declare the accessibility of the monitored PDU every 15 seconds (3 pings * 5 seconds) when that PDU is accessible, enter the following data.

Field	Data entered
Number of successful pings to enable feature	3
Wait time after successful ping	5

- To make the PX3 declare the inaccessibility of the monitored PDU when that PDU becomes inaccessible for around 12 seconds (4 seconds * 3 pings), enter the following data.

Field	Data entered
Wait time after unsuccessful ping	4
Number of consecutive unsuccessful pings for failure	3

- To make the PX3 stop pinging the target PDU for 60 seconds (1 minute) after the PDU inaccessibility is declared, enter the following data. After 60 seconds, the PX3 will re-ping the target PDU,

Field	Data entered
Wait time before resuming pinging after failure	60

- The "Number of consecutive failures before disabling feature (0 = unlimited)" can be set to any value you want.
5. Click Create.

▶ **Step 2: Create an event rule to send SNMP notifications for the target PDU**

1. Choose Device Settings > Event Rules.
2. Click  **New Rule**.
3. Select the Enabled checkbox to enable this new rule.
4. Configure the following.

Field/setting	Data specified
Rule name	Send SNMP notifications for PDU (192.168.84.95) inaccessibility
Event	Choose Server Monitoring > 192.168.84.95 > Unreachable
Trigger condition	Select the Unreachable radio button

This will make the PX3 react only when the target PDU becomes inaccessible.

5. Select the System SNMP Notification Action.

*Note: If you have not configured the System SNMP Notification Action to specify the SNMP destination(s), see **Editing or Deleting a Rule/Action** (on page 419).*

Front Panel Settings

You can set up the default mode of the front panel display, and front panel functions for outlet switching, actuator control, beeper mute or RCM self-test.

Note that available front panel settings are model dependent.

- Outlet switching -- available on outlet-switching capable models only.
- Actuator control -- available on all models.
- Internal beeper's mute function -- available on all PX3 models
- Default front panel mode setup -- available on all models, except for the PX3-3000 series, which does NOT provide inlet sensor information.
- RCM self-test -- available on those PX3 models which support residual current monitoring. See **PX3 Models with Residual Current Monitoring** (on page 786).

► To configure the front panel settings:

1. Choose Device Settings > Front Panel.
2. Configure the following:
 - To configure the default view of the LCD display, select one mode below.

*Note: The default view is shown in the automatic mode. See **Automatic and Manual Modes** (on page 121).*

Mode	Data entered
Automatic mode	The LCD display cycles through both the inlet and overcurrent protector information. This is the default. Overcurrent protector information is available only when your PX3 has overcurrent protectors.
Inlet overview	The LCD display cycles through the inlet information only.

- To enable the front panel outlet-switching function, select the 'Outlet switching' checkbox.
 - To enable the front panel actuator-control function, select the 'Peripheral actuator control' checkbox.
 - The built-in beeper's mute control function is enabled per default. To disable it, **deselect** the 'Mute beeper' checkbox.
 - By default the front panel RCM self-test function, if available, is enabled. See **Disabling or Enabling Front Panel RCM Self-Test** (on page 794).
3. Click Save.

If the 'Mute beeper' feature is enabled, you can operate the front panel to mute it whenever it beeps. See **Muting the Internal Beeper** (on page 131).
 Or you can turn on or off outlets/actuators by operating the front panel. See **Power Control** (on page 137) and **Peripherals** (on page 145).

Configuring the Serial Port

You can change the bit rate of the serial port labeled CONSOLE / MODEM on the PX3. The default bit rate for console and modem operation is 115200 bps.

The PX3 supports using the following devices via the serial interface:

- A computer for console management.
- A Raritan KVM product.
- An analog modem for remote dial-in and access to the CLI.
- A GSM modem for sending out SMS messages to a cellular phone.

Bit-rate adjustment may be necessary. Change the bit rate before connecting the supported device to the PX3 through the serial port, or there are communication problems.

Note: The serial port bit-rate change is required when the PX3 works in conjunction with Raritan's Dominion LX KVM switch. Dominion LX only supports 19200 bps for communications over the serial interface.

You can set diverse bit-rate settings for console and modem operations. Usually the PX3 can detect the device type, and automatically apply the preset bit rate.

The PX3 will indicate the detected device in the Port State section of the Serial Port page.

To configure serial port and modem settings, choose Device Settings > Serial Port.

► **To change the serial port's baud rate settings:**

1. Click the 'Connected device' field to make the serial port enter an appropriate state.

Options	Description
Automatic detection	The PX3 automatically detects the type of the device connected to the serial port. Select this option unless your PX3 cannot correctly detect the device type.
Force console	The PX3 attempts to recognize that the connected device is set for the console mode.
Force analog modem	The PX3 attempts to recognize that the connected device is an analog modem.

Options	Description
Force GSM modem	The PX3 attempts to recognize that the connected device is a GSM modem.

- Click the 'Console baud rate' field to select the baud rate intended for console management.

Note: For a serial RS-232 or USB connection between a computer and the PX3, leave it at the default (115200 bps).

- Click the 'Modem baud rate' field to select the baud rate for the modem connected to the PX3.

The following modem settings/fields appear in the web interface after the PX3 detects the connection of an analog or GSM modem.

► **To configure the analog modem:**

- Select the 'Answer incoming calls' checkbox to enable the remote access via a modem. Otherwise, deselect it.
- Type a value in the 'Number of rings before answering' field to determine the number of rings the PX3 must wait before answering the call.

► **To configure the GSM modem:**

- Enter the SIM PIN code.
- Select the 'Use custom SMS center number' checkbox if a custom SMS center will be used.
 - Enter the SMS center number in the 'SMS center' field.
- If needed, click Advanced Information to view detailed information about the modem, SIM and mobile network.
- To test whether the PX3 can successfully send out SMS messages with the modem settings:
 - Enter the number of the recipient's phone in the Recipient Phone field.
 - Click Send SMS Test to send a test SMS message.

Lua Scripts

If you can write or obtain any Lua scripts, you can create or load them into the PX3 to control its behaviors.

Raritan also provides some Lua scripts examples, which you can load as needed.

Note: Not all Raritan Lua script examples can apply to your PX3 model. You should read each example's introduction before applying them.

You must have the Administrator Privileges to manage Lua scripts.

Writing or Loading a Lua Script

You can enter or load up to 4 scripts to the PX3.

*Tip: If you can no longer enter or load a new script after reaching the upper limit, you can either delete any existing script or simply modify/replace an existing script's codes. See **Modifying or Deleting a Script** (on page 452).*

► **To write or load a Lua script:**

1. Choose Device Settings > Lua Scripts > .
2. Type a name for this script. Its length ranges between 1 to 63 characters. The name must contain the following characters only.
 - Alphanumeric characters
 - Underscore (_)
 - Minus (-)

Note: Spaces are NOT permitted.

3. Determine whether and when to automatically execute the loaded script.

Checkbox	Behavior when selected
Start automatically at system boot	Whenever the PX3 reboots, the script is automatically executed.
Restart after termination	The script is automatically executed each time after 10 seconds since the script execution finishes.

4. (Optional) Determine the arguments that will be executed by default.



- a. Click .
- b. Type the key and value.
- c. Repeat the same steps to enter more arguments as needed.

- To remove any existing argument, click  adjacent to it.

*Note: The above default arguments will be overridden by new arguments specified with the "Start with Arguments" command or with any Lua-script-related event rule. See **Manually Starting or Stopping a Script** (on page 450) or **Start or Stop a Lua Script** (on page 402).*

5. In the Source Code section, do one of the following. It is recommended to leave the Enable Syntax Highlighting checkbox selected unless you do not need different text colors to identify diverse code syntaxes.

- To write a Lua script, type the codes in the Source Code section.

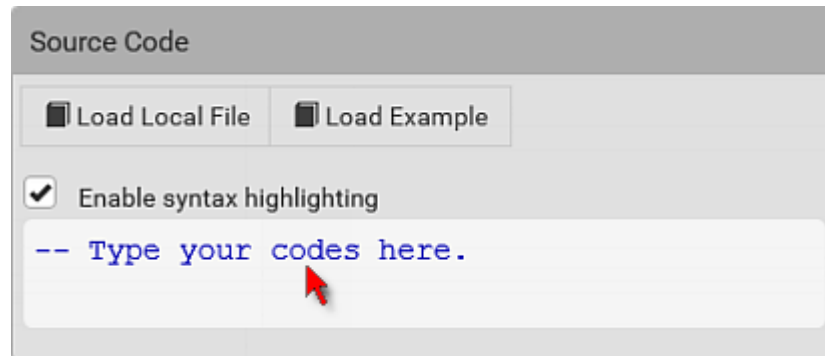



- To load an existing Lua script file, click Load Local File.
- To use one of Raritan's Lua script examples, click Load Example.

Warning: The newly-loaded script will overwrite all existing codes in the Source Code section. Therefore, do not load a new script if the current script meets your needs.

6. If you chose to load a script or Raritan's example in the previous step, its codes are then displayed in the Source Code section. Double check the codes. If needed, modify the codes to meet your needs.
7. Click Create.

▶ **Next steps:**

- To execute the newly-added script immediately, click  **Start**, or click  > Start With Arguments. See **Manually Starting or Stopping a Script** (on page 450).
- To add more scripts, first return to the scripts list by clicking "Lua Scripts" on the top (see below) or in the **Menu** (on page 178), and then repeat the above steps.

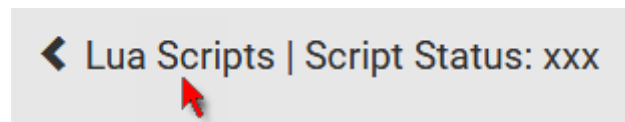

Manually Starting or Stopping a Script

You can manually start or stop an existing Lua script at any time.

When starting a script, you can choose to start it either with its default arguments or with new arguments.

Tip: To have the PX3 automatically start or stop a script in response to an event, create an event rule. See **Event Rules and Actions** (on page 364) and **Start or Stop a Lua Script** (on page 402).

► **To manually start a script:**

1. Choose Device Settings > Lua Scripts. The Lua scripts list displays.

Lua Scripts + Create New Script			
Name	State	Autostart	Restart
script-1	Terminated	yes	no
script-2	New	no	yes
script-3	Running	no	no

2. Click the desired script whose state is either 'Terminated' or 'New.' For details, see **Checking Lua Scripts States** (on page 452).

3. To start with default arguments, click  **Start**.

To start with new arguments, click  > Start With Arguments. Newly-assigned arguments will override default ones.

4. If you chose "Start With Arguments" in the above step, enter the key and value in the Start Lua Script dialog.

- Click  if needing additional arguments.

Start Lua Script

Key	Value
<input style="width: 90%;" type="text"/>	<input style="width: 90%;" type="text"/> 
	
 	

5. Click Start.
6. The script output will be shown in the Script Output section.
 - If needed, click  **Clear** to delete the existing output data.

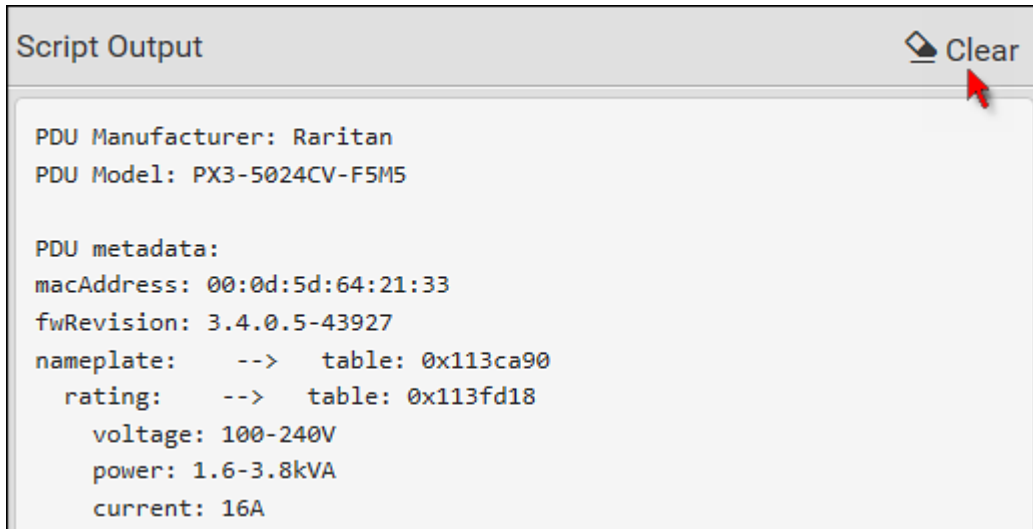

► **To manually stop a script:**

1. Choose Device Settings > Lua Scripts.
2. Click the desired script whose state is either 'Running' or 'Restarting.' For details, see **Checking Lua Scripts States** (on page 452).
3. Click  **Stop** on the top-right corner.
4. Click Stop on the confirmation message.

► **To return to the scripts list:**

- Click "Lua Scripts" on the top of the page.

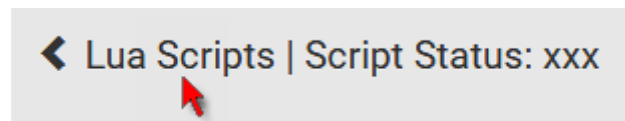

- Or click "Lua Scripts" in the **Menu** (on page 178).

Checking Lua Scripts States

Choose Device Settings > Lua Scripts to show the scripts list, which indicates the current state and settings of each script.

Lua Scripts			+ Create New Script
Name	State	Autostart	Restart
script-1	Terminated	yes	no
script-2	New	no	yes
script-3	Running	no	no

► **State:**

Four script states are available.

State	Description
New	The script is never executed since the device boot.
Running	The script is currently being executed.
Terminated	The script was once executed, but stops now.
Restarting	The script will be executed. Only the scripts with the "Restart" column set to "yes" will show this state.

► **Autostart:**

This column indicates whether the checkbox labeled "Start automatically at system boot" is enabled. See **Writing or Loading a Lua Script** (on page 448).

► **Restart:**

This column indicates whether the checkbox labeled "Restart after termination" is enabled. See **Writing or Loading a Lua Script** (on page 448).

Modifying or Deleting a Script

You can edit an existing script's codes or even replace it with a new script. Or you can simply remove a unnecessary script from the PX3.

► **To modify or replace a script:**

1. Choose Device Settings > Lua Scripts.
2. Click the desired one in the scripts list.
3. Click  > Edit Script.

4. Make changes to the information shown, except for the script's name, which cannot be revised.
 - To replace the current script, click Load Local File or Load Example to select a new script.

▶ **To delete a script:**

1. Choose Device Settings > Lua Scripts.
2. Click the desired one in the scripts list.
3. Click  > Delete.
4. Click Delete on the confirmation message.

▶ **To return to the scripts list:**

- Click "Lua Scripts" on the top of the page.

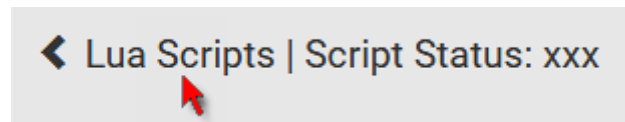

- Or click "Lua Scripts" in the **Menu** (on page 178).

Miscellaneous

By default, the Schroff LHX/SHX heat exchanger support and Cisco EnergyWise feature implemented on the PX3 are disabled.

Support needs to be enabled for the LHX/SHX information to appear in the PX3 web interface. Besides, Schroff LHX/SHX support must be enabled in order for the LHX-MIB to be accessible through SNMP.

If a Cisco® EnergyWise energy management architecture is implemented in your place, you can enable the Cisco EnergyWise endpoint implemented on the PX3 so that this PX3 becomes part of the Cisco EnergyWise domain.

In addition, if you have to prevent others from accessing your PX3 via USB-A for security reasons, you can disable all of USB-A ports on the PX3. By default, USB-A ports are enabled.

Important: Disabling USB-A ports will disable all of 'USB-A' based features, such as wireless networking, USB cascading or pdView access using iOS mobile devices. Therefore, re-think about it before disabling USB-A.

To configure any of the above features, choose Device Settings > Miscellaneous.

▶ **To enable the support for Schroff LHX/SHX:**

1. Select the LHX/SHX checkbox.
2. Click Save in the *Features* section.
3. Click Apply on the confirmation message.
4. PX3 reboots.

► **To set the Cisco EnergyWise configuration:**

1. Select the Enable EnergyWise checkbox.
2. Configure the following:

Field	Description
Domain name	Type the name of a Cisco EnergyWise domain where the PX3 belongs <ul style="list-style-type: none"> ▪ Up to 127 printable ASCII characters are permitted. ▪ Spaces and asterisks are NOT acceptable.
Domain password	Type the authentication password (secret) for entering the Cisco EnergyWise domain <ul style="list-style-type: none"> ▪ Up to 127 printable ASCII characters are permitted. ▪ Spaces and asterisks are NOT acceptable.
Port	Type a User Datagram Protocol (UDP) port number for communications in the Cisco EnergyWise domain. <ul style="list-style-type: none"> ▪ Range from 1 to 65535. ▪ Default is 43440.
Polling interval	Type a polling interval to determine how often the PX3 is queried in the Cisco EnergyWise domain. <ul style="list-style-type: none"> ▪ Range from 30 to 600 ms. ▪ Default is 180 ms.

3. Click Save in the *EnergyWise* section.

For Raritan's PDU models of 3000, 4000, and 5000 series, the parent/child relationship is formed after the Cisco EnergyWise feature is enabled.

- The PDU becomes a parent domain member.
- All outlets become children of the PDU.

► **To disable the access to USB-A port(s):**

1. Deselect the Enable USB Host Ports checkbox.
2. Click Save in the USB Host Ports section.

Tip: After the Enable USB Host Ports checkbox is deselected, only the access to USB-A port(s) is prevented while the USB-B port works as normal. That is, users still can access the USB-B port, such as accessing CLI via USB-B. To disable the access to the USB-B port, you have to apply a mechanical method.

Maintenance

Click 'Maintenance' in the **Menu** (on page 178), and the following submenu displays.

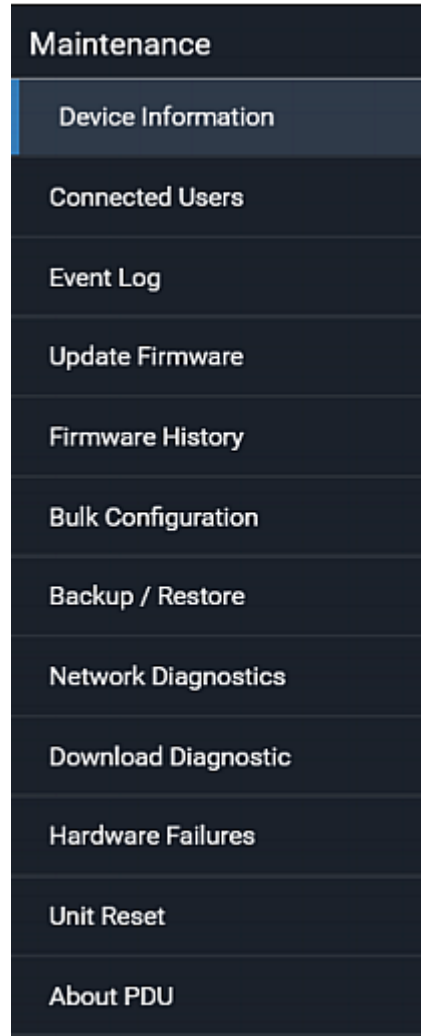

Submenu command	Refer to...
Device Information	<i>Device Information</i> (on page 457)
Connected Users	<i>Viewing Connected Users</i> (on page 462)
Event Log	<i>Viewing or Clearing the Local Event Log</i> (on page 464)
Update Firmware	<i>Updating the PX3 Firmware</i> (on page 465)
Firmware History	<i>Viewing Firmware Update History</i> (on page 469)

Submenu command	Refer to...
Bulk Configuration	Bulk Configuration (on page 470)
Backup/Restore	Backup and Restore of Device Settings (on page 477)
Network Diagnostic	Network Diagnostics (on page 479)
Download Diagnostic	Downloading Diagnostic Information (on page 480)
Hardware Failures	Hardware Issue Detection (on page 480)
Unit Reset	<ul style="list-style-type: none"> ▪ Rebooting the PX3 (on page 482) ▪ Resetting All Settings to Factory Defaults (on page 482)
About PDU	Retrieving Software Packages Information (on page 483)

Device Information

Using the web interface, you can retrieve hardware and software information of components or peripheral devices connected to your PX3.

Tip: If the information shown on this page does not match the latest status, press F5 to reload it.

▶ To display device information:

1. Choose Maintenance > Device Information.

Device Information	
Information ▲	
Model	PX3-5024CV-F5M5
Serial number	13P1231231
Rating	100-240V, 16A, 1.6-3.8kVA, 50/60Hz
Firmware version	3.5.0.5-45323
Board ID	1371234567
Board revision	0x10
PDU2-MIB	download
ASSETMANAGEMENT-MIB	download
LHX-MIB	download
Network ▼	
Port Forwarding ▼	
Outlets ▼	
Overcurrent Protectors ▼	
Controllers ▼	
Peripheral Devices ▼	
Asset Management ▼	

2. Click the desired section's title bar to show that section's information. For example, click the Network section.

The number of available sections is model dependent.

Section title	Information shown
Information	General device information, such as model

Section title	Information shown
	<p>name, serial number, firmware version, hardware revision, MIB download link(s) and so on.</p> <p>Note that the download link of LHX-MIB is available only after enabling the Schroff LHX/SHX support. See Miscellaneous (on page 453).</p>
Network	<p>The network information, such as the current networking mode, IPv4 and/or IPv6 addresses and so on.</p> <p>This tab also indicates whether the PX3 is part of a cascading configuration. See Identifying Cascaded Devices (on page 459).</p>
Port Forwarding	<p>If the port forwarding mode is activated, this section will show a list of port numbers for all cascaded devices.</p>
Outlets	<p>Each outlet's receptacle type, operating voltage and rated current.</p>
Overcurrent Protectors	<p>Each overcurrent protector's type, rated current and the outlets that it protects.</p>
Controllers	<p>Each inlet or outlet controller's serial number, board ID, firmware version and hardware version.</p>
Inlets	<p>Each inlet's plug type, rated voltage and current.</p>
Peripheral Devices	<p>Serial numbers, model names, position and firmware-related information of connected Raritan's environmental sensor packages.</p>
Asset Management	<p>Each asset strip's ID, boot version, application version and protocol version.</p>

Identifying Cascaded Devices

For information on how to cascade PX3 devices, see ***Cascading Multiple PX3 Devices for Sharing Ethernet Connectivity*** (on page 33).

This section explains how to identify a cascaded device on the Device Information page.

*Note: For more information on cascading configurations and restrictions, refer to the Cascading Guide on the Raritan **Support page** (<http://www.raritan.com/support/>).*

▶ **To identify the cascading status:**

1. Choose Maintenance > Device Information.
2. Click the Network title bar.



- If the information shown on this page does not match the latest status, press F5 to reload it.

▶ **Cascading information in the Bridging mode:**

- The Common section contains two read-only fields for indicating the cascading status. Note that the cascading position is NOT available in the Bridging mode.

Fields	Description
Port forwarding	Indicates the Port Forwarding is disabled. See <i>Setting the Cascading Mode</i> (on page 318).
BRIDGE section	Indicates the device is in the Bridging mode and its IP address.



► **Cascading information in the Port Forwarding mode:**

- The Common section contains three read-only fields for indicating the cascading status.

Fields	Description
Port forwarding	Indicates the Port Forwarding is enabled. See Setting the Cascading Mode (on page 318).
Cascade position	Indicates the position of the PX3 in the cascading chain. <ul style="list-style-type: none"> ▪ 0 (zero) represents the master device. ▪ A non-zero number represents a slave device. 1 is Slave 1, 2 is Slave 2, 3 is Slave 3 and so on.
Cascaded device connected	Indicates whether a slave device is detected on the USB-A or Ethernet port. <ul style="list-style-type: none"> ▪ yes: Connection to a slave device is detected. ▪ no: NO connection to a slave device is detected.

- A master device shows 0 (zero) in the 'Cascade position' field and yes in the 'Cascaded device connected' field.

Network	
Common	
DNS servers	192.168.80.249, 192.168.80.19
DNS suffixes	rgp.raritan.com.
DNS resolver preference	IPv6 address
IPv4 routes	192.168.84.0/24 dev ETH1 Default via 192.168.84.254 (ETH1)
IPv6 routes	none
Port forwarding	enabled
Cascade position	0 (Master)
Cascaded device connected	yes

- A slave device in the middle position shows a non-zero number which indicates its exact position in the 'Cascade position' field and yes in the 'Cascaded device connected' field.

The following diagram shows 1, indicating it is the first slave device - Slave 1.

Network	
Common	
DNS servers	192.168.80.249, 192.168.80.19
DNS suffixes	rgp.raritan.com.
DNS resolver preference	IPv6 address
Port forwarding	enabled
Cascade position	1 (Slave)
Cascaded device connected	yes
IPv4 address	192.168.84.94

- The final slave device shows a non-zero number which indicates its position in the 'Cascade position' field and no in the 'Cascaded device connected' field.

The following diagram shows 2, indicating it is the second slave device - Slave 2. The 'Cascaded device connected' field shows *no*, indicating that it is the final one in the chain.

Network	
Common	
DNS servers	192.168.80.249, 192.168.80.19
DNS suffixes	rgp.raritan.com.
DNS resolver preference	IPv6 address
Port forwarding	enabled
Cascade position	2 (Slave)
Cascaded device connected	no
IPv4 address	192.168.84.94

- For a list of port numbers required for accessing each cascaded device in the Port Forwarding mode, click the Port Forwarding title bar on the same page.



Viewing Connected Users

You can check which users have logged in to the PX3 and their status. If you have administrator privileges, you can terminate any user's connection to the PX3.

► **To view and manage connected users:**

1. Choose Maintenance > Connected Users. A list of logged-in users displays.

Connected Users				
User Name ▲	IP Adress	Client Type	Idle Time	
admin	192.168.84.22	Web GUI	0 min	Disconnect
Mary	192.168.84.24	Web GUI	0 min	Disconnect

If wanted, you can resort the list by clicking the desired column header. See **Sorting a List** (on page 182).

Column	Description
User Name	The login name of each connected user.
IP Address	The IP address of each user's host. For the login via a local connection (serial RS-232 or USB), <local> is displayed instead of an IP address.
Client Type	The interface through which the user is being connected to the PX3. <ul style="list-style-type: none"> ▪ Web GUI: Refers to the web interface. ▪ CLI: Refers to the command line interface (CLI). The information in parentheses following "CLI" indicates how this user is connected to the CLI. <ul style="list-style-type: none"> - Serial: The local connection, such as the serial RS-232 or USB connection. - SSH: The SSH connection. - Telnet: The Telnet connection. ▪ Webcam Live Preview: Refers to the live webcam image sessions. See below.
Idle Time	The length of time for which a user remains idle.

Disconnect

2. To disconnect any user, click the corresponding
 - a. Click Disconnect on the confirmation message.
 - b. The disconnected user is forced to log out.

► **If there are live webcam sessions:**

All Live Preview window sessions sharing the same URL, including one Primary Standalone Live Preview window and multiple Secondary Standalone Live Preview windows, are identified as one single "<webcam>" user in the Connected Users list. You can disconnect a "<webcam>" user to terminate all sessions sharing the same URL.

User Name ▲	IP Address	Client Type	Idle Time	
<webcam>	192.168.84.22	Webcam Live Preview	0 min	Disconnect

The IP address refers to the IP address of the host where the Primary Standalone Live Preview window exists, NOT the IP address of the other two associated sessions.

For more webcam information, see **Webcam Management** (on page 484).

Viewing or Clearing the Local Event Log

By default, the PX3 captures certain system events and saves them in a local (internal) event log.

You can view over 2000 historical events that occurred on the PX3 in the local event log. When the log size exceeds 256KB, each new entry overwrites the oldest one.

► **To display the local log:**

1. Choose Maintenance > Event Log.

Each event entry consists of:

- ID number of the event
- Date and time of the event

Tip: The date and time shown on the PX3 web interface are automatically converted to your computer's time zone. To avoid time confusion, it is suggested to apply the same time zone settings as those of PX3 to your computer or mobile device.

- Event type
- A description of the event

2. To view a specific type of events only, select the desired event type in the 'Filter event class' field.

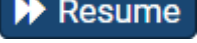

3. The log is refreshed automatically at a regular interval of five seconds. To avoid any new events' interruption during data browsing, you can suspend the automatic update by clicking  **Pause**.

- To restore automatic update, click  **Resume**. Those new events that have not been listed yet due to suspension will be displayed in the log now.

► **To clear the local log:**

1. Click  **Clear Log** on the top-right corner.
2. Click Clear Log on the confirmation message.

Updating the PX3 Firmware

Firmware files are available on Raritan website's **Support page** (<http://www.raritan.com/support/>).

When performing the firmware upgrade, the PX3 keeps each outlet's power status unchanged so no server operation is interrupted. During and after the firmware upgrade, outlets that have been powered on prior to the firmware upgrade remain powered ON and outlets that have been powered off remain powered OFF.

You must be the administrator or a user with the Firmware Update permission to update the PX3 firmware.

Before starting the upgrade, read the release notes downloaded from Raritan website's **Support page** (<http://www.raritan.com/support/>). If you have any questions or concerns about the upgrade, contact Raritan Technical Support BEFORE upgrading.

On a multi-inlet PDU, all inlets must be connected to power for the PDU to successfully upgrade its firmware.

Note that firmware upgrade via iOS mobile devices, such as iPad, requires the use of iCloud Drive or a file manager app.

Warning: Do NOT perform the firmware upgrade over a wireless network connection.

► Firmware upgrade restrictions:

- **Intermediate firmware required for upgrades from "pre-3.3.0" to 3.5.0 or later:**

If your PX3 is running any firmware version older than 3.3.0, such as 3.2.30, an intermediate firmware is required for the upgrade to 3.5.0 or later. Follow the sequence below:

- a. Upgrade to an intermediate firmware first, which is either 3.3.x or 3.4.x.
- b. Then upgrade from the intermediate firmware to 3.5.0 or later.

- **Upgrade from "pre-3.3.10" versions on a cascading CHAIN:**

If you are upgrading an existing cascading chain from a "pre-3.3.10" firmware version, you must follow the **Upgrade Guidelines for Existing Cascading Chains** (on page 467).

► To update the firmware:

1. Choose Maintenance > Update Firmware.

2. Click  to select an appropriate firmware file.

3. Click Upload. A progress bar appears to indicate the upload process.

4. Once complete, information of both installed and uploaded firmware versions as well as compatibility and signature-checking results are displayed.
 - If anything is incorrect, click Discard Upload.
5. To proceed with the update, click Update Firmware.

Warning: Do NOT power off the PX3 during the update.

6. During the firmware update:
 - A progress bar appears on the web interface, indicating the update status.
 - The front panel display shows the firmware upgrade message. See **Showing the Firmware Upgrade Progress** (on page 161).
 - The outlet LEDs flash if the relay boards are being updated. If the firmware update does not include the update of the relay board firmware, outlet LEDs do NOT flash.
 - No users can successfully log in to the PX3.
 - Other users' operation, if any, is forced to suspend.
7. When the update is complete, the PX3 resets, and the Login page re-appears.
 - Other logged-in users are logged out when the firmware update is complete.

Important: If you are using the PX3 with an SNMP manager, download its MIB again after the firmware update to ensure your SNMP manager has the correct MIB for the latest release you are using. See *Using SNMP* (on page 506).

► **Alternatives:**

To use a different method to update the firmware, refer to:

- **Firmware Update via SCP** (on page 707)
- **Bulk Configuration or Firmware Upgrade via DHCP/TFTP** (on page 755)
- **Firmware Upgrade via USB** (on page 753)

Upgrade Guidelines for Existing Cascading Chains

You must obey the following guidelines when upgrading a chain. Otherwise, a networking issue occurs.

- Firmware version 3.3.10 or later is NOT compatible with pre-3.3.10 firmware versions in terms of the cascading feature so all Raritan devices in the cascading chain must run version 3.3.10 or later.

Alternative: You can also choose to have the USB-cascading chain comprising Raritan devices run any pre-3.3.10 firmware. The disadvantage is that you will not benefit from the latest software enhancements and features.

- To upgrade an existing Raritan USB-cascading chain from a firmware version older than 3.3.10, you must start from the last slave device and so on until the master device. See **Upgrade Sequence in an Existing Cascading Chain** (on page 467).

Upgrade Sequence in an Existing Cascading Chain

Depending on the firmware version(s) of your cascading chain, there may or may not be limitations for the firmware upgrade sequence in the chain.

► Upgrade from "pre-3.3.10" to 3.3.10 or post-3.3.10:

You must follow the firmware upgrade sequence below to upgrade a cascading chain from a firmware version older than 3.3.10 to version 3.3.10 or later. If you do not follow this upgrade sequence, you will not be able to access some cascaded devices over the Internet.

- The upgrade must start from the last slave device (S), then the second to last, the third to last, and so on until the master device (M).
Red numbers below represent the appropriate upgrade sequence. 'N' is the final one to upgrade.



- You must upgrade ALL devices in the chain to 3.3.10 or later. If you upgrade only some devices in the chain, networking issues occur on some cascaded devices.

*Exception: A few products, such as SRC, are developed much later so they may not support older firmware versions, such as 3.5.0, 3.4.0, and so on. Therefore, it is suggested to AVOID downgrading your cascading chain unless instructed by Raritan or Legrand Technical Support. For minimum firmware versions, see Cascading Restrictions in the Cascading Guide on the **Support page** (<http://www.raritan.com/support/>).*

► **Upgrade from 3.3.10 or post-3.3.10 to post-3.3.10:**

There is no upgrade sequence limitation.

Firmware version 3.3.10 is compatible with later firmware versions so you can upgrade all devices of the chain in a random order.

Important: Raritan does not guarantee that no upgrade sequence limitation will be required for all future firmware versions. It is highly suggested to check the latest revision of the Cascading Guide or your product's User Guide/Online Help before performing the firmware upgrade. The other alternative is to always stick to the same sequence as the above diagram.

► **Downgrade from 3.3.10 to pre-3.3.10:**

There is no downgrade sequence limitation. However, firmware downgrade in a cascading chain is NOT recommended. Consult Raritan (or Legrand) Technical Support first if downgrade is needed.

Firmware versions earlier than 3.3.10 are compatible with any pre-3.3.10 version so you can downgrade or upgrade all devices of the chain in a random order when all firmware versions in the chain are prior to version 3.3.10.

Note: It is suggested to always stick to the same sequence as the above diagram though there is no firmware downgrade limitation.

A Note about Firmware Upgrade Time

The PDU firmware upgrade time varies from unit to unit, depending on various external and internal factors.

External factors include, but are not limited to: network throughput, firmware file size, and speed at which the firmware is retrieved from the storage location. Internal factors include: the necessity of upgrading the firmware on the microcontroller and the number of microcontrollers that require upgrade (which depends on the number of outlets). The microcontroller is upgraded only when required. Therefore, the length of firmware upgrade time ranges from approximately 3 minutes (without any microcontroller updated) to almost 7 minutes (with all microcontrollers for 48 outlets updated). Take the above factors into account when estimating the PDU's firmware upgrade time.

The time indicated in this note is for PX3 web-interface-based upgrades. Upgrades through other management systems, such as Sunbird's Power IQ, may take additional time beyond the control of the PDU itself. This note does not address the upgrades using other management systems.

Full Disaster Recovery

For PX3 with iX7™, disaster recovery can be performed via the USB connection only.

If the firmware upgrade fails, causing the PX3 to stop working, you can recover it by using a special utility rather than returning the device to Raritan.

Contact Raritan Technical Support for the recovery utility, which works in Windows XP/Vista/7/10 and Linux. In addition, an appropriate PX3 firmware file is required in the recovery procedure.

*Note: For old PX3 without iX7™ controller, you can recover it via either a USB or serial RS-232 connection. See **Old Generations of PX3 Models** (on page 804).*

Viewing Firmware Update History

The firmware upgrade history is permanently stored on the PX3. It remains available even though you perform a device reboot or any firmware update.

► **To view the firmware update history:**

1. Choose Maintenance > Firmware History.

Each firmware update event consists of:

- Update date and time
- Previous firmware version
- Update firmware version
- Update result

2. If wanted, you can resort the list by clicking the desired column header. See **Sorting a List** (on page 182).

Bulk Configuration

The Bulk Configuration feature lets you save generic settings of a configured PX3 device to your computer. You can use this configuration file to copy common settings to other PX3 devices of the same model and firmware version. See **Bulk Configuration Restrictions** (on page 471).

A source device is the PX3 device where the configuration file is downloaded/saved. A target device is the PX3 device that loads the configuration file.

By default the configuration file downloaded from the source device contains settings based on the built-in bulk profile. The built-in bulk profile defines that all settings should be saved except for device-specific settings.

You can decide which settings are downloaded and which are not by creating your own bulk configuration profile.

Note that "device-specific" settings, such as the device's IP address or environmental sensor settings, will never be included into any profile you will create so they will never be downloaded from any source device. See **Device-Specific Settings** (on page 905).

When the date and time settings are included in the bulk configuration file, exercise caution when distributing that file to target devices located in a different time zone than the source device.

*Tip: To back up or restore "all" settings, including device-specific ones, use the Backup/Restore feature instead. See **Backup and Restore of Device Settings** (on page 477).*

► **Main bulk configuration procedure:**

1. If you prefer customizing the bulk configuration file, create your own bulk configuration profile(s) first. See **Customizing Bulk Configuration Profiles** (on page 473).
2. Perform the bulk configuration operation, which includes the following steps. For details, see **Performing Bulk Configuration** (on page 474).
 - a. Make sure the desired bulk configuration profile has been selected on the source device.
 - b. Save a bulk configuration file from the source device.
 - c. Perform bulk configuration on one or multiple target devices.

Note: On startup, PX3 performs all of its functions, including event rules and logs, based on the new configuration you have copied instead of the previous configuration prior to the device reset. For example, the "Bulk configuration copied" event is logged only when the new configuration file contains the "Bulk configuration copied" event rule.

▶ **The last configuration-copying record:**

If you once copied any bulk configuration or device backup file to the PX3, the last record similar to the following is displayed at the bottom of both the Bulk Configuration and Backup/Restore pages.

Last restore: 3/16/2019, 10:11:03 AM UTC+0800, status: OK

Tip: The date and time shown on the PX3 web interface are automatically converted to your computer's time zone. To avoid time confusion, it is suggested to apply the same time zone settings as those of PX3 to your computer or mobile device.

▶ **Alternatives:**

To use a different bulk configuration method, refer to:

- **Bulk Configuration via SCP** (on page 708)
 - **Bulk Configuration or Firmware Upgrade via DHCP/TFTP** (on page 755)
 - **Configuration or Firmware Upgrade with a USB Drive** (on page 740)
 - **Raw Configuration Upload and Download** (on page 778)
-

Tip: Both methods of uploading 'bulk configuration' file or 'raw configuration' file via SCP can serve the purpose of bulk configuration. The only difference is that you can configure device-specific settings with the upload of raw configuration but not with the 'bulk configuration' file.

Bulk Configuration Restrictions

Before performing bulk configuration, make sure your source and target devices are compatible devices for sharing general settings.

▶ **Restrictions for bulk configuration:**

- The target device must be running the same firmware version as the source device.
- The target device must be of the same model type as the source device.
- Bulk configuration is permitted if the differences between the target and source devices are only "mechanical" designs which are indicated in the model name's suffix.

For example, you can perform bulk configuration between PX3-4724-E2N1K2 and PX3-4724-E2N1K9 since the only difference between the two models is their chassis colors represented by K2 (blue) and K9 (gray).

► **Mechanical designs ignored by bulk configuration:**

When the source and target devices share the same technical specifications but are only different with any "mechanical designs" which are indicated in the table below, the bulk configuration remains feasible.

These mechanical designs are represented by suffixes added to the model name of a PX3 device. In the table, x represents a number. For example, Ax can be A1, A2, A3, and so on.



Suffix	Mechanical design	Example
Ax	The line cord's length in meters <i>Note: For a PX2 or PX3 inline monitor, it is likely two Ax's are added to the model name for indicating the lengths of its inlets' and outlets' line cords.</i>	A20 = 3.3 meters
Bx	The line cord's color	B501 = bright red orange
Cx	Cord types or options	C4 = power cord with the standard gauge
Dx	Plug types or options	D1 = IP67 watertight plug
Ex	Outlet types or options	E2 = Locking C13 or Locking C19
Gx	Controller options	G0 = no controller
Kx	Chassis colors	K6 = yellow
Lx	The line cord's length in centimeters	
Nx	Chassis dimensions or other mechanical changes	
Ox	OCP brand options	
Px	Special requests for device painting or printing	
Qx	Special requests for physical placement arrangements	
Ux	Different power plug brands	

Customizing Bulk Configuration Profiles

A bulk profile defines which settings are downloaded/saved from the source device and which are not. The default is to apply the built-in bulk profile, which downloads all settings from the source device except for device-specific data.

If the built-in profile does not meet your needs, you can create your own profile(s), and then apply the wanted profile before downloading/saving any settings from the source device.

► To create new bulk profile(s):

1. Log in to the source PX3, whose settings you want to download.
2. Choose Maintenance > Bulk Configuration.
3. Click  in the Bulk Profiles section.
4. In the 'Profile name' and 'Description' fields, enter information for identifying the new profile.
5. To make this new profile the default one for future bulk configuration operations, select the 'Select as default profile' checkbox.
 - After setting any profile as the default, the original default profile will no longer function as the default one.
6. Now decide which settings are wanted and which are not.
 - a. Click  of the setting which you want to configure.
 - b. When the pop-up menu appears, select one of the options.
Note that the two options 'Inherited' and 'Built-in' are mutually exclusive.

Option	Description
Excluded	The setting will <i>not</i> be downloaded.
Included	The setting will be downloaded.
Inherited	<p>The setting will follow its parent setting (that is, the upper-level setting).</p> <ul style="list-style-type: none"> ▪ If you select 'Excluded' for its upper-level setting, this setting will be also excluded. ▪ If you select 'Included' for its upper-level setting, this setting will be also included. <p>The option inherited from its parent setting will be enclosed in parentheses.</p>

Option	Description
Built-in	<p>The setting will follow the same setting of Raritan's built-in profile.</p> <ul style="list-style-type: none"> ▪ If 'Excluded' is selected in the built-in profile, this setting will be also excluded. ▪ If 'Included' is selected in the built-in profile, this setting will be also included. <p>The option inherited from the built-in profile will be enclosed in parentheses.</p> <hr/> <p><i>Note: The option 'Built-in' is available in those settings whose corresponding settings in the built in profile have been set to a non-inherited option -- Excluded or Included.</i></p>

7. Click Save.
8. Repeat the same steps if you want to create more bulk profiles.

Performing Bulk Configuration

On the source device, make sure the wanted profile has been set as the default one. If not, start from step 1 below. If yes, go to step 2 directly.

Bulk Profiles ✉ +			
# ▲	Name	Description	Default Profile
1	Built-in		<input checked="" type="checkbox"/>
2	custom-1	No network settings copied	<input type="checkbox"/>
3	custom-2	No user settings copied	<input type="checkbox"/>

▶ **Step 1: Select the desired bulk configuration profile (optional)**

1. Log in to the source PX3, whose settings you want to copy.
2. Choose Maintenance > Bulk Configuration.
3. Click on the row of the wanted profile to open the Edit Bulk Profile page.
4. Select the 'Select as default profile' checkbox.
5. Click Save.

▶ Step 2: Save a bulk configuration file

You must have the Administrator Privileges or "Unrestricted View Privileges" to download the configuration.

1. Log in to the source PX3 if you have not yet.
2. Choose Maintenance > Bulk Configuration.
3. Check the 'Bulk format' field. If the chosen value does not match your need, change it.

Option	Description
Encrypted	<ul style="list-style-type: none"> ▪ Partial content is base64 encoded. ▪ Its content is encrypted using the AES-128 encryption algorithm. ▪ The file is saved to the TXT format
Cleartext	<ul style="list-style-type: none"> ▪ Content is displayed in clear text. ▪ The file is saved to the TXT format.

4. Click Download Bulk Configuration.
5. When prompted to open or save the configuration file, click Save.

▶ Step 3: Perform bulk configuration

You must have the Administrator Privileges to upload the configuration.

1. Log in to the target PX3, which is of the same model and runs the same firmware as the source PX3.
2. Choose Maintenance > Bulk Configuration.
3. Click  to select the configuration file.
4. Click 'Upload & Restore Bulk Configuration' to copy it.
5. A message appears, prompting you to confirm the operation and enter the admin password.
Enter the admin password, and click Restore.
6. Wait until the PX3 resets and the login page re-appears.

► **Alternatives:**

To use a different bulk configuration method, refer to:

- **Bulk Configuration via SCP** (on page 708)
- **Bulk Configuration or Firmware Upgrade via DHCP/TFTP** (on page 755)
- **Configuration or Firmware Upgrade with a USB Drive** (on page 740)
- **Raw Configuration Upload and Download** (on page 778)

Tip: Both methods of uploading 'bulk configuration' file or 'raw configuration' file via SCP can serve the purpose of bulk configuration. The only difference is that you can configure device-specific settings with the upload of raw configuration but not with the 'bulk configuration' file.

Modifying or Removing Bulk Profiles

You can modify or remove any bulk profile except for the built-in one.

Note that a profile that has been set as the default cannot be removed, either. To remove it, you have to remove its default setting first.

Choose Maintenance > Bulk Configuration. A list of profiles displays and then do one of the following.

► **To modify an existing profile:**

1. Click on the row of the wanted profile in the list.
2. Change the settings you want.
3. Click Save.

► **To remove a single profile:**

1. Click on the row of the wanted profile.
2. Click  on the top-right corner.
3. Click Delete on the confirmation message.

► **To remove one or multiple profiles:**

1. Click  to make checkboxes appear in front of profiles.
2. Select one or multiple profiles.

- To select ALL profiles, select the topmost checkbox in the header row.

<input checked="" type="checkbox"/>	# ▲	Name
<input type="checkbox"/>	1	Built in
<input type="checkbox"/>	2	custom-1
<input type="checkbox"/>	3	custom-2

3. Click  on the top-right corner.
4. Click Delete on the confirmation message.

Backup and Restore of Device Settings

Unlike the bulk configuration file, the backup file contains ALL device settings, including device-specific data like device names and all network settings. To back up or restore the settings of PX3, you should perform the Backup/Restore feature.

All PX3 information is captured in the plain-TEXT-formatted backup file except for the device logs and TLS certificate.

*Note: To perform bulk configuration among multiple PX3 devices, use the Bulk Configuration feature instead. See **Bulk Configuration** (on page 470).*

► To download a backup PX3 file:

You must have the Administrator Privileges or "Unrestricted View Privileges" to download a backup file.

1. Choose Maintenance > Backup/Restore.
2. Check the 'Backup format' field. If the chosen value does not match your need, change it.

Option	Description
Encrypted	<ul style="list-style-type: none"> ▪ Partial content is base64 encoded. ▪ Its content is encrypted using the AES-128 encryption algorithm. ▪ The file is saved to the TXT format
Cleartext	<ul style="list-style-type: none"> ▪ Content is displayed in clear text. ▪ The file is saved to the TXT format.

3. Click Download Device Settings. Save the file onto your computer.

► **To restore the PX3 using a backup file:**

You must have the Administrator Privileges to restore the device settings.

1. Choose Maintenance > Backup/Restore.
2. Click  to select the backup file.
3. Click 'Upload & Restore Device Settings' to upload the file.
 - A message appears, prompting you to confirm the operation and enter the admin password.
4. Enter the admin password, then click Restore.
5. Wait until the PX3 resets and the Login page re-appears, indicating that the restore is complete.

Note: On startup, PX3 performs all of its functions, including event rules and logs, based on the new configuration you have copied instead of the previous configuration prior to the device reset. For example, the "Bulk configuration copied" event is logged only when the new configuration file contains the "Bulk configuration copied" event rule.

► **The last configuration-copying record:**

If you once copied any bulk configuration or device backup file to the PX3, the last record similar to the following is displayed at the bottom of both the Bulk Configuration and Backup/Restore pages.

Last restore: 3/16/2019, 10:11:03 AM UTC+0800, status: OK

► **Alternative:**

To use a different method to perform backup/restore, refer to:

- **Backup and Restore via SCP** (on page 709)

Network Diagnostics

PX3 provides the following tools in the web interface for diagnosing potential networking issues.

- Ping: The tool is useful for checking whether a host is accessible through the network or Internet.
- Trace Route: The tool lets you find out the route over the network between two hosts or systems.
- List TCP Connections: You can use this function to display a list of TCP connections.

*Tip: These network diagnostic tools are also available through CLI. See **Network Troubleshooting** (on page 701).*

Choose Maintenance > Network Diagnostics, and then perform any function below.

► Ping:

1. Type values in the following fields.

Field	Description
Network host	The name or IP address of the host that you want to check.
Number of requests	A number up to 20. This determines how many packets are sent for pinging the host.

2. Click Run Ping to ping the host. The Ping results are then displayed.

► Trace Route:

1. Type values in the following fields.

Field/setting	Description
Hostname	The IP address or name of the host whose route you want to check.
Timeout(s)	A timeout value in seconds to end the trace route operation.
Use ICMP packets	To use the Internet Control Message Protocol (ICMP) packets to perform the trace route command, select this checkbox.

2. Click Run. The Trace Route results are then displayed.

► List TCP Connections:

1. Click the List TCP Connections title bar to show the list.

Downloading Diagnostic Information

Important: This function is for use by Raritan Field Engineers or when you are directed by Raritan Technical Support.

You can download the diagnostic file from the PX3 to a client machine. The file is compressed into a .tgz file and should be sent to Raritan Technical Support for interpretation.

This feature is accessible only by users with Administrative Privileges or Unrestricted View Privileges.

► **To retrieve a diagnostic file:**

1. Choose Maintenance > Download Diagnostic >

Download Diagnostic

2. The system prompts you to save or open the file. Save the file then.
3. E-mail this file as instructed by Raritan Technical Support.

Hardware Issue Detection

This page lists any internal hardware issues PX3 has detected, including current events and historical records.

Choose Maintenance > Hardware Failures, and the page similar to either of the following diagrams opens.

► **NO hardware failures detected:**

Hardware Failures

No hardware failures

► **Hardware failure(s) detected:**

Hardware Failures

Current Hardware Failures			
Failure Message	Last Asserted ▲	Last Deasserted	Number of Occurrences
I2C bus 0 is stuck.	1/1/2018, 1:18:24 AM UTC+0100	1/1/2018, 1:00:00 AM UTC+0100	17

Past Hardware Failures			
Failure Message	Last Asserted ▲	Last Deasserted	Number of Occurrences
Network device ETH2 was not detected.	8/3/2018, 3:06:46 PM UTC+0200	8/3/2018, 3:13:10 PM UTC+0200	7

▶ **Hardware Failure alerts on the Dashboard page:**

Note that *current* hardware failure events, if any, will also display on the ***Dashboard*** (on page 183).

▶ **Hardware failure types:**

Hardware issues	Description
Network device not detected	A specific networking interface of PX3 is NOT detected.
I2C Bus stuck	A specific I2C bus is stuck, which affects the communication with sensors.
Slave controller not reachable	Communication with a specific slave controller fails.
Slave controller malfunction	A specific slave controller does not work properly.
Outlet power state inconsistent	The physical power state of a specific outlet is different from the chosen power state set by the software.

Rebooting the PX3

You can remotely reboot the PX3 via the web interface.

Resetting the PX3 does not interrupt the operation of connected servers because there is no loss of power to outlets. During and after the reboot, outlets that have been powered on prior to the reboot remain powered on, and outlets that have been powered off remain powered off.

Warning: Rebooting the PX3 deletes all webcam snapshots that are saved onto the PX3 locally. If needed, download important snapshots before rebooting the device. See **Viewing and Managing Locally-Saved Snapshots** (on page 491).

► **To reboot the device:**

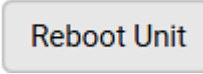
1. Choose Maintenance > Unit Reset > 

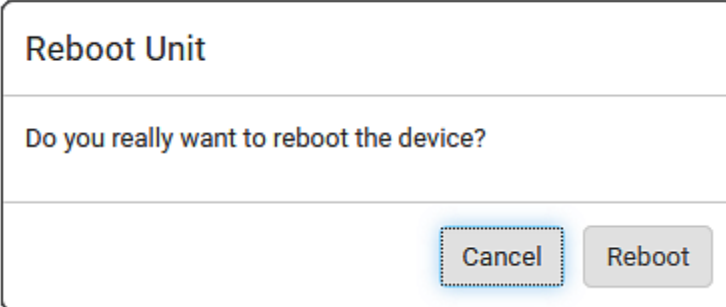

2. Click Reboot to restart the PX3.
3. A message appears, with a countdown timer showing the remaining time of the operation. It takes about one minute to complete.
4. When the restart is complete, the login page opens.

Tip: If you are not redirected to the login page after the restart is complete, click the text "this link" in the countdown message.

Note: Device reset will cause CLI communications over an "USB" connection to be lost. Therefore, re-connect the USB cable after the reset is complete.

Resetting All Settings to Factory Defaults

You must have the Administrator Privileges to reset all settings of the PX3 to factory defaults.

Important: Exercise caution before resetting the PX3 to its factory defaults. This erases existing information and customized settings, such as user profiles, threshold values, and so on. Only active energy data and firmware upgrade history are retained.

► **To reset the device to factory defaults:**

1. Choose Maintenance > Unit Reset >

Reset to Factory Defaults

Reset to Factory Defaults

Do you really want to reset the device to factory defaults?

Saying yes will clear all settings, including the network setup.

Please confirm with your password:

Enter password

2. Type your password and then click Factory Reset to reset the PX3 to factory defaults.
3. A message appears, with a countdown timer showing the remaining time of the operation. It takes about two minutes to complete.
4. When the reset is complete, the login page opens.

Tip: If you are not redirected to the login page after the reset is complete, click the text "this link" in the countdown message.

► **Alternative:**

There are two more methods to reset the device to factory defaults.

- Use the "mechanical" reset button
- Perform the CLI command

For details, see **Resetting to Factory Defaults** (on page 784).

Note: Device reset will cause CLI communications over an "USB" connection to be lost. Therefore, re-connect the USB cable after the reset is complete.

Retrieving Software Packages Information

You can check the current firmware version and the information of all open source packages embedded in the PX3 through the web interface.

► **To retrieve the embedded software packages information:**

1. Choose Maintenance > About PDU. A list of open source packages is displayed.
2. You can click any link to access related information or download any software package.

Webcam Management

The 'Webcams' menu item appears when there is any webcam(s) connected to the PX3, or when there are snapshots saved onto the PX3 already. See ***Connecting a Logitech Webcam*** (on page 77).

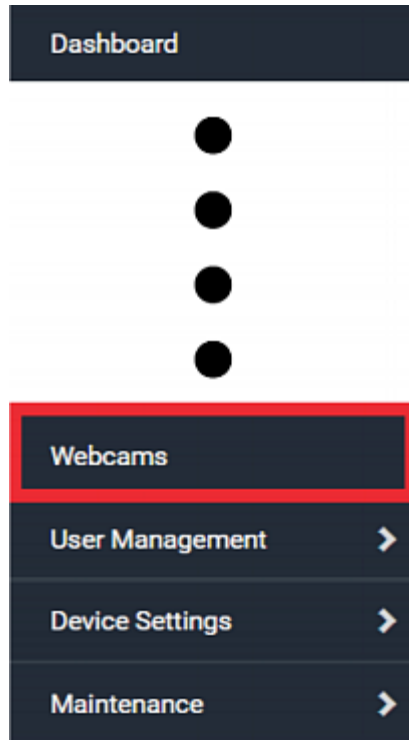

With a Logitech® webcam connected to the PX3, you can visually monitor the environment around the PX3 via snapshots or videos captured by the webcam.

► **Permissions required:**

To do...	Permission(s) required
View snapshots and videos	Either permission below: <ul style="list-style-type: none"> ▪ Change Webcam Configuration ▪ View Webcam Snapshots and Configuration
Configure webcam settings	Change Webcam Configuration

► **Additional webcam-related actions you can take:**

Action	Refer to
Manually store snapshots taken from the webcam onto the PX3 or a remote server	<ul style="list-style-type: none"> ▪ Configuring Webcams and Viewing Live Images (on page 486) ▪ Changing Storage Settings (on page 493)
Send a snapshot or video session's link to other people via email or instant message	Sending Links to Snapshots or Videos (on page 489)
Create event rules to trigger emails containing snapshots from a webcam	Available Actions (on page 384)

For more information on your Logitech webcam, refer to the user documentation accompanying it.

Configuring Webcams and Viewing Live Images

To configure a webcam or view live snapshot/video sessions, choose Webcams in the **Menu** (on page 178). Then click the desired webcam to open that webcam's page.

Note that default webcam names are determined by the detection order. The one that is detected first is named *Webcam*, and the other that is detected later is named *Webcam 2*.

Webcams			
Name ▲	Location	Resolution	Mode
Webcam		352x288	Snapshot

The Webcam page consists of three sections -- *Live Preview*, *Image Controls* and *Settings*.

► **Live Preview:**

1. By default the Live Preview section is opened, displaying the live snapshot/video session captured by the webcam.
 - The default is to show live snapshots. Interval time and capture date/time of the image are displayed on the top of the image.

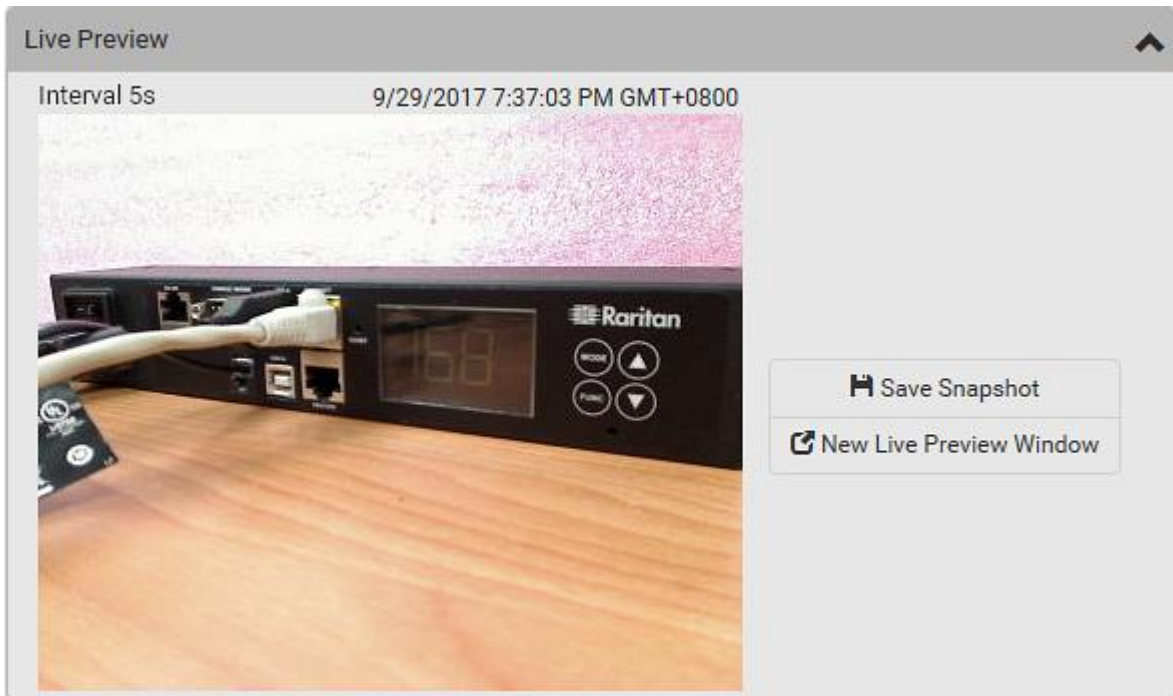

Tip: The date and time shown on the PX3 web interface are automatically converted to your computer's time zone. To avoid time confusion, it is suggested to apply the same time zone settings as those of PX3 to your computer or mobile device.

- To save the current image onto PX3 or a remote server, click

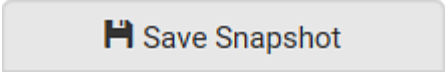

The image shows a button with a floppy disk icon and the text "Save Snapshot".

- The default storage location for snapshots is the PX3 device. To save them onto a remote server, see **Changing Storage Settings** (on page 493).
 - To download an image onto your computer, move your mouse to that image, right click on it, and choose Save Image As.
- To have the same live session displayed in a separate window, click

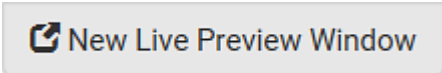

The image shows a button with a window icon and the text "New Live Preview Window".

- A separate window appears, which is called the Primary Standalone Live Preview window in this User Guide.
- You can send out this window's URL to share the live image with others. See **Sending Links to Snapshots or Videos** (on page 489).

Note: Make sure your browser does not block the pop-up window, or the separate window does not show up.

- To switch between snapshot and video modes, refer to the *Settings* section below.
 - In the video mode, the number of frames to take per second (fps) and the video capture date/time are displayed on the top of the image.

▶ Image Controls:

- Click the Image Controls title bar to expand it.



The image shows a grey title bar with the text "Image Controls" on the left, a mouse cursor in the center, and a downward-pointing chevron on the right.

- Adjust the brightness, contrast, saturation and gain by modifying their values or adjusting the corresponding slide bar.
 - To customize the gain value, you must deselect the Auto Gain checkbox first.
 - To restore all settings to this webcam's factory defaults, click

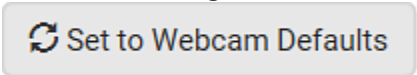

The image shows a button with a circular arrow icon and the text "Set to Webcam Defaults".

▶ Settings:

- By default the Settings section is open. If not, click the Settings title bar.

2. Click Edit Settings.
3. Enter a name for the webcam. Up to 64 ASCII printable characters are supported.
 - If configured to store snapshots on a *remote* server, the webcam's name determines the name of the folder where snapshots are stored. See **Changing Storage Settings** (on page 493) and **Identifying Snapshots Folders on Remote Servers** (on page 495).
 - It is suggested to customize a webcam's name "prior to" saving snapshots on the remote server. In case you change the webcam's name after saving any snapshots, PX3 will create a new folder with the new webcam name while keeping the old folder with the old name.
4. Type the location information in each location field as needed. Up to 63 ASCII printable characters are supported.
 - Note that the location data you enter is not available in those snapshots stored on remote servers.

Tip: If the webcam's location is important, you can customize the webcam's name based on its location when configuring PX3 to save snapshots onto a remote server.

5. Select a resolution for the webcam.
 - If you connect two webcams to one USB-A port using a powered USB hub, set the resolution to 352x288 or lower for optimal performance.
6. Select the webcam mode.

Mode	Description
Video	The webcam enters the video mode. <ul style="list-style-type: none"> ▪ Set the 'Framerate' (frames per second) as needed.
Snapshot	The webcam shows static images captured by the webcam at a regular interval. <ul style="list-style-type: none"> ▪ To determine the interval, set the 'Time Between Snapshots' (seconds) as needed.

7. Click Save. The changes made to the settings are applied to the live session in the above *Live Preview* section immediately.

▶ **To return to the Webcam Management page:**

- Click Webcam Management on the top of the page.

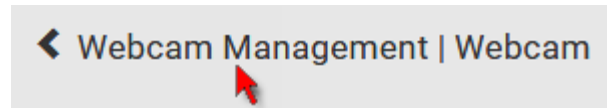

- Or click Webcams again in the **Menu** (on page 178).

Sending Links to Snapshots or Videos

When opening a Primary Standalone Live Preview window, a unique URL is generated for this window session. You can email or instant message this URL to as many people as possible as long as your system resources permit. Recipients can then click on the provided link and view live snapshots or videos simultaneously in the Secondary Standalone Live Preview window(s).

*Tip: All Live Preview window sessions sharing the same URL, including one Primary Standalone Live Preview window and multiple Secondary Standalone Live Preview windows, are identified as one single "<webcam>" user in the Connected Users list. You can disconnect a "<webcam>" user to terminate all sessions sharing the same URL. See **Viewing Connected Users** (on page 462).*

▶ Best practice:

1. The sender opens the Primary Standalone Live Preview window, and sends the link to one or multiple recipients.
2. The sender must wait until at least one recipient opens the Secondary Standalone Live Preview window.
3. The recipient(s) should inform the sender that the link has been opened.
4. Now the sender can close the Primary Standalone Live Preview window.
 - For additional information, see **How Long a Link Remains Accessible** (on page 491).

▶ To send a snapshot or video link via email or instant message:

1. Choose Webcams in the **Menu** (on page 178).
2. Click the desired webcam to open the Webcam page.
 - Note that default webcam names are determined by the detection order. The one that is detected first is named *Webcam*, and the other that is detected later is named *Webcam 2*.

Webcams			
Name ▲	Location	Resolution	Mode
Webcam		352x288	Snapshot

 New Live Preview Window

3. Click  in the Live Preview section. The live snapshot or video in a standalone window opens. See **Configuring Webcams and Viewing Live Images** (on page 486).
4. Copy the URL from that live preview window.

- a. Select the URL shown on the top of the image.

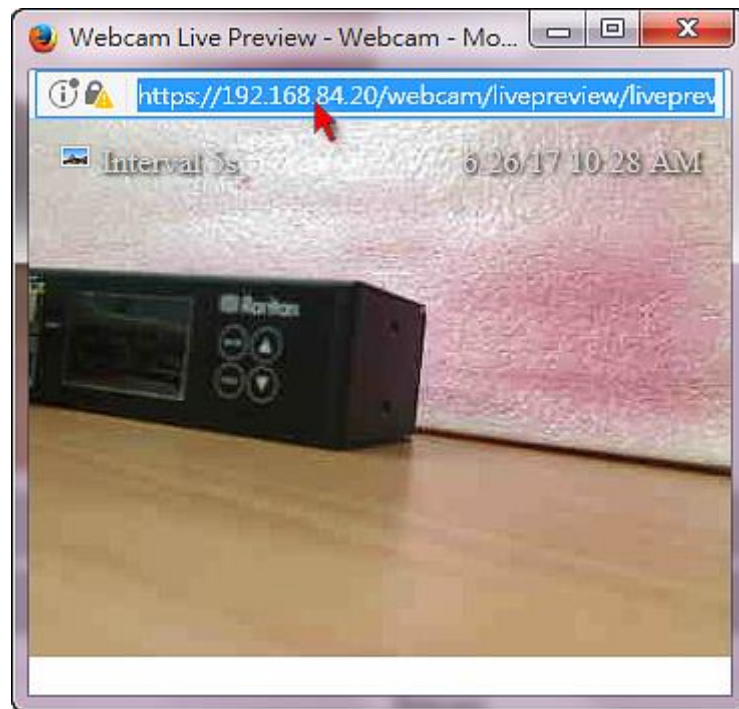

- b. Right click to copy the URL, or press CTRL+ C.
5. Send the URL link through an email or instant message application to one or multiple persons.
6. Leave the live preview window open until the recipient(s) opens the snapshot or video via the link.

How Long a Link Remains Accessible

For documentation purposes, the one who opens and sends the URL of the Primary Standalone Live Preview window is called *User A* and the two recipients of the same URL link are called *User B* and *C*.

User C is able to access the snapshot or video image via the link when the URL link remains valid, which can be one of these scenarios:

- The Primary Standalone Live Preview window remains open on User A's computer. If so, even though User A logs out of the PX3 or the login session times out, the link remains accessible.
- User B's Secondary Standalone Live Preview window remains open. If so, even though User A already closes the Primary Standalone Live Preview window, the link remains accessible.
- Neither User A's Primary Standalone Live Preview window nor User B's Secondary Standalone Live Preview window remains open, but it has not exceeded two minutes yet after the final live preview window session was closed.

Note: The link is no longer valid after two minutes since the final live preview window is closed.

Viewing and Managing Locally-Saved Snapshots

This section describes the operation for snapshots saved onto the PX3 device only. To access snapshots saved onto remote servers, you must use appropriate third-party applications, such as an FTP client, to access them.

When saving a snapshot, it is stored locally on the PX3 device by default. For snapshot-saving operations, see **Configuring Webcams and Viewing Live Images** (on page 486).

Up to 10 snapshots can be stored onto the PX3. The oldest snapshot is automatically overridden by the newest one when the total of snapshots exceeds 10, if no snapshots are deleted manually.

When there are more than one webcam connected, then the oldest snapshot of the webcam "with the most snapshots" is overridden.

*Tip: To save more than 10 snapshots, you must change the storage location from the PX3 to an FTP or Common Internet File System (CIFS)/Samba server. See **Changing Storage Settings** (on page 493).*

Snapshots are saved as JPG files, and named based on the sequential numbers, such as *1.jpg*, *2.jpg*, *3.jpg* and the like.

Warning: Rebooting the PX3 deletes all webcam snapshots that are saved onto the PX3 locally. If needed, download important snapshots before rebooting the device.

► **To view saved snapshots:**

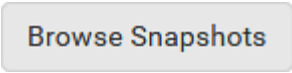
1. Choose Webcams > . The Snapshots page opens.
2. Click the snapshot you want to view from the list.

◀ Webcam Management Snapshots ↻ 🗑️ 📧			
Snapshot	Size	Time ▼	Webcam
4.jpg	3.9 kiB	9/29/2017, 7:44:04 PM GMT+0800	Webcam
3.jpg	8.0 kiB	9/29/2017, 7:43:03 PM GMT+0800	Webcam
2.jpg	8.0 kiB	9/29/2017, 7:38:12 PM GMT+0800	Webcam
1.jpg	8.2 kiB	9/29/2017, 7:34:42 PM GMT+0800	Webcam

Tip: The date and time shown on the PX3 web interface are automatically converted to your computer's time zone. To avoid time confusion, it is suggested to apply the same time zone settings as those of PX3 to your computer or mobile device.

3. The selected snapshot as well as its information, such as captured time and resolution, is displayed on the same page.
4. If the latest saved snapshot is not listed yet, click .

► **To manually delete any snapshots:**

1. Click  to make checkboxes appear.
2. Select the checkboxes of the images you want to remove.
 - To select all images, select the topmost checkbox in the header row.

<input checked="" type="checkbox"/>	Snapshot
<input type="checkbox"/>	4.jpg
<input type="checkbox"/>	3.jpg
<input type="checkbox"/>	2.jpg
<input type="checkbox"/>	1.jpg

3. On the top of the list, click .
4. Click Delete on the confirmation message.

▶ **To download any image onto the computer:**

- To download an image onto your computer, move your mouse to that image, right click on it, and choose Save Image As.

Changing Storage Settings

Important: The PX3 web interface only lists the snapshots stored locally on the PX3 device, but does NOT list those saved onto remote servers. You must launch appropriate third-party applications, such as an FTP client, to access and manage the snapshots stored on remote servers.

The default is to store snapshots onto the PX3 device, which has a limitation of 10 snapshots. Note that any operation involving device reboot will remove the snapshots saved on the PX3, such as firmware upgrade.

If you have either or both needs below, you must save snapshots onto a remote server like FTP or CIFS/Samba, instead of the PX3.

- Total number of saved snapshots will exceed 10.
- Saved snapshots must be stored *permanently*, or at least should *not* be removed by the PX3 device's reboot.

▶ **To configure the storage settings:**

1. Choose Webcams > Edit Settings.

Snapshot Storage	
	Edit Settings
Storage Type	Local 
Browse Snapshots	

2. Click the Storage Type field to select the desired storage location and configure as needed.

Note: When entering user credentials for remote servers, make sure the user credentials you enter have the write permission, or NO snapshots can be successfully saved onto remote servers.

Storage location	Description
Local	<p>'Local' means the PX3. This is the default.</p> <ul style="list-style-type: none"> ▪ It can store a maximum of 10 snapshots only. ▪ The web interface can list and display all snapshots stored on the PX3. See Viewing and Managing Locally-Saved Snapshots (on page 491). ▪ All snapshots are CLEARED when the PX3 is rebooted.
CIFS/Samba	<p>Snapshots are saved onto a Common Internet File System/Samba.</p> <ul style="list-style-type: none"> ▪ Total number of saved snapshots depends on the server's capacity. ▪ All saved snapshots remain available after rebooting the PX3. ▪ Configure the following fields: <ul style="list-style-type: none"> * <i>Server</i> - the desired CIFS/Samba server * <i>Share/folder</i> - this is the share drive/folder * <i>Username</i> - for server access * <i>Password</i> - for server access
FTP	<p>Snapshots are saved onto a FTP server.</p> <ul style="list-style-type: none"> ▪ Total number of saved snapshots depends on the server's capacity. ▪ All saved snapshots remain available after rebooting the PX3. ▪ Configure the following fields: <ul style="list-style-type: none"> * <i>Server URL</i> - the FTP server's path * <i>Username</i> - for server access * <i>Password</i> - for server access

To find where the snapshots are saved on CIFS/Samba or FTP, see **Identifying Snapshots Folders on Remote Servers** (on page 495).

3. Click Save.

Warning: Before disconnecting or powering off any remote server where the webcam snapshots are being stored, you must first change the storage settings, or the connectivity issue of the remote server may degrade the performance of the PX3 web interface. If this issue occurs, first restore the connectivity of the remote server and then change the storage settings of the webcam snapshots.

► **Tip for notifications showing the snapshots path on FTP:**

If you are using SNMP to retrieve PX3 data, you can make PX3 automatically send a notification containing the full path or URL to the snapshots saved onto FTP with this SNMP code: `webcamStorageUploadStarted`.

Identifying Snapshots Folders on Remote Servers

If saving snapshots onto a remote server, you can access those snapshots via an appropriate third-party application, such as an FTP client.

All snapshots are saved as JPEG and named according to the date and time when saving the snapshots. Note that the date and time of the filename are based on the time zone of the PX3 rather than that of the computer or mobile device you are operating.

*Tip: To check the time zone of your PX3, choose Device Settings > Date/Time. See **Setting the Date and Time** (on page 360).*

The structure of a snapshots folder looks similar to the diagram below.

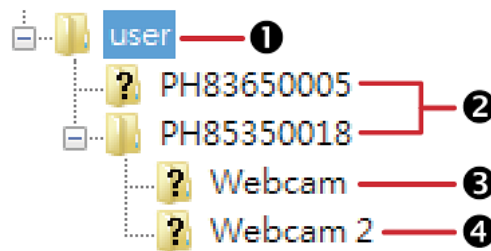

Number	Folder name description
①	User-defined parent directory, whose name depends your server settings, such as your FTP configuration.
②	Serial number of your PX3 device where the webcam is connected. For example, <i>PH85350018</i> . <ul style="list-style-type: none"> To find your PX3 serial number, see Device Information (on page 457).

Number	Folder name description
3	<p>The name of the webcam that your PX3 detects first.</p> <p>This is the folder where the snapshots captured by the first webcam are stored.</p> <ul style="list-style-type: none"> ▪ The first webcam's default name is "Webcam". ▪ You can customize the webcam's name, which will change the snapshots folder's name. <p>See Configuring Webcams and Viewing Live Images (on page 486).</p> <ul style="list-style-type: none"> ▪ If the webcam's location is important, you can customize the webcam's name based on its location when configuring PX3 to save snapshots onto a remote server.
4	<p>The name of the webcam that your PX3 detects later, if an additional webcam is connected.</p> <p>This is the folder where the snapshots captured by the second webcam are stored.</p> <ul style="list-style-type: none"> ▪ The second webcam's default name is "Webcam 2". ▪ Changing this webcam's name also changes the second snapshots folder's name. ▪ If the webcam's location is important, you can customize the webcam's name based on its location when configuring PX3 to save snapshots onto a remote server.

Note: It is suggested to customize a webcam's name "prior to" saving snapshots on the remote server. In case you change the webcam's name after saving any snapshots, PX3 will create a new folder with the new webcam name while keeping the old folder with the old name.

SmartLock and Card Reader

Raritan's SmartLock kits provide several cabinet access control solutions.

If you have purchased a SmartLock kit with the door handle controller "DX2-DH2C2", both menu items "SmartLock" and "Card Readers" will appear in the menu after connecting and configuring properly DX2-DH2C2 and the door handles included in the kit.

*Note: For more information on DX2-DH2C2, such as its hardware installation, refer to the SmartLock Quick Setup Guide accompanying the SmartLock kit or 'Environmental Sensors and Actuators Guide' (or its Online Help version) on the Raritan **Support page** (<http://www.raritan.com/support/>).*

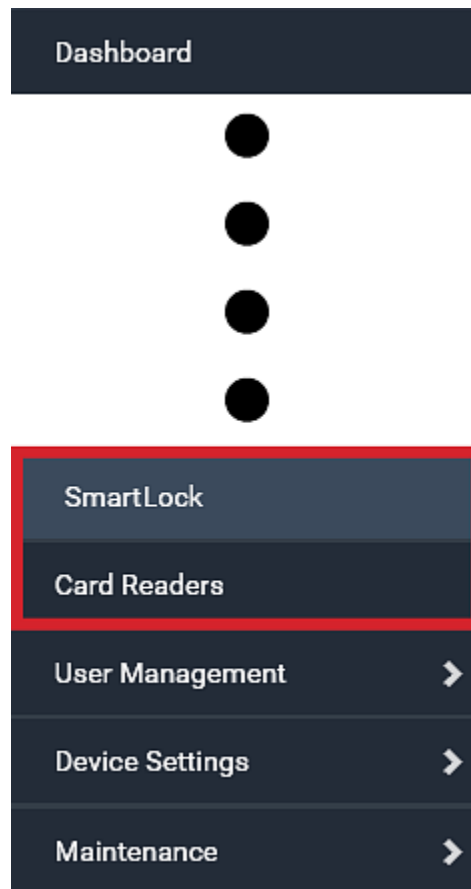

Note that "SmartLock" appears only when your door handles are connected to PX3 via **DX2-DH2C2**, but "Card Readers" appears as long as PX3 detects the presence of any card reader -- either a standalone USB card reader or a card reader integrated with the door handles.

▶ **"SmartLock" page:**

- Shows the information of all door handle controllers (that is, DX2-DH2C2 modules) attached to PX3.
- Shows the status of the door handle-integrated card readers connected to DX2-DH2C2.

Note: Data of "external" USB card readers is NOT shown on the SmartLock page. It is shown on the Card Readers page instead.

- You can control the door handles on this page. See **SmartLock** (on page 499).

▶ **"Card Readers" page:**

- Shows the information of all card readers connected to PX3, including:
 - Door handle-integrated card readers connected to the DX2-DH2C2 module.
 - External USB card readers connected to the USB-A port of PX3.
- See **Card Readers** (on page 504).

SmartLock

To open the SmartLock page, choose SmartLock in the **Menu** (on page 178).

The page shows information of all DX2-DH2C2 modules attached to PX3, including its serial number, position and its door handle configuration.

SmartLock Controller

Details

Position	Port 1, Chain position 1
Serial number	1GE8200098

Door Handle 1

⏻ Open
 ⏻ Close
 🔒

Door State

Name	State	Type
Door 1	open	Door
Door Lock 1	unavailable	Door Lock
Door Handle Lock 1	unavailable	Door Handle Lock

Card Reader

Settings

[Edit Settings](#)

Door handle type	None
Door sensor polarity	Normally closed

Door Handle 2

⏻ Open
 ⏻ Close
 🔒

Door State

Name	State	Type
Door 2	open	Door
Door Lock 2	unavailable	Door Lock
Door Handle Lock 2	unavailable	Door Handle Lock

Card Reader

Settings

[Edit Settings](#)

Door handle type	None
Door sensor polarity	Normally closed

On this page you can:

- View the status of the cabinet door and card reader.

Note: Data of "external" USB card readers is NOT shown on the SmartLock page. It is shown on the Card Readers page instead.

Raritan
A brand of Legrand

499

- Configure the door handles connected to DX2-DH2C2. You must set this because PX3 cannot detect the types of connected door handles.
- Control the door handles connected to DX2-DH2C2.

► **To configure the door handles:**

There are two door handle sections per DX2-DH2C2 because a DX2-DH2C2 has two door handle ports. Before you configure the connected door handle(s), a lock icon is displayed on each door handle section's top-right corner, and both the Door State and Card Reader sections are unavailable.

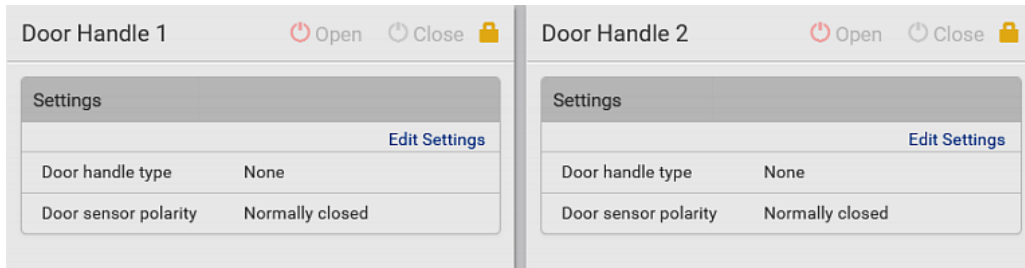

1. Click Edit Settings in the Settings section.
2. In the 'Door handle type' field, select the door handle type you are using.
 - If your specific Southco H3-EM model is listed, select it. For all other supported Southco H3-EM models, select "Southco H3-EM".

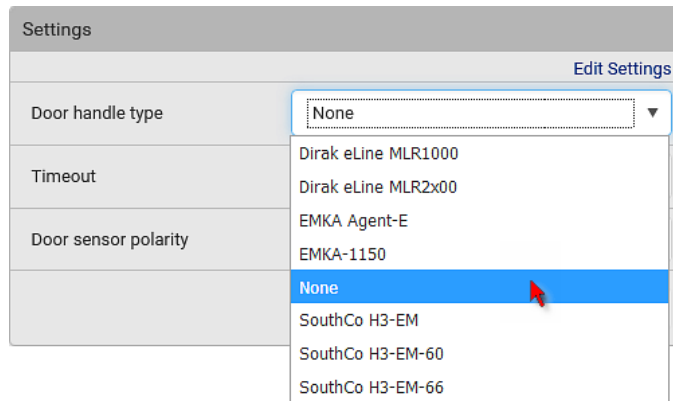

3. Make changes to the remaining fields as needed.

Section	Description
Timeout	<ul style="list-style-type: none"> ▪ Specify how long the door handle lock can remain open after someone opens the door handle via a smart card or via remote control using the software. When the timeout expires, the door handle lock will be automatically closed. Default is 600 seconds (that is, 10 minutes).
Door sensor polarity	<p>Choose the correct setting based on the type of contact closure sensors used to monitor the door:</p> <ul style="list-style-type: none"> ▪ <i>Normally closed</i>: The contact is closed (conducting) when the door is closed and open (not conducting) when the door is open. This is the default. ▪ <i>Normally open</i>: The contact not conducting when the door is closed and conducting when the door is open. ▪ Note: For both normally closed and normally open sensors, the reported state is "alarmed" when the door is open and "normal" when the door is closed.

4. Click Save.

Door Handle Status and Control

After configuring the door handle type properly, two more sections are shown for the configured door handle -- **Door State** and **Card Reader**.

Door Handle 1 🔴 Open 🔴 Close

Door State ▲

Name	State	Type
Door 1	open	Door
Door Lock 1	closed	Door Lock
Door Handle Lock 1	closed	Door Handle Lock

Card Reader ▲

Manufacturer/model	EMKA Agent-E
Card type	---
Card ID	---

Settings

[Edit Settings](#)

Door handle type	EMKA Agent-E
Timeout	600
Door sensor polarity	Normally closed

► **To view the status of the door and card reader:**

Section	Description
Door State	<p>Shows all sensor states detected by DX2-DH2C2, including:</p> <ul style="list-style-type: none"> ▪ <i>Door</i>: States of contact closure sensors connected to DX2-DH2C2. Contact closure sensors detect whether the door is physically opened or closed. ▪ <i>Door Lock</i>: States of door locks integrated with the door handles. ▪ <i>Door Handle Lock</i>: States of the door handle locks. <p>Door locks and door handle locks are interrelated so their states are changed one after another. The door handle lock is opened first and then the door lock.</p> <hr/> <p><i>Exception: If you manually open the door lock with the key shipped with your door handle, the Door Lock state will enter the open state while the Door Handle Lock state remains closed.</i></p>
Card Reader	<p>Shows the data of the smart card scanned by the internal or external card reader accompanying each door handle connected to DX2-DH2C2.</p> <hr/> <p><i>Note: It is not necessary to use the internal card reader unless you are using a third-party application, such as Power IQ, for access control. Refer to the user documentation of your third-party application for more information.</i></p>

*Tip: All sensors of the connected door handles are also listed on the page of **Peripherals** (on page 249).*

Note that the same Card Reader information is also available on the page of **Card Readers** (on page 504).

► **To control the door handles:**

Per default, only one door handle can be opened at the same time so you must close one door handle before opening another door handle connected to the same PX3. To increase the upper limit of concurrently opened door handles, see **Peripherals** (on page 249).

1. Make sure you have configured the door handle type properly in the above procedure.

- Go to the proper door handle section, and click Open or Close to open or close the door handle lock.



- Confirm the operation when prompted.
- Now you can physically open the cabinet door with the opened door handle.

Tip: You can click Close to re-close the door handle lock when you change your mind before the door is physically opened, or when the door handle lock is mistakenly opened, or when someone opens it without pulling out the door handle. If not, then PX3 will automatically close the door handle lock after its timeout expires.

► **DX2-DH2C2 LED information:**

- For information on DX2-DH2C2 LED, refer to 'Environmental Sensors and Actuators Guide' (or its Online Help version) on the Raritan **Support page** (<http://www.raritan.com/support/>).

Card Readers

To open the Card Readers page, choose Card Readers in the **Menu** (on page 178).

This page lists all card readers connected to PX3, including:

- Standalone USB card readers
- Card readers integrated with door handles

*Note: To have card readers integrated with door handles display on this page, you must first configure the door handle properly on the page of **SmartLock** (on page 499).*

Card Readers					
# ▲	Manufacturer/Model	Serial Number	Channel	Card Type	Card ID
1	EMKA Agent-E	1GE8200098	1	---	---
2	EMKA Agent-E	1GE8200098	2	---	---

When a user scans his/her smart card with the card reader, PX3 will retrieve the card's type and ID and show them in the corresponding Card Type and Card ID column. If no data is shown in the two columns, it means the scanned card may not be supported by the card reader.

Tip: You can use a third-party application, such as Power IQ, to retrieve the card's data from PX3 to perform security features like cabinet access control. Refer to that application's user documentation for more information.

Listed card readers can be one or both of the following types.

▶ **Door handle-integrated card readers:**

- This type of card reader is integrated in the door handle, which is any series below:
 - Emka Agent E
 - SouthCo H3-EM
 - Dirak eLine MLR 2x00

Note: Not every SouthCo H3-EM door handle has a card reader integrated. For example, H3-EM-60-100 requires an external card reader.

- It is connected to PX3 via the DX2-DH2C2 module.
- The Channel column indicates which door handle port (channel) it is connected to.
- Note that the serial number displayed for this card reader is the same as DX2-DH2C2's serial number.

Each DX2-PD2C2 module can show two card readers because they have two ports for connecting two door handles with card readers integrated.

▶ **Standalone USB card readers:**

- It is directly connected to the USB-A port of PX3.
- The Channel column does not show any data.

Chapter 8 Using SNMP

This SNMP section helps you set up the PX3 for use with an SNMP manager. The PX3 can be configured to send traps or informs to an SNMP manager, as well as receive GET and SET commands in order to retrieve status and configure some basic settings.

In This Chapter

Enabling and Configuring SNMP	506
Downloading SNMP MIB.....	511
SNMP Gets and Sets	512

Enabling and Configuring SNMP

To communicate with an SNMP manager, you must enable SNMP protocols on the PX3. By default the "read-only" mode of SNMP v1/v2c is enabled.

The SNMP v3 protocol allows for encrypted communication. To take advantage of this, you must configure the users with the SNMP v3 access permission and set Authentication Pass Phrase and Privacy Pass Phrase, which act as shared secrets between SNMP and the PX3.

Important: You must download the SNMP MIB for your PX3 to use with your SNMP manager. See *Downloading SNMP MIB* (on page 511).

▶ **To enable SNMP v1/v2c and/or v3 protocols:**

1. Choose Device Settings > Network Services > SNMP.
2. In the SNMP Agent section, enable SNMP v1/v2c or SNMP v3, and configure related fields, such as the community strings.
 - If SNMP v3 is enabled, you must determine which users shall have the SNMP v3 access permission. See below.

For details, see ***Configuring SNMP Settings*** (on page 329).

▶ **To configure users for SNMP v3 access:**

1. Choose User Management > Users.
2. Create or modify users to enable their SNMP v3 access permission.
 - If authentication and privacy is enabled, configure the SNMP password(s) in the user settings.

For details, see ***Creating Users*** (on page 288).

▶ **To enable SNMP notifications:**

1. Choose Device Settings > Network Services > SNMP.

2. In the SNMP Notifications section, enable the SNMP notification feature, and configure related fields. For details, refer to:
 - **SNMPv2c Notifications** (on page 507)
 - **SNMPv3 Notifications** (on page 508)

*Note: Any changes made to the 'SNMP Notifications' section on the SNMP page will update the settings of the System SNMP Notification Action, and vice versa. See **Available Actions** (on page 384).*

SNMPv2c Notifications

1. Choose Device Settings > Network Services > SNMP.
2. In the SNMP Agent, make sure the Enable SNMP v1/v2c checkbox is selected.
3. In the SNMP Notifications section, make sure the 'Enable SNMP notifications' checkbox is selected.

SNMP Notifications

Enable SNMP notifications

Notification type SNMPv2c inform ▼

Timeout 3 s

Number of retries 5

#	Host	Port	Community
1	<input style="width: 100%;" type="text"/>	<input style="width: 100%; text-align: center;" type="text" value="162"/>	<input style="width: 100%;" type="text"/>
2	<input style="width: 100%;" type="text"/>	<input style="width: 100%; text-align: center;" type="text" value="162"/>	<input style="width: 100%;" type="text"/>
3	<input style="width: 100%;" type="text"/>	<input style="width: 100%; text-align: center;" type="text" value="162"/>	<input style="width: 100%;" type="text"/>

4. Select 'SNMPv2c trap' or 'SNMPv2c inform' as the notification type.
5. Type values in the following fields.

Field	Description
Timeout	The interval of time, in seconds, after which a new inform communication is resent if the first is not received. <ul style="list-style-type: none"> ▪ For example, resend a new inform communication

Field	Description
	once every 3 seconds.
Number of retries	The number of times you want to resend the inform communication if it fails. <ul style="list-style-type: none"> ▪ For example, inform communications are resent up to 5 times when the initial communication fails.
Host	The IP address of the device(s) you want to access. This is the address to which notifications are sent by the SNMP agent. You can specify up to 3 SNMP destinations.
Port	The port number used to access the device(s).
Community	The SNMP community string to access the device(s). The community is the group representing the PX3 and all SNMP management stations.

6. Click Save.

SNMPv3 Notifications

1. Choose Device Settings > Network Services > SNMP.
2. In the SNMP Agent, make sure the Enable SNMP v1/v2c checkbox is selected.

3. In the SNMP Notifications section, make sure the 'Enable SNMP notifications' checkbox is selected.

SNMP Notifications

Enable SNMP notifications	<input checked="" type="checkbox"/>
Notification type	SNMPv3 inform ▼
Host	required
Port	162
User ID	required
Timeout	3 s
Number of retries	5
Security level	authPriv ▼
Authentication protocol	SHA ▼
Authentication passphrase	required
Confirm authentication passphrase	
Privacy protocol	AES ▼
Privacy passphrase	required
Confirm privacy passphrase	

4. Select 'SNMPv3 trap' or 'SNMPv3 inform' as the notification type.
5. For SNMP TRAPS, the engine ID is prepopulated.
6. Type values in the following fields.

Field	Description
Host	The IP address of the device(s) you want to access.

Field	Description
	This is the address to which notifications are sent by the SNMP agent.
Port	The port number used to access the device(s).
User ID	User name for accessing the device. <ul style="list-style-type: none"> Make sure the user has the SNMP v3 access permission.
Timeout	The interval of time, in seconds, after which a new inform communication is resent if the first is not received. <ul style="list-style-type: none"> For example, resend a new inform communication once every 3 seconds.
Number of retries	Specify the number of times you want to resend the inform communication if it fails. <ul style="list-style-type: none"> For example, inform communications are resent up to 5 times when the initial communication fails.
Security level	Three types are available. <ul style="list-style-type: none"> noAuthNoPriv - neither authentication nor privacy protocols are needed. authNoPriv - only authentication is required. authPriv - both authentication and privacy protocols are required.
Authentication protocol, Authentication passphrase, Confirm authentication passphrase	The three fields are available when the security level is set to AuthNoPriv or authPriv. <ul style="list-style-type: none"> Select the authentication protocol - MD5 or SHA Enter the authentication passphrase
Privacy protocol, Privacy passphrase, Confirm privacy passphrase	The three fields are available when the security level is set to authPriv. <ul style="list-style-type: none"> Select the Privacy Protocol - DES or AES Enter the privacy passphrase and then confirm the privacy passphrase

7. Click Save.

Downloading SNMP MIB

You must download an appropriate SNMP MIB file for successful SNMP communications. Always use the latest SNMP MIB downloaded from the current firmware of your PX3.

You can download the MIBs from two different pages of the web interface.

▶ **MIB download via the SNMP page:**

1. Choose Device Settings > Network Services > SNMP.
2. Click the Download MIBs title bar.



3. Select the desired MIB file to download.
 - PDU2-MIB: The SNMP MIB file for PX3 management.
 - ASSETMANAGEMENT-MIB: The SNMP MIB file for asset management.
 - LHX-MIB: The SNMP MIB file for managing the LHX/SHX heat exchanger(s).
4. Click Save to save the file onto your computer.

▶ **MIB download via the Device Information page:**

1. Choose Maintenance > Device Information.
2. In the Information section, click the desired download link:
 - PDU2-MIB
 - ASSETMANAGEMENT-MIB
 - LHX MIB
3. Click Save to save the file onto your computer.

*Note: LHX-MIB is available only after the LHX/SHX support has been enabled. See **Miscellaneous** (on page 453).*

SNMP Gets and Sets

In addition to sending notifications, the PX3 is able to receive SNMP get and set requests from third-party SNMP managers.

- Get requests are used to retrieve information about the PX3, such as the system location, and the current on a specific outlet.
- Set requests are used to configure a subset of the information, such as the SNMP system name.

Note: The SNMP system name is the PX3 device name. When you change the SNMP system name, the device name shown in the web interface is also changed.

The PX3 does NOT support configuring IPv6-related parameters using the SNMP set requests.

Valid objects for these requests are limited to those found in the SNMP MIB-II System Group and the custom PX3 MIB.

The PX3 MIB

The SNMP MIB file is required for using your PX3 with an SNMP manager. An SNMP MIB file describes the SNMP functions.

Layout

Opening the MIB reveals the custom objects that describe the PX3 system at the unit level as well as at the individual-outlet level.

As standard, these objects are first presented at the beginning of the file, listed under their parent group. The objects then appear again individually, defined and described in detail.

```

measurementsGroup      OBJECT-GROUP
OBJECTS {
    measurementsUnitSensorIsAvailable,
    measurementsUnitSensorState,
    measurementsUnitSensorValue,
    measurementsUnitSensorTimeStamp,
    measurementsInletSensorIsAvailable,
    measurementsInletSensorState,
    measurementsInletSensorValue,
    measurementsInletSensorTimeStamp,
    measurementsInletPoleSensorIsAvailable,
    measurementsInletPoleSensorState,
    measurementsInletPoleSensorValue,
    measurementsInletPoleSensorTimeStamp,
    measurementsOutletSensorIsAvailable,
    measurementsOutletSensorState,
    measurementsOutletSensorValue,
    measurementsOutletSensorTimeStamp,
    measurementsOutletPoleSensorIsAvailable,
    measurementsOutletPoleSensorState,
    measurementsOutletPoleSensorValue,
    measurementsOutletPoleSensorTimeStamp,
    measurementsOverCurrentProtectorSensorIsAvailable,
    measurementsOverCurrentProtectorSensorState,
    measurementsOverCurrentProtectorSensorValue,
    measurementsOverCurrentProtectorSensorTimeStamp,
    measurementsExternalSensorIsAvailable,
    measurementsExternalSensorState,
    measurementsExternalSensorValue,
    measurementsExternalSensorTimeStamp
}
STATUS current
DESCRIPTION
    "A collection of objects providing the logging capabilities
    about the pdu."
  
```

For example, the measurementsGroup group contains objects for sensor readings of PX3 as a whole. One object listed under this group, measurementsUnitSensorValue, is described later in the MIB as "The sensor value". pduRatedCurrent, part of the configGroup group, describes the PDU current rating.

SNMP Sets and Thresholds

Some objects can be configured from the SNMP manager using SNMP set commands. Objects that can be configured have a MAX-ACCESS level of "read-write" in the MIB.

These objects include threshold objects, which cause the PX3 to generate a warning and send an SNMP notification when certain parameters are exceeded. See **Sensor Threshold Settings** (on page 879) for a description of how thresholds work.

Note: When configuring the thresholds via SNMP set commands, ensure the value of upper critical threshold is higher than that of upper warning threshold.

Configuring NTP Server Settings

Using SNMP, you can change the following NTP server-related settings in the `unitConfigurationTable`:

- Enable or disable synchronization of the device's date and time with NTP servers (`synchronizeWithNTPServer`)
- Enable or disable the use of DHCP-assigned NTP servers if synchronization with NTP servers is enabled (`useDHCPProvidedNTPServer`)
- Manually assign the primary NTP server if the use of DHCP-assigned NTP servers is disabled (`firstNTPServerAddressType` and `firstNTPServerAddress`)
- Manually assign the secondary NTP server (optional) (`secondNTPServerAddressType` and `secondNTPServerAddress`)

*Tip: To specify the time zone, use the CLI or web interface instead. For the CLI, see **Setting the Time Zone** (on page 599). For the web interface, see **Setting the Date and Time** (on page 360).*

When using the SNMP SET command to specify or change NTP servers, it is required that both the NTP server's address type and address be set in the command line simultaneously.

For example, the SNMP command to change the primary NTP server's address from IPv4 (192.168.84.84) to host name looks similar to the following:

```
snmpset -v2c -c private 192.168.84.84
firstNTPServerAddressType = dns firstNTPServerAddress =
"angu.pep.com"
```

Retrieving Energy Usage

You can discover how much energy an IT device consumes by retrieving the Active Energy for the outlet this IT device is plugged into. The Active Energy values are included in the `outletSensorMeasurementsTable`, along with other outlet sensor readings.

A Note about Enabling Thresholds

When enabling previously-disabled thresholds via SNMP, make sure you set a correct value for all thresholds that are supposed to be enabled prior to actually enabling them. Otherwise, you may get an error message.

Chapter 9 Using the Command Line Interface

This section explains how to use the command line interface (CLI) to administer the PX3.

Note that available CLI commands are model dependent.

CLI commands are case sensitive.

In This Chapter

About the Interface	515
Logging in to CLI	516
The ? Command for Showing Available Commands	519
Querying Available Parameters for a Command	520
Showing Information	521
Clearing Information	556
Configuring the PX3 Device and Network	557
Load Shedding Configuration Commands	693
Power Control Operations	694
Actuator Control Operations	698
Unblocking a User	699
Resetting the PX3	700
Network Troubleshooting	701
Retrieving Previous Commands	704
Automatically Completing a Command	705
Logging out of CLI	705

About the Interface

The PX3 provides a command line interface that enables data center administrators to perform some basic management tasks.

Using this interface, you can do the following:

- Reset the PX3
- Display the PX3 and network information, such as the device name, firmware version, IP address, and so on
- Configure the PX3 and network settings
- Troubleshoot network problems

You can access the interface over a local connection using a terminal emulation program such as HyperTerminal, or via a Telnet or SSH client such as PuTTY.

*Note: Telnet access is disabled by default because it communicates openly and is thus insecure. To enable Telnet, see **Changing Telnet Settings** (on page 333).*

Logging in to CLI

Logging in via HyperTerminal over a local connection is a little different than logging in using SSH or Telnet.

If a security login agreement has been enabled, you must accept the agreement in order to complete the login. Users are authenticated first and the security banner is checked afterwards.

With HyperTerminal

You can use any terminal emulation programs for local access to the command line interface.

This section illustrates HyperTerminal, which is part of Windows operating systems prior to Windows Vista.

► **To log in using HyperTerminal:**

1. Connect your computer to the product via a local (USB or RS-232) connection.
2. Launch HyperTerminal on your computer and open a console window. When the window first opens, it is blank.

Make sure the COM port settings use this configuration:

- Bits per second = 115200 (115.2Kbps)
- Data bits = 8
- Stop bits = 1
- Parity = None
- Flow control = None

Tip: For a USB connection, you can determine the COM port by choosing Control Panel > System > Hardware > Device Manager, and locating the "Dominion PX2 Serial Console" under the Ports group.

3. In the communications program, press Enter to send a carriage return to the PX3. The Username prompt appears.

```
Username: _
```

4. Type a name and press Enter. The name is case sensitive. Then you are prompted to enter a password.

```
Username: admin
Password: _
```

5. Type a password and press Enter. The password is case sensitive.

After properly entering the password, the PDU name appears at the prompt. See **Different CLI Modes and Prompts** (on page 518) in the User Guide for more information.

Tip: The 'Last login' information, including the date and time, is also displayed if the same user account was used to log in to this product's web interface or CLI.

6. You are now logged in to the command line interface and can begin administering this product.

With SSH or Telnet

You can remotely log in to the command line interface (CLI) using an SSH or Telnet client, such as PuTTY.

Note: PuTTY is a free program you can download from the Internet. Refer to PuTTY's documentation for details on configuration.

► To log in using SSH or Telnet:

1. Ensure SSH or Telnet has been enabled. See **Configuring Network Services** (on page 326) in the User Guide.
2. Launch an SSH or Telnet client and open a console window. A login prompt appears.

```
login as: █
```

3. Type a name and press Enter. The name is case sensitive.

Note: If using the SSH client, the name must NOT exceed 25 characters. Otherwise, the login fails.

Then you are prompted to enter a password.

```
login as: admin
admin@192.168.84.88's password: █
```

4. Type a password and press Enter. The password is case sensitive.
5. After properly entering the password, the PDU name appears at the prompt. See **Different CLI Modes and Prompts** (on page 518) in the User Guide for more information.

Tip: The 'Last login' information, including the date and time, is also displayed if the same user account was used to log in to this product's web interface or CLI.

6. You are now logged in to the command line interface and can begin administering this product.

With an Analog Modem

The PX3 supports remote access to the CLI via a connected analog modem. This feature is especially useful when the LAN access is not available.

► **To connect to the PX3 via the modem:**

1. Make sure the PX3 has an analog modem connected. See **Connecting an Analog Modem** (on page 78).
2. Make sure the computer you are using has an appropriate modem connected.
3. Launch a terminal emulation program, and configure its baud rate settings according to the baud rate set for the analog modem connected to the PX3. See **Configuring the Serial Port** (on page 446).
4. Type the following AT command to make a connection with the PX3.
`ATD<modem phone number>`
5. The CLI login prompt appears after the connection is established successfully. Then type the user name and password to log in to the CLI.

► **To disconnect from the PX3:**

1. Return to the modem's command mode using the escape code +++.
2. After the OK prompt appears, type the following AT command to disconnect from the PX3.
`ATH`

Different CLI Modes and Prompts

Depending on the login name you use and the mode you enter, the system prompt in the CLI varies. The PDU name appears with the prompt.

- **User Mode:** When you log in as a normal user, who may not have full permissions to configure the PX3, the > prompt appears.
- **Administrator Mode:** When you log in as an administrator, who has full permissions to configure the PX3, the # prompt appears.
- **Configuration Mode:** You can enter the configuration mode from the administrator or user mode. In this mode, the prompt changes to **config:#** or **config:>** and you can change PX3 device and network configurations. See **Entering Configuration Mode** (on page 557).
- **Diagnostic Mode:** You can enter the diagnostic mode from the administrator or user mode. In this mode, the prompt changes to **diag:#** or **diag:>** and you can perform the network troubleshooting commands, such as the ping command. See **Entering Diagnostic Mode** (on page 702).

Closing a Local Connection

Close the window or terminal emulation program when you finish accessing the PX3 over the local connection.

When accessing or upgrading multiple PX3 devices, do not transfer the local connection cable from one device to another without closing the local connection window first.

The ? Command for Showing Available Commands

When you are not familiar with CLI commands, you can press the ? key at anytime for one of the following purposes.

- Show a list of main CLI commands available in the current mode.
- Show a list of available commands or parameters for the command you type. See **Querying Available Parameters for a Command** (on page 520).

▶ **In the administrator mode:**

```
#                ?
```

▶ **In the configuration mode:**

```
config:#        ?
```

▶ **In the diagnostic mode:**

```
diag:#          ?
```

Press Enter after pressing the ? command, and a list of main commands for the current mode is displayed.

*Tip: To automatically complete a command after typing part of the full command, see **Automatically Completing a Command** (on page 705). To re-execute one of the previous commands, see **Retrieving Previous Commands** (on page 704).*

Querying Available Parameters for a Command

If you are not sure what commands or parameters are available for a particular type of CLI command or its syntax, you can have the CLI show them by adding a space and the help command (?) or list command (ls) to the end of that command. A list of available parameters and their descriptions will be displayed.

The following shows a few query examples.

▶ **To query available parameters for the "show" command:**

```
# show ?
```

▶ **To query available parameters for the "show user" command:**

```
# show user ?
```

▶ **To query available role configuration parameters:**

```
config:# role ?
```

▶ **To query available parameters for the "role create" command:**

```
config:# role create ?
```

*Tip: To automatically complete a command after typing part of the full command, see **Automatically Completing a Command** (on page 705). To re-execute one of the previous commands, see **Retrieving Previous Commands** (on page 704).*

Showing Information

You can use the show commands to view current settings or the status of the PX3 device or part of it, such as the IP address, networking mode, firmware version, states or readings of internal or external sensors, user profiles, and so on.

Some "show" commands have two formats: one with the parameter "details" and the other without. The difference is that the command without the parameter "details" displays a shortened version of information while the other displays in-depth information.

After typing a "show" command, press Enter to execute it.

*Note: Depending on your login name, the # prompt may be replaced by the > prompt. See **Different CLI Modes and Prompts** (on page 518).*

Network Configuration

This command shows all network configuration and all network interfaces' information, such as the IP address, MAC address, the Ethernet interfaces' duplex mode, and the wireless interface's status/settings.

```
#          show network
```

IP Configuration

This command shows the IP settings shared by all network interfaces, such as DNS and routes. Information shown will include both IPv4 and IPv6 configuration.

*Tip: To show IPv4-only and IPv6-only configuration data, see **IPv4-Only or IPv6-Only Configuration** (on page 523).*

```
# show network ip common
```

To show the IP settings of a specific network interface, use the following command.

```
# show network ip interface <ETH>
```

Variables:

- <ETH> is one of the network interfaces: *ETH1/ETH2, WIRELESS, or BRIDGE*. Note that you must choose/configure the bridge interface if your PX3 is set to the bridging mode.

Note: In the bridging mode, only the IP parameters of the BRIDGE interface function. The IP parameters of ETH1/ETH2 and WIRELESS interfaces do NOT function.

Interface	Description
eth1	Show the IP-related configuration of the ETH1 interface.
eth2	Show the IP-related configuration of the ETH2 interface.
wireless	Show the IP-related configuration of the WIRELESS interface.
bridge	Show the IP-related configuration of the BRIDGE interface.
all	Show the IP-related configuration of all interfaces. <hr/> <i>Tip: You can also type the command without adding this option "all" to get the same data. That is, show network ip interface.</i>

IPv4-Only or IPv6-Only Configuration

To show IPv4-only or IPv6-only configuration, use any of the following commands.

*Tip: To show both IPv4 and IPv6 configuration data, see **IP Configuration** (on page 522).*

▶ **To show IPv4 settings shared by all network interfaces, such as DNS and routes:**

```
# show network ipv4 common
```

▶ **To show IPv6 settings shared by all network interfaces, such as DNS and routes:**

```
# show network ipv6 common
```

▶ **To show the IPv4 configuration of a specific network interface:**

```
# show network ipv4 interface <ETH>
```

▶ **To show the IPv6 configuration of a specific network interface:**

```
# show network ipv6 interface <ETH>
```

Variables:

- <ETH> is one of the network interfaces: *ETH1/ETH2*, *WIRELESS*, or *BRIDGE*. Note that you must choose/configure the bridge interface if your PX3 is set to the bridging mode.

Note: In the bridging mode, only the IP parameters of the BRIDGE interface function. The IP parameters of ETH1/ETH2 and WIRELESS interfaces do NOT function.

Interface	Description
eth1	Show the IPv4 or IPv6 configuration of the ETH1 interface.
eth2	Show the IPv4 or IPv6 configuration of the ETH2 interface.
wireless	Show the IPv4 or IPv6 configuration of the WIRELESS interface.

Interface	Description
bridge	Show the IPv4 or IPv6 configuration of the BRIDGE interface.
all	Show the IPv4 or IPv6 configuration of all interfaces. <i>Tip: You can also type the command without adding this option "all" to get the same data. That is, show network ipv4 interface.</i>

Network Interface Settings

This command shows the specified network interface's information which is NOT related to IP configuration. For example, the Ethernet port's LAN interface speed and duplex mode, or the wireless interface's SSID parameter and authentication protocol.

```
# show network interface <ETH>
```

Variables:

- <ETH> is one of the network interfaces: *ETH1/ETH2*, *WIRELESS*, or *BRIDGE*. Note that you must choose/configure the bridge interface if your PX3 is set to the bridging mode.

Note: In the bridging mode, only the IP parameters of the BRIDGE interface function. The IP parameters of ETH1/ETH2 and WIRELESS interfaces do NOT function.

Interface	Description
eth1	Show the ETH1 interface's non-IP settings.
eth2	Show the ETH2 interface's non-IP settings.
wireless	Show the WIRELESS interface's non-IP settings.
bridge	Show the BRIDGE interface's non-IP settings.
all	Show the non-IP settings of all interfaces. <i>Tip: You can also type the command without adding this option "all" to get the same data. That is, show network interface.</i>

Network Service Settings

This command shows the network service settings only, including the Telnet setting, TCP ports for HTTP, HTTPS, SSH and Modbus/TCP services, and SNMP settings.

```
# show network services <option>
```

Variables:

- <option> is one of the options: *all*, *http*, *https*, *telnet*, *ssh*, *snmp*, *modbus* and *zeroconfig*.

Option	Description
all	Displays the settings of all network services, including HTTP, HTTPS, Telnet, SSH and SNMP. <i>Tip: You can also type the command without adding this option "all" to get the same data.</i>
http	Only displays the TCP port for the HTTP service.
https	Only displays the TCP port for the HTTPS service.
telnet	Only displays the settings of the Telnet service.
ssh	Only displays the settings of the SSH service.
snmp	Only displays the SNMP settings.
modbus	Only displays the settings of the Modbus/TCP service.
zeroconfig	Only displays the settings of the zero configuration advertising.

PDU Configuration

This command shows the PDU configuration, such as the device name, firmware version, model type and upper limit of active powered dry contact actuators.

```
# show pdu
```

To show detailed information, add the parameter "details" to the end of the command.

```
# show pdu details
```

Outlet Information

This command syntax shows the outlet information.

```
#          show outlets <n>
```

To show detailed information, add the parameter "details" to the end of the command.

```
#          show outlets <n> details
```

Variables:

- <n> is one of the options: *all*, or a number.

Option	Description
all	Displays the information for all outlets. <i>Tip: You can also type the command without adding this option "all" to get the same data.</i>
A specific outlet number	Displays the information for the specified outlet only.

Displayed information:

- Without the parameter "details," only the outlet name and state are displayed.
- With the parameter "details," more outlet information is displayed in addition to the state, such as rated current, voltage, active power, active energy, and outlet settings.

Outlet Group Information

This command syntax shows the outlet group information.

```
# show outletgroups <n>
```

To show detailed information, add the parameter "details" to the end of the command.

```
# show outletgroups <n> details
```

Variables:

- <n> is one of the options: *all*, or a number.

Option	Description
all	Displays the information for all outlet groups. <i>Tip: You can also type the command without adding this option "all" to get the same data.</i>
A specific outlet group number	Displays the information for the specified outlet group only.

Displayed information:

- Without the parameter "details," only the group's name, the group's index number, member outlets and the group's power state (if it is a switched PDU) are displayed.
- With the parameter "details," more inlet information is displayed in addition to the above outlet group information, such as each member outlet's power state and the group's active energy.

Tip: PX3 allows you to assign the same name to diverse outlet groups. If this really occurs, you still can identify different groups through their unique index numbers.

Inlet Information

This command syntax shows the inlet information.

```
# show inlets <n>
```

To show detailed information, add the parameter "details" to the end of the command.

```
# show inlets <n> details
```

Variables:

- <n> is one of the options: *all*, or a number.

Option	Description
all	Displays the information for all inlets. <i>Tip: You can also type the command without adding this option "all" to get the same data.</i>
A specific inlet number	Displays the information for the specified inlet only. An inlet number needs to be specified only when there are more than 1 inlet on your PDU.

Displayed information:

- Without the parameter "details," only the inlet's name and RMS current are displayed.
- With the parameter "details," more inlet information is displayed in addition to the inlet name and RMS current, such as the inlet's RMS voltage, active power and active energy.

Overcurrent Protector Information

This command is only available for models with overcurrent protectors for protecting outlets.

This command syntax shows the overcurrent protector information, such as a circuit breaker or a fuse.

```
#          show ocp <n>
```

To show detailed information, add the parameter "details" to the end of the command.

```
#          show ocp <n> details
```

Variables:

- <n> is one of the options: *all*, or a number.

Option	Description
all	Displays the information for all overcurrent protectors. <i>Tip: You can also type the command without adding this option "all" to get the same data.</i>
A specific overcurrent protector number	Displays the information for the specified overcurrent protector only.

Displayed information:

- Without the parameter "details," only the overcurrent protector status and name are displayed.
- With the parameter "details," more overcurrent protector information is displayed in addition to status, such as the rating and RMS current value.
- For Raritan's outlet-metered models that support "outlet peak current" sensors, information indicating which outlet MAY cause the OCP-tripped event is available with this command. See **Possible OCP-Tripped Root Cause** (on page 247).

Date and Time Settings

This command shows the current date and time settings on the PX3.

```
# show time
```

To show detailed information, add the parameter "details" to the end of the command.

```
# show time details
```

Default Measurement Units

This command shows the default measurement units applied to the PX3 web and CLI interfaces across all users, especially those users authenticated through remote authentication servers.

```
# show user defaultPreferences
```

*Note: If a user has set his/her own preferred measurement units or the administrator has changed any user's preferred units, the web and CLI interfaces show the preferred measurement units for that user instead of the default ones. See **Existing User Profiles** (on page 546) for the preferred measurement units for a specific user.*

Environmental Sensor Information

This command syntax shows the environmental sensor's information.

```
# show externalsensors <n>
```

To show detailed information, add the parameter "details" to the end of the command.

```
# show externalsensors <n> details
```

```
# show externalsensors 2 details
External sensor 2 ('Temperature 2')
Sensor type: Temperature
Reading:      24.0 deg C (normal)

Serial number:      QMSemu0004
Description:        Not configured
Location:           X Not configured
                   Y Not configured
                   Z Not configured
Position:           Port 1, Chain Position 4
Using default thresholds: yes
```

Variables:

- <n> is one of the options: *all*, or a number.

Option	Description
all	Displays the information of all environmental sensors. <i>Tip: You can also type the command without adding this option "all" to get the same data.</i>
A specific environmental sensor number*	Displays the information for the specified environmental sensor only.

* The environmental sensor number is the ID number assigned to the sensor, which can be found on the Peripherals page of the PX3 web interface.

Displayed information:

- Without the parameter "details," only the sensor ID, sensor type and reading are displayed.

Note: A state sensor displays the sensor state instead of the reading.

- With the parameter "details," more information is displayed in addition to the ID number and sensor reading, such as the serial number, sensor position, and X, Y, and Z coordinates.

Environmental Sensor Package Information

Different from the "show externalsensors" commands, which show the reading, status and configuration of an individual environmental sensor, the following command shows the information of all connected environmental sensor packages, each of which may contain more than one sensor or actuator.

```
# show peripheralDevicePackages
```

Information similar to the following is displayed. Peripheral Device Package refers to an environmental sensor package.

```
Peripheral Device Package 1
Serial Number:      1GE7A00022
Package Type:       DX2-T1H1
Position:           Port 1, Chain Position 1
Package State:      operational
Firmware Version:  33.0
```

```
Peripheral Device Package 2
Serial Number:      1GE7A00021
Package Type:       DX2-T3H1
Position:           Port 1, Chain Position 2
Package State:      operational
Firmware Version:  33.0
```

Actuator Information

This command syntax shows an actuator's information.

```
# show actuators <n>
```

To show detailed information, add the parameter "details" to the end of the command.

```
# show actuators <n> details
```

Variables:

- <n> is one of the options: *all*, or a number.

Option	Description
all	Displays the information for all actuators. <i>Tip: You can also type the command without adding this option "all" to get the same data.</i>
A specific actuator number*	Displays the information for the specified actuator only.

* The actuator number is the ID number assigned to the actuator. The ID number can be found using the PX3 web interface or CLI. It is an integer starting at 1.

Displayed information:

- Without the parameter "details," only the actuator ID, type and state are displayed.
- With the parameter "details," more information is displayed in addition to the ID number and actuator state, such as the serial number and X, Y, and Z coordinates.

Outlet Sensor Threshold Information

This command syntax shows the specified outlet sensor's threshold-related information.

```
# show sensor outlet <n> <sensor type>
```

To show detailed information, add the parameter "details" to the end of the command.

```
# show sensor outlet <n> <sensor type> details
```

Variables:

- <n> is the number of the outlet whose sensors you want to query.
- <sensor type> is one of the following sensor types:

Sensor type	Description
current	Current sensor
voltage	Voltage sensor
activePower	Active power sensor
apparentPower	Apparent power sensor
powerFactor	Power factor sensor
activeEnergy	Active energy sensor
lineFrequency	Line frequency sensor

Displayed information:

- Without the parameter "details," only the sensor reading, state, threshold, deassertion hysteresis and assertion timeout settings of the specified outlet sensor are displayed.
- With the parameter "details," more sensor information is displayed, including resolution and range.
- If the requested sensor type is not supported, the "Sensor is not available" message is displayed.

Outlet Pole Sensor Threshold Information

This command is available for an in-line monitor only, including PX2-3000 and PX3-3000 series.

This command syntax shows the specified outlet pole sensor's threshold-related information.

```
# show sensor outletpole <n> <p> <sensor type>
```

To show detailed information, add the parameter "details" to the end of the command.

```
# show sensor outletpole <n> <p> <sensor type> details
```

Variables:

- <n> is the number of the outlet whose pole sensors you want to query.
- <p> is the label of the outlet pole whose sensors you want to query.

Pole	Label <p>	Current sensor	Voltage sensor
1	L1	L1	L1 - L2
2	L2	L2	L2 - L3
3	L3	L3	L3 - L1

- <sensor type> is one of the following sensor types:

Sensor type	Description
current	Current sensor
voltage	Voltage sensor
activePower	Active power sensor
apparentPower	Apparent power sensor
powerFactor	Power factor sensor
activeEnergy	Active energy sensor

Displayed information:

- Without the parameter "details," only the reading, state, threshold, deassertion hysteresis and assertion delay settings of the specified outlet pole sensor are displayed.
- With the parameter "details," more sensor information is displayed, including resolution and range.
- If the requested sensor type is not supported, the "Sensor is not available" message is displayed.

Outlet Group Threshold Information

This command syntax shows the specified outlet group sensor's threshold-related information.

```
# show sensor outletgroup <ID> <sensor type>
```

To show detailed information, add the parameter "details" to the end of the command.

```
# show sensor outletgroup <ID> <sensor type> details
```

Variables:

- <ID> is an outlet group's index number.
- <sensor type> is one of the following sensor types:

Sensor type	Description
activePower	An outlet group's active power sensor
activeEnergy	An outlet group's active energy sensor

For definitions on an outlet group's sensors, see **Outlet Groups** (on page 226).

Displayed information:

- Without the parameter "details," only the sensor reading, state, threshold, deassertion hysteresis and assertion timeout settings of the specified group sensor are displayed.
- With the parameter "details," more sensor information is displayed, including resolution and range.

Inlet Sensor Threshold Information

This command is NOT available for an in-line monitor (PX3-3000 series).

This command syntax shows the specified inlet sensor's threshold-related information.

```
# show sensor inlet <n> <sensor type>
```

To show detailed information, add the parameter "details" to the end of the command.

```
# show sensor inlet <n> <sensor type> details
```

Variables:

- <n> is the number of the inlet whose sensors you want to query. For a single-inlet PDU, <n> is always 1.
- <sensor type> is one of the following sensor types:

Sensor type	Description
current	Current sensor
voltage	Voltage sensor
activePower	Active power sensor
apparentPower	Apparent power sensor
powerFactor	Power factor sensor
activeEnergy	Active energy sensor
unbalancedCurrent	Unbalanced load sensor
lineFrequency	Line frequency sensor

Displayed information:

- Without the parameter "details," only the reading, state, threshold, deassertion hysteresis and assertion timeout settings of the specified inlet sensor are displayed.
- With the parameter "details," more sensor information is displayed, including resolution and range.
- If the requested sensor type is not supported, the "Sensor is not available" message is displayed.

► **Additional sensors supported by specific models:**

Specific PX3 models support some or all of the following sensors. The CLI command(s) listed above can be also applied to the following sensors. Note that the measurement unit of current values in CLI is **A**, not mA.

Sensor type	Description	
peakCurrent	Peak current sensor	Supported on PXC and Legrand PDU only <ul style="list-style-type: none"> ▪ three-phase models also support pole-level peak current ▪ models with metered breakers also support breaker-level peak current
reactivePower	Reactive power sensor	
displacementPowerFactor or	Displacement power factor sensor	
residualCurrent	RCM current sensor <ul style="list-style-type: none"> ▪ For Type A, it is the sensor that detects residual AC current. ▪ For Type B, it is the sensor that detects both residual AC and DC current. 	
residualDCCurrent	RCM DC current sensor - detects residual DC current only. Available only on PDUs with RCM Type B.	

*Note: For information on RCM Type A and B sensors, see **RCM Current Sensor** (on page 786).*

Inlet Pole Sensor Threshold Information

This command is only available for a three-phase PDU except for an in-line monitor (PX3-3000 series).

This command syntax shows the specified inlet pole sensor's threshold-related information.

```
# show sensor inletpole <n> <p> <sensor type>
```

To show detailed information, add the parameter "details" to the end of the command.

```
# show sensor inletpole <n> <p> <sensor type> details
```

Variables:

- <n> is the number of the inlet whose pole sensors you want to query. For a single-inlet PDU, <n> is always 1.
- <p> is the label of the inlet pole whose sensors you want to query.

Pole	Label <p>	Current sensor	Voltage sensor
1	L1	L1	L1 - L2
2	L2	L2	L2 - L3
3	L3	L3	L3 - L1

- <sensor type> is one of the following sensor types:

Sensor type	Description
current	Current sensor
voltage	Voltage sensor
activePower	Active power sensor
apparentPower	Apparent power sensor
powerFactor	Power factor sensor
activeEnergy	Active energy sensor

Displayed information:

- Without the parameter "details," only the reading, state, threshold, deassertion hysteresis and assertion timeout settings of the specified inlet pole sensor are displayed.
- With the parameter "details," more sensor information is displayed, including resolution and range.
- If the requested sensor type is not supported, the "Sensor is not available" message is displayed.

► **Additional sensors supported by specific models:**

Specific PX3 models support some or all of the following sensors. The CLI command(s) listed above can be also applied to the following sensors. Note that the measurement unit of current values in CLI is **A**, not mA.

Sensor type	Description	
peakCurrent	Peak current sensor	Supported on PXC and Legrand PDU only <ul style="list-style-type: none"> ▪ three-phase models also support pole-level peak current ▪ models with metered breakers also support breaker-level peak current
reactivePower	Reactive power sensor	
displacementPowerFactor	Displacement power factor sensor	
residualCurrent	RCM current sensor <ul style="list-style-type: none"> ▪ For Type A, it is the sensor that detects residual AC current. ▪ For Type B, it is the sensor that detects both residual AC and DC current. 	
residualDCCurrent	RCM DC current sensor - detects residual DC current only. Available only on PDUs with RCM Type B.	

*Note: For information on RCM Type A and B sensors, see **RCM Current Sensor** (on page 786).*

Overcurrent Protector Sensor Threshold Information

This command is only available for models with overcurrent protectors for protecting outlets.

This command syntax shows the specified overcurrent protector sensor's threshold-related information.

```
# show sensor ocp <n> <sensor type>
```

To show detailed information, add the parameter "details" to the end of the command.

```
# show sensor ocp <n> <sensor type> details
```

Variables:

- <n> is the number of the overcurrent protector whose sensors you want to query.
- <sensor type> is one of the following sensor types:

Sensor type	Description
current	Current sensor

Displayed information:

- Without the parameter "details," only the reading, state, threshold, deassertion hysteresis and assertion timeout settings of the specified overcurrent protector sensor are displayed.
- With the parameter "details," more sensor information is displayed, including resolution and range.

Environmental Sensor Threshold Information

This command syntax shows the specified environmental sensor's threshold-related information.

```
# show sensor externalsensor <n>
```

To show detailed information, add the parameter "details" to the end of the command.

```
# show sensor externalsensor <n> details
```

```
External sensor 1 (Temperature):
Reading: 22.6 deg C
State: normal

Active Thresholds: Default thresholds

Default Thresholds for Temperature sensors:
Lower critical threshold: 10.0 deg C
Lower warning threshold: 15.0 deg C
Upper warning threshold: 30.0 deg C
Upper critical threshold: 35.0 deg C
Deassertion hysteresis: 1.0 deg C
Assertion timeout: 0 samples

Sensor Specific Thresholds:
Lower critical threshold: 10.0 deg C
Lower warning threshold: 15.0 deg C
Upper warning threshold: 30.0 deg C
Upper critical threshold: 35.0 deg C
Deassertion hysteresis: 1.0 deg C
Assertion timeout: 0 samples
```

Variables:

- <n> is the environmental sensor number. The environmental sensor number is the ID number assigned to the sensor, which can be found on the Peripherals page of the PX3 web interface.

Displayed information:

- Without the parameter "details," only the reading, threshold, deassertion hysteresis and assertion timeout settings of the specified environmental sensor are displayed.
- With the parameter "details," more sensor information is displayed, including resolution and range.

Note: For a state sensor, the threshold-related and accuracy-related data is NOT available.

Environmental Sensor Default Thresholds

This command syntax shows a certain sensor type's default thresholds, which are the initial thresholds applying to the specified type of sensor.

```
#          show defaultThresholds <sensor type>
```

To show detailed information, add the parameter "details" to the end of the command.

```
#          show defaultThresholds <sensor type> details
```

Variables:

- <sensor type> is one of the following numeric sensor types:

Sensor types	Description
absoluteHumidity	Absolute humidity sensors
relativeHumidity	Relative humidity sensors
temperature	Temperature sensors
airPressure	Air pressure sensors
airFlow	Air flow sensors
vibration	Vibration sensors

Sensor types	Description
all	All of the above numeric sensors <i>Tip: You can also type the command without adding this option "all" to get the same data.</i>

Displayed information:

- Without the parameter "details," only the default upper and lower thresholds, deassertion hysteresis and assertion timeout settings of the specified sensor type are displayed.
- With the parameter "details," the threshold range is displayed in addition to default thresholds settings.

Security Settings

This command shows the security settings of the PX3.

```
# show security
```

To show detailed information, add the parameter "details" to the end of the command.

```
# show security details
```

Displayed information:

- Without the parameter "details," the information including IP access control, role-based access control, password policy, and HTTPS encryption is displayed.
- With the parameter "details," more security information is displayed, such as user blocking time, user idle timeout and front panel permissions (if supported by your model).

Authentication Settings

▶ General authentication settings:

This command displays the authentication settings of the PX3, including both LDAP and Radius settings.

```
# show authentication
```

▶ One LDAP server's settings:

To show the configuration of a specific LDAP server, assign the desired LDAP server with its sequential number in the command. To get detailed information, add "details" to the end of the command.

```
# show authentication ldapServer <server_num>
```

-- OR --

```
# show authentication ldapServer <server_num> details
```

▶ One Radius server's settings:

To show the configuration of a specific Radius server, assign the desired Radius server with its sequential number in the command. To get detailed information, add "details" to the end of the command.

```
# show authentication radiusServer <server_num>
```

-- OR --

```
# show authentication radiusServer <server_num> details
```

Variables:

- <server_num> is the sequential number of the specified authentication server on the LDAP or Radius server list.

Displayed information:

- Without specifying any server, PX3 shows the authentication type and a list of both LDAP and Radius servers that have been configured.
- When specifying a server, only that server's basic configuration is displayed, such as IP address and port number.
- With the parameter "details" added, detailed information of the specified server is displayed, such as an LDAP server's bind DN and the login name attribute, or a Radius server's timeout and retries values.

Existing User Profiles

This command shows the data of one or all existing user profiles.

```
# show user <user_name>
```

To show detailed information, add the parameter "details" to the end of the command.

```
# show user <user_name> details
```

Variables:

- <user_name> is the name of the user whose profile you want to query. The variable can be one of the options: *all* or a user's name.

Option	Description
all	This option shows all existing user profiles. <i>Tip: You can also type the command without adding this option "all" to get the same data.</i>
a specific user's name	This option shows the profile of the specified user only.

Displayed information:

- Without the parameter "details," only four pieces of user information are displayed: user name, user "Enabled" status, SNMP v3 access privilege, and role(s).
- With the parameter "details," more user information is displayed, such as the telephone number, e-mail address, preferred measurement units and so on.

Existing Roles

This command shows the data of one or all existing roles.

```
# show roles <role_name>
```

Variables:

- <role_name> is the name of the role whose permissions you want to query. The variable can be one of the following options:

Option	Description
all	This option shows all existing roles. <i>Tip: You can also type the command without adding this option "all" to get the same data.</i>
a specific role's name	This option shows the data of the specified role only.

Displayed information:

- Role settings are displayed, including the role description and privileges.

Load Shedding Settings

This section applies to outlet-switching capable models only.

This command shows the load shedding settings.

```
# show loadshedding
```

Displayed information:

- The load shedding state is displayed along with non-critical outlets.

*Note: The load shedding mode is associated with critical and non-critical outlets. To specify critical and non-critical outlets through CLI, see **Specifying Non-Critical Outlets** (on page 562).*

Serial Port Settings

This command shows the baud rate setting of the serial port labeled CONSOLE / MODEM on the PX3.

```
# show serial
```

EnergyWise Settings

This command shows the PX3 device's current configuration for Cisco® EnergyWise.

```
# show energywise
```

Asset Strip Settings

This command shows the asset strip settings, such as the total number of rack units (tag ports), asset strip state, numbering mode, orientation, available tags and LED color settings.

```
# show assetStrip <n>
```

Variables:

- <n> is one of the options: *all*, or a number.

Option	Description
all	Displays all asset strip information. <i>Tip: You can also type the command without adding this option "all" to get the same data.</i>
A specific asset strip number	Displays the settings of the asset strip connected to the specified FEATURE port number. For the PX3 device with only one FEATURE port, the valid number is always 1.

Rack Unit Settings of an Asset Strip

A rack unit refers to a tag port on the asset strips. This command shows the settings of a specific rack unit or all rack units on an asset strip, such as a rack unit's LED color and LED mode.

```
#          show rackUnit <n> <rack_unit>
```

Variables:

- <n> is the number of the FEATURE port where the selected asset strip is physically connected. For the PX3 device with only one FEATURE port, the number is always 1.
- <rack_unit> is one of the options: *all* or a specific rack unit's index number.

Option	Description
all	<p>Displays the settings of all rack units on the specified asset strip.</p> <hr/> <p><i>Tip: You can also type the command without adding this option "all" to get the same data.</i></p>
A specific number	<p>Displays the settings of the specified rack unit on the specified asset strip.</p> <p>Use the index number to specify the rack unit. The index number is available on the asset strip or the Asset Strip page of the web interface.</p>

Event Log

The command used to show the event log begins with `show eventlog`. You can add either the *limit* or *class* parameters or both to show specific events.

▶ **Show the last 30 entries:**

```
# show eventlog
```

▶ **Show a specific number of last entries in the event log:**

```
# show eventlog limit <n>
```

▶ **Show a specific type of events only:**

```
# show eventlog class <event_type>
```

▶ **Show a specific number of last entries associated with a specific type of events only:**

```
# show eventlog limit <n> class <event_type>
```

Variables:

- <n> is one of the options: *all* or a number.

Option	Description
all	Displays all entries in the event log.
An integer number	Displays the specified number of last entries in the event log. The number ranges between 1 to 10,000.

- <event_type> is one of the following event types.

Event type	Description
all	All events.
device	Device-related events, such as system starting or firmware upgrade event.
userAdministration	User management events, such as a new user profile or a new role.
userActivity	User activities, such as login or logout.
pdu	Displays PDU-related events.
sensor	Internal or external sensor events, such as state changes of any sensors.

Event type	Description
serverMonitor	Server-monitoring records, such as a server being declared reachable or unreachable.
assetManagement	Raritan asset management events, such as asset tag connections or disconnections.
lhx	Schroff® LHX/SHX heat exchanger events.
modem	Modem-related events.
timerEvent	Scheduled action events.
webcam	Events for webcam management, if available.
cardReader	Events for card reader management, if available.
energywise	Cisco EnergyWise-related events, such as enabling the support of the EnergyWise function.

Network Connections Diagnostic Log

This command shows the diagnostic log for both the EAP authentication and wireless LAN connection.

```
#          show network diagLog
```

Server Reachability Information

This command shows all server reachability information with a list of monitored servers and status.

```
#          show serverReachability
```

Server Reachability Information for a Specific Server

To show the server reachability information for a certain IT device only, use the following command.

```
# show serverReachability server <n>
```

To show detailed information, add the parameter "details" to the end of the command.

```
# show serverReachability server <n> details
```

Variables:

- <n> is a number representing the sequence of the IT device in the monitored server list.
You can find each IT device's sequence number using the CLI command of `show serverReachability` as illustrated below.

#	IP address	Enabled	Status
1	192.168.84.126	Yes	Waiting for reliable connection
2	www.raritan.com	Yes	Waiting for reliable connection

Displayed information:

- Without the parameter "details," only the specified device's IP address, monitoring enabled/disabled state and current status are displayed.
- With the parameter "details," more settings for the specified device are displayed, such as number of pings and wait time prior to the next ping.

Command History

This command shows the command history for current connection session.

```
# show history
```

Displayed information:

- A list of commands that were previously entered in the current session is displayed.

Reliability Data

This command shows the reliability data.

```
# show reliability data
```

Reliability Error Log

This command shows the reliability error log.

```
# show reliability errorlog <n>
```

Variables:

- <n> is one of the options: 0 (zero) or any other integer number.

Option	Description
0	Displays all entries in the reliability error log. <i>Tip: You can also type the command without adding this option "0" to get all data.</i>
A specific integer number	Displays the specified number of last entries in the reliability error log.

Reliability Hardware Failures

This command shows a list of detected hardware failures.

```
# show reliability hwfailures
```

For details, see **Hardware Issue Detection** (on page 480).

Examples

This section provides examples of the show command.

Example 1 - Basic Security Information

The diagram shows the output of the *show security* command.

```
# show security
IPv4 access control: Disabled

IPv6 access control: Disabled

Role based access control for IPv4: Disabled
Role based access control for IPv6: Disabled

Password aging: Disabled

Prevent concurrent user login: No

Strong passwords: Disabled

Restricted Service Agreement: disabled
```

Example 2 - In-Depth Security Information

More information is displayed when typing the *show security details* command.

```
# show security details
IPv4 access control: Disabled

IPv6 access control: Disabled

Role based access control for IPv4: Disabled

Role based access control for IPv6: Disabled

Password aging: Disabled

Prevent concurrent user login: No
Maximum number of failed logins: 3
User block time: 10 minutes

User idle timeout: 10 minutes

Strong passwords: Disabled

Restricted Service Agreement: disabled
Restricted Service Agreement Banner Content:
Unauthorized access prohibited; all access and activities not explicitl
y authorized by management are unauthorized. All activities are monitor
ed and logged. There is no privacy on this system. Unauthorized access
and activities or any criminal activity will be reported to appropriate
authorities.

Front-Panel Permissions:
Switch Outlet: no
Switch Peripheral Actuator: no
```

Example 3 - Basic PDU Information

The diagram shows the output of the *show pdu* command.

```
# show pdu
PDU 'my PX'
Model: PX3-XXXX
Firmware Version: 2.X.0.5-40956
```

Example 4 - In-Depth PDU Information

More information is displayed when typing the `show pdu details` command. Displayed information varies depending on the model you purchased.

```
# show pdu details
PDU 'my PX'
Model:          PX3-XXXX
Firmware Version: 2.X.0.5-40956
Serial Number:  Q6Z3792136
Board Revision: 0x01

Voltage rating: 200-240V
Current rating: 16A
Frequency rating: 50/60Hz
Power rating:   3.2-3.8kVA

Sensor data retrieval: Enabled
Measurements per log entry: 60

External sensor Z coordinate format: Rack units
Device altitude:                   0 m
```

Clearing Information

You can use the clear commands to remove unnecessary data from the PX3. After typing a "clear" command, press Enter to execute it.

*Note: Depending on your login name, the # prompt may be replaced by the > prompt. See **Different CLI Modes and Prompts** (on page 518).*

Clearing Event Log

This command removes all data from the event log.

```
#          clear eventlog

-- OR --

#          clear eventlog /y
```

If you entered the command without "/y," a message appears, prompting you to confirm the operation. Type `y` to clear the event log or `n` to abort the operation.

If you type `y`, a message "Event log was cleared successfully" is displayed after all data in the event log is deleted.

Clearing Diagnostic Log for Network Connections

This command removes all data from the diagnostic log for both the EAP authentication and WLAN connection.

```
#          clear networkDiagLog
          -- OR --
#          clear networkDiagLog /y
```

If you entered the command without `/y`, a message appears, prompting you to confirm the operation. Type `y` to clear the log or `n` to abort the operation.

Configuring the PX3 Device and Network

To configure the PX3 device or network settings through the CLI, it is highly recommended to log in as the administrator so that you have full permissions.

To configure any settings, enter the configuration mode. Configuration commands are case sensitive so ensure you capitalize them correctly.

Entering Configuration Mode

Configuration commands function in configuration mode only.

► **To enter configuration mode:**

1. Ensure you have entered administrator mode and the `#` prompt is displayed.

*Note: If you enter configuration mode from user mode, you may have limited permissions to make configuration changes. See **Different CLI Modes and Prompts** (on page 518).*

2. Type `config` and press Enter.
3. The `config:#` prompt appears, indicating that you have entered configuration mode.

```
config:# _
```

4. Now you can type any configuration command and press Enter to change the settings.

Important: To apply new configuration settings, you must issue the "apply" command before closing the terminal emulation program. Closing the program does not save any configuration changes. See *Quitting Configuration Mode* (on page 558).

Quitting Configuration Mode

Both of "apply" and "cancel" commands let you quit the configuration mode. The difference is that "apply" saves all changes you made in the configuration mode while "cancel" aborts all changes.

► **To quit the configuration mode, use either command:**

```
config:#    apply
           -- OR --
config:#    cancel
```

The # or > prompt appears after pressing Enter, indicating that you have entered the administrator or user mode. See **Different CLI Modes and Prompts** (on page 518).

PDU Configuration Commands

One PDU configuration command begins with *pdu*. You can use the PDU configuration commands to change the settings that apply to the whole PX3 device.

Configuration commands are case sensitive so ensure you capitalize them correctly.

Changing the PDU Name

This command changes the device name of PX3.

```
config:#    pdu name "<name>"
```

Variables:

- <name> is a string comprising up to 64 ASCII printable characters. The <name> variable must be enclosed in quotes when it contains spaces.

Setting the Outlet Relay Behavior

This section applies to outlet-switching capable models only.

This command syntax determines the relay behavior of all outlets on a PX3 model.

```
config:# pdu relayBehaviorOnPowerLoss <option>
```

Variables:

- <option> is one of the options: *latching* or *nonLatching*.

*Note: For more information on the outlet relay behavior, see **PX3 Latching Relay Behavior** (on page 198).*

Setting the Outlet Power-On Sequence

This section applies to outlet-switching capable models only.

This command sets the outlet power-on sequence when the PDU powers up.

```
config:# pdu outletSequence <option>
```

Variables:

- <option> is one of the options: *default*, or a comma-separated list of outlet numbers.

Option	Description
default	All outlets are switched ON in the ASCENDING order (from outlet 1 to the final outlet) when the PX3 powers up.
A comma-separated list of outlet numbers	All outlets are switched ON in the order you specify using the comma-separated list. The list must include all outlets on the PDU.

*Note: Power-on sequencing is disabled in the latching mode. See **PX3 Latching Relay Behavior** (on page 198).*

Setting the Outlet Power-On Sequence Delay

This section applies to outlet-switching capable models only.

This command sets the delays (in seconds) for outlets when turning on all outlets in sequence.

```
config:# pdu outletSequenceDelay <outlet1>:<delay1>;<outlet2>:<delay2>;
<outlet3>:<delay3>;...
```

Separate outlet numbers and their delay settings with a colon. Outlets followed by delays are separated with a semicolon.

Variables:

- <outlet1>, <outlet2>, <outlet3> and the like are individual outlet numbers or a range of outlets using a dash. For example, 3-8 represents outlets 3 to 8.
- <delay1>, <delay2>, <delay3> and the like are the delay time in seconds.

*Note: Power-on sequencing is disabled in the latching mode. See **PX3 Latching Relay Behavior** (on page 198).*

Setting the PDU-Defined Default Outlet State

This section applies to outlet-switching capable models only.

This command determines the initial power condition of all outlets after powering up the PDU.

```
config:# pdu outletStateOnDeviceStartup <option>
```

Variables:

- <option> is one of the options: *off*, *on* or *lastKnownState*.

Option	Description
off	Switches OFF all outlets when the PX3 powers up.
on	Switches ON all outlets when the PX3 powers up.

Option	Description
lastKnownState	Restores all outlets to the previous status before powering down the PX3 when the PDU powers up again.

*Note: This feature does NOT take effect and cannot be configured on a PX3 device after the outlet relay is set to the "Latching" mode. See **PX3 Latching Relay Behavior** (on page 198).*

Setting the PDU-Defined Cycling Power-Off Period

This section applies to outlet-switching capable models only.

This command sets the power-off period of the power cycling operation for all outlets.

```
config:# pdu cyclingPowerOffPeriod <timing>
```

Variables:

- <timing> is the time of the cycling power-off period in seconds, which is an integer between 0 and 3600, or *pduDefined* for following the PDU-defined timing.

Setting the Inrush Guard Delay Time

This section applies to outlet-switching capable models only.

This command sets the inrush guard delay.

```
config:# pdu inrushGuardDelay <timing>
```

Variables:

- <timing> is a delay time between 100 and 100000 milliseconds.

Setting the Outlet Initialization Delay

This section applies to outlet-switching capable models only.

This command determines the outlet initialization delay timing on device startup. See **PDU** (on page 194) for information on outlet initialization delay.

```
config:# pdu outletInitializationDelayOnDeviceStartup <timing>
```

Variables:

- <timing> is a delay time between 1 and 3600 seconds.

*Note: This feature does NOT take effect and cannot be configured on a PX3 device after the outlet relay is set to the "Latching" mode. See **PX3 Latching Relay Behavior** (on page 198).*

Specifying Non-Critical Outlets

This section applies to outlet-switching capable models only.

This command determines critical and non-critical outlets. It is associated with the load shedding mode. See **Load Shedding Mode** (on page 215).

```
config:# pdu nonCriticalOutlets <outlets1>:false;<outlets2>:true
```

Separate outlet numbers and their settings with a colon. Separate each "false" and "true" setting with a semicolon.

Variables:

- <outlets1> is one or multiple outlet numbers to be set as critical outlets. Use commas to separate outlet numbers. Use a dash for a range of consecutive outlets. For example, 3-8 represents outlets 3 to 8.
- <outlets2> is one or multiple outlet numbers to be set as NON-critical outlets. Use commas to separate outlet numbers. Use a dash for a range of consecutive outlets. For example, 3-8 represents outlets 3 to 8.

Enabling or Disabling Data Logging

This command enables or disables the data logging feature.

```
config:# pdu dataRetrieval <option>
```

Variables:

- <option> is one of the options: *enable* or *disable*.

Option	Description
enable	Enables the data logging feature.
disable	Disables the data logging feature.

For more information, see **Setting Data Logging** (on page 427).

Setting Data Logging Measurements Per Entry

This command defines the number of measurements accumulated per log entry.

```
config:# pdu measurementsPerLogEntry <number>
```

Variables:

- <number> is an integer between 1 and 600. The default is 60 samples per log entry.

For more information, see **Setting Data Logging** (on page 427).

Specifying the Device Altitude

This command specifies the altitude of your PX3 above sea level (in meters). You must specify the altitude of PX3 above sea level if a Raritan's differential air pressure sensor is attached. This is because the device's altitude is associated with the altitude correction factor. See **Altitude Correction Factors** (on page 889).

```
config:# pdu deviceAltitude <altitude>
```

Variables:

- <altitude> is an integer between -425 and 3000 meters.
- Note that the lower limit "-425" is a negative value because some locations are below the seal level.

Setting the Z Coordinate Format for Environmental Sensors

This command enables or disables the use of rack units for specifying the height (Z coordinate) of environmental sensors.

```
config:# pdu externalSensorsZCoordinateFormat <option>
```

Variables:

- <option> is one of the options: *rackUnits* or *freeForm*.

Option	Description
rackUnits	The height of the Z coordinate is measured in standard rack units. When this is selected, you can type a numeric value in the rack unit to describe the Z coordinate of any environmental sensors or actuators.
freeForm	Any alphanumeric string can be used for specifying the Z coordinate.

*Note: After determining the format for the Z coordinate, you can set a value for it. See **Setting the Z Coordinate** (on page 658).*

Enabling or Disabling Peripheral Device Auto Management

This command enables or disables the Peripheral Device Auto Management feature.

```
config:# pdu peripheralDeviceAutoManagement <option>
```

Variables:

- <option> is one of the options: *enable* or *disable*.

Option	Description
enable	Enables the automatic management feature for environmental sensor packages.
disable	Disables the automatic management feature for environmental sensor packages.

For more information, see ***How the Automatic Management Function Works*** (on page 262)..

Setting the Maximum Number of Active Powered Dry Contact Actuators

This command determines the upper limit of "active" powered dry contact actuators on one PX3 device. You need either 'Change Peripheral Device Configuration' privilege or 'Administrator Privileges' to change its upper limit.

```
config:# pdu activePoweredDryContactLimit <number>
```

Variables:

- <number> is the number representing the maximum number of active powered dry contact actuators. Its value ranges between 0 to 24.

Note: An "active" actuator is the one that is turned ON, or, if with a door handle connected, is OPENED.

Examples

This section illustrates several PDU configuration examples.

Example 1 - PDU Naming

The following command assigns the name "my px12" to the PDU.

```
config:# pdu name "my px12"
```

Example 2 - Outlet Sequence

The following command causes a 10-outlet PDU to first power on the 8th to 6th outlets and then the rest of outlets in the ascending order after the PDU powers up.

```
config:# pdu outletSequence 8-6,1-5,9,10
```

Example 3 - Outlet Sequence Delay

The following command determines that the outlet 1's delay is 2.5 seconds, outlet 2's delay is 3 seconds, and the delay for outlets 3 through 5 is 10 seconds.

```
config:# pdu outletSequenceDelay 1:2.5;2:3;3-5:10
```

Example 4 - Non-Critical Outlets

The following command sets outlets 1, 2, 3, 7, and 9 to be critical outlets, and 4, 5, 6, 8, 10, 11 and 12 to be non-critical outlets on a 12-outlet PX3.

```
config:# pdu nonCriticalOutlets 1-3,7,9:false;4-6,8,10-12:true
```

Network Configuration Commands

A network configuration command begins with *network*. A number of network settings can be changed through the CLI, such as the IP address, transmission speed, duplex mode, and so on.

Configuring IPv4 Parameters

An IPv4 configuration command begins with *network ipv4*.

Setting the IPv4 Configuration Mode

This command determines the IP configuration mode.

```
config:# network ipv4 interface <ETH> configMethod <mode>
```

Variables:

- <ETH> is one of the network interfaces: *ETH1/ETH2*, *WIRELESS*, or *BRIDGE*. Note that you must choose/configure the bridge interface if your PX3 is set to the bridging mode.

Note: In the bridging mode, only the IP parameters of the BRIDGE interface function. The IP parameters of ETH1/ETH2 and WIRELESS interfaces do NOT function.

Interface	Description
eth1	Determine the IPv4 configuration mode of the ETH1 interface (wired networking).
eth2	Determine the IPv4 configuration mode of the ETH2 interface (wired networking).
wireless	Determine the IPv4 configuration mode of the WIRELESS interface (that is, wireless networking).
bridge	Determine the IPv4 configuration mode of the BRIDGE interface (that is, bridging mode).

- <mode> is one of the modes: *dhcp* or *static*.

Mode	Description
dhcp	The IPv4 configuration mode is set to DHCP.
static	The IPv4 configuration mode is set to static IP address.

Setting the IPv4 Preferred Host Name

After selecting DHCP as the IPv4 configuration mode, you can specify the preferred host name, which is optional. The following is the command:

```
config:# network ipv4 interface <ETH> preferredHostName <name>
```

Variables:

- <ETH> is one of the network interfaces: *ETH1/ETH2*, *WIRELESS*, or *BRIDGE*. Note that you must choose/configure the bridge interface if your PX3 is set to the bridging mode.

Note: In the bridging mode, only the IP parameters of the BRIDGE interface function. The IP parameters of ETH1/ETH2 and WIRELESS interfaces do NOT function.

Interface	Description
eth1	Determine the IPv4 preferred host name of the ETH1 interface (that is, wired networking).
eth2	Determine the IPv4 preferred host name of the ETH2 interface (that is, wired networking).
wireless	Determine the IPv4 preferred host name of the WIRELESS interface (that is, wireless networking).

Interface	Description
bridge	Determine the IPv4 preferred host name of the BRIDGE interface (that is, bridging mode).

- <name> is a host name which:
 - Consists of alphanumeric characters and/or hyphens
 - Cannot begin or end with a hyphen
 - Cannot contain more than 63 characters
 - Cannot contain punctuation marks, spaces, and other symbols

Setting the IPv4 Address

After selecting the static IP configuration mode, you can use this command to assign a permanent IP address to the PX3.

```
config:# network ipv4 interface <ETH> address <ip address>
```

Variables:

- <ETH> is one of the network interfaces: *ETH1/ETH2*, *WIRELESS*, or *BRIDGE*. Note that you must choose/configure the bridge interface if your PX3 is set to the bridging mode.

Note: In the bridging mode, only the IP parameters of the BRIDGE interface function. The IP parameters of ETH1/ETH2 and WIRELESS interfaces do NOT function.

Interface	Description
eth1	Determine the IPv4 address of the ETH1 interface (that is, wired networking).
eth2	Determine the IPv4 address of the ETH2 interface (that is, wired networking).
wireless	Determine the IPv4 address of the WIRELESS interface (that is, wireless networking).
bridge	Determine the IPv4 address of the BRIDGE interface (that is, the bridging mode).

- <ip address> is the IP address being assigned to your PX3. Its format is "IP address/prefix". For example, *192.168.84.99/24*.

Setting the IPv4 Gateway

After selecting the static IP configuration mode, you can use this command to specify the gateway.

```
config:# network ipv4 gateway <ip address>
```

Variables:

- <ip address> is the IP address of the gateway. The value ranges from 0.0.0.0 to 255.255.255.255.

Setting IPv4 Static Routes

If the IPv4 network mode is set to static IP and your local network contains two subnets, you can configure static routes to enable or disable communications between the PX3 and devices in the other subnet.

These commands are prefixed with *network ipv4 staticRoutes*.

Depending on whether the other network is directly reachable or not, there are two methods for adding a static route. For further information, see **Static Route Examples** (on page 314).

- ▶ **Method 1: add a static route when the other network is NOT directly reachable:**

```
config:# network ipv4 staticRoutes add <dest-1> nextHop <hop>
```

- ▶ **Method 2: add a static route when the other network is directly reachable:**

```
config:# network ipv4 staticRoutes add <dest-1> interface <ETH>
```

- ▶ **Delete an existing static route:**

```
config:# network ipv4 staticRoutes delete <route_ID>
```

- ▶ **Modify an existing static route:**

```
config:# network ipv4 staticRoutes modify <route_ID> dest <dest-2> nextHop <hop>
```

-- OR --

```
config:# network ipv4 staticRoutes modify <route_ID> dest <dest-2> interface <ETH>
```

Variables:

- <dest-1> is a combination of the IP address and subnet mask of the other subnet. The format is *IP address/subnet mask*.
- <hop> is the IP address of the next hop router.
- <ETH> is one of the interfaces: *ETH1/ETH2*, *WIRELESS* and *BRIDGE*. Type "bridge" only when your PX3 is in the bridging mode.
- <route_ID> is the ID number of the route setting which you want to delete or modify.
- <dest-2> is a modified route setting that will replace the original route setting. Its format is *IP address/subnet mask*. You can modify either the IP address or the subnet mask or both.

Configuring IPv6 Parameters

An IPv6 configuration command begins with *network ipv6*.

Setting the IPv6 Configuration Mode

This command determines the IP configuration mode.

```
config:# network ipv6 interface <ETH> configMethod <mode>
```

Variables:

- <ETH> is one of the network interfaces: *ETH1/ETH2*, *WIRELESS*, or *BRIDGE*. Note that you must choose/configure the bridge interface if your PX3 is set to the bridging mode.

Note: In the bridging mode, only the IP parameters of the BRIDGE interface function. The IP parameters of ETH1/ETH2 and WIRELESS interfaces do NOT function.

Interface	Description
eth1	Determine the IPv6 configuration mode of the ETH1 interface (wired networking).
eth2	Determine the IPv6 configuration mode of the ETH2 interface (wired networking).
wireless	Determine the IPv6 configuration mode of the WIRELESS interface (that is, wireless networking).

Interface	Description
bridge	Determine the IPv6 configuration mode of the BRIDGE interface (that is, bridging mode).

- <mode> is one of the modes: *automatic* or *static*.

Mode	Description
automatic	The IPv6 configuration mode is set to automatic.
static	The IPv6 configuration mode is set to static IP address.

Setting the IPv6 Preferred Host Name

After selecting DHCP as the IPv6 configuration mode, you can specify the preferred host name, which is optional. The following is the command:

```
config:# network ipv6 interface <ETH> preferredHostName <name>
```

Variables:

- <ETH> is one of the network interfaces: *ETH1/ETH2*, *WIRELESS*, or *BRIDGE*. Note that you must choose/configure the bridge interface if your PX3 is set to the bridging mode.

Note: In the bridging mode, only the IP parameters of the BRIDGE interface function. The IP parameters of ETH1/ETH2 and WIRELESS interfaces do NOT function.

Interface	Description
eth1	Determine the IPv6 preferred host name of the ETH1 interface (wired networking).
eth2	Determine the IPv6 preferred host name of the ETH2 interface (wired networking).
wireless	Determine the IPv6 preferred host name of the WIRELESS interface (that is, wireless networking).
bridge	Determine the IPv6 preferred host name of the BRIDGE interface (that is, bridging mode).

- <name> is a host name which:
 - Consists of alphanumeric characters and/or hyphens
 - Cannot begin or end with a hyphen
 - Cannot contain more than 63 characters

- Cannot contain punctuation marks, spaces, and other symbols

Setting the IPv6 Address

After selecting the static IP configuration mode, you can use this command to assign a permanent IP address to the PX3.

```
config:# network ipv6 interface <ETH> address <ip address>
```

Variables:

- <ETH> is one of the network interfaces: *ETH1/ETH2, WIRELESS, or BRIDGE*. Note that you must choose/configure the bridge interface if your PX3 is set to the bridging mode.

Note: In the bridging mode, only the IP parameters of the BRIDGE interface function. The IP parameters of ETH1/ETH2 and WIRELESS interfaces do NOT function.

Interface	Description
eth1	Determine the IPv6 address of the ETH1 interface (wired networking).
eth2	Determine the IPv6 address of the ETH2 interface (wired networking).
wireless	Determine the IPv6 address of the WIRELESS interface (that is, wireless networking).
bridge	Determine the IPv6 address of the BRIDGE interface (that is, the bridging mode).

- <ip address> is the IP address being assigned to your PX3. This value uses the IPv6 address format. Note that you must add /xx, which indicates a prefix length of bits such as /64, to the end of this IPv6 address.

Setting the IPv6 Gateway

After selecting the static IP configuration mode, you can use this command to specify the gateway.

```
config:# network ipv6 gateway <ip address>
```

Variables:

- <ip address> is the IP address of the gateway. This value uses the IPv6 address format.

Setting IPv6 Static Routes

If the IPv6 network mode is set to static IP and your local network contains two subnets, you can configure static routes to enable or disable communications between the PX3 and devices in the other subnet.

These commands are prefixed with *network ipv6 staticRoutes*.

Depending on whether the other network is directly reachable or not, there are two methods for adding a static route. For further information, see **Static Route Examples** (on page 314).

▶ **Method 1: add a static route when the other network is NOT directly reachable:**

```
config:# network ipv6 staticRoutes add <dest-1> nextHop <hop>
```

▶ **Method 2: add a static route when the other network is directly reachable:**

```
config:# network ipv6 staticRoutes add <dest-1> interface <ETH>
```

▶ **Delete an existing static route:**

```
config:# network ipv6 staticRoutes delete <route_ID>
```

▶ **Modify an existing static route:**

```
config:# network ipv6 staticRoutes modify <route_ID> dest <dest-2>
nextHop <hop>
```

-- OR --

```
config:# network ipv6 staticRoutes modify <route_ID> dest <dest-2> interface  
<ETH>
```

Variables:

- <dest-1> is the IP address and prefix length of the subnet where the PX3 belongs. The format is *IP address/prefix length*.
- <hop> is the IP address of the next hop router.
- <ETH> is one of the interfaces: *ETH1/ETH2, WIRELESS* and *BRIDGE*. Type "bridge" only when your PX3 is in the bridging mode.
- <route_ID> is the ID number of the route setting which you want to delete or modify.
- <dest-2> is a modified route setting that will replace the original route setting. Its format is *IP address/prefix length*. You can modify either the IP address or the prefix length or both.

Configuring DNS Parameters

Use the following commands to configure static DNS-related settings.

▶ **Specify the primary DNS server:**

```
config:# network dns firstServer <ip address>
```

▶ **Specify the secondary DNS server:**

```
config:# network dns secondServer <ip address>
```

▶ **Specify the third DNS server:**

```
config:# network dns thirdServer <ip address>
```

▶ **Specify one or multiple optional DNS search suffixes:**

```
config:# network dns searchSuffixes <suffix1>
```

-- OR --

```
config:# network dns searchSuffixes <suffix1>,<suffix2>,<suffix3>,...,<suffix6>
```

- ▶ **Determine which IP address is used when the DNS server returns both IPv4 and IPv6 addresses:**

```
config:# network dns resolverPreference <resolver>
```

Variables:

- <ip address> is the IP address of the DNS server.
- <suffix1>, <suffix2>, and the like are the DNS suffixes that automatically apply when searching for any device via PX3. For example, <suffix1> can be *raritan.com*, and <suffix2> can be *legrand.com*. You can specify up to 6 suffixes by separating them with commas.
- <resolver> is one of the options: *preferV4* or *preferV6*.

Option	Description
preferV4	Use the IPv4 addresses returned by the DNS server.
preferV6	Use the IPv6 addresses returned by the DNS server.

Setting LAN Interface Parameters

A LAN interface configuration command begins with *network ethernet*.

Enabling or Disabling the LAN Interface

This command enables or disables the LAN interface.

```
config:# network ethernet <ETH> enabled <option>
```

Variables:

- <ETH> is one of the options -- *eth1* or *eth2*.

Option	Description
eth1	ETH1 port
eth2	ETH2 port

- <option> is one of the options: *true* or *false*.

Option	Description
true	The specified network interface is enabled.
false	The specified network interface is disabled.

Changing the LAN Interface Speed

This command determines the LAN interface speed.

```
config:# network ethernet <ETH> speed <option>
```

Variables:

- <ETH> is one of the options -- *eth1* or *eth2*.

Option	Description
eth1	ETH1 port
eth2	ETH2 port

- <option> is one of the options: *auto*, *10Mbps*, *100Mbps* or *1000Mbps*.

Option	Description
auto	System determines the optimum LAN speed through auto-negotiation.
10Mbps	The LAN speed is always 10 Mbps.
100Mbps	The LAN speed is always 100 Mbps.
1000Mbps	The LAN speed is always 1000 Mbps.

Changing the LAN Duplex Mode

This command determines the LAN interface duplex mode.

```
config:# network ethernet <ETH> duplexMode <mode>
```

Variables:

- <ETH> is one of the options -- *eth1* or *eth2*.

Option	Description
eth1	ETH1 port
eth2	ETH2 port

- <mode> is one of the modes: *auto*, *half* or *full*.

Option	Description
auto	The PX3 selects the optimum transmission mode through auto-negotiation.
half	Half duplex: Data is transmitted in one direction (to or from the PX3) at a time.
full	Full duplex: Data is transmitted in both directions simultaneously.

Setting the Ethernet Authentication Method

This command sets the authentication method for the selected Ethernet interface to either none or Extensible Authentication Protocol (EAP).

```
config:# network ethernet <ETH> authMethod <method>
```

Variables:

- <ETH> is one of the options -- *eth1* or *eth2*.

Option	Description
eth1	ETH1 port
eth2	ETH2 port

- <method> is one of the authentication methods: *NONE* or *EAP*.

Method	Description
NONE	The authentication method is set to NONE.
EAP	The authentication method is set to EAP.

Setting Ethernet EAP Parameters

When the selected Ethernet interface's authentication method is set to EAP, you must configure EAP authentication parameters, including outer authentication, inner authentication, EAP identity, client certificate, client private key, password, CA certificate, and RADIUS authentication server. For more information, see **Ethernet Interface Settings** (on page 305).

- ▶ **Determine the outer authentication protocol:**

```
config:# network ethernet <ETH> eapOuterAuthentication <outer_auth>
```

- ▶ **Determine the inner authentication protocol for authentication set to "EAP + PEAP":**

```
config:# network ethernet <ETH> eapInnerAuthentication <inner_auth>
```

▶ **Set the EAP identity:**

```
config:# network ethernet <ETH> eapIdentity <identity>
```

▶ **Set the EAP password:**

```
config:# network ethernet <ETH> eapPassword
```

After performing the above command, the PX3 prompts you to enter the password. Then type the password and press Enter.

▶ **Provide a client certificate for authentication set to "EAP + TLS" or "EAP + PEAP + TLS":**

```
config:# network ethernet <ETH> eapClientCertificate
```

After performing any certificate or private key commands, including commands for the client certificate, client private key, and CA certificate, the system prompts you to enter the contents of the wanted certificate or key. For an example with detailed procedure, see *EAP CA Certificate Example* (on page 581).

▶ **Provide a client private key for authentication set to "EAP + TLS" or "EAP + PEAP + TLS":**

```
config:# network ethernet <ETH> eapClientPrivateKey
```

▶ **Provide a CA TLS certificate for EAP:**

```
config:# network ethernet <ETH> eapCACertificate
```

▶ **Eable or disable verification of the TLS certificate chain:**

```
config:# network ethernet <ETH> enableCertVerification <option1>
```

▶ **Allow expired and not yet valid TLS certificates:**

```
config:# network ethernet <ETH> allowOffTimeRangeCerts <option2>
```

▶ **Allow network connection with incorrect system time:**

```
config:# network ethernet <ETH> allowConnectionWithIncorrectClock
<option3>
```

► **Set the RADIUS authentication server for EAP:**

```
config:# network ethernet <ETH> eapAuthServerName <FQDN>
```

Variables:

- <ETH> is one of the options -- *eth1* or *eth2*.

Option	Description
eth1	ETH1 port
eth2	ETH2 port

- <outer_auth> is one of the options: *PEAP* or *TLS*.

Option	Description
PEAP	Outer authentication is set to Protected Extensible Authentication Protocol (PEAP).
TLS	Outer authentication is set to TLS.

- <inner_auth> is one of the options: *MS-CHAPv2* or *TLS*.

Option	Description
MSCHAPv2	Inner authentication is set to Microsoft's Challenge Authentication Protocol Version 2 (MS-CHAPv2).
TLS	Inner authentication is set to TLS.

- <identity> is your user name for the EAP authentication.
- <option1> is one of the options: *true* or *false*.

Option	Description
true	Enables the verification of the TLS certificate chain.
false	Disables the verification of the TLS certificate chain.

- <option2> is one of the options: *true* or *false*.

Option	Description
true	Always make the network connection successful even though the TLS certificate chain contains any certificate which is outdated or not valid yet.
false	The network connection is NOT successfully established when the TLS certificate chain contains any certificate which is outdated or not valid yet.

- <option3> is one of the options: *true* or *false*.

Option	Description
true	Make the network connection successful when the PX3 system time is earlier than the firmware build before synchronizing with the NTP server, causing the TLS certificate to become invalid.
false	The network connection is NOT successfully established when the PX3 finds that the TLS certificate is not valid due to incorrect system time.

- <FQDN> is the name of the RADIUS server if it is present in the TLS certificate. The name must match the fully qualified domain name (FQDN) of the host shown in the certificate.

EAP CA Certificate Example

This section provides a CA certificate example for the Ethernet interface "ETH1". Your CA certificate contents should be different from the contents displayed in this example.

In addition, the procedure of uploading the client certificate and client private key in CLI is similar to the following example, except for the CLI command.

► To provide a CA certificate:

1. Make sure you have entered the configuration mode. See **Entering Configuration Mode** (on page 557).
2. Type the following command for ETH1 and press Enter.

```
config:# network ethernet eth1 eapCACertificate
```
3. The system prompts you to enter the contents of the CA certificate.

4. Open a CA certificate using a text editor. You should see certificate contents similar to the following.

```

--- BEGIN CERTIFICATE ---
MIICjTCCAfigAwIBAgIEMaYgRzALBqkqhkiG9w0BAQQwRTELMAkGA1UEBhMCVVMx
NjA0BgNVBAoTLU5hdGlvbmFsIEFlcm9uYXV0aWNzIGFuZCBTcGFjZSBBZG1pbmlz
dHJhdGlvbjAmFxE5NjA1MjgxmZQ5MDUrMDgwMBcROTgwNTI4MTM0OTA1KzA4MDAw
ZzELMAkGA1UEBhMCVVMxNjA0BgNVBAoTLU5hdGlvbmFsIEFlcm9uYXV0aWNzIGFu
ZCBTcGFjZSBBZG1pbmlzdHJhdGlvbjEgMAkGA1UEBRMCMTYwEwYDVQQDEwXTdGV2
ZSBTY2hvY2gwWDALBqkqhkiG9w0BAQEESQAwwRgJBAALrAwYydgxmzNP/ts0Uyf6Bp
miJYktU/w4NG67ULaN4B5CnEz7k57s9o3YY3LecETgQ5iQHmkwlyDTL2ftgVfw0C
AQOjgaswgagwZAYDVR0ZAQH/BFowWDBWMMFQxCzAJBgNVBAYTAiVTMTYwNAYDVQQK
Ey1OYXRpb25hbCBBZjJvbmF1dGJjcyBhbmQGU3BhY2UgQWRtaW5pc3RyYXRpb24x
DTALBgNVBAMTBENSTDEwFwYDVROBAQH/BA0wC4AJODMyOTcwODEwMBgGA1UdAgQR
MA8ECTgzMjk3MDgyM4ACBSAwDQYDVROKBAYwBAMCBkAwCwYJKoZIhvcNAQEEA4GB
AH2y1VCEw/A4zaXzSYZJTUi3uawbbFiS2yxHvgf28+8Js0OHXk1H1w2d6qOHH21
X82tZXd/0JtG0g1T9usFFBDvYK8O0ebgz/P5ELJnBL2+atObEuJy1ZZ0pBDWINR3
WkDNLCGiTkCKp0F5EWIrVDwh54NNeVkcQRZita+z4IBO
--- END CERTIFICATE ---

```

5. Select and copy the contents as illustrated below, including the starting line containing "BEGIN CERTIFICATE" and the ending line containing "END CERTIFICATE."
6. Paste the contents in the terminal.
7. Press Enter.
8. Verify whether the system shows the following command prompt, indicating the provided CA certificate is valid.

```
config:#
```

Removing the Uploaded Certificate or Private Key

The procedures of removing an existing client certificate, client private key or CA certificate in CLI are similar.

This section illustrates such a procedure for the Ethernet interface "ETH1."

► To remove a certificate or private key for ETH1:

1. Make sure you have entered the configuration mode. See **Entering Configuration Mode** (on page 557).
2. Type the appropriate command, depending on which file you want to remove, and press Enter.

- *Client certificate:*

```
config:# network ethernet eth1 eapClientCertificate
```

- *Client private key:*

```
config:# network ethernet eth1 eapClientPrivateKey
```

- *CA certificate:*

```
config:# network ethernet eth1 eapCACertificate
```

3. The system prompts you to enter the contents of the chosen certificate or private key.
4. Press Enter without typing any data.
5. Verify whether the system shows the following command prompt, indicating the existing certificate or private key has been removed.

```
config:#
```

Setting Wireless Parameters

You must configure wireless parameters, including Service Set Identifier (SSID), authentication method, Pre-Shared Key (PSK), and Basic Service Set Identifier (BSSID) after the wireless networking mode is enabled.

A wireless configuration command begins with *network wireless*.

Note: If wireless networking mode is not enabled, the SSID, PSK and BSSID values are not applied until the wireless networking mode is enabled. In addition, a message appears, indicating that the active network interface is not wireless.

Setting the SSID

This command specifies the SSID string.

```
config:# network wireless SSID <ssid>
```

Variables:

- <ssid> is the name of the wireless access point, which consists of:
 - Up to 32 ASCII characters
 - No spaces
 - ASCII codes 0x20 ~ 0x7E

Enabling or Disabling 802.11n High Throughput

This command enables or disables the 802.11n high throughput protocol.

```
config:# network wireless enableHT <option>
```

Variables:

- <option> is one of the options: *true* or *false*.

Option	Description
true	802.11n is enabled.
false	802.11n is disabled.

Setting the Wireless Authentication Method

This command sets the wireless authentication method to either PSK or Extensible Authentication Protocol (EAP).

```
config:# network wireless authMethod <method>
```

Variables:

- <method> is one of the authentication methods: *PSK* or *EAP*.

Method	Description
PSK	The authentication method is set to PSK.
EAP	The authentication method is set to EAP.

Setting the PSK

If the Pre-Shared Key (PSK) authentication method is selected, you must assign a PSK passphrase by using this command.

```
config:# network wireless PSK <psk>
```

Variables:

- <psk> is a string or passphrase that consists of:
 - 8 to 63 characters
 - No spaces
 - ASCII codes 0x20 ~ 0x7E

Setting Wireless EAP Parameters

When the wireless authentication method is set to EAP, you must configure EAP authentication parameters, including outer authentication, inner authentication, EAP identity, client certificate, client private key, password, CA certificate, and RADIUS authentication server. For more information, see **Wireless Network Settings** (on page 308).

▶ **Determine the outer authentication protocol:**

```
config:# network wireless eapOuterAuthentication <outer_auth>
```

▶ **Determine the inner authentication protocol for authentication set to "EAP + PEAP":**

```
config:# network wireless eapInnerAuthentication <inner_auth>
```

▶ **Set the EAP identity:**

```
config:# network wireless eapIdentity <identity>
```

▶ **Set the EAP password:**

```
config:# network wireless eapPassword
```

After performing the above command, the PX3 prompts you to enter the password. Then type the password and press Enter.

▶ **Provide a Client Certificate for authentication set to "EAP + TLS" or "EAP + PEAP + TLS":**

```
config:# network wireless eapClientCertificate
```

After performing any certificate or private key commands, including commands for the client certificate, client private key, and CA certificate, the system prompts you to enter the contents of the wanted certificate or key. For an example with detailed procedure, see **EAP CA Certificate Example** (on page 581).

▶ **Provide a Client Private Key for authentication set to "EAP + TLS" or "EAP + PEAP + TLS":**

```
config:# network wireless eapClientPrivateKey
```

▶ **Provide a CA TLS certificate for EAP:**

```
config:# network wireless eapCACertificate
```

▶ **Enable or disable verification of the TLS certificate chain:**

```
config:# network wireless enableCertVerification <option1>
```

▶ **Allow expired and not yet valid TLS certificates:**

```
config:# network wireless allowOffTimeRangeCerts <option2>
```

▶ **Allow wireless network connection with incorrect system time:**

```
config:# network wireless allowConnectionWithIncorrectClock <option3>
```

▶ **Set the RADIUS authentication server for EAP:**

```
config:# network wireless eapAuthServerName <FQDN>
```

Variables:

- <outer_auth> is one of the options: *PEAP* or *TLS*.

Option	Description
PEAP	Outer authentication is set to Protected Extensible Authentication Protocol (PEAP).
TLS	Outer authentication is set to TLS.

- <inner_auth> is one of the options: *MS-CHAPv2* or *TLS*.

Option	Description
MSCHAPv2	Inner authentication is set to Microsoft's Challenge Authentication Protocol Version 2 (MS-CHAPv2).
TLS	Inner authentication is set to TLS.

- <identity> is your user name for the EAP authentication.
- <option1> is one of the options: *true* or *false*.

Option	Description
true	Enables the verification of the TLS certificate chain.
false	Disables the verification of the TLS certificate chain.

- <option2> is one of the options: *true* or *false*.

Option	Description
true	Always make the network connection successful even though the TLS certificate chain contains any certificate which is outdated or not valid yet.

Option	Description
false	The network connection is NOT successfully established when the TLS certificate chain contains any certificate which is outdated or not valid yet.

- <option3> is one of the options: *true* or *false*.

Option	Description
true	Make the network connection successful when the PX3 system time is earlier than the firmware build before synchronizing with the NTP server, causing the TLS certificate to become invalid.
false	The network connection is NOT successfully established when the PX3 finds that the TLS certificate is not valid due to incorrect system time.

- <FQDN> is the name of the RADIUS server if it is present in the TLS certificate. The name must match the fully qualified domain name (FQDN) of the host shown in the certificate.

Setting the BSSID

This command specifies the BSSID.

```
config:# network wireless BSSID <bssid>
```

Variables:

- <bssid> is either the MAC address of the wireless access point or *none* for automatic selection.

Configuring the Cascading Mode

This command determines the cascading mode.

```
config:# network <mode> enabled <option1>
```

Variables:

- <mode> is one of the following cascading modes.

Mode	Description
bridge	The Bridging mode, where each cascaded device is assigned a unique IP address.

Mode	Description
portForwarding	The Port Forwarding mode, where every cascaded device in the chain shares the same IP address, with diverse port numbers assigned.

Important: When enabling either cascading mode, you must make sure the other cascading mode is disabled, or the preferred cascading mode may not be enabled successfully.

- <option1> is one of the following options:

Option	Description
true	The selected cascading mode is enabled.
false	The selected cascading mode is disabled.

- ▶ **If Port Forwarding mode is enabled, you must configure two more settings to finish the configuration:**

On ALL cascaded devices, you must configure the 'role' setting one by one.

```
config:# network portForwarding role <option2>
```

On the master device, you must configure the 'downstream interface' setting.

```
config:# network portForwarding
        masterDownstreamInterface <option3>
```

Variables:

- <option2> is one of the following cascading roles:

Role	Description
master	The device is a master device.
slave	The device is a slave device.

- <option3> is one of the following options:

Option	Description
ETH1/ETH2	ETH1/ETH2 port is the port where the 1st slave device is connected.
Usb	USB port is the port where the 1st slave device is connected.

Setting Network Service Parameters

A network service command begins with *network services*.

Setting the HTTP Port

The commands used to configure the HTTP port settings begin with *network services http*.

▶ **Change the HTTP port:**

```
config:# network services http port <n>
```

▶ **Enable or disable the HTTP port:**

```
config:# network services http enabled <option>
```

▶ **Enforce redirection from HTTP to HTTPS:**

```
config:# network services http enforceHttps <option>
```

Variables:

- <n> is a TCP port number between 1 and 65535. The default HTTP port is 80.
- <option> is one of the options: *true* or *false*.

Option	Description
true	<ul style="list-style-type: none"> ▪ The HTTP port is enabled. - OR - ▪ HTTP redirection to HTTPS is enabled.
false	<ul style="list-style-type: none"> ▪ The HTTP port is disabled. - OR - ▪ HTTP redirection to HTTPS is disabled.

Setting the HTTPS Port

The commands used to configure the HTTPS port settings begin with *network services https*.

► **Change the HTTPS port:**

```
config:# network services https port <n>
```

► **Enable or disable the HTTPS access:**

```
config:# network services https enabled <option>
```

Variables:

- <n> is a TCP port number between 1 and 65535. The default HTTPS port is 443.
- <option> is one of the options: *true* or *false*.

Option	Description
true	Forces any access to the PX3 via HTTP to be redirected to HTTPS.
false	No HTTP access is redirected to HTTPS.

Changing the Telnet Configuration

You can enable or disable the Telnet service, or change its TCP port using the CLI commands.

A Telnet command begins with *network services telnet*.

Enabling or Disabling Telnet

This command enables or disables the Telnet service.

```
config:# network services telnet enabled <option>
```

Variables:

- <option> is one of the options: *true* or *false*.

Option	Description
true	The Telnet service is enabled.

Option	Description
false	The Telnet service is disabled.

Changing the Telnet Port

This command changes the Telnet port.

```
config:# network services telnet port <n>
```

Variables:

- <n> is a TCP port number between 1 and 65535. The default Telnet port is 23.

Changing the SSH Configuration

You can enable or disable the SSH service, or change its TCP port using the CLI commands.

An SSH command begins with *network services ssh*.

Enabling or Disabling SSH

This command enables or disables the SSH service.

```
config:# network services ssh enabled <option>
```

Variables:

- <option> is one of the options: *true* or *false*.

Option	Description
true	The SSH service is enabled.
false	The SSH service is disabled.

Changing the SSH Port

This command changes the SSH port.

```
config:# network services ssh port <n>
```

Variables:

- <n> is a TCP port number between 1 and 65535. The default SSH port is 22.

Determining the SSH Authentication Method

This command syntax determines the SSH authentication method.

```
config:# network services ssh authentication <auth_method>
```

Variables:

- <option> is one of the options: *passwordOnly*, *publicKeyOnly* or *passwordOrPublicKey*.

Option	Description
passwordOnly	Enables the password-based login only.
publicKeyOnly	Enables the public key-based login only.
passwordOrPublicKey	Enables both the password- and public key-based login. This is the default.

If the public key authentication is selected, you must enter a valid SSH public key for each user profile to log in over the SSH connection. See **Specifying the SSH Public Key** (on page 636).

Setting the SNMP Configuration

You can enable or disable the SNMP v1/v2c or v3 agent, configure the read and write community strings, or set the MIB-II parameters, such as sysContact, using the CLI commands.

An SNMP command begins with *network services snmp*.

Enabling or Disabling SNMP v1/v2c

This command enables or disables the SNMP v1/v2c protocol.

```
config:# network services snmp v1/v2c <option>
```

Variables:

- <option> is one of the options: *enable* or *disable*.

Option	Description
enable	The SNMP v1/v2c protocol is enabled.
disable	The SNMP v1/v2c protocol is disabled.

Enabling or Disabling SNMP v3

This command enables or disables the SNMP v3 protocol.

```
config:# network services snmp v3 <option>
```

Variables:

- <option> is one of the options: *enable* or *disable*.

Option	Description
enable	The SNMP v3 protocol is enabled.
disable	The SNMP v3 protocol is disabled.

Setting the SNMP Read Community

This command sets the SNMP read-only community string.

```
config:# network services snmp readCommunity <string>
```

Variables:

- <string> is a string comprising 4 to 64 ASCII printable characters.
- The string CANNOT include spaces.

Setting the SNMP Write Community

This command sets the SNMP read/write community string.

```
config:# network services snmp writeCommunity <string>
```

Variables:

- <string> is a string comprising 4 to 64 ASCII printable characters.
- The string CANNOT include spaces.

Setting the sysContact Value

This command sets the SNMP MIB-II sysContact value.

```
config:# network services snmp sysContact <value>
```

Variables:

- <value> is a string comprising 0 to 255 alphanumeric characters.

Setting the sysName Value

This command sets the SNMP MIB-II sysName value.

```
config:# network services snmp sysName <value>
```

Variables:

- <value> is a string comprising 0 to 255 alphanumeric characters.

Setting the sysLocation Value

This command sets the SNMP MIB-II sysLocation value.

```
config:# network services snmp sysLocation <value>
```

Variables:

<value> is a string comprising 0 to 255 alphanumeric characters.

Changing the Modbus Configuration

You can enable or disable the Modbus agent, configure its read-only capability, or change its TCP port.

A Modbus command begins with *network services modbus*.

Enabling or Disabling Modbus

This command enables or disables the Modbus protocol.

```
config:# network services modbus enabled <option>
```

Variables:

- <option> is one of the options: *true* or *false*.

Option	Description
true	The Modbus agent is enabled.
false	The Modbus agent is disabled.

Enabling or Disabling the Read-Only Mode

This command enables or disables the read-only mode for the Modbus agent.

```
config:# network services modbus readonly <option>
```

Variables:

- <option> is one of the options: *true* or *false*.

Option	Description
true	The read-only mode is enabled.
false	The read-only mode is disabled.

Changing the Modbus Port

This command changes the Modbus port.

```
config:# network services modbus port <n>
```

Variables:

- <n> is a TCP port number between 1 and 65535. The default Modbus port is 502.

Enabling or Disabling Service Advertising

This command enables or disables the zero configuration protocol, which enables advertising or auto discovery of network services. See **Enabling Service Advertising** (on page 336) for details.

```
config:# network services zeroconfig <method> <option>
```

Variables:

- <method> is one of the options: *mdns* or *llmnr*.

Option	Description
mdns	Service advertisement via MDNS is enabled or disabled.
llmnr	Service advertisement via LLNMR is enabled or disabled.

- <option> is one of the options: *enable* or *disable*.

Option	Description
enable	Service advertisement via the selected method (MDNS or LLMNR) is enabled.
disable	Service advertisement via the selected method (MDNS or LLMNR) is disabled.

Examples

This section illustrates several network configuration examples.

Example 1 - Wireless Networking Mode

The following command enables the wireless networking mode.

```
config:# network wireless enabled true
```

Example 2 - Enabling IPv6 Protocol on the Ethernet Interface

The following command enables the IPv6 protocol on the ETH1 interface.

```
config:# network ipv6 interface eth1 enabled true
```

Example 3 - Wireless Authentication Method

The following command sets the wireless authentication method to PSK.

```
config:# network wireless authMethod PSK
```

Example 4 - Static IPv4 Configuration

The following command enables the Static IPv4 configuration mode on the ETH1 interface.

```
config:# network ipv4 interface eth1 configMethod static
```

Time Configuration Commands

A time configuration command begins with *time*.

Determining the Time Setup Method

This command determines the method to configure the system date and time.

```
config:#    time method <method>
```

Variables:

- <method> is one of the time setup options: *manual* or *ntp*.

Mode	Description
manual	The date and time settings are customized.
ntp	The date and time settings synchronize with a specified NTP server.

Setting NTP Parameters

A time configuration command for NTP-related parameters begins with *time ntp*.

▶ **Specify the primary time server:**

```
config:#    time ntp firstServer <first_server>
```

▶ **Specify the secondary time server:**

```
config:#    time ntp secondServer <second_server>
```

▶ **To delete the primary time server:**

```
config:#    time ntp firstServer ""
```

▶ **To delete the secondary time server:**

```
config:#    time ntp secondServer ""
```

Variables:

- The <first_server> is the IP address or host name of the primary NTP server.
- The <second_server> is the IP address or host name of the secondary NTP server.

Customizing the Date and Time

To manually configure the date and time, use the following CLI commands to specify them.

*Note: You shall set the time configuration method to "manual" prior to customizing the date and time. See **Determining the Time Setup Method** (on page 597).*

► **Assign the date:**

```
config:# time set date <yyyy-mm-dd>
```

► **Assign the time:**

```
config:# time set time <hh:mm:ss>
```

Variables:

Variable	Description
<yyyy-mm-dd>	Type the date in the format of yyyy-mm-dd. For example, type <i>2015-11-30</i> for November 30, 2015.
<hh:mm:ss>	Type the time in the format of hh:mm:ss in the 24-hour format. For example, type <i>13:50:20</i> for 1:50:20 pm.

Setting the Time Zone

The CLI has a list of time zones to configure the date and time for PX3.

```
config:# time zone
```

After a list of time zones is displayed, type the index number of the time zone or press Enter to cancel.

Example

► **To set the time zone:**

1. Type the time zone command as shown below and press Enter.

```
config:# time zone
```

2. The system shows a list of time zones. Type the index number of the desired time zone and press Enter.

3. Type `apply` for the selected time zone to take effect.

Setting the Automatic Daylight Savings Time

This command determines whether the daylight saving time is applied to the time settings.

```
config:#    time autoDST <option>
```

Variables:

- <option> is one of the options: *enable* or *disable*.

Mode	Description
enable	Daylight savings time is enabled.
disable	Daylight savings time is disabled.

Examples

This section illustrates several time configuration examples.

Example 1 - Time Setup Method

The following command sets the date and time settings by using the NTP servers.

```
config:#    time method ntp
```

Example 2 - Primary NTP Server

The following command sets the primary time server to 192.168.80.66.

```
config:#    time ntp firstServer 192.168.80.66
```

Checking the Accessibility of NTP Servers

This command verifies the accessibility of NTP servers specified manually on your PX3 and then shows the result. For instructions on specifying NTP servers via CLI, see **Setting NTP Parameters** (on page 598).

To perform this command successfully, you must:

- Own the "Change Date/Time Settings" permission.
- Customize NTP servers. See **Setting NTP Parameters** (on page 598).

This command is available either in the administrator/user mode or in the configuration mode. See **Different CLI Modes and Prompts** (on page 518).

▶ **In the administrator/user mode:**

```
#          check ntp
```

▶ **In the configuration mode:**

```
config#   check ntp
```

Security Configuration Commands

A security configuration command begins with *security*.

Firewall Control

You can manage firewall control features through the CLI. The firewall control lets you set up rules that permit or disallow access to the PX3 from a specific or a range of IP addresses.

- An IPv4 firewall configuration command begins with *security ipAccessControl ipv4*.
- An IPv6 firewall configuration command begins with *security ipAccessControl ipv6*.

Modifying Firewall Control Parameters

There are different commands for modifying firewall control parameters.

- *IPv4 commands*

▶ **Enable or disable the IPv4 firewall control feature:**

```
config:#   security ipAccessControl ipv4 enabled <option>
```

▶ **Determine the default IPv4 firewall control policy for inbound traffic:**

```
config:# security ipAccessControl ipv4 defaultPolicyIn <policy>
```

- ▶ **Determine the default IPv4 firewall control policy for outbound traffic:**

```
config:# security ipAccessControl ipv4 defaultPolicyOut <policy>
```

- *IPv6 commands*

- ▶ **Enable or disable the IPv6 firewall control feature:**

```
config:# security ipAccessControl ipv6 enabled <option>
```

- ▶ **Determine the default IPv6 firewall control policy for inbound traffic:**

```
config:# security ipAccessControl ipv6 defaultPolicyIn <policy>
```

- ▶ **Determine the default IPv6 firewall control policy for outbound traffic:**

```
config:# security ipAccessControl ipv6 defaultPolicyOut <policy>
```

Variables:

- <option> is one of the options: *true* or *false*.

Option	Description
true	Enables the IP access control feature.
false	Disables the IP access control feature.

- <policy> is one of the options: *accept*, *drop* or *reject*.

Option	Description
accept	Accepts traffic from all IP addresses.
drop	Discards traffic from all IP addresses, without sending any failure notification to the source host.
reject	Discards traffic from all IP addresses, and an ICMP message is sent to the source host for failure notification.

*Tip: You can combine both commands to modify all firewall control parameters at a time. See **Multi-Command Syntax** (on page 691).*

Managing Firewall Rules

You can add, delete or modify firewall rules using the CLI commands.

- An IPv4 firewall control rule command begins with *security ipAccessControl ipv4 rule*.
- An IPv6 firewall control rule command begins with *security ipAccessControl ipv6 rule*.

Adding a Firewall Rule

Depending on where you want to add a new firewall rule in the list, the command for adding a rule varies.

- *IPv4 commands*

▶ **Add a new rule to the bottom of the IPv4 rules list:**

```
config:# security ipAccessControl ipv4 rule add <direction> <ip_mask> <policy>
```

▶ **Add a new IPv4 rule by inserting it above or below a specific rule:**

```
config:# security ipAccessControl ipv4 rule add <direction> <ip_mask> <policy> <insert>
<rule_number>
```

-- OR --

```
config:# security ipAccessControl ipv4 rule add <direction> <insert> <rule_number>
<ip_mask> <policy>
```

- *IPv6 commands*

▶ **Add a new rule to the bottom of the IPv6 rules list:**

```
config:# security ipAccessControl ipv6 rule add <direction> <ip_mask> <policy>
```

▶ **Add a new IPv6 rule by inserting it above or below a specific rule:**

```
config:# security ipAccessControl ipv6 rule add <direction> <ip_mask> <policy> <insert>
<rule_number>

-- OR --

config:# security ipAccessControl ipv6 rule add <direction> <insert> <rule_number>
<ip_mask> <policy>
```

Variables:

- <direction> is one of the options: *in* or *out*.

Direction	Description
in	Inbound traffic.
out	Outbound traffic.

- <ip_mask> is the combination of the IP address and subnet mask values (or prefix length), which are separated with a slash. For example, an IPv4 combination looks like this: *192.168.94.222/24*.
- <policy> is one of the options: *accept*, *drop* or *reject*.

Policy	Description
accept	Accepts traffic from/to the specified IP address(es).
drop	Discards traffic from/to the specified IP address(es), without sending any failure notification to the source or destination host.
reject	Discards traffic from/to the specified IP address(es), and an ICMP message is sent to the source or destination host for failure notification.

- <insert> is one of the options: *insertAbove* or *insertBelow*.

Option	Description
insertAbove	Inserts the new rule above the specified rule number. Then: <i>new rule's number = the specified rule number</i>
insertBelow	Inserts the new rule below the specified rule number. Then: <i>new rule's number = the specified rule number + 1</i>

- <rule_number> is the number of the existing rule which you want to insert the new rule above or below.

Modifying a Firewall Rule

Depending on what to modify in an existing rule, the command varies.

- *IPv4 commands*

▶ **Modify an IPv4 rule's IP address and/or subnet mask:**

```
config:# security ipAccessControl ipv4 rule modify <direction> <rule_number> ipMask
<ip_mask>
```

▶ **Modify an IPv4 rule's policy:**

```
config:# security ipAccessControl ipv4 rule modify <direction> <rule_number> policy
<policy>
```

▶ **Modify all contents of an existing IPv4 rule:**

```
config:# security ipAccessControl ipv4 rule modify <direction> <rule_number> ipMask
<ip_mask> policy <policy>
```

- *IPv6 commands*

▶ **Modify an IPv6 rule's IP address and/or prefix length:**

```
config:# security ipAccessControl ipv6 rule modify <direction> <rule_number> ipMask
<ip_mask>
```

▶ **Modify an IPv6 rule's policy:**

```
config:# security ipAccessControl ipv6 rule modify <direction> <rule_number> policy
<policy>
```

▶ **Modify all contents of an IPv6 existing rule:**

```
config:# security ipAccessControl ipv6 rule modify <direction> <rule_number> ipMask
<ip_mask> policy <policy>
```

Variables:

- <direction> is one of the options: *in* or *out*.

Direction	Description
in	Inbound traffic.

Direction	Description
out	Outbound traffic.

- <rule_number> is the number of the existing rule that you want to modify.
- <ip_mask> is the combination of the IP address and subnet mask values (or prefix length), which are separated with a slash. For example, an IPv4 combination looks like this: *192.168.94.222/24*.
- <policy> is one of the options: *accept*, *drop* or *reject*.

Option	Description
accept	Accepts traffic from/to the specified IP address(es).
drop	Discards traffic from/to the specified IP address(es), without sending any failure notification to the source or destination host.
reject	Discards traffic from/to the specified IP address(es), and an ICMP message is sent to the source or destination host for failure notification.

Deleting a Firewall Rule

The following commands remove a specific IPv4 or IPv6 rule from the list.

▶ IPv4 commands

```
config:# security ipAccessControl ipv4 rule delete <direction> <rule_number>
```

▶ IPv6 commands

```
config:# security ipAccessControl ipv6 rule delete <direction> <rule_number>
```

Variables:

- <direction> is one of the options: *in* or *out*.

Direction	Description
in	Inbound traffic.
out	Outbound traffic.

- <rule_number> is the number of the existing rule that you want to remove.

Restricted Service Agreement

The CLI command used to set the Restricted Service Agreement feature begins with `security restrictedServiceAgreement`,

Enabling or Disabling the Restricted Service Agreement

This command activates or deactivates the Restricted Service Agreement.

```
config:# security restrictedServiceAgreement enabled <option>
```

Variables:

- <option> is one of the options: *true* or *false*.

Option	Description
true	Enables the Restricted Service Agreement feature.
false	Disables the Restricted Service Agreement feature.

After the Restricted Service Agreement feature is enabled, the agreement's content is displayed on the login screen.

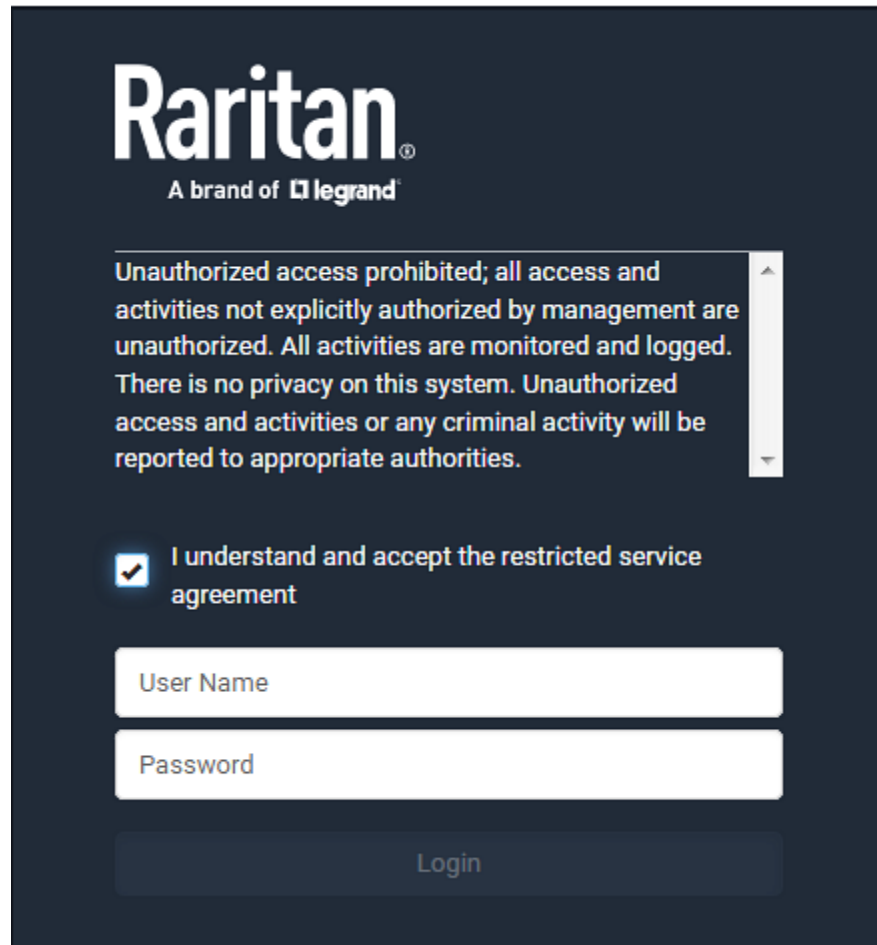

The screenshot shows the Raritan login interface. At the top, the Raritan logo is displayed with the tagline "A brand of legrand". Below the logo, a scrollable text box contains the following message: "Unauthorized access prohibited; all access and activities not explicitly authorized by management are unauthorized. All activities are monitored and logged. There is no privacy on this system. Unauthorized access and activities or any criminal activity will be reported to appropriate authorities." Below the scrollable box is a checkbox labeled "I understand and accept the restricted service agreement", which is currently checked. Underneath the checkbox are two input fields: "User Name" and "Password". At the bottom of the form is a "Login" button.

Do either of the following, or the login fails:

- In the web interface, select the checkbox labeled "I understand and accept the restricted service agreement."

Tip: To select the agreement checkbox using the keyboard, first press Tab to go to the checkbox and then Enter.

- In the CLI, type `y` when the confirmation message "I understand and accept the restricted service agreement" is displayed.

Specifying the Agreement Contents

This command allows you to create or modify contents of the Restricted Service Agreement.

```
config:# security restrictedServiceAgreement bannerContent
```

After performing the above command, do the following:

1. Type the text comprising up to 10,000 ASCII characters when the CLI prompts you to enter the content.
2. To end the content:
 - a. Press Enter.
 - b. Type `--END--` to indicate the end of the content.
 - c. Press Enter again.

If the content is successfully entered, the CLI displays this message "Successfully entered Restricted Service Agreement" followed by the total number of entered characters in parentheses.

*Note: The new content of Restricted Service Agreement is saved only after typing the `apply` command. See **Quitting Configuration Mode** (on page 558).*

Example

The following example illustrates how to specify the content of the Restricted Service Agreement.

1. Type the following command and press Enter to start entering the content.

```
config:# security restrictedServiceAgreement bannerContent
```

2. Type the following content when the CLI prompts you to enter the content.
 IMPORTANT!! You are accessing the PX3. If you are not the system administrator, do NOT operate it or change any settings without the permission of the system administrator.
3. Press Enter.
4. Type the following:
`--END--`
5. Press Enter again.
6. Verify that the message "Successfully entered Restricted Service Agreement" is displayed, indicating that the content input is successful.

Login Limitation

The login limitation feature controls login-related limitations, such as password aging, simultaneous logins using the same user name, and the idle time permitted before forcing a user to log out.

A login limitation command begins with *security loginLimits*.

You can combine multiple commands to modify various login limitation parameters at a time. See **Multi-Command Syntax** (on page 691).

Single Login Limitation

This command enables or disables the single login feature, which controls whether multiple logins using the same login name simultaneously is permitted.

```
config:# security loginLimits singleLogin <option>
```

Variables:

- <option> is one of the options: *enable* or *disable*.

Option	Description
enable	Enables the single login feature.
disable	Disables the single login feature.

Password Aging

This command enables or disables the password aging feature, which controls whether the password should be changed at a regular interval:

```
config:# security loginLimits passwordAging <option>
```

Variables:

- <option> is one of the options: *enable* or *disable*.

Option	Description
enable	Enables the password aging feature.
disable	Disables the password aging feature.

Password Aging Interval

This command determines how often the password should be changed.

```
config:# security loginLimits passwordAgingInterval <value>
```

Variables:

- <value> is a numeric value in days set for the password aging interval. The interval ranges from 7 to 365 days.

Idle Timeout

This command determines how long a user can remain idle before that user is forced to log out of the PX3 web interface or CLI.

```
config:# security loginLimits idleTimeout <value>
```

Variables:

- <value> is a numeric value in minutes set for the idle timeout. The timeout ranges from 1 to 1440 minutes (24 hours).

User Blocking

There are different commands for changing different user blocking parameters. These commands begin with `security userBlocking`.

You can combine multiple commands to modify the user blocking parameters at a time. See **Multi-Command Syntax** (on page 691).

▶ **Determine the maximum number of failed logins before blocking a user:**

```
config:# security userBlocking maximumNumberOfFailedLogins <value1>
```

▶ **Determine how long a user is blocked:**

```
config:# security userBlocking blockTime <value2>
```

Variables:

- <value1> is an integer between 3 and 10, or *unlimited*, which sets no limit on the maximum number of failed logins and thus disables the user blocking function.
- <value2> is a numeric value ranging from 1 to 1440 minutes (one day), or *infinite*, which blocks the user all the time until the user is unblocked manually.

Strong Passwords

The strong password commands determine whether a strong password is required for login, and what a strong password should contain at least.

A strong password command begins with `security strongPasswords`.

You can combine multiple strong password commands to modify different parameters at a time. See **Multi-Command Syntax** (on page 691).

Enabling or Disabling Strong Passwords

This command enables or disables the strong password feature.

```
config:# security strongPasswords enabled <option>
```

Variables:

- <option> is one of the options: *true* or *false*.

Option	Description
true	Enables the strong password feature.
false	Disables the strong password feature.

Minimum Password Length

This command determines the minimum length of the password.

```
config:# security strongPasswords minimumLength <value>
```

Variables:

- <value> is an integer between 8 and 32.

Maximum Password Length

This command determines the maximum length of the password.

```
config:# security strongPasswords maximumLength <value>
```

Variables:

- <value> is an integer between 16 and 64.

Lowercase Character Requirement

This command determines whether a strong password includes at least a lowercase character.

```
config:# security strongPasswords enforceAtLeastOneLowerCaseCharacter <option>
```

Variables:

- <option> is one of the options: *enable* or *disable*.

Option	Description
enable	At least one lowercase character is required.
disable	No lowercase character is required.

Uppercase Character Requirement

This command determines whether a strong password includes at least a uppercase character.

```
config:# security strongPasswords enforceAtLeastOneUpperCaseCharacter <option>
```

Variables:

- <option> is one of the options: *enable* or *disable*.

Option	Description
enable	At least one uppercase character is required.
disable	No uppercase character is required.

Numeric Character Requirement

This command determines whether a strong password includes at least a numeric character.

```
config:# security strongPasswords enforceAtLeastOneNumericCharacter <option>
```

Variables:

- <option> is one of the options: *enable* or *disable*.

Option	Description
enable	At least one numeric character is required.
disable	No numeric character is required.

Special Character Requirement

This command determines whether a strong password includes at least a special character.

```
config:# security strongPasswords enforceAtLeastOneSpecialCharacter <option>
```

Variables:

- <option> is one of the options: *enable* or *disable*.

Option	Description
enable	At least one special character is required.
disable	No special character is required.

Maximum Password History

This command determines the number of previous passwords that CANNOT be repeated when changing the password.

```
config:# security strongPasswords passwordHistoryDepth <value>
```

Variables:

- <value> is an integer between 1 and 12.

Role-Based Access Control

In addition to firewall access control based on IP addresses, you can configure other access control rules that are based on both IP addresses and users' roles.

- An IPv4 role-based access control command begins with *security roleBasedAccessControl ipv4*.
- An IPv6 role-based access control command begins with *security roleBasedAccessControl ipv6*.

Modifying Role-Based Access Control Parameters

There are different commands for modifying role-based access control parameters.

- *IPv4 commands*

▶ **Enable or disable the IPv4 role-based access control feature:**

```
config:# security roleBasedAccessControl ipv4 enabled <option>
```

▶ **Determine the IPv4 role-based access control policy:**

```
config:# security roleBasedAccessControl ipv4 defaultPolicy <policy>
```

- *IPv6 commands*

▶ **Enable or disable the IPv6 role-based access control feature:**

```
config:# security roleBasedAccessControl ipv6 enabled <option>
```

▶ **Determine the IPv6 role-based access control policy:**

```
config:# security roleBasedAccessControl ipv6 defaultPolicy <policy>
```

Variables:

- <option> is one of the options: *true* or *false*.

Option	Description
true	Enables the role-based access control feature.
false	Disables the role-based access control feature.

- <policy> is one of the options: *allow* or *deny*.

Policy	Description
allow	Accepts traffic from all IP addresses regardless of the user's role.
deny	Drops traffic from all IP addresses regardless of the user's role.

*Tip: You can combine both commands to modify all role-based access control parameters at a time. See **Multi-Command Syntax** (on page 691).*

Managing Role-Based Access Control Rules

You can add, delete or modify role-based access control rules.

- An IPv4 role-based access control command for managing rules begins with *security roleBasedAccessControl ipv4 rule*.
- An IPv6 role-based access control command for managing rules begins with *security roleBasedAccessControl ipv6 rule*.

Adding a Role-Based Access Control Rule

Depending on where you want to add a new rule in the list, the command syntax for adding a rule varies.

- *IPv4 commands*

▶ **Add a new rule to the bottom of the IPv4 rules list:**

```
config:# security roleBasedAccessControl ipv4 rule add <start_ip> <end_ip> <role> <policy>
```

▶ **Add a new IPv4 rule by inserting it above or below a specific rule:**

```
config:# security roleBasedAccessControl ipv4 rule add <start_ip> <end_ip> <role> <policy> <insert> <rule_number>
```

- *IPv6 commands*

▶ **Add a new rule to the bottom of the IPv6 rules list:**

```
config:# security roleBasedAccessControl ipv6 rule add <start_ip> <end_ip> <role> <policy>
```

▶ **Add a new IPv6 rule by inserting it above or below a specific rule:**

```
config:# security roleBasedAccessControl ipv6 rule add <start_ip> <end_ip> <role>
<policy> <insert> <rule_number>
```

Variables:

- <start_ip> is the starting IP address.
- <end_ip> is the ending IP address.
- <role> is the role for which you want to create an access control rule.
- <policy> is one of the options: *allow* or *deny*.

Policy	Description
allow	Accepts traffic from the specified IP address range when the user is a member of the specified role
deny	Drops traffic from the specified IP address range when the user is a member of the specified role

- <insert> is one of the options: *insertAbove* or *insertBelow*.

Option	Description
insertAbove	Inserts the new rule above the specified rule number. Then: <i>new rule's number = the specified rule number</i>
insertBelow	Inserts the new rule below the specified rule number. Then: <i>new rule's number = the specified rule number + 1</i>

- <rule_number> is the number of the existing rule which you want to insert the new rule above or below.

Modifying a Role-Based Access Control Rule

Depending on what to modify in an existing rule, the command syntax varies.

- *IPv4 commands*

► **Modify a rule's IPv4 address range:**

```
config:# security roleBasedAccessControl ipv4 rule modify <rule_number>
startIpAddress <start_ip> endIpAddress <end_ip>
```

► **Modify an IPv4 rule's role:**

```
config:# security roleBasedAccessControl ipv4 rule modify <rule_number> role <role>
```

▶ **Modify an IPv4 rule's policy:**

```
config:# security roleBasedAccessControl ipv4 rule modify <rule_number> policy  
<policy>
```

▶ **Modify all contents of an existing IPv4 rule:**

```
config:# security roleBasedAccessControl ipv4 rule modify <rule_number>  
startIpAddress <start_ip> endIpAddress <end_ip> role <role> policy <policy>
```

- *IPv6 commands*

▶ **Modify a rule's IPv6 address range:**

```
config:# security roleBasedAccessControl ipv6 rule modify <rule_number>  
startIpAddress <start_ip> endIpAddress <end_ip>
```

▶ **Modify an IPv6 rule's role:**

```
config:# security roleBasedAccessControl ipv6 rule modify <rule_number> role <role>
```

▶ **Modify an IPv6 rule's policy:**

```
config:# security roleBasedAccessControl ipv6 rule modify <rule_number> policy  
<policy>
```

▶ **Modify all contents of an existing IPv6 rule:**

```
config:# security roleBasedAccessControl ipv6 rule modify <rule_number>
startIpAddress <start_ip>endIpAddress <end_ip> role <role> policy <policy>
```

Variables:

- <rule_number> is the number of the existing rule that you want to modify.
- <start_ip> is the starting IP address.
- <end_ip> is the ending IP address.
- <role> is one of the existing roles.
- <policy> is one of the options: *allow* or *deny*.

Policy	Description
allow	Accepts traffic from the specified IP address range when the user is a member of the specified role
deny	Drops traffic from the specified IP address range when the user is a member of the specified role

Deleting a Role-Based Access Control Rule

These commands remove a specific rule from the list.

▶ IPv4 commands

```
config:# security roleBasedAccessControl ipv4 rule delete <rule_number>
```

▶ IPv6 commands

```
config:# security roleBasedAccessControl ipv6 rule delete <rule_number>
```

Variables:

- <rule_number> is the number of the existing rule that you want to remove.

Enabling or Disabling Front Panel Outlet Switching

This section applies to outlet-switching capable models only.

The following CLI commands control whether you can turn on or off an outlet by operating the front panel display.

► **To enable the front panel outlet control feature:**

```
config:# security frontPanelPermissions add switchOutlet
```

► **To disable the front panel outlet control feature:**

```
config:# security frontPanelPermissions remove switchOutlet
```

Tip: If your PX3 supports multiple front panel permissions, you can combine them into one command by adding a semicolon (;) between different permissions. For example, the following CLI command enables both front panel actuator control and outlet switching functions simultaneously.

```
security frontPanelPermissions add  
switchActuator;switchOutlet
```

Enabling or Disabling Front Panel Actuator Control

The following CLI commands control whether you can turn on or off connected actuator(s) by operating the front panel LCD display.

► **To enable the front panel actuator control feature:**

```
config:# security frontPanelPermissions add switchActuator
```

► **To disable the front panel actuator control feature:**

```
config:# security frontPanelPermissions remove switchActuator
```

Tip: If your PX3 supports multiple front panel permissions, you can combine them into one command by adding a semicolon (;) between different permissions. For example, the following CLI command enables both front panel actuator control and the internal beeper-muting functions simultaneously.

```
security frontPanelPermissions add  
switchActuator;muteBeeper
```

Enabling or Disabling Front Panel Beeper-Sound Control

The following CLI commands control whether you can mute the internal beeper by operating the front panel LCD display when the beeper sounds.

▶ **To enable the front panel beeper sound control feature:**

```
config:# security frontPanelPermissions add muteBeeper
```

▶ **To disable the front panel actuator control feature:**

```
config:# security frontPanelPermissions remove muteBeeper
```

Tip: If your PX3 supports multiple front panel permissions, you can combine them into one command by adding a semicolon (;) between different permissions. For example, the following CLI command enables both front panel actuator control and the the internal beeper-muting functions simultaneously.

```
security frontPanelPermissions add switchActuator;muteBeeper
```

Examples

This section illustrates several security configuration examples.

Example 1 - IPv4 Firewall Control Configuration

The following command sets up two parameters of the IPv4 access control feature.

```
config:# security ipAccessControl ipv4 enabled true defaultPolicyIn accept
defaultPolicyOut accept
```

Results:

- The IPv4 access control feature is enabled.
- The default policy for inbound traffic is set to "accept."
- The default policy for outbound traffic is set to "accept."

Example 2 - Adding an IPv4 Firewall Rule

The following command adds a new IPv4 access control rule and specifies its location in the list.

```
config:# security ipAccessControl ipv4 rule add in 192.168.84.123/24 accept
insertAbove 5
```

Results:

- A new IPv4 firewall control rule is added to accept all packets sent from the IPv4 address 192.168.84.123.
- The newly-added rule is inserted above the 5th rule. That is, the new rule becomes the 5th rule, and the original 5th rule becomes the 6th rule.

Example 3 - User Blocking

The following command sets up two user blocking parameters.

```
config:# security userBlocking maximumNumberOfFailedLogins 5 blockTime 30
```

Results:

- The maximum number of failed logins is set to 5.
- The user blocking time is set to 30 minutes.

Example 4 - Adding an IPv4 Role-based Access Control Rule

The following command creates a new IPv4 role-based access control rule and specifies its location in the list.

```
config:# security roleBasedAccessControl ipv4 rule add 192.168.78.50 192.168.90.100
admin deny insertAbove 3
```

Results:

- A new IPv4 role-based access control rule is added, dropping all packets from any IPv4 address between 192.168.78.50 and 192.168.90.100 when the user is a member of the role "admin."
- The newly-added IPv4 rule is inserted above the 3rd rule. That is, the new rule becomes the 3rd rule, and the original 3rd rule becomes the 4th rule.

Outlet Configuration Commands

An outlet configuration command begins with *outlet*. Such a command allows you to configure an individual outlet.

Changing the Outlet Name

This command names an outlet.

```
config:# outlet <n> name "<name>"
```

Variables:

- <n> is the number of the outlet that you want to configure.
- <name> is a string comprising up to 64 ASCII printable characters. The <name> variable must be enclosed in quotes when it contains spaces.

Changing an Outlet's Default State

This section applies to outlet-switching capable models only.

This command determines the initial power condition of an outlet after the PX3 powers up.

```
config:# outlet <n> stateOnDeviceStartup <option>
```

Variables:

- <n> is the number of the outlet that you want to configure.
- <option> is one of the options: *off*, *on*, *lastKnownState* and *pduDefined*.

Option	Description
off	Turn off the outlet.
on	Turn on the outlet.
lastKnownState	Restore the outlet to the state prior to last PDU power down.
pduDefined	PDU-defined setting.

*Note: Setting the outlet's default state to an option other than pduDefined overrides the PDU-defined default state on that outlet. See **Setting the PDU-Defined Default Outlet State** (on page 560).*

Setting an Outlet's Cycling Power-Off Period

This section applies to outlet-switching capable models only.

This command determines the power-off period of the power cycling operation for a specific outlet.

```
config:# outlet <n> cyclingPowerOffPeriod <timing>
```

Variables:

- <n> is the number of the outlet that you want to configure.
- <timing> is the time of the cycling power-off period in seconds, which is an integer between 0 and 3600, or *pduDefined* for following the PDU-defined timing.

*Note: This setting overrides the PDU-defined cycling power-off period on a particular outlet. See **Setting the PDU-Defined Cycling Power-Off Period** (on page 561).*

Example - Outlet Naming

The following command assigns the name "Win XP" to outlet 8.

```
config:# outlet 8 name "Win XP"
```

Outlet Group Configuration Commands

An outlet group configuration command begins with *outletgroup*. Such a command allows you to configure or operate an outlet group.

Creating an Outlet Group

This command creates a new outlet group.

```
config:# outletgroup add "<name>" <members>
```

Variables:

- <name> is a string comprising up to 64 ASCII printable characters. The <name> variable must be enclosed in quotes when it contains spaces.

Tip: PX3 allows you to assign the same name to diverse outlet groups. If this really occurs, you still can identify different groups through their unique index numbers.

- <members> is one or multiple member outlets' index numbers separated with commas. If the member outlets are consecutive outlets, you can type a hyphen between the initial and the final index number instead of using commas.

For example, to assign outlets 3, 4, 5, 8 and 10 to the outlet group named "servers", you have two choices -- either use a hyphen for consecutive outlets 3 to 5, or use commas for all of member outlets:

- `outletgroup add servers 3-5,8,10`
- OR --
- `outletgroup add servers 3,4,5,8,10`

Managing an Outlet Group

You can modify an outlet group's name and member outlets, or simply remove any existing outlet group.

You can modify both the name and members of an outlet group at a time by combining multiple commands. See **Multi-Command Syntax** (on page 691).

▶ Modify an outlet group's name:

```
config:# outletgroup modify <ID> name "<name>"
```

▶ Modify an outlet group's member outlets:

```
config:# outletgroup modify <ID> members <members>
```

▶ Delete an outlet group:

```
config:# outletgroup delete <ID>
```

Variables:

- <ID> is an outlet group's index number.
- <name> is a string comprising up to 64 ASCII printable characters. The <name> variable must be enclosed in quotes when it contains spaces.
- <members> is one or multiple member outlets' index numbers separated with commas. If the member outlets are consecutive outlets, you can type a hyphen between the initial and the final index number instead of using commas.

For example, to assign outlets 3, 4, 5, 8 and 10 to the outlet group named "servers", you have two choices -- either use a hyphen for consecutive outlets 3 to 5, or use commas for all of member outlets:

In the following examples, it is assumed that the "servers" outlet group's index number is 2.

- `outletgroup modify 2 members 3-5,8,10`
-- OR --
- `outletgroup modify 2 members 3,4,5,8,10`

Powering On/Off/Cycle Outlet Groups

This section applies to outlet-switching capable models only.

You must perform this operation in the *administrator mode*. See **Different CLI Modes and Prompts** (on page 518).

▶ Power on one outlet group:

```
# power outletgroup <ID> on
```

▶ Power off one outlet group:

```
# power outletgroup <ID> off
```

▶ Power cycle one outlet group:

```
# power outletgroup <ID> cycle
```

To quicken the operation, you can add the parameter `/y` to the end of the command, which confirms the operation.

For example:

```
# power outletgroup <ID> off /y
```

If you entered the command without `/y`, a message appears, prompting you to confirm the operation. Then:

- Type `y` to confirm the operation, OR
- Type `n` to abort the operation

Variables:

- `<ID>` is an outlet group's index number.

Inlet Configuration Commands

An inlet configuration command begins with *inlet*. You can configure an inlet by using the inlet configuration command.

Changing the Inlet Name

This command syntax names an inlet.

```
config:#    inlet <n> name "<name>"
```

Variables:

- <n> is the number of the inlet that you want to configure. For a single-inlet PDU, <n> is always 1. The value is an integer between 1 and 50.
- <name> is a string comprising up to 64 ASCII printable characters. The <name> variable must be enclosed in quotes when it contains spaces.

Enabling or Disabling an Inlet (for Multi-Inlet PDUs)

Enabling or disabling an inlet takes effect on a multi-inlet PDU only.

This command enables or disables an inlet.

```
config:#    inlet <n> enabled <option>
```

Variables:

- <n> is the number of the inlet that you want to configure. For a single-inlet PDU, <n> is always 1. The value is an integer between 1 and 50.
- <option> is one of the options: *true* or *false*.

Option	Description
true	The specified inlet is enabled.
false	The specified inlet is disabled.

Note: If performing this command causes all inlets to be disabled, a warning message appears, prompting you to confirm. When this occurs, press y to confirm or n to cancel the operation.

Example - Inlet Naming

The following command assigns the name "AC source" to the inlet 1. If your PX3 contains multiple inlets, this command names the 1st inlet.

```
config:#    inlet 1 name "AC source"
```

Overcurrent Protector Configuration Commands

An overcurrent protector configuration command begins with *ocp*. The command configures an individual circuit breaker or fuse which protects outlets.

Changing the Overcurrent Protector Name

This command names a circuit breaker or a fuse which protects outlets on your PX3.

```
config:# ocp <n> name "<name>"
```

Variables:

- <n> is the number of the overcurrent protector that you want to configure. The value is an integer between 1 and 50.
- <name> is a string comprising up to 64 ASCII printable characters. The <name> variable must be enclosed in quotes when it contains spaces.

Example - OCP Naming

The command assigns the name "Email servers CB" to the overcurrent protector labeled 2.

```
config:# ocp 2 name "Email servers CB"
```

User Configuration Commands

Most user configuration commands begin with *user* except for the password change command.

Creating a User Profile

This command creates a new user profile.

```
config:# user create <name> <option> <roles>
```

After performing the user creation command, the PX3 prompts you to assign a password to the newly-created user. Then:

1. Type the password and press Enter.
2. Re-type the same password for confirmation and press Enter.

Variables:

- <name> is a string comprising up to 32 ASCII printable characters. The <name> variable CANNOT contain spaces.
- <option> is one of the options: *enable* or *disable*.

Option	Description
enable	Enables the newly-created user profile.
disable	Disables the newly-created user profile.

- <roles> is a role or a list of comma-separated roles assigned to the specified user profile.

Modifying a User Profile

A user profile contains various parameters that you can modify.

*Tip: You can combine all commands to modify the parameters of a specific user profile at a time. See **Multi-Command Syntax** (on page 691).*

Changing a User's Password

This command allows you to change an existing user's password if you have the Administrator Privileges.

```
config:# user modify <name> password
```

After performing the above command, PX3 prompts you to enter a new password. Then:

1. Type a new password and press Enter.
2. Re-type the new password for confirmation and press Enter.

Variables:

- <name> is the name of the user whose settings you want to change.

Example

The following procedure illustrates how to change the password of the user "May."

1. Verify that you have entered the configuration mode. See **Entering Configuration Mode** (on page 557).

2. Type the following command to change the password for the user profile "May."

```
config:# user modify May password
```

3. Type a new password when prompted, and press Enter.
4. Type the same new password and press Enter.
5. If the password change is completed successfully, the config:# prompt appears.

Modifying a User's Personal Data

You can change a user's personal data, including the user's full name, telephone number, and email address.

Various commands can be combined to modify the parameters of a specific user profile at a time. See **Multi-Command Syntax** (on page 691).

▶ **Change a user's full name:**

```
config:# user modify <name> fullName "<full_name>"
```

▶ **Change a user's telephone number:**

```
config:# user modify <name> telephoneNumber "<phone_number>"
```

▶ **Change a user's email address:**

```
config:# user modify <name> emailAddress <email_address>
```

Variables:

- <name> is the name of the user whose settings you want to change.
- <full_name> is a string comprising up to 64 ASCII printable characters. The <full_name> variable must be enclosed in quotes when it contains spaces.
- <phone_number> is the phone number that can reach the specified user. The <phone_number> variable must be enclosed in quotes when it contains spaces.
- <email_address> is the email address of the specified user.

Enabling or Disabling a User Profile

This command enables or disables a user profile. A user can log in to the PX3 only after that user's user profile is enabled.

```
config:# user modify <name> enabled <option>
```

Variables:

- <name> is the name of the user whose settings you want to change.
- <option> is one of the options: *true* or *false*.

Option	Description
true	Enables the specified user profile.
false	Disables the specified user profile.

Forcing a Password Change

This command determines whether the password change is forced when a user logs in to the specified user profile next time.

```
config:# user modify <name> forcePasswordChangeOnNextLogin <option>
```

Variables:

- <name> is the name of the user whose settings you want to change.
- <option> is one of the options: *true* or *false*.

Option	Description
true	A password change is forced on the user's next login.
false	No password change is forced on the user's next login.

Modifying SNMPv3 Settings

There are different commands to modify the SNMPv3 parameters of a specific user profile. You can combine all of the following commands to modify the SNMPv3 parameters at a time. See **Multi-Command Syntax** (on page 691).

- ▶ **Enable or disable the SNMP v3 access to PX3 for the specified user:**

```
config:# user modify <name> snmpV3Access <option1>
```

▶ **Determine the security level:**

```
config:# user modify <name> securityLevel <option2>
```

▶ **Determine whether the authentication passphrase is identical to the password:**

```
config:# user modify <name> userPasswordAsAuthenticationPassphrase <option3>
```

▶ **Determine the authentication passphrase:**

```
config:# user modify <name> authenticationPassPhrase
```

After performing the above command, PX3 prompts you to enter the authentication passphrase.

▶ **Determine whether the privacy passphrase is identical to the authentication passphrase:**

```
config:# user modify <name> useAuthenticationPassPhraseAsPrivacyPassPhrase <option4>
```

▶ **Determine the privacy passphrase:**

```
config:# user modify <name> privacyPassPhrase
```

After performing the above command, PX3 prompts you to enter the privacy passphrase.

▶ **Determine the authentication protocol:**

```
config:# user modify <name> authenticationProtocol <option5>
```

▶ **Determine the privacy protocol:**

```
config:# user modify <name> privacyProtocol <option6>
```

Variables:

- <name> is the name of the user whose settings you want to change.
- <option1> is one of the options: *enable* or *disable*.

Option	Description
enable	Enables the SNMP v3 access permission for the specified user.
disable	Disables the SNMP v3 access permission for the specified user.

- <option2> is one of the options: *noAuthNoPriv*, *authNoPriv* or *authPriv*.

Option	Description
noAuthNoPriv	No authentication and no privacy.
authNoPriv	Authentication and no privacy.
authPriv	Authentication and privacy.

- <option3> is one of the options: *true* or *false*.

Option	Description
true	Authentication passphrase is identical to the password.
false	Authentication passphrase is different from the password.

- <option4> is one of the options: *true* or *false*.

Option	Description
true	Privacy passphrase is identical to the authentication passphrase.
false	Privacy passphrase is different from the authentication passphrase.

- <option5> is one of the options: *MD5* or *SHA-1*.

Option	Description
MD5	MD5 authentication protocol is applied.

Option	Description
SHA-1	SHA-1 authentication protocol is applied.

- <option6> is one of the options: *DES* or *AES-128*.

Option	Description
DES	DES privacy protocol is applied.
AES-128	AES-128 privacy protocol is applied.

- An authentication or privacy passphrase is a string comprising 8 to 32 ASCII printable characters.

Changing the Role(s)

This command changes the role(s) of a specific user.

```
config:# user modify <name> roles <roles>
```

Variables:

- <name> is the name of the user whose settings you want to change.
- <roles> is a role or a list of comma-separated roles assigned to the specified user profile. See **All Privileges** (on page 640).

Changing Measurement Units

You can change the measurement units displayed for temperatures, length, and pressure for a specific user profile. Different measurement unit commands can be combined so that you can set all measurement units at a time. To combine all commands, see **Multi-Command Syntax** (on page 691).

Note: The measurement unit change only applies to the web interface and command line interface.

*Tip: To set the default measurement units applied to the PX3 user interfaces for all users via CLI, see **Setting Default Measurement Units** (on page 637).*

▶ **Set the preferred temperature unit:**

```
config:# user modify <name> preferredTemperatureUnit <option1>
```

▶ **Set the preferred length unit:**

```
config:# user modify <name> preferredLengthUnit <option2>
```

▶ **Set the preferred pressure unit:**

```
config:# user modify <name> preferredPressureUnit <option3>
```

Variables:

- <name> is the name of the user whose settings you want to change.
- <option1> is one of the options: *C* or *F*.

Option	Description
C	This option displays the temperature in Celsius.
F	This option displays the temperature in Fahrenheit.

- <option2> is one of the options: *meter* or *feet*.

Option	Description
meter	This option displays the length or height in meters.
feet	This option displays the length or height in feet.

- <option3> is one of the options: *pascal* or *psi*.

Option	Description
pascal	This option displays the pressure value in Pascals (Pa).
psi	This option displays the pressure value in psi.

Specifying the SSH Public Key

If the SSH key-based authentication is enabled, specify the SSH public key for each user profile using the following procedure.

▶ **To specify or change the SSH public key for a specific user:**

1. Type the SSH public key command as shown below and press Enter.

```
config:# user modify <name> sshPublicKey
```
2. The system prompts you to enter the contents of the SSH public key. Do the following to input the contents:
 - a. Open your SSH public key with a text editor.
 - b. Copy all contents in the text editor.
 - c. Paste the contents into the terminal.
 - d. Press Enter.

▶ **To remove an existing SSH public key:**

1. Type the same command as shown above.
2. When the system prompts you to input the contents, press Enter without typing or pasting anything.

Example

The following procedure illustrates how to change the SSH public key for the user "assistant."

1. Verify that you have entered the configuration mode. See **Entering Configuration Mode** (on page 557).
2. Type the following command and press Enter.

```
config:# user modify assistant sshPublicKey
```
3. You are prompted to enter a new SSH public key.
4. Type the new key and press Enter.

Deleting a User Profile

This command deletes an existing user profile.

```
config:# user delete <name>
```

Changing Your Own Password

Every user can change their own password via this command if they have the Change Own Password privilege. Note that this command does not begin with *user*.

```
config:# password
```

After performing this command, the PX3 prompts you to enter both current and new passwords respectively.

Important: After the password is changed successfully, the new password is effective immediately no matter you type the command "apply" or not to save the changes.

Example

This procedure changes your own password:

1. Verify that you have entered the configuration mode. See **Entering Configuration Mode** (on page 557).
2. Type the following command and press Enter.

```
config:# password
```
3. Type the existing password and press Enter when the following prompt appears.

```
Current password:
```
4. Type the new password and press Enter when the following prompt appears.

```
Enter new password:
```
5. Re-type the new password for confirmation and press Enter when the following prompt appears.

```
Re-type new password:
```

Setting Default Measurement Units

Default measurement units, including temperature, length, and pressure units, apply to the PX3 user interfaces across all users except for those whose preferred measurement units are set differently by themselves or the administrator. Diverse measurement unit commands can be combined so that you can set all default measurement units at a time. To combine all commands, see **Multi-Command Syntax** (on page 691).

Note: The measurement unit change only applies to the web interface and command line interface.

*Tip: To change the preferred measurement units displayed in the PX3 user interfaces for a specific user via CLI, see **Changing Measurement Units** (on page 634).*

▶ **Set the default temperature unit:**

```
config:# user defaultpreferences preferredTemperatureUnit <option1>
```

▶ **Set the default length unit:**

```
config:# user defaultpreferences preferredLengthUnit <option2>
```

▶ **Set the default pressure unit:**

```
config:# user defaultpreferences preferredPressureUnit <option3>
```

Variables:

- <option1> is one of the options: *C* or *F*.

Option	Description
C	This option displays the temperature in Celsius.
F	This option displays the temperature in Fahrenheit.

- <option2> is one of the options: *meter* or *feet*.

Option	Description
meter	This option displays the length or height in meters.
feet	This option displays the length or height in feet.

- <option3> is one of the options: *pascal* or *psi*.

Option	Description
pascal	This option displays the pressure value in Pascals (Pa).
psi	This option displays the pressure value in psi.

Examples

This section illustrates several user configuration examples.

Example 1 - Creating a User Profile

The following command creates a new user profile and sets two parameters for the new user.

```
config:# user create Mary enable admin
```

Results:

- A new user profile "Mary" is created.
- The new user profile is enabled.
- The **admin** role is assigned to the new user profile.

Example 2 - Modifying a User's Roles

The following command assigns two roles to the user "May."

```
config:# user modify Mary roles admin,tester
```

Results:

- The user Mary has the union of all privileges of "admin" and "tester."

Example 3 - Default Measurement Units

The following command sets all default measurement units at a time.

```
config:# user defaultpreferences preferredTemperatureUnit F preferredLengthUnit feet  
preferredPressureUnit psi
```

Results:

- The default temperature unit is set to Fahrenheit.
- The default length unit is set to feet.
- The default pressure unit is set to psi.

Role Configuration Commands

A role configuration command begins with *role*.

Creating a Role

This command creates a new role, with a list of semicolon-separated privileges assigned to the role.

```
config:# role create <name> <privilege1>;<privilege2>;<privilege3>...
```

If a specific privilege contains any arguments, that privilege should be followed by a colon and the argument(s).

```
config:# role create <name> <privilege1>:<argument1>,<argument2>...;
<privilege2>:<argument1>,<argument2>...;
<privilege3>:<argument1>,<argument2>...;
...
```

Variables:

- <name> is a string comprising up to 32 ASCII printable characters.
- <privilege1>, <privilege2>, <privilege3> and the like are names of the privileges assigned to the role. Separate each privilege with a semi-colon. See **All Privileges** (on page 640).
- <argument1>, <argument2> and the like are arguments set for a particular privilege. Separate a privilege and its argument(s) with a colon, and separate arguments with a comma if there are more than one argument for a privilege.

All Privileges

This table lists all privileges. Note that available privileges vary according to the model you purchased. For example, a PDU without the outlet switching function does not have the privilege "switchOutlet."

Privilege	Description
acknowledgeAlarms	Acknowledge Alarms
adminPrivilege	Administrator Privileges
changeAssetStripConfiguration	Change Asset Strip Configuration
changeAuthSettings	Change Authentication Settings
changeDataTimeSettings	Change Date/Time Settings

Privilege	Description
changeExternalSensorsConfiguration	Change Peripheral Device Configuration
changeLhxConfiguration	Change LHX/SHX Configuration
changeModemConfiguration	Change Modem Configuration
changeNetworkSettings	Change Network Settings
changePassword	Change Own Password
changePduConfiguration	Change Pdu, Inlet, Outlet & Overcurrent Protector Configuration
changeSecuritySettings	Change Security Settings
changeSnmpSettings	Change SNMP Settings
changeUserSettings	Change Local User Management
changeWebcamSettings	Change Webcam Configuration
clearLog	Clear Local Event Log
firmwareUpdate	Firmware Update
performReset	Reset (Warm Start)
switchActuator*	Switch Actuator
switchOutlet**	Switch Outlet
switchOutletGroup***	Switch Outlet Group
viewAuthSettings	View Authentication Settings
viewEventSetup	View Event Settings
viewEverything	Unrestricted View Privileges
viewLog	View Local Event Log
viewSecuritySettings	View Security Settings
viewSnmpSettings	View SNMP Settings
viewUserSettings	View Local User Management
viewWebcamSettings	View Webcam Snapshots and Configuration

* The "switchActuator" privilege requires an argument that is separated with a colon. The argument could be:

- All actuators, that is,
`switchActuator:all`
- An actuator's ID number. For example:
`switchActuator:1`
`switchActuator:2`
`switchActuator:3`
- A list of comma-separated ID numbers of different actuators. For example:
`switchActuator:1,3,6`

Note: The ID number of each actuator is shown in the PX3 web interface. It is an integer.

** The "switchOutlet" privilege requires an argument that is separated with a colon. The argument could be:

- All outlets, that is,
`switchOutlet:all`
- An outlet number. For example:
`switchOutlet:1`
`switchOutlet:2`
`switchOutlet:3`
- A list of comma-separated outlets. For example:
`switchOutlet:1,3,5,7,8,9`

*** The "switchOutletGroup" privilege requires an argument that is separated with a colon. The argument could be:

- All outlet groups, that is,
`switchOutletGroup:all`
- An outlet group number. For example:
`switchOutletGroup:1`
`switchOutletGroup:2`
`switchOutletGroup:3`
- A list of comma-separated outlet groups. For example:
`switchOutletGroup:1,3,5,7,8,9`

Modifying a Role

You can modify diverse parameters of an existing role, including its privileges.

▶ **Modify a role's description:**

```
config:#    role modify <name> description "<description>"
```

▶ **Add more privileges to a specific role:**

```
config:#    role modify <name> addPrivileges
            <privilege1>;<privilege2>;<privilege3>...
```

If a specific privilege contains any arguments, add a colon and the argument(s) after that privilege.

```
config:#    role modify <name> addPrivileges
            <privilege1>:<argument1>,<argument2>...;
            <privilege2>:<argument1>,<argument2>...;
            <privilege3>:<argument1>,<argument2>...;
            ...
```

▶ **Remove specific privileges from a role:**

```
config:#    role modify <name> removePrivileges
            <privilege1>;<privilege2>;<privilege3>...
```

If a specific privilege contains any arguments, add a colon and the argument(s) after that privilege.

```
config:#    role modify <name> removePrivileges
           <privilege1>:<argument1>,<argument2>...;
           <privilege2>:<argument1>,<argument2>...;
           <privilege3>:<argument1>,<argument2>...;
           ...
```

Note: When removing privileges from a role, make sure the specified privileges and arguments (if any) exactly match those assigned to the role. Otherwise, the command fails to remove specified privileges that are not available.

Variables:

- <name> is a string comprising up to 32 ASCII printable characters.
- <description> is a description comprising alphanumeric characters. The <description> variable must be enclosed in quotes when it contains spaces.
- <privilege1>, <privilege2>, <privilege3> and the like are names of the privileges assigned to the role. Separate each privilege with a semi-colon. See **All Privileges** (on page 640).
- <argument1>, <argument2> and the like are arguments set for a particular privilege. Separate a privilege and its argument(s) with a colon, and separate arguments with a comma if there are more than one argument for a privilege. For arguments syntax, see **All Privileges** (on page 640).

Deleting a Role

This command deletes an existing role.

```
config:#    role delete <name>
```

Example - Creating a Role

The following command creates a new role and assigns privileges to the role.

```
config:#    role create tester firmwareUpdate;viewEventSetup
```

Results:

- A new role "tester" is created.
- Two privileges are assigned to the role: firmwareUpdate (Firmware Update) and viewEventSetup (View Event Settings).

Authentication Commands

An authentication configuration command begins with *authentication*.

Determining the Authentication Method

You can choose to set the authentication type only, or both set the authentication type and determine whether to switch to local authentication in case the remote authentication is not available.

► **Determine the authentication type only:**

```
config:# authentication type <option1>
```

► **Determine the authentication type and enable/disable the option of switching to local authentication:**

```
config:# authentication type <option1> useLocalIfRemoteUnavailable <option2>
```

Note: You cannot enable or disable the option of switching to local authentication without determining the authentication type in the CLI. Therefore, always type "authentication type <option1>" when setting up "useLocalIfRemoteUnavailable".

Variables:

- <option1> is one of the options: *local*, *ldap* or *radius*.

Option	Description
local	Enable Local authentication only.
ldap	Enable LDAP authentication.
radius	Enable Radius authentication.

- <option2> is one of the options: *true* or *false*.

Option	Description
true	Remote authentication is the first priority. The device will switch to local authentication when the remote authentication is not available.
false	Always stick to remote authentication regardless of the availability of remote authentication.

LDAP Settings

All LDAP-related commands begin with *authentication ldap*.

If you enable LDAP authentication, you must add at least one LDAP server. Later you can modify or delete any existing LDAP server as needed.

Adding an LDAP Server

Adding an LDAP server requires the entry of quite a lot of parameters, such as the server's IP address, TCP port number, Base DN and so on.

You can repeat the following CLI command to add more than one LDAP server.

*Tip: If any LDAP server's settings are identical to an existing LDAP server's, you can add it by just copying the existing one, instead of using the following command. See **Copying an Existing Server's Settings** (on page 650).*

► **Add a new LDAP server:**

```
config:# authentication ldap add <host> <port> <ldap_type> <security>
<bind_type> <base_DN> <login_name_att> <user_entry_class> "Optional
Parameters"
```

*Note: "Optional Parameters" refer to one or multiple parameters listed in the section **Optional Parameters** (on page 647). They are required only when your server settings need to specify these parameters. For example, if setting the <bind_type> to "authenticatedBind", then you must add the parameter "bindDN" to this command.*

When the above command is successfully performed, a list of all LDAP servers, including the newly-added one, will be displayed, which is similar to the following diagram.

#	IP address	Server type
1	192.1.1.1	OpenLDAP
2	192.2.2.2	OpenLDAP

*Tip: To verify all settings of a newly-added server, see **Authentication Settings** (on page 545).*

Variables:

- <host> is the IP address or host name of the LDAP server.
- <port> is the port number assigned for communication with the LDAP server.
- <ldap_type> is one of the LDAP server types: *openldap* or *activeDirectory*.

Type	Description
openldap	OpenLDAP server
activeDirectory	Microsoft Active Directory

- <security> is one of the security options: *none*, *startTls* or *tls*.

Type	Description
none	No security
startTls	StartTLS
tls	TLS

- <bind_type> is one of the bind options: *anonymousBind*, or *authenticatedBind*.

Type	Description
anonymousBind	Enable the anonymous Bind. Bind DN and password are NOT required.
authenticatedBind	Enable the Bind with authentication. Bind DN and password are required.

- <base_DN> is the base DN for search.
- <login_name_att> is the login name attribute.
- <user_entry_class> is the User Entry Object Class.

Optional Parameters

You can add one or multiple "optional parameters", such as specifying the Bind DN or certificate upload, to an LDAP-server-adding command as illustrated below. If adding multiple optional parameters, you must add them to the END of the command and separate them with a space.

- *Example 1 -- Specify an Active Directory Domain's name:*

```
config:# authentication ldap add <host> <port> <ldap_type> <security>
<bind_type> <base_DN> <login_name_att> <user_entry_class> adDomain
<AD_domain>
```

- *Example 2 -- Set up the bind DN:*

```
config:# authentication ldap add <host> <port> <ldap_type> <security>
<bind_type> <base_DN> <login_name_att> <user_entry_class> bindDN
<bind_DN>
```

► "Optional Parameters" table:

Parameters	To configure
userSearchSubfilter <filter>	User search subfilter
bindDN <bind_DN>	bind DN <ul style="list-style-type: none"> ▪ The system will prompt you to enter and re-confirm the bind password after adding this parameter to the command. ▪ For details, see <i>Illustrations of Adding LDAP Servers</i> (on page 649).
adDomain <AD_domain>	Active Directory Domain name
verifyServerCertificate <verify_cert>	Certificate verification setting <ul style="list-style-type: none"> ▪ After setting to true, the system will prompt you to upload a certificate. For details, see <i>Illustrations of Adding LDAP Servers</i> (on page 649).
allowExpiredCertificate <allow_exp_cert>	Whether to accept expired or not valid yet certificate

Variables:

- <filter> is the user search subfilter you specify.
- <bind_DN> is bind DN.
- <AD_domain> is the Active Directory Domain.
- <verify_cert> is one of the options: *true* or *false*.

Option	Description
true	Enable the verification of the LDAP server certificate.
false	Disable the verification of the LDAP server certificate.

- `<allow_exp_cert>` is one of the options: *true* or *false*.

Option	Description
true	Certificates that are either expired or not valid yet are all accepted.
false	Only valid certificates are accepted.

Illustrations of Adding LDAP Servers

This section shows several LDAP command examples. Those words highlighted in bold are required for their respective examples.

▶ An OpenLDAP server:

```
config:# authentication ldap add op-ldap.raritan.com 389 openldap none
anonymousBind dc=raritan,dc=com uid inetOrgPerson
```

▶ A Microsoft Active Directory server:

```
config:# authentication ldap add ac-ldap.raritan.com 389 activeDirectory none
anonymousBind dc=raritan,dc=com sAMAccountName user adDomain
raritan.com
```

▶ An LDAP server with a TLS certificate uploaded:

- Enter the CLI command with the following two TLS-related options set and/or added:
 - *<security>* is set to *tls* or *startTls*.
 - The *"verifyServerCertificate"* parameter is added to the command and set to *"true"*.

```
config:# authentication ldap add ldap.raritan.com 389 openldap startTls ...
inetOrgPerson verifyServerCertificate true
```

- The system now prompts you to enter the certificate's content.
- Type or copy the certificate's content in the CLI and press Enter.

Note: The certificate's content is located between the line containing "BEGIN CERTIFICATE" and the line containing "END CERTIFICATE".

▶ An LDAP server with the bind DN and bind password configured:

- Enter the CLI command with the *"bindDN"* parameter and its data added.

```
config:# authentication ldap add op-ldap.raritan.com 389 openldap none
authenticatedBind cn=Manager,dc=raritan,dc=com uid inetOrgPerson
bindDN user@raritan.com
```

- b. The system prompts you to specify the bind DN password.
- c. Type the password and press Enter.
- d. Re-type the same password.

Copying an Existing Server's Settings

If the server that you will add completely shares the same settings with any server that has been configured, use the following command.

▶ **Add an LDAP server by copying an existing server's settings:**

```
config:# authentication ldap addClone <server_num> <host>
```

Variables:

- <host> is the IP address or host name of the LDAP server.
- <server_num> is the sequential number of the specified server shown on the server list of the PX3. See ***Authentication Settings*** (on page 545).

Modifying an Existing LDAP Server

You can modify one or multiple parameters of an existing LDAP server, such as its IP address, TCP port number, Base DN and so on. Besides, you can also change the priority or sequence of existing LDAP servers in the server list.

▶ **Command syntax:**

A command to modify an existing LDAP server's settings looks like the following:

```
config:# authentication ldap modify <server_num> "parameters"
```

Variables:

- <server_num> is the sequential number of the specified server in the LDAP server list.
- Replace "**parameters**" with one or multiple commands in the following table, depending on which parameter(s) you want to modify.

▶ **A list of "parameters":**

Parameters	Description
host <host>	Change the IP address or host name. <ul style="list-style-type: none"> ▪ <host> is the new IP address or host name.
port <port>	Change the TCP port number. <ul style="list-style-type: none"> ▪ <port> is the new TCP port number.
serverType <ldap_type>	Change the server type. <ul style="list-style-type: none"> ▪ <ldap_type> is the new type of the LDAP server. ▪ <ldap_type> values include: <code>openldap</code> and <code>activeDirectory</code>.
securityType <security>	Change the security type. <ul style="list-style-type: none"> ▪ <security> is the new security type. ▪ <security> values include: <code>none</code>, <code>startTls</code>, and <code>ssl</code>
bindType <bind_type>	Change the bind type. <ul style="list-style-type: none"> ▪ <bind_type> is the new bind type. ▪ <bind_type> values include: <code>anonymousBind</code> and <code>authenticatedBind</code>.
searchBaseDN <base_DN>	Change the base DN for search. <ul style="list-style-type: none"> ▪ <base_DN> is the new base DN for search.
loginNameAttribute <login_name_att>	Change the login name attribute. <ul style="list-style-type: none"> ▪ <login_name_att> is the new login name attribute.
userEntryObjectClass <user_entry_class>	Change the user entry object class. <ul style="list-style-type: none"> ▪ <user_entry_class> is the new user entry class.
userSearchSubfilter <user_search_filter>	Change the user search subfilter. <ul style="list-style-type: none"> ▪ <user_search_filter> is the new user search subfilter.
adDomain <AD_domain>	Change the Active Directory Domain name. <ul style="list-style-type: none"> ▪ <AD_domain> is the new domain name of the Active Directory.
verifyServerCertificate <verify_cert>	Enable or disable the certificate verification. <ul style="list-style-type: none"> ▪ <verify_cert> enables or disables the certificate verification feature. ▪ Available values include: <code>true</code>, <code>false</code>

Parameters	Description
certificate	Re-upload a different certificate. <ol style="list-style-type: none"> First add the "certificate" parameter to the command, and press Enter. The system prompts you for the input of the certificate. Type or copy the content of the certificate in the CLI and press Enter.
allowExpiredCertificate <allow_exp_cert>	Determine whether to accept a certificate which is expired or not valid yet. <ul style="list-style-type: none"> ▪ <allow_exp_cert> determines whether to accept an expired or not valid yet certificate ▪ <allow_exp_cert> values include: true, and false
bindDN <bind_DN>	Change the bind DN. <ul style="list-style-type: none"> ▪ <bind_DN> is the new bind DN.
bindPassword	Change the bind DN password. <ol style="list-style-type: none"> First add the "bindPassword" parameter to the command, and press Enter. The system prompts you for the input of the password. Type the password and press Enter.
sortPosition <position>	Change the priority of the server (that is, resorting). <ul style="list-style-type: none"> ▪ <position> is the new sequential number of the server in the LDAP server list.

*Note: For details of the above variables' values, see **Adding an LDAP Server** (on page 646).*

► **Examples:**

- **Change the IP address of the 1st LDAP server**

```
config:# authentication ldap modify 1 host 192.168.3.3
```

- **Change both the IP address and TCP port of the 1st LDAP server**

```
config:# authentication ldap modify 1 host 192.168.3.3 port 633
```

- **Change the IP address, TCP port and the type of the 1st LDAP server**

```
config:# authentication ldap modify 1 host 192.168.3.3 port 633
serverType activeDirectory
```

Removing an Existing LDAP Server

This command removes an existing LDAP server from the server list.

```
config:# authentication ldap delete <server_num>
```

Variables:

- <server_num> is the sequential number of the specified server in the LDAP server list.

Radius Settings

All Radius-related commands begin with *authentication radius*.

If you enable Radius authentication, you must add at least one Radius server. Later you can modify or delete any existing Radius server as needed.

Adding a Radius Server

You can repeat the following commands to add Radius servers one by one.

▶ **Command syntax:**

```
config:# authentication radius add <host> <rds_type> <auth_port> <acct_port> <timeout> <retries>
```

Variables:

- <host> is the IP address or host name of the Radius server.
- <rds_type> is one of the Radius authentication types: *pap*, *chap*, *msChapV2*.

Type	Description
chap	CHAP
pap	PAP
msChapV2	MSCHAP v2

- <auth_port> is the authentication port number.
- <acct_port> is the accounting port number.
- <timeout> is the timeout value in seconds. It ranges between 1 to 10 seconds.
- <retries> is the number of retries. It ranges between 0 to 5.

▶ **To enter the shared secret:**

1. After executing the above Radius command, the system automatically prompts you to enter the shared secret.
2. Type the secret and press Enter.
3. Re-type the same secret and press Enter.

▶ **Example:**

```
config:# authentication radius add 192.168.7.99 chap 1812 1813 10 3
```

Modifying an Existing Radius Server

You can modify one or multiple parameters of an existing Radius server, or change the priority or sequence of existing servers in the server list.

▶ **Change the IP address or host name:**

```
config:# authentication radius modify <server_num> host <host>
```

▶ **Change the Radius authentication type:**

```
config:# authentication radius modify <server_num> authType <rds_type>
```

▶ **Change the authentication port:**

```
config:# authentication radius modify <server_num> authPort <auth_port>
```

▶ **Change the accounting port:**

```
config:# authentication radius modify <server_num> accountPort <acct_port>
```

▶ **Change the timeout value:**

```
config:# authentication radius modify <server_num> timeout <timeout>
```

▶ **Change the number of retries:**

```
config:# authentication radius modify <server_num> retries <retries>
```

▶ **Change the shared secret:**

```
config:# authentication radius modify <server_num> secret
```

▶ **Change the priority of the specified server:**

```
config:# authentication radius modify <server_num> sortPositon <position>
```

*Tip: You can add more than one parameters to the command. For example, "authentication radius modify <server_num> **host** <host> authType <rds_type> **authPort** <auth_port> accountPort <acct_port> ...".*

Variables:

- <server_num> is the sequential number of the specified server in the Radius server list.
- <host> is the new IP address or host name of the Radius server.
- <rds_type> is one of the Radius authentication types: *pap*, *chap*, *msChapV2*.
- <auth_port> is the new authentication port number.
- <acct_port> is the new accounting port number.
- <timeout> is the new timeout value in seconds. It ranges between 1 to 10 seconds.
- <retries> is the new number of retries. It ranges between 0 to 5.

▶ **To enter the shared secret:**

1. After executing the above Radius command, the system automatically prompts you to enter the shared secret.
2. Type the secret and press Enter.
3. Re-type the same secret and press Enter.

▶ **Example:**

```
config:# authentication radius add 192.168.7.99 chap 1812 1813 10 3
```

Removing an Existing Radius Server

This command removes an existing Radius server from the server list.

```
config:# authentication radius delete <server_num>
```

Variables:

- <server_num> is the sequential number of the specified server in the Radius server list.

Environmental Sensor Configuration Commands

An environmental sensor configuration command begins with *externalsensor*. You can configure the name and location parameters of an individual environmental sensor.

*Note: To configure an actuator, see **Actuator Configuration Commands** (on page 676).*

Changing the Sensor Name

This command names an environmental sensor.

```
config:#    externalsensor <n> name "<name>"
```

Variables:

- <n> is the ID number of the environmental sensor that you want to configure. The ID number is available in the PX3 web interface or using the command "show externalsensors <n>" in the CLI. It is an integer starting at 1.
- <name> is a string comprising up to 64 ASCII printable characters. The <name> variable must be enclosed in quotes when it contains spaces.

*Note: To name an actuator, see **Actuator Configuration Commands** (on page 676).*

Specifying the CC Sensor Type

Raritan's contact closure sensor supports the connection of diverse third-party. You must specify the type of connected detector/switch for proper operation. Use this command when you need to specify the sensor type.

```
config:#    externalsensor <n> sensorSubType <sensor_type>
```

Variables:

- <n> is the ID number of the environmental sensor that you want to configure. The ID number is available in the PX3 web interface or using the command "show externalsensors <n>" in the CLI. It is an integer starting at 1.
- <sensor_type> is one of these types: *contact*, *smokeDetection*, *waterDetection* or *vibration*.

Type	Description
contact	The connected detector/switch is for detection of door lock or door closed/open status.

Type	Description
smokeDetection	The connected detector/switch is for detection of the smoke presence.
waterDetection	The connected detector/switch is for detection of the water presence.
vibration	The connected detector/switch is for detection of the vibration.

Setting the X Coordinate

This command specifies the X coordinate of an environmental sensor.

```
config:#    externalsensor <n> xlabel "<coordinate>"
```

Variables:

- <n> is the ID number of the environmental sensor that you want to configure. The ID number is available in the PX3 web interface or using the command "show externalsensors <n>" in the CLI. It is an integer starting at 1.
- <coordinate> is a string comprising up to 24 ASCII printable characters, and it must be enclosed in quotes.

Setting the Y Coordinate

This command specifies the Y coordinate of an environmental sensor.

```
config:#    externalsensor <n> ylabel "<coordinate>"
```

Variables:

- <n> is the ID number of the environmental sensor that you want to configure. The ID number is available in the PX3 web interface or using the command "show externalsensors <n>" in the CLI. It is an integer starting at 1.
- <coordinate> is a string comprising up to 24 ASCII printable characters, and it must be enclosed in quotes.

Setting the Z Coordinate

This command specifies the Z coordinate of an environmental sensor.

```
config:#    externalsensor <n> zlabel "<coordinate>"
```

Variables:

- <n> is the ID number of the environmental sensor that you want to configure. The ID number is available in the PX3 web interface or using the command "show externalsensors <n>" in the CLI. It is an integer starting at 1.
- Depending on the Z coordinate format you set, there are two types of values for the <coordinate> variable:

Type	Description
Free form	<coordinate> is a string comprising up to 24 ASCII printable characters, and it must be enclosed in quotes.
Rack units	<coordinate> is an integer number in rack units.

*Note: To specify the Z coordinate using the rack units, see **Setting the Z Coordinate Format for Environmental Sensors** (on page 564).*

Changing the Sensor Description

This command provides a description for a specific environmental sensor.

```
config:#    externalsensor <n> description "<description>"
```

Variables:

- <n> is the ID number of the environmental sensor that you want to configure. The ID number is available in the PX3 web interface or using the command "show externalsensors <n>" in the CLI. It is an integer starting at 1.
- <description> is a string comprising up to 64 ASCII printable characters, and it must be enclosed in quotes when it contains spaces.

Using Default Thresholds

This command determines whether default thresholds, including the deassertion hysteresis and assertion timeout, are applied to a specific environmental sensor.

```
config:#    externalsensor <n> useDefaultThresholds <option>
```

Variables:

- <n> is the ID number of the environmental sensor that you want to configure. The ID number is available in the PX3 web interface or using the command "show externalsensors <n>" in the CLI. It is an integer starting at 1.
- <option> is one of the options: *true* or *false*.

Option	Description
true	Default thresholds are selected as the threshold option for the specified sensor.
false	Sensor-specific thresholds are selected as the threshold option for the specified sensor.

Setting the Alarmed to Normal Delay for DX-PIR

This command determines the value of the Alarmed to Normal Delay setting for a Raritan presence detector.

```
config:#    externalsensor <n> alarmedToNormalDelay <time>
```

Variables:

- <n> is the ID number of the environmental sensor that you want to configure. The ID number is available in the PX3 web interface or using the command "show externalsensors <n>" in the CLI. It is an integer starting at 1.
- <time> is an integer number in seconds, ranging between 0 and 300.

Examples

This section illustrates several environmental sensor configuration examples.

Example 1 - Environmental Sensor Naming

The following command assigns the name "Cabinet humidity" to the environmental sensor with the ID number 4.

```
config:#    externalsensor 4 name "Cabinet humidity"
```

Example 2 - Sensor Threshold Selection

The following command sets the environmental sensor #1 to use the default thresholds, including the deassertion hysteresis and assertion timeout, as its threshold settings.

```
config:#    externalsensor 1 useDefaultThresholds true
```

Configuring Environmental Sensors' Default Thresholds

You can set the default values of upper and lower thresholds, deassertion hysteresis and assertion timeout on a sensor type basis, including temperature, humidity, air pressure and air flow sensors. The default thresholds automatically apply to all environmental sensors that are newly detected or added.

A default threshold configuration command begins with *defaultThresholds*.

You can configure various default threshold settings for the same sensor type at a time by combining multiple commands. See **Multi-Command Syntax** (on page 691).

▶ **Set the Default Upper Critical Threshold for a specific sensor type:**

```
config:#    defaultThresholds <sensor type> upperCritical <value>
```

▶ **Set the Default Upper Warning Threshold for a specific sensor type:**

```
config:#    defaultThresholds <sensor type> upperWarning <value>
```

▶ **Set the Default Lower Critical Threshold for a specific sensor type:**

```
config:#    defaultThresholds <sensor type> lowerCritical <value>
```

▶ **Set the Default Lower Warning Threshold for a specific sensor type:**

```
config:#    defaultThresholds <sensor type> lowerWarning <value>
```

▶ **Set the Default Deassertion Hysteresis for a specific sensor type:**

```
config:# defaultThresholds <sensor type> hysteresis <hy_value>
```

► **Set the Default Assertion Timeout for a specific sensor type:**

```
config:# defaultThresholds <sensor type> assertionTimeout <as_value>
```

Variables:

- <sensor type> is one of the following numeric sensor types:

Sensor types	Description
absoluteHumidity	Absolute humidity sensors
relativeHumidity	Relative humidity sensors
temperature	Temperature sensors
airPressure	Air pressure sensors
airFlow	Air flow sensors
vibration	Vibration sensors

- <value> is the value for the specified threshold of the specified sensor type. Note that diverse sensor types use different measurement units.

Sensor types	Measurement units
absoluteHumidity	g/m ³ (that is, g/m ³)
relativeHumidity	%
temperature	Degrees Celsius (°C) or Fahrenheit (°F), depending on your measurement unit settings.
airPressure	Pascal (Pa) or psi, depending on your measurement unit settings.
airFlow	m/s
vibration	g

- <hy_value> is the deassertion hysteresis value applied to the specified sensor type.
- <as_value> is the assertion timeout value applied to the specified sensor type. It ranges from 0 to 100 (samples).

Example - Default Upper Thresholds for Temperature

It is assumed that your preferred measurement unit for temperature is set to degrees Celsius. Then the following command sets the default Upper Warning threshold to 20°C and Upper Critical threshold to 24°C for all temperature sensors.

```
config:# defaultThresholds temperature upperWarning 20
        upperCritical 24
```

Sensor Threshold Configuration Commands

A sensor configuration command begins with *sensor*. You can use the commands to configure the threshold, hysteresis and assertion timeout values for any sensor associated with the following items:

- Outlets
- Outlet groups
- Inlets
- Inlet poles (for three-phase PDUs only)
- Overcurrent protectors
- Environmental sensors

It is permitted to assign a new value to the threshold at any time regardless of whether the threshold has been enabled.

Commands for Outlet Sensors

A sensor configuration command for outlets begins with *sensor outlet*.

You can configure various outlet sensor threshold settings at a time by combining multiple commands. See **Multi-Command Syntax** (on page 691).

▶ **Set the Upper Critical threshold for an outlet sensor:**

```
config:# sensor outlet <n> <sensor type> upperCritical <option>
```

▶ **Set the Upper Warning threshold for an outlet sensor:**

```
config:# sensor outlet <n> <sensor type> upperWarning <option>
```

▶ **Set the Lower Critical threshold for an outlet sensor:**

```
config:# sensor outlet <n> <sensor type> lowerCritical <option>
```

▶ **Set the Lower Warning threshold for an outlet sensor:**

```
config:# sensor outlet <n> <sensor type> lowerWarning <option>
```

▶ **Set the deassertion hysteresis for an outlet sensor:**

```
config:# sensor outlet <n> <sensor type> hysteresis <hy_value>
```

▶ **Set the assertion timeout for an outlet sensor:**

```
config:# sensor outlet <n> <sensor type> assertionTimeout <as_value>
```

Variables:

- <n> is the number of the outlet that you want to configure.
- <sensor type> is one of the following sensor types:

Sensor type	Description
current	Current sensor
voltage	Voltage sensor
activePower	Active power sensor
apparentPower	Apparent power sensor
powerFactor	Power factor sensor
activeEnergy	Active energy sensor
lineFrequency	Line frequency sensor

Note: If the requested sensor type is not supported, the "Sensor is not available" message is displayed.

- <option> is one of the options: *enable*, *disable* or a numeric value.

Option	Description
enable	Enables the specified threshold for a specific outlet sensor.
disable	Disables the specified threshold for a specific outlet sensor.

Option	Description
A numeric value	Sets a value for the specified threshold of a specific outlet sensor and enables this threshold at the same time.

- <hy_value> is a numeric value that is assigned to the hysteresis for the specified outlet sensor. See **"To De-assert" and Deassertion Hysteresis** (on page 884).
- <as_value> is a number in samples that is assigned to the assertion timeout for the specified outlet sensor. See **"To Assert" and Assertion Timeout** (on page 882).

Commands for Outlet Group Sensors

A sensor configuration command for outlets begins with *sensor outletgroup*.

You can configure various outlet group sensor threshold settings at a time by combining multiple commands. See **Multi-Command Syntax** (on page 691).

▶ Set the Upper Critical threshold for an outlet group sensor:

```
config:# sensor outletgroup <ID> <sensor type> upperCritical <option>
```

▶ Set the Upper Warning threshold for an outlet group sensor:

```
config:# sensor outletgroup <ID> <sensor type> upperWarning <option>
```

▶ Set the Lower Critical threshold for an outlet group sensor:

```
config:# sensor outletgroup <ID> <sensor type> lowerCritical <option>
```

▶ Set the Lower Warning threshold for an outlet group sensor:

```
config:# sensor outletgroup <ID> <sensor type> lowerWarning <option>
```

▶ Set the deassertion hysteresis for an outlet group sensor:

```
config:# sensor outletgroup <ID> <sensor type> hysteresis <hy_value>
```

▶ Set the assertion timeout for an outlet group sensor:

```
config:# sensor outletgroup <ID> <sensor type> assertionTimeout <as_value>
```

Variables:

- <ID> is an outlet group's index number.
- <sensor type> is one of the following sensor types:

Sensor type	Description
activePower	An outlet group's active power sensor
activeEnergy	An outlet group's active energy sensor

For definitions on an outlet group's sensors, see **Outlet Groups** (on page 226).

- <option> is one of the options: *enable*, *disable* or a numeric value.

Option	Description
enable	Enables the specified threshold for a specific group sensor of the chosen outlet group.
disable	Disables the specified threshold for a specific group sensor of the chosen outlet group.
A numeric value	Sets a value for the specified threshold of the chosen outlet group's specific group sensor, and enables this threshold at the same time.

- <hy_value> is a numeric value that is assigned to the hysteresis for the specified group sensor of the chosen outlet group. See **"To De-assert" and Deassertion Hysteresis** (on page 884).
- <as_value> is a number in samples that is assigned to the assertion timeout for the specified group sensor of the chosen outlet group. See **"To Assert" and Assertion Timeout** (on page 882).

Commands for Inlet Sensors

A sensor configuration command for inlets begins with *sensor inlet*.

You can configure various inlet sensor threshold settings at a time by combining multiple commands. See **Multi-Command Syntax** (on page 691).

▶ **Set the Upper Critical threshold for an inlet sensor:**

```
config:# sensor inlet <n> <sensor type> upperCritical <option>
```

▶ **Set the Upper Warning threshold for an inlet sensor:**

```
config:# sensor inlet <n> <sensor type> upperWarning <option>
```

▶ **Set the Lower Critical threshold for an inlet sensor:**

```
config:# sensor inlet <n> <sensor type> lowerCritical <option>
```

▶ **Set the Lower Warning threshold for an inlet sensor:**

```
config:# sensor inlet <n> <sensor type> lowerWarning <option>
```

▶ **Set the deassertion hysteresis for an inlet sensor:**

```
config:# sensor inlet <n> <sensor type> hysteresis <hy_value>
```

▶ **Set the assertion timeout for an inlet sensor:**

```
config:# sensor inlet <n> <sensor type> assertionTimeout <as_value>
```

Variables:

- <n> is the number of the inlet that you want to configure. For a single-inlet PDU, <n> is always 1.
- <sensor type> is one of the following sensor types:

Sensor type	Description
current	Current sensor
voltage	Voltage sensor
activePower	Active power sensor
apparentPower	Apparent power sensor
powerFactor	Power factor sensor
activeEnergy	Active energy sensor
unbalancedCurrent	Unbalanced load sensor
lineFrequency	Line frequency sensor
phaseAngle	Inlet phase angle sensor

Note: If the requested sensor type is not supported, the "Sensor is not available" message is displayed.

- <option> is one of the options: *enable*, *disable* or a numeric value.

Option	Description
enable	Enables the specified threshold for a specific inlet sensor.
disable	Disables the specified threshold for a specific inlet sensor.
A numeric value	Sets a value for the specified threshold of a specific inlet sensor and enables this threshold at the same time.

- <hy_value> is a numeric value that is assigned to the hysteresis for the specified inlet sensor. See **"To De-assert" and Deassertion Hysteresis** (on page 884).
- <as_value> is a numeric value that is assigned to the assertion timeout for the specified inlet sensor. See **"To Assert" and Assertion Timeout** (on page 882).

► **Additional sensors supported by specific models:**

Specific PX3 models support some or all of the following sensors. The CLI command(s) listed above can be also applied to the following sensors. Note that the measurement unit of current values in CLI is **A**, not mA.

Sensor type	Description	
peakCurrent	Peak current sensor	Supported on PXC and Legrand PDU only <ul style="list-style-type: none"> ▪ three-phase models also support pole-level peak current ▪ models with metered breakers also support breaker-level peak current
reactivePower	Reactive power sensor	
displacementPowerFactor	Displacement power factor sensor	
residualCurrent	RCM current sensor <ul style="list-style-type: none"> ▪ For Type A, it is the sensor that detects residual AC current. ▪ For Type B, it is the sensor that detects both residual AC and DC current. 	

Sensor type	Description
residualDCCurrent	RCM DC current sensor - detects residual DC current only. Available only on PDUs with RCM Type B.

*Note: For information on RCM Type A and B sensors, see **RCM Current Sensor** (on page 786).*

Commands for Inlet Pole Sensors

A sensor configuration command for inlet poles begins with *sensor inletpole*. This type of command is available on a three-phase PDU only.

You can configure various inlet pole sensor threshold settings at a time by combining multiple commands. See **Multi-Command Syntax** (on page 691).

▶ Set the Upper Critical Threshold for an Inlet Pole:

```
config:# sensor inletpole <n> <p> <sensor type> upperCritical <option>
```

▶ Set the Upper Warning Threshold for an Inlet Pole:

```
config:# sensor inletpole <n> <p> <sensor type> upperWarning <option>
```

▶ Set the Lower Critical Threshold for an Inlet Pole:

```
config:# sensor inletpole <n> <p> <sensor type> lowerCritical <option>
```

▶ Set the Lower Warning Threshold for an Inlet Pole:

```
config:# sensor inletpole <n> <p> <sensor type> lowerWarning <option>
```

▶ Set the Inlet Pole's Deassertion Hysteresis:

```
config:# sensor inletpole <n> <p> <sensor type> hysteresis <hy_value>
```

▶ Set the Inlet Pole's Assertion Timeout:

```
config:# sensor inletpole <n> <p> <sensor type> assertionTimeout <as_value>
```

Variables:

- <n> is the number of the inlet whose pole sensors you want to configure. For a single-inlet PDU, <n> is always 1.
- <p> is the label of the inlet pole that you want to configure.

Pole	Label <p>	Current sensor	Voltage sensor
1	L1	L1	L1 - L2
2	L2	L2	L2 - L3
3	L3	L3	L3 - L1

- <sensor type> is one of the following sensor types:

Sensor type	Description
current	Current sensor
voltage	Voltage sensor
activePower	Active power sensor
apparentPower	Apparent power sensor
powerFactor	Power factor sensor
activeEnergy	Active energy sensor
unbalancedCurrent	Unbalanced load sensor

Note: If the requested sensor type is not supported, the "Sensor is not available" message is displayed.

- <option> is one of the options: *enable*, *disable* or a numeric value.

Option	Description
enable	Enables the specified threshold for the specified inlet pole sensor.
disable	Disables the specified threshold for the specified inlet pole sensor.
A numeric value	Sets a value for the specified threshold of the specified inlet pole sensor and enables this threshold at the same time.

- <hy_value> is a numeric value that is assigned to the hysteresis for the specified inlet pole sensor. See **"To De-assert" and Deassertion Hysteresis** (on page 884).
- <as_value> is a number in samples that is assigned to the assertion timeout for the specified inlet pole sensor. See **"To Assert" and Assertion Timeout** (on page 882).

► **Additional sensors supported by specific models:**

Specific PX3 models support some or all of the following sensors. The CLI command(s) listed above can be also applied to the following sensors. Note that the measurement unit of current values in CLI is **A**, not mA.

Sensor type	Description	
peakCurrent	Peak current sensor	Supported on PXC and Legrand PDU only <ul style="list-style-type: none"> ▪ three-phase models also support pole-level peak current ▪ models with metered breakers also support breaker-level peak current
reactivePower	Reactive power sensor	
displacementPowerFactor or	Displacement power factor sensor	
residualCurrent	RCM current sensor <ul style="list-style-type: none"> ▪ For Type A, it is the sensor that detects residual AC current. ▪ For Type B, it is the sensor that detects both residual AC and DC current. 	
residualDCCurrent	RCM DC current sensor - detects residual DC current only. Available only on PDUs with RCM Type B.	

*Note: For information on RCM Type A and B sensors, see **RCM Current Sensor** (on page 786).*

Commands for Overcurrent Protector Sensors

A sensor configuration command for overcurrent protectors begins with *sensor ocp*.

You can configure various overcurrent protector threshold settings at a time by combining multiple commands. See **Multi-Command Syntax** (on page 691).

▶ **Set the Upper Critical threshold for an overcurrent protector:**

```
config:# sensor ocp <n> <sensor type> upperCritical <option>
```

▶ **Set the Upper Warning threshold for an overcurrent protector:**

```
config:# sensor ocp <n> <sensor type> upperWarning <option>
```

▶ **Set the Lower Critical threshold for an overcurrent protector:**

```
config:# sensor ocp <n> <sensor type> lowerCritical <option>
```

▶ **Set the Lower Warning threshold for an overcurrent protector:**

```
config:# sensor ocp <n> <sensor type> lowerWarning <option>
```

▶ **Set the deassertion hysteresis for an overcurrent protector:**

```
config:# sensor ocp <n> <sensor type> hysteresis <hy_value>
```

▶ **Set the assertion timeout for an overcurrent protector:**

```
config:# sensor ocp <n> <sensor type> assertionTimeout <as_value>
```

Variables:

- <n> is the number of the overcurrent protector that you want to configure.
- <sensor type> is one of the following sensor types:

Sensor type	Description
current	Current sensor

Note: If the requested sensor type is not supported, the "Sensor is not available" message is displayed.

- <option> is one of the options: *enable*, *disable* or a numeric value.

Option	Description
enable	Enables the specified threshold for the overcurrent protector sensor.
disable	Disables the specified threshold for the overcurrent protector sensor.
A numeric value	Sets a value for the specified threshold of the overcurrent protector sensor and enables this threshold at the same time.

- <hy_value> is a numeric value that is assigned to the hysteresis for the specified overcurrent protector sensor. See **"To De-assert" and Deassertion Hysteresis** (on page 884).
- <as_value> is a number in samples that is assigned to the assertion timeout for the specified overcurrent protector sensor. See **"To Assert" and Assertion Timeout** (on page 882).

Commands for Environmental Sensors

A sensor threshold configuration command for environmental sensors begins with *sensor externalsensor*.

You can configure various environmental sensor threshold settings at a time by combining multiple commands. See **Multi-Command Syntax** (on page 691).

▶ **Set the Upper Critical threshold for an environmental sensor:**

```
config:# sensor externalsensor <n> <sensor type> upperCritical <option>
```

▶ **Set the Upper Warning threshold for an environmental sensor:**

```
config:# sensor externalsensor <n> <sensor type> upperWarning <option>
```

▶ **Set the Lower Critical threshold for an environmental sensor:**

```
config:# sensor externalsensor <n> <sensor type> lowerCritical <option>
```

▶ **Set the Lower Warning threshold for an environmental sensor:**

```
config:# sensor externalsensor <n> <sensor type> lowerWarning <option>
```

▶ **Set the deassertion hysteresis for an environmental sensor:**

```
config:# sensor externalsensor <n> <sensor type> hysteresis <hy_value>
```

► **Set the assertion timeout for an environmental sensor:**

```
config:# sensor externalsensor <n> <sensor type> assertionTimeout <as_value>
```

Variables:

- <n> is the ID number of the environmental sensor that you want to configure. The ID number is available in the PX3 web interface or using the command "show externalsensors <n>" in the CLI. It is an integer starting at 1.
- <sensor type> is one of the following numeric sensor types:

Sensor types	Description
absoluteHumidity	Absolute humidity sensors
relativeHumidity	Relative humidity sensors
temperature	Temperature sensors
airPressure	Air pressure sensors
airFlow	Air flow sensors
vibration	Vibration sensors

Note: If the specified sensor type does not match the type of the specified environmental sensor, this error message appears: "Specified sensor type 'XXX' does not match the sensor's type (<sensortype>)," where XXX is the specified sensor type, and <sensortype> is the correct sensor type.

- <option> is one of the options: *enable*, *disable* or a numeric value.

Option	Description
enable	Enables the specified threshold for a specific environmental sensor.
disable	Disables the specified threshold for a specific environmental sensor.
A numeric value	Sets a value for the specified threshold of a specific environmental sensor and enables this threshold at the same time.

- <hy_value> is a numeric value that is assigned to the hysteresis for the specified environmental sensor. See **"To De-assert" and Deassertion Hysteresis** (on page 884).
- <as_value> is a number in samples that is assigned to the assertion timeout for the specified environmental sensor. It ranges between 1 and 100. See **"To Assert" and Assertion Timeout** (on page 882).

Examples

This section illustrates several environmental sensor threshold configuration examples.

Example 1 - Upper Critical Threshold for a Temperature Sensor

The following command sets the Upper Critical threshold of the environmental "temperature" sensor with the ID number 2 to 40 degrees Celsius. It also enables the upper critical threshold if this threshold has not been enabled yet.

```
config:# sensor externalsensor 2 temperature upperCritical 40
```

Example 2 - Warning Thresholds for Inlet Sensors

The following command sets both the Upper Warning and Lower Warning thresholds for the inlet 1 RMS current.

```
config:# sensor inlet 1 current upperWarning 20 lowerWarning 12
```

Results:

- The Upper Warning threshold for the inlet 1 RMS current is set to 20A. It also enables the upper warning threshold if this threshold has not been enabled yet.
- The Lower Warning threshold for the inlet 1 RMS current is set to 12A. It also enables the lower warning threshold if this threshold has not been enabled yet.

Example 3 - Upper Thresholds for Overcurrent Protector Sensors

The following command sets both the Upper Critical and Upper Warning thresholds for the 2nd overcurrent protector.

```
config:# sensor ocp 2 current upperWarning enable upperCritical 16
```

Results:

- The Upper Critical threshold for the 2nd overcurrent protector's RMS current is set to 16A. It also enables the upper critical threshold if this threshold has not been enabled yet.
- The Upper Warning threshold for the 2nd overcurrent protector's RMS current is enabled.

Actuator Configuration Commands

An actuator configuration command begins with *actuator*. You can configure the name and location parameters of an individual actuator.

You can configure various parameters for one actuator at a time. See **Multi-Command Syntax** (on page 691).

▶ **Change the name:**

```
config:# actuator <n> name "<name>"
```

▶ **Set the X coordinate:**

```
config:# actuator <n> xlabel "<coordinate>"
```

▶ **Set the Y coordinate:**

```
config:# actuator <n> ylabel "<coordinate>"
```

▶ **Set the Z coordinate:**

```
config:# actuator <n> zlabel "<z_label>"
```

▶ **Modify the actuator's description:**

```
config:# actuator <n> description "<description>"
```

Variables:

- <n> is the ID number assigned to the actuator. The ID number can be found using the PX3 web interface or CLI. It is an integer starting at 1.
- <name> is a string comprising up to 64 ASCII printable characters. The <name> variable must be enclosed in quotes when it contains spaces.
- <coordinate> is a string comprising up to 24 ASCII printable characters, and it must be enclosed in quotes.
- There are two types of values for the <z_label> variable, depending on the Z coordinate format you set:

Type	Description
Free form	<coordinate> is a string comprising up to 24 ASCII printable characters, and it must be enclosed in quotes.
Rack units	<coordinate> is an integer number in rack units.

Note: To specify the Z coordinate using the rack units, see **Setting the Z Coordinate Format for Environmental Sensors** (on page 564).

- <description> is a string comprising up to 64 ASCII printable characters, and it must be enclosed in quotes when it contains spaces.

Example - Actuator Naming

The following command assigns the name "Door lock of cabinet 3" to the actuator whose ID number is 9.

```
config:# actuator 9 name "Door lock of cabinet 3"
```

Server Reachability Configuration Commands

You can use the CLI to add or delete an IT device, such as a server, from the server reachability list, or modify the settings for a monitored IT device. A server reachability configuration command begins with *serverReachability*.

Adding a Monitored Device

This command adds a new IT device to the server reachability list.

```
config:# serverReachability add <IP_host> <enable> <succ_ping>
<fail_ping> <succ_wait> <fail_wait> <resume> <disable_count>
```

Variables:

- <IP_host> is the IP address or host name of the IT device that you want to add.
- <enable> is one of the options: *true* or *false*.

Option	Description
true	Enables the ping monitoring feature for the newly added device.
false	Disables the ping monitoring feature for the newly added device.

- <succ_ping> is the number of successful pings for declaring the monitored device "Reachable." Valid range is 0 to 200.
- <fail_ping> is the number of consecutive unsuccessful pings for declaring the monitored device "Unreachable." Valid range is 1 to 100.
- <succ_wait> is the wait time to send the next ping after a successful ping. Valid range is 5 to 600 (seconds).
- <fail_wait> is the wait time to send the next ping after a unsuccessful ping. Valid range is 3 to 600 (seconds).
- <resume> is the wait time before the PX3 resumes pinging after declaring the monitored device "Unreachable." Valid range is 5 to 120 (seconds).
- <disable_count> is the number of consecutive "Unreachable" declarations before the PX3 disables the ping monitoring feature for the monitored device and returns to the "Waiting for reliable connection" state. Valid range is 1 to 100 or *unlimited*.

Deleting a Monitored Device

This command removes a monitored IT device from the server reachability list.

```
config:# serverReachability delete <n>
```

Variables:

- <n> is a number representing the sequence of the IT device in the monitored server list.
You can find each IT device's sequence number using the CLI command of `show serverReachability` as illustrated below.

#	IP address	Enabled	Status
1	192.168.84.126	Yes	Waiting for reliable connection
2	www.raritan.com	Yes	Waiting for reliable connection

Modifying a Monitored Device's Settings

The command to modify a monitored IT device's settings begins with `serverReachability modify`.

You can modify various settings for a monitored device at a time. See **Multi-Command Syntax** (on page 691).

► **Modify a device's IP address or host name:**

```
config:# serverReachability modify <n> ipAddress <IP_host>
```

► **Enable or disable the ping monitoring feature for the device:**

```
config:# serverReachability modify <n> pingMonitoringEnabled <option>
```

▶ **Modify the number of successful pings for declaring "Reachable":**

```
config:# serverReachability modify <n> numberOfSuccessfulPingsToEnable
<succ_number>
```

▶ **Modify the number of unsuccessful pings for declaring "Unreachable":**

```
config:# serverReachability modify <n> numberOfUnsuccessfulPingsForFailure
<fail_number>
```

▶ **Modify the wait time after a successful ping:**

```
config:# serverReachability modify <n> waitTimeAfterSuccessfulPing
<succ_wait>
```

▶ **Modify the wait time after an unsuccessful ping:**

```
config:# serverReachability modify <n> waitTimeAfterUnsuccessfulPing
<fail_wait>
```

▶ **Modify the wait time before resuming pinging after declaring "Unreachable":**

```
config:# serverReachability modify <n> waitTimeBeforeResumingPinging
<resume>
```

▶ **Modify the number of consecutive "Unreachable" declarations before disabling the ping monitoring feature:**

```
config:# serverReachability modify <n> numberOfFailuresToDisable
<disable_count>
```

Variables:

- <n> is a number representing the sequence of the IT device in the server monitoring list.
- <IP_host> is the IP address or host name of the IT device whose settings you want to modify.
- <option> is one of the options: *true* or *false*.

Option	Description
true	Enables the ping monitoring feature for the monitored device.
false	Disables the ping monitoring feature for the monitored device.

- <succ_number> is the number of successful pings for declaring the monitored device "Reachable." Valid range is 0 to 200.
- <fail_number> is the number of consecutive unsuccessful pings for declaring the monitored device "Unreachable." Valid range is 1 to 100.
- <succ_wait> is the wait time to send the next ping after a successful ping. Valid range is 5 to 600 (seconds).
- <fail_wait> is the wait time to send the next ping after a unsuccessful ping. Valid range is 3 to 600 (seconds).
- <resume> is the wait time before the PX3 resumes pinging after declaring the monitored device "Unreachable." Valid range is 5 to 120 (seconds).
- <disable_count> is the number of consecutive "Unreachable" declarations before the PX3 disables the ping monitoring feature for the monitored device and returns to the "Waiting for reliable connection" state. Valid range is 1 to 100 or *unlimited*.

Example - Server Settings Changed

The following command modifies several ping monitoring settings for the second server in the server reachability list.

```
config:# serverReachability modify 2 numberOfSuccessfulPingsToEnable 10
        numberOfUnsuccessfulPingsForFailure 8
        waitTimeAfterSuccessfulPing 30
```

EnergyWise Configuration Commands

An EnergyWise configuration command begins with *energywise*.

Enabling or Disabling EnergyWise

This command syntax determines whether the Cisco® EnergyWise endpoint implemented on the PX3 is enabled.

```
config:# energywise enabled <option>
```

Variables:

- <option> is one of the options: *true* or *false*.

Option	Description
true	The Cisco EnergyWise feature is enabled.
false	The Cisco EnergyWise feature is disabled.

Specifying the EnergyWise Domain

This command syntax specifies to which Cisco® EnergyWise domain the PX3 belongs.

```
config:# energywise domain <name>
```

Variables:

- <name> is a string comprising up to 127 ASCII printable characters. Spaces and asterisks are NOT acceptable.

Specifying the EnergyWise Secret

This command syntax specifies the password (secret) to enter the Cisco® EnergyWise domain.

```
config:# energywise secret <password>
```

Variables:

- <password> is a string comprising up to 127 ASCII printable characters. Spaces and asterisks are NOT acceptable.

Changing the UDP Port

This command syntax specifies the UDP port for communications in the Cisco® EnergyWise domain.

```
config:# energywise port <port>
```

Variables:

- <port> is the UDP port number ranging between 1 and 65535.

Setting the Polling Interval

This command syntax determines the polling interval at which the Cisco® EnergyWise domain queries the PX3.

```
config:# energywise polling <timing>
```

Variables:

- <timing> is an integer number in seconds. It ranges between 30 and 600 seconds.

Example - Setting Up EnergyWise

The following command sets up two Cisco® EnergyWise-related features.

```
config:# energywise enabled true port 10288
```

Results:

- The EnergyWise feature implemented on the PX3 is enabled.
- The UDP port is set to 10288.

Asset Management Commands

You can use the CLI commands to change the settings of the connected asset strip (if any) or the settings of LEDs on the asset strip.

Asset Strip Management

An asset strip management configuration command begins with `assetStrip`.

Naming an Asset Strip

This command syntax names or changes the name of an asset strip connected to the PX3 device.

```
config:#  assetStrip <n> name "<name>"
```

Variables:

- <n> is the number of the FEATURE port where the selected asset strip is physically connected. For the PX3 device with only one FEATURE port, the number is always 1.
- <name> is a string comprising up to 64 ASCII printable characters. The <name> variable must be enclosed in quotes when it contains spaces.

Specifying the Number of Rack Units

This command syntax specifies the total number of rack units on an asset strip connected to the PX3 device.

```
config:#  assetStrip <n> numberOfRackUnits <number>
```

Note: A rack unit refers to a tag port on the asset strips.

Variables:

- <n> is the number of the FEATURE port where the selected asset strip is physically connected. For the PX3 device with only one FEATURE port, the number is always 1.
- <number> is the total number of rack units available on the connected asset strip. This value ranges from 8 to 64.

Specifying the Rack Unit Numbering Mode

This command syntax specifies the numbering mode of rack units on the asset strips connected to the PX3 device. The numbering mode changes the rack unit numbers.

```
config:#  assetStrip <n> rackUnitNumberingMode <mode>
```

Variables:

- <n> is the number of the FEATURE port where the selected asset strip is physically connected. For the PX3 device with only one FEATURE port, the number is always 1.
- <mode> is one of the numbering modes: *topDown* or *bottomUp*.

Mode	Description
topDown	The rack units are numbered in the ascending order from the highest to the lowest rack unit.
bottomUp	The rack units are numbered in the descending order from the highest to the lowest rack unit.

Specifying the Rack Unit Numbering Offset

This command syntax specifies the starting number of rack units on the asset strips connected to the PX3 device.

```
config:#  assetStrip <n> rackUnitNumberingOffset <number>
```

Variables:

- <n> is the number of the FEATURE port where the selected asset strip is physically connected. For the PX3 device with only one FEATURE port, the number is always 1.
- <number> is a starting number for numbering rack units on the connected asset strip. This value is an integer number.

Specifying the Asset Strip Orientation

This command syntax specifies the orientation of the asset strips connected to the PX3 device. Usually you do not need to perform this command unless your asset strips do NOT come with the tilt sensor, causing the PX3 unable to detect the asset strips' orientation.

```
config:#    assetStrip <n> assetStripOrientation <orientation>
```

Variables:

- <n> is the number of the FEATURE port where the selected asset strip is physically connected. For the PX3 device with only one FEATURE port, the number is always 1.
- <orientation> is one of the options: *topConnector* or *bottomConnector*.

Orientation	Description
topConnector	This option indicates that the asset strip is mounted with the RJ-45 connector located on the top.
bottomConnector	This option indicates that the asset strip is mounted with the RJ-45 connector located at the bottom.

Setting LED Colors for Connected Tags

This command syntax sets the LED color for all rack units on the asset strip #1 to indicate the presence of a connected asset tag.

```
config:#    assetStrip <n> LEDColorForConnectedTags <color>
```

Variables:

- <color> is the hexadecimal RGB value of a color in HTML format. The <color> variable ranges from #000000 to #FFFFFF.

Setting LED Colors for Disconnected Tags

This command syntax sets the LED color for all rack units on the connected asset strip(s) to indicate the absence of a connected asset tag.

```
config:#    assetStrip <n> LEDColorForDisconnectedTags <color>
```

Variables:

- <color> is the hexadecimal RGB value of a color in HTML format. The <color> variable ranges from #000000 to #FFFFFF.

Rack Unit Configuration

A rack unit refers to a tag port on the asset strips. A rack unit configuration command begins with `rackUnit`.

Naming a Rack Unit

This command syntax assigns or changes the name of the specified rack unit on the specified asset strip.

```
config:#    rackUnit <n> <rack_unit> name "<name>"
```

Variables:

- <n> is the number of the FEATURE port where the selected asset strip is physically connected. For the PX3 device with only one FEATURE port, the number is always 1.
- <rack_unit> is the index number of the desired rack unit. The index number is available on the asset strip or the Asset Strip page of the web interface.
- <name> is a string comprising up to 64 ASCII printable characters. The <name> variable must be enclosed in quotes when it contains spaces.

Setting the LED Operation Mode

This command syntax determines whether a specific rack unit on the specified asset strip follows the global LED color settings.

```
config:# rackUnit <n> <rack_unit> LEDOperationMode <mode>
```

Variables:

- <n> is the number of the FEATURE port where the selected asset strip is physically connected. For the PX3 device with only one FEATURE port, the number is always 1.
- <rack_unit> is the index number of the desired rack unit. The index number is available on the asset strip or the Asset Strip page of the web interface.
- <mode> is one of the LED modes: *automatic* or *manual*.

Mode	Description
automatic	This option makes the LED of the specified rack unit follow the global LED color settings. See Setting LED Colors for Connected Tags (on page 685) and Setting LED Colors for Disconnected Tags (on page 686). This is the default.
manual	This option enables selection of a different LED color and LED mode for the specified rack unit. When this option is selected, see Setting an LED Color for a Rack Unit (on page 688) and Setting an LED Mode for a Rack Unit (on page 688) to set different LED settings.

Setting an LED Color for a Rack Unit

This command syntax sets the LED color for a specific rack unit on the specified asset strip. You need to set a rack unit's LED color only when the LED operation mode of this rack unit has been set to "manual."

```
config:#    rackUnit <n> <rack_unit> LEDColor <color>
```

Variables:

- <n> is the number of the FEATURE port where the selected asset strip is physically connected. For the PX3 device with only one FEATURE port, the number is always 1.
- <rack_unit> is the index number of the desired rack unit. The index number is available on the asset strip or the Asset Strip page of the web interface.
- <color> is the hexadecimal RGB value of a color in HTML format. The <color> variable ranges from #000000 to #FFFFFF.

*Note: A rack unit's LED color setting overrides the global LED color setting on it. See **Setting LED Colors for Connected Tags** (on page 685) and **Setting LED Colors for Disconnected Tags** (on page 686).*

Setting an LED Mode for a Rack Unit

This command syntax sets the LED mode for a specific rack unit on the specified asset strip. You need to set a rack unit's LED mode only when the LED operation mode of this rack unit has been set to "manual."

```
config:#    rackUnit <n> <rack_unit> LEDMode <mode>
```

Variables:

- <n> is the number of the FEATURE port where the selected asset strip is physically connected. For the PX3 device with only one FEATURE port, the number is always 1.
- <rack_unit> is the index number of the desired rack unit. The index number is available on the asset strip or the Asset Strip page of the web interface.
- <mode> is one of the LED modes: *on*, *off*, *blinkSlow* or *blinkFast*.

Mode	Description
on	This mode has the LED stay lit permanently.
off	This mode has the LED stay off permanently.

Mode	Description
blinkSlow	This mode has the LED blink slowly.
blinkFast	This mode has the LED blink quickly.

Examples

This section illustrates several asset management examples.

Example 1 - Asset Strip LED Colors for Disconnected Tags

This command syntax sets the LED color for all rack units on the asset sensor #1 to BLACK (that is, 000000) to indicate the absence of a connected asset tag.

```
config:#    assetStrip 1 LEDColorForDisconnectedTags #000000
```

Note: Black color causes the LEDs to stay off.

Example 2 - Rack Unit Naming

The following command assigns the name "Linux server" to the rack unit whose index number is 25 on the asset sensor#1.

```
config:#    rackUnit 1 25 name "Linux server"
```

Serial Port Configuration Commands

A serial port configuration command begins with *serial*.

Setting the Baud Rates

The following commands set the baud rate (bps) of the serial port labeled CONSOLE / MODEM on the PX3 device. Change the baud rate before connecting it to the desired device, such as a computer, a Raritan's P2CIM-SER, or a modem, through the serial port, or there are communications errors. If you change the baud rate dynamically after the connection has been made, you must reset the PX3 or power cycle the connected device for proper communications.

▶ **Determine the CONSOLE baud rate:**

```
config:# serial consoleBaudRate <baud_rate>
```

Note: The serial port bit-rate change is required when the PX3 works in conjunction with Raritan's Dominion LX KVM switch. Dominion LX only supports 19200 bps for communications over the serial interface.

▶ **Determine the MODEM baud rate:**

```
config:# serial modemBaudRate <baud_rate>
```

Variables:

- <baud_rate> is one of the baud rate options: 1200, 2400, 4800, 9600, 19200, 38400, 57600, 115200.

Forcing the Device Detection Mode

This command forces the serial port on the PX3 to enter a specific device detection mode.

```
config:# serial deviceDetectionType <mode>
```

Variables:

- <mode> is one of the detection modes: *automatic*, *forceConsole*, *forceAnalogModem*, or *forceGsmModem*.

Option	Description
automatic	The PX3 automatically detects the type of the device connected to the serial port. Select this option unless your PX3 cannot correctly detect the device type.
forceConsole	The PX3 attempts to recognize that the connected device is set for the console mode.

Option	Description
forceAnalogModem	The PX3 attempts to recognize that the connected device is an analog modem.
forceGsmModem	The PX3 attempts to recognize that the connected device is a GSM modem.

Example

The following command sets the CONSOLE baud rate of the PX3 device's serial port to 9600 bps.

```
config:# serial consoleBaudRate 9600
```

Multi-Command Syntax

To shorten the configuration time, you can combine various configuration commands in one command to perform all of them at a time. All combined commands must belong to the same configuration type, such as commands prefixed with *network*, *user modify*, *sensor externalsensor* and so on.

A multi-command syntax looks like this:

```
<configuration type> <setting 1> <value 1> <setting 2>
<value 2> <setting 3> <value 3> ...
```

Example 1 - Combination of ETH1's Activation, Configuration Method and IP

The following multi-command syntax configures IPv4 address, configuration method and activation status for ETH1's network connectivity simultaneously.

```
config:# network ipv4 interface eth1 enabled true configMethod static
address 192.168.84.225/24
```

Results:

- The ETH1 interface is enabled.
- ETH1's configuration method is set to static IP address.
- ETH1's IPv4 address is set to 192.168.84.225/24.

Example 2 - Combination of Upper Critical and Upper Warning Settings

The following multi-command syntax simultaneously configures Upper Critical and Upper Warning thresholds for the RMS current of the 2nd overcurrent protector.

```
config:# sensor ocp 2 current upperCritical disable upperWarning 15
```

Results:

- The Upper Critical threshold of the 2nd overcurrent protector's RMS current is disabled.
- The Upper Warning threshold of the 2nd overcurrent protector's RMS current is set to 15A and enabled at the same time.

Example 3 - Combination of SSID and PSK Parameters

This multi-command syntax configures both SSID and PSK parameters simultaneously for the wireless feature.

```
config:# network wireless SSID myssid PSK encryp_key
```

Results:

- The SSID value is set to myssid.
- The PSK value is set to encryp_key.

Example 4 - Combination of Upper Critical, Upper Warning and Lower Warning Settings

The following multi-command syntax configures Upper Critical, Upper Warning and Lower Warning thresholds for the outlet 5 RMS current simultaneously.

```
config:# sensor outlet 5 current upperCritical disable upperWarning enable  
lowerWarning 1.0
```

Results:

- The Upper Critical threshold of outlet 5 RMS current is disabled.
- The Upper Warning threshold of outlet 5 RMS current is enabled.
- The Lower Warning threshold of outlet 5 RMS current is set to 1.0A and enabled at the same time.

Load Shedding Configuration Commands

This section applies to outlet-switching capable models only.

A load shedding configuration command begins with *loadshedding*.

Unlike other CLI configuration commands, the load shedding configuration command is performed in the *administrator mode* rather than the configuration mode. See ***Different CLI Modes and Prompts*** (on page 518).

Enabling or Disabling Load Shedding

This section applies to outlet-switching capable models only.

This command determines whether to enter or exit from the load shedding mode.

```
#          loadshedding <option>
```

After performing the above command, PX3 prompts you to confirm the operation. Press *y* to confirm or *n* to abort the operation.

To skip the confirmation step, you can add the *"/y"* parameter to the end of the command so that the operation is executed immediately.

```
#          loadshedding <option> /y
```

Variables:

- *<option>* is one of the options: *enable* or *disable*.

Option	Description
start	Enter the load shedding mode.
stop	Quit the load shedding mode.

Example

The following command has the PX3 enter the load shedding mode.

```
config:#  loadshedding start
```

Power Control Operations

This section applies to outlet-switching capable models only.

Outlets on the PX3 can be turned on or off, or power cycled through the CLI. Besides, you can cancel the power-on process while the PX3 is powering on ALL outlets.

You must perform this operation in the *administrator mode*. See **Different CLI Modes and Prompts** (on page 518).

Turning On the Outlet(s)

This section applies to outlet-switching capable models only.

This command turns on one or multiple outlets.

```
# power outlets <numbers> on
```

To quicken the operation, you can add the parameter "/y" to the end of the command, which confirms the operation.

```
# power outlets <numbers> on /y
```

Variables:

- <numbers> is one of the options: *all*, an outlet number, a list or a range of outlets.

Option	Description
all	Switches ON all outlets.
A specific outlet number	Switches ON the specified outlet.
A comma-separated list of outlets	Switches ON multiple, inconsecutive or consecutive outlets. For example, to specify 7 outlets -- 2, 4, 9, 11, 12, 13 and 15, type: outlets 2,4,9,11-13,15.
A range of outlets with a hyphen in between	Switches ON multiple, consecutive outlets. For example, to specify 6 consecutive outlets -- 3, 4, 5, 6, 7, 8, type: outlets 3-8.

If you entered the command without `/y`, a message appears, prompting you to confirm the operation. Then:

- Type `y` to confirm the operation, OR
- Type `n` to abort the operation

If you have configured outlet switching sequence and/or delay, PX3 will prompt you with one more question:

Should outlet sequence order and delays be used during switching?

- Type `y` to apply the current outlet sequence and delay settings when switching on outlets. See **Setting Outlet Power-On Sequence and Delay** (on page 212).
- Type `n` to apply the default sequence and delays.

Turning Off the Outlet(s)

This section applies to outlet-switching capable models only.

This command turns off one or multiple outlets.

```
# power outlets <numbers> off
```

To quicken the operation, you can add the parameter `/y` to the end of the command, which confirms the operation.

```
# power outlets <numbers> off /y
```

Variables:

- `<numbers>` is one of the options: *all*, an outlet number, a list or a range of outlets.

Option	Description
all	Switches OFF all outlets.
A specific outlet number	Switches OFF the specified outlet.
A comma-separated list of outlets	Switches OFF multiple, inconsecutive or consecutive outlets. For example, to specify 7 outlets -- 2, 4, 9, 11, 12, 13 and 15, type: <code>outlets 2, 4, 9, 11-13, 15.</code>

Option	Description
A range of outlets with a hyphen in between	Switches OFF multiple, consecutive outlets. For example, to specify 6 consecutive outlets -- 3, 4, 5, 6, 7, 8, type: outlets 3-8.

If you entered the command without "/y", a message appears, prompting you to confirm the operation. Then:

- Type `y` to confirm the operation, OR
- Type `n` to abort the operation

Power Cycling the Outlet(s)

This section applies to outlet-switching capable models only.

This command power cycles one or multiple outlets.

```
# power outlets <numbers> cycle
```

To quicken the operation, you can add the parameter "/y" to the end of the command, which confirms the operation.

```
# power outlets <numbers> cycle /y
```

Variables:

- <numbers> is one of the options: *all*, an outlet number, a list or a range of outlets.

Option	Description
all	Power cycles all outlets.
A specific outlet number	Power cycles the specified outlet.
A comma-separated list of outlets	Power cycles multiple, inconsecutive or consecutive outlets. For example, to specify 7 outlets -- 2, 4, 9, 11, 12, 13 and 15, type: outlets 2, 4, 9, 11-13, 15.

Option	Description
A range of outlets with a hyphen in between	Power cycles multiple, consecutive outlets. For example, to specify 6 consecutive outlets -- 3, 4, 5, 6, 7, 8, type: outlets 3-8.

If you entered the command without `/y`, a message appears, prompting you to confirm the operation. Then:

- Type `y` to confirm the operation, OR
- Type `n` to abort the operation

If you have configured outlet switching sequence and/or delay, PX3 will prompt you with one more question:

Should outlet sequence order and delays be used during switching?

- Type `y` to apply the current outlet sequence and delay settings when switching on outlets. See **Setting Outlet Power-On Sequence and Delay** (on page 212).
- Type `n` to apply the default sequence and delays.

Canceling the Power-On Process

This section applies to outlet-switching capable models only.

After issuing the command to power on ALL outlets, you can use the following command to stop the power-on process.

```
# power cancelSequence
```

To quicken the operation, you can add the parameter `/y` to the end of the command, which confirms the operation.

```
# power cancelSequence /y
```

Example - Power Cycling Specific Outlets

The following command power cycles these outlets: 2, 6, 7, 8, 10, 13, 14, 15 and 16.

```
# power outlets 2,6-8,10,13-16 cycle
```

Actuator Control Operations

An actuator, which is connected to a dry contact signal channel of a Raritan sensor package, can control a mechanism or system. You can switch on or off that mechanism or system through the actuator control command in the CLI.

Perform these commands in the administrator or user mode. See ***Different CLI Modes and Prompts*** (on page 518).

Switching On an Actuator

This command syntax turns on one actuator.

```
#          control actuator <n> on
```

To quicken the operation, you can add the parameter `"/y"` to the end of the command, which confirms the operation.

```
#          control actuator <n> on /y
```

Variables:

- `<n>` is an actuator's ID number.
The ID number is available in the PX3 web interface or using the `show` command in the CLI. It is an integer starting at 1.

If you entered the command without `"/y"`, a message appears, prompting you to confirm the operation. Then:

- Type `y` to confirm the operation, OR
- Type `n` to abort the operation

Switching Off an Actuator

This command syntax turns off one actuator.

```
#          control actuator <n> off
```

To quicken the operation, you can add the parameter `"/y"` to the end of the command, which confirms the operation.

```
#          control actuator <n> off /y
```

Variables:

- `<n>` is an actuator's ID number.
The ID number is available in the PX3 web interface or using the `show` command in the CLI. It is an integer starting at 1.

If you entered the command without `"/y"`, a message appears, prompting you to confirm the operation. Then:

- Type `y` to confirm the operation, OR
- Type `n` to abort the operation

Example - Turning On a Specific Actuator

The following command turns on the actuator whose ID number is 8.

```
#          control actuator 8 on
```

Unblocking a User

If any user is blocked from accessing the PX3, you can unblock them at the local console.

► To unblock a user:

1. Access the CLI interface using any terminal program via a local connection. See *With HyperTerminal* (on page 516).
2. When the Username prompt appears, type `unlock` and press Enter.

Username: `unlock`

3. When the "Username to unblock" prompt appears, type the name of the blocked user and press Enter.

Username to unblock:

4. A message appears, indicating that the specified user was unblocked successfully.

Resetting the PX3

You can reset the PX3 to factory defaults or simply restart it using the CLI commands.

Restarting the PDU

This command restarts the PX3. It is not a factory default reset.

► **To restart the PX3:**

1. Ensure you have entered administrator mode and the # prompt is displayed.
2. Type either of the following commands to restart the PX3.

```
# reset unit
```

```
-- OR --
```

```
# reset unit /y
```

3. If you entered the command without "/y" in Step 2, a message appears prompting you to confirm the operation. Type y to confirm the reset.
4. Wait until the reset is complete.

Note: Device reset will cause CLI communications over an "USB" connection to be lost. Therefore, re-connect the USB cable after the reset is complete.

Resetting Active Energy Readings

You can reset either one active energy sensor or all active energy sensors at a time to restart the energy accumulation process.

Only users with the "Admin" role assigned can reset active energy readings.

► **To reset all active energy readings of the PX3:**

```
# reset activeEnergy pdu
```

```
-- OR --
```

```
# reset activeEnergy pdu /y
```

► **To reset one inlet's active energy readings:**

```
# reset activeEnergy inlet <n>
```

```
-- OR --
```

```
# reset activeEnergy inlet <n> /y
```

▶ **To reset one outlet's active energy readings:**

```
#    reset activeEnergy outlet <outlet_n>
    -- OR --
#    reset activeEnergy outlet <outlet_n> /y
```

▶ **To reset one outlet group's active energy readings:**

```
#    reset activeEnergy outletgroup <ID>
    -- OR --
#    reset activeEnergy outletgroup <ID> /y
```

If you entered the command without `/y`, a message appears prompting you to confirm the operation. Type `y` to confirm the reset or `n` to abort it.

Variables:

- `<n>` is the inlet number.
- `<outlet_n>` is an outlet number.
- `<ID>` is an outlet group's index number.

Resetting to Factory Defaults

The following commands restore all settings of the PX3 to factory defaults.

▶ **To reset PX3 settings after login, use either command:**

```
#    reset factorydefaults
    -- OR --
#    reset factorydefaults /y
```

▶ **To reset PX3 settings before login:**

```
Username:    factorydefaults
```

See *Using the CLI Command* (on page 785) for details.

Note: Device reset will cause CLI communications over an "USB" connection to be lost. Therefore, re-connect the USB cable after the reset is complete.

Network Troubleshooting

The PX3 provides 4 diagnostic commands for troubleshooting network problems: *nslookup*, *netstat*, *ping*, and *traceroute*. The diagnostic commands function as corresponding Linux commands and can get corresponding Linux outputs.

Entering Diagnostic Mode

Diagnostic commands function in the diagnostic mode only.

▶ **To enter the diagnostic mode:**

1. Enter either of the following modes:
 - Administrator mode: The # prompt is displayed.
 - User mode: The > prompt is displayed.
2. Type `diag` and press Enter. The `diag#` or `diag>` prompt appears, indicating that you have entered the diagnostic mode.
3. Now you can type any diagnostic commands for troubleshooting.

Quitting Diagnostic Mode

▶ **To quit the diagnostic mode, use this command:**

```
diag>      exit
```

The # or > prompt appears after pressing Enter, indicating that you have entered the administrator or user mode. See *Different CLI Modes and Prompts* (on page 518).

Diagnostic Commands

The diagnostic command syntax varies from command to command.

Querying DNS Servers

This command syntax queries Internet domain name server (DNS) information of a network host.

```
diag>      nslookup <host>
```

Variables:

- <host> is the name or IP address of the host whose DNS information you want to query.

Showing Network Connections

This command syntax displays network connections and/or status of ports.

```
diag> netstat <option>
```

Variables:

- <option> is one of the options: *ports* or *connections*.

Option	Description
ports	Shows TCP/UDP ports.
connections	Shows network connections.

Testing the Network Connectivity

This ping command sends the ICMP ECHO_REQUEST message to a network host for checking its network connectivity. If the output shows the host is responding properly, the network connectivity is good. If not, either the host is shut down or it is not being properly connected to the network.

```
diag> ping <host>
```

Variables:

- <host> is the host name or IP address whose networking connectivity you want to check.

Options:

- You can include any or all of additional options listed below in the ping command.

Options	Description
count <number1>	Determines the number of messages to be sent. <number1> is an integer number between 1 and 100.
size <number2>	Determines the packet size. <number2> is an integer number in bytes between 1 and 65468.
timeout <number3>	Determines the waiting period before timeout. <number3> is an integer number in seconds ranging from 1 to 600.

The command looks like the following when it includes all options:

```
diag> ping <host> count <number1> size <number2> timeout <number3>
```

Tracing the Route

This command syntax traces the network route between your PX3 and a network host.

```
diag> traceroute <host> <useICMP>
```

Variables:

- <host> is the name or IP address of the host you want to trace.
- <useICMP> is optional. It has only one value -- useICMP. Type useICMP in the end of this command only when you want to use ICMP packets rather than UDP packets.

Example - Ping Command

The following command checks the network connectivity of the host 192.168.84.222 by sending the ICMP ECHO_REQUEST message to the host for 5 times.

```
diag> ping 192.168.84.222 count 5
```

Retrieving Previous Commands

If you would like to retrieve any command that was previously typed in the same connection session, press the Up arrow (↑) on the keyboard several times until the desired command is displayed.

Automatically Completing a Command

A CLI command always consists of several words. You can easily enter a command by typing first word(s) or letter(s) and then pressing Tab or Ctrl+i instead of typing the whole command word by word.

► **To have a command completed automatically:**

1. Type initial letters or words of the desired command. Make sure the letters or words you typed are unique so that the CLI can identify the command you want.
2. Press Tab or Ctrl+i until the complete command appears.
3. If there are more than one possible commands, a list of these commands is displayed. Then type the full command.

► **Examples:**

• **Example 1 (only one possible command):**

- a. Type the first word and the first letter of the second word of the "reset factorydefaults" command -- that is, reset f.
- b. Then press Tab or Ctrl+i to complete the second word.

• **Example 2 (only one possible command):**

- a. Type the first word and initial letters of the second word of the "security strongPasswords" command -- that is, security str.
- b. Then press Tab or Ctrl+i to complete the second word.

• **Example 3 (more than one possible commands):**

- a. Type only the first two words of the "network ipv4 gateway xxx.xxx.xxx.xxx" command -- that is, network ipv4.
- b. Then press Tab or Ctrl+i one or two times, a list of possible commands displays as shown below.

```
gateway           interface         staticRoutes
```

- c. Type the full command "network ipv4 gateway xxx.xxx.xxx.xxx", according to the onscreen command list.

Logging out of CLI

After completing your tasks using the CLI, always log out of the CLI to prevent others from accessing the CLI.

► **To log out of the CLI:**

1. Ensure you have entered administrator mode and the # prompt is displayed.

2. Type `exit` and press Enter.

Chapter 10 Using SCP Commands

You can perform a Secure Copy (SCP) command to update the PX3 firmware, do bulk configuration, or back up and restore the configuration.

In This Chapter

Firmware Update via SCP	707
Bulk Configuration via SCP	708
Backup and Restore via SCP	709
Downloading Diagnostic Data via SCP	710
Uploading or Downloading Raw Configuration Data	712

Firmware Update via SCP

Same as any PX3 firmware update, all user management operations are suspended and all login attempts fail during the SCP firmware update. For details, see **Updating the PX3 Firmware** (on page 465).

Warning: Do NOT perform the firmware upgrade over a wireless network connection.

► To update the firmware via SCP:

1. Type the following SCP command and press Enter.

```
scp <firmware file> <user name>@<device ip>:/fwupdate
```

 - *<firmware file>* is the PX3 firmware's filename. If the firmware file is not in the current directory, you must include the path in the filename.
 - *<user name>* is the "admin" or any user profile with the Firmware Update permission.
 - *<device ip>* is the IP address or hostname of the PX3 where you want to upload the specified file.
2. Type the password when prompted, and press Enter.
3. The system transmits the specified firmware file to the PX3, and shows the transmission speed and percentage.
4. When the transmission is complete, it shows the following message, indicating that the PX3 starts to update its firmware now. Wait until the upgrade completes.

```
Starting firmware update. The connection will be closed now.
```

▶ **SCP example:**

```
scp pdu-px2-030410-44599.bin  
admin@192.168.87.50:/fwupdate
```

▶ **Windows PSCP command:**

PSCP in Windows works in a similar way to the SCP.

- `pscp <firmware file> <user name>@<device ip>:/fwupdate`

Bulk Configuration via SCP

Like performing bulk configuration via the web interface, there are two steps with the bulk configuration using the SCP commands:

- a. Save a configuration from a source PX3.
- b. Copy the configuration file to one or multiple destination PX3.

For detailed information on the bulk configuration requirements, see **Bulk Configuration** (on page 470).

▶ **To save the configuration via SCP:**

1. Type the following SCP command and press Enter.

```
scp <user name>@<device ip>:/bulk_config.txt <filename>
```

- *<user name>* is the "admin" or any user profile with Administrator Privileges.
 - *<device ip>* is the IP address or hostname of the PX3 whose configuration you want to save.
 - *<filename>* is the custom filename you assign to the "bulk_config.txt" of the source PX3.
2. Type the user password when prompted.
 3. The system saves the configuration from the PX3 to a file named "bulk_config.txt."

▶ **To copy the configuration via SCP:**

1. Type the following SCP command and press Enter.

```
scp bulk_config.txt <user name>@<device ip>:/bulk_restore
```

- *<user name>* is the "admin" or any user profile with Administrator Privileges
 - *<device ip>* is the IP address of the PX3 whose configuration you want to copy.
2. Type the user password when prompted.

- The system copies the configuration included in the file "bulk_config.txt" to another PX3, and displays the following message.

Starting restore operation. The connection will be closed now.

▶ **SCP examples:**

- Save operation:

```
scp admin@192.168.87.50:/bulk_config.txt today_config.txt
```

- Copy operation:

```
scp today_config.txt admin@192.168.87.47:/bulk_restore
```

▶ **Windows PSCP commands:**

PSCP in Windows works in a similar way to the SCP.

- Save operation:

```
pscp <user name>@<device ip>:/bulk_config.txt today_config.txt
```

- Copy operation:

```
pscp today_config.txt <user name>@<device ip>:/bulk_restore
```

▶ **Alternative of bulk configuration via SCP:**

Both methods of uploading 'bulk configuration' file or 'raw configuration' file via SCP can serve the purpose of bulk configuration. The only difference is that you can configure *device-specific* settings with the upload of raw configuration but not with the 'bulk configuration' file.

- **Uploading or Downloading Raw Configuration Data** (on page 712)

Backup and Restore via SCP

To back up ALL settings of a PX3, including device-specific settings, you should perform the backup operation instead of the bulk configuration.

You can restore all settings to previous ones after a backup file is available.

▶ **To back up the settings via SCP:**

- Type the following SCP command and press Enter.

```
scp <user name>@<device ip>:/backup_settings.txt
```

- *<user name>* is the "admin" or any user profile with Administrator Privileges

- *<device ip>* is the IP address or hostname of the PX3 whose settings you want to back up.
2. Type the user password when prompted.
 3. The system saves the settings from the PX3 to a file named "backup_settings.txt."

▶ **To restore the settings via SCP:**

1. Type the following SCP command and press Enter.

```
scp backup_settings.txt <user name>@<device ip>:/settings_restore
```

 - *<user name>* is the "admin" or any user profile with Administrator Privileges
 - *<device ip>* is the IP address or hostname of the PX3 whose settings you want to restore.
2. Type the user password when prompted.
3. The system copies the configuration included in the file "backup_settings.txt" to the PX3, and displays the following message.
Starting restore operation. The connection will be closed now.

▶ **SCP examples:**

- Backup operation:

```
scp admin@192.168.87.50:/backup_settings.txt
```
- Restoration operation:

```
scp backup_settings.txt  
admin@192.168.87.50:/settings_restore
```

▶ **Windows PSCP commands:**

PSCP in Windows works in a similar way to the SCP.

- Backup operation:

```
pscp <user name>@<device ip>:/backup_settings.txt
```
- Restoration operation:

```
pscp backup_settings.txt <user name>@<device ip>:/settings_restore
```

Downloading Diagnostic Data via SCP

You can download the diagnostic data via SCP.

▶ **To download the diagnostic data via SCP:**

1. Type one of the following SCP commands and press Enter.

Scenario 1: Use the default SCP port and default filename

- SSH/SCP port is the default (22), and the accessed PX3 is a standalone device.
- The diagnostic file's default filename "diag-data.zip" is wanted. Then add a dot (.) in the end of the SCP command as shown below.

```
scp <user name>@<device ip>:/diag-data.zip .
```

Scenario 2: Specify a different SCP port but use the default filename

- SSH/SCP port is NOT the default (22), or the accessed PX3 is a Port-Forwarding slave device.
- The diagnostic file's default filename "diag-data.zip" is wanted. Then add a dot in the end of the SCP command as shown below.

```
scp -P <port> <user name>@<device ip>:/diag-data.zip .
```

Scenario 3: Specify a new filename but use the default SCP port

- SSH/SCP port is the default (22), and the accessed PX3 is a standalone device.
- Renaming the diagnostic file is wanted.

```
scp <user name>@<device ip>:/diag-data.zip <filename>
```

Scenario 4: Specify a different SCP port and a new filename

- SSH/SCP port is NOT the default (22), or the accessed PX3 is a Port-Forwarding slave device.
- Renaming the diagnostic file is wanted.

```
scp -P <port> <user name>@<device ip>:/diag-data.zip <filename>
```

- *<user name>* is the "admin" or any user profile with Administrator Privileges or "Unrestricted View Privileges" privileges.
 - *<device ip>* is the IP address or hostname of the PX3 whose data you want to download.
 - *<port>* is the current SSH/SCP port number, or the port number of a specific slave device in the Port-Forwarding chain.
 - *<filename>* is the new filename of the downloaded file.
2. Type the password when prompted.
 3. The system downloads the specified data from the PX3 onto your computer.
 - If you do NOT specify a new filename in the command, such as Scenarios 1 or 2, the downloaded file's default name is "diag-data.zip."
 - If you specify a new filename in the command, such as Scenarios 3 or 4, the downloaded file is renamed accordingly.

▶ **SCP example:**

```
scp admin@192.168.87.50:/diag-data.zip .
```

▶ **Windows PSCP command:**

PSCP in Windows works in a similar way to the SCP.

- `pscp -P <port> <user name>@<device ip>:/diag-data.zip <filename>`

Uploading or Downloading Raw Configuration Data

You can download the raw configuration data of a specific PX3 for review, backup or modification.

After modifying or creating any raw configuration data, you can upload it to a specific PX3 for changing its configuration. The uploaded raw configuration file can contain only partial configuration keys that you want to modify. Other settings that are not contained in the uploaded file will remain unchanged.

Syntax of the raw configuration data is completely the same as the syntax in the config.txt file. See *config.txt* (on page 747).

Warning: Some configuration keys in the downloaded raw configuration are commented out, and those must NOT be part of the configuration that will be uploaded to any PX3. See *Keys that Cannot Be Uploaded* (on page 715).

▶ **To download raw configuration data:**

1. Type one of the following SCP commands and press Enter.

Scenario 1: Use the default SCP port and default filename

- SSH/SCP port is the default (22), and the accessed PX3 is a standalone device.
- The raw configuration file's default filename "raw_config.txt" is wanted. Then add a dot (.) in the end of the SCP command as shown below.

```
scp <user name>@<device ip>:/raw_config.txt .
```

Scenario 2: Specify a different SCP port but use the default filename

- SSH/SCP port is NOT the default (22), or the accessed PX3 is a Port-Forwarding slave device.
- The raw configuration file's default filename "raw_config.txt" is wanted. Then add a dot in the end of the SCP command as shown below.

```
scp -P <port> <user name>@<device ip>:/raw_config.txt .
```

Scenario 3: Specify a new filename but use the default SCP port

- SSH/SCP port is the default (22), and the accessed PX3 is a standalone device.
- Renaming the raw configuration file is wanted.

```
scp <user name>@<device ip>:/raw_config.txt <filename>
```

Scenario 4: Specify a different SCP port and a new filename

- SSH/SCP port is NOT the default (22), or the accessed PX3 is a Port-Forwarding slave device.
- Renaming the raw configuration file is wanted.

```
scp -P <port> <user name>@<device ip>:/raw_config.txt <filename>
```

- *<user name>* is the "admin" or any user profile with Administrator Privileges.
 - *<device ip>* is the IP address or hostname of the PX3 whose data you want to download.
 - *<port>* is the current SSH/SCP port number, or the port number of a specific slave device in the Port-Forwarding chain.
 - *<filename>* is the new filename of the downloaded file.
2. Type the password when prompted.
 3. The system downloads the specified data from the PX3 onto your computer.
 - If you do NOT specify a new filename in the command, such as Scenarios 1 or 2, the downloaded file's default name is "raw_config.txt."
 - If you specify a new filename in the command, such as Scenarios 3 or 4, the downloaded file is renamed accordingly.

► **To upload raw configuration data:**

1. Type one of the following SCP commands and press Enter.

Scenario 1: Only one PX3 to configure, with the default SCP port

- SSH/SCP port is the default (22), and the accessed PX3 is a standalone device.
- There is only one device to configure so a CSV file for device-specific settings is NOT needed.

```
scp <config file> <user name>@<device ip>:/raw_config_update
```

Scenario 2: Only one PX3 to configure, with a non-default SCP port

- SSH/SCP port is NOT the default (22), or the accessed PX3 is a Port-Forwarding slave device.
- There is only one device to configure so a CSV file for device-specific settings is NOT needed.

```
scp -P <port> <config file> <user name>@<device ip>:/raw_config_update
```

Scenario 3: Multiple PX3 to configure, with the default SCP port

- SSH/SCP port is the default (22), and the accessed PX3 is a standalone device.
- There are multiple devices to configure so a CSV file for device-specific settings is needed during the upload.

```
scp <dev_list file> <config file> <user name>@<device ip>:/raw_config_update /match=<col>
```

Scenario 4: Multiple PX3 to configure, with a non-default SCP port

- SSH/SCP port is NOT the default (22), or the accessed PX3 is a Port-Forwarding slave device.
- There are multiple devices to configure so a CSV file for device-specific settings is needed during the upload.

```
scp -P <port> <dev_list file> <config file> <user name>@<device ip>:/raw_config_update /match=<dev_col>
```

- <config file> is the filename of the custom raw configuration that you want to upload.
- <user name> is the "admin" or any user profile with Administrator Privileges.
- <device ip> is the IP address or hostname of the PX3 where you want to upload the specified file.
- <port> is the current SSH/SCP port number, or the port number of a specific slave device in the Port-Forwarding chain.
- <dev_list file> is the name of the CSV file for configuring multiple PX3 with device-specific settings. For this file's format, see **devices.csv** (on page 750).
 - For device-specific settings in the <config file>, refer each device-specific configuration key to a specific column in the <dev_list file>. See **config.txt** (on page 747).
- <dev_col> comprises "serial:" or "mac:" and the number of the column where the serial number or MAC address of each PX3 is in the uploaded CSV file. This is the data based on which each device finds its device-specific settings.

For example:

- If the second column contains each device's serial number, the parameter is then `serial:2`.
- If the seventh column contains each device's MAC address, the parameter is then `mac:7`.

▶ **SCP examples:**

- Raw configuration download example --

```
scp admin@192.168.87.50:/raw_config.txt config.txt
```
- Raw configuration upload example with the configuration file only --

```
scp config.txt
admin@192.168.87.50:/raw_config_update
```
- Raw configuration upload example with both configuration and device list files --

```
scp devices.csv config.txt
admin@192.168.87.50:/raw_config_update
/match=serial:2
```

▶ **Windows PSCP commands:**

PSCP in Windows works in a similar way to the SCP.

- `pscp -P <port> <user name>@<device ip>:/raw_config.txt <filename>`
- `pscp -P <port> <CSV file> <config file> <user name>@<device ip>:/raw_config_update /match=<col>`

▶ **Alternative of bulk configuration via SCP:**

Both methods of uploading 'bulk configuration' file or 'raw configuration' file via SCP can serve the purpose of bulk configuration. The only difference is that you can configure *device-specific* settings with the upload of raw configuration but not with the 'bulk configuration' file.

- **Bulk Configuration via SCP** (on page 708)

Keys that Cannot Be Uploaded

The raw configuration downloaded from any PX3 contains a few configuration keys that are commented out with either syntax below.

Comment syntax	Description
#INTERNAL#	These keys are internal ones. They are NOT user configurable settings.
#OLD/INVALID#	These keys are old or invalid ones.

Note that these configuration keys cannot be part of the configuration that you will upload to any PX3. That is, they should be either not available or they remain to be commented out in the configuration file you will upload.

Chapter 11 In-Line Monitors

The model name of a PX3 in-line monitor follows this format: PX3-3nnn, where n is a number, such as PX3-3411.

Unlike most of PX3 devices, each inlet of an in-line monitor is connected to an outlet only, so an inlet's rating/power data is the same as an outlet's rating/power data.

In This Chapter

Overview	717
Safety Instructions	717
Flexible Cord Installation Instructions	718
In-Line Monitor's Web Interface.....	725

Overview

An in-line monitor is implemented with the same number of inlets and outlets.

- Inlets are located at the side labeled **Line**.
- Outlets are located at the side labeled **Load**.

An inlet is connected to a power source for receiving electricity, such as electric distribution panels or branch circuit receptacles. An outlet is connected to a device that draws power, such as a cooling or IT device.

Safety Instructions

1. Installation of this product should only be performed by a licensed electrician.
2. Make sure the line cord is disconnected from power before physically mounting or moving the location of this product.
3. This product is intended to be located in an equipment rack in an information technology room. In the United States, installation must comply and be done in accordance with NEC (2011) Article 645 *Information Technology Equipment*.
4. This product is designed to be used within an electronic equipment rack. The metal case of this product is electrically bonded to the line cord ground wire. A threaded grounding point on the case may be used as an additional means of protectively grounding this product and the rack.
5. Examine the branch circuit receptacle that will supply electric power to this product. Make sure the receptacle's power lines, neutral and protective earth ground pins are wired correctly and are the correct voltage and phase. Make sure the branch circuit receptacle is protected by a suitably rated fuse or circuit breaker.

6. If the product is a model that contains receptacles that can be switched on/off, electric power may still be present at a receptacle even when it is switched off.

Flexible Cord Installation Instructions

The following instructions are for Raritan products manufactured to accept user-installed flexible cords. These products are visually identified by the cable gland used to hold the flexible cord.



Important: Complete and the most updated instructions on installing a flexible cord on Raritan PDUs are included in the *Raritan PX Power Cord Installation Guide*, which is available on the Raritan website's *Support page* (<http://www.raritan.com/support/>).

Flexible Cord Selection

- The preferred flexible cable is type SOOW, 600V, 90°C or 105°C. Consult Raritan before using a different flexible cable type.
- The rated ampacity of the flexible cord must be greater than or equal to the Raritan product's rated ampacity marked on its nameplate. In the United States, relevant ampacity ratings for flexible cords can be found in NEC(2011) section 400.5.
- The number of wires in the flexible cord must match the number of terminals (including the ground terminal) inside the Raritan product. See ***Wiring of 3-Phase In-Line Monitors*** (on page 720) for exceptions.
- If a plug is to be attached to the flexible cord, the length of the flexible cord must not exceed 4.5 meters - as specified in UL 60950-1 (2007) and NEC 645.5 (2011).
- The flexible cord may be permanently connected to power subject to local regulatory agency approval. In the United States, relevant electrical regulations can be found in NEC (2011) sections 400.7(A)(8), 400.7(B), 368.56 and table 400.4.

Plug Selection

If a plug is to be attached to the flexible cord, the plug's rated ampacity is chosen as follows:

- In the United States, as specified in UL 60950-1, the plug's rated ampacity must be 125% greater than the Raritan product's rated ampacity. In some Raritan products, such as 35A 3-phase delta wired PDUs, an exactly 125% rated plug is not available. In these cases, choose the closest plug that is more than 125%. For example, a 50A plug is the closest fit for a 35A 3-phase PDU.
- For all other locations, subject to local regulatory agency policy, the plug's rated ampacity is the same as the Raritan products rated ampacity.

Receptacle Selection

For Raritan in-line monitors, any receptacle fitted to the outlet flexible cord must have identical ratings as the plug attached to the inlet flexible cord.

Derating a Raritan Product

Lower rated plugs, receptacles and flexible cords may be connected to a Raritan product. This results in a derated (reduced) ampacity rating for the product.

▶ Derating guidelines:

1. Choose the plug and use its rated ampacity to determine the derated ampacity.
 - In the United States, as specified in UL 60950-1, the derated ampacity is 80% of the plug's rated ampacity. For example, a 30A plug would result in a derated ampacity of 24A.
 - In other geographic locations, subject to local regulatory agency approval, the derated ampacity is the plug's rated ampacity. For example, using a 16A plug would result in a derated ampacity of 16A.
2. The derated ampacity must be marked on the Raritan product so the new reduced rating can be easily identified.
3. For in-line monitors, the receptacles used must have the same voltage and ampacity rating as the plug chosen in step 1.

4. The flexible cord must have a rated ampacity greater than or equal to the derated ampacity. Since the new flexible cord may be smaller diameter, a check must be performed to insure the cable gland nut, when tightened, will securely hold the flexible cord so that it cannot be twisted, pulled or pushed in the cable gland. A sealing ring, for small diameter flexible cords, may have been included with the Raritan product, or one can be requested from Raritan, to reduce the inside diameter of the cable gland.

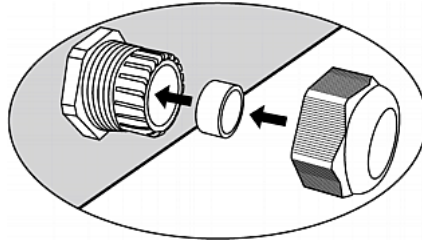

Wiring of 3-Phase In-Line Monitors

3-phase in-line monitors contain 4-pole wiring terminal blocks (L1, L2, L3, N) to monitor 5-wire (4P+PE) 3-phase wye connections. Delta wired 4-wire (3P+PE) 3-phase connections are also permitted (no wire connected to the terminal block neutral “N”). No additional hardware or firmware configuration is required to specify whether the connection is 5-wire wye or 4-wire delta.

In-Line Monitor Unused Channels

It is not necessary to wire up all channels of multi-channel in-line monitors. The inlet and outlet openings of unused channels must be completely closed off. “Goof plugs” for this purpose may be a good choice if they are available in your country or region.

Step by Step Flexible Cord Installation

The following items are required to complete the installation:

- Flexible cord(s).
- Insulated ring terminals (one for each wire) and appropriate crimp tool.
- Plug(s) and receptacle(s) (for in-line monitors)
- Torque screwdriver, torque nut driver and torque wrench to tighten the wiring terminal block screws, ground nut and cable gland nut.

► **To install a flexible cord:**

1. Open the PDU's access panel (or in-line monitor top panel) to expose the power wiring terminal block(s).

One-channel in-line monitor

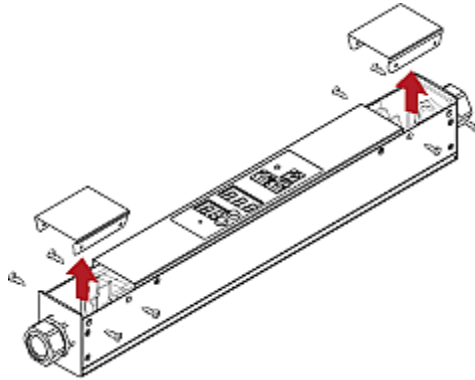

Zero U PDU

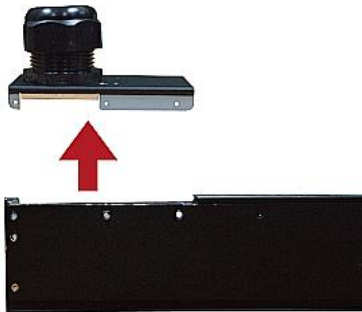

Make sure to locate the ground wire mounting stud(s). There is a separate ground wire mounting stud for each terminal block. Each flexible cord **MUST** have its green (or green/yellow) ground wire bonded to a ground wire mounting stud.

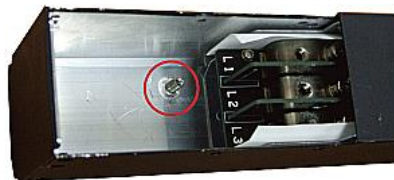

For in-line monitors, make sure to identify the inlet terminal blocks (rear of monitor) and outlet terminal blocks (front of monitor). Each inlet terminal block has a corresponding outlet terminal block.

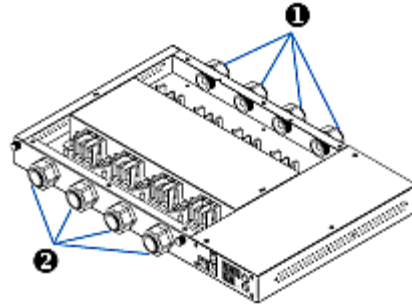

Number	Description
1	Inlets (labeled LINE)
2	Outlets (labeled LOAD)

2. Strip off the outer jacket of the flexible cord and remove any jute, paper or other fillers. Use the following to help determine how much jacket to remove:
 - In the finished assembly, the outer jacket should protrude inside the Raritan product.
 - The wires will have ring terminals crimped onto them.
 - In the finished assembly, the wires should have some slack and not be taught.
 - In the finished assembly, if the flexible cord slips in the cable gland placing a strain on the cord's wires, the ground wire must be the last wire to take the strain.
3. Crimp an insulated ring terminal onto each wire. A non-insulated ring terminal may be used for the ground wire. Inspect each crimp to insure it is secure and verify no exposed wire protrudes from the rear of an insulated ring terminal.
4. Loosen the cable gland nut and push the flexible cord assembly through the gland.



Temporarily hand tighten the gland nut and verify the cord cannot be twisted or pushed or pulled in the gland. Do not proceed if hand tightening results in a loose cord. In some models, especially in-line monitors, the flexible cord's diameter may be too small for the cable gland. A sealing ring for smaller diameter line cords may have been included with the Raritan product, or can be requested from Raritan, to reduce the inside diameter of the cable gland.

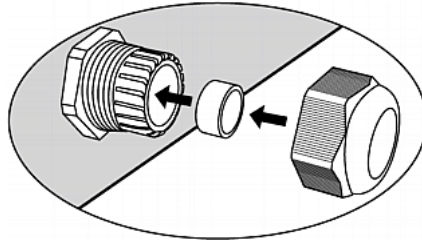

5. Fasten the ring terminal of the green (or green/yellow) ground wire to the chassis's threaded ground stud in this order:
 - a. Place the lock washer on the stud.
 - b. Place the ground wire ring terminal on the stud.
 - c. Place the nut on the stud and tighten with a torque wrench. The appropriate torque settings vary according to the nut size.

Nut size	Torque setting (N·m)	Tolerance
M3	0.49	10%
M4	1.27	8%
M5	1.96	5%
M6	2.94	3.5%
M8	4.9	2%

- d. Check the ground wire connection. It should be secure and not move or rotate.



6. Fasten the ring terminals of all remaining wires to the terminal block and tighten each using a torque screwdriver. The appropriate torque settings vary according to the screw size.

Screw size	Torque setting (N·m)	Tolerance
M3	0.49	10%
M4	1.27	8%
M5	1.96	5%
M6	2.94	3.5%
M8	4.9	2%

Make sure each ring terminal is firmly fastened and cannot be twisted by hand. Use the following guidelines to help terminal block wiring.

- In single-phase Raritan products with world-wide ratings, the terminals are labeled L1 and L2. L1 is the phase wire. L2 is either the neutral (120/230V installations) or another phase wire (208V installations).

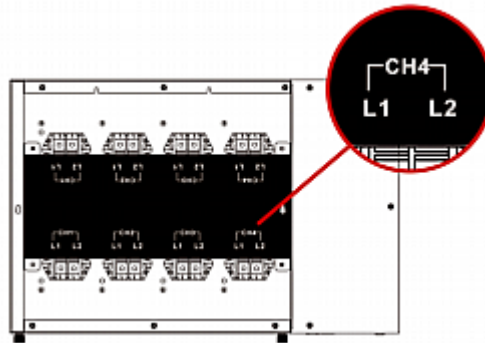

- In all 3-phase products, L1 is phase A, L2 is phase B, L3 is phase C and N is neutral.
- If your PDU is inlet metered, such as PDU models PX2-1nnn and PX2-2nnn (where n is a number), you must pass each line cord wire through the correct CT in the correct direction. Each CT is labeled and contains a direction arrow. Push the ring terminal end of the line cord through the CT in the direction indicated by the arrow. For example, push the L1 line cord wire through the CT labeled L1 and then connect it to the L1 terminal block.

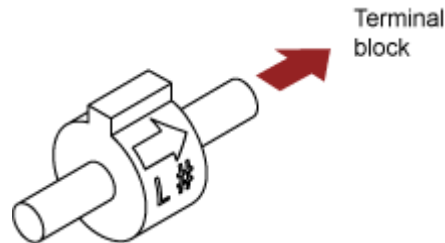

- For Raritan in-line monitors, where there is a one to one correspondence between plug and receptacle, maintain the same wire colors for inlet and outlet flexible cords.

7. Make final adjustments to the cable gland and verify the jacket of the flexible cord extends into the Raritan product. Hand tighten the gland nut and finish tightening with a torque wrench. Appropriate torque settings vary according to the cable gland size.

Cable gland size	Torque setting (N·m)
M12x1.5	0.7 to 0.9
M16x1.5	2.0 to 3.0
M20x1.5	2.7 to 4.0
M25x1.5	5.0 to 7.5
M32x1.5	7.5 to 10.0
M40x1.5	7.5 to 10.0
M50x1.5	7.5 to 10.0
M63x1.5	7.5 to 10.0

Note: The cable gland size is marked on the cable gland body.

After tightening, examine the flexible cord and cable gland for the following:

- Make sure you can see a few remaining threads between the cable gland body and cable gland nut. The gland nut must not bottom out on the gland body.
 - Make sure the flexible cord does not move in the cable gland when it is twisted, pushed or pulled.
8. Re-install the PDU wiring access panel or in-line monitor cover plate. This completes internal wiring of the Raritan product.
 9. For in-line monitors, fasten the receptacles to the outlet flexible cords following the manufacturer's instructions.
 10. Complete the wiring of the inlet flexible cord by performing one of these steps:
 - Assemble the plug following the manufacturer's instructions.
 - Permanently attach and strain relief the flexible cord to a junction box following applicable electrical codes.

In-Line Monitor's Web Interface

An in-line monitor's web interface is similar to a regular PX3 model's web interface.

See *Using the Web Interface* (on page 170) for login instructions and additional information.

Dashboard Page

An in-line monitor's Dashboard page looks slightly different from a regular PX3 device's Dashboard page.

Note: Depending on your model, elements shown on your page may appear slightly different from this image.

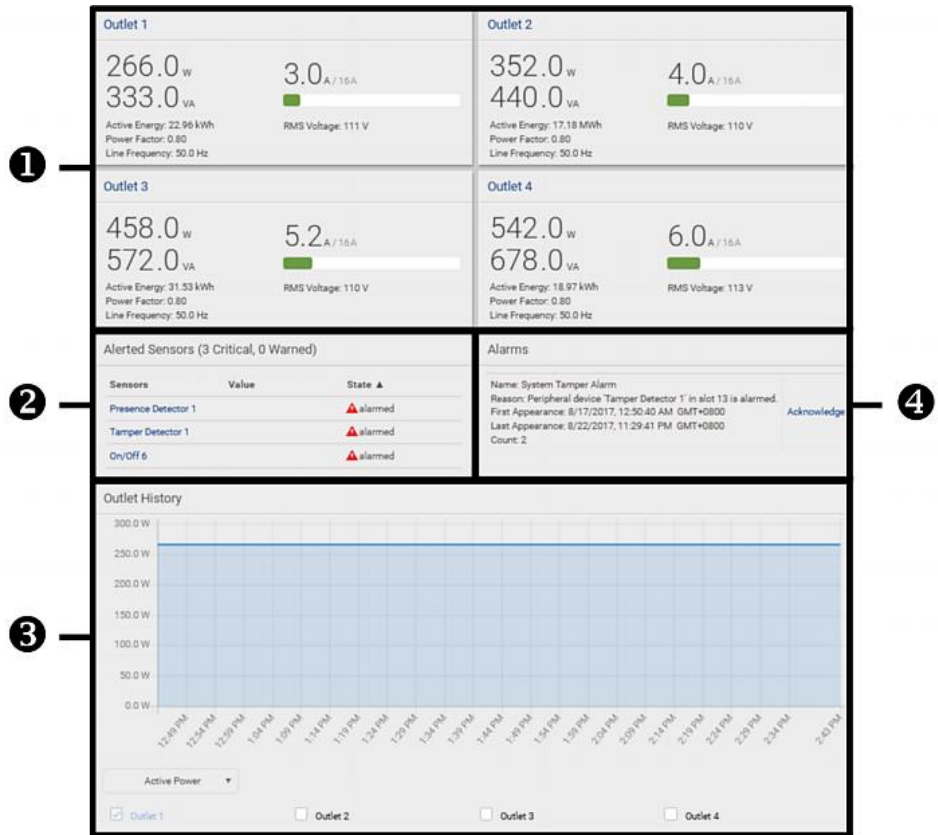

Number	Section	Content
1	Outlet(s)	<ul style="list-style-type: none"> Overview of each outlet's power data -- in the above diagram, there are 4 outlets. A current bar per outlet, which changes colors to indicate the RMS current state -- normal (green), warning (yellow) or critical (red). <p>This is similar to Dashboard - Inlet 1 (on page 185).</p>
2	Alerted Sensors	<ul style="list-style-type: none"> When no sensors enter the alarmed state, this section shows the message "No Altered Sensors." When any sensor enters the alarmed state, this section lists all of them. <p>See Dashboard - Alerted Sensors (on page 188).</p>
3	Outlet History	<p>The historical chart of the first outlet's active power is displayed by default.</p> <p>You can make the diagram show another outlet's or multiple outlets' active power history or select a different data type. See instructions below.</p>
4	Alarms	<p>This section can show data only after you have set event rules requiring users to take the acknowledgment action.</p> <ul style="list-style-type: none"> When there are no unacknowledged events, this section shows the message "No Alarms." When there are unacknowledged events, this section lists all of them. <p>See Dashboard - Alarms (on page 192).</p>

► **To go to each outlet's setup page:**

1. Locate the desired outlet section.
2. Click its title, such as Inlet/Outlet 1, Inlet/Outlet 2, and the like. The selected outlet's page opens.

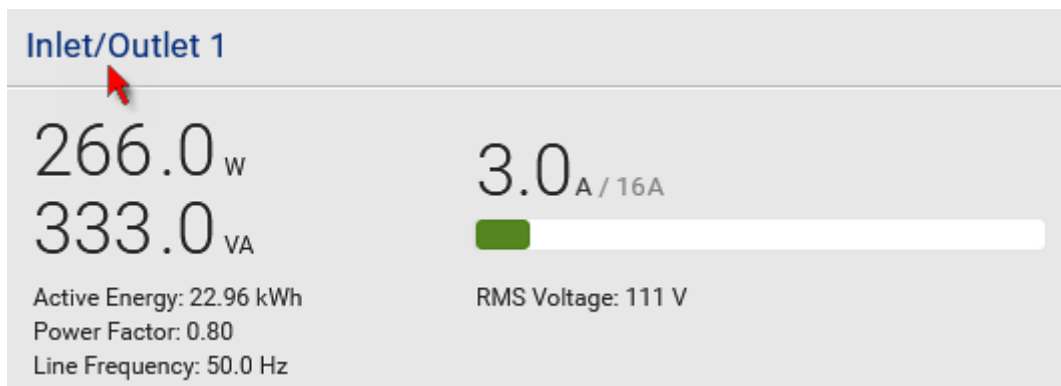

► **To view the inlet power chart:**

1. To view the power chart of one or multiple outlets, select one or multiple outlet checkboxes below the diagram.

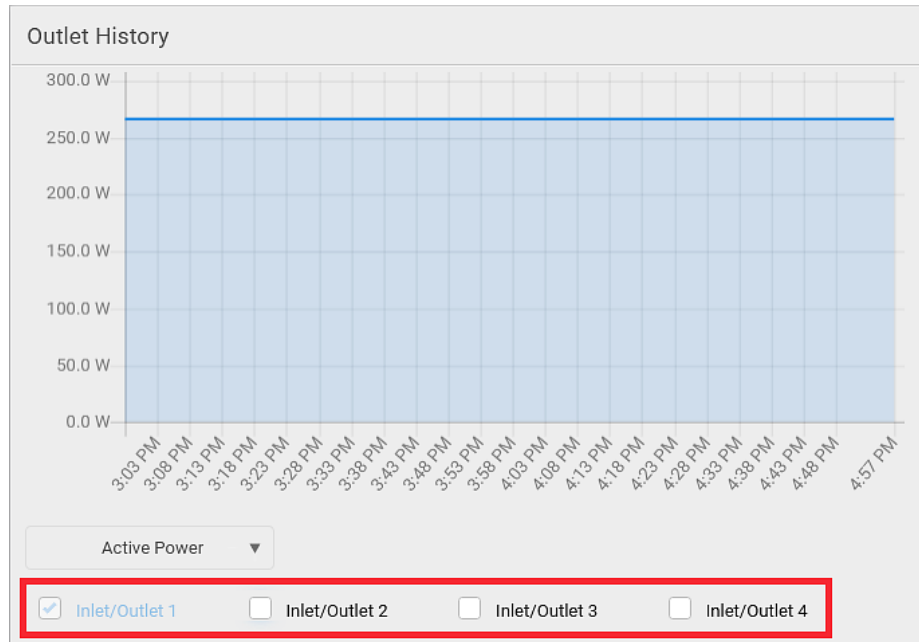

- When multiple outlets are displayed in the chart, their data lines' colors differ. You can identify their lines according to the colors of the selected outlet checkboxes as illustrated below.

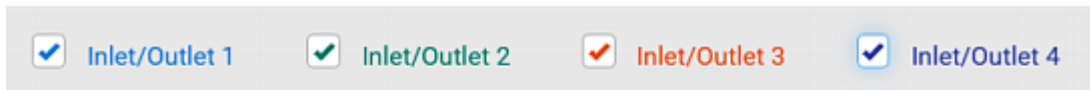

2. To view a different data type, click the selector  at the bottom.

- Available data types include RMS current, RMS voltage, active power and apparent power.

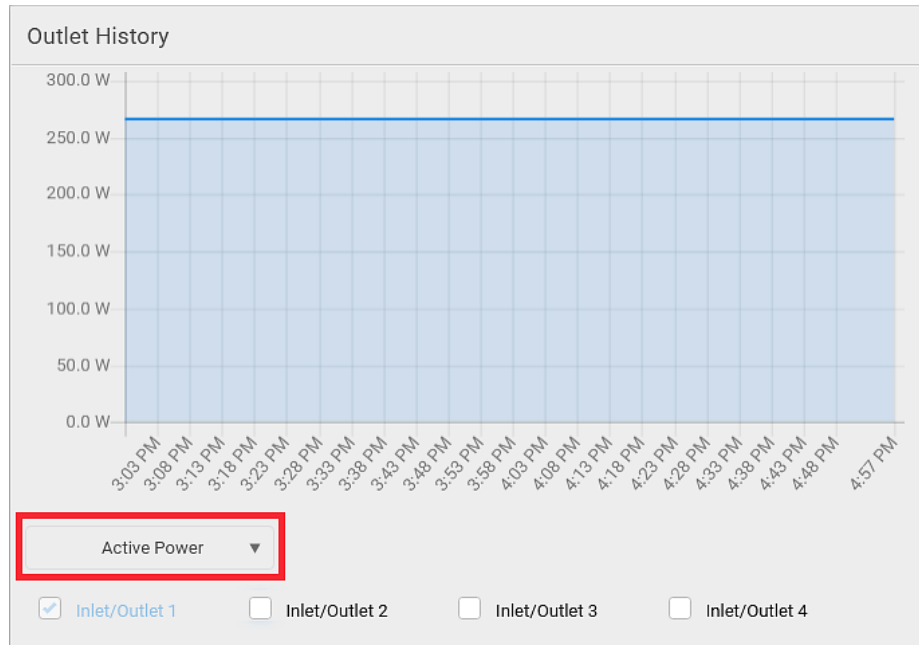

- To retrieve the exact data at a particular time, hover your mouse over the data line in the chart. Both the time and data are displayed as illustrated below.

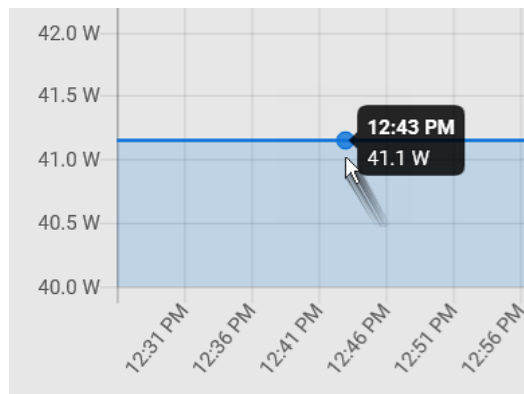

- When the data of multiple outlets is shown in the chart, simply hover your mouse over any outlet's data line. Values of *all* outlets display simultaneously, marked with corresponding colors.

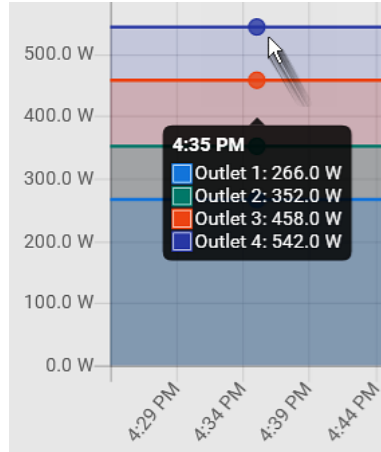

Inlets/Outlets Page

On the Inlets/Outlets page, you can:

- View each outlet's power data (which is also each inlet's power data)
- Configure each inlet/outlet as needed, such as customizing outlet names, setting thresholds or resetting energy.

Outlet thresholds, when enabled, help you identify whether the outlet enters the warning or critical level. In addition, you can have PX3 automatically generate alert notifications for any warning or critical status. See **Event Rules and Actions** (on page 364).

Number of available outlet sensors are model dependent.

► **Operation:**

1. Click Inlets/Outlets to open the Inlet(s)/Outlet(s) page.

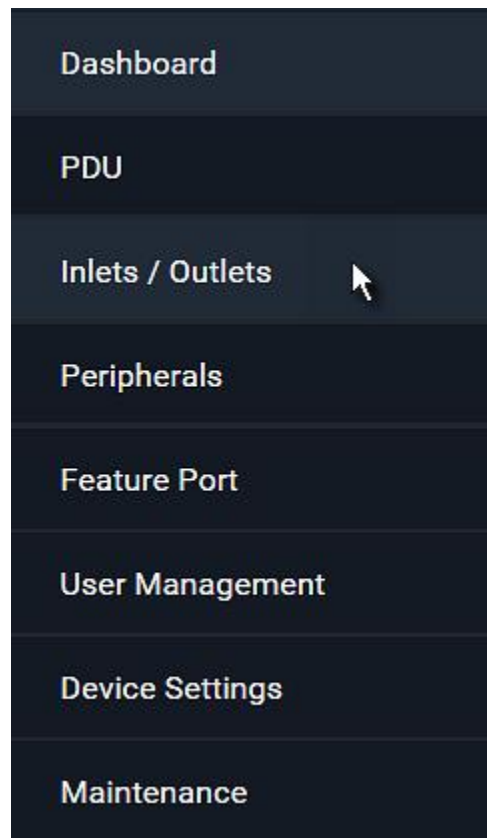

2. A list of inlets/outlets is displayed. Click "Show Details" of the desired inlet/outlet.

Inlet/Outlet 1	Inlet/Outlet 2	Inlet/Outlet 3	Inlet/Outlet 4
266.0 _W 333.0 _{VA} Active Energy: 22.96 kWh Power Factor: 0.80 Line Frequency: 50.0 Hz	352.0 _W 440.0 _{VA} Active Energy: 17.18 MWh Power Factor: 0.80 Line Frequency: 50.0 Hz	458.0 _W 572.0 _{VA} Active Energy: 31.53 kWh Power Factor: 0.80 Line Frequency: 50.0 Hz	542.0 _W 678.0 _{VA} Active Energy: 18.97 kWh Power Factor: 0.80 Line Frequency: 50.0 Hz
3.0 _{A / 16A} RMS Voltage: 111 V	4.0 _{A / 16A} RMS Voltage: 110 V	5.2 _{A / 16A} RMS Voltage: 110 V	6.0 _{A / 16A} RMS Voltage: 113 V

3. The individual inlet/outlet page opens.

On this page, you can:

- View details, such as its receptacle type
- View all of its sensors data
- Reset its active energy
- View its power chart
- Configure its power thresholds

For detailed instructions, see **Individual Outlet Pages** (on page 218).

Appendix A Specifications

In This Chapter

Maximum Ambient Operating Temperature	733
Serial RS-232 "RJ-45" Port Pinouts	733
Sensor RJ-45 Port Pinouts	733
Feature RJ-45 Port Pinouts	734
Expansion RJ-45 Port Pinouts	735

Maximum Ambient Operating Temperature

The maximum ambient operating temperature (TMA) for PX3 is 60 degrees Celsius.

Serial RS-232 "RJ-45" Port Pinouts

RJ-45 Pin/signal definition			
Pin No.	Signal	Direction	Description
1	RTS	Output	Request to send
2	DTR	Output	Data terminal ready
3	TxD	Output	Transmit data
4	GND	—	Signal ground
5	DCD	Input	Data
6	RxD	Input	Receive data (data in)
7	DSR	Input	Data set ready
8	CTS	Input	Clear to send

Sensor RJ-45 Port Pinouts

RJ-45 Pin/signal definition			
Pin No.	Signal	Direction	Description

RJ-45 Pin/signal definition			
1	+12V	—	Power (fuse protected)
2	+12V	—	Power (fuse protected)
3	GND	—	Signal Ground
4	RS485_DP	bi-directional	Data Positive of the RS-485 bus
5	RS485_DN	bi-directional	Data Negative of the RS-485 bus
6	GND	—	Signal Ground
7	1-wire	—	1-wire signal for Raritan environmental sensor packages
8	GND	—	Signal Ground

Note: A maximum of 500mA power is permitted for both pin 1 and pin 2 altogether.

Feature RJ-45 Port Pinouts

RJ-45 Pin/signal definition			
Pin No.	Signal	Direction	Description
1	DTR	Output	Reserved
2	GND	—	Signal Ground
3	+5V	—	Power for CIM (200mA, fuse protected) Warning: Pin 3 is only intended for use with Raritan devices.
4	TxD	Output	Transmit Data (Data out)
5	RxD	Input	Receive Data (Data in)
6	+12V	—	Warning: Pin 6 is only intended for use with

RJ-45 Pin/signal definition			
Pin No.	Signal	Direction	Description
			Raritan devices. Do NOT connect.
7	GND	—	Signal Ground
8	DCD	Input	Reserved

Expansion RJ-45 Port Pinouts

RJ-45 Pin/signal definition			
Pin No.	Signal	Direction	Description
1	+12V	—	Power (fuse protected)
2	+12V	—	Power (fuse protected)
3	GND	—	Signal Ground
4	RS485_DP	bi-directional	Data Positive of the RS-485 bus
5	RS485_DN	bi-directional	Data Negative of the RS-485 bus
6	GND	—	Signal Ground
7	NC	—	No Connection
8	GND	—	Signal Ground

Appendix B Equipment Setup Worksheet

PX3 Series Model _____

PX3 Series Serial Number _____

OUTLET 1	OUTLET 2	OUTLET 3
MODEL	MODEL	MODEL
SERIAL NUMBER	SERIAL NUMBER	SERIAL NUMBER
USE	USE	USE
OUTLET 4	OUTLET 5	OUTLET 6
MODEL	MODEL	MODEL
SERIAL NUMBER	SERIAL NUMBER	SERIAL NUMBER
USE	USE	USE

OUTLET 7	OUTLET 8	OUTLET 9
MODEL	MODEL	MODEL
SERIAL NUMBER	SERIAL NUMBER	SERIAL NUMBER
USE	USE	USE
OUTLET 10	OUTLET 11	OUTLET 12
MODEL	MODEL	MODEL
SERIAL NUMBER	SERIAL NUMBER	SERIAL NUMBER
USE	USE	USE
OUTLET 13	OUTLET 14	OUTLET 15
MODEL	MODEL	MODEL
SERIAL NUMBER	SERIAL NUMBER	SERIAL NUMBER
USE	USE	USE

Appendix B: Equipment Setup Worksheet

OUTLET 16	OUTLET 17	OUTLET 18
MODEL	MODEL	MODEL
SERIAL NUMBER	SERIAL NUMBER	SERIAL NUMBER
USE	USE	USE
OUTLET 19	OUTLET 20	OUTLET 21
MODEL	MODEL	MODEL
SERIAL NUMBER	SERIAL NUMBER	SERIAL NUMBER
USE	USE	USE

OUTLET 22	OUTLET 23	OUTLET 24
MODEL	MODEL	MODEL
SERIAL NUMBER	SERIAL NUMBER	SERIAL NUMBER
USE	USE	USE

Types of adapters

Types of cables

Name of software program

Appendix C Configuration or Firmware Upgrade with a USB Drive

You can accomplish part or all of the following tasks simultaneously by plugging a USB flash drive which contains one or several special configuration files into the PX3.

- Configuration changes
- Firmware upgrade
- Diagnostic data download

*Tip: You can also accomplish the same tasks via the TFTP server in a DHCP network. See **Bulk Configuration or Firmware Upgrade via DHCP/TFTP** (on page 755).*

In This Chapter

Device Configuration/Upgrade Procedure	740
System and USB Requirements	741
Configuration Files	742
Firmware Upgrade via USB	753

Device Configuration/Upgrade Procedure

Any firmware **downgrade** using "fwupdate.cfg" is NOT supported by default. Only firmware upgrade is permitted with "fwupdate.cfg". A special parameter is required to permit firmware downgrade via "fwupdate.cfg". See **fwupdate.cfg** (on page 743).

Therefore, **firmware downgrade via USB** is disallowed by default.

You can use one USB drive to configure or upgrade multiple PX3 devices one by one as long as it contains valid configuration files.

► **To use a USB drive to configure the PX3 or upgrade firmware:**

1. Verify that both the USB drive and your PX3 meet the requirements. See **System and USB Requirements** (on page 741).
2. Prepare required configuration files. See **Configuration Files** (on page 742).
3. Copy required configuration files to the root directory of the USB drive.
 - For firmware upgrade, an appropriate firmware binary file is also required.
4. Plug the USB drive into the USB-A port of the PX3.
5. The initial message shown on the front panel display depends on the first task performed by the PX3.

- If no firmware upgrade task will be performed, a happy smiley is displayed after around 30 seconds.

The happy smiley looks like one of the following, depending on your Raritan product. For the first diagram, its background color will turn green.

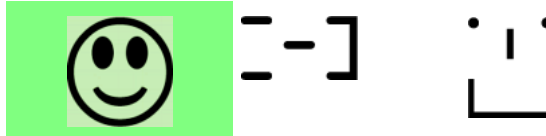

- If the USB drive contains the firmware upgrade data, the PX3:
 - a. First performs the firmware upgrade, showing the upgrade message on the front panel display.
 - b. Then shows the happy smiley when the firmware upgrade completes successfully. See **Firmware Upgrade via USB** (on page 753).
6. After the happy smiley appears, press one of the control buttons next to the display for one second until the smiley disappears.

Tip: You can remove the USB drive and plug it into another PX3 device for performing the same task(s) once the happy smiley or the firmware upgrade message displays.

7. Wait for several seconds until the PX3 resumes normal operation, indicated by the normal message of the display.

If nothing is shown on the display and no task is performed after plugging the USB drive, check the log file in the USB drive.

System and USB Requirements

You must satisfy ALL of the following requirements prior to using a USB flash drive to perform device configuration and/or firmware upgrade.

▶ **PX3 system requirements:**

- There is at least one USB-A port available on your Raritan device.
- Your PX3 must run firmware version 2.2.13 or later.

Note that the PX3 interpreted the USB drive's contents using the firmware which was running when plugging the USB drive, not the new firmware after firmware upgrade.

▶ **USB drive requirements:**

- The drive contains either a single partition formatted as a Windows FAT32 filesystem, or NO partition tables (that is, a superfloppy-formatted drive).
- The drive contains a configuration file called *fwupdate.cfg* in its root directory. See **fwupdate.cfg** (on page 743).

Configuration Files

There are three types of configuration files.

- **fwupdate.cfg:**
This file MUST be always present for performing configuration or firmware upgrade tasks. See **fwupdate.cfg** (on page 743).
- **config.txt:**
This file is used for configuring device settings. See **config.txt** (on page 747).
- **devices.csv:**
This file is required only when there are device-specific settings to configure for multiple PX3 devices. See **devices.csv** (on page 750).

Raritan provides a Mass Deployment Utility, which helps you quickly generate all configuration files for your PX3. See **Creating Configuration Files via Mass Deployment Utility** (on page 751).

fwupdate.cfg

The configuration file, *fwupdate.cfg*, is an ASCII text file containing key-value pairs, one per line.

Each value in the file must be separated by an equal sign (=), without any surrounding spaces. Keys are not case sensitive.

Illustration:

```
user=admin
password=raritan
logfile=log.txt
config=config.txt
device_list=devices.csv
```

This section only explains common options in the file.

Note: To make sure all of the following options work fine, you must update your PX3 to the latest firmware version.

▶ user

- A required option.
- Specify the name of a user account with Administrator Privileges.
- For PX3 with factory default configuration, set this option to `admin`.

▶ password

- A required option.
- Specify the password of the specified admin user.
- For PX3 with factory default configuration, set this option to `raritan`.

Tip: You can add multiple user credentials to *fwupdate.cfg*. Each 'user' line must be immediately followed by its 'password' line. PX3 will authenticate listed user credentials one by one until one of them succeeds, or until all user credentials fail.

▶ **logfile**

- Specify the name of a text file where the PX3 will append the log messages when interpreting the USB drive contents.
- If the specified file does not exist in the USB drive, it will be automatically created.
- If this option is not set, no log messages are recorded. The disadvantage is that no feedback is available if the PX3 detects a problem with the USB drive contents.

▶ **firmware**

- Specify the name of a firmware binary file used to upgrade your PX3.
- The specified firmware file must be compatible with your PX3 and have an official Raritan signature.
- If the specified firmware file is the same as the current firmware version of your PX3, no firmware upgrade is performed.
- The default is to NOT permit any firmware **downgrade** via USB drive on Raritan power products with "USB-A" port(s). To do this, the parameter "allow_downgrade" must be present and properly set in the *fwupdate.cfg* file.

▶ **config**

- Specify the name of the configuration file containing device settings.
- The suggested filename is *config.txt*. See ***config.txt*** (on page 747).

▶ **device_list**

- Specify the name of the configuration file listing all PX3 devices to configure and their device-specific settings.
- This file is required if any macros are used in the device configuration file "config.txt."
- The suggested filename is *devices.csv*. See ***devices.csv*** (on page 750).

▶ **match**

- Specify a match condition for identifying a line or one PX3 device in the device configuration file "devices.csv."

The option's value comprises one word and one number as explained below:

- The word prior to the colon is an identification property, which is either `serial` for serial number or `mac` for MAC address.
- The number following the colon indicates a column in the *devices.csv* file.

For example, `mac:7` instructs the PX3 to search for the MAC address in the 7th column of the "devices.csv" file.

- The default value is `serial:1`, making the PX3 search for its serial number in the first column.
- This option is used only if the "device_list" option has been set.

▶ **factory_reset**

- If this option is set to `true`, the PX3 will be reset to factory defaults.
- If the device configuration will be updated at the same time, the factory reset will be executed before updating the device configuration.

▶ **bulk_config_restore**

- Specify the name of the bulk configuration file used to configure or restore the PX3.

*Note: See **Bulk Configuration** (on page 470) for instructions on generating a bulk configuration file.*

- Additional configuration keys set via the `config.txt` file will be applied after performing the bulk restore operation.
- This option CANNOT be used with the option "full_config_restore."
- If a firmware upgrade will be performed at the same time, you must generate the bulk configuration file based on the NEW firmware version instead of the current firmware version.

▶ **full_config_restore**

- Specify the name of the full configuration backup file used to restore the PX3.

*Note: See **Backup and Restore of Device Settings** (on page 477) for instructions on generating the full configuration backup file.*

- Additional configuration keys set via the `config.txt` file will be applied after performing the configuration restore operation.
- This option CANNOT be used with the option "bulk_config_restore."
- If a firmware upgrade will be performed at the same time, you must generate the full configuration backup file based on the NEW firmware version instead of the current firmware version.

▶ **collect_diag**

- If this option is set to `true`, the diagnostic data of the PX3 is transmitted to the USB drive.
- The filename of the diagnostic data written into the USB drive is:
`diag_<unit-serial>.zip`

- The PX3 device beeps after it finishes writing the diagnostic data to the USB drive.

▶ **switch_outlets**

- This feature works on outlet-switching capable models only.
- Switch on or off specific outlets.
- The option's value comprises outlet numbers and the setting "on" or "off" as explained below:
 - Each "on" or "off" setting consists of three parts: outlet numbers, a colon, and the word "on" or "off".
 - Each "on" or "off" setting is separated with a semicolon.
 - If all outlets will share the same "on" or "off" setting, replace the outlet numbers with the word "all".
- Examples:
 - Turn on outlets 1 to 3, and 10, and turn off outlets 4 to 9.
`switch_outlets=1,2,3:on;4-9:off;10:on`
 - Turn on all outlets.
`switch_outlets=all:on`

▶ **tls_cert_file**

- Specify the filename of the wanted TLS server certificate. The filename can contain a single placeholder `#{SERIAL}` that is replaced with the serial number of the PX3.
- This option should be used with **tls_key_file** listed below.
- *This option is NOT supported by bulk configuration or backup/restore via DHCP/TFTP.*

▶ **tls_key_file**

- Specify the filename of the wanted TLS server key. The filename can contain a single placeholder `#{SERIAL}` that is replaced with the serial number of the PX3.
- This option should be used with **tls_cert_file** listed above.
- *This option is NOT supported by bulk configuration or backup/restore via DHCP/TFTP.*

▶ **execute_lua_script**

- Specify a Lua script file. For example:
`execute_lua_script=my_script.lua`

- Script output will be recorded to a log file -- <BASENAME_OF_SCRIPT>.<SERIAL_NUMBER>.log. Note this log file's size is limited on DHCP/TFTP.
- A DHCP/TFTP-located script has a timeout of 60 seconds. After that duration the script will be removed.
- This feature can be used to manage LuaService, such as upload, start, get output, and so on.
- If you unplug the USB drive while the Lua script is still running, the script will be removed.
- An exit handler can be used but the execution time is limited to three seconds. Note that this is not implemented on DHCP/TFTP yet.

► **allow_downgrade**

- This parameter is required for any firmware **downgrade** via *USB drive*, or the firmware upgrade via USB drive will fail.
- Add this parameter to this configuration file and set its value to *yes*.

Tip: Only firmware downgrade via USB is disabled by default. To downgrade firmware using other methods is still feasible by default, such as firmware downgrade via web interface.

config.txt

To perform device configuration using a USB drive, you must:

- Copy the device configuration file "config.txt" to the root directory of the USB drive.
- Reference the "config.txt" file in the *config* option of the "fwupdate.cfg" file. See **fwupdate.cfg** (on page 743).

The file, *config.txt*, is a text file containing a number of configuration keys and values to configure or update.

This section only introduces the device configuration file in brief, and does not document all configuration keys, which vary according to the firmware version and your PX3 model.

You can use Raritan's Mass Deployment Utility to create this file by yourself, or contact Raritan to get a device configuration file specific to your PX3 model and firmware version.

*Tip: You can choose to encrypt important data in the "config.txt" file so that people cannot easily recognize it, such as the SNMP write community string. See **Data Encryption in 'config.txt'** (on page 752).*

► **Regular configuration key syntax:**

- Each configuration key and value pair is in a single line as shown below:
key=value

Note: Each value in the file must be separated by an equal sign (=), without any surrounding spaces.

- Multi-line values are supported by using the *Here Document Syntax* with a user-chosen delimiter.

The following illustration declares a value in two lines. You can replace the delimiter `EOF` with other delimiter strings.

```
key<<EOF
value line 1
value line 2
EOF
```

Note: The line break before the closing EOF is not part of the value. If a line break is required in the value, insert an additional empty line before the closing EOF.

► Special configuration keys:

There are 3 special configuration keys that are prefixed with `magic:`.

- A special key that sets a user account's password without knowing the firmware's internal encryption/hashing algorithms is implemented.

Example:

```
magic:users[1].cleartext_password=joshua
```

- Two special keys that set the SNMPv3 passphrases without knowing the firmware's internal encryption/hashing algorithms are implemented.

Examples:

```
magic:users[1].snmp_v3.auth_phrase=swordfish
magic:users[1].snmp_v3.priv_phrase=opensesame
```

► To configure device-specific settings:

1. Make sure the device list configuration file "devices.csv" is available in the USB drive. See **devices.csv** (on page 750)
2. In the "config.txt" file, refer each device-specific configuration key to a specific column in the "devices.csv" file. The syntax is: `${column}`, where "column" is a column number.

Examples:

```
net.interfaces[eth0].ipv4.static.addr_cidr.addr=${4}
pdu.name=${16}
```

▶ **To rename the admin user:**

You can rename the admin user by adding the following configuration key:

```
users[0].name=new admin name
```

Example:

```
users[0].name=May
```

▶ **To encrypt any settings:**

You can encrypt the value of any setting in the config.txt. See **Data Encryption in 'config.txt'** (on page 752).

▶ **To restore a specific setting to factory default:**

Add "delete:" to the beginning of the key whose setting you want to remove. The custom setting will be removed and then reset to factory default.

Example:

```
delete:net.port_forwarding
```

▶ **Tip:**

You can also download "config.txt" from a specific PX3 or upload it to a specific PX3 from anywhere in the world via Internet. See **Raw Configuration Upload and Download** (on page 778).

devices.csv

If there are device-specific settings to configure, you must create a device list configuration file - *devices.csv*, to store unique data of each PX3 device.

This file must be:

- A CSV (comma-separated values) format file exported from a spreadsheet application like Excel.
- Copied to the root directory of USB drive.
- Referenced in the *device_list* option of the "fwupdate.cfg" file. See ***fwupdate.cfg*** (on page 743).

Every PX3 identifies its entry in the "devices.csv" file by comparing its serial number or MAC address to one of the columns in the file.

▶ **Determine the column to identify PX3 devices:**

- By default, the PX3 searches for its serial number in the 1st column of "devices.csv".
- To override the default, set the *match* option in the "fwupdate.cfg" file to a different column.

▶ **Syntax:**

- Values containing commas, line breaks or double quotes are all supported.
- The commas and line breaks to be included in the values must be enclosed in double quotes.
- Every double quote to be included in the value must be escaped with another double quote.

For example:

```
Value-1, "Value-2, with, three, commas", Value-3
```

```
Value-1, "Value-2, ""with""three""double-quotes", Value-3
```

```
Value-1, "Value-2  
with a line break", Value-3
```

Configuration Files for PDU Linking

When PDU Linking is enabled, the mass deployment tool will create the usual files, and multiple versions of config.txt:

- config_link_unit.txt containing the configuration for all link units
- config_<serial>.txt for each master unit containing its specific settings, including a list of link units.

Creating Configuration Files via Mass Deployment Utility

The Mass Deployment Utility is an Excel file that lets you fill in basic information required for the three configuration files, such as the admin account and password.

After entering required information, you can generate all configuration files with only one click, including *fwupdate.cfg*, *config.txt* and *devices.csv*.

► To use the Mass Deployment Utility:

1. Download the Mass Deployment Utility from the Raritan website.
 - The utility is named *mass_deployment-xxx* (where xxx is the firmware version number).
 - It is available on the PX3 product section of Raritan website's **Support page** (<http://www.raritan.com/support/>).

2. Launch Excel to open this utility.

Note: Other office suites, such as OpenOffice and LibreOffice, are not supported.

3. Read the instructions in the 1st worksheet of the utility, and make sure Microsoft Excel's security level has been set to Medium or the equivalent for executing unsigned macros of this utility.
4. Enter information in the 2nd and 3rd worksheets.
 - The 2nd worksheet contains information required for *fwupdate.cfg* and *config.txt*.
 - The 3rd worksheet contains device-specific information for *devices.csv*.
5. Return to the 2nd worksheet to execute the export macro.
 - a. In the Target Directory field, specify the folder where to generate the configuration files. For example, you can specify the root directory of a connected USB drive.
 - b. Click Export Lists to generate configuration files.

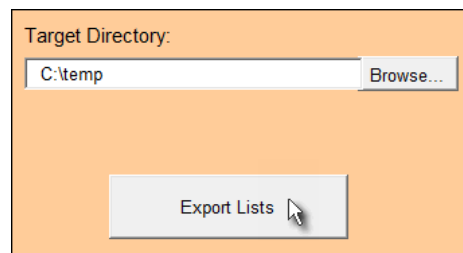

Verify that at least 3 configuration files are created - *fwupdate.cfg*, *config.txt* and *devices.csv*. You are ready to configure or upgrade any PX3 with these files.

See **Configuration or Firmware Upgrade with a USB Drive** (on page 740).

Data Encryption in 'config.txt'

When intending to prevent people from identifying the values of any settings, you can encrypt them. Encrypted data still can be properly interpreted and performed by any PX3 running firmware version 3.2.20 or later.

► **Data encryption procedure:**

1. Open the "config.txt" file to determine which setting(s) to encrypt.
 - If an appropriate "config.txt" is not created yet, see **Creating Configuration Files via Mass Deployment Utility** (on page 751).
2. Launch a terminal to log in to the CLI of any PX3 running version 3.2.20 or later. See **Logging in to CLI** (on page 516).
3. Type the encryption command and the value of the setting you want to encrypt.
 - The value *cannot* contain any double quotes (") or backslashes (-).
 - If the value contains spaces, it must be enclosed in double quotes.

```
# config encrypt <value>
```

-- OR --

```
# config encrypt "<value with spaces>"
```

4. Press Enter. The CLI generates and displays the encrypted form of the typed value.
5. Go to the "config.txt" file and replace the chosen value with the encrypted one by typing or copying the encrypted value from the CLI.
6. Add the text "encrypted:" to the beginning of the encrypted setting.
7. Repeat steps 3 to 6 for additional settings you intend to encrypt.
8. Save the changes made to the "config.txt" file. Now you can use this file to configure any PX3 running version 3.2.20 or later. See **Configuration or Firmware Upgrade with a USB Drive** (on page 740).

► **Illustration:**

In this example, we will encrypt the word "private", which is the value of the SNMP write community in the "config.txt" file.

```
snmp.write_community=private
```

1. In the CLI, type the following command to encrypt "private."

```
# config encrypt private
```

2. The CLI generates and shows the encrypted form of "private."

```
ZTtnYcvQUw==
```

3. In the "config.txt" file, make the following changes to the SNMP write community setting.
 - a. Replace the word "private" with the encrypted value that CLI shows.

```
snmp.write_community=ZTtnYcvQUw==
```

- b. Add "encrypted:" to the beginning of that setting.

```
encrypted:snmp.write_community=ZTtnYcvQUw==
```

Firmware Upgrade via USB

Firmware files are available on Raritan website's **Support page** (<http://www.raritan.com/support/>).

Note that if the firmware file used for firmware upgrade is the same as the firmware version running on the PX3, no firmware upgrade will be performed unless you have set the *force_update* option to true in the "fwupdate.cfg" file. See **fwupdate.cfg** (on page 743).

► To use a USB drive to upgrade the PX3:

1. Copy the configuration file "fwupdate.cfg" and an appropriate firmware file to the root directory of the USB drive.
2. Reference the firmware file in the *firmware* option of the "fwupdate.cfg" file.
3. Plug the USB drive into the USB-A port on the PX3.
4. The PX3 performs the firmware upgrade.
 - The front panel display shows the firmware upgrade progress.

Tip: You can remove the USB drive and plug it into another PX3 for firmware upgrade when the firmware upgrade message displays.

5. It may take one to five minutes to complete the firmware upgrade, depending on your product.
6. When the firmware upgrade finishes, the front panel display indicates the firmware upgrade result.
 - **Happy smiley:** Successful.
Depending on your product, the happy smiley looks like one of the following. For the first diagram, its background color will turn green.

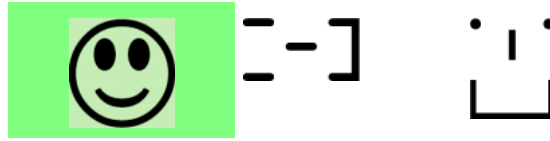

- **Sad smiley:** Failed. Check the log file in the USB drive or contact Raritan Technical Support to look into the failure cause.

The sad smiley looks like one of the following. For the first diagram, its background color will turn red.



Appendix D Bulk Configuration or Firmware Upgrade via DHCP/TFTP

If a TFTP server is available, you can use it and appropriate configuration files to perform any or all of the following tasks for a large number of PX3 devices in the same network.

- Initial deployment
- Configuration changes
- Firmware upgrade
- Downloading diagnostic data

This feature is drastically useful if you have hundreds or even thousands of PX3 devices to configure or upgrade.

Warning: The feature of bulk configuration or firmware upgrade via DHCP/TFTP only works on standalone PX3 devices directly connected to the network. This feature does NOT work for slave devices in the cascading configuration.

*Tip: For the other alternatives, see **Configuration or Firmware Upgrade with a USB Drive** (on page 740) or **Raw Configuration Upload and Download** (on page 778).*

In This Chapter

Bulk Configuration/Upgrade Procedure	756
TFTP Requirements.....	757
DHCP IPv4 Configuration in Windows	757
DHCP IPv6 Configuration in Windows	767
DHCP IPv4 Configuration in Linux.....	774
DHCP IPv6 Configuration in Linux.....	776

Bulk Configuration/Upgrade Procedure

Any firmware **downgrade** using "fwupdate.cfg" is NOT supported by default. Only firmware upgrade is permitted with "fwupdate.cfg". A special parameter is required to permit firmware downgrade via "fwupdate.cfg". See **fwupdate.cfg** (on page 743).

Therefore, firmware "downgrade" via DHCP/TFTP is disallowed by default.

► **Steps of using DHCP/TFTP for bulk configuration/upgrade:**

1. Create configuration files specific to your PX3 models and firmware versions. See **Configuration Files** (on page 742) or contact Raritan Technical Support to properly prepare some or all of the following files:
 - *fwupdate.cfg* (always required)
 - *config.txt*
 - *devices.csv*

Note: Supported syntax of "fwupdate.cfg" and "config.txt" may vary based on different firmware versions. If you have existing configuration files, it is suggested to double check with Raritan Technical Support for the correctness of these files prior to using this feature.

2. Configure your TFTP server properly. See **TFTP Requirements** (on page 757).
3. Copy ALL required configuration files into the TFTP root directory. If the tasks you will perform include firmware upgrade, an appropriate firmware binary file is also required.
4. Properly configure your DHCP server so that it refers to the file "fwupdate.cfg" on the TFTP server for your PX3.

Click one or more of the following links for detailed DHCP configuration instructions, based on your operating system and the IP address type.

 - **DHCP IPv4 Configuration in Windows** (on page 757)
 - **DHCP IPv6 Configuration in Windows** (on page 767)
 - **DHCP IPv4 Configuration in Linux** (on page 774)
 - **DHCP IPv6 Configuration in Linux** (on page 776)
5. Make sure all of the desired PX3 devices use DHCP as the IP configuration method and have been *directly* connected to the network.
6. Re-boot these PX3 devices. The DHCP server will execute the commands in the "fwupdate.cfg" file on the TFTP server to configure or upgrade those PX3 devices supporting DHCP in the same network.

DHCP will execute the "fwupdate.cfg" commands once for IPv4 and once for IPv6 respectively if both IPv4 and IPv6 settings are configured properly in DHCP.

TFTP Requirements

To perform bulk configuration or firmware upgrade successfully, your TFTP server must meet the following requirements:

- The server is able to work with both IPv4 and IPv6.

In Linux, remove any IPv4 or IPv6 flags from `/etc/xinetd.d/tftp`.

Note: DHCP will execute the "fwupdate.cfg" commands once for IPv4 and once for IPv6 respectively if both IPv4 and IPv6 settings are configured properly in DHCP.

- All required configuration files are available in the TFTP root directory. See **Bulk Configuration/Upgrade Procedure** (on page 756).

If you are going to upload any PX3 diagnostic file or create a log file in the TFTP server, the first of the following requirements is also required.

- The TFTP server supports the write operation, including file creation and upload.

In Linux, provide the option "-c" for write support.

- **Required for uploading the diagnostic file only** - the timeout for file upload is set to one minute or longer.

DHCP IPv4 Configuration in Windows

For those PX3 devices using IPv4 addresses, follow this procedure to configure your DHCP server. The following illustration is based on Microsoft® Windows Server 2012 system.

▶ **Required Windows IPv4 settings in DHCP:**

1. Add a new vendor class for Raritan's PX3 under IPv4.
 - a. Right-click the IPv4 node in DHCP to select Define Vendor Classes.

- b. Click Add to add a new vendor class.

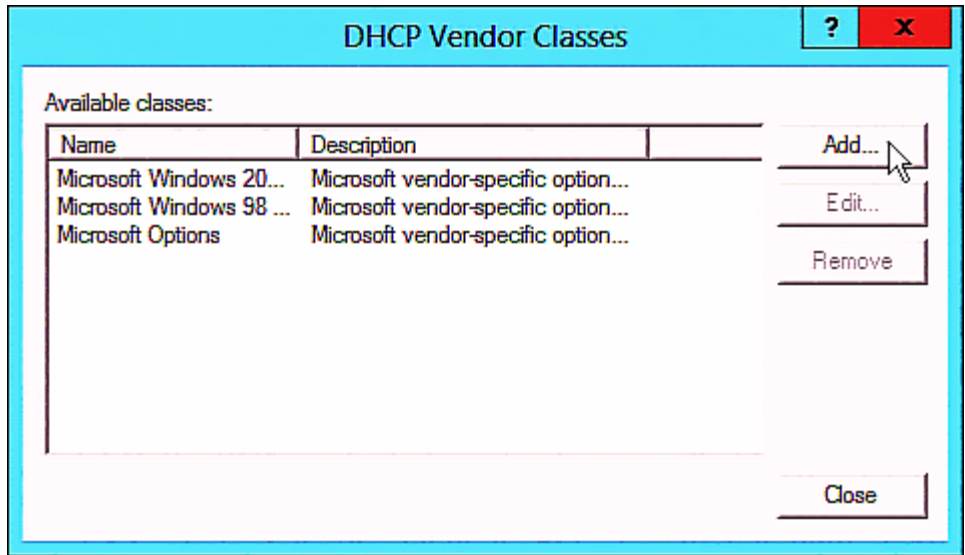

- c. Specify a unique name for this vendor class and type the binary codes of "Raritan PDU 1.0" in the New Class dialog.

The vendor class is named "Raritan PDU" in this illustration.

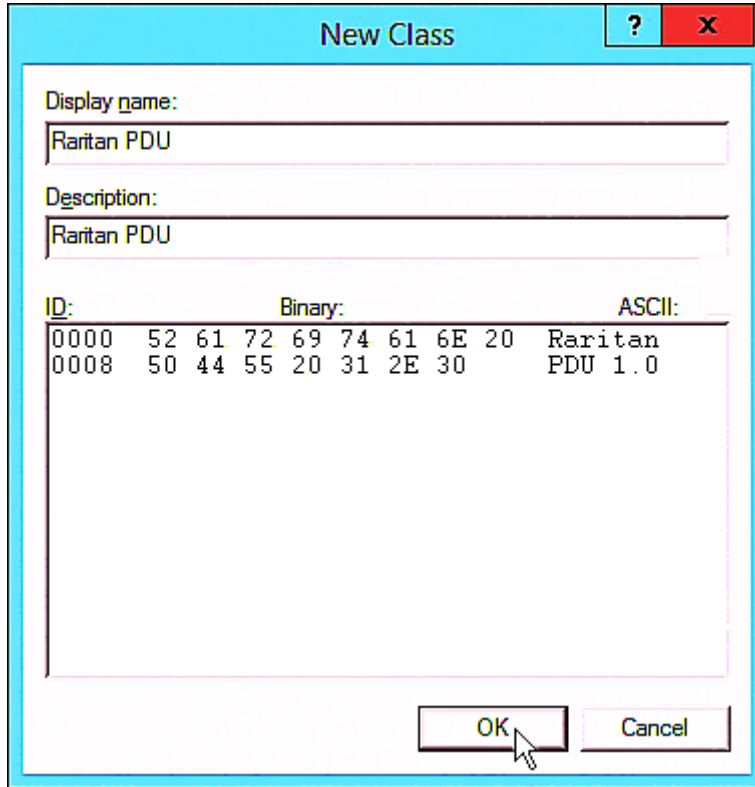

- 2. Define one DHCP standard option - Vendor Class Identifier.

- a. Right-click the IPv4 node in DHCP to select Set Predefined Options.
- b. Select DHCP Standard Options in the "Option class" field, and Vendor Class Identifier in the "Option name" field. Leave the String field blank.

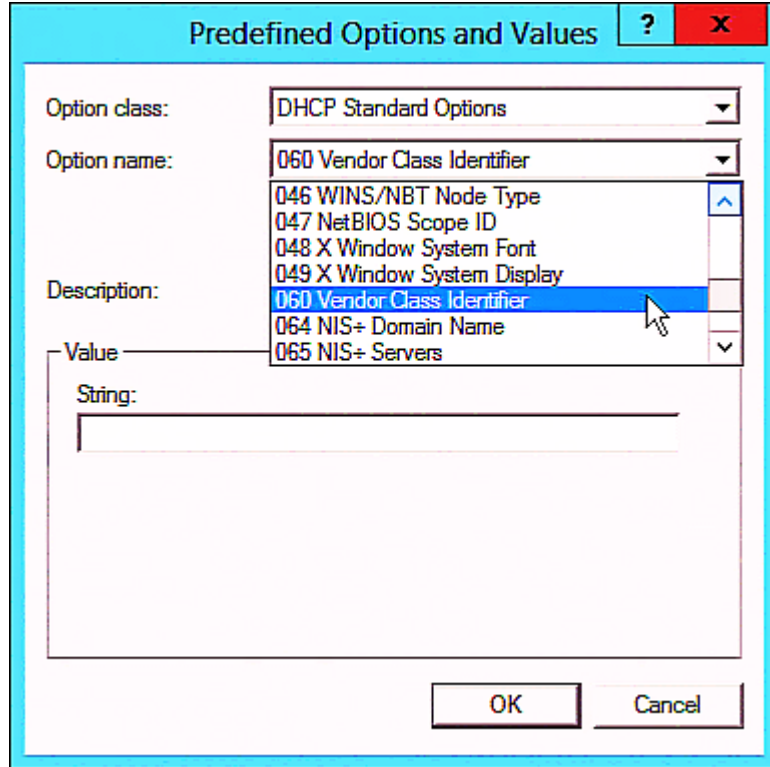

3. Add three options to the new vendor class "Raritan PDU" in the same dialog.

- a. Select Raritan PDU in the "Option class" field.

The screenshot shows a dialog box titled "Predefined Options and Values". It has a light blue header with a question mark and a close button (X). The "Option class:" field is a dropdown menu currently showing "Raritan PDU". Below it, the "Option name:" field is a list box containing several entries: "DHCP Standard Options", "Microsoft Windows 2000 Options", "Microsoft Windows 98 Options", "Microsoft Options", and "Raritan PDU". The "Raritan PDU" entry is highlighted in blue, and a mouse cursor is pointing at it. Below the list is a "Description:" field. Underneath is a "Value" section with a "String:" label and a text input field. At the bottom of the dialog are "OK" and "Cancel" buttons.

- b. Click Add to add the first option. Type "pdu-tftp-server" in the Name field, select IP Address as the data type, and type 1 in the Code field.

The screenshot shows a dialog box titled "Option Type". It has a light blue header with a question mark and a close button (X). The "Class:" field is set to "Raritan PDU". The "Name:" field is a text input containing "pdu-tftp-server". The "Data type:" field is a dropdown menu set to "IP Address" with an unchecked "Array" checkbox. The "Code:" field is a text input containing "1". The "Description:" field is empty. At the bottom are "OK" and "Cancel" buttons, with a mouse cursor pointing at the "OK" button.

- c. Click Add to add the second option. Type "pdu-update-control-file" in the Name field, select String as the data type, and type 2 in the Code field.

The screenshot shows a dialog box titled "Option Type" with a light blue header and a red close button. The form fields are as follows:

- Class:** Raritan PDU
- Name:** pdu-update-control-file
- Data type:** String (dropdown menu), Array
- Code:** 2
- Description:** (empty text box)

Buttons for "OK" and "Cancel" are located at the bottom right of the dialog.

- d. Click Add to add the third one. Type "pdu-update-magic" in the Name field, select String as the data type, and type 3 in the Code field.

The screenshot shows a dialog box titled "Option Type" with a light blue header and a red close button. The form fields are as follows:

- Class:** Raritan PDU
- Name:** pdu-update-magic
- Data type:** String (dropdown menu), Array
- Code:** 3
- Description:** (empty text box)

Buttons for "OK" and "Cancel" are located at the bottom right of the dialog.

- 4. Create a new policy associated with the "Raritan PDU" vendor class.
 - a. Right-click the Policies node under IPv4 to select New Policy.
 - b. Specify a policy name, and click Next.

The policy is named "PDU" in this illustration.

DHCP Policy Configuration Wizard

Policy based IP Address and Option Assignment

This feature allows you to distribute configurable settings (IP address, DHCP options) to clients based on certain conditions (e.g. vendor class, user class, MAC address, etc.).

This wizard will guide you setting up a new policy. Provide a name (e.g. VoIP Phone Configuration Policy) and description (e.g. NTP Server option for VoIP Phones) for your policy.

Policy Name:

Description:

< Back Next > Cancel

c. Click Add to add a new condition.

- d. Select the vendor class "Raritan PDU" in the Value field, click Add and then Ok.

Add/Edit Condition ? X

Specify a condition for the policy being configured. Select a criteria, operator and values for the condition.

Criteria: Vendor Class

Operator: Equals

Value(s)

Value: Raritan PDU Add

Prefix wildcard(*)

Append wildcard(*)

Raritan PDU Remove

Ok Cancel

- e. Click Next.

- f. Select DHCP Standard Options in the "Vendor class" field, select "060 Vendor Class Identifier" from the Available Options list, and type "Raritan PDU 1.0" in the "String value" field.

DHCP Policy Configuration Wizard

Configure settings for the policy
If the conditions specified in the policy match a client request, the settings will be applied.

Vendor class:

Available Options	Description
<input type="checkbox"/> 049 X Window System Display	Array of X Windows Display M
<input checked="" type="checkbox"/> 060 Vendor Class Identifier	
<input type="checkbox"/> 064 NIS+ Domain Name	The name of the client's NIS+

Data entry

String value:

< Back Next > Cancel

- g. Select the "Raritan PDU" in the "Vendor class" field, select "001 pdu-tftp-server" from the Available Options list, and type your TFTP server's IPv4 address in the "IP address" field.

DHCP Policy Configuration Wizard

Configure settings for the policy
 If the conditions specified in the policy match a client request, the settings will be applied.

Vendor class: Raritan PDU

Available Options	Description
<input checked="" type="checkbox"/> 001 pdu-tftp-server	
<input type="checkbox"/> 002 pdu-update-control-file	
<input type="checkbox"/> 003 pdu-update-magic	

Data entry

IP address: 192 . 168 . 85 . 93

< Back
Next >
Cancel

- h. Select "002 pdu-update-control-file" from the Available Options list, and type the filename "fwupdate.cfg" in the "String value" field.

DHCP Policy Configuration Wizard

Configure settings for the policy
If the conditions specified in the policy match a client request, the settings will be applied.

Vendor class: Raritan PDU

Available Options	Description
<input checked="" type="checkbox"/> 001 pdu-tftp-server	
<input checked="" type="checkbox"/> 002 pdu-update-control-file	
<input type="checkbox"/> 003 pdu-update-magic	

Data entry

String value:
fwupdate.cfg

< Back Next > Cancel

- i. Select "003 pdu-update-magic" from the Available Options list, and type any string in the "String value" field. This third option/code is the magic cookie to prevent the *fwupdate.cfg* commands from being executed repeatedly. It does NOT matter whether the IPv4 magic cookie is identical to or different from the IPv6 magic cookie. The magic cookie is a string comprising numerical and/or alphabetical digits in any format. In the following illustration diagram, it is a combination of a date and a serial number.

Important: The magic cookie is transmitted to and stored in PX3 at the time of executing the "fwupdate.cfg" commands. The DHCP/TFTP operation is triggered only when there is a mismatch between the magic cookie in DHCP and the one stored in PX3. Therefore, you must modify the magic cookie's value in DHCP when intending to execute the "fwupdate.cfg" commands next time.

DHCP Policy Configuration Wizard

Configure settings for the policy
If the conditions specified in the policy match a client request, the settings will be applied.

Vendor class:

Available Options	Description
<input checked="" type="checkbox"/> 001 pdu-tftp-server	
<input checked="" type="checkbox"/> 002 pdu-update-control-file	
<input checked="" type="checkbox"/> 003 pdu-update-magic	

Data entry

String value:

DHCP IPv6 Configuration in Windows

For those PX3 devices using IPv6 addresses, follow this procedure to configure your DHCP server. The following illustration is based on Microsoft® Windows Server 2012 system.

► **Required Windows IPv6 settings in DHCP:**

1. Add a new vendor class for Raritan's PX3 under IPv6.

- a. Right-click the IPv6 node in DHCP to select Define Vendor Classes.
- b. Click Add to add a new vendor class.

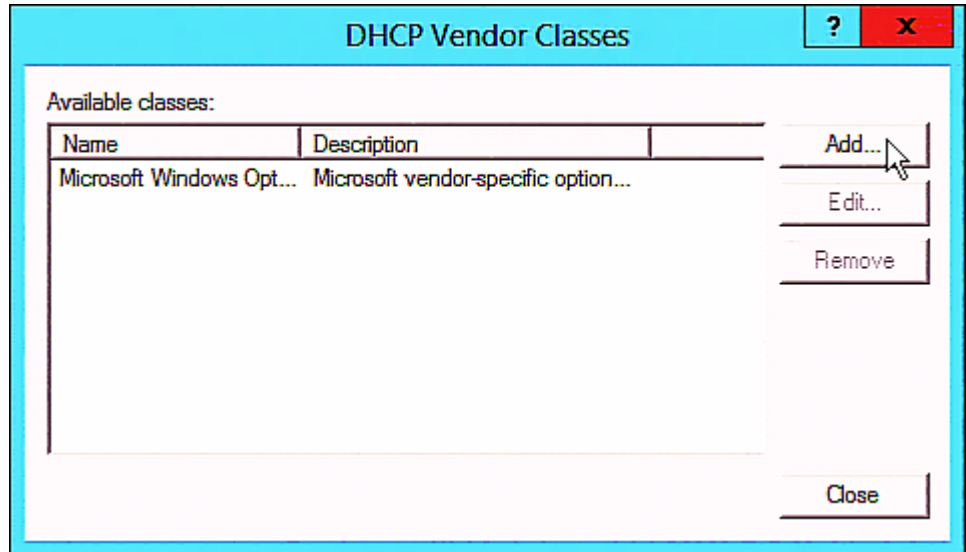

- c. Specify a unique name for the vendor class, type "13742" in the "Vendor ID (IANA)" field, and type the binary codes of "Raritan PDU 1.0" in the New Class dialog.

The vendor class is named "Raritan PDU 1.0" in this illustration.

New Class
? X

Display name:

Description:

Vendor ID (IANA):

ID:	Binary:	ASCII:
0000	52 61 72 69 74 61 6E 20	Raritan
0008	50 44 55 20 31 2E 30	PDU 1.0

2. Add three options to the "Raritan PDU 1.0" vendor class.
 - a. Right-click the IPv6 node in DHCP to select Set Predefined Options.

- b. Select Raritan PDU 1.0 in the "Option class" field.

Predefined Options and Values for v6 [?] [X]

Option class: Raritan PDU 1.0

Option name: DHCP Standard Options
Microsoft Windows Options
Raritan PDU 1.0

Description:

Value

String:

OK Cancel

- c. Click Add to add the first option. Type "pdu-tftp-server" in the Name field, select IP Address as the data type, and type 1 in the Code field.

Option Type [?] [X]

Class: Raritan PDU 1.0

Name: pdu-tftp-server

Data type: IP Address Array

Code: 1

Description:

OK Cancel

- d. Click Add to add the second option. Type "pdu-update-control-file" in the Name field, select String as the data type, and type 2 in the Code field.

The screenshot shows a dialog box titled "Option Type" with a light blue header and a red close button. The form fields are as follows:

- Class:** Raritan PDU 1.0
- Name:** pdu-update-control-file
- Data type:** String (dropdown menu), with an unchecked checkbox for Array.
- Code:** 2
- Description:** (empty text box)

Buttons for "OK" and "Cancel" are located at the bottom right of the dialog.

- e. Click Add to add the third one. Type "pdu-update-magic" in the Name field, select String as the data type, and type 3 in the Code field.

The screenshot shows a dialog box titled "Option Type" with a light blue header and a red close button. The form fields are as follows:

- Class:** Raritan PDU 1.0
- Name:** pdu-update-magic
- Data type:** String (dropdown menu), with an unchecked checkbox for Array.
- Code:** 3
- Description:** (empty text box)

Buttons for "OK" and "Cancel" are located at the bottom right of the dialog.

3. Configure server options associated with the "Raritan PDU 1.0" vendor class.
 - a. Right-click the Server Options node under IPv6 to select Configure Options.
 - b. Click the Advanced tab.

- c. Select "Raritan PDU 1.0" in the "Vendor class" field, select "00001 pdu-tftp-server" from the Available Options list, and type your TFTP server's IPv6 address in the "IPv6 address" field.

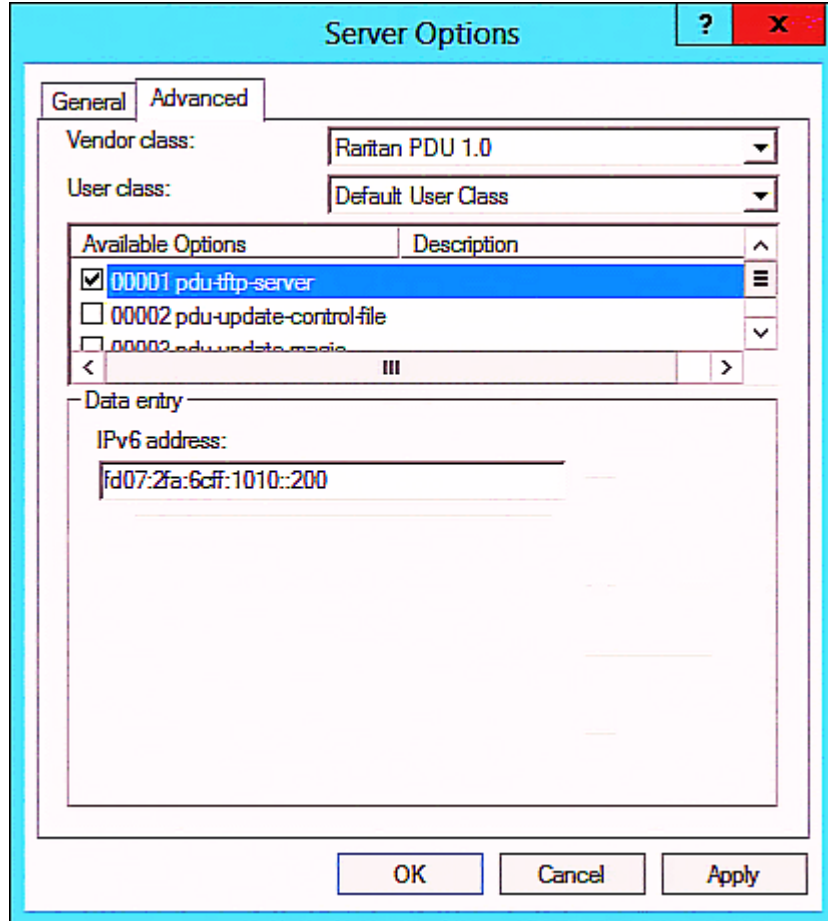

- d. Select "00002 pdu-update-control-file" from the Available Options list, and type the filename "fwupdate.cfg" in the "String value" field.

The screenshot shows the 'Server Options' dialog box with the 'Advanced' tab selected. The 'Vendor class' is set to 'Raritan PDU 1.0' and the 'User class' is 'Default User Class'. The 'Available Options' list contains three entries: '00001 pdu-tftp-server', '00002 pdu-update-control-file' (which is selected), and '00003 pdu-update-magic'. The 'String value' field is populated with 'fwupdate.cfg'. The dialog has 'OK', 'Cancel', and 'Apply' buttons at the bottom.

- e. Select "00003 pdu-update-magic" from the Available Options list, and type any string in the "String value" field. This third option/code is the magic cookie to prevent the *fwupdate.cfg* commands from being executed repeatedly. It does NOT matter whether the IPv6 magic cookie is identical to or different from the IPv4 magic cookie. The magic cookie is a string comprising numerical and/or alphabetical digits in any format. In the following illustration diagram, it is a combination of a date and a serial number.

Important: The magic cookie is transmitted to and stored in PX3 at the time of executing the "fwupdate.cfg" commands. The DHCP/TFTP operation is triggered only when there is a mismatch between the magic cookie in DHCP and the one stored in PX3. Therefore, you must modify the magic cookie's value in DHCP when intending to execute the "fwupdate.cfg" commands next time.

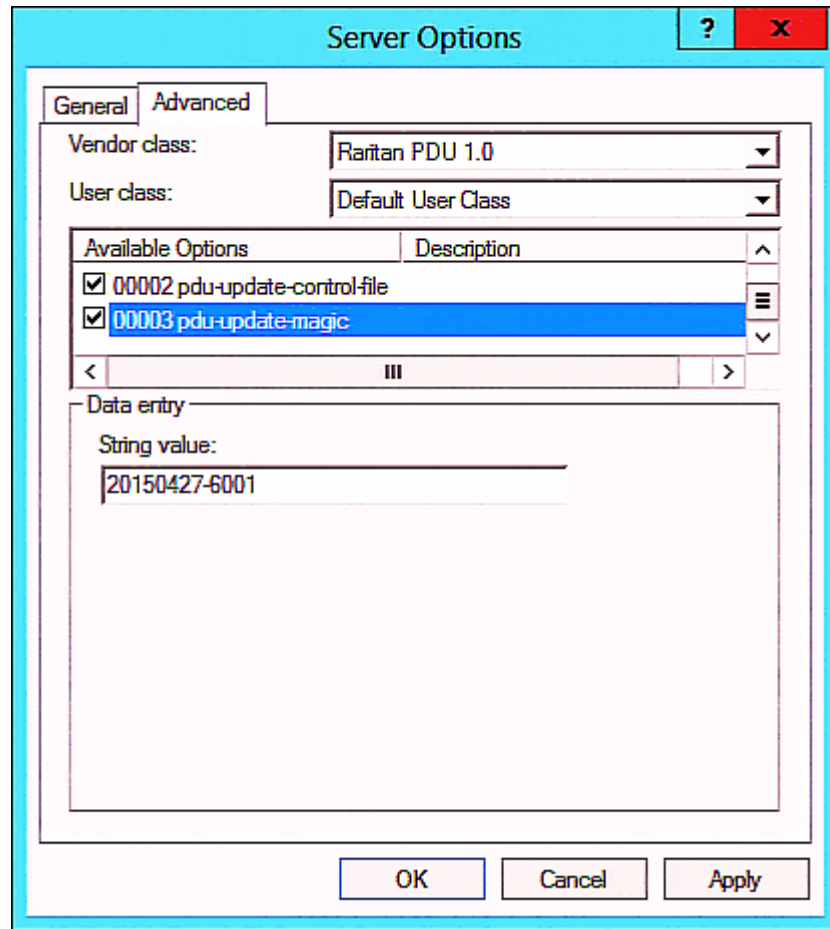

DHCP IPv4 Configuration in Linux

Modify the "dhcpd.conf" file for IPv4 settings when your DHCP server is running Linux.

► **Required Linux IPv4 settings in DHCP:**

1. Locate and open the "dhcpd.conf" file of the DHCP server.
2. The PX3 will provide the following value of the vendor-class-identifier option (option 60).
 - vendor-class-identifier = "Raritan PDU 1.0"

Configure the same option in DHCP accordingly. The PX3 accepts the configuration or firmware upgrade only when this value in DHCP matches.

3. Set the following three sub-options in the "vendor-encapsulated-options" (option 43).
 - code 1 (pdu-tftp-server) = the TFTP server's IPv4 address
 - code 2 (pdu-update-control-file) = the name of the control file "fwupdate.cfg"
 - code 3 (pdu-update-magic) = any string

This third option/code is the magic cookie to prevent the *fwupdate.cfg* commands from being executed repeatedly. It does NOT matter whether the IPv4 magic cookie is identical to or different from the IPv6 magic cookie.

The magic cookie is a string comprising numerical and/or alphabetical digits in any format. In the following illustration diagram, it is a combination of a date and a serial number.

Important: The magic cookie is transmitted to and stored in PX3 at the time of executing the "fwupdate.cfg" commands. The DHCP/TFTP operation is triggered only when there is a mismatch between the magic cookie in DHCP and the one stored in PX3. Therefore, you must modify the magic cookie's value in DHCP when intending to execute the "fwupdate.cfg" commands next time.

► IPv4 illustration example in dhcpd.conf:

```
[...]

set vendor-string = option vendor-class-identifier;
option space RARITAN code width 1 length width 1 hash size 3;
option RARITAN.pdu-tftp-server code 1 = ip-address;
option RARITAN.pdu-update-control-file code 2 = text;
option RARITAN.pdu-update-magic code 3 = text;

class "raritan" {
    match if option vendor-class-identifier = "Raritan PDU 1.0";
    vendor-option-space          RARITAN;
    option RARITAN.pdu-tftp-server 192.168.1.7;
    option RARITAN.pdu-update-control-file "fwupdate.cfg";
    option RARITAN.pdu-update-magic "20150123-0001";
    option vendor-class-identifier "Raritan PDU 1.0";
}

[...]
```

DHCP IPv6 Configuration in Linux

Modify the "dhcpd6.conf" file for IPv6 settings when your DHCP server is running Linux.

► Required Linux IPv6 settings in DHCP:

1. Locate and open the "dhcpd6.conf" file of the DHCP server.
2. The PX3 will provide the following values to the "vendor-class" option (option 16). Configure related settings in DHCP accordingly.
 - 13742 (Raritan's IANA number)
 - Raritan PDU 1.0
 - 15 (the length of the above string "Raritan PDU 1.0")
3. Set the following three sub-options in the "vendor-opts" (option 17).
 - code 1 (pdu-tftp-server) = the TFTP server's IPv6 address
 - code 2 (pdu-update-control-file) = the name of the control file "fwupdate.cfg"

- code 3 (pdu-update-magic) = any string

This third option/code is the magic cookie to prevent the *fwupdate.cfg* commands from being executed repeatedly. It does NOT matter whether the IPv6 magic cookie is identical to or different from the IPv4 magic cookie.

The magic cookie is a string comprising numerical and/or alphabetical digits in any format. In the following illustration diagram, it is a combination of a date and a serial number.

Important: The magic cookie is transmitted to and stored in PX3 at the time of executing the "fwupdate.cfg" commands. The DHCP/TFTP operation is triggered only when there is a mismatch between the magic cookie in DHCP and the one stored in PX3. Therefore, you must modify the magic cookie's value in DHCP when intending to execute the "fwupdate.cfg" commands next time.

► IPv6 illustration example in *dhcpcd6.conf*:

```
[...]

option space RARITAN code width 2 length width 2 hash size 3;
option RARITAN.pdu-tftp-server code 1 = ip6-address;
option RARITAN.pdu-update-control-file code 2 = text;
option RARITAN.pdu-update-magic code 3 = text;
option vsio.RARITAN code 13742 = encapsulate RARITAN;

[...]

subnet6 xxxx {

[...]

    option RARITAN.pdu-tftp-server 1::2;
    option RARITAN.pdu-update-control-file "fwupdate.cfg";
    option RARITAN.pdu-update-magic "20150123-0001";

[...]

}
```

Appendix E Raw Configuration Upload and Download

You can modify any existing "config.txt", and then upload it to a specific PX3 for modifying part or all of its settings.

There are two ways to get one "config.txt":

- You create this file by yourself, either using or not using the Mass Deployment Utility. See **Configuration Files** (on page 742) and **config.txt** (on page 747).
- You download the raw configuration data from any PX3.

The downloaded raw configuration contains "almost" all of current settings on your PX3.

Warning: Some configuration keys in the downloaded raw configuration are commented out, and those must NOT be part of the configuration that will be uploaded to any PX3. See **Keys that Cannot Be Uploaded** (on page 715).

Both configuration download and upload operations require the Administrator Privileges.

In This Chapter

Downloading Raw Configuration	778
Uploading Raw Configuration	780

Downloading Raw Configuration

There are three download methods:

- *Web browsers*: See **Download via Web Browsers** (on page 778).
- *SCP or PSCP command*: See **Uploading or Downloading Raw Configuration Data** (on page 712).
- *CURL command*: See **Download via Curl** (on page 779).

Download via Web Browsers

There are two scenarios by using web browsers.

► **URL containing login credentials:**

To log in immediately while issuing the download request, type an URL containing the login credentials in the web browser.

```
http(s)://<user>:<password>@<device IP>/cgi-bin/raw_config_download.cgi
```

Parameter	Description
<user>	Any user name that has the Administrator Privileges.
<password>	The password of the specified user name.
<device IP>	Hostname or IP address of the PX3 whose raw configuration you want to download.

- For example:

```
https://admin:raritan@192.168.84.114/cgi-bin/raw_config_download.cgi
```

► **URL without login credentials contained:**

If you would like to log in after issuing the download request, type an URL without login credentials contained in the web browser. The system will then prompt you to enter the login credentials.

```
http(s)://<device IP>/cgi-bin/raw_config_download.cgi
```

- For example:

```
https://192.168.84.114/cgi-bin/raw_config_download.cgi
```

Download via Curl

If you have installed curl on your computer, you can download the raw configuration from your PX3 by performing the curl command.

► **To download raw configuration from PX3 via curl:**

1. Type the following curl command in the command line interface.

```
curl -k https://<user>:<password>@<device IP>/cgi-bin/raw_config_download.cgi > config.txt
```

Parameter	Description
<user>	Any user name that has the Administrator Privileges.

Parameter	Description
<password>	The password of the specified user name.
<device IP>	Hostname or IP address of the PX3 whose raw configuration you want to download.

2. When the download is complete, a line indicates 100 in the first % column.

```

% Total    % Received % Xferd  Average Speed   Time    Time     Time  Current
           Dload  Upload   Total             Spent    Left     Speed
100 20184    0 20184    0     0    9511      0  --:--:--  0:00:02  --:--:--  9584
  
```

3. Go to the directory where you perform the curl command to find the "config.txt" file.

Tip: In the above curl command, you can replace the filename "config.txt" with any filename you prefer.

▶ **Example:**

```

curl -k https://admin:raritan@192.168.84.114/cgi-bin/raw_config_download.cgi >
config.txt
  
```

Uploading Raw Configuration

There are two upload methods:

- *SCP or PSCP command:* See **Uploading or Downloading Raw Configuration Data** (on page 712).
- *CURL command:* See **Upload via Curl** (on page 781).

The uploaded raw configuration file can contain only partial configuration keys that you want to modify. Other settings that are not contained in the uploaded file will remain unchanged.

Authentication-related data or HTTP(S) port may be no longer the same after uploading raw configuration. Therefore, it is suggested to **double check** what configuration keys will be changed in the raw configuration file that you will upload.

Upload via Curl

If curl is available on your computer, you can upload the raw configuration to PX3 with the curl command.

There are two scenarios with the curl upload methods.

- When there are NO device-specific settings involved, you upload the configuration file only, regardless of the number of PX3 devices to update.
- When there are device-specific settings involved for updating more than one PX3 devices, you must upload two files. including one configuration file and one device list file.

► To upload one configuration file only:

1. Type the following curl command in the command line interface.

```
curl -k -F "config_file=@<config file>" https://<user>:<password>@<device IP>/cgi-bin/raw_config_update.cgi
```

Parameter	Description
<user>	Any user name that has the Administrator Privileges.
<password>	The password of the specified user name.
<device IP>	Hostname or IP address of the PX3 whose raw configuration you want to upload.
<config file>	Filename of the configuration file. <ul style="list-style-type: none"> ▪ For the syntax, see config.txt (on page 747).

2. When the upload is completed successfully, the curl returns the code 0 (zero).

*Note: If the upload fails and curl returns other codes, see **Curl Upload Return Codes** (on page 782).*

3. After several seconds, PX3 reboots automatically. Changed settings take effect after the reboot process finishes.

► To upload both configuration and device list files:

1. Type the following curl command in the command line interface.

```
curl -k -F "config_file=@<config file>" -F "device_list_file=@<dev_list file>" https://<user>:<password>@<device IP>/cgi-bin/raw_config_update.cgi?match=<dev_col>
```

Parameter	Description
<user>, <password>, <device IP>, <config file>	Refer to the above table for explanation. <ul style="list-style-type: none"> For device-specific settings in the <config file>, refer each device-specific configuration key to a specific column in the <dev_list file>. See config.txt (on page 747).
<dev_list file>	Filename of the device list file in CSV format. <ul style="list-style-type: none"> For the content format, see devices.csv (on page 750).
<dev_col>	<dev_col> comprises "serial:" or "mac:" and the number of the column where the serial number or MAC address of each PX3 is in the uploaded CSV file. This is the data based on which each device finds its device-specific settings. <p>For example:</p> <ul style="list-style-type: none"> If the second column contains each device's serial number, the parameter is then <code>serial:2</code>. If the seventh column contains each device's MAC address, the parameter is then <code>mac:7</code>.

- PX3 will reboot after Curl shows the return code 0. For details, refer to above steps 2 to 3.

► **Examples:**

- Upload of the configuration file only:

```
curl -k -F "config_file=@config.txt"
https://admin:raritan@192.168.84.114/cgi-bin/raw_config_download.cgi
```

- Upload of both configuration and device list files:

```
curl -k -F "config_file=@config.txt" -F "device_list_file=@devices.csv"
https://admin:raritan@192.168.84.114/cgi-bin/raw_config_download.cgi
```

Curl Upload Return Codes

After performing raw configuration **Upload via Curl** (on page 781), curl will return a code to indicate the result of the file upload.

Code	Description
0	Operation was successful.

Code	Description
1	An internal error occurred.
2	A parameter error occurred.
3	A raw configuration update operation is already running.
4	The file is too large.
5	Invalid raw configuration file provided.
6	Invalid device list file or match provided.
7	Device list file required but missing.
8	No matching entry in device list found.
9	Macro substitution error.
10	Decrypting value failed.
11	Unknown magic line.
12	Processing magic line failed.

Appendix F Resetting to Factory Defaults

You can use either the reset button or the command line interface (CLI) to reset the PX3.

Important: Exercise caution before resetting the PX3 to its factory defaults. This erases existing information and customized settings, such as user profiles, threshold values, and so on. Only active energy data and firmware upgrade history are retained.

► **Alternative:**

Another method to reset it to factory defaults is to use the web interface. See *Resetting All Settings to Factory Defaults* (on page 482).

In This Chapter

Using the Reset Button	784
Using the CLI Command.....	785

Using the Reset Button

An RS-232 serial connection to a computer is required for using the reset button.

► **To reset to factory defaults using the reset button:**

1. Connect a computer to the PX3. See *Connecting the PX3 to a Computer* (on page 30).
2. Launch a terminal emulation program such as Kermit or PuTTY, and open a window on the PX3. For information on the serial port configuration, see Step 2 of *Initial Network Configuration via CLI* (on page 898).
3. Press (and release) the Reset button of the PX3 device while pressing the Esc key of the keyboard several times in rapid succession. A prompt (=) should appear after about one second.
4. Type *defaults* to reset the PX3 to its factory defaults.
5. Wait until the reset is complete.

The following illustrates the reset button on Zero U PDUs. Port locations may differ on your models.

▪ **PX3 Zero U:**

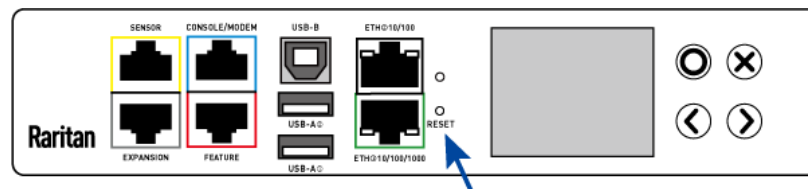

Note: PuTTY is a free program you can download from the Internet. See PuTTY's documentation for details on configuration.

Using the CLI Command

The Command Line Interface (CLI) provides a reset command for restoring the PX3 to factory defaults. For information on CLI, see **Using the Command Line Interface** (on page 515).

► To reset to factory defaults after logging in to the CLI:

1. Connect to the PX3. See **Logging in to CLI** (on page 516) or **Connecting the PX3 to a Computer** (on page 30).
2. Launch a terminal emulation program such as HyperTerminal, Kermit, or PuTTY, and open a window on the PX3. For information on the serial port configuration, see Step 2 of **Initial Network Configuration via CLI** (on page 898).
3. Log in to the CLI by typing the user name "admin" and its password.
4. After the # system prompt appears, type either of the following commands and press Enter.

```
# reset factorydefaults
```

```
-- OR --
```

```
# reset factorydefaults /y
```

5. If you entered the command without "/y" in Step 4, a message appears prompting you to confirm the operation. Type y to confirm the reset.
6. Wait until the reset is complete.

► To reset to factory defaults without logging in to the CLI:

The PX3 provides an easier way to reset the product to factory defaults in the CLI prior to login.

1. Connect to the PX3 and launch a terminal emulation program as described in the above procedure.
2. At the Username prompt in the CLI, type "factorydefaults" and press Enter.

```
Username: factorydefaults
```

3. Type y on a confirmation message to perform the reset.

Appendix G PX3 Models with Residual Current Monitoring

PX3 models with residual current monitoring (RCM) detect and report residual current - abnormal flow of current into the protective earth conductor.

Residual current is a safety issue since electrocution is possible if the rack or any device within it is touched.

Depending on the model you purchase, some models report residual current by inlet only, while some models report residual current by inlet pole. In addition, some models are able to report residual DC current in addition to the total residual current.

Warning: PX3 RCM cannot disconnect power to stop residual current flow. Devices like RCD and GFI disconnect power when residual current is detected, but the PX3 with RCM are NOT RCD or GFI protected devices.

In This Chapter

RCM Current Sensor	786
RCM State Sensor	787
Compliance with IEC 62020	788
RCM Self-Test.....	789
Web Interface Operations for RCM	790
Front Panel Operations for RCM	796
RCM SNMP Operations.....	799
CLI Operations for RCM	800

RCM Current Sensor

The RCM current sensor detects current imbalance which indicates current is flowing to ground. The sensor cannot determine the exact location. It just reports the sum of all residual current in the PDU and devices plugged into it, which is either per inlet or per inlet pole, depending on the model.

Most equipment leaks a small amount of current and the UL/IEC 60950-1 standard for IT equipment permits up to 3mA. For example, if a PDU has one RCM sensor on its inlet and twenty plugged-in devices -- each leaking 1mA, the RCM sensor then reports the sum - 20mA.

Raritan offers two types of RCM sensors.

RCM sensor type	Description	PDU models
Type A	Detects AC leakage and is sensitive down to 6mA leakage.	Models ending in M5.
Type B	<p>Detects AC and DC leakage and is sensitive down to 14mA.</p> <p>Type B has an RCM "DC" sensor in addition to the RCM sensor. Differences of the two sensors are described below.</p> <ul style="list-style-type: none"> ▪ RCM sensor reports the sum of all residual current, including AC and DC current. ▪ RCM DC sensor reports the residual DC current only. 	<p>Models ending in:</p> <ul style="list-style-type: none"> ▪ M11 ▪ M18

Important: When your PX3 enters the power-sharing mode, the RCM sensor enters the 'unavailable' state and will not work until the power-sharing mode ends. For information on power sharing, see *Power-Sharing Restrictions and Connection* (on page 42).

RCM State Sensor

The RCM state sensor reports events based on residual current thresholds or RCM self-test failure.

The RCM state is always determined by the magnitude of "total" residual current values per inlet or per inlet pole as explained below.

- For Type A, it is the sum of residual AC current.
- For Type B, it is the sum of residual AC and DC current.

In other words, the RCM state is NOT determined by the residual DC current detected by the separate RCM "DC" sensor on Type B models.

RCM state	Description
normal	Residual current is within normal range.
warning	Residual current is above warning level.
critical	<p>Residual current is above critical level.</p> <p>In addition to an event, the CRITICAL state causes the PX3 front panel to display a special error message.</p>
self-test active	RCM diagnostics are running.
failure	RCM current sensor has malfunctioned. Contact Raritan Technical Support.

*Note: The factory default is to disable the Warning state. To define and enable this state, see **Setting RCM Current Thresholds** (on page 792).*

Important: When your PX3 enters the power-sharing mode, the RCM sensor enters the 'unavailable' state and will not work until the power-sharing mode ends. For information on power sharing, see *Power-Sharing Restrictions and Connection* (on page 42).

Compliance with IEC 62020

IEC 62020 is an international standard for Residual Current Monitors. All PX3 with RCM are IEC 62020 compliant.

IEC 62020 uses the term *rated residual operating current* ($I_{\Delta n}$) to specify residual current, equal to or above which causes an alarm. IEC 62020 recommends preferred values 6mA, 10mA, 30mA, 100mA, 300mA and 500mA. In the PX3 with RCM, $I_{\Delta n}$ is specified using the Critical Rated Residual Operating Current threshold.

IEC 62020 uses the term *residual non-operating current* ($I_{\Delta no}$) to specify residual current, below which does not cause an alarm. IEC 62020 specifies $I_{\Delta no}$ be no higher than 0.5 $I_{\Delta n}$. In PX3 with RCM, $I_{\Delta no}$ is set using the RCM Deassertion Hysteresis and this value must be no higher than 0.5 the RCM critical threshold.

PX3 with RCM allows you to establish an optional WARNING state, which is not part of the IEC 62020 specification. PX3 RCM remains IEC 62020 compliant when the RCM deassertion hysteresis is configured properly.

IEC 62020 specification	PX3 with RCM characteristics
Method of operation	Dependent on line voltage. RCM only functions if line voltage is present.
Type of installation	PX3 with flexible line cords and plugs are for mobile installation and corded connection.
Current paths	1-phase PX3 are two current paths RCM. 3-phase 3W+PE are three current paths RCM. 3-phase 4W+PE are four current paths RCM.
Ability to adjust residual operating current	Adjustable. <ul style="list-style-type: none"> ▪ Type A: 6mA-500mA. ▪ Type B: 14mA-300mA.
Adjustable time delay	Non-adjustable time delay.
Protection against external influence	Enclosed-type RCM.
Method of mounting	Panel board type RCM.
Method of connection	Not associated with mechanical mounting.

IEC 62020 specification	PX3 with RCM characteristics
Connection of load conductors	Monitored line is directly connected.
Fault indicating means	Visual, with other output signals.
Ability to directly discriminate	Directionally non-discriminating.
Rated residual operating current	0.5A (highest value).
Residual currents with direct current components	Model dependent. <ul style="list-style-type: none"> ▪ Models ending in M5 are Type A. ▪ Models ending in M11 or M18 are Type B.

RCM Self-Test

PX3 with RCM have a built-in self-test feature that performs these functions:

- When residual current is less than 3mA, 15mA is momentarily added to determine whether the low reading is due to a faulty sensor. The residual current added is done in a safe manner which does not run current into ground or pose operator risk.
- The RCM state sensor changes to SELF-TEST and then back to its original state if self-test passes, or to the FAILURE state if self-test fails. These state changes are useful to verify your monitoring systems (SNMP, syslog, or email) are correctly set up to receive PX3 event notifications.
- For Type B "M18" models, the self-test feature will perform tests on all poles of the selected inlet simultaneously.

Note: If self-test fails, the FAILURE state persists until another self-test runs and passes.

Web Interface Operations for RCM

The RCM on PX3 is either an inlet sensor or an inlet pole sensor. To view, configure or run self-test, click Inlet in the **Menu** (on page 178).

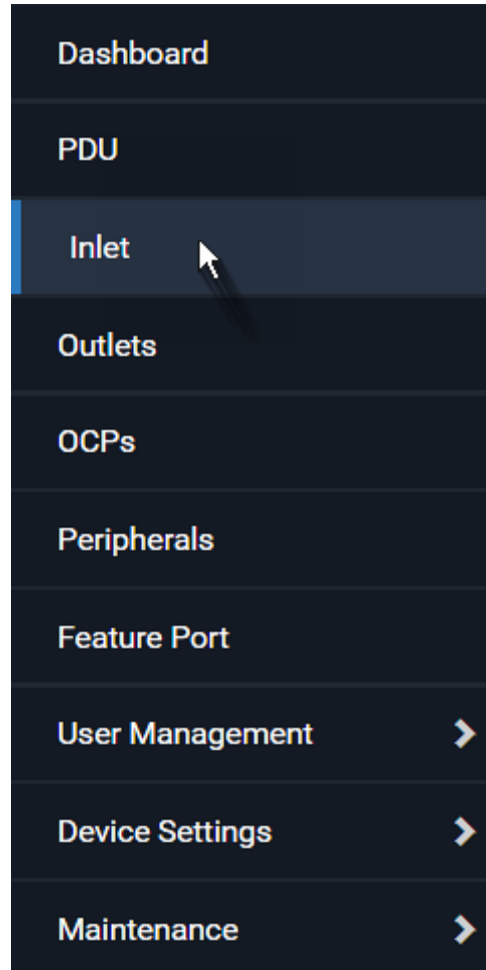

Checking RCM State and Current

A section titled 'Residual Current Monitor' is available on the Inlet page, showing both the present RCM state and residual current.

Important: When your PX3 enters the power-sharing mode, the RCM sensor enters the 'unavailable' state and will not work until the power-sharing mode ends. For information on power sharing, see *Power-Sharing Restrictions and Connection* (on page 42).

▶ **To check RCM state and current on the Inlet page:**

1. Click Inlet.

2. Locate the Residual Current Monitor section on the Inlet page.
 - RCM State: There are five states - normal, warning, critical, self-test active and failure. For more information, see **RCM State Sensor** (on page 787).
 - Residual Current:
 - For Type A, it is the sum of residual AC current.
 - For Type B, it is the sum of residual AC and DC current.

Residual Current Monitor	
	Setup
RCM State	normal
Residual Current	0.0 mA
Self Test	<input type="button" value="Start Self Test"/>

For Type B "M18" models, the listed fields are available per inlet pole as shown below. Besides, a Type B model, either "M11" or "M18", is able to display the residual DC current.

Residual Current Monitor			
			Setup
	L1	L2	L3
Status	normal	normal	normal
Residual Current	0.0 mA	0.0 mA	0.0 mA
Residual DC Current	0.0 mA	0.0 mA	0.0 mA
			<input type="button" value="Start Self Test"/>

*Note: To determine the RCM's normal, warning and critical levels, configure the RCM current thresholds. See **Setting RCM Current Thresholds** (on page 792). To configure the residual DC current thresholds, see **Setting RCM DC Current Thresholds** (on page 794).*

RCM Critical State Alarm

When a PX3 device's RCM sensor enters the Critical state, the PX3 beeps and this alarm is displayed in the Alerted Sensors section of the Dashboard page. Note that only the RCM sensor will cause the PDU to beep while RCM "DC" sensor does not cause the PDU to beep regardless of its sensor state.

Warning: RCM sensors do not work in power-sharing mode. See **Power-Sharing Restrictions and Connection** (on page 42).

Alerted Sensors (2 Critical, 0 Warned)

Sensors	Value	State ▲
Inlet I1 Residual Operating Current	0.091 A	▲ above upper critical
Inlet I1 RCM Status		▲ critical

①
②

Number	Description
①	The magnitude of residual current reported by the RCM current sensor.
②	Critical state reported by the RCM state sensor.

*Tip: RCM critical state is also indicated on the Inlet page or the Internal Beeper section of the PDU page. See **Checking RCM State and Current** (on page 790) or **Internal Beeper State** (on page 197).*

Setting RCM Current Thresholds

The RCM current thresholds define the critical, warning and normal range of residual current.

- For Type A, RCM current thresholds are the thresholds of residual AC current.
- For Type B, they are the thresholds of total residual current including AC and DC current.

*Tip: To configure the thresholds of residual DC current, if the RCM DC sensor is available on your PDU, see **Setting RCM DC Current Thresholds** (on page 794).*

► **To configure RCM current thresholds and run self-test:**

1. Click Inlet to open the Inlet page.

- In the Residual Current Monitor section, click Setup.

Residual Current Monitor	
	Setup
RCM State	normal
Residual Current	0.0 mA
Self Test	<input type="button" value="Start Self Test"/>

- Set up RCM thresholds.

Residual Current Monitor	
Residual operating current	a <input checked="" type="checkbox"/> 30 mA
Residual current warning threshold	b <input type="checkbox"/> 0 mA
Deassertion hysteresis	c 15 mA
Note: Saving this dialog will update the thresholds of the residual current sensor.	
<input type="button" value="Cancel"/> <input type="button" value="Save"/>	

- Enable or disable the Residual Operating Current, which is the critical threshold. Residual current greater than this value triggers Critical RCM state.
 - Enable or disable the RCM warning threshold. Residual current greater than this value triggers Warning RCM state.
 - Determine the residual current decrease to end Warning or Critical RCM state.
For a model that detects residual current per inlet pole, the above fields are available for each pole. Configure them one by one.
 - Click Save.
- Click 'Start Self Test' to run RCM self-test.

Scheduling RCM Self-Test

You can have the PX3 run RCM self-test automatically at a regular time interval or on a specific date and time. See **Scheduling an Action** (on page 406) for the procedure and select "Start residual current monitor self test" to create the scheduled RCM self-test action.

Note: For Type B "M18" models, the self-test feature will perform tests on all poles of the selected inlet simultaneously.

Disabling or Enabling Front Panel RCM Self-Test

You can enable or disable the function of performing the RCM self-test by operating the front panel buttons. By default, this function is enabled.

▶ **To disable or enable the front panel RCM self-test:**

1. Choose Device Settings > Front Panel.
2. Do either below:
 - To disable this function, deselect the "Perform RCM self-test" checkbox.
 - To enable this function, select the "Perform RCM self-test" checkbox.
3. Click Save.

Setting RCM DC Current Thresholds

RCM DC current sensors are available on Type B models only. See **RCM Current Sensor** (on page 786).

You can also configure upper thresholds for RCM DC current sensors so that an alarm will be displayed on the page of **Dashboard** (on page 183) when RCM DC sensors enter an alerted state.

▶ **To configure RCM DC's upper thresholds:**

1. Click Inlet to open the Inlet page.
2. Click the Thresholds title bar at the bottom of the page to display inlet thresholds.



3. Click the desired sensor (required), and then click Edit Thresholds. For example, select "L1 Residual DC Current".

Thresholds				
Edit Thresholds				
Sensor ▲	Lower Critical	Lower Warning	Upper Warning	Upper Critical
Inlet Active Energy	--	--	--	--
Inlet Active Power	--	--	--	--
Inlet Apparent Power	--	--	--	--
Inlet Line Frequency	--	--	--	--
Inlet Power Factor	--	--	--	--
Inlet RMS Current	--	--	--	--
Inlet RMS Voltage	--	--	--	--
Inlet Unbalanced Current	--	--	--	--
L1 RMS Current	--	--	10.4 A	12.8 A
L1 Residual Operating Current	--	--	--	0.03 A
L1 Residual DC Current	--	--	--	0.03 A
L1-L2 RMS Voltage	357 V	369 V	427 V	440 V

4. Make changes as needed.
 - To enable any threshold, select the corresponding checkbox.
 - Type a new value in the accompanying text box.

Thresholds

L1 Residual DC Current

Lower Critical 0 A

Lower Warning 0 A

Upper Warning 0 A

Upper Critical 0.03 A

Deassertion Hysteresis 0.015 A

Assertion Timeout 0 Samples

For concepts of thresholds, deassertion hysteresis and assertion timeout, see **Sensor Threshold Settings** (on page 879).

5. Click Save.

Front Panel Operations for RCM

The front panel LCD display shows an alarm message when the RCM enters the critical state. Besides, you can operate the LCD display to check the RCM status.

This section introduces the RCM information shown on the dot-matrix LCD display.

*Note: For RCM information shown on the character LCD display of an old PX3 model, see **RCM Information** (on page 820).*

LCD Message for RCM Critical State

In the RCM critical state, the PDU beeps and the LCD display indicates the RCM critical state.

The RCM alarm information continues to display as long as RCM is in a critical state. The top and bottom bars on the display turn red at the same time.

► **RCM alarm information in the critical state:**

1. The LCD display shows two or three pieces of information for the inlet or inlet pole with the RCM alarm:
 - RCM State: Critical.
 - Residual Current: Residual current value in Amps.
 - For Type A, it is the sum of residual AC current.
 - For Type B, it is the sum of residual AC and DC current.
 - Residual DC Current: If your PDU is an RCM Type B model, an additional DC-only residual current value is also reported on the LCD.

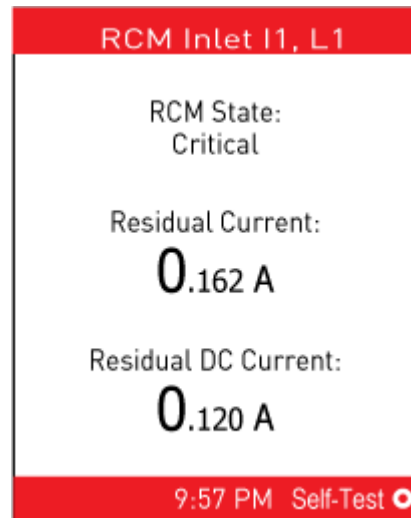





If your PX3 has more than one inlet, only the inlet which has the RCM alarm enters the critical state.

- If needed, you can press  to perform RCM self-test for this inlet. For details, see steps 4 to 5 in the topic titled **Running RCM Self-Test** (on page 798).

Checking RCM States and Current

You can retrieve RCM information from the LCD display.

► **To check RCM information:**

- Press  or  to access the **Main Menu** (on page 124).
- Press  or  to select "Residual Current", and press .
- The LCD display shows two or three pieces of information for Inlet 1 as shown below, or a list of inlet poles.

If a list of inlet poles displays, press  or , and then  to select one inlet pole.

- RCM State: Normal or Warning.
- Residual Current: Residual current value in Amps.
 - For Type A, it is the sum of residual AC current.
 - For Type B, it is the sum of residual AC and DC current.
- Residual DC Current: If your PDU is an RCM Type B model, an additional DC-only residual current value is also reported on the LCD.

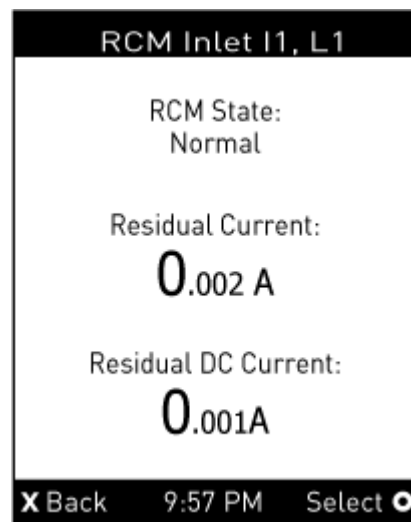

If your PX3 has more than one inlet, a list of inlets is displayed, along with each inlet's RCM state and reading(s).

- To return to the Main Menu, press .















Running RCM Self-Test

You can perform the RCM self-test by operating the front panel buttons.

For Type B "M18" models, the self-test feature will perform tests on all poles of the selected inlet simultaneously.

To disable or enable this front panel function, see **Disabling or Enabling Front Panel RCM Self-Test** (on page 794). By default, this function is enabled.



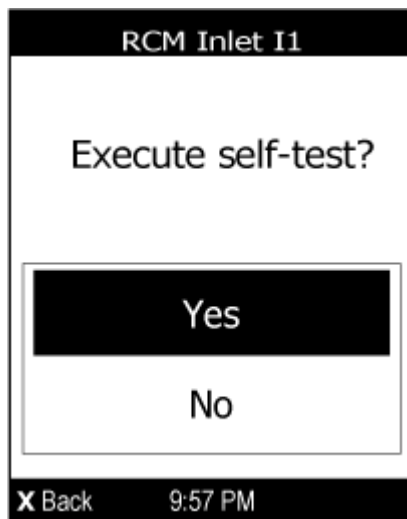

▶ **To run RCM self-test:**

1. Press  or  to access the **Main Menu** (on page 124).
2. Press  or  to select "Residual Current," and press .
3. The LCD display shows the RCM information of the inlet(s) or inlet poles.
 - If your PDU shows multiple inlets or inlet poles, press  or  to select the desired inlet or inlet pole and press .
4. Press  to perform RCM self-test on the selected inlet.
5. A confirmation message displays. By default, Yes is selected.
 - To execute the RCM self-test, press .
 - To cancel the RCM self-test, do either of the following:
 - Press .
 - Press  or  to select No and then press .

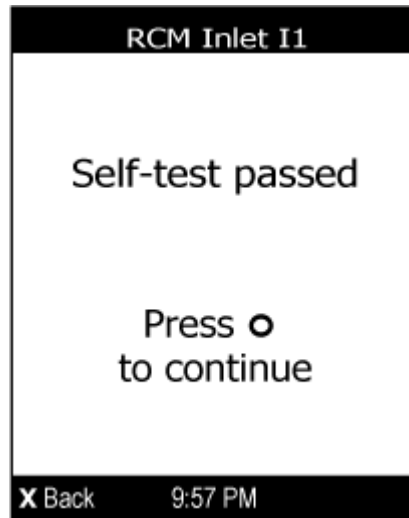

6. After completing the RCM self-test, the LCD display indicates the RCM self-test result: passed or failed.



7. Press  or  to return to the RCM information page.
8. Do one of the following:
- To return to the Main Menu, press .
 - To perform RCM self-test for additional inlets, press  or  to select a different inlet and repeat the same steps.

RCM SNMP Operations

Make sure you have the correct version of SNMP MIB. The PX3 supports the RCM feature as of firmware version 2.5.20. See **Downloading SNMP MIB** (on page 511) for details.

RCM Trap

An *InletSensorStateChange* trap is sent when the RCM state sensor changes. *InletSensorStateChange* is the generic trap sent for all inlet sensors. The specific trap for RCM has the object *typeOfSensor* set to 27. Included with the trap are *measurementsInletSensorValue* (the residual current value) and *measurementsInletSensorState* (the RCM state that caused the trap).

RCM Residual Current and State Objects

The *inletSensorMeasurementsTable* contains entries for RCM residual current and states.

Use index *sensorType* = 26 to retrieve the row for residual current. Column *measurementsInletSensorValue* contains the residual current.

Use index *sensorType* = 27 to retrieve the row for RCM state. Column *measurementsInletSensorState* contains the RCM state enumeration value.

Setting RCM Thresholds

The *inletSensorConfigurationTable* contains a row for configuring RCM thresholds. Use index *sensorType* = 26 to reference the row. Columns *inletSensorUpperWarningThreshold*, *inletSensorUpperCriticalThreshold* and *inletSensorHysteresis* set values for RCM warning, critical and deassertion hysteresis respectively.

Running RCM Self-Test

To initiate RCM self-test using SNMP, set column *rcmState* to value 29 in table *rcmSelfTestTable*.

For Type B "M18" models, the self-test feature will perform tests on all poles of the selected inlet simultaneously.

CLI Operations for RCM

For information on entering and using the CLI, see *Using the Command Line Interface* (on page 515).

Showing Residual Current Monitoring Information

This command syntax shows the residual current monitoring (RCM) information, which is only available on the models with RCM. The information displayed include the RCM current, state and thresholds.

For Type B "M18" models, this command shows the information of all RCM sensors of the same inlet at a time.

```
#          show residualCurrentMonitor <n>
```

Variables:

- <n> is one of the options: *all*, or a number.

Option	Description
all	Displays the RCM information of all inlets. <i>Tip: You can also type the command without adding this option "all" to get the same data.</i>
A specific inlet number	Displays the RCM information of the specified inlet only. An inlet number needs to be specified only when there are more than 1 inlet on your PDU.

► **Tip -- other RCM-related "show" commands:**

- For models detecting residual current per inlet, see ***Inlet Sensor Threshold Information*** (on page 537)
- For models detecting residual current per inlet pole, see ***Inlet Pole Sensor Threshold Information*** (on page 539)

Setting RCM Current Thresholds

Warning Rated Residual Operating Current is the upper warning threshold of the PX3 RCM sensor, and Critical Rated Residual Operating Current is the upper critical threshold of the RCM sensor. These thresholds are set in the configuration mode. See ***Entering Configuration Mode*** (on page 557).

Note: A residual current sensor's LOWER warning and LOWER critical thresholds do NOT affect the operations of the RCM state sensor so you can ignore them.

For Type B "M18" models, this command configures all RCM sensors of the same inlet simultaneously.

► **To configure the RCM's Critical level:**

```
config:# residualCurrentMonitor <n> criticalRatedResidualOperatingCurrent <value>
```

*Note: The PX3 triggers events when residual current values are above (but not equal to) thresholds. For example, you would set the critical threshold to 29mA to specify the IEC 62020 IΔn of 30mA. See **Compliance with IEC 62020** (on page 788).*

► **To configure the RCM's Warning level:**

```
config:# residualCurrentMonitor <n> warningRatedResidualOperatingCurrent <value>
```

► **To configure the RCM's deassertion hysteresis:**

```
config:# residualCurrentMonitor <n> deassertionHysteresis <hy_value>
```

Variables:

- <n> is the number of the inlet where the desired RCM current sensor is mounted. For a single-inlet PDU, this number is always 1.
- <value> is one of the options: *enable*, *disable* or a numeric value measured in amperes.

Option	Description
enable	Enables the specified RCM current threshold for the specified inlet.
disable	Disables the specified RCM current threshold for the specified inlet.
A numeric value	Sets a value for the specified RCM current threshold of the specified inlet and enables this threshold simultaneously. Note that this value is measured in A, not mA. Therefore, to set the value to 6mA, type <i>0.006</i> .

- <hy_value> is a numeric value measured in amperes (A), not milliamperes (mA). For example, to set the value to 15mA, type *0.015*.

► **Tip -- other RCM-related "threshold-setting" commands:**

- For models detecting residual current per inlet, see **Commands for Inlet Sensors** (on page 665)
- For models detecting residual current per inlet pole, see **Commands for Inlet Pole Sensors** (on page 668)

Setting Front Panel RCM Self-Test

You can enable or disable the front panel RCM self-test function via CLI in addition to the web interface.

▶ **To enable the front panel RCM self-test:**

```
# security frontPanelPermissions add rcmSelfTest
```

▶ **To disable the front panel RCM self-test:**

```
# security frontPanelPermissions remove rcmSelfTest
```

Running RCM Self-Test

You can perform RCM self-test for a specific inlet via CLI. After the self-test finishes, the test result is shown: pass or fail.

For Type B "M18" models, the self-test feature will perform tests on all poles of the selected inlet simultaneously.

▶ **To perform RCM self-test:**

```
# rcm selfTest inlet <n>
```

Variables:

- <n> is the inlet's number. For a single-inlet PDU, <n> is always 1.

Degaussing RCM Type B Sensors

Only the models with RCM 'Type B' sensors support degaussing the RCM sensors. Those with RCM Type A sensors do NOT support this feature.

You can degauss the RCM sensor after a current surge, such as a short circuit.

For Type B "M18" models, this command will degauss all RCM sensors simultaneously.

▶ **To degauss RCM Type B sensors:**

```
# rcm degauss
```

Appendix H Old Generations of PX3 Models

There are two types of old PX3 PDUs.

- PX3 phase I models
- PX3 phase II models

Old PX3 PDUs are different from PX3 with iX7™ controller in terms of the following designs:

- RS-232 port is a DB9 connector.
- Have only one Ethernet port.
 - Therefore, the networking-related commands in CLI do not have the options of 'eth1' and 'eth2'. Instead it uses the option of 'ethernet' to refer to its ETHERNET port.
- The controller is *not* replaceable.
- Have no EXPANSION port for the power-sharing feature.

In This Chapter

PX3 'Phase II' Front Panel Display.....	804
PX3 'Phase I' Front Panel Display.....	805
Serial RS-232 "DB9" Port Pinouts	822





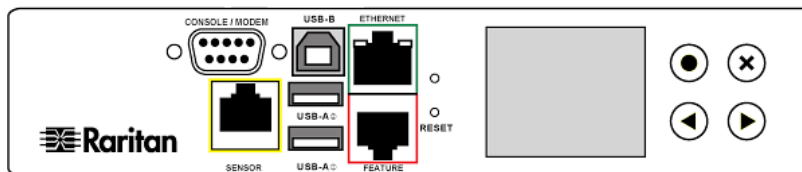



PX3 'Phase II' Front Panel Display

The following diagram is the Zero U model of PX3 'phase II' PDUs.



The operation of its front panel button is similar to the front panel operation of PX3 with iX7™ controller (PX3-iX7). See **Operating the Dot-Matrix LCD Display** (on page 123).

The major difference between PX3 'phase II' and PX3-iX7 is the symbols of their control buttons.

-  functions the same as PX3-iX7's .
-  functions the same as PX3-iX7's .
-  functions the same as PX3-iX7's .
-  functions the same as PX3-iX7's .

PX3 'Phase I' Front Panel Display

The following diagram is the Zero U model of PX3 'phase II' PDUs.

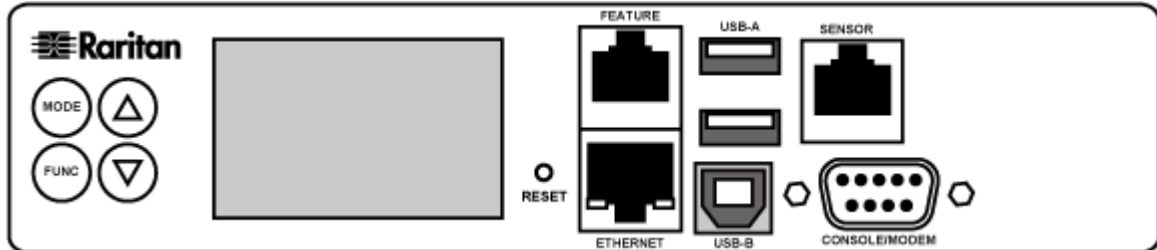

Its LCD display on the panel can show the reading or status of different components on the PX3, or its MAC address and IP address.

It consists of:

- A character LCD display
- Control buttons



Overview of the LCD Display

Different types of information are shown in different sections of the LCD display. The diagram indicates the sections.

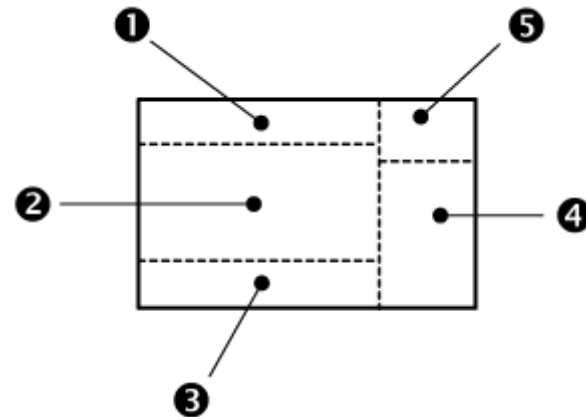

Section	Information shown
1	The selected mode and target, such as INLET 1, OUTLET 1, SENSOR 1, SENSOR 2, and so on.

Section	Information shown
2	The following information is displayed: <ul style="list-style-type: none"> • Readings, data or state of the selected target. • During the firmware upgrade, "FUP" is displayed.
3	Two types of information may be displayed: <ul style="list-style-type: none"> • The "ALARM" status of the selected target. • The selected inlet line number if your PX3 is a 3-phase model.
4	The measurement unit of the displayed data, such as % or °C.
5	This section indicates: <ul style="list-style-type: none"> • The Asset Strip mode if an asset strip has been connected to the PX3. • The device's USB-cascading state - <i>MASTER</i> or <i>SLAVE</i>. If it is a standalone device, neither <i>MASTER</i> nor <i>SLAVE</i> is displayed.

Note: During the firmware upgrade, some PX3 models may show b_x in the section 1 to indicate the relay or meter board numbered x is being updated.

Control Buttons

There are four control buttons.

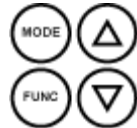

- Up and Down buttons for selecting a specific target, which can be an inlet, outlet, overcurrent protector, environmental sensor or a device setting
- MODE button for switching between various modes, including:
 - Inlet mode
 - Outlet mode
 - Overcurrent Protector mode
 - Device mode
 - Sensor mode
 - Asset Strip mode, indicated by the word ASSET, for showing the asset strip information

See **Overview of the LCD Display** (on page 805) for details.

- FUNC (Function) button for switching between different data of the selected target, such as the current, voltage or power readings of a particular outlet

Operating the LCD Display

After powering on or resetting this product, the LCD display panel shows the current reading of OUTLET 1 by default before you select a different target.

Outlet Information

The Outlet mode is displayed as "OUTLET" on the LCD display. By default the PX3 displays the current reading of OUTLET 1.

Below illustrates the outlet information shown on the LCD display.



Section	Example information
①	The selected target is OUTLET 3.
②	This outlet's current reading is 2 amps.
③	"MASTER" indicates the PX3 is the master device in a cascading chain. For a slave device, it shows "SLAVE" instead. <i>Note: "MASTER/SLAVE" information is only available in Port Forwarding mode.</i>
④	The measurement unit is A (Amp), indicating that the reading is the RMS current.

▶ To display a single-phase outlet's information:

1. By default this product enters the Outlet mode. If not, press the MODE button until the word "OUTLET" is displayed.
2. In the Outlet mode, press the Up or Down button until the desired outlet's number is displayed at the top of the LCD display.
3. Press the FUNC button to switch between voltage, active power and current readings of the selected target.
 - A is displayed for the current reading. A means Amp.
 - V is displayed for the voltage reading. V means Volt.

- W is displayed for the power reading. W means Watt.

If the word "ALARM" appears below the reading, it means the currently displayed reading already reaches or crosses the upper or lower thresholds.

► **To display a 3-phase outlet's information**

1. In the Outlet mode, press the Up or Down button until the desired 3-phase outlet is selected.
2. While that 3-phase outlet is being selected, press the Up or Down button to switch between each line, indicated as L1, L2 or L3 at the bottom of the display.
3. When the desired line is being displayed, press the FUNC button to switch between voltage, active power and current readings of this particular line.
 - A is displayed for the current reading. A means Amp.
 - V is displayed for the voltage reading. V means Volt. When voltage is selected, L1-L2, L2-L3, or L3-L1 is displayed at the bottom of the display.
 - W is displayed for the power reading. W means Watt.
4. To show the unbalanced load and active power of this 3-phase outlet, do the following:
 - a. Switch to the current reading of L1.
 - b. Press the Down button until '%' or 'W' is displayed to the right of the display. Make sure NONE of the lines (L1, L2, L3, L1-L2, L2-L3 or L3-L1) is displayed at the bottom of the display.
 - Unbalanced load - % is displayed for the unbalanced current value.
 - Active power - W is displayed for the power reading. W means Watt.

Inlet Information

The Inlet mode is displayed as "INLET" on the LCD display. Below illustrates the inlet information shown on the LCD display.



Section	Example information
①	The selected target is INLET 1.

Section	Example information
2	This inlet's L1 current reading is 23 amps.
3	The selected inlet line is L1.
4	"MASTER" indicates the PX3 is the master device in a cascading chain. For a slave device, it shows "SLAVE" instead. <hr/> <i>Note: "MASTER/SLAVE" information is only available in Port Forwarding mode.</i> <hr/>
5	The measurement unit is A (ampere).

► **To display an inlet's information:**

1. Press the MODE button until the term "INLET" is displayed.
2. On a multi-inlet model, press the Up or Down button until the desired inlet's number is displayed at the top.
3. If your PX3 is a 3-phase model, the selected inlet line is indicated below the reading. Press the Up or Down button until the desired inlet line's number (L1, L2, L3, L1-L2, L2-L3 or L3-L1) is shown.
4. Press the FUNC button to switch between voltage, active power and current readings of the selected target.
 - A is displayed for the current reading. A means Amp.
 - V is displayed for the voltage reading. V means Volt.
 - W is displayed for the power reading. W means Watt.

If the word "ALARM" appears below the reading, it means the currently displayed reading already reaches or crosses the upper or lower thresholds.

► **To display the unbalanced load and active power of a 3-phase inlet:**

1. Switch to the current reading of any inlet line.
2. Press the Up or Down button until "W" or "%" is displayed to the right of the LCD display. Make sure NONE of the inlet's line number is displayed at the bottom of the display.
 - Unbalanced load - % is displayed for the unbalanced current value.
 - Active power - W is displayed for the power reading. W means Watt.

Overcurrent Protector Information

The Overcurrent Protector mode is displayed as either "CB" or "FUSE" on the LCD display, which varies according to the type of overcurrent protector implemented on your PX3. CB refers to the circuit breaker and FUSE refers to the fuse.

Below illustrates an overcurrent protector's information.

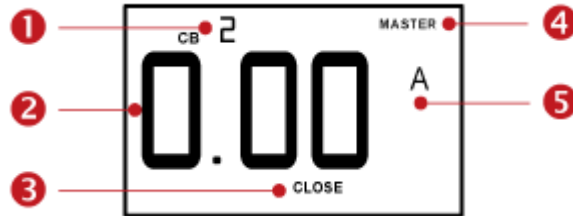

Section	Example information
①	The selected target is the second circuit breaker (CB 2).
②	This circuit breaker's current reading is 0 amps.
③	The word "CLOSE" indicates that the state of the selected circuit breaker is closed.
④	"MASTER" indicates the PX3 is the master device in a cascading chain. For a slave device, it shows "SLAVE" instead. <i>Note: "MASTER/SLAVE" information is only available in Port Forwarding mode.</i>
⑤	The measurement unit is A (Amp), indicating that the reading is the current.

► **To display the overcurrent protector information:**

1. Press the MODE button until the word "CB" or "FUSE" is displayed.
2. In the Overcurrent Protector mode, press the Up or Down button until the desired overcurrent protector's number is displayed at the top of the LCD display.
3. Check the reading and the text shown below the reading: CLOSE or OPEN.
 - CLOSE: The selected circuit breaker is closed, or the selected fuse is normal.
 - OPEN: The selected circuit breaker is open, or the selected fuse has burned out. When this occurs, the term CbE is displayed in place of the reading and a blinking word "ALARM" appears next to the word OPEN.

IPv4 Address

The IP address is available in the Device mode, which is indicated by the alphabet 'd' shown at the top of the LCD display. Note that this type of LCD display only shows the IPv4 address (if available).

Below illustrates the IP address information.

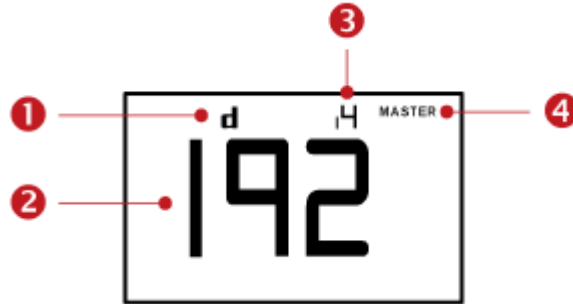

Section	Example information
①	"d" means the LCD display has entered the Device mode.
②	The LCD display is showing 192, which is one of the four IP address octets. It will cycle through four octets.
③	"i4" indicates that the IP address shown on the LCD display is an IPv4 address.
④	"MASTER" indicates the PX3 is the master device in a cascading chain. For a slave device, it shows "SLAVE" instead. <i>Note: "MASTER/SLAVE" information is only available in Port Forwarding mode.</i>

If you connect your PX3 to the wireless network, a Wi-Fi icon is displayed at the bottom-right corner.



► **To retrieve the "IPv4" address on PX3:**

1. Press the MODE button to enter the Device mode, indicated by an alphabet "d" at the top left of the display.
2. The LCD display cycles between the four octets of the IPv4 address, indicated by "i4" at the upper right corner of the display.

For example, 192.168.84.4 cycles in this sequence:

192 --> 168 --> 84 --> 4

MAC Address

This product's MAC address is retrievable by operating the LCD display.

Below illustrates the MAC address information.



Section	Example information
①	"d" means the LCD display has entered the Device mode.
②	"M" indicates that the displayed information is the MAC address.
③	"MASTER" indicates the PX3 is the master device in a cascading chain. For a slave device, it shows "SLAVE" instead. <i>Note: "MASTER/SLAVE" information is only available in Port Forwarding mode.</i>
④	The LCD display is showing "03," which is part of the MAC address.

► **To display the MAC address:**

1. Press the MODE button to enter the Device mode, indicated by a 'd' in at the top left of the display.
2. Press the FUNC button until the MAC address is displayed. The character "M" appears in the left side of the LCD display.
3. The MAC address is displayed as "M:XX", where XX are two digits of the MAC address. The LCD will cycle through the MAC address from the first two digits to the final two.

For example, if the MAC address is 00:0d:5d:03:5E:1A, the LCD display shows the following information one after another:

M 00 --> M:0d --> M:5d --> M:03 --> M:5E --> M:1A

Note that 'M' is NOT followed by the colon symbol when showing the first two digits of the MAC address.

Outlet Switching

This section applies to outlet-switching capable models only.

You can turn on or off any outlet using the LCD display in the outlet switching mode. To do this, you must first enable the front panel outlet control function. See **Front Panel Settings** (on page 445).

► To turn on or off an outlet:

1. Press the MODE button until the LCD display enters the outlet switching mode, which is indicated by the power state of OUTLET 1.
 - When outlet 1 has been powered on, the word 'on' is displayed as shown below.



- When outlet 1 has been powered off, the word "oFF" is displayed instead.
2. Press the Up or Down button to select the desired outlet. The selected outlet's number is displayed at the top of the LCD display.
 3. Press the FUNC button to perform the outlet switching operation. The LCD display cycles between two messages as shown in the two diagrams below. In the following diagrams, X represents the selected outlet's number.

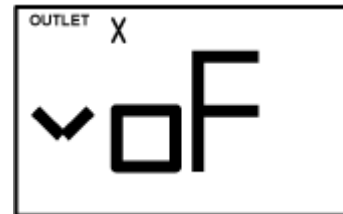
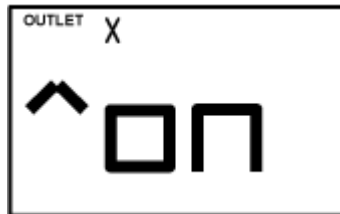

To cancel the outlet switching operation, press the FUNC button again.

- To turn on the outlet, press the Up button. The "on?" confirmation message displays.



To turn off the outlet, press the Down button. The "oF?" confirmation message displays.



- Press the same button as step 4 again to confirm the operation.

Note: If you press a different button in this step, for example, pressed the Down button in step 4 but the Up button in step 5, the outlet switching operation is not confirmed and the LCD display will return to the messages in step 3.

- The outlet switching operation is confirmed now and the LCD display indicates the latest power state of the selected outlet.
 - on: The outlet has been turned on.
 - oFF: The outlet has been turned off.
- You can verify the power state of the selected outlet by checking its LED color. Green indicates the power off state and red indicates the power on state.

Environmental Sensor Information

The environmental sensor mode is displayed as "SENSOR" on the LCD display. Basic information about a specific environmental sensor is available, including the sensor's reading or state, X, Y, Z coordinates and its serial number.

Below illustrates the environmental sensor information.

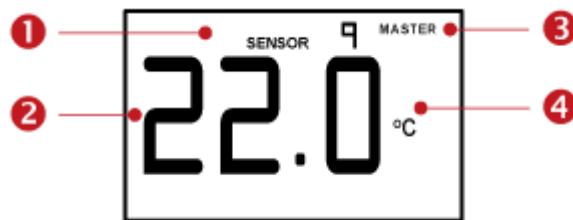

Number	Example information
①	The selected target is the environmental sensor whose ID number is 9 (SENSOR 9).
②	The selected environmental sensor's reading is 22 °C.
③	"MASTER" indicates the PX3 is the master device in a cascading chain. For a slave device, it shows "SLAVE" instead. <hr/> <i>Note: "MASTER/SLAVE" information is only available in Port Forwarding mode.</i>
④	The measurement unit is °C (degrees in Celsius).

► **To display the environmental sensor information:**

1. Press the MODE button until this product enters the Sensor mode, as indicated by "SENSOR" at the top of the LCD display.
2. Press the Up or Down button until the desired environmental sensor's ID number is displayed.
3. For example, "SENSOR 1" refers to the sensor #1 listed on the PX3 web interface.
4. The LCD display shows the reading or state of the selected sensor in the middle of the LCD display.
 - When showing a numeric sensor's reading, the appropriate measurement unit is displayed to the right of the reading.

Measurement units	Sensor types
%	A relative humidity sensor
°C	A temperature sensor
m/s	An air flow sensor
Pa	An air pressure sensor
NO measurement units	For an "absolute" humidity sensor, the measurement unit is g/m ³ , which cannot be displayed on the LCD.

- Available states for a state sensor:

States	Description
nor	Normal state.

States	Description
ALA	Alarmed state. <ul style="list-style-type: none"> This state is accompanied with the word "ALARM" below it.

- Available states for a dry contact signal actuator (DX sensor series):

States	Description
On	The actuator is turned on.
Off	The actuator is turned off.

Note: Numeric sensors show both numeric readings and sensor states to indicate environmental or internal conditions while state sensors show sensor states only to indicate state changes.

- Press the FUNC button to show the sensor's port position. There are two types of information.
 - P:n* (where n is the SENSOR port's number): This information indicates the SENSOR port number.
 - C:x* (where x is the sensor's position in a sensor chain): This information indicates the sensor's position in a chain, which is available for DPX2, DPX3 and DX sensors only. The LCD display will cycle between the port information (*P:n*) and chain position information (*C:x*).

Note that if the DPX3-ENVHUB4 sensor hub is used to connect the DPX2, DPX3 or DX sensors, the chain position information (*C:x*) is displayed twice - the first one indicates the sensor hub's chain position, which is always *C:1*, and the second one indicates the sensor's chain position.

- Press the FUNC button to display the X, Y and Z coordinates of the sensor respectively.
 - X coordinate is shown as "x:NN," where NN are the first two numeric digits entered for the X coordinate in the web interface.
 - Y coordinate is shown as "y:NN," where NN are the first two numeric digits entered for the Y coordinate in the web interface.
 - Z coordinate is shown as "z:NN," where NN are the first two numeric digits entered for the Z coordinate in the web interface.

If one or both of the first two digits for a specific coordinate are alphabetical characters, these alphabetical characters are replaced with dashes (-).

- Press the FUNC button to display the serial number of the sensor, which is shown as "s:XX," where XX are two digits of the serial number. The LCD will cycle through the serial number from the first two digits to the final two. For example, if the serial number is AE17A00022, the LCD display shows the following information one after another:

s:AE --> s:17 --> s:A0 --> s:00 --> s:22

Note: Some alphabets cannot be properly displayed due to the LCD display restriction. For example, Q looks like 9, Z looks like 2, and M looks like \equiv . Check the sensor's label or the web interface when you have doubts.

Asset Strip Information

If there is any asset strip connected to the PX3, you can enter the Asset Strip mode to show the asset tag state of each rack unit on the asset strip. A rack unit refers to a tag port on the asset strips.

When there are no asset strips connected, this mode is not available.

Below illustrates the asset strip information.



Section	Example information
①	"1" refers to the asset strip connected to the first FEATURE port.
②	This symbol \diamond indicates that you can switch between diverse rack units now by pressing the Up or Down button.
③	"30" indicates that the selected target is the 30th rack unit.
④	"MASTER" indicates the PX3 is the master device in a cascading chain. For a slave device, it shows "SLAVE" instead. <i>Note: "MASTER/SLAVE" information is only available in Port Forwarding mode.</i>
⑤	"ASSET" means that the LCD display enters the Asset Strip mode.

► **To display the asset management information:**

1. Press the MODE button until the PX3 enters the Asset Strip mode, as indicated by "ASSET" to the right of the LCD.
2. By default the PX3 selects the asset strip connected to the first FEATURE port so it shows "1" at the top. Because the PX3 has only one FEATURE port, "1" is the only option.

3. Press the FUNC button. When a blinking double-arrow symbol \diamond appears to the left of the LCD display, press the Up or Down button to select the desired rack unit on the asset strip. The rack unit number appears in the middle of the LCD display.

Note: Press and hold the Up or Down button for at least two (2) seconds to quickly move through several items at once.

- If the word "ALARM" appears below the rack unit number, it means no asset tag is physically connected to that rack unit.
- If the word "ALARM" does NOT appear, it means a connected asset tag is detected on the rack unit.

USB-Cascaded Device's Position

Note: As of release 3.3.10, the following cascading information is no longer available in the Bridging mode, but remains available in the Port Forwarding mode.

A cascaded device's position is available by operating the LCD display. Below illustrates a slave device's position.

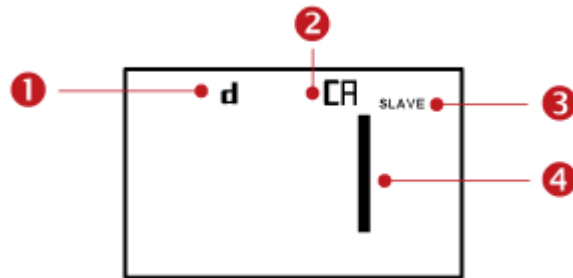

Section	Example information
①	"d" means the LCD display has entered the Device mode.
②	"CA" indicates that the cascading information is being displayed.
③	"SLAVE" indicates that this PX3 is a slave device. <i>Note: For a master device, it shows the word "MASTER" instead.</i>
④	The number 1 means the device position is Slave 1.

► **To retrieve the device's cascading position information:**

1. Press the MODE button to enter the Device mode, indicated by a 'd' in at the top left of the display.

2. Press the FUNC button until "CA" is displayed at the top right of the display.
3. The device's position is represented by any number defined below:

Number	Device position	Number	Device position
0	Master device	8	Slave 8
1	Slave 1	9	Slave 9
2	Slave 2	10	Slave 10
3	Slave 3	11	Slave 11
4	Slave 4	12	Slave 12
5	Slave 5	13	Slave 13
6	Slave 6	14	Slave 14
7	Slave 7	15	Slave 15

RCM Information

If your "old" PX3 model supports residual current monitoring (RCM), this information is available in the front panel LCD display. For more information on RCM, see **PX3 Models with Residual Current Monitoring** (on page 786).

The front panel LCD display shows an alarm message when the RCM enters the critical state. Besides, you can operate the LCD display to check the RCM status.

*Note: For the RCM information shown on the dot-matrix LCD display, see **Front Panel Operations for RCM** (on page 796).*

► RCM alarm information in the critical state:

In the RCM critical state, the PDU beeps and the LCD display indicates the RCM critical state.

The RCM alarm information continues to display as long as RCM is in a critical state. The following RCM alarm messages are displayed one by one in the critical state.

rCA --> rCA --> Residual current value (mA)

The diagram below illustrates the RCM alarm on the LCD display.

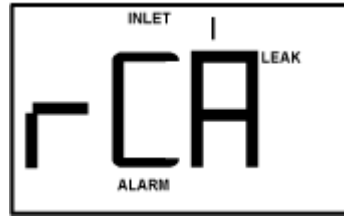

► To display the RCM current:

1. Press the MODE button until the term "INLET" is displayed.
2. Verify the LCD is showing the inlet's current, which is indicated by the presence of the letter "A." If not, switch to current by pressing the FUNC button.
3. Depending on the type of your PX3, the procedure to display the residual current slightly differs.
 - Single-phase PDU: Press the Up or Down button until the word "LEAK" displays.
 - 3-phase PDU: Press the Up button until the word "LEAK" displays.

Below illustrates the residual current information shown on the LCD display.

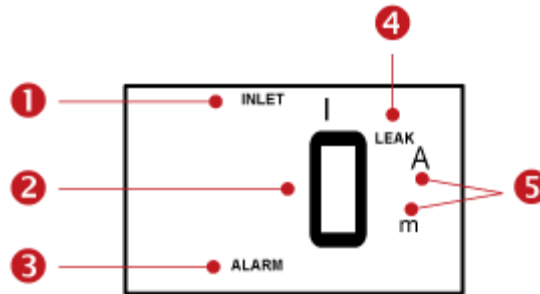

Section	Example information
①	The inlet containing RCM sensor is INLET 1.
②	This residual current is 0 mA.
③	<i>ALARM</i> always displays for residual current sensor.
④	<i>LEAK</i> always displays for residual current sensor.
⑤	Measurement units are mA.

► **To run RCM self-test:**

1. Press the MODE button until the LCD alternates between "SLF" and "tSt," which means **SELF TEST**.
2. Press the FUNC button to start RCM self-test.
3. The LCD shows dash symbols during RCM self-test.
4. Upon completion, RCM self-test results are displayed for 30 seconds, or until you press any button.
 - PAS: Self-test passed.
 - FAL: Self-test failed (the PX3 also beeps).

Below illustrates the RCM self-test mode.



Section	Example information
①	The inlet containing RCM sensor is INLET 1.

Section	Example information
2	The LCD alternates between "SLF" and "tSt" to indicate that this is self-test mode.
3	ALARM always displays for residual current sensor.
4	LEAK always displays for residual current sensor.

*Note: To disable or enable this front panel function, see **Disabling or Enabling Front Panel RCM Self-Test** (on page 794). By default, this function is enabled.*

Serial RS-232 "DB9" Port Pinouts

RS-232 Pin/signal definition			
Pin No.	Signal	Direction	Description
1	DCD	Input	Data
2	RxD	Input	Receive data (data in)
3	TxD	Output	Transmit data
4	DTR	Output	Data terminal ready
5	GND	—	Signal ground
6	DSR	Input	Data set ready
7	RTS	Output	Request to send
8	CTS	Input	Clear to send
9	RI	Input	Ring indicator

Appendix I LDAP Configuration Illustration

This section provides an LDAP example for illustrating the configuration procedure using Microsoft Active Directory® (AD). To configure LDAP authentication, four main steps are required:

- a. Determine user accounts and roles (groups) intended for the PX3
- b. Create user groups for the PX3 on the AD server
- c. Configure LDAP authentication on the PX3
- d. Configure roles on the PX3

Important: Raritan disables SSL 3.0 and uses TLS due to published security vulnerabilities in SSL 3.0. Make sure your network infrastructure, such as LDAP and mail services, uses TLS rather than SSL 3.0.

In This Chapter

Step A. Determine User Accounts and Roles823
Step B. Configure User Groups on the AD Server824
Step C. Configure LDAP Authentication on the PX3825
Step D. Configure Roles on the PX3828

Step A. Determine User Accounts and Roles

Determine the user accounts and roles (groups) that are authenticated for accessing the PX3. In this example, we will create two user roles with different permissions. Each role (group) will consist of two user accounts available on the AD server.

User roles	User accounts (members)
PX_User	usera
	pxuser2
PX_Admin	userb
	pxuser

Group permissions:

- The PX_User role will have neither system permissions nor outlet permissions.
- The PX_Admin role will have full system and outlet permissions.

Step B. Configure User Groups on the AD Server

You must create the groups (roles) for the PX3 on the AD server, and then make appropriate users members of these groups.

In this illustration, we assume:

- The groups (roles) for the PX3 are named *PX_Admin* and *PX_User*.
- User accounts *pxuser*, *pxuser2*, *usera* and *userb* already exist on the AD server.

▶ **To configure user groups on the AD server:**

1. On the AD server, create new groups -- *PX_Admin* and *PX_User*.

Note: Refer to the documentation or online help accompanying Microsoft AD for detailed instructions.

2. Add the *pxuser2* and *usera* accounts to the *PX_User* group.
3. Add the *pxuser* and *userb* accounts to the *PX_Admin* group.
4. Verify whether each group comprises correct users.



Step C. Configure LDAP Authentication on the PX3

You must enable and set up LDAP authentication properly on the PX3 to use external authentication.

In the illustration, we assume:

- The DNS server settings have been configured properly. See **Wired Network Settings** (on page 302) and **Role of a DNS Server** (on page 892).
- The AD server's domain name is *techadssl.com*, and its IP address is *192.168.56.3*.
- The AD protocol is NOT encrypted over TLS.
- The AD server uses the default TCP port *389*.
- Anonymous bind is used.

► **To configure LDAP authentication:**

1. Choose Device Settings > Security > Authentication.
2. In the LDAP Servers section, click New to add an LDAP/LDAPS server.
3. Provide the PX3 with the information about the AD server.

Field/setting	Do this...
IP address / hostname	Type the domain name <i>techadssl.com</i> or IP address <i>192.168.56.3</i> . <ul style="list-style-type: none"> ▪ Without the encryption enabled, you can type either the domain name or IP address in this field, but you must type the fully qualified domain name if the encryption is enabled.
Copy settings from existing LDAP server	Leave the checkbox deselected unless the new LDAP server's settings are similar to any existing LDAP settings.
Type of LDAP server	Select "Microsoft Active Directory."
Security	Select "None" since the TLS encryption is not applied in this example.
Port (None/StartTLS)	Ensure the field is set to <i>389</i> .
Port (TLS), CA certificate	Skip the two fields since the TLS encryption is not enabled.
Anonymous bind	Select this checkbox because anonymous bind is used.
Bind DN, Bind password, Confirm bind password	Skip the three fields because of anonymous bind.
Base DN for search	Type <i>dc=techadssl, dc=com</i> as the starting point where your search begins on the AD server.

Appendix I: LDAP Configuration Illustration

Field/setting	Do this...
Login Name Attribute	Ensure the field is set to <code>sAMAccountName</code> because the LDAP server is Microsoft Active Directory.
User entry object class	Ensure the field is set to <code>user</code> because the LDAP server is Microsoft Active Directory.
User search subfilter	The field is optional. The subfilter information is also useful for filtering out additional objects in a large directory structure. In this example, we leave it blank.
Active Directory domain	Type <code>techadssl.com</code> .

Add LDAP Server

IP address/hostname	192.168.52.55
	<input type="checkbox"/> Copy settings from existing LDAP server Select LDAP Server ▼
Type of LDAP server	Microsoft Active Directory ▼
Security	None ▼
Port (None/StartTLS)	389
Port (TLS)	636
	<input type="checkbox"/> Enable verification of LDAP server certificate
CA certificate	not set Show Remove Browse... Certificate file <input type="checkbox"/> Allow expired and not yet valid certificates <input checked="" type="checkbox"/> Anonymous bind
Bind DN	
Bind password	
Confirm bind password	
Base DN for search	techadssl.dc-com
Login Name Attribute	sAMAccountName
User entry object class	user
User search subfilter	
Active Directory domain	techadssl.com
	Test Connection
	Note: LDAP authenticated users will see units from Default Preferences .
	<input type="button" value="✕ Cancel"/> <input type="button" value="✓ Add Server"/>

4. Click Add Server. The LDAP server is saved.
5. In the Authentication Type field, select LDAP.
6. Click Save. The LDAP authentication is activated.

Note: If the PX3 clock and the LDAP server clock are out of sync, the installed TLS certificates, if any, may be considered expired. To ensure proper synchronization, administrators should configure the PX3 and the LDAP server to use the same NTP server(s).

Step D. Configure Roles on the PX3

A role on the PX3 determines the system and outlet permissions. You must create the roles whose names are identical to the user groups created for the PX3 on the AD server or authorization will fail. Therefore, we will create the roles named *PX_User* and *PX_Admin* on the PDU.

In this illustration, we assume:

- Users assigned to the *PX_User* role can view settings only, but they can neither configure PX3 nor access the outlets.
- Users assigned to the *PX_Admin* role have the Administrator Privileges so they can both configure PX3 and access the outlets.

► **To create the *PX_User* role with appropriate permissions assigned:**

1. Choose User Management > Roles.
2. Click  to add a new role.
 - a. Type *PX_User* in the Role Name field.
 - b. Type a description for the *PX_User* role in the Description field. In this example, we type "View PX settings" to describe the role.

- c. In the Privileges list, select Unrestricted View Privileges, which includes all View permissions. The Unrestricted View Privileges permission lets users view all settings without the capability to configure or change them.

<input checked="" type="checkbox"/>	Unrestricted View Privileges
<input type="checkbox"/>	View Authentication Settings
<input type="checkbox"/>	View Event Settings
<input type="checkbox"/>	View Local Event Log
<input type="checkbox"/>	View Local User Management
<input type="checkbox"/>	View Security Settings
<input type="checkbox"/>	View SNMP Settings
<input type="checkbox"/>	View Webcam Snapshots and Configuration

- d. Click Save.
3. The PX_User role is created.

Role Name ▲	Description
Admin	System defined administrator role including all privileges. 
Operator	Predefined operator role.
PX_User	View PX settings

- 4. Keep the Roles page open to create the PX_Admin role.

► **To create the PX_Admin role with full permissions assigned:**

- 1. Click  to add another role.
 - a. Type PX_Admin in the Role Name field.
 - b. Type a description for the PX_Admin role in the Description field. In this example, we type "Includes all PX privileges" to describe the role.

- c. In the Privileges list, select Administrator Privileges. The Administrator Privileges allows users to configure or change all PX3 settings.

Privileges 

Select privilege to add to role. Be aware some privileges may require additional arguments.

Acknowledge Alarms

Administrator Privileges

- d. Click Save.
2. The PX_Admin role is created.

Role Name ▲	Description
Admin	System defined administrator role including all privileges. 
Operator	Predefined operator role.
PX_Admin	Includes all PX privileges
PX_User	View PX settings

Appendix J Updating the LDAP Schema

In This Chapter

Returning User Group Information.....	831
Setting the Registry to Permit Write Operations to the Schema	832
Creating a New Attribute.....	832
Adding Attributes to the Class	833
Updating the Schema Cache.....	835
Editing rcusergroup Attributes for User Members	835

Returning User Group Information

Use the information in this section to return User Group information (and assist with authorization) once authentication is successful.

From LDAP/LDAPS

When an LDAP/LDAPS authentication is successful, the PX3 determines the permissions for a given user based on the permissions of the user's role. Your remote LDAP server can provide these user role names by returning an attribute named as follows:

rcusergroup attribute type: string

This may require a schema extension on your LDAP/LDAPS server. Consult your authentication server administrator to enable this attribute.

In addition, for Microsoft® Active Directory®, the standard LDAP memberOf is used.

From Microsoft Active Directory

Note: This should be attempted only by an experienced Active Directory® administrator.

Returning user role information from Microsoft's® Active Directory for Windows 2000® operating system server requires updating the LDAP/LDAPS schema. See your Microsoft documentation for details.

1. Install the schema plug-in for Active Directory. See Microsoft Active Directory documentation for instructions.
2. Run Active Directory Console and select Active Directory Schema.

Setting the Registry to Permit Write Operations to the Schema

To allow a domain controller to write to the schema, you must set a registry entry that permits schema updates.

► **To permit write operations to the schema:**

1. Right-click the Active Directory® Schema root node in the left pane of the window and then click Operations Master. The Change Schema Master dialog appears.

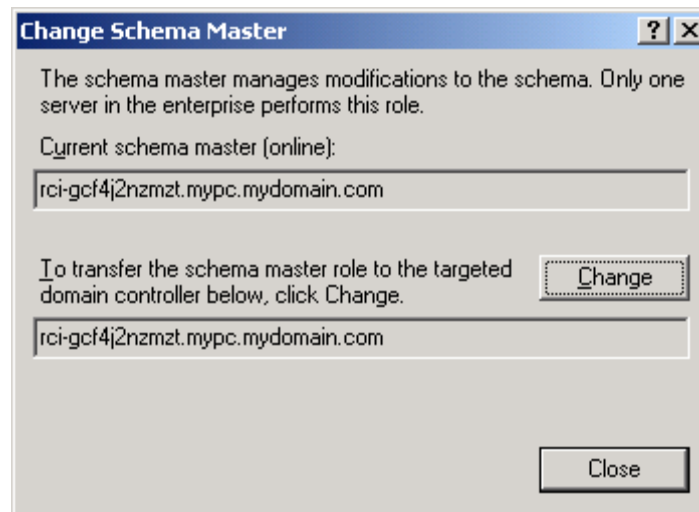

2. Select the "Schema can be modified on this Domain Controller" checkbox.
Optional
3. Click OK.

Creating a New Attribute

► **To create new attributes for the rcigroup class:**

1. Click the + symbol before Active Directory® Schema in the left pane of the window.
2. Right-click Attributes in the left pane.

- Click New and then choose Attribute. When the warning message appears, click Continue and the Create New Attribute dialog appears.

- Type *rciusergroup* in the Common Name field.
- Type *rciusergroup* in the LDAP Display Name field.
- Type *1.3.6.1.4.1.13742.50* in the Unique x5000 Object ID field.
- Type a meaningful description in the Description field.
- Click the Syntax drop-down arrow and choose Case Insensitive String from the list.
- Type *1* in the Minimum field.
- Type *24* in the Maximum field.
- Click OK to create the new attribute.

Adding Attributes to the Class

▶ **To add attributes to the class:**

- Click Classes in the left pane of the window.

2. Scroll to the user class in the right pane and right-click it.

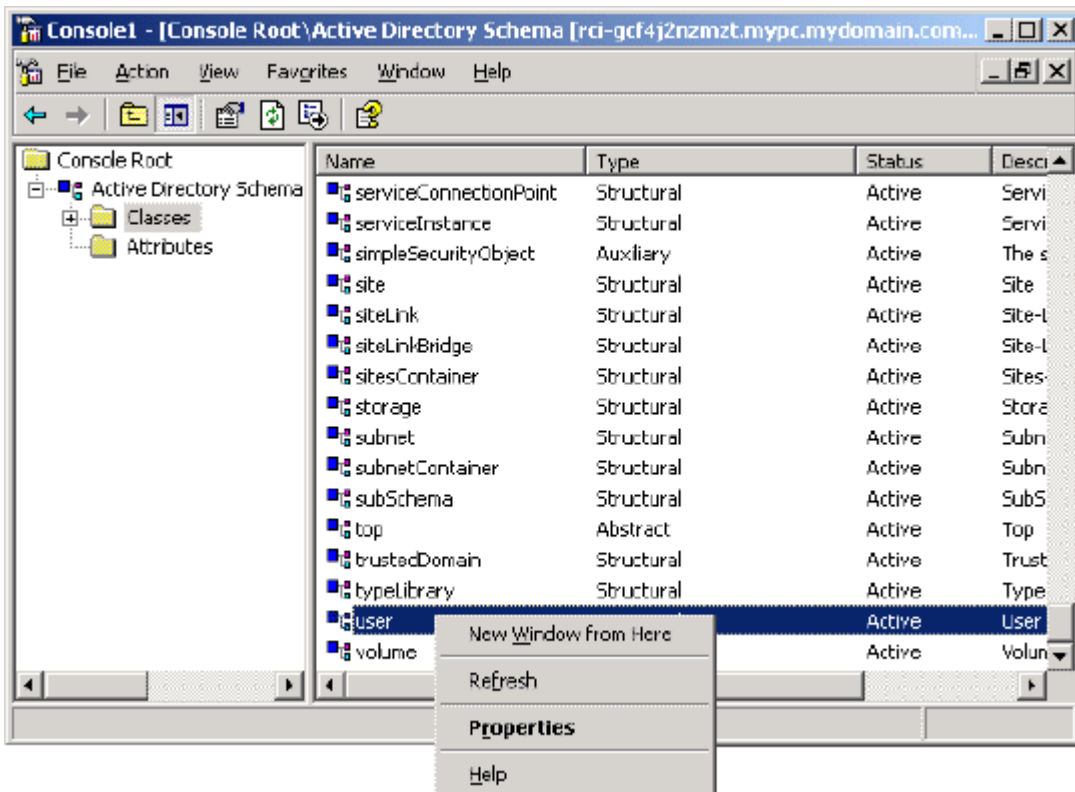

3. Choose Properties from the menu. The user Properties dialog appears.
4. Click the Attributes tab to open it.
5. Click Add.
6. Choose rcusergroup from the Select Schema Object list.

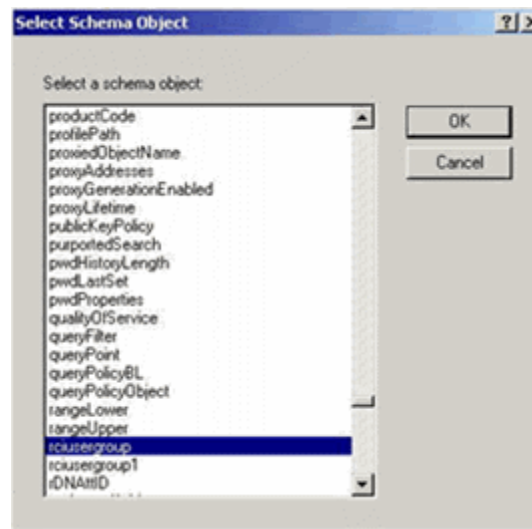

7. Click OK in the Select Schema Object dialog.
8. Click OK in the User Properties dialog.

Updating the Schema Cache

▶ **To update the schema cache:**

1. Right-click Active Directory® Schema in the left pane of the window and select Reload the Schema.
2. Minimize the Active Directory Schema MMC (Microsoft® Management Console) console.

Editing rcusergroup Attributes for User Members

To run the Active Directory® script on a Windows 2003® server, use the script provided by Microsoft® (available on the Windows 2003 server installation CD). These scripts are loaded onto your system with a Microsoft® Windows 2003 installation. ADSI (Active Directory Service Interface) acts as a low-level editor for Active Directory, allowing you to perform common administrative tasks such as adding, deleting, and moving objects with a directory service.

▶ **To edit the individual user attributes within the group rcusergroup:**

1. From the installation CD, choose Support > Tools.
2. Double-click SUPTOOLS.MSI to install the support tools.

- Go to the directory where the support tools were installed. Run `adsiedit.msc`. The ADSI Edit window opens.

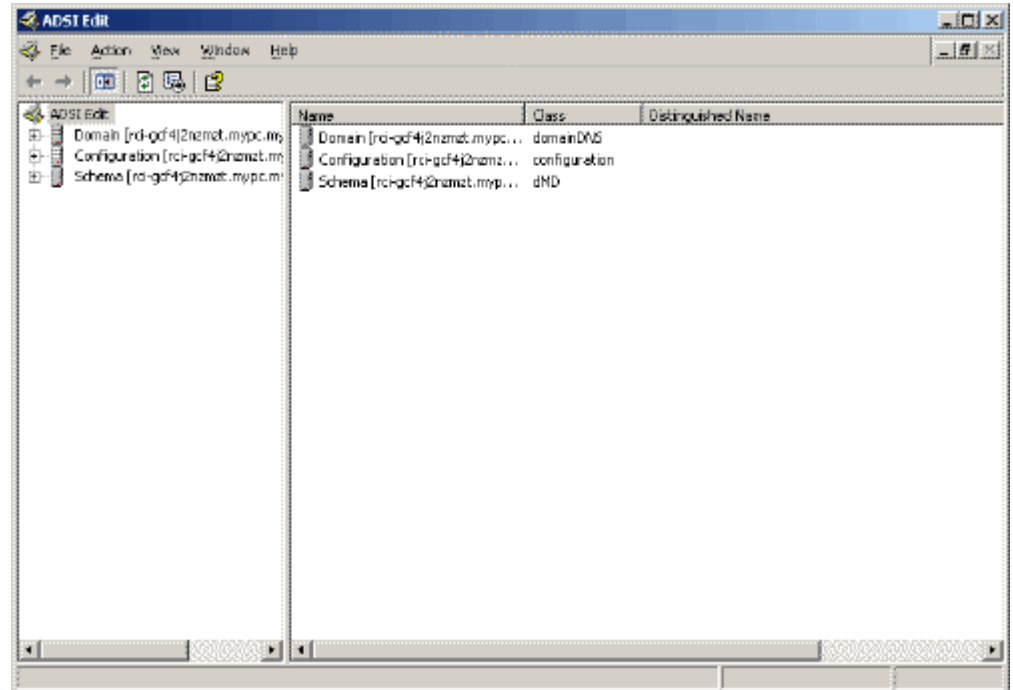

- Open the Domain.
- In the left pane of the window, select the CN=Users folder.

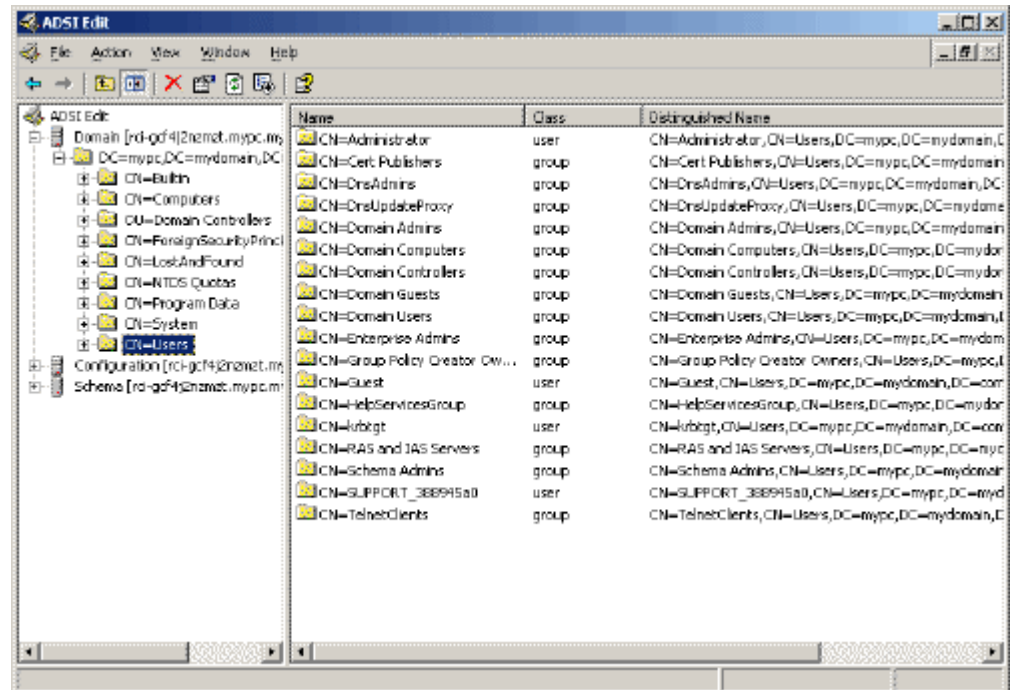

6. Locate the user name whose properties you want to adjust in the right pane. Right-click the user name and select Properties.
7. Click the Attribute Editor tab if it is not already open. Choose rcusergroup from the Attributes list.

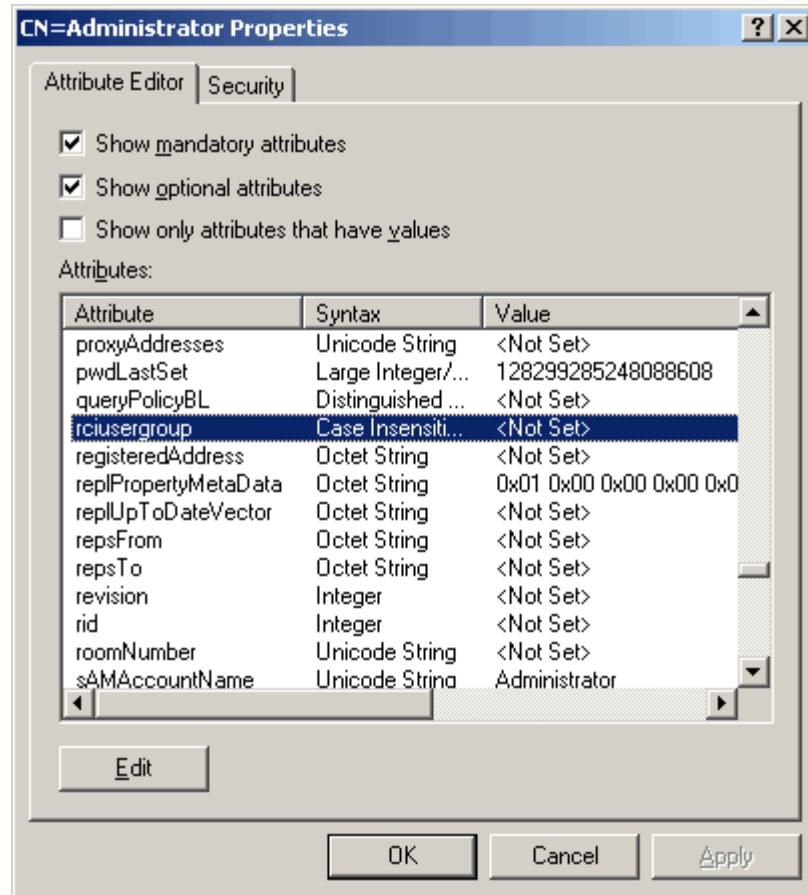

8. Click Edit. The String Attribute Editor dialog appears.
9. Type the user role (created in the PX3) in the Edit Attribute field. Click OK.

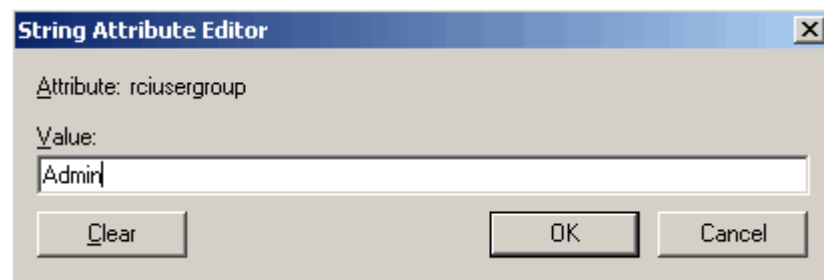

Appendix K RADIUS Configuration Illustration

This section provides illustrations for configuring RADIUS authentication. One illustration is based on the Microsoft® Network Policy Server (NPS), and the other is based on a FreeRADIUS server.

The following steps are required for any RADIUS authentication:

1. Configure RADIUS authentication on the PX3. See **Adding Radius Servers** (on page 354).
2. Configure roles on the PX3. See **Creating Roles** (on page 293).
3. Configure PX3 user credentials and roles on your RADIUS server.
 - To configure using standard attributes, see **Standard Attributes** (on page 838).
 - To configure using vendor-specific attributes, see **Vendor-Specific Attributes** (on page 857).

Note that we assume that the NPS is running on a Windows 2008 system in the NPS illustrations.

In This Chapter

Standard Attributes	838
Vendor-Specific Attributes	857
AD-Related Configuration	870

Standard Attributes

The RADIUS standard attribute "Filter-ID" is used to convey the group membership, that is, roles.

- If a user has multiple roles, configure multiple standard attributes for this user.
- The syntax of a standard attribute is:
`Raritan:G{role-name}`

For configuration on NPS, see **NPS Standard Attribute Illustration** (on page 838).

For configuration on FreeRADIUS, see **FreeRADIUS Standard Attribute Illustration** (on page 856).

NPS Standard Attribute Illustration

To configure Windows 2008 NPS with the *standard attribute*, you must:

- a. Add your PX3 to NPS. See **Step A: Add Your PX3 as a RADIUS Client** (on page 839).

- b. On the NPS, configure Connection Request Policies and the standard attribute. See **Step B: Configure Connection Policies and Standard Attributes** (on page 843).

Some configuration associated with Microsoft Active Directory (AD) is also required for RADIUS authentication. See **AD-Related Configuration** (on page 870).

Step A: Add Your PX3 as a RADIUS Client

The RADIUS implementation on the PX3 follows the standard RADIUS Internet Engineering Task Force (IETF) specification so you must select "RADIUS Standard" as its vendor name when configuring the NPS server.

► Presumptions in the illustration:

- IP address of your PX3 = 192.168.56.29
- RADIUS authentication port specified for PX3: 1812
- RADIUS accounting port specified for PX3: 1813

► To add your PX3 to the RADIUS NPS:

1. Choose Start > Administrative Tools > Network Policy Server. The Network Policy Server console window opens.

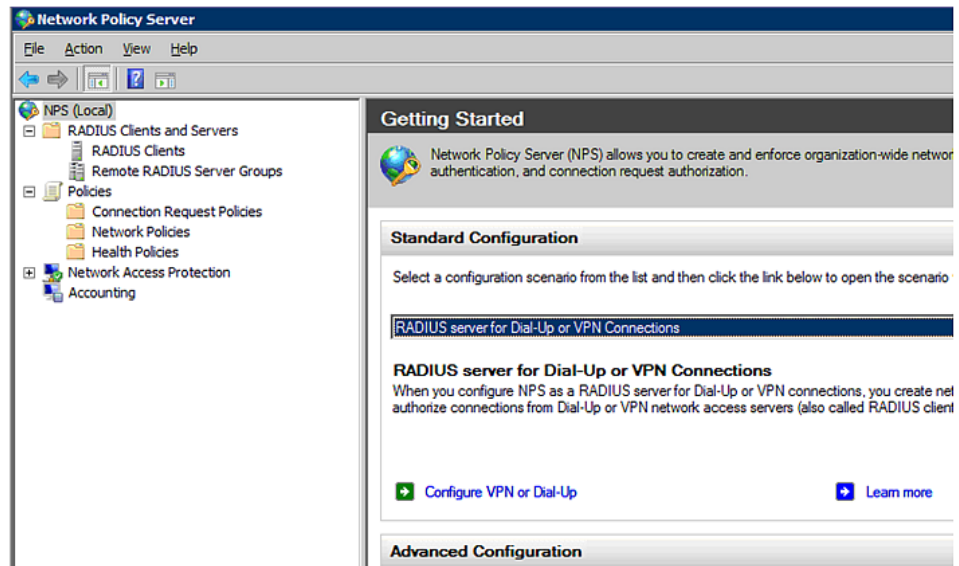

2. Right-click NPS (Local), and select Properties.

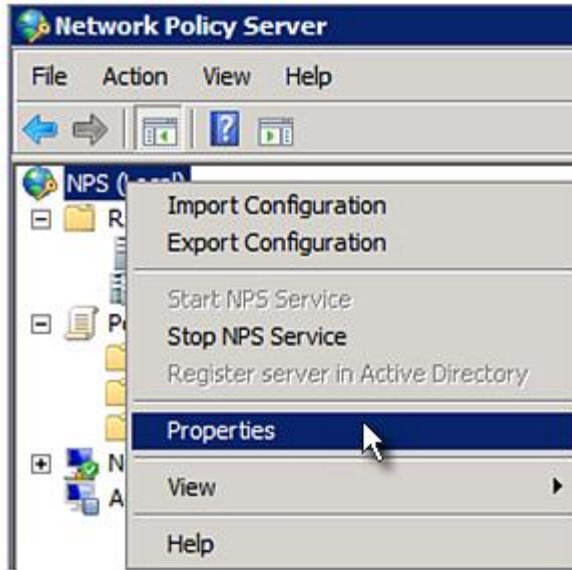

Verify the authentication and accounting port numbers shown in the properties dialog are the same as those specified on your PX3. In this example, they are 1812 and 1813. Then close this dialog.

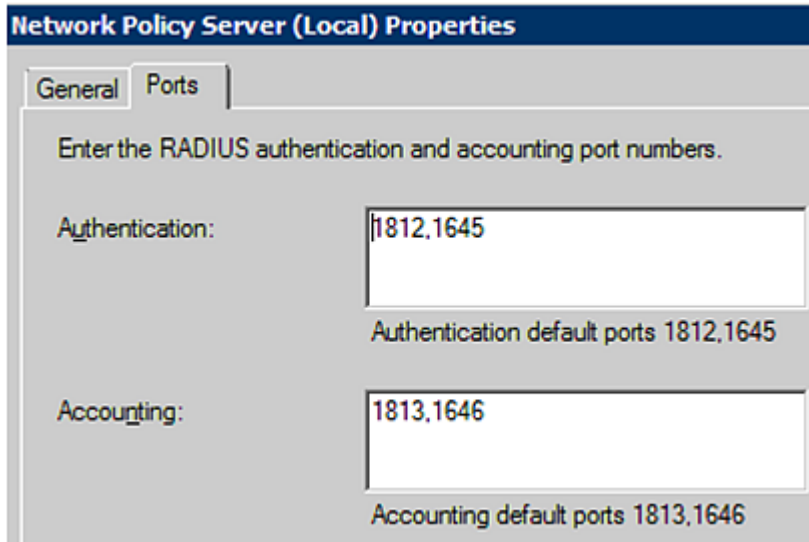

3. Under "RADIUS Clients and Servers," right-click RADIUS Client and select New RADIUS Client. The New RADIUS Client dialog appears.

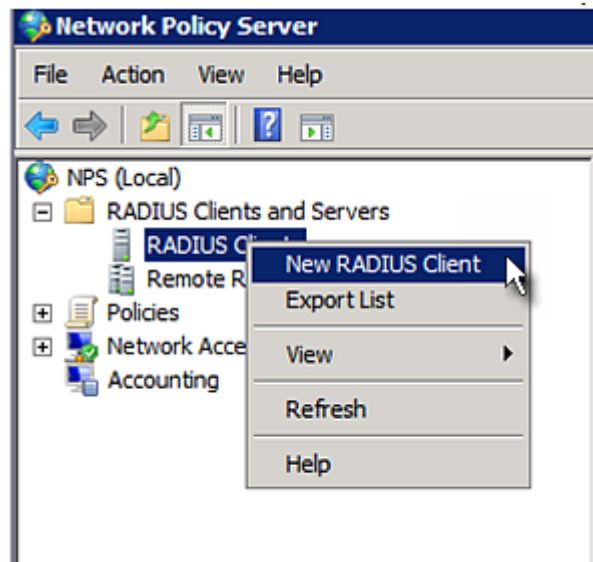

4. Do the following to add your PX3 to NPS:
 - a. Verify the "Enable this RADIUS client" checkbox is selected.
 - b. Type a name for identifying your PX3 in the "Friendly name" field.
 - c. Type *192.168.56.29* in the "Address (IP or DNS)" field.
 - d. Select *RADIUS Standard* in the "Vendor name" field.
 - e. Select the *Manual* radio button.

- f. Type the shared secret in the "Shared secret" and "Confirm shared secret" fields. The shared secret must be the same as the one specified on your PX3.

New RADIUS Client

Enable this RADIUS client

Name and Address

Friendly name:
RaritanDominion

Address (IP or DNS):
192.168.56.29 Verify...

Vendor

Specify RADIUS Standard for most RADIUS clients, or select the RADIUS client vendor from the list.

Vendor name:
RADIUS Standard

Shared Secret

To manually type a shared secret, click Manual. To automatically generate a shared secret, click Generate. You must configure the RADIUS client with the same shared secret entered here. Shared secrets are case-sensitive.

Manual Generate

Shared secret:
.....

Confirm shared secret:
.....

Additional Options

Access-Request messages must contain the Message-Authenticator attribute

RADIUS client is NAP-capable

OK Cancel

- 5. Click OK.

Step B: Configure Connection Policies and Standard Attributes

You need to configure the following for connection request policies:

- IP address or host name of the PX3
- Connection request forwarding method
- Authentication method(s)
- Standard RADIUS attributes

▶ **Presumptions in the illustration:**

- IP address of your PX3 = 192.168.56.29
- *Local* NPS server is used
- RADIUS protocol selected on your PX3 = CHAP
- Existing role of your PX3 = Admin

▶ **Illustration:**

1. Open the NPS console, and expand the Policies folder.

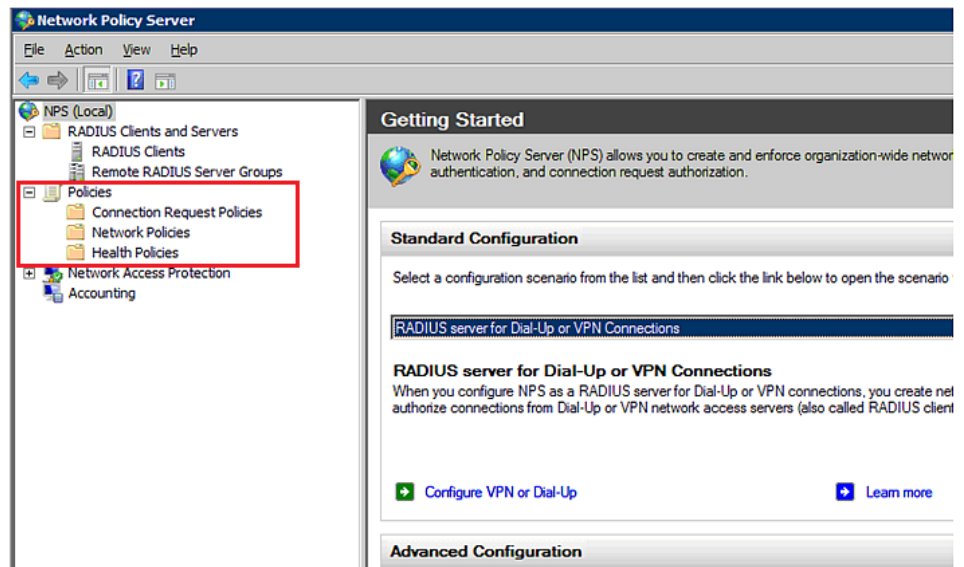

2. Right-click Connection Request Policies and select New. The New Connection Request Policy dialog appears.

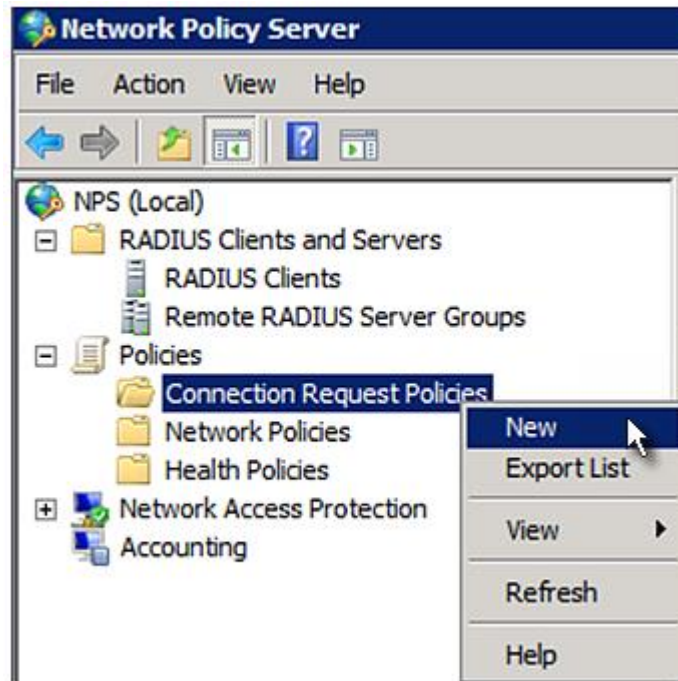

3. Type a descriptive name for identifying this policy in the "Policy name" field.

- You can leave the "Type of network access server" field to the default -- Unspecified.

New Connection Request Policy

 **Specify Connection Request Policy Name**

You can specify a name for your connection request policy and it will be applied.

Policy name:
RaritanDominionPolicy

Network connection method
Select the type of network access server that sends the connection request to NPS.
type or Vendor specific.

Type of network access server:
Unspecified

Vendor specific:
10

- Click Next to show the "Specify Conditions" screen. Click Add.

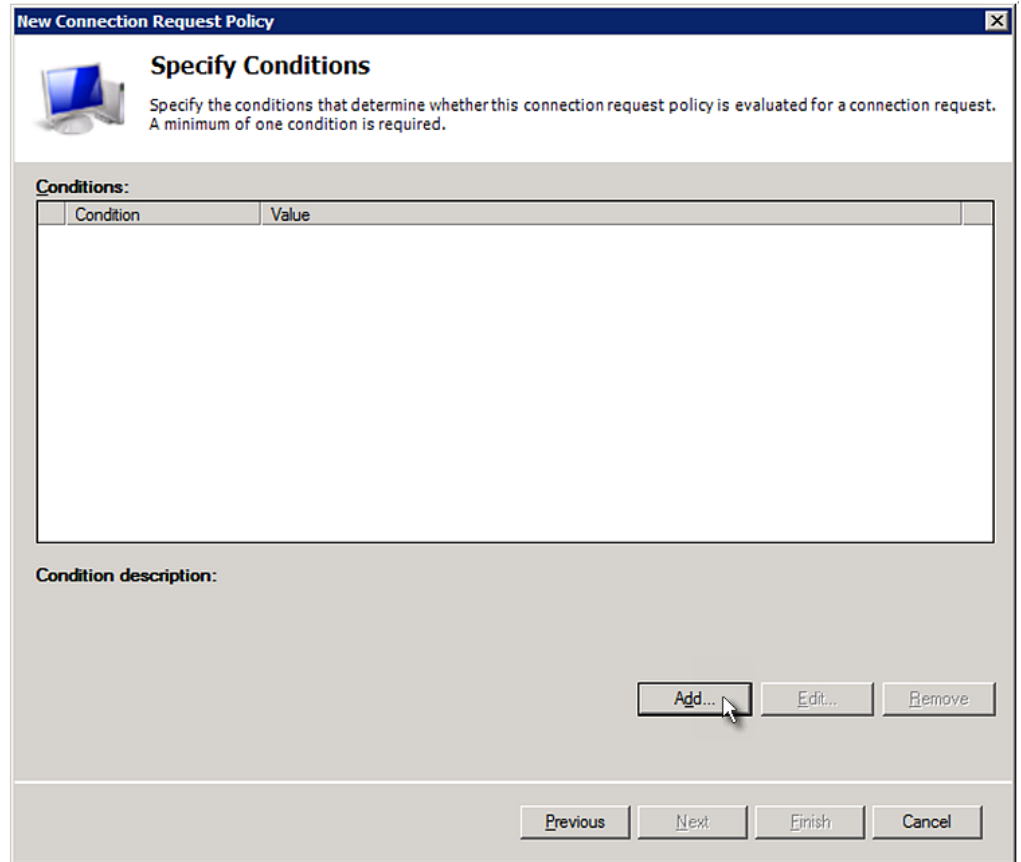

- The "Select condition" dialog appears. Click Add.

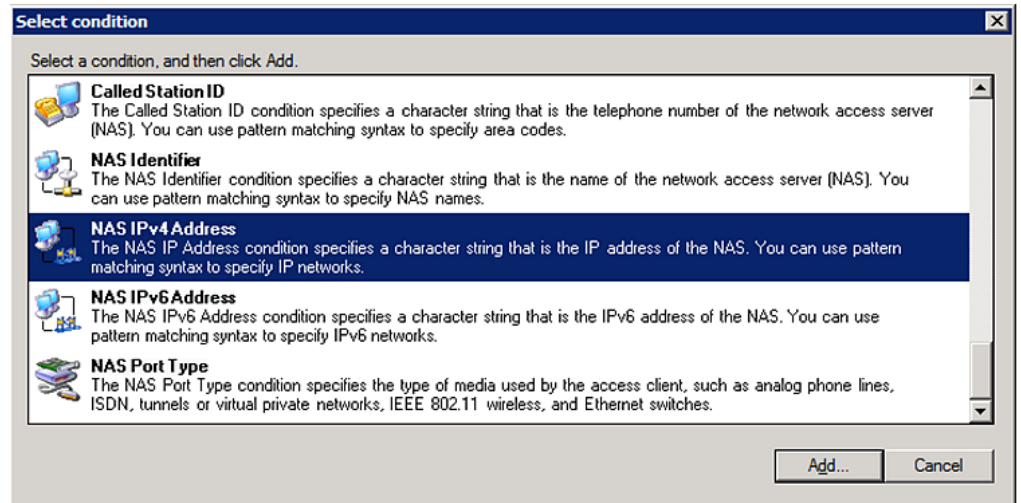

- The NAS IPv4 Address dialog appears. Type the PX3 IP address -- 192.168.56.29, and click OK.

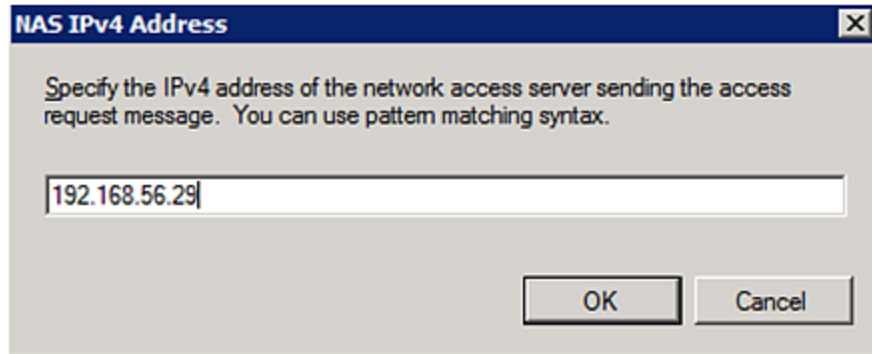

- Click Next in the New Connection Request Policy dialog.

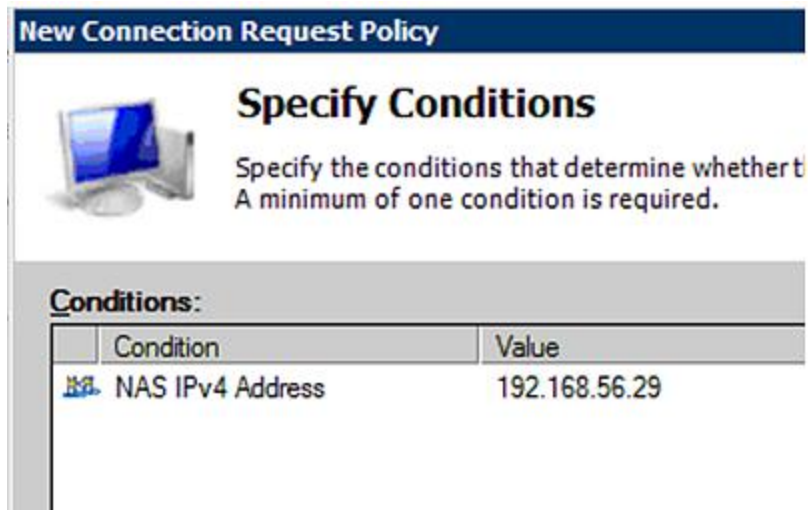

- Select "Authenticate requests on this server" because a local NPS server is used in this example. Then click Next.

Note: Connection Request Forwarding options must match your environment.

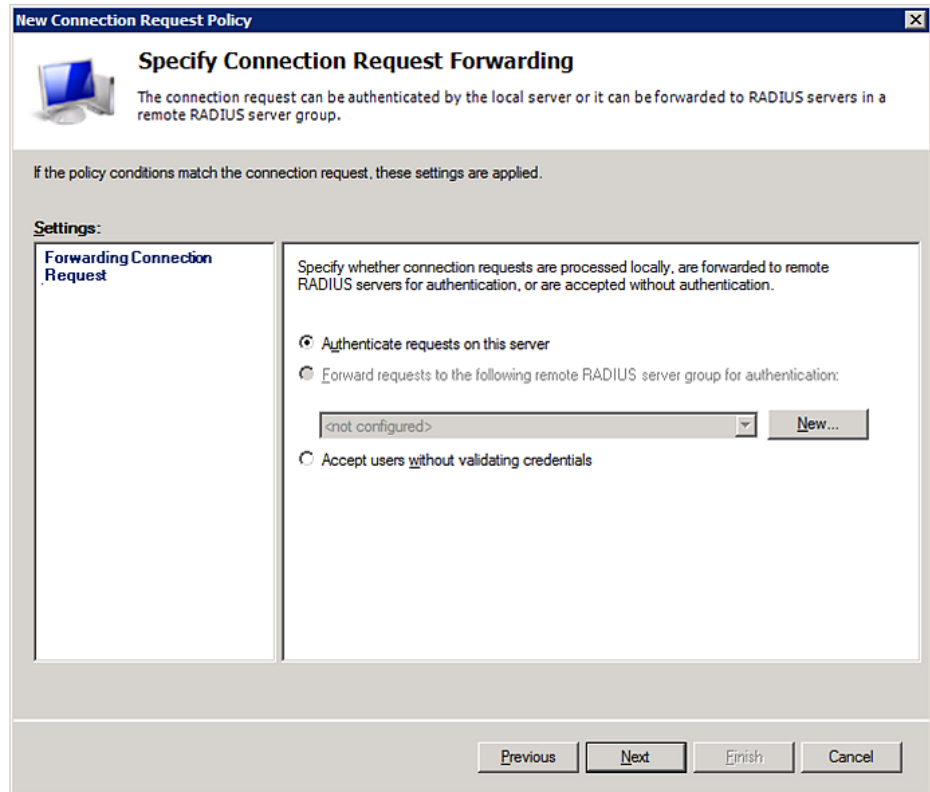

9. When the system prompts you to select the authentication method, select the following two options:
 - Override network policy authentication settings
 - CHAP -- the PX3 uses "CHAP" in this example

Note: If your PX3 uses PAP, then select "PAP."

New Connection Request Policy



Specify Authentication Methods

Configure one or more authentication methods required authentication, you must configure an EAP type. If you d Protected EAP.

Override network policy authentication settings

These authentication settings are used rather than the constraints and authentication connections with NAP. you must configure PEAP authentication here.

EAP types are negotiated between NPS and the client in the order in which

EAP Types:

Less secure authentication methods:

- Microsoft Encrypted Authentication version 2 (MS-CHAP-v2)
 - User can change password after it has expired
- Microsoft Encrypted Authentication (MS-CHAP)
 - User can change password after it has expired
- Encrypted authentication (CHAP)
- Unencrypted authentication (PAP, SPAP)
- Allow clients to connect without negotiating an authentication method.

10. Select Standard to the left of the dialog and then click Add.

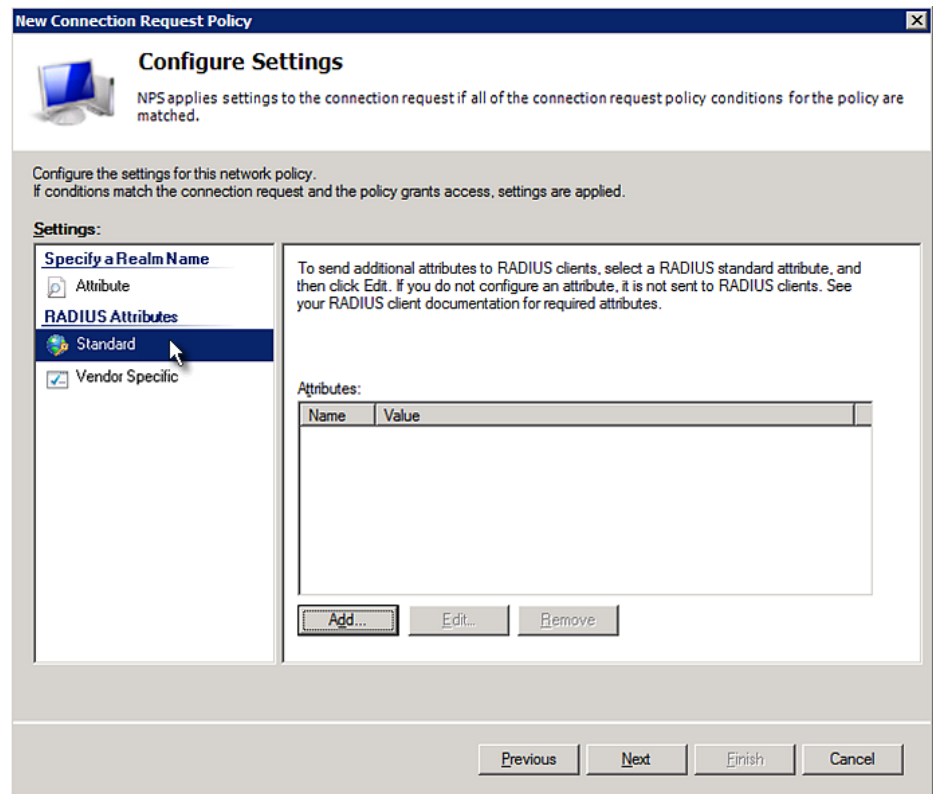

11. Select Filter-Id from the list of attributes and click Add.

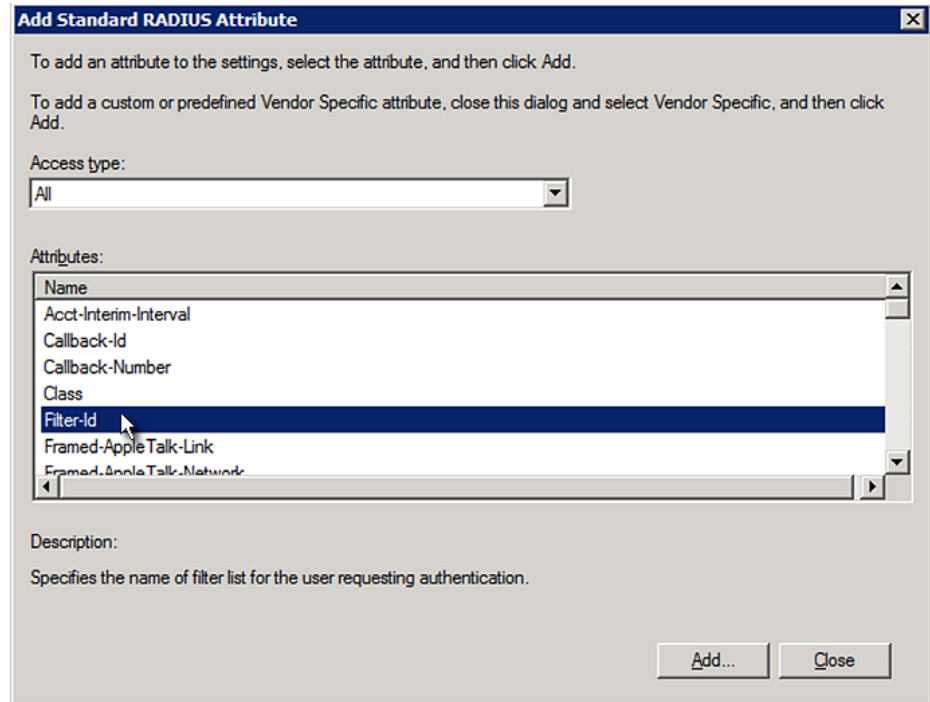

12. In the Attribute Information dialog, click Add.

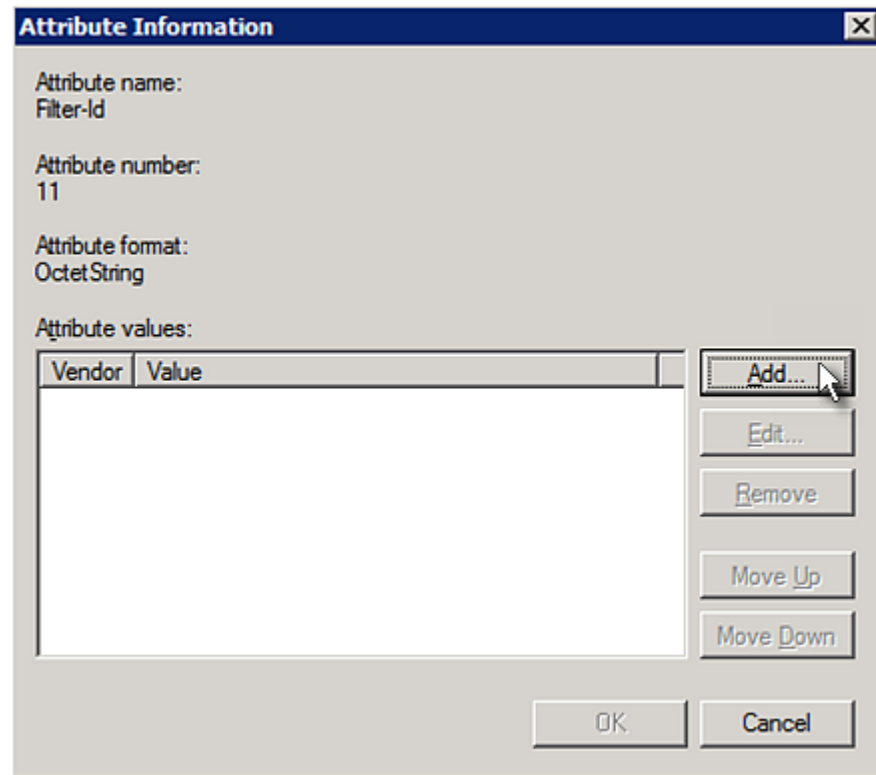

13. Select String, type *Raritan:G{Admin}* in the text box, and then click OK.

Admin inside the curved brackets {} is the existing role on the PX3. It is recommended to use the Admin role to test this configuration. The role name is case sensitive.

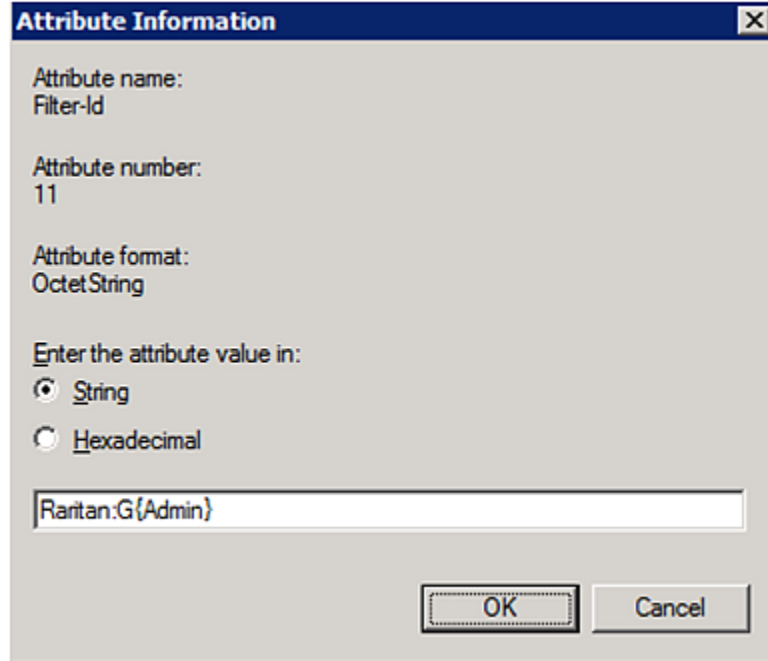

The image shows a dialog box titled "Attribute Information" with a close button (X) in the top right corner. The dialog contains the following fields and options:

- Attribute name: Filter-Id
- Attribute number: 11
- Attribute format: OctetString
- Enter the attribute value in:
 - String
 - Hexadecimal
- Text input field containing: Raritan:G{Admin}
- Buttons: OK and Cancel

14. The new attribute is added. Click OK.

The dialog box, titled "Attribute Information", displays the following configuration:

- Attribute name: Filter-Id
- Attribute number: 11
- Attribute format: OctetString
- Attribute values: A table with two columns: Vendor and Value.

Vendor	Value
RADIUS Standard	Raritan:G{Admin}

Buttons on the right side of the table include: Add..., Edit..., Remove, Move Up, and Move Down. At the bottom right, there are OK and Cancel buttons. A mouse cursor is pointing at the OK button.

15. Click Next to continue.

New Connection Request Policy

Configure Settings

 NPS applies settings to the connection request if all of the connect matched.

Configure the settings for this network policy.
If conditions match the connection request and the policy grants access, settings are a

Settings:

Specify a Realm Name

 Attribute

RADIUS Attributes

Standard

Vendor Specific

To send additional attributes to RADIUS client then click Edit. If you do not configure an attr your RADIUS client documentation for require

Attributes:

Name	Value
Filter-Id	Raritan.G{Admin}

16. A summary showing connection request policy settings is displayed. Click Finish to close the dialog.

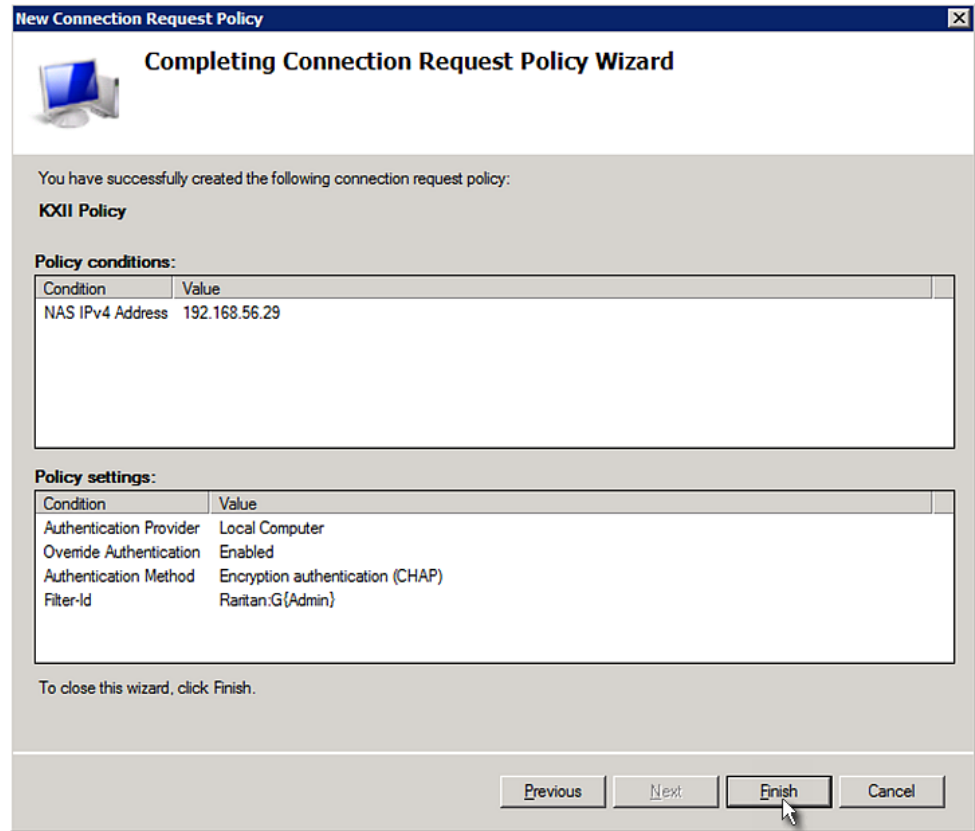

FreeRADIUS Standard Attribute Illustration

With standard attributes, NO dictionary files are required. You simply add all user data, including user names, passwords, and roles, in the following FreeRADIUS path.

`/etc/raddb/users`

► **Presumptions in the illustration:**

- User name = `steve`
- Steve's password = `test123`
- Steve's roles = `Admin` and `SystemTester`

► **To create a user profile for "steve" in FreeRADIUS:**

1. Go to this location: `/etc/raddb/users`.
2. Add the data of the user "steve" by typing the following. Note that the values after the equal sign (=) must be enclosed in double quotes (").

```

steve Cleartext-Password := "test123"
Filter-ID = "Raritan:G{Admin}",
Filter-ID = "Raritan:G{SystemTester}"

```

Vendor-Specific Attributes

You must specify the following properties when using a RADIUS vendor-specific attribute (VSA).

- Vendor code = 13742
- Vendor-assigned attribute number = 26
- Attribute format = String

The syntax of the vendor-specific attribute for specifying one or multiple roles is:

```
Raritan:G{role-name1 role-name2 role-name3}
```

For configuration on NPS, see **NPS VSA Illustration** (on page 857).

For configuration on FreeRADIUS, see **FreeRADIUS VSA Illustration** (on page 869).

NPS VSA Illustration

To configure Windows 2008 NPS with the *vendor-specific attribute*, you must:

- Add your PX3 to NPS. See **Step A: Add Your PX3 as a RADIUS Client** (on page 839).
- On the NPS, configure connection request policies and the vendor-specific attribute. See **Step B: Configure Connection Policies and Vendor-Specific Attributes** (on page 862).

Some configuration associated with Microsoft Active Directory (AD) is also required for RADIUS authentication. See **AD-Related Configuration** (on page 870).

Step A: Add Your PX3 as a RADIUS Client

The RADIUS implementation on the PX3 follows the standard RADIUS Internet Engineering Task Force (IETF) specification so you must select "RADIUS Standard" as its vendor name when configuring the NPS server.

► Presumptions in the illustration:

- IP address of your PX3 = 192.168.56.29
- RADIUS authentication port specified for PX3: 1812
- RADIUS accounting port specified for PX3: 1813

► To add your PX3 to the RADIUS NPS:

1. Choose Start > Administrative Tools > Network Policy Server. The Network Policy Server console window opens.

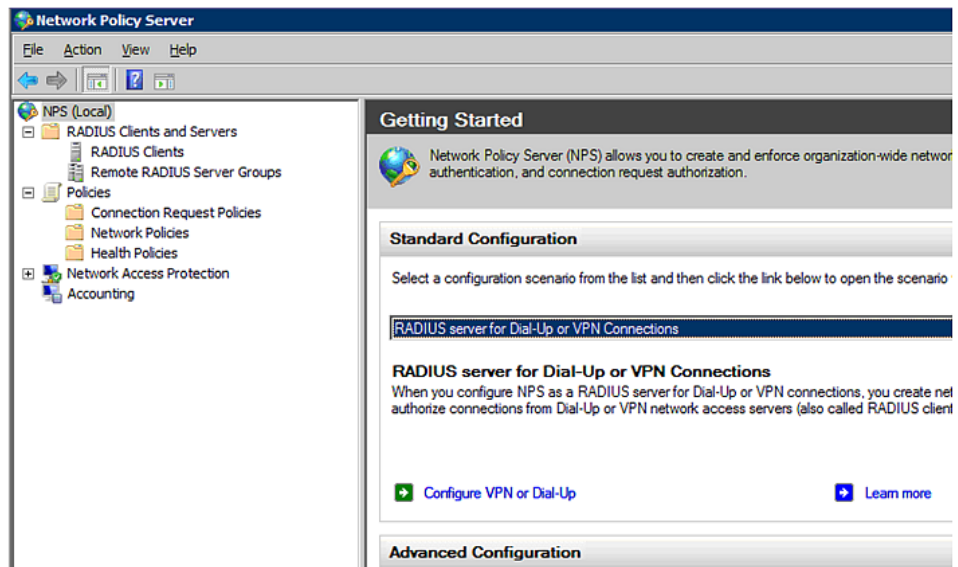

2. Right-click NPS (Local), and select Properties.

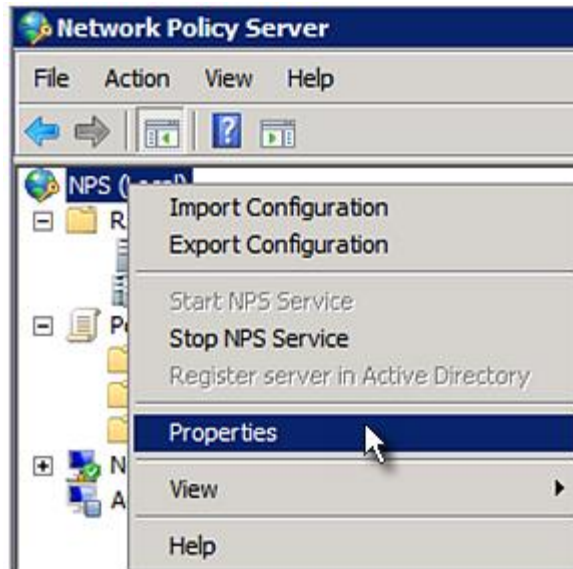

Verify the authentication and accounting port numbers shown in the properties dialog are the same as those specified on your PX3. In this example, they are 1812 and 1813. Then close this dialog.

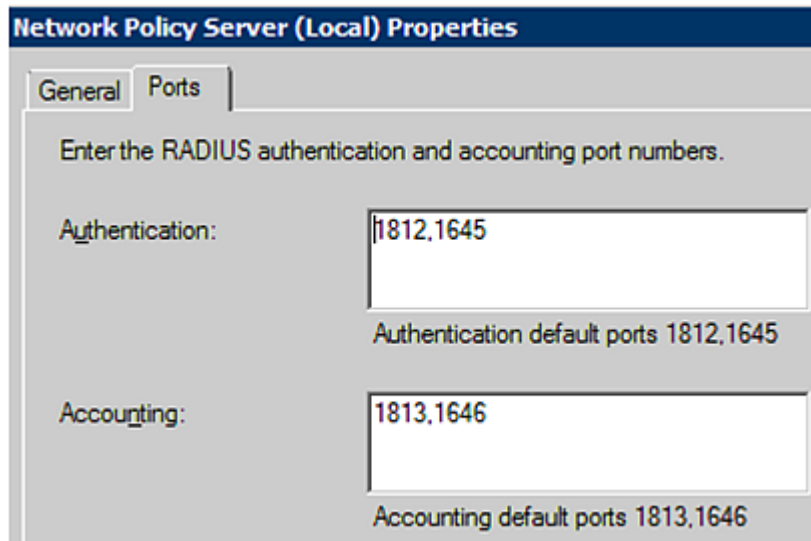

3. Under "RADIUS Clients and Servers," right-click RADIUS Client and select New RADIUS Client. The New RADIUS Client dialog appears.

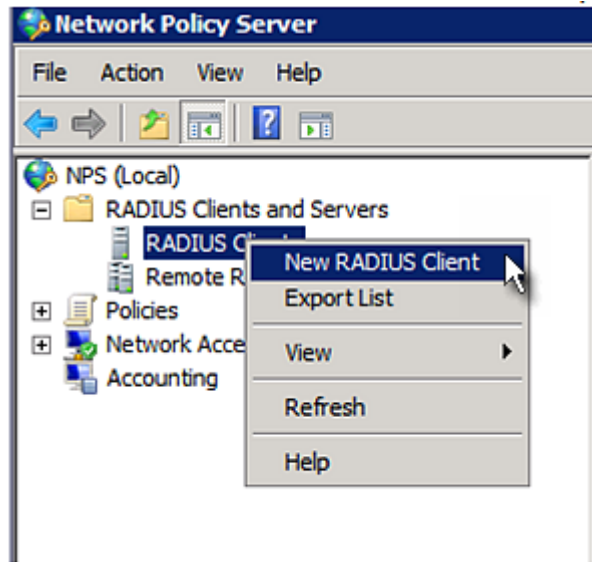

4. Do the following to add your PX3 to NPS:
 - a. Verify the "Enable this RADIUS client" checkbox is selected.
 - b. Type a name for identifying your PX3 in the "Friendly name" field.
 - c. Type *192.168.56.29* in the "Address (IP or DNS)" field.
 - d. Select *RADIUS Standard* in the "Vendor name" field.
 - e. Select the *Manual* radio button.

- f. Type the shared secret in the "Shared secret" and "Confirm shared secret" fields. The shared secret must be the same as the one specified on your PX3.

New RADIUS Client

Enable this RADIUS client

Name and Address

Friendly name:
RaritanDominion

Address (IP or DNS):
192.168.56.29 Verify...

Vendor

Specify RADIUS Standard for most RADIUS clients, or select the RADIUS client vendor from the list.

Vendor name:
RADIUS Standard

Shared Secret

To manually type a shared secret, click Manual. To automatically generate a shared secret, click Generate. You must configure the RADIUS client with the same shared secret entered here. Shared secrets are case-sensitive.

Manual Generate

Shared secret:
●●●●●●●

Confirm shared secret:
●●●●●●●

Additional Options

Access-Request messages must contain the Message-Authenticator attribute

RADIUS client is NAP-capable

OK Cancel

5. Click OK.

Step B: Configure Connection Policies and Vendor-Specific Attributes

You need to configure the following for connection request policies:

- IP address or host name of the PX3
- Connection request forwarding method
- Authentication method(s)
- Standard RADIUS attributes

► Presumptions in the illustration:

- IP address of your PX3 = 192.168.56.29
- *Local* NPS server is used
- RADIUS protocol selected on your PX3 = CHAP
- Existing roles of your PX3 = Admin, User and SystemTester

► Illustration:

1. Open the NPS console, and expand the Policies folder.

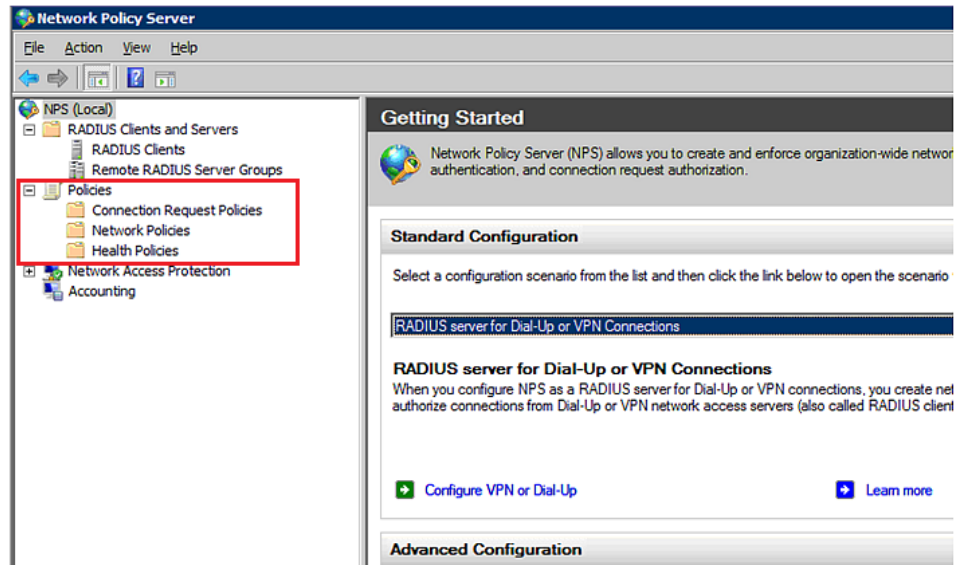

2. Right-click Connection Request Policies and select New. The New Connection Request Policy dialog appears.

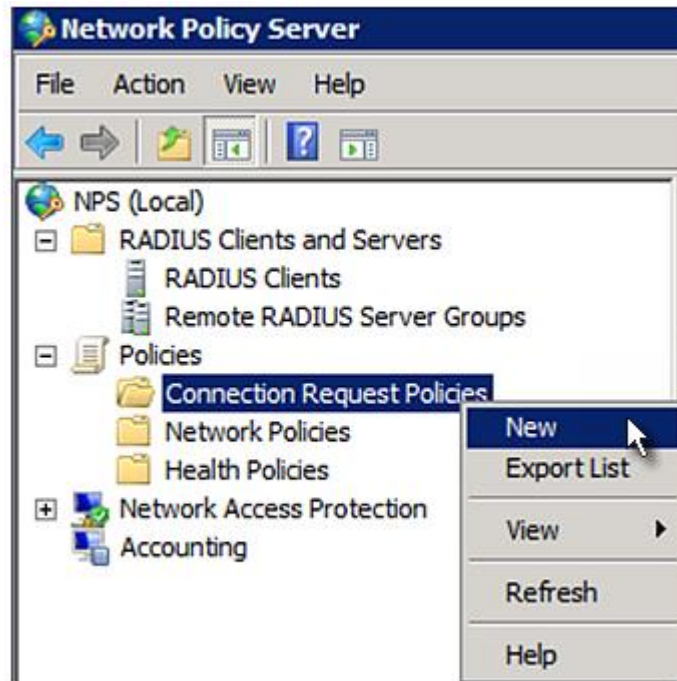

3. Type a descriptive name for identifying this policy in the "Policy name" field.

- You can leave the "Type of network access server" field to the default -- Unspecified.

New Connection Request Policy



Specify Connection Request Policy Name

You can specify a name for your connection request policy and it will be applied.

Policy name:

Network connection method
Select the type of network access server that sends the connection request to NPS.
type or Vendor specific.

Type of network access server:

Vendor specific:

- Click Next to show the "Specify Conditions" screen. Click Add.

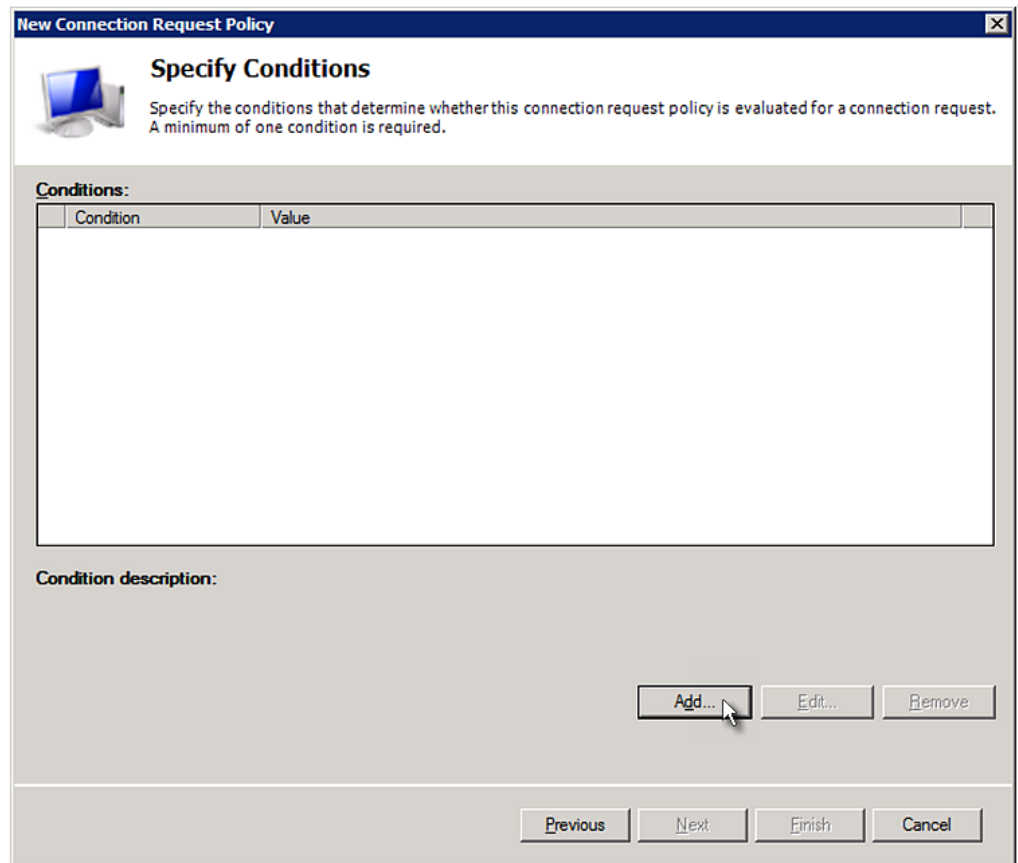

- The "Select condition" dialog appears. Click Add.

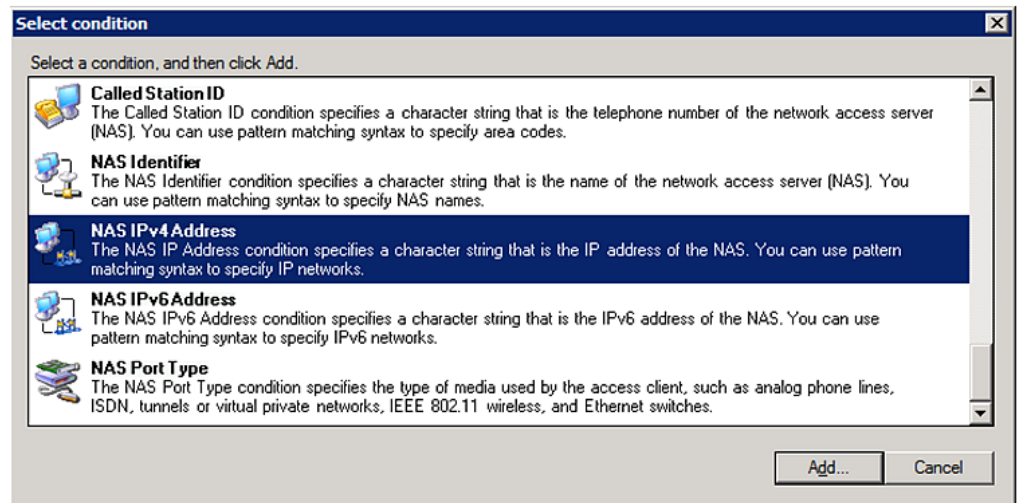

6. The NAS IPv4 Address dialog appears. Type the PX3 IP address -- 192.168.56.29, and click OK.

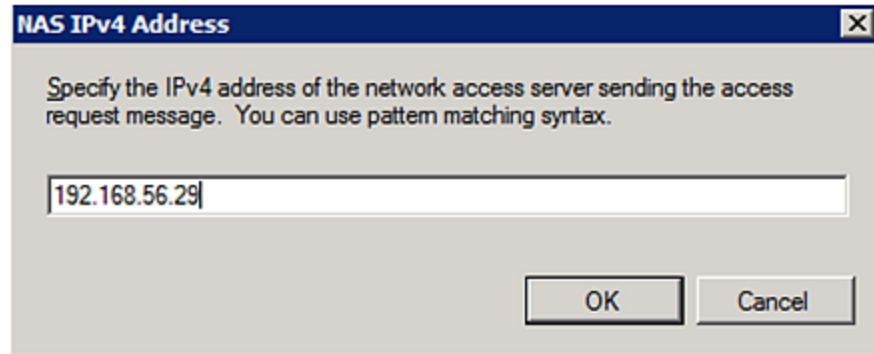

7. Click Next in the New Connection Request Policy dialog.

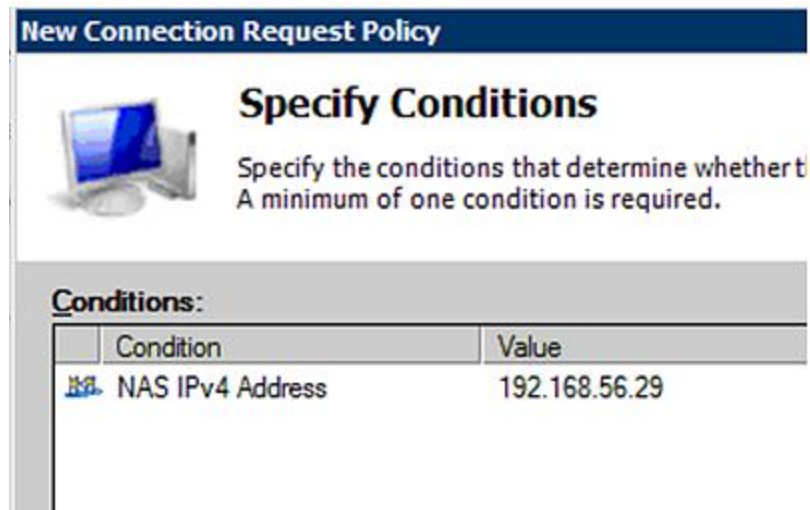

8. Select "Authenticate requests on this server" because a local NPS server is used in this example. Then click Next.

Note: Connection Request Forwarding options must match your environment.

New Connection Request Policy

Specify Connection Request Forwarding

The connection request can be authenticated by the local server or it can be forwarded to RADIUS servers in a remote RADIUS server group.

If the policy conditions match the connection request, these settings are applied.

Settings:

Forwarding Connection Request
<p>Specify whether connection requests are processed locally, are forwarded to remote RADIUS servers for authentication, or are accepted without authentication.</p> <p><input checked="" type="radio"/> Authenticate requests on this server</p> <p><input checked="" type="radio"/> Forward requests to the following remote RADIUS server group for authentication:</p> <p><not configured> <input type="button" value="New..."/></p> <p><input type="radio"/> Accept users without validating credentials</p>

- When the system prompts you to select the authentication method, select the following two options:
 - Override network policy authentication settings
 - CHAP -- the PX3 uses "CHAP" in this example

Note: If your PX3 uses PAP, then select "PAP."

New Connection Request Policy



Specify Authentication Methods

Configure one or more authentication methods required authentication, you must configure an EAP type. If you d Protected EAP.

Override network policy authentication settings

These authentication settings are used rather than the constraints and authentication connections with NAP. you must configure PEAP authentication here.

EAP types are negotiated between NPS and the client in the order in which

EAP Types:

Add...
Edit...
Remove

Less secure authentication methods:

Microsoft Encrypted Authentication version 2 (MS-CHAP-v2)

User can change password after it has expired

Microsoft Encrypted Authentication (MS-CHAP)

User can change password after it has expired

Encrypted authentication (CHAP)

Unencrypted authentication (PAP, SPAP)

Allow clients to connect without negotiating an authentication method.

10. Select Vendor Specific to the left of the dialog, and click Add. The Add Vendor Specific Attribute dialog appears.
11. Select Custom in the Vendor field, and click Add. The Attribute Information dialog appears.
12. Click Add, and the Vendor-Specific Attribute Information dialog appears.
13. Click "Enter Vendor Code" and type 13742.
14. Select "Yes, it conforms" to indicate that the custom attribute conforms to the RADIUS Request For Comment (RFC).
15. Click Configure Attribute, and then:
 - a. Type 26 in the "Vendor-assigned attribute number" field.
 - b. Select String in the "Attribute format" field.
 - c. Type *Raritan:G{Admin User SystemTester}* in the "Attribute value" field. In this example, three roles 'Admin,' 'User' and 'SystemTester' are specified inside the curved brackets {}.

Note that multiple roles are separated with a space.

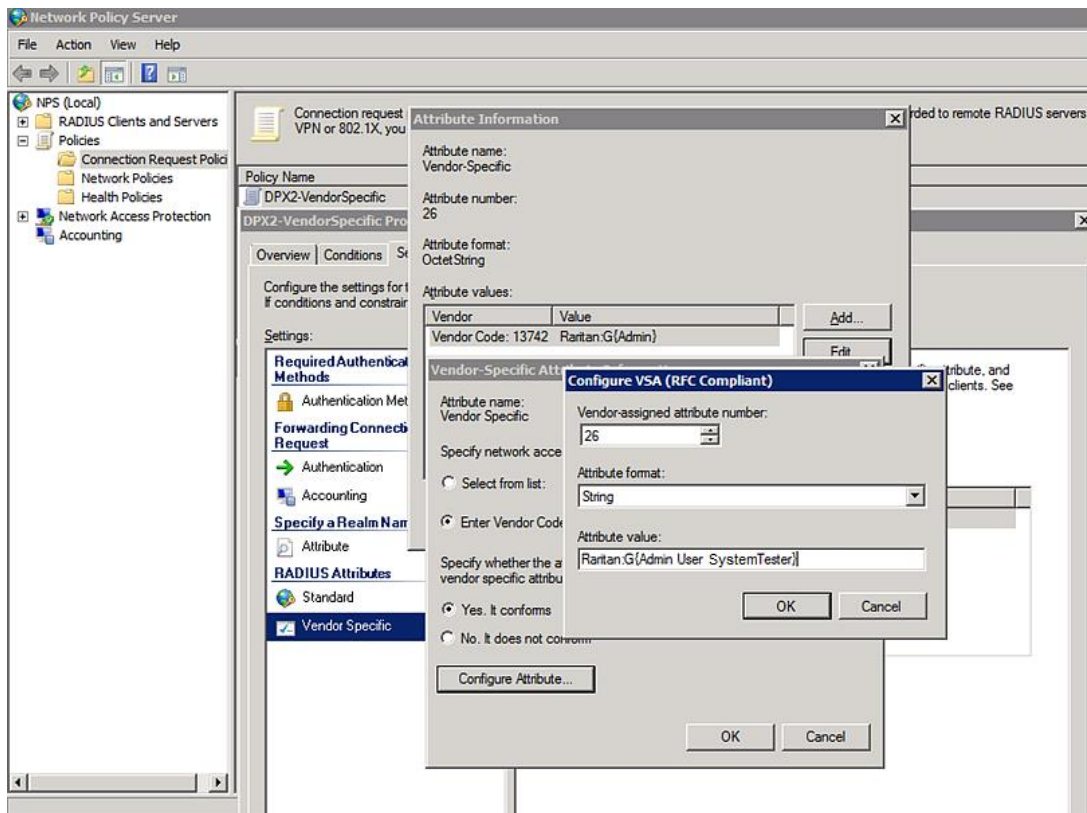

16. Click OK.

FreeRADIUS VSA Illustration

A vendor-specific dictionary file is required for the vendor-specific-attribute configuration on FreeRADIUS. Therefore, there are two major configuration steps.

- Use a dictionary to define the Raritan vendor-specific attribute
- Add all user data, including user names, passwords, and roles

► Presumptions in the illustration:

- Raritan attribute = Raritan-User-Roles
- User name = steve
- Steve's password = test123
- Steve's roles = Admin, User and SystemTester

► Step A -- define the vendor-specific attribute in FreeRADIUS:

- Go to this location: `/etc/raddb/dictionary`.
- Type the following in the Raritan dictionary file.

```
VENDOR Raritan 13742
BEGIN-VENDOR Raritan
ATTRIBUTE Raritan-User-Roles 26 string
END-VENDOR Raritan
```

▶ **Step B -- create a user profile for "steve" in FreeRADIUS:**

1. Go to this location: /etc/raddb/users.
2. Add the data of the user "steve" by typing the following. Note that the values after the equal sign (=) must be enclosed in double quotes (").

```
steve Cleartext-Password := "test123"
Raritan-PDU-User-Roles = "Raritan:G{Admin User SystemTester}"
```

AD-Related Configuration

When RADIUS authentication is intended, make sure you also configure the following settings related to Microsoft Active Directory (AD):

- Register the NPS server in AD
- Configure remote access permission for users in AD

The NPS server is registered in AD only when NPS is configured for the FIRST time and user accounts are created in AD.

If CHAP authentication is used, you must enable the following feature for user accounts created in AD:

- Store password using reversible encryption

Important: Reset the user password if the password is set before you enable the "Store password using reversible encryption" feature.

▶ **To register NPS:**

1. Open the NPS console.

- Right-click NPS (Local) and select "Register server in Active Directory."

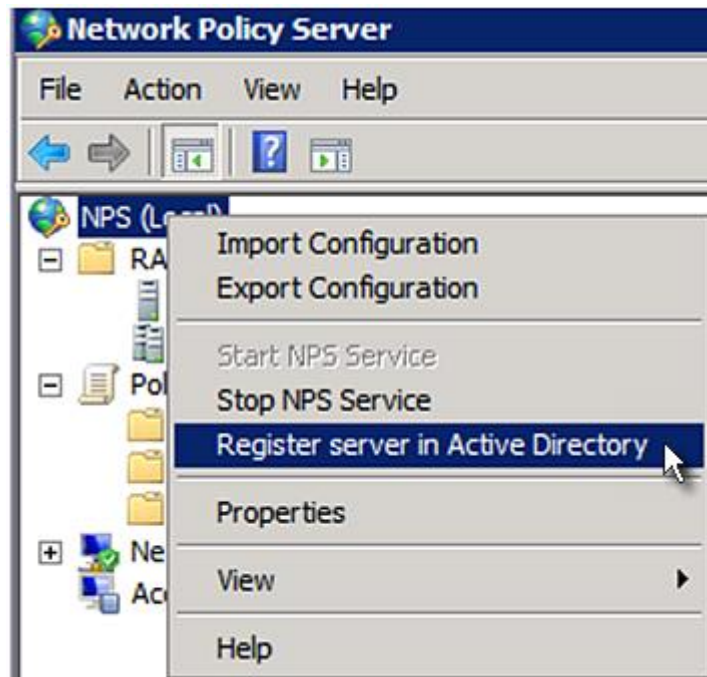

- Click OK, and then OK again.

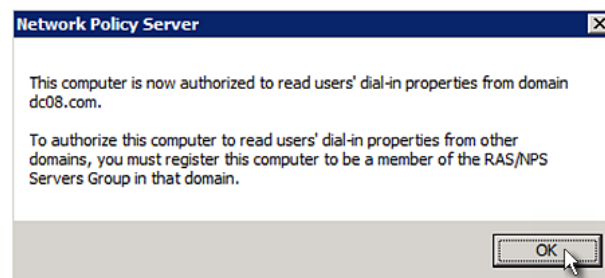

► **To grant PX3 users remote access permission:**

- Open Active Directory Users and Computers.
- Open the properties dialog of the user whom you want to grant the access permission.

3. Click the Dial-in tab and select the "Allow access" checkbox.

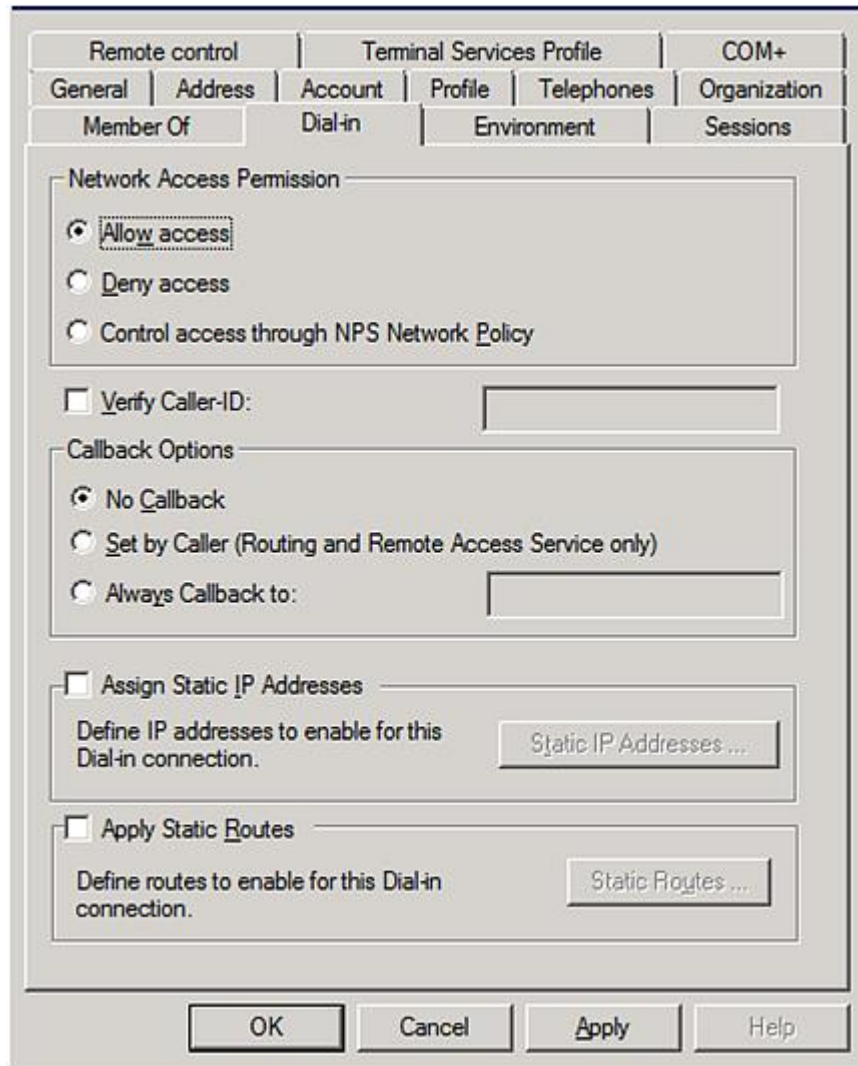

► **To enable reversible encryption for CHAP authentication:**

1. Open Active Directory Users and Computers.
2. Open the properties dialog of the user that you want to configure.

3. Click the Account tab and select the "Store password using reversible encryption" checkbox.

The screenshot shows a configuration dialog box with the following elements:

- Member Of:** Remote control
- Dial-in:** Terminal Services Profile
- Environment:** COM+
- Sessions:** COM+
- General:** Address, **Account**, Profile, Telephones, Organization
- User logon name:** [Empty text box] [Dropdown arrow]
- User logon name (pre-Windows 2000):** DC08\ [Empty text box] Administrator
- Logon Hours...** [Button] **Log On To...** [Button]
- Unlock account**
- Account options:**
 - User must change password at next logon
 - User cannot change password
 - Password never expires
 - Store password using reversible encryption
- Account expires:**
 - Never**
 - End of:** Saturday, May 23, 2009 [Dropdown arrow]
- Buttons:** OK, Cancel, Apply, Help

Appendix L Additional PX3 Information

In This Chapter

RJ45-to-DB9 Cable Requirements for Modem Connections.....	874
Reserving IP Addresses in DHCP Servers	875
Sensor Threshold Settings	879
Default Voltage and Current Thresholds	887
Altitude Correction Factors	889
Unbalanced Current Calculation.....	889
Data for BTU Calculation	890
Ways to Probe Existing User Profiles.....	891
Raritan Training Website	891
Role of a DNS Server	892
Cascading Troubleshooting.....	892
Installing the USB-to-Serial Driver (Optional).....	897
Initial Network Configuration via CLI	898
Device-Specific Settings	905
TLS Certificate Chain	906
Browsing through the Online Help	912

RJ45-to-DB9 Cable Requirements for Modem Connections

An RJ45-to-DB9 adapter/cable is required for connecting a modem to the PX3 device.

A third party RJ45-to-DB9 adapter/cable needs to meet the following requirements.

- RJ-45 to "DB9 male"
- RX/TX and according control pins are NOT crossed
- With the following pin assignments:

Pin signal	DB9 pin No.	RJ-45 pin No.
DCD	1	5
RxD	2	6
TxD	3	3
DTR	4	2
GND	5	4
DSR	6	7
RTS	7	1
CTS	8	8

Pin signal	DB9 pin No.	RJ-45 pin No.
RIR	9	N/A

*Note: The RJ45-to-DB9 adapter/cable used for connecting modems CANNOT be used to connect the PX3 to a computer. See **RJ45-to-DB9 Cable Requirements for Computer Connections** (on page 31).*

Reserving IP Addresses in DHCP Servers

PX3 uses its serial number as the client identifier in the DHCP request. Therefore, to successfully reserve an IP address for the PX3 in a DHCP server, use the PX3 device's serial number as the unique ID instead of the MAC address.

Since all network interfaces of the PX3 can be simultaneously enabled and configured with diverse static IP addresses, the client identifier of each network interface is different. The main difference is the absence/presence of a suffix, which is the interface name added to the end of the serial number. The table below lists the client identifiers of all network interfaces.

Interface	Client identifier
ETH1	serial number
ETH2	serial number plus the uppercase suffix "-ETH2"
WIRELESS	serial number plus the uppercase suffix "-WIRELESS"
BRIDGE	serial number

You can reserve the IP addresses of more than one interfaces in the DHCP server if preferred. Note that you must choose/configure the bridge interface if your PX3 is set to the bridging mode.

Important: In the bridging mode, only the IP parameters of the BRIDGE interface function. The IP parameters of ETH1/ETH2 and WIRELESS interfaces do NOT function.

Reserving IP in Windows

To reserve the IP address of any network interface in the Windows DHCP server, you must convert that interface's client identifier into *hexadecimal* ASCII codes.

For each interface's client identifier, see **Reserving IP Addresses in DHCP Servers** (on page 875).

In the following illustration, it is assumed that the PX3 serial number is PEG1A00003.

► **Windows IP address reservation illustration:**

1. Convert the client identifier of the desired network interface into ASCII codes (*hexadecimal*).

Interface	Client identifier conversion
ETH1	PEG1A00003 = 50 45 47 31 41 30 30 30 30 33
ETH2	PEG1A00003-ETH2 = 50 45 47 31 41 30 30 30 30 33 2D 45 54 48 32 <ul style="list-style-type: none"> ▪ The suffix comprising the dash symbol and the word "ETH2" is also converted.
WIRELESS	PEG1A00003-WIRELESS = 50 45 47 31 41 30 30 30 30 33 2D 57 49 52 45 4C 45 53 53 <ul style="list-style-type: none"> ▪ The suffix comprising the dash symbol and the word "WIRELESS" is also converted.
BRIDGE	PEG1A00003 = 50 45 47 31 41 30 30 30 30 33

2. In your DHCP server, bring up the New Reservation dialog, and separate the converted ASCII codes with spaces.

For example, to reserve the ETH1 interface's IP address, enter the following data in the dialog.

Field	Data entered
IP address	The IP address you want to reserve.
MAC address	The following ASCII codes. 50 45 47 31 41 30 30 30 30 33
Other fields	Configure as needed.

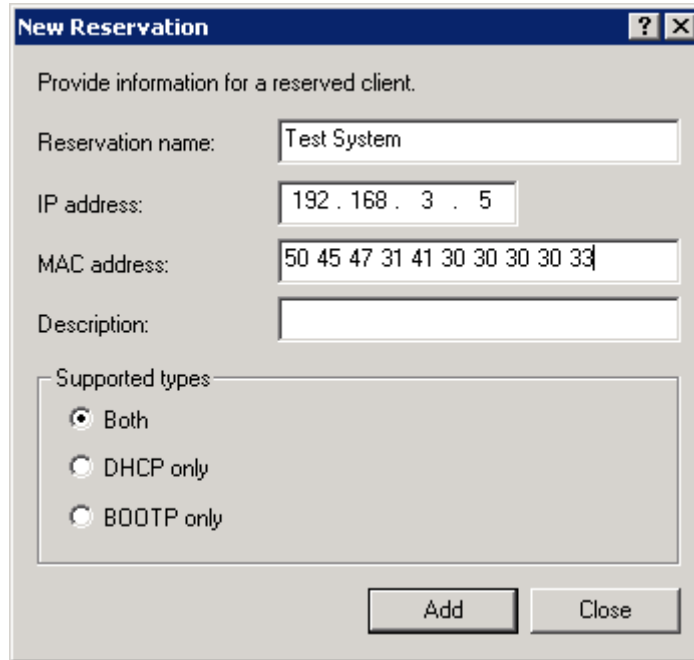

Reserving IP in Linux

There are two methods to reserve the IP address of any network interface in the standard Linux DHCP server (ISC DHCP server):

- Convert an interface's client identifier into *hexadecimal* ASCII codes.
- Use an interface's original client identifier without converting it into ASCII codes.

For each interface's client identifier, see **Reserving IP Addresses in DHCP Servers** (on page 875).

In the following illustrations, it is assumed that the PX3 serial number is PEG1A00003, and the IP address you want to reserve is 192.168.20.1.

► **Illustration with ASCII code conversion:**

1. Convert the client identifier of the desired network interface into ASCII codes (*hexadecimal*).

Interface	Client identifier conversion
ETH1	PEG1A00003 = 50 45 47 31 41 30 30 30 30 33
ETH2	PEG1A00003-ETH2 = 50 45 47 31 41 30 30 30 30 33 2D 45 54 48 32 <ul style="list-style-type: none"> ▪ The suffix comprising the dash symbol and the word "ETH2" is also converted.

Interface	Client identifier conversion
WIRELESS	PEG1A00003-WIRELESS = 50 45 47 31 41 30 30 30 30 33 2D 57 49 52 45 4C 45 53 53 <ul style="list-style-type: none"> The suffix comprising the dash symbol and the word "WIRELESS" is also converted.
BRIDGE	PEG1A00003 = 50 45 47 31 41 30 30 30 30 33

- Separate the converted ASCII codes with a colon, and a prefix "00:" must be added to the beginning of the converted codes.

For example, the *converted* client identifier of the ETH1 interface looks like the following:

```
00:50:45:47:31:41:30:30:30:30:33
```

- Now enter the converted client identifier with the following syntax.

```
host mypx {
option dhcp-client-identifier = 00:50:45:47:31:41:30:30:30:30:33;
fixed-address 192.168.20.1;
}
```

► **Illustration without ASCII code conversion:**

- Use the original client identifier of the desired network interface. DO NOT convert them into ASCII codes.

- A prefix "\000" must be added to the beginning of the client identifier.

For example, the client identifier of the ETH1 interface looks like the following:

```
\000PEG1A00003
```

- Now enter the original client identifier with the following syntax. The client identifier is enclosed in quotation marks.

```
host mypx {
option dhcp-client-identifier = "\000PEG1A00003";
fixed-address 192.168.20.1;
}
```

Sensor Threshold Settings

This section explains the thresholds settings for a numeric sensor.

Lower critical	<input checked="" type="checkbox"/>	<input type="text" value="10"/>	<input type="text"/>
Lower warning	<input checked="" type="checkbox"/>	<input type="text" value="20"/>	<input type="text"/>
Upper warning	<input checked="" type="checkbox"/>	<input type="text" value="30"/>	<input type="text"/>
Upper critical	<input checked="" type="checkbox"/>	<input type="text" value="40"/>	<input type="text"/>
Deassertion hysteresis		<input type="text" value="1"/>	<input type="text"/>
Assertion timeout		<input type="text" value="0"/>	<input type="text" value="Samples"/>

Thresholds and Sensor States

A numeric sensor has four thresholds: Lower Critical, Lower Warning, Upper Warning and Upper Critical.

The threshold settings determine how many sensor states are available for a certain sensor and the range of each sensor state. The diagram below shows how each threshold relates to each state.

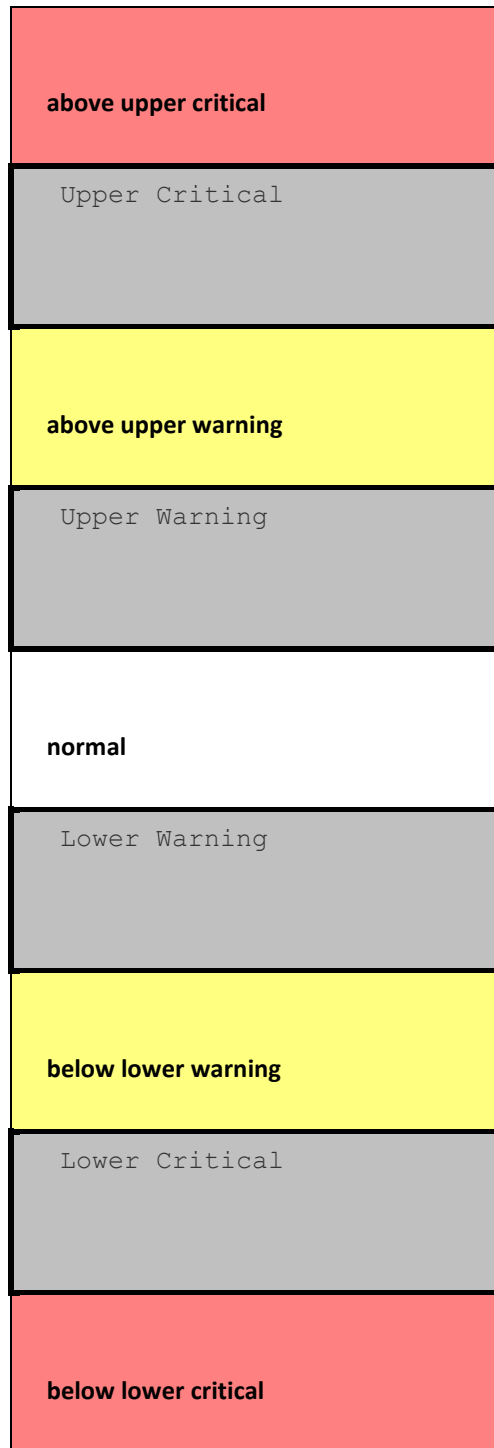

► Available sensor states:

The more thresholds are enabled for a sensor, the more sensor states are available for it. The "normal" state is always available regardless of whether any threshold is enabled.

For example:

- When a sensor only has the Upper Critical threshold enabled, it has two sensor states: normal and above upper critical.
- When a sensor has both the Upper Critical and Upper Warning thresholds enabled, it has three sensor states: normal, above upper warning, and above upper critical.

States of "above upper warning" and "below lower warning" are warning states to call for your attention.

States of "above upper critical" and "below lower critical" are critical states that require you to immediately handle.

► **Range of each available sensor state:**

The value of each enabled threshold determines the reading range of each available sensor state. For details, see **Yellow- or Red-Highlighted Sensors** (on page 255).

"To Assert" and Assertion Timeout

If multiple sensor states are available for a specific sensor, the PX3 asserts a state for it whenever a bad state change occurs.

► **To assert a state:**

To assert a state is to announce a new, "worse" state.

Below are bad state changes that cause the PX3 to assert.

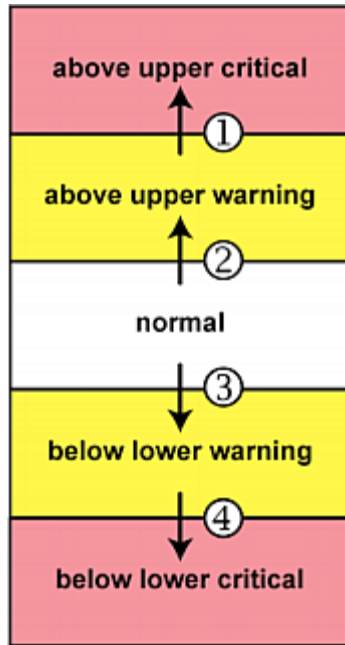

1. above upper warning --> above upper critical
2. normal --> above upper warning
3. normal --> below lower warning
4. below lower warning --> below lower critical

► **Assertion Timeout:**

Lower Critical	<input checked="" type="checkbox"/>	0	
Lower Warning	<input checked="" type="checkbox"/>	0	
Upper Warning	<input checked="" type="checkbox"/>	0	
Upper Critical	<input checked="" type="checkbox"/>	0	
Deassertion Hysteresis		0	
Assertion Timeout		0	Samples

In the threshold settings, the Assertion Timeout field postpones the "assertion" action. It determines how long a sensor must remain in the "worse" new state before the PX3 triggers the "assertion" action. If that sensor changes its state again within the specified wait time, the PX3 does NOT assert the worse state.

To disable the assertion timeout, set it to 0 (zero).

Note: For most sensors, the measurement unit in the "Assertion Timeout" field is sample. Sensors are measured every second, so the timing of a sample is equal to a second. Raritan's BCM2 is an exception to this, with a sample of 3 seconds.

► **How "Assertion Timeout" is helpful:**

If you have created an event rule that instructs the PX3 to send notifications for assertion events, setting the "Assertion Timeout" is helpful for eliminating a number of notifications that you may receive in case the sensor's readings fluctuate around a certain threshold.

Assertion Timeout Example for Temperature Sensors

Assumption:

```
Upper Warning threshold is enabled.
Upper Warning = 25 (degrees Celsius)
Assertion Timeout = 5 samples (that is, 5 seconds)
```

When a temperature sensor's reading exceeds 25 degrees Celsius, moving from the "normal" range to the "above upper warning" range, the PX3 does NOT immediately announce this warning state. Instead it waits for 5 seconds, and then does either of the following:

- If the temperature remains above 25 degrees Celsius in the "above upper warning" range for 5 seconds, the PX3 performs the "assertion" action to announce the "above upper warning" state.
- If the temperature drops below 25 degrees Celsius within 5 seconds, the PX3 does NOT perform the "assertion" action.

"To De-assert" and Deassertion Hysteresis

After the PX3 asserts a worse state for a sensor, it may de-assert that state later on if the readings improve.

► **To de-assert a state:**

To de-assert a state is to announce the end of the previously-asserted worse state.

Below are good state changes that cause the PX3 to de-assert the previous state.

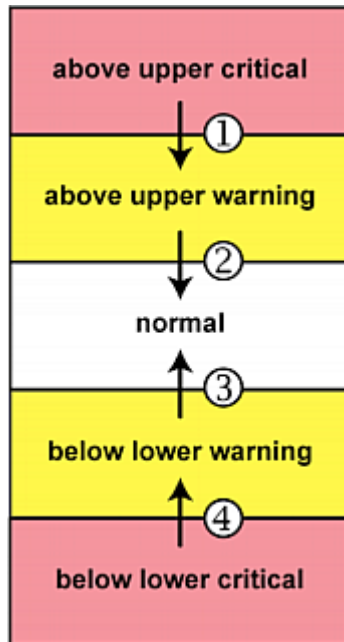

1. above upper critical --> above upper warning
2. above upper warning --> normal
3. below lower warning --> normal
4. below lower critical --> below lower warning

► **Deassertion Hysteresis:**

Lower Critical	<input checked="" type="checkbox"/>	0	
Lower Warning	<input checked="" type="checkbox"/>	0	
Upper Warning	<input checked="" type="checkbox"/>	0	
Upper Critical	<input checked="" type="checkbox"/>	0	
Deassertion Hysteresis		0	
Assertion Timeout		0	Samples

In the threshold settings, the Deassertion Hysteresis field determines a new level to trigger the "deassertion" action.

This function is similar to a thermostat, which instructs the air conditioner to turn on the cooling system when the temperature exceeds a pre-determined level. "Deassertion Hysteresis" instructs the PX3 to de-assert the worse state for a sensor only when that sensor's reading reaches the pre-determined "deassertion" level.

For upper thresholds, this "deassertion" level is a decrease against each threshold. For lower thresholds, this level is an increase to each threshold. The absolute value of the decrease/increase is exactly the hysteresis value.

For example, if Deassertion Hysteresis = 2, then the deassertion level of each threshold is either "+2" or "-2" as illustrated below.

Threshold value	Deassertion value
Upper Critical = 33	Deassertion level = 31 <ul style="list-style-type: none"> • $33 - 2 = 31$
Upper Warning = 25	Deassertion level = 23 <ul style="list-style-type: none"> • $25 - 2 = 23$
Lower Critical = 10	Deassertion level = 12 <ul style="list-style-type: none"> • $10 + 2 = 12$
Lower Warning = 18	Deassertion level = 20 <ul style="list-style-type: none"> • $18 + 2 = 20$

To use each threshold as the "deassertion" level instead of determining a new level, set the Deassertion Hysteresis to 0 (zero).

Note: The difference between Upper Warning and Lower Warning must be at least "two times" of the deassertion value.

► **How "Deassertion Hysteresis" is helpful:**

If you have created an event rule that instructs the PX3 to send notifications for deassertion events, setting the "Deassertion Hysteresis" is helpful for eliminating a number of notifications that you may receive in case a sensor's readings fluctuate around a certain threshold.

Deassertion Hysteresis Example for Temperature Sensors

Assumption:
 Upper Warning threshold is enabled.
 Upper Warning = 20 (degrees Celsius)
 Deassertion Hysteresis = 3 (degrees Celsius)
 "Deassertion" level = 20-3 = 17 (degrees Celsius)

When the PX3 detects that a temperature sensor's reading drops below 20 degrees Celsius, moving from the "above upper warning" range to the "normal" range, either of the following may occur:

- If the temperature falls between 20 and 17 degrees Celsius, the PX3 does NOT perform the "deassertion" action.
- If the temperature drops to 17 degrees Celsius or lower, the PX3 performs the "deassertion" action to announce the end of the "above upper warning" state.

Default Voltage and Current Thresholds

The following are factory-default voltage and current thresholds applied to a Raritan power product. There are no default values set for *lower* current thresholds because lower thresholds are not useful.

Availability of diverse thresholds depends on the capability of the model you purchased.

▶ **Single-phase inlets or outlets:**

- **RMS voltage:**

Threshold	Default value
Lower critical	-6% of minimum rating
Lower warning	-3% of minimum rating
Upper warning	+3% of maximum rating
Upper critical	+6% of maximum rating
Hysteresis	2V

- **RMS current:**

Threshold	Default value
Upper warning	65% of rating
Upper critical	80% of rating
Hysteresis	1A

▶ **Multi-phase inlets or outlets:**

• **Line-Line RMS voltage:**

Threshold	Default value
Lower critical	-6% of minimum rating
Lower warning	-3% of minimum rating
Upper warning	+3% of maximum rating
Upper critical	+6% of maximum rating
Hysteresis	2V

• **Line RMS current:**

Threshold	Default value
Upper warning	65% of rating
Upper critical	80% of rating
Hysteresis	1A

• **Unbalanced current:**

Threshold	Default value
Upper critical	10% -- disabled by default
Upper warning	5% -- disabled by default
Hysteresis	2%

▶ **Overcurrent protectors which aims to protect the PDU's outlets:**

• **OCP RMS current:**

Threshold	Default value
Upper critical	80% of OCP rating
Upper warning	65% of OCP rating
Hysteresis	1A

► **Total residual current:**

Threshold	Default value
Upper critical	30mA
Hysteresis	15mA

Altitude Correction Factors

If a Raritan differential air pressure sensor is attached to your device, the altitude you enter for the device can serve as an altitude correction factor. That is, the reading of the differential air pressure sensor will be multiplied by the correction factor to get a correct reading.

This table shows the relationship between different altitudes and correction factors.

Altitude (meters)	Altitude (feet)	Correction factor
0	0	0.95
250	820	0.98
425	1394	1.00
500	1640	1.01
740	2428	1.04
1500	4921	1.15
2250	7382	1.26
3000	9842	1.38

Unbalanced Current Calculation

Unbalanced current information is available on 3-phase models only. This section explains how PX3 calculates the unbalanced current percentage.

► **Calculation:**

1. Calculate the average current of all 3 lines.
Average current = $(L1+L2+L3) / 3$

2. Calculate each line's current unbalance by having each line current subtracted and divided with the average current.

Appendix L: Additional PX3 Information

L1 current unbalance = (L1 - average current) / average current

L2 current unbalance = (L2 - average current) / average current

L3 current unbalance = (L3 - average current) / average current

3. Determine the maximum absolute value among three lines' current unbalance values.

Maximum (|L1 current unbalance|, |L2 current unbalance|, |L3 current unbalance|)

4. Convert the maximum value to a percentage.

Unbalanced load percent = 100 * maximum current unbalance

► **Example:**

- Each line's current:

L1 = 5.5 amps

L2 = 5.2 amps

L3 = 4.0 amps

- Average current: $(5.5+5.2+4.0) / 3 = 4.9$ amps

- L1 current unbalance: $(5.5 - 4.9) / 4.9 = 0.1224$
- L2 current unbalance: $(5.2 - 4.9) / 4.9 = 0.0612$
- L3 current unbalance: $(4.0 - 4.9) / 4.9 = -0.1837$

- Maximum current unbalance:

Maximum (|0.1224|, |0.0612|, |-0.1837|) = 0.1837

- Current unbalance converted to a percentage:

$100 * (0.1837) = 18\%$

Data for BTU Calculation

The heat generated by the PX3 device differs according to the model you purchased. To calculate the heat (BTU/hr), use the following power data according to your model type in the BTU calculation formula.

Model name	Maximum power (Watt)
1000 series	5

Model name	Maximum power (Watt)
2000 series	20
3000 series	24
4000 series	24
5000 series	24

Ways to Probe Existing User Profiles

This section indicates available ways to query existing user accounts on the PX3.

- With SNMP v3 activated, you get the "user unknown" error when the user name used to authenticate does not exist.
- Any user with the permission to view event rules can query all local existing users via JSON RPC.
- Any user with the permission to view the event log may get information about existing users from the log entries.
- Any authenticated users can query currently-existing connection sessions, including Webcam-Live-Preview sessions, which show a list of associated user names.

Raritan Training Website

Raritan offers free training materials for various Raritan products on the **Raritan training website <http://www.raritantraining.com>**. The Raritan products introduced on this website include intelligent PDU, KVM, EMX, BCM, and CommandCenter Secure Gateway (CC-SG).

To get access to these training materials or courses, you need to apply for a username and password through the Raritan training website. After you are verified, you can access the Raritan training website anytime.

Role of a DNS Server

As Internet communications are carried out on the basis of IP addresses, appropriate DNS server settings are required for mapping domain names (host names) to corresponding IP addresses, or the PX3 may fail to connect to the given host.

Therefore, DNS server settings are important for external authentication. With appropriate DNS settings, the PX3 can resolve the external authentication server's name to an IP address for establishing a connection. If the *SSL/TLS encryption* is enabled, the DNS server settings become critical since only fully qualified domain name can be used for specifying the LDAP server.

For information on external authentication, see **Setting Up External Authentication** (on page 349).

Cascading Troubleshooting

Any accessibility problem occurred on one of the devices in the cascading chain may result in failure to access all downstream slave devices that are connected to it.

Possible Root Causes

The following lists the network accessibility issues and possible root causes.

You can always troubleshoot the software settings by connecting the PX3 to a computer if network access to that PX3 fails. See **Connecting the PX3 to a Computer** (on page 30).

Symptom	Probable cause
Failure to access the master device	<ul style="list-style-type: none"> • Anything below is lost or loose on the master device: <ul style="list-style-type: none"> ▪ Network connection ▪ Power supply • Anything below is disabled on the master device: <ul style="list-style-type: none"> ▪ The Ethernet or wireless interface ▪ IPv4 or IPv6 settings • In the Port Forwarding mode, related settings are incorrectly configured on the master device. <ul style="list-style-type: none"> ▪ The master device's role is incorrectly set to 'Slave'. ▪ The interface where the network is connected is incorrectly set as the downstream interface. • For the wireless networking, one of the following issues occurs: <ul style="list-style-type: none"> ▪ The USB wireless LAN adapter attached to the master device is not the Raritan USB WIFI LAN adapter. See USB Wireless LAN Adapters (on page 22). ▪ The wireless LAN configuration is not supported. See Supported Wireless LAN Configuration (on page 22). ▪ The installed CA certificate chain contains any certificate that has expired or is not valid yet.

Symptom	Probable cause
Failure to access a slave device	<ul style="list-style-type: none"> • One of the following issues occurs on the master device: <ul style="list-style-type: none"> ▪ Network connection is lost. ▪ Power is lost. ▪ The Ethernet or wireless interface is disabled. • One of the following issues occurs on the slave device in question or any upstream device (if available): <ul style="list-style-type: none"> ▪ Connection of the cascading cable is loose or lost. ▪ No power supply. ▪ The cascading mode is set incorrectly. For example, the master device is set to Bridging, but the slave device in question or any upstream device is set to Port Forwarding. • In the Bridging mode, IPv4 (or IPv6) settings are disabled on the slave device in question. • In the Port Forwarding mode, one of the following issues occurs: <ul style="list-style-type: none"> ▪ The master device's role is incorrectly set to 'Slave'. ▪ The master device's downstream interface is incorrectly set. For example, you use a USB cable to connect the 1st slave device, but select the Ethernet port as the downstream interface. ▪ The role of the slave device in question or any upstream device is set to 'Master' instead of 'Slave'. ▪ The port number you added to the IP address is incorrect. See Port Number Syntax (on page 321). ▪ IPv4 (or IPv6) settings are disabled on the master device. • The slave device in question or any upstream device is a Raritan product that runs a "pre-3.3.10" firmware version while the rest of the chain runs firmware version 3.3.10 or later.

*Tip: To determine which PX3 may be the failure point of network, you may ping each PX3 in the cascading chain, or check the slave-related events in the event log of each PX3. See **The Ping Tool** (on page 896) and **Slave Device Events in the Log** (on page 895).*

► **For a cascading chain comprising only products with "dual" Ethernet ports, also check the following:**

- Whether the Ethernet interface (ETH1 or ETH2) where the network or cascading cable is connected is disabled on the cascaded device in question or any upstream device.
- Whether the connection complies with the cascading guidelines, when set to the Port Forwarding mode. See **Restrictions of Port-Forwarding Connections** (on page 40).
- Whether a newer product model, if involved in the chain, runs the appropriate minimum firmware version or later.

Slave Device Events in the Log

The log messages for connection/disconnection of a cascaded device are different for USB-cascading and Ethernet-cascading chains.

► **Messages for the Ethernet-cascading chain:**

Whenever the connection or disconnection of a master/slave device is detected, both PX3 devices connected via that network cable record this event in their internal logs.

There are two slave-related events:

Event	Description
The ETH1/2 network interface link is now up.	This log entry is generated when the PX3 detects the connection of the upstream or downstream cascaded device on one of its Ethernet ports.
The ETH1/2 network interface link is now down.	This log entry is generated when the PX3 detects the disconnection of the upstream or downstream cascaded device on one of its Ethernet ports.

▶ **Messages for the USB-cascading chain:**

In the Bridging mode, events regarding connection/disconnection of a downstream slave device via USB is NOT logged.

However, in the Port Forwarding mode, whenever the connection or disconnection of a downstream slave device via USB is detected, the PX3 at the USB-A end of the USB cable logs it in the internal log. Note that the PX3 at the USB-B end of the cable does NOT log these events.

There are two slave-related events in the Port Forwarding mode:

Event	Description
Slave connected	This log entry is generated when the PX3 detects the presence of a slave device on its USB-A port.
Slave disconnected	This log entry is generated when it detects the disconnection of a slave device from its USB-A port.

The Ping Tool

The PX3 provides a ping tool in the web interface and CLI so you can ping any host or PX3 in your data center.

▶ **Ping via the Web Interface:**

To log in to the web interface, see **Login** (on page 171).

The Ping tool is useful for checking whether a host is accessible through the network or Internet.

- Choose Maintenance > Network Diagnostics

▶ **Ping via the CLI:**

You can access the CLI interface by connecting a computer to the PX3 or using SSH/Telnet. See **With SSH or Telnet** (on page 517).

1. You must perform the ping command in the diagnostic mode. See **Entering Diagnostic Mode** (on page 702).
2. Then perform the ping command. See **Testing the Network Connectivity** (on page 703).

Installing the USB-to-Serial Driver (Optional)

The PX3 can emulate a USB-to-serial converter over a USB connection. A USB-to-serial driver named "Dominion PX2 Serial Console" is required for Microsoft® Windows® operating systems.

Download the Windows driver for USB serial console from the Raritan website's **Support page** (<http://www.raritan.com/support/>). The downloaded driver's name is *dominion-serial-setup-<n>.exe*, where <n> represents the file's version number.

There are two ways to install this driver: automatic and manual installation. Automatic driver installation is highly recommended.

▶ Automatic driver installation in Windows®:

1. Make sure the PX3 is NOT connected to the computer via a USB cable.
2. Run *dominion-serial-setup-<n>.exe* on the computer and follow online instructions to install the driver.

Note: If any Windows security warning appears, accept it to continue the installation.

3. Connect the PX3 to the computer via a USB cable. The driver is automatically installed.

▶ Manual driver installation in Windows®:

1. Make sure the PX3 has been connected to the computer via a USB cable.
2. The computer detects the new device and the "Found New Hardware Wizard" dialog appears.
 - If this dialog does not appear, choose Control Panel > System > Hardware > Device Manager, right-click the *Dominion PX2 Serial Console*, and choose Update Driver.
3. Select the option of driver installation from a specific location, and then specify the location where both *dominion-serial.inf* and *dominion-serial.cat* are stored.

Note: If any Windows security warning appears, accept it to continue the installation.

4. Wait until the installation is complete.

Note: If the PX3 enters the disaster recovery mode when the USB serial driver is not installed yet, it may be shown as a 'GPS camera' in the Device Manager on the computer connected to it.

► **In Linux:**

No additional drivers are required, but you must provide the name of the tty device, which can be found in the output of the "dmesg" after connecting the PX3 to the computer. Usually the tty device is "/dev/ttyACM#" or "/dev/ttyUSB#", where # is an integer number.

For example, if you are using the kermit terminal program, and the tty device is "/dev/ttyACM0," perform the following commands:

```
> set line /dev/ttyACM0
> Connect
```

Initial Network Configuration via CLI

After the PX3 is connected to your network, you must provide it with an IP address and some additional networking information.

This section describes the initial network configuration via a serial RS-232 or USB connection. To configure the network settings using the web interface, see **Configuring Network Settings** (on page 301).

► **To configure the PX3 device:**

1. On the computer connected to the PX3, open a communications program such as HyperTerminal or PuTTY.
2. Select the appropriate COM port, and set the following port settings:
 - Bits per second = 115200 (115.2Kbps)
 - Data bits = 8
 - Stop bits = 1
 - Parity = None
 - Flow control = None

Tip: For a USB connection, you can determine the COM port by choosing Control Panel > System > Hardware > Device Manager, and locating the "Dominion PX2 Serial Console" under the Ports group.

3. In the communications program, press Enter to send a carriage return to the PX3.
4. The PX3 prompts you to log in. Both user name and password are case sensitive.
 - a. Username: admin
 - b. Default password: raritan (or a new password if you have changed it).
5. If prompted to change the default password, change or ignore it.

- To change it, follow onscreen instructions to type your new password.
 - To ignore it, simply press Enter.
6. The # prompt appears.
 7. Type `config` and press Enter.
 8. To configure network settings, type appropriate commands and press Enter. Refer to the following commands list. CLI commands are case sensitive.
 9. After finishing the network settings, type `apply` to save changes. To abort, type `cancel`.

► **Commands for wired networking:**

The <ipvX> variable in the following commands is either *ipv4* or *ipv6*, depending on the type of IP protocol you are configuring.

For PX2 and "old" PX3 that have only one Ethernet port, replace the variable <ETH> with the word "ethernet". For PX3 that has two Ethernet ports, replace the variable <ETH> with either 'ETH1' or 'ETH2', depending on which Ethernet port you are configuring.

• **General IP settings:**

To set or enable	Use this command
IPv4 or IPv6 protocol	network <ipvX> interface <ETH> enabled <option> <option> = <i>true</i> , or <i>false</i>
IPv4 configuration method	network ipv4 interface <ETH> configMethod <mode> <mode> = <i>dhcp</i> (default) or <i>static</i>
IPv6 configuration method	network ipv6 interface <ETH> configMethod <mode> <mode> = <i>automatic</i> (default) or <i>static</i>
Preferred host name (optional)	network <ipvX> interface <ETH> preferredHostName <name> <name> = preferred host name
IP address returned by the DNS server	network dns resolverPreference <resolver> <resolver> = <i>preferV4</i> or <i>preferV6</i>

- **Static IP configuration:**

To set	Use this command
Static IPv4 or IPv6 address	<pre>network <ipvX> interface <ETH> address <ip address></pre> <p><ip address> = static IP address, with a syntax similar to the example below.</p> <ul style="list-style-type: none"> ▪ Example: <i>192.168.7.9/24</i>
Static IPv4 or IPv6 gateway	<pre>network <ipvX> gateway <ip address></pre> <p><ip address> = gateway's IP address</p>
IPv4 or IPv6 primary DNS server	<pre>network dns firstServer <ip address></pre> <p><ip address> = DNS server's IP address</p>
IPv4 or IPv6 secondary DNS server	<pre>network dns secondServer <ip address></pre> <p><ip address> = DNS server's IP address</p>
IPv4 or IPv6 third DNS server	<pre>network dns thirdServer <ip address></pre> <p><ip address> = DNS server's IP address</p>

- ▶ **Commands for "Ethernet" authentication method:**

To set or enable	Use this command
Authentication method	<pre>network ethernet <ETH> authMethod <method></pre> <p><method> = <i>none</i> or <i>eap</i></p>
EAP outer authentication	<pre>network ethernet <ETH> eapOuterAuthentication <outer_auth></pre> <p><outer_auth> = <i>PEAP</i> or <i>TLS</i></p>
EAP inner authentication	<pre>network ethernet <ETH> eapInnerAuthentication <inner_auth></pre> <p><inner_auth> = <i>MSCHAPv2</i> or <i>TLS</i></p>

To set or enable	Use this command
EAP identity	<pre>network ethernet <ETH> eapIdentity <identity></pre> <p><identity> = your user name for EAP authentication</p>
EAP TLS client certificate	<pre>network ethernet <ETH> eapClientCertificate</pre> <p>When prompted to enter the client certificate, open the certificate with a text editor, copy and paste the content into the communications program.</p>
EAP TLS client private key	<pre>network ethernet <ETH> eapClientPrivateKey</pre> <p>When prompted to enter the private key, open the key with a text editor, copy and paste the content into the communications program.</p>
EAP password	<pre>network ethernet <ETH> eapPassword</pre> <p>When prompted to enter the password for EAP authentication, type the password.</p>
EAP CA certificate	<pre>network ethernet <ETH> eapCACertificate</pre> <p>When prompted to enter the CA certificate, open the certificate with a text editor, copy and paste the content into the communications program.</p>
Radius authentication server's name	<pre>network ethernet <ETH> eapAuthServerName <FQDN></pre> <p><FQDN> = Fully qualified domain name of the Radius server name shown in the CA certificate</p>

The content to be copied from the CA certificate does NOT include the first line containing "BEGIN CERTIFICATE" and the final line containing "END CERTIFICATE." If a certificate is installed, configure the following:

Whether to	Use this command
Verify the certificate	<pre>network ethernet <ETH> enableCertVerification <option1></pre> <p><option1> = <i>true</i> or <i>false</i></p>
Accept an expired or not valid certificate	<pre>network ethernet <ETH> allowOffTimeRangeCerts <option2></pre> <p><option2> = <i>true</i> or <i>false</i></p>
Make the connection successful by ignoring the "incorrect" system time	<pre>network ethernet <ETH> allowConnectionWithIncorrectClock <option3></pre> <p><option3> = <i>true</i> or <i>false</i></p>

► **Commands for wireless networking:**

• **General wireless settings:**

To set or enable	Use this command
Wireless interface	<pre>network wireless enabled <option></pre> <p><option> = <i>true</i>, or <i>false</i></p>
SSID	<pre>network wireless SSID <ssid></pre> <p><ssid> = SSID string</p>
BSSID	<pre>network wireless BSSID <bssid></pre> <p><bssid> = AP MAC address or <i>none</i></p>
802.11n protocol	<pre>network wireless enableHT <option></pre> <p><option> = <i>true</i>, or <i>false</i></p>

To set or enable	Use this command
Wireless authentication method	<pre>network wireless authMethod <method></pre> <p><method> = <i>psk</i> or <i>eap</i></p>
PSK	<pre>network wireless PSK <psk></pre> <p><psk> = PSK string</p>
Wireless EAP outer authentication	<pre>network wireless eapOuterAuthentication <outer_auth></pre> <p><outer_auth> = <i>PEAP</i> or <i>TLS</i></p>
Wireless EAP inner authentication	<pre>network wireless eapInnerAuthentication <inner_auth></pre> <p><inner_auth> = <i>MSCHAPv2</i> or <i>TLS</i></p>
Wireless EAP identity	<pre>network wireless eapIdentity <identity></pre> <p><identity> = your user name for EAP authentication</p>
Wireless EAP TLS client certificate	<pre>network wireless eapClientCertificate</pre> <p>When prompted to enter the client certificate, open the certificate with a text editor, copy and paste the content into the communications program.</p>
Wireless EAP TLS client private key	<pre>network wireless eapClientPrivateKey</pre> <p>When prompted to enter the private key, open the key with a text editor, copy and paste the content into the communications program.</p>
Wireless EAP password	<pre>network wireless eapPassword</pre> <p>When prompted to enter the password for EAP authentication, type the password.</p>

To set or enable	Use this command
Wireless EAP CA certificate	<pre>network wireless eapCACertificate</pre> <p>When prompted to enter the CA certificate, open the certificate with a text editor, copy and paste the content into the communications program.</p>
Radius authentication server's name for wireless connection	<pre>network wireless eapAuthServerName <FQDN></pre> <p><FQDN> = Fully qualified domain name of the Radius server name shown in the CA certificate</p>

The content to be copied from the CA certificate does NOT include the first line containing "BEGIN CERTIFICATE" and the final line containing "END CERTIFICATE." If a certificate is installed, configure the following:

Whether to	Use this command
Verify the certificate	<pre>network wireless enableCertVerification <option1></pre> <p><option1> = <i>true</i> or <i>false</i></p>
Accept an expired or not valid certificate	<pre>network wireless allowOffTimeRangeCerts <option2></pre> <p><option2> = <i>true</i> or <i>false</i></p>
Make the connection successful by ignoring the "incorrect" system time	<pre>network wireless allowConnectionWithIncorrectClock <option3></pre> <p><option3> = <i>true</i> or <i>false</i></p>

- **Wireless IPv4 / IPv6 settings:**

Commands for wireless IP settings are identical to those for wired networking. Just replace the variable <ETH> with the word 'wireless'. The following illustrates a few examples.

To set or enable	Use this command
IPv4 configuration method	<code>network ipv4 interface WIRELESS configMethod <mode></code> <mode> = <i>dhcp</i> (default) or <i>static</i>
IPv6 configuration method	<code>network ipv6 interface WIRELESS configMethod <mode></code> <mode> = <i>automatic</i> (default) or <i>static</i>

▶ **To verify network settings:**

After exiting the above configuration mode and the # prompt re-appears, type this command to verify all network settings.

- `show network`

The IP address configured may take seconds to take effect.

Device-Specific Settings

A bulk configuration file will NOT contain any device-specific information like the following list.

For further information, simply open the built-in bulk profile for a detailed list of 'excluded' settings.

- Device name
- SNMP system name, contact and location
- Part of network settings (IP address, gateway, netmask and so on)
- Device logs
- Names, states and values of environmental sensors and actuators
- TLS certificate
- Server monitoring entries
- Asset strip names and rack unit names
- Outlet names and states

TLS Certificate Chain

A TLS server sends out a certificate to any client attempting to connect to it. The receiver determines whether a TLS server can be trusted by verifying that server's certificate, using the certificate (chain) stored on the receiver.

Therefore, to successfully connect to a TLS server, you must upload a valid certificate or (partial) certificate chain to the receiver.

The uploaded certificate (chain) must contain all missing certificates "related to" that TLS server's certificate in some way. Otherwise, the connection made to that TLS server will fail.

- For information on how the uploaded certificate (chain) is related to a TLS server's certificate, see **What is a Certificate Chain** (on page 906).
- For an example of creating and uploading a TLS certificate to PX3, see **Illustration - GMAIL SMTP Certificate Chain** (on page 909).

What is a Certificate Chain

If you are familiar with a certificate chain, you can ignore this topic and refer to **Illustration - GMAIL SMTP Certificate Chain** (on page 909).

A certificate or a chain of certificates is used for trusting a TLS server that you want to connect.

The receiver, such as PX3, can trust a TLS server only after an appropriate certificate (chain) which is "related to" that TLS server's certificate is uploaded to the receiver.

► How a certificate chain is generated:

To explain how a TLS server's certificate is "related to" the certificate (chain) that is uploaded to the receiver, we assume that there are three "related" certificates.

- **Certificate C.** The certificate issued to the TLS server you want to connect. 'Certificate C' is issued by the certificate authority (CA) entity called 'Issuer B'.
- **Certificate B.** The certificate issued to 'Issuer B'. 'Certificate B' is issued by a CA entity called 'Issuer A', and it is an intermediate certificate.

- **Certificate A.** The self-signed certificate issued by Issuer A. Issuer A is a root CA.

The above three certificates form a certificate path, which is called the "certificate chain".



Each certificate in the chain is the issuer certificate of the certificate that follows it. That is, A is the issuer certificate of B, and B is the issuer certificate of C.

Note: In fact many certificate chains may comprise only the root certificate and a TLS server's certificate and do not have any intermediate certificate(s) like 'Certificate B' involved. Or some chains may contain more than one intermediate certificates.

► **Certificate (chain) that you must upload to the receiver, such as PX3:**

Because the TLS server provides only 'Certificate C', you need to upload a file containing the missing certificates of the chain (that is, 'Certificate A' and 'Certificate B') to the receiver.

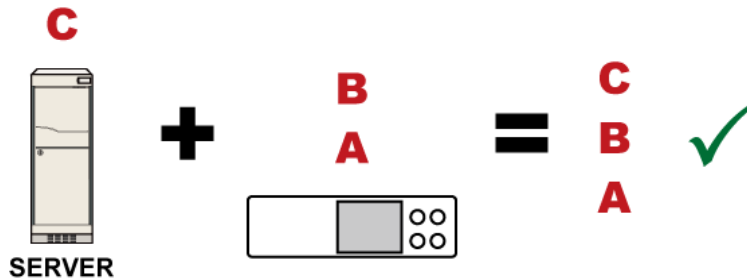

In reality some servers may provide a partial (or even a full) certificate chain instead of a single server certificate. If your server provides a partial certificate chain containing 'Certificate B' and 'Certificate C', then you only need to upload 'Certificate A' to the receiver. If the server has a full certificate chain containing Certificates 'A', 'B', and 'C', then you also need to upload the root certificate 'A'.

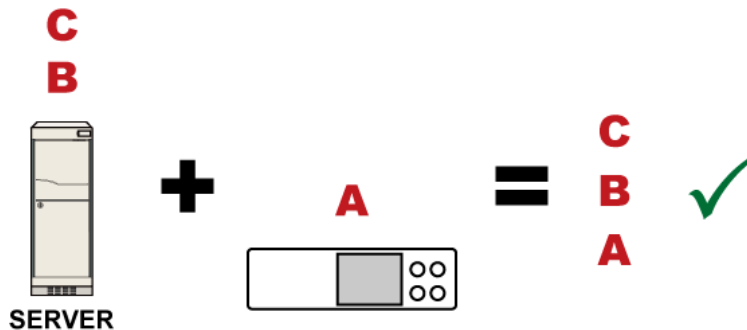

Warning: The certificate (chain) uploaded to the receiver must always contain the ROOT certificate even though the TLS server provides the root certificate. When uploading a (partial) chain onto the PX3, it means you trust each certificate in the chain to certify the authenticity of certificates a server sends to PX3. Therefore, at least the root certificate must be authentic, issued by a CA you trust, and downloaded from that CA over a secure channel. Never implicitly trust a root certificate that is sent by the server which you want to connect to. It could have been created by an attacker.

If either certificate 'A' or 'B' is missing in the certificate file uploaded to the receiver, the connection to the wanted TLS server will fail.

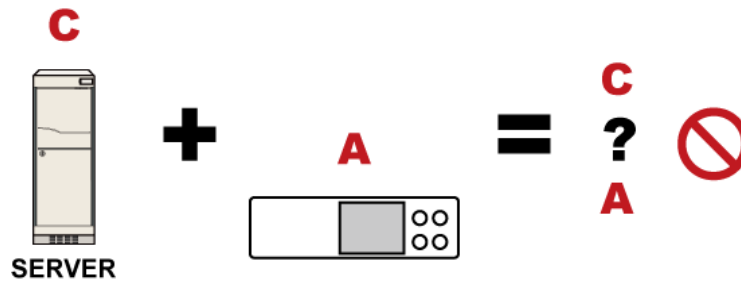

For PX3, if any required certificate is missing, a certificate error message similar to the following is shown on the PX3 web interface.

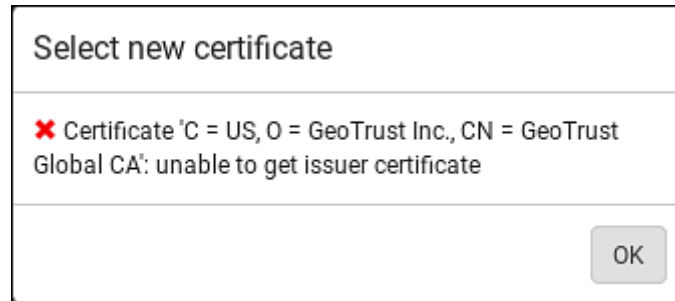

It is NOT recommended to upload the server certificate to the receiver except when it is a self-signed certificate. Using self-signed server certificates is also not recommended and may not even work in all cases.

► **Order of the chain in the certificate file:**

The order of a certificate chain's content in the certificate file uploaded to the receiver must look like the following.

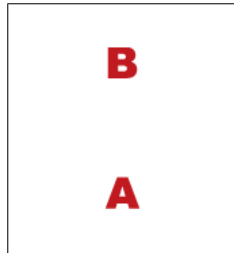

- The top is the final intermediate certificate of the chain "B" if you have to upload a partial chain.
- The bottom is always the root certificate "A".
- When copying multiple certificates to a single file, make sure you also copy the lines of BEGIN CERTIFICATE and END CERTIFICATE from each certificate.

Illustration - GMAIL SMTP Certificate Chain

If you will apply your company's SMTP service to PX3, ignore this GMAIL illustration topic. Simply contact your IT department to retrieve the appropriate certificate (chain) file and upload it to the PX3.

This section illustrates the upload of a TLS "root" certificate for using the "gmail.com" SMTP service.

Unlike normal TLS websites, where you can easily find its server certificate by using a Web browser, the method to find an SMTP server's certificate is more difficult, which requires appropriate tools and sufficient technical knowledge. For example, you may have to use the openssl command as illustrated below to retrieve the certificate of the GMAIL SMTP server.

► **Step 1 -- Find the certificate(s) the SMTP server has:**

1. Issue the following command in the appropriate command line application.
 - In the following example command, we assume the server "smtp.gmail.com" provides the SMTP service. You can change the server name, port number, command or even the tool as needed.

```
openssl s_client -showcerts -connect smtp.gmail.com:465
```

Alternative: To view the certificate chain instead of all certificates, you can remove the "-showcerts" option from the above command.

2. Information that shows the certificates the SMTP server has is displayed.

```
.  
. .  
Certificate chain  
0 s:/C=US/ST=California/L=Mountain View/O=Google Inc/CN=smtp.gmail.com  
i:/C=US/O=Google Inc/CN=Google Internet Authority G2  
-----BEGIN CERTIFICATE-----  
MIIEdjCCA16gAwIBAgIIbzO9vIL2OXcwDQYJKoZIhvcNAQELBQAwSTELMAkGA1UE  
. .  
YHKKJH96sSNC+6dLpOOoRritL5z+jn2WFLcQkL2mRoWQi6pYTzPyXB4D  
-----END CERTIFICATE-----  
1 s:/C=US/O=Google Inc/CN=Google Internet Authority G2  
i:/C=US/O=GeoTrust Inc./CN=GeoTrust Global CA  
-----BEGIN CERTIFICATE-----  
MIIEKDCCAxCGAwIBAgIQAQAhJYiw+lmnd+8Fe2Yn3zANBgkqhkiG9w0BAQsFADBC  
. .  
MqO5tzHpCvX2HzLc  
-----END CERTIFICATE-----  
2 s:/C=US/O=GeoTrust Inc./CN=GeoTrust Global CA  
i:/C=US/O=Equifax/OU=Equifax Secure Certificate Authority  
-----BEGIN CERTIFICATE-----  
MIIDfTCCAuagAwIBAgIDervmMA0GCSqGSIb3DQEBBQUAME4xCzAJBgNVBAYTAlVT  
. .  
b8ravHNjkOR/ez4iyz0H7V84dJzjA1BOoa+Y7mHyhD8S  
-----END CERTIFICATE-----  
---  
Server certificate  
subject=/C=US/ST=California/L=Mountain View/O=Google  
Inc/CN=smtp.gmail.com  
issuer=/C=US/O=Google Inc/CN=Google Internet Authority G2  
. . .
```

3. Onscreen information under the title 'Certificate chain' indicates that there are three issuers and three certificates on this server.
- Each line beginning with the letter "i" indicates an issuer. They are:

- *Google Internet Authority G2*
 - *GeoTrust Global CA*
 - *Equifax Secure Certificate Authority*
 - Each certificate's content is located between the line of "BEGIN CERTIFICATE" and the line of "END CERTIFICATE".
 - The topmost certificate is the server certificate.
4. The section titled "Server certificate" indicates that the issuer (CA) *Google Internet Authority G2* issues the server certificate.
 5. As the server has the server certificate and two intermediate certificates, we conclude that this server sends a partial certificate chain to the receiver.
 6. Check whether the issuer "Equifax Secure Certificate Authority" is the root CA.
 - If yes, you only need to upload the root certificate self-signed by *Equifax Secure Certificate Authority* to PX3.
 - If not, you need to find all missing issuer certificates, including the root certificate, and upload them to PX3.

▶ **Step 2 -- Find and download the content of missing issuer certificate(s):**

1. View the name of the issuer (CA) at the bottom. In this example, this issuer is 'Equifax Secure Certificate Authority'.
2. Use the issuer's name 'Equifax Secure Certificate Authority' to search for its certificate on the Internet, and then download or copy the content from an authentic source, which is usually its official website.

Important: To prevent the downloaded certificate from being modified or manipulated, you must secure the download with TLS via a trusted certificate.

3. As it is found the Equifax Secure Certificate Authority's certificate is self signed by 'Equifax Secure Certificate Authority', which indicates it is the root CA, there are no more missing certificates to search for.

▶ **Step 3 -- Upload the missing certificate(s) to PX3:**

1. Paste the root certificate's content into a plain text file that will be uploaded to PX3.
 - Content copying must include the lines of "BEGIN CERTIFICATE" and "END CERTIFICATE".
2. Save that file as a *.pem*, *.crt* or *.cer* file. In this example, it is named as "my-root.pem."
3. Upload the file "my-root.pem" to PX3 for using the GMAIL SMTP service.

*Note: If your SMTP server requires the upload of a certificate file comprising multiple certificates, make sure the order of these certificates is correct in the file. See **What is a Certificate Chain** (on page 906).*

► **IMPORTANT NOTE:**









If your SMTP server provides a full certificate chain, you should be suspicious whether any attacker fakes the certificate chain and doubt whether the root certificate on that server is authentic. It is **STRONGLY** recommended to download the root certificate from an authentic source, which is usually the root CA's website, rather than from the server you want to connect.

Browsing through the Online Help



The PX3 Online Help is accessible over the Internet.

To use online help, Active Content must be enabled in your browser. Consult your browser help for information on enabling the feature.

► **To use the PX3 online help:**

1. Click Online Documentation. See **Web Interface Overview** (on page 175).
2. The online help opens in the default web browser.
3. To view the content of any topic, click the topic in the left pane. Then its content is displayed in the right pane.
4. To select a different topic, do any of the following:
 - To view the next topic, click the Next icon  in the toolbar.
 - To view the previous topic, click the Previous icon .
 - To view the first topic, click the Home icon .
5. To expand or collapse a topic that contains sub-topics, do the following:
 - To expand any topic, click the white arrow  prior to the topic, or double-click that topic. The arrow turns into a black, gradient arrow  and sub-topics appear below the topic.
 - To collapse any expanded topic, click the black, gradient arrow  prior to the topic, or double-click the expanded topic. The arrow then turns into a white arrow , and all sub-topics below that topic disappear.
6. To search for specific information, type the key word(s) or string(s) in the Search text box, and press Enter or click the Search icon  to start the search.
 - If necessary, select the "Match partial words" checkbox to include information matching part of the words entered in the Search text box.

The search results are displayed in the left pane.

7. To have the left pane show the list of topics, click the Contents tab at the bottom.
8. To show the Index page, click the Index tab.
9. To email any URL link to the currently selected topic to any person, click the "Email this page" icon  in the toolbar.
10. To email your comments or suggestions regarding the online help to Raritan, click the "Send feedback" icon .
11. To print the currently selected topic, click the "Print this page" icon .

Appendix M Integration

The PX3 can work with certain Raritan or third-party products to provide diverse power solutions.

In This Chapter

Dominion KX II / III Configuration	914
Dominion KSX II, SX or SX II Configuration	919
Power IQ Configuration	924
dcTrack.....	925

Dominion KX II / III Configuration

Raritan PX2, PX3 or PX3TS series can be connected to the Raritan's Dominion KX II or KX III device (a digital KVM switch) to provide one more alternative of power management.

Note that this integration requires the following firmware versions:

- Dominion KX II -- 2.4 or later
- Dominion KX III -- ALL versions
- PX2 series -- 2.2 or later
- PX3 series -- 2.5.10 or later
- PX3TS series -- 2.6.1 or later

Dominion KX II or KX III integration requires D2CIM-PWR and straight CAT5 cable.

For more information on KX II / III, refer to:

- KX II or KX III User Guide on the **Support page** (<http://www.raritan.com/support/>)
- KX II or KX III Online Help on the **Product Online Help page** (<http://www.raritan.com/support/online-help/>)

Note: For documentation conveniences, both Dominion KX II and KX III products are referred to as "KX III" in the following sections.

Configuring Rack PDU Targets

KX III allows you to connect rack PDUs (power strips) to KX III ports.

KX III rack PDU configuration is done from the KX III Port Configuration page.

Note: Raritan recommends no more than eight (8) rack PDUs (power strips) be connected to a KX III at once since performance may be affected.

Connecting a PX PDU

Raritan PX series rack PDUs (power strips) are connected to the Dominion device using the D2CIM-PWR CIM.

► **To connect the rack PDU:**

1. Connect the male RJ-45 of the D2CIM-PWR to the following female RJ-45 connector of the rack PDU.
 - PX1 series: RJ-45 "SERIAL" port
 - PX2, PX3 or PX3TS series: RJ-45 "FEATURE" port
2. Connect the female RJ-45 connector of the D2CIM-PWR to any of the available female system port connectors on the KX III using a straight through Cat5 cable.
3. Attach an AC power cord to the target server and an available rack PDU outlet.
4. Connect the rack PDU to an AC power source.
5. Power on the device.

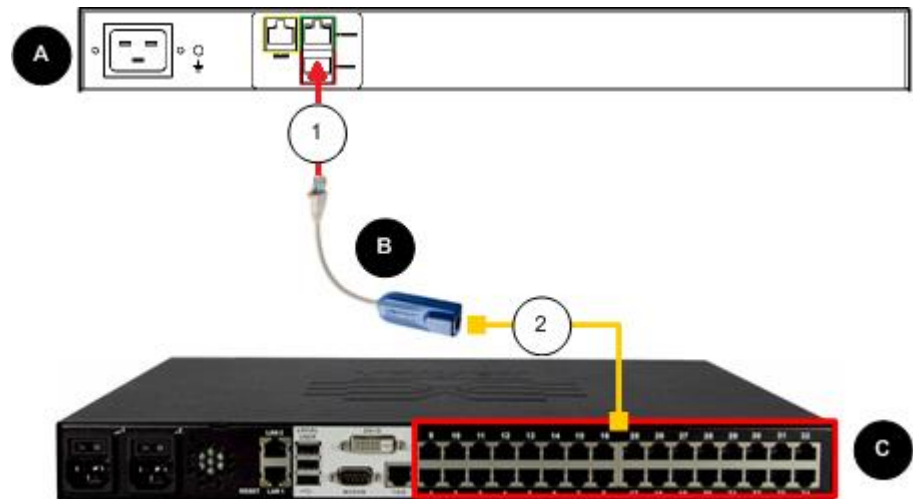

Diagram key

A	PX rack PDU
B	D2CIM-PWR
C	KX III

1	D2CIM-PWR to rack PDU connection
2	D2CIM-PWR to KX III target device port via Cat5 cable

Naming the Rack PDU (Port Page for Power Strips)

Note: PX rack PDUs (power strips) can be named in the PX as well as in the KX III.

Once a Raritan remote rack PDU is connected to the KX III, it will appear on the Port Configuration page. Click on the power port name on that page to access it. The Type and the Name fields are prepopulated.

Note: The (CIM) Type cannot be changed.

The following information is displayed for each outlet on the rack PDU: [Outlet] Number, Name, and Port Association.

Use this page to name the rack PDU and its outlets. Names can be up to 32 alphanumeric characters and can include special characters.

Note: When a rack PDU is associated with a target server (port), the outlet name is replaced by the target server name, even if you assigned another name to the outlet.

► **To name the rack PDU and outlets:**

Note: CommandCenter Secure Gateway does not recognize rack PDU names containing spaces.

1. Enter the Name of the rack PDU (if needed).
2. Change the [Outlet] Name if desired. (Outlet names default to the outlet #.)

3. Click OK.

Home > Device Settings > Port Configuration > Port

Port 17

Type:
PowerStrip

Name:

Outlets

Number	Name	Port Association
1	<input type="text" value="Dominion-Port1(1)"/>	Dominion- Port7
2	<input type="text" value="Outlet 2"/>	
3	<input type="text" value="Outlet 3"/>	
4	<input type="text" value="Outlet 4"/>	
5	<input type="text" value="Outlet 5"/>	
6	<input type="text" value="Outlet 6"/>	
7	<input type="text" value="Outlet 7"/>	
8	<input type="text" value="Outlet 8"/>	

Associating Outlets with Target Devices

The Port page opens when you click on a port on the Port Configuration page.

If an outlet is connected to the same server that the port is connected to, a power association can be made with the target device.

A server can have up to four power plugs and you can associate a different rack PDU (power strip) with each. From this page, you can define those associations so that you can power on, power off, and power cycle the server from the Port Access page.

To use this feature, you will need:

- Raritan remote rack PDU(s)
- Power CIMs (D2CIM-PWR)

Make a Power Association

► **To make power associations (associate rack PDU outlets to KVM target servers):**

Note: When a rack PDU is associated to a target server (port), the outlet name is replaced by the target server name (even if you assigned another name to the outlet).

1. On the Port Configuration page, select the target server you are associating the PDU with.
2. Choose the rack PDU from the Power Strip Name drop-down list.
3. For that rack PDU, choose the outlet from the Outlet Name drop-down list.
4. Repeat steps 1 and 2 for all desired power associations.
5. Click OK. A confirmation message is displayed.

Turning Outlets On/Off and Cycling Power

► **To turn an outlet on:**

1. Click the Power menu to access the Powerstrip page.
2. From the Powerstrip drop-down, select the PX rack PDU (power strip) you want to turn on.
3. Click Refresh to view the power controls.
4. Click On next to the outlet you want to power on.
5. Click OK to close the Power On confirmation dialog. The outlet will be turned on and its state will be displayed as 'on'.

► **To turn an outlet off:**

1. Click Off next to the outlet you want to power off.
2. Click OK on the Power Off dialog.

- Click OK on the Power Off confirmation dialog. The outlet will be turned off and its state will be displayed as 'off'.

► **To cycle the power of an outlet:**

- Click Cycle next to the outlet you want to cycle. The Power Cycle Port dialog opens.
- Click OK. The outlet will then cycle (note that this may take a few seconds).
- Once the cycling is complete the dialog will open. Click OK to close the dialog.

Dominion KSX II, SX or SX II Configuration

Raritan PX3 support the integration with Raritan's serial access products - Dominion KSX II, Dominion SX and Dominion SX II.

Cables used for connecting the PX3 to different Dominion access products are different.

- KSX II - a standard network patch cable (CAT5 or higher)
- SX - a CSCSPCS cable
- SX II - a CSCSPCS cable

Note: To only access the CLI of the PX3 via SX / SX II, treat the PX3 as a serial device by connecting SX /SX II to the PDU's serial port instead of the FEATURE port.

For more information on these Dominion serial access product, refer to:

- KSX II, SX or SX II User Guide on the **Support page** (<http://www.raritan.com/support/>)
- KSX II, SX or SX II Online Help on the **Product Online Help page** (<http://www.raritan.com/support/online-help/>)

Dominion KSX II

After connecting a Dominion KSX II to the Raritan PDU, you can monitor the PDU and even control its outlets if the PDU is an outlet-switching capable model.

Connecting a Rack PDU

► **To connect the Raritan PX to the KSX II:**

- Connect one end of a Cat5 cable to the following ports of different Raritan PX.
 - PX1 series: RJ-45 "SERIAL" port
 - PX2, PX3 or PX3TS series: RJ-45 "FEATURE" port
- Connect the other end of the Cat5 cable to either the Power Ctrl. 1 or Power Ctrl. 2 ports on the back of the KSX II.

3. Attach an AC power cord to the target server and an available rack PDU outlet.
4. Connect the rack PDU to an AC power source.
5. Power on the KSX II device.

Important: When using CC-SG, the power ports should be inactive before attaching rack PDUs that were swapped between the power ports. If this is not done, there is a possibility that the number of power outlets will not be correctly detected, especially after swapping 8 and 20 outlet rack PDU models.

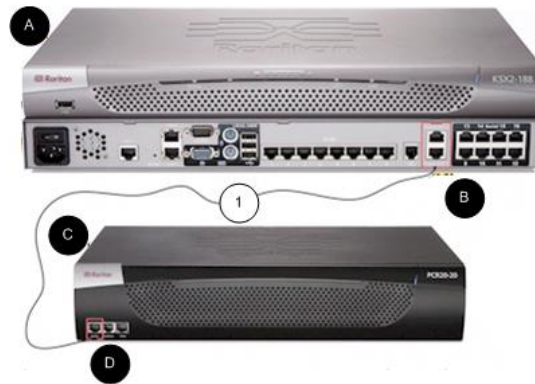

Diagram key			
A	KSX II	D	PX SERIAL or FEATURE port
B	KSX II Power Ctrl. 1 Port or Power Ctrl. 2 Port	1	Cat5 cable
C	PX		

Power Control

The KSX II operation to turn on/off or power cycle a PX is the same as the KX III operation. See **Turning Outlets On/Off and Cycling Power** (on page 918).

Dominion SX and SX II

By connecting to a Dominion SX or SX II device, you can associate one or more outlets on a PX3 device to specific SX or SX II ports.

Dominion SX II

The way to use Dominion SX II to configure and control a Raritan PDU is similar to using Dominion KX III, but the connection method is different from KX III.

Note: If using a CSCSPCS-1 cable for the connection, it must be "Rev.OC". If using a CSCSPCS-10 cable, it must be "Rev.OD".

Note that the appliances used in the diagram may not match your specific models. However, the connections and ports used are the same across models.

► **To connect the SX II to the Feature port on the PX:**

1. Connect the gray end of the CSCSPCS crossover Cat5 cable into the Feature port on the PX.
2. Connect the yellow end of the CSCSPCS crossover Cat5 cable into a port on the SX II.
3. Power on the PX (if it is not already).
4. You can now add the PX as a managed power strip to the SX II. See *Configure Power Strips from the Remote Console* or *Configure Power Strips Using CLI* in the SX II User Guide or Online Help.

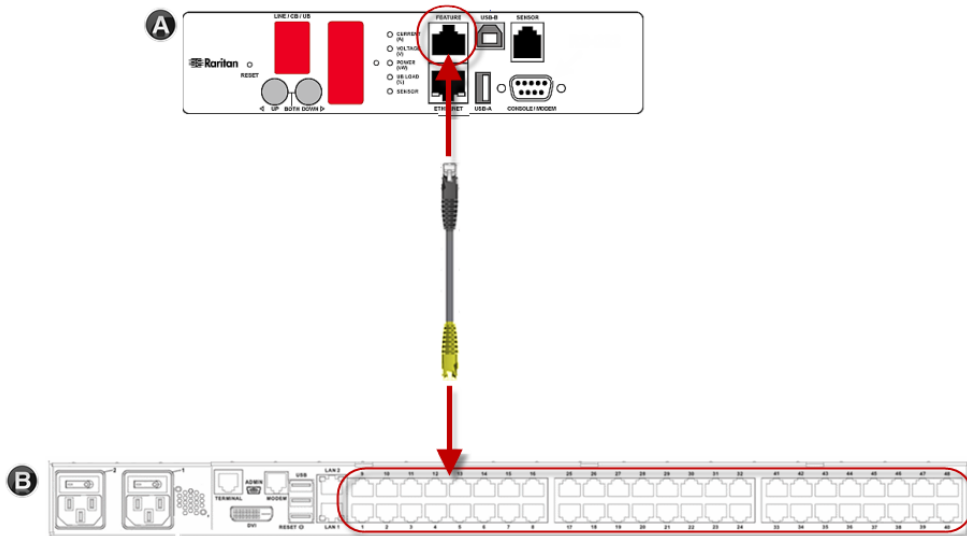

A	PX appliance
B	SX II

Dominion SX

Configuring a PX3 on Dominion SX

1. Choose Setup > Power Strip Configuration.
2. Click Add. The Power Strip Configuration screen appears.

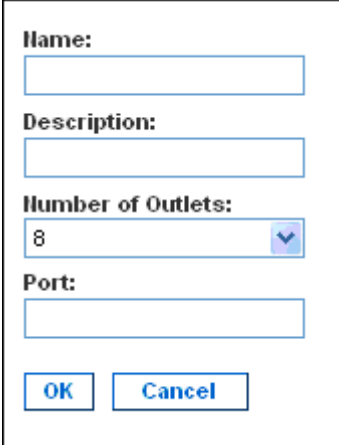

The screenshot shows a configuration dialog box with the following fields and controls:

- Name:** A text input field.
- Description:** A text input field.
- Number of Outlets:** A dropdown menu with the value '8' selected.
- Port:** A text input field.
- Buttons:** 'OK' and 'Cancel' buttons at the bottom.

3. Type a name and description in the Name and Description fields.
4. Select the number of outlets from the Number of Outlets drop-down menu.
5. Type the port number in the Port field.
6. Click OK.

Power Control

1. Choose Power Control > Power Strip Power Control. The Outlet Control screen appears.

The screenshot shows the 'Outlet Control' interface. It features a table with 20 rows, each representing an outlet. The table has two columns: 'Outlet' and 'State'. Each row includes a checkbox in the 'Outlet' column and a state indicator in the 'State' column. A 'Select All' button is located to the right of the table. At the bottom of the interface, there are three buttons: 'On', 'Off', and 'Recycle'.

Outlet	State
<input type="checkbox"/> Outlet 1	OFF
<input checked="" type="checkbox"/> Outlet 2	OFF
<input type="checkbox"/> Outlet 3	OFF
<input type="checkbox"/> Outlet 4	ON
<input checked="" type="checkbox"/> Outlet 5	OFF
<input type="checkbox"/> Outlet 6	OFF
<input type="checkbox"/> Outlet 7	ON
<input type="checkbox"/> Outlet 8	OFF
<input checked="" type="checkbox"/> Outlet 9	OFF
<input type="checkbox"/> Outlet 10	OFF
<input type="checkbox"/> Outlet 11	OFF
<input type="checkbox"/> Outlet 12	OFF
<input type="checkbox"/> Outlet 13	OFF
<input type="checkbox"/> Outlet 14	OFF
<input type="checkbox"/> Outlet 15	OFF
<input type="checkbox"/> Outlet 16	OFF
<input type="checkbox"/> Outlet 17	OFF
<input type="checkbox"/> Outlet 18	OFF
<input type="checkbox"/> Outlet 19	OFF
<input type="checkbox"/> Outlet 20	ON

Buttons: On, Off, Recycle

2. Check the box of outlet number you wish to control, and click On/Off buttons to power on/off the selected outlet(s).
3. A confirmation message appears, indicating successful operation.

Outlet 19: The power operation has been sent.

The system shall reflect successful operations shortly.

Checking Power Strip Status

1. Choose Power Control > Power Strip Status.

DPX Status:

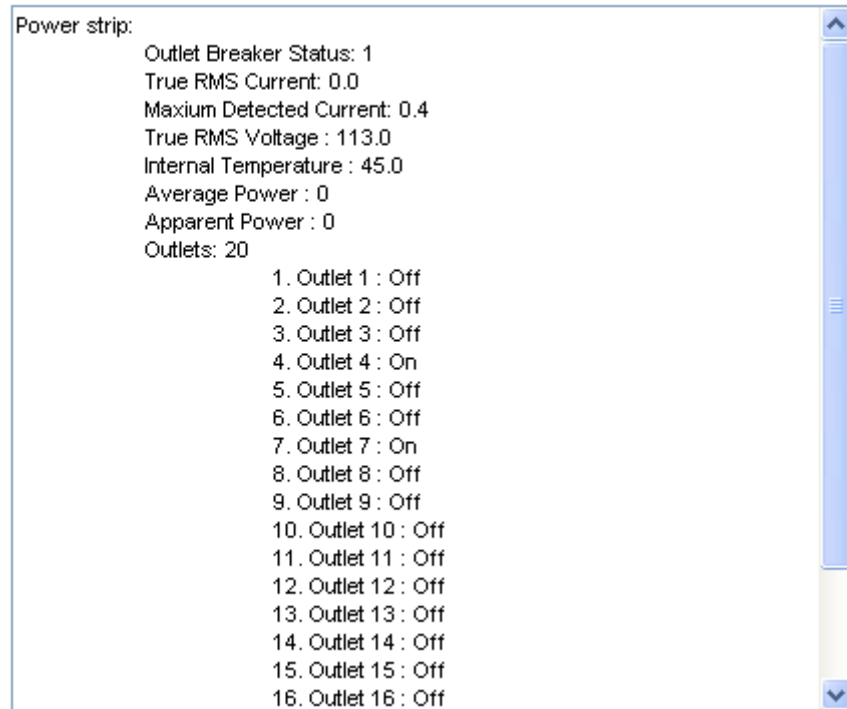

2. A status box appears, displaying details of the controlled PX3, including power state of each outlet on the device.

Power IQ Configuration

Sunbird's Power IQ is a software application that collects and manages the data from different PDUs installed in your server room or data center. With this software, you can:

- Do bulk configuration for multiple PDUs
- Name outlets on different PDUs
- Switch on/off outlets on outlet-switching capable PDUs

For more information on Power IQ, refer to the Power IQ online help on the Sunbird website: <http://support.sunbirdcim.com>.

dcTrack

Sunbird's dcTrack® is a product that allows you to manage the data center. The PX3 is categorized as a power item in dcTrack. dcTrack offers an import wizard for conveniently adding the PX3 as well as other IT equipment to dcTrack for management.

You can use dcTrack to:

- Record and manage the data center infrastructure and assets
- Monitor the electrical consumption of the data center
- Track environmental factors in the data center, such as temperature and humidity
- Optimize the data center growth

For more information on dcTrack, refer to the online help accessible from the dcTrack application, or user documentation available on the Sunbird's website: <http://support.sunbirdcim.com>.

dcTrack Overview

dcTrack® is a powerful and intelligent data center management and automation application.

It has been designed by data center and IT professionals to provide broad and deep visibility into the data center. It empowers data center managers to plan for growth and change by optimizing their current operations, assets, and infrastructure.

With dcTrack, you can view everything in the data center from servers, blades, virtual servers and applications to data networks, IP addressing space and cabling. dcTrack also allows you to track real-time power consumption and manage raised floor space and rack elevations.

Use dcTrack to build your floor map data center map directly in the application, or import an existing floor map into the dcTrack. Further, dcTrack allows you to import AutoCAD® 2012 (and earlier) objects to build a data center map.

If you currently maintain data center information in spreadsheet format, that data can be imported into dcTrack using the Import wizard.

Isolate potential problems with end-to-end power and data circuits by visually tracing them. This allows you to identify all intermediate circuit points and locate problems.

By using dcTrack's workflow and change management feature, data center managers are better able to enforce best practices across the enterprise and meet ITIL framework guidelines. You can also opt to skip the Change Control workflow process and work in Request Bypass so requests are processed immediately.

dcTrack® can be used as a standalone product or integrated with Power IQ® for power and environmental monitoring.

Asset Management Strips and dcTrack

If any asset strips are connected to the PX3, the PX3 can transmit their information to Sunbird's dcTrack. All you have to do is to add the PX3 to dcTrack, and also add each IT item where an asset tag is attached to dcTrack.

*Note: For instructions on connecting asset strips, see **Connecting Asset Management Strips** (on page 67).*

If SNMP is enabled, event information can be transmitted to dcTrack. Specifically, Sunbird's Power IQ detects when an asset tag is connected or disconnected from an asset strip. Power IQ then generates a connection or disconnection event. When dcTrack polls Power IQ, the connection/disconnection events are pulled into dcTrack, and displayed in the dcTrack Web Client.

► **To poll and display asset management events in dcTrack**

- The PX3 that the asset strip is connected to must exist in dcTrack.
- Each IT item connected to the asset strip via an asset tag must exist in dcTrack.

You do not need to manually enter the asset tag IDs for IT items that already exist in dcTrack as long as these items are in the Installed status.

Simply, plug the item's asset tag into an asset strip that is connected to the PX3 that exists in dcTrack. dcTrack automatically assigns the asset tag ID to the existing IT item.

Note: If needed, the asset tag number can be overwritten.

For more information on dcTrack as well as how asset strips work with dcTrack, contact Sunbird Professional Services and Support from the <http://support.sunbirdcim.com>.

Appendix N Third Party Licenses

This appendix contains third party licenses for software used by Xerus that require including the license in documentation.

For information on open source software, see raritan.com/about-us/legal/open-source-software-statement

In This Chapter

Licenses - Bind9	927
Licenses - Clish	937
Licenses - Dropbear	945
Licenses - FreeType.....	948
Licenses - IW	950
Licenses - JSON-C	951
Licenses - LIBTIRPC.....	952
Licenses - LIBXML2.....	952
Licenses - Mbus	953
Licenses - Net-SNMP.....	953
Licenses - Open LDAP	962
Licenses - OpenSSL.....	964
Licenses - Wireless-RegDB	967
Licenses - WPA Supplicant and Hostapd.....	967

Licenses - Bind9

Copyright (C) 2004-2016 Internet Systems Consortium, Inc. ("ISC")

Copyright (C) 1996-2003 Internet Software Consortium.

Permission to use, copy, modify, and/or distribute this software for any purpose with or without fee is hereby granted, provided that the above copyright notice and this permission notice appear in all copies.

THE SOFTWARE IS PROVIDED "AS IS" AND ISC DISCLAIMS ALL WARRANTIES WITH REGARD TO THIS SOFTWARE INCLUDING ALL IMPLIED WARRANTIES OF MERCHANTABILITY AND FITNESS. IN NO EVENT SHALL ISC BE LIABLE FOR ANY SPECIAL, DIRECT, INDIRECT, OR CONSEQUENTIAL DAMAGES OR ANY DAMAGES WHATSOEVER RESULTING FROM LOSS OF USE, DATA OR PROFITS, WHETHER IN AN ACTION OF CONTRACT, NEGLIGENCE OR OTHER TORTIOUS ACTION, ARISING OUT OF OR IN CONNECTION WITH THE USE OR PERFORMANCE OF THIS SOFTWARE.

Portions of this code release fall under one or more of the following Copyright notices. Please see individual source files for details.

For binary releases also see: OpenSSL-LICENSE.

Copyright (C) 1996-2001 Nominum, Inc.

Permission to use, copy, modify, and distribute this software for any purpose with or without fee is hereby granted, provided that the above copyright notice and this permission notice appear in all copies.

THE SOFTWARE IS PROVIDED "AS IS" AND NOMINUM DISCLAIMS ALL WARRANTIES WITH REGARD TO THIS SOFTWARE INCLUDING ALL IMPLIED WARRANTIES OF MERCHANTABILITY AND FITNESS. IN NO EVENT SHALL NOMINUM BE LIABLE FOR ANY SPECIAL, DIRECT, INDIRECT, OR CONSEQUENTIAL DAMAGES OR ANY DAMAGES WHATSOEVER RESULTING FROM LOSS OF USE, DATA OR PROFITS, WHETHER IN AN ACTION OF CONTRACT, NEGLIGENCE OR OTHER TORTIOUS ACTION, ARISING OUT OF OR IN CONNECTION WITH THE USE OR PERFORMANCE OF THIS SOFTWARE.

Copyright (C) 1995-2000 by Network Associates, Inc.

Permission to use, copy, modify, and/or distribute this software for any purpose with or without fee is hereby granted, provided that the above copyright notice and this permission notice appear in all copies.

THE SOFTWARE IS PROVIDED "AS IS" AND ISC AND NETWORK ASSOCIATES DISCLAIMS ALL WARRANTIES WITH REGARD TO THIS SOFTWARE INCLUDING ALL IMPLIED WARRANTIES OF MERCHANTABILITY AND FITNESS. IN NO EVENT SHALL ISC BE LIABLE FOR ANY SPECIAL, DIRECT, INDIRECT, OR CONSEQUENTIAL DAMAGES OR ANY DAMAGES WHATSOEVER RESULTING FROM LOSS OF USE, DATA OR PROFITS, WHETHER IN AN ACTION OF CONTRACT, NEGLIGENCE OR OTHER TORTIOUS ACTION, ARISING OUT OF OR IN CONNECTION WITH THE USE OR PERFORMANCE OF THIS SOFTWARE.

Copyright (C) 2002 Stichting NLnet, Netherlands, stichting@nlnet.nl.

Permission to use, copy, modify, and distribute this software for any purpose with or without fee is hereby granted, provided that the above copyright notice and this permission notice appear in all copies.

THE SOFTWARE IS PROVIDED "AS IS" AND STICHTING NLNET DISCLAIMS ALL WARRANTIES WITH REGARD TO THIS SOFTWARE INCLUDING ALL IMPLIED WARRANTIES OF MERCHANTABILITY AND FITNESS. IN NO EVENT SHALL STICHTING NLNET BE LIABLE FOR ANY SPECIAL, DIRECT, INDIRECT, OR CONSEQUENTIAL DAMAGES OR ANY DAMAGES WHATSOEVER RESULTING FROM LOSS OF USE, DATA OR PROFITS, WHETHER IN AN ACTION OF CONTRACT, NEGLIGENCE OR OTHER TORTIOUS ACTION, ARISING OUT OF OR IN CONNECTION WITH THE USE OR PERFORMANCE OF THIS SOFTWARE.

The development of Dynamically Loadable Zones (DLZ) for Bind 9 was conceived and contributed by Rob Butler.

Permission to use, copy, modify, and distribute this software for any purpose with or without fee is hereby granted, provided that the above copyright notice and this permission notice appear in all copies.

THE SOFTWARE IS PROVIDED "AS IS" AND ROB BUTLER DISCLAIMS ALL WARRANTIES WITH REGARD TO THIS SOFTWARE INCLUDING ALL IMPLIED WARRANTIES OF MERCHANTABILITY AND FITNESS. IN NO EVENT SHALL ROB BUTLER BE LIABLE FOR ANY SPECIAL, DIRECT, INDIRECT, OR CONSEQUENTIAL DAMAGES OR ANY DAMAGES WHATSOEVER RESULTING FROM LOSS OF USE, DATA OR PROFITS, WHETHER IN AN ACTION OF CONTRACT, NEGLIGENCE OR OTHER TORTIOUS ACTION, ARISING OUT OF OR IN CONNECTION WITH THE USE OR PERFORMANCE OF THIS SOFTWARE.

Copyright (c) 1987, 1990, 1993, 1994

The Regents of the University of California. All rights reserved.

Redistribution and use in source and binary forms, with or without modification, are permitted provided that the following conditions are met:

1. Redistributions of source code must retain the above copyright notice, this list of conditions and the following disclaimer.
2. Redistributions in binary form must reproduce the above copyright notice, this list of conditions and the following disclaimer in the documentation and/or other materials provided with the distribution.
3. Neither the name of the University nor the names of its contributors may be used to endorse or promote products derived from this software without specific prior written permission.

THIS SOFTWARE IS PROVIDED BY THE REGENTS AND CONTRIBUTORS ``AS IS'' AND ANY EXPRESS OR IMPLIED WARRANTIES, INCLUDING, BUT NOT LIMITED TO, THE IMPLIED WARRANTIES OF MERCHANTABILITY AND FITNESS FOR A PARTICULAR PURPOSE ARE DISCLAIMED. IN NO EVENT SHALL THE REGENTS OR CONTRIBUTORS BE LIABLE FOR ANY DIRECT, INDIRECT, INCIDENTAL, SPECIAL, EXEMPLARY, OR CONSEQUENTIAL DAMAGES (INCLUDING, BUT NOT LIMITED TO, PROCUREMENT OF SUBSTITUTE GOODS OR SERVICES; LOSS OF USE, DATA, OR PROFITS; OR BUSINESS INTERRUPTION) HOWEVER CAUSED AND ON ANY THEORY OF LIABILITY, WHETHER IN CONTRACT, STRICT LIABILITY, OR TORT (INCLUDING NEGLIGENCE OR OTHERWISE) ARISING IN ANY WAY OUT OF THE USE OF THIS SOFTWARE, EVEN IF ADVISED OF THE POSSIBILITY OF SUCH DAMAGE.

Copyright (C) The Internet Society 2005. This version of this module is part of RFC 4178; see the RFC itself for full legal notices.

(The above copyright notice is per RFC 3978 5.6 (a), q.v.)

Copyright (c) 2004 Masarykova universita

(Masaryk University, Brno, Czech Republic)

All rights reserved.

Redistribution and use in source and binary forms, with or without modification, are permitted provided that the following conditions are met:

1. Redistributions of source code must retain the above copyright notice, this list of conditions and the following disclaimer.
2. Redistributions in binary form must reproduce the above copyright notice, this list of conditions and the following disclaimer in the documentation and/or other materials provided with the distribution.
3. Neither the name of the University nor the names of its contributors may be used to endorse or promote products derived from this software without specific prior written permission.

THIS SOFTWARE IS PROVIDED BY THE COPYRIGHT HOLDERS AND CONTRIBUTORS "AS IS" AND ANY EXPRESS OR IMPLIED WARRANTIES, INCLUDING, BUT NOT LIMITED TO, THE IMPLIED WARRANTIES OF MERCHANTABILITY AND FITNESS FOR A PARTICULAR PURPOSE ARE DISCLAIMED. IN NO EVENT SHALL THE COPYRIGHT OWNER OR CONTRIBUTORS BE LIABLE FOR ANY DIRECT, INDIRECT, INCIDENTAL, SPECIAL, EXEMPLARY, OR CONSEQUENTIAL DAMAGES (INCLUDING, BUT NOT LIMITED TO, PROCUREMENT OF SUBSTITUTE GOODS OR SERVICES; LOSS OF USE, DATA, OR PROFITS; OR BUSINESS INTERRUPTION) HOWEVER CAUSED AND ON ANY THEORY OF LIABILITY, WHETHER IN CONTRACT, STRICT LIABILITY, OR TORT (INCLUDING NEGLIGENCE OR OTHERWISE) ARISING IN ANY WAY OUT OF THE USE OF THIS SOFTWARE, EVEN IF ADVISED OF THE POSSIBILITY OF SUCH DAMAGE.

Copyright (c) 1997 - 2003 Kungliga Tekniska Hogskolan
(Royal Institute of Technology, Stockholm, Sweden).

All rights reserved.

Redistribution and use in source and binary forms, with or without modification, are permitted provided that the following conditions are met:

1. Redistributions of source code must retain the above copyright notice, this list of conditions and the following disclaimer.
2. Redistributions in binary form must reproduce the above copyright notice, this list of conditions and the following disclaimer in the documentation and/or other materials provided with the distribution.
3. Neither the name of the Institute nor the names of its contributors may be used to endorse or promote products derived from this software without specific prior written permission.

THIS SOFTWARE IS PROVIDED BY THE INSTITUTE AND CONTRIBUTORS ``AS IS'' AND ANY EXPRESS OR IMPLIED WARRANTIES, INCLUDING, BUT NOT LIMITED TO, THE IMPLIED WARRANTIES OF MERCHANTABILITY AND FITNESS FOR A PARTICULAR PURPOSE ARE DISCLAIMED. IN NO EVENT SHALL THE INSTITUTE OR CONTRIBUTORS BE LIABLE FOR ANY DIRECT, INDIRECT, INCIDENTAL, SPECIAL, EXEMPLARY, OR CONSEQUENTIAL DAMAGES (INCLUDING, BUT NOT LIMITED TO, PROCUREMENT OF SUBSTITUTE GOODS OR SERVICES; LOSS OF USE, DATA, OR PROFITS; OR BUSINESS INTERRUPTION) HOWEVER CAUSED AND ON ANY THEORY OF LIABILITY, WHETHER IN CONTRACT, STRICT LIABILITY, OR TORT (INCLUDING NEGLIGENCE OR OTHERWISE) ARISING IN ANY WAY OUT OF THE USE OF THIS SOFTWARE, EVEN IF ADVISED OF THE POSSIBILITY OF SUCH DAMAGE.

Copyright (c) 1998 Doug Rabson

All rights reserved.

Redistribution and use in source and binary forms, with or without modification, are permitted provided that the following conditions are met:

1. Redistributions of source code must retain the above copyright notice, this list of conditions and the following disclaimer.
2. Redistributions in binary form must reproduce the above copyright notice, this list of conditions and the following disclaimer in the documentation and/or other materials provided with the distribution.

THIS SOFTWARE IS PROVIDED BY THE AUTHOR AND CONTRIBUTORS ``AS IS'' AND ANY EXPRESS OR IMPLIED WARRANTIES, INCLUDING, BUT NOT LIMITED TO, THE IMPLIED WARRANTIES OF MERCHANTABILITY AND FITNESS FOR A PARTICULAR PURPOSE ARE DISCLAIMED. IN NO EVENT SHALL THE AUTHOR OR CONTRIBUTORS BE LIABLE FOR ANY DIRECT, INDIRECT, INCIDENTAL, SPECIAL, EXEMPLARY, OR CONSEQUENTIAL DAMAGES (INCLUDING, BUT NOT LIMITED TO, PROCUREMENT OF SUBSTITUTE GOODS OR SERVICES; LOSS OF USE, DATA, OR PROFITS; OR BUSINESS INTERRUPTION) HOWEVER CAUSED AND ON ANY THEORY OF LIABILITY, WHETHER IN CONTRACT, STRICT LIABILITY, OR TORT (INCLUDING NEGLIGENCE OR OTHERWISE) ARISING IN ANY WAY OUT OF THE USE OF THIS SOFTWARE, EVEN IF ADVISED OF THE POSSIBILITY OF SUCH DAMAGE.

Copyright ((c)) 2002, Rice University

All rights reserved.

Redistribution and use in source and binary forms, with or without modification, are permitted provided that the following conditions are met:

- * Redistributions of source code must retain the above copyright notice, this list of conditions and the following disclaimer.
- * Redistributions in binary form must reproduce the above copyright notice, this list of conditions and the following disclaimer in the documentation and/or other materials provided with the distribution.

* Neither the name of Rice University (RICE) nor the names of its contributors may be used to endorse or promote products derived from this software without specific prior written permission.

This software is provided by RICE and the contributors on an "as is" basis, without any representations or warranties of any kind, express or implied including, but not limited to, representations or warranties of non-infringement, merchantability or fitness for a particular purpose. In no event shall RICE or contributors be liable for any direct, indirect, incidental, special, exemplary, or consequential damages (including, but not limited to, procurement of substitute goods or services; loss of use, data, or profits; or business interruption) however caused and on any theory of liability, whether in contract, strict liability, or tort (including negligence or otherwise) arising in any way out of the use of this software, even if advised of the possibility of such damage.

Copyright (c) 1993 by Digital Equipment Corporation.

Permission to use, copy, modify, and distribute this software for any purpose with or without fee is hereby granted, provided that the above copyright notice and this permission notice appear in all copies, and that the name of Digital Equipment Corporation not be used in advertising or publicity pertaining to distribution of the document or software without specific, written prior permission.

THE SOFTWARE IS PROVIDED "AS IS" AND DIGITAL EQUIPMENT CORP. DISCLAIMS ALL WARRANTIES WITH REGARD TO THIS SOFTWARE, INCLUDING ALL IMPLIED WARRANTIES OF MERCHANTABILITY AND FITNESS. IN NO EVENT SHALL DIGITAL EQUIPMENT CORPORATION BE LIABLE FOR ANY SPECIAL, DIRECT, INDIRECT, OR CONSEQUENTIAL DAMAGES OR ANY DAMAGES WHATSOEVER RESULTING FROM LOSS OF USE, DATA OR PROFITS, WHETHER IN AN ACTION OF CONTRACT, NEGLIGENCE OR OTHER TORTIOUS ACTION, ARISING OUT OF OR IN CONNECTION WITH THE USE OR PERFORMANCE OF THIS SOFTWARE.

Copyright 2000 Aaron D. Gifford. All rights reserved.

Redistribution and use in source and binary forms, with or without modification, are permitted provided that the following conditions are met:

1. Redistributions of source code must retain the above copyright notice, this list of conditions and the following disclaimer.
2. Redistributions in binary form must reproduce the above copyright notice, this list of conditions and the following disclaimer in the documentation and/or other materials provided with the distribution.
3. Neither the name of the copyright holder nor the names of contributors may be used to endorse or promote products derived from this software without specific prior written permission.

THIS SOFTWARE IS PROVIDED BY THE AUTHOR(S) AND CONTRIBUTOR(S) ``AS IS" AND ANY EXPRESS OR IMPLIED WARRANTIES, INCLUDING, BUT NOT LIMITED TO, THE IMPLIED WARRANTIES OF MERCHANTABILITY AND FITNESS FOR A PARTICULAR PURPOSE ARE DISCLAIMED. IN NO EVENT SHALL THE AUTHOR(S) OR CONTRIBUTOR(S) BE LIABLE FOR ANY DIRECT, INDIRECT, INCIDENTAL, SPECIAL, EXEMPLARY, OR CONSEQUENTIAL DAMAGES (INCLUDING, BUT NOT LIMITED TO, PROCUREMENT OF SUBSTITUTE GOODS OR SERVICES; LOSS OF USE, DATA, OR PROFITS; OR BUSINESS INTERRUPTION) HOWEVER CAUSED AND ON ANY THEORY OF LIABILITY, WHETHER IN CONTRACT, STRICT LIABILITY, OR TORT (INCLUDING NEGLIGENCE OR OTHERWISE) ARISING IN ANY WAY OUT OF THE USE OF THIS SOFTWARE, EVEN IF ADVISED OF THE POSSIBILITY OF SUCH DAMAGE.

Copyright (c) 1998 Doug Rabson.

Copyright (c) 2001 Jake Burkholder.

All rights reserved.

Redistribution and use in source and binary forms, with or without modification, are permitted provided that the following conditions are met:

1. Redistributions of source code must retain the above copyright notice, this list of conditions and the following disclaimer.
2. Redistributions in binary form must reproduce the above copyright notice, this list of conditions and the following disclaimer in the documentation and/or other materials provided with the distribution.

THIS SOFTWARE IS PROVIDED BY THE AUTHOR AND CONTRIBUTORS ``AS IS" AND ANY EXPRESS OR IMPLIED WARRANTIES, INCLUDING, BUT NOT LIMITED TO, THE IMPLIED WARRANTIES OF MERCHANTABILITY AND FITNESS FOR A PARTICULAR PURPOSE ARE DISCLAIMED. IN NO EVENT SHALL THE AUTHOR OR CONTRIBUTORS BE LIABLE FOR ANY DIRECT, INDIRECT, INCIDENTAL, SPECIAL, EXEMPLARY, OR CONSEQUENTIAL DAMAGES (INCLUDING, BUT NOT LIMITED TO, PROCUREMENT OF SUBSTITUTE GOODS OR SERVICES; LOSS OF USE, DATA, OR PROFITS; OR BUSINESS INTERRUPTION) HOWEVER CAUSED AND ON ANY THEORY OF LIABILITY, WHETHER IN CONTRACT, STRICT LIABILITY, OR TORT (INCLUDING NEGLIGENCE OR OTHERWISE) ARISING IN ANY WAY OUT OF THE USE OF THIS SOFTWARE, EVEN IF ADVISED OF THE POSSIBILITY OF SUCH DAMAGE.

Copyright (C) 1995, 1996, 1997, and 1998 WIDE Project.

All rights reserved.

Redistribution and use in source and binary forms, with or without modification, are permitted provided that the following conditions are met:

1. Redistributions of source code must retain the above copyright notice, this list of conditions and the following disclaimer.

2. Redistributions in binary form must reproduce the above copyright notice, this list of conditions and the following disclaimer in the documentation and/or other materials provided with the distribution.

3. Neither the name of the project nor the names of its contributors may be used to endorse or promote products derived from this software without specific prior written permission.

THIS SOFTWARE IS PROVIDED BY THE PROJECT AND CONTRIBUTORS ``AS IS'' AND ANY EXPRESS OR IMPLIED WARRANTIES, INCLUDING, BUT NOT LIMITED TO, THE IMPLIED WARRANTIES OF MERCHANTABILITY AND FITNESS FOR A PARTICULAR PURPOSE ARE DISCLAIMED. IN NO EVENT SHALL THE PROJECT OR CONTRIBUTORS BE LIABLE FOR ANY DIRECT, INDIRECT, INCIDENTAL, SPECIAL, EXEMPLARY, OR CONSEQUENTIAL DAMAGES (INCLUDING, BUT NOT LIMITED TO, PROCUREMENT OF SUBSTITUTE GOODS OR SERVICES; LOSS OF USE, DATA, OR PROFITS; OR BUSINESS INTERRUPTION) HOWEVER CAUSED AND ON ANY THEORY OF LIABILITY, WHETHER IN CONTRACT, STRICT LIABILITY, OR TORT (INCLUDING NEGLIGENCE OR OTHERWISE) ARISING IN ANY WAY OUT OF THE USE OF THIS SOFTWARE, EVEN IF ADVISED OF THE POSSIBILITY OF SUCH DAMAGE.

Copyright (c) 1999-2000 by Nortel Networks Corporation

Permission to use, copy, modify, and distribute this software for any purpose with or without fee is hereby granted, provided that the above copyright notice and this permission notice appear in all copies.

THE SOFTWARE IS PROVIDED "AS IS" AND NORTEL NETWORKS DISCLAIMS ALL WARRANTIES WITH REGARD TO THIS SOFTWARE INCLUDING ALL IMPLIED WARRANTIES OF MERCHANTABILITY AND FITNESS. IN NO EVENT SHALL NORTEL NETWORKS BE LIABLE FOR ANY SPECIAL, DIRECT, INDIRECT, OR CONSEQUENTIAL DAMAGES OR ANY DAMAGES WHATSOEVER RESULTING FROM LOSS OF USE, DATA OR PROFITS, WHETHER IN AN ACTION OF CONTRACT, NEGLIGENCE OR OTHER TORTIOUS ACTION, ARISING OUT OF OR IN CONNECTION WITH THE USE OR PERFORMANCE OF THIS SOFTWARE.

Copyright (c) 2000-2002 Japan Network Information Center. All rights reserved.

By using this file, you agree to the terms and conditions set forth bellow.

LICENSE TERMS AND CONDITIONS

The following License Terms and Conditions apply, unless a different license is obtained from Japan Network Information Center ("JPNIC"), a Japanese association, Kokusai-Kougyou-Kanda Bldg 6F, 2-3-4 Uchi-Kanda, Chiyoda-ku, Tokyo 101-0047, Japan.

1. Use, Modification and Redistribution (including distribution of any modified or derived work) in source and/or binary forms is permitted under this License Terms and Conditions.

2. Redistribution of source code must retain the copyright notices as they appear in each source code file, this License Terms and Conditions.

3. Redistribution in binary form must reproduce the Copyright Notice, this License Terms and Conditions, in the documentation and/or other materials provided with the distribution. For the purposes of binary distribution the "Copyright Notice" refers to the following language:

"Copyright (c) 2000-2002 Japan Network Information Center. All rights reserved."

4. The name of JPNIC may not be used to endorse or promote products derived from this Software without specific prior written approval of JPNIC.

5. Disclaimer/Limitation of Liability: THIS SOFTWARE IS PROVIDED BY JPNIC "AS IS" AND ANY EXPRESS OR IMPLIED WARRANTIES, INCLUDING, BUT NOT LIMITED TO, THE IMPLIED WARRANTIES OF MERCHANTABILITY AND FITNESS FOR A PARTICULAR PURPOSE ARE DISCLAIMED. IN NO EVENT SHALL JPNIC BE LIABLE FOR ANY DIRECT, INDIRECT, INCIDENTAL, SPECIAL, EXEMPLARY, OR CONSEQUENTIAL DAMAGES (INCLUDING, BUT NOT LIMITED TO, PROCUREMENT OF SUBSTITUTE GOODS OR SERVICES; LOSS OF USE, DATA, OR PROFITS; OR BUSINESS INTERRUPTION) HOWEVER CAUSED AND ON ANY THEORY OF LIABILITY, WHETHER IN CONTRACT, STRICT LIABILITY, OR TORT (INCLUDING NEGLIGENCE OR OTHERWISE) ARISING IN ANY WAY OUT OF THE USE OF THIS SOFTWARE, EVEN IF ADVISED OF THE POSSIBILITY OF SUCH DAMAGES.

Copyright (C) 2004 Nominet, Ltd.

Permission to use, copy, modify, and distribute this software for any purpose with or without fee is hereby granted, provided that the above copyright notice and this permission notice appear in all copies.

THE SOFTWARE IS PROVIDED "AS IS" AND NOMINET DISCLAIMS ALL WARRANTIES WITH REGARD TO THIS SOFTWARE INCLUDING ALL IMPLIED WARRANTIES OF MERCHANTABILITY AND FITNESS. IN NO EVENT SHALL ISC BE LIABLE FOR ANY SPECIAL, DIRECT, INDIRECT, OR CONSEQUENTIAL DAMAGES OR ANY DAMAGES WHATSOEVER RESULTING FROM LOSS OF USE, DATA OR PROFITS, WHETHER IN AN ACTION OF CONTRACT, NEGLIGENCE OR OTHER TORTIOUS ACTION, ARISING OUT OF OR IN CONNECTION WITH THE USE OR PERFORMANCE OF THIS SOFTWARE.

Portions Copyright RSA Security Inc.

License to copy and use this software is granted provided that it is identified as "RSA Security Inc. PKCS #11 Cryptographic Token Interface (Cryptoki)" in all material mentioning or referencing this software.

License is also granted to make and use derivative works provided that such works are identified as "derived from the RSA Security Inc. PKCS #11 Cryptographic Token Interface (Cryptoki)" in all material mentioning or referencing the derived work.

RSA Security Inc. makes no representations concerning either the merchantability of this software or the suitability of this software for any particular purpose. It is provided "as is" without express or implied warranty of any kind.

Copyright (c) 1996, David Mazieres <dm@uun.org>

Copyright (c) 2008, Damien Miller <djm@openbsd.org>

Permission to use, copy, modify, and distribute this software for any purpose with or without fee is hereby granted, provided that the above copyright notice and this permission notice appear in all copies.

THE SOFTWARE IS PROVIDED "AS IS" AND THE AUTHOR DISCLAIMS ALL WARRANTIES WITH REGARD TO THIS SOFTWARE INCLUDING ALL IMPLIED WARRANTIES OF MERCHANTABILITY AND FITNESS. IN NO EVENT SHALL THE AUTHOR BE LIABLE FOR ANY SPECIAL, DIRECT, INDIRECT, OR CONSEQUENTIAL DAMAGES OR ANY DAMAGES WHATSOEVER RESULTING FROM LOSS OF USE, DATA OR PROFITS, WHETHER IN AN ACTION OF CONTRACT, NEGLIGENCE OR OTHER TORTIOUS ACTION, ARISING OUT OF OR IN CONNECTION WITH THE USE OR PERFORMANCE OF THIS SOFTWARE.

Copyright (c) 2000-2001 The OpenSSL Project. All rights reserved.

Redistribution and use in source and binary forms, with or without modification, are permitted provided that the following conditions are met:

1. Redistributions of source code must retain the above copyright notice, this list of conditions and the following disclaimer.
2. Redistributions in binary form must reproduce the above copyright notice, this list of conditions and the following disclaimer in the documentation and/or other materials provided with the distribution.
3. All advertising materials mentioning features or use of this software must display the following acknowledgment:

"This product includes software developed by the OpenSSL Project for use in the OpenSSL Toolkit. (<http://www.OpenSSL.org/>)"

4. The names "OpenSSL Toolkit" and "OpenSSL Project" must not be used to endorse or promote products derived from this software without prior written permission. For written permission, please contact licensing@OpenSSL.org.
5. Products derived from this software may not be called "OpenSSL" nor may "OpenSSL" appear in their names without prior written permission of the OpenSSL Project.

6. Redistributions of any form whatsoever must retain the following acknowledgment:

"This product includes software developed by the OpenSSL Project for use in the OpenSSL Toolkit (<http://www.OpenSSL.org/>)"

THIS SOFTWARE IS PROVIDED BY THE OpenSSL PROJECT ``AS IS" AND ANY EXPRESSED OR IMPLIED WARRANTIES, INCLUDING, BUT NOT LIMITED TO, THE IMPLIED WARRANTIES OF MERCHANTABILITY AND FITNESS FOR A PARTICULAR PURPOSE ARE DISCLAIMED. IN NO EVENT SHALL THE OpenSSL PROJECT OR ITS CONTRIBUTORS BE LIABLE FOR ANY DIRECT, INDIRECT, INCIDENTAL, SPECIAL, EXEMPLARY, OR CONSEQUENTIAL DAMAGES (INCLUDING, BUT NOT LIMITED TO, PROCUREMENT OF SUBSTITUTE GOODS OR SERVICES; LOSS OF USE, DATA, OR PROFITS; OR BUSINESS INTERRUPTION) HOWEVER CAUSED AND ON ANY THEORY OF LIABILITY, WHETHER IN CONTRACT, STRICT LIABILITY, OR TORT (INCLUDING NEGLIGENCE OR OTHERWISE) ARISING IN ANY WAY OUT OF THE USE OF THIS SOFTWARE, EVEN IF ADVISED OF THE POSSIBILITY OF SUCH DAMAGE.

Copyright (c) 1995, 1997, 1998 The NetBSD Foundation, Inc.

All rights reserved.

Redistribution and use in source and binary forms, with or without modification, are permitted provided that the following conditions are met:

1. Redistributions of source code must retain the above copyright notice, this list of conditions and the following disclaimer.
2. Redistributions in binary form must reproduce the above copyright notice, this list of conditions and the following disclaimer in the documentation and/or other materials provided with the distribution.

THIS SOFTWARE IS PROVIDED BY THE NETBSD FOUNDATION, INC. AND CONTRIBUTORS ``AS IS" AND ANY EXPRESS OR IMPLIED WARRANTIES, INCLUDING, BUT NOT LIMITED TO, THE IMPLIED WARRANTIES OF MERCHANTABILITY AND FITNESS FOR A PARTICULAR PURPOSE ARE DISCLAIMED. IN NO EVENT SHALL THE FOUNDATION OR CONTRIBUTORS BE LIABLE FOR ANY DIRECT, INDIRECT, INCIDENTAL, SPECIAL, EXEMPLARY, OR CONSEQUENTIAL DAMAGES (INCLUDING, BUT NOT LIMITED TO, PROCUREMENT OF SUBSTITUTE GOODS OR SERVICES; LOSS OF USE, DATA, OR PROFITS; OR BUSINESS INTERRUPTION) HOWEVER CAUSED AND ON ANY THEORY OF LIABILITY, WHETHER IN CONTRACT, STRICT LIABILITY, OR TORT (INCLUDING NEGLIGENCE OR OTHERWISE) ARISING IN ANY WAY OUT OF THE USE OF THIS SOFTWARE, EVEN IF ADVISED OF THE POSSIBILITY OF SUCH DAMAGE.

Licenses - Clish

This package contains code which is copyrighted to multiple sources. The initial public release of this software was developed by Graeme McKerrill whilst in the employment of 3Com Europe Ltd.

Copyright (c) 2005, 3Com Corporation

All rights reserved.

Redistribution and use in source and binary forms, with or without modification, are permitted provided that the following conditions are met:

* Redistributions of source code must retain the above copyright notice, this list of conditions and the following disclaimer.

* Redistributions in binary form must reproduce the above copyright notice, this list of conditions and the following disclaimer in the documentation and/or other materials provided with the distribution.

* Neither the name of 3Com Corporation nor the names of its contributors may be used to endorse or promote products derived from this software without specific prior written permission.

THIS SOFTWARE IS PROVIDED BY THE COPYRIGHT HOLDERS AND CONTRIBUTORS "AS IS" AND ANY EXPRESS OR IMPLIED WARRANTIES, INCLUDING, BUT NOT LIMITED TO, THE IMPLIED WARRANTIES OF MERCHANTABILITY AND FITNESS FOR A PARTICULAR PURPOSE ARE DISCLAIMED. IN NO EVENT SHALL THE COPYRIGHT OWNER OR CONTRIBUTORS BE LIABLE FOR ANY DIRECT, INDIRECT, INCIDENTAL, SPECIAL, EXEMPLARY, OR CONSEQUENTIAL DAMAGES (INCLUDING, BUT NOT LIMITED TO, PROCUREMENT OF SUBSTITUTE GOODS OR SERVICES; LOSS OF USE, DATA, OR PROFITS; OR BUSINESS INTERRUPTION) HOWEVER CAUSED AND ON ANY THEORY OF LIABILITY, WHETHER IN CONTRACT, STRICT LIABILITY, OR TORT (INCLUDING NEGLIGENCE OR OTHERWISE) ARISING IN ANY WAY OUT OF THE USE OF THIS SOFTWARE, EVEN IF ADVISED OF THE POSSIBILITY OF SUCH DAMAGE.

Newport Networks Ltd.

The 0.6-0.7 releases of this software was developed by Graeme McKerrell whilst in the employment of Newport Networks Ltd.

As well as enhancing the existing code the following new modules were developed.

Copyright (c) 2005,2006, Newport Networks Ltd

All rights reserved.

Redistribution and use in source and binary forms, with or without modification, are permitted provided that the following conditions are met:

* Redistributions of source code must retain the above copyright notice, this list of conditions and the following disclaimer.

* Redistributions in binary form must reproduce the above copyright notice, this list of conditions and the following disclaimer in the documentation and/or other materials provided with the distribution.

* Neither the name of Newport Networks Ltd nor the names of its contributors may be used to endorse or promote products derived from this software without specific prior written permission.

THIS SOFTWARE IS PROVIDED BY THE COPYRIGHT HOLDERS AND CONTRIBUTORS "AS IS" AND ANY EXPRESS OR IMPLIED WARRANTIES, INCLUDING, BUT NOT LIMITED TO, THE IMPLIED WARRANTIES OF MERCHANTABILITY AND FITNESS FOR A PARTICULAR PURPOSE ARE DISCLAIMED. IN NO EVENT SHALL THE COPYRIGHT OWNER OR CONTRIBUTORS BE LIABLE FOR ANY DIRECT, INDIRECT, INCIDENTAL, SPECIAL, EXEMPLARY, OR CONSEQUENTIAL DAMAGES (INCLUDING, BUT NOT LIMITED TO, PROCUREMENT OF SUBSTITUTE GOODS OR SERVICES; LOSS OF USE, DATA, OR PROFITS; OR BUSINESS INTERRUPTION) HOWEVER CAUSED AND ON ANY THEORY OF LIABILITY, WHETHER IN CONTRACT, STRICT LIABILITY, OR TORT (INCLUDING NEGLIGENCE OR OTHERWISE) ARISING IN ANY WAY OUT OF THE USE OF THIS SOFTWARE, EVEN IF ADVISED OF THE POSSIBILITY OF SUCH DAMAGE.

tinyxml

Yves Berquin

As of release 0.6 the tinyxml library is included (unchanged) as part of the distribution.

tinyxml (v2.5.1)

<http://www.sourceforge.net/projects/tinyxml>

Original file by Yves Berquin.

This software is provided 'as-is', without any express or implied warranty. In no event will the authors be held liable for any damages arising from the use of this software.

Permission is granted to anyone to use this software for any purpose, including commercial applications, and to alter it and redistribute it freely, subject to the following restrictions:

1. The origin of this software must not be misrepresented; you must not claim that you wrote the original software. If you use this software in a product, an acknowledgment in the product documentation would be appreciated but is not required.
2. Altered source versions must be plainly marked as such, and must not be misrepresented as being the original software.
3. This notice may not be removed or altered from any source distribution.

GNU binutils

As of release 0.7.1 libbfd can be used to resolve symbols forstacktraces. This feature can be turned off if linking with GPL code is problematic, using "configure --without-gpl".

The Binary File Descriptor library is part of GNU binutils

<http://www.gnu.org/software/binutils/>

The following file is licensed under the GPLv2.

This file is part of the CLISH project <http://clish.sourceforge.net/>

The code in this file is free software; you can redistribute it and/or modify it under the terms of the GNU General Public License as published by the Free Software Foundation; version 2

This code is distributed in the hope that it will be useful, but WITHOUT ANY WARRANTY; without even the implied warranty of MERCHANTABILITY or FITNESS FOR A PARTICULAR PURPOSE. See the GNU General Public License for more details.

You should have received a copy of the GNU General Public License along with this program; if not, write to the Free Software Foundation, 59 Temple Place - Suite 330, Boston, MA 02111-1307, USA.

Derived from addr2line.c in the GNU binutils package by Ulrich.Lauther@mchp.siemens.de

GNU GENERAL PUBLIC LICENSE

Version 2, June 1991

Copyright (C) 1989, 1991 Free Software Foundation, Inc.

51 Franklin Street, Fifth Floor, Boston, MA 02110-1301 USA

Everyone is permitted to copy and distribute verbatim copies of this license document, but changing it is not allowed.

Preamble

The licenses for most software are designed to take away your freedom to share and change it. By contrast, the GNU General Public License is intended to guarantee your freedom to share and change free software--to make sure the software is free for all its users. This General Public License applies to most of the Free Software Foundation's software and to any other program whose authors commit to using it. (Some other Free Software Foundation software is covered by the GNU Lesser General Public License instead.) You can apply it to your programs, too.

When we speak of free software, we are referring to freedom, not price. Our General Public Licenses are designed to make sure that you have the freedom to distribute copies of free software (and charge for this service if you wish), that you receive source code or can get it if you want it, that you can change the software or use pieces of it in new free programs; and that you know you can do these things.

To protect your rights, we need to make restrictions that forbid anyone to deny you these rights or to ask you to surrender the rights. These restrictions translate to certain responsibilities for you if you distribute copies of the software, or if you modify it.

For example, if you distribute copies of such a program, whether gratis or for a fee, you must give the recipients all the rights that you have. You must make sure that they, too, receive or can get the source code. And you must show them these terms so they know their rights.

We protect your rights with two steps: (1) copyright the software, and (2) offer you this license which gives you legal permission to copy, distribute and/or modify the software.

Also, for each author's protection and ours, we want to make certain that everyone understands that there is no warranty for this free software. If the software is modified by someone else and passed on, we want its recipients to know that what they have is not the original, so that any problems introduced by others will not reflect on the original authors' reputations.

Finally, any free program is threatened constantly by software patents. We wish to avoid the danger that redistributors of a free program will individually obtain patent licenses, in effect making the program proprietary. To prevent this, we have made it clear that any patent must be licensed for everyone's free use or not licensed at all.

The precise terms and conditions for copying, distribution and modification follow.

GNU GENERAL PUBLIC LICENSE

TERMS AND CONDITIONS FOR COPYING, DISTRIBUTION AND MODIFICATION

0. This License applies to any program or other work which contains a notice placed by the copyright holder saying it may be distributed under the terms of this General Public License. The "Program", below, refers to any such program or work, and a "work based on the Program" means either the Program or any derivative work under copyright law: that is to say, a work containing the Program or a portion of it, either verbatim or with modifications and/or translated into another language. (Hereinafter, translation is included without limitation in the term "modification".) Each licensee is addressed as "you".

Activities other than copying, distribution and modification are not covered by this License; they are outside its scope. The act of running the Program is not restricted, and the output from the Program is covered only if its contents constitute a work based on the Program (independent of having been made by running the Program). Whether that is true depends on what the Program does.

1. You may copy and distribute verbatim copies of the Program's source code as you receive it, in any medium, provided that you conspicuously and appropriately publish on each copy an appropriate copyright notice and disclaimer of warranty; keep intact all the notices that refer to this License and to the absence of any warranty; and give any other recipients of the Program a copy of this License along with the Program.

You may charge a fee for the physical act of transferring a copy, and you may at your option offer warranty protection in exchange for a fee.

2. You may modify your copy or copies of the Program or any portion of it, thus forming a work based on the Program, and copy and distribute such modifications or work under the terms of Section 1 above, provided that you also meet all of these conditions:

a) You must cause the modified files to carry prominent notices stating that you changed the files and the date of any change.

b) You must cause any work that you distribute or publish, that in whole or in part contains or is derived from the Program or any part thereof, to be licensed as a whole at no charge to all third parties under the terms of this License.

c) If the modified program normally reads commands interactively when run, you must cause it, when started running for such interactive use in the most ordinary way, to print or display an announcement including an appropriate copyright notice and a notice that there is no warranty (or else, saying that you provide a warranty) and that users may redistribute the program under these conditions, and telling the user how to view a copy of this License. (Exception: if the Program itself is interactive but does not normally print such an announcement, your work based on the Program is not required to print an announcement.)

These requirements apply to the modified work as a whole. If identifiable sections of that work are not derived from the Program, and can be reasonably considered independent and separate works in themselves, then this License, and its terms, do not apply to those sections when you distribute them as separate works. But when you distribute the same sections as part of a whole which is a work based on the Program, the distribution of the whole must be on the terms of this License, whose permissions for other licensees extend to the entire whole, and thus to each and every part regardless of who wrote it. Thus, it is not the intent of this section to claim rights or contest your rights to work written entirely by you; rather, the intent is to exercise the right to control the distribution of derivative or collective works based on the Program. In addition, mere aggregation of another work not based on the Program with the Program (or with a work based on the Program) on a volume of a storage or distribution medium does not bring the other work under the scope of this License.

3. You may copy and distribute the Program (or a work based on it, under Section 2) in object code or executable form under the terms of Sections 1 and 2 above provided that you also do one of the following:

a) Accompany it with the complete corresponding machine-readable source code, which must be distributed under the terms of Sections 1 and 2 above on a medium customarily used for software interchange; or, b) Accompany it with a written offer, valid for at least three years, to give any third party, for a charge no more than your cost of physically performing source distribution, a complete machine-readable copy of the corresponding source code, to be distributed under the terms of Sections 1 and 2 above on a medium customarily used for software interchange; or, c) Accompany it with the information you received as to the offer to distribute corresponding source code. (This alternative is allowed only for noncommercial distribution and only if you received the program in object code or executable form with such an offer, in accord with Subsection b above.)

The source code for a work means the preferred form of the work for making modifications to it. For an executable work, complete source code means all the source code for all modules it contains, plus any associated interface definition files, plus the scripts used to control compilation and installation of the executable. However, as a special exception, the source code distributed need not include anything that is normally distributed (in either source or binary form) with the major components (compiler, kernel, and so on) of the operating system on which the executable runs, unless that component itself accompanies the executable.

If distribution of executable or object code is made by offering access to copy from a designated place, then offering equivalent access to copy the source code from the same place counts as distribution of the source code, even though third parties are not compelled to copy the source along with the object code.

4. You may not copy, modify, sublicense, or distribute the Program except as expressly provided under this License. Any attempt otherwise to copy, modify, sublicense or distribute the Program is void, and will automatically terminate your rights under this License. However, parties who have received copies, or rights, from you under this License will not have their licenses terminated so long as such parties remain in full compliance.

5. You are not required to accept this License, since you have not signed it. However, nothing else grants you permission to modify or distribute the Program or its derivative works. These actions are prohibited by law if you do not accept this License. Therefore, by modifying or distributing the Program (or any work based on the Program), you indicate your acceptance of this License to do so, and all its terms and conditions for copying, distributing or modifying the Program or works based on it.

6. Each time you redistribute the Program (or any work based on the Program), the recipient automatically receives a license from the original licensor to copy, distribute or modify the Program subject to these terms and conditions. You may not impose any further restrictions on the recipients' exercise of the rights granted herein. You are not responsible for enforcing compliance by third parties to this License.

7. If, as a consequence of a court judgment or allegation of patent infringement or for any other reason (not limited to patent issues), conditions are imposed on you (whether by court order, agreement or otherwise) that contradict the conditions of this License, they do not excuse you from the conditions of this License. If you cannot distribute so as to satisfy simultaneously your obligations under this License and any other pertinent obligations, then as a consequence you may not distribute the Program at all. For example, if a patent license would not permit royalty-free redistribution of the Program by all those who receive copies directly or indirectly through you, then the only way you could satisfy both it and this License would be to refrain entirely from distribution of the Program.

If any portion of this section is held invalid or unenforceable under any particular circumstance, the balance of the section is intended to apply and the section as a whole is intended to apply in other circumstances.

It is not the purpose of this section to induce you to infringe any patents or other property right claims or to contest validity of any such claims; this section has the sole purpose of protecting the integrity of the free software distribution system, which is implemented by public license practices. Many people have made generous contributions to the wide range of software distributed through that system in reliance on consistent application of that system; it is up to the author/donor to decide if he or she is willing to distribute software through any other system and a licensee cannot impose that choice. This section is intended to make thoroughly clear what is believed to be a consequence of the rest of this License.

8. If the distribution and/or use of the Program is restricted in certain countries either by patents or by copyrighted interfaces, the original copyright holder who places the Program under this License may add an explicit geographical distribution limitation excluding those countries, so that distribution is permitted only in or among countries not thus excluded. In such case, this License incorporates the limitation as if written in the body of this License.

9. The Free Software Foundation may publish revised and/or new versions of the General Public License from time to time. Such new versions will be similar in spirit to the present version, but may differ in detail to address new problems or concerns.

Each version is given a distinguishing version number. If the Program specifies a version number of this License which applies to it and "any later version", you have the option of following the terms and conditions either of that version or of any later version published by the Free Software Foundation. If the Program does not specify a version number of this License, you may choose any version ever published by the Free Software Foundation.

10. If you wish to incorporate parts of the Program into other free programs whose distribution conditions are different, write to the author to ask for permission. For software which is copyrighted by the Free Software Foundation, write to the Free Software Foundation; we sometimes make exceptions for this. Our decision will be guided by the two goals of preserving the free status of all derivatives of our free software and of promoting the sharing and reuse of software generally.

NO WARRANTY

11. BECAUSE THE PROGRAM IS LICENSED FREE OF CHARGE, THERE IS NO WARRANTY FOR THE PROGRAM, TO THE EXTENT PERMITTED BY APPLICABLE LAW. EXCEPT WHEN OTHERWISE STATED IN WRITING THE COPYRIGHT HOLDERS AND/OR OTHER PARTIES PROVIDE THE PROGRAM "AS IS" WITHOUT WARRANTY OF ANY KIND, EITHER EXPRESSED OR IMPLIED, INCLUDING, BUT NOT LIMITED TO, THE IMPLIED WARRANTIES OF MERCHANTABILITY AND FITNESS FOR A PARTICULAR PURPOSE. THE ENTIRE RISK AS TO THE QUALITY AND PERFORMANCE OF THE PROGRAM IS WITH YOU. SHOULD THE PROGRAM PROVE DEFECTIVE, YOU ASSUME THE COST OF ALL NECESSARY SERVICING, REPAIR OR CORRECTION.

12. IN NO EVENT UNLESS REQUIRED BY APPLICABLE LAW OR AGREED TO IN WRITING WILL ANY COPYRIGHT HOLDER, OR ANY OTHER PARTY WHO MAY MODIFY AND/OR REDISTRIBUTE THE PROGRAM AS PERMITTED ABOVE, BE LIABLE TO YOU FOR DAMAGES, INCLUDING ANY GENERAL, SPECIAL, INCIDENTAL OR CONSEQUENTIAL DAMAGES ARISING OUT OF THE USE OR INABILITY TO USE THE PROGRAM (INCLUDING BUT NOT LIMITED TO LOSS OF DATA OR DATA BEING RENDERED INACCURATE OR LOSSES SUSTAINED BY YOU OR THIRD PARTIES OR A FAILURE OF THE PROGRAM TO OPERATE WITH ANY OTHER PROGRAMS), EVEN IF SUCH HOLDER OR OTHER PARTY HAS BEEN ADVISED OF THE POSSIBILITY OF SUCH DAMAGES.

END OF TERMS AND CONDITIONS

Licenses - Dropbear

Dropbear contains a number of components from different sources, hence there are a few licenses and authors involved. All licenses are fairly non-restrictive.

The majority of code is written by Matt Johnston, under the license below.

Portions of the client-mode work are (c) 2004 Mihnea Stoenescu, under the same license:

Copyright (c) 2002-2015 Matt Johnston

Portions copyright (c) 2004 Mihnea Stoenescu

All rights reserved.

Permission is hereby granted, free of charge, to any person obtaining a copy of this software and associated documentation files (the "Software"), to deal in the Software without restriction, including without limitation the rights to use, copy, modify, merge, publish, distribute, sublicense, and/or sell copies of the Software, and to permit persons to whom the Software is furnished to do so, subject to the following conditions:

The above copyright notice and this permission notice shall be included in all copies or substantial portions of the Software.

THE SOFTWARE IS PROVIDED "AS IS", WITHOUT WARRANTY OF ANY KIND, EXPRESS OR IMPLIED, INCLUDING BUT NOT LIMITED TO THE WARRANTIES OF MERCHANTABILITY, FITNESS FOR A PARTICULAR PURPOSE AND NONINFRINGEMENT. IN NO EVENT SHALL THE AUTHORS OR COPYRIGHT HOLDERS BE LIABLE FOR ANY CLAIM, DAMAGES OR OTHER LIABILITY, WHETHER IN AN ACTION OF CONTRACT, TORT OR OTHERWISE, ARISING FROM, OUT OF OR IN CONNECTION WITH THE SOFTWARE OR THE USE OR OTHER DEALINGS IN THE SOFTWARE.

=====

LibTomCrypt and LibTomMath are written by Tom St Denis, and are Public Domain.

=====

sshpty.c is taken from OpenSSH 3.5p1,

Copyright (c) 1995 Tatu Ylonen <ylo@cs.hut.fi>, Espoo, Finland

All rights reserved

"As far as I am concerned, the code I have written for this software can be used freely for any purpose. Any derived versions of this software must be clearly marked as such, and if the derived work is incompatible with the protocol description in the RFC file, it must be called by a name other than "ssh" or "Secure Shell". "

=====

loginrec.c

loginrec.h

atomicio.h

atomicio.c

and strlcat() (included in util.c) are from OpenSSH 3.6.1p2, and are licensed under the 2 point BSD license.

loginrec is written primarily by Andre Lucas, atomicio.c by Theo de Raadt.

strlcat() is (c) Todd C. Miller

=====

Import code in keyimport.c is modified from PuTTY's import.c, licensed as follows:

PuTTY is copyright 1997-2003 Simon Tatham.

Portions copyright Robert de Bath, Joris van Rantwijk, Delian Delchev, Andreas Schultz, Jeroen Massar, Wez Furlong, Nicolas Barry, Justin Bradford, and CORE SDI S.A.

Permission is hereby granted, free of charge, to any person obtaining a copy of this software and associated documentation files (the "Software"), to deal in the Software without restriction, including without limitation the rights to use, copy, modify, merge, publish, distribute, sublicense, and/or sell copies of the Software, and to permit persons to whom the Software is furnished to do so, subject to the following conditions:

The above copyright notice and this permission notice shall be included in all copies or substantial portions of the Software.

THE SOFTWARE IS PROVIDED "AS IS", WITHOUT WARRANTY OF ANY KIND, EXPRESS OR IMPLIED, INCLUDING BUT NOT LIMITED TO THE WARRANTIES OF MERCHANTABILITY, FITNESS FOR A PARTICULAR PURPOSE AND NONINFRINGEMENT. IN NO EVENT SHALL THE COPYRIGHT HOLDERS BE LIABLE FOR ANY CLAIM, DAMAGES OR OTHER LIABILITY, WHETHER IN AN ACTION OF CONTRACT, TORT OR OTHERWISE, ARISING FROM, OUT OF OR IN CONNECTION WITH THE SOFTWARE OR THE USE OR OTHER DEALINGS IN THE SOFTWARE.

=====

curve25519-donna:

/* Copyright 2008, Google Inc.

* All rights reserved.

*

* Redistribution and use in source and binary forms, with or without modification, are permitted provided that the following conditions are met:

*

Redistributions of source code must retain the above copyright notice, this list of conditions and the following disclaimer.

Redistributions in binary form must reproduce the above copyright notice, this list of conditions and the following disclaimer in the documentation and/or other materials provided with the distribution.

Neither the name of Google Inc. nor the names of its contributors may be used to endorse or promote products derived from this software without specific prior written permission.

THIS SOFTWARE IS PROVIDED BY THE COPYRIGHT HOLDERS AND CONTRIBUTORS "AS IS" AND ANY EXPRESS OR IMPLIED WARRANTIES, INCLUDING, BUT NOT LIMITED TO, THE IMPLIED WARRANTIES OF MERCHANTABILITY AND FITNESS FOR A PARTICULAR PURPOSE ARE DISCLAIMED. IN NO EVENT SHALL THE COPYRIGHT OWNER OR CONTRIBUTORS BE LIABLE FOR ANY DIRECT, INDIRECT, INCIDENTAL, SPECIAL, EXEMPLARY, OR CONSEQUENTIAL DAMAGES (INCLUDING, BUT NOT LIMITED TO, PROCUREMENT OF SUBSTITUTE GOODS OR SERVICES; LOSS OF USE, DATA, OR PROFITS; OR BUSINESS INTERRUPTION) HOWEVER CAUSED AND ON ANY THEORY OF LIABILITY, WHETHER IN CONTRACT, STRICT LIABILITY, OR TORT (INCLUDING NEGLIGENCE OR OTHERWISE) ARISING IN ANY WAY OUT OF THE USE OF THIS SOFTWARE, EVEN IF ADVISED OF THE POSSIBILITY OF SUCH DAMAGE.

* curve25519-donna: Curve25519 elliptic curve, public key function

* <http://code.google.com/p/curve25519-donna/>

* Adam Langley <agl@imperialviolet.org>

* Derived from public domain C code by Daniel J. Bernstein <djb@cr.yp.to>

* More information about curve25519 can be found here

- * <http://cr.yip.to/ecdh.html>
- * djb's sample implementation of curve25519 is written in a special assembly language called qhasm and uses the floating point registers.
- * This is, almost, a clean room reimplementation from the curve25519 paper. It uses many of the tricks described therein. Only the crecip function is taken from the sample implementation.

Licenses - FreeType

The FreeType Project LICENSE

2006-Jan-27

Copyright 1996-2002, 2006 by

David Turner, Robert Wilhelm, and Werner Lemberg

Introduction

=====

The FreeType Project is distributed in several archive packages; some of them may contain, in addition to the FreeType font engine, various tools and contributions which rely on, or relate to, the FreeType Project.

This license applies to all files found in such packages, and which do not fall under their own explicit license. The license affects thus the FreeType font engine, the test programs, documentation and makefiles, at the very least.

This license was inspired by the BSD, Artistic, and IJG (Independent JPEG Group) licenses, which all encourage inclusion and use of free software in commercial and freeware products alike. As a consequence, its main points are that:

- o We don't promise that this software works. However, we will be interested in any kind of bug reports. ('as is' distribution)
- o You can use this software for whatever you want, in parts or full form, without having to pay us. ('royalty-free' usage)
- o You may not pretend that you wrote this software. If you use it, or only parts of it, in a program, you must acknowledge somewhere in your documentation that you have used the FreeType code. ('credits')

We specifically permit and encourage the inclusion of this software, with or without modifications, in commercial products.

We disclaim all warranties covering The FreeType Project and assume no liability related to The FreeType Project.

Finally, many people asked us for a preferred form for a credit/disclaimer to use in compliance with this license. We thus encourage you to use the following text:

Portions of this software are copyright <year> The FreeType Project (www.freetype.org). All rights reserved.

Please replace <year> with the value from the FreeType version you actually use.

Legal Terms

=====

0. Definitions

Throughout this license, the terms 'package', 'FreeType Project', and 'FreeType archive' refer to the set of files originally distributed by the authors (David Turner, Robert Wilhelm, and Werner Lemberg) as the 'FreeType Project', be they named as alpha, beta or final release.

'You' refers to the licensee, or person using the project, where 'using' is a generic term including compiling the project's source code as well as linking it to form a 'program' or 'executable'.

This program is referred to as 'a program using the FreeType engine'.

This license applies to all files distributed in the original FreeType Project, including all source code, binaries and documentation, unless otherwise stated in the file in its original, unmodified form as distributed in the original archive.

If you are unsure whether or not a particular file is covered by this license, you must contact us to verify this.

The FreeType Project is copyright (C) 1996-2000 by David Turner, Robert Wilhelm, and Werner Lemberg. All rights reserved except as specified below.

1. No Warranty

THE FREETYPE PROJECT IS PROVIDED 'AS IS' WITHOUT WARRANTY OF ANY KIND, EITHER EXPRESS OR IMPLIED, INCLUDING, BUT NOT LIMITED TO, WARRANTIES OF MERCHANTABILITY AND FITNESS FOR A PARTICULAR PURPOSE. IN NO EVENT WILL ANY OF THE AUTHORS OR COPYRIGHT HOLDERS BE LIABLE FOR ANY DAMAGES CAUSED BY THE USE OR THE INABILITY TO USE, OF THE FREETYPE PROJECT.

2. Redistribution

This license grants a worldwide, royalty-free, perpetual and irrevocable right and license to use, execute, perform, compile, display, copy, create derivative works of, distribute and sublicense the FreeType Project (in both source and object code forms) and derivative works thereof for any purpose; and to authorize others to exercise some or all of the rights granted herein, subject to the following conditions:

o Redistribution of source code must retain this license file ('FTL.TXT') unaltered; any additions, deletions or changes to the original files must be clearly indicated in accompanying documentation. The copyright notices of the unaltered, original files must be preserved in all copies of source files.

o Redistribution in binary form must provide a disclaimer that states that the software is based in part of the work of the FreeType Team, in the distribution documentation. We also encourage you to put an URL to the FreeType web page in your documentation, though this isn't mandatory.

These conditions apply to any software derived from or based on the FreeType Project, not just the unmodified files. If you use our work, you must acknowledge us. However, no fee need be paid to us.

3. Advertising

Neither the FreeType authors and contributors nor you shall use the name of the other for commercial, advertising, or promotional purposes without specific prior written permission.

We suggest, but do not require, that you use one or more of the following phrases to refer to this software in your documentation or advertising materials: 'FreeType Project', 'FreeType Engine', 'FreeType library', or 'FreeType Distribution'.

As you have not signed this license, you are not required to accept it. However, as the FreeType Project is copyrighted material, only this license, or another one contracted with the

authors, grants you the right to use, distribute, and modify it. Therefore, by using, distributing, or modifying the FreeType Project, you indicate that you understand and accept all the terms of this license.

4. Contacts

There are two mailing lists related to FreeType:

o freetype@nongnu.org

Discusses general use and applications of FreeType, as well as future and wanted additions to the library and distribution. If you are looking for support, start in this list if you haven't found anything to help you in the documentation.

o freetype-devel@nongnu.org

Discusses bugs, as well as engine internals, design issues, specific licenses, porting, etc.

Our home page can be found at <http://www.freetype.org>

Licenses - IW

Copyright (c) 2007, 2008 Johannes Berg

Copyright (c) 2007 Andy Lutomirski

Copyright (c) 2007 Mike Kershaw

Copyright (c) 2008-2009 Luis R. Rodriguez

Permission to use, copy, modify, and/or distribute this software for any purpose with or without fee is hereby granted, provided that the above copyright notice and this permission notice appear in all copies.

THE SOFTWARE IS PROVIDED "AS IS" AND THE AUTHOR DISCLAIMS ALL WARRANTIES WITH REGARD TO THIS SOFTWARE INCLUDING ALL IMPLIED WARRANTIES OF MERCHANTABILITY AND FITNESS. IN NO EVENT SHALL THE AUTHOR BE LIABLE FOR ANY SPECIAL, DIRECT, INDIRECT, OR CONSEQUENTIAL DAMAGES OR ANY DAMAGES WHATSOEVER RESULTING FROM LOSS OF USE, DATA OR PROFITS, WHETHER IN AN ACTION OF CONTRACT, NEGLIGENCE OR OTHER TORTIOUS ACTION, ARISING OUT OF OR IN CONNECTION WITH THE USE OR PERFORMANCE OF THIS SOFTWARE.

Licenses - JSON-C

Copyright (c) 2009-2012 Eric Haszlakiewicz

Permission is hereby granted, free of charge, to any person obtaining a copy of this software and associated documentation files (the "Software"), to deal in the Software without restriction, including without limitation the rights to use, copy, modify, merge, publish, distribute, sublicense, and/or sell copies of the Software, and to permit persons to whom the Software is furnished to do so, subject to the following conditions:

The above copyright notice and this permission notice shall be included in all copies or substantial portions of the Software.

THE SOFTWARE IS PROVIDED "AS IS", WITHOUT WARRANTY OF ANY KIND, EXPRESS OR IMPLIED, INCLUDING BUT NOT LIMITED TO THE WARRANTIES OF MERCHANTABILITY, FITNESS FOR A PARTICULAR PURPOSE AND NONINFRINGEMENT. IN NO EVENT SHALL THE AUTHORS OR COPYRIGHT HOLDERS BE LIABLE FOR ANY CLAIM, DAMAGES OR OTHER LIABILITY, WHETHER IN AN ACTION OF CONTRACT, TORT OR OTHERWISE, ARISING FROM, OUT OF OR IN CONNECTION WITH THE SOFTWARE OR THE USE OR OTHER DEALINGS IN THE SOFTWARE.

Copyright (c) 2004, 2005 Metaparadigm Pte Ltd

Permission is hereby granted, free of charge, to any person obtaining a copy of this software and associated documentation files (the "Software"), to deal in the Software without restriction, including without limitation the rights to use, copy, modify, merge, publish, distribute, sublicense, and/or sell copies of the Software, and to permit persons to whom the Software is furnished to do so, subject to the following conditions:

The above copyright notice and this permission notice shall be included in all copies or substantial portions of the Software.

THE SOFTWARE IS PROVIDED "AS IS", WITHOUT WARRANTY OF ANY KIND, EXPRESS OR IMPLIED, INCLUDING BUT NOT LIMITED TO THE WARRANTIES OF MERCHANTABILITY, FITNESS FOR A PARTICULAR PURPOSE AND NONINFRINGEMENT. IN NO EVENT SHALL THE AUTHORS OR COPYRIGHT HOLDERS BE LIABLE FOR ANY CLAIM, DAMAGES OR OTHER LIABILITY, WHETHER IN AN ACTION OF CONTRACT, TORT OR OTHERWISE, ARISING FROM, OUT OF OR IN CONNECTION WITH THE SOFTWARE OR THE USE OR OTHER DEALINGS IN THE SOFTWARE.

Licenses - LIBTIRPC

Copyright (c) Copyright (c) Bull S.A. 2005 All Rights Reserved.

Redistribution and use in source and binary forms, with or without modification, are permitted provided that the following conditions are met:

1. Redistributions of source code must retain the above copyright notice, this list of conditions and the following disclaimer.
2. Redistributions in binary form must reproduce the above copyright notice, this list of conditions and the following disclaimer in the documentation and/or other materials provided with the distribution.
3. The name of the author may not be used to endorse or promote products derived from this software without specific prior written permission.

THIS SOFTWARE IS PROVIDED BY THE AUTHOR "AS IS" AND ANY EXPRESS OR IMPLIED WARRANTIES, INCLUDING, BUT NOT LIMITED TO, THE IMPLIED WARRANTIES OF MERCHANTABILITY AND FITNESS FOR A PARTICULAR PURPOSE ARE DISCLAIMED. IN NO EVENT SHALL THE AUTHOR BE LIABLE FOR ANY DIRECT, INDIRECT, INCIDENTAL, SPECIAL, EXEMPLARY, OR CONSEQUENTIAL DAMAGES (INCLUDING, BUT NOT LIMITED TO, PROCUREMENT OF SUBSTITUTE GOODS OR SERVICES; LOSS OF USE, DATA, OR PROFITS; OR BUSINESS INTERRUPTION) HOWEVER CAUSED AND ON ANY THEORY OF LIABILITY, WHETHER IN CONTRACT, STRICT LIABILITY, OR TORT (INCLUDING NEGLIGENCE OR OTHERWISE) ARISING IN ANY WAY OUT OF THE USE OF THIS SOFTWARE, EVEN IF ADVISED OF THE POSSIBILITY OF SUCH DAMAGE.

Licenses - LIBXML2

Except where otherwise noted in the source code (e.g. the files hash.c, list.c and the trio files, which are covered by a similar licence but with different Copyright notices) all the files are:

Copyright (C) 1998-2012 Daniel Veillard. All Rights Reserved.

Permission is hereby granted, free of charge, to any person obtaining a copy of this software and associated documentation files (the "Software"), to deal in the Software without restriction, including without limitation the rights to use, copy, modify, merge, publish, distribute, sublicense, and/or sell copies of the Software, and to permit persons to whom the Software is furnished to do so, subject to the following conditions:

The above copyright notice and this permission notice shall be included in all copies or substantial portions of the Software.

THE SOFTWARE IS PROVIDED "AS IS", WITHOUT WARRANTY OF ANY KIND, EXPRESS OR IMPLIED, INCLUDING BUT NOT LIMITED TO THE WARRANTIES OF MERCHANTABILITY, FITNESS FOR A PARTICULAR PURPOSE AND NONINFRINGEMENT. IN NO EVENT SHALL THE AUTHORS OR COPYRIGHT HOLDERS BE LIABLE FOR ANY CLAIM, DAMAGES OR OTHER LIABILITY, WHETHER IN AN ACTION OF CONTRACT, TORT OR OTHERWISE, ARISING FROM, OUT OF OR IN CONNECTION WITH THE SOFTWARE OR THE USE OR OTHER DEALINGS IN THE SOFTWARE.

Licenses - Mbus

Copyright (c) 2002-2003, 2013-2019 Victor Antonovich
(v.antonovich@gmail.com)

Copyright (c) 2011 Andrew Denysenko <nitr0@seti.kr.ua>

All rights reserved.

Redistribution and use in source and binary forms, with or without modification, are permitted provided that the following conditions are met:

1. Redistributions of source code must retain the above copyright notice, this list of conditions and the following disclaimer.
2. Redistributions in binary form must reproduce the above copyright notice, this list of conditions and the following disclaimer in the documentation and/or other materials provided with the distribution.
3. Neither the name of the copyright holder nor the names of its contributors may be used to endorse or promote products derived from this software without specific prior written permission.

THIS SOFTWARE IS PROVIDED BY THE COPYRIGHT HOLDERS AND CONTRIBUTORS "AS IS" AND ANY EXPRESS OR IMPLIED WARRANTIES, INCLUDING, BUT NOT LIMITED TO, THE IMPLIED WARRANTIES OF MERCHANTABILITY AND FITNESS FOR A PARTICULAR PURPOSE ARE DISCLAIMED. IN NO EVENT SHALL THE COPYRIGHT HOLDER OR CONTRIBUTORS BE LIABLE FOR ANY DIRECT, INDIRECT, INCIDENTAL, SPECIAL, EXEMPLARY, OR CONSEQUENTIAL DAMAGES (INCLUDING, BUT NOT LIMITED TO, PROCUREMENT OF SUBSTITUTE GOODS OR SERVICES; LOSS OF USE, DATA, OR PROFITS; OR BUSINESS INTERRUPTION) HOWEVER CAUSED AND ON ANY THEORY OF LIABILITY, WHETHER IN CONTRACT, STRICT LIABILITY, OR TORT (INCLUDING NEGLIGENCE OR OTHERWISE) ARISING IN ANY WAY OUT OF THE USE OF THIS SOFTWARE, EVEN IF ADVISED OF THE POSSIBILITY OF SUCH DAMAGE.

Licenses - Net-SNMP

Various copyrights apply to this package, listed in various separate parts below. Please make sure that you read all the parts.

Part 1: CMU/UCD copyright notice: (BSD like) -----

Copyright 1989, 1991, 1992 by Carnegie Mellon University

Derivative Work - 1996, 1998-2000

Copyright 1996, 1998-2000 The Regents of the University of California

All Rights Reserved

Permission to use, copy, modify and distribute this software and its documentation for any purpose and without fee is hereby granted, provided that the above copyright notice appears in all copies and that both that copyright notice and this permission notice appear in supporting documentation, and that the name of CMU and The Regents of the University of California not be used in advertising or publicity pertaining to distribution of the software without specific written permission.

CMU AND THE REGENTS OF THE UNIVERSITY OF CALIFORNIA DISCLAIM ALL WARRANTIES WITH REGARD TO THIS SOFTWARE, INCLUDING ALL IMPLIED WARRANTIES OF MERCHANTABILITY AND FITNESS. IN NO EVENT SHALL CMU OR THE REGENTS OF THE UNIVERSITY OF CALIFORNIA BE LIABLE FOR ANY SPECIAL, INDIRECT OR CONSEQUENTIAL DAMAGES OR ANY DAMAGES WHATSOEVER RESULTING FROM THE LOSS OF USE, DATA OR PROFITS, WHETHER IN AN ACTION OF CONTRACT, NEGLIGENCE OR OTHER TORTIOUS ACTION, ARISING OUT OF OR IN CONNECTION WITH THE USE OR PERFORMANCE OF THIS SOFTWARE.

Part 2: Networks Associates Technology, Inc copyright notice (BSD) -----

Copyright (c) 2001-2003, Networks Associates Technology, Inc

All rights reserved.

Redistribution and use in source and binary forms, with or without modification, are permitted provided that the following conditions are met:

Redistributions of source code must retain the above copyright notice, this list of conditions and the following disclaimer.

Redistributions in binary form must reproduce the above copyright notice, this list of conditions and the following disclaimer in the documentation and/or other materials provided with the distribution.

Neither the name of the Networks Associates Technology, Inc nor the names of its contributors may be used to endorse or promote products derived from this software without specific prior written permission.

THIS SOFTWARE IS PROVIDED BY THE COPYRIGHT HOLDERS AND CONTRIBUTORS ``AS IS" AND ANY EXPRESS OR IMPLIED WARRANTIES, INCLUDING, BUT NOT LIMITED TO, THE IMPLIED WARRANTIES OF MERCHANTABILITY AND FITNESS FOR A PARTICULAR PURPOSE ARE DISCLAIMED. IN NO EVENT SHALL THE COPYRIGHT HOLDERS OR CONTRIBUTORS BE LIABLE FOR ANY DIRECT, INDIRECT, INCIDENTAL, SPECIAL, EXEMPLARY, OR CONSEQUENTIAL DAMAGES (INCLUDING, BUT NOT LIMITED TO, PROCUREMENT OF SUBSTITUTE GOODS OR SERVICES; LOSS OF USE, DATA, OR PROFITS; OR BUSINESS INTERRUPTION) HOWEVER CAUSED AND ON ANY THEORY OF LIABILITY, WHETHER IN CONTRACT, STRICT LIABILITY, OR TORT (INCLUDING NEGLIGENCE OR OTHERWISE) ARISING IN ANY WAY OUT OF THE USE OF THIS SOFTWARE, EVEN IF ADVISED OF THE POSSIBILITY OF SUCH DAMAGE.

Part 3: Cambridge Broadband Ltd. copyright notice (BSD) -----

Portions of this code are copyright (c) 2001-2003, Cambridge Broadband Ltd.
All rights reserved.

Redistribution and use in source and binary forms, with or without modification, are permitted provided that the following conditions are met:

Redistributions of source code must retain the above copyright notice, this list of conditions and the following disclaimer.

Redistributions in binary form must reproduce the above copyright notice, this list of conditions and the following disclaimer in the documentation and/or other materials provided with the distribution.

The name of Cambridge Broadband Ltd. may not be used to endorse or promote products derived from this software without specific prior written permission.

THIS SOFTWARE IS PROVIDED BY THE COPYRIGHT HOLDER ``AS IS" AND ANY EXPRESS OR IMPLIED WARRANTIES, INCLUDING, BUT NOT LIMITED TO, THE IMPLIED WARRANTIES OF MERCHANTABILITY AND FITNESS FOR A PARTICULAR PURPOSE ARE DISCLAIMED. IN NO EVENT SHALL THE COPYRIGHT HOLDER BE LIABLE FOR ANY DIRECT, INDIRECT, INCIDENTAL, SPECIAL, EXEMPLARY, OR CONSEQUENTIAL DAMAGES (INCLUDING, BUT NOT LIMITED TO, PROCUREMENT OF SUBSTITUTE GOODS OR SERVICES; LOSS OF USE, DATA, OR PROFITS; OR BUSINESS INTERRUPTION) HOWEVER CAUSED AND ON ANY THEORY OF LIABILITY, WHETHER IN CONTRACT, STRICT LIABILITY, OR TORT (INCLUDING NEGLIGENCE OR OTHERWISE) ARISING IN ANY WAY OUT OF THE USE OF THIS SOFTWARE, EVEN IF ADVISED OF THE POSSIBILITY OF SUCH DAMAGE.

Part 4: Sun Microsystems, Inc. copyright notice (BSD) -----

Copyright (c) 2003 Sun Microsystems, Inc., 4150 Network Circle, Santa Clara, California 95054, U.S.A. All rights reserved.

Use is subject to license terms below.

This distribution may include materials developed by third parties.

Sun, Sun Microsystems, the Sun logo and Solaris are trademarks or registered trademarks of Sun Microsystems, Inc. in the U.S. and other countries.

Redistribution and use in source and binary forms, with or without modification, are permitted provided that the following conditions are met:

Redistributions of source code must retain the above copyright notice, this list of conditions and the following disclaimer.

Redistributions in binary form must reproduce the above copyright notice, this list of conditions and the following disclaimer in the documentation and/or other materials provided with the distribution.

Neither the name of the Sun Microsystems, Inc. nor the names of its contributors may be used to endorse or promote products derived from this software without specific prior written permission.

THIS SOFTWARE IS PROVIDED BY THE COPYRIGHT HOLDERS AND CONTRIBUTORS ``AS IS" AND ANY EXPRESS OR IMPLIED WARRANTIES, INCLUDING, BUT NOT LIMITED TO, THE IMPLIED WARRANTIES OF MERCHANTABILITY AND FITNESS FOR A PARTICULAR PURPOSE ARE DISCLAIMED. IN NO EVENT SHALL THE COPYRIGHT HOLDERS OR CONTRIBUTORS BE LIABLE FOR ANY DIRECT, INDIRECT, INCIDENTAL, SPECIAL, EXEMPLARY, OR CONSEQUENTIAL DAMAGES (INCLUDING, BUT NOT LIMITED TO, PROCUREMENT OF SUBSTITUTE GOODS OR SERVICES; LOSS OF USE, DATA, OR PROFITS; OR BUSINESS INTERRUPTION) HOWEVER CAUSED AND ON ANY THEORY OF LIABILITY, WHETHER IN CONTRACT, STRICT LIABILITY, OR TORT (INCLUDING NEGLIGENCE OR OTHERWISE) ARISING IN ANY WAY OUT OF THE USE OF THIS SOFTWARE, EVEN IF ADVISED OF THE POSSIBILITY OF SUCH DAMAGE.

Part 5: Sparta, Inc copyright notice (BSD) -----

Copyright (c) 2003-2013, Sparta, Inc

All rights reserved.

Redistribution and use in source and binary forms, with or without modification, are permitted provided that the following conditions are met:

Redistributions of source code must retain the above copyright notice, this list of conditions and the following disclaimer.

Redistributions in binary form must reproduce the above copyright notice, this list of conditions and the following disclaimer in the documentation and/or other materials provided with the distribution.

Neither the name of Sparta, Inc nor the names of its contributors may be used to endorse or promote products derived from this software without specific prior written permission.

THIS SOFTWARE IS PROVIDED BY THE COPYRIGHT HOLDERS AND CONTRIBUTORS ``AS IS" AND ANY EXPRESS OR IMPLIED WARRANTIES, INCLUDING, BUT NOT LIMITED TO, THE IMPLIED WARRANTIES OF MERCHANTABILITY AND FITNESS FOR A PARTICULAR PURPOSE ARE DISCLAIMED. IN NO EVENT SHALL THE COPYRIGHT HOLDERS OR CONTRIBUTORS BE LIABLE FOR ANY DIRECT, INDIRECT, INCIDENTAL, SPECIAL, EXEMPLARY, OR CONSEQUENTIAL DAMAGES (INCLUDING, BUT NOT LIMITED TO, PROCUREMENT OF SUBSTITUTE GOODS OR SERVICES; LOSS OF USE, DATA, OR PROFITS; OR BUSINESS INTERRUPTION) HOWEVER CAUSED AND ON ANY THEORY OF LIABILITY, WHETHER IN CONTRACT, STRICT LIABILITY, OR TORT (INCLUDING NEGLIGENCE OR OTHERWISE) ARISING IN ANY WAY OUT OF THE USE OF THIS SOFTWARE, EVEN IF ADVISED OF THE POSSIBILITY OF SUCH DAMAGE.

Part 6: Cisco/BUPTNIC copyright notice (BSD) -----

Copyright (c) 2004, Cisco, Inc and Information Network
Center of Beijing University of Posts and Telecommunications.

All rights reserved.

Redistribution and use in source and binary forms, with or without modification, are permitted provided that the following conditions are met:

Redistributions of source code must retain the above copyright notice, this list of conditions and the following disclaimer.

Redistributions in binary form must reproduce the above copyright notice, this list of conditions and the following disclaimer in the documentation and/or other materials provided with the distribution.

Neither the name of Cisco, Inc, Beijing University of Posts and Telecommunications, nor the names of their contributors may be used to endorse or promote products derived from this software without specific prior written permission.

THIS SOFTWARE IS PROVIDED BY THE COPYRIGHT HOLDERS AND CONTRIBUTORS ``AS IS" AND ANY EXPRESS OR IMPLIED WARRANTIES, INCLUDING, BUT NOT LIMITED TO, THE IMPLIED WARRANTIES OF MERCHANTABILITY AND FITNESS FOR A PARTICULAR PURPOSE ARE DISCLAIMED. IN NO EVENT SHALL THE COPYRIGHT HOLDERS OR CONTRIBUTORS BE LIABLE FOR ANY DIRECT, INDIRECT, INCIDENTAL, SPECIAL, EXEMPLARY, OR CONSEQUENTIAL DAMAGES (INCLUDING, BUT NOT LIMITED TO, PROCUREMENT OF SUBSTITUTE GOODS OR SERVICES; LOSS OF USE, DATA, OR PROFITS; OR BUSINESS INTERRUPTION) HOWEVER CAUSED AND ON ANY THEORY OF LIABILITY, WHETHER IN CONTRACT, STRICT LIABILITY, OR TORT (INCLUDING NEGLIGENCE OR OTHERWISE) ARISING IN ANY WAY OUT OF THE USE OF THIS SOFTWARE, EVEN IF ADVISED OF THE POSSIBILITY OF SUCH DAMAGE.

Part 7: Fabasoft R&D Software GmbH & Co KG copyright notice (BSD) -----

Copyright (c) Fabasoft R&D Software GmbH & Co KG, 2003

oss@fabasoft.com

Author: Bernhard Penz <bernhard.penz@fabasoft.com>

Redistribution and use in source and binary forms, with or without modification, are permitted provided that the following conditions are met:

Redistributions of source code must retain the above copyright notice, this list of conditions and the following disclaimer.

Redistributions in binary form must reproduce the above copyright notice, this list of conditions and the following disclaimer in the documentation and/or other materials provided with the distribution.

The name of Fabasoft R&D Software GmbH & Co KG or any of its subsidiaries, brand or product names may not be used to endorse or promote products derived from this software without specific prior written permission.

THIS SOFTWARE IS PROVIDED BY THE COPYRIGHT HOLDER ``AS IS'' AND ANY EXPRESS OR IMPLIED WARRANTIES, INCLUDING, BUT NOT LIMITED TO, THE IMPLIED WARRANTIES OF MERCHANTABILITY AND FITNESS FOR A PARTICULAR PURPOSE ARE DISCLAIMED. IN NO EVENT SHALL THE COPYRIGHT HOLDER BE LIABLE FOR ANY DIRECT, INDIRECT, INCIDENTAL, SPECIAL, EXEMPLARY, OR CONSEQUENTIAL DAMAGES (INCLUDING, BUT NOT LIMITED TO, PROCUREMENT OF SUBSTITUTE GOODS OR SERVICES; LOSS OF USE, DATA, OR PROFITS; OR BUSINESS INTERRUPTION) HOWEVER CAUSED AND ON ANY THEORY OF LIABILITY, WHETHER IN CONTRACT, STRICT LIABILITY, OR TORT (INCLUDING NEGLIGENCE OR OTHERWISE) ARISING IN ANY WAY OUT OF THE USE OF THIS SOFTWARE, EVEN IF ADVISED OF THE POSSIBILITY OF SUCH DAMAGE.

Part 8: Apple Inc. copyright notice (BSD) -----

Copyright (c) 2007 Apple Inc. All rights reserved.

Redistribution and use in source and binary forms, with or without modification, are permitted provided that the following conditions are met:

1. Redistributions of source code must retain the above copyright notice, this list of conditions and the following disclaimer.
2. Redistributions in binary form must reproduce the above copyright notice, this list of conditions and the following disclaimer in the documentation and/or other materials provided with the distribution.
3. Neither the name of Apple Inc. ("Apple") nor the names of its contributors may be used to endorse or promote products derived from this software without specific prior written permission.

THIS SOFTWARE IS PROVIDED BY APPLE AND ITS CONTRIBUTORS "AS IS" AND ANY EXPRESS OR IMPLIED WARRANTIES, INCLUDING, BUT NOT LIMITED TO, THE IMPLIED WARRANTIES OF MERCHANTABILITY AND FITNESS FOR A PARTICULAR PURPOSE ARE DISCLAIMED. IN NO EVENT SHALL APPLE OR ITS CONTRIBUTORS BE LIABLE FOR ANY DIRECT, INDIRECT, INCIDENTAL, SPECIAL, EXEMPLARY, OR CONSEQUENTIAL DAMAGES (INCLUDING, BUT NOT LIMITED TO, PROCUREMENT OF SUBSTITUTE GOODS OR SERVICES; LOSS OF USE, DATA, OR PROFITS; OR BUSINESS INTERRUPTION) HOWEVER CAUSED AND ON ANY THEORY OF LIABILITY, WHETHER IN CONTRACT, STRICT LIABILITY, OR TORT (INCLUDING NEGLIGENCE OR OTHERWISE) ARISING IN ANY WAY OUT OF THE USE OF THIS SOFTWARE, EVEN IF ADVISED OF THE POSSIBILITY OF SUCH DAMAGE.

Part 9: ScienceLogic, LLC copyright notice (BSD) -----

Copyright (c) 2009, ScienceLogic, LLC

All rights reserved.

Redistribution and use in source and binary forms, with or without modification, are permitted provided that the following conditions are met:

Redistributions of source code must retain the above copyright notice, this list of conditions and the following disclaimer.

Redistributions in binary form must reproduce the above copyright notice, this list of conditions and the following disclaimer in the documentation and/or other materials provided with the distribution.

Neither the name of ScienceLogic, LLC nor the names of its contributors may be used to endorse or promote products derived from this software without specific prior written permission.

THIS SOFTWARE IS PROVIDED BY THE COPYRIGHT HOLDERS AND CONTRIBUTORS "AS IS" AND ANY EXPRESS OR IMPLIED WARRANTIES, INCLUDING, BUT NOT LIMITED TO, THE IMPLIED WARRANTIES OF MERCHANTABILITY AND FITNESS FOR A PARTICULAR PURPOSE ARE DISCLAIMED. IN NO EVENT SHALL THE COPYRIGHT HOLDERS OR CONTRIBUTORS BE LIABLE FOR ANY DIRECT, INDIRECT, INCIDENTAL, SPECIAL, EXEMPLARY, OR CONSEQUENTIAL DAMAGES (INCLUDING, BUT NOT LIMITED TO, PROCUREMENT OF SUBSTITUTE GOODS OR SERVICES; LOSS OF USE, DATA, OR PROFITS; OR BUSINESS INTERRUPTION) HOWEVER CAUSED AND ON ANY THEORY OF LIABILITY, WHETHER IN CONTRACT, STRICT LIABILITY, OR TORT (INCLUDING NEGLIGENCE OR OTHERWISE) ARISING IN ANY WAY OUT OF THE USE OF THIS SOFTWARE, EVEN IF ADVISED OF THE POSSIBILITY OF SUCH DAMAGE.

Part 10: Lennart Poettering copyright notice (BSD-like) -----

Copyright 2010 Lennart Poettering

Permission is hereby granted, free of charge, to any person obtaining a copy of this software and associated documentation files (the "Software"), to deal in the Software without restriction, including without limitation the rights to use, copy, modify, merge, publish, distribute, sublicense, and/or sell copies of the Software, and to permit persons to whom the Software is furnished to do so, subject to the following conditions:

The above copyright notice and this permission notice shall be included in all copies or substantial portions of the Software.

THE SOFTWARE IS PROVIDED "AS IS", WITHOUT WARRANTY OF ANY KIND, EXPRESS OR IMPLIED, INCLUDING BUT NOT LIMITED TO THE WARRANTIES OF MERCHANTABILITY, FITNESS FOR A PARTICULAR PURPOSE AND NONINFRINGEMENT. IN NO EVENT SHALL THE AUTHORS OR COPYRIGHT HOLDERS BE LIABLE FOR ANY CLAIM, DAMAGES OR OTHER LIABILITY, WHETHER IN AN ACTION OF CONTRACT, TORT OR OTHERWISE, ARISING FROM, OUT OF OR IN CONNECTION WITH THE SOFTWARE OR THE USE OR OTHER DEALINGS IN THE SOFTWARE.

Part 11: IETF copyright notice (BSD) ----

Copyright (c) 2013 IETF Trust and the persons identified as authors of the code. All rights reserved.

Redistribution and use in source and binary forms, with or without modification, are permitted provided that the following conditions are met:

Redistributions of source code must retain the above copyright notice, this list of conditions and the following disclaimer.

Redistributions in binary form must reproduce the above copyright notice, this list of conditions and the following disclaimer in the documentation and/or other materials provided with the distribution. Neither the name of Internet Society, IETF or IETF Trust, nor the names of specific contributors, may be used to endorse or promote products derived from this software without specific prior written permission.

THIS SOFTWARE IS PROVIDED BY THE COPYRIGHT HOLDERS AND CONTRIBUTORS "AS IS" AND ANY EXPRESS OR IMPLIED WARRANTIES, INCLUDING, BUT NOT LIMITED TO, THE IMPLIED WARRANTIES OF MERCHANTABILITY AND FITNESS FOR A PARTICULAR PURPOSE ARE DISCLAIMED. IN NO EVENT SHALL THE COPYRIGHT OWNER OR CONTRIBUTORS BE LIABLE FOR ANY DIRECT, INDIRECT, INCIDENTAL, SPECIAL, EXEMPLARY, OR CONSEQUENTIAL DAMAGES (INCLUDING, BUT NOT LIMITED TO, PROCUREMENT OF SUBSTITUTE GOODS OR SERVICES; LOSS OF USE, DATA, OR PROFITS; OR BUSINESS INTERRUPTION) HOWEVER CAUSED AND ON ANY THEORY OF LIABILITY, WHETHER IN CONTRACT, STRICT LIABILITY, OR TORT (INCLUDING NEGLIGENCE OR OTHERWISE) ARISING IN ANY WAY OUT OF THE USE OF THIS SOFTWARE, EVEN IF ADVISED OF THE POSSIBILITY OF SUCH DAMAGE.

Part 12: Arista Networks copyright notice (BSD) ----

Copyright (c) 2013, Arista Networks, Inc.

All rights reserved.

Redistribution and use in source and binary forms, with or without modification, are permitted provided that the following conditions are met:

Redistributions of source code must retain the above copyright notice, this list of conditions and the following disclaimer.

Redistributions in binary form must reproduce the above copyright notice, this list of conditions and the following disclaimer in the documentation and/or other materials provided with the distribution.

Neither the name of Arista Networks, Inc. nor the names of its contributors may be used to endorse or promote products derived from this software without specific prior written permission.

THIS SOFTWARE IS PROVIDED BY THE COPYRIGHT HOLDERS AND CONTRIBUTORS ``AS IS" AND ANY EXPRESS OR IMPLIED WARRANTIES, INCLUDING, BUT NOT LIMITED TO, THE IMPLIED WARRANTIES OF MERCHANTABILITY AND FITNESS FOR A PARTICULAR PURPOSE ARE DISCLAIMED. IN NO EVENT SHALL THE COPYRIGHT HOLDERS OR CONTRIBUTORS BE LIABLE FOR ANY DIRECT, INDIRECT, INCIDENTAL, SPECIAL, EXEMPLARY, OR CONSEQUENTIAL DAMAGES (INCLUDING, BUT NOT LIMITED TO, PROCUREMENT OF SUBSTITUTE GOODS OR SERVICES; LOSS OF USE, DATA, OR PROFITS; OR BUSINESS INTERRUPTION) HOWEVER CAUSED AND ON ANY THEORY OF LIABILITY, WHETHER IN CONTRACT, STRICT LIABILITY, OR TORT (INCLUDING NEGLIGENCE OR OTHERWISE) ARISING IN ANY WAY OUT OF THE USE OF THIS SOFTWARE, EVEN IF ADVISED OF THE POSSIBILITY OF SUCH DAMAGE.

Part 13: VMware, Inc. copyright notice (BSD) -----

Copyright (c) 2016, VMware, Inc.

All rights reserved.

Redistribution and use in source and binary forms, with or without modification, are permitted provided that the following conditions are met:

Redistributions of source code must retain the above copyright notice, this list of conditions and the following disclaimer.

Redistributions in binary form must reproduce the above copyright notice, this list of conditions and the following disclaimer in the documentation and/or other materials provided with the distribution.

Neither the name of VMware, Inc. nor the names of its contributors may be used to endorse or promote products derived from this software without specific prior written permission.

THIS SOFTWARE IS PROVIDED BY THE COPYRIGHT HOLDERS AND CONTRIBUTORS ``AS IS" AND ANY EXPRESS OR IMPLIED WARRANTIES, INCLUDING, BUT NOT LIMITED TO, THE IMPLIED WARRANTIES OF MERCHANTABILITY AND FITNESS FOR A PARTICULAR PURPOSE ARE DISCLAIMED. IN NO EVENT SHALL THE COPYRIGHT HOLDERS OR CONTRIBUTORS BE LIABLE FOR ANY DIRECT, INDIRECT, INCIDENTAL, SPECIAL, EXEMPLARY, OR CONSEQUENTIAL DAMAGES (INCLUDING, BUT NOT LIMITED TO, PROCUREMENT OF SUBSTITUTE GOODS OR SERVICES; LOSS OF USE, DATA, OR PROFITS; OR BUSINESS INTERRUPTION) HOWEVER CAUSED AND ON ANY THEORY OF LIABILITY, WHETHER IN CONTRACT, STRICT LIABILITY, OR TORT (INCLUDING NEGLIGENCE OR OTHERWISE) ARISING IN ANY WAY OUT OF THE USE OF THIS SOFTWARE, EVEN IF ADVISED OF THE POSSIBILITY OF SUCH DAMAGE.

Part 14: USC/Information Sciences Institute copyright notice (BSD) -----

Copyright (c) 2017-2018, Information Sciences Institute

All rights reserved.

Redistribution and use in source and binary forms, with or without modification, are permitted provided that the following conditions are met:

Redistributions of source code must retain the above copyright notice, this list of conditions and the following disclaimer.

Redistributions in binary form must reproduce the above copyright notice, this list of conditions and the following disclaimer in the documentation and/or other materials provided with the distribution.

Neither the name of Information Sciences Institute nor the names of its contributors may be used to endorse or promote products derived from this software without specific prior written permission.

THIS SOFTWARE IS PROVIDED BY THE COPYRIGHT HOLDERS AND CONTRIBUTORS ``AS IS" AND ANY EXPRESS OR IMPLIED WARRANTIES, INCLUDING, BUT NOT LIMITED TO, THE IMPLIED WARRANTIES OF MERCHANTABILITY AND FITNESS FOR A PARTICULAR PURPOSE ARE DISCLAIMED. IN NO EVENT SHALL THE COPYRIGHT HOLDERS OR CONTRIBUTORS BE LIABLE FOR ANY DIRECT, INDIRECT, INCIDENTAL, SPECIAL, EXEMPLARY, OR CONSEQUENTIAL DAMAGES (INCLUDING, BUT NOT LIMITED TO, PROCUREMENT OF SUBSTITUTE GOODS OR SERVICES; LOSS OF USE, DATA, OR PROFITS; OR BUSINESS INTERRUPTION) HOWEVER CAUSED AND ON ANY THEORY OF LIABILITY, WHETHER IN CONTRACT, STRICT LIABILITY, OR TORT (INCLUDING NEGLIGENCE OR OTHERWISE) ARISING IN ANY WAY OUT OF THE USE OF THIS SOFTWARE, EVEN IF ADVISED OF THE POSSIBILITY OF SUCH DAMAGE.

Licenses - Open LDAP

Copyright 1998-2019 The OpenLDAP Foundation

All rights reserved.

Redistribution and use in source and binary forms, with or without modification, are permitted only as authorized by the OpenLDAP Public License.

A copy of this license is available in the file LICENSE in the top-level directory of the distribution or, alternatively, at <<http://www.OpenLDAP.org/license.html>>.

OpenLDAP is a registered trademark of the OpenLDAP Foundation.

Individual files and/or contributed packages may be copyright by other parties and/or subject to additional restrictions.

This work is derived from the University of Michigan LDAP v3.3 distribution.

Information concerning this software is available at <<http://www.umich.edu/~dirsvcs/ldap/ldap.html>>.

This work also contains materials derived from public sources. Additional information about OpenLDAP can be obtained at <<http://www.openldap.org/>>.

Portions Copyright 1998-2012 Kurt D. Zeilenga.

Portions Copyright 1998-2006 Net Boolean Incorporated.

Portions Copyright 2001-2006 IBM Corporation.

All rights reserved.

Redistribution and use in source and binary forms, with or without modification, are permitted only as authorized by the OpenLDAP Public License.

Portions Copyright 1999-2008 Howard Y.H. Chu.

Portions Copyright 1999-2008 Symas Corporation.

Portions Copyright 1998-2003 Hallvard B. Furuseth.

Portions Copyright 2007-2011 Gavin Henry.

Portions Copyright 2007-2011 Suretec Systems Ltd.

All rights reserved.

Redistribution and use in source and binary forms, with or without modification, are permitted provided that this notice is preserved. The names of the copyright holders may not be used to endorse or promote products derived from this software without their specific prior written permission. This software is provided "as is" without express or implied warranty.

Portions Copyright (c) 1992-1996 Regents of the University of Michigan.

All rights reserved.

Redistribution and use in source and binary forms are permitted provided that this notice is preserved and that due credit is given to the University of Michigan at Ann Arbor. The name of the University may not be used to endorse or promote products derived from this software without specific prior written permission. This software is provided "as is" without express or implied warranty.

The OpenLDAP Public License

Version 2.8, 17 August 2003

Redistribution and use of this software and associated documentation ("Software"), with or without modification, are permitted provided that the following conditions are met:

1. Redistributions in source form must retain copyright statements and notices,
2. Redistributions in binary form must reproduce applicable copyright statements and notices, this list of conditions, and the following disclaimer in the documentation and/or other materials provided with the distribution, and
3. Redistributions must contain a verbatim copy of this document.

The OpenLDAP Foundation may revise this license from time to time. Each revision is distinguished by a version number. You may use this Software under terms of this license revision or under the terms of any subsequent revision of the license.

THIS SOFTWARE IS PROVIDED BY THE OPENLDAP FOUNDATION AND ITS CONTRIBUTORS "AS IS" AND ANY EXPRESSED OR IMPLIED WARRANTIES, INCLUDING, BUT NOT LIMITED TO, THE IMPLIED WARRANTIES OF MERCHANTABILITY AND FITNESS FOR A PARTICULAR PURPOSE ARE DISCLAIMED. IN NO EVENT SHALL THE OPENLDAP FOUNDATION, ITS CONTRIBUTORS, OR THE AUTHOR(S) OR OWNER(S) OF THE SOFTWARE BE LIABLE FOR ANY DIRECT, INDIRECT, INCIDENTAL, SPECIAL, EXEMPLARY, OR CONSEQUENTIAL DAMAGES (INCLUDING, BUT NOT LIMITED TO, PROCUREMENT OF SUBSTITUTE GOODS OR SERVICES; LOSS OF USE, DATA, OR PROFITS; OR BUSINESS INTERRUPTION) HOWEVER CAUSED AND ON ANY THEORY OF LIABILITY, WHETHER IN CONTRACT, STRICT LIABILITY, OR TORT (INCLUDING NEGLIGENCE OR OTHERWISE) ARISING IN ANY WAY OUT OF THE USE OF THIS SOFTWARE, EVEN IF ADVISED OF THE POSSIBILITY OF SUCH DAMAGE.

The names of the authors and copyright holders must not be used in advertising or otherwise to promote the sale, use or other dealing in this Software without specific, written prior permission. Title to copyright in this Software shall at all times remain with copyright holders.

OpenLDAP is a registered trademark of the OpenLDAP Foundation.

Copyright 1999-2003 The OpenLDAP Foundation, Redwood City, California, USA. All Rights Reserved. Permission to copy and distribute verbatim copies of this document is granted.

Licenses - OpenSSL

LICENSE ISSUES

The OpenSSL toolkit stays under a double license, i.e. both the conditions of the OpenSSL License and the original SSLeay license apply to the toolkit. See below for the actual license texts.

OpenSSL License

Copyright (c) 1998-2019 The OpenSSL Project. All rights reserved.

Redistribution and use in source and binary forms, with or without modification, are permitted provided that the following conditions are met:

1. Redistributions of source code must retain the above copyright notice, this list of conditions and the following disclaimer.
2. Redistributions in binary form must reproduce the above copyright notice, this list of conditions and the following disclaimer in the documentation and/or other materials provided with the distribution.
3. All advertising materials mentioning features or use of this software must display the following acknowledgment:

"This product includes software developed by the OpenSSL Project for use in the OpenSSL Toolkit. (<http://www.openssl.org/>)"

4. The names "OpenSSL Toolkit" and "OpenSSL Project" must not be used to endorse or promote products derived from this software without prior written permission. For written permission, please contact openssl-core@openssl.org.
5. Products derived from this software may not be called "OpenSSL" nor may "OpenSSL" appear in their names without prior written permission of the OpenSSL Project.
6. Redistributions of any form whatsoever must retain the following acknowledgment:

"This product includes software developed by the OpenSSL Project for use in the OpenSSL Toolkit (<http://www.openssl.org/>)"

THIS SOFTWARE IS PROVIDED BY THE OpenSSL PROJECT ``AS IS'' AND ANY EXPRESSED OR IMPLIED WARRANTIES, INCLUDING, BUT NOT LIMITED TO, THE IMPLIED WARRANTIES OF MERCHANTABILITY AND FITNESS FOR A PARTICULAR PURPOSE ARE DISCLAIMED. IN NO EVENT SHALL THE OpenSSL PROJECT OR ITS CONTRIBUTORS BE LIABLE FOR ANY DIRECT, INDIRECT, INCIDENTAL, SPECIAL, EXEMPLARY, OR CONSEQUENTIAL DAMAGES (INCLUDING, BUT NOT LIMITED TO, PROCUREMENT OF SUBSTITUTE GOODS OR SERVICES; LOSS OF USE, DATA, OR PROFITS; OR BUSINESS INTERRUPTION) HOWEVER CAUSED AND ON ANY THEORY OF LIABILITY, WHETHER IN CONTRACT, STRICT LIABILITY, OR TORT (INCLUDING NEGLIGENCE OR OTHERWISE) ARISING IN ANY WAY OUT OF THE USE OF THIS SOFTWARE, EVEN IF ADVISED OF THE POSSIBILITY OF SUCH DAMAGE.

=====
===

This product includes cryptographic software written by Eric Young (eay@cryptsoft.com). This product includes software written by Tim Hudson (tjh@cryptsoft.com).

Original SSLeay License

Copyright (C) 1995-1998 Eric Young (eay@cryptsoft.com)

All rights reserved.

This package is an SSL implementation written by Eric Young (eay@cryptsoft.com).

The implementation was written so as to conform with Netscapes SSL.

This library is free for commercial and non-commercial use as long as the following conditions are adhered to. The following conditions apply to all code found in this distribution, be it the RC4, RSA, lhash, DES, etc., code; not just the SSL code. The SSL documentation included with this distribution is covered by the same copyright terms except that the holder is Tim Hudson (tjh@cryptsoft.com).

Copyright remains Eric Young's, and as such any Copyright notices in the code are not to be removed.

If this package is used in a product, Eric Young should be given attribution as the author of the parts of the library used.

This can be in the form of a textual message at program startup or in documentation (online or textual) provided with the package.

Redistribution and use in source and binary forms, with or without modification, are permitted provided that the following conditions are met:

1. Redistributions of source code must retain the copyright notice, this list of conditions and the following disclaimer.
2. Redistributions in binary form must reproduce the above copyright notice, this list of conditions and the following disclaimer in the documentation and/or other materials provided with the distribution.
3. All advertising materials mentioning features or use of this software must display the following acknowledgement:

"This product includes cryptographic software written by Eric Young (eay@cryptsoft.com)"

The word 'cryptographic' can be left out if the routines from the library being used are not cryptographic related :-).

4. If you include any Windows specific code (or a derivative thereof) from the apps directory (application code) you must include an acknowledgement: "This product includes software written by Tim Hudson (tjh@cryptsoft.com)"

THIS SOFTWARE IS PROVIDED BY ERIC YOUNG ``AS IS'' AND ANY EXPRESS OR IMPLIED WARRANTIES, INCLUDING, BUT NOT LIMITED TO, THE IMPLIED WARRANTIES OF MERCHANTABILITY AND FITNESS FOR A PARTICULAR PURPOSE ARE DISCLAIMED. IN NO EVENT SHALL THE AUTHOR OR CONTRIBUTORS BE LIABLE FOR ANY DIRECT, INDIRECT, INCIDENTAL, SPECIAL, EXEMPLARY, OR CONSEQUENTIAL DAMAGES (INCLUDING, BUT NOT LIMITED TO, PROCUREMENT OF SUBSTITUTE GOODS OR SERVICES; LOSS OF USE, DATA, OR PROFITS; OR BUSINESS INTERRUPTION) HOWEVER CAUSED AND ON ANY THEORY OF LIABILITY, WHETHER IN CONTRACT, STRICT LIABILITY, OR TORT (INCLUDING NEGLIGENCE OR OTHERWISE) ARISING IN ANY WAY OUT OF THE USE OF THIS SOFTWARE, EVEN IF ADVISED OF THE POSSIBILITY OF SUCH DAMAGE.

The licence and distribution terms for any publically available version or derivative of this code cannot be changed. i.e. this code cannot simply be copied and put under another distribution licence [including the GNU Public License.]

Licenses - Wireless-RegDB

Copyright (c) 2008, Luis R. Rodriguez <mcgrof@gmail.com>

Copyright (c) 2008, Johannes Berg <johannes@sipsolutions.net>

Copyright (c) 2008, Michael Green <Michael.Green@Atheros.com>

Permission to use, copy, modify, and/or distribute this software for any purpose with or without fee is hereby granted, provided that the above copyright notice and this permission notice appear in all copies.

THE SOFTWARE IS PROVIDED "AS IS" AND THE AUTHOR DISCLAIMS ALL WARRANTIES WITH REGARD TO THIS SOFTWARE INCLUDING ALL IMPLIED WARRANTIES OF MERCHANTABILITY AND FITNESS. IN NO EVENT SHALL THE AUTHOR BE LIABLE FOR ANY SPECIAL, DIRECT, INDIRECT, OR CONSEQUENTIAL DAMAGES OR ANY DAMAGES WHATSOEVER RESULTING FROM LOSS OF USE, DATA OR PROFITS, WHETHER IN AN ACTION OF CONTRACT, NEGLIGENCE OR OTHER TORTIOUS ACTION, ARISING OUT OF OR IN CONNECTION WITH THE USE OR PERFORMANCE OF THIS SOFTWARE.

Licenses - WPA Supplicant and Hostapd

Copyright (c) 2002-2019, Jouni Malinen <j@w1.fi> and contributors

All Rights Reserved.

These programs are licensed under the BSD license (the one with advertisement clause removed).

If you are submitting changes to the project, please see CONTRIBUTIONS file for more instructions.

This package may include either wpa_supplicant, hostapd, or both. See README file respective subdirectories (wpa_supplicant/README or hostapd/README) for more details.

Source code files were moved around in v0.6.x releases and compared to earlier releases, the programs are now built by first going to a subdirectory (wpa_supplicant or hostapd) and creating build configuration (.config) and running 'make' there (for Linux/BSD/cygwin builds).

License

This software may be distributed, used, and modified under the terms of BSD license:

Redistribution and use in source and binary forms, with or without modification, are permitted provided that the following conditions are met:

1. Redistributions of source code must retain the above copyright notice, this list of conditions and the following disclaimer.
2. Redistributions in binary form must reproduce the above copyright notice, this list of conditions and the following disclaimer in the documentation and/or other materials provided with the distribution.

3. Neither the name(s) of the above-listed copyright holder(s) nor the names of its contributors may be used to endorse or promote products derived from this software without specific prior written permission.

THIS SOFTWARE IS PROVIDED BY THE COPYRIGHT HOLDERS AND CONTRIBUTORS "AS IS" AND ANY EXPRESS OR IMPLIED WARRANTIES, INCLUDING, BUT NOT LIMITED TO, THE IMPLIED WARRANTIES OF MERCHANTABILITY AND FITNESS FOR A PARTICULAR PURPOSE ARE DISCLAIMED. IN NO EVENT SHALL THE COPYRIGHT OWNER OR CONTRIBUTORS BE LIABLE FOR ANY DIRECT, INDIRECT, INCIDENTAL, SPECIAL, EXEMPLARY, OR CONSEQUENTIAL DAMAGES (INCLUDING, BUT NOT LIMITED TO, PROCUREMENT OF SUBSTITUTE GOODS OR SERVICES; LOSS OF USE, DATA, OR PROFITS; OR BUSINESS INTERRUPTION) HOWEVER CAUSED AND ON ANY THEORY OF LIABILITY, WHETHER IN CONTRACT, STRICT LIABILITY, OR TORT (INCLUDING NEGLIGENCE OR OTHERWISE) ARISING IN ANY WAY OUT OF THE USE OF THIS SOFTWARE, EVEN IF ADVISED OF THE POSSIBILITY OF SUCH DAMAGE.

Index

+

+12V Power Supply Sensor • 43, 130, 194, 201

1

1U and 2U Port Locations • 117

1U Products • 2

2

2U Products • 2

A

A Note about Enabling Thresholds • 514

A Note about Firmware Upgrade Time • 469

A Note about Infinite Loop • 425

A Note about Untriggered Rules • 426

About the Interface • 515

About the Link ID • 89

Action Group • 385, 388

Actuator Configuration Commands • 656, 676

Actuator Control Operations • 698

Actuator Information • 533

Adding a Firewall Rule • 603

Adding a Link Unit • 86

Adding a Monitored Device • 677

Adding a Radius Server • 653

Adding a Role-Based Access Control Rule • 616

Adding an LDAP Server • 646, 652

Adding Attributes to the Class • 833

Adding LDAP/LDAPS Servers • 349, 351, 355

Adding Radius Servers • 349, 354, 355, 838

Adding, Removing or Swapping Cascaded Devices
• 325

Additional PX3 Information • 874

AD-Related Configuration • 839, 857, 870

Alarm • 385, 387

Alerts • 125, 126, 160, 161

Alerts Notice in a Yellow or Red Screen • 121, 158,
193

All Privileges • 634, 640, 644

Altitude Correction Factors • 253, 564, 889

APIPA and Link-Local Addressing • 2, 30, 171, 318,
336

Applicable Models • xix

Assertion Timeout Example for Temperature
Sensors • 883

Asset Management Commands • 682

Asset Management Strips and dcTrack • 926

Asset Management Tag List • 429, 433

Asset Management Tag Log • 429, 436

Asset Strip • 149, 151, 271, 272

Asset Strip Automatic Firmware Upgrade • 280

Asset Strip Information • 817

Asset Strip Management • 682

Asset Strip Settings • 548

Assets • 125, 149

Associating Outlets with Target Devices • 918

Authentication Commands • 644

Authentication Settings • 545, 647, 650

Automatic and Manual Modes • 121, 125, 445

Automatically Completing a Command • 519, 520,
705

Automatically Create Pairwise Outlet Groups • 107

Available Actions • 78, 330, 364, 384, 388, 396,
406, 419, 485, 507

Available Data of the Outlets Overview Page • 208,
210, 215, 216

B

Backup and Restore of Device Settings • 456, 470,
477, 745

Backup and Restore via SCP • 478, 709

Beeper • 167, 197

Before You Begin • 3

Best Practices for Cascading • 34

Browsing through the Online Help • 177, 912

Built-in Rules and Rule Configuration • 364, 365,
419

Bulk Configuration • 32, 456, 470, 477, 708, 745

Bulk Configuration for Outlet Thresholds • 208,
211, 222

Bulk Configuration Methods • 24, 32

Bulk Configuration or Firmware Upgrade via
DHCP/TFTP • 32, 466, 471, 476, 740, 755

Bulk Configuration Restrictions • 470, 471

Bulk Configuration via SCP • 471, 476, 708, 715

Bulk Configuration/Upgrade Procedure • 756, 757

Button-Type Locking Outlets • 19

C

- Calendar • 360, 362
- Canceling the Power-On Process • 697
- Card Readers • 498, 503, 504
- Cascading All Devices via USB • 35, 39, 118
- Cascading Multiple PX3 Devices for Sharing Ethernet Connectivity • 21, 23, 33, 304, 318, 459
- Cascading Troubleshooting • 34, 325, 892
- Change Load Shedding State • 385, 388
- Changing a User's Password • 629
- Changing an Outlet's Default State • 623
- Changing HTTP(S) Settings • 299, 327, 337
- Changing Measurement Units • 634, 638
- Changing Modbus Settings • 80, 300, 327, 333
- Changing SSH Settings • 288, 300, 327, 332
- Changing Storage Settings • 391, 392, 485, 487, 488, 491, 493
- Changing Telnet Settings • 300, 327, 333, 515
- Changing the Inlet Name • 627
- Changing the LAN Duplex Mode • 577
- Changing the LAN Interface Speed • 576
- Changing the Modbus Configuration • 594
- Changing the Modbus Port • 595
- Changing the Outlet Name • 623
- Changing the Overcurrent Protector Name • 628
- Changing the PDU Name • 558
- Changing the Role(s) • 634
- Changing the Sensor Description • 658
- Changing the Sensor Name • 656
- Changing the SSH Configuration • 591
- Changing the SSH Port • 591
- Changing the Telnet Configuration • 590
- Changing the Telnet Port • 591
- Changing the UDP Port • 681
- Changing Your Own Password • 637
- Changing Your Password • 173, 287, 288
- Checking Lua Scripts States • 450, 451, 452
- Checking Power Strip Status • 924
- Checking RCM State and Current • 790, 792
- Checking RCM States and Current • 797
- Checking the Accessibility of NTP Servers • 601
- Checking the Branch Circuit Rating • 4
- Circuit Breaker Orientation Limitation • 5, 6, 7, 8, 10
- Circuit Breakers • 162
- Clearing Diagnostic Log for Network Connections • 557
- Clearing Event Log • 556
- Clearing Information • 556
- CLI Operations for RCM • 800
- Closing a Local Connection • 519
- Combining Regular Asset Strips • 68
- Command History • 552
- Commands for Environmental Sensors • 672
- Commands for Inlet Pole Sensors • 668, 802
- Commands for Inlet Sensors • 665, 802
- Commands for Outlet Group Sensors • 664
- Commands for Outlet Sensors • 662
- Commands for Overcurrent Protector Sensors • 671
- Common Network Settings • 301, 304
- Compliance with IEC 62020 • 788, 802
- config.txt • 32, 712, 714, 742, 744, 747, 778, 781, 782
- Configuration Files • 740, 742, 756, 778
- Configuration Files for PDU Linking • 750
- Configuration or Firmware Upgrade with a USB Drive • 33, 84, 471, 476, 740, 751, 752, 755
- Configuring a Multi-Inlet Model • 202, 205
- Configuring a PX3 on Dominion SX • 922
- Configuring Data Push Settings • 300, 391, 428
- Configuring DNS Parameters • 574
- Configuring Environmental Sensors' Default Thresholds • 660
- Configuring IPv4 Parameters • 566
- Configuring IPv6 Parameters • 570
- Configuring Login Settings • 300, 337, 356
- Configuring Network Services • 326, 517
- Configuring Network Settings • 3, 22, 36, 39, 299, 301, 313, 898
- Configuring NTP Server Settings • 514
- Configuring Password Policy • 300, 337, 357
- Configuring Rack PDU Targets • 914
- Configuring Security Settings • 337
- Configuring SMTP Settings • 300, 327, 331, 394, 399
- Configuring SNMP Settings • 289, 299, 327, 329, 384, 506
- Configuring the Cascading Mode • 587
- Configuring the PX3 • 23
- Configuring the PX3 Device and Network • 557
- Configuring the Serial Port • 78, 79, 300, 446, 518

- Configuring Webcams and Viewing Live Images • 77, 393, 485, 486, 489, 491, 496
 - Connecting a DPX2 Sensor Package to DX2, DX or DPX3 • 49, 51, 52, 55, 67
 - Connecting a GSM Modem • 78, 398
 - Connecting a Logitech Webcam • 77, 484
 - Connecting a Mobile Device to PX3 • 24, 118
 - Connecting a Modbus RTU Device or Bus • 80, 334
 - Connecting a PX PDU • 915
 - Connecting a PX3 Locking Line Cord • 13, 115
 - Connecting a Rack PDU • 919
 - Connecting a Schroff LHX/SHX Heat Exchanger • 79, 281
 - Connecting an Analog Modem • 78, 518
 - Connecting an External Beeper • 79, 280
 - Connecting Asset Management Strips • 67, 272, 428, 926
 - Connecting Blade Extension Strips • 72
 - Connecting Composite Asset Strips (AMS-Mx-Z) • 74
 - Connecting External Equipment (Optional) • 47, 118
 - Connecting Raritan Environmental Sensor Packages • 46, 47, 249
 - Connecting Regular Asset Strips to PX3 • 70, 76
 - Connecting the PDU to a Power Source • 20
 - Connecting the PX3 to a Computer • 2, 24, 30, 318, 784, 785, 892
 - Connecting the PX3 to Your Network • 21, 23, 301
 - Connection Port Functions • 23, 117
 - Connection Ports • 23, 117
 - Control Buttons • 122, 806
 - Controlling Outlets in Groups • 106
 - Copying an Existing Server's Settings • 646, 650
 - Creating a CSR • 344, 345, 346
 - Creating a New Attribute • 832
 - Creating a Role • 640
 - Creating a Self-Signed Certificate • 344, 347
 - Creating a User Profile • 628
 - Creating an Outlet Group • 140, 226, 227, 624
 - Creating Configuration Files via Mass Deployment Utility • 742, 751, 752
 - Creating IP Access Control Rules • 300, 337, 338, 341
 - Creating Role Based Access Control Rules • 300, 337, 342, 344
 - Creating Roles • 173, 287, 291, 293, 838
 - Creating Users • 170, 173, 287, 288, 292, 295, 297, 298, 333, 349, 506
 - Curl Upload Return Codes • 781, 782
 - Customizing Bulk Configuration Profiles • 470, 473
 - Customizing the Date and Time • 599
- ## D
- Daisy-Chain Limitations of Composite Asset Strips • 75, 76
 - Dashboard • 178, 183, 202, 242, 387, 481, 794
 - Dashboard - Alarms • 184, 192, 384, 727
 - Dashboard - Alerted Sensors • 126, 184, 188, 727
 - Dashboard - Inlet History • 184, 190, 203
 - Dashboard - Inlet I1 • 184, 185, 202, 727
 - Dashboard - OCP • 184, 187
 - Dashboard Page • 726
 - Data Encryption in 'config.txt' • 747, 749, 752
 - Data for BTU Calculation • 890
 - Data Push Format • 428, 429
 - Date and Time Settings • 530
 - dcTrack • 925
 - dcTrack Overview • 925
 - Deassertion Hysteresis Example for Temperature Sensors • 886
 - Default Log Messages • 43, 358, 365, 370, 389, 394
 - Default Measurement Units • 530
 - Default Voltage and Current Thresholds • 203, 211, 222, 241, 244, 887
 - Degaussing RCM Type B Sensors • 803
 - Deleting a Firewall Rule • 606
 - Deleting a Monitored Device • 678
 - Deleting a Role • 644
 - Deleting a Role-Based Access Control Rule • 619
 - Deleting a User Profile • 636
 - Deleting an Outlet Group • 236
 - Derating a Raritan Product • 719
 - Designating the Master Unit • 85
 - Detailed Information on Outlet Pages • 218, 224
 - Determining the Authentication Method • 645
 - Determining the SSH Authentication Method • 592
 - Determining the Time Setup Method • 597, 599
 - Device Configuration/Upgrade Procedure • 740
 - Device Info • 3, 23, 24, 125, 152, 318
 - Device Information • 393, 455, 457, 495
 - Device Settings • 180, 299
 - devices.csv • 32, 714, 742, 744, 748, 750, 782
 - Device-Specific Settings • 470, 905

- DHCP IPv4 Configuration in Linux • 756, 774
 - DHCP IPv4 Configuration in Windows • 756, 757
 - DHCP IPv6 Configuration in Linux • 756, 776
 - DHCP IPv6 Configuration in Windows • 756, 767
 - Diagnostic Commands • 702
 - Diagnostic Log for Network Connections • 304, 312, 313
 - Different CLI Modes and Prompts • 517, 518, 521, 556, 557, 558, 601, 626, 693, 694, 698, 702
 - Disabling or Enabling Front Panel RCM Self-Test • 445, 794, 798, 822
 - Disconnecting a PX3 Locking Line Cord • 14
 - Displays for Master and Link Units • 110
 - Dominion KSX II • 919
 - Dominion KSX II, SX or SX II Configuration • 286, 919
 - Dominion KX II / III Configuration • 286, 914
 - Dominion SX • 922
 - Dominion SX and SX II • 920
 - Dominion SX II • 921
 - Door Handle Status and Control • 255, 502
 - Dot-Matrix LCD Display • 119
 - Download via Curl • 778, 779
 - Download via Web Browsers • 778
 - Downloading Diagnostic Data via SCP • 710
 - Downloading Diagnostic Information • 456, 480
 - Downloading Raw Configuration • 778
 - Downloading SNMP MIB • 330, 506, 511, 799
 - DPX Sensor Packages • 45, 47, 56
 - DPX2 Sensor Packages • 45, 47, 53
 - DPX3 Sensor Packages • 45, 47, 51
 - Dual Ethernet Connection • 21, 23
 - DX Sensor Packages • 45, 47, 50
 - DX2 Sensor Packages • 45, 47, 48, 404
- E**
- EAP CA Certificate Example • 579, 581, 585
 - Editing or Deleting a Rule/Action • 384, 419, 444
 - Editing or Deleting IP Access Control Rules • 341
 - Editing or Deleting Ping Monitoring Settings • 442
 - Editing or Deleting Role Based Access Control Rules • 343
 - Editing or Deleting Roles • 231, 295
 - Editing or Deleting Users • 173, 292, 295, 296
 - Editing rcusergroup Attributes for User Members • 835
 - Enabling and Configuring SNMP • 421, 422, 427, 506
 - Enabling or Disabling 802.11n High Throughput • 584
 - Enabling or Disabling a User Profile • 631
 - Enabling or Disabling an Inlet (for Multi-Inlet PDUs) • 627
 - Enabling or Disabling Data Logging • 563
 - Enabling or Disabling EnergyWise • 680
 - Enabling or Disabling Front Panel Actuator Control • 620
 - Enabling or Disabling Front Panel Beeper-Sound Control • 621
 - Enabling or Disabling Front Panel Outlet Switching • 620
 - Enabling or Disabling Load Shedding • 693
 - Enabling or Disabling Modbus • 594
 - Enabling or Disabling Peripheral Device Auto Management • 565
 - Enabling or Disabling Service Advertising • 595
 - Enabling or Disabling SNMP v1/v2c • 592
 - Enabling or Disabling SNMP v3 • 593
 - Enabling or Disabling SSH • 591
 - Enabling or Disabling Strong Passwords • 612
 - Enabling or Disabling Telnet • 590
 - Enabling or Disabling the LAN Interface • 575
 - Enabling or Disabling the Read-Only Mode • 595
 - Enabling or Disabling the Restricted Service Agreement • 607
 - Enabling Service Advertising • 300, 327, 336, 595
 - Enabling the Restricted Service Agreement • 171, 300, 337, 358
 - EnergyWise Configuration Commands • 680
 - EnergyWise Settings • 548
 - Entering Configuration Mode • 518, 557, 581, 582, 629, 636, 637, 801
 - Entering Diagnostic Mode • 518, 702, 896
 - Environmental Sensor Configuration Commands • 656
 - Environmental Sensor Default Thresholds • 543
 - Environmental Sensor Information • 531, 814
 - Environmental Sensor Package Information • 532
 - Environmental Sensor Threshold Information • 542
 - Equipment Setup Worksheet • 4, 736
 - Ethernet Interface Settings • 23, 156, 301, 305, 578
 - Event Log • 550

- Event Rules and Actions • 43, 79, 167, 192, 197, 202, 211, 241, 264, 284, 300, 329, 331, 364, 387, 428, 437, 450, 731
 - Example • 599, 609, 629, 636, 637, 691, 693
 - Ping Monitoring and SNMP Notifications • 437, 443
 - Example - Actuator Naming • 677
 - Example - Creating a Role • 644
 - Example - Default Upper Thresholds for Temperature • 662
 - Example - Inlet Naming • 627
 - Example - OCP Naming • 628
 - Example - Outlet Naming • 624
 - Example - Ping Command • 704
 - Example - Power Cycling Specific Outlets • 697
 - Example - Server Settings Changed • 680
 - Example - Setting Up EnergyWise • 682
 - Example - Turning On a Specific Actuator • 699
 - Example 1 • 425
 - Example 1 - Asset Strip LED Colors for Disconnected Tags • 689
 - Example 1 - Basic Security Information • 554
 - Example 1 - Combination of ETH1's Activation, Configuration Method and IP • 691
 - Example 1 - Creating a User Profile • 639
 - Example 1 - Environmental Sensor Naming • 660
 - Example 1 - IPv4 Firewall Control Configuration • 621
 - Example 1 - PDU Naming • 565
 - Example 1 - Time Setup Method • 600
 - Example 1 - Upper Critical Threshold for a Temperature Sensor • 674
 - Example 1 - Wireless Networking Mode • 596
 - Example 2 • 426
 - Example 2 - Adding an IPv4 Firewall Rule • 621
 - Example 2 - Combination of Upper Critical and Upper Warning Settings • 691
 - Example 2 - Enabling IPv6 Protocol on the Ethernet Interface • 596
 - Example 2 - In-Depth Security Information • 555
 - Example 2 - Modifying a User's Roles • 639
 - Example 2 - Outlet Sequence • 566
 - Example 2 - Primary NTP Server • 600
 - Example 2 - Rack Unit Naming • 689
 - Example 2 - Sensor Threshold Selection • 660
 - Example 2 - Warning Thresholds for Inlet Sensors • 674
 - Example 3 • 426
 - Example 3 - Basic PDU Information • 555
 - Example 3 - Combination of SSID and PSK Parameters • 692
 - Example 3 - Default Measurement Units • 639
 - Example 3 - Outlet Sequence Delay • 566
 - Example 3 - Upper Thresholds for Overcurrent Protector Sensors • 674
 - Example 3 - User Blocking • 622
 - Example 3 - Wireless Authentication Method • 596
 - Example 4 - Adding an IPv4 Role-based Access Control Rule • 622
 - Example 4 - Combination of Upper Critical, Upper Warning and Lower Warning Settings • 692
 - Example 4 - In-Depth PDU Information • 556
 - Example 4 - Non-Critical Outlets • 566
 - Example 4 - Static IPv4 Configuration • 596
 - Examples • 553, 565, 596, 600, 621, 638, 659, 674, 689
 - Existing Roles • 547
 - Existing User Profiles • 530, 546
 - Expansion RJ-45 Port Pinouts • 735
 - Extended Cascading with PX3 Devices • 37, 119
 - External Beeper • 271, 280, 385, 389
- ## F
- FAQs • 82
 - Feature Port • 179, 270, 272, 280, 282, 286
 - Feature Ports Page • 110
 - Feature RJ-45 Port Pinouts • 734
 - Filling Out the Equipment Setup Worksheet • 4
 - Finding the Sensor's Serial Number • 250, 259
 - Firewall Control • 601
 - Firmware Update via SCP • 466, 707
 - Firmware Upgrade via USB • 466, 741, 753
 - Flexible Cord Installation Instructions • 718
 - Flexible Cord Selection • 718
 - Forcing a Password Change • 631
 - Forcing the Device Detection Mode • 690
 - FreeRADIUS Standard Attribute Illustration • 838, 856
 - FreeRADIUS VSA Illustration • 857, 869
 - From LDAP/LDAPS • 831
 - From Microsoft Active Directory • 831
 - Front Panel Operations for RCM • 125, 796, 820
 - Front Panel Settings • 121, 131, 135, 137, 140, 142, 255, 300, 445, 813
 - Full Disaster Recovery • 469
 - Fuse • 164

Fuse Replacement on 1U Models • 166
Fuse Replacement on Zero U Models • 164
fwupdate.cfg • 740, 741, 742, 743, 747, 750, 753, 756

G

Gathering LDAP/Radius Information • 349, 350
Group's Power Control • 142

H

Hardware Issue Detection • 185, 456, 480, 553
How Long a Link Remains Accessible • 489, 491
How the Automatic Management Function Works
• 252, 262, 565

I

Identifying Cascaded Devices • 458, 459
Identifying Snapshots Folders on Remote Servers • 488, 494, 495
Identifying the Sensor Port • 48
Identifying the Sensor Position and Channel • 251, 260
Idle Timeout • 611
If Switchable Outlet Groups are Limited • 231
Illustration - GMAIL SMTP Certificate Chain • 906, 909
Illustrations of Adding LDAP Servers • 648, 649
Individual OCP Pages • 242
Individual Outlet Pages • 195, 196, 198, 199, 207, 209, 214, 218, 225, 732
Individual Sensor/Actuator Pages • 148, 188, 250, 252, 253, 254, 264, 270
Initial Installation and Configuration • 20
Initial Network Configuration via CLI • 24, 31, 784, 785, 898
Initialization Delay Use Cases • 195, 199
Inlet • 115, 125, 132, 178, 185, 186, 196, 202, 205
Inlet Configuration Commands • 626
Inlet Information • 528, 808
Inlet Pole Sensor Threshold Information • 539, 801
Inlet Sensor Threshold Information • 537, 801
Inlets/Outlets Page • 731
In-Line Monitor Unused Channels • 720
In-Line Monitors • 717
In-Line Monitor's Web Interface • 725
Inrush Current and Inrush Guard Delay • 196, 199
Installing a CA-Signed Certificate • 344, 346

Installing Cable Retention Clips on Outlets (Optional) • 16
Installing Cable Retention Clips on the Inlet (Optional) • 15
Installing or Downloading Existing Certificate and Key • 344, 348
Installing the USB-to-Serial Driver (Optional) • 31, 897
Integration • 914
Interface Names • 314, 317
Internal Beeper • 385, 389
Internal Beeper State • 194, 197, 792
Introduction • 1
Introduction to Asset Tags • 70
Introduction to PDU Components • 114
IP Configuration • 522, 523
IPv4 Address • 811
IPv4-Only or IPv6-Only Configuration • 522, 523

K

Keys that Cannot Be Uploaded • 712, 715, 778

L

Layout • 513
LCD Message for RCM Critical State • 796
LDAP Configuration Illustration • 349, 823
LDAP Settings • 646
Licenses - Bind9 • 927
Licenses - Clish • 937
Licenses - Dropbear • 945
Licenses - FreeType • 948
Licenses - IW • 950
Licenses - JSON-C • 951
Licenses - LIBTIRPC • 952
Licenses - LIBXML2 • 952
Licenses - Mbus • 953
Licenses - Net-SNMP • 953
Licenses - Open LDAP • 962
Licenses - OpenSSL • 964
Licenses - Wireless-RegDB • 967
Licenses - WPA Supplicant and Hostapd • 967
Load Shedding Configuration Commands • 693
Load Shedding Mode • 208, 210, 213, 215, 220, 388, 562
Load Shedding Settings • 547
Locking Outlets and Cords • 16, 17
Log an Event Message • 385, 389
Log Rows • 430, 432

Logging in to CLI • 516, 752, 785
 Logging out of CLI • 705
 Login • 24, 30, 171, 318, 896
 Login Limitation • 610
 Login, Logout and Password Change • 170
 Logout • 174
 Lowercase Character Requirement • 612
 Lua Scripts • 300, 402, 447

M

MAC Address • 812
 Main Menu • 121, 124, 797, 798
 Maintenance • 180, 455
 Make a Power Association • 918
 Making a Power-Sharing Connection • 43
 Managed vs Unmanaged Sensors/Actuators • 249, 256, 257
 Managing an Outlet Group • 625
 Managing External Authentication Settings • 349, 353, 355
 Managing Firewall Rules • 603
 Managing One Sensor or Actuator • 251, 252, 262
 Managing Role-Based Access Control Rules • 616
 Manually Changing PX3's Zero U LCD Orientation • 120, 157
 Manually Starting or Stopping a Script • 448, 449, 450
 Master Units Manage Link Units • 89
 Maximum Ambient Operating Temperature • 4, 733
 Maximum Password History • 614
 Maximum Password Length • 612
 Menu • 176, 178, 194, 202, 206, 226, 240, 249, 271, 272, 280, 281, 286, 287, 299, 449, 451, 453, 455, 486, 488, 489, 499, 504, 790
 Minimum Password Length • 612
 Miscellaneous • 79, 145, 271, 272, 281, 300, 393, 403, 453, 458, 511
 Mixing Diverse Sensor Types • 61, 62
 Modifying a Firewall Rule • 605
 Modifying a Monitored Device's Settings • 678
 Modifying a Role • 643
 Modifying a Role-Based Access Control Rule • 617
 Modifying a User Profile • 629
 Modifying a User's Personal Data • 630
 Modifying an Existing LDAP Server • 650
 Modifying an Existing Radius Server • 654
 Modifying an Outlet Group • 227, 233

Modifying Firewall Control Parameters • 601
 Modifying or Deleting a Script • 448, 452
 Modifying or Removing Bulk Profiles • 476
 Modifying Role-Based Access Control Parameters • 614
 Modifying SNMPv3 Settings • 631
 Monitoring Server Accessibility • 300, 390, 437, 443
 Mounting 1U or 2U Models • 11
 Mounting Zero U Models Using Button Mount • 7
 Mounting Zero U Models Using Claw-Foot Brackets • 8
 Mounting Zero U Models Using L-Brackets • 6
 Mounting Zero U Models Using Two Rear Buttons • 10
 Multi-Command Syntax • 603, 610, 611, 612, 615, 625, 629, 630, 631, 634, 637, 660, 662, 664, 665, 668, 671, 672, 676, 678, 691
 Muting the Internal Beeper • 129, 131, 446

N

Naming a Rack Unit • 686
 Naming an Asset Strip • 683
 Naming the Rack PDU (Port Page for Power Strips) • 916
 Network Configuration • 521
 Network Configuration Commands • 566
 Network Connections Diagnostic Log • 551
 Network Diagnostics • 456, 479
 Network Interface Settings • 524
 Network Service Settings • 525
 Network Troubleshooting • 479, 701
 NPS Standard Attribute Illustration • 838
 NPS VSA Illustration • 857
 Numeric Character Requirement • 613

O

OCPs • 125, 134, 179, 188, 240, 242, 244, 248
 OCPs Page • 109
 Off and Lock Icons for Outlets • 216, 217
 Old Generations of PX3 Models • 120, 469, 804
 Operating the Dot-Matrix LCD Display • 121, 123, 124, 126, 146, 162, 804
 Operating the LCD Display • 807
 Optional Parameters • 646, 647
 Options for Outlet State on Startup • 195, 198, 219
 Outlet Configuration Commands • 622

Outlet Group Configuration Commands • 624
 Outlet Group Information • 527
 Outlet Group Power Control • 227, 228
 Outlet Group Threshold Information • 536
 Outlet Groups • 102, 125, 140, 179, 196, 226, 232, 234, 390, 536, 665
 Outlet Information • 526, 807
 Outlet Pole Sensor Threshold Information • 535
 Outlet Sensor Threshold Information • 534
 Outlet Switching • 813
 Outlets • 116, 125, 135, 178, 206, 210, 211, 215, 216, 218, 404
 Overcurrent Protector Configuration Commands • 628
 Overcurrent Protector Information • 248, 529, 810
 Overcurrent Protector Sensor Threshold Information • 541
 Overview • 717
 Overview of the Cascading Modes • 318, 320
 Overview of the LCD Display • 805, 806

P

Package Contents • 1, 3
 Pairwise Outlet Groups • 107
 Panel Components • 114
 Password Aging • 610
 Password Aging Interval • 611
 PDU • 125, 128, 167, 177, 178, 194, 198, 199, 200, 202, 203, 209, 220, 221, 225, 233, 562
 PDU Configuration • 198, 525
 PDU Configuration Commands • 558
 PDU Linking • xxi, 81
 PDU Linking CLI Commands • 113
 PDU Linking in the CLI • 112
 PDU Linking in the Web GUI • 84
 Performing Bulk Configuration • 470, 474
 Peripherals • 45, 48, 50, 125, 145, 179, 249, 253, 255, 257, 259, 262, 264, 265, 266, 269, 270, 424, 446, 503
 Peripherals Page • 109
 Placeholders for Custom Messages • 394, 395, 397, 398, 399, 415
 Plug Selection • 719
 Port Forwarding Examples • 172, 319, 322, 323
 Port Number Syntax • 318, 321, 323, 894
 Possible OCP-Tripped Root Cause • 242, 247, 529
 Possible Root Causes • 892
 Power CIM • 271, 286

Power Control • 137, 219, 446, 920, 923
 Power Control Operations • 694
 Power Cycling the Outlet(s) • 696
 Power IQ Configuration • 924
 Powering On/Off/Cycle Outlet Groups • 626
 Power-Off Period Options for Individual Outlets • 220, 225
 Power-Sharing Configurations and Restrictions • 42, 43, 44
 Power-Sharing Restrictions and Connection • 42, 119, 202, 787, 788, 790, 792
 Preparing the Installation Site • 4
 Product Models • 1
 Push Out Sensor Readings • 385, 391
 PX3 Latching Relay Behavior • 195, 198, 559, 560, 561, 562
 PX3 Models with Residual Current Monitoring • 197, 445, 786, 820
 PX3 'Phase I' Front Panel Display • 805
 PX3 'Phase II' Front Panel Display • 804
 PX3-3000 Series • 116
 PX3-4000 Series • 116
 PX3-5000 Series • 116

Q

Querying Available Parameters for a Command • 519, 520
 Querying DNS Servers • 702
 Quick Access to a Specific Page • 171, 181
 Quitting Configuration Mode • 557, 558, 609
 Quitting Diagnostic Mode • 702

R

Rack Unit Configuration • 686
 Rack Unit Settings of an Asset Strip • 549
 Rackmount Safety Guidelines • 5
 Rackmount, Inlet and Outlet Connections • 5
 Rack-Mounting the PDU • 5
 RADIUS Configuration Illustration • 349, 838
 Radius Settings • 653
 Raritan Training Website • 891
 Raw Configuration Upload and Download • 471, 476, 749, 755, 778
 RCM Critical State Alarm • 792
 RCM Current Sensor • 538, 540, 668, 670, 786, 794
 RCM Information • 796, 820
 RCM Residual Current and State Objects • 800

RCM Self-Test • 789
 RCM SNMP Operations • 799
 RCM State Sensor • 787, 791
 RCM Trap • 799
 Rebooting the PX3 • 456, 482
 Receptacle Selection • 719
 Record Snapshots to Webcam Storage • 385, 391
 Releasing a Link Unit • 90
 Reliability Data • 553
 Reliability Error Log • 553
 Reliability Hardware Failures • 553
 Re-linking a Link Unit • 92
 Remembering User Names and Passwords • 174
 Removing an Existing LDAP Server • 653
 Removing an Existing Radius Server • 655
 Removing the Uploaded Certificate or Private Key
 • 582
 Replaceable Controller • 114, 168
 Request LHX/SHX Maximum Cooling • 386, 393
 Reserving IP Addresses in DHCP Servers • 875, 876,
 877
 Reserving IP in Linux • 877
 Reserving IP in Windows • 876
 Reset Button • 162
 Resetting a Group's Active Energy • 227, 232
 Resetting Active Energy Readings • 700
 Resetting All Settings to Factory Defaults • 456,
 482, 784
 Resetting the Button-Type Circuit Breaker • 163
 Resetting the Handle-Type Circuit Breaker • 163
 Resetting the PX3 • 700
 Resetting to Factory Defaults • 162, 483, 701, 784
 Restarting the PDU • 700
 Restricted Service Agreement • 607
 Restrictions of Port-Forwarding Connections • 37,
 40, 895
 Retrieving Energy Usage • 514
 Retrieving Previous Commands • 519, 520, 704
 Retrieving Software Packages Information • 456,
 483
 Returning User Group Information • 831
 RJ45-to-DB9 Cable Requirements for Computer
 Connections • 31, 118, 875
 RJ45-to-DB9 Cable Requirements for Modem
 Connections • 32, 78, 79, 118, 874
 Role Configuration Commands • 640
 Role of a DNS Server • 825, 892
 Role-Based Access Control • 614

Running RCM Self-Test • 797, 798, 800, 803

S

Safety Guidelines • ii
 Safety Instructions • iii, 4, 717
 Sample Environmental-Sensor-Level Event Rule •
 216, 423
 Sample Event Rules • 367, 419
 Sample Inlet-Level Event Rule • 422
 Sample Outlet-Level Event Rule • 420
 Sample PDU-Level Event Rule • 419
 Saving User Credentials for PDView's Automatic
 Login • 27, 28
 Scheduling an Action • 365, 391, 406, 413, 793
 Scheduling RCM Self-Test • 793
 Schroff LHX/SHX • 271, 281
 SecureLock™ Outlets and Cords • 17
 Security Configuration Commands • 601
 Security Settings • 544
 Send an SNMP Notification • 330, 386, 401
 Send Email • 370, 386, 394, 409, 415
 Send Sensor Report • 298, 386, 396, 412
 Send Sensor Report Example • 396, 408, 409
 Send SMS Message • 386, 398, 415
 Send Snapshots via Email • 386, 399, 415
 Sending Links to Snapshots or Videos • 485, 487,
 489
 Sensor Descriptors for Inlet Active Power • 430,
 431
 Sensor Log • 429, 430
 Sensor RJ-45 Port Pinouts • 733
 Sensor Threshold Configuration Commands • 662
 Sensor Threshold Settings • 201, 204, 212, 223,
 236, 242, 245, 254, 255, 265, 513, 795, 879
 Sensor/Actuator Location Example • 266, 269, 270
 Sensor/Actuator States • 127, 146, 189, 250, 251,
 257, 258
 Serial Port Configuration Commands • 689
 Serial Port Settings • 547
 Serial RS-232 • 733, 822
 Server Reachability Configuration Commands •
 677
 Server Reachability Information • 551
 Server Reachability Information for a Specific
 Server • 552
 Server Status Checking or Power Control • 441
 Setting an LED Color for a Rack Unit • 687, 688
 Setting an LED Mode for a Rack Unit • 687, 688

- Setting an Outlet's Cycling Power-Off Period • 624
- Setting Data Logging • 300, 427, 429, 563
- Setting Data Logging Measurements Per Entry • 563
- Setting Default Measurement Units • 253, 287, 296, 297, 635, 637
- Setting Ethernet EAP Parameters • 578
- Setting Front Panel RCM Self-Test • 803
- Setting IPv4 Static Routes • 569
- Setting IPv6 Static Routes • 573
- Setting LAN Interface Parameters • 575
- Setting LED Colors for Connected Tags • 685, 687, 688
- Setting LED Colors for Disconnected Tags • 686, 687, 688
- Setting Network Service Parameters • 589
- Setting Non-Critical Outlets • 208, 213, 215
- Setting NTP Parameters • 598, 601
- Setting Outlet Power-On Sequence and Delay • 208, 212, 695, 697
- Setting RCM Current Thresholds • 787, 791, 792, 801
- Setting RCM DC Current Thresholds • 791, 792, 794
- Setting RCM Thresholds • 800
- Setting the Alarmed to Normal Delay for DX-PIR • 659
- Setting the Automatic Daylight Savings Time • 600
- Setting the Baud Rates • 690
- Setting the BSSID • 587
- Setting the Cascading Mode • 2, 23, 33, 35, 36, 37, 39, 154, 301, 302, 304, 308, 318, 320, 325, 459, 460
- Setting the Date and Time • 300, 360, 393, 495, 514
- Setting the Ethernet Authentication Method • 577
- Setting the HTTP Port • 589
- Setting the HTTPS Port • 590
- Setting the Inrush Guard Delay Time • 561
- Setting the IPv4 Address • 568
- Setting the IPv4 Configuration Mode • 566
- Setting the IPv4 Gateway • 569
- Setting the IPv4 Preferred Host Name • 567
- Setting the IPv6 Address • 572
- Setting the IPv6 Configuration Mode • 570
- Setting the IPv6 Gateway • 573
- Setting the IPv6 Preferred Host Name • 571
- Setting the LED Operation Mode • 687
- Setting the Maximum Number of Active Powered Dry Contact Actuators • 565
- Setting the Outlet Initialization Delay • 562
- Setting the Outlet Power-On Sequence • 559
- Setting the Outlet Power-On Sequence Delay • 560
- Setting the Outlet Relay Behavior • 559
- Setting the PDU-Defined Cycling Power-Off Period • 561, 624
- Setting the PDU-Defined Default Outlet State • 560, 623
- Setting the Polling Interval • 682
- Setting the PSK • 584
- Setting the Registry to Permit Write Operations to the Schema • 832
- Setting the SNMP Configuration • 592
- Setting the SNMP Read Community • 593
- Setting the SNMP Write Community • 593
- Setting the SSID • 583
- Setting the sysContact Value • 593
- Setting the sysLocation Value • 594
- Setting the sysName Value • 594
- Setting the Time Zone • 514, 599
- Setting the Wireless Authentication Method • 584
- Setting the X Coordinate • 657
- Setting the Y Coordinate • 657
- Setting the Z Coordinate • 564, 658
- Setting the Z Coordinate Format for Environmental Sensors • 564, 658, 676
- Setting Thresholds for Total Active Energy or Power • 197, 200
- Setting Up a TLS Certificate • 300, 337, 344
- Setting Up External Authentication • 300, 337, 349, 892
- Setting Wireless EAP Parameters • 585
- Setting Wireless Parameters • 583
- Setting Your Preferred Measurement Units • 253, 287, 291, 296, 297
- Showing an Outlet Group's Information • 140
- Showing an Outlet's Information • 135, 138
- Showing Information • 521
- Showing Network Connections • 703
- Showing Residual Current Monitoring Information • 801
- Showing the Firmware Upgrade Progress • 161, 466
- Shut down a Server and Control its Power • 385, 390

- SHX Request Maximum Cooling • 285, 286
 - Single Login Limitation • 610
 - Slave Device Events in the Log • 895
 - SmartLock • 498, 499, 504
 - SmartLock and Card Reader • 180, 497
 - SNMP Gets and Sets • 512
 - SNMP Sets and Thresholds • 513
 - SNMPv2c Notifications • 330, 507
 - SNMPv3 Notifications • 330, 507, 508
 - Sorting a List • 182, 188, 208, 240, 250, 274, 292, 295, 313, 415, 462, 470
 - Special Character Requirement • 614
 - Specifications • 5, 733
 - Specifying Non-Critical Outlets • 547, 562
 - Specifying the Agreement Contents • 609
 - Specifying the Asset Strip Orientation • 685
 - Specifying the CC Sensor Type • 656
 - Specifying the Device Altitude • 564
 - Specifying the EnergyWise Domain • 681
 - Specifying the EnergyWise Secret • 681
 - Specifying the Number of Rack Units • 683
 - Specifying the Rack Unit Numbering Mode • 684
 - Specifying the Rack Unit Numbering Offset • 684
 - Specifying the SSH Public Key • 592, 636
 - Standard Attributes • 838
 - Start or Stop a Lua Script • 386, 402, 448, 450
 - Static Route Examples • 301, 305, 314, 569, 573
 - Step A
 - Add Your PX3 as a RADIUS Client • 838, 839, 857, 858
 - Step A. Determine User Accounts and Roles • 823
 - Step B
 - Configure Connection Policies and Standard Attributes • 839, 843
 - Configure Connection Policies and Vendor-Specific Attributes • 857, 862
 - Step B. Configure User Groups on the AD Server • 824
 - Step by Step Flexible Cord Installation • 720
 - Step C. Configure LDAP Authentication on the PX3 • 825
 - Step D. Configure Roles on the PX3 • 828
 - Strong Passwords • 612
 - Supported Maximum DPX Sensor Distances • 56, 60
 - Supported Sensor Configurations for Power Sharing • 44, 45
 - Supported Web Browsers • 170
 - Supported Wireless LAN Configuration • 22, 893
 - Switch LHX/SHX • 386, 403
 - Switch Outlet Group • 386, 403
 - Switch Outlets • 386, 404
 - Switch Peripheral Actuator • 386, 404
 - Switching Off an Actuator • 699
 - Switching On an Actuator • 698
 - Switching to a Different PDU • 91
 - Syslog Message • 386, 405
 - System and USB Requirements • 740, 741
- ## T
- Testing the Network Connectivity • 703, 896
 - TFTP Requirements • 756, 757
 - The ? Command for Showing Available Commands • 519
 - The Ping Tool • 895, 896
 - The PX3 MIB • 512
 - Third Party Licenses • 927
 - Threaded Grounding Point • 169
 - Thresholds and Sensor States • 879
 - Time Configuration Commands • 596
 - Time Units • 194, 200, 225, 356, 357
 - TLS Certificate Chain • 307, 311, 331, 352, 406, 428, 906
 - Tracing the Route • 704
 - Turning Off the Outlet(s) • 695
 - Turning On the Outlet(s) • 694
 - Turning Outlets On/Off and Cycling Power • 918, 920
- ## U
- Unbalanced Current Calculation • 889
 - Unblocking a User • 357, 699
 - Unpacking the Product and Components • 3
 - Updating the LDAP Schema • 831
 - Updating the PX3 Firmware • xxi, 455, 465, 707
 - Updating the Schema Cache • 835
 - Upgrade Guidelines for Existing Cascading Chains • 465, 467
 - Upgrade Sequence in an Existing Cascading Chain • 33, 467
 - Upload via Curl • 32, 780, 781, 782
 - Uploading or Downloading Raw Configuration Data • 32, 709, 712, 778, 780
 - Uploading Raw Configuration • 780
 - Uppercase Character Requirement • 613
 - USB Wireless LAN Adapters • 22, 36, 39, 893

- USB-Cascaded Device's Position • 818
- User Blocking • 611
- User Configuration Commands • 628
- User Interfaces Showing Default Units • 297, 298
- User Management • 180, 287
- Using an Optional DPX3-ENVHUB4 Sensor Hub • 57, 61
- Using an Optional DPX-ENVHUB2 cable • 58
- Using an Optional DPX-ENVHUB4 Sensor Hub • 57
- Using Default Thresholds • 659
- Using SCP Commands • 707
- Using SNMP • 466, 506
- Using the CLI Command • 701, 785
- Using the Command Line Interface • 202, 327, 515, 785, 800
- Using the Reset Button • 784
- Using the Web Interface • 170, 725

V

- Vendor-Specific Attributes • 838, 857
- Viewing and Managing Locally-Saved Snapshots • 391, 482, 491, 494
- Viewing Connected Users • 455, 462, 489
- Viewing Firmware Update History • 455, 469
- Viewing Link Unit Information • 94
- Viewing More Information • 238
- Viewing or Clearing the Local Event Log • 331, 349, 405, 455, 464

W

- Ways to Probe Existing User Profiles • 891
- Web Interface Operations for RCM • 204, 790
- Web Interface Overview • 175, 912
- Webcam Management • 179, 463, 484
- What is a Certificate Chain • 906, 912
- What's New in the PX3 User Guide • xxi
- Windows NTP Server Synchronization Solution • 361, 363
- Wired Network Settings • 21, 23, 301, 302, 319, 336, 825
- Wireless Network Settings • 301, 308, 319, 585
- Wiring of 3-Phase In-Line Monitors • 718, 720
- With an Analog Modem • 518
- With HyperTerminal • 516, 699
- With SSH or Telnet • 517, 896
- Writing or Loading a Lua Script • 448, 452

Y

- Yellow- or Red-Highlighted Sensors • 123, 126, 145, 158, 202, 206, 211, 225, 240, 250, 255, 258, 264, 284, 881

Z

- Z Coordinate Format • 252, 269
- Zero U Connection Ports • 117
- Zero U Models' Relocatable Inlet • 115
- Zero U Products • 2