



Operation Manual

Smart-UPS[™]

Uninterruptible Power Supply

Rack-Mount 1U

1200/1500 VA
100/120 Vac

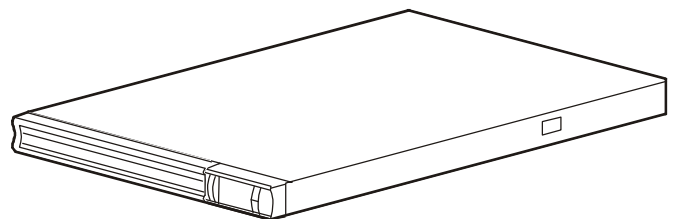

Important Safety Instructions

SAVE THESE INSTRUCTIONS - This manual contains important instructions that should be followed during installation and maintenance of the Smart-UPS and batteries.

Read these instructions carefully and look at the equipment to become familiar with the device before trying to install, operate, service or maintain it. The following special messages may appear throughout this document or on the equipment to warn of potential hazards or to call attention to information that clarifies or simplifies a procedure.



The addition of this symbol either to a “Danger” or “Warning” safety label indicates that an electrical hazard exists which will result in personal injury if the instructions are not followed.



This is the safety alert symbol. It is used to alert you to potential personal injury hazards. Obey all safety messages that follow this symbol to avoid possible injury or death.

DANGER

DANGER indicates a hazardous situation which, if not avoided, **will result in** death or serious injury.

WARNING

WARNING indicates a hazardous situation which, if not avoided, **could result in** death or serious injury.

CAUTION

CAUTION indicates a hazardous situation which, if not avoided, **could result in** minor or moderate injury.

NOTICE

NOTICE is used to address practices not related to physical injury.

Product Handling Guidelines

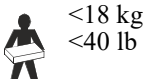

<18 kg
<40 lb



18-32 kg
40-70 lb



32-55 kg
70-120 lb



>55 kg
>120 lb



Safety and General Information

Inspect the package contents upon receipt. Notify the carrier and dealer if there is any damage.

Read the Safety Guide supplied with this unit before installing the UPS.

- Adhere to all local and national electrical codes.
- This UPS is intended for indoor use only.
- Do not operate this UPS in direct sunlight, in contact with fluids, or where there is excessive dust or humidity.
- Be sure the air vents on the UPS are not blocked. Allow adequate space for proper ventilation.
- The battery typically lasts for three to five years. Environmental factors impact battery life. Elevated ambient temperatures, poor quality utility power, and frequent short duration discharges will shorten battery life.
- Connect the UPS power cable directly to a wall outlet. Do not use surge protectors or extension cords.

Battery Safety

CAUTION

RISK OF HYDROGEN SULPHIDE GAS AND EXCESSIVE SMOKE

- Replace the battery at least every 5 years or at the end of its service life, whichever is earlier.
- Replace the battery immediately when the UPS indicates battery replacement is necessary.
- Replace batteries with the same number and type of batteries as originally installed in the equipment.
- Replace the battery immediately when the UPS indicates a battery overtemperature condition, or UPS internal overtemperature, or when there is evidence of electrolyte leakage. Power off the UPS, unplug it from the AC input, and disconnect the batteries. Do not operate the UPS until the batteries have been replaced.
- *Replace all battery modules (including the modules in External Battery Packs) which are older than one year, when installing additional battery packs or replacing the battery module(s).

Failure to follow these instructions could result in equipment damage and minor or moderate injury.

*Contact APC by Schneider Electric Worldwide Customer Support to determine the age of the installed battery modules.

- Servicing of batteries should be performed or supervised by personnel knowledgeable about batteries and the required precautions.
- CAUTION: A battery can present a risk of electrical shock and high short-circuit current. Contact with any part of a grounded battery can result in electrical shock. The following precautions should be observed when working on batteries:
 - Wear rubber gloves and boots.
 - Do not lay tools or metal parts on top of batteries.
 - Disconnect charging source and load prior to installing or maintaining the battery.
 - Remove battery grounds during installation and maintenance to reduce likelihood of shock.
 - Remove the connection from ground if any part of the battery is determined to be grounded.

FCC Warning

NOTE: This equipment has been tested and found to comply with the limits for a Class A digital device, pursuant to part 15 of the FCC Rules. These limits are designed to provide reasonable protection against harmful interference when the equipment is operated in a commercial environment. This equipment generates, uses, and can radiate radio frequency energy and, if not installed and used in accordance with the instruction manual, may cause harmful interference to radio communications. Operation of this equipment in a residential area is likely to cause harmful interference in which case the user will be required to correct the interference at his own expense.

VCCI-A Caution

この装置は、クラスA機器です。この装置を住宅環境で使用すると電波妨害を引き起こすことがあります。この場合には使用者が適切な対策を講ずるよう要求されることがあります。

VCCI-A

sur115a

Product Description

The APC by Schneider Electric Smart-UPS™ is a high performance uninterruptible power supply (UPS). The UPS provides protection for electronic equipment from utility power blackouts, brownouts, sags, and surges, small utility power fluctuations and large disturbances. The UPS also provides battery backup power for connected equipment until utility power returns to safe levels or the batteries are fully discharged.

This user manual is available on the enclosed CD and on the APC by Schneider Electric Web site, www.apc.com.

Product Overview

Front panel features

1	Battery
2	Battery connector
3	Display interface
4	Bezel

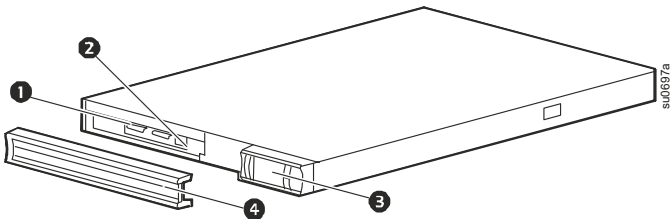

Rear panel features

1500 VA 120 VAC

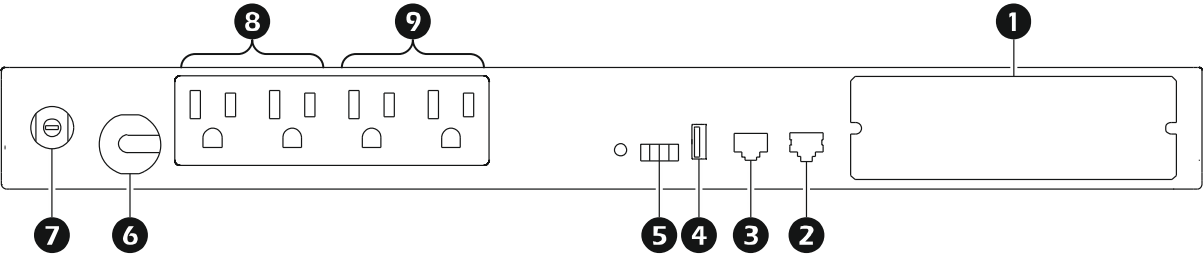

1200 VA 100 VAC

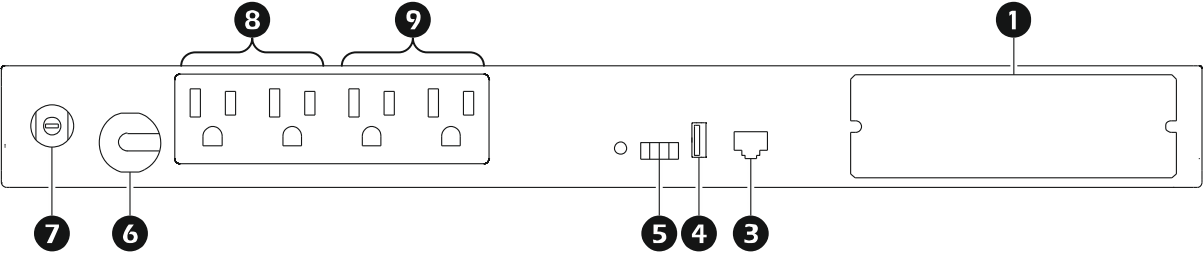

1	Smart slot for optional accessory card	6	UPS input
2	APC™ SmartConnect port	7	Circuit breaker / Overload protection
3	RJ45 connector - serial UPS monitoring port	8	Controlled outlet group 1
4	USB port	9	Controlled outlet group 2
5	EPO connector		

Specifications

Environmental

For additional specifications, refer to the APC by Schneider Electric Web site at www.apc.com.

Temperature	Operating	0 to 40 °C (32 to 104 °F)
	Storage	-15 to 45 °C (5 to 113 °F) Charge UPS battery every six months
Maximum Elevation	Operating	3,000 m (10,000 ft)
	Storage	15,000 m (50,000 ft)
Humidity		0% to 95% relative humidity, non-condensing
International Protection Code		IP20

Battery

	SMT1500RM1UC	SMT1K2RJ1U
Battery Type	Sealed, maintenance-free, Valve Regulated Lead-Acid battery	
Replacement battery module This UPS has replaceable battery modules. Refer to the appropriate replacement battery user manual for installation instructions. Contact your dealer or go the APC by Schneider Electric web site, www.apc.com for information on replacement batteries.	APCRBC88	APCRBC88J
Number of battery modules	1 battery module	
Voltage for each battery module	6 V	
Total battery voltage for the UPS	36 V	
Ah rating	9 Ah	

Installation

UPS

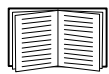

For UPS installation information, refer to the Smart-UPS X Installation Guide that is included with the UPS. The guide is also available on the enclosed CD and the APC by Schneider Electric Web site at www.apc.com.

Network Management Card

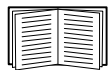

For installation information, refer to the user manual provided with the Network Management Card (NMC). The user manual is also available on the APC by Schneider Electric Web site at www.apc.com.

Operation

Connect Equipment to the UPS

CAUTION

RISK OF ELECTRIC SHOCK

- Adhere to all local and national electrical codes.
- Wiring should be performed by qualified electrician.
- Always connect the UPS to a grounded outlet.



Failure to follow these instructions could result in minor or moderate injury.

Note: The UPS will charge to 90% capacity in the first three hours of normal operation. **Do not expect full battery runtime capability during this initial charge period.**

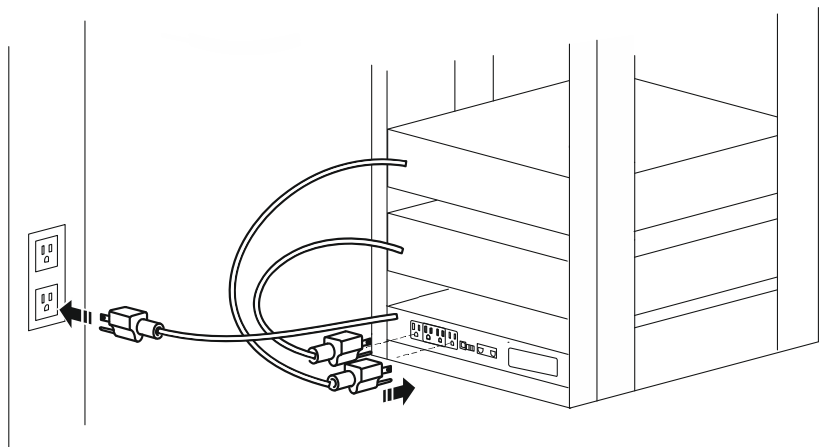
1. Connect equipment to the outlets on the rear panel of the UPS.
2. Connect the UPS to the building utility power.
Always connect the UPS to a two pole, three wire, grounded source.
3. To use the UPS as a master ON/OFF switch, turn on all the equipment that is connected to the UPS.
4. Press the ON/OFF button on the front panel of the UPS to turn on the UPS and all connected equipment.
5. See “Switched Outlet Groups” on page 10 for details on how to use the Controllable Outlet Groups.



Basic Connectors

	Serial port: Connect to a computer to use power management software.
	USB port: Connect to a computer to use power management software. Note: Serial and USB communication can not be used simultaneously.
	APC SmartConnect Port: APC™ SmartConnect allows you to monitor the health and status of your UPS from any device connected to the Internet. Log onto www.smartconnect.apc.com or scan the QR code to launch the registration process. The website includes instructions to setup your online account, activate your warranty and begin monitoring your UPS remotely.

Display Interface

Overview

- ❶ Online LED
- ❷ On Battery LED
- ❸ Alert LED
- ❹ Replace Battery LED
- ❺ UP/DOWN arrow buttons
- ❻ Display screen
- ❼ ENTER button
- ❽ UPS Output ON/OFF button
- ❾ ESCAPE button

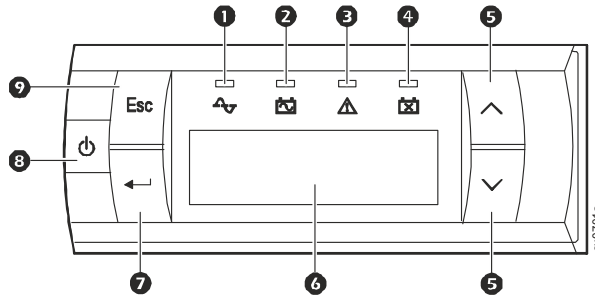

Display interface operation

Press either the ESC or ENTER buttons to access the main menu.

Use the UP/DOWN arrow buttons to scroll through menu options.

Press ENTER to view sub menus. Scroll through the list of options. Press ENTER to select an option.

Press ESCAPE to exit a sub menu and return to a main menu.

Menu overview

The display interface has Standard and Advanced menu screens. The preference for Standard or Advanced menu options is made during initial installation and can be changed at any time using the Configuration menu.

Standard menus are the most commonly used menus. The default screen shows Load and Battery Capacity bar graphs.

The Advanced menus include more status information and additional sub menus. The default screen shows scrolling status information.

Note: Actual menu screens may differ by model and firmware revision.

Main Menu	Display Description	Standard Option	Advanced Option
Status * Advanced menu Status items displayed as scrolling information	Operating mode*	X	X
	Efficiency	X	X
	Load power (W)*	X	X
	Load power (VA)*	X	X
	Load amperage		X
	Load energy meter		X
	Battery charge state%	X	X
	Battery runtime*	X	X
	Battery voltage		X
	Battery temperature	X	X
	Input voltage and frequency*	X	X
	Output voltage and frequency*	X	X
	Outlet group status*	X	X
	SmartConnect		X
Control	UPS control		X
	Outlet Group control		X
Configuration	Language	X	X
	Green mode	X	X
	Output voltage setting (if applicable)		X
	Power quality	X	X
	Menu type	X	X
	Audible alarms	X	X
	Display mode	X	X

Main Menu	Display Description	Standard Option	Advanced Option
Configuration	Sensitivity		X
	Low voltage transfer points		X
	High voltage transfer points		X
	Low battery alert threshold		X
	Automatic self test interval		X
	Reset energy meter		X
	Enter set-up wizard		X
	Perform firmware update (UPS output must be off)		X
	Reset to factory defaults	X	X
	Site wiring fault (feature available only in SMT1500RM1U)		X
	Outlet group configuration		X
	ModBus settings		X
	SmartConnect (feature available only in SMT1500RM1U)	X	X
	UPS IP Address setting (feature available only in SMT1500RM1U)		X
	NMC IP Address setting (feature available only when NMC is installed)		X
Test and Diagnostics	UPS self test	X	X
	UPS alarms test	X	X
	UPS calibration test	X	X
Logs	Event Logs		X
About	UPS model	X	X
	UPS part number	X	X
	UPS serial number	X	X
	UPS manufacture date	X	X
	Battery part no.	X	X
	XBP Battery (if installed)	X	X
	Battery install date	X	X
	Replace battery by	X	X
	Running UPS FW	X	X
	Available UPS FW (if available)	X	X
	UPS MAC Address (available only when network interface is enabled)	X	X
	UPS IP address	X	X
	UPS product key	X	X
	SmartSlot card (if installed)	X	X

Configuration

UPS Settings

Start up settings

At initial start up use the Setup Wizard to configure the following settings.

Function	Factory Default	Options	Description
Language	English	<ul style="list-style-type: none">• English• French• German• Spanish• Italian• Portuguese• Japanese	<p>The language for the display interface.</p> <p>Language options will vary by model.</p>
Connect Ethernet Cable			<p>This menu is for reminding users to connect the ethernet cable.</p> <p>This menu will not be displayed if the UPS does not have the SmartConnect feature.</p> <p>The user can continue the configuration process by pressing the ENTER button even if the ethernet cable is not connected.</p>
Local Power Quality	Good	<ul style="list-style-type: none">• Good• Fair• Poor	<p>Select the desired utility input power quality.</p> <ul style="list-style-type: none">• Good: The UPS will go on battery power more often to provide the cleanest power supply to connected equipment.• Fair: The UPS will tolerate some voltage fluctuations before switching to battery power.• Poor: The UPS will tolerate more voltage fluctuations and will go on battery power less often. <p>The Power Quality setting will automatically change the high and low transfer points and the transfer sensitivity setting.</p>
Menu Type	Standard	<ul style="list-style-type: none">• Standard• Advanced	<p>The Advanced menus include all parameters. The Standard menus display a limited set of menus and options.</p>
Date	UPS manufacture date + 90 days	mm-yyyy	At initial start up, enter the current date.

General settings

Configure these settings at any time, using the display interface or PowerChute™ software .

Function	Factory Default	Options	Description
Local Power Quality	Good	<ul style="list-style-type: none"> • Good • Fair • Poor 	<p>Select the desired utility input power quality.</p> <ul style="list-style-type: none"> • Good: The UPS will go on battery power more often to provide the cleanest power supply to connected equipment. • Fair: The UPS will tolerate some voltage fluctuations before switching to battery power. • Poor: The UPS will tolerate more voltage fluctuations and will go on battery power less often. <p>The Power Quality setting will automatically change the high and low transfer points and the transfer sensitivity setting.</p>
High Transfer Point	100 Vac models: 108 Vac 120 Vac models: 127 Vac	100 Vac models: 108-114 Vac 120 Vac models: 127-136 Vac	<p>To avoid unnecessary battery usage, the high and low transfer points can be adjusted.</p> <ul style="list-style-type: none"> • Set the transfer point higher if the AC voltage is chronically high. • Set the transfer point lower if the AC voltage is chronically low.
Low Transfer Point	100 Vac models: 92 Vac 120 Vac models: 106 Vac	100 Vac models: 86-92 Vac 120 Vac models: 97-106 Vac	<p>When the Power Quality setting is changed the high and low transfer points will automatically be adjusted.</p>
Transfer Sensitivity	Normal	<ul style="list-style-type: none"> • Normal • Reduced • Low 	<p>Set the sensitivity to a level that is appropriate for the connected equipment.</p> <ul style="list-style-type: none"> • Normal: The UPS will go on battery power more often to provide the cleanest power supply to the connected equipment. • Reduced: The UPS will tolerate some voltage fluctuations before switching to battery power. • Low: The UPS will tolerate more voltage fluctuations and will go on battery power less often. <p>When the Power Quality setting is changed the transfer sensitivity will automatically be adjusted.</p>
Low Battery Setting	150 sec	Value set in seconds	The UPS will emit an audible alarm when the remaining runtime has reached this level.
Audible Alarm	On	<ul style="list-style-type: none"> • On • Off 	The UPS will mute all audible alarms if this is set to Off or when any of the display buttons are pressed.
Display Mode	Auto Dim	<ul style="list-style-type: none"> • Always On • Auto Dim • Auto Off 	<ul style="list-style-type: none"> • The display interface remains continuously illuminated. • The display interface illumination will diminish after two minutes of inactivity. • The display interface illumination will extinguish after two minutes of inactivity.
Auto Self-Test Interval	On start up and 14 days after each self-test.	<ul style="list-style-type: none"> • Start up + 14 days • Start up + 7 days • On start up only • Never 	<p>The interval at which the UPS will execute a self-test.</p> <p>The batteries must be charged to at least 70% capacity to perform a self-test.</p> <p>“Start up” on these menus refers to any time the UPS is turned on.</p>
Reset to Factory Default	No	<ul style="list-style-type: none"> • Yes • No 	Restore the UPS factory default settings.
Site Wiring Fault	Enable	<ul style="list-style-type: none"> • Enable • Disable • Can Ack 	Sets the Site Wiring Fault detection to Enable, Disable or User Can Acknowledge

Function	Factory Default	Options	Description
SmartConnect Control	Enable - No control	<ul style="list-style-type: none"> • Enable - No control • Enable - with control • Disable 	<p>This will permit UPS to connect to APC SmartConnect Cloud.</p> <ul style="list-style-type: none"> • Select Disable when UPS should not be connected to cloud. • Select Enable- without control to monitor only a few UPS status through SmartConnect web • Select Enable-with control to send supported commands through SmartConnect web.
Green Mode	Enable	<ul style="list-style-type: none"> • Enable • Disable 	<p>This will enable or disable Green mode function. Green Mode conserves energy while the UPS is operating on line</p>

Switched Outlet Groups

Overview

The UPS has two Switched Outlet Groups. Each can be configured to independently perform the following actions:

- Turn off: Disconnect from power immediately and restart only with a manual command.
- Turn on: Connect to power immediately.
- Shutdown: Disconnect power, and automatically reapply power when utility power becomes available.
- Reboot: Shut down and restart.
- Turn on or off in a specified sequence.
- Automatically turn off or shut down when various conditions occur.

Note: If the Switched Outlet Groups are not configured, all of the outlets on the unit will provide battery backup power.

Configure the Switched Outlet Groups

1. Connect equipment to the Switched Outlet Groups.
 - Nonessential equipment that should shut off quickly in the event of a power outage to conserve battery runtime can be added to a short power off delay.
 - If equipment has dependent peripherals that must restart or shut down in a specific order, such as an ethernet switch that must restart before a connected server, connect the devices to separate groups.
 - Equipment that needs to reboot independently from other equipment should be added to a separate group.
2. Use the Configuration menus to configure how the Switched Outlet Group will react in the event of a power outage.

Customize Switched Outlet Groups

Use the **Configuration** menu to change the Switched Outlet Group settings.

Function	Factory Default	Options	Description
Turn On Delay	0 sec	Set the value in seconds	The amount of time the UPS or Switched Outlet Group will wait between receiving the command to turn on and the actual startup.
Turn Off Delay	90 sec	Set the value in seconds	The amount of time that the UPS or Switched Outlet Group will wait between receiving the command to turn off and the actual shut down.
Reboot Duration	8 sec	Set the value in seconds	The amount of time that the UPS or Switched Outlet Group must remain off before it will restart.
Minimum Return Run Time	0 sec	Set the value in seconds	The amount of battery runtime that must be available before the UPS or Switched Outlet Group will turn on.
Load Shed Time On Battery	Disabled	<ul style="list-style-type: none"> • Enable • Disable 	When the unit switches to battery power, the UPS can disconnect power to the Switched Outlet Group to save runtime.
Load Shed Time On Battery	1800 sec	Set the value in seconds	The amount of time the Switched Outlet Group will continue function after the UPS begins operating on battery.
Load Shed Runtime Remain	Disabled	<ul style="list-style-type: none"> • Enable • Disable 	When the battery runtime falls below the specified value, the Switched Outlet Group will turn off.

Function	Factory Default	Options	Description
Load Shed Runtime Remain	120 sec	Set the value in seconds	Remaining runtime required for the outlets to stay on.
Load Shed on Overload	Disabled	<ul style="list-style-type: none"> • Enable • Disable 	In the event of an overload (greater than 100% output), the Switched Outlet Group will immediately turn off to conserve power for essential loads. The Switched Outlet Group will only turn on again with a manual command.

Modbus settings

Setting	Factory Default	Options	Description
Slave ID	1	1 - 223	Sets the Modbus slave address of UPS
Ser+USB	Disable	<ul style="list-style-type: none"> • Enable • Disable 	Enables or disables UPS Modbus protocol over serial and USB ports
TCP Settings			
TCP Protocols	Disable	<ul style="list-style-type: none"> • Disable • Read-Only • Read-Write 	<p>Enables or disables UPS Modbus TCP/IP protocol provided by the embedded SmartConnect port.</p> <ul style="list-style-type: none"> • Disable: Disables UPS Modbus TCP/IP protocol • Read-Only: Modbus master over TCP/IP protocol is only allowed to get UPS status. • Read-Write: Modbus master over TCP/IP protocol is allowed to get UPS status and control the UPS. <p>The port number of UPS Modbus TCP/IP protocol is fixed at 502.</p>
Master IP Addr	000.000.000.000	A valid IPv4 address	<p>Specifies the IPv4 address of the Modbus master.</p> <p>The <i>Master IP Addr</i> when set as 000.000.000.000 will allow connection of external Modbus master with any IP address. When not set as 000.000.000.000, only the Modbus master with the specified IP address is allowed to connect to the UPS.</p> <p>Example: <i>Master IP Address</i> is set to 192.168.0.10, only Modbus master with IP address 192.168.0.10 could connect to the UPS.</p>

UPS IP Address settings

Setting	Factory Default	Options	Description
UPS IP Address Mode	DHCP	<ul style="list-style-type: none"> • DHCP • Manual 	<p>Selects the IP address configuration mode of UPS embedded SmartConnect port:</p> <ul style="list-style-type: none"> • DHCP: UPS will automatically configure its IPv4 address via DHCP protocol. • Manual: Manually assigns a static IPv4 address to UPS
IP Address	000.000.000.000	A valid IPv4 address	<p>This is the IPv4 address assigned to the embedded SmartConnect port.</p> <p>When DHCP IP address mode is selected, it will display the UPS IPv4 address assigned by DHCP server.</p> <p>When Manual IP address mode is selected, you need to manually specify a static IPv4 address.</p>
Subnet Mask	000.000.000.000	A valid IPv4 subnet mask	<p>Assigns the subnet mask of the network where UPS IPv4 address belongs.</p> <p>When DHCP IP address mode is selected, it will display the subnet mask assigned by DHCP server.</p> <p>When Manual IP address mode is selected, you need to manually specify the subnet mask of the network where the specified static IPv4 address belongs.</p>
Default Gateway	000.000.000.000	A valid IPv4 address	<p>This is the IPv4 address of the host from where the UPS sends data to another network or Internet.</p> <p>When DHCP IP address mode is selected, it will display the default gateway assigned by DHCP server.</p> <p>When Manual IP address mode is selected, you need to manually specify the IPv4 address of default gateway.</p>

Setting	Factory Default	Options	Description
DNS Server 1	000.000.000.000	A valid IPv4 address	The IPv4 address of first domain name server (DNS) the UPS uses to resolve host names to IPv4 addresses. When DHCP IP address mode is selected, it will display the IPv4 address of the first DNS server assigned by DHCP server. When Manual IP address mode is selected, you need to manually specify the IPv4 address of the first DNS server.
DNS Server 2	000.000.000.000	A valid IPv4 address	The IPv4 address of second domain name server (DNS) the UPS uses to resolve host names to IPv4 addresses (<i>only when UPS is unable to resolve IP address through first domain name server</i>). This setting is optional. When DHCP IP address mode is selected, it will display the IPv4 address of the second DNS server assigned by DHCP server. When Manual IP address mode is selected, you can manually specify the IPv4 address of the second DNS server or leave it as 000.000.000.000.

Network Management Card Settings

These settings are available only on units that have a Network Management Card (NMC) and are set in the factory. These settings can only be modified using an external interface, like the NMC web interface.

- NMC IP Address Mode
- NMC IP Address
- NMC Subnet Mask
- NMC Default Gateway

EcoStruxure™ Ready Smart-UPS™ Web Portal

The Web Portal allows you to remotely view the status of your UPS, receive automatic notifications about UPS events, and firmware updates. Visit smartconnect.apc.com to learn more.

Log onto smartconnect.apc.com or scan the QR code to begin the registration process. For instructions on how to register your SmartConnect-compatible UPS, visit smartconnect-support.apc.com.

By connecting this product to the Internet using the APC™ SmartConnect Ethernet port, you are agreeing to the APC™ SmartConnect Terms of Use and Data Privacy Notice, as found at smartconnect.apc.com/terms-and-privacy. The Schneider Electric Data Privacy Policy can also be found at smartconnect.apc.com/terms-and-privacy.

Emergency Power Off

Overview

The Emergency Power Off (EPO) option is a feature that will immediately disconnect all connected equipment from mains power. The UPS will immediately shut down and will not switch to battery power. Connect each UPS to the EPO switch. If multiple units are to be controlled with an EPO switch, each UPS must be connected separately to the EPO switch.

The UPS must be restarted for power to return to connected equipment. Press the ON/OFF button on the front panel of the UPS.

CAUTION

RISK OF ELECTRIC SHOCK

- Adhere to all national and local electrical codes.
- Wiring must be performed by a qualified electrician.
- Always connect the UPS to a grounded outlet.

Failure to follow these instructions could result in minor or moderate injury.

Normally open contacts

1. If the EPO switch or relay contacts are normally open, insert the wires from the switch or contacts at pins 1 and 2 of the EPO terminal block. Use 16-28 AWG wire.
2. Secure the wires by tightening the screws.

If the contacts are closed, the UPS will turn OFF and power will be removed from the load.

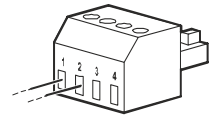

Normally closed contacts

1. If the EPO switch or relay contacts are normally closed, insert the wires from the switch or contacts at pins 2 and 3 of the EPO terminal block. Use 16-28 AWG wire.
2. Insert a wire jumper between pins 1 and 2. Secure the wires by tightening the three screws at positions 1, 2, and 3.

If the contacts are opened, the UPS will turn OFF and power will be removed from the load.

Note: Pin 1 is the power source for the EPO circuit, it provides a few milliamperes of 24 V power.

If the normally closed (NC) EPO configuration is used, the EPO switch or relay should be rated for dry circuit applications, the rating should be for low voltage and low current applications. This normally implies the contacts are gold-plated.

The EPO interface is a Safety Extra Low Voltage (SELV) circuit. Connect the EPO interface only to other SELV circuits. The EPO interface monitors circuits that have no determined voltage potential. SELV circuits are controlled by a switch or relay properly isolated from utility power. To avoid damage to the UPS, do not connect the EPO interface to any circuit other than a SELV circuit.

Use one of the following cable types to connect the UPS to the EPO switch.

- CL2: Class 2 cable for general use.
- CL2P: Plenum cable for use in ducts, plenums, and other spaces used for environmental air.
- CL2R: Riser cable for use in a vertical run in a floor-to-floor shaft.
- CLEX: Limited use cable for use in dwellings and for use in raceways.
- Installation in Canada: Use only CSA certified, type ELC, (extra low voltage control cable).
- Installation in countries other than Canada and the USA: Use standard low voltage cable in accordance with national and local regulations.

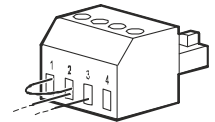

Troubleshooting

Problem and Possible Cause	Solution
The UPS will not turn on or there is no output	
The UPS has not been turned on.	Press the ON button once to turn on the UPS.
The UPS is not connected to utility power.	Ensure that the power cable is securely connected to the unit and to the utility power supply.
The input circuit breaker has tripped.	Reduce the load to the UPS, disconnect nonessential equipment and reset the circuit breaker.
The unit shows very low or no input utility voltage.	Check the utility power supply to the UPS by plugging in a table lamp. If the light is very dim, check the utility voltage.
The UPS has detected an internal fault.	Do not attempt to use the UPS. Unplug the UPS and have it serviced immediately.
The UPS is operating on battery, while connected to utility power	
The input circuit breaker has tripped.	Reduce the load to the UPS, disconnect nonessential equipment and reset the circuit breaker.
There is very high, very low, or distorted input line voltage.	Move the UPS to a different outlet on a different circuit. Test the input voltage with the utility voltage display. If acceptable to the connected equipment, reduce the UPS sensitivity.
The UPS is beeping	
The UPS is in normal operation.	None. The UPS is protecting the connected equipment.
UPS does not provide expected backup time	
The UPS battery is weak due to a recent outage or is near the end of its service life.	Charge the battery. Batteries require recharging after extended outages and wear out faster when put into service often or when operated at elevated temperatures. If the battery is near the end of its service life, consider replacing the battery even if the replace battery indicator is not yet illuminated.
The UPS is experiencing an overload condition.	Check the UPS load display. Unplug unnecessary equipment, such as printers.
Display interface LEDs flash sequentially	
The UPS has been shut down remotely through software or an optional accessory card.	None. The UPS will restart automatically when AC power returns.
The Alert LED is illuminated, the UPS displays a message and emits a constant beeping	
The UPS has detected an internal fault.	Do not attempt to use the UPS. Turn the UPS off and have it serviced immediately.
The replace battery LED is illuminated	
The battery has a weak charge.	Allow the battery to recharge for at least four hours. Then, perform a Self-Test. If the problem persists after recharging, replace the battery.
The replacement battery is not properly connected.	Ensure that the battery connector is securely connected.

Service

If the unit requires service, do not return it to the dealer. Follow these steps:

1. Review the Troubleshooting section of the manual to eliminate common problems.
2. If the problem persists, contact APC by Schneider Electric Customer Support through the Web site, **www.apc.com**.
 - a. Note the model number and serial number and the date of purchase. The model and serial numbers are located on the rear panel of the unit and are available through the LCD display on select models.
 - b. Call APC by Schneider Electric Customer Support and a technician will attempt to solve the problem over the phone. If this is not possible, the technician will issue a Returned Material Authorization Number (RMA#).
 - c. If the unit is under warranty, the repairs are free.
 - d. Service procedures and returns may vary internationally. Refer to the APC by Schneider Electric Web site for country specific instructions.
3. Pack the unit in the original packaging whenever possible to avoid damage in transit. Never use foam beads for packaging. Damage sustained in transit is not covered under warranty.
 - a. **Always DISCONNECT THE UPS BATTERIES before shipping. The United States Department of Transportation (DOT), and the International Air Transport Association (IATA) regulations require that UPS batteries be disconnected before shipping.** The internal batteries may remain in the UPS.
 - b. External Battery Pack products are deenergized when disconnected from the associated UPS product. It is not necessary to disconnect the internal batteries for shipping. Not all units utilize an external battery pack.
4. Write the RMA# provided by Customer Support on the outside of the package.
5. Return the unit by insured, prepaid carrier to the address provided by Customer Support.

Transport the unit

1. Shut down and disconnect all connected equipment.
2. Disconnect the unit from utility power.
3. Disconnect all internal and external batteries (if applicable).
4. Follow the shipping instructions outlined in the *Service* section of this manual.

Limited Factory Warranty

Schneider Electric IT Corporation (SEIT), warrants its products to be free from defects in materials and workmanship for a period of three (3) years for the UPS and two (2) years for the battery, from the date of purchase. The SEIT obligation under this warranty is limited to repairing or replacing, at its own sole option, any such defective products. Repair or replacement of a defective product or part thereof does not extend the original warranty period.

This warranty applies only to the original purchaser who must have properly registered the product within 10 days of purchase. Products may be registered online at warranty.apc.com.

SEIT shall not be liable under the warranty if its testing and examination disclose that the alleged defect in the product does not exist or was caused by end user or any third person misuse, negligence, improper installation, testing, operation or use of the product contrary to SEIT recommendations of specifications. Further, SEIT shall not be liable for defects resulting from: 1) unauthorized attempts to repair or modify the product, 2) incorrect or inadequate electrical voltage or connection, 3) inappropriate on site operation conditions, 4) Acts of God, 5) exposure to the elements, or 6) theft. In no event shall SEIT have any liability under this warranty for any product where the serial number has been altered, defaced, or removed.

EXCEPT AS SET FORTH ABOVE, THERE ARE NO WARRANTIES, EXPRESS OR IMPLIED, BY OPERATION OF LAW OR OTHERWISE, APPLICABLE TO PRODUCTS SOLD, SERVICED OR FURNISHED UNDER THIS AGREEMENT OR IN CONNECTION HEREWITH.

SEIT DISCLAIMS ALL IMPLIED WARRANTIES OF MERCHANTABILITY, SATISFACTION AND FITNESS FOR A PARTICULAR PURPOSE.

SEIT EXPRESS WARRANTIES WILL NOT BE ENLARGED, DIMINISHED, OR AFFECTED BY AND NO OBLIGATION OR LIABILITY WILL ARISE OUT OF, SEIT RENDERING OF TECHNICAL OR OTHER ADVICE OR SERVICE IN CONNECTION WITH THE PRODUCTS.

THE FOREGOING WARRANTIES AND REMEDIES ARE EXCLUSIVE AND IN LIEU OF ALL OTHER WARRANTIES AND REMEDIES. THE WARRANTIES SET FORTH ABOVE CONSTITUTE SEIT'S SOLE LIABILITY AND PURCHASER EXCLUSIVE REMEDY FOR ANY BREACH OF SUCH WARRANTIES. SEIT WARRANTIES EXTEND ONLY TO ORIGINAL PURCHASER AND ARE NOT EXTENDED TO ANY THIRD PARTIES.

IN NO EVENT SHALL SEIT, ITS OFFICERS, DIRECTORS, AFFILIATES OR EMPLOYEES BE LIABLE FOR ANY FORM OF INDIRECT, SPECIAL, CONSEQUENTIAL OR PUNITIVE DAMAGES, ARISING OUT OF THE USE, SERVICE OR INSTALLATION OF THE PRODUCTS, WHETHER SUCH DAMAGES ARISE IN CONTRACT OR TORT, IRRESPECTIVE OF FAULT, NEGLIGENCE OR STRICT LIABILITY OR WHETHER SEIT HAS BEEN ADVISED IN ADVANCE OF THE POSSIBILITY OF SUCH DAMAGES. SPECIFICALLY, SEIT IS NOT LIABLE FOR ANY COSTS, SUCH AS LOST PROFITS OR REVENUE, WHETHER DIRECT OR INDIRECT, LOSS OF EQUIPMENT, LOSS OF USE OF EQUIPMENT, LOSS OF SOFTWARE, LOSS OF DATA, COSTS OF SUBSTITUANTS, CLAIMS BY THIRD PARTIES, OR OTHERWISE.

NOTHING IN THIS LIMITED WARRANTY SHALL SEEK TO EXCLUDE OR LIMIT SEIT LIABILITY FOR DEATH OR PERSONAL INJURY RESULTING FROM ITS NEGLIGENCE OR ITS FRAUDULENT MISREPRESENTATION OF TO THE EXTENT THAT IT CANNOT BE EXCLUDED OR LIMITED BY APPLICABLE LAW.

To obtain service under warranty you must obtain a Returned Material Authorization (RMA) number from customer support. Customers with warranty claims issues may access the SEIT worldwide customer support network through the APC by Schneider Electric Web site: www.apc.com. Select your country from the country selection drop down menu. Open the Support tab at the top of the web page to obtain information for customer support in your region. Products must be returned with transportation charges prepaid and must be accompanied by a brief description of the problem encountered and proof of date and place of purchase.

APC™ by Schneider Electric Worldwide Customer Support

Customer support for this or any other APC by Schneider Electric product is available at no charge in any of the following ways:

- Visit the APC by Schneider Electric Web site to access documents in the APC by Schneider Electric Knowledge Base and to submit customer support requests.
 - **www.apc.com** (Corporate Headquarters)
Connect to localized APC by Schneider Electric Web sites for specific countries, each of which provides customer support information.
 - **www.apc.com/support/**
Global support searching APC by Schneider Electric Knowledge Base and using e-support.
- Contact the APC by Schneider Electric Customer Support Center by telephone or e-mail.
 - Local, country specific centers: go to **www.apc.com/support/contact** for contact information.
 - For information on how to obtain local customer support, contact the APC by Schneider Electric representative or other distributors from whom you purchased your APC by Schneider Electric product.



Select models are ENERGY STAR® qualified.

For more information on your specific model visit the APC by Schneider Electric web site, www.apc.com.

© 2022 APC by Schneider Electric. APC, the APC logo, Smart-UPS and PowerChute are owned by Schneider Electric Industries S.A.S. or their affiliated companies. All other trademarks are property of their respective owners.