

**ASUS®**

**ROG STRIX**

**XG16AHP/XG16AHP-W**

**Portable Gaming  
Monitor**

**User Guide**

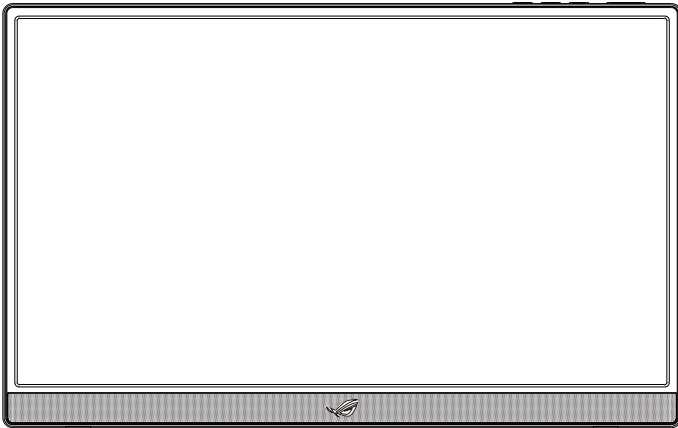

**HDMI™**  
HIGH-DEFINITION MULTIMEDIA INTERFACE

# Table of contents

<b>Notices</b> .....	<b>iii</b>
<b>Safety information</b> .....	<b>v</b>
<b>Care &amp; cleaning</b> .....	<b>vi</b>
<b>Takeback services</b> .....	<b>vii</b>
<b>1.1 Welcome!</b> .....	<b>1-1</b>
<b>1.2 Package contents</b> .....	<b>1-1</b>
<b>1.3 Monitor introduction</b> .....	<b>1-2</b>
1.3.1 Front View and Charging Instructions.....	1-2
<b>2.1 Monitor standing positions</b> .....	<b>2-1</b>
<b>2.2 Connect the USB monitor with system</b> .....	<b>2-2</b>
<b>2.3 Assembling/Dis-assembling the ROG tripod</b> .....	<b>2-3</b>
<b>2.4 How to Adjust tilt strength of ROG Tripod</b> .....	<b>2-3</b>
<b>2.5 Announcements</b> .....	<b>2-5</b>
<b>3.1 OSD (On-Screen Display) menu</b> .....	<b>3-1</b>
3.1.1 How to reconfigure.....	3-1
3.1.2 OSD Function Introduction.....	3-2
<b>3.2 Specifications</b> .....	<b>3-11</b>
<b>3.3 Troubleshooting (FAQ)</b> .....	<b>3-12</b>
<b>3.4 Supported Timing List</b> .....	<b>3-13</b>

Copyright © 2021 ASUSTeK COMPUTER INC. All Rights Reserved.

No part of this manual, including the products and software described in it, may be reproduced, transmitted, transcribed, stored in a retrieval system, or translated into any language in any form or by any means, except documentation kept by the purchaser for backup purposes, without the express written permission of ASUSTeK COMPUTER INC. (“ASUS”).

Product warranty or service will not be extended if: (1) the product is repaired, modified or altered, unless such repair, modification or alteration is authorized in writing by ASUS; or (2) the serial number of the product is defaced or missing.

ASUS PROVIDES THIS MANUAL “AS IS” WITHOUT WARRANTY OF ANY KIND, EITHER EXPRESS OR IMPLIED, INCLUDING BUT NOT LIMITED TO THE IMPLIED WARRANTIES OR CONDITIONS OF MERCHANTABILITY OR FITNESS FOR A PARTICULAR PURPOSE. IN NO EVENT SHALL ASUS, ITS DIRECTORS, OFFICERS, EMPLOYEES OR AGENTS BE LIABLE FOR ANY INDIRECT, SPECIAL, INCIDENTAL, OR CONSEQUENTIAL DAMAGES (INCLUDING DAMAGES FOR LOSS OF PROFITS, LOSS OF BUSINESS, LOSS OF USE OR DATA, INTERRUPTION OF BUSINESS AND THE LIKE), EVEN IF ASUS HAS BEEN ADVISED OF THE POSSIBILITY OF SUCH DAMAGES ARISING FROM ANY DEFECT OR ERROR IN THIS MANUAL OR PRODUCT.

SPECIFICATIONS AND INFORMATION CONTAINED IN THIS MANUAL ARE FURNISHED FOR INFORMATIONAL USE ONLY, AND ARE SUBJECT TO CHANGE AT ANY TIME WITHOUT NOTICE, AND SHOULD NOT BE CONSTRUED AS A COMMITMENT BY ASUS. ASUS ASSUMES NO RESPONSIBILITY OR LIABILITY FOR ANY ERRORS OR INACCURACIES THAT MAY APPEAR IN THIS MANUAL, INCLUDING THE PRODUCTS AND SOFTWARE DESCRIBED IN IT.

Products and corporate names appearing in this manual may or may not be registered trademarks or copyrights of their respective companies, and are used only for identification or explanation and to the owners’ benefit, without intent to infringe.

# Notices

## **Federal Communications Commission Statement**

This device complies with Part 15 of the FCC Rules. Operation is subject to the following two conditions:

- This device may not cause harmful interference, and
- This device must accept any interference received including interference that may cause undesired operation.

This equipment has been tested and found to comply with the limits for a Class B digital device, pursuant to Part 15 of the FCC Rules. These limits are designed to provide reasonable protection against harmful interference in a residential installation. This equipment generates, uses and can radiate radio frequency energy and, if not installed and used in accordance with the instructions, may cause harmful interference to radio communications. However, there is no guarantee that interference will not occur in a particular installation. If this equipment does cause harmful interference to radio or television reception, which can be determined by turning the equipment off and on, the user is encouraged to try to correct the interference by one or more of the following measures:

- Reorient or relocate the receiving antenna.
- Increase the separation between the equipment and receiver.
- Connect the equipment to an outlet on a circuit different from that to which the receiver is connected.
- Consult the dealer or an experienced radio/TV technician for help.

## **Canadian Department of Communications Statement**

This digital apparatus does not exceed the Class B limits for radio noise emissions from digital apparatus set out in the Radio Interference Regulations of the Canadian Department of Communications.

This class B digital apparatus complies with Canadian ICES-003.



## WEEE Symbol Statement

This symbol on the product or on its packaging indicates that this product must not be disposed of with your other household waste. Instead, it is your responsibility to dispose of your waste equipment by handing it over to a designated collection point for the recycling of waste electrical and electronic equipment. The separate collection and recycling of your waste equipment at the time of disposal will help to conserve natural resources and ensure that it is recycled in a manner that protects human health and the environment. For more information about where you can drop off your waste equipment for recycling, please contact your local city office, your household waste disposal service or the shop where you purchased the product.



## Safety information

- Before setting up this Portable Gaming Monitor, carefully read all the documentation that came with the package.
- To prevent fire or shock hazard, never expose this Portable Gaming Monitor to rain or moisture.
- Never try to open this Portable Gaming Monitor cabinet.
- Before using this Portable Gaming Monitor, make sure all cables are correctly connected and the power cables are not damaged. If you detect any damage, contact your dealer immediately.
- Avoid dust, humidity, and temperature extremes. Do not place this Portable Gaming Monitor in any area where it may become wet. Place this Portable Gaming Monitor on a stable surface.
- Never push objects or spill liquid of any kind into the slots on this Portable Gaming Monitor cabinet.
- If you encounter technical problems with this Portable Gaming Monitor, contact a qualified service technician or your retailer.
- This Portable Gaming Monitor is powered by USB port which complies with LPS and SELV circuit according to IEC60950-1:2005.
- DO NOT dispose of the product in fire
- DO NOT use monitor near heating equipment or in places where there is likelihood of high temperature
- Keep your monitor away from sharp objects
- DO NOT place objects on top of your monitor
- If the unit uses batteries, please ensure that they are inserted correctly- observing the polarity (+/-) Please make sure that used batteries are disposed of correctly.
- Do not burn or incinerate. Do not expose the batteries(battery pack or batteries installed) to excessive heat such as sunshine, fire or the like.

## Care & cleaning

- Cleaning. Turn your monitor off and unplug the cable. Clean the monitor surface with a lint-free, non-abrasive cloth. Stubborn stains may be removed with a cloth dampened with mild cleaner.
- Avoid using a cleaner containing alcohol or acetone. Use a cleaner intended for use with the LCD. Never spray cleaner directly on the screen, as it may drip inside the monitor and cause an electric shock.

### The following symptoms are normal with the monitor:

- You may find slightly uneven brightness on the screen depending on the desktop pattern you use.
- When the same image is displayed for hours, an afterimage of the previous screen may remain after switching the image. The screen will recover slowly or you can turn off the Power Switch for hours.
- When the screen becomes black or flashes, or cannot work anymore, contact your dealer or service center to fix it. Do not repair the screen by yourself!

### Conventions used in this guide



**WARNING:** Information to prevent injury to yourself when trying to complete a task.



**CAUTION:** Information to prevent damage to the components when trying to complete a task.



**CAUTION:** Replacement of a battery with an incorrect type that can defeat a safeguard.



**CAUTION:** Disposal of a battery into fire or a hot oven, or mechanically crushing or cutting of a battery, that can result in an explosion.



**CAUTION:** Leaving a battery in an extremely high temperature surrounding environment that can result in an explosion or the leakage of flammable liquid or gas.



**CAUTION:** A battery subjected to extremely low air pressure that may result in an explosion or the leakage of flammable liquid or gas.



**CAUTION:** Risk of fire or explosion if the battery is replaced by an incorrect type.



**IMPORTANT:** Information that you **MUST** follow to complete a task.



NOTE: Tips and additional information to aid in completing a task.

## Where to find more information

Refer to the following sources for additional information and for product and software updates.

### 1. **ASUS websites**

The ASUS websites worldwide provide updated information on ASUS hardware and software products. Refer to **<http://www.asus.com>**

### 2. **Optional documentation**

Your product package may include optional documentation that may have been added by your dealer. These documents are not part of the standard package.

## Takeback services

ASUS recycling and takeback programs come from our commitment to the highest standards for protecting our environment. We believe in providing solutions for our customers to be able to responsibly recycle our products, batteries and other components as well as the packaging materials.

Please go to **<http://csr.asus.com/english/Takeback.htm>** for detail recycling information in different region.

## 1.1 Welcome!

Thank you for purchasing the ASUS® Portable Gaming Monitor!

The latest ASUS Portable Gaming Monitor provides great portability and simplicity to your daily life, enhancing both of your viewing experience and style.

## 1.2 Package contents

Check your package for the following items:

- ✓ Portable Gaming Monitor
- ✓ Quick Start Guide
- ✓ Warranty Card
- ✓ USB Type-C Cable
- ✓ Protective Sleeve
- ✓ USB Type-C to A Adapter
- ✓ Micro HDMI to HDMI cable
- ✓ Power Adapter
- ✓ ROG Tripod
- ✓ ROG Tripod Hole Cover
- ✓ Calibration Report





- 
- If any of the above items is damaged or missing, contact your retailer immediately.
-



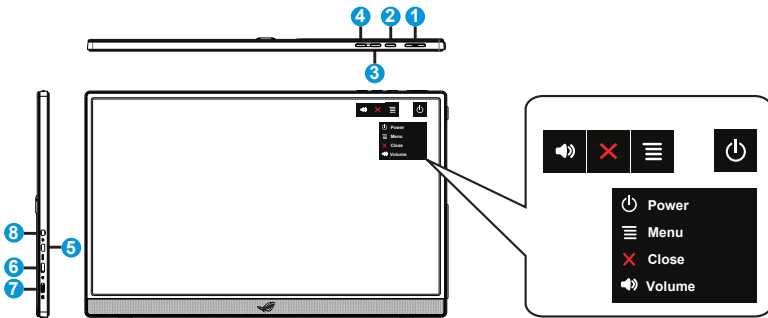

## 1.3 Monitor introduction

### 1.3.1 Front View and Charging Instructions



1.  Power button/Power LED
  - Press this button to turn the monitor on/off when connected to a valid source.
  - The color definition of the power indicator is as the below table.

Status	Description
Blue	ON/Standby mode
Dark	OFF
Red	Charging Mode
Green	Finished charging

2.  MENU Button:
  - Press this button to enter the OSD menu.
  - Long pressing the button allows you to have a quick check on battery % even the device is OFF.
  - When connect XG16 to a valid source, you can press this button to do “input select”.
3.  Close Button
  - Exit the OSD menu.
  - Key Lock shortcut key. Press and hold it for 5 seconds to enable/disable Keys Lock.
4.  Volume Button & Shortcut Button
  - Adjust the volume level.

- Default setting for shortcut is “Volume”, it can be changed to other functions by selecting under menu “My favorite”- “Shortcut”.
5. Micro-HDMI port
    - Connect your computer with Micro-HDMI cable.
  6. USB Type-C port
    - Used to connect to a valid source such as Notebook/PC/Mobile phone that supports USB Type C DP Alt Mode; signal input supports maximum to resolution 1920 x 1080 @144Hz.
    - Used to do battery charging; up to 9V@2A 18W power supply by inbox QC3.0 adapter or up to 12V@2A by certified PD3.0 power adapters on the market.
  7. USB Type-C port
    - Used to do battery charging; up to 9V@2A 18W power supply by inbox QC3.0 adapter or up to 12V@2A by certified PD3.0 power adapters on the market.
  8. Earphone - out Port



**IMPORTANT:**

- Charge the monitor for 4 hours before using it for the first time
- Use only bundled power adapter and USB cable to charge your monitor. Using different power adapter and cable might bring potential damage to your device.



**WARNING:** The adapter may become warm to hot while in use. DO NOT cover the adapter and keep it away from your body while it is connected to a power source. If your device become unusual hot, disconnect the USB cable from your device and send the device including the power adapter and USB cable to an ASUS qualified service personnel

## 2.1 Monitor standing positions

You can stand up the monitor by embedded kickstand in both landscape and portrait mode.

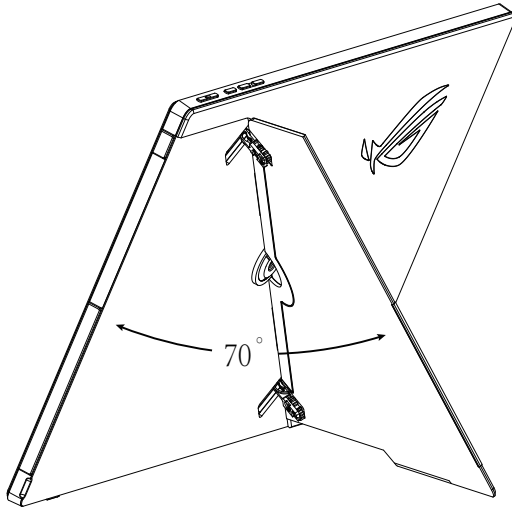

## 2.2 Connect the USB monitor with system

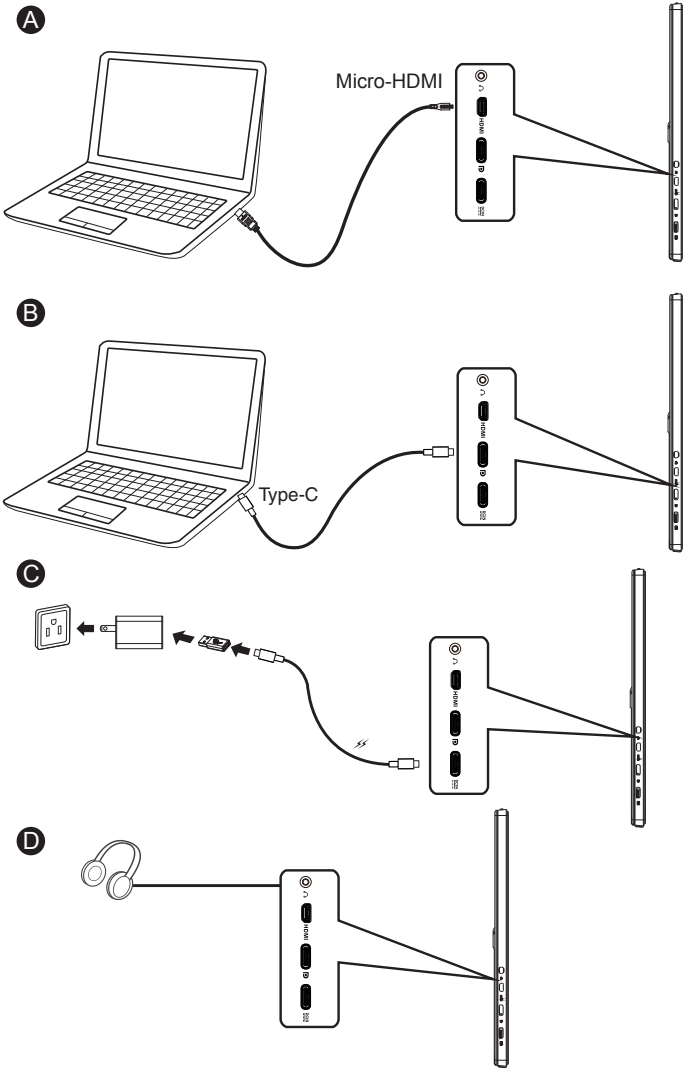

## 2.3 Assembling/Dis-assembling the ROG tripod

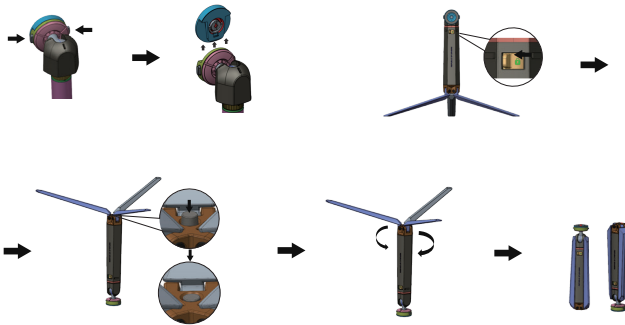
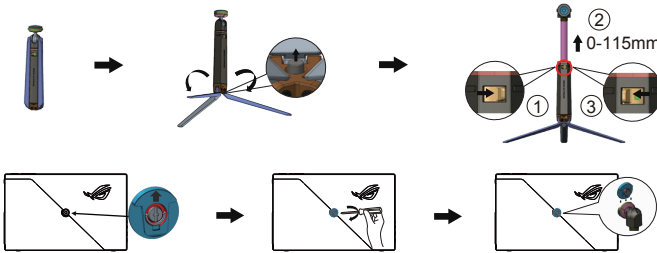

## 2.4 How to Adjust tilt strength of ROG Tripod

The tilt strength is adjustable according to personal habits.

Depends on the usage, the tilt strength could get loose as used frequency gets more , you can also follow below steps to do the adjustment.

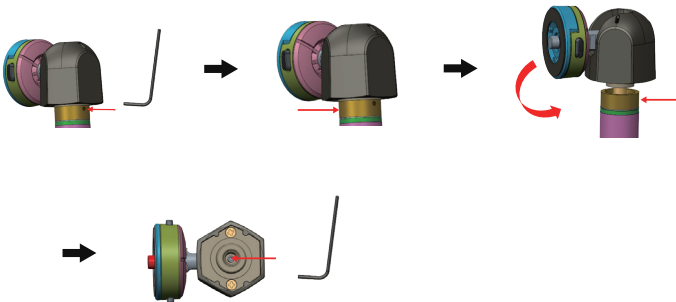

After adjusting the tilt strength by inbox Allen wrench, following below to assemble ball shaft back

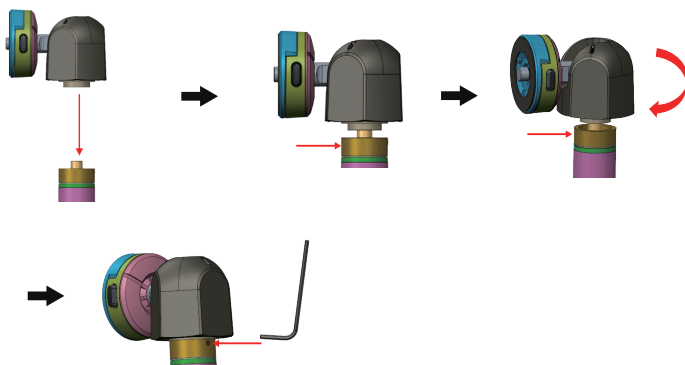

---

**NOTE:**

- ROG tripod supports tilt -5~90 degrees and swivel 360 degrees.
  - ROG tripod can be the stand for products that implement standard tripod hole.
  - When the ball shaft is removed, it becomes a standard tripod, a standard 1/4 thread is seen embedded.
  - ROG tripod can only support product that is within 1.5kg, please don't connect with product that is over this weight.
- 



---

**CAUTION:** ROG tripod doesn't support Pivot function, please don't turn the monitor in clockwise or counterclockwise when connecting with ROG tripod in case of any damage.

---

## 2.5 Announcements

As this product includes magnet in the structure, there could be potential risk to cause the damage of computer hard disc and objects that are sensitive to magnet.

Please ensure not to stack the product with the computer when computer is in use (power on or standby mode) otherwise the hard drive could possibly be influenced by the result of permanent data missing or the computer display could be switched off due to computer auto protection mechanism. When place this product together with computer in the bag, must have the computer power off to avoid possible hard drive damage problem.(Check Picture A)

The battery capacity will vary depending on the environment temperature, humidity, and monitor usage

The battery used in this device may present a risk of fire or chemical burn if removed or disassembled

Risk of explosion if the battery is placed by an incorrect type

Never attempt to short-circuit your monitor battery

Never attempt to disassemble and reassemble the monitor battery

Discontinue usage if leakage is found

The battery and its components must be recycled or disposed of properly

Keep the battery and other small components away from children

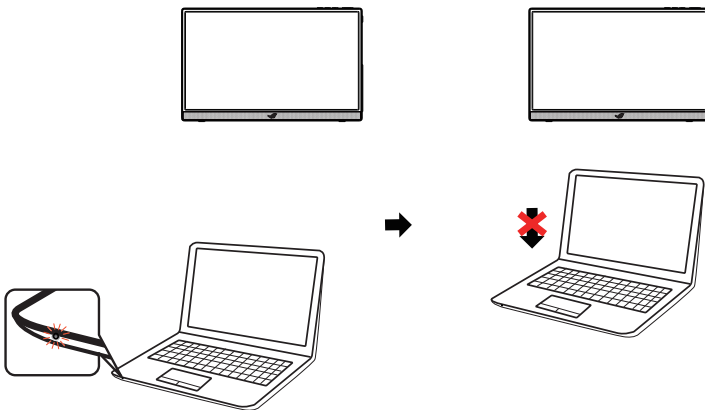

Picture A

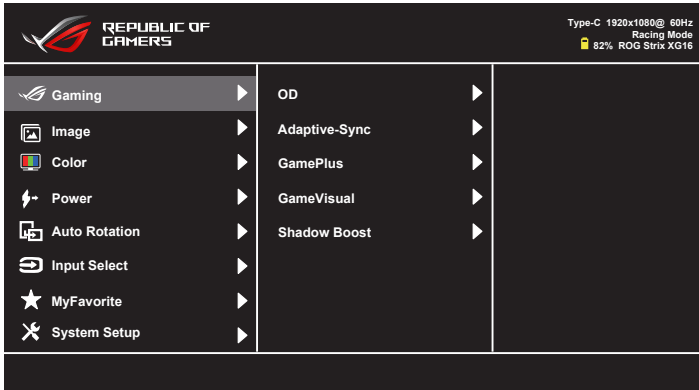

## 3.1 OSD (On-Screen Display) menu

### 3.1.1 How to reconfigure



1. Press the MENU button to activate the OSD menu.
2. Press the ▼ and ▲ buttons to toggle between options in the Menu. As you move from one icon to another, the option name is highlighted.
3. To select the highlighted item on the menu press the ✓ button.
4. Press the ▼ and ▲ buttons to select the desired parameter.
5. Press the ✓ button to enter the slide bar and then use the ▼ or ▲ buttons, according to the indicators on the menu, to make your changes.
6. Select the ↶ to return to previous menu or ✓ to accept and return to previous menu.



-  : Get power from source when this icon is shown
-  : Battery power
-  : Battery is being charged



## 3.1.2 OSD Function Introduction

### 1. Gaming

This function contains OD, Adaptive-Sync/G-Sync Compatible, GamePlus, GameVisual, Shadow Boost.

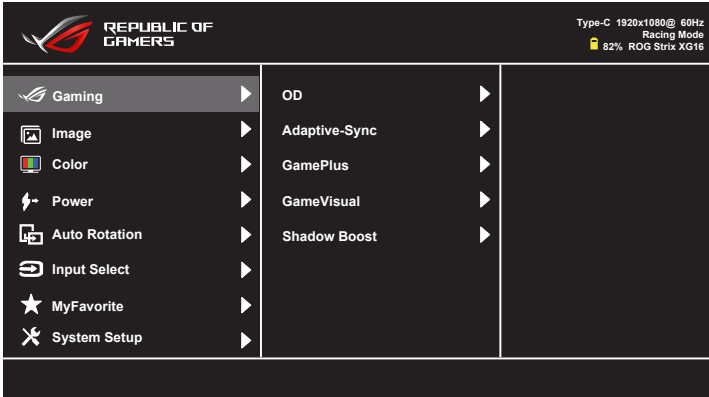

- **OD:** Speeds up the response time by Over Drive technology. Including Level 0~Level 5.
- **Adaptive-Sync (G-Sync Compatible via Type C port)/Variable Refresh Rate (HDMI port):** It can allow Adaptive-Sync supported graphics source to dynamically adjust display refresh rate (60-144Hz) based on typical content frame rates for power efficient, virtually stutter free and low-latency display update.
- **GamePlus:** The GamePlus Function provides a toolkit and creates a better gaming environment for users when playing different types of games. Particularly, Crosshair function is specially designed for new gamers or beginners interested in First Person Shooter (FPS) games. To active GamePlus:
  - Activate Crosshair, Timer or FPS Counter or Display Alignment function.

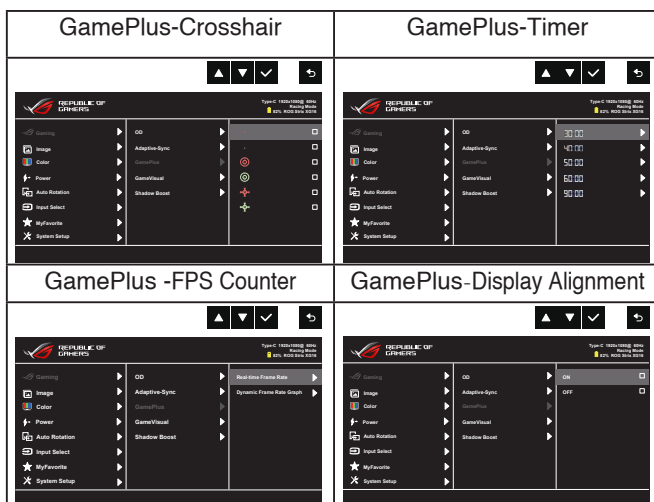

- **GameVisual:** This function contains eight sub-functions that you can select for your preference. Each mode has the Reset selection, allowing you to maintain your setting or return to the preset mode.
  - Scenery Mode: This is the best choice for scenery photo displaying with GameVisual™ Video Intelligence Technology.
  - Racing Mode: This is the best choice for racing game playing with GameVisual™ Video Intelligence Technology.
  - Cinema Mode: This is the best choice for movie watching with GameVisual™ Video Intelligence Technology.
  - RTS/RPG Mode: This is the best choice for Real-Time Strategy(RTS)/Role-Playing Game(RPG) playing with GameVisual™ Video Intelligence Technology.
  - FPS Mode: This is the best choice for First Person Shooter game playing with GameVisual™ Video Intelligence Technology.
  - sRGB Mode: This is the best choice for viewing photos and graphics from PCs.
  - MOBA Mode : This is the best choice for Multiplayer Online Battle Arena (MOBA) games playing with GameVisual™ Video intelligence Technology.
  - User Mode: More items are adjustable in the Color menu.



- In the Racing Mode, the Saturation, Sharpness, and ASCR functions are not user-configurable.
- In the sRGB, the Saturation, Color Temp., Sharpness, Brightness, Contrast and ASCR functions are not user-configurable.
- In the MOBA Mode, the Saturation, Sharpness and ASCR functions are not user-configurable.

- **Shadow Boost:** Dark color enhancement adjust monitor gamma curve to enrich the dark tones in an image making dark scenes and objects much easier be found.

## 2. Image

You can adjust Brightness, Contrast, Sharpness, VividPixel, ASCR, Aspect Control, and Blue Light Filter from this main function.

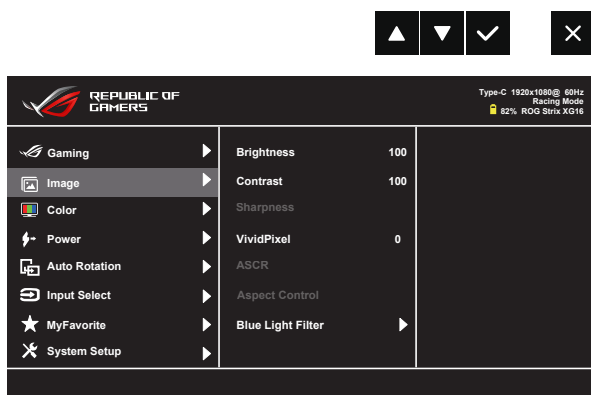

- **Brightness:** The adjusting range is from 0 to 100.
- **Contrast:** The adjusting range is from 0 to 100.
- **Sharpness:** Adjust the picture sharpness. The adjusting range is from 0 to 100.
- **VividPixel:** ASUS Exclusive Technology that brings lifelike visuals for crystal-clear and detail-oriented enjoyment. The adjusting range is from 0 to 100.
- **ASCR:** Select **ON** or **OFF** to enable or disable dynamic contrast ratio function.
- **Aspect Control:** Adjust the aspect ratio to “**Full**” and “**4:3**”.
- **Blue Light Filter:** Adjust the energy level of blue light emitted from LED backlight.



- Choose 4:3 to display the picture according to the original aspect ratio of the input source.



- When Blue Light Filter is activated, the default settings of Racing Mode will be automatically imported.
- Between Level 1 to Level 3, the Brightness function is user-configurable.
- Level 4 is optimized setting. It is compliance with TUV Low Blue Light Certification. The Brightness function is not user-configurable.



Please refer to the following to alleviate eye strains:

- Users should take some time away from the display if working for long hours. It is advised to take short breaks (at least 5 mins) after around 1 hour of continuous working at the computer. Taking short and frequent breaks is more effective than a single longer break.
- To minimize eye strain and dryness in your eyes, users should rest the eye periodically by focusing on objects that are far away.
- Eye exercises can help to reduce eye strain. Repeat these exercises often. If eye strain continues please consult a physician. Eye exercises: (1) Repeating look up and down (2) Slowly roll your eyes (3) Move your eyes diagonal.
- High energy blue light may lead to eye strain and AMD (Age-Related Macular Degeneration). Blue light filter to reduce 70% (max.) harmful blue light to avoiding CVS (Computer Vision Syndrome).

### 3. Color

Select the image color you like from this function.

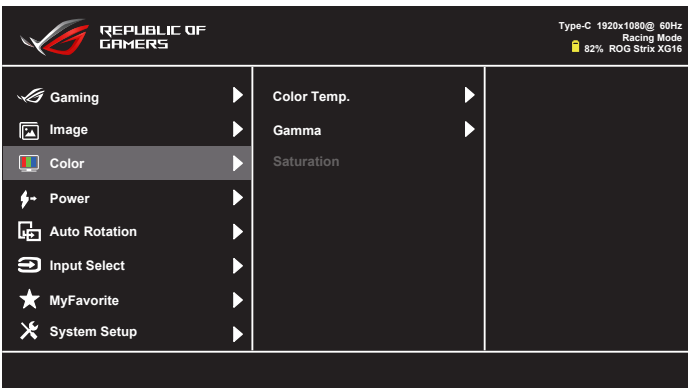

- **Color Temp.:** Contains three preset color modes (**Cool, Normal, Warm**) and **User Mode**.
- **Gamma:** Contains three gamma modes including 1.8, 2.2, 2.5
- **Saturation:** The adjusting range is from 0 to 100.



- In the User Mode, colors of R (Red), G (Green), and B (Blue) are user-configurable; the adjusting range is from 0 ~ 100.

#### 4. Power

You can adjust the Input Device Pop-up, Input Device and Standby Mode from this main function.

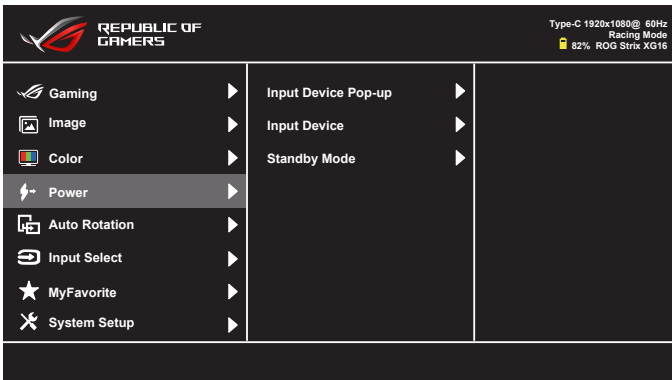

- **Input Device Pop-up :** To enable/disable Input Device & Power Supply from NB/PC pop-up questions WHENEVER in connection.
- **Input Device :** Select “Mobile Phone” if connect to mobile phone ( Power supply function is not provided under “Mobile Phone” due to common mobile devices cannot provide enough power output ). Select “NB/PC” if connect to NB/PC and then select “Charging From NB/PC” with charging function. This function allows you to sustain the working time for longer. In NB/PC sub-function, you can disable power supply function by selecting “No Charging From NB/PC”
  - \* No Charging here means getting power under 100mA, and this does not affect the battery life/usage of host devices connected.
  - \* Monitor battery power could still drop after turning on Charging from NB/PC or ECO Mode due to some of devices have limited power output.
- **Standby Mode:** Select ON for wake up during power saving; Select OFF to power off monitor after power saving 15 second.

## 5. Auto Rotation

Select the Auto Rotation on or off.

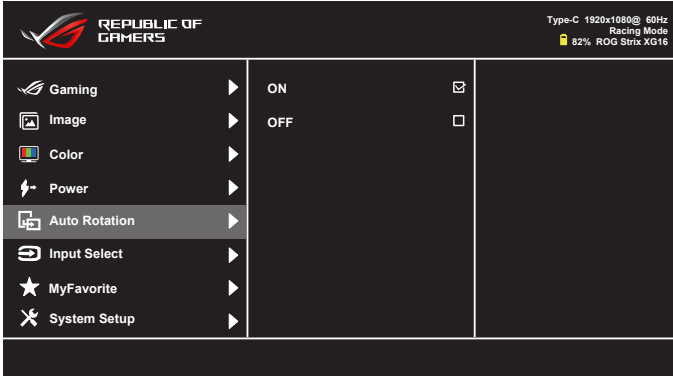

\* Auto rotation is supported by software DisplayWidget and only working under Windows OS, please go to [www.asus.com](http://www.asus.com) to download the latest DisplayWidget for this function.

## 6. Input Select

Select the input source:

- HDMI, Type-C and DP to Type-C.

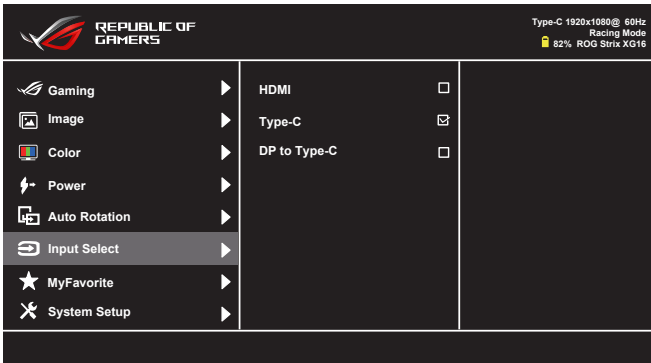

\*By using the connection of HDMI or DP to Type C , if PC/NB is shutdown or in sleeping mode, we suggest you to remove the cable, or the monitor power will be consumed continuously.

## 7. MyFavorite

You can adjust Shortcut and Customized Setting from this main function.

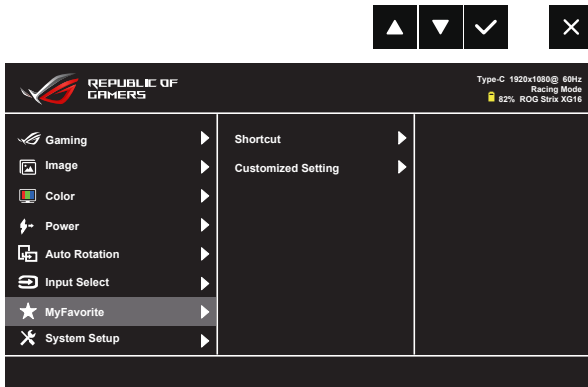

- **Shortcut** : User can select from “Blue Light Filter” “GameVisual”, “Brightness”, “Contrast”, “Auto Rotation”, “Input Select”, “Volume”, “GamePlus” and set as shortcut key. The default setting is Volume.
- **Customized Setting** : You can do your setting according to your favorite.

## 8. System Setup

Adjust the system configuration.

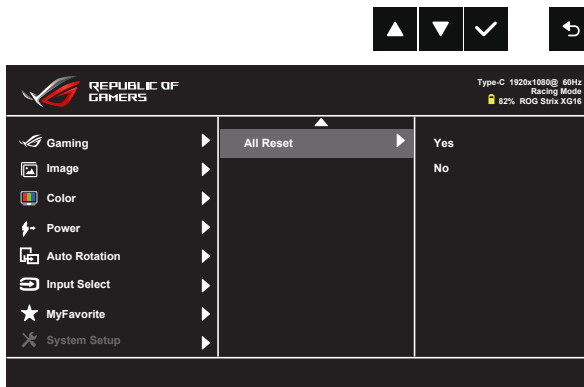
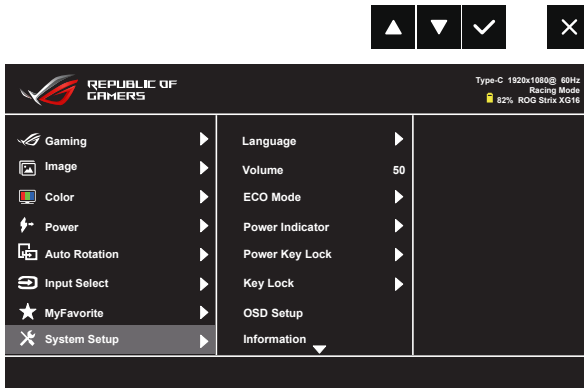

- **Language:** Select OSD language. The selections are: **English, French, German, Spanish, Italian, Dutch, Russian, Poland, Czech, Croatia, Hungary, Romania, Portugal, Turkey, Simplified Chinese, Traditional Chinese, Japanese, Korean, Persian, Thai, and Indonesian.**
- **Volume:** Selects “Volume” to adjust the output volume level.
- **ECO Mode:** Activate the ecology mode for power saving.
- **Power Indicator:** Turn the power LED indicator on/off.
- **Power Key Lock:** To disable / enable power key.
- **Key Lock:** Disable all key functions. Pressing down key (shortcut key) for more than five seconds to disable key lock function.



- **OSD Setup:** Adjust the **OSD Timeout**, **DDC/CI**, and **Transparency** of the OSD screen.
- **Information:** Displays the monitor information.
- **All Reset:** Selects “**Yes**” to revert all settings to the factory default mode.

## 3.2 Specifications

Model	XG16AHP/XG16AHP-W
Panel Size	15.6"(16:9) Wide Screen
Resolution	1920 x 1080
Brightness (Typ.)	300 nites
Contrast (Typ.)	800:1
Display Colors	16.7M
Digital Input	DisplayPort™ Alt Mode for USB Type-C™ HDMI via Micro HDMI
Earphone out	Yes
Power Consumption	≤ 10 W
Operating Temp.	0°C ~ 40°C
Operating Humidity	20-90% RH
Speaker	1W x 2
Phys. Dimension (WxHxD)	360.52x225.52x11.8 mm (w/o ROG Tripod) 360.52x(348.73~463.73)x282.45 mm (w/ ROG Tripod)
Box Dimension (WxHxD)	498 x 362 x 120 mm
Net Weight (Esti.)	0.9 kg
Gross Weight (Esti.)	3.6 kg(XG16AHP) 3.8 kg(XG16AHP-W)
Regulation Approvals	UL/cUL, CB, CE, CCC, KCC, FCC, BSMI, EAC(CU), RCM, VCCI, J-Moss, UkrSEPRO, RoHS, WEEE, Windows 7 & 8.1 & 10 WHQL, Blue light filter, Flicker free, BIS
Voltage Rating	5 - 9V ---, 2.0A QC3.0 charging spec is supported
Adapter	ASUS/AD2068M20 for AP/EU , AD2068320 for JP/NA/TW, AD2068520 for China 100-240V~50/60Hz 0.5A 5V ---,2A(Normal model) OR 9V ---, 2A(Quick charge model)

\*Specifications are subject to change without notice.

### 3.3 Troubleshooting (FAQ)

Problem	Possible Solution
Power LED is not ON	<ul style="list-style-type: none"><li>• Check if the Type-C and HDMI port connected to source of signal.</li><li>• Check if the signal source is ON.</li><li>• Connect to the ASUS adapter and check if the battery is low; if so, charge the battery before using it.</li><li>• Press the  button to check if the monitor is in the ON mode.</li><li>• Check Power Indicator function in main menu OSD. Select "ON" to turn on power LED.</li></ul>
The power LED lights blue and there is no screen image	<ul style="list-style-type: none"><li>• Check if the monitor and the computer are in the ON mode.</li><li>• Make sure the USB Type-C and HDMI cable is properly connected between the Portable Gaming Monitor and the computer.</li><li>• Inspect the signal cable and make sure none of the pins are bent.</li><li>• Connect the computer with another available monitor to check if the computer is properly working.</li></ul>
Screen image is too light or dark	<ul style="list-style-type: none"><li>• Adjust the Brightness settings via the button.</li></ul>
Screen image bounces or a wave pattern is present in the image	<ul style="list-style-type: none"><li>• Make sure the USB Type-C and HDMI cable is properly connected between the Portable Gaming Monitor and the computer.</li><li>• Move electrical devices that may cause electrical interference.</li></ul>
Screen image has color defects (white does not look white)	<ul style="list-style-type: none"><li>• Inspect the USB Type-C and HDMI cable and make sure that none of the pins are bent.</li></ul>
The monitor automatically turns off	<ul style="list-style-type: none"><li>• The monitor automatically turns off when the battery power is zero. Please connect to the ASUS adapter and check if the battery is low; if so, charge the battery before using it.</li><li>• Please check if the source of signal went into sleep mode. The monitor automatically turns off after the signal source slept for more than 15 seconds to save power consumption.</li></ul>

The signal source is shown in power supply mode	<ul style="list-style-type: none"> <li>The monitor will get a small amount of electricity from the signal source. This is normal.</li> </ul>
When there's no signal or power charging input, but LED light keep showing in green	<ul style="list-style-type: none"> <li>Please press both on/off button and menu key together for few seconds to allow the system to reset</li> </ul>
Mobile phone is no working after reset mobile phone.	<ul style="list-style-type: none"> <li>Disconnect XG16AHP/XG16AHP-W before reset mobile phone.</li> </ul>

### 3.4 Supported Timing List

#### PC Supported Primary Timing

Resolution	H(KHz)	V(Hz)	Pixel(MHz)
640x480, 60Hz	31.469	59.94	25.175
640x480, 67Hz	35	66.667	30.24
640x480,72Hz	37.861	72.809	31.5
640x480,75Hz	37.5	75	31.5
720x400, 70Hz	31.469	70.087	28.322
800x600,56Hz	35.156	56.25	36
800x600,60Hz	37.879	60.317	40
800x600,72Hz	48.077	72.188,	50
800x600,75Hz	46.875	75	49.5
832x624, 75Hz	35	66.667	30.24
1024x768,60Hz	48.363	60.004	65
1024x768,70Hz	56.476	70.069	75
1024x768,75Hz	60.023	75.029	78.75
1152x864,75Hz	67.5	75	108
1280x960,60Hz	60	60	108
1280x1024,60Hz	63.981	60.02	108
1280x1024,75Hz	79.976	75.025	135
1280x720, 60Hz	44.772	59.855	74.5
1280x800, 60Hz	49.702	59.81	83.5
1440x900,60Hz	55.935	59.887	106.5
1680x1050,60Hz	65.29	59.954	146.25
1920x1080, 50Hz	56.25	50	148.5
1920x1080, 60Hz	67.5	60	148.5
1920x1080, 75Hz	84.6434	74.90567	220.75
1920x1080, 100Hz	112.5	100	297
1920x1080, 120Hz	135	120	297
1920x1080, 144Hz	158.414	144	325.7