

2U 19in Steel Vertical Wall Mount Rack Bracket - Black

User Manual

Y10E031-B1

Introduction & Installation

1- Installation of M6 Cage Nuts provides an attachment point into the square opening to the M6 Mounting Screws. Note: Check your user manual to see how many cage nuts will be needed and where they need to be installed.

A- Insert one of the flanges of the cage nut through the square opening from the inside of the mounting rails and press it against the side of the square opening.

B- You may have to apply some slight compression to the sides so the remaining flange will be able to fit through the square opening. If the cage nut has been installed correctly, then both flanges will jut out through the square opening and will be noticeable on the outer surface of the mounting rail. Repeat steps 1a and 1b until all required cage nuts are installed.

2- Once the required cage nuts have been installed, you can use the included M6 Mounting Screws and M6 Washers to secure your equipment into the installed M6 Cage Nuts.

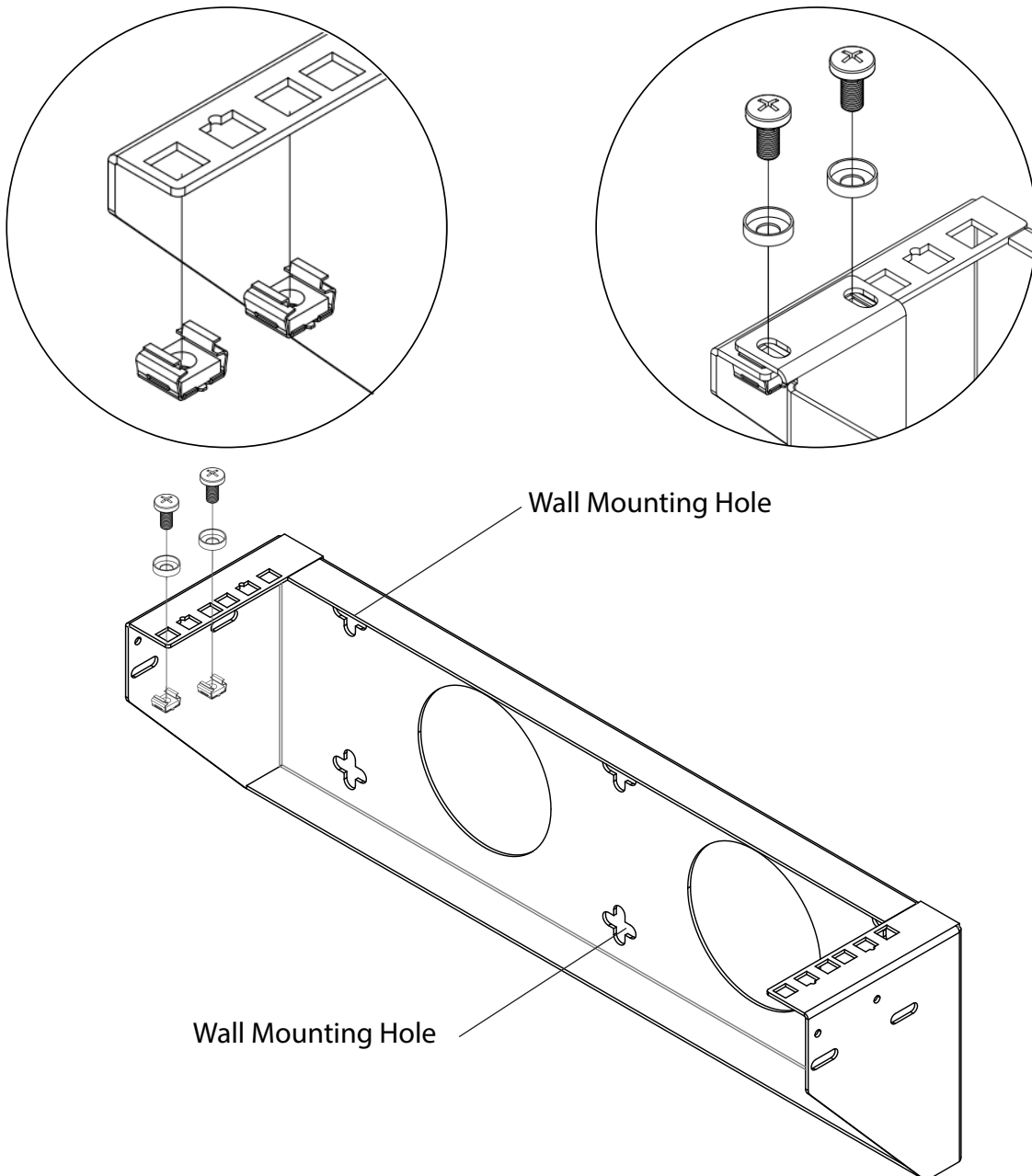

Measurements

Units Dimension (Millimeter):

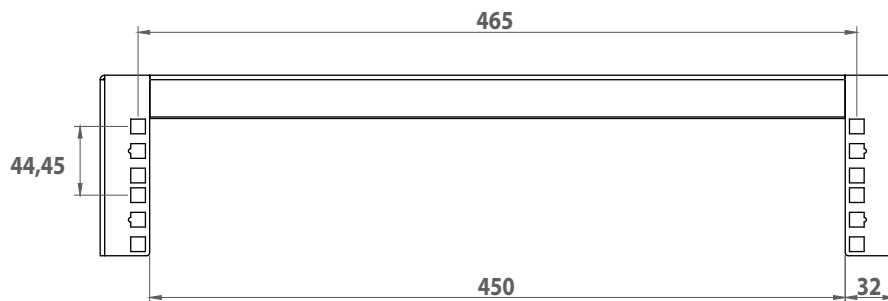
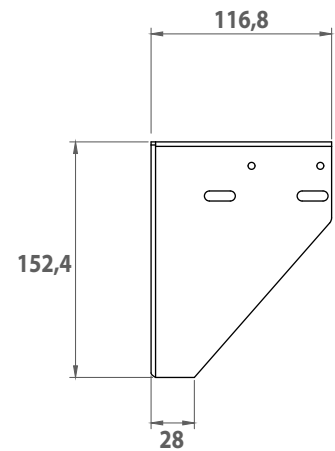
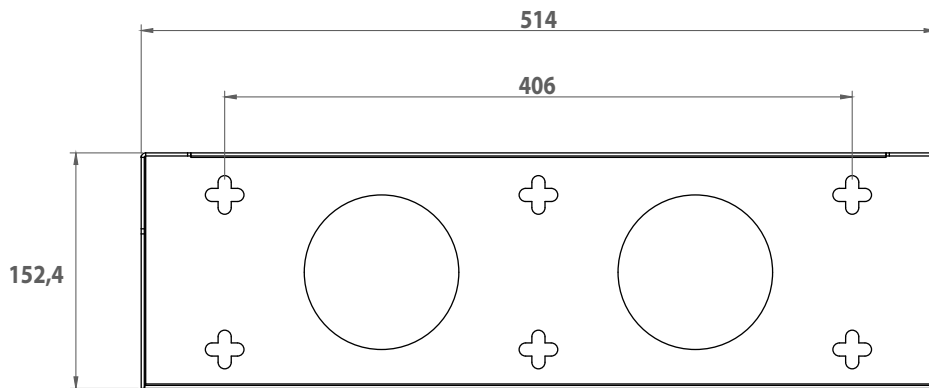

Package Content:

- M6 Cage Nut x 12
- M6 Plastic Washers x 12
- M6 Phillips Head Screw x 12
- Expansion Bolt x4

Five-Year Factory Warranty

Rocstor provides a Limited Factory Warranty which applies to products you have purchased for commercial or industrial use in the ordinary course of your business.

Terms of warranty

Rocstor warrants its SolidRack product series to be free from defects in materials and workmanship for a period of five years from the date of purchase. Rocstor's obligation under this warranty coverage is limited to repairing or replacing, at its sole discretion, any such defective products. This warranty does not apply to equipment that has been damaged by accident, negligence, or misapplication or has been altered or modified in any way. In the event Rocstor repairs or provide a replacement of a defective product or part, the warranty does not extend the original warranty period. Rocstor reserves the right to repair or replace any parts under warranty as new or factory re manufactured.

Non-transferable warranty

This warranty extends only to the original purchaser who must have properly registered the product. The product may be registered at the Rocstor Web site, [https://rocstor.com/customer-support/warranty registration](https://rocstor.com/customer-support/warranty-registration).

Exclusions

If Rocstor tests or examines the alleged defect in the product and finds that the damages or defects do not exist or were caused by a third party or an end user's misuse, improper installation or testing, or negligence, then Rocstor shall not be liable under the warranty. Furthermore, unauthorized attempts to repair or modify the product by wrong or inadequate electrical connection or voltage, inadequate or inappropriate site operation conditions, repair, installation corrosive area or atmosphere, a change in location or operating conditions or use, repair by non-Rocstor designated personnel, exposure to the elements, fire, Acts of God, theft, or equipment installation not recommended or contrary to Rocstor's specifications or recommendations. Warranties will be void and Rocstor will not be liable if the product serial number is tampered with, altered, removed, defaced or any other cause beyond the range of intended use.

Contact Information

Corporate Headquarters

12979 Arroyo Ave
San Fernando, CA 91340 - USA

Office: +1 (818) 727-7000
Fax: +1 (818) 875-0002
Email: info@Rocstor.com

Technical Support / RMA

Hours: 9:00 am - 5:00 pm PST
Mon - Fri (excluding holidays)

Tell: +1 (818) 727-7000 (Domestic and Internationals)
Fax: +1 (818) 875-0002
Email: support@Rocstor.com

Sales Info

Hours: 8:00 am - 5:00 pm PST
Mon - Fri (excluding holidays)

Tell: +1 (818) 727-7000 (Domestic and Internationals)
Fax: +1 (818) 875-0002
Email: support@Rocstor.com

Corporate, Government and Academic Customers

Our Corporate Sales Team's goal is to help our U.S.A. and Canadian customers find a storage solution that best serves their needs. We will help you determine your best purchasing options. For more information please contact the appropriate department below or call us at +1 (818) 727-7000.

General sales information:	sales@Rocstor.com
Corporate sales information:	corporate_sales@Rocstor.com
Educational sales information:	academic_sales@Rocstor.com
Federal, State & Local government sales information:	government_sales@Rocstor.com

Resellers/Business Development/OEM Partners

All Channel National and International Resellers, VARs, Consultants ...

contact Rocstor Channel Sales: call: +1 (818) 727-7000
Email: reseller_info@Rocstor.com