

2U 19in Wall Mount Bracket for Patch Panels - Hinged - Black

User Manual

Y10E035-B1

Introduction & Installation

Wall-Mount Bracket Installation

Warnings:

Rocstor recommends viewing your wall structure first before installing the bracket. You may want to consult or have a professional installer to mount the bracket to your wall structure. The bracket must be installed on a wall structure that is able to support the mounted equipment properly. The wall structure should be able to support at least four times the weight of the installed mounted equipment. Make sure the wall-mount bracket is securely installed before you mount any equipment. Failure to mount the bracket securely, it may result in personal and/or equipment damages.

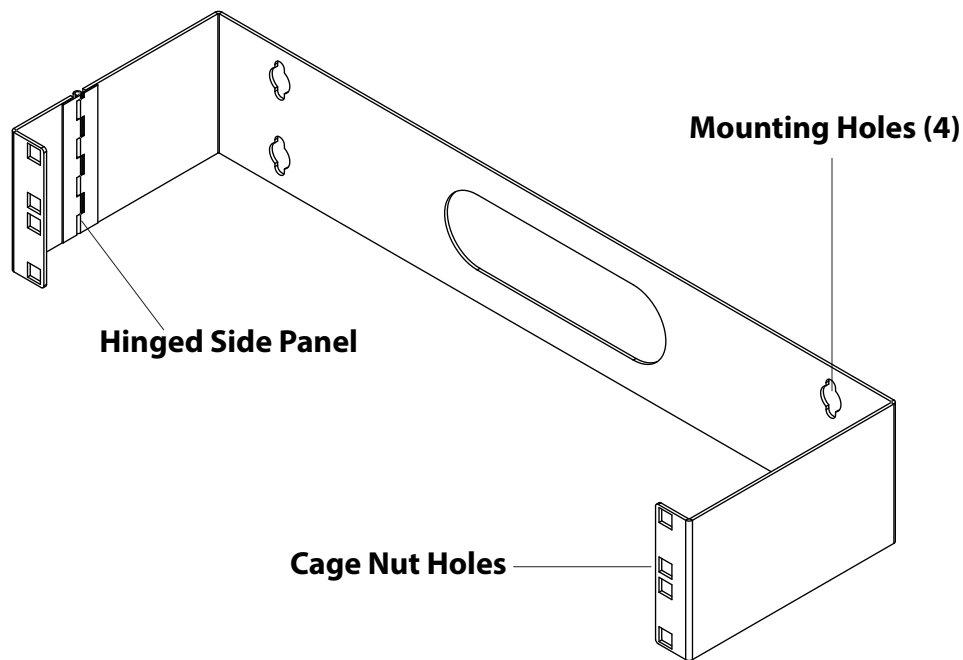

Equipment Installation to the Wall-Mount Bracket

Included in this mounting bracket, you will find M6 Cage Nuts, Screws, and Plastic Washers. Use these to install equipment into the Wall-Mount Bracket.

1. Use the Wing (side) of an M6 Cage and insert it into the back of the Cage Nut hole.
2. Use a Cage Nut Tool or hand to apply pressure to insert a 2nd Wing of the M6 Cage Nut into a designated Cage Nut Hole. Please repeat steps 1 and 2 by inserting the remainder of the Cage Nuts for your application.
3. Make sure you use the Threaded Plastic Washer over the M6 Screw.
4. At this time use the M6 Cage Nuts and align the Mounting Holes in the equipment and apply the Cage Nuts in step 2.
5. Now please insert the assembled Screws through the Mounting Holes in the Equipment and into the M6 Cage Nuts.
6. Make sure the Screws are Tightened by using a Phillips Screwdriver.

Measurements & Package Content

Units Dimension (Millimeter):

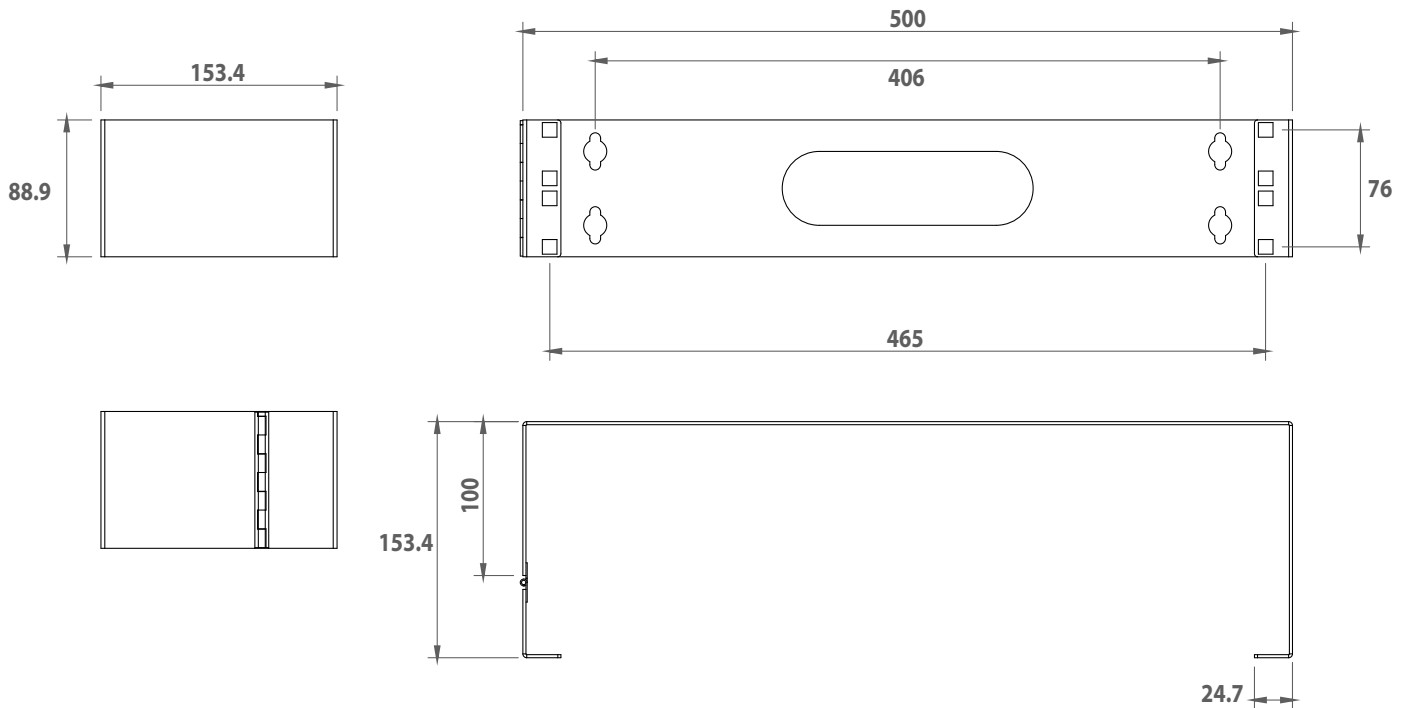

Package Contents

- 2U Wall-Mount Bracket x 1
- M6 Screws x 4
- M6 Cage Nuts x 4
- Plastic Washers x 4
- Wall Screws x 4
- Plastic Anchors x 4
- User Manual x 1

Five-Year Factory Warranty

Rocstor provides a Limited Factory Warranty which applies to products you have purchased for commercial or industrial use in the ordinary course of your business.

Terms of warranty

Rocstor warrants its SolidRack product series to be free from defects in materials and workmanship for a period of five years from the date of purchase. Rocstor's obligation under this warranty coverage is limited to repairing or replacing, at its sole discretion, any such defective products. This warranty does not apply to equipment that has been damaged by accident, negligence, or misapplication or has been altered or modified in any way. In the event Rocstor repairs or provide a replacement of a defective product or part, the warranty does not extend the original warranty period. Rocstor reserves the right to repair or replace any parts under warranty as new or factory re manufactured.

Non-transferable warranty

This warranty extends only to the original purchaser who must have properly registered the product. The product may be registered at the Rocstor Web site, [https://rocstor.com/customer-support/warranty registration](https://rocstor.com/customer-support/warranty-registration).

Exclusions

If Rocstor tests or examines the alleged defect in the product and finds that the damages or defects do not exist or were caused by a third party or an end user's misuse, improper installation or testing, or negligence, then Rocstor shall not be liable under the warranty. Furthermore, unauthorized attempts to repair or modify the product by wrong or inadequate electrical connection or voltage, inadequate or inappropriate site operation conditions, repair, installation corrosive area or atmosphere, a change in location or operating conditions or use, repair by non-Rocstor designated personnel, exposure to the elements, fire, Acts of God, theft, or equipment installation not recommended or contrary to Rocstor's specifications or recommendations. Warranties will be void and Rocstor will not be liable if the product serial number is tampered with, altered, removed, defaced or any other cause beyond the range of intended use.

Contact Information

Corporate Headquarters

12979 Arroyo Ave
San Fernando, CA 91340 - USA

Office: +1 (818) 727-7000
Fax: +1 (818) 875-0002
Email: info@Rocstor.com

Technical Support / RMA

Hours: 9:00 am - 5:00 pm PST
Mon - Fri (excluding holidays)

Tell: +1 (818) 727-7000 (Domestic and Internationals)
Fax: +1 (818) 875-0002
Email: support@Rocstor.com

Sales Info

Hours: 8:00 am - 5:00 pm PST
Mon - Fri (excluding holidays)

Tell: +1 (818) 727-7000 (Domestic and Internationals)
Fax: +1 (818) 875-0002
Email: support@Rocstor.com

Corporate, Government and Academic Customers

Our Corporate Sales Team's goal is to help our U.S.A. and Canadian customers find a storage solution that best serves their needs. We will help you determine your best purchasing options. For more information please contact the appropriate department below or call us at +1 (818) 727-7000.

General sales information:	sales@Rocstor.com
Corporate sales information:	corporate_sales@Rocstor.com
Educational sales information:	academic_sales@Rocstor.com
Federal, State & Local government sales information:	government_sales@Rocstor.com

Resellers/Business Development/OEM Partners

All Channel National and International Resellers, VARs, Consultants ...

contact Rocstor Channel Sales: call: +1 (818) 727-7000
Email: reseller_info@Rocstor.com