

Latitude 5340/Latitude 5340 2-in-1

Owner's Manual

Notes, cautions, and warnings

 **NOTE:** A NOTE indicates important information that helps you make better use of your product.

 **CAUTION:** A CAUTION indicates either potential damage to hardware or loss of data and tells you how to avoid the problem.

 **WARNING:** A WARNING indicates a potential for property damage, personal injury, or death.

Chapter 1: Views of Latitude 5340/Latitude 5340 2-in-1	7
Right	7
Left	8
Top	9
Front	10
Bottom	11
Service Tag	11
Modes	12
Battery charge and status light	14
Chapter 2: Set up your Latitude 5340/Latitude 5340 2-in-1	15
Chapter 3: Specifications of Latitude 5340/Latitude 5340 2-in-1	17
Dimensions and weight	17
Processor	17
Chipset	18
Operating system	18
Memory	19
External ports	19
Internal slots	20
Wireless module	20
WWAN module	20
Audio	22
Storage	22
Keyboard	23
Keyboard function keys	23
Camera	24
Touchpad	25
Power adapter	25
Battery	26
Display	27
Fingerprint reader (optional)	28
Sensor	29
GPU—Integrated	29
Hardware security	29
Smart-card reader	30
Contactless smart-card reader	30
Contacted smart-card reader	31
Operating and storage environment	32
Dell Support policy	32
ComfortView Plus	33
Using the privacy shutter	33
Dell Optimizer	34

Chapter 4: Working inside your computer.....	35
Safety instructions.....	35
Before working inside your computer.....	35
Safety precautions.....	36
Electrostatic discharge—ESD protection.....	36
ESD field service kit	37
Transporting sensitive components.....	38
After working inside your computer.....	38
BitLocker.....	38
Recommended tools.....	38
Screw list.....	39
Major components of Latitude 5340/Latitude 5340 2-in-1.....	40
Chapter 5: Removing and installing Customer Replaceable Units (CRUs).....	43
SIM card tray.....	43
Removing the SIM card tray.....	43
Installing the SIM card tray.....	44
Base cover.....	45
Removing the base cover.....	45
Installing the base cover.....	48
WLAN card.....	50
Removing the WLAN card.....	50
Installing the WLAN card.....	51
WWAN card.....	52
Removing the WWAN 5G card.....	52
Installing the WWAN 5G card.....	53
Removing the WWAN 4G card.....	55
Installing the WWAN 4G card.....	56
M.2 solid-state drive.....	57
Removing the M.2 2230 solid-state drive.....	57
Installing the M.2 2230 solid-state drive.....	58
Fan.....	60
Removing the fan.....	60
Installing the fan.....	61
Chapter 6: Removing and installing Field Replaceable Units (FRUs).....	63
Battery.....	63
Removing the battery.....	63
Installing the battery.....	64
Battery cable.....	65
Removing the battery cable.....	65
Installing the battery cable.....	66
Coin-cell battery.....	67
Removing the coin-cell battery.....	67
Installing the coin-cell battery.....	68
Heat sink.....	69
Removing the heat sink.....	69
Installing the heat sink.....	70

System board.....	72
Removing the system board.....	72
Installing the system board.....	74
Speakers.....	76
Removing the speakers.....	76
Installing the speakers.....	77
Power-button board.....	79
Removing the power button.....	79
Installing the power button.....	80
Removing the power button with fingerprint reader.....	80
Installing the power button with fingerprint reader.....	81
Keyboard assembly.....	82
Removing the keyboard assembly.....	82
Installing the keyboard assembly.....	84
Display assembly.....	87
Removing the display assembly (laptop).....	87
Installing the display assembly (laptop).....	88
Display bezel.....	91
Removing the display bezel (laptop).....	91
Installing the display bezel.....	92
Display hinges.....	93
Removing the display hinges (laptop).....	93
Installing the display hinges (laptop).....	94
Display panel.....	95
Removing the display panel (laptop).....	95
Installing the display panel (laptop).....	98
eDP cable.....	100
Removing the eDP cable (laptop).....	100
Installing the eDP cable (laptop).....	101
Camera.....	102
Removing the camera (laptop).....	102
Installing the camera (laptop).....	103
Display back cover.....	105
Removing the display back cover (laptop).....	105
Installing the display back-cover (laptop).....	106
Sensor board.....	107
Removing the sensor board (laptop).....	107
Installing the sensor board (laptop).....	107
Smart card reader.....	108
Removing the smart card reader (optional).....	108
Installing the smart card reader (optional).....	109
SIM card slot filler.....	110
Removing the SIM-card slot filler.....	110
Installing the SIM-card slot filler.....	111
Palm-rest assembly.....	112
Removing the palm-rest.....	112
Installing the palm-rest.....	113
Chapter 7: Software.....	115
Operating system.....	115

Drivers and downloads.....	115
Chapter 8: BIOS setup.....	116
Entering BIOS setup program.....	116
Navigation keys.....	116
One Time Boot menu.....	116
System setup options.....	117
Updating the BIOS.....	126
Updating the BIOS in Windows.....	126
Updating the BIOS using the USB drive in Windows.....	126
Updating the BIOS in Linux and Ubuntu.....	126
Updating the BIOS from the F12 One Time Boot menu.....	127
System and setup password.....	127
Assigning a system setup password.....	128
Deleting or changing an existing system setup password.....	128
Clearing CMOS settings.....	128
Clearing BIOS (System Setup) and System passwords.....	129
Chapter 9: Troubleshooting.....	130
Handling swollen rechargeable Li-ion batteries.....	130
Locate the Service Tag or Express Service Code of your Dell computer	130
Dell SupportAssist Pre-boot System Performance Check diagnostics.....	131
Running the SupportAssist Pre-Boot System Performance Check.....	131
Built-in self-test (BIST).....	131
M-BIST.....	131
LCD Power rail test (L-BIST).....	132
LCD Built-in Self Test (BIST).....	132
System-diagnostic lights.....	133
Recovering the operating system.....	134
Recovering the operating system.....	135
Real-Time Clock (RTC Reset).....	135
Backup media and recovery options.....	135
Wi-Fi power cycle.....	135
Drain residual flea power (perform hard reset).....	136
Chapter 10: Getting help and contacting Dell.....	137

Views of Latitude 5340/Latitude 5340 2-in-1

Right

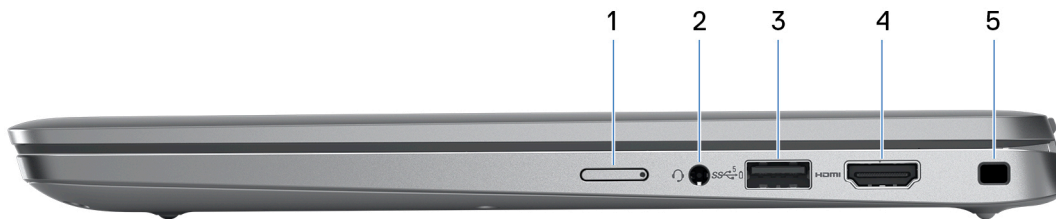

1. Nano-SIM card slot (optional)

Insert a nano-SIM card to connect to a mobile broadband network.

NOTE: Availability of the nano-SIM card slot depends on the region and configuration ordered.

2. Universal audio jack

Connect headphones or a headset (headphone and microphone combo).

3. USB 3.2 Gen 1 Type-C port with PowerShare

Connect devices such as an external storage device, printer, Type-C docking station or an external display.

Provides data transfer speeds up to 5 Gbps. Supports Power Delivery that enables two-way power supply between devices. Provides up to 15 W power output that enables faster charging.

NOTE: If the charge on your computer's battery is less than 10 percent, you must connect the power adapter to charge your computer, and USB devices connected to the PowerShare port. PowerShare enables you to charge your USB devices even when your computer is turned off.

NOTE: Your computer supports USB Type-C charging. If you need an additional power adapter, search for a compatible 45 W Dell USB-C power adapter at www.dell.com.

NOTE: To expand the number of ports and connectors on your computer, connect it to a USB Type-C docking station. Search for a compatible USB Type-C docking station at www.dell.com.

4. HDMI 2.0 port

Connect to a TV, external display or another HDMI-in enabled device. Provides video and audio output.

5. Security-cable slot (wedge-shaped)

Connect a security cable to prevent unauthorized movement of your computer.

Left

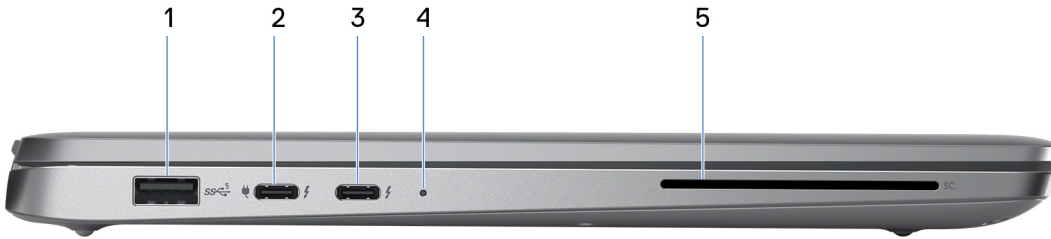

1. USB 3.2 Gen 1 port

Connect devices such as external storage devices and printers. Provides data transfer speeds up to 5 Gbps.

2. Thunderbolt 4.0 with DisplayPort Alt Mode/USB Type-C/USB4/Power Delivery

Supports USB4, DisplayPort 1.4, Thunderbolt 4 and also enables you to connect to an external display using a display adapter. Provides data transfer rates of up to 40 Gbps for USB4 and Thunderbolt 4.

NOTE: You can connect a Dell Docking Station to the Thunderbolt 4 ports. For more information, search in the Knowledge Base Resource at www.dell.com/support.

NOTE: A USB Type-C to DisplayPort adapter (sold separately) is required to connect a DisplayPort device.

NOTE: USB4 is backward compatible with USB 3.2, USB 2.0, and Thunderbolt 3.

NOTE: Thunderbolt 4 supports two 4K displays or one 8K display.

3. Thunderbolt 4.0 with DisplayPort Alt Mode/USB Type-C/USB4/Power Delivery

Supports USB4, DisplayPort 1.4, Thunderbolt 4 and also enables you to connect to an external display using a display adapter. Provides data transfer rates of up to 40 Gbps for USB4 and Thunderbolt 4.

NOTE: You can connect a Dell Docking Station to the Thunderbolt 4 ports. For more information, search in the Knowledge Base Resource at www.dell.com/support.

NOTE: A USB Type-C to DisplayPort adapter (sold separately) is required to connect a DisplayPort device.

NOTE: USB4 is backward compatible with USB 3.2, USB 2.0, and Thunderbolt 3.

NOTE: Thunderbolt 4 supports two 4K displays or one 8K display.

4. Power and battery-status light

Indicates the power state and battery state of the computer.

Solid white—Power adapter is connected and the battery is charging.

Solid amber—Battery charge is low or critical.

Off—Battery is fully charged.

NOTE: On certain computer models, the power and battery-status light are also used for diagnostics. For more information, see the *Troubleshooting* section in your computer's *Service Manual*.

5. Smart card reader (optional)

Provides authentication in a corporate networks using a smart card.

Top

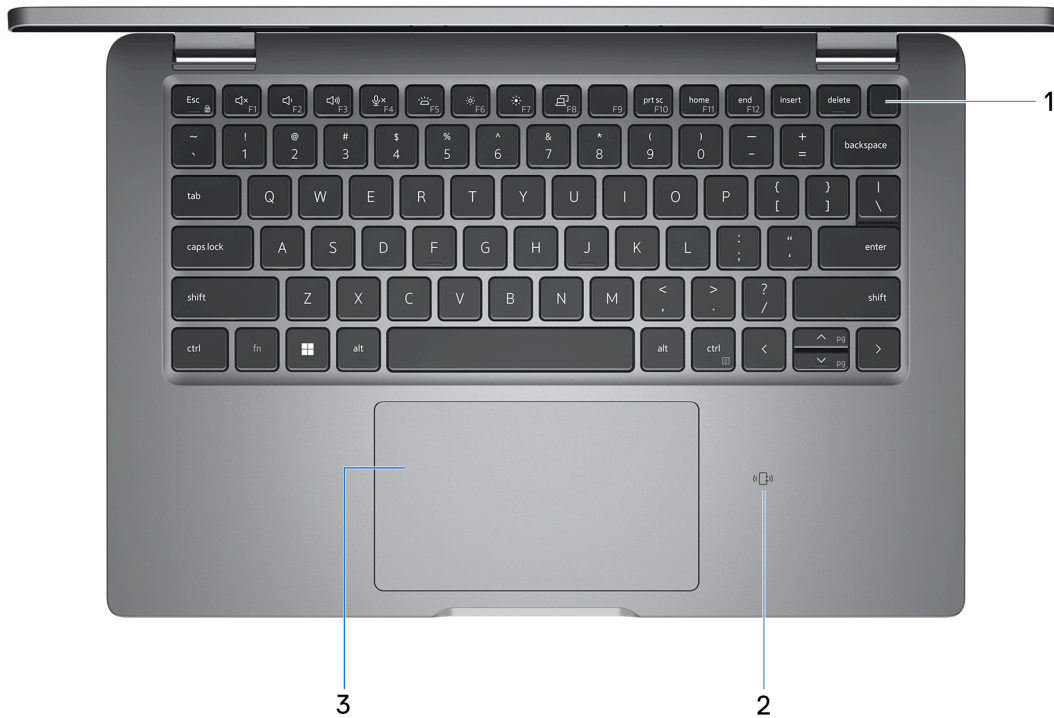

1. Power button with optional fingerprint reader

Press to turn on the computer if it is turned off, in sleep state, or in hibernate state.

When the computer is turned on, press the power button to put the computer into sleep state; press and hold the power button for 10 seconds to force shut-down the computer.

If the power button has a fingerprint reader, place your finger on the power button steadily to log in.

NOTE: The power-status light on the power button is available only on computers without the fingerprint reader. Computers that are shipped with the fingerprint reader that is integrated on the power button will not have the power-status light on the power button.

NOTE: You can customize the power-button behavior in Windows.

2. NFC/Contactless smart card reader (optional)

Provides contactless access of cards in corporate networks.

3. Touchpad

Move your finger on the touchpad to move the mouse pointer. Tap to left-click and two fingers tap to right-click.

Front



1. Left microphone

Provides digital sound input for audio recording and voice calls.

2. Infrared emitter (optional)

Emits infrared light, which enables the infrared camera to sense and track motion.

3. Infrared camera (optional)

Enhances security when paired with Windows Hello face authentication.

4. Camera shutter

Slide the privacy shutter to the left to access the camera lens.

5. Camera

Enables you to video chat, capture photos, and record videos.

6. Camera-status light

Turns on when the camera is in use.

7. Ambient-light sensor

The sensor detects the ambient light and automatically adjusts the display brightness.

8. Right microphone

Provides digital sound input for audio recording and voice calls.

Bottom

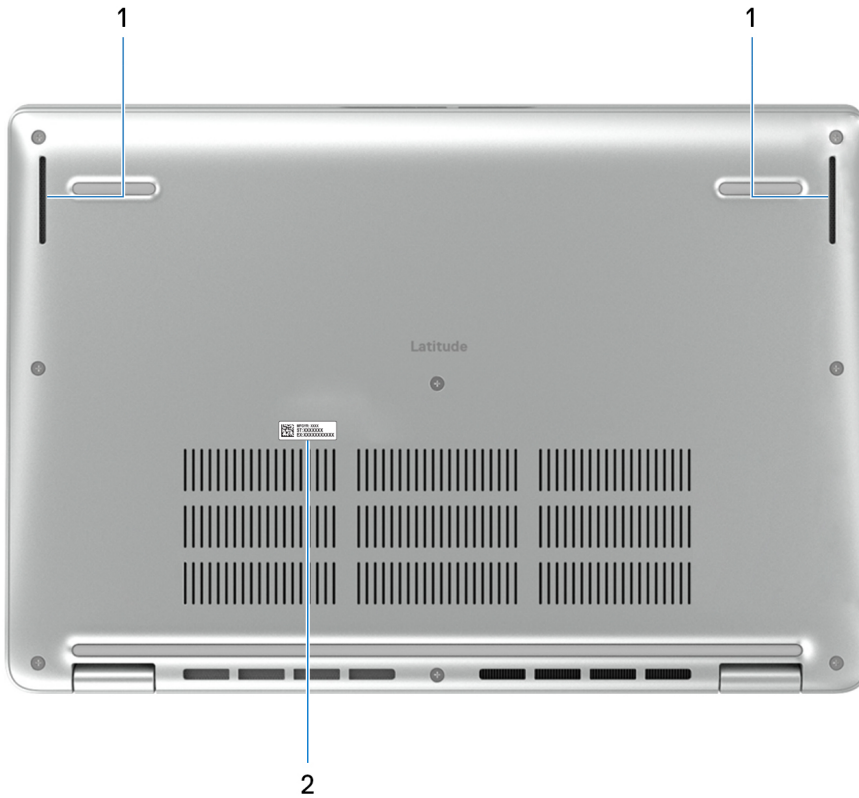

1. Speakers

Provide audio output.

2. Service Tag label

The Service Tag is a unique alphanumeric identifier that enables Dell service technicians to identify the hardware components in your computer and access warranty information.

Service Tag

The service tag is a unique alphanumeric identifier that allows Dell service technicians to identify the hardware components in your computer and access warranty information.

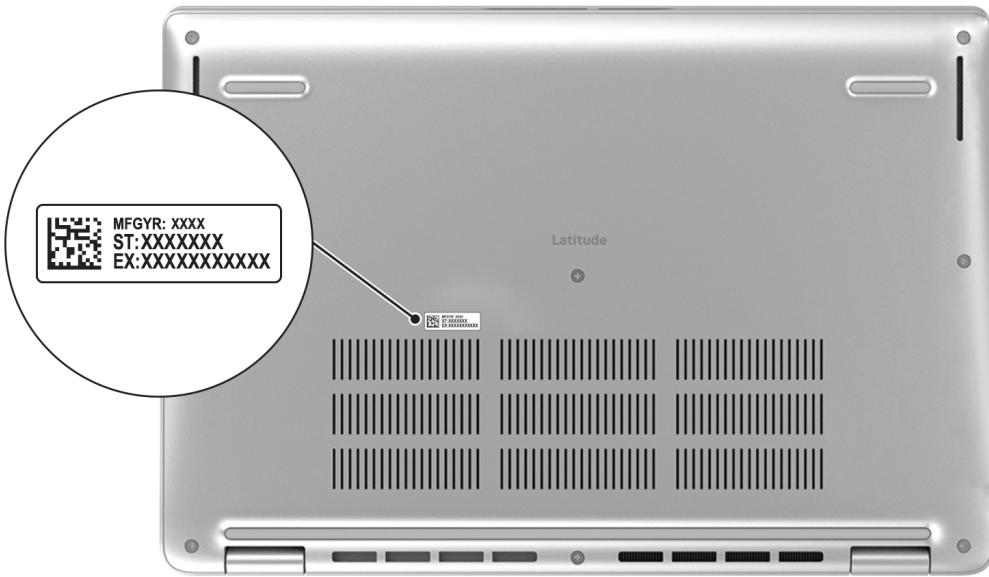

Modes

The following modes are applicable for your 2-in-1 computers.

Notebook



Tablet



Stand



Tent



Battery charge and status light

The following table lists the battery charge and status light behavior of your Latitude 5340/Latitude 5340 2-in-1.

Table 1. Battery charge and status light behavior

Power Source	LED Behavior	System Power State	Battery Charge Level
AC Adapter	Off	S0 - S5	Fully Charged
AC Adapter	Solid White	S0 - S5	< Fully Charged
Battery	Off	S0 - S5	11-100%
Battery	Solid Amber (590+/-3 nm)	S0 - S5	< 10%

- S0 (ON) - System is turned on.
- S4 (Hibernate) - The system consumes the least power compared to all other sleep states. The system is almost at an OFF state, expect for a trickle power. The context data is written to hard drive.
- S5 (OFF) - The system is in a shutdown state.

Set up your Latitude 5340/Latitude 5340 2-in-1

About this task

NOTE: The images in this document may differ from your computer depending on the configuration you ordered.

Steps

1. Connect the power adapter and press the power button.



NOTE: To conserve battery power, the battery might enter power saving mode. Connect the power adapter and press the power button to turn on the computer.

2. Finish operating system setup.

For Ubuntu:

Follow the on-screen instructions to complete the setup. For more information about installing and configuring Ubuntu, search in the Knowledge Base Resource at www.dell.com/support.

For Windows:

Follow the on-screen instructions to complete the setup. When setting up, Dell recommends that you:





- Connect to a network for Windows updates.

NOTE: If connecting to a secured wireless network, enter the password for the wireless network access when prompted.

- If connected to the internet, sign-in with or create a Microsoft account. If not connected to the internet, create an offline account.
- On the **Support and Protection** screen, enter your contact details.

3. Locate and use Dell apps from the Windows Start menu—Recommended.

Table 2. Locate Dell apps

Resources	Description
	<p>Dell Product Registration Register your computer with Dell.</p>
	<p>Dell Help & Support Access help and support for your computer.</p>
	<p>SupportAssist SupportAssist is the smart technology that keeps your computer running at its best by optimizing settings, detecting issues, removing viruses and notifies when you need to make system updates. SupportAssist proactively checks the health of your system's hardware and software. When an issue is detected, the necessary system state information is sent to Dell to begin troubleshooting. SupportAssist is preinstalled on most of the Dell devices running Windows operating system. For more information, see SupportAssist for Home PCs User's Guide on www.dell.com/serviceabilitytools.</p> <p>NOTE: In SupportAssist, click the warranty expiry date to renew or upgrade your warranty.</p>
	<p>Dell Update Updates your computer with critical fixes and latest device drivers as they become available. For more information on using Dell Update, search in the Knowledge Base Resource at www.dell.com/support.</p>
	<p>Dell Digital Delivery Download software applications, which are purchased but not preinstalled on your computer. For more information on using Dell Digital Delivery, search in the Knowledge Base Resource at www.dell.com/support.</p>

Specifications of Latitude 5340/Latitude 5340 2-in-1

Dimensions and weight

The following table lists the height, width, depth, and weight of your Latitude 5340/Latitude 5340 2-in-1.

Table 3. Dimensions and weight

Description	Values
Height:	
Front height	16.79 mm (0.66 in.)
Rear height	18.44 mm (0.73 in.)
Width	305.70 mm (12.04 in.)
Depth	207.50 mm (8.17 in.)
Weight	<ul style="list-style-type: none"> Laptop: 1.23 kg (2.71 lb) 2-in-1: 1.35 kg (2.97 lb)
<p>NOTE: The weight of your computer depends on the configuration ordered and manufacturing variability.</p>	

Processor

The following table lists the details of the processors supported by your Latitude 5340/Latitude 5340 2-in-1.

Table 4. Processor

Description	Option one	Option two	Option three	Option four
Processor type	13 th Generation Intel Core i3-1315U	13 th Generation Intel Core i5-1335U	13 th Generation Intel Core i5-1345U vPro	13 th Generation Intel Core i7-1365U vPro
Processor wattage	15 W	15 W	15 W	15 W
Processor total core count	6	10	10	10
Performance-cores	2	2	2	2
Efficient-cores	4	8	8	8
Processor total thread counts	8	12	12	12
<p>NOTE: Intel Hyper-Threading Technology is only available on Performance-cores.</p>				

Table 4. Processor (continued)

Description	Option one	Option two	Option three	Option four
Processor speed	Up to 4.50 GHz	Up to 4.60 GHz	Up to 4.70 GHz	Up to 5.20 GHz
Performance-cores frequency				
Processor base frequency	1.20 GHz	1.30 GHz	1.60 GHz	1.80 GHz
Maximum turbo frequency	4.50 GHz	4.60 GHz	4.70 GHz	5.20 GHz
Efficient-cores frequency				
Processor base frequency	0.9 GHz	0.9 GHz	1.20 GHz	1.30 GHz
Maximum turbo frequency	3.30 GHz	3.40 GHz	3.50 GHz	3.90 GHz
Processor cache	10 MB	12 MB	12 MB	12 MB
Integrated graphics	Intel UHD Graphics	Intel Iris Xe Graphics	Intel Iris Xe Graphics	Intel Iris Xe Graphics

Chipset

The following table lists the details of the chipset supported by your Latitude 5340/Latitude 5340 2-in-1.

Table 5. Chipset

Description	Values
Chipset	Integrated in the processor
Processor	13 th Generation Intel Core i3/i5/i7 processors
DRAM bus width	64-bit (for dual-channel)
Flash EPROM	<ul style="list-style-type: none"> vPro: 16 MB + 32 MB Non-vPro: 32 MB
PCIe bus	Up to Gen 4.0

Operating system

Your Latitude 5340/Latitude 5340 2-in-1 supports the following operating systems:

- Windows 11 Home
- Windows 11 Pro
- Windows 11 Pro Downgrade (Windows 10 Pro Image-factory installed + Windows 11 Pro DPK)
- Ubuntu Linux 22.04 LTS (applicable only for Latitude 5340 laptop and not for the 2-in-1 configuration)

Memory

The following table lists the memory specifications of your Latitude 5340/Latitude 5340 2-in-1.

Table 6. Memory specifications

Description	Values
Memory slots	Dual-channel on-board memory  NOTE: Memory cannot be upgraded
Memory type	LPDDR5
Memory speed	4800 MT/s
Maximum memory configuration	32 GB
Minimum memory configuration	8 GB
Memory size per slot	8 GB, 16 GB, or 32 GB
Memory configurations supported	<ul style="list-style-type: none"> • 8 GB, LPDDR5, 4800 MT/s, dual-channel • 16 GB, LPDDR5, 4800 MT/s, dual-channel • 32 GB, LPDDR5, 4800 MT/s, dual-channel

External ports

The following table lists the external ports on your Latitude 5340/Latitude 5340 2-in-1.

Table 7. External ports

Description	Values
USB ports	<ul style="list-style-type: none"> • One USB 3.2 Gen 1 port • One USB 3.2 Gen 1 port with PowerShare • Two Thunderbolt 4 port with DisplayPort Alt Mode/USB Type-C/USB4/Power Delivery  NOTE: You can connect a Dell Docking Station to this port. For more information, search in the Knowledge Base Resource at www.dell.com/support .
Audio port	One Universal audio jack
Video port/ports	One HDMI 2.0 port
Media-card reader	Not supported
Power-adaptor port	USB Type-C power input
Security-cable slot	One security-cable slot (wedge-shaped)

Internal slots

The following table lists the internal slots of your Latitude 5340/Latitude 5340 2-in-1.

Table 8. Internal slots

Description	Values
M.2	<ul style="list-style-type: none"> One M.2 2230 slot for WiFi and Bluetooth card One M.2 2230 slot for solid-state drive <p>NOTE: To learn more about the features of different types of M.2 cards, search in the Knowledge Base Resource at www.dell.com/support.</p>

Wireless module

The following table lists the Wireless Local Area Network (WLAN) modules that are supported on your Latitude 5340/Latitude 5340 2-in-1.

Table 9. Wireless module specifications

Description	Option one	Option two
Model number	Realtek RTL8852BE	Intel AX211
Transfer rate	Up to 1201 Mbps	Up to 2400 Mbps
Frequency bands supported	2.4 GHz/5 GHz	2.4 GHz/5 GHz/6 GHz
Wireless standards	<ul style="list-style-type: none"> Wi-Fi 802.11a/b/g Wi-Fi 4 (WiFi 802.11n) Wi-Fi 5 (WiFi 802.11ac) Wi-Fi 6 (WiFi 802.11ax) 	<ul style="list-style-type: none"> Wi-Fi 802.11a/b/g Wi-Fi 4 (WiFi 802.11n) Wi-Fi 5 (WiFi 802.11ac) Wi-Fi 6E (WiFi 802.11ax) <p>NOTE: Wi-Fi 6 is supported in regions where Wi-Fi 6E is unavailable.</p>
Encryption	<ul style="list-style-type: none"> 64-bit/128-bit WEP AES-CCMP TKIP 	<ul style="list-style-type: none"> 64-bit/128-bit WEP AES-CCMP TKIP
Bluetooth wireless card	Bluetooth 5.3	Bluetooth 5.3
	<p>NOTE: The version of the Bluetooth wireless card may vary depending on the operating system that is installed on your computer.</p>	

WWAN module

The following table lists the Wireless Wide Area Network (WWAN) module supported on your Latitude 5340/Latitude 5340 2-in-1.

Table 10. WWAN module specifications

Description	Option one	Option two
Model number	Intel 7560R (DW5823e, DW5823e-eSIM)	Intel 5000 Global 5G Modem

Table 10. WWAN module specifications (continued)

Description	Option one	Option two
Form factor	M.2 3042 Key-B	M.2 3042 Key-B
Host interface	PCIe Gen2	PCIe Gen3
Network standard	LTE FDD/TDD, WCDMA/HSPA+, GPS/BDS/GLONASS/Galileo	LTE FDD/TDD, WCDMA/HSPA+, GNSS/Beidou NR FR1(Sub6) FDD/TDD, LTE FDD/TDD, WCDMA/HSPA+, GPS/GLONASS/Galileo/BDS/QZSS
Transfer data rate	<ul style="list-style-type: none"> ● LTE FDD 1 Gbps DL(Cat16)/150 Mbps UL(Cat13) ● LTE TDD 756 Mbps DL(Cat16)/90 Mbps UL(Cat13) ● UMTS 384 Kbps DL/384 Kbps UL ● HSPA+ 42 Mbps DL/5.76 Mbps UL 	<ul style="list-style-type: none"> ● SA: DL 4.67 Gbps/UL 1.25 Gbps ● NSA: DL 3.74 Gbps/UL 700 Mbps ● LTE: DL 1.6 Gbps (CAT19)/UL 150 Mbps ● UMTS: DL 384 kbps/UL 384 kbps ● DL DC-HSPA+: 42 Mbps (CAT24)/UL 11.5 Mbps (CAT7)
Operating frequency bands	<ul style="list-style-type: none"> ● FDD-LTE: B1/2/3/4/5/7/8/12/13/14/17/18/19/20/25/26/28/29/30/32/66/71 ● TDD-LTE: B34/38/39/40/41(HPUE)/42/43/48, LAA B46 receiver only ● WCDMA/HSPA+: B1/2/4/5/8 	<ul style="list-style-type: none"> ● NR (n1, n2, n3, n5, n7, n8, n20, n25, n28, n30, n38, n40, n41, n48, n66, n71, n77, n78, n79) ● LTE (B1, B2, B3, B4, B5, B7, B8, B12, B13, B14, B17, B18, B19, B20, B25, B26, B28, B29, B30, B32, B34, B38, B39, B40, B41, B42, B43, B46, B48, B66, B71) ● WCDMA/HSPA+ (1, 2, 4, 5, 8)
Power supply	DC 3.135 V to 4.4 V, Typical 3.3 V	DC 3.135 V to 4.4 V, Typical 3.3 V
SIM card	Supported through external SIM slot	Supported through external SIM slot
eSIM with dual SIM (DSSA)	Supported	Supported
Antenna diversity	Supported	Supported
Radio On/Off	Supported	Supported
Wake on wireless	Supported	Supported
Temperature	<ul style="list-style-type: none"> ● Normal operating temperature: -10°C to + 55°C ● Extended Operating temperature: -20°C to +65°C 	<ul style="list-style-type: none"> ● Normal operating temperature: -10°C to + 55°C ● Extended Operating temperature: -20°C to +65°C
Antenna connector	<ul style="list-style-type: none"> ● WWAN Main Antenna x 1 ● WWAN Diversity Antenna x 1 ● 4 x 4 MIMO Antenna x 2 	<ul style="list-style-type: none"> ● WWAN Main Antenna x 1 ● WWAN Diversity Antenna x 1 ● 4 x 4 MIMO Antenna x 2
<p>i NOTE: For instructions on how to find your computer's IMEI (International Mobile Station Equipment Identity) number, search in the Knowledge Base Resource at www.dell.com/support.</p>		

Audio

The following table lists the audio specifications of your Latitude 5340/Latitude 5340 2-in-1.

Table 11. Audio specifications

Description		Values
Audio controller		Realtek Waves, MaxxAudio 12.0
Stereo conversion		Supported
Internal audio interface		High definition audio interface
External audio interface		Universal audio jack
Number of speakers		Two
Internal-speaker amplifier		Supported (audio codec integrated)
External volume controls		Keyboard shortcut controls
Speaker output:		
	Average speaker output	2 W
	Peak speaker output	2 W
Subwoofer output		Not supported
Microphone		Dual-array microphones

Storage

This section lists the storage options on your Latitude 5340/Latitude 5340 2-in-1.

Table 12. Storage specifications

Storage type	Interface type	Capacity
M.2 2230, Class 25 SSD	PCIe NVMe Gen4 x4, up to 64 Gb/s	2 TB
M.2 2230, Class 35 SSD	PCIe NVMe Gen4 x4, up to 64 Gb/s	1 TB
M.2 2230, Class 35 SSD	PCIe NVMe Gen4 x4, up to 64 Gb/s	512 GB
M.2 2230, Class 35 SSD	PCIe NVMe Gen4 x4, up to 64 Gb/s	256 GB
M.2 2230, Class 35 SSD, self-encrypting drive	PCIe NVMe Gen4 x4, up to 64 Gb/s	256 GB

Keyboard

The following table lists the keyboard specifications of your Latitude 5340/Latitude 5340 2-in-1.

Table 13. Keyboard specifications

Description	Values
Keyboard type	<ul style="list-style-type: none"> Standard backlit keyboard Standard non-backlit keyboard
Keyboard layout	QWERTY
Number of keys	<ul style="list-style-type: none"> United States and Canada: 79 keys United Kingdom: 80 keys Japan: 83 keys
Keyboard size	X=18.05 mm key pitch Y=18.05 mm key pitch
Keyboard shortcuts	<p>Some keys on your keyboard have two symbols on them. These keys can be used to type alternate characters or to perform secondary functions. To type the alternate character, press Shift and the desired key. To perform secondary functions, press fn and the desired key. For more information, see Keyboard function keys.</p> <p>NOTE: You can define the primary behavior of the function keys (F1–F12) by changing Function Key Behavior in BIOS setup program.</p>

Keyboard function keys

The **F1-F12** keys at the top of the keyboard are function keys. By default, these keys are used to perform specific functions defined by the software application in use.

You can run the secondary tasks that are indicated by the symbols on the function keys by pressing the function key with **fn**, for example, **fn** and **F1**. See the table below for the list of secondary tasks and the key combinations to run them.

NOTE: Keyboard characters may differ depending on the keyboard language configuration. Keys that are used for tasks remain the same, regardless of the keyboard language.

NOTE: You can define the primary behavior of function keys in the **Function Key Behavior** menu of the BIOS setup program.

Table 14. Secondary tasks of keyboard keys

Key combination for task	What the task does
fn and F1	Operating system and application specific F1 behavior
fn and F2	Operating system and application specific F2 behavior
fn and F3	Operating system and application specific F3 behavior
fn and F4	Operating system and application specific F4 behavior
fn and F5	Operating system and application specific F5 behavior
fn and F6	Operating system and application specific F6 behavior
fn and F8	Operating system and application specific F8 behavior
fn and F9	Operating system and application specific F9 behavior

Table 14. Secondary tasks of keyboard keys (continued)

Key combination for task	What the task does
fn and F10	Operating system and application specific F10 behavior
fn and F11	Operating system and application specific F11 behavior
fn and F12	Operating system and application specific F12 behavior
fn and Right Ctrl	Open application menu
fn and PgUp	Page up
fn and PgDn	Page down

Keys with alternate characters

There are other keys on your keyboard with alternate characters. The symbol shown on the lower part of the key refers to the character that is typed out when the key is pressed. If you press shift and the key, the symbol shown on the upper part of the key is typed out. For example, if you press **2**, **2** is typed out; if you press **Shift + 2**, **@** is typed out.

Camera

The following table lists the camera specifications of your Latitude 5340/Latitude 5340 2-in-1.

Table 15. Camera specifications

Description	Option one	Option two	Option three
Number of cameras	One	One	One
Camera type	FHD RGB camera	FHD RGB + IR camera	FHD RGB + IR camera with Ambient light sensor, and Express Sign-In with Presence Detection and Intelligent Privacy
Camera location	Front camera	Front camera	Front camera
Camera sensor type	CMOS sensor technology	CMOS sensor technology	CMOS sensor technology
Camera resolution:			
Still image	2.07 megapixel	2.07 megapixel	2.07 megapixel
Video	1920 x 1080 (FHD) at 30 fps	1920 x 1080 (FHD) at 30 fps	1920 x 1080 (FHD) at 30 fps
Infrared camera resolution:			
Still image	0.23 megapixel	0.23 megapixel	0.23 megapixel
Video	640 x 360 at 30 fps	640 x 360 at 30 fps	640 x 360 at 30 fps
Diagonal viewing angle:			
Camera	80 degrees	80 degrees	80 degrees
Infrared camera	86.60 degrees	86.60 degrees	86.60 degrees

Touchpad

The following table lists the touchpad specifications of your Latitude 5340/Latitude 5340 2-in-1.

Table 16. Touchpad specifications

Description	Values
Touchpad resolution:	>=300 dpi
Touchpad dimensions:	
Horizontal	115 mm (4.53 in.)
Vertical	67 mm (2.64 in.)
Touchpad gestures	For more information about touchpad gestures available on: <ul style="list-style-type: none"> Windows, see the Microsoft knowledge base article at support.microsoft.com Ubuntu, see ubuntu.com/support

Power adapter

The following table lists the power adapter specifications of your Latitude 5340/Latitude 5340 2-in-1.

Table 17. Power adapter specifications

Description	Option one	Option two	Option three	Option four
Type	60 W AC adapter, USB-C	60 W AC adapter, USB-C, 2-pin	65 W AC adapter, USB-C	100 W AC adapter, USB-C
Power-adapter dimensions:				
Height	22 mm (0.87 in.)	22 mm (0.87 in.)	28 mm (1.10 in.)	26.50 mm (1.04 in.)
Width	55 mm (2.16 in.)	55 mm (2.16 in.)	51 mm (2.01 in.)	60 mm (2.36 in.)
Depth	66 mm (2.60 in.)	66 mm (2.60 in.)	112 mm (4.41 in.)	122 mm (4.80 in.)
Input voltage	100 VAC–240 VAC	100 VAC–240 VAC	100 VAC–240 VAC	100 VAC–240 VAC
Input frequency	50 Hz–60 Hz	50 Hz–60 Hz	50 Hz to 60 Hz	50 Hz to 60 Hz
Input current (maximum)	1.70 A	1.70 A	1.70 A	1.70 A
Output current (continuous)	<ul style="list-style-type: none"> 20 V/3 A (Continuous) 15 V/3 A (Continuous) 9 V/3 A (Continuous) 5 V/3 A (Continuous) 	<ul style="list-style-type: none"> 20 V/3 A (Continuous) 15 V/3 A (Continuous) 9 V/3 A (Continuous) 5 V/3 A (Continuous) 	<ul style="list-style-type: none"> 20 V/3.25 A (Continuous) 15 V/3 A (Continuous) 9 V/3 A (Continuous) 5 V/3 A (Continuous) 	<ul style="list-style-type: none"> 20 V/5 A (Continuous) 15 V/3 A (Continuous) 9 V/3 A (Continuous) 5 V/3 A (Continuous)
Rated output voltage	20 VDC/15 VDC/9 VDC/5 VDC	20 VDC/15 VDC/9 VDC/5 VDC	20 VDC/15 VDC/9 VDC/5 VDC	20 VDC/15 VDC/9 VDC/5 VDC
Temperature range:				

Table 17. Power adapter specifications (continued)

Description		Option one	Option two	Option three	Option four
	Operating	0°C to 40°C (32°F to 104°F)	0°C to 40°C (32°F to 104°F)	0°C to 40°C (32°F to 104°F)	0°C to 40°C (32°F to 104°F)
	Storage	-20°C to 70°C (-4°F to 158°F)	-20°C to 70°C (-4°F to 158°F)	-40°C to 70°C (-40°F to 158°F)	-40°C to 70°C (-40°F to 158°F)
 CAUTION: Operating and storage temperature ranges may differ among components, so operating or storing the device outside these ranges may impact the performance of specific components.					

Battery

The following table lists the battery specifications of your Latitude 5340/Latitude 5340 2-in-1.

Table 18. Battery specifications

Description		Option one	Option two	Option three	Option four
	Battery type	3 cell, 42 Wh, ExpressCharge, ExpressCharge Boost	3 cell, 42 Wh, Long Cycle Life, ExpressCharge	3 cell, 54 Wh, ExpressCharge, ExpressCharge Boost	3 cell, 54 Wh, Long Cycle Life, ExpressCharge
	Battery voltage	11.40 VDC	11.40 VDC	11.40 VDC	11.40 VDC
	Battery weight (minimum)	0.19 kg (0.41 lb)	0.19 kg (0.41 lb)	0.22 kg (0.48 lb)	0.22 kg (0.48 lb)
Battery dimensions:					
	Height	5.73 mm (0.22 in.)	5.73 mm (0.22 in.)	5.73 mm (0.22 in.)	5.73 mm (0.22 in.)
	Width	263 mm (10.35 in.)	263 mm (10.35 in.)	263 mm (10.53 in.)	263 mm (10.35 in.)
	Depth	68.90 mm (2.71 in.)	68.90 mm (2.71 in.)	68.90 mm (2.71 in.)	68.90 mm (2.71 in.)
Temperature range:					
	Operating	<ul style="list-style-type: none"> Charge: 0°C to 45°C (32°F to 113°F) Discharge: 0°C to 70°C (32°F to 158°F) 	<ul style="list-style-type: none"> Charge: 0°C to 45°C (32°F to 113°F) Discharge: 0°C to 70°C (32°F to 158°F) 	<ul style="list-style-type: none"> Charge: 0°C to 45°C (32°F to 113°F) Discharge: 0°C to 70°C (32°F to 158°F) 	<ul style="list-style-type: none"> Charge: 0°C to 45°C (32°F to 113°F) Discharge: 0°C to 70°C (32°F to 158°F)
	Storage	-20°C to 65°C (-4°F to 149°F)	-20°C to 65°C (-4°F to 149°F)	-20°C to 65°C (-4°F to 149°F)	-20°C to 65°C (-4°F to 149°F)
	Battery operating time	Varies depending on operating conditions and can significantly reduce under certain power-intensive conditions.	Varies depending on operating conditions and can significantly reduce under certain power-intensive conditions.	Varies depending on operating conditions and can significantly reduce under certain power-intensive conditions.	Varies depending on operating conditions and can significantly reduce under certain power-intensive conditions.
	Battery charging time (approximate)	Express Charge Method: <ul style="list-style-type: none"> 0°C to 15°C maximum allowable charge time from 	Standard Charge/Predominately AC User Charge Method: <ul style="list-style-type: none"> 0°C to 15°C maximum allowable 	Express Charge Method: <ul style="list-style-type: none"> 0°C to 15°C maximum allowable charge time from 	Standard Charge/Predominately AC User Charge Method: <ul style="list-style-type: none"> 0°C to 15°C maximum allowable

Table 18. Battery specifications (continued)

Description	Option one	Option two	Option three	Option four
Dell Power Manager application. For more information on the Dell Power Manager see, <i>Me and My Dell</i> on www.dell.com .	<p>0% to 100% RSOC is 4 hours</p> <ul style="list-style-type: none"> 16°C to 45°C normal express charge 46°C to 50°C maximum allowable charge time from 0% to 100% RSOC is 3 hours <p>Standard Charge/ Predominately AC User Charge Method:</p> <ul style="list-style-type: none"> 0°C to 15°C maximum allowable charge time from 0% to 100% RSOC is 4 hours 16°C to 50°C maximum allowable charge time from 0% to 100% RSOC is 3 hours <p>Express Charge Boost Charge Method (Fast Charge for Initial 35%):</p> <ul style="list-style-type: none"> 16°C to 45°C target charge time from 0% to 35% RSOC is 20 mins for Accelerated Charge 	<p>charge time from 0% to 100% RSOC is 4 hours</p> <ul style="list-style-type: none"> 16°C to 50°C maximum allowable charge time from 0% to 100% RSOC is 3 hours 	<p>0% to 100% RSOC is 4 hours</p> <ul style="list-style-type: none"> 16°C to 45°C normal express charge 46°C to 50°C maximum allowable charge time from 0% to 100% RSOC is 3 hours <p>Standard Charge/ Predominately AC User Charge Method:</p> <ul style="list-style-type: none"> 0°C to 15°C maximum allowable charge time from 0% to 100% RSOC is 4 hours 16°C to 50°C maximum allowable charge time from 0% to 100% RSOC is 3 hours <p>Express Charge Boost Charge Method (Fast Charge for Initial 35%):</p> <ul style="list-style-type: none"> 16°C to 45°C target charge time from 0% to 35% RSOC is 20 mins for Accelerated Charge 	<p>charge time from 0 to 100% RSOC is 4 hours</p> <ul style="list-style-type: none"> 16°C to 50°C maximum allowable charge time from 0 to 100% RSOC is 3 hours
Coin-cell battery	Supported	Supported	Supported	Supported
<p>⚠ CAUTION: Operating and storage temperature ranges may differ among components, so operating or storing the device outside these ranges may impact the performance of specific components.</p> <p>⚠ CAUTION: Dell recommends that you charge the battery regularly for optimal power consumption. If your battery charge is completely depleted, connect the power adapter, turn on your computer, and then restart your computer to reduce the power consumption.</p>				

Display

The following table lists the display specifications of your Latitude 5340/Latitude 5340 2-in-1.

Table 19. Display specifications

Description	Option one	Option two	Option three	Option for 2-in-1 only
Display type	Full High Definition (FHD)	Full High Definition (FHD), ComfortView Plus Low Blue Light, Battery saving	Full High Definition (FHD)	Full High Definition (FHD)

Table 19. Display specifications (continued)

Description		Option one	Option two	Option three	Option for 2-in-1 only
Display-panel technology		In-Plane Switching (IPS)	In-Plane Switching (IPS)	In-Plane Switching (IPS)	In-Plane Switching (IPS)
Display-panel dimensions (active area):					
	Height	165.24 mm (6.51 in.)	165.24 mm (6.51 in.)	165.24 mm (6.51 in.)	165.24 mm (6.51 in.)
	Width	293.76 mm (11.57 in.)	293.76 mm (11.57 in.)	293.76 mm (11.57 in.)	293.76 mm (11.57 in.)
	Diagonal	337.08 mm (13.27 in.)	337.08 mm (13.27 in.)	337.08 mm (13.27 in.)	337.08 mm (13.27 in.)
Display-panel native resolution		1920 x 1080	1920 x 1080	1920 x 1080	1920 x 1080
Luminance (typical)		250 nits	400 nits	300 nits	270 nits
Megapixels		2073600	2073600	2073600	2073600
Color gamut		45% NTSC typical	100% sRGB typical	72% NTSC typical	72% NTSC typical
Pixels Per Inch (PPI)		166	166	166	166
Contrast ratio (typical)		800:1	1000:1	700:1	800:1
Response time (max)		35 ms	35 ms	35 ms	35 ms
Refresh rate		60 Hz	60 Hz	60 Hz	60 Hz
Horizontal view angle		80/80 min. 85/85 typ. +/- degrees	80/80 min. 85/85 typ. +/- degrees	80/80 min. 85/85 typ. +/- degrees	80/80 min. 85/85 typ. +/- degrees
Vertical view angle		80/80 min. 85/85 typ. +/- degrees	80/80 min. 85/85 typ. +/- degrees	80/80 min. 85/85 typ. +/- degrees	80/80 min. 85/85 typ. +/- degrees
Pixel pitch		0.153 x 0.153 mm	0.153 x 0.153 mm	0.153 x 0.153 mm	0.153 x 0.153 mm
Power consumption (maximum)		3.5 W@Mosaic	2.52 W@Mosaic	4.4 W@Mosaic	4.5 W@Mosaic
Anti-glare vs glossy finish		Anti-glare	Anti-glare	Anti-glare	(DXC) Anti-reflection/Anti-smudge
Touch options		No	No	Yes	Yes

Fingerprint reader (optional)

The following table lists the specifications of the optional fingerprint-reader of your Latitude 5340/Latitude 5340 2-in-1.

Table 20. Fingerprint reader specifications

Description	Values
Fingerprint-reader sensor technology	Capacitive

Table 20. Fingerprint reader specifications (continued)

Description	Values
Fingerprint-reader sensor resolution	500 dpi
Fingerprint-reader sensor pixel size	108 x 88

Sensor

The following table lists the sensor of your Latitude 5340/Latitude 5340 2-in-1.

Table 21. Sensor

Sensor support
Ambient Light Sensor on the hinge-up (optional)
P-sensor on the hinge-up (optional)
1 Accelerometer in the base (system board) for both laptop and 2-in-1
1 Accelerometer (Accelerometer + Gyro) in the hinge-up sensor board (Upsell on laptops with Proximity/ALS/IR camera and 100% attached on 2-in-1)

GPU—Integrated

The following table lists the specifications of the integrated Graphics Processing Unit (GPU) supported by your Latitude 5340/Latitude 5340 2-in-1.

Table 22. GPU—Integrated

Controller	Memory size	Processor
Intel Iris Xe Graphics	Dual-channel memory	13 th Generation Intel Core i5/i7 processors
Intel UHD Graphics	Single-channel memory	13 th Generation Intel Core i3 processor

Hardware security

The following table lists the hardware security of your Latitude 5340/Latitude 5340 2-in-1.

Table 23. Hardware security

Hardware security
Windows Hello - Fingerprint Reader (optional)
Trusted Platform Module (TPM) 2.0 FIPS 140-2 Certified
TCG Certification for TPM (Trusted Computing Group)
One wedge-shaped lock slot
Fingerprint Reader in Power Button tied to ControlVault 3
ControlVault 3 Advanced Authentication (optional) FIPS 140-2 Level 3 Certified
Contacted Smart-card reader with Control Vault 3 (optional)
Contactless Smart-card, NFC/FPR with CV3 (optional)
NVMe SED SSD (Opal 2.0) and NVMe Non SED SSD as per SDL

Smart-card reader

Contactless smart-card reader

This section lists the contactless smart-card reader specifications of your Latitude 5340/Latitude 5340 2-in-1.

Table 24. Contactless smart-card reader specifications

Title	Description	Dell ControlVault 3 contactless smart-card reader with NFC
Felica Card Support	Reader and software capable of supporting Felica contactless cards	Yes
ISO 14443 Type A Card Support	Reader and software capable of supporting ISO 14443 Type A contactless cards	Yes
ISO 14443 Type B Card Support	Reader and software capable of supporting ISO 14443 Type B contactless cards	Yes
ISO/IEC 21481	Reader and software capable of supporting ISO/IEC 21481 compliant contactless cards and tokens	Yes
ISO/IEC 18092	Reader and software capable of supporting ISO/IEC 21481 compliant contactless cards and tokens	Yes
ISO 15693 Card Support	Reader and software capable of supporting ISO15693 contactless cards	Yes
NFC Tag Support	Supports reading and processing of NFC compliant tag information	Yes
NFC Reader Mode	Support for NFC Forum Defined Reader mode	Yes
NFC Writer Mode	Support for NFC Forum Defined Writer mode	Yes
NFC Peer-to-Peer Mode	Support for NFC Forum Defined Peer to Peer mode	Yes
EMVCo Compliant	Compliant with EMVCO smart-card standards as posted to www.emvco.com	Yes
EMVCo Certified	Formally certified based on EMVCO smart-card standards	Yes
NFC Proximity OS Interface	Enumerates NFP (Near Field Proximity) device for OS to utilize	Yes
PC/SC OS interface	Personal Computer/Smart-card specification for integration of hardware readers into personal computer environments	Yes
CCID driver compliance	Common driver support for Integrated Circuit Card Interface Device for OS level drivers	Yes
Windows Certified	Device certified by Microsoft WHCK	Yes
Dell ControlVault support	Device connects to Dell ControlVault for usage and processing	Yes

Table 24. Contactless smart-card reader specifications (continued)

Title	Description	Dell ControlVault 3 contactless smart-card reader with NFC
FIDO2 compliance	Dell ControlVault 3 Smart-card reader is compliant with the FIDO SPEC	Yes

 **NOTE:** 125 kHz proximity cards are not supported.

Table 25. Supported cards

Manufacturer	Card
HID	jCOP readertest3 A card (14443a)
	1430 1L
	DESFire D8H
	iClass (Legacy)
	iClass SEOS
NXP/Mifare	Mifare DESFire 8K White PVC card
	Mifare Classic 1K White PVC card
	NXP Mifare Classic S50 ISO card
G&D	idOnDemand - SCE3.2 144K
	SCE6.0 FIPS 80K Dual+ 1 K Mifare
	SCE6.0 nonFIPS 80K Dual+ 1 K Mifare
	SCE6.0 FIPS 144K Dual + 1K Mifare
	SCE6.0 nonFIPS 144K Dual + 1 K Mifare
	SCE7.0 FIPS 144K
Oberthur	idOnDemand - OCS5.2 80K
	ID-One Cosmo 64 RSA D V5.4 T=0 card

Contacted smart-card reader

The following table lists the contacted smart-card reader specifications of your Latitude 5340/Latitude 5340 2-in-1.

Table 26. Contacted smart-card reader specifications

Title	Description	Dell ControlVault 3 smart-card reader
ISO 7816 -3 Class A Card Support	Reader capable of reading 5 V powered smart-card	Yes
ISO 7816 -3 Class B Card Support	Reader capable of reading 3 V powered smart-card	Yes
ISO 7816 -3 Class C Card support	Reader capable of reading 1.8 V powered smart-card	Yes
ISO 7816-1 Compliant	Specification for the reader	Yes
ISO 7816 -2 Compliant	Specification for smart-card device physical characteristics (size, location of connection points, and so on)	Yes

Table 26. Contacted smart-card reader specifications (continued)

Title	Description	Dell ControlVault 3 smart-card reader
T=0 support	Cards support character level transmission	Yes
T=1 support	Cards support block level transmission	Yes
EMVCo Compliant	Compliant with EMVCo (for electronic payment standards) smart-card standards as posted to www.emvco.com	Yes
EMVCo Certified	Formally certified based on EMVCO smart-card standards	Yes
PC/SC OS interface	Personal Computer/Smart-card specification for integration of hardware readers into personal computer environments	Yes
CCID driver compliance	Common driver support for Integrated Circuit Card Interface Device for OS level drivers.	Yes
Windows Certified	Device certified by WHCK	Yes
FIPS 201 (PIV/HSPD-12) Compliant through GSA	Device compliant with FIPS 201/PIV/HSPD-12 requirements	Yes
FIDO2 compliance	Dell ControlVault 3 Smart-card reader is compliant with the FIDO SPEC	Yes

Operating and storage environment

This table lists the operating and storage specifications of your Latitude 5340/Latitude 5340 2-in-1.

Airborne contaminant level: G1 as defined by ISA-S71.04-1985

Table 27. Computer environment

Description	Operating	Storage
Temperature range	0°C to 35°C (32°F to 95°F)	-40°C to 65°C (-40°F to 149°F)
Relative humidity (maximum)	10% to 90% (non-condensing)	0% to 95% (non-condensing)
Vibration (maximum)*	0.66 GRMS	1.30 GRMS
Shock (maximum)	110 G†	160 G†
Altitude range	-15.2 m to 3048 m (-49.87 ft to 10000 ft)	-15.2 m to 10668 m (-49.87 ft to 35000 ft)

CAUTION: Operating and storage temperature ranges may differ among components, so operating or storing the device outside these ranges may impact the performance of specific components.

* Measured using a random vibration spectrum that simulates user environment.

† Measured using a 2 ms half-sine pulse.

Dell Support policy

For information on Dell support policy, search in the Knowledge Base Resource at www.dell.com/support.

ComfortView Plus

⚠ WARNING: Prolonged exposure to blue light from the display may lead to long-term effects such as eye strain, eye fatigue, or damage to the eyes.

Blue light is a color in the light spectrum which has a short wavelength and high energy. Chronic exposure to blue light, particularly from digital sources, may disrupt sleep patterns and cause long-term effects such as eye strain, eye fatigue, or damage to the eyes.

The display on this computer is designed to minimize blue light and complies with TÜV Rheinland's requirement for low blue light displays.

Low blue light mode is enabled at the factory, so no further configuration is necessary.

To reduce the risk of eye strain, it is also recommended that you:

- Position the display at a comfortable viewing distance between 20 and 28 inches (50 and 70 cm) from your eyes.
- Blink frequently to moisten your eyes, wet your eyes with water, or apply suitable eye drops.
- Look away from your display, and gaze at a distant object at 20 ft (609.60 cm) away for at least 20 seconds during each break.
- Take an extended break for 20 minutes every two hours.

Using the privacy shutter

1. Slide the privacy shutter to the left to access the camera lens.
2. Slide the privacy shutter to the right to cover the camera lens.



Figure 1. Camera shutter

Dell Optimizer

This section provides the Dell Optimizer specifications of your Latitude 5340/Latitude 5340 2-in-1.

On Latitude 5340/Latitude 5340 2-in-1 with Dell Optimizer, the following features are supported:











- **ExpressConnect**—Automatically joins the access point with the strongest signal, and directs bandwidth to conferencing applications when in use.
- **ExpressSign-in**—The Intel Context Sensing Technology's proximity sensor detects your presence to instantly wake up the computer and login using the IR camera and Windows Hello feature. Windows locks when you walk away.
- **ExpressResponse**—Prioritizes the most important applications. Applications open faster and perform better.
- **ExpressCharge**—Extends the battery runtime and improves battery performance by adapting to your patterns.
- **Intelligent Audio**—Collaborate like you're in the same room. Intelligent Audio enhances your audio quality and reduces background noises, so you can hear and be heard, creating a better conference experience for all.

For more information about configuring and using these features, see [Dell Optimizer User Guide](#).

Working inside your computer



Safety instructions

Use the following safety guidelines to protect your computer from potential damage and to ensure your personal safety. Unless otherwise noted, each procedure included in this document assumes that you have read the safety information that shipped with your computer.

-  **WARNING:** Before working inside your computer, read the safety information that is shipped with your computer. For more safety best practices, see the Regulatory Compliance home page at www.dell.com/regulatory_compliance.
-  **WARNING:** Disconnect your computer from all power sources before opening the computer cover or panels. After you finish working inside the computer, replace all covers, panels, and screws before connecting your computer to an electrical outlet.
-  **CAUTION:** To avoid damaging the computer, ensure that the work surface is flat, dry, and clean.
-  **CAUTION:** To avoid damaging the components and cards, handle them by their edges, and avoid touching the pins and the contacts.
-  **CAUTION:** You should only perform troubleshooting and repairs as authorized or directed by the Dell technical assistance team. Damage due to servicing that is not authorized by Dell is not covered by your warranty. See the safety instructions that is shipped with the product or at www.dell.com/regulatory_compliance.
-  **CAUTION:** Before touching anything inside your computer, ground yourself by touching an unpainted metal surface, such as the metal at the back of the computer. While you work, periodically touch an unpainted metal surface to dissipate static electricity which could harm internal components.
-  **CAUTION:** When you disconnect a cable, pull it by its connector or its pull tab, not the cable itself. Some cables have connectors with locking tabs or thumbscrews that you must disengage before disconnecting the cable. When disconnecting cables, keep them evenly aligned to avoid bending the connector pins. When connecting cables, ensure that the ports and the connectors are correctly oriented and aligned.
-  **CAUTION:** Press and eject any installed card from the media-card reader.
-  **CAUTION:** Exercise caution when handling rechargeable Li-ion batteries in laptops. Swollen batteries should not be used and should be replaced and disposed properly.
-  **NOTE:** The color of your computer and certain components may appear differently than shown in this document.

Before working inside your computer

Steps

1. Save and close all open files and exit all open applications.
2. Shut down your computer. For Windows operating system, click **Start** >  **Power** > **Shut down**.
 -  **NOTE:** If you are using a different operating system, see the documentation of your operating system for shut-down instructions.
3. Disconnect your computer and all attached devices from their electrical outlets.
4. Disconnect all attached network devices and peripherals, such as keyboard, mouse, and monitor from your computer.

5. Remove any media card and optical disk from your computer, if applicable.
6. Enter the service mode, if you are able to power on your computer.

Service Mode

Service Mode is used to cut-off power, without disconnecting battery cable from system board prior conducting repairs in the computer.

 **CAUTION:** If you are unable to turn on the computer to put it into Service Mode, or the computer does not support Service Mode, proceed to disconnect the battery cable. To disconnect the battery cable, follow the steps in [Removing the battery](#).

 **NOTE:** Ensure that your computer is shut down and the AC adapter is disconnected.

- a. Hold **** key on the keyboard and press the power button for 3 seconds or until the Dell logo appears on the screen.
- b. Press any key to continue.
- c. If the AC adapter is not disconnected, a message prompting you to remove the AC adapter appears on the screen. Remove the AC adapter and then press any key to continue the **Service Mode** process. The **Service Mode** process automatically skips the following step if the **Owner Tag** of the computer is not set up in advance by the user.
- d. When the **ready-to-proceed** message appears on the screen, press any key to proceed. The computer emits three short beeps and shuts down immediately.
- e. Once the computer shuts down, it has successfully entered Service Mode.

 **NOTE:** If you are unable to power on your computer or unable to enter Service Mode, skip this process.

Safety precautions

The safety precautions chapter details the primary steps to be taken before performing any disassembly instructions.

Observe the following safety precautions before you perform any installation or break/fix procedures involving disassembly or reassembly:

- Turn off the system and all attached peripherals.
- Disconnect the system and all attached peripherals from AC power.
- Disconnect all network cables, telephone, and telecommunications lines from the system.
- Use an ESD field service kit when working inside any to avoid electrostatic discharge (ESD) damage.
- After removing any system component, carefully place the removed component on an anti-static mat.
- Wear shoes with non-conductive rubber soles to reduce the chance of getting electrocuted.

Standby power

Dell products with standby power must be unplugged before you open the case. Systems that incorporate standby power are essentially powered while turned off. The internal power enables the system to be remotely turned on (wake on LAN) and suspended into a sleep mode and has other advanced power management features.

Unplugging, pressing, and holding the power button for 15 seconds should discharge residual power in the system board.

Bonding

Bonding is a method for connecting two or more grounding conductors to the same electrical potential. This is done through the use of a field service electrostatic discharge (ESD) kit. When connecting a bonding wire, ensure that it is connected to bare metal and never to a painted or non-metal surface. The wrist strap should be secure and in full contact with your skin, and ensure that you remove all jewelry such as watches, bracelets, or rings prior to bonding yourself and the equipment.

Electrostatic discharge—ESD protection

ESD is a major concern when you handle electronic components, especially sensitive components such as expansion cards, processors, memory DIMMs, and system boards. Very slight charges can damage circuits in ways that may not be obvious, such as intermittent problems or a shortened product life span. As the industry pushes for lower power requirements and increased density, ESD protection is an increasing concern.

Due to the increased density of semiconductors used in recent Dell products, the sensitivity to static damage is now higher than in previous Dell products. For this reason, some previously approved methods of handling parts are no longer applicable.

Two recognized types of ESD damage are catastrophic and intermittent failures.

- **Catastrophic** – Catastrophic failures represent approximately 20 percent of ESD-related failures. The damage causes an immediate and complete loss of device functionality. An example of catastrophic failure is a memory DIMM that has received a static shock and immediately generates a "No POST/No Video" symptom with a beep code emitted for missing or nonfunctional memory.
- **Intermittent** – Intermittent failures represent approximately 80 percent of ESD-related failures. The high rate of intermittent failures means that most of the time when damage occurs, it is not immediately recognizable. The DIMM receives a static shock, but the tracing is merely weakened and does not immediately produce outward symptoms related to the damage. The weakened trace may take weeks or months to melt, and in the meantime may cause degradation of memory integrity, intermittent memory errors, etc.

The more difficult type of damage to recognize and troubleshoot is the intermittent (also called latent or "walking wounded") failure.

Perform the following steps to prevent ESD damage:

- Use a wired ESD wrist strap that is properly grounded. The use of wireless anti-static straps is no longer allowed; they do not provide adequate protection. Touching the chassis before handling parts does not ensure adequate ESD protection on parts with increased sensitivity to ESD damage.
- Handle all static-sensitive components in a static-safe area. If possible, use anti-static floor pads and workbench pads.
- When unpacking a static-sensitive component from its shipping carton, do not remove the component from the anti-static packing material until you are ready to install the component. Before unwrapping the anti-static packaging, ensure that you discharge static electricity from your body.
- Before transporting a static-sensitive component, place it in an anti-static container or packaging.

ESD field service kit

The unmonitored Field Service kit is the most commonly used service kit. Each Field Service kit includes three main components: anti-static mat, wrist strap, and bonding wire.

Components of an ESD field service kit

The components of an ESD field service kit are:

- **Anti-Static Mat** – The anti-static mat is dissipative and parts can be placed on it during service procedures. When using an anti-static mat, your wrist strap should be snug and the bonding wire should be connected to the mat and to any bare metal on the system being worked on. Once deployed properly, service parts can be removed from the ESD bag and placed directly on the mat. ESD-sensitive items are safe in your hand, on the ESD mat, in the system, or inside a bag.
- **Wrist Strap and Bonding Wire** – The wrist strap and bonding wire can be either directly connected between your wrist and bare metal on the hardware if the ESD mat is not required, or connected to the anti-static mat to protect hardware that is temporarily placed on the mat. The physical connection of the wrist strap and bonding wire between your skin, the ESD mat, and the hardware is known as bonding. Use only Field Service kits with a wrist strap, mat, and bonding wire. Never use wireless wrist straps. Always be aware that the internal wires of a wrist strap are prone to damage from normal wear and tear, and must be checked regularly with a wrist strap tester in order to avoid accidental ESD hardware damage. It is recommended to test the wrist strap and bonding wire at least once per week.
- **ESD Wrist Strap Tester** – The wires inside of an ESD strap are prone to damage over time. When using an unmonitored kit, it is a best practice to regularly test the strap prior to each service call, and at a minimum, test once per week. A wrist strap tester is the best method for doing this test. If you do not have your own wrist strap tester, check with your regional office to find out if they have one. To perform the test, plug the wrist-strap's bonding-wire into the tester while it is strapped to your wrist and push the button to test. A green LED is lit if the test is successful; a red LED is lit and an alarm sounds if the test fails.
- **Insulator Elements** – It is critical to keep ESD sensitive devices, such as plastic heat sink casings, away from internal parts that are insulators and often highly charged.
- **Working Environment** – Before deploying the ESD Field Service kit, assess the situation at the customer location. For example, deploying the kit for a server environment is different than for a desktop or portable environment. Servers are typically installed in a rack within a data center; desktops or portables are typically placed on office desks or cubicles. Always look for a large open flat work area that is free of clutter and large enough to deploy the ESD kit with additional space to accommodate the type of system that is being repaired. The workspace should also be free of insulators that can cause an ESD event. On the work area, insulators such as Styrofoam and other plastics should always be moved at least 12 inches or 30 centimeters away from sensitive parts before physically handling any hardware components

- **ESD Packaging** – All ESD-sensitive devices must be shipped and received in static-safe packaging. Metal, static-shielded bags are preferred. However, you should always return the damaged part using the same ESD bag and packaging that the new part arrived in. The ESD bag should be folded over and taped shut and all the same foam packing material should be used in the original box that the new part arrived in. ESD-sensitive devices should be removed from packaging only at an ESD-protected work surface, and parts should never be placed on top of the ESD bag because only the inside of the bag is shielded. Always place parts in your hand, on the ESD mat, in the system, or inside an anti-static bag.
- **Transporting Sensitive Components** – When transporting ESD sensitive components such as replacement parts or parts to be returned to Dell, it is critical to place these parts in anti-static bags for safe transport.

ESD protection summary

It is recommended to use the traditional wired ESD grounding wrist strap and protective anti-static mat at all times when servicing Dell products. In addition, it is critical to keep sensitive parts separate from all insulator parts while performing service and that they use anti-static bags for transporting sensitive components.

Transporting sensitive components

When transporting ESD sensitive components such as replacement parts or parts to be returned to Dell, it is critical to place these parts in anti-static bags for safe transport.

After working inside your computer

About this task

 **CAUTION:** Leaving stray or loose screws inside your computer may severely damage your computer.

Steps

1. Replace all screws and ensure that no stray screws remain inside your computer.
2. Connect any external devices, peripherals, or cables you removed before working on your computer.
3. Replace any media cards, discs, or any other parts that you removed before working on your computer.
4. Connect your computer and all attached devices to their electrical outlets.
 -  **NOTE:** To exit service mode, ensure to connect the AC adapter to the power-adapter port on your computer.
5. Press the power button to turn on the computer. Your computer will automatically return to normal functioning mode.

BitLocker

 **CAUTION:** If BitLocker is not suspended before updating the BIOS, the next time you reboot the system it will not recognize the BitLocker key. You will then be prompted to enter the recovery key to progress, and the system will ask for this on each reboot. If the recovery key is not known this can result in data loss or an unnecessary operating system reinstall. For more information about this subject, see Knowledge Article: [updating the BIOS on Dell systems with BitLocker enabled](#).

The installation of the following components triggers BitLocker:

- Hard disk drive or solid state drive
- System board

Recommended tools

The procedures in this document may require the following tools:

- Phillips screwdriver #0
- Phillips screwdriver #1
- Plastic scribe

Screw list

- NOTE:** When removing screws from a component, it is recommended to note the screw type, the quantity of screws, and then place them in a screw storage box. This is to ensure that the correct number of screws and correct screw type is restored when the component is replaced.
- NOTE:** Some computers have magnetic surfaces. Ensure that the screws are not left attached to such surfaces when replacing a component.
- NOTE:** Screw color may vary with the configuration ordered.

Table 28. Screw list















Component	Screw type	Quantity	Screw image
WLAN card	M2x3	1	
WWAN 5G bracket	M2x3.5	1	
WWAN 5G card	M2x3	2	
WWAN 4G bracket	M2x3.5	1	
M.2 solid-state drive	M2x2.5	2	
Fan	M2x3	3	
Power-button /Power button with fingerprint reader	M2x2	1	
eDP bracket	M2x4	1	
Type-C bracket	M2x5	3	
Display hinges	M2.5x3 M2.5x4	6 4	
Display panel	M2.5x3 M2x2.5	6 2	
Smart-card reader	M2x2	2	
Keyboard bracket	M2x2	2	

Table 28. Screw list (continued)

Component	Screw type	Quantity	Screw image
Keyboard	M2x2	18	
System board	M2x3 M2x4	4 1	

Major components of Latitude 5340/Latitude 5340 2-in-1

The following image shows the major components of Latitude 5340/Latitude 5340 2-in-1.

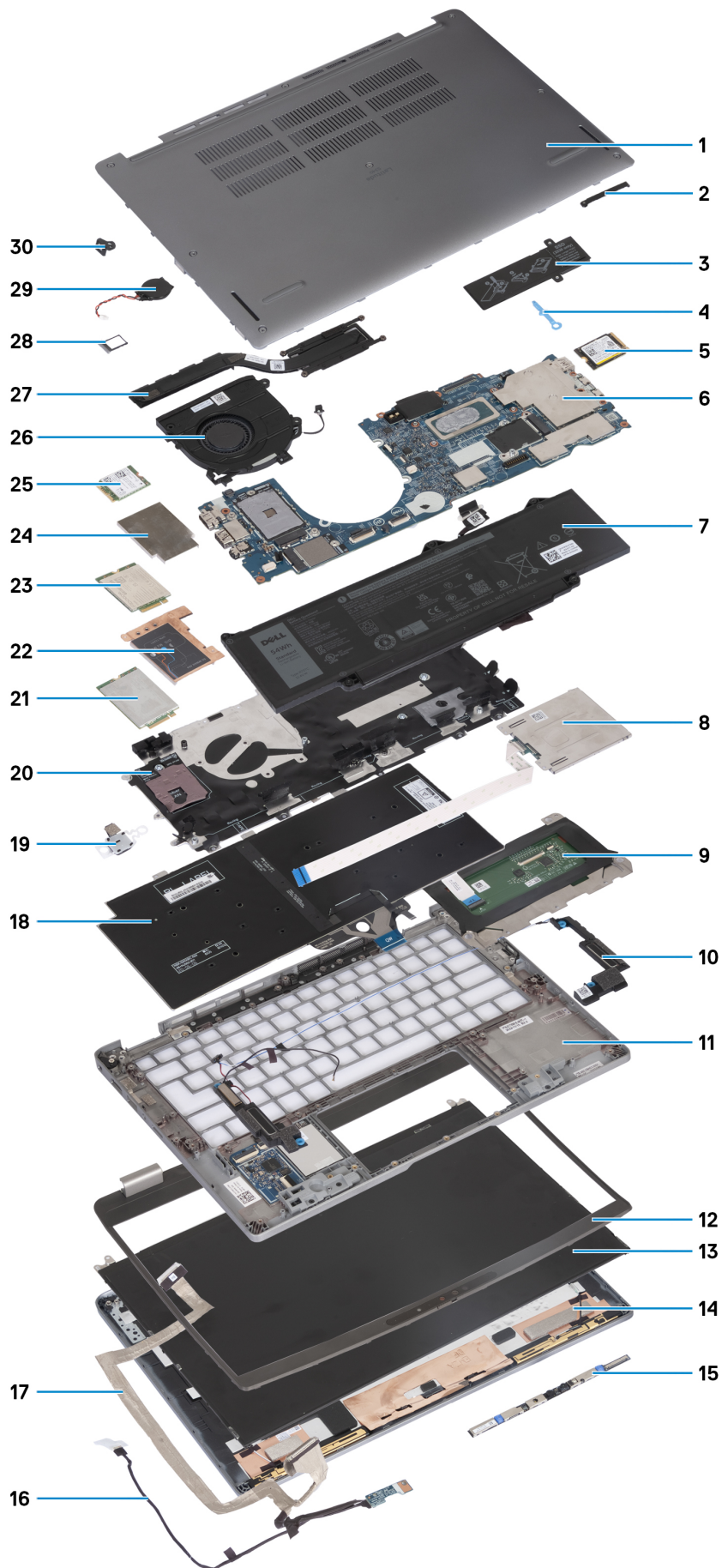

1. Base cover
3. Solid-state drive thermal plate
5. M.2 2230 solid-state drive
7. Battery
9. Touchpad
11. Palm rest assembly
13. Display panel
15. Camera
17. Camera cable
19. Power button
21. WWAN 5G card
23. WWAN 4G card
25. WLAN card
27. Heat sink
29. Coin-cell battery
2. eDP bracket
4. Solid-state drive hook
6. System board
8. Smart-card reader
10. Speakers
12. Display bezel
14. Display back cover
16. Display cable
18. Keyboard assembly
20. WWAN card slot
22. WWAN 5G thermal shield
24. WWAN 4G thermal shield
26. Fan
28. SIM card tray
30. N-lock bracket

 **NOTE:** Dell provides a list of components and their part numbers for the original system configuration purchased. These parts are available according to warranty coverages purchased by the customer. Contact your Dell sales representative for purchase options.

Removing and installing Customer Replaceable Units (CRUs)

The replaceable components in this chapter are Customer Replaceable Units (CRUs).

CAUTION: Customers can replace only the Customer Replaceable Units (CRUs) following the safety precautions and replacement procedures.

NOTE: The images in this document may differ from your computer depending on the configuration you ordered.

SIM card tray

Removing the SIM card tray

Prerequisites

Follow the procedure in [Before working inside your computer](#).

About this task

The following image provides a visual representation of the SIM card tray removal procedure.

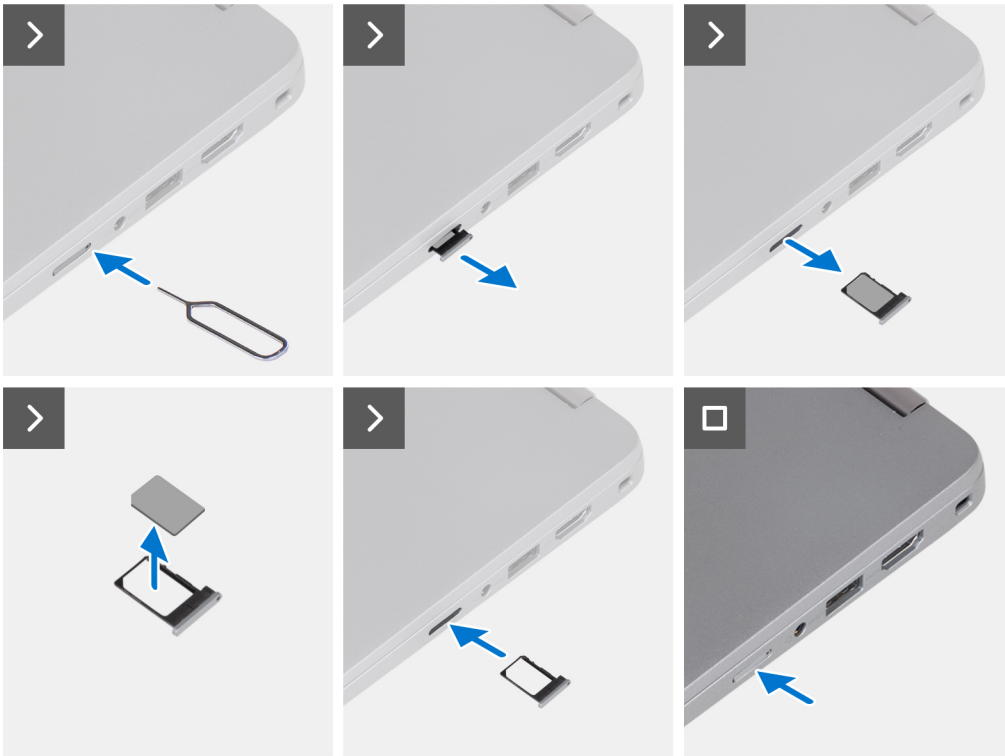

Steps

1. Insert a pin into the release hole to release the SIM card tray.
2. Push the pin to disengage the lock, and eject the SIM card tray.
3. Slide the SIM card tray out of the slot on the system.
4. Remove the SIM card from the SIM card tray.
5. Slide and push the SIM card tray back into the slot.

Installing the SIM card tray

Prerequisites

If you are replacing a component, remove the necessary component before the installation procedure.

About this task

The following image provides a visual representation of the SIM card tray installation procedure.

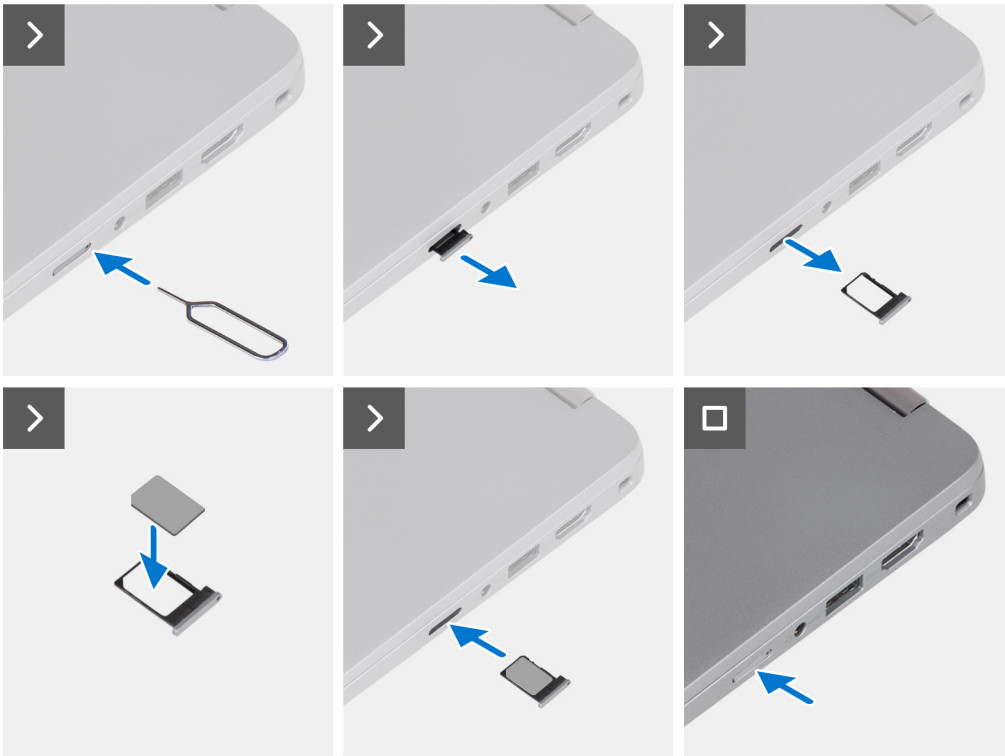

Steps

1. Insert a pin into the release hole to release the SIM card tray.
2. Push the pin to disengage the lock, and eject the SIM card tray.
3. Slide the SIM card tray out of the slot on the system.
4. Align and place the SIM card in the dedicated slot on the SIM card tray.
5. Slide the SIM card tray into the slot in the system, and push it to lock in place.

Next steps

Follow the procedure in [After working inside your computer](#).

Base cover

Removing the base cover

Prerequisites

1. Follow the procedure in [Before working inside your computer](#).

 **NOTE:** Ensure that your computer is in Service Mode. For more information see, [Before working inside your computer](#).

 **CAUTION:** If you are unable to turn on the computer, if your computer is unable to enter Service Mode, or the computer does not support Service Mode, proceed to disconnect the battery cable.

About this task

The following images indicate the location of the base cover and provide a visual representation of the removal procedure.



8x



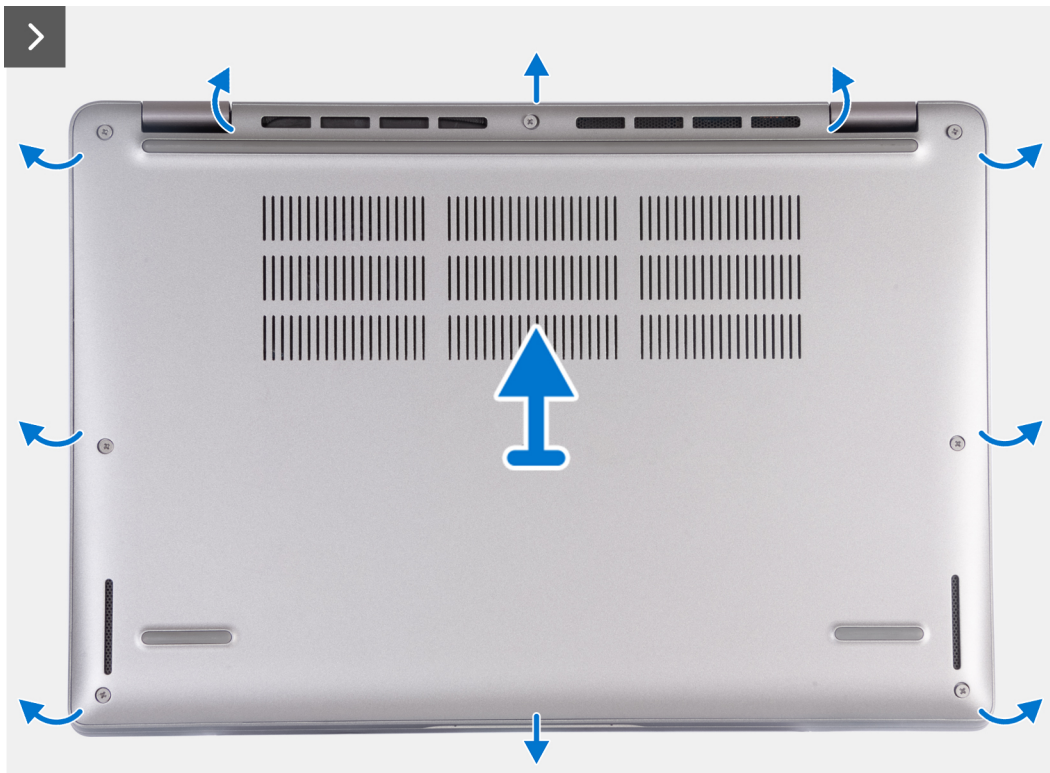

Steps

1. Loosen the eight captive screws that secure the base cover to the palm-rest assembly.
2. Using a plastic scribe, pry open the base cover from the recesses located in the U-shaped indents at the top edge of the base cover near the hinges.
3. Lift the base cover off the palm-rest assembly.
 - NOTE:** Ensure that your computer is in Service Mode. If your computer is unable to enter Service Mode, disconnect the battery cable from the system board. To disconnect the battery cable, follow step 4 to step 6.
4. Disconnect the battery cable from the system board.
5. Peel the tape that secures the battery cable to the battery.
6. Press and hold the power button for five seconds to ground the computer and drain the flea power.

Installing the base cover

Prerequisites

If you are replacing a component, remove the existing component before performing the installation procedure.

About this task

The following images indicate the location of the base cover and provide a visual representation of the installation procedure.

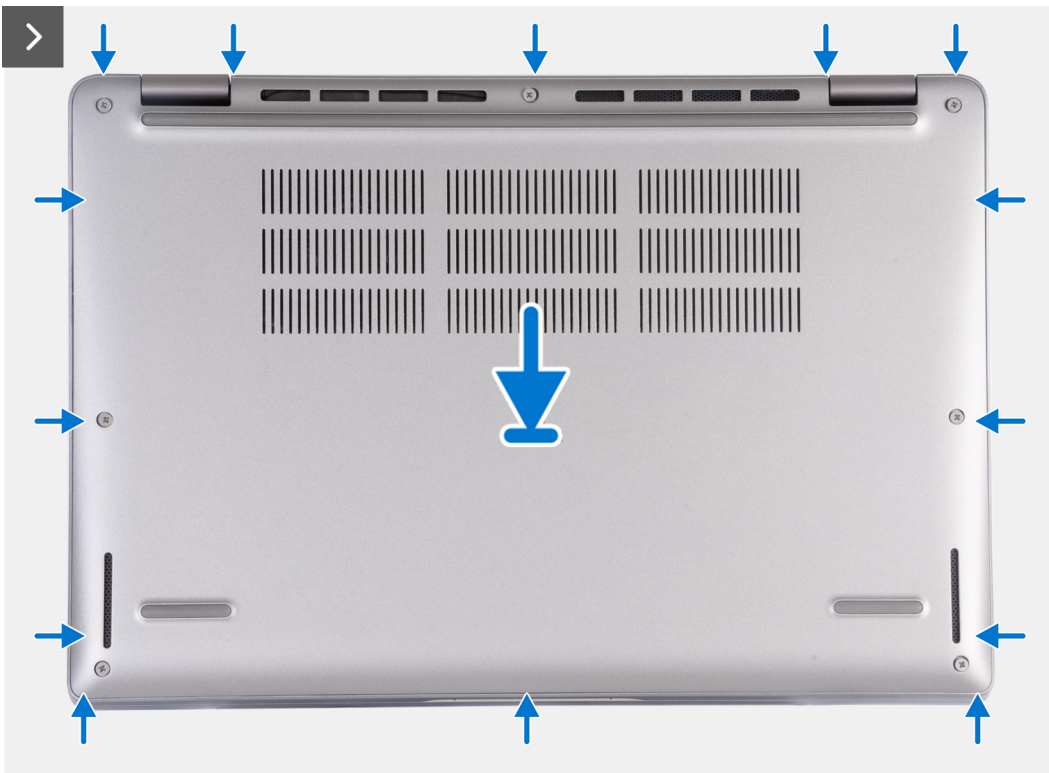



8x



i NOTE:

If battery is not a pre-requisite and if you have disconnected the battery cable, ensure to connect the battery cable. To connect the battery cable, follow step 1 and step 2 in the procedure.

Steps

1. Connect the battery cable to the system board.
2. Adhere the tape that secures the battery cable to the battery.
3. Align the tabs on the base cover with the slots on the system and snap the base cover to the palm-rest assembly.
4. Tighten the eight captive screws to secure the base cover to the palm-rest assembly.

Next steps

1. Follow the procedure in [After working inside your computer](#).

i NOTE: Ensure that your computer is in Service Mode. For more information see, [Before working inside your computer](#).

WLAN card

Removing the WLAN card

Prerequisites

1. Follow the procedure in [Before working inside your computer](#).
2. Remove the [base cover](#).

About this task

The following images indicate the location of the WLAN card and provide a visual representation of the removal procedure.

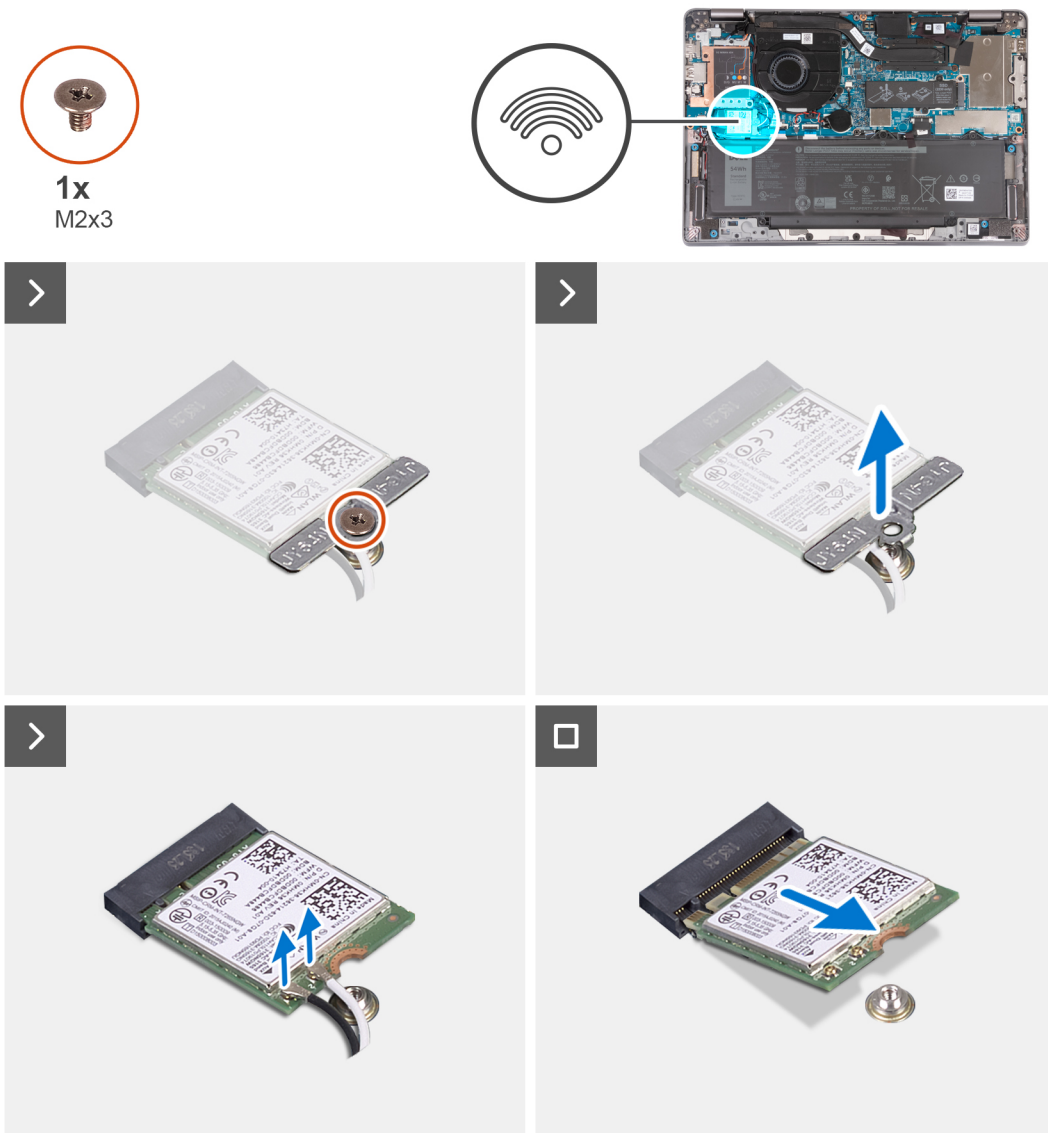

Steps

1. Remove the screw (M2x3) that secures the WLAN-card bracket to the system board.
2. Lift the WLAN-card bracket from the WLAN card.
3. Disconnect the antenna cables from the WLAN card.
4. Slide and remove the WLAN card from the WLAN-card slot on the system board.

Installing the WLAN card

Prerequisites

If you are replacing a component, remove the existing component before performing the installation procedure.

About this task

The following images indicate the location of the WLAN card and provides a visual representation of the installation procedure.

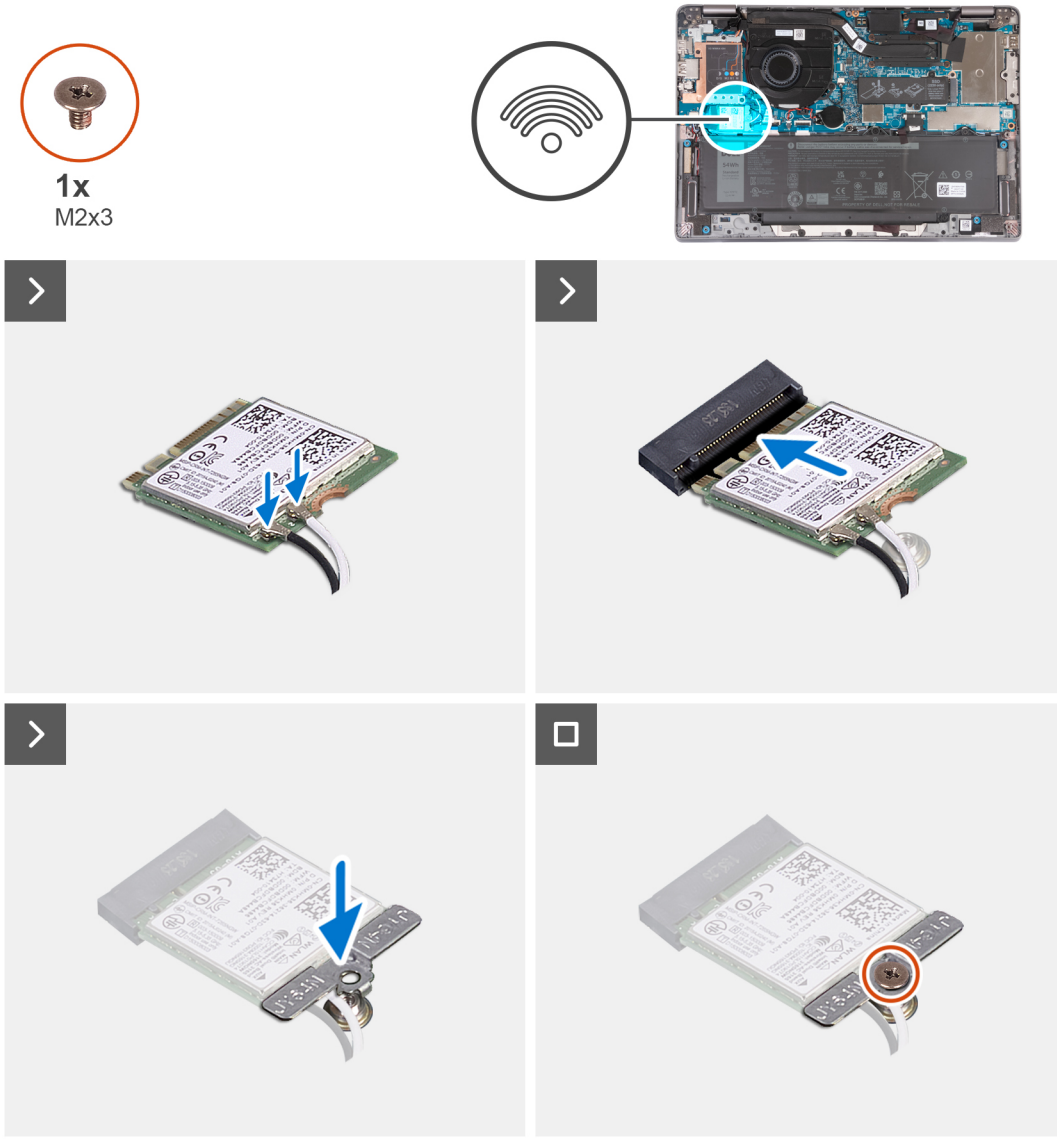

Steps

1. Connect the antenna cables to the WLAN card.

The following table provides the antenna-cable color scheme for the wireless card supported by your computer.

Table 29. Antenna-cable color scheme

Connectors on the wireless card	Antenna-cable color	Silkscreen marking	
Main	White	MAIN	△ (white triangle)
Auxiliary	Black	AUX	▲ (black triangle)

2. Align the notch on the WLAN card with the tab on the WLAN-card slot and insert the WLAN card into the WLAN-card slot.
3. Align and place the WLAN-card bracket on the WLAN card.
4. Replace the screw (M2x3) to secure the WLAN-card bracket to the system board.

Next steps

1. Install the [base cover](#).
2. Follow the procedure in [After working inside your computer](#).

WWAN card

Removing the WWAN 5G card

Prerequisites

1. Follow the procedure in [Before working inside your computer](#).
2. Remove the [base cover](#).

About this task

 **NOTE:** When you replace the system board, transfer the reuseable WWAN thermal pad on mylar to the new system board.

The following images indicate the location of the WWAN 5G card and provide a visual representation of the removal procedure.



1x
M2x3.5



2x
M2x3

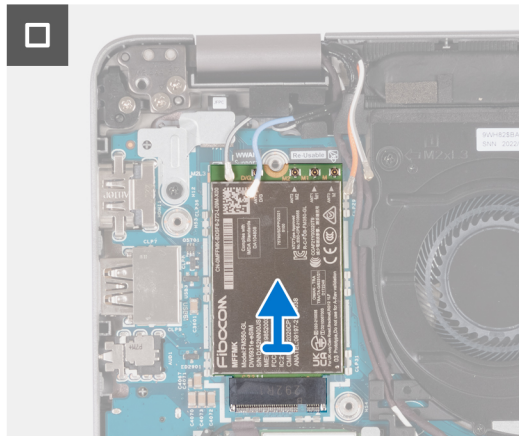
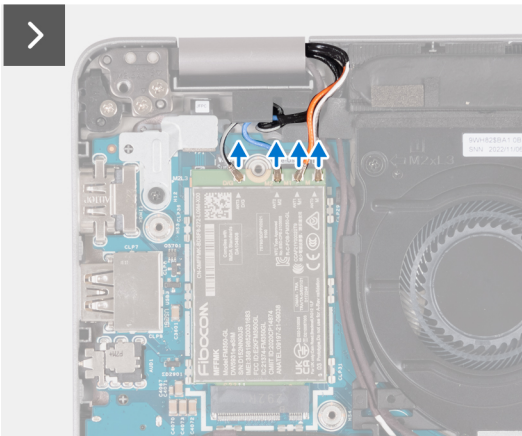
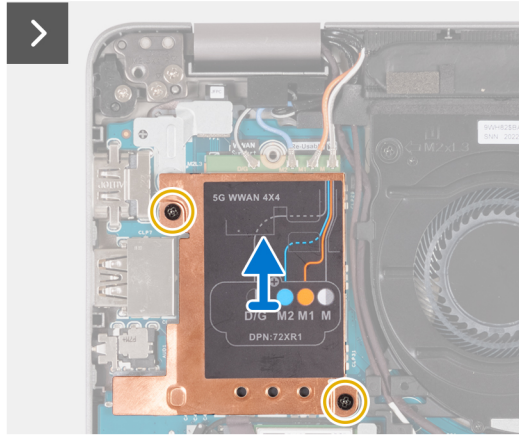
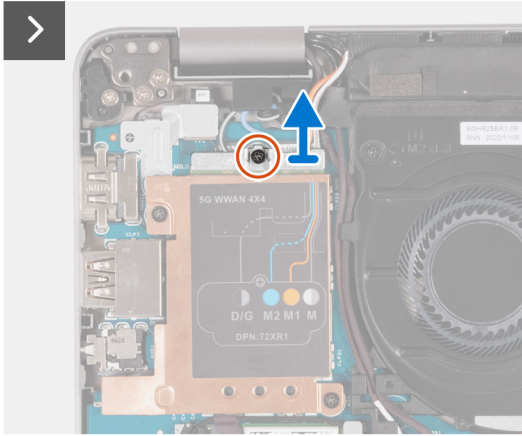
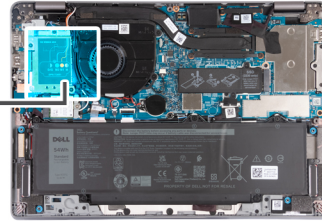

Steps

1. Remove the screw (M2x3.5) that secures the WWAN-card bracket to the WWAN 5G card.
2. Remove the two screws (M2x3) that secure the WWAN-thermal shield to the WWAN 5G card.
3. Lift the WWAN-thermal shield out of the system.
4. Disconnect the antenna cables from the connectors on the WWAN card.
5. Slide and remove the WWAN 5G card from the WWAN-card slot.

Installing the WWAN 5G card

Prerequisites

If you are replacing a component, remove the existing component before performing the installation procedure.

About this task

The following images indicate the location of the WWAN 5G card and provides a visual representation of the installation procedure.

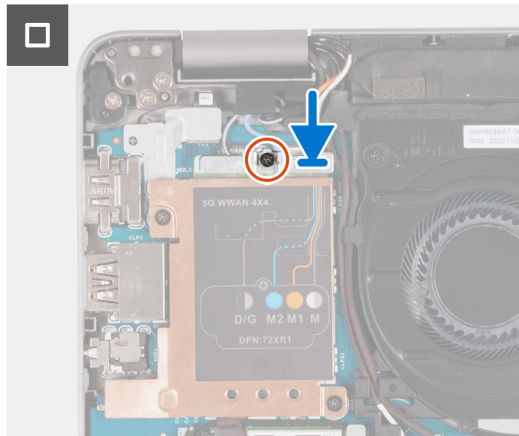
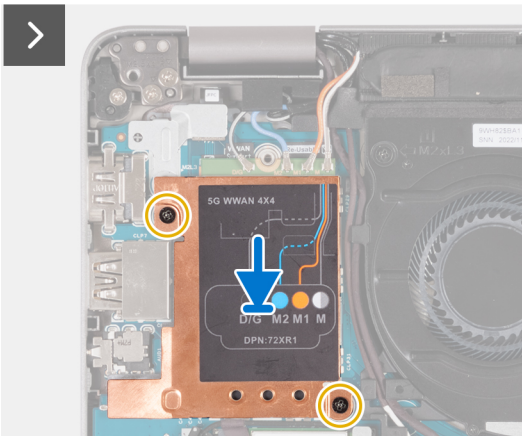
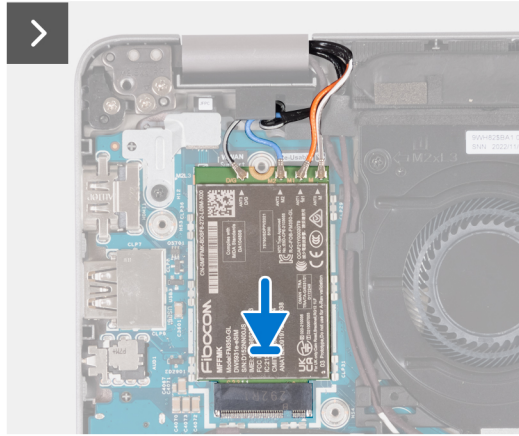
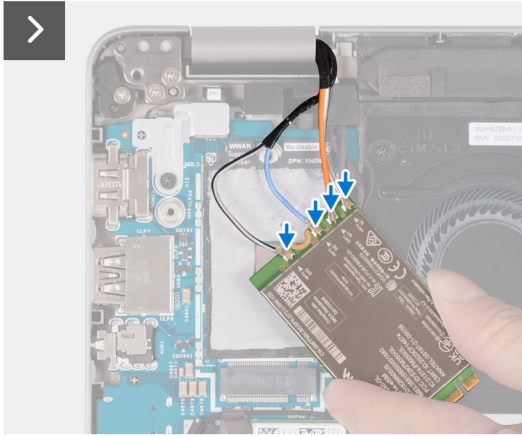

NOTE: For instructions on how to find your computer's IMEI (International Mobile Station Equipment Identity) number, see the knowledge base article [000143678](http://www.dell.com/support) at www.dell.com/support.

Steps

1. Connect the antenna cables to the connectors on the WWAN 5G card.

The following table provides the antenna-cable color scheme for the WWAN 5G card supported by your computer.

Table 30. Antenna-cable color scheme

Connectors on the WWAN card	Antenna-cable color	Silkscreen marking	
D/G	Black with a thin white stripe	ANT3 D/G	△ (white triangle)
M2	Blue	ANT2 M2	△ (white triangle)
M1	Orange	ANT1 M1	△ (white triangle)
M	White with a thin gray stripe	ANT0 M	△ (white triangle)

2. Align the notch on the WWAN card and slide the WWAN 5G card at an angle into the WWAN-card slot.

3. Align and place the WWAN-thermal shield on the WWAN 5G card, and tighten the two screws (M2x3).
4. Align and place the WWAN-card bracket the WWAN 5G card and tighten the screw (M2x3.5).

Next steps

1. Install the [base cover](#).
2. Follow the procedure in [After working inside your computer](#).

Removing the WWAN 4G card

Prerequisites

1. Follow the procedure in [Before working inside your computer](#).
2. Remove the [base cover](#).

About this task

 **NOTE:** When you replace the system board, transfer the reusable WWAN thermal pad on mylar to the new system board.

The following images indicate the location of the WWAN 4G card and provide a visual representation of the removal procedure.



1x
M2x3.5

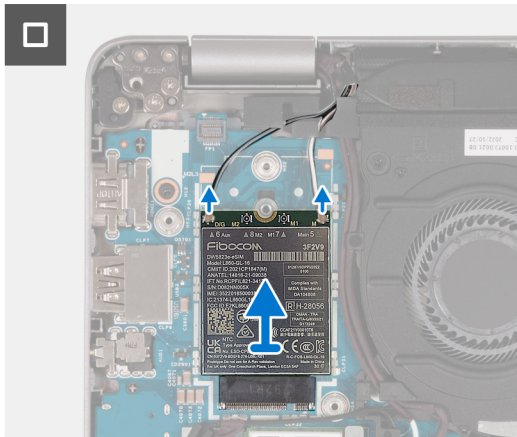
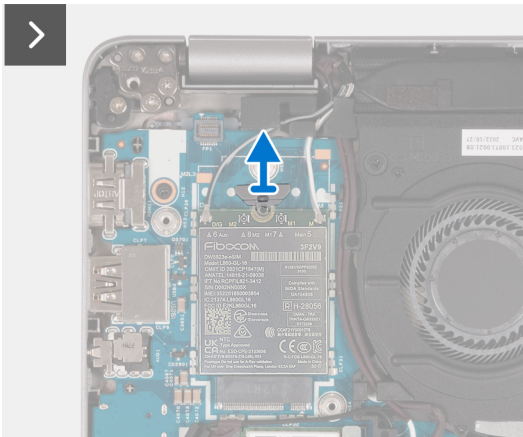
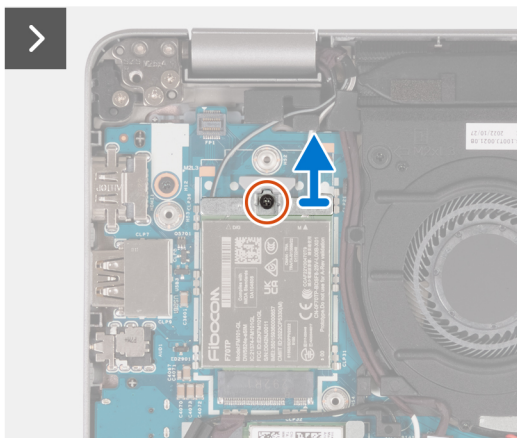
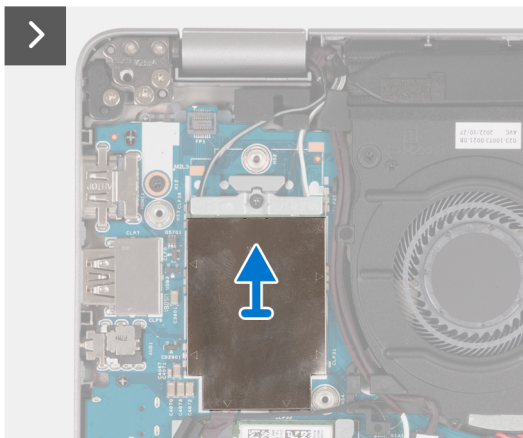

Steps

1. Remove the WWAN-thermal shield covering the WWAN 4G card.
2. Remove the screw (M2x3.5) that secures the WWAN-card bracket to the WWAN 4G card.
3. Lift the WWAN-card bracket out of the system board.
4. Disconnect the antenna cables from the WWAN card.
5. Slide and remove the WWAN 4G card from the WWAN-card slot.

Installing the WWAN 4G card

Prerequisites

If you are replacing a component, remove the existing component before performing the installation procedure.

About this task

The following images indicate the location of the WWAN 4G card and provides a visual representation of the installation procedure.



1x
M2x3.5

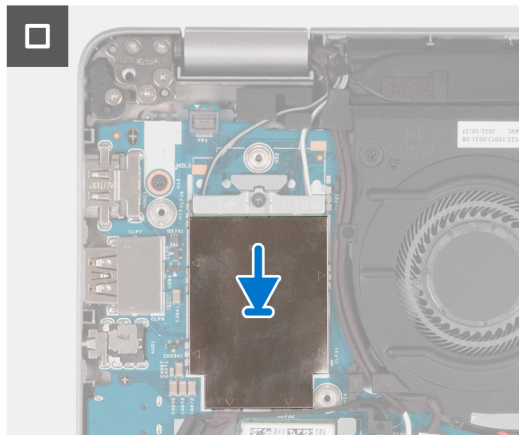
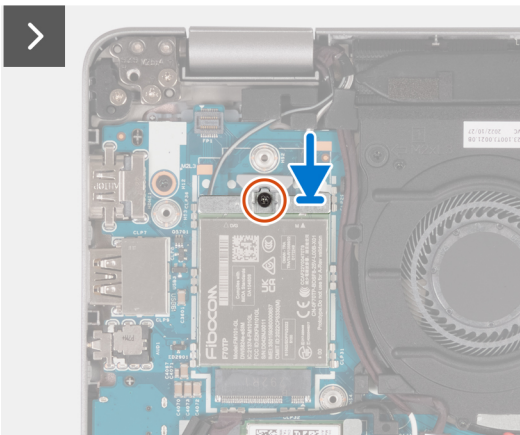
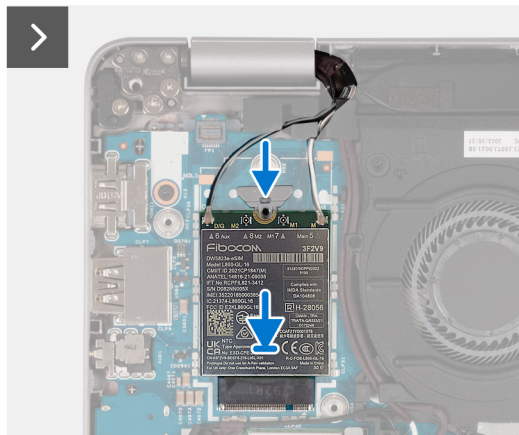
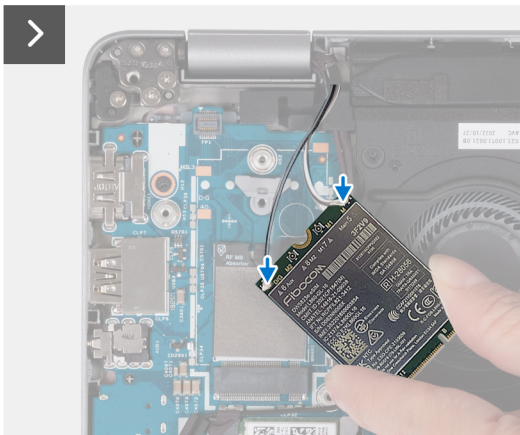
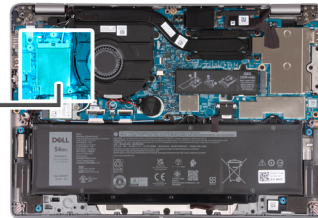

NOTE: For instructions on how to find your computer's IMEI (International Mobile Station Equipment Identity) number, see the knowledge base article [000143678](https://www.dell.com/support) at www.dell.com/support.

Steps

1. Connect the antenna cables to the connectors on the WWAN 4G card.

The following table provides the antenna-cable color scheme for the WWAN card supported by your computer.

Table 31. Antenna-cable color scheme

Connectors on the wireless card	Antenna-cable color	Silkscreen marking	
Main	White	MAIN	△ (white triangle)
Auxiliary	Black	AUX	▲ (black triangle)

2. Align the notch on the WWAN card and slide the WWAN 4G card into the WWAN-card slot.
3. Align and place the WWAN-card bracket on the WWAN 4G card, and tighten the screw (M2x3.5).
4. Replace the WWAN-thermal shield covering the WWAN 4G card.

Next steps

1. Install the [base cover](#).
2. Follow the procedure in [After working inside your computer](#).

M.2 solid-state drive

Removing the M.2 2230 solid-state drive

Prerequisites

1. Follow the procedure in [Before working inside your computer](#).
2. Remove the [base cover](#).

About this task

The following images indicate the location of the solid-state drive and provide a visual representation of the removal procedure of M.2 2230 SSD.



2x
M2x2.5

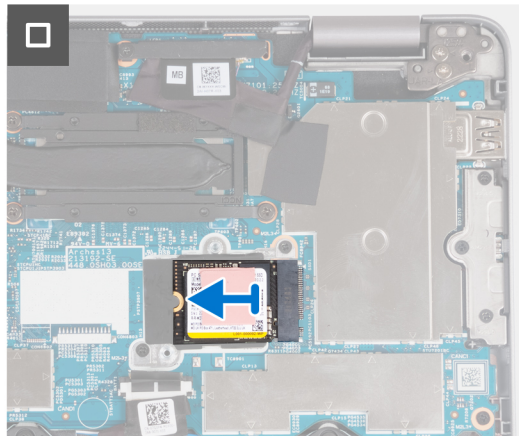
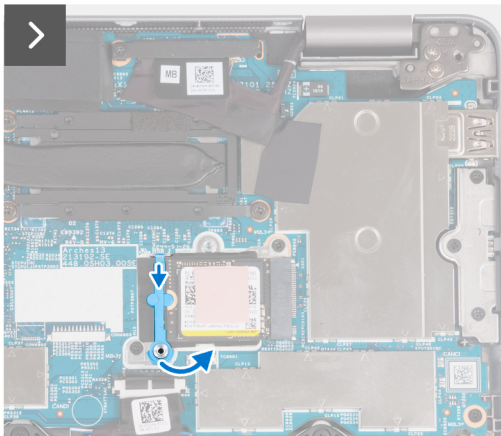
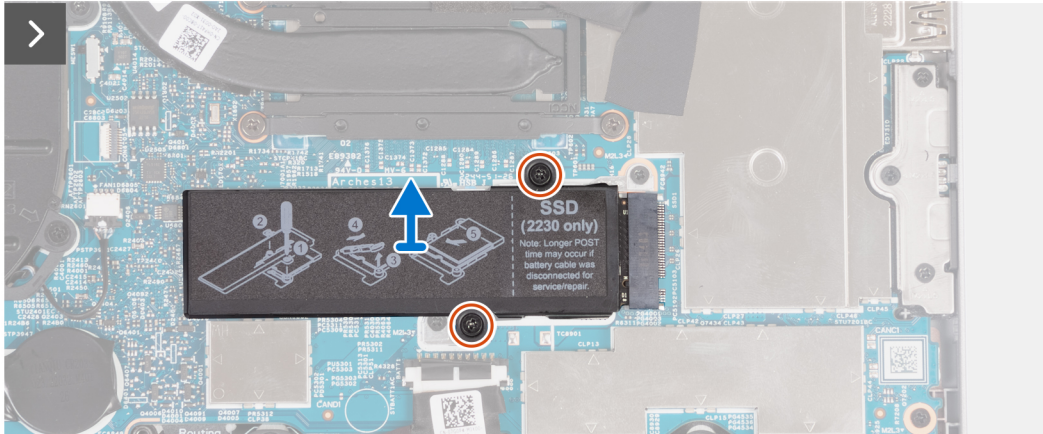
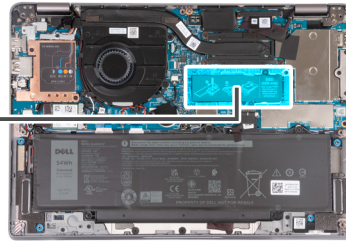

Steps

1. Remove the two screws (M2x2.5) that secure the solid-state drive thermal plate to the system board.
2. Lift the solid-state drive thermal plate from the solid-state drive..

NOTE: If the thermal pad located on the thermal plate, gets detached, adhere it back to the solid-state drive thermal plate.

3. Lift the solid-state drive holder and carefully release it from the hook to remove it.
4. Slide and remove the solid-state drive from the solid-state drive slot on the system board.

Installing the M.2 2230 solid-state drive

Prerequisites

If you are replacing a component, remove the existing component before performing the installation procedure.

About this task

The following images indicate the location of the solid-state drive and provides a visual representation of the installation procedure of M.2 2230 SSD.

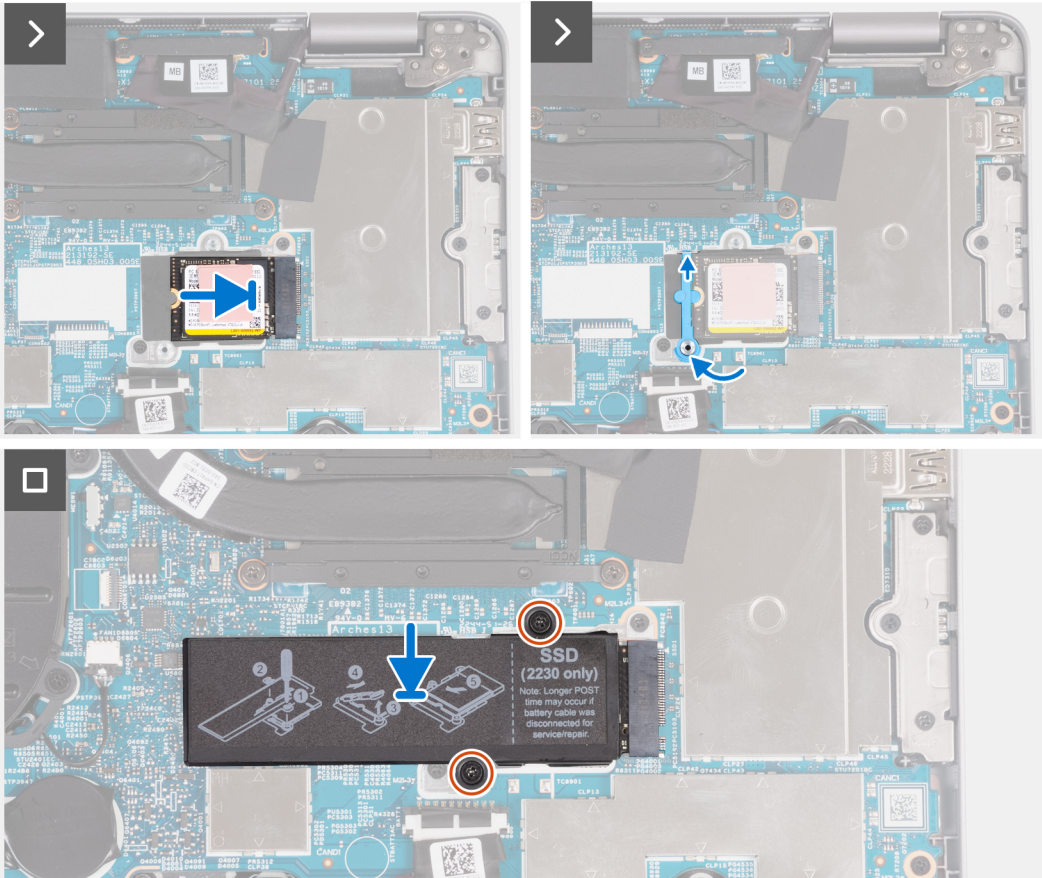
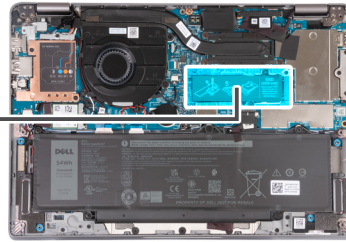

Steps

1. Align the notch on the solid-state drive with the tab on the M.2 card slot.
2. Slide the solid-state drive into the M.2 card slot.
3. Slide the solid-state drive holder over the hook and press it down.
4. Align the solid-state drive thermal plate and firmly press to cover the solid-state drive.
5. Replace the two screws (M2x2.5) that secure the solid-state drive thermal plate to the system board.

Next steps

1. Install the [base cover](#).
2. Follow the procedure in [After working inside your computer](#).

Fan

Removing the fan

Prerequisites

1. Follow the procedure in [Before working inside your computer](#).
2. Remove the [base cover](#).
3. Remove the [WLAN card](#).

About this task

The following images indicate the location of the fan and provide a visual representation of the removal procedure.



3x
M2x3

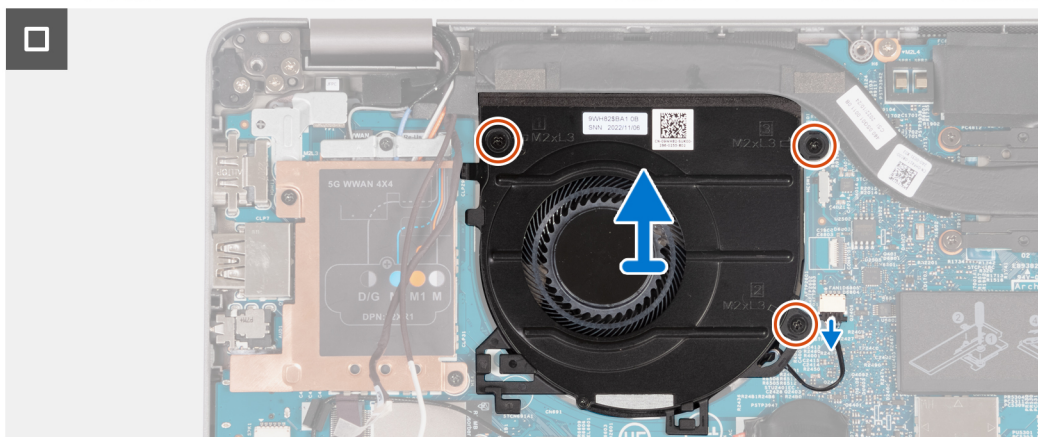
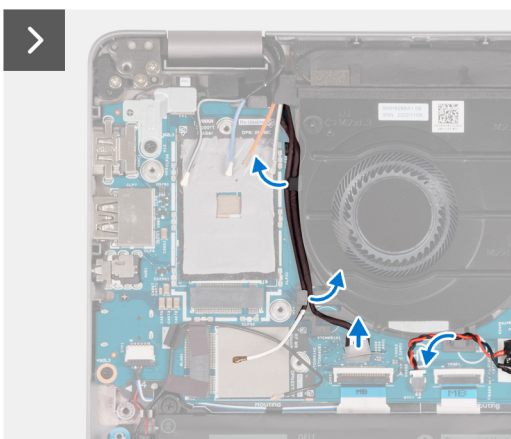
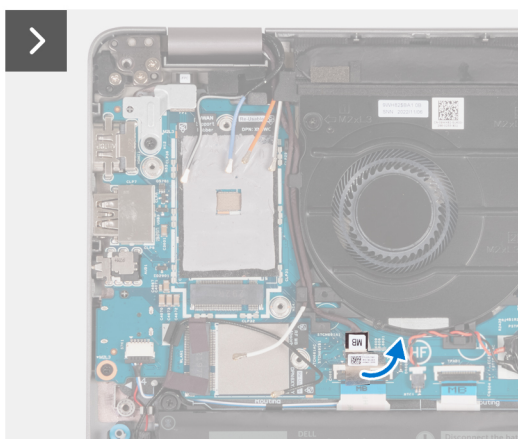
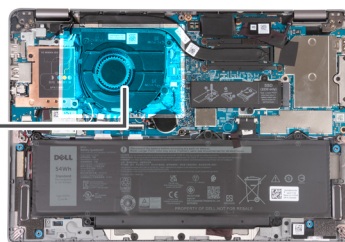
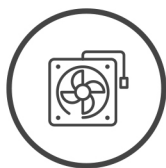

Steps

1. Carefully peel off the mylar from the sensor board cable.
2. Disconnect the sensor board cable from the system board.
3. Note the WLAN antenna cable routing, and remove the WLAN antenna cables from the routing guide on the fan.
4. Remove the coin-cell battery cable from the routing guide on the fan.

5. Disconnect the fan cable from the system board.
6. Remove the three screws (M2x3) that secure the fan to the palm-rest assembly.
7. Remove the fan from the system board.

Installing the fan

Prerequisites

If you are replacing a component, remove the existing component before performing the installation procedure.

About this task

The following image indicates the location of the fan and provides a visual representation of the installation procedure.

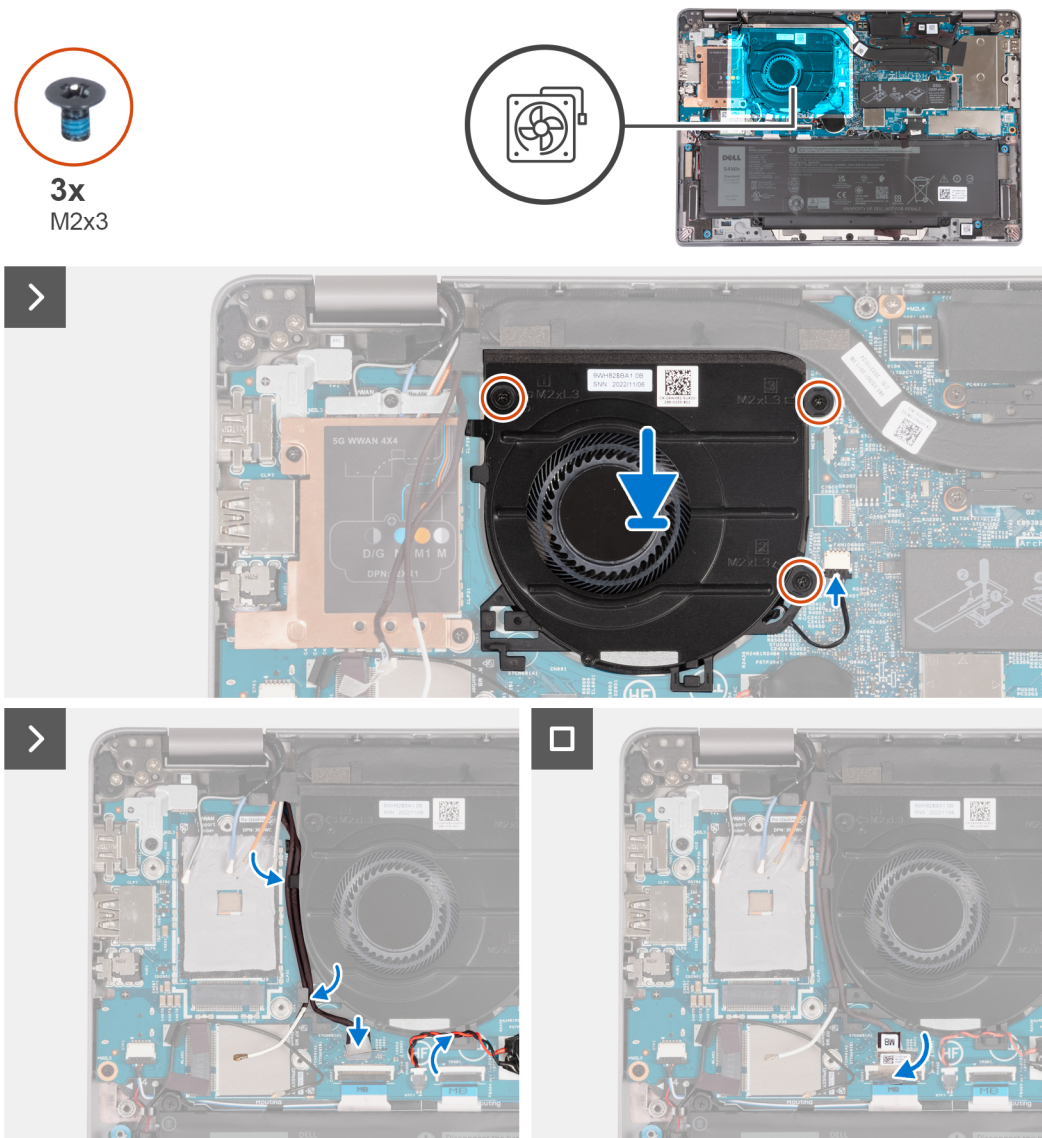

Steps

1. Align the screw holes on the fan with the screw holes on the system board.
2. Replace the three screws (M2x3) to secure the fan to the palm-rest assembly.
3. Connect the fan cable to the system board.
4. Route the WLAN antenna cables through the routing guides on the fan.
5. Route the coin-cell battery cable through the routing guide on the fan.

6. Connect the sensor board cable to the system board.
7. Adhere the mylar to the sensor board cable.

Next steps

1. Install the [WLAN card](#).
2. Install the [base cover](#).
3. Follow the procedure in [After working inside your computer](#).

Removing and installing Field Replaceable Units (FRUs)

The replaceable components in this chapter are Field Replaceable Units (FRUs).

CAUTION: The information in this section is intended for authorized service technicians only.

CAUTION: To avoid any potential damage to the component or loss of data, ensure that an authorized service technician replaces the Field Replaceable Units (FRUs).

CAUTION: Dell Technologies recommends that this set of repairs, if needed, to be conducted by trained technical repair specialists.

CAUTION: As a reminder, your warranty does not cover damages that may occur during the courses of FRU repairs that are not authorized by Dell Technologies.

NOTE: The images in this document may differ from your computer depending on the configuration you ordered.

Battery

Removing the battery

Prerequisites

CAUTION: The information in this section is intended for authorized service technicians only.

1. Follow the procedure in [Before working inside your computer](#).
2. Remove the [base cover](#).

About this task

NOTE: Latitude 5340 supports both 3-cell 42 WHr and 3-cell 54 WHr battery configurations.

The following image indicates the location of the 3-cell 54 WHr battery and provides a visual representation of the removal procedure.

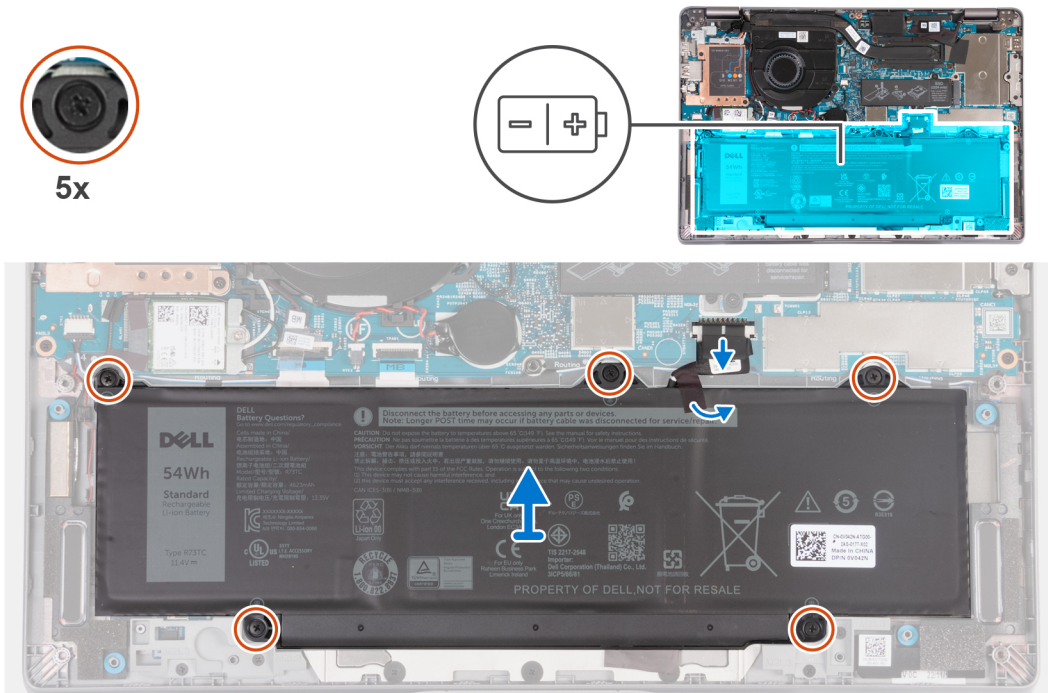

Steps

1. Disconnect the battery cable from the system board.
2. Peel off the mylar securing the battery.
3. Loosen the five captive screws that secure the battery to the palm-rest assembly.
4. Lift the battery off the palm-rest assembly.

Installing the battery

Prerequisites

CAUTION: The information in this section is intended for authorized service technicians only.

If you are replacing a component, remove the existing component before performing the installation procedure.

About this task

NOTE: Latitude 5340 supports both 3-cell 42 WHr and 3-cell 54 WHr battery configurations.

The following image indicates the location of the 3-cell 54 WHr battery and provides a visual representation of the installation procedure.

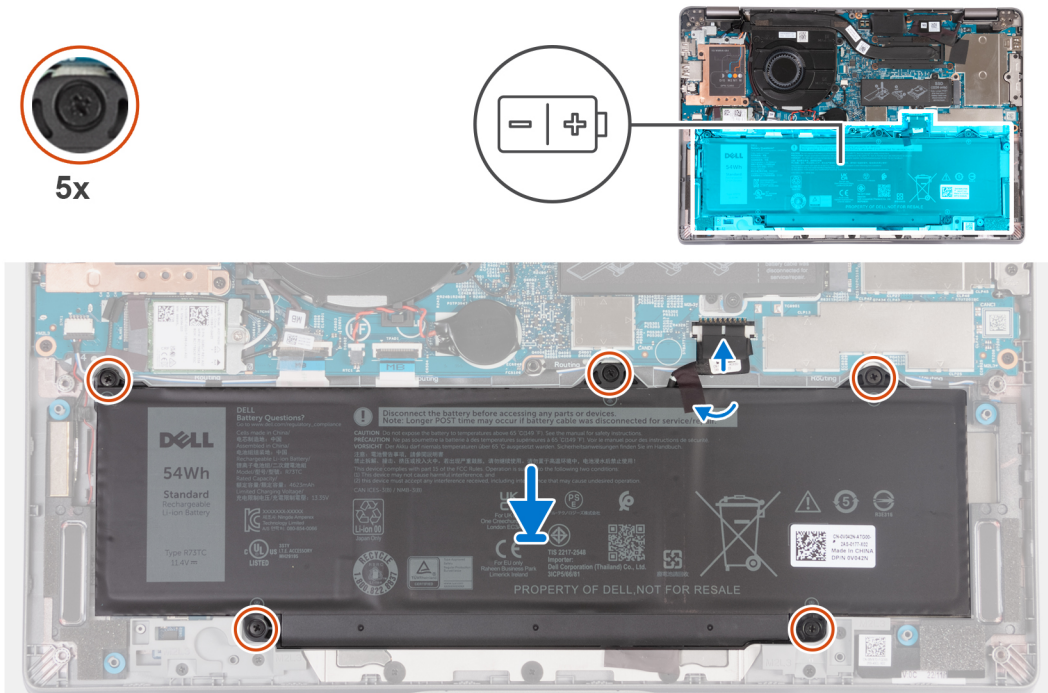

Steps

1. Align the screw holes on the battery with the screw holes on the palm-rest assembly.
2. Tighten the five captive screws to secure the battery in place.
3. Connect the battery cable to the system board.
4. Adhere the mylar to the battery.

Next steps

1. Install the [base cover](#).
2. Follow the procedure in [After working inside your computer](#).

Battery cable

Removing the battery cable

Prerequisites

CAUTION: The information in this section is intended for authorized service technicians only.

1. Follow the procedure in [Before working inside your computer](#).
2. Remove the [base cover](#).
3. Remove the [battery](#).

NOTE: If battery is disconnected from system board for service, then there is a delay during system boot as the system undergoes RTC battery reset.

About this task

The following images indicate the location of the battery cable and provide a visual representation of the removal procedure.

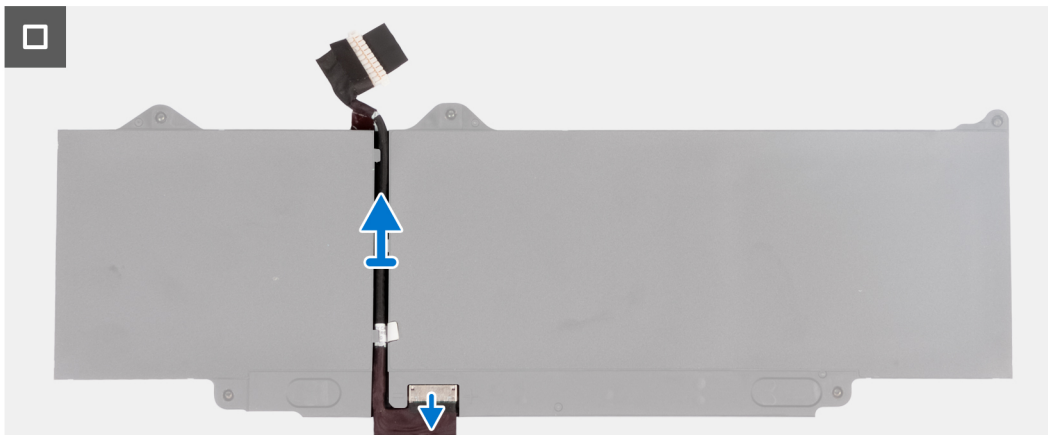
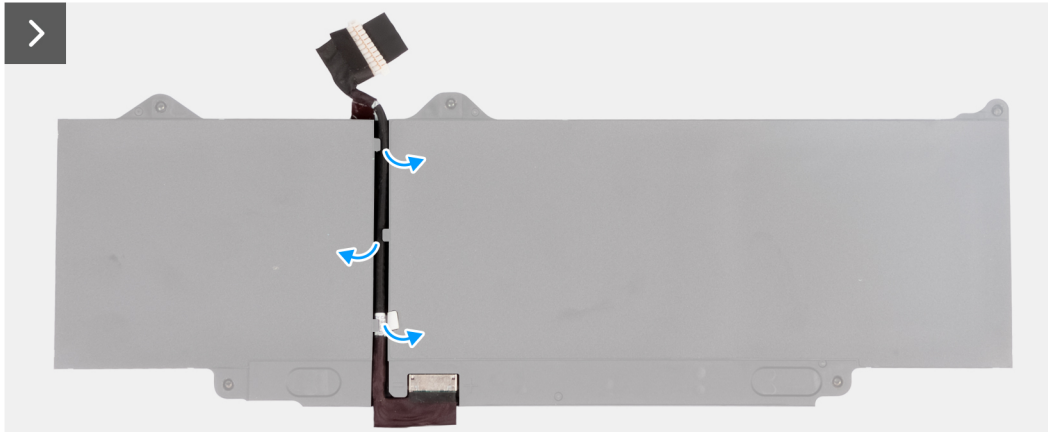
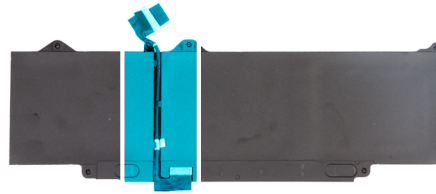

Steps

1. Flip the battery and peel off the tape that adheres the battery cable to the battery.
2. Remove the battery cable from the routing guides on the battery.
3. Disconnect the battery cable from the connector on the battery.
4. Remove the battery cable from the battery.

Installing the battery cable

Prerequisites

 **CAUTION:** The information in this section is intended for authorized service technicians only.

If you are replacing a component, remove the existing component before performing the installation procedure.

About this task

The following image indicates the location of the battery cable and provides a visual representation of the installation procedure.

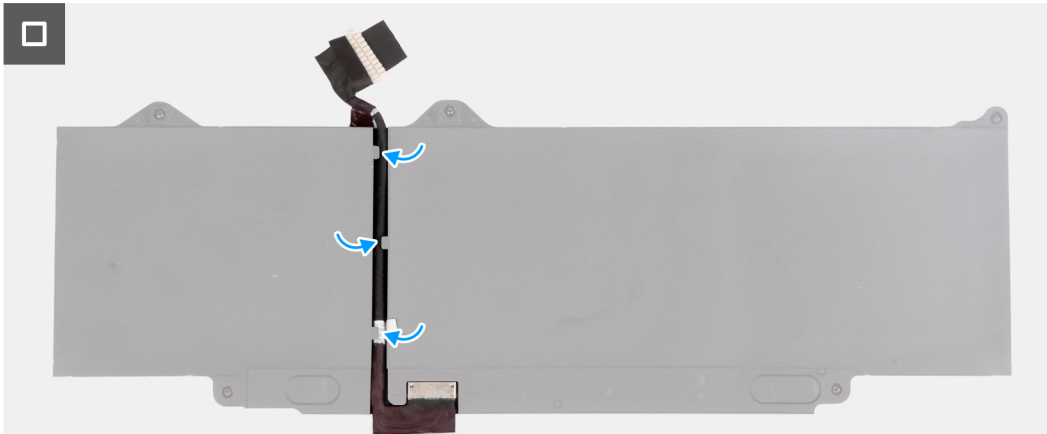
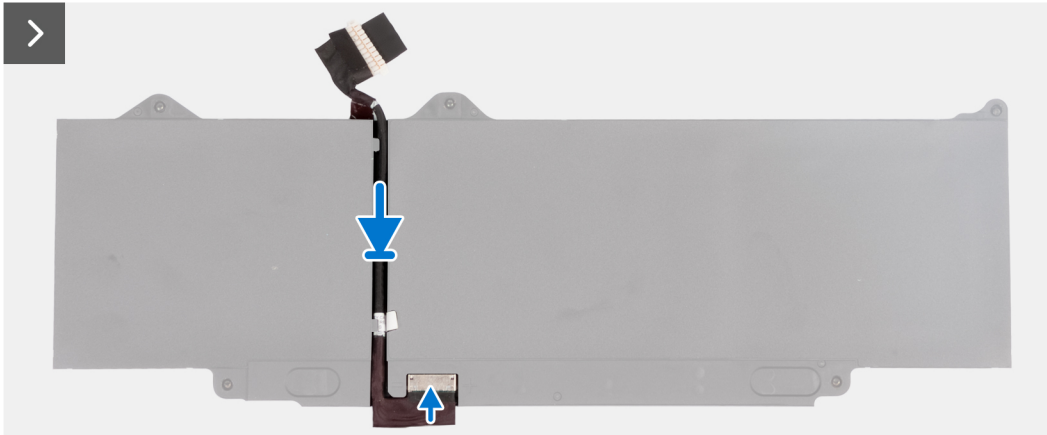
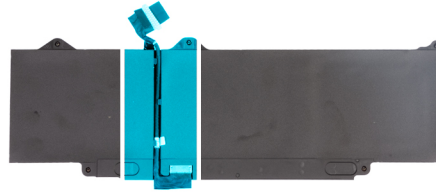

Steps

1. Align and route the battery cable through the routing guides on the battery.
2. Adhere the tape that secures the battery cable to the battery.
3. Connect the battery cable to the connector on the battery.
4. Flip over the battery.

Next steps

1. Install the [battery](#).
2. Install the [base cover](#).
3. Follow the procedure in [After working inside your computer](#).

Coin-cell battery

Removing the coin-cell battery

Prerequisites

 **CAUTION:** The information in this section is intended for authorized service technicians only.

1. Follow the procedure in [Before working inside your computer](#).

CAUTION: Removing the coin-cell battery resets the BIOS setup program's settings to default. It is recommended that you note the BIOS setup program's settings before removing the coin-cell battery.

2. Remove the [base cover](#).

About this task

The following image indicates the location of the coin-cell battery and provides a visual representation of the removal procedure.

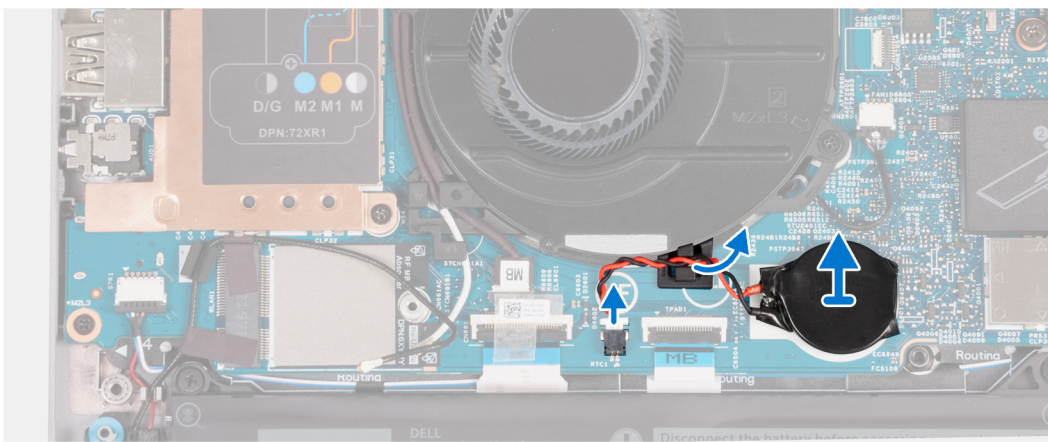
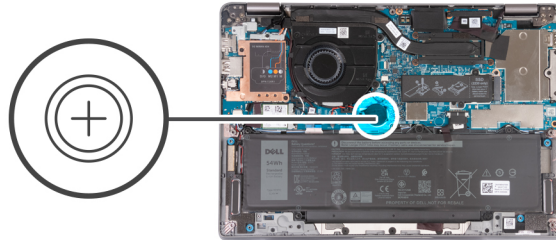

Steps

1. Disconnect the coin-cell battery cable from the connector on the system board.
2. Unroute the coin-cell battery cable from the routing guides on the system board.
3. Lift the coin-cell battery from the system board.

Installing the coin-cell battery

Prerequisites

CAUTION: The information in this section is intended for authorized service technicians only.

If you are replacing a component, remove the existing component before performing the installation procedure.

About this task

The following image indicates the location of the coin-cell battery and provides a visual representation of the installation procedure.

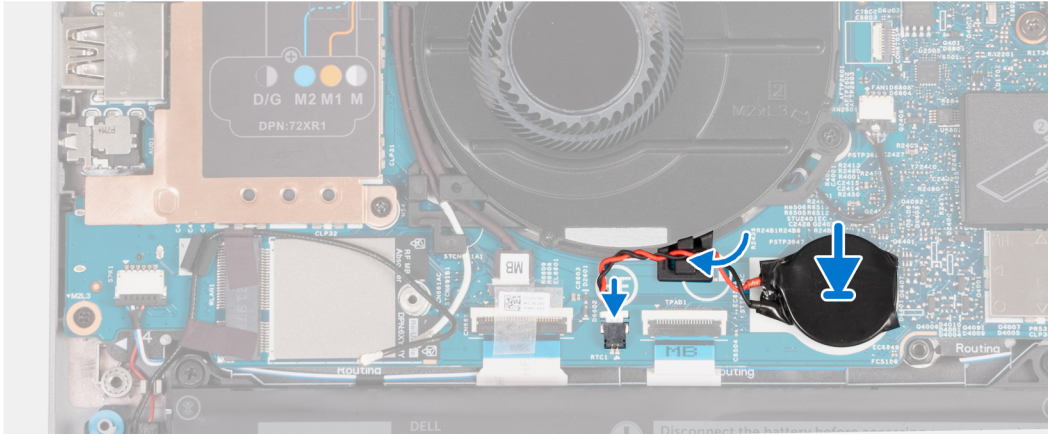
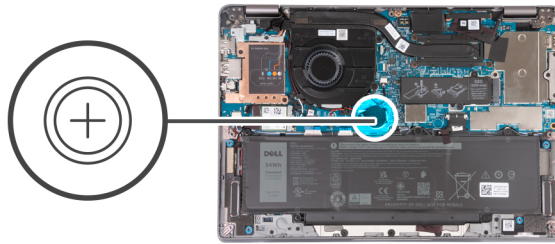

Steps

1. Adhere the coin-cell battery to the slot on the system board.
2. Route the coin-cell battery cable through the routing guide on the system board.
3. Connect the coin-cell battery cable to the connector on the system board.

Next steps

1. Install the [base cover](#).
2. Follow the procedure in [After working inside your computer](#).

Heat sink

Removing the heat sink

Prerequisites

CAUTION: The information in this section is intended for authorized service technicians only.

- NOTE:** The heat sink may become hot during normal operation. Allow sufficient time for the heat sink to cool before you touch it.
- NOTE:** For maximum cooling of the processor, do not touch the heat transfer areas on the heat sink. The oils in your skin can reduce the heat transfer capability of the thermal grease.

1. Follow the procedure in [Before working inside your computer](#).
2. Remove the [base cover](#).
3. Remove the [battery](#).

About this task

The following images indicate the location of the heat sink and provide a visual representation of the removal procedure.



4x

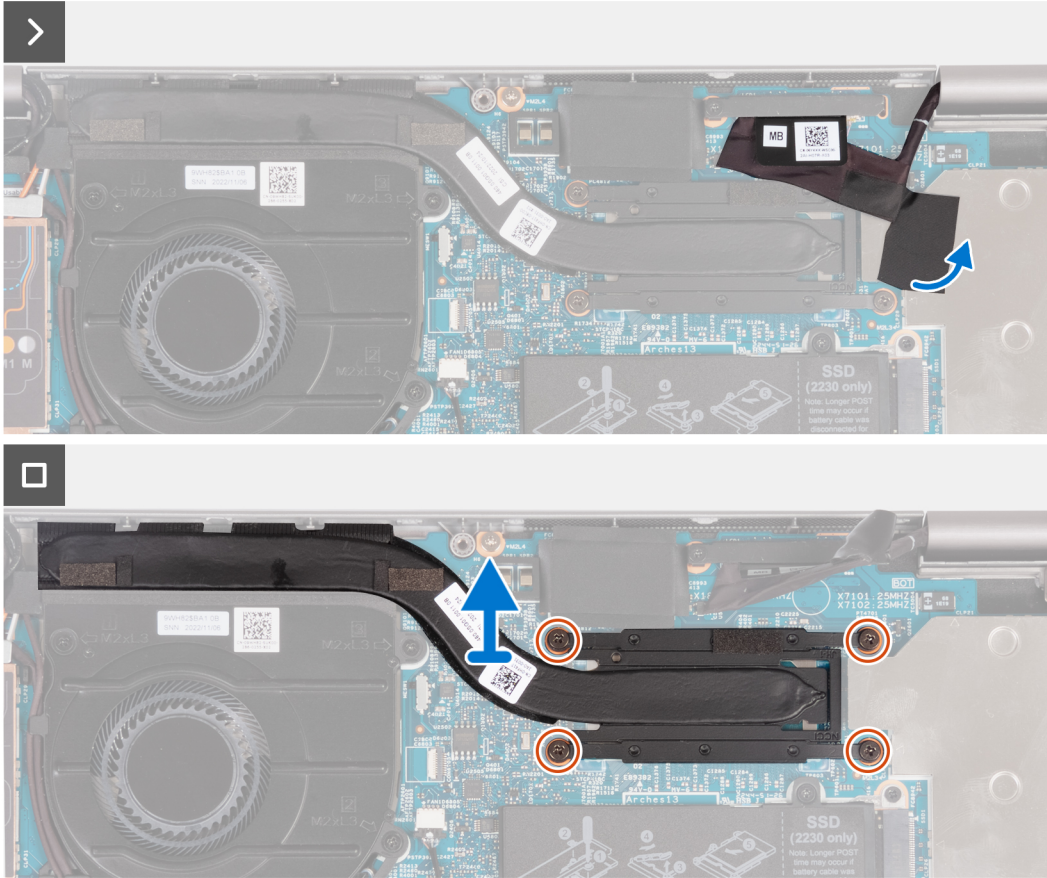
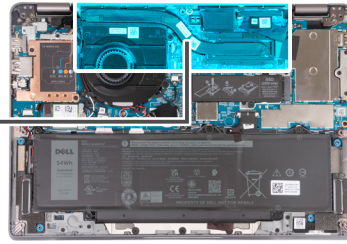

Steps

1. Peel the tape that secures the eDP cable to show the hidden captive screw on the heat sink.
2. Loosen the four captive screws in reverse sequential order (4 > 3 > 2 > 1) as indicated by the numbers on the heat sink.
3. Lift the heat sink off the system board.

Installing the heat sink

Prerequisites

⚠ CAUTION: The information in this section is intended for authorized service technicians only.

If you are replacing a component, remove the existing component before performing the installation procedure.

i NOTE: Incorrect alignment of the heat sink can damage the system board and processor.

i NOTE: If either the system board or the heat sink is replaced, use the thermal pad/paste provided in the kit to ensure that thermal conductivity is achieved.

About this task

The following image indicates the location of the heat sink and provides a visual representation of the installation procedure.

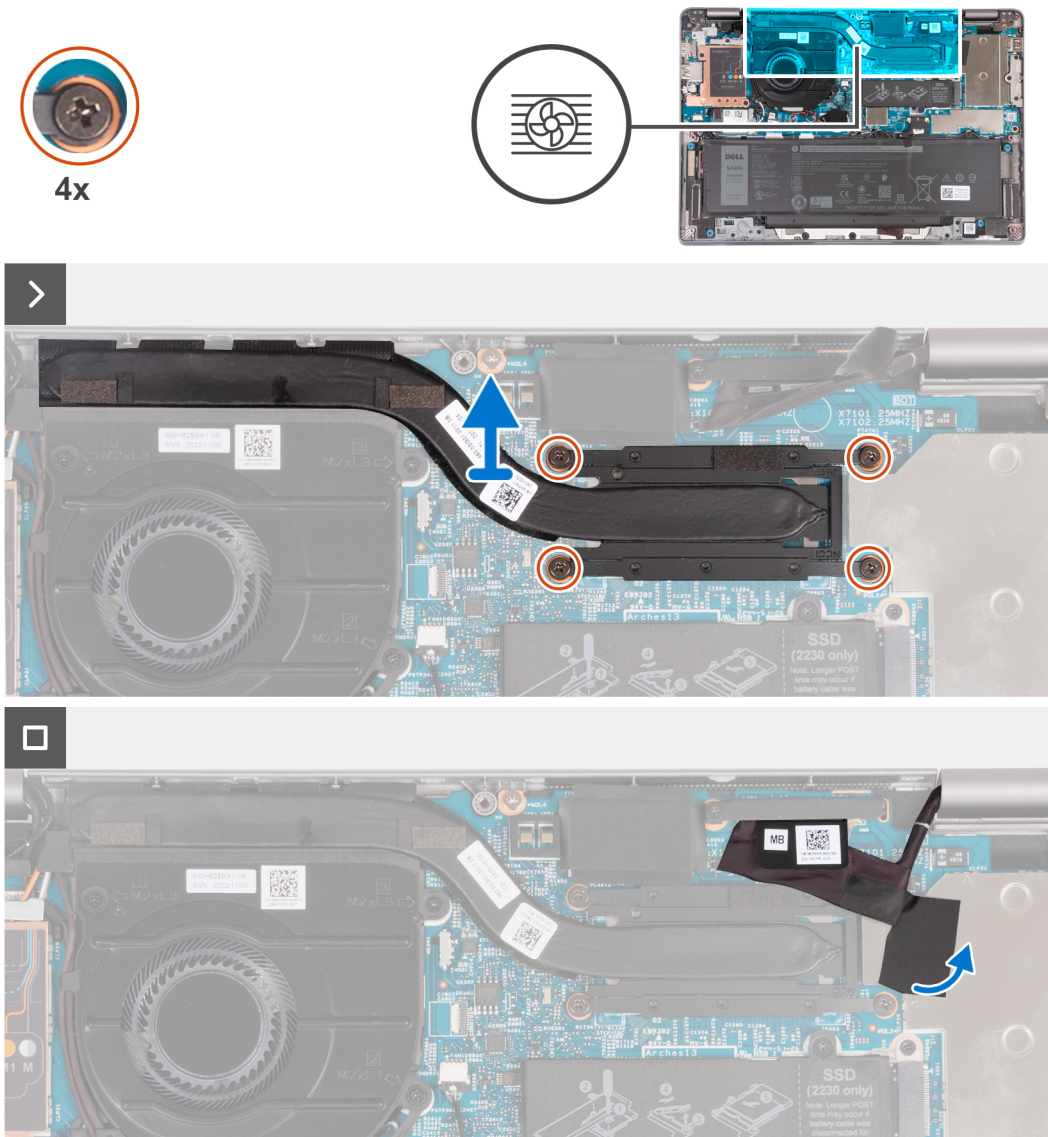

Steps

1. Align the screw holes on the heat sink with the screw holes on the system board.
2. In sequential order (1 > 2 > 3 > 4), as indicated by the numbers on the heat sink, tighten the four captive screws to secure the heat sink to the system board.
3. Replace the tape that secures the eDP cable in place.

Next steps

1. Install the [battery](#).
2. Install the [base cover](#).
3. Follow the procedure in [After working inside your computer](#).

System board

Removing the system board

Prerequisites

CAUTION: The information in this section is intended for authorized service technicians only.

1. Follow the procedure in [Before working inside your computer](#).
2. Remove the [SIM card tray](#) (for computers with nano-SIM card option).
3. Remove the [base cover](#).
4. Remove the [battery](#).
5. Remove the [M.2 2230 solid-state drive](#).
6. Remove the [WWAN 4G card](#) or [WWAN 5G card](#).
7. Remove the [WLAN card](#).
8. Remove the [fan](#).
9. Remove the [heat sink](#).

About this task

NOTE: When removing the system board to replace/access other parts, the system board can be removed and installed with the heat sink attached to simplify the procedure and preserve the thermal bond between the system board and heat-sink.

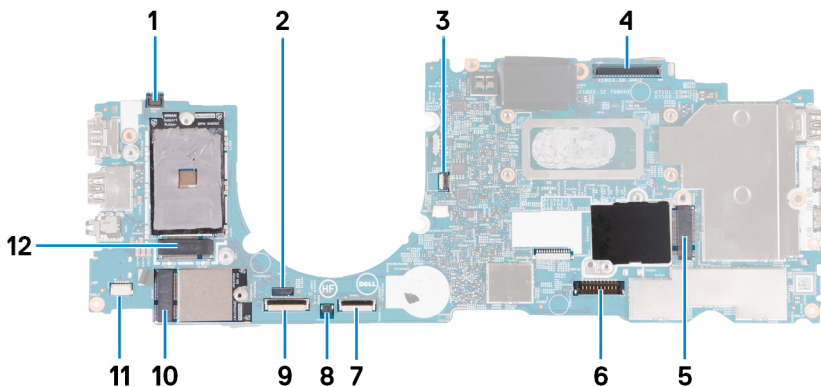

1. Fingerprint-reader cable connector
2. Sensor cable connector
3. Fan-cable connector
4. eDP-cable connector
5. Solid-state drive slot
6. Battery-cable connector
7. Touchpad-cable connector
8. Coin-cell battery connector
9. Universal Security Hub (USH) cable connector
10. WLAN-card connector
11. Speaker-cable connector
12. WWAN 5G/4G-card connector

The following images indicate the location of the system board and provide a visual representation of the removal procedure.



5x
M2x3



2x
M2x4



3x
M2x5

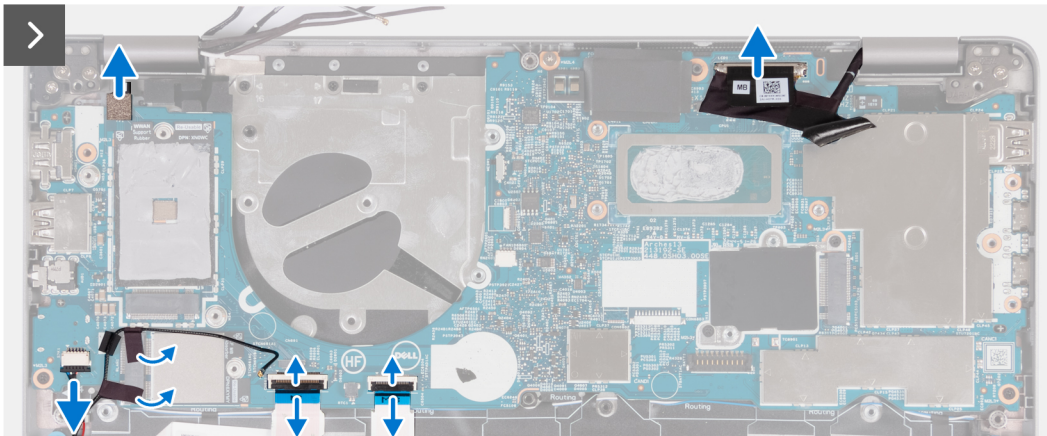
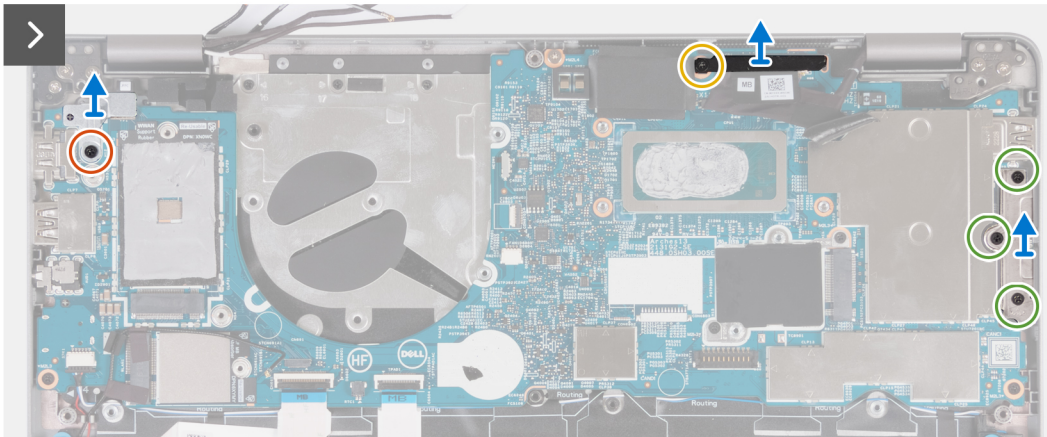
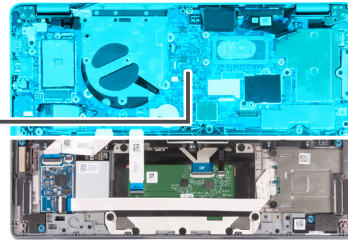

Steps

1. Remove the screw (M2x3) that secures the fingerprint reader metal bracket.

 **NOTE:** Systems with non-fingerprint reader configuration do not have a fingerprint-reader bracket.

2. Remove the fingerprint-reader bracket from the system.
3. Remove the screw (M2x4) that secures the eDP bracket to the system board and lift it.
4. Remove the three screws (M2x5) securing the USB Type-C bracket.
5. Remove the USB Type-C port bracket.
6. Disconnect the fingerprint-reader cable from the system board.
7. Peel the conductive tape covering the eDP cable.
8. Disconnect the eDP cable from the system board.
9. Disconnect the touchpad cable from the system board.
10. Disconnect the USB cable from the system board.
11. Disconnect the speaker cable from the system board and peel off the tape that secures the speaker cable to the system board.

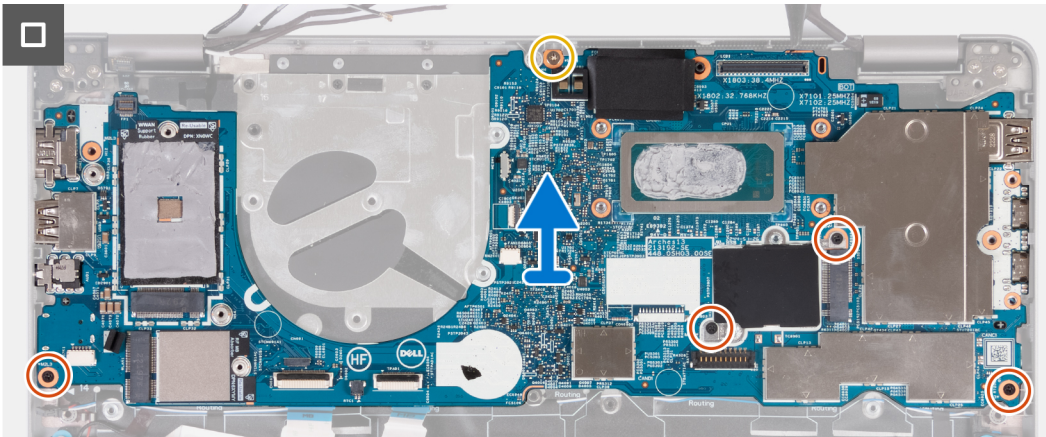

12. Remove the screw (M2x4) that secures the system board to the palm-rest assembly.
13. Remove the four screws (M2x3) that secures the system board to the palm-rest assembly.
14. Lift the system board off the palm-rest assembly.

Installing the system board

Prerequisites

CAUTION: The information in this section is intended for authorized service technicians only.

If you are replacing a component, remove the existing component before performing the installation procedure.

About this task

NOTE: When replacing/accessing other parts, the system board can be installed with the heat sink attached in order to simplify the procedure and preserve the thermal bond between the system board and heat-sink.

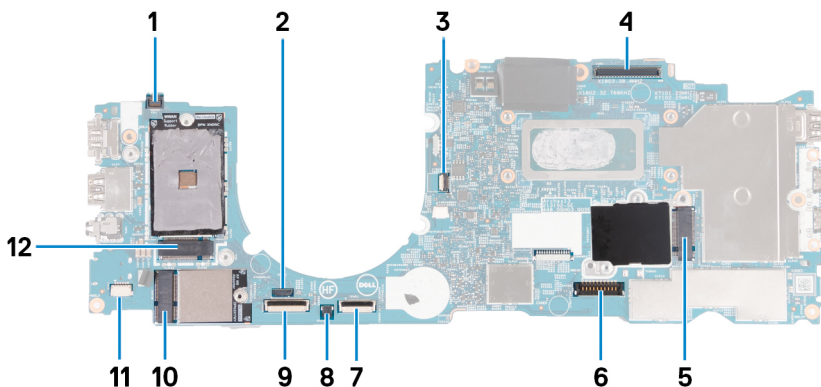

1. Fingerprint-reader cable connector
2. Sensor cable connector
3. Fan-cable connector
4. eDP-cable connector
5. Solid-state drive slot
6. Battery-cable connector
7. Touchpad-cable connector
8. Coin-cell battery connector
9. Universal Security Hub (USH) cable connector
10. WLAN-card connector
11. Speaker-cable connector

12. WWAN 5G/4G-card connector

The following image indicates the location of the system board and provides a visual representation of the installation procedure.

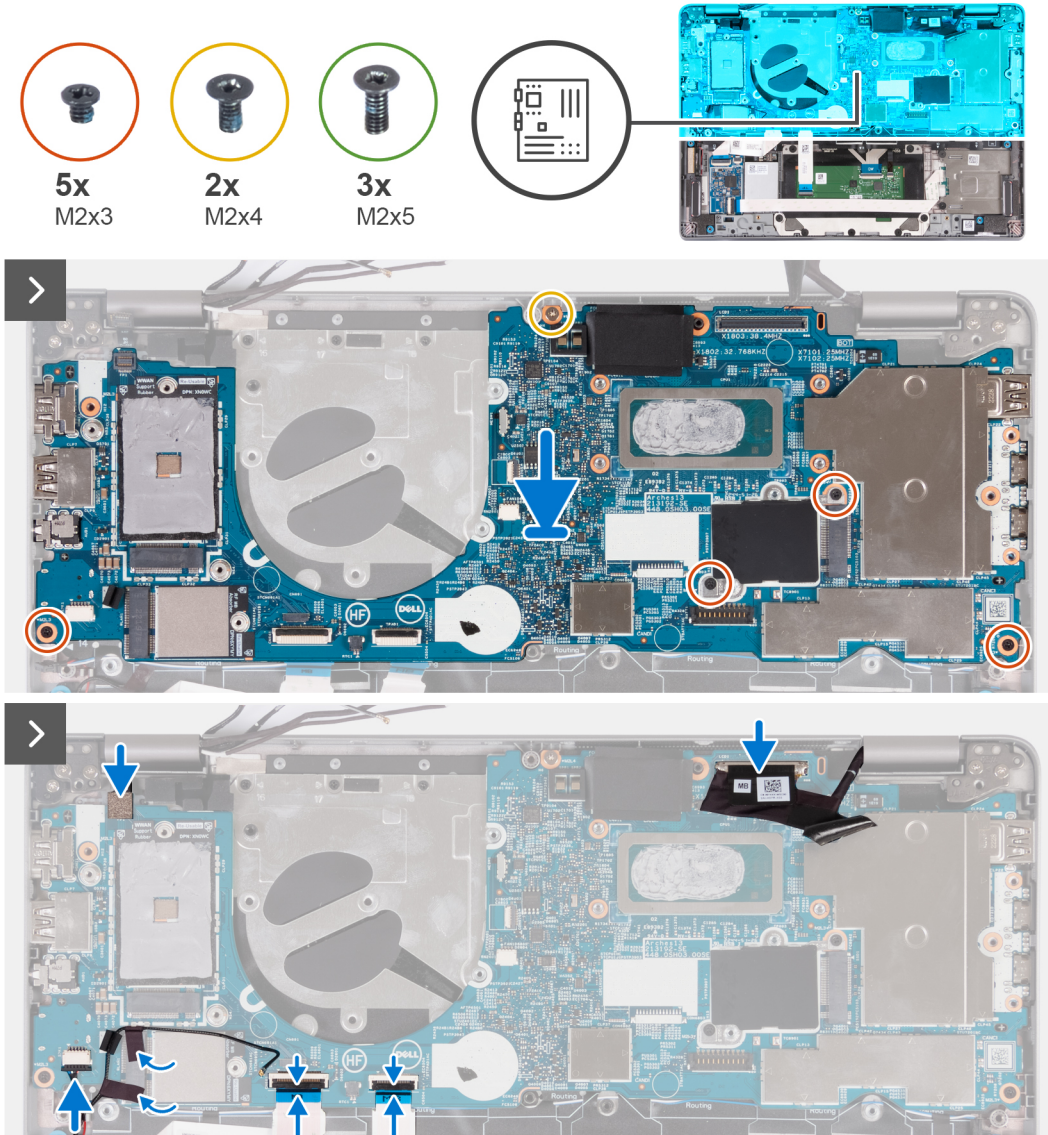

Steps

1. Place the system board on the palm-rest assembly.
2. Replace the four screws (M2x3) to secure the system board to the palm-rest assembly.
3. Replace the screw (M2x4) to secure the system board to the palm-rest assembly.
4. Connect the fingerprint-reader cable to the system board.
5. Connect the eDP cable to the system board.
6. Adhere the tape to cover the eDP cable.
7. Connect the touchpad cable on the system board and close the latch.
8. Connect the USH board cable on the system board and close the latch.
9. Connect the speaker cable on the system board and adhere the tape to secure the speaker cable.

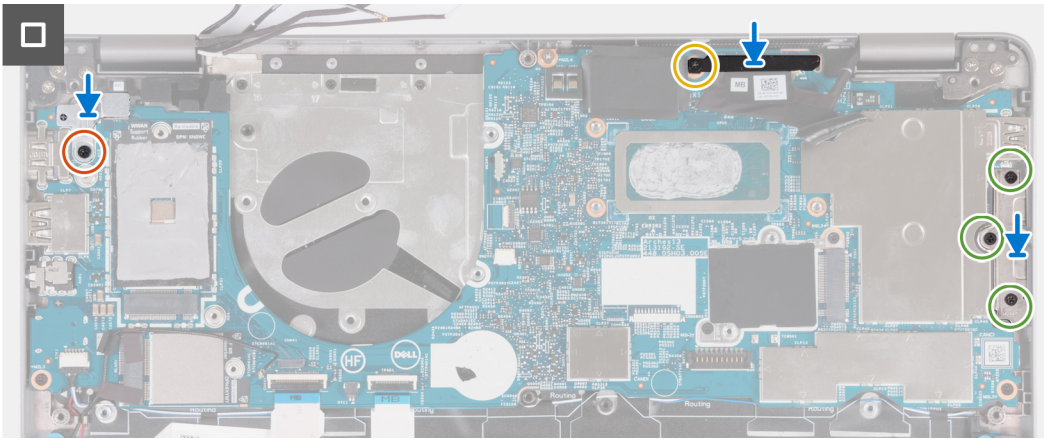

10. Align the fingerprint-reader bracket and replace the screw (M2x3) to secure it to the system board.

i **NOTE:** Systems with non-fingerprint reader configuration do not have a fingerprint reader bracket.

11. Align the eDP bracket and replace the screw (M2x4) to secure the eDP bracket to the system board.

12. Place the USB Type-C port bracket and replace the three screws (M2x5) to secure it to the system board.

Next steps

1. Install the [heat sink](#).
2. Install the [fan](#).
3. Install the [WLAN card](#).
4. Install the [WWAN 4G card](#) or [WWAN 5G card](#).
5. Install the [M.2 2230 solid-state drive](#).
6. Install the [battery](#).
7. Install the [base cover](#).
8. Install the [SIM card tray](#) (for computers with nano-SIM card option).
9. Follow the procedure in [After working inside your computer](#).

Speakers

Removing the speakers

Prerequisites

⚠ CAUTION: The information in this section is intended for authorized service technicians only.

1. Follow the procedure in [Before working inside your computer](#).
2. Remove the [SIM card tray](#) (for computers with nano-SIM card option).
3. Remove the [base cover](#).
4. Remove the [battery](#).
5. Remove the [M.2 2230 solid-state drive](#).
6. Remove the [WWAN 4G card](#) or [WWAN 5G card](#).
7. Remove the [WLAN card](#).
8. Remove the [fan](#).
9. Remove the [system board](#).

About this task

i **NOTE:** The system board can be removed with the heat sink attached to simplify the procedure and preserve the thermal bond between the system board and heat-sink.

The following images indicate the location of the speakers and provide a visual representation of the removal procedure.

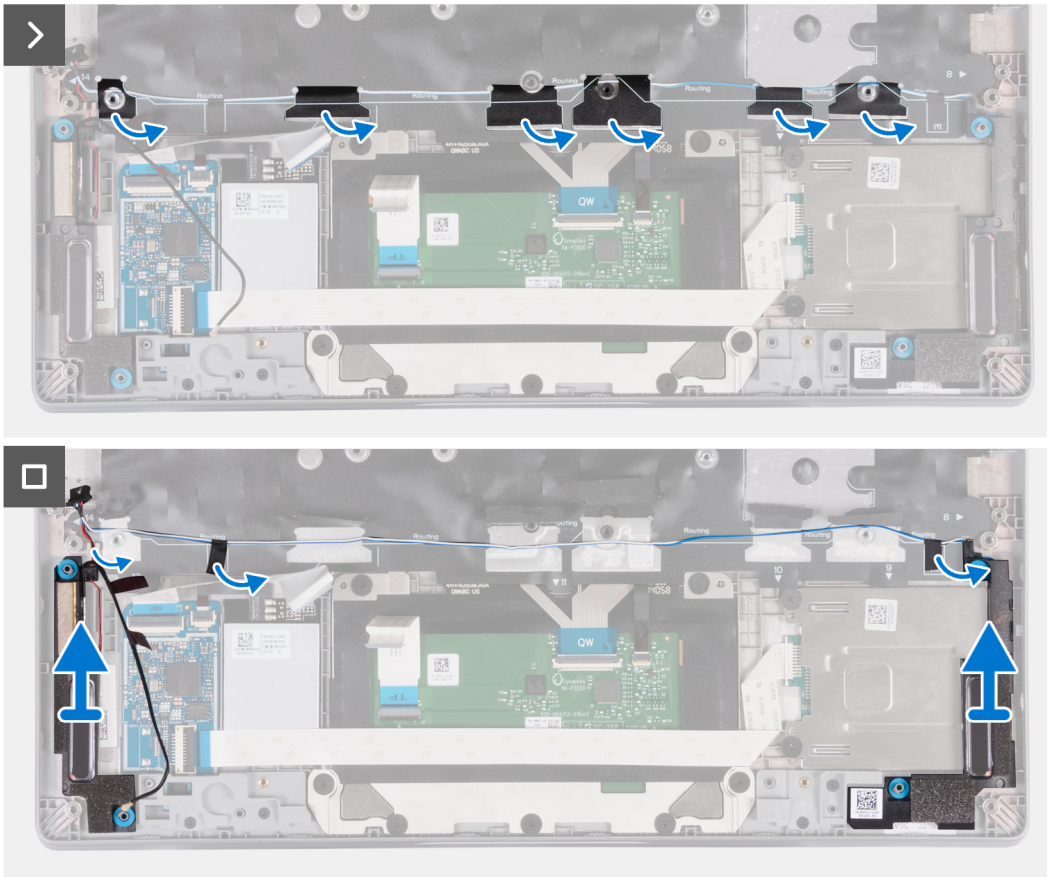
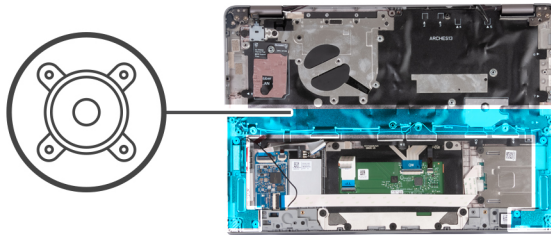

Steps

1. Note the routing of the speaker cable, and remove the speaker cable from the routing guides on the palm-rest assembly.
2. Peel off the adhesive tape that secures the speaker cable.
3. Disconnect the speaker cable from the system board.
4. Lift the speakers along with the cable off the palm-rest assembly.

Installing the speakers

Prerequisites

CAUTION: The information in this section is intended for authorized service technicians only.

If you are replacing a component, remove the existing component before performing the installation procedure.

About this task

NOTE: The system board can be installed with the heat sink attached to simplify the procedure and preserve the thermal bond between the system board and heat-sink.

The following image indicates the location of the speaker and provides a visual representation of the installation procedure.

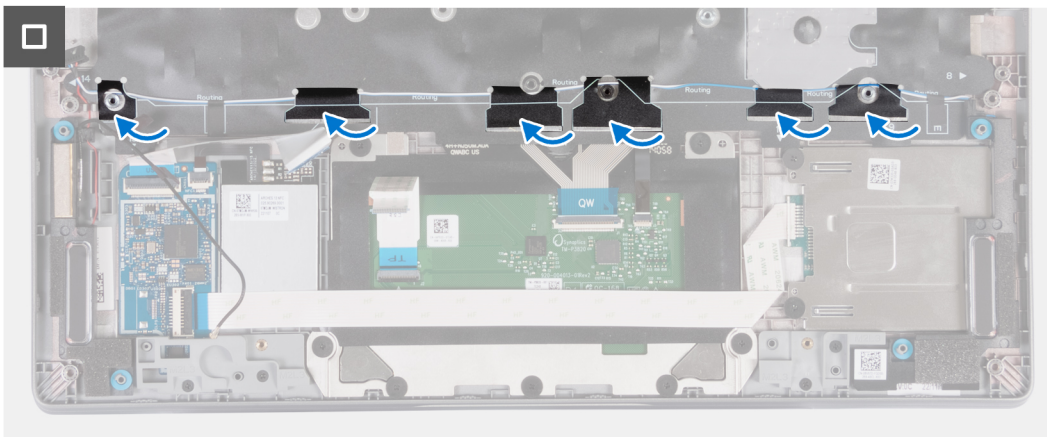
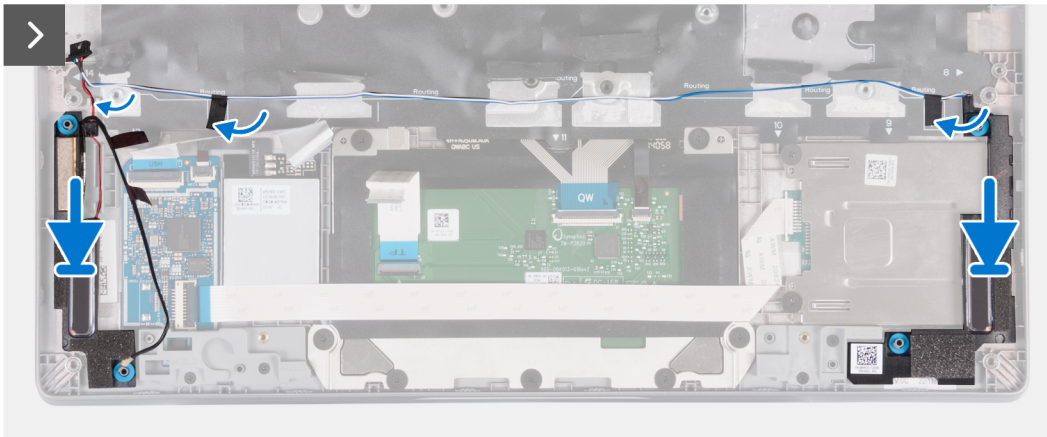
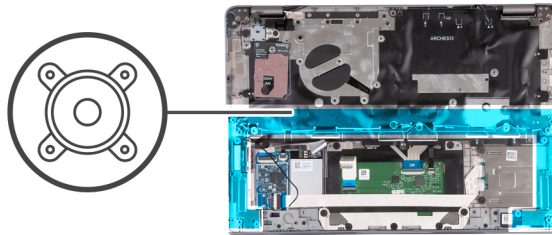

Steps

1. Using the alignment posts, place the left and right speakers into their slots on the palm-rest assembly.
2. Route the speaker cables through the routing guides on the palm-rest assembly.
3. Adhere the tape to secure the speaker cables to the palm-rest assembly.
4. Connect the speaker cable to the system board.

Next steps

1. Install the [system board](#).
2. Install the [fan](#).
3. Install the [WLAN card](#).
4. Install the [WWAN 4G card](#) or [WWAN 5G card](#).
5. Install the [M.2 2230 solid-state drive](#).
6. Install the [battery](#).
7. Install the [base cover](#).
8. Install the [SIM card tray](#) (for computers with nano-SIM card option).
9. Follow the procedure in [After working inside your computer](#).

Power-button board

Removing the power button

Prerequisites

CAUTION: The information in this section is intended for authorized service technicians only.

1. Follow the procedure in [Before working inside your computer](#).
2. Remove the [SIM card tray](#) (for computers with nano-SIM card option).
3. Remove the [base cover](#).
4. Remove the [battery](#).
5. Remove the [M.2 2230 solid-state drive](#).
6. Remove the [WWAN 4G card](#) or [WWAN 5G card](#).
7. Remove the [WLAN card](#).
8. Remove the [fan](#).
9. Remove the [system board](#).

About this task

NOTE: The system board can be removed with the heat sink attached to simplify the procedure and preserve the thermal bond between the system board and heat-sink.

The following images indicate the location of the power-button and provide a visual representation of the removal procedure.



1x
M2x2

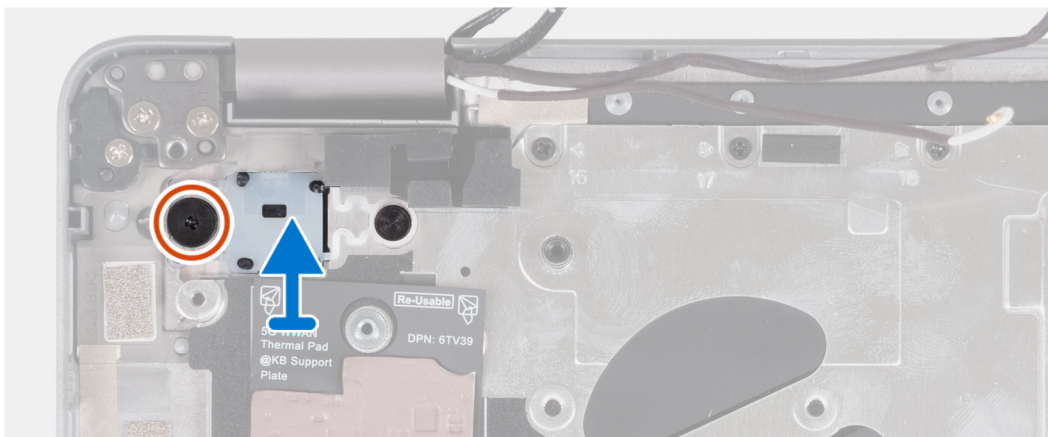

Steps

1. Remove the screw (M2x2) that secures the power button to the palm-rest assembly.
2. Lift the power button out of the computer.

Installing the power button

About this task

CAUTION: The information in this section is intended for authorized service technicians only.

NOTE: The system board can be installed with the heat sink attached to simplify the procedure and preserve the thermal bond between the system board and heat sink.

The following images indicate the location of the power button and provide a visual representation of the removal procedure.

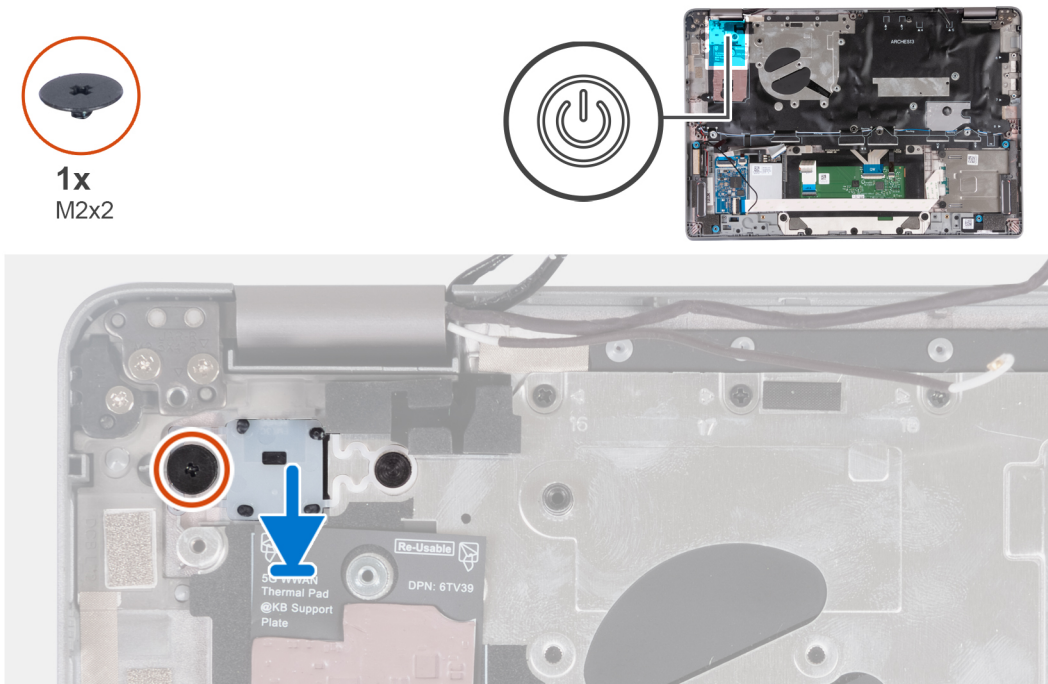

Steps

1. Align and place the power button on the palm-rest assembly.
2. Replace the screw (M2x2) to secure the power button to the palm-rest assembly.

Next steps

1. Install the [system board](#).
2. Install the [fan](#).
3. Install the [WLAN card](#).
4. Install the [WWAN 4G card](#) or [WWAN 5G card](#).
5. Install the [M.2 2230 solid-state drive](#).
6. Install the [battery](#).
7. Install the [base cover](#).
8. Install the [SIM card tray](#) (for computers with nano-SIM card option).
9. Follow the procedure in [After working inside your computer](#).

Removing the power button with fingerprint reader

Prerequisites

CAUTION: The information in this section is intended for authorized service technicians only.

1. Follow the procedure in [Before working inside your computer](#).
2. Remove the [SIM card tray](#) (for computers with nano-SIM card option).

3. Remove the [base cover](#).
4. Remove the [battery](#).
5. Remove the [M.2 2230 solid-state drive](#).
6. Remove the [WWAN 4G card](#) or [WWAN 5G card](#).
7. Remove the [WLAN card](#).
8. Remove the [fan](#).
9. Remove the [system board](#).

About this task

NOTE: The system board can be removed with the heat sink attached to simplify the procedure and preserve the thermal bond between the system board and heat sink.

The following images indicate the location of the power-button with optional fingerprint reader and provide a visual representation of the removal procedure.

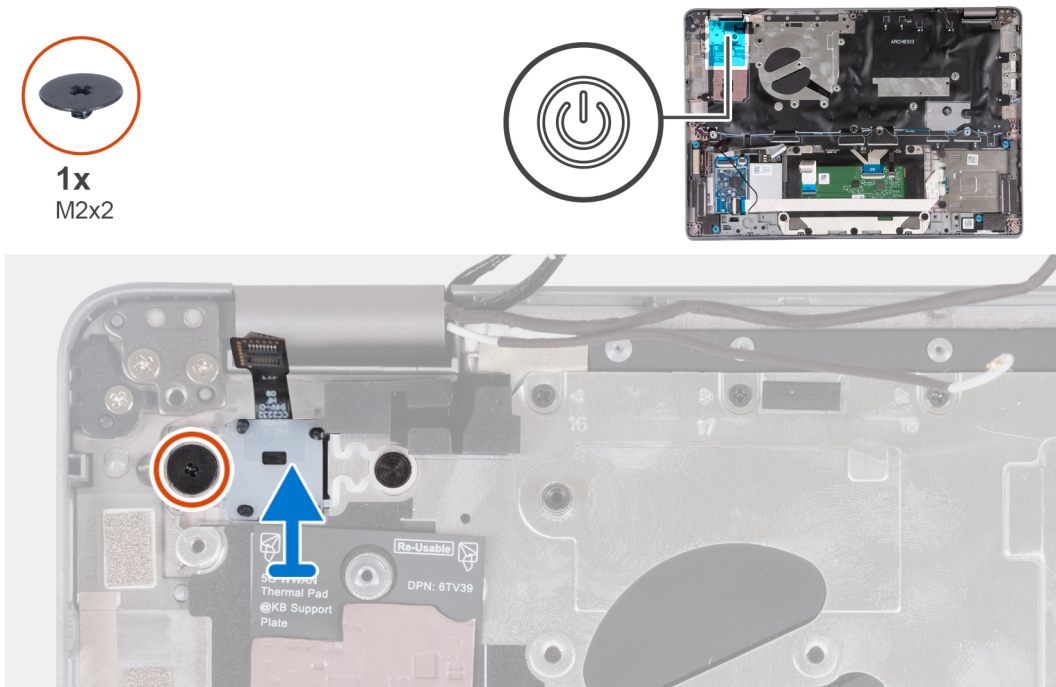

Steps

1. Remove the screw (M2x2) that secures the power button with fingerprint reader to the palm-rest assembly.
2. Lift the power button with fingerprint reader and cable out of the computer.

Installing the power button with fingerprint reader

About this task

CAUTION: The information in this section is intended for authorized service technicians only.

NOTE: The system board can be installed with the heat sink attached in order to simplify the procedure and preserve the thermal bond between the system board and heat sink.

The following images indicate the location of the power button with fingerprint reader and provide a visual representation of the removal procedure.



1x
M2x2

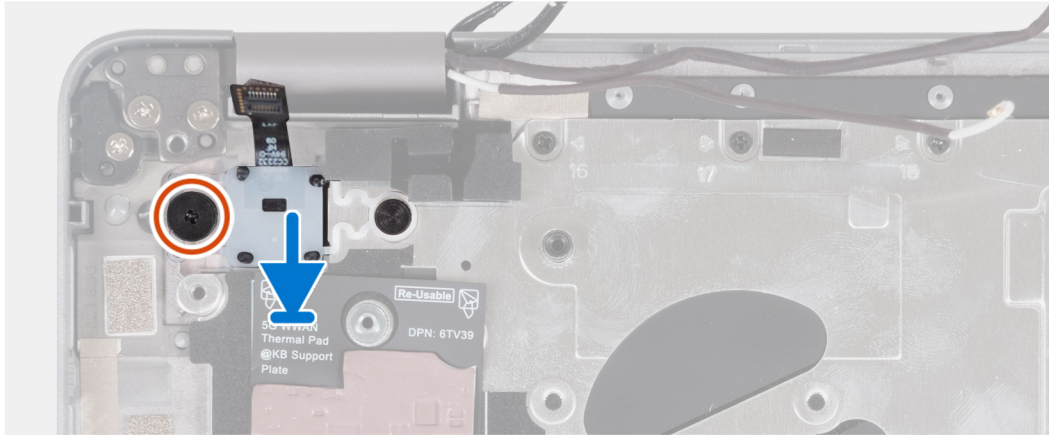
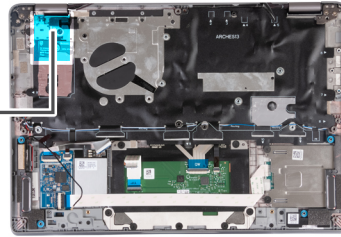

Steps

1. Align and place the power button with the fingerprint reader and cable on the palm-rest assembly.
2. Replace the screw (M2x2) to secure the power button with optional fingerprint reader to the palm-rest assembly.

Next steps

1. Install the [system board](#).
2. Install the [heat sink](#).
3. Install the [fan](#).
4. Install the [WLAN card](#).
5. Install the [WWAN 4G card](#) or [WWAN 5G card](#).
6. Install the [M.2 2230 solid-state drive](#).
7. Install the [battery](#).
8. Install the [base cover](#).
9. Install the [SIM card tray](#) (for computers with nano-SIM card option).
10. Follow the procedure in [After working inside your computer](#).

Keyboard assembly

Removing the keyboard assembly

Prerequisites

 **CAUTION:** The information in this section is intended for authorized service technicians only.

1. Follow the procedure in [Before working inside your computer](#).
2. Remove the [SIM card tray](#) (for computers with nano-SIM card option).
3. Remove the [base cover](#).
4. Remove the [battery](#).
5. Remove the [M.2 2230 solid-state drive](#).
6. Remove the [WWAN 4G card](#) or [WWAN 5G card](#).
7. Remove the [WLAN card](#).

8. Remove the fan.
9. Remove the system board.
10. Remove the power button or power button with optional fingerprint reader.
11. Remove the smart card reader (optional).
12. Remove the speakers.
13. Remove the display assembly.

About this task

NOTE: The system board can be removed with the heat sink attached to simplify the procedure and preserve the thermal bond between the system board and heat sink.

The following images indicate the location of the keyboard assembly and provide a visual representation of the removal procedure.



18x
M2x2

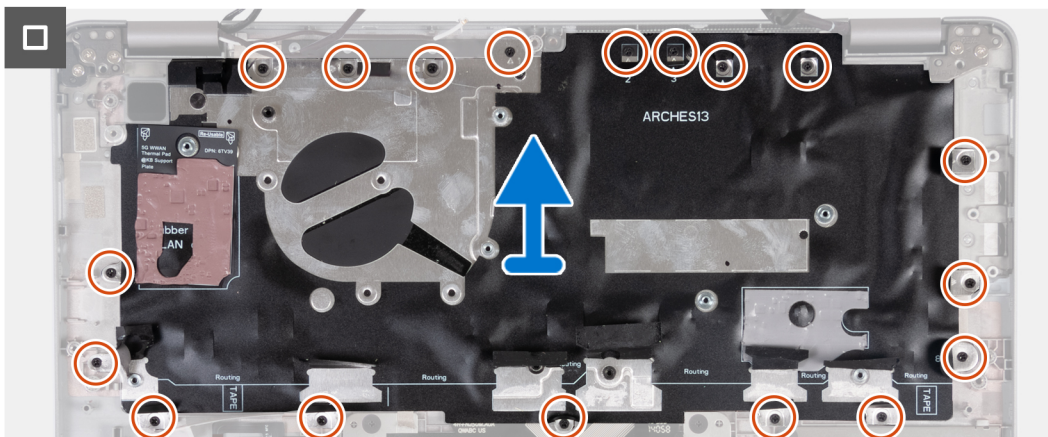
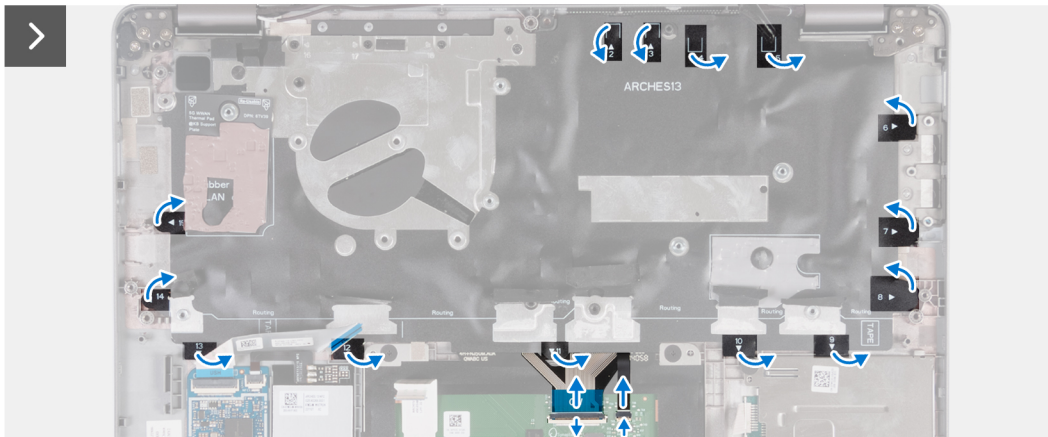
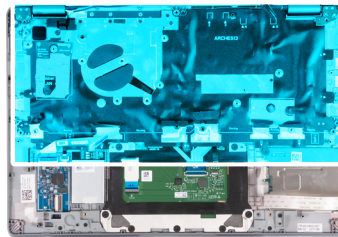

Steps

1. Lift the latch and disconnect the keyboard cable and keyboard backlit cable.
2. Lift the mylar covering the screws.
3. Remove the eighteen screws (M2x2) that secure the keyboard assembly to the palm-rest assembly.
4. Carefully lift the keyboard assembly from the palm-rest assembly.



2x
M2x2



5. Flip the keyboard assembly.
6. Remove the two screws (M2x2) that secure the keyboard to the keyboard bracket.
7. Remove the keyboard from the keyboard bracket.

Installing the keyboard assembly

Prerequisites

CAUTION: The information in this section is intended for authorized service technicians only.

If you are replacing a component, remove the existing component before performing the installation procedure.

About this task

NOTE: The system board can be installed with the heat sink attached to simplify the procedure and preserve the thermal bond between the system board and heat sink.

The following image indicates the location of the keyboard assembly and provides a visual representation of the installation procedure.



2x
M2x2



Steps

1. Replace the two screws (M2x2) to secure the keyboard to the keyboard bracket.
2. Flip the keyboard assembly and align it to its slot on the palm-rest assembly.
3. Press down on the lattice at the snap points to secure the keyboard assembly to the palm-rest assembly.



18x
M2x2

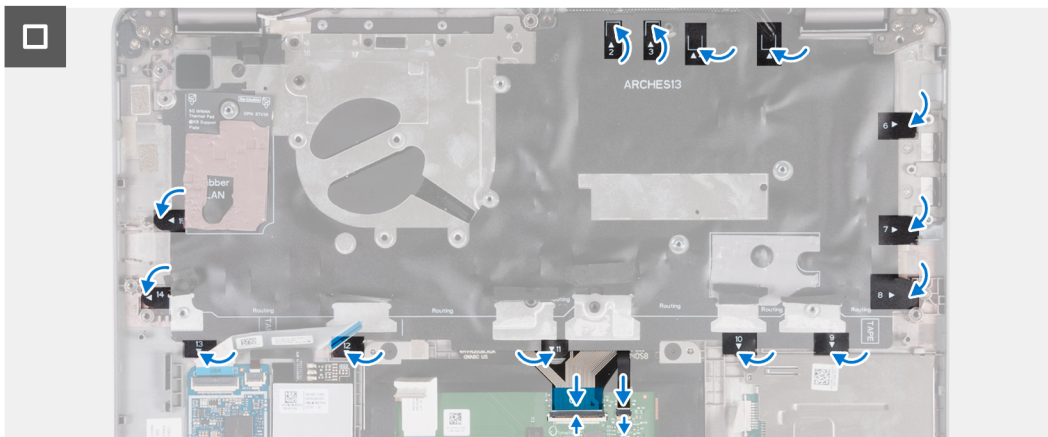
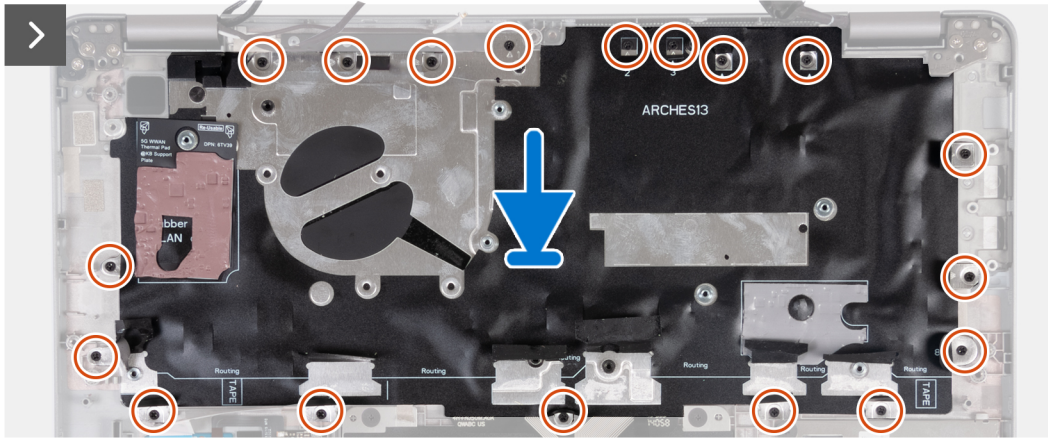
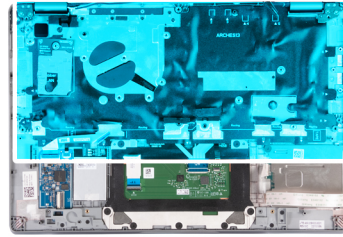

4. Replace the eighteen screws (M2x2) to secure the keyboard assembly to the palm-rest assembly.
5. Adhere the mylar back on the screws.
6. Connect the keyboard cable and keyboard-backlight cable to the system board.

Next steps

1. Install the [display assembly](#).
2. Install the [speakers](#).
3. Install the [smart card reader](#) (optional).
4. Install the [power button](#) or [power button with optional fingerprint reader](#).
5. Install the [system board](#).
6. Install the [fan](#).
7. Install the [WLAN card](#).
8. Install the [WWAN 4G card](#) or [WWAN 5G card](#).
9. Install the [M.2 2230 solid-state drive](#).
10. Install the [battery](#).
11. Install the [base cover](#).
12. Install the [SIM card tray](#) (for computers with nano-SIM card option).
13. Follow the procedure in [After working inside your computer](#).

Display assembly

Removing the display assembly (laptop)

Prerequisites

CAUTION: The information in this section is intended for authorized service technicians only.

1. Follow the procedure in [Before working inside your computer](#).
2. Remove the [base cover](#).
3. Remove the [battery](#).
4. Remove the [WWAN 4G card](#) or [WWAN 5G card](#).
5. Remove the [WLAN card](#).

About this task

The following images indicate the location of the display assembly and provide a visual representation of the removal procedure.

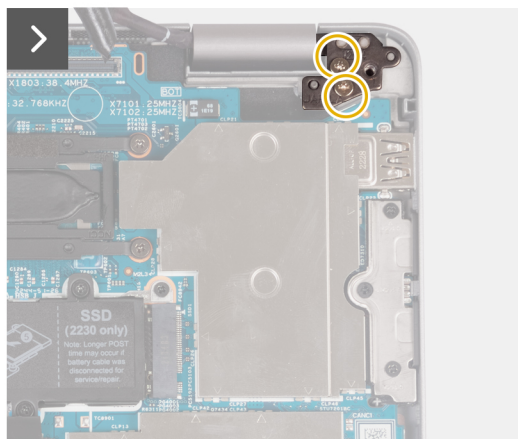
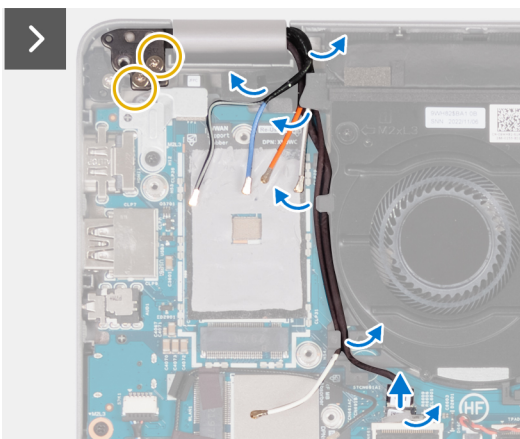
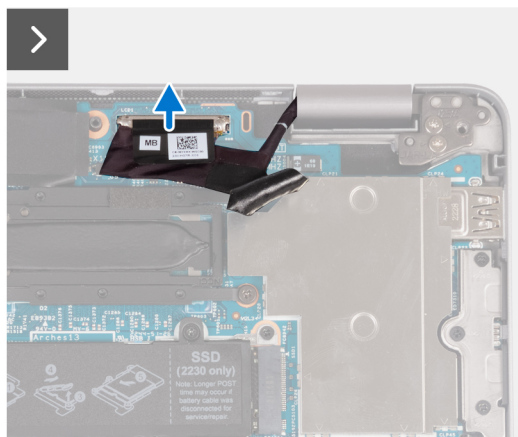
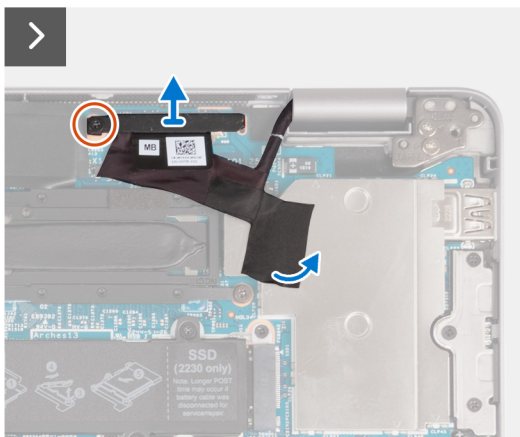
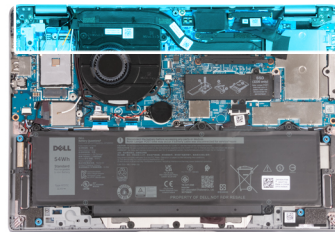

Steps

1. Remove the screw (M2x4) that secures the eDP bracket to the system board.

2. Peel the adhesive tape that covers the eDP cable.
3. Disconnect the eDP cable from the system board.
4. Note the WLAN-antenna cable routing, and remove the WLAN-antenna cables from the routing guide on the fan.
5. Disconnect the sensor cable from the system board.
6. Remove the four screws (M2.5x4) that secure the left-display hinge and right-display hinge to the system board.

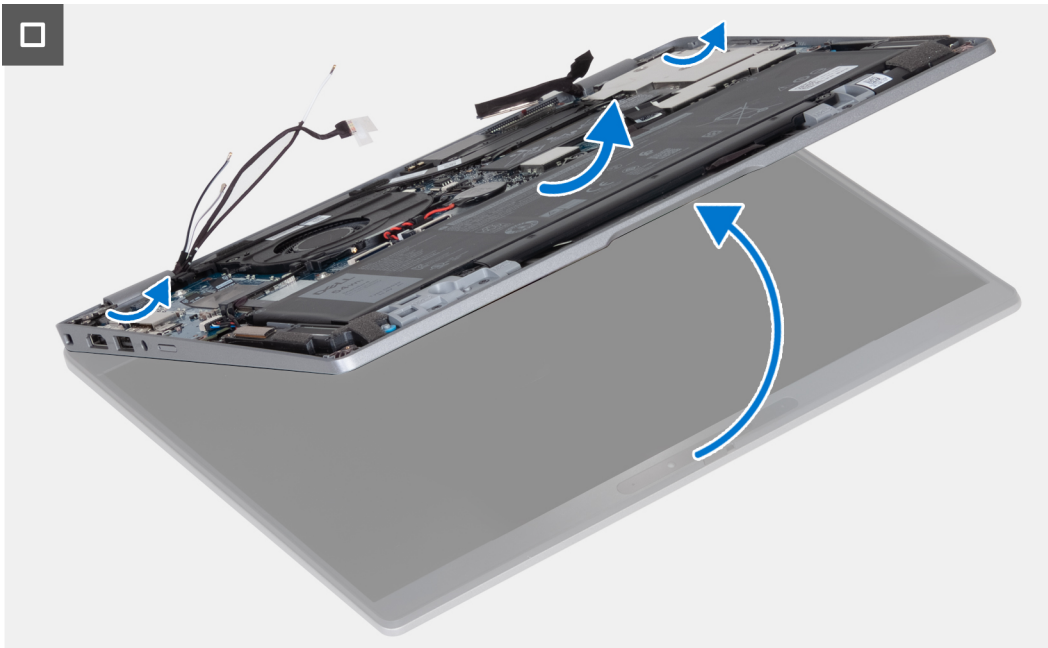

7. Open the palm-rest assembly at an angle.
8. Gently lift the display assembly off the palm-rest assembly.

Installing the display assembly (laptop)

Prerequisites

CAUTION: The information in this section is intended for authorized service technicians only.

If you are replacing a component, remove the existing component before performing the installation procedure.

About this task

The following image indicates the location of the display assembly and provides a visual representation of the installation procedure.

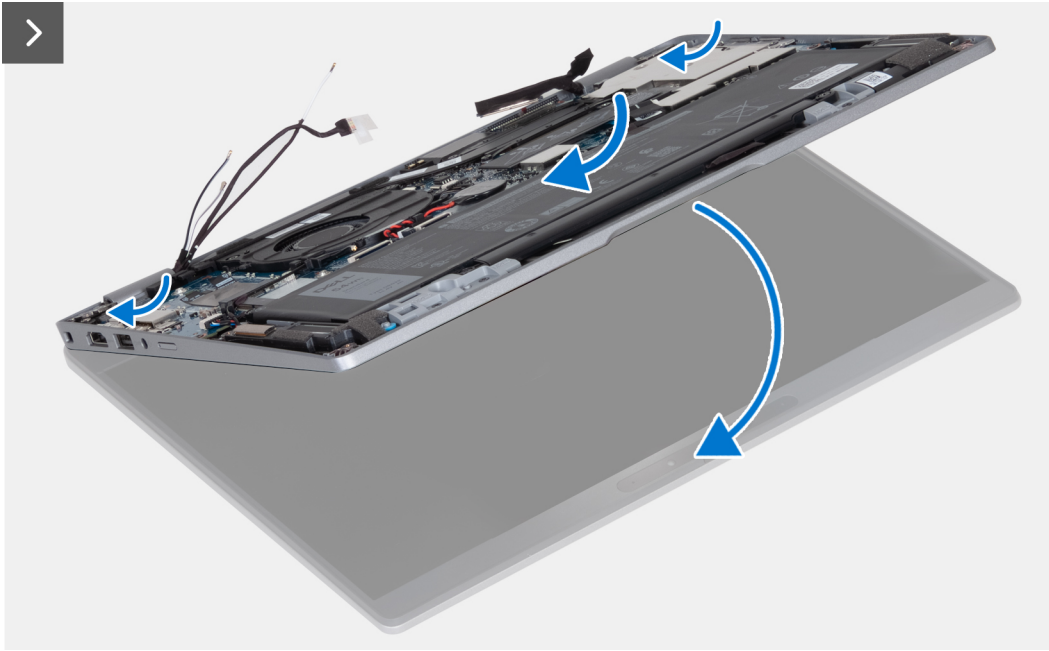

Steps

1. Place the display assembly on a clean and flat surface.
2. Align and place the palm-rest assembly on the display assembly.
3. Using the alignment posts, close the display hinges.



1x
M2x4



4x
M2.5x4

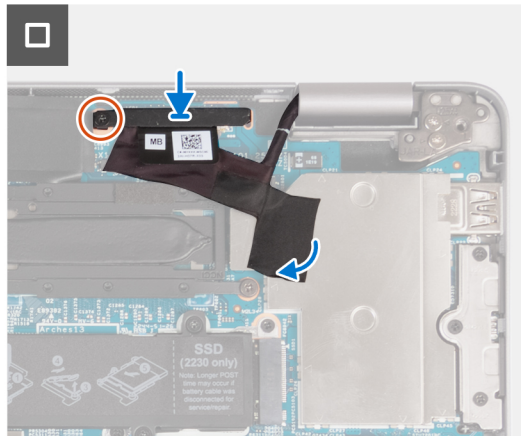
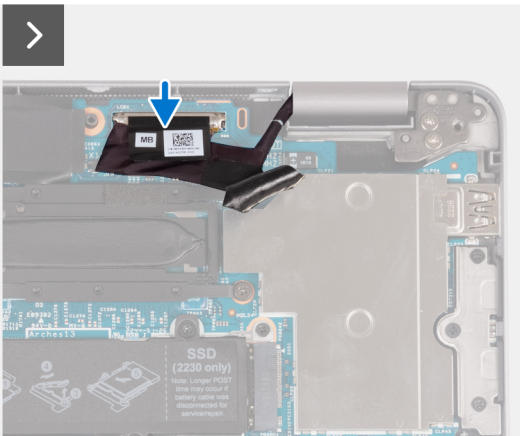
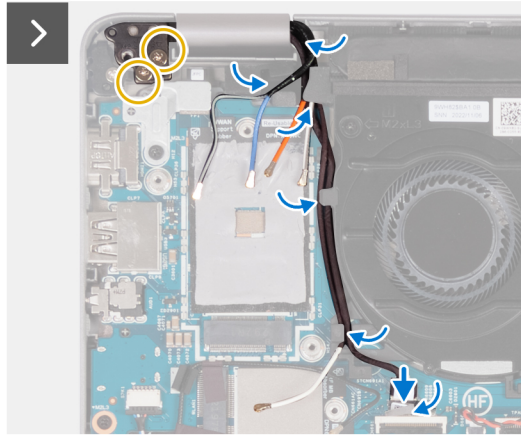
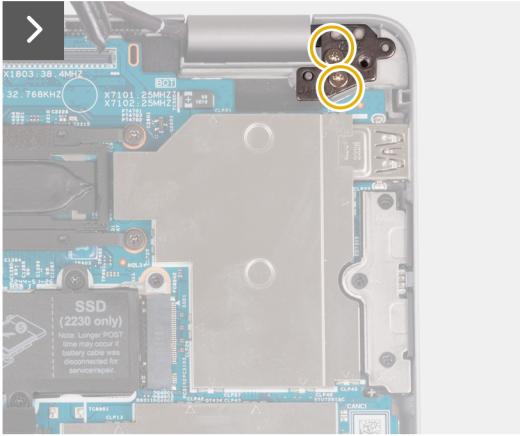
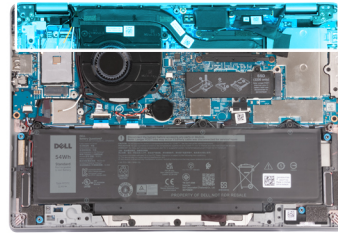

4. Replace the four screws (M2.5x4) that secure the left-display hinge and right-display hinge to the system board.
5. Route the WLAN-antenna cables into the routing guide underneath the fan.
6. Connect the sensor cable to the system board.
7. Connect the eDP cable to the connector on the system board and adhere the mylar.
8. Replace the screw (M2x4) that secures the eDP bracket to the system board.

Next steps

1. Install the [WLAN card](#).
2. Install the [WWAN 4G card](#) or [WWAN 5G card](#).
3. Install the [battery](#).
4. Install the [base cover](#).
5. Follow the procedure in [After working inside your computer](#).

Display bezel

Removing the display bezel (laptop)

Prerequisites

NOTE: The display bezel removal procedure is applicable only for Latitude 5340 laptop and not for the 2-in-1 configuration.

1. Follow the procedure in [Before working inside your computer](#).
2. Remove the [base cover](#).
3. Remove the [battery](#).
4. Remove the [display assembly](#).

About this task

The following images indicate the location of the display bezel and provide a visual representation of the removal procedure.

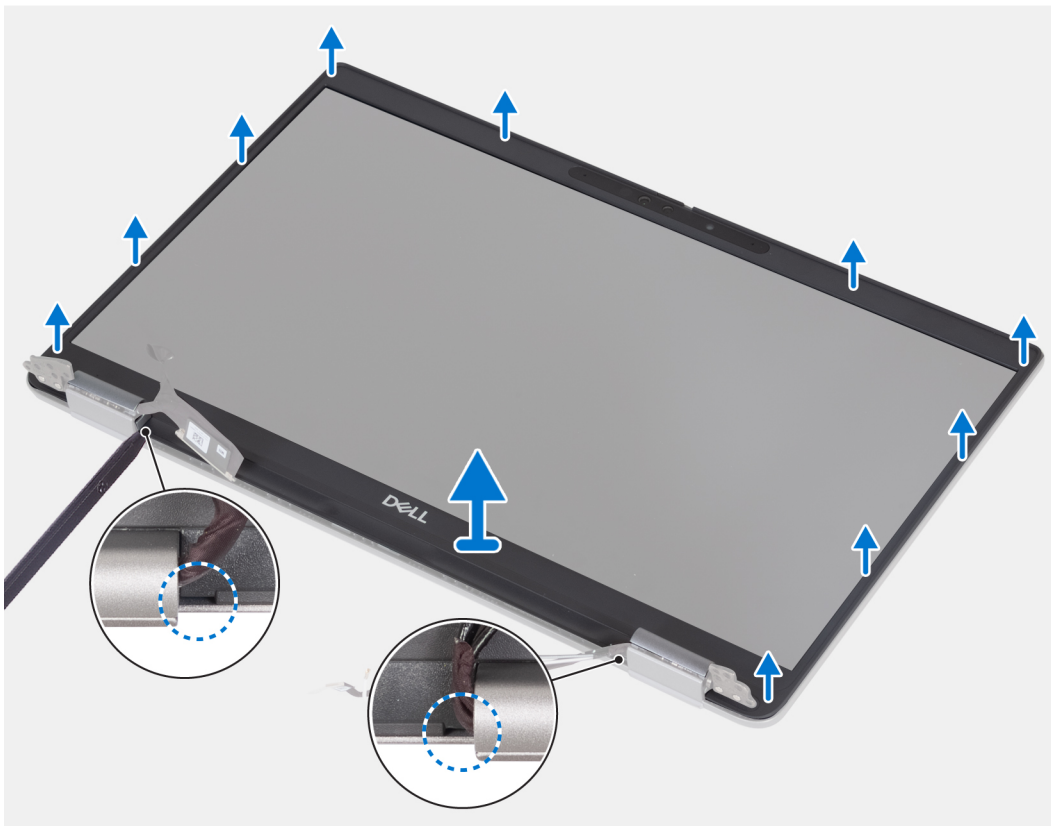

Steps

1. Insert a plastic scribe into the recesses near both the hinge caps to start the prying and release the display bezel.
 - NOTE:** The display bezel is adhered to the display panel with adhesive. Work your way around the entire display bezel to disengage the adhesive first before prying upwards.
 - NOTE:** Carefully pry and remove the bezel to minimize risk of display panel damages.
2. Carefully pry along the outside edge of the display bezel and work your way around the entire display bezel until the display bezel is separated from the display cover.
 - NOTE:** Do not use a plastic scribe or any other objects to pry up the display bezel in the manner that is shown in the following image as the pressure applied on the display panel by the plastic scribe will damage the display panel.

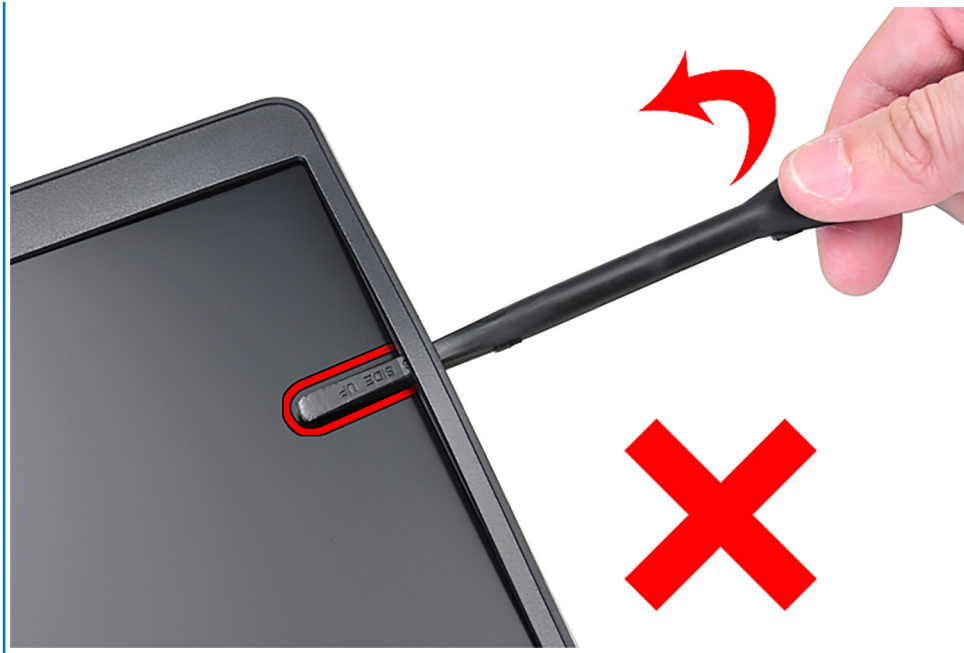

3. Remove the display bezel off the display back cover.

Installing the display bezel

Prerequisites

i **NOTE:** The display-bezel installation procedure is applicable only for Latitude 5340 laptop and not for the 2-in-1 configuration.

If you are replacing a component, remove the existing component before performing the installation procedure.

About this task

The following image indicates the location of the display bezel and provides a visual representation of the installation procedure.



Steps

Align the display bezel with the display back cover and antenna assembly, and gently snap the display bezel into place.

Next steps

1. Install the [display assembly](#).
2. Install the [battery](#).
3. Install the [base cover](#).
4. Follow the procedure in [After working inside your computer](#).

Display hinges

Removing the display hinges (laptop)

Prerequisites

NOTE: The display-hinge removal procedure is applicable only for Latitude 5340 laptop and not for the 2-in-1 configuration.

1. Follow the procedure in [Before working inside your computer](#).
2. Remove the [base cover](#).
3. Remove the [battery](#).
4. Remove the [display assembly](#).

About this task

The following images indicate the location of the display hinges and provide a visual representation of the removal procedure.



6x
M2.5x3

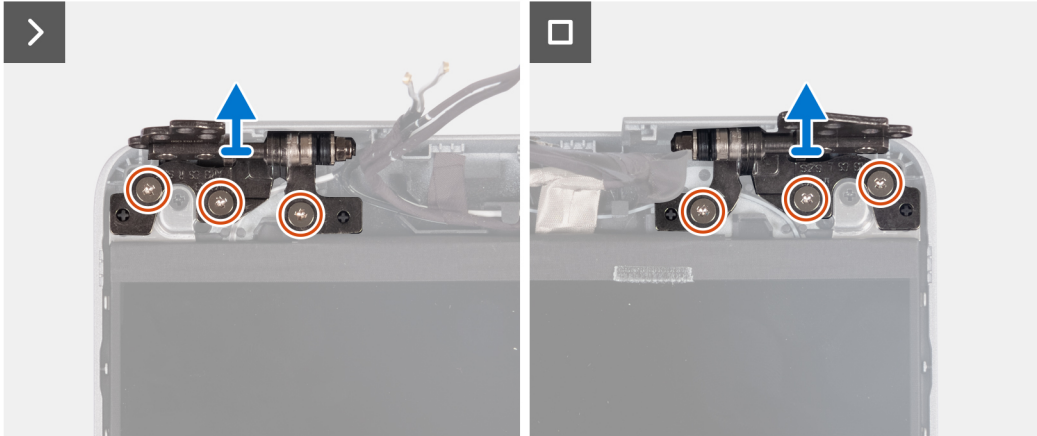
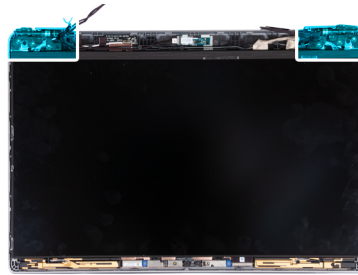

Steps

1. Remove the six screws (M2.5x3) that secure the right and left display hinges to the display back cover.
2. Lift the display hinges from the display back cover.

Installing the display hinges (laptop)

Prerequisites

 **NOTE:** The display-hinge installation procedure is applicable only for Latitude 5340 laptop and not for the 2-in-1 configuration.

If you are replacing a component, remove the existing component before performing the installation procedure.

About this task

The following image indicates the location of the display hinges and provides a visual representation of the installation procedure.



6x
M2.5x3

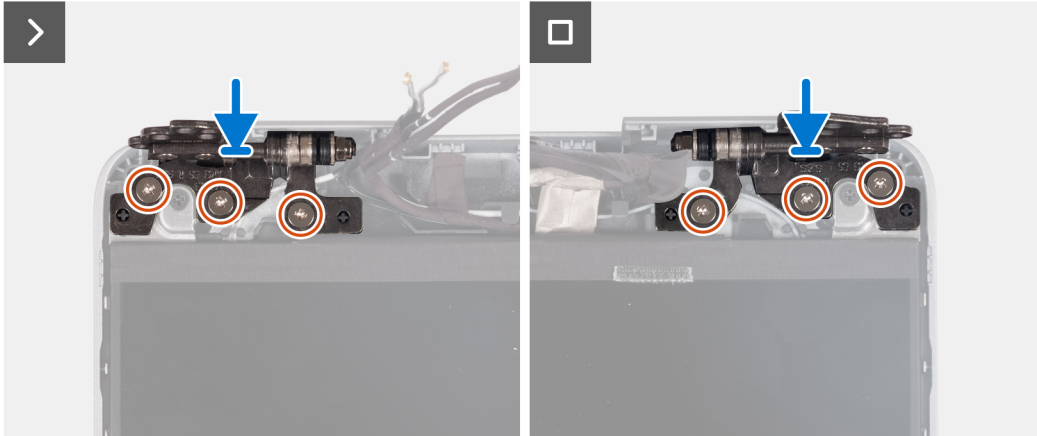
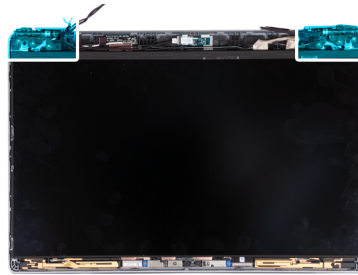

Steps

1. Lower the display hinges on the display assembly.
2. Replace the six screws (M2.5x3) to secure the left and right display hinges to the display back cover.

Next steps

1. Install the [display assembly](#).
2. Install the [battery](#).
3. Install the [base cover](#).
4. Follow the procedure in [After working inside your computer](#).

Display panel

Removing the display panel (laptop)

Prerequisites

⚠ CAUTION: The information in this section is intended for authorized service technicians only.

i NOTE: The display-panel removal procedure is applicable only for Latitude 5340 laptop and not for the 2-in-1 configuration.

i NOTE: The display panel and its support brackets are a single assembly and cannot be further disassembled once it is removed from the display back cover. Do not remove the support brackets from the display panel.

1. Follow the procedure in [Before working inside your computer](#).
2. Remove the [base cover](#).
3. Remove the [battery](#).
4. Remove the [display assembly](#).
5. Remove the [display bezel](#).
6. Remove the [display hinges](#).

About this task

The following images indicate the location of the display panel and provide a visual representation of the removal procedure.



6x
M2.5x3



2x
M2x2.5



NOTE: Do not pull and release the Stretch Release (SR) tapes from the display panel. Separation of the brackets from the display panel is not required.



Steps

1. Remove the six screws (M2.5x3) that secure the right and left display hinges to the display.
2. Remove the two screws (M2x2.5) that secure the display panel to the display assembly.

NOTE: When removing the display panel, disengage the display panel tabs from the display cover before flipping it over for removal.

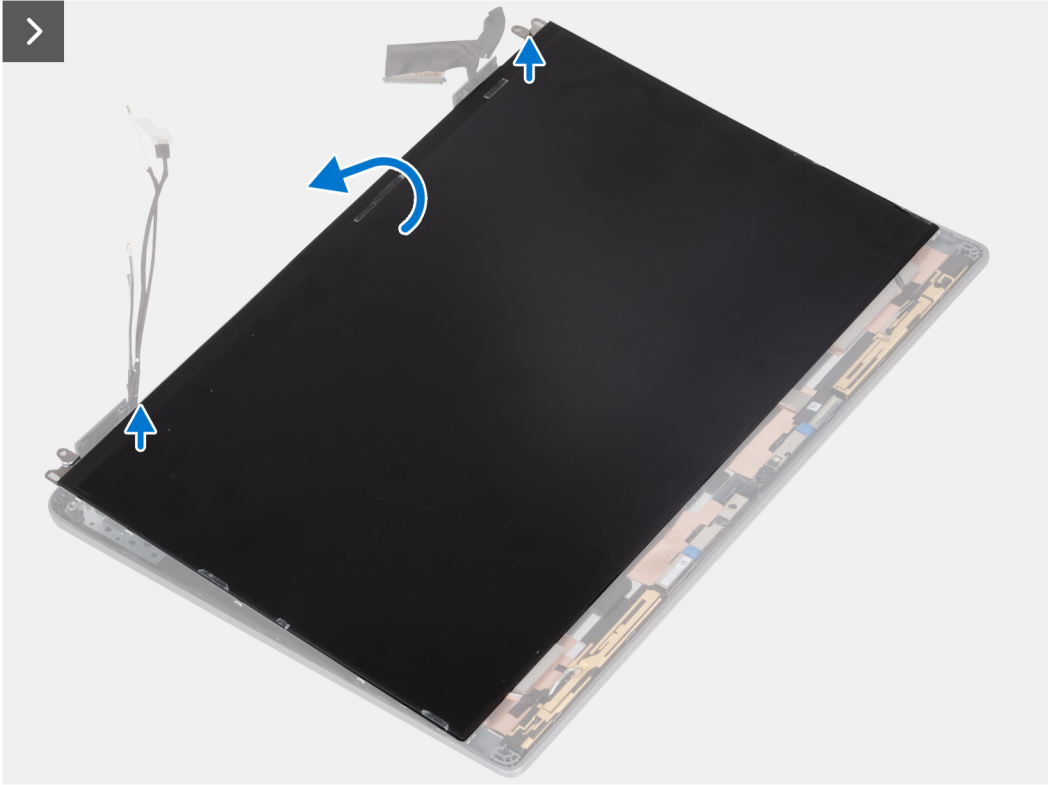

3. Lift the display panel from the display assembly starting from the hinges.

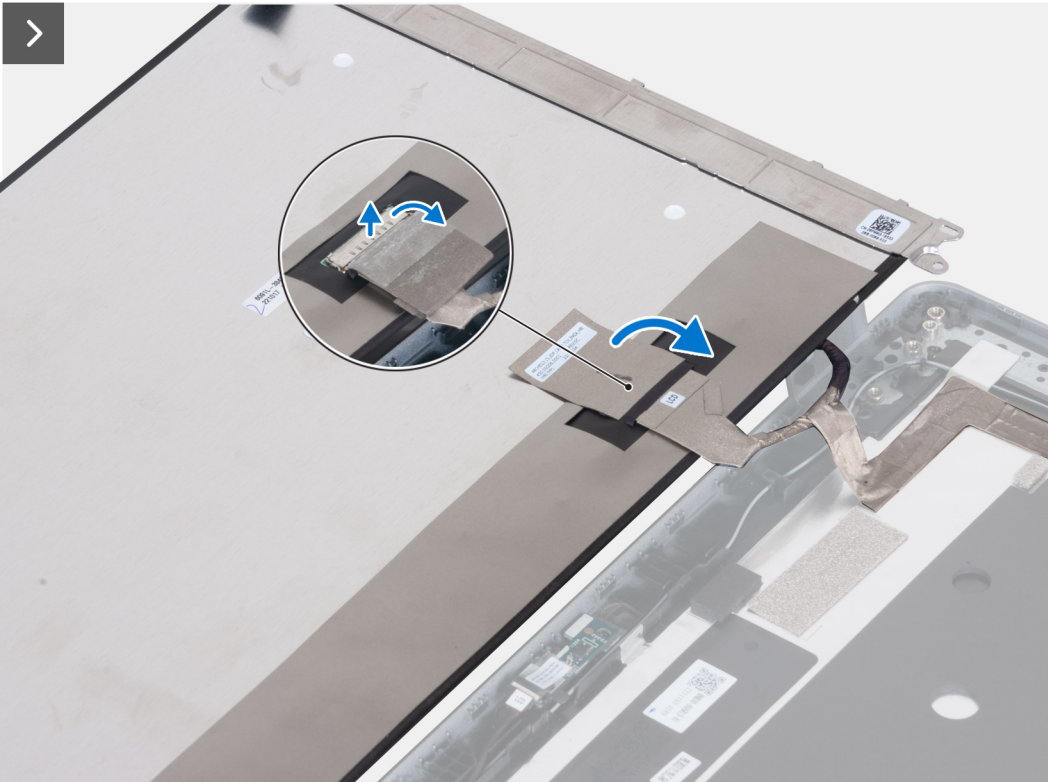



4. Peel off the conductive tape on the display cable connector.
5. Lift the latch and disconnect the display cable from the connector on the display panel.

Installing the display panel (laptop)

Prerequisites

CAUTION: The information in this section is intended for authorized service technicians only.

NOTE: The display panel installation procedure is applicable only for Latitude 5340 laptop and not for the 2-in-1 configuration.

NOTE: The display panel and its support brackets are a single assembly and cannot be further disassembled once it is removed from the display back cover. Do not remove the support brackets from the display panel.

If you are replacing a component, remove the existing component before performing the installation procedure.

About this task

The following image indicates the location of the display panel and provides a visual representation of the installation procedure.

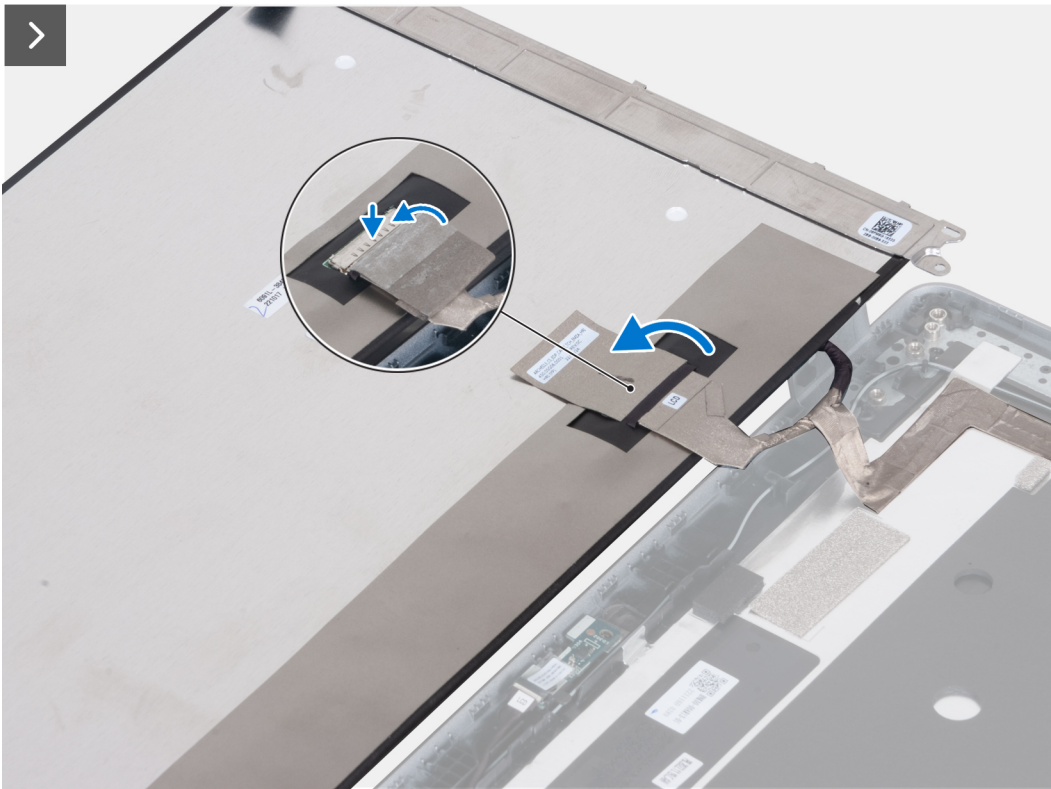

Steps

1. Connect the display cable to the connector and close the latch.
2. Adhere the adhesive strip to secure the display-cable connector.

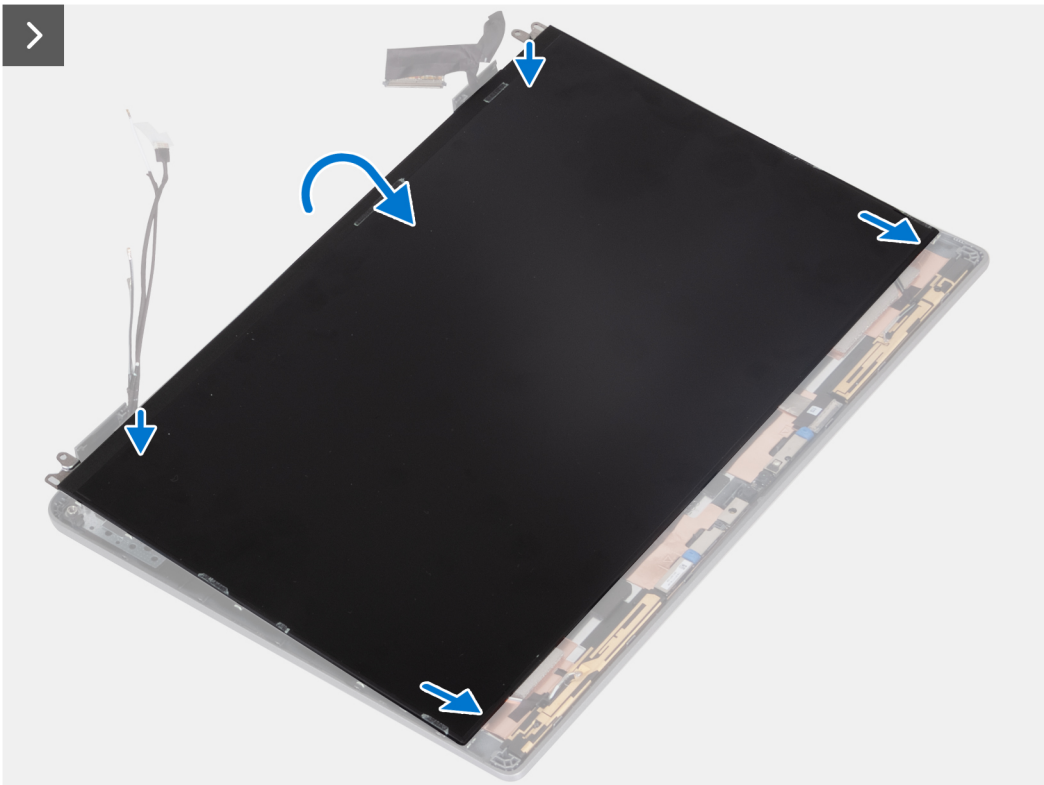

3. Insert the display-panel tabs into the slots on the display cover.



6x
M2.5x3



2x
M2x2.5



4. Replace the two screws (M2x2.5) that secure the display panel to the display assembly.
5. Replace the six screws (M2.5x3) that secure the right and left display hinges to the display.

Next steps

1. Install the [display hinges](#).
2. Install the [display bezel](#).
3. Install the [display assembly](#).
4. Install the [battery](#).
5. Install the [base cover](#).
6. Follow the procedure in [After working inside your computer](#).

eDP cable

Removing the eDP cable (laptop)

Prerequisites

⚠ CAUTION: The information in this section is intended for authorized service technicians only.

i NOTE: The eDP cable removal procedure is applicable only for Latitude 5340 laptop and not for the 2-in-1 configuration.

1. Follow the procedure in [Before working inside your computer](#).

2. Remove the [base cover](#).
3. Remove the [battery](#).
4. Remove the [display assembly](#).
5. Remove the [display bezel](#).
6. Remove the [display hinges](#).
7. Remove the [display panel](#).

About this task

The following images indicate the location of the eDP cable and provide a visual representation of the removal procedure.

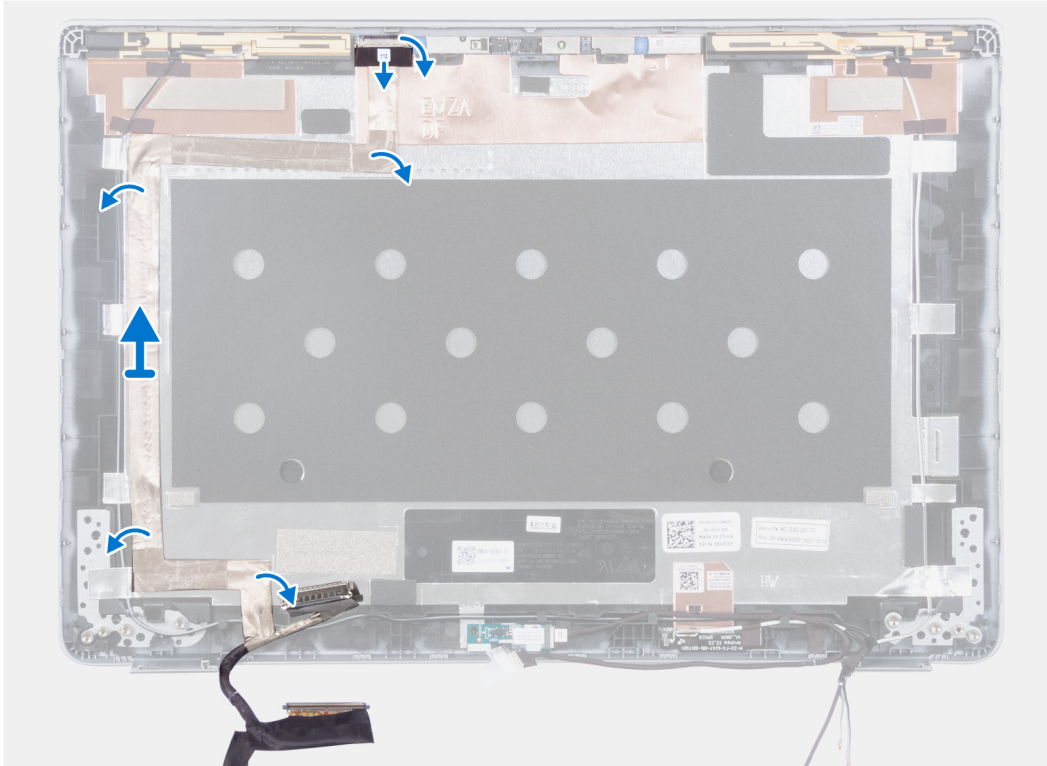

Steps

1. Peel off the conductive tape that secures the camera cable in place.
2. Open the latch and disconnect the camera cable from the connector on the camera module.
3. Peel the tape that secures the eDP cable to the back cover.
4. Remove the eDP cable from the back cover.

Installing the eDP cable (laptop)

About this task

CAUTION: The information in this section is intended for authorized service technicians only.

NOTE: The eDP cable installation procedure is applicable only for Latitude 5340 laptop and not for the 2-in-1 configuration.

The following image indicates the location of the eDP cable and provides a visual representation of the installation procedure.

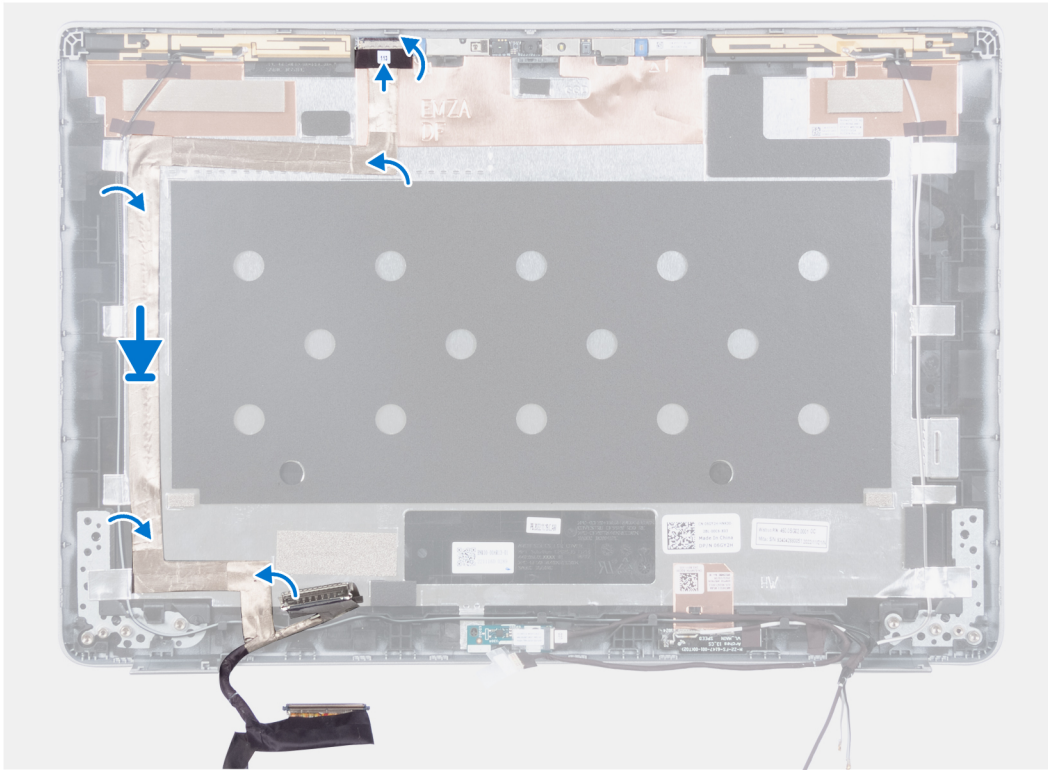

Steps

1. Adhere the conductive tape to secure the camera cable in place.
2. Connect the camera cable from the connector on the camera module and close the latch.
3. Connect the eDP cable to the display back cover.

Next steps

1. Install the [display panel](#).
2. Install the [display hinges](#).
3. Install the [display bezel](#).
4. Install the [display assembly](#).
5. Install the [battery](#).
6. Install the [base cover](#).
7. Follow the procedure in [After working inside your computer](#).

Camera

Removing the camera (laptop)

Prerequisites

⚠ CAUTION: The information in this section is intended for authorized service technicians only.

i NOTE: The camera removal procedure is applicable only for Latitude 5340 laptop and not for the 2-in-1 configuration.

1. Follow the procedure in [Before working inside your computer](#).
2. Remove the [base cover](#).
3. Remove the [battery](#).
4. Remove the [display assembly](#).
5. Remove the [display bezel](#).

6. Remove the [display hinges](#).
7. Remove the [display panel](#).

About this task

The following images indicate the location of the camera and provide a visual representation of the removal procedure.

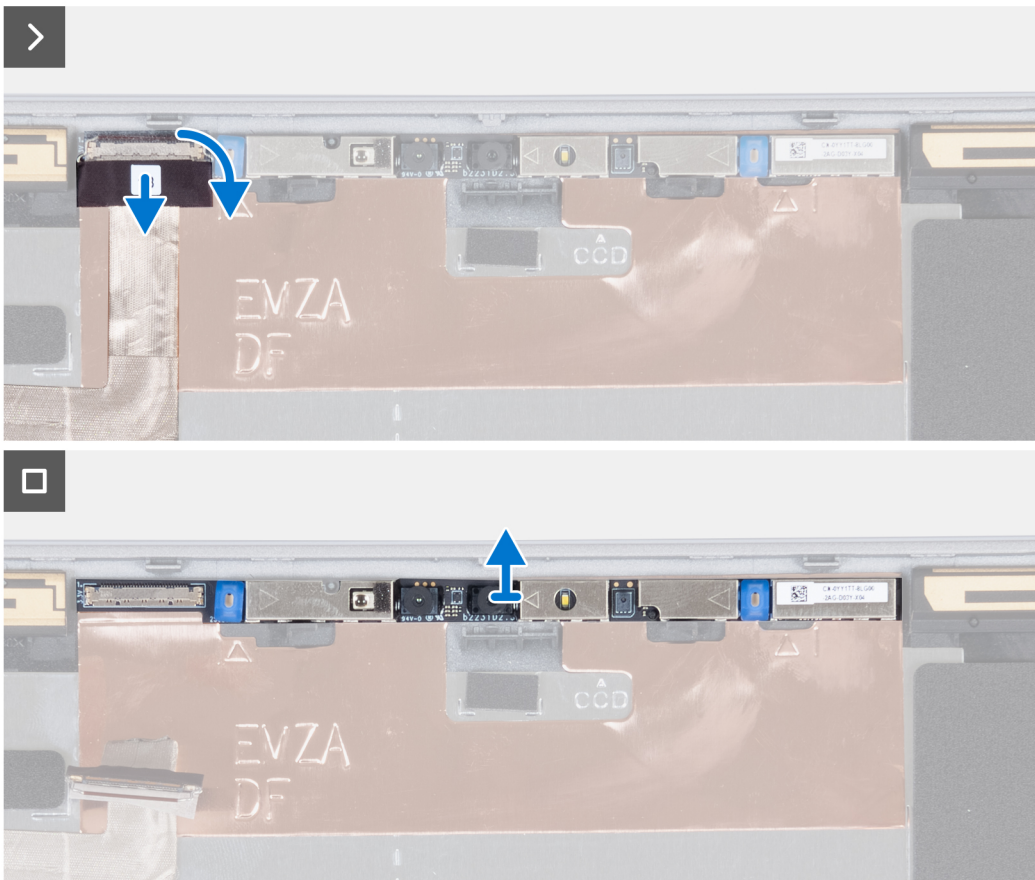
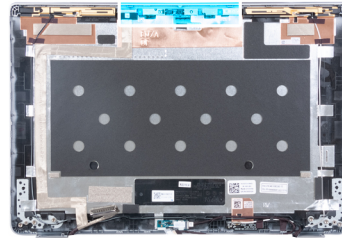

Steps

1. Peel off the conductive tape that secures the camera cable in place.
2. Lift the latch and disconnect the camera cable from the connector on the camera module.
3. Carefully pry and lift the camera module from the display back cover.

Installing the camera (laptop)

Prerequisites

⚠ CAUTION: The information in this section is intended for authorized service technicians only.

ℹ NOTE: The camera installation procedure is applicable only for Latitude 5340 laptop and not for the 2-in-1 configuration.

If you are replacing a component, remove the existing component before performing the installation procedure.

About this task

The following image indicates the location of the camera and provides a visual representation of the installation procedure.

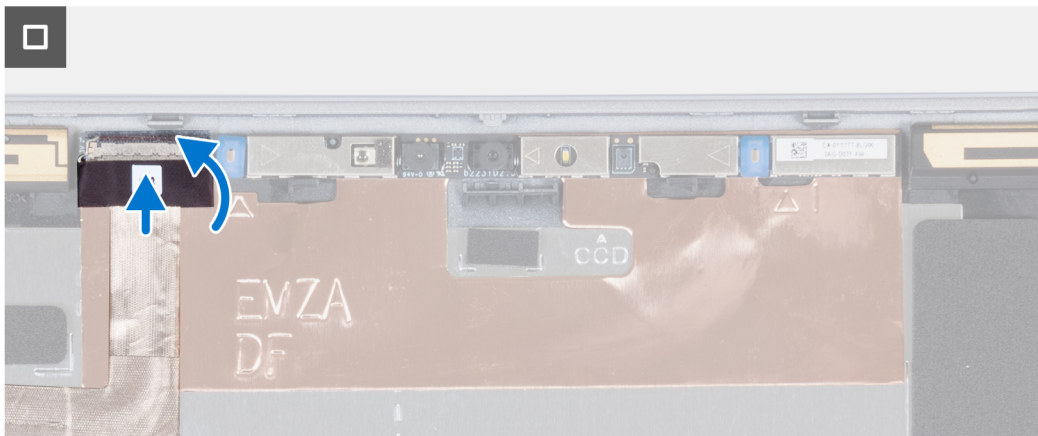
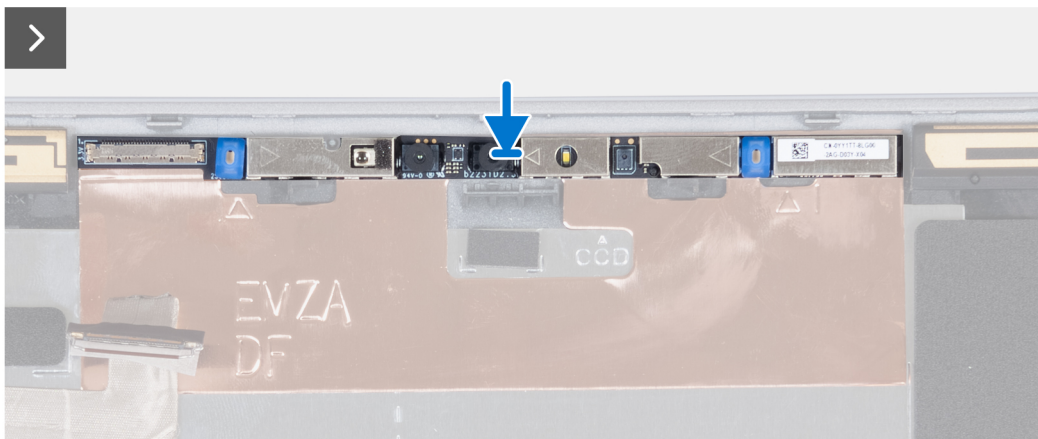
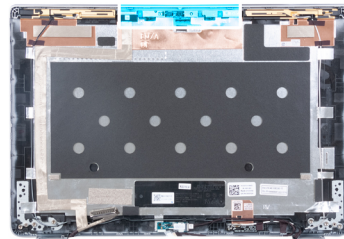

Steps

1. Insert the camera into the slot on the display back cover.
2. Connect the camera cable to the connector.
3. Adhere the adhesive tape above the camera connector.

Next steps

1. Install the [display panel](#).
2. Install the [display hinges](#).
3. Install the [display bezel](#).
4. Install the [display assembly](#).
5. Install the [battery](#).
6. Install the [base cover](#).
7. Follow the procedure in [After working inside your computer](#).

Display back cover

Removing the display back cover (laptop)

Prerequisites

CAUTION: The information in this section is intended for authorized service technicians only.

NOTE: The display back-cover removal procedure is applicable only for Latitude 5340 laptop and not for the 2-in-1 configuration.

1. Follow the procedure in [Before working inside your computer](#).
2. Remove the [base cover](#).
3. Remove the [battery](#).
4. Remove the [display assembly](#).
5. Remove the [display bezel](#).
6. Remove the [display hinges](#).
7. Remove the [display panel](#).
8. Remove the [camera](#).
9. Remove the [eDP cable](#).

About this task

The following images indicate the location of the display back-cover and provide a visual representation of the removal procedure.

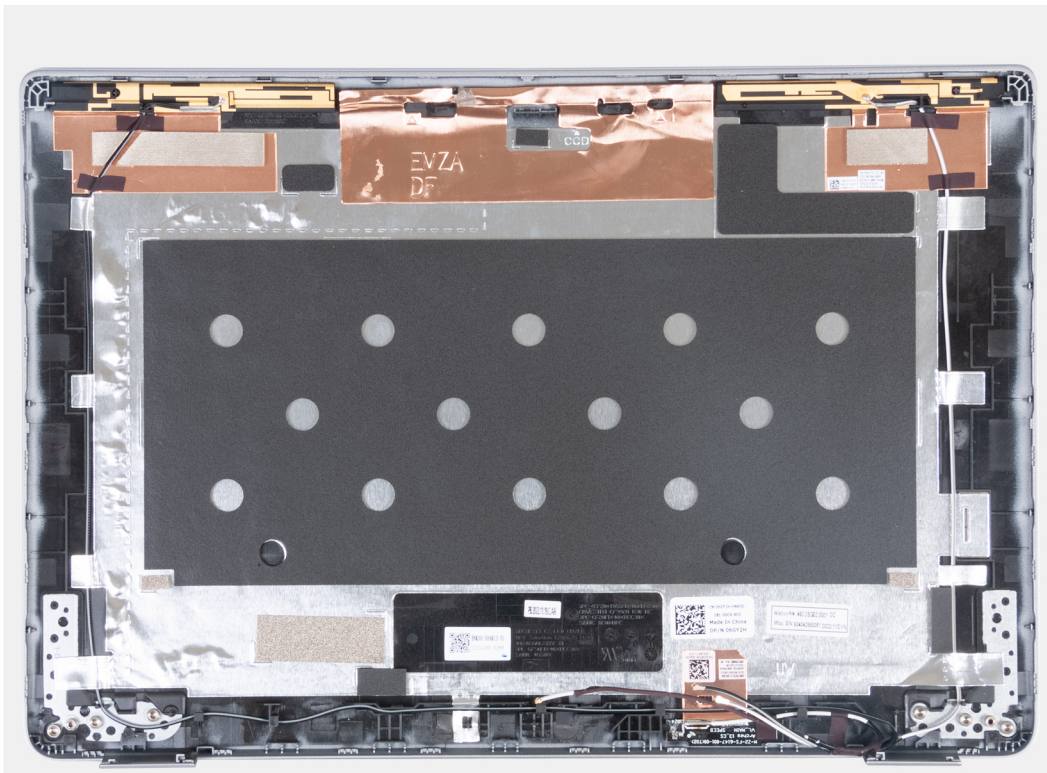

Steps

After performing the preceding steps, you are left with the display back cover.

Installing the display back-cover (laptop)

Prerequisites

CAUTION: The information in this section is intended for authorized service technicians only.

NOTE: The display back-cover installation procedure is applicable only for Latitude 5340 laptop and not for the 2-in-1 configuration.

If you are replacing a component, remove the existing component before performing the installation procedure.

About this task

The following image indicates the location of the display back-cover and provides a visual representation of the installation procedure.

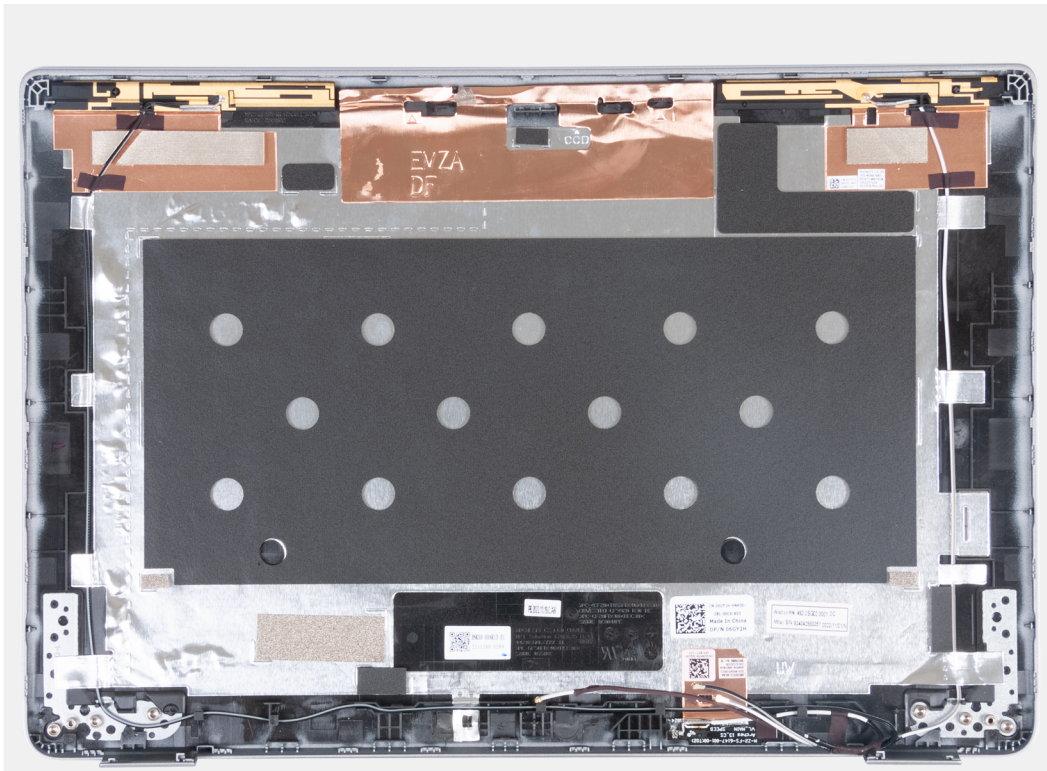

Steps

Place the display back-cover on a flat surface and perform the following steps to install the display back cover.

Next steps

1. Install the [eDP cable](#).
2. Install the [camera](#).
3. Install the [display panel](#).
4. Install the [display hinges](#).
5. Install the [display bezel](#).
6. Install the [display assembly](#).
7. Install the [battery](#).
8. Install the [base cover](#).
9. Follow the procedure in [After working inside your computer](#).

Sensor board

Removing the sensor board (laptop)

Prerequisites

CAUTION: The information in this section is intended for authorized service technicians only.

NOTE: The sensor board removal procedure is applicable only for Latitude 5340 laptop and not for the 2-in-1 configuration.

1. Follow the procedure in [Before working inside your computer](#).
2. Remove the [base cover](#).
3. Remove the [battery](#).
4. Remove the [display assembly](#).
5. Remove the [display bezel](#).
6. Remove the [display panel](#).

About this task

The following images indicate the location of the sensor board and provide a visual representation of the removal procedure.

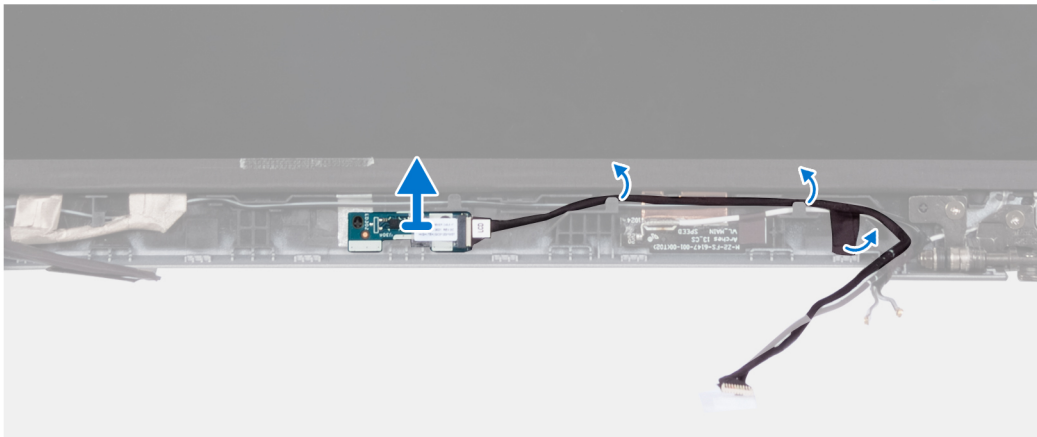

Steps

1. Open the latch and disconnect the display cable from connector on the sensor board.
2. Unroute the display cable from the display assembly.
3. Gently lift the sensor board away from the display assembly.

Installing the sensor board (laptop)

About this task

CAUTION: The information in this section is intended for authorized service technicians only.

NOTE: The sensor board installation procedure is applicable only for Latitude 5340 laptop and not for the 2-in-1 configuration.

The following images indicate the location of the sensor board and provide a visual representation of the removal procedure.

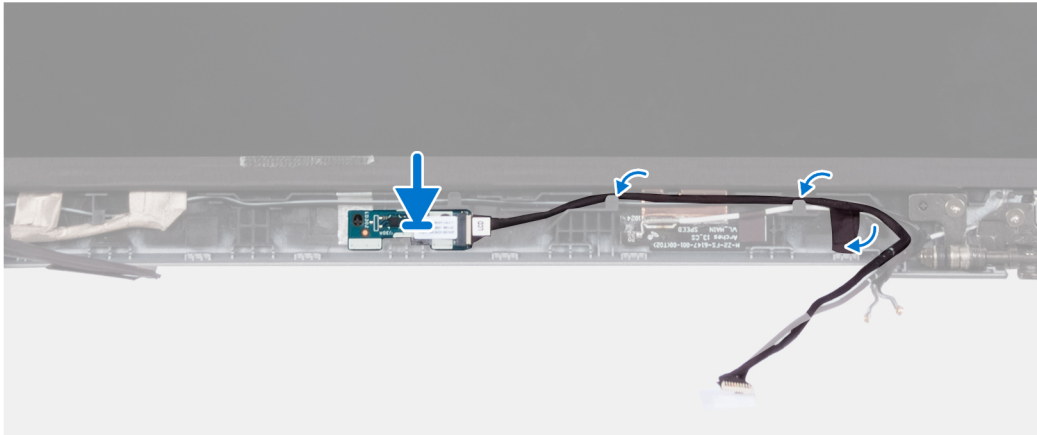

Steps

1. Align and place the sensor board on the display assembly.
2. Connect the display to the sensor board and close the latch.
3. Route the display cable along the routing guide on the display assembly.

Next steps

1. Install the [display panel](#).
2. Install the [display bezel](#).
3. Install the [display assembly](#).
4. Install the [battery](#).
5. Install the [base cover](#).
6. Follow the procedure in [After working inside your computer](#).

Smart card reader

Removing the smart card reader (optional)

Prerequisites

CAUTION: The information in this section is intended for authorized service technicians only.

1. Follow the procedure in [Before working inside your computer](#).
2. Remove the [SIM card tray](#).
3. Remove the [base cover](#).
4. Remove the [battery](#).
5. Remove the [M.2 2230 solid-state drive](#).
6. Remove the [WWAN 4G card](#) or [WWAN 5G card](#).

7. Remove the [WLAN card](#).
8. Remove the [fan](#).
9. Remove the [speakers](#).

About this task

NOTE: For models with smart card reader configuration, the smart card reader is preinstalled in the replacement palm-rest assembly.

The following images indicate the location of the smart card reader and provide a visual representation of the removal procedure.



2x
M2x2

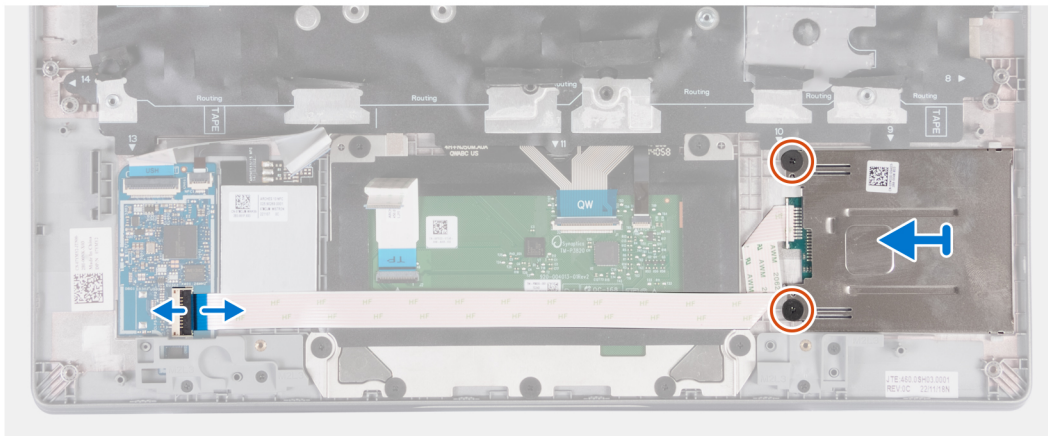
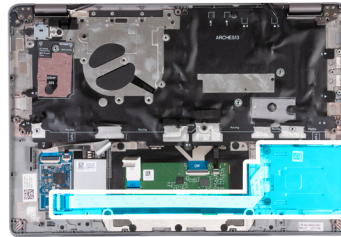

Steps

1. Open the latch and disconnect the smart card reader cable from the USH board.
2. Remove the two screws (M2x2) that secure the smart card reader to the palm-rest assembly.
3. Lift the smart card reader off the palm-rest assembly.

Installing the smart card reader (optional)

Prerequisites

CAUTION: The information in this section is intended for authorized service technicians only.

If you are replacing a component, remove the existing component before performing the installation procedure.

About this task

The following image indicates the location of the smart card reader and provides a visual representation of the installation procedure.



2x
M2x2

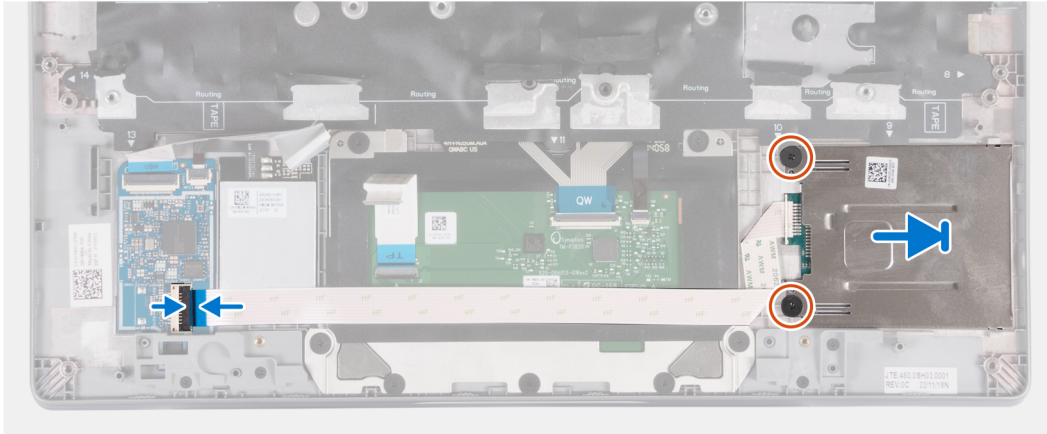
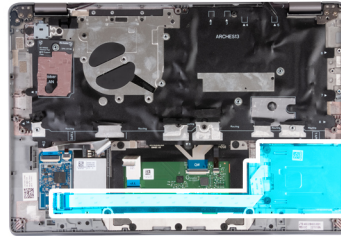

Steps

1. Align and slide the smart card reader inwards.
2. Replace the two screws (M2x2) to secure the smart card reader to the palm-rest assembly.
3. Connect the smart card reader cable to its connector on the USH board and close the latch.

Next steps

1. Install the [speakers](#).
2. Install the [fan](#).
3. Install the [WLAN card](#).
4. Install the [WWAN 4G card](#) or [WWAN 5G card](#).
5. Install the [M.2 2230 solid-state drive](#).
6. Install the [battery](#).
7. Install the [base cover](#).
8. Install the [SIM card tray](#) (for computers with nano-SIM card option).
9. Follow the procedure in [After working inside your computer](#).

SIM card slot filler

Removing the SIM-card slot filler

Prerequisites

⚠ CAUTION: The information in this section is intended for authorized service technicians only.

1. Follow the procedure in [Before working inside your computer](#).
2. Remove the [SIM card tray](#) (for computers with nano-SIM card option).
3. Remove the [base cover](#).
4. Remove the [battery](#).
5. Remove the [M.2 2230 solid-state drive](#).
6. Remove the [WWAN 4G card](#) or [WWAN 5G card](#).
7. Remove the [WLAN card](#).

8. Remove the [fan](#).
9. Remove the [power button](#) or [power button with optional fingerprint reader](#).
10. Remove the [smart card reader](#) (optional).
11. Remove the [speakers](#).
12. Remove the [display assembly](#).
13. Remove the [system board](#).

i **NOTE:** The system board can be removed with the heat sink attached in order to simplify the procedure and preserve the thermal bond between the system board and heat sink.

14. Remove the [keyboard](#).
15. Remove the [palm-rest assembly](#).

About this task

i **NOTE:** For models shipped with WLAN antennas only, the SIM-card slot filler is a separate service part and is not included with replacement palm rest. Hence, the SIM-card slot filler must be removed and then re-installed when replacing the palm rest.

The following image provides a visual representation of the SIM-card slot filler removal procedure.

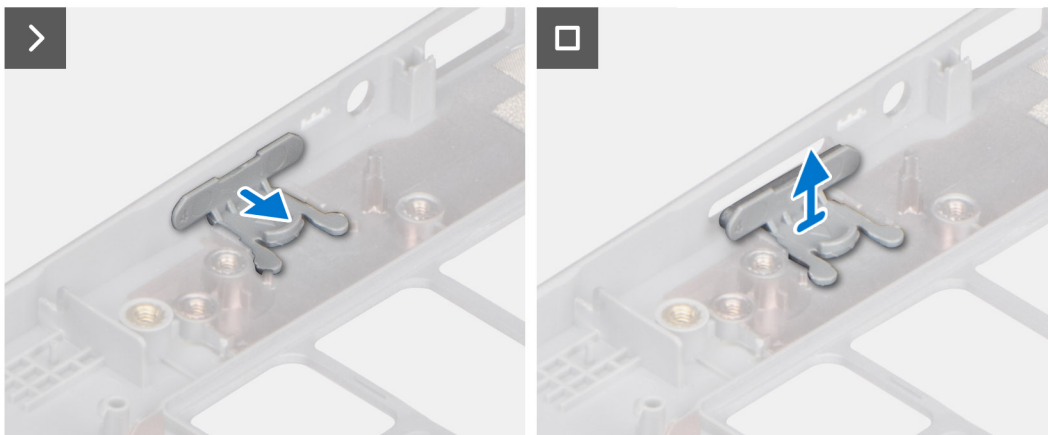
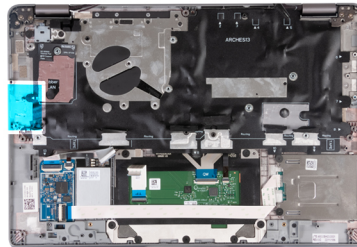

Steps

1. Pull the SIM-card slot filler from the top side of the palm rest.
2. Lift the SIM-card slot filler out of the system.

Installing the SIM-card slot filler

Prerequisites

⚠ CAUTION: The information in this section is intended for authorized service technicians only.

If you are replacing a component, remove the necessary component before the installation procedure.

About this task

The following image provides a visual representation of the SIM-card slot filler installation procedure.

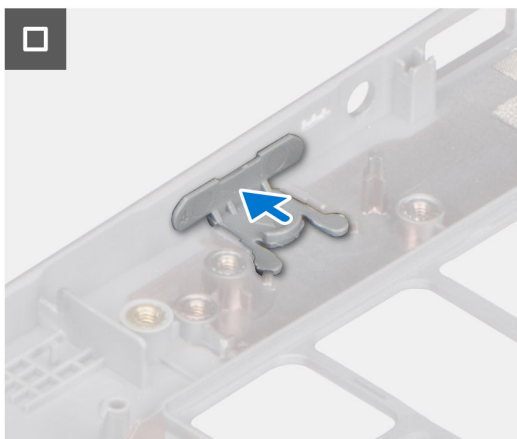
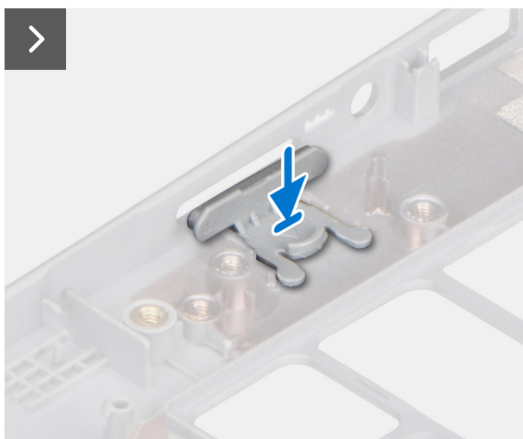

Steps

1. Place the SIM-card slot filler into its compartment on the palm rest ensuring that the SIM-card slot filler is aligned with the ribs on the palm rest.
2. Press the SIM-card slot filler until you hear it click ensuring it fits securely into the SIM-card slot filler.

Next steps

1. Install the [palm-rest assembly](#).
2. Install the [keyboard](#).
3. Install the [display assembly](#).
4. Install the [speakers](#).
5. Install the [smart card reader](#) (optional).
6. Install the [power button](#) or [power button with optional fingerprint reader](#).
7. Install the [system board](#).
8. Install the [fan](#).
9. Install the [WLAN card](#).
10. Install the [WWAN 4G card](#) or [WWAN 5G card](#).
11. Install the [M.2 2230 solid-state drive](#).
12. Install the [battery](#).
13. Install the [base cover](#).
14. Install the [SIM card tray](#) (for computers with nano-SIM card option).
15. Follow the procedure in [After working inside your computer](#).

Palm-rest assembly

Removing the palm-rest

Prerequisites

 **CAUTION:** The information in this section is intended for authorized service technicians only.

NOTE: For models with smart card reader configuration, the smart card reader is preinstalled in the replacement palm-rest assembly.

1. Follow the procedure in [Before working inside your computer](#).
2. Remove the [SIM card tray](#) (for computers with nano-SIM card option).
3. Remove the [base cover](#).
4. Remove the [battery](#).
5. Remove the [M.2 2230 solid-state drive](#).
6. Remove the [WWAN 4G card](#) or [WWAN 5G card](#).
7. Remove the [WLAN card](#).
8. Remove the [fan](#).
9. Remove the [heat sink](#).
10. Remove the [system board](#).

NOTE: The system board can be removed with the heat sink attached in order to simplify the procedure and preserve the thermal bond between the system board and heat sink.

11. Remove the [power button](#) or [power button with optional fingerprint reader](#).
12. Remove the [smart card reader](#) (optional).
13. Remove the [speakers](#).
14. Remove the [display assembly](#).
15. Remove the [SIM card slot filler](#) (for computers without nano-SIM card option).

About this task

The following images indicate the location of the palm-rest and provide a visual representation of the removal procedure.

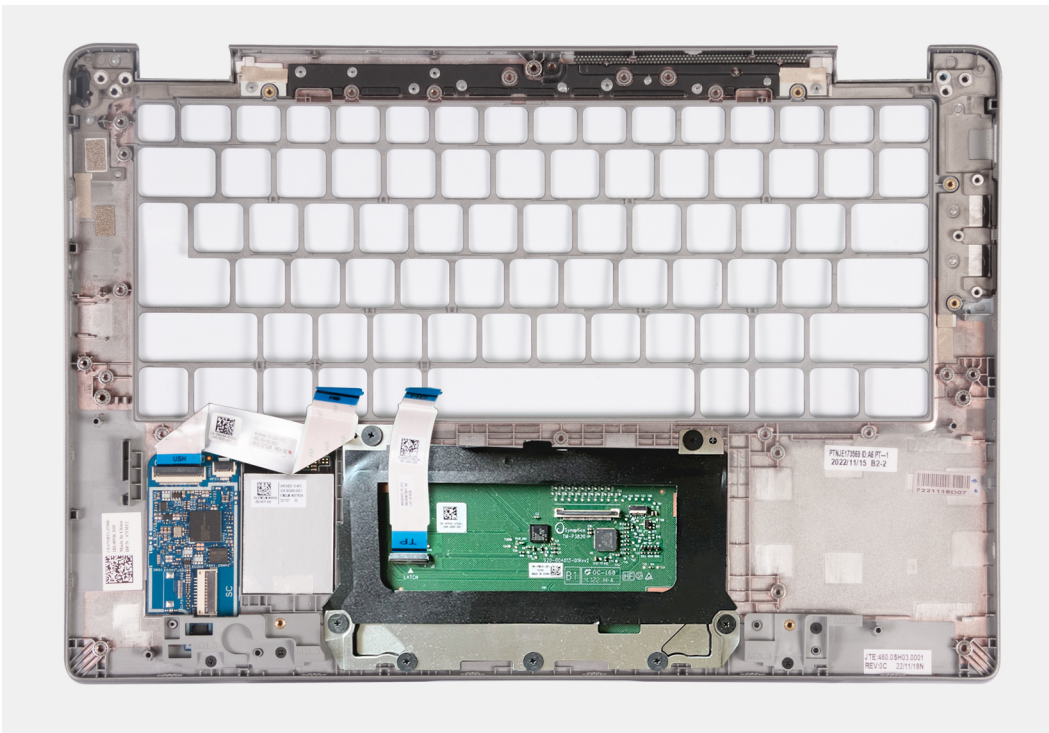

Steps

After performing the preceding steps, you are left with the palm-rest.

Installing the palm-rest

Prerequisites

CAUTION: The information in this section is intended for authorized service technicians only.

If you are replacing a component, remove the existing component before performing the installation procedure.

About this task

The following image indicates the palm-rest and provides a visual representation of the installation procedure.

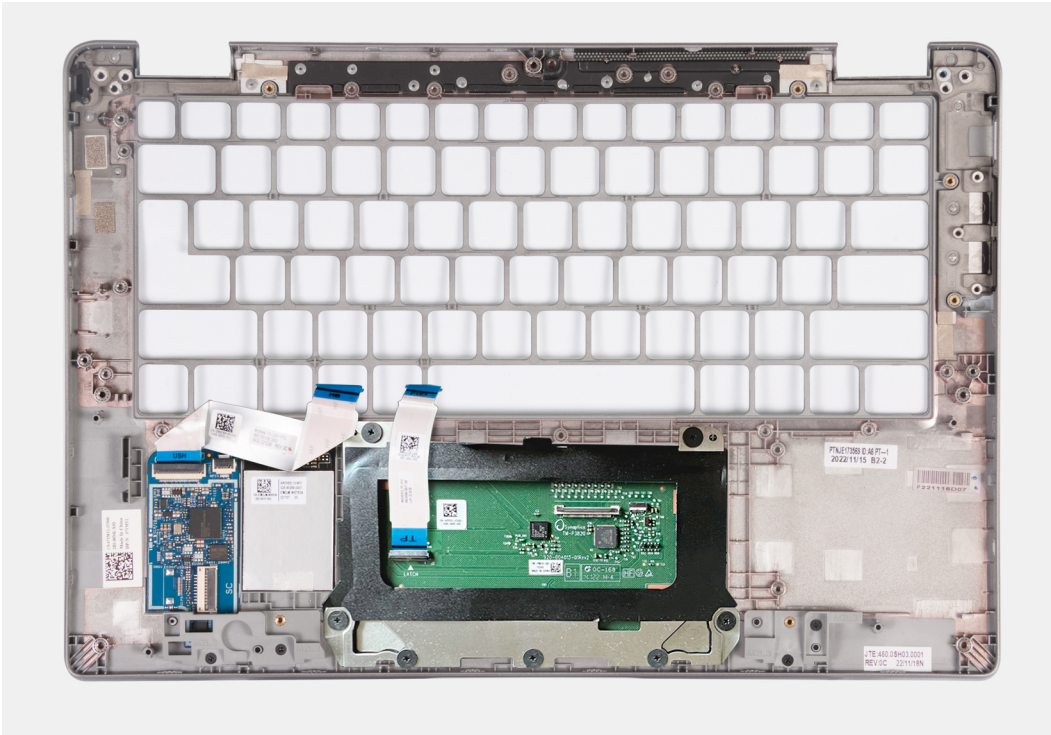

Steps

Place the palm-rest assembly on a flat surface.

Next steps

NOTE: The system board can be installed with the heat sink attached in order to simplify the procedure and preserve the thermal bond between the system board and heat sink.

1. Install the [SIM card slot filler](#) (for computers without nano-SIM card option).
2. Install the [display assembly](#).
3. Install the [speakers](#).
4. Install the [smart card reader](#) (optional).
5. Install the [power button](#) or [power button with optional fingerprint reader](#).
6. Install the [system board](#).
7. Install the [heat sink](#).
8. Install the [fan](#).
9. Install the [WLAN card](#).
10. Install the [WWAN 4G card](#) or [WWAN 5G card](#).
11. Install the [M.2 2230 solid-state drive](#).
12. Install the [battery](#).
13. Install the [base cover](#).
14. Install the [SIM card tray](#) (for computers with nano-SIM card option).
15. Follow the procedure in [After working inside your computer](#).

Software

This chapter details the supported operating systems along with instructions on how to install the drivers.

Operating system

Your Latitude 5340/Latitude 5340 2-in-1 supports the following operating systems:

- Windows 11 Home
- Windows 11 Pro
- Windows 11 Pro Downgrade (Windows 10 Pro Image-factory installed + Windows 11 Pro DPK)
- Ubuntu Linux 22.04 LTS (applicable only for Latitude 5340 laptop and not for the 2-in-1 configuration)

Drivers and downloads

When troubleshooting, downloading or installing drivers it is recommended that you read the Dell Knowledge Base article, Drivers and Downloads FAQ [000123347](#).

BIOS setup

CAUTION: Unless you are an expert computer user, do not change the settings in the BIOS Setup program. Certain changes can make your computer work incorrectly.

NOTE: Depending on the computer and its installed devices, the items listed in this section may or may not be displayed.

NOTE: Before you change BIOS Setup program, it is recommended that you write down the BIOS Setup program screen information for future reference.

Use the BIOS Setup program for the following purposes:

- Get information about the hardware installed in your computer, such as the amount of RAM and the size of the hard drive.
- Change the system configuration information.
- Set or change a user-selectable option, such as the user password, type of hard drive installed, and enabling or disabling base devices.

Entering BIOS setup program

About this task

Turn on (or restart) your computer and press F2 immediately.

Navigation keys

NOTE: For most of the System Setup options, changes that you make are recorded but do not take effect until you restart the system.

Table 32. Navigation keys

Keys	Navigation
Up arrow	Moves to the previous field.
Down arrow	Moves to the next field.
Enter	Selects a value in the selected field (if applicable) or follow the link in the field.
Spacebar	Expands or collapses a drop-down list, if applicable.
Tab	Moves to the next focus area. NOTE: For the standard graphics browser only.
Esc	Moves to the previous page until you view the main screen. Pressing Esc in the main screen displays a message that prompts you to save any unsaved changes and restarts the system.

One Time Boot menu

To enter **One Time Boot menu**, turn on your computer, and then press F12 immediately.

NOTE: It is recommended to shutdown the computer if it is on.

The one-time boot menu displays the devices that you can boot from including the diagnostic option. The boot menu options are:

- Removable Drive (if available)
- STXXXX Drive (if available)
- **i** **NOTE:** XXX denotes the SATA drive number.
- Optical Drive (if available)
- SATA Hard Drive (if available)
- Diagnostics

The boot sequence screen also displays the option to access the System Setup screen.

System setup options

i **NOTE:** Depending on your computer and its installed devices, the items listed in this section may or may not appear.

Table 33. System setup options—System information menu

Overview	
BIOS Version	Displays the BIOS version number.
Service Tag	Displays the Service Tag of the computer.
Asset Tag	Displays the Asset Tag of the computer.
Manufacture Date	Displays the manufacture date of the computer.
Ownership Date	Displays the ownership date of the computer.
Express Service Code	Displays the express service code of the computer.
Ownership Tag	Displays the Ownership Tag of the computer.
Signed Firmware Update	Displays whether the Signed Firmware Update is enabled on your computer.
Battery Information	
Primary	Displays that battery is primary.
Battery Level	Displays the battery level of the computer.
Battery State	Displays the battery state of the computer.
Health	Displays the battery health of the computer.
AC Adapter	Displays whether the AC adapter is connected or not.
Processor Information	
Processor Type	Displays the processor type.
Maximum Clock Speed	Displays the maximum processor clock speed.
Minimum Clock Speed	Displays the minimum processor clock speed.
Current Clock Speed	Displays the current processor clock speed.
Core Count	Displays the number of cores on the processor.
Processor ID	Displays the processor identification code.
Processor L2 Cache	Displays the processor L2 Cache size.
Processor L3 Cache	Displays the processor L3 Cache size.
Microcode Version	Displays the microcode version.
Intel Hyper-Threading Capable	Displays whether the processor is Hyper-Threading (HT) capable.
64-Bit Technology	Displays whether 64-bit technology is used.
Memory Information	

Table 33. System setup options—System information menu (continued)

Overview	
Memory Installed	Displays the total computer memory installed.
Memory Available	Displays the total computer memory available.
Memory Speed	Displays the memory speed.
Memory Channel Mode	Displays single or dual channel mode.
Memory Technology	Displays the technology used for the memory.
DIMM_SLOT B	Displays the DIMM B memory size.
DIMM_SLOT A	Displays the DIMM A memory size.
Devices Information	
Panel Type	Displays the Panel Type of the computer.
Video Controller	Displays the video controller type of the computer.
Video Memory	Displays the video memory information of the computer.
Wi-Fi Device	Displays the wireless device information of the computer.
Native Resolution	Displays the native resolution of the computer.
Video BIOS Version	Displays the video BIOS version of the computer.
Audio Controller	Displays the audio controller information of the computer.
Bluetooth Device	Displays the Bluetooth device information of the computer.
LOM MAC Address	Displays the LAN On Motherboard (LOM) MAC address of the computer.
Pass Through MAC Address	Displays the pass through MAC address of the computer.
Cellular Device	Displays the M.2 PCIe SSD information of the computer.

Table 34. System setup options—Boot Configuration menu

Boot Configuration	
Boot Sequence	
Boot mode	Displays the boot mode.
Boot Sequence	Displays the boot sequence.
Secure Boot	
Enable Secure Boot	Enable or disable the secure boot feature. By default, the option is enabled.
Secure Boot Mode	Enable or disable to change the secure boot mode options. By default, the Deployed Mode is enabled.
Expert Key Management	
Enable Custom Mode	Enable or disable custom mode. By default, the custom mode option is not enabled.
Custom Mode Key Management	Select the custom values for expert key management.

Table 35. System setup options—Integrated Devices menu

Integrated Devices	
Date/Time	Displays the current date in MM/DD/YYYY format and current time in HH:MM:SS AM/PM format.
Camera	Enables or disable the camera.

Table 35. System setup options—Integrated Devices menu (continued)

Integrated Devices	
	By default, the Enable Camera option is selected
Audio	
Enable Audio	Enable or disable the integrated audio controller. By default, all the options are enabled.
USB/Thunderbolt Configuration	<ul style="list-style-type: none"> Enable or disable booting from USB mass storage devices connected to external USB ports. By default, the Enable External USB Ports option is enabled. Enable or disable booting from USB mass storage devices such as external hard drive, optical drive, and USB drive. By default, the Enable USB Boot Support option is enabled.
Enable Thunderbolt Technology Support	Enable or disable the associated ports and adapters. By default, the Enable Thunderbolt Technology Support option is selected.
Enable Thunderbolt Boot Support	Enable or disable the Thunderbolt adapter peripheral device and USB devices connected to the Thunderbolt adapter to be used during BIOS Pre-boot. By default, the Enable Thunderbolt Boot Support option is disabled.
Enable Thunderbolt (and PCIe behind TBT) pre-boot modules	Enable or disable the PCIe devices that are connected through a Thunderbolt adapter to execute the PCIe devices UEFI Option ROM (if present) during pre-boot. By default, the Enable Thunderbolt (and PCIe behind TBT) pre-boot modules option is disabled.
Disable USB4 PCIe Tunneling	Disable the USB4 PCIe Tunneling option. By default, the option is disabled.
Video/Power only on Type-C Ports	Enable or disable the Type-C port functionality to video or only power. By default, the Video/Power only on Type-C Ports option is disabled.
Type-C Dock Override	Enables to use connected Type-C Dell Dock to provide data stream with external USB ports disabled. When Type-C Dock override is enabled, the Video/Audio/Lan submenu is activated. By default, the Type-C Dock Override option is enabled.
Video	Enable or disable the usage of video on Dell Dock external ports. By default, the Video option is disabled.
Audio	Enable or disable the usage of audio on Dell Dock external ports. By default, the Audio option is enabled.
Lan	Enable or disable the usage of LAN on Dell Dock external ports. By default, the Lan option is enabled.
Miscellaneous Devices	Enable or disable Fingerprint Reader device. By default, the Enable Fingerprint Reader Device option is enabled.
Unobtrusive Mode	
Enable Unobtrusive Mode	Enable or disable all the computer light and sound. By default, the Enable Unobtrusive Mode option is disabled.

Table 36. System setup options—Storage menu

Storage	
SMART Reporting	
Enable SMART Reporting	Enable or disable Self-Monitoring, Analysis, and Reporting Technology (SMART) during computer startup. By default, the Enable SMART Reporting option is not enabled.
Drive Information	
M.2 PCIe SSD-1	
Type	Displays the M.2 PCIe SSD-1 type information of the computer.
Device	Displays the M.2 PCIe SSD-1 device information of the computer.

Table 37. System setup options—Display menu

Display	
Display Brightness	
Brightness on battery power	Enable to set screen brightness when the computer is running on battery power.
Brightness on AC power	Enable to set screen brightness when the computer is running on AC power.
Full Screen Logo	
	Enable or disable full screen logo. By default, the option is not enabled.

Table 38. System setup options—Connection menu

Connection	
Network Controller Configuration	
Integrated NIC	Controls the on-board LAN controller. By default, the Enabled with PXE option is enabled.
Enable UEFI Network Stack	Enable or disable UEFI Network Stack. By default, the Enable UEFI Network Stack and Enabled w/PXE option are enabled.
Wireless Device Enable	
WWAN/GPS	Enable or disable the internal WWAN/GPS device By default, the option enabled.
WLAN	Enable or disable the internal WLAN device By default, the option enabled.
Bluetooth	Enable or disable the internal Bluetooth device By default, the option enabled.
Contactless smartcard/NFC	Enable or disable the internal Contactless smartcard/NFC device By default, the option enabled.
Enable UEFI Network Stack	Enable or disable UEFI Network Stack and controls the on-board LAN Controller. By default, the Enable UEFI Network Stack option are enabled.
Wireless Radio Control	
Control WLAN radio	Sense the connection of the computer to a wired network and subsequently disable the selected wireless radios (WLAN).

Table 38. System setup options—Connection menu (continued)

Connection	
Control WWAN radio	<p>By default, the option is disabled.</p> <p>Sense the connection of the computer to a wired network and subsequently disable the selected wireless radios (WWAN).</p> <p>By default, the option is disabled.</p>
HTTPs Boot Feature	
HTTPs Boot	<p>Enable or disable the HTTPs Boot feature.</p> <p>By default, the HTTPs Boot option is enabled.</p>
HTTPs Boot Mode	<p>With Auto Mode, the HTTPs Boot extracts Boot URL from the DHCP. With Manual Mode, the HTTPs Boot reads Boot URL from the user-provided data.</p> <p>By default, the Auto Mode option is enabled.</p>

Table 39. System setup options—Power menu

Power	
Battery configuration	<p>Enables the computer to run on battery during peak power usage hours. Use the table Custom Charge Start and Custom Charge Stop, to prevent AC power usage between certain times of each day.</p> <p>By default, the Adaptive option is enabled.</p>
Advanced Configuration	
Enable Advanced Battery Charge Configuration	<p>Enable or disable the advanced battery charge configuration.</p> <p>By default, the Enable Advanced Battery Charge Configuration option is disabled.</p>
Peak Shift	
Enable Peak Shift	<p>Enables the computer to run on battery during peak power usage hours.</p> <p>By default, the Enable Peak Shift option is enabled.</p>
USB PowerShare	
Enable USB PowerShare	<p>Enable or disable the USB PowerShare.</p> <p>By default, the Enable USB PowerShare option is disabled</p>
Thermal Management	
	<p>Enables to cool the fan and processor heat management to adjust the computer performance, noise, and temperature.</p> <p>By default, the Optimized option is enabled.</p>
USB Wake Support	
Wake on Dell USB-C Dock	<p>When enabled, connecting a Dell USB-C Dock will wake the computer from standby.</p> <p>By default, the Wake on Dell USB-C Dock option is enabled.</p>
Block Sleep	
	<p>Enables to block entering sleep (S3) mode in the operating system.</p> <p>By default, the Block Sleep option is disabled.</p>
Lid Switch	
	<p>Enable or disable the lid switch.</p> <p>By default, the Lid Switch option is enabled.</p>
Intel Speed Shift Technology	
	<p>Enable or disable the Intel speed shift technology support.</p> <p>By default, the Intel Speed Shift Technology option is enabled.</p>
Long Life Cycle Primary Battery	
	<p>By default, the Normal Battery option is enabled.</p>

Table 40. System setup options—Security menu

Security	
TPM 2.0 Security	
TPM 2.0 Security On	Enable or disable TPM 2.0 security options. By default, the TPM 2.0 Security On option is enabled.
Attestation Enable	Enables to control whether the Trusted Platform Module (TPM) Endorsement Hierarchy is available to the operating system. By default, the Attestation Enable option is enabled.
Key Storage Enable	Enables to control whether the Trusted Platform Module (TPM) Storage Hierarchy is available to the operating system. By default, the Key Storage Enable option is enabled.
SHA-256	BIOS and the TPM will use the SHA-256 hash algorithm to extend measurements into the TPM PCRs during BIOS boot. By default, the SHA-256 option is enabled.
Clear	Enables to clear the TPM owner information and returns the TPM to the default state. By default, the Clear option is disabled.
PPI ByPass for Clear Commands	Controls the TPM Physical Presence Interface (PPI). By default, the PPI ByPass for clear Commands option is disabled.
Intel Total Memory Encryption	
Total Memory Encryption	Enable or disable you to protect memory from physical attacks including freeze spray, probing DDR to read the cycles, and others. By default, the Total Memory Encryption option is disabled.
Chassis intrusion	
	Controls the chassis intrusion feature. By default, the On-Silent option is enabled.
SMM Security Mitigation	
	Enable or disable SMM Security Mitigation. By default, the option is enabled.
Data Wipe on Next Boot	
Start Data Wipe	Enable or disable the data wipe on next boot. By default, the option is enabled.
Absolute	Enable or disable or permanently disable the BIOS module interface of the optional Absolute Persistence Module service from Absolute software. By default, the option is enabled.
UEFI Boot Path Security	Controls whether or not the computer will prompt the user to enter the admin password (if set) when booting to a UEFI boot device from the F12 boot menu. By default, the Always Except Internal HDD option is enabled.

Table 41. System setup options—Passwords menu

Passwords	
Admin Password	Set, change, or delete the administrator password.
System Password	Set, change, or delete the computer password.
NVMe SSD0	Set, change, or delete the NVMe SSD0 password.
Password Configuration	

Table 41. System setup options—Passwords menu (continued)

Passwords	
Upper Case Letter	Reinforces password must have at least one upper case letter. By default, the option is disabled.
Lower Case Letter	Reinforces password must have at least one lower case letter. By default, the option is disabled.
Digit	Reinforces password must have at least one digit. By default, the option is disabled.
Special Character	Reinforces password must have at least one special character. By default, the option is disabled.
Minimum Characters	Set the minimum characters allowed for password.
Password Bypass	When enabled, this always prompts for computer and internal hard drive passwords when powered on from the off state. By default, the Disabled option is enabled.
Password Changes	
Enable Non-Admin Password Changes	Enable or disable to change computer and hard drive password without the need for admin password. By default, the option is enabled.
Admin Setup Lockout	
Enable Admin Setup Lockout	Enables administrators control over how their users can or cannot access BIOS setup. By default, the option is disabled.
Master Password Lockout	
Enable Master Password Lockout	When enabled, this will disable the master password support. By default, the option is disabled.
Allow Non-Admin PSID Revert	
Enable Allow Non-Admin PSID Revert	Controls access to the Physical Security ID (PSID) revert of NVMe hard-drives from the Dell Security Manager prompt. By default, the option is disabled.

Table 42. System setup options—Update, Recovery menu

Update, Recovery	
UEFI Capsule Firmware Updates	Enable or disable BIOS updates through UEFI capsule update packages. By default, the option is enabled.
BIOS Recovery from Hard Drive	Enables the user to recover from certain corrupted BIOS conditions from a recovery file on the user primary hard drive or an external USB key. By default, the option is enabled.
BIOS Downgrade	
Allow BIOS Downgrade	Enable or disable the flashing of the computer firmware to previous revision is blocked. By default, the option is enabled.
SupportAssist OS Recovery	Enable or disable the boot flow for SupportAssist OS Recovery tool in the event of certain computer errors.

Table 42. System setup options—Update, Recovery menu (continued)

Update, Recovery	
BISOConnect	<p>By default, the option is enabled.</p> <p>Enable or disable cloud Service OS recovery if the main operating system fails to boot with the number of failures equal to or greater than the value specified by the Auto OS Recovery Threshold setup option and local Service OS does not boot or is not installed.</p>
Dell Auto OS Recovery Threshold	<p>By default, the option is enabled.</p> <p>Controls the automatic boot flow for SupportAssist System Resolution Console and for Dell OS Recovery Tool.</p> <p>By default, the threshold value is set to 2.</p>

Table 43. System setup options—System Management menu

System Management	
Service Tag	Display the Service Tag of the computer.
Asset Tag	Create a computer Asset Tag.
AC Behavior	
Wake on AC	<p>Enable or disable the wake on AC option.</p> <p>By default, the option is disabled.</p>
Wake on LAN	
Wake on LAN	<p>Enable or disable the computer to power on by special LAN signals when it receives a wakeup signal from the WLAN.</p> <p>By default, the Disabled option is selected.</p>
Auto on Time	<p>Enable to set the computer to turn on automatically every day or on a preselected date and time. This option can be configured only if the Auto On Time is set to Everyday, Weekdays, or Selected Days.</p> <p>By default, the option is disabled.</p>

Table 44. System setup options—Keyboard menu

Keyboard	
Numlock Enable	<p>Enable or disable the Numlock function when the computer boots.</p> <p>By default, the option is enabled.</p>
Fn Lock Options	By default, the Fn lock option is enabled.
Keyboard Illumination	<p>Enables to change the keyboard illumination settings.</p> <p>By default, the Bright option is enabled.</p>
Keyboard Backlight Timeout on AC	<p>Set the timeout value for the keyboard backlight when an AC adapter is connected to the computer.</p> <p>By default, the 10 seconds option is enabled.</p>
Keyboard Backlight Timeout on Battery	<p>Set the timeout value for the keyboard backlight when the is running only on battery power.</p> <p>By default, the 10 seconds option is enabled.</p>
Device Configuration Hotkey Access	<p>Manages whether you can access device configuration screens through hotkeys during computer startup.</p> <p>By default, the option is enabled.</p>

Table 45. System setup options—Pre-boot Behavior menu

Pre-boot Behavior	
Adapter Warnings	
Enable Adapter Warnings	Enable or disable the warning messages during boot when the adapters with less power capacity are detected. By default, the option is enabled.
Warning and Errors	
	Enable or disable the action to be done when a warning or error is encountered. By default, the Prompt on Warnings and Errors option is enabled.
Fastboot	
	Enable to set the speed of the boot process. By default, the Minimal option is enabled.
Extend BIOS POST Time	
	Set the BIOS POST time. By default, the 0 seconds option is enabled.
MAC Address Pass-Through	
	Replaces the external NIC MAC address with the selected MAC address from the computer. By default, the System Unique MAC Address option is enabled.

Table 46. System setup options—Performance menu

Performance	
Multi Core Support	
Active Cores	Enables to change the number of CPU cores available to the operating system. By default, the All Cores options is enabled.
Intel SpeedStep	
Enable Intel SpeedStep Technology	Enables the computer to dynamically adjust processor voltage and core frequency, decreasing average power consumption and heat production. By default, the option is enabled.
C-States Control	
Enable C-State Control	Enable or disable additional processor sleep states. By default, the option is enabled.
Intel TurbocBoost Technology	
Enable Intel Turbo Boost Technology	Enable or disable Intel TurboBoost mode of the processor. By default, the option is enabled.
Intel Hyper-Threading Technology	
Enable Intel Hyper-Threading Technology	Enable or disable Hyper-Threading in the processor. By default, the option is enabled.

Table 47. System setup options—System Logs menu

System Logs	
BIOS Event Log	
Clear Bios Event Log	Display BIOS events. By default, the Keep option is enabled.
Thermal Event Log	
Clear Thermal Event Log	Display Thermal events.

Table 47. System setup options—System Logs menu (continued)

System Logs	
Power Event Log	By default, the Keep option is enabled.
Clear Power Event Log	Display power events. By default, the Keep option is enabled.
License Information	Displays the license information of the computer.

Updating the BIOS

Updating the BIOS in Windows

Steps

1. Go to www.dell.com/support.
2. Click **Product support**. In the **Search support** box, enter the Service Tag of your computer, and then click **Search**.
 **NOTE:** If you do not have the Service Tag, use the SupportAssist feature to automatically identify your computer. You can also use the product ID or manually browse for your computer model.
3. Click **Drivers & Downloads**. Expand **Find drivers**.
4. Select the operating system installed on your computer.
5. In the **Category** drop-down list, select **BIOS**.
6. Select the latest version of BIOS, and click **Download** to download the BIOS file for your computer.
7. After the download is complete, browse the folder where you saved the BIOS update file.
8. Double-click the BIOS update file icon and follow the on-screen instructions.
For more information about how to update the system BIOS, search in the Knowledge Base Resource at www.dell.com/support.

Updating the BIOS using the USB drive in Windows

Steps

1. Follow the procedure from step 1 to step 6 in [Updating the BIOS in Windows](#) to download the latest BIOS setup program file.
2. Create a bootable USB drive. For more information, search the Knowledge Base Resource at www.dell.com/support.
3. Copy the BIOS setup program file to the bootable USB drive.
4. Connect the bootable USB drive to the computer that needs the BIOS update.
5. Restart the computer and press **F12**.
6. Select the USB drive from the **One Time Boot Menu**.
7. Type the BIOS setup program filename and press **Enter**.
The **BIOS Update Utility** appears.
8. Follow the on-screen instructions to complete the BIOS update.

Updating the BIOS in Linux and Ubuntu

To update the system BIOS on a computer that is installed with Linux or Ubuntu, see the knowledge base article [000131486](#) at www.dell.com/support.

Updating the BIOS from the F12 One Time Boot menu

Update your computer BIOS using the BIOS update.exe file that is copied to a FAT32 USB drive and booting from the F12 **One Time Boot** menu.

About this task

BIOS Update

You can run the BIOS update file from Windows using a bootable USB drive or you can also update the BIOS from the F12 **One Time Boot** menu on the computer.

Most of the Dell computers built after 2012 have this capability, and you can confirm by booting your computer to the F12 **One Time Boot** Menu to see if BIOS FLASH UPDATE is listed as a boot option for your computer. If the option is listed, then the BIOS supports this BIOS update option.

 **NOTE:** Only computers with BIOS Flash Update option in the F12 **One Time Boot** menu can use this function.

Updating from the One Time Boot menu

To update your BIOS from the F12 **One Time Boot** menu, you need the following:

- USB drive formatted to the FAT32 file system (key does not have to be bootable)
- BIOS executable file that you downloaded from the Dell Support website and copied to the root of the USB drive
- AC power adapter that is connected to the computer
- Functional computer battery to flash the BIOS

Perform the following steps to perform the BIOS update flash process from the F12 menu:

 **CAUTION:** Do not turn off the computer during the BIOS update process. The computer may not boot if you turn off your computer.

Steps

1. From a turn off state, insert the USB drive where you copied the flash into a USB port of the computer.
2. Turn on the computer and press F12 to access the **One Time Boot** Menu, select BIOS Update using the mouse or arrow keys then press Enter.
The flash BIOS menu is displayed.
3. Click **Flash from file**.
4. Select external USB device.
5. Select the file and double-click the flash target file, and then click **Submit**.
6. Click **Update BIOS**. The computer restarts to flash the BIOS.
7. The computer will restart after the BIOS update is completed.

System and setup password

Table 48. System and setup password

Password type	Description
System password	Password that you must enter to log in to your system.
Setup password	Password that you must enter to access and make changes to the BIOS settings of your computer.

You can create a system password and a setup password to secure your computer.

 **CAUTION:** The password features provide a basic level of security for the data on your computer.

 **CAUTION:** Anyone can access the data that is stored on your computer if it is not locked and left unattended.

 **NOTE:** System and setup password feature is disabled.

Assigning a system setup password

Prerequisites

You can assign a new **System or Admin Password** only when the status is in **Not Set**.

About this task

To enter the system setup, press F12 immediately after a power-on or reboot.

Steps

1. In the **System BIOS** or **System Setup** screen, select **Security** and press Enter.
The **Security** screen is displayed.
2. Select **System/Admin Password** and create a password in the **Enter the new password** field.
Use the following guidelines to assign the system password:
 - A password can have up to 32 characters.
 - At least one special character: ! " # \$ % & ' () * + , - . / : ; < = > ? @ [\] ^ _ ` { | }
 - Numbers 0 through 9.
 - Upper case letters from A to Z.
 - Lower case letters from a to z.
3. Type the system password that you entered earlier in the **Confirm new password** field and click **OK**.
4. Press Esc and save the changes as prompted by the pop-up message.
5. Press Y to save the changes.
The computer restarts.

Deleting or changing an existing system setup password

Prerequisites

Ensure that the **Password Status** is Unlocked (in the System Setup) before attempting to delete or change the existing System and/or Setup password. You cannot delete or change an existing System or Setup password, if the **Password Status** is Locked.

About this task

To enter the System Setup, press F12 immediately after a power-on or reboot.

Steps

1. In the **System BIOS** or **System Setup** screen, select **System Security** and press Enter.
The **System Security** screen is displayed.
2. In the **System Security** screen, verify that **Password Status** is **Unlocked**.
3. Select **System Password**, update, or delete the existing system password, and press Enter or Tab.
4. Select **Setup Password**, update, or delete the existing setup password, and press Enter or Tab.
 **NOTE:** If you change the System and/or Setup password, reenter the new password when prompted. If you delete the System and/or Setup password, confirm the deletion when prompted.
5. Press Esc and a message prompts you to save the changes.
6. Press Y to save the changes and exit from System Setup.
The computer restarts.

Clearing CMOS settings

About this task

 **CAUTION:** Clearing CMOS settings will reset the BIOS settings on your computer.

Steps

1. Remove the [base cover](#).
2. Disconnect the battery cable from the system board.
3. Remove the [coin-cell battery](#).
4. Wait for one minute.
5. Replace the [coin-cell battery](#).
6. Connect the battery cable to the system board.
7. Replace the [base cover](#).

Clearing BIOS (System Setup) and System passwords

About this task

To clear the system or BIOS passwords, contact Dell technical support as described at www.dell.com/contactdell.

 **NOTE:** For information on how to reset Windows or application passwords, refer to the documentation accompanying Windows or your application.

Troubleshooting

Handling swollen rechargeable Li-ion batteries

Like most laptops, Dell laptops use Lithium-ion batteries. One type of Lithium-ion battery is the rechargeable Li-ion battery. Rechargeable Li-ion batteries have increased in popularity in recent years and have become standard in the electronics industry due to customer preferences for a slim form factor (especially with newer ultra-thin laptops) and long battery life. Inherent to rechargeable Li-ion battery technology is the potential for swelling of the battery cells.

Swollen battery may impact the performance of the laptop. To prevent possible further damage to the device enclosure or internal components leading to malfunction, discontinue the use of the laptop and discharge it by disconnecting the AC adapter and letting the battery drain.

Swollen batteries should not be used and should be replaced and disposed of properly. We recommend contacting Dell product support for options to replace a swollen battery under the terms of the applicable warranty or service contract, including options for replacement by a Dell authorized service technician.

The guidelines for handling and replacing rechargeable Li-ion batteries are as follows:

- Exercise caution when handling rechargeable Li-ion batteries.
- Discharge the battery before removing it from the system. To discharge the battery, unplug the AC adapter from the system and operate the system only on battery power. When the system will no longer power on when the power button is pressed, the battery is fully discharged.
- Do not crush, drop, mutilate, or penetrate the battery with foreign objects.
- Do not expose the battery to high temperatures, or disassemble battery packs and cells.
- Do not apply pressure to the surface of the battery.
- Do not bend the battery.
- Do not use tools of any type to pry on or against the battery.
- If a battery gets stuck in a device as a result of swelling, do not try to free it as puncturing, bending, or crushing a battery can be dangerous.
- Do not attempt to reassemble a damaged or swollen battery into a laptop.
- Swollen batteries that are covered under warranty should be returned to Dell in an approved shipping container (provided by Dell)—this is to comply with transportation regulations. Swollen batteries that are not covered under warranty should be disposed of at an approved recycling center. Contact Dell product support at <https://www.dell.com/support> for assistance and further instructions.
- Using a non-Dell or incompatible battery may increase the risk of fire or explosion. Replace the battery only with a compatible battery purchased from Dell that is designed to work with your Dell computer. Do not use a battery from other computers with your computer. Always purchase genuine batteries from <https://www.dell.com> or otherwise directly from Dell.

Rechargeable Li-ion batteries can swell for various reasons such as age, number of charge cycles, or exposure to high heat. For more information on how to improve the performance and lifespan of the laptop battery and to minimize the possibility of occurrence of the issue, search Dell Laptop Battery in the Knowledge Base Resource at www.dell.com/support.

Locate the Service Tag or Express Service Code of your Dell computer

Your Dell computer is uniquely identified by a Service Tag or Express Service Code. To view relevant support resources for your Dell computer, we recommend entering the Service Tag or Express Service Code at www.dell.com/support.

For more information on how to find the Service Tag for your computer, see [Locate the Service Tag on your computer](#).

Dell SupportAssist Pre-boot System Performance Check diagnostics

About this task

SupportAssist diagnostics (also known as system diagnostics) performs a complete check of your hardware. The Dell SupportAssist Pre-boot System Performance Check diagnostics is embedded with the BIOS and is launched by the BIOS internally. The embedded system diagnostics provides a set of options for particular devices or device groups allowing you to:

- Run tests automatically or in an interactive mode
- Repeat tests
- Display or save test results
- Run thorough tests to introduce additional test options to provide extra information about the failed device(s)
- View status messages that inform you if tests are completed successfully
- View error messages that inform you of problems encountered during testing

 **NOTE:** Some tests for specific devices require user interaction. Always ensure that you are present at the computer terminal when the diagnostic tests are performed.

For more information, see <https://www.dell.com/support/kbdoc/000180971>.

Running the SupportAssist Pre-Boot System Performance Check

Steps

1. Turn on your computer.
2. As the computer boots, press the F12 key as the Dell logo appears.
3. On the boot menu screen, select the **Diagnostics** option.
4. Click the arrow at the bottom left corner.
Diagnostics front page is displayed.
5. Click the arrow in the lower-right corner to go to the page listing.
The items detected are listed.
6. To run a diagnostic test on a specific device, press Esc and click **Yes** to stop the diagnostic test.
7. Select the device from the left pane and click **Run Tests**.
8. If there are any issues, error codes are displayed.
Note the error code and validation number and contact Dell.

Built-in self-test (BIST)

M-BIST

M-BIST (Built In Self-Test) is the system board's built-in self-test diagnostics tool that improves the diagnostics accuracy of system board embedded controller (EC) failures.

 **NOTE:** M-BIST can be manually initiated before POST (Power On Self Test).

How to run M-BIST

 **NOTE:** M-BIST must be initiated on the system from a power-off state either connected to AC power or with battery only.

1. Press and hold both the **M** key on the keyboard and the **power button** to initiate M-BIST.
2. With both the **M** key and the **power button** held down, the battery indicator LED may exhibit two states:
 - a. OFF: No fault detected with the system board
 - b. AMBER: Indicates a problem with the system board
3. If there is a failure with the system board, the battery status LED will flash one of the following error codes for 30 seconds:

Table 49. LED error codes

Blinking Pattern		Possible Problem
Amber	White	
2	1	CPU Failure
2	8	LCD Power Rail Failure
1	1	TPM Detection Failure
1	2	Unrecoverable SPI Failure

4. If there is no failure with the system board, the LCD will cycle through the solid color screens described in the LCD-BIST section for 30 seconds and then power off.

LCD Power rail test (L-BIST)

L-BIST is an enhancement to the single LED error code diagnostics and is automatically initiated during POST. L-BIST will check the LCD power rail. If there is no power being supplied to the LCD (that is if the L-BIST circuit fails), the battery status LED will flash either an error code [2,8] or an error code [2,7].

 **NOTE:** If L-BIST fails, LCD-BIST cannot function as no power will be supplied to the LCD.

How to invoke L-BIST Test:

1. Press the power button to start the system.
2. If the system does not start up normally, look at the battery status LED:
 - If the battery status LED flashes an error code [2,7], the display cable may not be connected properly.
 - If the battery status LED flashes an error code [2,8], there is a failure on the LCD power rail of the system board, hence there is no power supplied to the LCD.
3. For cases, when a [2,7] error code is shown, check to see if the display cable is properly connected.
4. For cases when a [2,8] error code is shown, replace the system board.

LCD Built-in Self Test (BIST)

Dell laptops have a built-in diagnostic tool that helps you determine if the screen abnormality you are experiencing is an inherent problem with the LCD (screen) of the Dell laptop or with the video card (GPU) and PC settings.

When you notice screen abnormalities like flickering, distortion, clarity issues, fuzzy or blurry image, horizontal or vertical lines, color fade etc., it is always a good practice to isolate the LCD (screen) by running the Built-In Self Test (BIST).

How to invoke LCD BIST Test

1. Power off the Dell laptop.
2. Disconnect any peripherals that are connected to the laptop. Connect only the AC adapter (charger) to the laptop.
3. Ensure that the LCD (screen) is clean (no dust particles on the surface of the screen).
4. Press and hold **D** key and **Power on** the laptop to enter LCD built-in self test (BIST) mode. Continue to hold the D key, until the system boots up.
5. The screen will display solid colors and change colors on the entire screen to white, black, red, green, and blue twice.
6. Then it will display the colors white, black and red.
7. Carefully inspect the screen for abnormalities (any lines, fuzzy color or distortion on the screen).
8. At the end of the last solid color (red), the system will shut down.

 **NOTE:** Dell SupportAssist Pre-boot diagnostics upon launch, initiates an LCD BIST first, expecting a user intervention confirm functionality of the LCD.

System-diagnostic lights

Power and battery-status light

The power and battery status light indicates the power and battery status of the computer. These are the power states:

Solid white:Power adapter is connected and the battery has more than 5% charge.

Amber:Computer is running on battery and the battery has less than 5% charge.

Off:

- Power adapter is connected, and the battery is fully charged.
- Computer is running on battery, and the battery has more than 5% charge.
- Computer is in sleep state, hibernation, or turned off.

The power and battery-status light may blink amber or white according to pre-defined "beep codes" indicating various failures.

For example, the power and battery-status light blinks amber two times followed by a pause, and then blinks white three times followed by a pause. This 2,3 pattern continues until the computer is turned off, indicating no memory or RAM is detected.

Table 50. System-diagnostic lights

Blinking pattern		Problem description	Suggested resolution
Amber	White		
1	1	TPM detection failure	Replace the system board.
1	2	Unrecoverable SPI Flash Failure	Replace the system board.
1	5	EC unable to program i-Fuse	Replace the system board.
1	6	Generic catch-all for ungraceful EC code flow errors	Disconnect all power source (AC, battery, coin cell) and drain flea power by pressing and holding down power button for 3~5 seconds.
2	1	CPU failure	<ul style="list-style-type: none"> • Run the Dell Support Assist/Dell Diagnostics tool. • If problem persists, replace the system board.
2	2	System board failure (included BIOS corruption or ROM error)	<ul style="list-style-type: none"> • Flash latest BIOS version • If problem persists, replace the system board.
2	3	No memory/RAM detected	<ul style="list-style-type: none"> • Confirm that the memory module is installed properly. • If problem persists, replace the memory module.
2	4	Memory/RAM failure	<ul style="list-style-type: none"> • Reset and swap memory modules among the slots. • If problem persists, replace the memory module.
2	5	Invalid memory installed	<ul style="list-style-type: none"> • Reset and swap memory modules among the slots. • If problem persists, replace the memory module.

Table 50. System-diagnostic lights (continued)

Blinking pattern		Problem description	Suggested resolution
Amber	White		
2	6	System board/Chipset Error	Replace the system board.
2	7	LCD failure (SBIOS message)	Replace the LCD module.
2	8	LCD failure (EC detection of power rail failure)	Replace the system board.
3	1	CMOS battery failure	<ul style="list-style-type: none"> Reset the main battery connection. If problem persists, replace the main battery.
3	2	PCI or Video card/chip failure	Replace the system board.
3	3	BIOS Recovery image not found	<ul style="list-style-type: none"> Flash latest BIOS version If problem persists, replace the system board.
3	4	BIOS Recovery image found but invalid	<ul style="list-style-type: none"> Flash latest BIOS version If problem persists, replace the system board.
3	5	Power rail failure	Replace the system board.
3	6	Flash corruption detected by SBIOS.	<ul style="list-style-type: none"> Press power button for over 25 seconds to do RTC reset. If problem persists, replace the system board. Disconnect all power source (AC, battery, coin cell) and drain flea power by pressing and holding down power button 3~5 seconds to ensure all power are drained. Run "BIOS recovery from USB", and the instructions are in the website Dell support. If problem persists, replace the system board.
3	7	Timeout waiting on ME to reply to HECI message.	Replace the system board.

i NOTE: Blinking 3-3-3 LEDs on Lock LED (Caps-Lock or Num-Lock), Power button LED (without Fingerprint reader), and Diagnostic LED indicates failure to provide input during LCD panel test on Dell SupportAssist Pre-boot System Performance. Check diagnostics.

Recovering the operating system

When your computer is unable to boot to the operating system even after repeated attempts, it automatically starts Dell SupportAssist OS Recovery.

Dell SupportAssist OS Recovery is a standalone tool that is preinstalled in all Dell computers installed with Windows operating system. It consists of tools to diagnose and troubleshoot issues that may occur before your computer boots to the operating

system. It enables you to diagnose hardware issues, repair your computer, back up your files, or restore your computer to its factory state.

You can also download it from the Dell Support website to troubleshoot and fix your computer when it fails to boot into their primary operating system due to software or hardware failures.

For more information about the Dell SupportAssist OS Recovery, see *Dell SupportAssist OS Recovery User's Guide* at www.dell.com/serviceabilitytools. Click **SupportAssist** and then, click **SupportAssist OS Recovery**.

Recovering the operating system

When your Chromebook's operating system (OS) isn't working properly, you can recover it. Recovery is removing and reinstalling the OS.

To know how to recover your Chromebook's operating system, see [Recover your Chromebook](https://support.google.com/chromebook) at <https://support.google.com/chromebook>

Real-Time Clock (RTC Reset)

The Real Time Clock (RTC) reset function allows you or the service technician to recover Dell systems from No POST/No Power/No Boot situations. The legacy jumper enabled RTC reset has been retired on these models.

Start the RTC reset with the system powered off and connected to AC power. Press and hold the power button for thirty (30) seconds

. The system RTC Reset occurs after you release the power button.

Backup media and recovery options

It is recommended to create a recovery drive to troubleshoot and fix problems that may occur with Windows. Dell proposes multiple options for recovering Windows operating system on your Dell PC. For more information, see [Dell Windows Backup Media and Recovery Options](#).

Wi-Fi power cycle

About this task

If your computer is unable to access the Internet due to Wi-Fi connectivity issues a Wi-Fi power cycle procedure may be performed. The following procedure provides the instructions on how to conduct a Wi-Fi power cycle:

 **NOTE:** Some ISPs (Internet Service Providers) provide a modem/router combo device.

Steps

1. Turn off your computer.
2. Turn off the modem.
3. Turn off the wireless router.
4. Wait for 30 seconds.
5. Turn on the wireless router.
6. Turn on the modem.
7. Turn on your computer.

Drain residual flea power (perform hard reset)

About this task

Flea power is the residual static electricity that remains in the computer even after it has been powered off and the battery is removed.

For your safety, and to protect the sensitive electronic components in your computer, you are requested to drain residual flea power before removing or replacing any components in your computer.

Draining residual flea power, also known as a performing a "hard reset", is also a common troubleshooting step if your computer does not power on or boot into the operating system.

To drain residual flea power (perform a hard reset)

Steps

1. Turn off your computer.
2. Disconnect the power adapter from your computer.
3. Remove the base cover.
4. Remove the battery.
5. Press and hold the power button for 20 seconds to drain the flea power.
6. Install the battery.
7. Install the base cover.
8. Connect the power adapter to your computer.
9. Turn on your computer.

 **NOTE:** For more information about performing a hard reset, search in the Knowledge Base Resource at www.dell.com/support.

Getting help and contacting Dell

Self-help resources

You can get information and help on Dell products and services using these self-help resources:

Table 51. Self-help resources

Self-help resources	Resource location
Information about Dell products and services	www.dell.com
Tips	
Contact Support	In Windows search, type <code>Contact Support</code> , and press Enter.
Online help for operating system	www.dell.com/support/windows www.dell.com/support/linux
Access top solutions, diagnostics, drivers and downloads, and learn more about your computer through videos, manuals and documents.	Your Dell computer is uniquely identified by a Service Tag or Express Service Code. To view relevant support resources for your Dell computer, enter the Service Tag or Express Service Code at www.dell.com/support . For more information on how to find the Service Tag for your computer, see Locate the Service Tag on your computer .
Dell knowledge base articles for a variety of computer concerns	<ol style="list-style-type: none"> 1. Go to www.dell.com/support. 2. On the menu bar at the top of the Support page, select Support > Knowledge Base. 3. In the Search field on the Knowledge Base page, type the keyword, topic, or model number, and then click or tap the search icon to view the related articles.

Contacting Dell

To contact Dell for sales, technical support, or customer service issues, see www.dell.com/contactdell.

 **NOTE:** Availability varies by country/region and product, and some services may not be available in your country/region.

 **NOTE:** If you do not have an active Internet connection, you can find contact information about your purchase invoice, packing slip, bill, or Dell product catalog.