

SAMSUNG

INSTALL GUIDE

QLED

HG43Q60B HG50Q60B HG55Q60B
HG65Q60B HG75Q60B

Thank you for purchasing this Samsung product.

To receive more complete service, please register your product at www.samsung.com

Model _____ Serial No. _____

Before Reading This Install Guide

This TV B2B (Business to Business) model is designed for hotels or the other hospitality businesses, supports a variety of special functions, and lets you limit some user (guest) controls.

Figures and illustrations in this Install Guide are provided for reference only and may differ from the actual product appearance. Product design and specifications may change without notice.

Operational Modes

This TV has two modes: **Interactive** and **Standalone** mode.

- **Interactive** mode: In this mode, the TV communicates with and is fully or partially controlled by a connected Set Back Box (SBB) or Set Top Box (STB) provided by a hospitality System Integration (SI) vendor. When the TV is initially plugged in, it sends a command that attempts to identify the SBB or STB connected to it. If the TV identifies the SBB or STB and the SBB or STB identifies the TV, the TV gives full control to the SBB or STB.
- **Standalone** mode: In this mode, the TV works alone without an external SBB or the STB.

The TV has a **Hotel Option** menu that lets you easily set its various hospitality functions. Please see page 24.

The menu also lets you activate or de-activate some TV and hospitality functions so you can create your optimal hospitality configuration.

Still image warning







Avoid displaying still images (such as jpeg picture files) or still image elements (such as TV channel logos, panorama or 4:3 format images, stock or news bars or crawls) on the screen. Displaying still pictures continually can cause uneven screen wear, which will affect image quality. To reduce the chance that this effect will occur, please follow the recommendations below:

- Avoid displaying the same TV channel for long periods.
- Always try to display a full screen image.
- Reduce brightness and contrast to help prevent the occurrence of after-images.
- Use all TV features designed to reduce image retention and screen burn-in.

Warning! Important Safety Instructions

Please read the Safety Instructions before using your TV.

Refer to the table below for an explanation of symbols which may be on your Samsung product.

CAUTION			Class II product: This symbol indicates that a safety connection to electrical earth (ground) is not required. If this symbol is not present on a product with a power cord, the product MUST have a reliable connection to protective earth (ground).
RISK OF ELECTRIC SHOCK. DO NOT OPEN.			
CAUTION: TO REDUCE THE RISK OF ELECTRIC SHOCK, DO NOT REMOVE COVER (OR BACK). THERE ARE NO USER SERVICEABLE PARTS INSIDE. REFER ALL SERVICING TO QUALIFIED PERSONNEL.			AC voltage: Rated voltage marked with this symbol is AC voltage.
	This symbol indicates that high voltage is present inside. It is dangerous to make any kind of contact with any internal part of this product.		DC voltage: Rated voltage marked with this symbol is DC voltage.
	This symbol indicates that this product has included important literature concerning operation and maintenance.		Caution. Consult instructions for use: This symbol instructs the user to consult the install guide for further safety related information.

- The slots and openings in the cabinet and in the back or bottom are provided for necessary ventilation. To ensure reliable operation of this apparatus and to protect it from overheating, these slots and openings must never be blocked or covered.
 - Do not place this apparatus in a confined space, such as a bookcase or built-in cabinet, unless proper ventilation is provided.
 - Do not place this apparatus near or over a radiator or heat register, or where it is exposed to direct sunlight.
 - Do not place vessels (vases etc.) containing water on this apparatus, as this can result in a fire or electric shock.
- Do not expose this apparatus to rain or place it near water (near a bathtub, washbowl, kitchen sink, or laundry tub, in a wet basement, or near a swimming pool, etc.). If this apparatus accidentally gets wet, unplug it and contact an authorized dealer immediately.
- Please contact your local authorities for disposal or recycling information.
- Do not overload wall outlets, extension cords, or adaptors beyond their capacity, since this can result in fire or electric shock.
- Power-supply cords should be placed so that they are not likely to be walked on or pinched by items placed upon or against them. Pay particular attention to cords at the plug end, at wall outlets, and at the point where they exit from the appliance.
- To protect this apparatus from a lightning storm, or when left unattended and unused for long periods of time, unplug it from the wall outlet and disconnect the antenna or cable system. This will prevent damage to the set due to lightning and power line surges.

- Before plugging in the AC power cord of the TV, make sure that the operational voltage of the TV matches the voltage of your local electrical power supply. Refer to the power specifications section of the manual and/or the power supply label on the product for voltage and amperage information.
- Never insert anything metallic into the open parts of this apparatus. This may cause electric shock.
- To avoid electric shock, never touch the inside of this apparatus. Only a qualified technician should open this apparatus.
- Be sure to plug in the power cord until it is firmly seated. When unplugging the power cord from a wall outlet, always pull on the power cord's plug. Never unplug it by pulling on the power cord. Do not touch the power cord with wet hands.
- If this apparatus does not operate normally - in particular, if there are any unusual sounds or smells coming from it - unplug it immediately and contact an authorized dealer or Samsung service center.
- Be sure to pull the power plug out of the outlet if the TV is to remain unused or if you are to leave the house for an extended period of time (especially when children, elderly, or disabled people will be left alone in the house).
 - Accumulated dust can cause an electric shock, an electric leakage, or a fire by causing the power cord to generate sparks and heat or by causing the insulation to deteriorate.
- Be sure to contact an authorized Samsung service center for information if you intend to install your TV in a location with heavy dust, high or low temperatures, high humidity, chemical substances, or where it will operate 24 hours a day such as in an airport, a train station, etc. Failure to do so may lead to serious damage to your TV.
- Use only a properly grounded plug and wall outlet.
 - An improper ground may cause electric shock or equipment damage. (Class I Equipment only.)
- To turn off this apparatus completely, disconnect it from the wall outlet. To ensure you can unplug this apparatus quickly if necessary, make sure that the wall outlet and power plug are readily accessible.
- Store the accessories in a location safely out of the reach of children.
- Do not drop or strike the product. If the product is damaged, disconnect the power cord and contact a Samsung service center.
- To clean this apparatus, unplug the power cord from the wall outlet and wipe the product with a soft, dry cloth. Do not use any chemicals such as wax, benzene, alcohol, thinners, insecticide, air fresheners, lubricants, or detergents. These chemicals can damage the appearance of the TV or erase the printing on the product.
- Do not expose this apparatus to dripping or splashing.
- **WARNING - TO PREVENT THE SPREAD OF FIRE, KEEP CANDLES AND OTHER ITEMS WITH OPEN FLAMES AWAY FROM THIS PRODUCT AT ALL TIMES.**
- Use care when touching the TV after it has been on for some time. Some parts can be warm to the touch.



Contents

	Before Reading This Install Guide	2
	Warning! Important Safety Instructions	3
01	Package Content	
	Installing the LED TV Stand	8
	Installing the wall mount kit	10
	Securing the TV to the Wall	10
	Wall Mount Kit Specifications (VESA)	11
	Providing proper ventilation for your TV	11
02	The Samsung Smart Remote	
	About the Buttons on the Samsung SolarCell Remote (Samsung Smart Remote)	12
	Pairing the TV to the Samsung Smart Remote	13
	Charging the battery	13
03	Controlling external devices with a Samsung Smart Remote - Using the Universal Remote	
	Downloading the Universal Remote icon	16
04	Initial Setup	
	Using the TV Controller	18
05	The Connection Panel	

06	Connections	
	Connecting to your Internet network	21
	Connecting the TV to a SBB or STB	23
07	Setting the Hotel Option menu	
	Hotel Option menu items	25
	USB Cloning	30
	Settings Cloned in the Hotel Option Menu	31
	Setting Auto Initialize	33
	Updating the TV's Software	38
08	Editing Channels	
	Using Channel Editor	39
09	Specifications and Other Information	
	Specifications	42
	Environmental Considerations	43
	Decreasing power consumption	43
	Supported Resolutions for UHD Input Signals	44
	Supported Resolutions for Connecting a Computer	45
	Supported Resolutions for Video Signals	47
	Read Before Using the Internet Function	48
	Dimensions	49
	Licenses	51
	Important Warranty Information Regarding Television	
	Format Viewing	52
	SAMSUNG ELECTRONICS NORTH AMERICAN LIMITED WARRANTY STATEMENT	53

01 Package Content

Make sure the following items are included with your TV. If any items are missing, contact your dealer.

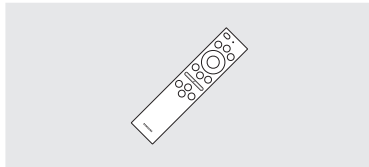

Samsung Smart Remote

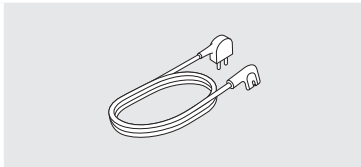

Power cord

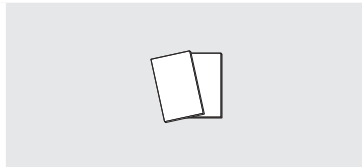

Quick Setup Guide / Regulatory Guide

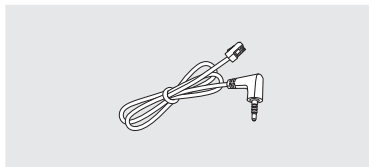

Data Cable x 2
(Depending on the model)

- The items' colors and shapes may vary depending on the models.
- Cables not included can be purchased separately.
- Check for any accessories hidden behind or in the packing materials when opening the box.



The screen can be damaged from direct pressure when handled incorrectly. As shown in the figure, make sure to grip the edges of the screen when you lift the TV.

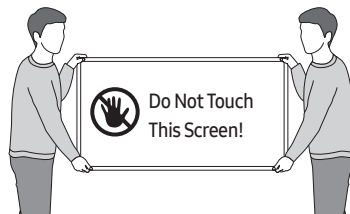

Installing the LED TV Stand

Assembling the Stand and Components

When installing the stand, use the provided components and parts.

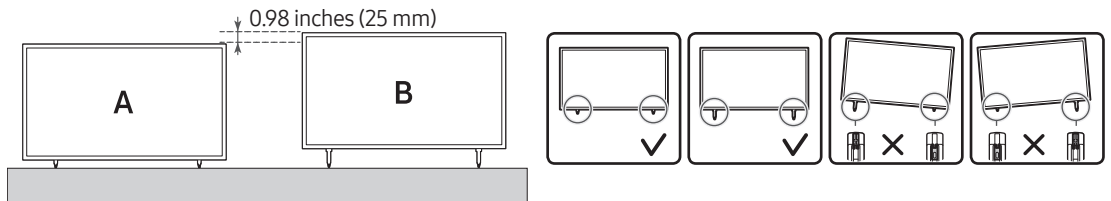
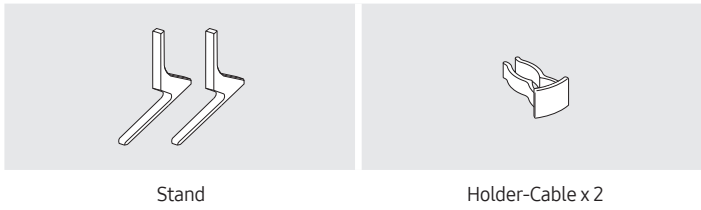

- Place a soft cloth over the table to protect the TV, and then place the TV so that its screen faces down toward the table surface.

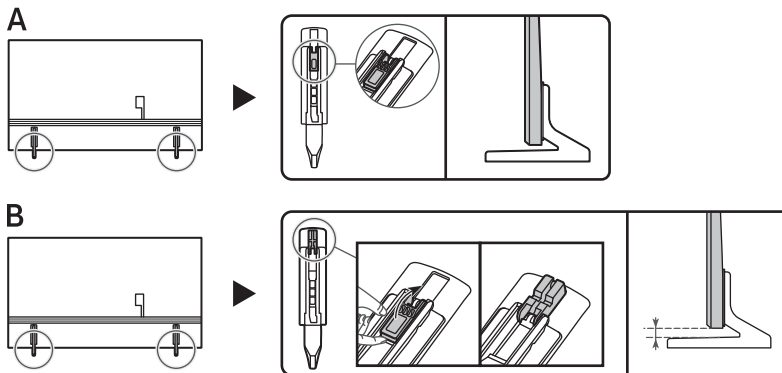

1 43-65"

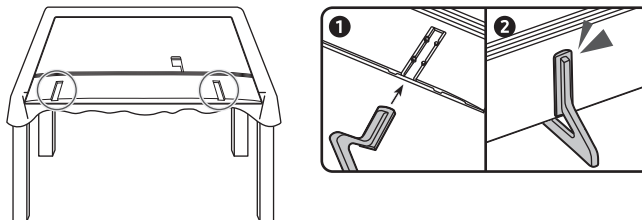

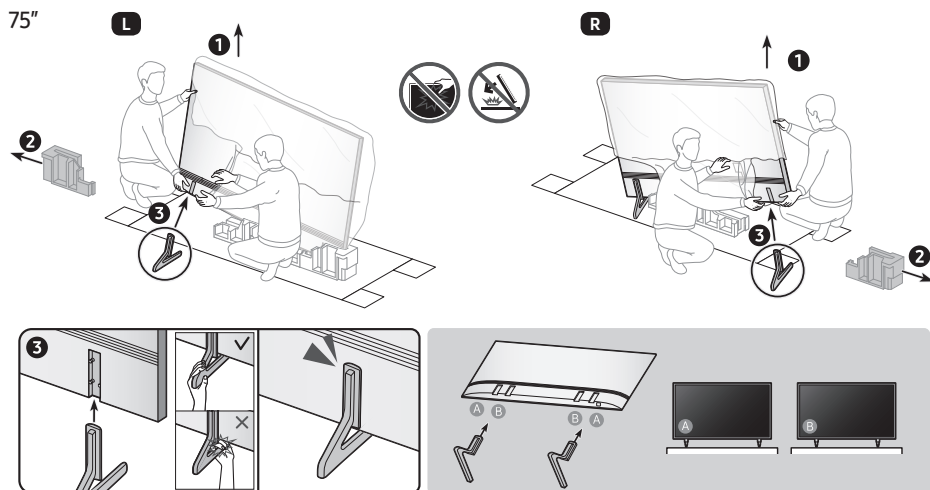

- Insert the Stands into the slot on the bottom of the TV.
- Slide and assemble it to the end line in the direction of arrow.

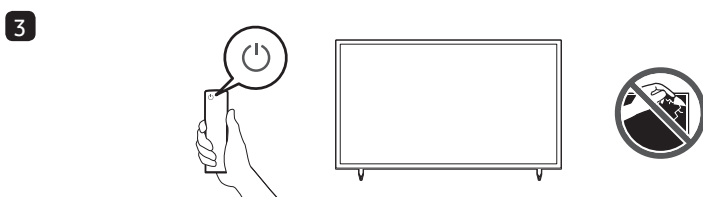
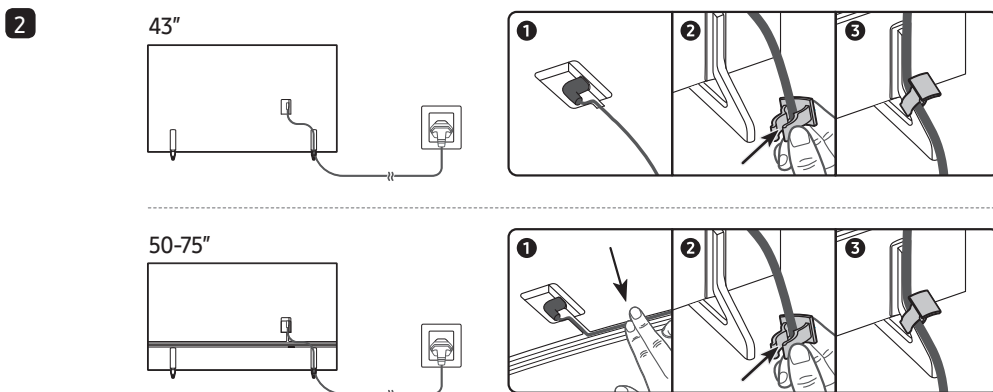

NOTE

- Make sure to distinguish between the front and back of each component when assembling them.
- Make sure that at least two persons lift and move the TV.

Installing the wall mount kit

You can mount the TV on the wall using a wall mount kit (sold separately).

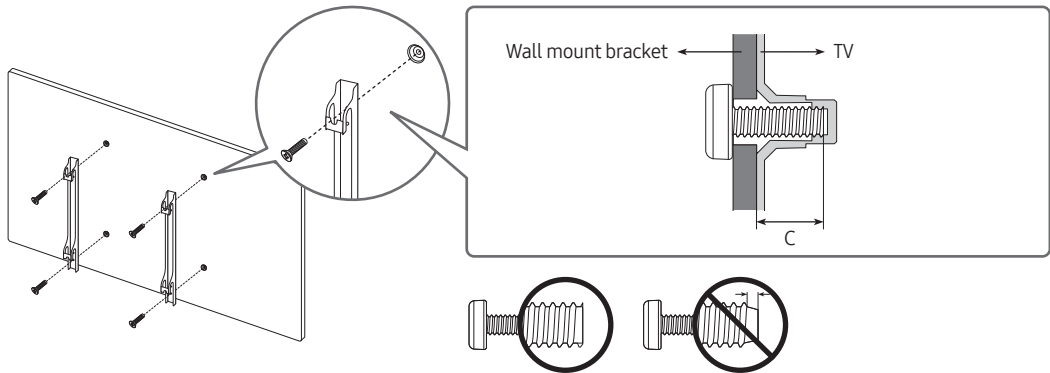

- The Product shape may differ depending on the model.

The wall mount kit (sold separately) allows you to mount the TV on a wall.

For detailed information on installing the wall mount, see the instructions provided with the wall mount. Contact a technician for assistance when installing the wall mount bracket. Samsung Electronics is not responsible for any damage to the product or injury to yourself or others if you select to install the TV on your own.

Securing the TV to the Wall



Caution: Pulling, pushing, or climbing on the TV may cause the TV to fall. In particular, ensure your children do not hang on or destabilize the TV. This action may cause the TV to tip over, causing serious injuries or death. Follow all safety precautions provided in the Safety Flyer included with your TV. For added stability and safety, you can purchase and install the anti-tip device.

Preventing the TV from falling

1. Using the appropriate screws, firmly fasten a set of brackets to the wall.
Confirm that the screws are firmly attached to the wall.
 - You may need additional material such as wall anchors depending on the type of wall.
2. Using the appropriately sized screws, firmly fasten a set of brackets to the TV.
 - For the screw specifications, refer to "Wall Mount Kit Specifications (VESA)" in the table on page 11.
3. Connect the brackets fixed to the TV and the brackets fixed to the wall with a durable, heavy-duty string, and then tie the string tightly.
 - Install the TV near the wall so that it does not fall backwards.
 - Connect the string so that the brackets fixed to the wall are at the same height as or lower than the brackets fixed to the TV.

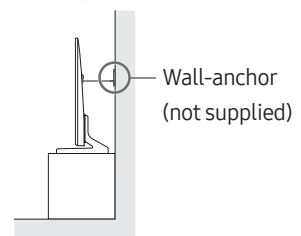
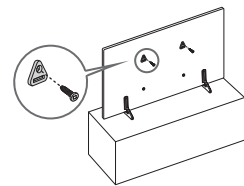

- The displayed image may differ from your TV, depending on the model.

Wall Mount Kit Specifications (VESA)

Install your wall mount on a solid wall perpendicular to the floor. If you are attaching the wall mount to building materials other than plaster board, contact your nearest dealer. If installed on a ceiling or slanted wall, the TV may fall and cause severe personal injury.

- The wall mount kit is not supplied, but sold separately.
- NOTE
 - Standard dimensions for wall mount kits are shown in the table below.
 - Samsung wall mount kits contain a detailed installation manual. All parts necessary for assembly are provided.
 - Do not use screws that do not comply with the VESA standard screw specifications.
 - Do not use screws that are longer than the standard dimension or do not comply with the VESA standard screw specifications. Screws that are too long may cause damage to the inside of the TV set.
 - For wall mounts that do not comply with the VESA standard screw specifications, the length of the screws may differ depending on the wall mount specifications.
 - Do not fasten the screws too firmly. This may damage the product or cause the product to fall, leading to personal injury. Samsung is not liable for these kinds of accidents.
 - Samsung is not liable for product damage or personal injury when a non-VESA or non-specified wall mount is used or the consumer fails to follow the product installation instructions.
 - Do not mount the TV at more than a 15 degree tilt.
 - Always have two people mount the TV onto a wall.

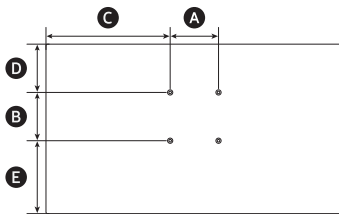

TV size in inches	VESA screw hole specs (A * B) in millimeters	C (inches)	D (inches)	E (inches)	C (mm)	Standard Screw	Quantity
43	200 x 200	15.1	7.6	6.6	11-13	M8	4
50		18.1	8.2	9.3			
55		20.3	9.4	10.6			
65	400 x 300	20.7	10.4	10.5			
75	400 x 400	25.1	10.2	11.8			



Do not install your wall mount kit while your TV is turned on. This may result in personal injury from electric shock.

Providing proper ventilation for your TV

When you install your TV, maintain a distance of at least 4 inches (10 cm) between the TV and other objects (walls, cabinet sides, etc.) to ensure proper ventilation. Failing to maintain proper ventilation may result in a fire or a problem with the product caused by an increase in its internal temperature.

- When you install your TV with a stand or a wall mount, we strongly recommend you use parts provided by Samsung Electronics only. Using parts provided by another manufacturer may cause difficulties with the product or result in injury caused by the product falling.

02 The Samsung Smart Remote

About the Buttons on the Samsung SolarCell Remote (Samsung Smart Remote)

- The images, buttons, and functions of the Samsung Smart Remote may differ depending on the model.
- The Universal Remote function operates normally only when you use the Samsung Smart Remote that comes with the TV.
- A button without a description in the image below is not supported on the product.

Power (Power)
Press to turn the TV on or off.

Voice Assistant
Runs Voice Assistant. Press and hold the button, say a command, and then release the button to run Voice Assistant.

- The supported Voice Assistant's languages and features may differ by geographical region.

Warning
Keep the remote more than 0.6 inches (15.24 mm) from your face when using and speaking to Voice Assistant through the mic on the remote.

Settings - Number - Color button
Each time you press this button, Settings menu / virtual numeric pad / Option pad with Color buttons are displayed alternately.

- Use this button to access additional options that are specific to the feature in use.
- Press to bring up the virtual numeric keypad on the screen. Use the numeric keypad to enter numeric values. Select numbers and then select **Done** or **Enter Number** to enter a numeric value. Use to change the channel, enter a PIN, enter a ZIP code, etc.

+ / - (Volume)
Move the button up or down to adjust the volume. To mute the sound, press the button. When pressed for 2 seconds or more, the **Accessibility Shortcuts** appears.

^ / v (Channel)
Move the button up or down to change the channel. To see the **Guide** screen, press the button. When pressed for 1 second or more, the **Channel List** screen appears. Press and hold the button up or down to quickly change the channel.

MIC / LED
Used as MIC when using voice recognition with the remote control.
When charging the remote control via the USB port, the LED is lit if charging is in progress. When charging is complete, the LED is turned off.

- Do not impact the MIC hole or use a sharp object to poke into the hole.

Multi View
Press the button to directly enter the **Multi View** function.

Select
Selects or runs a focused item. When pressed while you are watching content, detailed program information appears.

Directional button (up/down/left/right)
Use to navigate the menu or move the focus to highlight items on the Home Screen.

Return
Returns to the previous menu. When pressed for 1 second or more, the running function is terminated. When pressed while you are watching a program, the previous channel appears.

Play/pause
When pressed, the playback controls appear. Using these controls, you can control the media content that is playing.

Smart Hub
Press to switch to the **Media Home**.



Launch app button
Launch the app indicated by the button.

- Available apps may differ depending on the geographical area or contents provider.

SAMSUNG

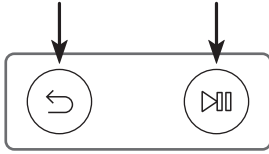
Pairing the TV to the Samsung Smart Remote



When you turn on the TV for the first time, the Samsung Smart Remote pairs to the TV automatically. If the Samsung Smart Remote does not pair to the TV automatically, point it at the remote control sensor of the TV, and then press and hold the buttons labeled  and  as shown in the figure on the left simultaneously for 3 seconds or more.

Charging the battery

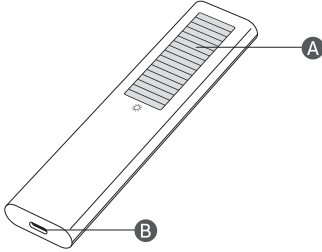

A Solar Cell

Expose to light when the remote is not in use. This will extend the remote's operating time.

B USB port (C-type) for charging

Used for quick charging. The LED on the front will light when charging. When the battery is fully charged, the LED will turn off.

- The USB Cable is not provided.

- It is recommended to use an original Samsung charger. Otherwise, it may cause performance degradation or failure of the product. In this case, the warranty service is not applicable.
- When the remote control does not work due to low battery, charge it by using the USB-C type port.
- Battery consumption may differ depending on the usage environment.



Fire or explosion may occur, resulting in damage to the remote control or personal injury.

- Do not apply shock to the remote control.
- Be careful not to let foreign substances such as metal, liquid, or dust come in contact with the charging terminal of the remote control.
- When the remote control is damaged or you smell smoke or burning fumes, immediately stop operation and then repair it at the Samsung service center.
- Do not arbitrarily disassemble the remote control.
- Be careful not to let infants or pets suck or bite the remote control. Fire or explosion may occur, resulting in damage to the remote control or personal injury.

For battery recycling
go to call2recycle.org;
or call 1-800-822-8837



THE PLASTIC PART OF 22
SMART CONTROL CONTAINS A
MINIMUM OF 24% POST-
CONSUMER RECYCLED
PLASTIC
UL.COM/ECV

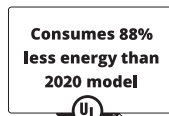

03 Controlling external devices with a Samsung Smart Remote - Using the Universal Remote

You can control external devices connected to the TV using a Samsung Smart Remote. To control external devices, register them by following instructions.

- The images on your TV may differ from the images accompanying the instructions depending on the model and geographical area.

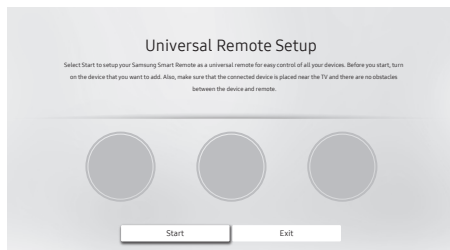

1. Go to the **Hotel Option** menu, and then select **Universal Remote Setting**. The **Universal Remote Setup** screen appears.
 - **Hotel Option** menu > **Universal Remote** > **Universal Remote Setting**

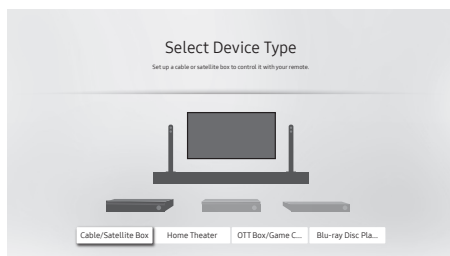

2. If the TV is connected to a set-top box, select **Cable/Satellite Box**.

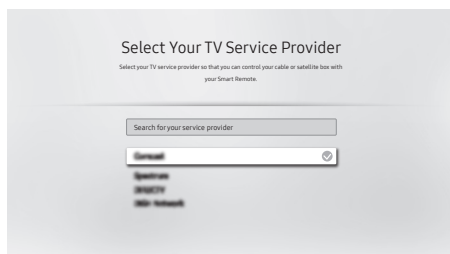

3. Select your service provider from the list in the screen. If your service provider is not listed, search manually.

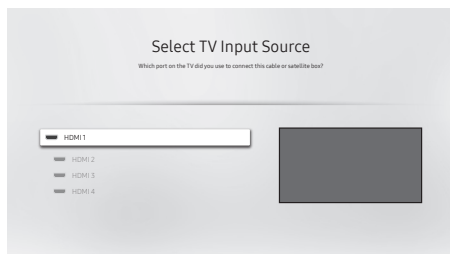

4. Select the HDMI port on the TV to which the set-top box is connected.

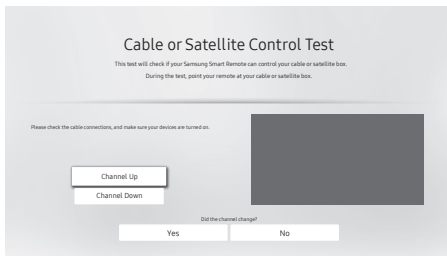

5. Press the CH button on the remote control according to the instructions on the screen in order to test whether the TV and the set-box operate correctly when you press the remote control buttons.
 - If the TV and the set-box operate correctly, select **Yes**. The setup is completed. Go to step 7.
 - If the TV and the set-box do not operate correctly, select **No**. Go to step 6.

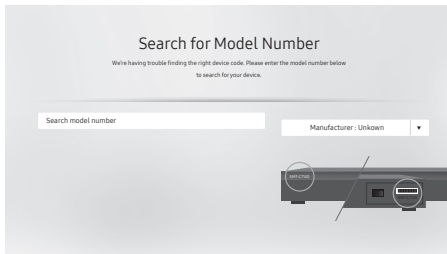

6. Follow the instructions on the screen to search for the model number of the set-top box connected to the TV. When the model number is found, repeat step 5 for the operation test.

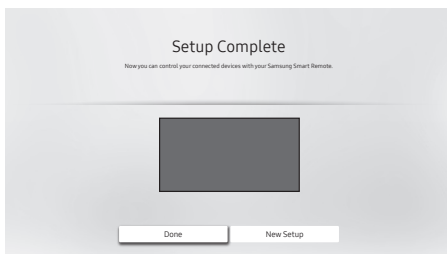

7. When you have completed all the settings, select **Done** in the following screen:

- This function may not be supported depending on the model or geographical area.
- You can also use the **Anynet+ (HDMI-CEC)** function to operate external Samsung devices with your TV's remote control without any additional setup.
- Specific external devices connected to the TV may not support the universal remote feature.
- Do not place any obstacles in front of an external device and TV's logo. It may cause signals from the remote control to be transmitted improperly.
- The TV memorizes both the external device and its connection port (HDMI 1, HDMI 2, etc.).

Downloading the Universal Remote icon

1. Store the following files in the root directory of your USB device:

	File name	File type	File Size
App tile	stb_app_icon	jpg, png	245 x 138, 2MB
Source icon	stb_source_icon	jpg, png	66 x 66 to 135 x 135, 2MB

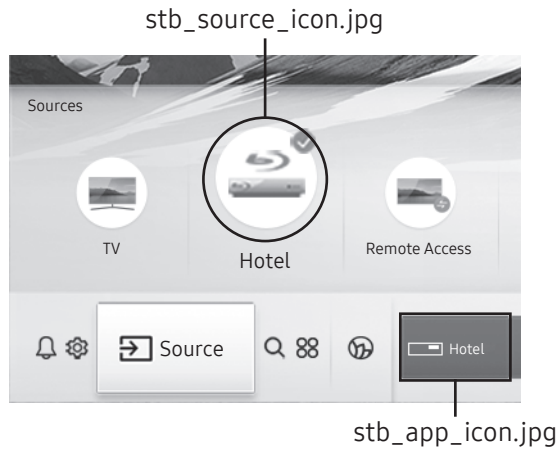

- The image on your TV may differ from the image above depending on the model and geographical area.
2. Go to the **Hotel Option** menu, and then select **Universal Remote Icon DL**.
- **Hotel Option** menu > **Universal Remote** > **Universal Remote Icon DL**
 - The **Universal Remote Icon DL** is only available after you have completely set up the Universal Remote.

04 Initial Setup

When you turn on your TV for the first time, it immediately starts the Initial Setup. Follow the instructions displayed on the screen and configure the TV's basic settings to suit your viewing environment.

If you already completed the Initial Setup, run the Initial Setup again using the following menu.

- **Hotel Option** menu > **System** > **TV Reset**

If you select **TV Reset**, the TV resets all values to their factory defaults. When the TV turns off, press the **Power** button on the remote control to turn on the TV. The TV starts the Initial Setup.

Select the region settings

- 1
 - Before select region, refer to the country list information on the right.
 - If you select the incorrect region, execute **TV Reset** again after the Initial Setup is completed.
 - If the region is changed, the TV automatically turns off and on.

Selecting your TV installation type

- 2
 - **TV Basic Setup**: Select to proceed to the next step to set the basic options for using your TV.
 - **Cloning Mode**: Copy the system settings from the USB or server to the TV.
 - **Factory Menu**: End Initial Setup and go to **Hotel Option** menu directly.

-
- Follow the instructions on the screen to configure the settings for your own viewing environment.

Using the TV Controller

You can turn on the TV with the **TV Controller** button at the bottom of the TV, and then use the **Control menu**. The **Control menu** appears when the **TV Controller** button is pressed while the TV is On. For more information about its usage, refer to the figure below.

- The screen may dim if the protective film on the **SAMSUNG** logo or the bottom of the TV is not removed. Please remove the protective film.

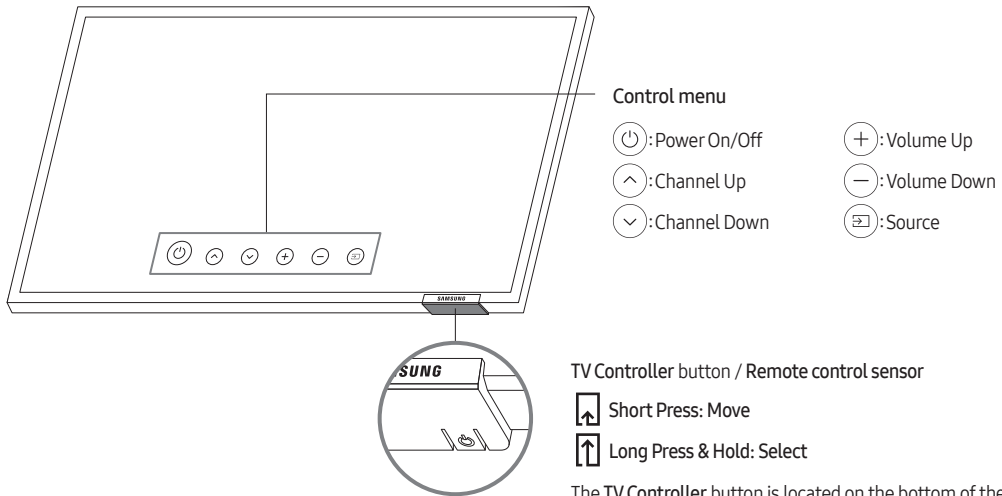

05 The Connection Panel

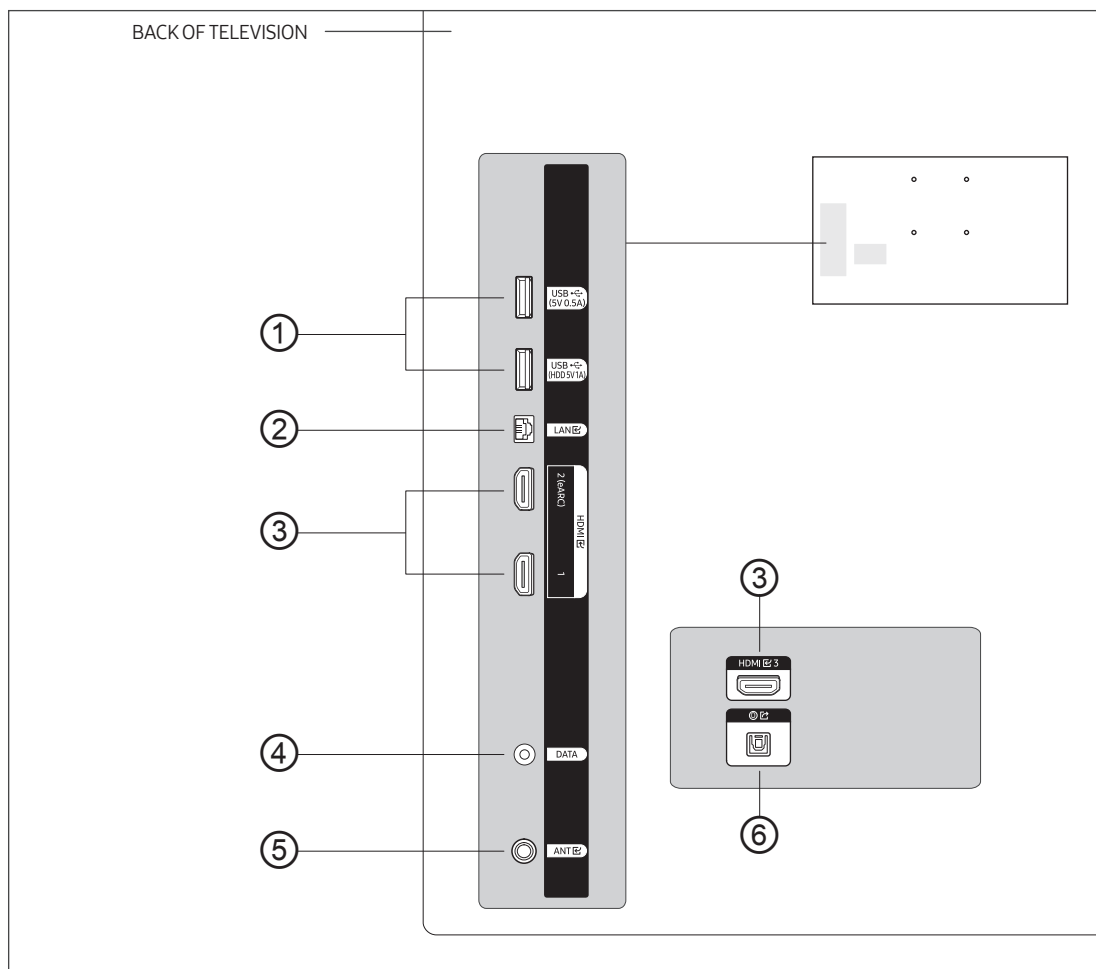

- When connecting an external device, match the color of the connection port to the cable.
- Whenever you connect an external device to your TV, make sure that power on the TV and the device is turned off.

① USB (5V 0.5A), USB (HDD 5V1A)

- Connector for software upgrades and Media Play, etc.
- Service connection.

② LAN

To connect a LAN cable, use a CAT 7 (*STP type) cable for the connection. (100/10 Mbps)

* Shielded Twisted Pair

③ **HDMI IN 1, 2 (eARC), 3**

Connects to the HDMI jack of a device with an HDMI output.

- No separate sound connection is needed for an HDMI to HDMI connection. HDMI connections carry both audio and video.
- It is recommended that the external device of the HDMI 1.3 or 1.4 version will be used with this TV. If you meet the compatible problem like no sound or the abnormal screen or etc with the device of the HDMI 1.2 version, contact to the Samsung customer care center.

④ **DATA**

- Used to support data communication between the TV and the SBB or STB.
- Connects using RJ-12 TV type plugs.

⑤ **ANT IN**

To view television channels correctly, the TV must receive a signal from one of the following sources:

- An outdoor antenna / A cable television system

⑥ **DIGITAL AUDIO OUT (OPTICAL)**

Connects to a Digital Audio component.

06 Connections

Connecting to your Internet network

You can set up your TV so that it can access the SMART TV applications through your local area network (LAN) using a wired or wireless connection.

- After you have physically connected the TV to your network, you must configure the network connection to complete the process. You can configure the connection after the Initial Setup process, through the TV's menu (Hotel Option menu > Smart Service > Network Setup > (Open Network Settings > Wireless or Wired)).

Establishing a wireless Internet connection

Connect the TV to the Internet using a wireless access point or modem.

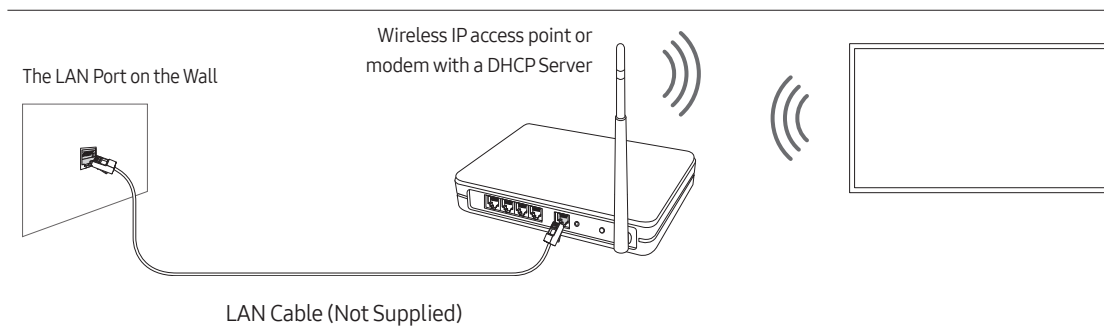

- This TV supports the IEEE 802.11 a /b /g /n /ac communication protocols. Samsung recommends using IEEE 802.11n. Otherwise, when you play video over a network connection, the video may not play smoothly.
 - Some of the IEEE 802.11 communication protocols may not be supported depending on the model or geographical area.
- To use a wireless network, the TV must be connected to a wireless access point or modem. If the wireless access point supports DHCP, the TV can use a DHCP or static IP address to connect to the wireless network.
- Select a channel that is not currently in use for the wireless access point. If the channel set for the wireless access point is currently being used by another device, the result is usually interference and/or a communications failure.
- Most wireless networks have an optional security system. To enable a wireless network's security system, you need to create a security key using characters and numbers, and then enter that key into the access point through its menu. You then must enter this security key into any other devices you want to connect to the wireless network.

Network Security Protocols

The TV only supports the following wireless network security protocols:

- Authentication Modes: WEP, WPAPSK, WPA2PSK
- Encryption Types: WEP, TKIP, AES

In compliance with the Wi-Fi certification specifications, Samsung TVs do not support WEP or TKIP security encryption in networks running in the 802.11n mode.

If the wireless access point supports WPS (Wi-Fi Protected Setup), you can connect the TV to your network using PBC (Push Button Configuration) or a PIN (Personal Identification Number). WPS automatically configures the SSID and WPA key settings.

Your Smart TV cannot connect to uncertified wireless access point.

Establishing a wired Internet connection

There are three main ways to connect the TV to your network using cable, depending on your network setup. They are illustrated below:

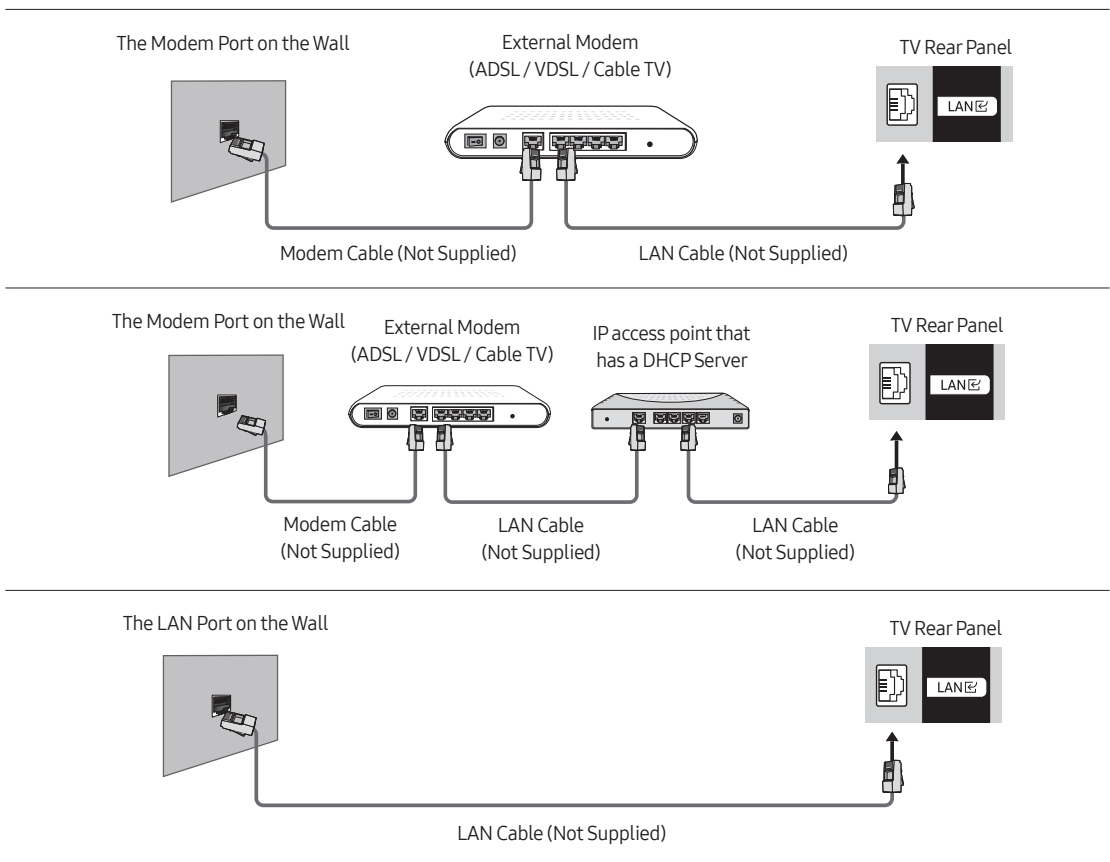

- The TV will not be able to connect to the Internet if your network speed is below 10 Mbps.
- To connect a LAN cable, use a CAT 7 (*STP type) cable for the connection. (100/10 Mbps)
 - * Shielded Twisted Pair

Connecting the TV to a SBB or STB

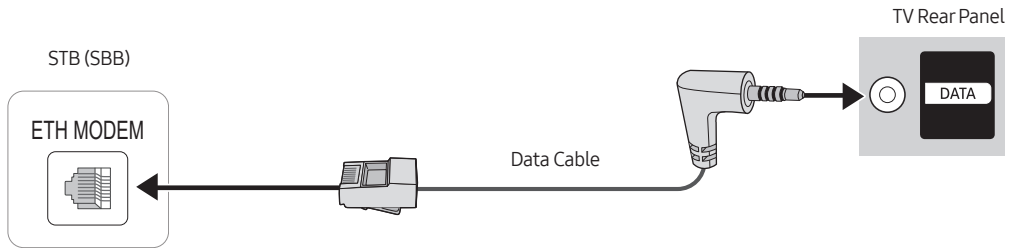

Connect the **DATA** port of the TV to the **ETH MODEM** port of the STB (SBB) with the Data cable.

- The **ETH MODEM** port name that you connect the Data Cable to may differ depending on the SBB or STB type.
- IR signals sent by the remote control to the TV or SBB / STB must meet the following specification to use IR pass through function.

IR signal receiver specification

- Band pass filter center frequency: 37.9 kHz
- Carrier Frequency, Duty 50%
- Minimum Burst Length (tburst): 12 pulses (316 us)
- Minimum Gap Time Between the burst (tburst gap): 16 pulses (422 us)
- Minimum Gap Time between the data commands (tpause): 25 ms

List of Hospitality SI Vendors and compatible data cables supplied with the TV

- Confirm you are using the correct data cable for your SI vendor. Refer to the code label on the data cables.
- Contact your nearest dealer or your SI Vendor to buy the data cable not included in the TV.

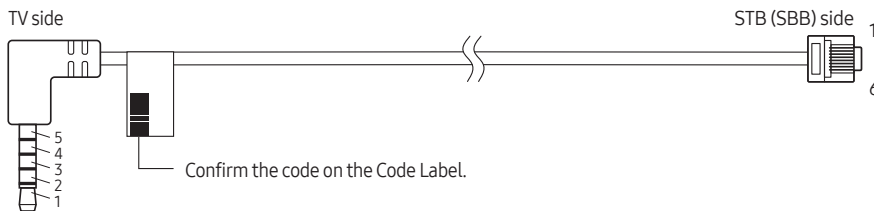

Cable code	Pin assign			REMARK
BN39-02462A (Color : BLACK)				SAMSUNG and others
BN39-02461A (Color : LIGHT GRAY)				MTI

- RX and TX notation is based on TV.
- Operation Specification of Data Cable(RJ12): RS232

07 Setting the Hotel Option menu

To access the **Hotel Option** menu, press the following buttons on the remote control:

1. Press the **+/-** button.
2. Press the up directional button.
3. Press the down directional button.
4. Press the **Select** button.

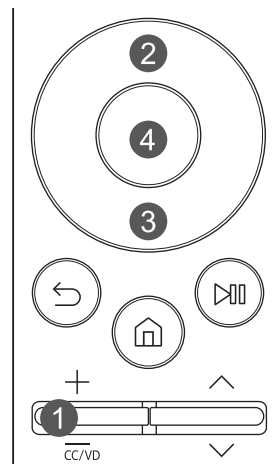

To control the TV functions in the **Hotel Option** menu, the TV has the **Standalone** mode.

- **SI Vendor: OFF / SSCP**

After a menu appears, follow these general directions to navigate and change values:

- Use the directional buttons on the remote control to move from menu item to menu item.
- Press the **Select** button on the remote control to select a menu item. The screen displays that menu item only.
- Press the left or right directional button to change a value. The right directional button increases numerical values. The left arrow button decreases numerical values.
- When the screen is displaying one menu item, you can press the up or down directional button to display the next or previous menu item.
- Press the **Back** button to exit the current menu item and go to a higher menu level.
- To exit a **Hotel Option** menu, turn off the TV, and then turn it on again. Any changes you made are saved except changes to SI (System Integration) vendor. For changes to SI vendor, you must turn the TV off, wait until the power indicator at the bottom of the TV glows steadily. And then unplug the TV's power cord, wait for the power indicator to go off, and then plug the TV's power cord in again.

Hotel Option menu items

To exit from this menu, turn off the TV, and then turn on again. Any changes you made are saved.

- The menu items may not be supported depending on the models.

Hotel Option menu Item		Description
Hospitality Mode		Select Hospitality Mode . <ul style="list-style-type: none"> • Interactive: TV works with an SI STB or SBB. • Standalone: TV works alone, without an SI STB or SBB.
SI Vendor		<ul style="list-style-type: none"> • Interactive: Samsung / OCC / MTI / Nstreams / Enseio / Cardinal / Guestek / Seachange / MDC / Innvue • Standalone: Off / SSCP
SI Config	MDC ID Settings	This function is only available when set to Hospitality Mode: Interactive , SI Vender: MDC .
Power On	Power On Channel	Set the channel to display when the TV is turned on. <ul style="list-style-type: none"> • User Defined: Lets you set the channel number manually on Power On Channel Num. See Power On Channel Num below. • Last Saved: If you select this item, when the TV is turned on, it displays the channel it was displaying when it was turned off.
	Power On Channel Num	When the TV is turned on, it switches automatically to this channel.
	Power On Channel Type	Select the type of the channel will be displayed when the TV is turned on. ATV (analog air band), DTV (digital air band), CATV (analog cable band), CDTV (digital cable band), IPTV (IP channel, IPTV is set when deployed from solution.)
	Power On Volume	Set volume level when the TV is turned on. <ul style="list-style-type: none"> • User Defined: Lets you set volume level manually. • Last Saved: When the TV is turned on, it returns to the volume that had been set when the power had been turned off.
	Power On Volume Num	The TV turns on with set volume level in Standalone mode.
	Min Volume	The minimum volume level the user can set in Standalone mode.
	Max Volume	The maximum volume level the user can set in Standalone mode.
	Power On Source	Select the input source to be displayed when the TV is turned on.
Power On Option		Determines the TV's state when power returns after a power failure or after you have unplugged the TV and then plugged it in again. <ul style="list-style-type: none"> • Power ON: When the power returns, the TV turns on. • Standby: When the power returns, the TV enters the standby mode. • Last Option: Returns to its last power state. If it was in standby mode, it returns to standby mode. If it was on, it turns on.

Hotel Option menu Item		Description
Channel	Channel Setup	Gives you direct, immediate access to some of the channel menu functions on the Broadcasting menu such as Audio Options , Service Provider etc.
	Channel Editor	Lets you edit the channels stored in the TV's memory. <ul style="list-style-type: none"> Change the channel numbers and names, manage genre and language groups and delete channels. Apply the Screen Off to channels you select. The Screen Off blanks out the video from a channel and outputs only audio. Lets you view information about each channel easily, without your having to display each channel directly.
	Mixed Channel Map	Enables showing/browsing all antenna type (Air/Cable) channels at the same time. <ul style="list-style-type: none"> ON: When set to on, guests can access the complete channel map irrespective of the selected antenna type. The Channel List/Channel Editor will also populate Air as well Cable type channels. OFF: When set to off, guest can access the channel map corresponding to the selected antenna type (Air/Cable) only. The Channel List/Channel Editor will only show the selected antenna type channels.
	Dynamic SI	<ul style="list-style-type: none"> ON: Do not check the DTV program channel number. OFF: Check the DTV program channel number.
	MyChannel	ON or OFF the MyChannel function. <ul style="list-style-type: none"> This function is available when set to Hospitality Mode: Standalone.
Menu OSD	Picture Menu Lock	ON or OFF the Picture menu.
	Menu Display	<ul style="list-style-type: none"> ON: The main menu is displayed. OFF: The main menu is not displayed.
	Channel Menu Display	<ul style="list-style-type: none"> ON: Broadcasting menu is enable for guest. OFF: Broadcasting menu is disable for guest.
	Panel Button Lock	Turning the TV Controller button operations on or off. <ul style="list-style-type: none"> Unlock: Unlocks TV Controller button. Lock: Locks TV Controller button. OnlyPower: Locks TV Controller button except the power off function.
Clock	Local Time	Select the way to update the clock data <ul style="list-style-type: none"> Standalone: Manual / Time Channel Interactive: Manual / Auto / Time Channel Manual: The clock is set manually by the user when the TV is in Standalone mode. Auto: The clock is set automatically when the TV is in Interactive mode. Time Channel: The clock is set from the selected channel.
	Time Channel Type	Select the type of the channel to update the clock data. DTV (digital air band), CDTV (digital cable band), SDTV <ul style="list-style-type: none"> This function is only available Local Time set to Time Channel.
	Time Channel Num	Select the number of the channel to update the clock data. <ul style="list-style-type: none"> This function is only available Local Time set to Time Channel.
External Source	USB Pop-up Screen	When USB is connected to the TV : <ul style="list-style-type: none"> Automatic: This enters the USB content menu automatically. Disable: Neither the popup window nor the menu appears.

Hotel Option menu Item		Description
Power and Energy Saving	Brightness Reduction	<ul style="list-style-type: none"> • ON: Turns on the energy saving function. • OFF: Turns off the energy saving function.
Cloning	Clone TV to USB	Clone the current TV options to a USB device.
	Clone USB to TV	Clone the saved TV options on a USB device to the TV.
	Setting Auto Initialize	If you set Setting Auto Initialize to On , the TV menu items are restored again to their values cloned initially when the TV turns off and then on.
Zero Touch Configuration		Before starting Zero Touch Configuration, connect to the network and agree to the Terms & Conditions.
Smart Service	Network Setup	Run the Network menu to configure your TV's network settings. You can set the following items: <ul style="list-style-type: none"> • Network Status: View the current network and Internet status. • Open Network Settings: Connect to an available network. • Reset Network: Restore the network settings to the factory default. • Expert Settings: Configure advanced network settings.
	Download by App ID	Enter the App ID. Only a registered ID can be entered.
	Apps Editable	Provide a way to enable or disable the Apps and Notification Settings menu. <ul style="list-style-type: none"> • ON: Enable the Apps and Notification Settings menu. • OFF: Disable the Apps and Notification Settings menu.
	Ambient Editable	Provide a way to enable or disable the Ambient Settings menu in Ambient Mode . <ul style="list-style-type: none"> • ON: Enable the Ambient Settings menu. • OFF: Disable the Ambient Settings menu.
	Terms & Policy	View the entire text of the Terms & Policy document. <ul style="list-style-type: none"> • You must agree to the Smart Hub service agreement.
	Smart Features	Run the Smart Features menu. <ul style="list-style-type: none"> • Autorun Smart Hub: If Autorun Smart Hub is set to On, the TV automatically displays the Home Screen when you turn on the TV.
	Quick Settings Editor	Edit the items to be displayed in Quick Settings and change their order.
	Samsung Account	Create and manage your own Samsung account.
Universal Remote	Universal Remote Setting	Run the Universal Remote Setup function.
	Universal Remote Type	This function is only available when set to Hospitality Mode: Interactive, SI Vender: Samsung .
	Universal Remote Icon DL	Lets you download Universal Remote icons from USB device and applying downloaded icons to the connected Universal Remote source.

Hotel Option menu Item		Description
Security	Factory Lock	Disable entry to Hotel Option menu. <ul style="list-style-type: none"> • ON: The password is needed before entering Hotel Option menu. • OFF: Disable this function.
	Password Popup	Enable or disable password input popup window. If this option is set to off, the TV will not display the password input popup window when entering the Hotel Option menu. If set to ON , the password input popup window appears.
	Password Input	If this function is enabled, the password input popup window appears which asks for an 8-character security password. The admin must enter a password before applying or updating security preferences. After the correct password is entered, options such as Password Setting , Password Reset and Security Mode are available.
	Password Setting	User can change the password.
	Password Reset	Password is reset to "00000000."
	Security Mode	Provides password protected administrative functionality to enable or disable features of hospitality TV, such as USB , HDMI . To use this option, Security Mode set to ON . After Security Mode set to ON , options such as USB , HDMI are automatically enabled.
	USB	Enable or disable USB access. If this function is set to Disable , access to USB media is blocked. Clone USB to TV and TV Reset will be disabled in the Hotel Option menu.
	HDMI	Enable or disable HDMI access. If this function is set to Disable , Anynet+, HDMI source, HDMI type external channels will not be accessible to the user.
DRM	DRM Mode	Configures DRM support. <ul style="list-style-type: none"> • OFF: Turns off DRM support. • LYNK DRM: Select to turn on LYNK CAS support only. • Pro:idiom: Select when there are any Pro:Idiom channels. • LYNK DRM, PI: Select when there are LYNK-DRM and Pro:Idiom channels at the same time.

Hotel Option menu Item		Description
System	Self Diagnosis for HTV	Lets you check the state of Pro:Idiom and its communication with the SI STB or SBB. If you have any problems with the Pro:Idiom encryption channel or the communications with the SI STB or SBB, use this diagnosis function. If PI DTV Channel Key Loss (Pro:Idiom DTV Channel Key Loss) appears to have failed and the Pro:Idim encryption channel has failed to play content, first check the broadcasting systems related to Pro:Idiom encryption. If your broadcasting system does not have a problem, contact Samsung Service. If STB SI VendorSetting appears to have failed and communication with the SI STB or SBB has failed, first check your SI STB or SBB. If your SI STB or SBB does not have a problem, contact to Samsung Service.
	Self Diagnosis for TV	Run the Device Care menu. <ul style="list-style-type: none"> • Video Test: Use this test when you experience a problem with your TV's video. • Smart Hub Connection Test: Use this test when you experience a problem with your TV's smart hub. • HDMI Troubleshooting: Use this test when you experience a problem with your TV's HDMI connection. • Start Picture Test: Use this test when you experience a problem with your TV's picture. • Start Sound Test: Use this test when you experience a problem with your TV's sound. • Signal Information: Show digital broadcasting signal information. • Reset Smart Hub: Reset the Smart Hub and Samsung account settings stored on your TV.
	System Manager	Gives you direct, immediate access to System Manager functions such as Time, Language, Change PIN. System Manager allow you to adjust your TV's system and customize settings for your viewing environment.
	OTN Update	Lets you upgrade the TV Software over the network when a valid upgrade file is present on server. <ul style="list-style-type: none"> • OTN Update changed to ON and disabled when Enrollment Status in LYNK Cloud is Yes.
	SW Update	Lets you upgrade the TV Software with a USB device.
	Remote Management	Allow the Samsung Call Center to remotely access and troubleshoot your TV when you need assistance.
	About This TV	Display the Samsung web site, and product and software information.
	Standby LED	When the TV is in standby mode, you can configure the settings of the power indicator. <ul style="list-style-type: none"> • ON: The LED is on. • OFF: The LED is off.
	TV Reset	Returns all settings on the TV to their factory defaults.
LYNK Cloud	Enrollment	Lets you enroll the TV with LYNK Cloud solution.
	Enrollment Status	Check the status of the TV enrollment in the LYNK Cloud service.
*Virtual Standby	Virtual Standby Mode	When the AC power cord is plugged in and the power is off, this option maintains the TV's important features even after the screen is off. <ul style="list-style-type: none"> • Electricity consumption may vary depending on the environment.
	Reboot Time	After the TV power is off (in Virtual Standby Mode) if there is no input from the user within the set Reboot Time , the TV will reboot and enter Virtual Standby Mode again.
Room Number	You can set the room number of the TV's location.	

- *: This function is available when **Enrollment Status** in **LYNK Cloud** is set to **ON**.
- Refer to the manual of each solution for details about functions and settings of the solutions such as **LYNK Cloud**.

USB Cloning

Hotel Option menu > Cloning

The USB cloning function lets you download user-configured settings (Picture, Sound, Broadcasting, and Hotel Option menu) from one TV to a USB device, and then upload these settings from the USB device to other TV sets. This lets you create a standard file of settings and distribute that standard file to all the TVs in your facility.

- After cloning, certain features are applied when the TV is turned on again.

Cloning TV to USB: Copies stored menu settings from a TV to a USB device

Hotel Option menu > Cloning > Clone TV to USB

1. Insert a USB device into the USB port on the rear of the TV.
2. Go to the **Hotel Option** menu.
3. Press the up or down directional button to select **Clone TV to USB**, and press the **Select** button on the remote control.
4. The cloning message is displayed.
 - The clone folder will be labeled T-NKLBAKUC.
 - The cloned values include the values on the guest side menu (Picture, Sound, Broadcasting and so on) and the **Hotel Option** menu.

Cloning USB to TV: Copies menu settings and channel data in a USB device to a TV

Shortcut: Turn the TV off, insert the USB device, turn the TV on, and then press the **Select** button on the remote control for 5 seconds.

To clone data to the TV using the **Hotel Option** menu, follow these steps:

1. Turn the TV off.
2. Insert the USB device into the USB port on the rear of the TV.
3. Turn the TV on.
4. Go to the **Hotel Option** menu.
5. Press the up or down directional button to select **Clone USB to TV**, and press the **Select** button on the remote control.
6. The message **Clone settings from USB to TV** is displayed. Press the **Select** button on the remote control.
 - If there is no file to copy on the USB device or the message that there is no file appears, check the folder on your USB device.
 - The folder name should be T-NKLBAKUC.
 - Tables that list the settings that are cloned in the **Hotel Option** menu begin on the next page.

-  To enter the function, turn off the TV and insert a USB device, and then turn on the TV and press the **Select** button for 5 seconds.

Pre-condition for cloning (check point)

- Cloning should be done between the devices with the same model and same software version.
- Before cloning, all displays should be updated at the latest version (same software version).

Settings Cloned in the Hotel Option Menu

- The menu items may not be supported depending on the models.

Menu Item		Sub Item	Cloned or not
Hospitality Mode		Standalone / Interactive (Default : Standalone)	Yes
SI Vendor		Interactive: Samsung / OCC / MTI / Nstreams / Enseo / Cardinal / Guestek / Seachange / MDC / Innvue Standalone: Off / SSCP	Yes
SI Config	MDC ID Settings	—	Yes
Power On	Power On Channel	User Defined / Last Saved	Yes
	Power On Channel Num	***	Yes
	Power On Channel Type	ATV / DTV / CATV / CDTV / IPTV	Yes
	Power On Volume	User Defined / Last Saved	Yes
	Power On Volume Num	0~100	Yes
	Min Volume	0~100	Yes
	Max Volume	0~100	Yes
	Power On Source	TV / HDMI1 / MDMI 2 / HDMI 3 / Last Saved	Yes
	Power On Option	Power On / Standby / Last Option	Yes
Channel	Channel Setup	—	Yes
	Channel Editor	—	Yes
	Mixed Channel Map	On / Off	Yes
	Dynamic SI	On / Off	Yes
	MyChannel	On / Off	Yes
Menu OSD	Picture Menu Lock	On / Off	Yes
	Menu Display	On / Off	Yes
	Channel Menu Display	On / Off	Yes
	Panel Button Lock	Unlock / Lock / OnlyPower	Yes
Clock	Local Time	Standalone Mode: Manual / Time Channel Interactive Mode: Manual / Auto / Time Channel	Yes
	Time Channel Type	DTV / CDTV	Yes
	Time Channel Num	***	Yes
External Source	USB Pop-up Screen	Automatic / Disable	Yes
Power and Energy Saving	Brightness Reduction	On / Off	Yes
Cloning	Clone TV to USB	—	No
	Clone USB to TV	—	No
	Setting Auto initialize	On / Off	Yes

Menu Item		Sub Item	Cloned or not	
Smart Service	Network Setup		—	No
	Download by App ID		—	Yes
	Apps Editable		On / Off	Yes
	Ambient Editable		On / Off	Yes
	Terms & Policy		—	Yes
	Smart Features		—	Yes
	Quick Settings Editor		—	Yes
	Samsung Account		—	No
Universal Remote	Universal Remote Setting		—	No
	Universal Remote Type		Samsung / SI	Yes
	Universal Remote Icon DL		—	Yes
Security	FactoryLock		On / Off	Yes
	Password Popup		On / Off	Yes
	Password Input		—	No
	Password Setting		—	Yes
	Password Reset		—	No
	Security Mode		On / Off	Yes
	USB		Enable / Disable	Yes
	HDMI		Enable / Disable	Yes
DRM	DRM Mode		Off / LYNK DRM / Pro:idiom / LYNK DRM, PI	Yes
System	Self Diagnosis for HTV	STB SI Vendor Setting	"Si Name" Ok / Failure	No
	Self Diagnosis for TV		—	No
	System Manager		—	No
	OTN Update		On / Off	Yes
	SW Update		—	No
	Remote Management		—	No
	About This TV		—	No
	Standby LED		On / Off	Yes
TV Reset		—	No	
LYNK Cloud	Enrollment		—	No
	Enrollment Status		Yes / No	No
Virtual Standby	Virtual Standby Mode		On / Off	No
	Reboot Time		5 / 15 / 30 / 60	Yes
Room Number		—	No	

Setting Auto Initialize

Hotel Option menu > Cloning > Setting Auto Initialize

When you clone settings from one TV to another, you clone both the guest side menu and hotel side menu settings: **Picture, Sound, Broadcasting, and Hotel Option** menu. This lets you set nearly all of the menu values on your hospitality TVs to the same, standard settings. If you allow guests access to the guest side menus, for example the **Picture** menu, they can change the settings in those menus so they are no longer standard. If you set the **Setting Auto Initialize** function to on, the TV automatically restores (initializes) any guest side menu values to the cloned, standard values when the TV is turned off and then turned on again. Note that **Setting Auto Initialize** works on cloned guest side menu values only. Settings which have not been cloned are ignored.

The table below lists the settings that are restored to their cloned values when you set the **Setting Auto Initialize** function to on.

- The menu items may not be supported depending on the models.

Menu Item			
Picture	Picture Mode	Dynamic	
		Standard	
		Movie	
		FILMMAKER MODE	
	Picture Size Settings	Picture Size	
		Screen Fit	
		Zoom and Position	
	Expert Settings	Brightness	
		Contrast	
		Sharpness	
		Color	
		Tint (G/R)	
		Apply Picture Settings	
		Picture Clarity Settings	Picture Clarity
			Judder Reduction
			LED Clear Motion
			Noise Reduction
		Contrast Enhancer	
		Film Mode	
	Color Tone		

Menu Item				
Picture	Expert Settings	White Balance	2 Point	R-Gain
				G-Gain
				B-Gain
				R-Offset
				G-Offset
				B-Offset
			Reset	
			20 Point Settings	20 Point
				Interval
				Red
				Green
				Blue
		Reset		
		Gamma	HLG	
			ST.2084	
			BT.1886	
			2.2	
		BT.1886		
		Shadow Detail		
		Color Space Settings	Color Space	
			Color Gamut	
Color				
Red				
Green				
Blue				
Reset				
Reset Picture				

Menu Item			
Sound	Sound Output	TV Speaker	
		Receiver(Optical)	
		Bluetooth Speaker List	
	Sound Mode	Standard	
		Adaptive Sound	
		Amplify	
	Wi-Fi Speaker Surround Setup		
	Expert Settings	Balance	
		Equalizer	
		HDMI-eARC Mode	
		Digital Output Audio Format	
		Digital Output Audio Delay	
		Dolby Atmos	
		Auto Volume	
Sound Feedback			
Simultaneous Optical Output			
Reset Sound			
Device Name			
Network	Network Status		
	Open Network Settings		
	Reset Network		
	Expert Settings	Power On with Mobile	
		IP Remote	
		Wi-Fi	
Connection	Anynet+ (HDMI-CEC)		
	Input Signal Plus		
	HDMI Black Level		
	Input Device Manager	Bluetooth Device List	
		Keyboard Settings	Keyboard Language
			Keyboard Type
		Mouse Settings	Primary Button
	Pointer Speed		
	Device Connect Manager	Access Notification	
		Device List	
	Game Mode Settings	Game Mode	
Game Motion Plus Settings			
Game HDR			

Menu Item						
Broadcasting	Antenna					
	Auto Program					
	Audio Options	Preferred Language				
		Multi-Track Sound				
	Service Provider					
Service Provider Info & Settings						
General & Privacy	Accessibility	Voice Guide Settings	Voice Guide			
			Volume			
			Speed			
			Pitch			
			TV Background Volume			
		Video Description		Caption Settings	Caption	
					Separate Closed Caption	
					Caption Mode	
					Digital Caption Options	Size
						Font
						Font Style
						Foreground Color
						Background Color
						Window Color
						Foreground Opacity
						Background Opacity
						Window Opacity
						Edge Type
						Edge Color
				Position		
				Return to Default		
		Sign Language Zoom Settings		Sign Language Zoom	Edit Sign Language Zoom	
		Sign Language Guide Settings		Sign Language Guide		
				Sign Language Size		
				Sign Language Speed		
				Sign Language Position		
				Sign Language Mode		
Picture Off						
Multi-output Audio						
High Contrast						
Enlarge						
Grayscale						
Color Inversion						
Remote Button Repeat Settings	Slow Button Repeat	Repeat Interval				
Terms & Privacy						

Menu Item				
General & Privacy	System Manager	Time	Clock	Clock Mode
			Date	
			Time	
			Time Offset	
			Time Zone	
			DST	
			Sleep Timer	
		Alarm		
		Language		
		Samsung Account		
	Change PIN			
	Parental Settings	Parental Lock	Program Rating Lock Settings	Program Rating Lock
				TV Rating
		Movie Rating (MPAA)		
		Canadian English Rating		
		Canadian French Rating		
		Downloadable U.S. Rating		
		App Lock Settings		
		Power and Energy Saving		Brightness Optimization
	Minimum Brightness			
Brightness Reduction				
Motion Lighting				
Screen Saver				
Auto Power Saving				
Auto Power Off				
Start Screen Option	Start with Smart Hub Home			
Support	Software Update	Update now		
	Device Care			
	Remote Management			
	About This TV			

Updating the TV's Software

DO NOT turn off the TV's power until the update is complete. The TV will turn off and on automatically after completing the software update. Video and audio settings will be reset to their defaults after a software update. To easily reset the settings after software update, we recommend you to copy the TV's settings.

- For more information about the USB cloning function, refer to page 30.

Updating through a USB device

To update the TV's software, follow these steps:

1. Insert a USB device containing the software update file into the USB port of the TV.
 2. Run **SW Update**.
 - **Hotel Option** menu > **System** > **SW Update**
 3. The TV displays a pop-up message that checks for the updated version.
 4. Move the focus to **OK**, and then press the **Select** button on the remote control.
- Please be careful to not disconnect the power or remove the USB device while upgrades are being applied. The TV will turn off and turn on automatically after completing the SW upgrade. Please check the SW version after the upgrades are complete.

08 Editing Channels

Using Channel Editor

 **Hotel Option menu > Channel > Channel Editor**

Using **Channel Editor** you can edit the channels stored in the TV's memory.

- Change the channel numbers and names, edit the channel language and channel genre and delete channels.
- If you set the **Screen Off** function to **On** for the selected channels, a screen off message is displayed, and pictures are turned off by the **Screen Off** function and only audio is output from those channels.
- **Channel Editor** also lets you view information about each channel easily, without your having to display each channel directly.

General Steps for Using the Channel Editor in Standalone Mode



- The image on your TV may differ from the image above depending on the model and geographical area.
1. Run **Channel Setup (Channel > Channel Setup)** in the **Hotel Option** menu.
 2. Enter **Channel Editor (Channel > Channel Editor)** in the **Hotel Option** menu.
 3. On a piece of paper, compile a list of channels you want to have, arranged in the order you want.
 4. Based on the list created in Step 3, rearrange the channels and edit the channel names.
 5. Press the  button to exit.

Editing the Channel Number

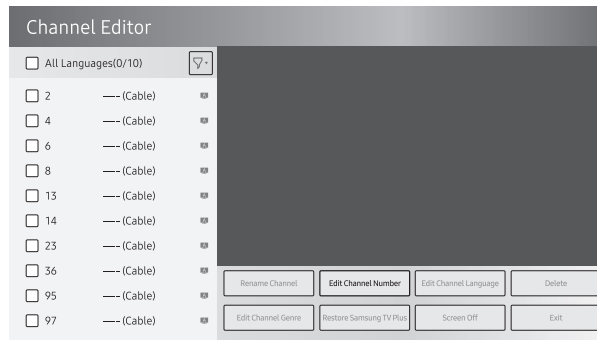

Change the channel number of a channel you select. To change a channel number, follow these steps:

1. Select a channel on the **Channel Edit** screen.
2. Use the directional buttons on the remote control, move the focus to **Edit Channel Number**, and press the **Select** button.
3. Use the up or down directional buttons on the remote control to change the channel number.
4. Move the focus to **OK** when done, and then press the **Select** button on the remote control.
 - When you change the channel number, the channel information is updated automatically.

Rename the Channel

Change the name of a channel you select. To change the name of a channel, follow these steps:

1. Select a channel on the **Channel Edit** screen.
2. Use the directional buttons on the remote control, move the focus to **Rename Channel**, and then press the **Select** button.
3. Use the on-screen keyboard that appears to enter the new name for the channel. Use the directional buttons on the remote control, move the focus a letter or number, and then press the **Select** button. Repeat for each letter or number you want to enter.
4. When finished, move the focus to **Done**, and then press the **Select** button on the remote control.

Assigning the Channel Number to the external device

The external device source of the TV are displayed in the last page of the **Channel Editor** menu as shown below.

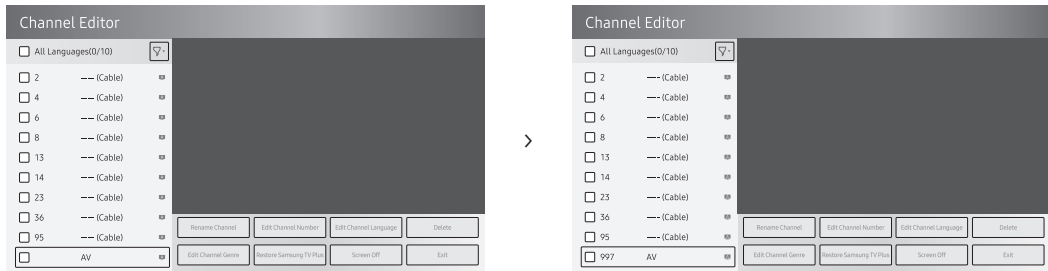

1. Select a external device source on the **Channel Edit** screen.
 2. Use the directional buttons on the remote control, move the focus to **Edit Channel Number**, and press the **Select** button.
 3. Use the up or down directional buttons on the remote control to assign the channel number.
 4. Move the focus to **OK** when done, and then press the **Select** button on the remote control.
- Once you assign a channel number to an external device, you can enter the external device without opening the TV source menu.

09 Specifications and Other Information

Specifications

Model Name	HG43Q60B	HG50Q60B
Display Resolution	3840 x 2160	3840 x 2160
Screen Size Diagonal Measured Diagonally	43" Class 42.5 inches	50" Class 49.5 inches
Sound (Output)	20 W	20 W
Dimensions (W x H x D) Body With Stand	38.0 x 22.0 x 1.0 inches (965.5 x 559.4 x 25.7 mm) 38.0 x 23.5 x 71 inches (965.5 x 598.1 x 181.0 mm)	44.0 x 25.4 x 1.0 inches (1118.3 x 644.1 x 25.7 mm) 44.0 x 26.8 x 8.8 inches (1118.3 x 681.7 x 224.0 mm)
Weight Without Stand With Stand	18.5 lbs (8.4 kg) 19.0 lbs (8.6 kg)	25.4 lbs (11.5 kg) 26.0 lbs (11.8 kg)
Model Name	HG55Q60B	HG65Q60B
Display Resolution	3840 x 2160	3840 x 2160
Screen Size Diagonal Measured Diagonally	55" Class 54.6 inches	65" Class 64.5 inches
Sound (Output)	20 W	20 W
Dimensions (W x H x D) Body With Stand	48.5 x 27.9 x 1.0 inches (1232.1 x 708.3 x 25.7 mm) 48.5 x 29.4 x 8.8 inches (1232.1 x 745.9 x 224.0 mm)	57.1 x 32.7 x 1.0 inches (1450.9 x 831.4 x 25.7 mm) 57.1 x 34.3 x 10.8 inches (1450.9 x 872.2 x 274.0 mm)
Weight Without Stand With Stand	34.2 lbs (15.5 kg) 34.8 lbs (15.8 kg)	46.1 lbs (20.9 kg) 47.0 lbs (21.3 kg)

Model Name	HG75Q60B
Display Resolution	3840 x 2160
Screen Size Diagonal Measured Diagonally	75" Class 74.5 inches
Sound (Output)	20 W
Dimensions (W x H x D) Body With Stand	66.0 x 37.8 x 1.0 inches (1676.7 x 959.8 x 26.6 mm) 66.0 x 39.3 x 12.6 inches (1676.7 x 997.3 x 320.0 mm)
Weight Without Stand With Stand	69.2 lbs (31.4 kg) 70.5 lbs (32.0 kg)

Environmental Considerations

Operating Temperature	50 °F to 104 °F (10 °C to 40 °C)
Operating Humidity	10 % to 80 %, non-condensing
Storage Temperature	-4 °F to 113 °F (-20 °C to 45 °C)
Storage Humidity	5 % to 95 %, non-condensing

Notes

- This device is a Class B digital apparatus.
- Design and specifications are subject to change without prior notice.
- For information about the power supply, and more information about power consumption, refer to the information on the label attached to the product.
 - On most models, the label is attached to the back of the TV. (On some models, the label is inside the cover terminal.)
- Your TV and its accessories may look different than the product images presented in this manual, depending on the model.
- All drawings are not necessarily to scale. Some dimensions are subject to change without prior notice. Refer to the dimensions before installing your TV. Not responsible for typographical or printed errors.
- Recommended hours of use per day of this product is under 8 hours. If the product is used for longer than 8 hours a day, the warranty may be void.

Decreasing power consumption

When you shut the TV off, it enters Standby mode. In Standby mode, it continues to draw a small amount of power. To decrease power consumption, unplug the power cord when you don't intend to use the TV for a long time.

Supported Resolutions for UHD Input Signals

- Resolution: 3840 x 2160p, 4096 x 2160p

If Input Signal Plus is set to Off

Frame rate (fps)	Color Depth / Chroma Sampling	RGB 4:4:4	YCbCr 4:4:4	YCbCr 4:2:2	YCbCr 4:2:0
50 / 60	8 bit	-	-	-	0

If Input Signal Plus is set to On

Frame rate (fps)	Color Depth / Chroma Sampling	RGB 4:4:4	YCbCr 4:4:4	YCbCr 4:2:2	YCbCr 4:2:0
50 / 60	8 bit	0	0	0	0
	10 bit	-	-	0	0

Supported Resolutions for Connecting a Computer

When you use your TV as a computer monitor, you can also select one of the standard resolutions listed in the Resolution column. The TV will automatically adjust to the resolution you choose.

Mode	Resolution	Display format	Horizontal frequency (KHz)	Vertical frequency (Hz)	Clock frequency (MHz)	Polarity (horizontal / vertical)
IBM	720 x 400	70 Hz	31.469	70.087	28.322	-/+
MAC	640 x 480	67 Hz	35.000	66.667	30.240	-/-
	832 x 624	75 Hz	49.726	74.551	57.284	-/-
	1152 x 870	75 Hz	68.681	75.062	100.000	-/-
VESA DMT	640 x 480	60 Hz	31.469	59.940	25.175	-/-
	640 x 480	72 Hz	37.861	72.809	31.500	-/-
	640 x 480	75 Hz	37.500	75.000	31.500	-/-
	800 x 600	60 Hz	37.879	60.317	40.000	+/+
	800 x 600	72 Hz	48.077	72.188	50.000	+/+
	800 x 600	75 Hz	46.875	75.000	49.500	+/+
	1024 x 768	60 Hz	48.363	60.004	65.000	-/-
	1024 x 768	70 Hz	56.476	70.069	75.000	-/-
	1024 x 768	75 Hz	60.023	75.029	78.750	+/+
	1152 x 864	75 Hz	67.500	75.000	108.000	+/+
	1280 x 720	60 Hz	45.000	60.000	74.250	+/+
	1280 x 800	60 Hz	49.702	59.810	83.500	-/+
	1280 x 1024	60 Hz	63.981	60.020	108.000	+/+
	1280 x 1024	75 Hz	79.976	75.025	135.000	+/+
	1440 x 900	60 Hz	55.935	59.887	106.500	-/+
	1600 x 900	60 Hz	60.000	60.000	108.000	+/+
	1680 x 1050	60 Hz	65.290	59.954	146.250	-/+
1920 x 1080	60 Hz	67.500	60.000	148.500	+/+	
VESA CVT	2560 x 1440	60 Hz	88.787	59.951	241.500	+/-
	2560 x 1440	120 Hz	192.996	119.998	497.750	+/-

Mode	Resolution	Display format	Horizontal frequency (KHz)	Vertical frequency (Hz)	Clock frequency (MHz)	Polarity (horizontal / vertical)
CTA-861	*1920 x 1080	100 Hz	112.500	100.000	297.000	+ / +
	*1920 x 1080	120 Hz	135.000	120.003	297.000	+ / +
	3840 x 2160	30 Hz	67.500	30.000	297.000	- / -
	*3840 x 2160	60 Hz	135.000	60.000	594.000	- / -
	*3840 x 2160	100 Hz	225.000	100.000	1188.000	+ / +
	*3840 x 2160	120 Hz	270.000	120.000	1188.000	+ / +
	4096 x 2160	24 Hz	54.000	24.000	297.000	+ / +
	4096 x 2160	25 Hz	56.250	25.000	297.000	+ / +
	4096 x 2160	30 Hz	67.500	30.000	297.000	+ / +
	*4096 x 2160	50 Hz	112.500	50.000	594.000	+ / +
	*4096 x 2160	60 Hz	135.000	60.000	594.000	+ / +
	*4096 x 2160	100 Hz	225.000	100.000	1188.000	+ / +
	*4096 x 2160	120 Hz	270.000	120.000	1188.000	+ / +
	*7680 x 4320	24 Hz	108.000	24.000	1188.000	+ / +
	*7680 x 4320	30 Hz	132.000	30.000	1188.000	+ / +
	*7680 x 4320	50 Hz	220.000	50.000	2376.000	+ / +
	*7680 x 4320	60 Hz	264.000	60.000	2376.000	+ / +

- *: The resolution may not be supported depending on the model.
- The interlaced mode is not supported.
- The set might operate abnormally if you select a non-standard video format.
- Separate and Composite modes are supported. SOG (Sync On Green) is not supported.
- Set **Apps Editable** to **ON** to change the input source (**Edit Name/Icon**) manually.
 - **Hotel Option menu > Smart Service > Apps Editable**

Supported Resolutions for Video Signals

Check the resolutions supported for video signals.

Mode	Resolution	Display format	Horizontal frequency (KHz)	Vertical frequency (Hz)	Clock frequency (MHz)	Polarity (horizontal / vertical)
CTA-861	720 (1440) x 576i	50 Hz	15.625	50.000	27.000	- / -
	720 (1440) x 480i	60 Hz	15.734	59.940	27.000	- / -
	720 x 576	50 Hz	31.250	50.000	27.000	- / -
	720 x 480	60 Hz	31.469	59.940	27.000	- / -
	1280 x 720	50 Hz	37.500	50.000	74.250	+ / +
	1280 x 720	60 Hz	45.000	60.000	74.250	+ / +
	1920 x 1080i	50 Hz	28.125	50.000	74.250	+ / +
	1920 x 1080i	60 Hz	33.750	60.000	74.250	+ / +
	1920 x 1080	24 Hz	27.000	24.000	74.250	+ / +
	1920 x 1080	25 Hz	28.125	25.000	74.250	+ / +
	1920 x 1080	30 Hz	33.750	30.000	74.250	+ / +
	1920 x 1080	50 Hz	56.250	50.000	148.500	+ / +
	*1920 x 1080	100 Hz	112.500	100.000	297.000	+ / +
	*1920 x 1080	120 Hz	135.000	120.003	297.000	+ / +
	1920 x 1080	60 Hz	67.500	60.000	148.500	+ / +
	3840 x 2160	24 Hz	54.000	24.000	297.000	+ / +
	3840 x 2160	25 Hz	56.250	25.000	297.000	+ / +
	3840 x 2160	30 Hz	67.500	30.000	297.000	+ / +
	*3840 x 2160	50 Hz	112.500	50.000	594.000	+ / +
	*3840 x 2160	60 Hz	135.000	60.000	594.000	+ / +
	*3840 x 2160	100 Hz	225.000	100.000	1188.000	+ / +
	*3840 x 2160	120 Hz	270.000	120.000	1188.000	+ / +
	4096 x 2160	24 Hz	54.000	24.000	297.000	+ / +
	4096 x 2160	25 Hz	56.250	25.000	297.000	+ / +
	4096 x 2160	30 Hz	67.500	30.000	297.000	+ / +
	*4096 x 2160	50 Hz	112.500	50.000	594.000	+ / +
	*4096 x 2160	60 Hz	135.000	60.000	594.000	+ / +
	*4096 x 2160	100 Hz	225.000	100.000	1188.000	+ / +
	*4096 x 2160	120 Hz	270.000	120.000	1188.000	+ / +
	*7680 x 4320	24 Hz	108.000	24.000	1188.000	+ / +
	*7680 x 4320	30 Hz	132.000	30.000	1188.000	+ / +
	*7680 x 4320	50 Hz	220.000	50.000	2376.000	+ / +
*7680 x 4320	60 Hz	264.000	60.000	2376.000	+ / +	
VESA CVT	2560 x 1440	60 Hz	88.787	59.951	241.500	+ / -
	2560 x 1440	120 Hz	192.996	119.998	497.750	+ / -

- *: The resolution may not be supported depending on the model.
- Set **Apps Editable** to **ON** to change the input source (**Edit Name/Icon**) manually.
 - **Hotel Option menu > Smart Service > Apps Editable**

Read Before Using the Internet Function

Read this information before using the Internet function.

- File download is not supported.
- The **Internet** function may not be able to access certain websites, including websites operated by certain companies.
- The TV does not support playback of flash videos.
- E-commerce for online purchases is not supported.
- ActiveX is not supported.
- Only a limited number of fonts are supported. Certain symbols and characters may not be displayed properly.
- The response to remote commands and the resulting on-screen display may be delayed while a web page is loading.
- Loading a web page may be delayed or suspended completely depending on the status of the participating systems.
- Copy and paste operations are not supported.
- When composing an email or a simple message, certain functions such as the font size and color selection may not be available.
- There is a limit to the number of bookmarks and the size of the log file that can be saved.
- The number of windows that can be opened concurrently is limited.
- Web browsing speed will differ with the network environment.
- Browsing history is saved from latest to oldest, with the oldest entries being overwritten first.
- Depending on the types of video/audio codecs supported, you may not be able to play certain HTML5 video and audio files.
- Video sources from PC-optimized streaming service providers may not play properly on our proprietary **Internet** browser.

Dimensions

Front view / Side view

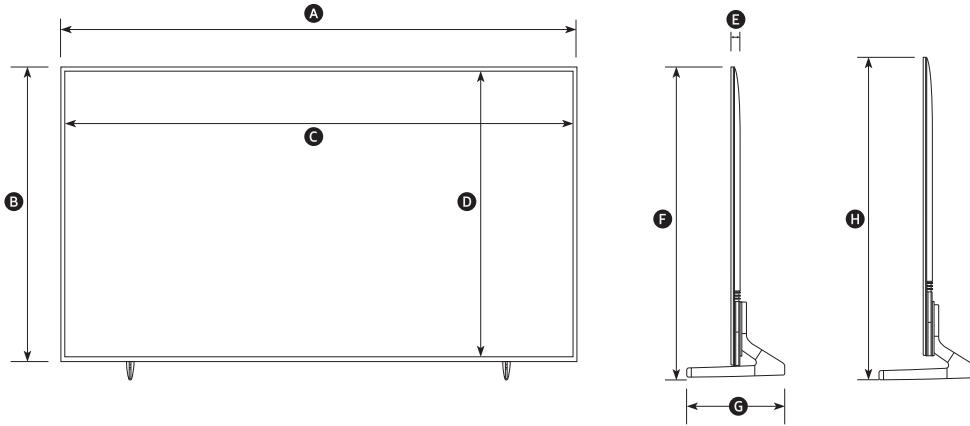

Unit: inches	A	B	C	D	E	F	G	H
43	38.0	22.0	37.5	21.2	1.0	23.5	7.1	24.5
50	44.0	25.4	43.5	24.5	1.0	26.8	8.8	27.8
55	48.5	27.9	48.0	27.0	1.0	29.4	8.8	30.4
65	57.1	32.7	56.6	31.9	1.0	34.3	10.8	35.3
75	66.0	37.8	65.4	36.9	1.0	39.3	12.6	40.2

Rearview

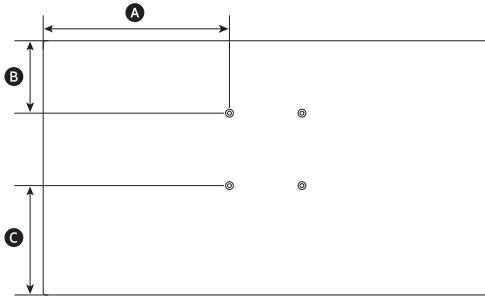

Unit: inches	A	B	C
43	15.1	7.6	6.6
50	18.1	8.2	9.3
55	20.3	9.4	10.6
65	20.7	10.4	10.5
75	25.1	10.2	11.8

Base Stand detail

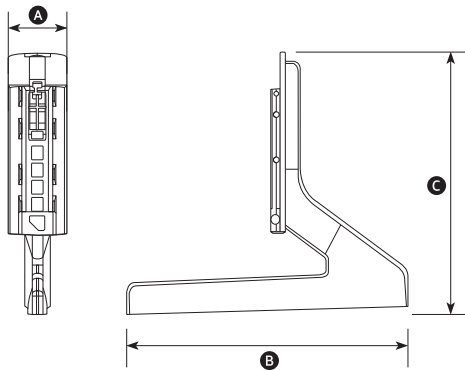

Unit: inches	A	B	C
43	1.5	7.1	8.3
50-55	1.6	8.8	8.5
65	1.6	10.8	8.6
75	1.6	12.6	9.2

Licenses



Dolby, Dolby Atmos, Dolby Audio and the double-D symbol are registered trademarks of Dolby Laboratories Licensing Corporation. Manufactured under license from Dolby Laboratories. Confidential unpublished works. Copyright © 2012-2021 Dolby Laboratories. All rights reserved.

POWERED BY

QUICKSET[®]



THIS PRODUCT IS SOLD WITH A LIMITED LICENCE AND IS AUTHORISED TO BE USED ONLY IN CONNECTION WITH HEVC CONTENT THAT MEETS EACH OF THE THREE FOLLOWING QUALIFICATIONS: (1) HEVC CONTENT ONLY FOR PERSONAL USE; (2) HEVC CONTENT THAT IS NOT OFFERED FOR SALE; AND (3) HEVC CONTENT THAT IS CREATED BY THE OWNER OF THE PRODUCT.

THIS PRODUCT MAY NOT BE USED IN CONNECTION WITH HEVC ENCODED CONTENT CREATED BY A THIRD PARTY, WHICH THE USER HAS ORDERED OR PURCHASED FROM A THIRD PARTY, UNLESS THE USER IS SEPARATELY GRANTED RIGHTS TO USE THE PRODUCT WITH SUCH CONTENT BY A LICENSED SELLER OF THE CONTENT.

YOUR USE OF THIS PRODUCT IN CONNECTION WITH HEVC ENCODED CONTENT IS DEEMED ACCEPTANCE OF THE LIMITED AUTHORITY TO USE AS NOTED ABOVE.



The terms HDMI and HDMI High-Definition Multimedia Interface, and the HDMI Logo are trademarks or registered trademarks of HDMI Licensing Administrator, Inc. in the United States and other countries.

Open Source License Notice

Open Source used in this product can be found on the following webpage. (<https://opensource.samsung.com>)

Important Warranty Information Regarding Television Format Viewing

- See the warranty card for more information on warranty terms.

Wide screen format LED Displays (16:9, the aspect ratio of the screen width to height) are primarily designed to view wide screen format full-motion video. The images displayed on them should primarily be in the wide screen 16:9 ratio format, or expanded to fill the screen if your model offers this feature and the images are constantly moving. Displaying stationary graphics and images on screen, such as the dark sidebars on nonexpanded standard format television video and programming, should be limited to no more than 5% of the total television viewing per week.

Additionally, viewing other stationary images and text such as stock market reports, video game displays, station logos, web sites or computer graphics and patterns, should be limited as described above for all televisions. Displaying stationary images that exceed the above guidelines can cause uneven aging of LED Displays that leave subtle, but permanent burned-in ghost images in the LED picture. To avoid this, vary the programming and images, and primarily display full screen moving images, not stationary patterns or dark bars. On LED models that offer picture sizing features, use these controls to view different formats as a full screen picture.

Be careful in the selection and duration of television formats used for viewing. Uneven LED aging as a result of format selection and use, as well as burned-in images, are not covered by your Samsung limited warranty.

SAMSUNG ELECTRONICS NORTH AMERICAN LIMITED WARRANTY STATEMENT

Subject to the requirements, conditions, exclusions and limitations of the original Limited Warranty supplied with Samsung Electronics (SAMSUNG) products, and the requirements, conditions, exclusions and limitations contained herein, SAMSUNG will additionally provide Warranty Repair Service in the United States on SAMSUNG products purchased in Canada, and in Canada on SAMSUNG products purchased in the United States, for the warranty period originally specified, and to the Original Purchaser only.

The above described warranty repairs must be performed by a SAMSUNG Authorized Service Center. Along with this Statement, the Original Limited Warranty Statement and a dated Bill of Sale as Proof of Purchase must be presented to the Service Center. Transportation to and from the Service Center is the responsibility of the purchaser. Conditions covered are limited only to manufacturing defects in material or workmanship, and only those encountered in normal use of the product.

Excluded, but not limited to, are any originally specified provisions for, in-home or on-site services, minimum or maximum repair times, exchanges or replacements, accessories, options, upgrades, or consumables.

For the location of a SAMSUNG Authorized Service Center, please call toll-free:

- In the United States: 1-866-sam4biz
- In Canada: 1-800-749-0205

SAMSUNG

Contact SAMSUNG WORLD WIDE

If you have any questions or comments relating to Samsung products, please contact the Samsung service center.

Samsung Hospitality Hotline 1-866-sam4biz (US)
 1-800-749-0205 (CANADA)
 800-1488-747 (MEXICO)

Web site: <https://www.samsung.com/us/business>