

LS832WU

Projector User Guide

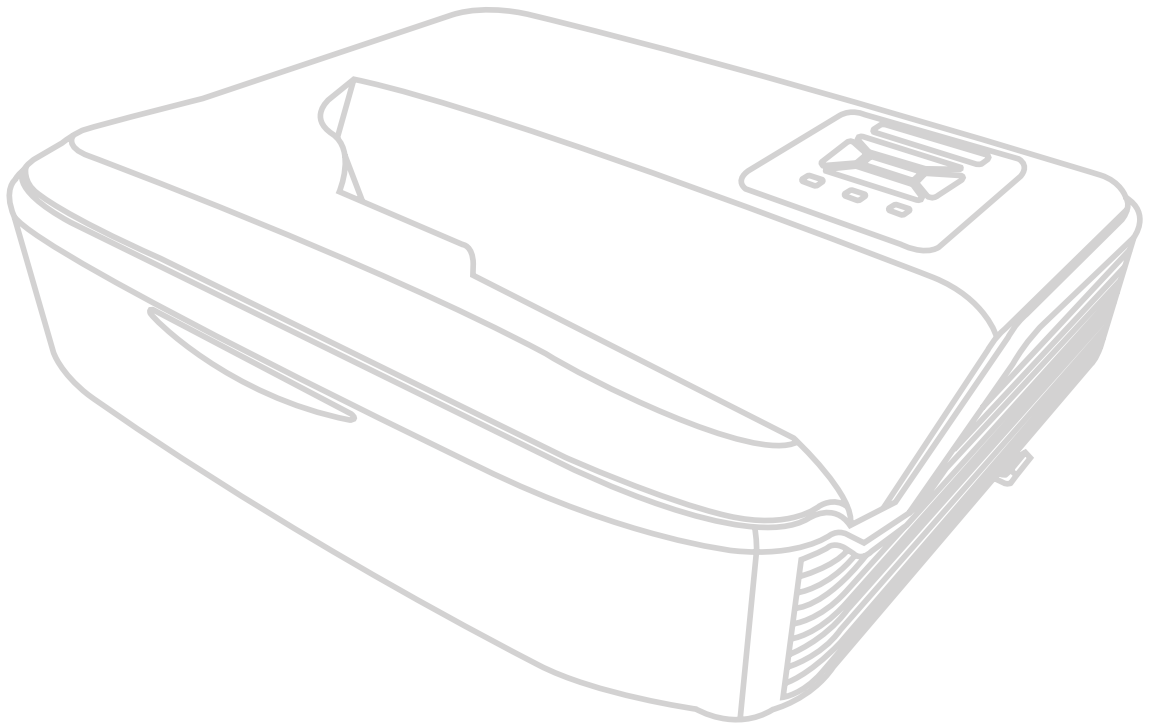

IMPORTANT: Please read this User Guide to obtain important information on installing and using your product in a safe manner, as well as registering your product for future service. Warranty information contained in this User Guide will describe your limited coverage from ViewSonic® Corporation, which is also found on our web site at <http://www.viewsonic.com> in English, or in specific languages using the Regional selection box on our website.

Model No. VS19516
P/N: LS832WU

Thank you for choosing ViewSonic®

As a world-leading provider of visual solutions, ViewSonic® is dedicated to exceeding the world's expectations for technological evolution, innovation, and simplicity. At ViewSonic®, we believe that our products have the potential to make a positive impact in the world, and we are confident that the ViewSonic® product you have chosen will serve you well.

Once again, thank you for choosing ViewSonic®!

Safety Precautions

Please read the following **Safety Precautions** before you start using the projector.

- Keep this user guide in a safe place for later reference.
- Read all warnings and follow all instructions.
- Allow at least 20" (50 cm) clearance around the projector to ensure proper ventilation.
- Place the projector in a well-ventilated area. Do not place anything on the projector that prevents heat dissipation.
- Do not place the projector on an uneven or unstable surface. The projector may fall over, causing personal injury or projector malfunction.
- Do not look straight at the projector lens during operation. The intense light beam may damage your eyes.
- Always open the lens shutter or remove the lens cap when the projector lamp is on.
- Do not block the projection lens with any objects when the projector is under operation as this could cause objects to become heated and deformed or even cause a fire.
- The lamp becomes extremely hot during operation. Allow the projector to cool for approximately 45 minutes prior to removing the lamp assembly for replacement.
- Do not use lamps beyond the rated lamp life. Excessive use of lamps beyond the rated life could cause them to break on rare occasions.
- Never replace the lamp assembly or any electronic component unless the projector is unplugged.
- Do not attempt to disassemble the projector. There are dangerous high voltages inside which may cause death if you should come into contact with live parts.
- When moving the projector, be careful not to drop or bump the projector on anything.
- Do not place any heavy objects on the projector or connection cables.
- Do not stand the projector on end vertically. Doing so may cause the projector to fall over, causing personal injury or projector malfunction.
- Avoid exposing the projector to direct sunlight or other sources of sustained heat. Do not install near any heat sources such as radiators, heat registers, stoves, or other devices (including amplifiers) that may increase the temperature of the projector to dangerous levels.

- Do not place liquids near or on the projector. Liquids spilled into the projector may cause it to fail. If the projector does become wet, disconnect it from the power supply and call your local service center to have the projector serviced.
- When the projector is under operation, you may sense some heated air and odor from its ventilation grill. It is a normal operation and not a defect.
- Do not attempt to circumvent the safety provisions of the polarized or grounding-type plug. A polarized plug has two blades with one wider than the other. A grounding-type plug has two blades and a third grounding prong. The wide and third blade are provided for your safety. If the plug does not fit into your outlet, obtain an adapter and do not attempt to force the plug into the outlet.
- When connecting to a power outlet, DO NOT remove the grounding prong. Please ensure grounding prongs are NEVER REMOVED.
- Protect the power cord from being treaded upon or pinched, particularly at the plug, and at the point where it emerges from the projector.
- In some countries, the voltage is NOT stable. This projector is designed to operate safely within a voltage between 100 to 240 volts AC, but could fail if power cuts or surges of ± 10 volts occur. In areas where voltage may fluctuate or cut out, it is recommended that you connect your projector through a power stabilizer, surge protector, or uninterruptable power supply (UPS).
- If smoke, an abnormal noise, or a strange odor is present, immediately switch the projector off and call your dealer or ViewSonic®. It is dangerous to continue using the projector.
- Use only attachments/accessories specified by the manufacturer.
- Disconnect the power cord from the AC outlet if the projector is not being used for a long period of time.
- Refer all servicing to qualified service personnel.



CAUTION: Possibly hazardous optical radiation is emitted from this product. As with any bright light source, do not stare into the beam, RG2 IEC 62471-5:2015.

Safety Precautions - Ceiling Mounting

Please read the following **Safety Precautions** before you start using the projector.

If you intend to mount the projector on the ceiling, it is strongly recommended that you use a proper fitting projector ceiling mount kit and that you ensure it is securely and safely installed.

If you use an inappropriate projector ceiling mount kit, there is a safety risk that the projector may fall from the ceiling due to an improper attachment through the use of the wrong gauge or length screws.

Laser Caution

This product belongs to CLASS I laser product and complies with IEC 60825-1:2014.



Above laser cautions are located on the bottom of this apparatus.

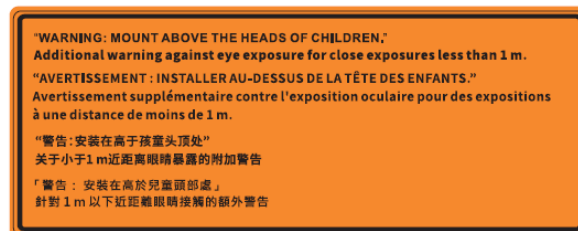

- Notice is given to supervise children and to never allow them to stare into the projector beam at any distance from the projector.
- Notice is given to use caution when using the remote control for starting the projector while in front of the projection lens.
- Notice is given to the user to avoid the use of optical aids such as binoculars or telescopes inside the beam.

Contents

Safety Precautions.....	3
Introduction	8
Package Contents	8
Product Overview	9
Projector.....	9
Keypad.....	10
Indicator Lights.....	10
I/O Ports	11
Remote Control	12
Initial Setup.....	16
Choosing a Location - Projection Orientation.....	16
Projection Dimensions.....	17
Mounting the Projector	18
Making Connections.....	19
Connecting to Power	19
Connecting to External Devices	20
VGA Connection	20
VGA Out Connection	21
HDMI Connection	22
Audio and Microphone Connection	23
USB Connection.....	24
Network Connection	25
RS-232 Connection	26
Using the Projector.....	27
Starting Up the Projector.....	27
Selecting an Input Source	28
Adjusting the Projected Image	29
Adjusting the Projector’s Height and Projection Angle.....	29
Adjusting the Focus and Keystone	30
Shutting Down the Projector	31

Operating the Projector.....	32
On-Screen Display (OSD) Menu	32
Menu Navigation	33
On-Screen Display (OSD) Menu Tree.....	34
Menu Operation	43
Display Menu.....	43
Audio Menu.....	50
Setup Menu.....	51
Network Menu	56
Information Menu.....	58
Appendix.....	59
Specifications.....	59
Projector Dimensions	60
Timing Chart	61
HDMI PC Timing	63
3D Support Timing.....	65
Troubleshooting	66
LED Indicators.....	68
Maintenance.....	69
General Precautions	69
Cleaning the Lens	69
Cleaning the Case	69
Storing the Projector	69
Regulatory and Service Information	70
Compliance Information.....	70
FCC Compliance Statement.....	70
Industry Canada Statement.....	70
CE Conformity for European Countries	71
Declaration of RoHS2 Compliance.....	72
Indian Restriction of Hazardous Substances	73
Product Disposal at End of Product Life	73
Copyright Information	74
Customer Service	75
Limited Warranty	76
Mexico Limited Warranty.....	79

Introduction

Package Contents

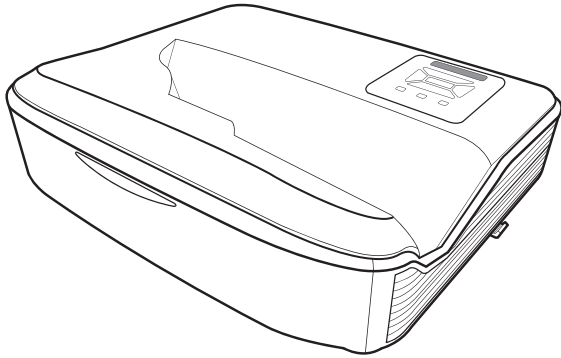

①



②



③



④

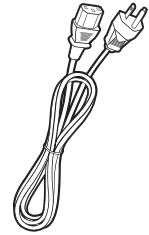

⑤

Number	Description
1	Projector
2	Remote Control
3	Batteries
4	Quick Start Guide
5	Power Cord

NOTE: The power cord and remote control included in your package may vary depending on your country. Please contact your local reseller for more information.

Product Overview

Projector

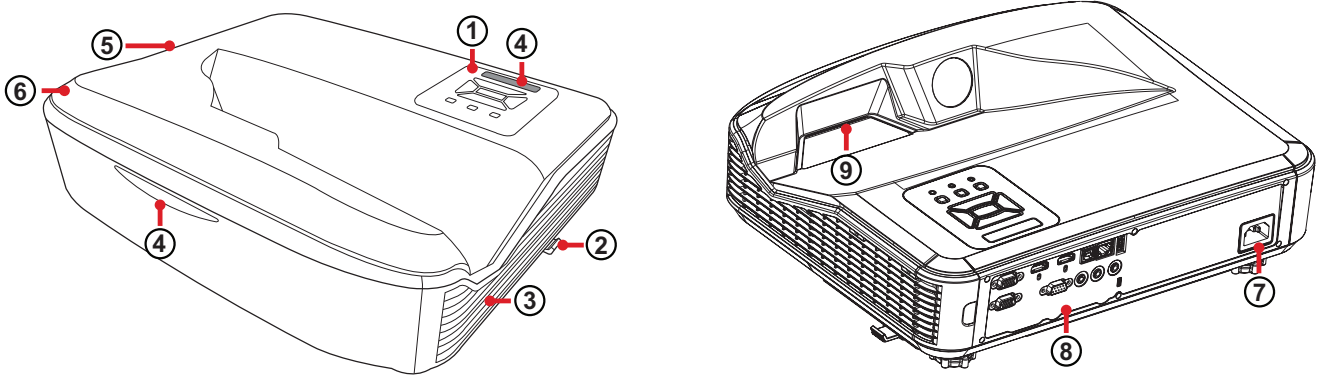

Number	Description
1	Keypad
2	Focus Switch
3	Vent (inlet)
4	Remote IR Sensor
5	Vent (outlet)
6	Speaker
7	AC IN Socket
8	I/O Ports
9	Lens

NOTE:

- Do not block projector intake and exhaust vents.
- When operating the projector in an enclosed space, allow at least 30 cm (11 ¹³/₁₆” in.) clearance around the intake and exhaust vents.

Keypad

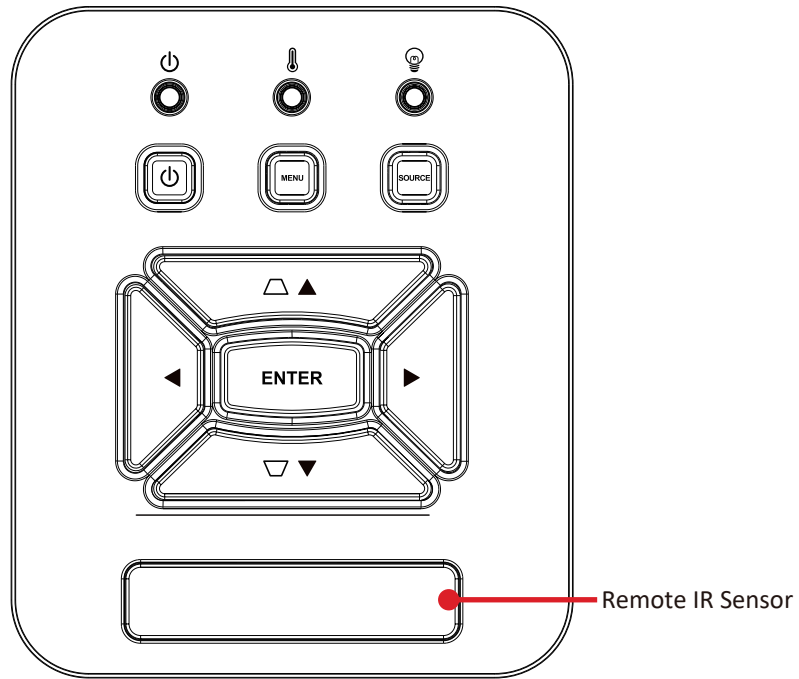



Key		Description
	Power	Toggles the projector between standby mode and Power On.
	Keystone	Manually corrects distorted images resulting from an angled projection.
	Navigation	Selects the desired menu items and makes adjustments when the On-Screen Display (OSD) Menu is activated.
MENU	Menu/Exit	Turns on or off the On-Screen Display (OSD) Menu.
SOURCE	Source	Displays the input source selection bar.
ENTER	Enter	Enacts the selected On-Screen Display (OSD) Menu item when the OSD Menu is activated.

Indicator Lights

Indicator Light	Description
	Power indicator light
	Light source indicator light
	Temperature indicator light

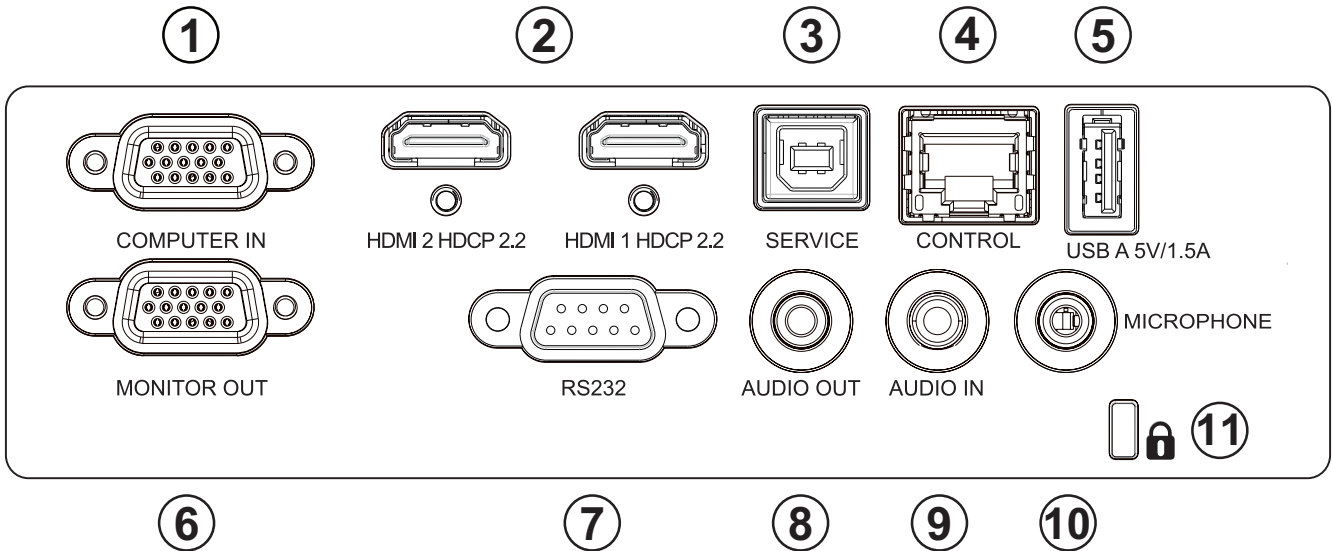
I/O Ports









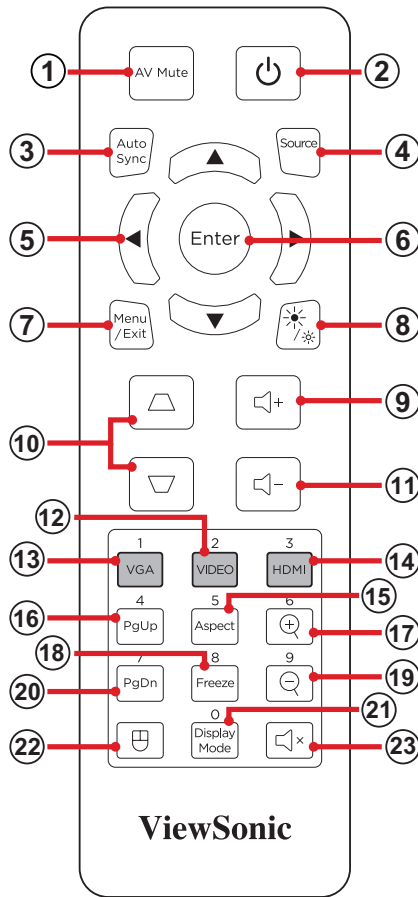















Port		Description
1	COMPUTER IN	RGB (PC)/Component video (YPbPr/YCbCr) signal input socket.
2	HDMI ¹	HDMI port.
3	SERVICE	USB Type B port for service.
4	RJ-45	LAN port.
5	USB (5V/1.5A Out)	USB Type A port for power.
6	MONITOR OUT	RGB signal output socket.
7	RS232	RS-232 control port.
8	AUDIO OUT	Audio signal output socket.
9	AUDIO IN	Audio signal input socket.
10	Microphone	Microphone signal input socket. NOTE: Only supports microphone input; does not support audio in. Plugging in the wrong cable may damage the projector.
11		Kensington anti-theft security lock.

¹ Supports HDCP 2.2.

Remote Control



Button		Description	
1	AV Mute		Hides the screen picture and volume mute.
2	Power		Turns the projector On or Off
3	Auto Sync		Automatically determines the best picture timings for the displayed image.
4	Source		Displays the input source selection bar.
5	Navigation Buttons		Navigates and selects the desired menu items and make adjustments.
6	Enter		Confirms the selection.
7	Menu/Exit		<ul style="list-style-type: none"> • Turns the On-Screen Display (OSD) Menu On or Off. • Go back to a previous OSD Menu. • Exit and Save menu settings.
8	Brightness		Displays the brightness mode selection bar.
9	Volume Up		Increase the volume level.

Button			Description
10	Keystone		Manually correct distorted images.
11	Volume Down		Decrease the volume level.
12	Video		<i>Unsupported Button</i>
13	VGA		Selects the COMPUTER IN port for display.
14	HDMI		Selects the HDMI 1 or HDMI 2 input source.
15	Aspect		Displays the aspect ratio selection bar.
16	Page Up		<i>Unsupported Button</i>
17	Zoom In		Increases the projected image size.
18	Freeze		Freeze the projected image.
19	Zoom Out		Reduces the projected image size.
20	Page Down		<i>Unsupported Button</i>
21	Display Mode		Displays the color mode selection bar.
22	Mouse Mode		<i>Unsupported Button</i>
23	Mute		Mute/Unmute.

Remote Control - Receiver Range

To ensure proper function of the remote control follow the steps below:

1. The remote control must be held at an angle within 30° perpendicular to the projector's IR remote control sensor(s).
2. The distance between the remote control and the sensor(s) should not exceed 7 m (23 feet).

NOTE: Refer to the illustration for the location of the infrared (IR) remote control sensor(s).

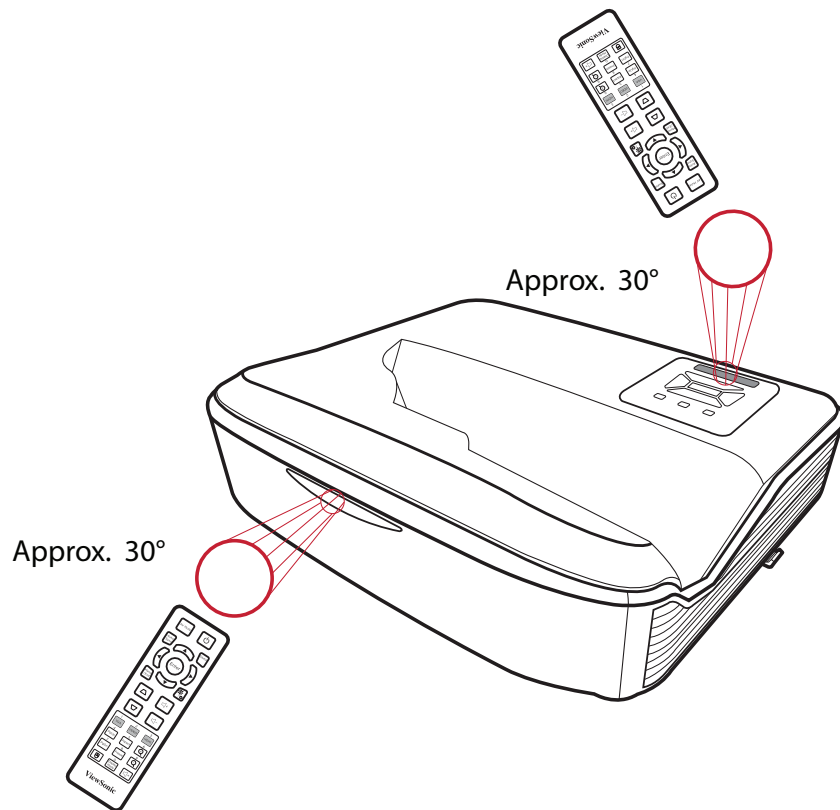

Remote Control - Replacing the Batteries

1. Remove the battery cover from the bottom of the remote control by pressing the finger grip and sliding it across.
2. Remove any existing batteries (if necessary) and install two AAA batteries.

NOTE: Observe the battery's polarities as indicated.

3. Replace the battery cover by aligning it with the base and pushing it back into position.

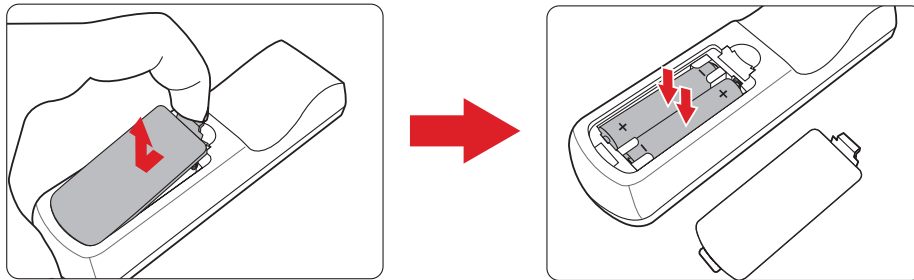

NOTE:

- Avoid leaving the remote control and batteries in excessive heat or a humid environment.
- Replace only with the same or equivalent type recommended by the battery manufacturer.
- If the batteries are drained or if you will not be using the remote control for an extended period of time, remove the batteries to avoid damage to the remote control.
- Dispose of the used batteries according to the manufacturer's instructions and local environment regulations for your region.

Initial Setup

This section provides detailed instructions for the initial set up your projector.

Choosing a Location - Projection Orientation

Personal preference and room layout will decide the installation location. Consider the following:

- Size and position of your screen.
- Location of a suitable power outlet.
- Location and distance between the projector and other equipment.

The projector is designed to be installed in one of the following locations:

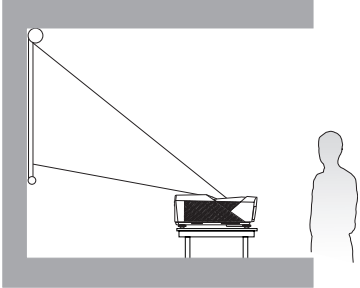
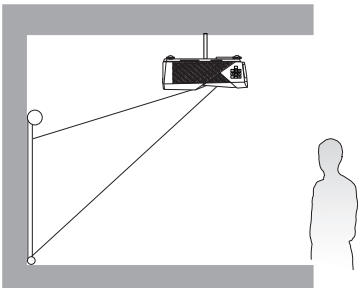
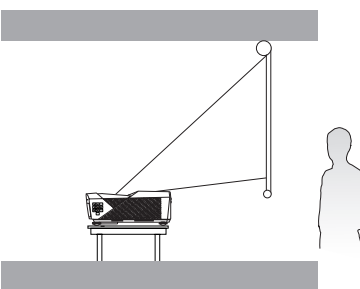
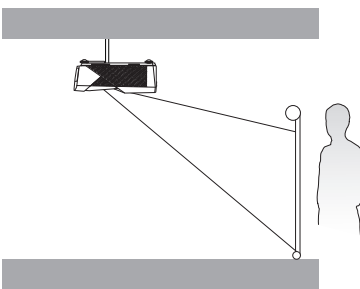
Location	
<p>Front Table</p> <p>The projector is placed near the floor in front of the screen.</p>	
<p>Front Ceiling</p> <p>The projector is suspended upside-down from the ceiling in front of the screen.</p>	
<p>Rear Table¹</p> <p>The projector is placed near the floor behind the screen.</p>	
<p>Rear Ceiling¹</p> <p>The projector is suspended upside-down from the ceiling behind the screen.</p>	

¹ A rear projection screen is required.

Projection Dimensions

- 16:10 Image on a 16:10 Screen

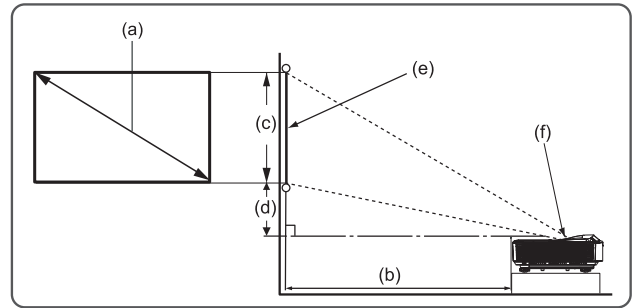
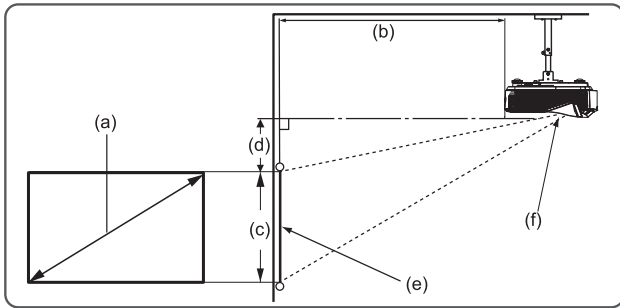

NOTE:

- (e) = Screen
- (f) = Center of Lens
- » The distance from the center of the lens to the rear of the projector is 262 mm (10.31 in.).

16:10 Image on a 16:10 Screen

(a) Screen Size		(b) Projection Distance		(c) Image Height		(d) Vertical Offset	
in.	mm	in.	mm	in.	mm	in.	mm
80	2032	6.85	174	42.40	1077	9.82	249
90	2286	8.99	228	47.70	1212	10.71	272
100	2540	11.14	283	53.00	1346	11.60	295
110	2794	13.28	337	58.30	1481	12.49	317
120	3048	15.43	392	63.60	1615	13.37	340
130	3302	17.58	446	68.90	1750	14.26	362
140	3556	19.72	501	74.20	1885	15.15	385
150	3810	21.87	555	79.50	2019	16.04	407
160	4064	24.01	610	84.80	2154	16.93	430
170	4318	26.16	664	90.10	2289	17.81	452

NOTE:

- These figures are for reference purposes only. Please refer to the actual projector for the precise dimensions.
- It is recommended that if you intend to permanently install the projector to physically test the projection size and distance using the actual projector before you permanently install it.

Mounting the Projector

NOTE: If you buy a third party mount, please use the correct screw size. Screw size can vary depending on the thickness of the mounting plate.

1. To ensure the most secure installation, please use a ViewSonic® wall or ceiling mount.
2. Ensure the screws used to attach the mount to the projector meet the following specifications:
 - Screw type: M4 x 10
 - Maximum Screw Length: 10 mm

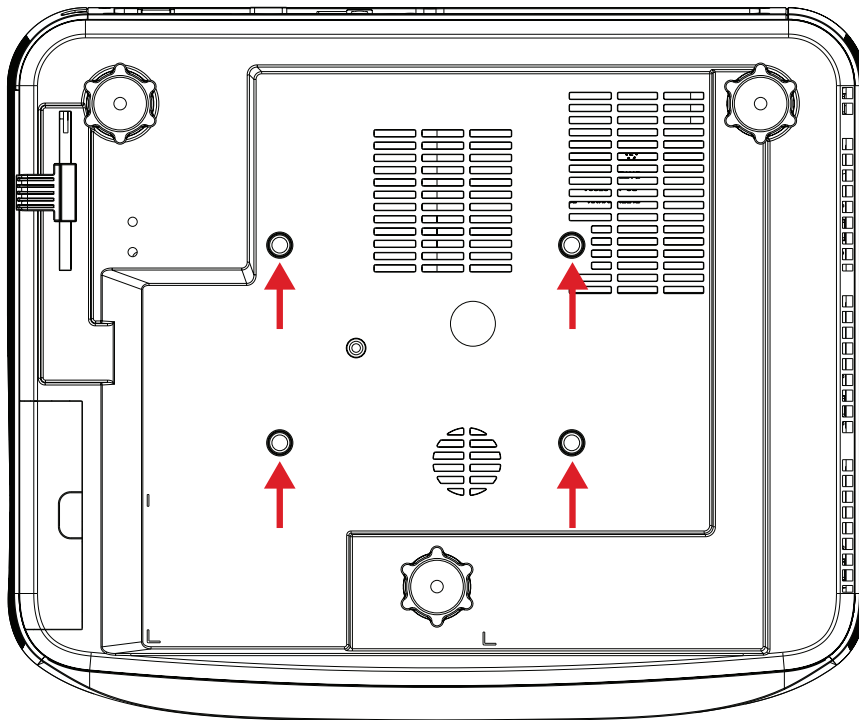

CAUTION:

- Avoid installing the projector near a heat source or air conditioner.
- Keep at least a 10 cm (3.9 in.) gap between the ceiling and the bottom of the projector.

Making Connections

Connecting to Power

1. Connect the power cord to the AC IN jack at the rear of the projector.
2. Plug the power cord into a power outlet.

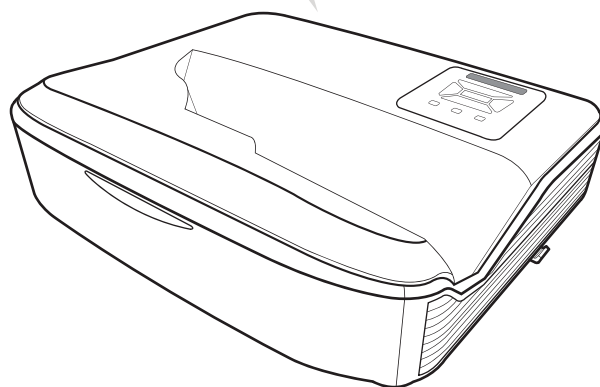
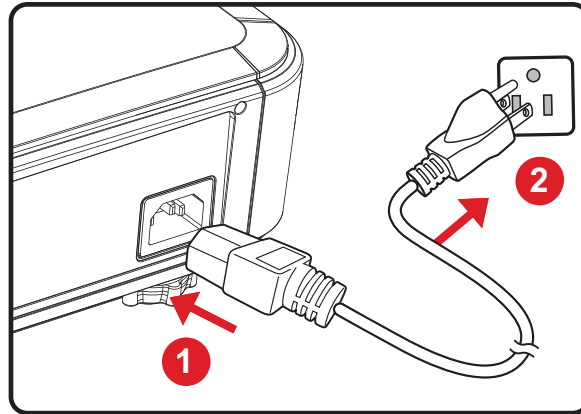

NOTE: When installing the projector, incorporate a readily accessible disconnect device in the fixed wiring, or connect the power plug to an easily accessible outlet near the unit. If a fault should occur during operation of the projector, use the disconnect device to switch off the power supply, or disconnect the power plug.

Connecting to External Devices

VGA Connection

Connect one end of a VGA cable to the VGA port of the computer. Then connect the other end of the cable to the **COMPUTER IN** port of the projector.

NOTE: Some computers do not turn on their external displays automatically when connected to a projector. You may have to adjust your computer's projection settings.

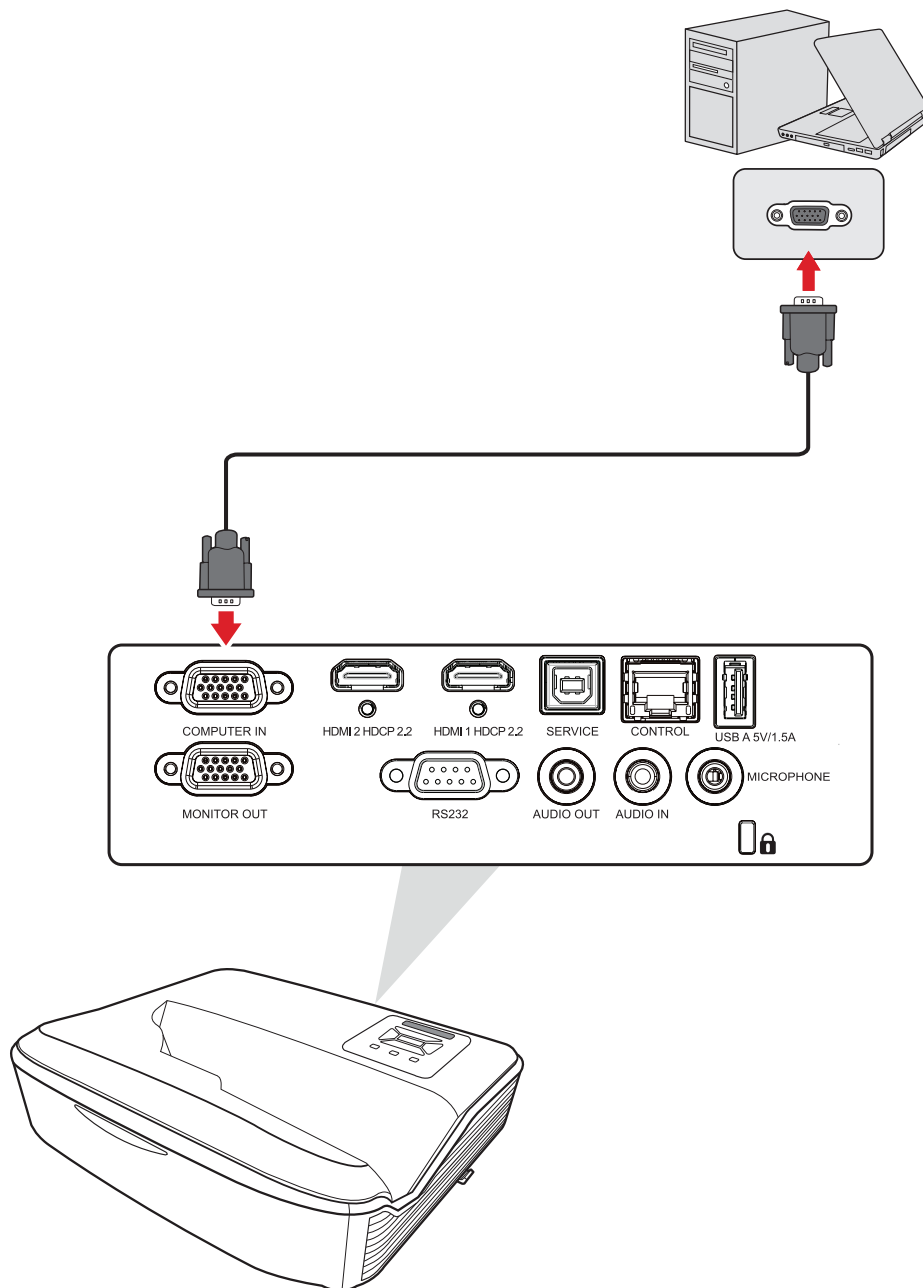

VGA Out Connection

To view the projected content up close on a monitor as well as project it, a monitor can be connected to the **MONITOR OUT** port of the projector.

After establishing the VGA Connection, connect one end of a VGA cable to the VGA port of your monitor. Then connect the other end of the cable to the **MONITOR OUT** port of your projector.

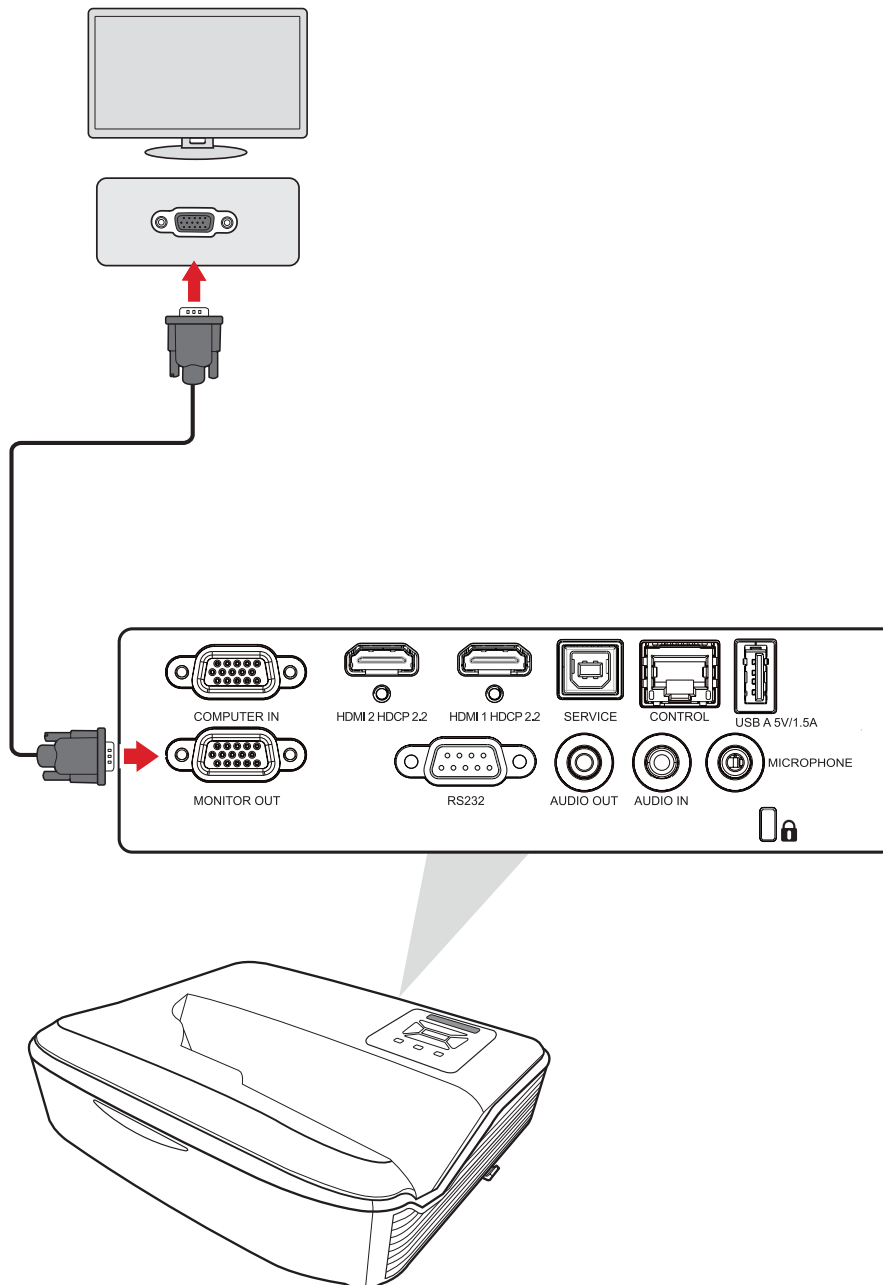

HDMI Connection

Connect one end of an HDMI cable to the HDMI port of your video device. Then connect the other end of the cable to the **HDMI 1/2** port of your projector.

NOTE: The **HDMI 1** and **2** ports support HDCP 2.2.

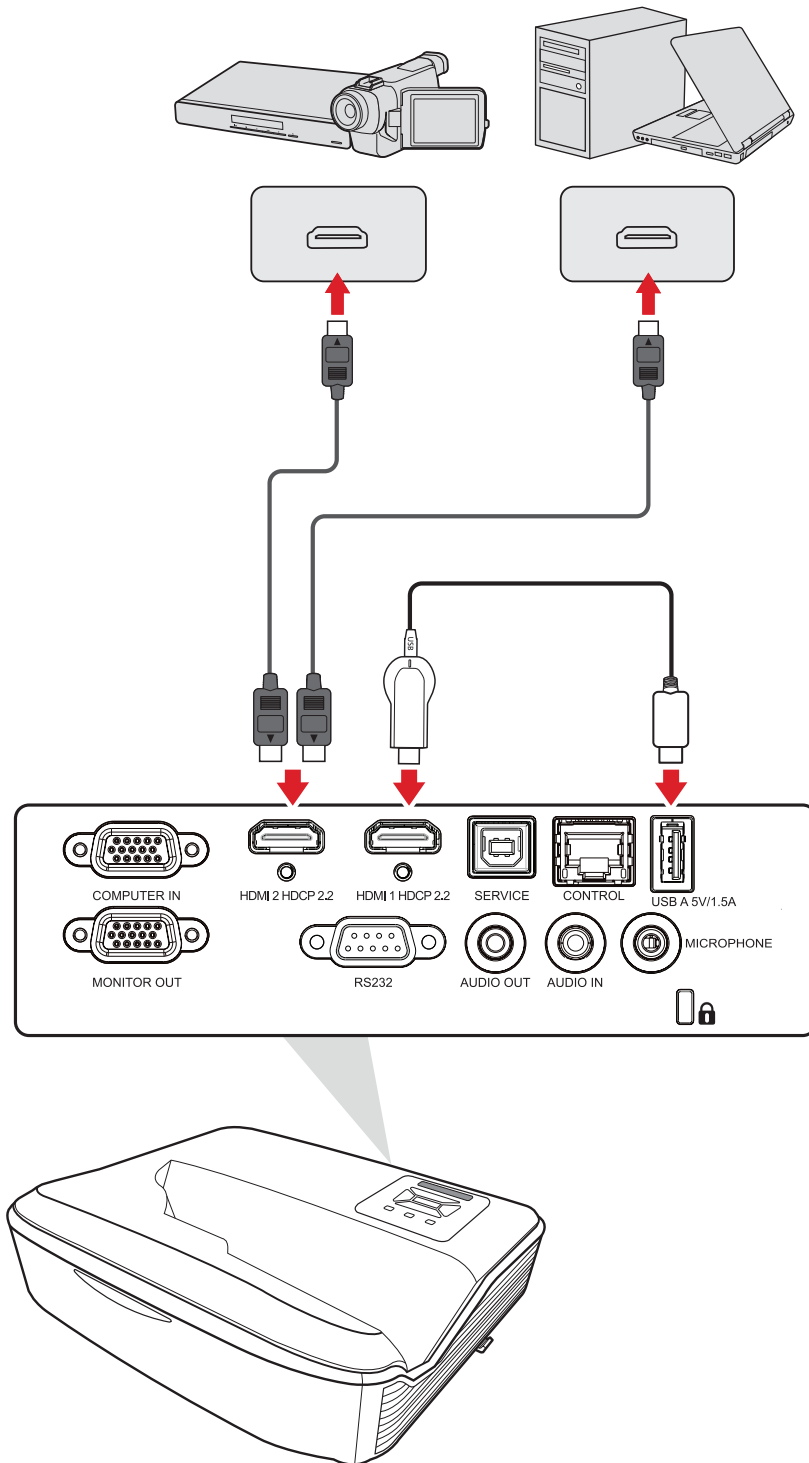

Audio and Microphone Connection

The projector supports both **Audio In** and **Audio Out** as well as **Microphone** input.

Audio In

To play audio from your external device through the projector's speakers, connect one end of an audio cable to your external device, and the other end to the projector's **Audio In** port.

Audio Out

To play audio from the projector through an external speaker, connect one end of an audio cable to the external speaker, and the other end to the projector's **Audio Out** port.

Microphone

Connect a microphone directly to the Microphone port.

NOTE: Only supports microphone input; does not support audio in. Plugging in the wrong cable may damage the projector.

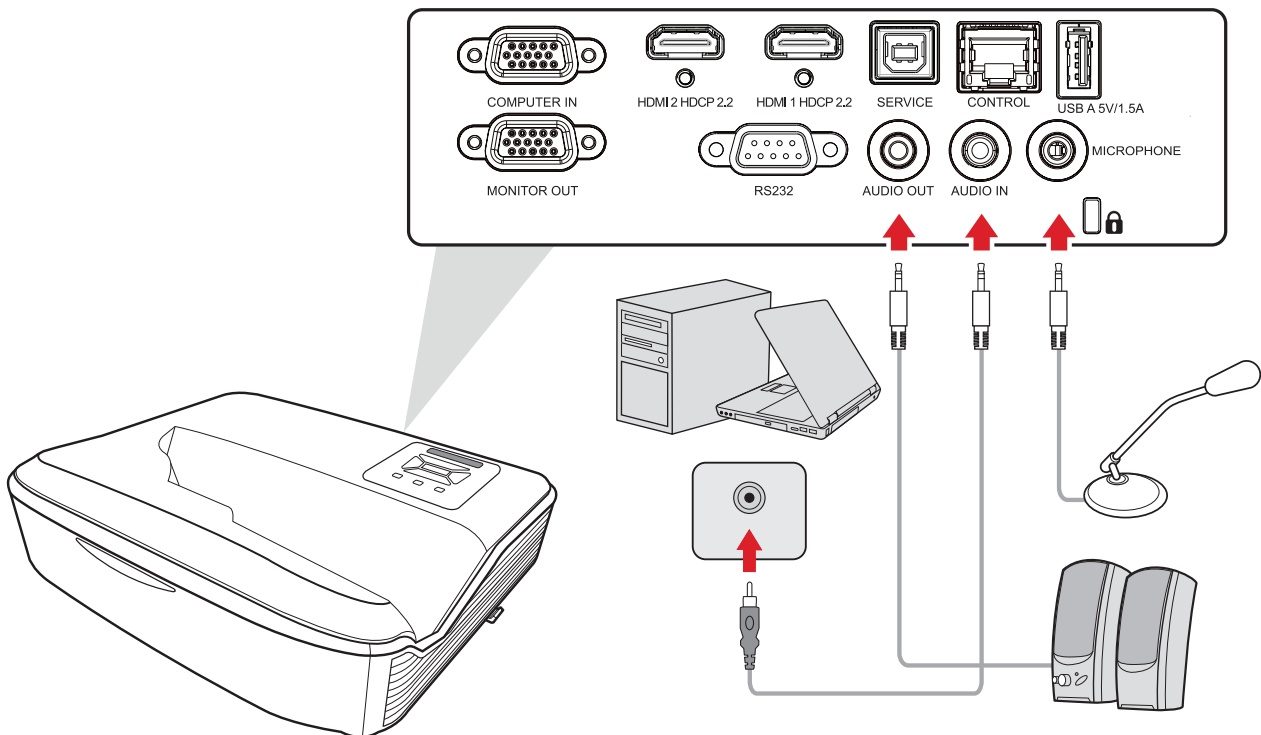

USB Connection

USB Type A Connection

The USB Type A port is for supplying power (e.g., dongles).

USB Type B Connection

The USB Type B port is for servicing the projector.

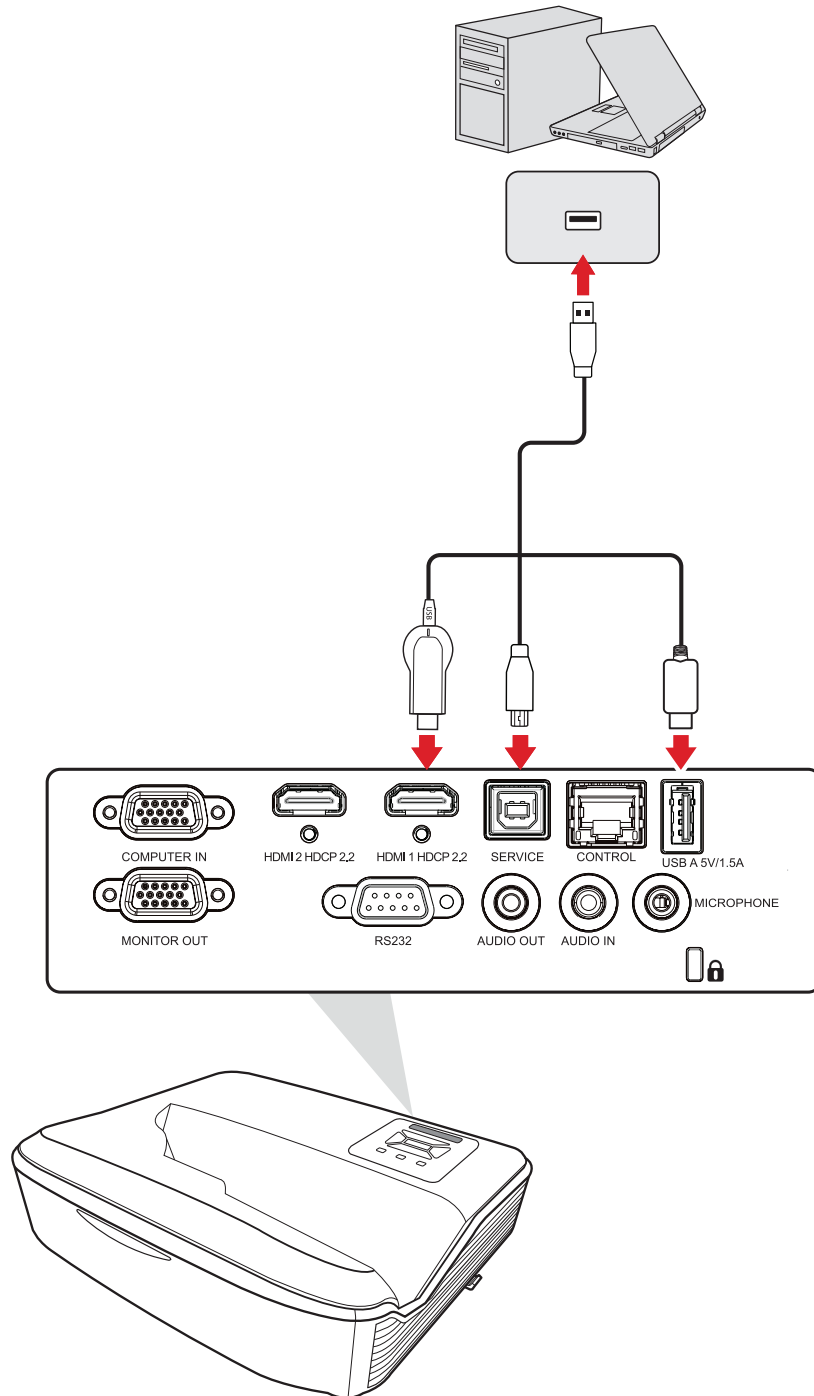

Network Connection

Plug the network cable into the **LAN** port for network connectivity.

The projector provides several networking and remote management features. The LAN /RJ45 function of the projector, through a network, can control the projector remotely.

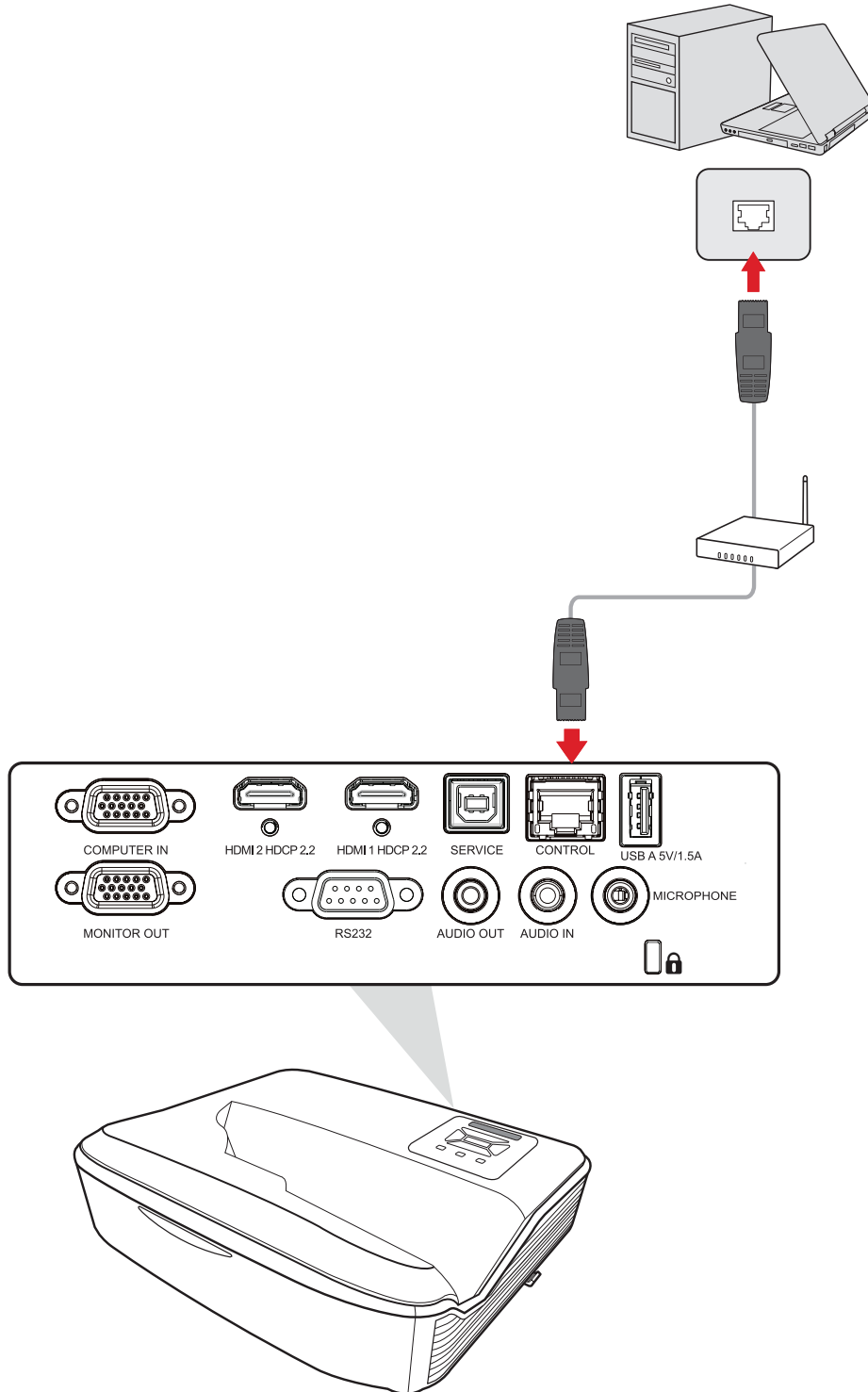

RS-232 Connection

When you use a RS-232 serial port cable to connect the projector to an external computer certain functions can be controlled remotely by the PC, including Power On/Off, Volume adjustment, Input select, Brightness, and more.

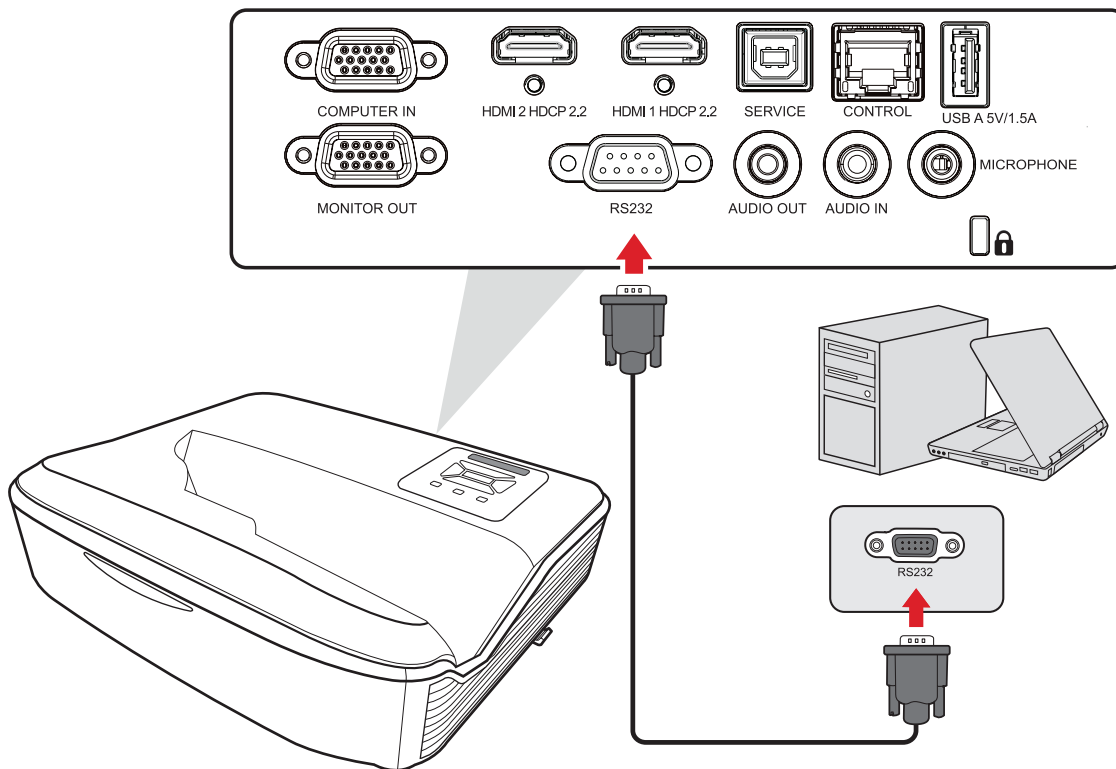

Using the Projector

Starting Up the Projector

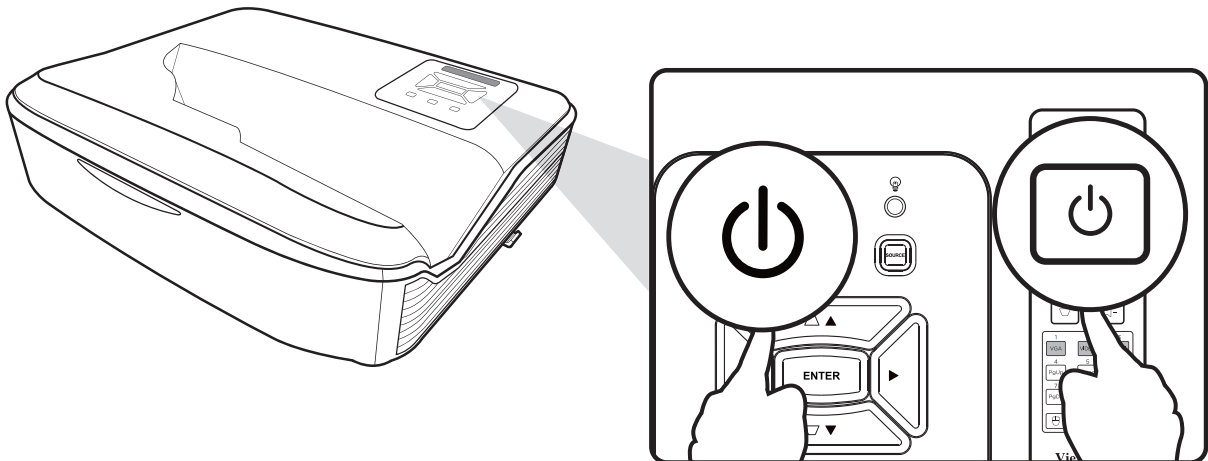

1. Ensure the projector's power cord is properly connected to a power outlet.
2. Press the **Power** button on the projector or remote control to turn on the projector.

NOTE:

- The Power Indicator Light will be flashing blue during startup.
- The first time the projector is turned on, you will be prompted to select the preferred language, projection orientation, and other settings.

Selecting an Input Source

The projector can be connected to multiple devices at the same time. However, it can only display one full screen at a time.

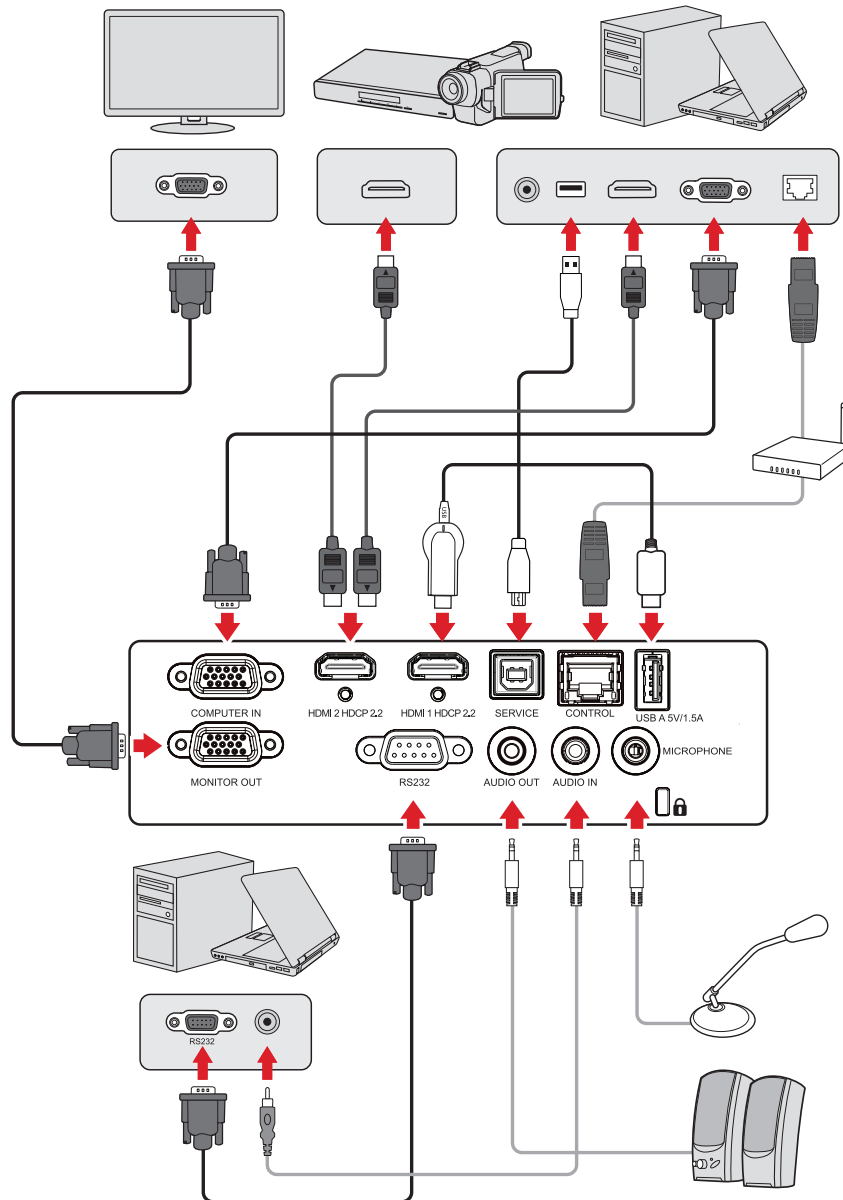

When Auto Source is On, the projector will automatically search for input sources. If multiple sources are connected, press the **Source** button on the projector or remote control to select the desired input.

NOTE: Ensure the connected sources are also turned on.

Adjusting the Projected Image

Adjusting the Projector's Height and Projection Angle

The projector is equipped with three (3) adjustment feet. Adjusting the feet will change the projector's height and the vertical projection angle.

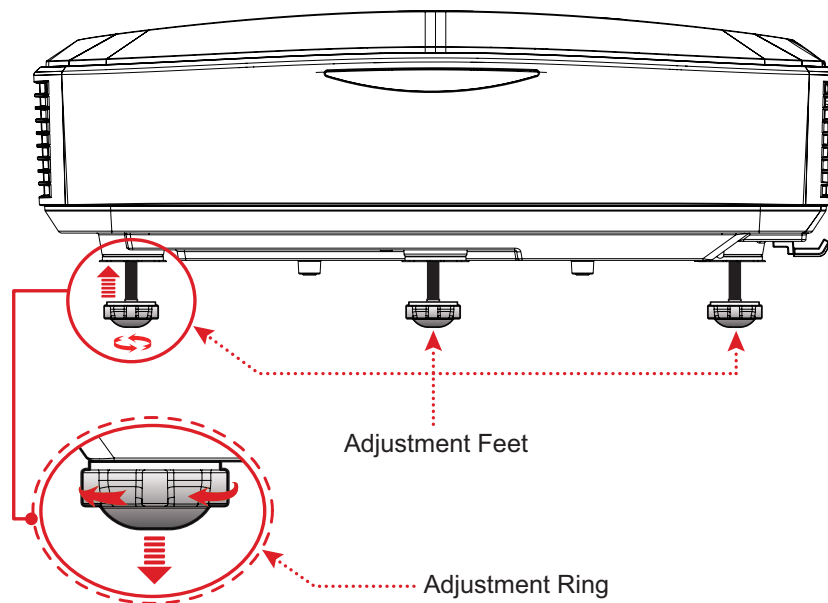

Adjusting the Focus and Keystone

You can improve and adjust the clarity and position of the image by adjusting the **Focus Switch** or **Keystone Keys**.

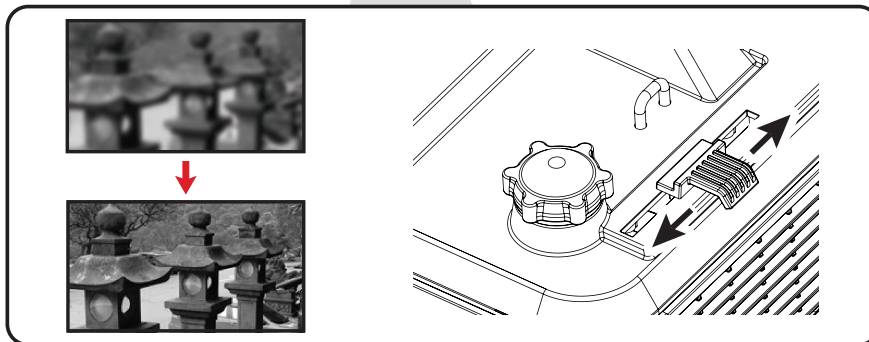
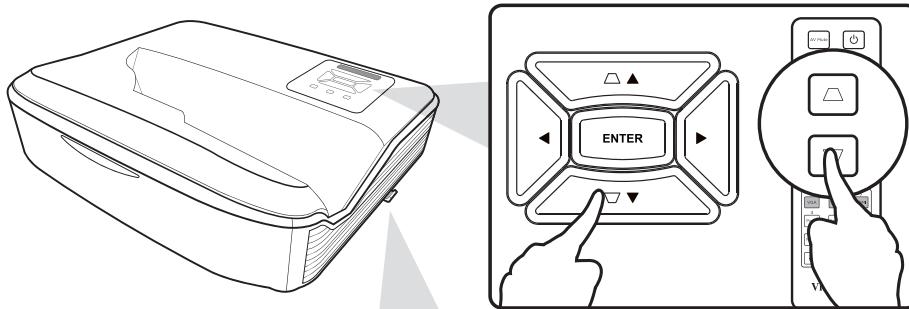
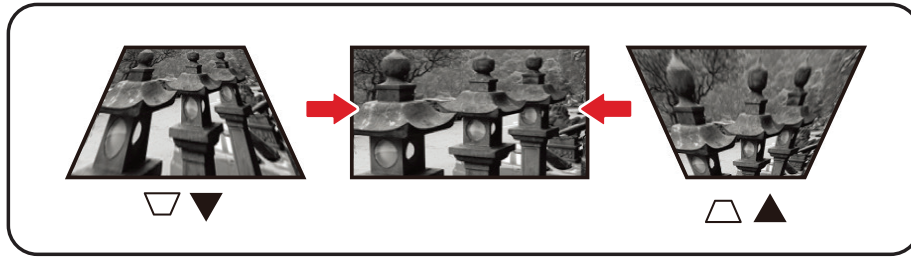

Shutting Down the Projector





1. Press the **Power** button on the projector or remote control and a “power off message” will appear.
2. Press the **Power** button again to confirm and shut down the projector.
3. The Power Indicator Light will turn solid red and enter standby mode.

Operating the Projector

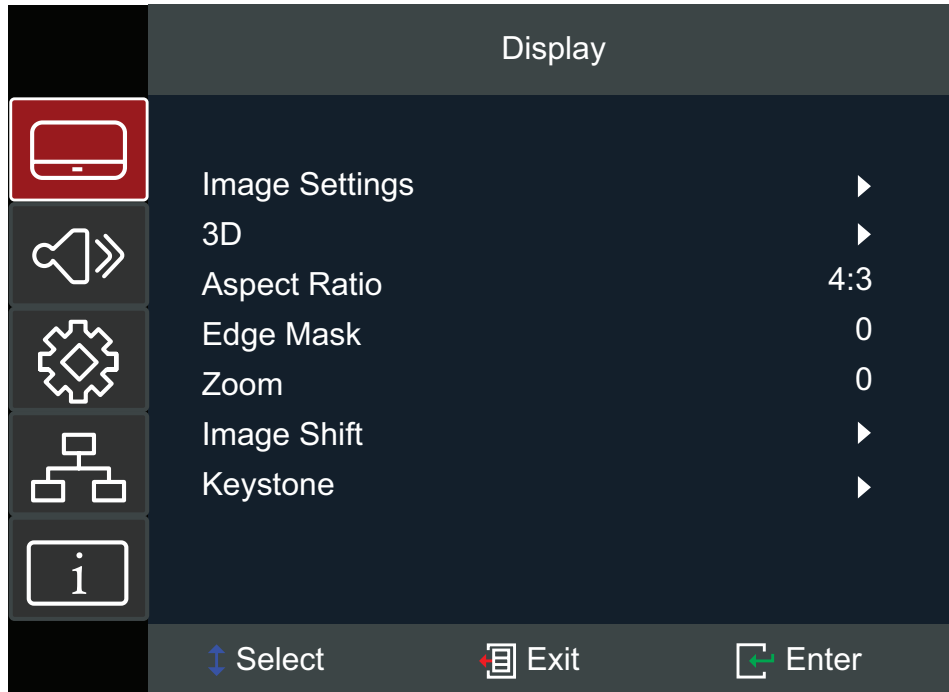
On-Screen Display (OSD) Menu

The projector has multilingual on-screen display menus that allow you to make image adjustments and change a variety of settings.

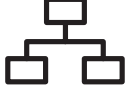

Menu		Description
Display		Adjust Image, 3D, Aspect Ratio, Edge Mask, Zoom, Image Shift, and Keystone settings.
Audio		Adjust the volume level or mute.
Setup		Adjust Projection, Power, Security, Language, Menu, Input Source, etc. settings.
Network		Adjust LAN control settings.
Information		View projector and network information.

Menu Navigation

1. To open the On-Screen Display (OSD) Menu, press the **Menu/Exit** button on the projector or the remote control.
2. When the OSD is displayed, use the **Navigation** buttons (**▲▼**) to select any item in the main menu. While making a selection on a particular page, press the **Enter** button on the projector or the remote control to enter a sub-menu.
3. Use the **Navigation** buttons (**◀▶**) to select the desired item in the sub-menu and then press **Enter** to view further settings. Adjust the settings by using the **Navigation** buttons (**◀▶**).
4. Select the next item to be adjusted in the sub-menu and adjust as described above.
5. Press **Enter** to confirm, and the screen will return to the main menu.
6. To exit, press the **Menu/Exit** button again. The OSD menu will close and the projector will automatically save the new settings.

On-Screen Display (OSD) Menu Tree

Main Menu	Sub-menu	Menu Option		
Display	Image Settings	Display Mode	Presentation	
			Bright	
			HDR SIM.	
			Cinema	
			sRGB	
			DICOM SIM.	
			Blending	
			User	
			3D	
		Wall Color	Off	
			Blackboard	
			Light Yellow	
			Light Green	
			Light Blue	
			Pink	
			Gray	
		Brightness	(-/+, -50~50)	
		Contrast	(-/+, -50~50)	
		Sharpness	(-/+, 1~15)	
		Color	(-/+, -50~50)	
		Tint	(-/+, -50~50)	
		Gamma	Film	
			Video	
			Graphics	
			Standard (2.2)	
			1.8	
			2.0	
			2.4	
2.6				

Main Menu	Sub-menu	Menu Option					
Display	Image Settings	Color Settings	Brilliant Color™	(-/+ , 1~10)			
			Color Temperature	Warm			
				Standard			
				Cool			
			Color Matching	Color	Red		
					Green		
					Blue		
					Cyan		
					Yellow		
					Magenta		
					Hue/R	(-/+ , -50~50)	
					Saturation/G	(-/+ , -50~50)	
					Gain/B	(-/+ , -50~50)	
					Reset		
				Exit			
			RGB Gain/Bias	Red Gain	(-/+ , -50~50)		
				Green Gain	(-/+ , -50~50)		
				Blue Gain	(-/+ , -50~50)		
				Red Bias	(-/+ , -50~50)		
				Green Bias	(-/+ , -50~50)		
				Blue Bias	(-/+ , -50~50)		
				Reset			
				Exit			
			Color Space	(Non-HDMI Signal)	Auto		
					RGB		
					YUV		
				(HDMI Signal)	Auto		
					RGB (0~255)		
					RGB (16~235)		
					YUV		

Main Menu	Sub-menu	Menu Option			
Display	Image Settings	Signal	Automatic	Off	
				On	
			Frequency	(-/+ , -10~10)	
			Phase	(-/+ , 0~31)	
			H. Position	(-/+)	
		V. Position	(-/+)		
		Brightness Mode	Dynamic Black		
			Eco		
			Constant Power 100%~20%		
		Reset			
	3D	3D Mode	Off		
			DLP-Link		
		3D - 2D	3D		
			L		
			R		
		3D Format	Auto		
			SBS		
			Top and Bottom		
			Frame Sequential		
		3D Sync Invert	Off		
			On		
	Reset				
	Aspect Ratio	4:3			
		16:9			
		16:10			
		LBX			
		Native			
Auto					
Edge Mask	(-/+ , 0~10)				
Zoom	(-/+ , -5~25)				
Image Shift	Horizontal (H.)	(-/+ , -100~100)			
	Vertical (V.)	(-/+ , -100~100)			

Main Menu	Sub-menu	Menu Option		
Display	Keystone	Four Corners	Top-Left	
			Top-Right	
			Bottom-Left	
			Bottom-Right	
		H. Keystone	(-/+ , -40~40)	
		V. Keystone	(-/+ , -40~40)	
		Reset		
Audio	Audio Settings	Auto		
		Internal Speaker		
		Audio Out		
	Mute	Off		
		On		
	Mic	Off		
		On		
	Volume	(-/+ , 0~10)		
Mic Volume	(-/+ , 0~10)			
Setup	Projection	Front		
		Rear		
		Ceiling-Top		
		Rear-Top		
	Screen Type	16:9		
		16:10		
	Filter Settings	Filter Usage Hours		
		Optional Filter Installed	No	
			Yes	
		Filter Reminder	Off	
			300 hr	
			500 hr	
			800 hr	
			1000 hr	
Filter Reset		Cancel		
	Yes			

Main Menu	Sub-menu	Menu Option				
Setup	Power Settings	Direct Power On	Off			
			On			
		Signal Power On	Off			
			On			
		Sleep Timer (min.)	(-/+ , 0~990)			
			Always On			No
		Yes				
	Auto Power Off	(-/+ , 0~180) minutes				
	Power Mode (Standby)	Eco				
		Active				
	Security	Security	Off			
			On			
		Security Timer	Month	(-/+ , 0~12)		
			Day	(-/+ , 0~30)		
			Hour	(-/+ , 0~24)		
	Change Password					
	HDMI CEC	HDMI CEC	Off			
			On			
	Test Pattern	Test Pattern	Off			
			Green Grid			
Magenta Grid						
White Grid						
White						

Main Menu	Sub-menu	Menu Option	
Setup	Options	Language	English
			Deutsch
			Français
			Italiano
			Español
			Português
			Polski
			Nederlands
			Svenska
			Norsk
			Suomi
			ελληνικά
			繁體中文
			簡體中文
			日本語
			한국어
			Русский
			Magyar
			Čeština
			يبرع
			ไทย
			Türkçe
			یسرائف
Tiếng Việt			
Bahasa Indonesia			
Română			
Slovenčina			

Main Menu	Sub-menu	Menu Option			
Setup	Options	Menu Settings	Menu Location	Top-Left	
				Top-Right	
				Center	
				Bottom-Left	
				Bottom-Right	
			Menu Timer	Off	
				5 seconds	
		10 seconds			
		Auto Source	Off		
			On		
		Input Source	HDMI 1		
			HDMI 2		
			VGA		
		High Altitude	Off		
			On		
		Logo	Default		
			Neutral		
		Background Color	None		
			Blue		
			Red		
			Green		
			Gray		
			Logo		
		HDMI Settings	HDMI 1 EDID		1.4
					2.0
			HDMI 2 EDID		1.4
					2.0
Reset	Reset to Default				

Main Menu	Sub-menu	Menu Option		
Network	LAN	Network Status		
		MAC Address		
		DHCP	Off	
			On	
		IP Address	xxx.xxx.xxx	
		Subnet Mask	xxx.xxx.xxx	
		Gateway	xxx.xxx.xxx	
		DNS	xxx.xxx.xxx	
	Reset			
	Control	Crestron	Off	
			On	
		Extron	Off	
			On	
		PJ Link	Off	
			On	
		AMX Device Discovery	Off	
			On	
		Telnet	Off	
On				
HTTP	Off			
	On			

Main Menu	Sub-menu	Menu Option		
Information	Serial Number			
	Source			
	Resolution			
	Refresh Rate			
	Display Mode			
	Power Mode (Standby)			
	Light Source Hours			
	Network Status			
	IP Address			
	Filter Usage Hours			
	Brightness Mode			
	Firmware Version	System		
		LAN		
MCU				

Menu Operation

Display Menu

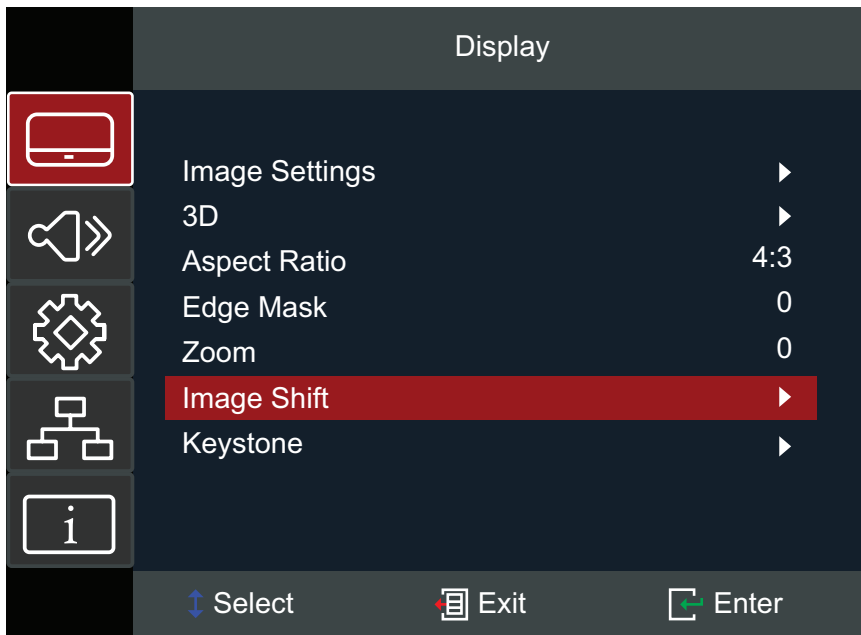

Menu	Description																				
Image Settings	<p><u>Display Mode</u> There are several predefined display modes that you can choose from to suit your viewing preference.</p> <table border="1" style="width: 100%; border-collapse: collapse;"> <thead> <tr> <th style="background-color: #ff0000; color: white;">Mode</th> <th style="background-color: #ff0000; color: white;">Description</th> </tr> </thead> <tbody> <tr> <td style="text-align: center;">Presentation</td> <td>Suitable for most presenting needs for business and education environments.</td> </tr> <tr> <td style="text-align: center;">Bright</td> <td>Suitable for bright, well-lit environments.</td> </tr> <tr> <td style="text-align: center;">HDR SIM.</td> <td>Decodes and displays High Dynamic Range (HDR) content for the deepest blacks, brightest whites, and vivid cinematic color using REC.2020 color gamut. This mode can be selected to enhances non-HDR content with simulated High Dynamic Range (HDR). NOTE: When HDMI EDID 2.0 is selected, HDMI 1/2 can support HDR/HLG format.</td> </tr> <tr> <td style="text-align: center;">Cinema</td> <td>Provides the best balance of detail and colors for watching movies.</td> </tr> <tr> <td style="text-align: center;">sRGB</td> <td>Standardized sRGB color gamut.</td> </tr> <tr> <td style="text-align: center;">DICOM SIM.</td> <td>Suitable for projecting monochrome images.</td> </tr> <tr> <td style="text-align: center;">User</td> <td>User's custom settings.</td> </tr> <tr> <td style="text-align: center;">Blending</td> <td>A video mode which is appropriate for blending application.</td> </tr> <tr> <td style="text-align: center;">3D</td> <td>Optimized for 3D content. NOTE: 3D glasses are needed.</td> </tr> </tbody> </table>	Mode	Description	Presentation	Suitable for most presenting needs for business and education environments.	Bright	Suitable for bright, well-lit environments.	HDR SIM.	Decodes and displays High Dynamic Range (HDR) content for the deepest blacks, brightest whites, and vivid cinematic color using REC.2020 color gamut. This mode can be selected to enhances non-HDR content with simulated High Dynamic Range (HDR). NOTE: When HDMI EDID 2.0 is selected, HDMI 1/2 can support HDR/HLG format.	Cinema	Provides the best balance of detail and colors for watching movies.	sRGB	Standardized sRGB color gamut.	DICOM SIM.	Suitable for projecting monochrome images.	User	User's custom settings.	Blending	A video mode which is appropriate for blending application.	3D	Optimized for 3D content. NOTE: 3D glasses are needed.
Mode	Description																				
Presentation	Suitable for most presenting needs for business and education environments.																				
Bright	Suitable for bright, well-lit environments.																				
HDR SIM.	Decodes and displays High Dynamic Range (HDR) content for the deepest blacks, brightest whites, and vivid cinematic color using REC.2020 color gamut. This mode can be selected to enhances non-HDR content with simulated High Dynamic Range (HDR). NOTE: When HDMI EDID 2.0 is selected, HDMI 1/2 can support HDR/HLG format.																				
Cinema	Provides the best balance of detail and colors for watching movies.																				
sRGB	Standardized sRGB color gamut.																				
DICOM SIM.	Suitable for projecting monochrome images.																				
User	User's custom settings.																				
Blending	A video mode which is appropriate for blending application.																				
3D	Optimized for 3D content. NOTE: 3D glasses are needed.																				

Menu	Description
Image Settings	<p><u>Wall Color</u> Designed to adjust the colors of the projected image when projecting on to a wall without a screen. NOTE: A screen is recommended for more accurate color reproduction.</p> <p><u>Brightness</u> The higher the value, the brighter the image. Lower values will result in a darker image.</p> <p><u>Contrast</u> Use this to set the peak white level after you have previously adjusted the Brightness setting to suit your selected input and viewing environment.</p> <p><u>Sharpness</u> A high value results in a sharper picture; a low value softens the picture.</p> <p><u>Color</u> Adjust an image from black and white to fully saturated color.</p> <p><u>Tint</u> The higher the value, the more greenish the picture becomes. The lower the value, the more reddish the picture becomes.</p> <p><u>Gamma</u> Reflects the relationship between input source and picture brightness.</p>

Menu	Description												
Image Settings	<u>Color Settings</u>												
	<table border="1" style="width: 100%; border-collapse: collapse;"> <thead> <tr> <th data-bbox="608 215 885 259">Setting</th> <th data-bbox="885 215 1396 259">Description</th> </tr> </thead> <tbody> <tr> <td data-bbox="608 259 885 423" style="text-align: center;">Brilliant Color™</td> <td data-bbox="885 259 1396 423">A color-processing algorithm and enhancements to enable higher brightness while providing true, more vibrant colors in picture.</td> </tr> <tr> <td data-bbox="608 423 885 506" style="text-align: center;">Color Temperature</td> <td data-bbox="885 423 1396 506">Select from Warm, Standard, or Cool.</td> </tr> <tr> <td data-bbox="608 506 885 1191" style="text-align: center;">Color Matching</td> <td data-bbox="885 506 1396 1191"> <p>Only in permanent installations with controlled lighting levels such as: boardrooms, lecture halls, or home theaters should Color Matching be considered.</p> <p>Color Matching provides fine color control adjustment to allow for more accurate color reproduction, should you require it.</p> <p>If you have purchased a test disc, which contains various color test patterns and can be used to test the color presentation on monitors, TVs, projectors, etc., you can project any image from the disc on the screen and enter the Color Matching menu to make adjustments.</p> </td> </tr> <tr> <td data-bbox="608 1191 885 1274" style="text-align: center;">RGB Gain/Bias</td> <td data-bbox="885 1191 1396 1274">Configure the brightness (gain) and contrast (bias).</td> </tr> <tr> <td data-bbox="608 1274 885 1565" style="text-align: center;">Color Space</td> <td data-bbox="885 1274 1396 1565"> <p><u>non-HDMI input only:</u> Select an appropriate color matrix type from the following: AUTO, RGB, or YUV.</p> <p><u>HDMI input only:</u> Select an appropriate color matrix type from the following: Auto, RGB(0- 255), RGB(16-235), and YUV.</p> </td> </tr> </tbody> </table>	Setting	Description	Brilliant Color™	A color-processing algorithm and enhancements to enable higher brightness while providing true, more vibrant colors in picture.	Color Temperature	Select from Warm, Standard, or Cool.	Color Matching	<p>Only in permanent installations with controlled lighting levels such as: boardrooms, lecture halls, or home theaters should Color Matching be considered.</p> <p>Color Matching provides fine color control adjustment to allow for more accurate color reproduction, should you require it.</p> <p>If you have purchased a test disc, which contains various color test patterns and can be used to test the color presentation on monitors, TVs, projectors, etc., you can project any image from the disc on the screen and enter the Color Matching menu to make adjustments.</p>	RGB Gain/Bias	Configure the brightness (gain) and contrast (bias).	Color Space	<p><u>non-HDMI input only:</u> Select an appropriate color matrix type from the following: AUTO, RGB, or YUV.</p> <p><u>HDMI input only:</u> Select an appropriate color matrix type from the following: Auto, RGB(0- 255), RGB(16-235), and YUV.</p>
	Setting	Description											
	Brilliant Color™	A color-processing algorithm and enhancements to enable higher brightness while providing true, more vibrant colors in picture.											
	Color Temperature	Select from Warm, Standard, or Cool.											
	Color Matching	<p>Only in permanent installations with controlled lighting levels such as: boardrooms, lecture halls, or home theaters should Color Matching be considered.</p> <p>Color Matching provides fine color control adjustment to allow for more accurate color reproduction, should you require it.</p> <p>If you have purchased a test disc, which contains various color test patterns and can be used to test the color presentation on monitors, TVs, projectors, etc., you can project any image from the disc on the screen and enter the Color Matching menu to make adjustments.</p>											
RGB Gain/Bias	Configure the brightness (gain) and contrast (bias).												
Color Space	<p><u>non-HDMI input only:</u> Select an appropriate color matrix type from the following: AUTO, RGB, or YUV.</p> <p><u>HDMI input only:</u> Select an appropriate color matrix type from the following: Auto, RGB(0- 255), RGB(16-235), and YUV.</p>												

Menu	Description												
Image Settings	<p><u>Signal</u> Adjust the signal options.</p>												
	<table border="1"> <thead> <tr> <th data-bbox="608 277 879 322">Setting</th> <th data-bbox="879 277 1393 322">Description</th> </tr> </thead> <tbody> <tr> <td data-bbox="608 322 879 517" style="text-align: center;">Automatic</td> <td data-bbox="879 322 1393 517">Automatically configure the signal (Frequency and Phase will be grayed out). If Automatic is disabled, Frequency and Phase can be then be adjusted.</td> </tr> <tr> <td data-bbox="608 517 879 719" style="text-align: center;">Frequency</td> <td data-bbox="879 517 1393 719">Change the display data frequency to match the frequency of your computer's graphics card. Use this function only if the image appears to flicker vertically.</td> </tr> <tr> <td data-bbox="608 719 879 875" style="text-align: center;">Phase</td> <td data-bbox="879 719 1393 875">Synchronize the signal timing of the display with the graphics card. If the image appears to be unstable, use this function to correct it.</td> </tr> <tr> <td data-bbox="608 875 879 958" style="text-align: center;">H. Position</td> <td data-bbox="879 875 1393 958">Adjust the horizontal positioning of the image.</td> </tr> <tr> <td data-bbox="608 958 879 1043" style="text-align: center;">V. Position</td> <td data-bbox="879 958 1393 1043">Adjust the vertical positioning of the image.</td> </tr> </tbody> </table>	Setting	Description	Automatic	Automatically configure the signal (Frequency and Phase will be grayed out). If Automatic is disabled, Frequency and Phase can be then be adjusted.	Frequency	Change the display data frequency to match the frequency of your computer's graphics card. Use this function only if the image appears to flicker vertically.	Phase	Synchronize the signal timing of the display with the graphics card. If the image appears to be unstable, use this function to correct it.	H. Position	Adjust the horizontal positioning of the image.	V. Position	Adjust the vertical positioning of the image.
	Setting	Description											
	Automatic	Automatically configure the signal (Frequency and Phase will be grayed out). If Automatic is disabled, Frequency and Phase can be then be adjusted.											
	Frequency	Change the display data frequency to match the frequency of your computer's graphics card. Use this function only if the image appears to flicker vertically.											
	Phase	Synchronize the signal timing of the display with the graphics card. If the image appears to be unstable, use this function to correct it.											
	H. Position	Adjust the horizontal positioning of the image.											
	V. Position	Adjust the vertical positioning of the image.											
	<p>NOTE: This menu is only available if the input source is RGB/Component.</p>												
	<p><u>Brightness Mode</u></p>												
<table border="1"> <thead> <tr> <th data-bbox="608 1207 879 1252">Mode</th> <th data-bbox="879 1207 1393 1252">Description</th> </tr> </thead> <tbody> <tr> <td data-bbox="608 1252 879 1373" style="text-align: center;">Dynamic Black</td> <td data-bbox="879 1252 1393 1373">Automatically adjust the picture brightness in order to give optimum contrast performance.</td> </tr> <tr> <td data-bbox="608 1373 879 1456" style="text-align: center;">Eco</td> <td data-bbox="879 1373 1393 1456">Dim the light output, lowering power consumption.</td> </tr> <tr> <td data-bbox="608 1456 879 1541" style="text-align: center;">Constant Power</td> <td data-bbox="879 1456 1393 1541">Select the power percentage (20%~100%) for brightness mode.</td> </tr> </tbody> </table>	Mode	Description	Dynamic Black	Automatically adjust the picture brightness in order to give optimum contrast performance.	Eco	Dim the light output, lowering power consumption.	Constant Power	Select the power percentage (20%~100%) for brightness mode.					
Mode	Description												
Dynamic Black	Automatically adjust the picture brightness in order to give optimum contrast performance.												
Eco	Dim the light output, lowering power consumption.												
Constant Power	Select the power percentage (20%~100%) for brightness mode.												
<p><u>Reset</u> Return current display mode settings (Brightness, Contrast, Sharpness, Color, Tint, Gamma, Brilliant Color™, Color Temperature, Color Matching, RGB Gain/Bias, Color Space, Brightness Mode, Signal settings) to default values.</p>													

Menu	Description									
3D	<u>3D Mode</u> Enable or disable the 3D function. <table border="1" style="margin-left: 20px;"> <thead> <tr> <th style="background-color: #ff0000; color: white;">Option</th> <th style="background-color: #ff0000; color: white;">Description</th> </tr> </thead> <tbody> <tr> <td style="text-align: center;">Off</td> <td>Turn off the DLP-Link function.</td> </tr> <tr> <td style="text-align: center;">DLP-Link</td> <td>Optimized settings for DLP 3D glasses.</td> </tr> </tbody> </table>	Option	Description	Off	Turn off the DLP-Link function.	DLP-Link	Optimized settings for DLP 3D glasses.			
	Option	Description								
	Off	Turn off the DLP-Link function.								
	DLP-Link	Optimized settings for DLP 3D glasses.								
	<u>3D-2D</u> Select how the 3D content should appear on screen. <table border="1" style="margin-left: 20px;"> <thead> <tr> <th style="background-color: #ff0000; color: white;">Option</th> <th style="background-color: #ff0000; color: white;">Description</th> </tr> </thead> <tbody> <tr> <td style="text-align: center;">3D</td> <td>Display the 3D signal.</td> </tr> <tr> <td style="text-align: center;">L (Left)</td> <td>Display the left frame of the 3D content.</td> </tr> <tr> <td style="text-align: center;">R (Right)</td> <td>Display the right frame of the 3D content.</td> </tr> </tbody> </table>	Option	Description	3D	Display the 3D signal.	L (Left)	Display the left frame of the 3D content.	R (Right)	Display the right frame of the 3D content.	
	Option	Description								
	3D	Display the 3D signal.								
	L (Left)	Display the left frame of the 3D content.								
	R (Right)	Display the right frame of the 3D content.								
	<u>3D Format</u> Select the 3D content format. <p style="margin-left: 40px;">NOTE: A Blu-ray 3D source will be detected automatically, and options will not be selectable.</p> <table border="1" style="margin-left: 20px;"> <thead> <tr> <th style="background-color: #ff0000; color: white;">Option</th> <th style="background-color: #ff0000; color: white;">Description</th> </tr> </thead> <tbody> <tr> <td style="text-align: center;">Auto</td> <td>When a 3D identification signal is detected, the 3D format is selected automatically.</td> </tr> <tr> <td style="text-align: center;">SBS</td> <td>Display in Side-by-Side format.</td> </tr> <tr> <td style="text-align: center;">Top and Bottom</td> <td>Display in Top and Bottom format.</td> </tr> <tr> <td style="text-align: center;">Frame Sequential</td> <td>Display in Frame Sequential format.</td> </tr> </tbody> </table>	Option	Description	Auto	When a 3D identification signal is detected, the 3D format is selected automatically.	SBS	Display in Side-by-Side format.	Top and Bottom	Display in Top and Bottom format.	Frame Sequential
Option	Description									
Auto	When a 3D identification signal is detected, the 3D format is selected automatically.									
SBS	Display in Side-by-Side format.									
Top and Bottom	Display in Top and Bottom format.									
Frame Sequential	Display in Frame Sequential format.									
<u>3D Sync Invert</u> Enable or disable the 3D Sync Invert function.										
<u>Reset</u> Return current 3D settings to default values.										

NOTE:

- This projector is a 3D ready projector with DLP-Link 3D solution. Please make sure your 3D glasses are for DLP-Link 3D. This projector supports frame sequential (page-flip) 3D via the **HDMI 1/HDMI 2/VGA** ports. For the best performance, 1920 x 1080 resolution is recommended. Please note that 4K (3840 x 2160) resolution is not supported in 3D mode.

Menu	Description														
<p style="text-align: center;">Aspect Ratio</p>	<p>Select the aspect ratio of the projected image.</p> <table border="1" data-bbox="611 226 1398 1693"> <thead> <tr> <th data-bbox="611 226 884 275">Aspect Ratio</th> <th data-bbox="884 226 1398 275">Description</th> </tr> </thead> <tbody> <tr> <td data-bbox="611 275 884 546" style="text-align: center;">4:3</td> <td data-bbox="884 275 1398 546">Scales an image so that it is displayed in the center of the screen with a 4:3 aspect ratio. This is most suitable for 4:3 images like computer monitors, standard definition TV, and 4:3 aspect DVD movies, as it displays them without aspect alteration.</td> </tr> <tr> <td data-bbox="611 546 884 784" style="text-align: center;">16:9</td> <td data-bbox="884 546 1398 784">Scales an image so that it is displayed in the center of the screen with a 16:9 aspect ratio. This is most suitable for images which are already in a 16:9 aspect, like high definition TV.</td> </tr> <tr> <td data-bbox="611 784 884 1021" style="text-align: center;">16:10</td> <td data-bbox="884 784 1398 1021">Scales an image so that it is displayed in the center of the screen with a 16:10 aspect ratio. This is most suitable for images which are already in a 16:10 aspect, as it displays them without aspect alteration.</td> </tr> <tr> <td data-bbox="611 1021 884 1182" style="text-align: center;">LBX</td> <td data-bbox="884 1021 1398 1182">For non-16:9 letterbox source and if you use an external 16:9 lens to display 2.35:1 aspect ratio in full resolution.</td> </tr> <tr> <td data-bbox="611 1182 884 1420" style="text-align: center;">Native</td> <td data-bbox="884 1182 1398 1420">Projects the image as its original resolution and resizes it to fit within the display area. For input signals with lower resolutions, the projected image will be displayed in its original size.</td> </tr> <tr> <td data-bbox="611 1420 884 1693" style="text-align: center;">Auto</td> <td data-bbox="884 1420 1398 1693">Scales an image proportionally to fit the projector's native resolution in its horizontal width. This is suitable for the incoming image which is neither 4:3 nor 16:9 and you want to make the most use of the screen without altering the image's aspect ratio.</td> </tr> </tbody> </table> <p style="text-align: center;">NOTE: When the Screen Type is 16:9, the aspect ratio 16:10 will be unavailable. When the Screen Type is 16:10, the aspect ratio 16:9 will be unavailable.</p>	Aspect Ratio	Description	4:3	Scales an image so that it is displayed in the center of the screen with a 4:3 aspect ratio. This is most suitable for 4:3 images like computer monitors, standard definition TV, and 4:3 aspect DVD movies, as it displays them without aspect alteration.	16:9	Scales an image so that it is displayed in the center of the screen with a 16:9 aspect ratio. This is most suitable for images which are already in a 16:9 aspect, like high definition TV.	16:10	Scales an image so that it is displayed in the center of the screen with a 16:10 aspect ratio. This is most suitable for images which are already in a 16:10 aspect, as it displays them without aspect alteration.	LBX	For non-16:9 letterbox source and if you use an external 16:9 lens to display 2.35:1 aspect ratio in full resolution.	Native	Projects the image as its original resolution and resizes it to fit within the display area. For input signals with lower resolutions, the projected image will be displayed in its original size.	Auto	Scales an image proportionally to fit the projector's native resolution in its horizontal width. This is suitable for the incoming image which is neither 4:3 nor 16:9 and you want to make the most use of the screen without altering the image's aspect ratio.
	Aspect Ratio	Description													
	4:3	Scales an image so that it is displayed in the center of the screen with a 4:3 aspect ratio. This is most suitable for 4:3 images like computer monitors, standard definition TV, and 4:3 aspect DVD movies, as it displays them without aspect alteration.													
	16:9	Scales an image so that it is displayed in the center of the screen with a 16:9 aspect ratio. This is most suitable for images which are already in a 16:9 aspect, like high definition TV.													
	16:10	Scales an image so that it is displayed in the center of the screen with a 16:10 aspect ratio. This is most suitable for images which are already in a 16:10 aspect, as it displays them without aspect alteration.													
	LBX	For non-16:9 letterbox source and if you use an external 16:9 lens to display 2.35:1 aspect ratio in full resolution.													
	Native	Projects the image as its original resolution and resizes it to fit within the display area. For input signals with lower resolutions, the projected image will be displayed in its original size.													
Auto	Scales an image proportionally to fit the projector's native resolution in its horizontal width. This is suitable for the incoming image which is neither 4:3 nor 16:9 and you want to make the most use of the screen without altering the image's aspect ratio.														
Edge Mask	Remove the video encoding noise on the edge of the video source.														
Zoom	Reduce or magnify the projected image.														
Image Shift	Adjust the projected image horizontally or vertically.														

Menu	Description	
<p style="text-align: center;">Keystone</p>	<p style="text-align: center;">Option</p>	<p style="text-align: center;">Description</p>
	<p style="text-align: center;">Four Corners</p>	<p>Adjust each corner to make a square image when the projection surface is not level.</p> <p>NOTE: While adjusting the Four Corners, the Aspect Ratio, Edge Mask, Image Shift, and Zoom menus will be disabled. To enable them, reset the Keystone settings to default.</p>
	<p style="text-align: center;">H. Keystone</p>	<p>Adjust image distortion horizontally.</p>
	<p style="text-align: center;">V. Keystone</p>	<p>Adjust image distortion vertically.</p>
<p style="text-align: center;">Reset</p>	<p>Return the Keystone settings to default.</p>	

Audio Menu

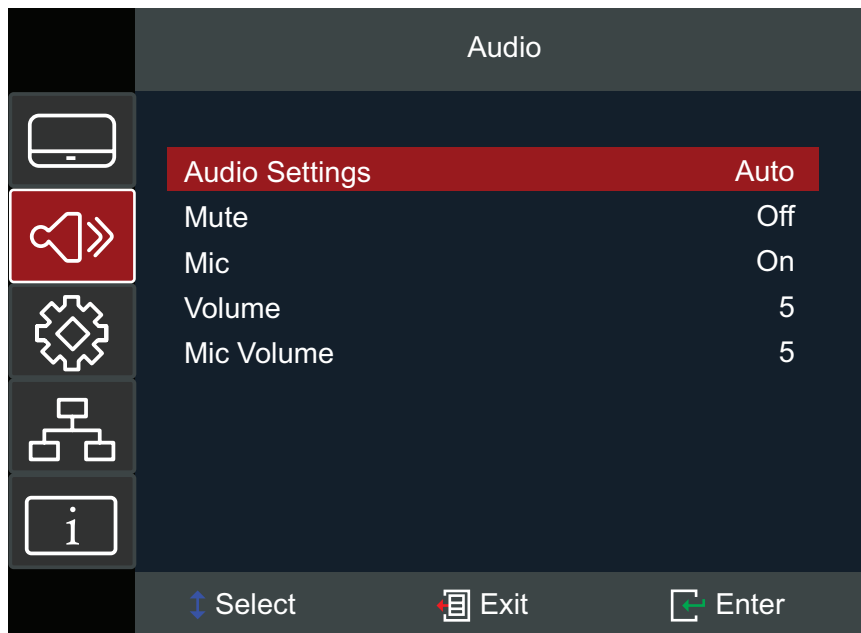

Menu	Description
Audio Settings	Select the audio output device.
Mute	Temporarily turn off the sound.
Mic	Enable or disable the microphone. NOTE: Only supports microphone input; does not support audio in. Plugging in the wrong cable may damage the projector.
Volume	Adjust the volume level.
Mic Volume	Adjust the microphone volume level.

Setup Menu

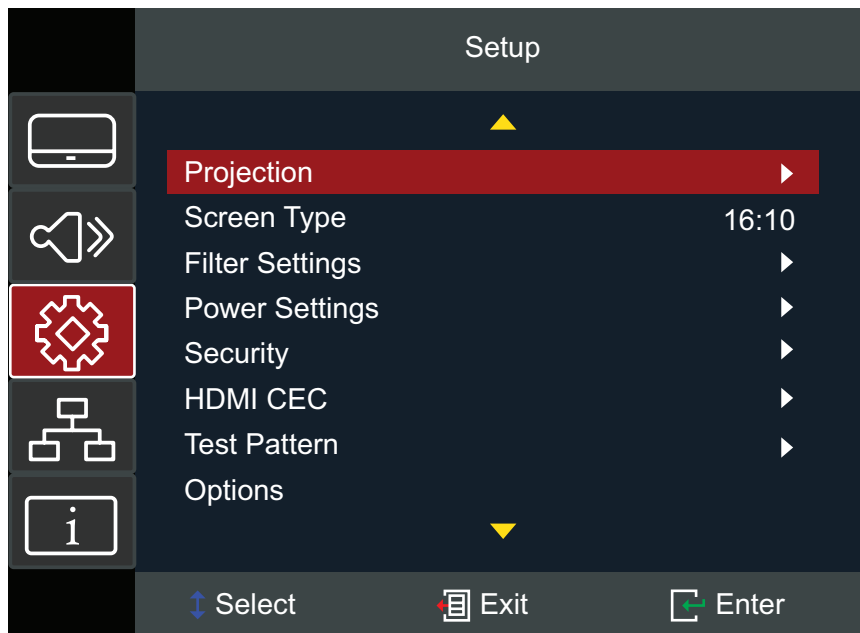

Menu	Description
Projection	Select the preferred projection: Front, Rear, Ceiling-Top, and Rear-Top.
Screen Type	Choose the screen type from 16:9 and 16:10. NOTE: When the Screen Type is 16:9, the aspect ratio 16:10 will be unavailable. When the Screen Type is 16:10, the aspect ratio 16:9 will be unavailable.
Filter Settings	View and adjust filter settings. NOTE: <ul style="list-style-type: none"> The dust filter may not be included in the packaging (depending on your country). Please contact your local reseller for more information. After installing the dust filter, please select Optional Filter Installed > YES and set the Filter Reminder. The counter will display the filter usage time.

Menu	Description						
Power Settings	<p><u>Direct Power On</u> Automatically power on the projector when AC power is supplied, without pressing the Power button on the projector or the remote control.</p>						
	<p><u>Signal Power On</u> Automatically power on the projector when a signal is detected, without pressing the Power button on the projector or on the remote control.</p>						
	<p><u>Auto Power Off</u> A countdown timer will start when there is no signal being sent to the projector. The projector will automatically power off when the countdown has finished (in minutes).</p>						
	<p><u>Sleep Timer</u></p> <table border="1" data-bbox="619 768 1406 1178"> <thead> <tr> <th data-bbox="619 768 892 813">Option</th> <th data-bbox="892 768 1406 813">Description</th> </tr> </thead> <tbody> <tr> <td data-bbox="619 813 892 1093" style="text-align: center;">Sleep Timer</td> <td data-bbox="892 813 1406 1093"> <p>Allows the projector to turn off automatically after a set period of time to prevent unnecessary waste of light source life.</p> <p>NOTE: The Sleep Timer is reset every time when the projector is powered off.</p> </td> </tr> <tr> <td data-bbox="619 1093 892 1178" style="text-align: center;">Always On</td> <td data-bbox="892 1093 1406 1178">Check to set the Sleep Timer as always on.</td> </tr> </tbody> </table>	Option	Description	Sleep Timer	<p>Allows the projector to turn off automatically after a set period of time to prevent unnecessary waste of light source life.</p> <p>NOTE: The Sleep Timer is reset every time when the projector is powered off.</p>	Always On	Check to set the Sleep Timer as always on.
	Option	Description					
	Sleep Timer	<p>Allows the projector to turn off automatically after a set period of time to prevent unnecessary waste of light source life.</p> <p>NOTE: The Sleep Timer is reset every time when the projector is powered off.</p>					
Always On	Check to set the Sleep Timer as always on.						
<p><u>Power Mode (Standby)</u></p> <table border="1" data-bbox="619 1245 1406 1458"> <thead> <tr> <th data-bbox="619 1245 892 1290">Mode</th> <th data-bbox="892 1245 1406 1290">Description</th> </tr> </thead> <tbody> <tr> <td data-bbox="619 1290 892 1373" style="text-align: center;">Active</td> <td data-bbox="892 1290 1406 1373">Normal standby (> 0.5W) with VGA Out and LAN Power available.</td> </tr> <tr> <td data-bbox="619 1373 892 1458" style="text-align: center;">Eco</td> <td data-bbox="892 1373 1406 1458">Reduce power use (< 0.5W) with no VGA Out and LAN Power available.</td> </tr> </tbody> </table>	Mode	Description	Active	Normal standby (> 0.5W) with VGA Out and LAN Power available.	Eco	Reduce power use (< 0.5W) with no VGA Out and LAN Power available.	
Mode	Description						
Active	Normal standby (> 0.5W) with VGA Out and LAN Power available.						
Eco	Reduce power use (< 0.5W) with no VGA Out and LAN Power available.						

Menu	Description
<p style="text-align: center;">Security</p>	<p><u>Security</u> Enable or disable a password prompt before using the projector. NOTE: The default password is: 1234</p> <p><u>Security Timer</u> Set the amount of time the projector can be used. Once this time has elapsed you will be requested to enter your password again.</p> <p><u>Change Password</u> Set or modify the password. NOTE: Please follow the OSD message to input the current password first, then enter a new password (security code). Confirm the new password by entering the new password again.</p>
<p style="text-align: center;">HDMI CEC</p>	<p>When you connect HDMI CEC-compatible devices to the projector with HDMI cables, you can control them on the same power on or power off status using the HDMI CEC control feature in the projector's OSD. This lets one device or multiple devices in a group power on or power off via HDMI CEC in a typical configuration.</p> <p>NOTE:</p> <ul style="list-style-type: none"> • In order for the CEC function to work properly, make sure that the device is correctly connected to the HDMI input of the projector via an HDMI cable, and its CEC function is turned on. • Depending on the connected device, the CEC function may not work.
<p style="text-align: center;">Test Pattern</p>	<p>Select the test pattern from green grid, magenta grid, white grid, white, or disable this function (off).</p>

Menu	Description						
Options	<p><u>Language</u> Select the On-Screen Display (OSD) Menu language.</p>						
	<p><u>Menu Settings</u> Set the menu location on screen and configure the menu timer settings.</p>						
	<p><u>Auto Source</u> Find an available input source.</p>						
	<table border="1"> <thead> <tr> <th data-bbox="584 506 858 551">Option</th> <th data-bbox="858 506 1369 551">Description</th> </tr> </thead> <tbody> <tr> <td data-bbox="584 551 858 674" style="text-align: center;">Off</td> <td data-bbox="858 551 1369 674">Only search the current input selection. Press the Source button to display a list of sources.</td> </tr> <tr> <td data-bbox="584 674 858 909" style="text-align: center;">On</td> <td data-bbox="858 674 1369 909">Automatically finds an available input source. Press the Source button to automatically detect the next source. NOTE: The scan order is: HDMI 1 > HDMI 2 > VGA.</td> </tr> </tbody> </table>	Option	Description	Off	Only search the current input selection. Press the Source button to display a list of sources.	On	Automatically finds an available input source. Press the Source button to automatically detect the next source. NOTE: The scan order is: HDMI 1 > HDMI 2 > VGA.
	Option	Description					
	Off	Only search the current input selection. Press the Source button to display a list of sources.					
	On	Automatically finds an available input source. Press the Source button to automatically detect the next source. NOTE: The scan order is: HDMI 1 > HDMI 2 > VGA.					
	<p><u>Input Source</u> Select the input signal: HDMI 1, HDMI 2, or VGA.</p>						
	<p><u>High Altitude</u> When On, the fans will spin faster for better cooling and performance. This is useful for high altitude environments where the air is thin.</p>						
	<p><u>Logo</u> Set the “startup screen”. If changes are made, they will take effect the next time the projector is powered on.</p>						
<p><u>Background Color</u> Display a blue, red, green, or gray color, none, or logo screen when no signal is available. NOTE: If the background color is set to None, then the background color will be black.</p>							

Menu	Description						
<p style="text-align: center;">Options</p>	<p><u>HDMI Settings</u> Configure the HDMI settings.</p> <table border="1" data-bbox="584 271 1369 698"> <thead> <tr> <th data-bbox="584 271 858 315">Option</th> <th data-bbox="858 271 1369 315">Description</th> </tr> </thead> <tbody> <tr> <td data-bbox="584 315 858 443"> <p style="text-align: center;">EDID 1.4</p> </td> <td data-bbox="858 315 1369 443"> <p>Select this option when using 1080p sources (e.g., Xbox 360, Cable Box, Satellite Box, etc.).</p> </td> </tr> <tr> <td data-bbox="584 443 858 698"> <p style="text-align: center;">EDID 2.0</p> </td> <td data-bbox="858 443 1369 698"> <p>Select this option when using 1080p HDR sources (e.g., Xbox One S or PS4) and 4K HDR sources (e.g., 4K HDR Blu-ray Player, Roku Ultra 4K, SHIELD TV, Xbox One X, PS4 Pro, etc.).</p> </td> </tr> </tbody> </table> <p>NOTE: When the HDMI source is abnormal in color and/or has color banding, change the EDID to 1.4.</p>	Option	Description	<p style="text-align: center;">EDID 1.4</p>	<p>Select this option when using 1080p sources (e.g., Xbox 360, Cable Box, Satellite Box, etc.).</p>	<p style="text-align: center;">EDID 2.0</p>	<p>Select this option when using 1080p HDR sources (e.g., Xbox One S or PS4) and 4K HDR sources (e.g., 4K HDR Blu-ray Player, Roku Ultra 4K, SHIELD TV, Xbox One X, PS4 Pro, etc.).</p>
Option	Description						
<p style="text-align: center;">EDID 1.4</p>	<p>Select this option when using 1080p sources (e.g., Xbox 360, Cable Box, Satellite Box, etc.).</p>						
<p style="text-align: center;">EDID 2.0</p>	<p>Select this option when using 1080p HDR sources (e.g., Xbox One S or PS4) and 4K HDR sources (e.g., 4K HDR Blu-ray Player, Roku Ultra 4K, SHIELD TV, Xbox One X, PS4 Pro, etc.).</p>						
<p style="text-align: center;">Reset</p>	<p>Return the settings to default.</p> <p>NOTE: When resetting, the following settings will still remain: High Altitude, Keystone Settings, Language, Light Source Hours, Network Settings, Projection, Power Mode (Standby), Security Settings, Zoom.</p> <p>If Security is On, the system will ask for your password to proceed with the reset.</p>						

Network Menu

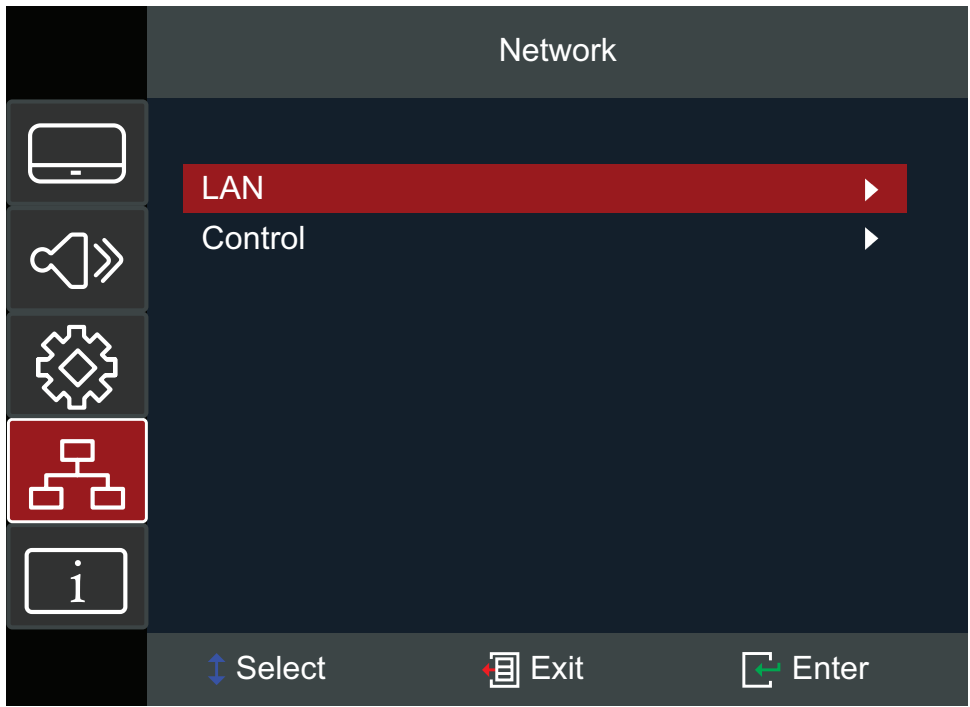

Menu	Description
LAN	View network information and enable/disable DHCP.
Control	<p>Enable or disable network control suites.</p> <p>NOTE: To connect successfully, the control suite must be enabled.</p>

Controlling the Projector through a Network

The projector provides diverse networking and remote management features. The LAN /RJ45 function of the projector, through a network, can remotely manage: Power On/Off, Volume adjustment, Input select, Brightness, and more.

NOTE: Please ensure **Network > Control > HTTP** is enabled.

1. Connect the projector to a network via the LAN/RJ45 port.

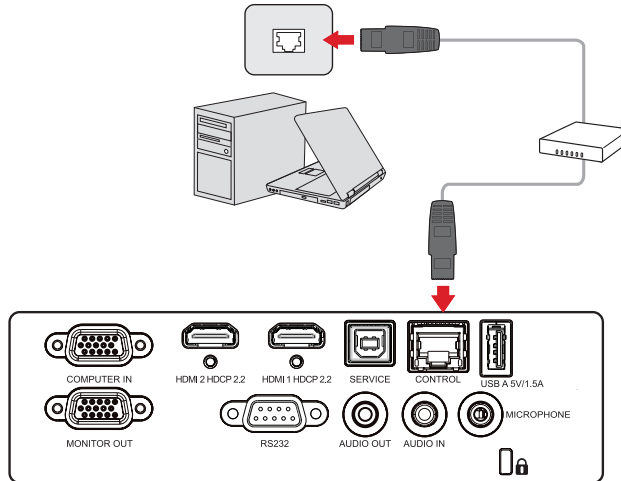

2. Open the On-Screen Display Menu and go to: **Network > LAN**.

3. Select **DHCP** and turn it **On** to obtain an IP address automatically; or select **Off** to enter the network information manually. (Press the **MENU** button to apply the entered values.)

NOTE: Please wait for around 15~20 seconds, then re-enter the **LAN** settings page. The Projector IP Address, Subnet Mask, Default Gateway, DNS Server settings will be displayed. Make note of the IP address displayed in the Projector IP Address row.

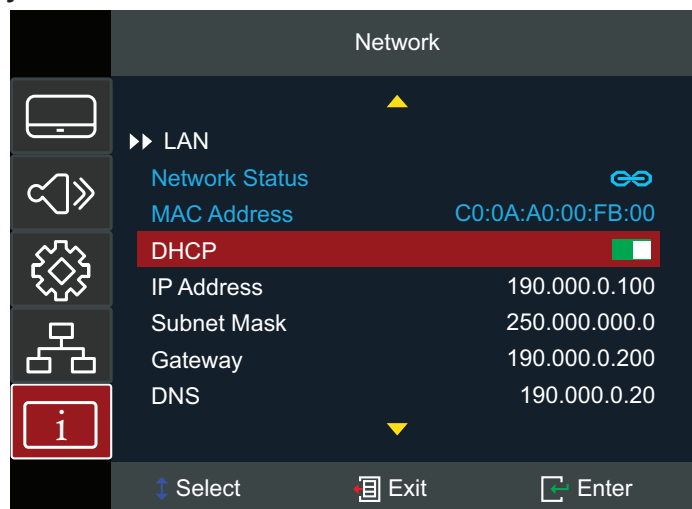

4. Using a web browser, and under the same network, type in the projector's IP address.

5. Enter the user name and password, then click **Log in**.

NOTE: The default user name is *admin*.

Information Menu

View Serial Number, Source, Resolution, Refresh Rate, Display Mode, Power Mode (Standby), Light Source Hours, Network Status, IP Address, Brightness Mode, Filter Usage Hours, and Firmware Version information.

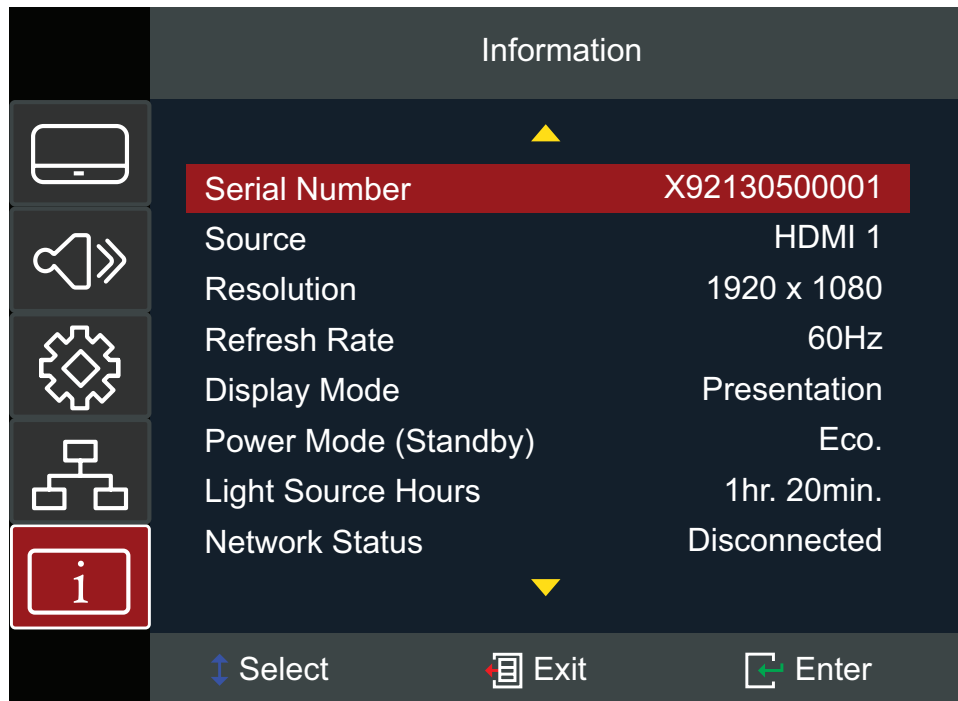

Appendix

Specifications

Item	Category	Specifications
Projector	Type	Laser
	Display Size	80"~170"
	Throw Ratio	0.253 (100" @ 0.28 m)
	Lens	F=2.44; f=3.70 mm
	Display System	1-CHIP DMD
Input Signal	HDMI 1.4	f_h : 15~98 kHz, f_v : 23~120 Hz, Pixel rate: 170 MHz
	HDMI 2.0	f_h : 15~135 kHz, f_v : 23~120 Hz, Pixel rate: 600 MHz
	VGA	f_h : 15~98 kHz, f_v : 23~120 Hz, Pixel rate: 170 MHz
Resolution	Native	1920 x 1200
Power	Input Voltage	AC 100~240V, 50/60 Hz (auto switch)
Operating Conditions	Temperature	5°C to 40°C (41°F to 104°F)
	Humidity	10% to 85% (non-condensing)
	Altitude	0 to 2,500 ft. at 5°C to 40°C 2,500 to 5,000 ft. at 5°C to 35°C 5,000 to 10,000 ft. at 5°C to 30°C
Storage Conditions	Temperature	-20°C to 60°C (-4°F to 140°F)
	Humidity	5% to 95% (non-condensing)
	Altitude	0 to 12.1 km (0 to 40,000 ft.)
Dimensions	Physical (W x H x D)	382 x 132 x 318 mm (15.04" x 5.20" x 12.52")
Weight	Physical	5.80 kg (12.79 lbs)
Power Consumption	On ¹	328W (Typical)
	Off	< 0.5W (Standby)

¹ The test condition follows EEI standards.

Projector Dimensions

382 mm (W) x 132 mm (H) x 318 mm (D)

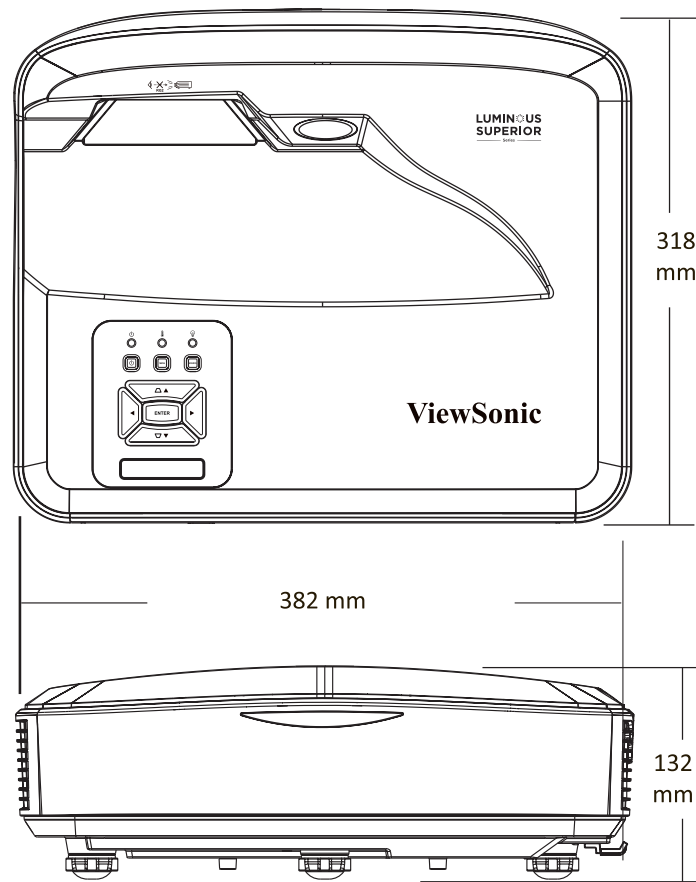

Timing Chart

Analog RGB Timing

Timing	Resolution	Refresh Rate (Hz)
VGA	640 x 480	60/67/72/75/85/120
SVGA	800 x 600	56/60/72/75/85/120
XGA	1024 x 768	60/70/75/85/120
	1152 x 864	70/75/85
WXGA	1280 x 768	60/75/85
Quad-VGA	1280 x 960	60/75
SXGA	1280 x 1024	60/72/75/85
WXGA	1366 x 768	60
WXGA+	1440 x 900	60
UXGA	1600 x 1200	60
WSXGA+	1680 x 1050	60
WUXGA	1920 x 1200-RB ²	59.94
HD	1280 x 720	50/60/120
MAC 13"	640 x 480	67
MAC 19"	1024 x 768	75
MAC 21"	1152 x 870	75
FHD	1920 x 1080	50/60

Analog Video Timing

Timing	Resolution	Refresh Rate (Hz)
HDTV(1080i) ³	1920 x 1080	50/60
HDTV(1080p) ³	1920 x 1080	50/60
HDTV (720p)	1280 x 720	50/60
SDTV(480p)	720 X 480	60
SDTV(576p)	720 x 576	50
SDTV(480i)	720 X 480	60
SDTV(576i)	720 x 576	50

² 1920 x 1080 @ 60Hz only supports RB (Reduced Blanking)

³ Mac 60

HDMI Video Timing

HDMI 1.4

Timing	Resolution	Refresh Rate (Hz)
HDTV(1080p)	1920 x 1080	50/60
HDTV(1080i)	1920 x 1080	50/60
HDTV(720p)	1280 x 720	50/60
SDTV(480p)	720 x 480	60
SDTV(576p)	720 x 576	50
SDTV(480i)	720 x 480	60
SDTV(576i)	720 x 576	50

HDMI 2.0

Timing	Resolution	Refresh Rate (Hz)
UHDTV(2160p)	3840 x 2160	24/25/30/50/60
	4096 x 2160	24/25/30/50/60
HDTV(1080p)	1920 x 1080	50/60
HDTV(1080i)	1920 x 1080	50/60
HDTV(720p)	1280 x 720	50/60
SDTV(480p)	720 x 480	60
SDTV(576p)	720 x 576	50
SDTV(480i)	720 x 480	60
SDTV(576i)	720 x 576	50

HDMI PC Timing

HDMI 1.4

Signal	Resolution	Refresh Rate (Hz)
VGA	640 x 480	60/67/72/75/85/120
SVGA	800 x 600	56/60/72/75/85/120
XGA	1024 x 768	60/70/75/85/120
	1152 x 864	70/75/85
WXGA	1280 x 768	60/75/85
Quad-VGA	1280 x 960	60/75
SXGA	1280 x 1024	60/72/75/85
WXGA	1366 x 768	60
WXGA+	1440 x 900	60
UXGA	1600 x 1200	60
WSXGA+	1680 x 1050	60
WUXGA	1920 x 1200-RB ⁴	59.94
HD	1280 x 720	50/60/120
MAC 13"	640 x 480	67
MAC 19"	1024 x 768	75
MAC 21"	1152 x 870	75
FHD	1920 x 1080	50/60

⁴ 1920 x 1200 @ 60Hz only supports RB (Reduced Blanking)

HDMI 2.0

Signal	Resolution	Refresh Rate (Hz)
VGA	640 x 480	60/67/72/75/85/120
SVGA	800 x 600	56/60/72/75/85/120
XGA	1024 x 768	60/70/75/85/120
	1152 x 864	70/75/85
WXGA	1280 x 768	60/75/85
Quad-VGA	1280 x 960	60/75
SXGA	1280 x 1024	60/72/75/85
WXGA	1366 x 768	60
WXGA+	1440 x 900	60
UXGA	1600 x 1200	60
WSXGA+	1680 x 1050	60
WUXGA	1920 x 1200-RB ⁵	59.94
HD	1280 x 720	50/60/120
MAC 13"	640 x 480	67
MAC 19"	1024 x 768	75
MAC 21"	1152 x 870	75
4K	3840 x 2160	50/60
FHD	1920 x 1080	50/60

⁵ 1920 x 1200 @ 60Hz only supports RB (Reduced Blanking)

3D Support Timing

HDMI 3D		
Frame Packing Format		
Signal	Resolution	Refresh Rate (Hz)
1080p	1920 x 1080	24
720p	1280 x 720	50/60
Side by Side Format		
Signal	Resolution	Refresh Rate (Hz)
1080i	1920 x 1080	50/60
1080p	1920 x 1080	50/60
Top and Bottom Format		
Signal	Resolution	Refresh Rate (Hz)
1080p	1920 x 1080	24/50/60
720p	1280 x 720	50/60

NOTE:

- 1080i@25hz and 720p@50hz will run in 100 Hz; other 3D timing will run in 120 Hz.
- 1080P@24hz will run 144Hz (XGA, WXGA, 1080p)/96Hz (WUXGA).
- If the input frame rate is 48 Hz or greater, the output frame rate is set to twice the input frame rate (FRC = 2X mode).
- If the 3D input frame rate is 25Hz or greater, the output frame rate is set to four times the input frame rate (FRC = 4X mode).
- If the 3D input frame rate is 24Hz (includes 23.9Hz), the output frame rate is set to six times the input frame rate (FRC = 6X mode).

Troubleshooting

This section describes some common problems that you may experience when using the projector.

Problem or Issue	Possible Solutions
The projector does not turn on	<ul style="list-style-type: none">• Ensure the power cord is properly attached to the projector and to the power outlet.• If the cooling process has not completed, please wait until it has finished then try to turn on the projector again.• If the above does not work, try another power outlet or another electrical device with the same power outlet.
There is no picture	<ul style="list-style-type: none">• Ensure the video source cable is connected properly, and that the video source is turned on.• If the input source is not selected automatically, select the correct source with the “Source Input” on either the projector or the remote control.
The image is blurred	<ul style="list-style-type: none">• Adjusting focus with the Focus Switch will help correctly focus the projection lens.• Ensure the projector and screen are aligned properly. If necessary, adjust the height of the projector as well as the projection angle and direction.
The image is reversed	<ul style="list-style-type: none">• Open the OSD Menu and go to: Setup > Projection and adjust the projection option.
The image is stretched when projecting a 16:9 DVD	<ul style="list-style-type: none">• When you play an anamorphic DVD or 16:9 DVD, the projector will show the best image in 16:9.• If you play a 4:3 format DVD title, please change the format as 4:3 in projector OSD Menu.• Please setup the display format as 16:9 (wide) aspect ratio on the DVD player.

Problem or Issue	Possible Solutions
The remote control does not work	<ul style="list-style-type: none"> • Ensure there are no obstacles between the remote control and projector; and that they are within range, 7 m (23 ft.). • The batteries may be out of power, please check and replace if necessary.
The projector stops responding to all controls	<ul style="list-style-type: none"> • Turn off the projector and unplug the power cord. Wait at least 20 seconds then reconnect and try again.

LED Indicators

When the warning indicators (see below) light up or flash, the projector will automatically shutdown. Unplug the power cord from the projector, wait for 30 seconds and try again. If the warning indicators light up or flash, please contact your nearest service center for assistance.

Status and Description	Power Indicator Light		Temperature Indicator Light	Light Source Indicator Light
	Red	Blue	Red	Red
Standby State (Power cord input)	Steady Light			
Power On (Warming)	Flashing (1 sec. off/1 sec. on)			
Power On and Lamp Lighting		Steady Light		
Power Off (Cooling)	Flashing (0.5 sec off/0.5 sec on) Back to red steady light when the cooling fan turns off.			
Error (Lamp overheat)			Steady Light	
Error (Lamp failure)				Steady Light
Error (Fan failure)			Flashing	
Error (Overheat)			Steady Light	

Maintenance

General Precautions

- Make sure the projector is turned off and the power cable is unplugged from the power outlet.
- Never remove any parts from the projector. Contact ViewSonic® or a reseller when any part of the projector needs replacing.
- Never spray or pour any liquid directly onto the case.
- Handle the projector with care, as a darker-colored projector, if scuffed, may show marks more clearly than a lighter-colored projector.

Cleaning the Lens

- Use a canister of compressed air to remove dust.
- If the lens is still not clean, use lens-cleaning paper or moisten a soft cloth with lens cleaner and gently wipe the surface.

CAUTION: Never rub the lens with abrasive materials.

Cleaning the Case

- Use a soft, lint-free, dry cloth to remove dirt or dust.
- If the case is still not clean, apply a small amount of non-ammonia, non-alcohol based, mild non-abrasive detergent onto a clean, soft, lint-free cloth, then wipe the surface.

CAUTION: Never use wax, alcohol, benzene, thinner, or other chemical detergents.

Storing the Projector

If you intend to store the projector for an extended period of time:

- Ensure the temperature and humidity of the storage area are within the recommend range.
- Retract the adjuster foot completely.
- Remove the batteries from the remote control.
- Pack the projector in its original packaging or equivalent.

Disclaimer

- ViewSonic® does not recommend the use of any ammonia or alcohol-based cleaners on the lens or case. Some chemical cleaners have been reported to damage the lens and/or case of the projector.
- ViewSonic® will not be liable for damage resulting from use of any ammonia or alcohol-based cleaners.

Regulatory and Service Information

Compliance Information

This section addresses all connected requirements and statements regarding regulations. Confirmed corresponding applications shall refer to nameplate labels and relevant markings on the unit.

FCC Compliance Statement

This device complies with part 15 of FCC Rules. Operation is subject to the following two conditions: (1) this device may not cause harmful interference, and (2) this device must accept any interference received, including interference that may cause undesired operation. This equipment has been tested and found to comply with the limits for a Class B digital device, pursuant to part 15 of the FCC Rules.

These limits are designed to provide reasonable protection against harmful interference in a residential installation. This equipment generates, uses, and can radiate radio frequency energy, and if not installed and used in accordance with the instructions, may cause harmful interference to radio communications. However, there is no guarantee that interference will not occur in a particular installation. If this equipment does cause harmful interference to radio or television reception, which can be determined by turning the equipment off and on, the user is encouraged to try to correct the interference by one or more of the following measures:

- Reorient or relocate the receiving antenna.
- Increase the separation between the equipment and receiver.
- Connect the equipment into an outlet on a circuit different from that to which the receiver is connected.
- Consult the dealer or an experienced radio/TV technician for help.

Warning: You are cautioned that changes or modifications not expressly approved by the party responsible for compliance could void your authority to operate the equipment.

Industry Canada Statement

CAN ICES-003(B) / NMB-003(B)

CE Conformity for European Countries

CE The device complies with the EMC Directive 2014/30/EU and Low Voltage Directive 2014/35/EU. Ecodesign Directive 2009/125/EC.

The following information is only for EU-member states:

The mark shown to the right is in compliance with the Waste Electrical and Electronic Equipment Directive 2012/19/EU (WEEE). The mark indicates the requirement NOT to dispose of the equipment as unsorted municipal waste, but use the return and collection systems according to local law.



Declaration of RoHS2 Compliance

This product has been designed and manufactured in compliance with Directive 2011/65/EU of the European Parliament and the Council on restriction of the use of certain hazardous substances in electrical and electronic equipment (RoHS2 Directive) and is deemed to comply with the maximum concentration values issued by the European Technical Adaptation Committee (TAC) as shown below:

Substance	Proposed Maximum Concentration	Actual Concentration
Lead (Pb)	0.1%	< 0.1%
Mercury (Hg)	0.1%	< 0.1%
Cadmium (Cd)	0.01%	< 0.01%
Hexavalent Chromium (Cr6 ⁺)	0.1%	< 0.1%
Polybrominated biphenyls (PBB)	0.1%	< 0.1%
Polybrominated diphenyl ethers (PBDE)	0.1%	< 0.1%
Bis (2-ethylhexyl) phthalate (DEHP)	0.1%	< 0.1%
Butyl benzyl phthalate (BBP)	0.1%	< 0.1%
Dibutyl phthalate (DBP)	0.1%	< 0.1%
Diisobutyl phthalate (DIBP)	0.1%	< 0.1%

Certain components of products as stated above are exempted under the Annex III of the RoHS2 Directives as noted below. Examples of exempted components are:

- Mercury in cold cathode fluorescent lamps and external electrode fluorescent lamps (CCFL and EEFL) for special purposes not exceeding (per lamp):
 - » Short length (500 mm): maximum 3.5 mg per lamp.
 - » Medium length (> 500 mm and 1,500 mm): maximum 5 mg per lamp.
 - » Long length (> 1,500 mm): maximum 13 mg per lamp.
- Lead in glass of cathode ray tubes.
- Lead in glass of fluorescent tubes not exceeding 0.2% by weight.
- Lead as an alloying element in aluminum containing up to 0.4% lead by weight.
- Copper alloy containing up to 4% lead by weight.
- Lead in high melting temperature type solders (i.e. lead-based alloys containing 85% by weight or more lead).
- Electrical and electronic components containing lead in a glass or ceramic other than dielectric ceramic in capacitors, e.g. piezoelectronic devices, or in a glass or ceramic matrix compound.

Indian Restriction of Hazardous Substances

Restriction on Hazardous Substances statement (India). This product complies with the “India E-waste Rule 2011” and prohibits use of lead, mercury, hexavalent chromium, polybrominated biphenyls or polybrominated diphenyl ethers in concentrations exceeding 0.1 weight % and 0.01 weight % for cadmium, except for the exemptions set in Schedule 2 of the Rule.

Product Disposal at End of Product Life

ViewSonic® respects the environment and is committed to working and living green. Thank you for being part of Smarter, Greener Computing. Please visit the ViewSonic® website to learn more.

USA & Canada:

<https://www.viewsonic.com/us/go-green-with-viewsonic>

Europe:

<https://www.viewsonic.com/eu/go-green-with-viewsonic>

Taiwan:

<https://recycle.epa.gov.tw/>

Copyright Information

Copyright© ViewSonic® Corporation, 2023. All rights reserved.

Macintosh and Power Macintosh are registered trademarks of Apple Inc.

Microsoft, Windows, and the Windows logo are registered trademarks of Microsoft Corporation in the United States and other countries.

ViewSonic®, the three birds logo, OnView, ViewMatch, and ViewMeter are registered trademarks of ViewSonic® Corporation.

VESA is a registered trademark of the Video Electronics Standards Association. DPMS, DisplayPort, and DDC are trademarks of VESA.

ENERGY STAR® is a registered trademark of the U.S. Environmental Protection Agency (EPA).

As an ENERGY STAR® partner, ViewSonic® Corporation has determined that this product meets the ENERGY STAR® guidelines for energy efficiency.

Disclaimer: ViewSonic® Corporation shall not be liable for technical or editorial errors or omissions contained herein; nor for incidental or consequential damages resulting from furnishing this material, or the performance or use of this product.

In the interest of continuing product improvement, ViewSonic® Corporation reserves the right to change product specifications without notice. Information in this document may change without notice.

No part of this document may be copied, reproduced, or transmitted by any means, for any purpose without prior written permission from ViewSonic® Corporation.

Customer Service

For technical support or product service, see the table below or contact your reseller.

NOTE: You will need the product's serial number.

Country/ Region	Website	Country/ Region	Website
Asia Pacific & Africa			
Australia	www.viewsonic.com/au/	Bangladesh	www.viewsonic.com/bd/
中国 (China)	www.viewsonic.com.cn	香港 (繁體中文)	www.viewsonic.com/hk/
Hong Kong (English)	www.viewsonic.com/hk-en/	India	www.viewsonic.com/in/
Indonesia	www.viewsonic.com/id/	Israel	www.viewsonic.com/il/
日本 (Japan)	www.viewsonic.com/jp/	Korea	www.viewsonic.com/kr/
Malaysia	www.viewsonic.com/my/	Middle East	www.viewsonic.com/me/
Myanmar	www.viewsonic.com/mm/	Nepal	www.viewsonic.com/np/
New Zealand	www.viewsonic.com/nz/	Pakistan	www.viewsonic.com/pk/
Philippines	www.viewsonic.com/ph/	Singapore	www.viewsonic.com/sg/
臺灣 (Taiwan)	www.viewsonic.com/tw/	ประเทศไทย	www.viewsonic.com/th/
Việt Nam	www.viewsonic.com/vn/	South Africa & Mauritius	www.viewsonic.com/za/
Americas			
United States	www.viewsonic.com/us	Canada	www.viewsonic.com/us
Latin America	www.viewsonic.com/la		
Europe			
Europe	www.viewsonic.com/eu/	France	www.viewsonic.com/fr/
Deutschland	www.viewsonic.com/de/	Қазақстан	www.viewsonic.com/kz/
Россия	www.viewsonic.com/ru/	España	www.viewsonic.com/es/
Türkiye	www.viewsonic.com/tr/	Україна	www.viewsonic.com/ua/
United Kingdom	www.viewsonic.com/uk/		

Limited Warranty

ViewSonic® Projector

What the warranty covers:

ViewSonic® warrants its products to be free from defects in material and workmanship, under normal use, during the warranty period. If a product proves to be defective in material or workmanship during the warranty period, ViewSonic® will, at its sole option, repair or replace the product with a like product. Replacement product or parts may include remanufactured or refurbished parts or components.

Limited Three (3) year General Warranty:

Subject to the more limited one (1) year warranty set out below, North and South America: Three (3) years warranty for all parts excluding the lamp, three (3) years for labor, and one (1) year for the original lamp from the date of the first consumer purchase.

Other regions or countries: Please check with your local dealer or local ViewSonic® office for the warranty information.

Limited One (1) year Heavy Usage Warranty:

Under heavy usage settings, where a projector's use includes more than fourteen (14) hours average daily usage, North and South America: One (1) year warranty for all parts excluding the lamp, one (1) year for labor, and ninety (90) days for the original lamp from the date of the first consumer purchase; Europe: One (1) year warranty for all parts excluding the lamp, one (1) year for labor, and ninety (90) days for the original lamp from the date of the first consumer purchase. Other regions or countries: Please check with your local dealer or local ViewSonic® office for the warranty information. Lamp warranty subject to terms and conditions, verification and approval. Applies to manufacturer's installed lamp only. All accessory lamps purchased separately are warranted for 90 days.

Who the warranty protects:

This warranty is valid only for the first consumer purchaser.

What the warranty does not cover:

1. Any product on which the serial number has been defaced, modified, or removed.
2. Damage, deterioration, or malfunction resulting from:
 - » Accident, misuse, neglect, fire, water, lightning, or other acts of nature, unauthorized product modification, or failure to follow instructions supplied with the product.
 - » Operation outside of product specifications.
 - » Operation of the product for other than the normal intended use or not under normal conditions.
 - » Repair or attempted repair by anyone not authorized by ViewSonic®.
 - » Any damage of the product due to shipment.
 - » Removal or installation of the product.
 - » Causes external to the product, such as electric power fluctuations or failure.
 - » Use of supplies or parts not meeting Viewsonic's specifications.
 - » Normal wear and tear.
 - » Any other cause which does not relate to a product defect.
3. Removal, installation, and set-up service charges.

How to get service:

1. For information about receiving service under warranty, contact ViewSonic® Customer Support (Please refer to the "Customer Support" page). You will need to provide your product's serial number.
2. To obtain warranted service, you will be required to provide: (a) the original dated sales slip, (b) your name, (c) your address, (d) a description of the problem, and (e) the serial number of the product.
3. Take or ship the product, freight prepaid, in the original container to an authorized ViewSonic® service center or ViewSonic®.
4. For additional information or the name of the nearest ViewSonic® service center, contact ViewSonic®.

Limitation of implied warranties:

There are no warranties, express or implied, which extend beyond the description contained herein including the implied warranty of merchantability and fitness for a particular purpose.

Exclusion of damages:

ViewSonic's liability is limited to the cost of repair or replacement of the product. ViewSonic® shall not be liable for:

1. Damage to other property caused by any defects in the product, damages based upon inconvenience, loss of use of the product, loss of time, loss of profits, loss of business opportunity, loss of goodwill, interference with business relationships, or other commercial loss, even if advised of the possibility of such damages.
2. Any other damages, whether incidental, consequential or otherwise.
3. Any claim against the customer by any other party.

Effect of state law:

This warranty gives you specific legal rights, and you may also have other rights which vary from local authority. Some local governments do not allow limitations on implied warranties and/or do not allow the exclusion of incidental or consequential damages, so the above limitations and exclusions may not apply to you.

Sales outside the U.S.A. and Canada:

For warranty information and service on ViewSonic® products sold outside of the U.S.A. and Canada, contact ViewSonic® or your local ViewSonic® dealer.

The warranty period for this product in mainland China (Hong Kong, Macao, and Taiwan Excluded) is subject to the terms and conditions of the Maintenance Guarantee Card.

For users in Europe and Russia, full details of warranty provided can be found at: <http://www.viewsonic.com/eu/> under "Support/Warranty Information".

Mexico Limited Warranty

ViewSonic® Projector

What the warranty covers:

ViewSonic® warrants its products to be free from defects in material and workmanship, under normal use, during the warranty period. If a product proves to be defective in material or workmanship during the warranty period, ViewSonic® will, at its sole option, repair or replace the product with a like product. Replacement product or parts may include remanufactured or refurbished parts or components & accessories.

How long the warranty is effective:

3 years for all parts excluding the lamp, 3 years for labor, 1 year for the original lamp from the date of the first consumer purchase.

Lamp warranty subject to terms and conditions, verification and approval. Applies to manufacturer's installed lamp only.

All accessory lamps purchased separately are warranted for 90 days.

Who the warranty protects:

This warranty is valid only for the first consumer purchaser.

What the warranty excludes and does not cover:

1. Any product on which the serial number has been defaced, modified or removed.
2. Damage, deterioration, or malfunction resulting from:
 - » Accident, misuse, neglect, fire, water, lightning, or other acts of nature, unauthorized product modification, unauthorized attempted repair, or failure to follow instructions supplied with the product.
 - » Any damage of the product due to shipment.
 - » Causes external to the product, such as electrical power fluctuations or failure.
 - » Use of supplies or parts not meeting ViewSonic®'s specifications.
 - » Normal wear and tear.
 - » Any other cause which does not relate to a product defect.
3. Any product exhibiting a condition commonly known as "image burn-in" which results when a static image is displayed on the product for an extended period of time.
4. Removal, installation, insurance, and set-up service charges.

How to get service:

For information about receiving service under warranty, contact ViewSonic® Customer Support (Please refer to the attached “Customer Service” page). You will need to provide your product’s serial number, so please record the product information in the space provided below on your purchase for your future use. Please retain your receipt of proof of purchase to support your warranty claim.

For Your Records

Product Name: _____ Model Number: _____

Document Number: _____ Serial Number: _____

Purchase Date: _____ Extended Warranty Purchase? _____ (Y/N)

If so, what date does warranty expire? _____

1. To obtain warranty service, you will be required to provide (a) the original dated sales slip, (b) your name, (c) your address, (d) a description of the problem, and (e) the serial number of the product.
2. Take or ship the product, in the original container packaging, to an authorized ViewSonic® service center.
3. Round trip transportation costs for in-warranty products will be paid by ViewSonic®.

Limitation of implied warranties:

There are no warranties, express or implied, which extend beyond the description contained herein including the implied warranty of merchantability and fitness for a particular purpose.

Exclusion of damages:

ViewSonic®’s liability is limited to the cost of repair or replacement of the product. ViewSonic® shall not be liable for:

1. Damage to other property caused by any defects in the product, damages based upon inconvenience, loss of use of the product, loss of time, loss of profits, loss of business opportunity, loss of goodwill, interference with business relationships, or other commercial loss, even if advised of the possibility of such damages.
2. Any other damages, whether incidental, consequential or otherwise.
3. Any claim against the customer by any other party.
4. Repair or attempted repair by anyone not authorized by ViewSonic®.

Contact Information for Sales & Authorized Service (Centro Autorizado de Servicio) within Mexico:	
Name, address, of manufacturer and importers: México, Av. de la Palma #8 Piso 2 Despacho 203, Corporativo Interpalmas, Col. San Fernando Huixquilucan, Estado de México Tel: (55) 3605-1099 http://www.viewsonic.com/la/soporte/index.htm	
NÚMERO GRATIS DE ASISTENCIA TÉCNICA PARA TODO MÉXICO: 001.866.823.2004	
Hermosillo: Distribuciones y Servicios Computacionales SA de CV. Calle Juárez 284 local 2 Col. Bugambilias C.P: 83140 Tel: 01-66-22-14-9005 E-Mail: disc2@hmo.megared.net.mx	Villahermosa: Compumantenimientos Garantizados, S.A. de C.V. AV. GREGORIO MENDEZ #1504 COL, FLORIDA C.P. 86040 Tel: 01 (993) 3 52 00 47 / 3522074 / 3 52 20 09 E-Mail: compumantenimientos@prodigy.net.mx
Puebla, Pue. (Matriz): RENTA Y DATOS, S.A. DE C.V. Domicilio: 29 SUR 721 COL. LA PAZ 72160 PUEBLA, PUE. Tel: 01(52).222.891.55.77 CON 10 LINEAS E-Mail: datos@puebla.megared.net.mx	Veracruz, Ver.: CONEXION Y DESARROLLO, S.A DE C.V. Av. Americas # 419 ENTRE PINZÓN Y ALVARADO Fracc. Reforma C.P. 91919 Tel: 01-22-91-00-31-67 E-Mail: gacosta@qplus.com.mx
Chihuahua: Soluciones Globales en Computación C. Magisterio # 3321 Col. Magisterial Chihuahua, Chih. Tel: 4136954 E-Mail: Cefeo@soluglobales.com	Cuernavaca: Compusupport de Cuernavaca SA de CV Francisco Leyva # 178 Col. Miguel Hidalgo C.P. 62040, Cuernavaca Morelos Tel: 01 777 3180579 / 01 777 3124014 E-Mail: aquevedo@compusupportcva.com
Distrito Federal: QPLUS, S.A. de C.V. Av. Coyoacán 931 Col. Del Valle 03100, México, D.F. Tel: 01(52)55-50-00-27-35 E-Mail : gacosta@qplus.com.mx	Guadalajara, Jal.: SERVICRECE, S.A. de C.V. Av. Niños Héroes # 2281 Col. Arcos Sur, Sector Juárez 44170, Guadalajara, Jalisco Tel: 01(52)33-36-15-15-43 E-Mail: mmiranda@servicrece.com
Guerrero Acapulco: GS Computación (Grupo Sesicomp) Progreso #6-A, Colo Centro 39300 Acapulco, Guerrero Tel: 744-48-32627	Monterrey: Global Product Services Mar Caribe # 1987, Esquina con Golfo Pérsico Fracc. Bernardo Reyes, CP 64280 Monterrey N.L. México Tel: 8129-5103 E-Mail: aydeem@gps1.com.mx
MERIDA: ELECTROSER Av Reforma No. 403Gx39 y 41 Mérida, Yucatán, México CP97000 Tel: (52) 999-925-1916 E-Mail: rrrb@sureste.com	Oaxaca, Oax.: CENTRO DE DISTRIBUCION Y SERVICIO, S.A. de C.V. Murguía # 708 P.A., Col. Centro, 68000, Oaxaca Tel: 01(52)95-15-15-22-22 Fax: 01(52)95-15-13-67-00 E-Mail: gpotai2001@hotmail.com
Tijuana: STD Av Ferrocarril Sonora #3780 L-C Col 20 de Noviembre Tijuana, Mexico	FOR USA SUPPORT: ViewSonic® Corporation 381 Brea Canyon Road, Walnut, CA. 91789 USA Tel: 800-688-6688 E-Mail: http://www.viewsonic.com

