

User Manual

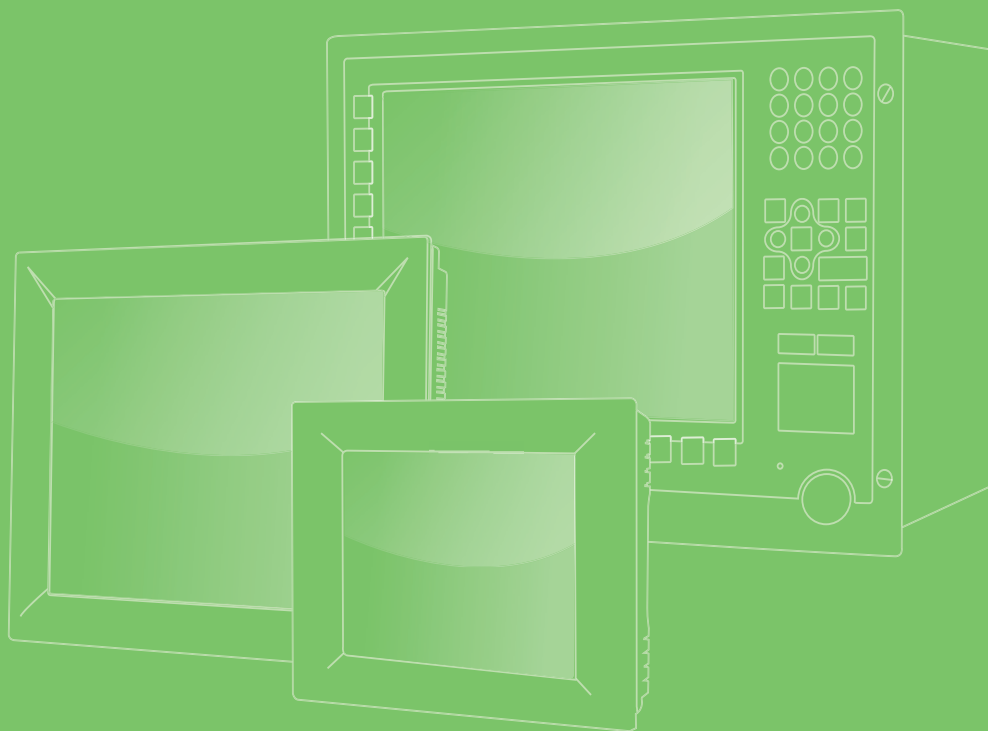

FPM-700/700W Series

**15" XGA/17" SXGA/19" SXGA
Industrial Monitors with
Resistive Touch, Direct HDMI,
DP, and VGA Ports**

**15.6" Full HD Industrial Monitor
with PCAP Touch, Direct HDMI,
DP, and VGA Ports**

液晶顯示器

申請商：研華股份有限公司

地址：台北市內湖區瑞光路 26 巷 20 弄 1 號

電話：02-27927818

ADVANTECH

Enabling an Intelligent Planet

限用物質含有情況標示聲明書

Declaration of the Presence Condition of the Restricted Substances Marking

設備名稱:	液晶顯示器	型號 (型式):	FPM-715-R9AE, FPM-715W-P9AE,			
Equipment name	Type designation (Type)		FPM-717-R9AE, FPM-719-R9AE			
單元 Unit	限用物質及其化學符號 Restricted substances and its chemical symbols					
	鉛 Lead (Pb)	汞 Mercury (Hg)	鎘 Cadmium (Cd)	六價鉻 Hexavalent chromium (Cr ⁺⁶)	多溴聯苯 Polybrominated biphenyls (PBB)	多溴二苯醚 Polybrominated diphenyl ethers (PBDE)
電路板	—	○	○	○	○	○
內外殼 (外殼、內部框架 ... 等)	○	○	○	○	○	○
其它固定組件 (螺絲、夾具、卡榫)	—	○	○	○	○	○
配件 (滑鼠、鍵盤、電源線、排線、傳輸線、網路線 ... 等)	—	○	○	○	○	○
液晶面板	—	○	○	○	○	○
觸控模組	—	○	○	○	○	○
<p>備考 1. “超出 0.1 wt %” 及 “超出 0.01 wt %” 係指限用物質之百分比含量超出百分比含量基準值。 Note 1. “Exceeding 0.1 wt %” and “exceeding 0.01 wt %” indicate that the percentage content of the restricted substance exceeds the reference percentage value of presence condition.</p> <p>備考 2. “○” 係指該項限用物質之百分比含量未超出百分比含量基準值。 Note 2. “○” indicates that the percentage content of the restricted substance does not exceed the percentage of reference value of presence.</p> <p>備考 3. “—” 係指該項限用物質為排除項目。 Note 3. The “-” indicates that the restricted substance corresponds to the exemption.</p>						

Copyright

The documentation and the software included with this product are copyrighted 2023 by Advantech Co., Ltd. All rights are reserved. Advantech Co., Ltd. reserves the right to make improvements in the products described in this manual at any time without notice. No part of this manual may be reproduced, copied, translated or transmitted in any form or by any means without the prior written permission of Advantech Co., Ltd. Information provided in this manual is intended to be accurate and reliable. However, Advantech Co., Ltd. assumes no responsibility for its use, nor for any infringements of the rights of third parties, which may result from its use

Acknowledgments

Intel® and Pentium® are trademarks of Intel Corporation.

Microsoft Windows are registered trademarks of Microsoft Corp.

All other product names or trademarks are properties of their respective owners.

This manual includes the following products:

FPM-715-R9AE

FPM715R9A2201-T, FPM715R9A2202-T, FPM715R9A2203-T,
FPM715R9A2204-T, FPM715R9A2205-T, FPM715R9A2206-T,
FPM715R9A2301-T, FPM715R9A2302-T, FPM715R9A2303-T,
FPM715R9A2304-T, FPM715R9A2305-T, FPM715R9A2306-T,
FPM715R9A2401-T, FPM715R9A2402-T, FPM715R9A2403-T,
FPM715R9A2404-T, FPM715R9A2405-T, FPM715R9A2406-T,
FPM715R9A2501-T, FPM715R9A2502-T, FPM715R9A2503-T,
FPM715R9A2504-T, FPM715R9A2505-T, FPM715R9A2506-T,
FPM715R9A2601-T, FPM715R9A2602-T, FPM715R9A2603-T,
FPM715R9A2604-T, FPM715R9A2605-T, FPM715R9A2606-T,
FPM715R9A2701-T, FPM715R9A2702-T, FPM715R9A2703-T,
FPM715R9A2704-T, FPM715R9A2705-T, FPM715R9A2706-T,,

FPM-717-R9AE

FPM717R9A2201-T, FPM717R9A2202-T, FPM717R9A2203-T,
FPM717R9A2204-T, FPM717R9A2205-T, FPM717R9A2206-T,
FPM717R9A2301-T, FPM717R9A2302-T, FPM717R9A2303-T,
FPM717R9A2304-T, FPM717R9A2305-T, FPM717R9A2306-T,
FPM717R9A2401-T, FPM717R9A2402-T, FPM717R9A2403-T,
FPM717R9A2404-T, FPM717R9A2405-T, FPM717R9A2406-T,
FPM717R9A2501-T, FPM717R9A2502-T, FPM717R9A2503-T,
FPM717R9A2504-T, FPM717R9A2505-T, FPM717R9A2506-T,
FPM717R9A2601-T, FPM717R9A2602-T, FPM717R9A2603-T,
FPM717R9A2604-T, FPM717R9A2605-T, FPM717R9A2606-T,
FPM717R9A2701-T, FPM717R9A2702-T, FPM717R9A2703-T,

FPM717R9A2704-T, FPM717R9A2705-T, FPM717R9A2706-T,

FPM-719-R9AE

FPM719R9A2201-T, FPM719R9A2202-T, FPM719R9A2203-T,
FPM719R9A2204-T, FPM719R9A2205-T, FPM719R9A2206-T,
FPM719R9A2301-T, FPM719R9A2302-T, FPM719R9A2303-T,
FPM719R9A2304-T, FPM719R9A2305-T, FPM719R9A2306-T,
FPM719R9A2401-T, FPM719R9A2402-T, FPM719R9A2403-T,
FPM719R9A2404-T, FPM719R9A2405-T, FPM719R9A2406-T,
FPM719R9A2501-T, FPM719R9A2502-T, FPM719R9A2503-T,
FPM719R9A2504-T, FPM719R9A2505-T, FPM719R9A2506-T,
FPM719R9A2601-T, FPM719R9A2602-T, FPM719R9A2603-T,
FPM719R9A2604-T, FPM719R9A2605-T, FPM719R9A2606-T,
FPM719R9A2701-T, FPM719R9A2702-T, FPM719R9A2703-T,
FPM719R9A2704-T, FPM719R9A2705-T, FPM719R9A2706-T,

FPM-715W-P9AE

FPM715WP9A2201-T, FPM715WP9A2202-T, FPM715WP9A2203-T,
FPM715WP9A2204-T, FPM715WP9A2205-T, FPM715WP9A2206-T,
FPM715WP9A2301-T, FPM715WP9A2302-T, FPM715WP9A2303-T,
FPM715WP9A2304-T, FPM715WP9A2305-T, FPM715WP9A2306-T,
FPM715WP9A2401-T, FPM715WP9A2402-T, FPM715WP9A2403-T,
FPM715WP9A2404-T, FPM715WP9A2405-T, FPM715WP9A2406-T,
FPM715WP9A2501-T, FPM715WP9A2502-T, FPM715WP9A2503-T,
FPM715WP9A2504-T, FPM715WP9A2505-T, FPM715WP9A2506-T,
FPM715WP9A2601-T, FPM715WP9A2602-T, FPM715WP9A2603-T,
FPM715WP9A2604-T, FPM715WP9A2605-T, FPM715WP9A2606-T,
FPM715WP9A2701-T, FPM715WP9A2702-T, FPM715WP9A2703-T,
FPM715WP9A2704-T, FPM715WP9A2705-T, FPM715WP9A2706-T

Part No. 2004070000
Printed in China

Edition 1
March 2023

Product Warranty (2 years)

Advantech warrants to you, the original purchaser, that each of its products will be free from defects in materials and workmanship for two years from the date of purchase.

This warranty does not apply to any products which have been repaired or altered by persons other than repair personnel authorized by Advantech, or which have been subject to misuse, abuse, accident or improper installation. Advantech assumes no liability under the terms of this warranty as a consequence of such events.

Because of Advantech's high quality-control standards and rigorous testing, most of our customers never need to use our repair service. If an Advantech product is defective, it will be repaired or replaced at no charge during the warranty period. For out-of-warranty repairs, you will be billed according to the cost of replacement materials, service time and freight. Please consult your dealer for more details.

If you think you have a defective product, follow these steps:

1. Collect all the information about the problem encountered. (For example, CPU speed, Advantech products used, other hardware and software used, etc.) Note anything abnormal and list any onscreen messages you get when the problem occurs.
2. Call your dealer and describe the problem. Please have your manual, product, and any helpful information readily available.
3. If your product is diagnosed as defective, obtain an RMA (return merchandise authorization) number from your dealer. This allows us to process your return more quickly.
4. Carefully pack the defective product, a fully-completed Repair and Replacement Order Card and a photocopy proof of purchase date (such as your sales receipt) in a shippable container. A product returned without proof of the purchase date is not eligible for warranty service.
5. Write the RMA number visibly on the outside of the package and ship it prepaid to your dealer.

Declaration of Conformity

FCC Class A

Note: This equipment has been tested and found to comply with the limits for a Class A digital device, pursuant to part 15 of the FCC Rules. These limits are designed to provide reasonable protection against harmful interference when the equipment is operated in a commercial environment. This equipment generates, uses, and can radiate radio frequency energy and, if not installed and used in accordance with the instruction manual, may cause harmful interference to radio communications. Operation of this equipment in a residential area is likely to cause harmful interference in which case the user will be required to correct the interference at his own expense.

Technical Support and Assistance

1. Visit the Advantech web site at www.advantech.com/support where you can find the latest information about the product.
2. Contact your distributor, sales representative, or Advantech's customer service center for technical support if you need additional assistance. Please have the following information ready before you call:
 - Product name and serial number
 - Description of your peripheral attachments
 - Description of your software (operating system, version, application software, etc.)
 - A complete description of the problem
 - The exact wording of any error messages

Safety Instructions

1. Read these safety instructions carefully.
2. Keep this User Manual for later reference.
3. Disconnect this equipment from any AC outlet before cleaning. Use a damp cloth. Do not use liquid or spray detergents for cleaning.
4. For plug-in equipment, the power outlet socket must be located near the equipment and must be easily accessible.
5. Keep this equipment away from humidity.
6. Put this equipment on a reliable surface during installation. Dropping it or letting it fall may cause damage.
7. The openings on the enclosure are for air convection. Protect the equipment from overheating. **DO NOT COVER THE OPENINGS.**
8. Make sure the voltage of the power source is correct before connecting the equipment to the power outlet.
9. Position the power cord so that people cannot step on it. Do not place anything over the power cord.
10. All cautions and warnings on the equipment should be noted.
11. If the equipment is not used for a long time, disconnect it from the power source to avoid damage by transient overvoltage.
12. Never pour any liquid into an opening. This may cause fire or electrical shock.
13. Never open the equipment. For safety reasons, the equipment should be opened only by qualified service personnel.
14. If one of the following situations arises, get the equipment checked by service personnel:
 - The power cord or plug is damaged.
 - Liquid has penetrated into the equipment.
 - The equipment has been exposed to moisture.
 - The equipment does not work well, or you cannot get it to work according to the user's manual.
 - The equipment has been dropped and damaged.
 - The equipment has obvious signs of breakage.
15. **DO NOT LEAVE THIS EQUIPMENT IN AN ENVIRONMENT WHERE THE STORAGE TEMPERATURE MAY GO BELOW 0 °C OR ABOVE 50 °C. THIS COULD DAMAGE THE EQUIPMENT. THE EQUIPMENT SHOULD BE KEPT IN A CONTROLLED ENVIRONMENT.**
16. The sound pressure level at the operator's position according to IEC 704-1:1982 is no more than 70 dB (A).

DISCLAIMER: This set of instructions is given according to IEC 704-1. Advantech disclaims all responsibility for the accuracy of any statements contained herein.

By means of a power cord connected to a socket-outlet with earthing connection.

Note!



This product is intended to be supplied by an UL listed power supply suitable for use at Tma 60 °C min., altitude operation up to 2000m, whose output meets PS2(or LPS), ES1(or SELV) and output is rated: 24Vdc, 2.5A for Models

FPM-715xxxxxxxxxxxxxxxxxx,

FPM-717xxxxxxxxxxxxxxxxxx,

FPM-719xxxxxxxxxxxxxxxxxx,

FPM-715Wxxxxxxxxxxxxxxxxxx,

If need further assistance, please contact Advantech for further information.

Warning! *This product may cause radio interference if the customer uses DC power. Please be prepared for this.*



Warning! *The customer should use one of the power adapters listed on the product datasheet. Using a power adapter not listed on the product datasheet may cause radio interference.*



Warning! *Avoid exposing FPM-700 to direct sunlight for long periods of time. Direct sunlight hitting the LCD screen can cause it to become very hot. This may damage the LCD as the components are not designed to tolerate high heat.*



1. The power outlet socket should have a grounded connection. This is achieved using a power cord connected to a grounded socket-outlet.
2. This product is intended to be supplied by an UL listed power supply or DC source suitable for use at minimum Tma 60 ° C whose output meets LPS(or PS2), SELV (or ES1), output is rated: 24Vdc, 2A min. and match the unit rating. Please contact Advantech for further information or assistance.
3. The EUT only operates in landscape mode (horizontal(0°)).

Consignes de Sécurité

1. Lire attentivement les instructions de sécurité
2. Conserver ce manuel pour utilisation ultérieure
3. Débranchez cet équipement de toute prise secteur avant de le nettoyer. Utilisez seulement un chiffon humide. N'utilisez pas de détergent liquide ou pulvérisé pour le nettoyage.
4. Gardez cet équipement à l'abri de l'humidité.
5. Placez cet équipement sur une surface fiable pendant l'installation. Le faire ou bien le laisser tomber peut causer des dégâts.
6. Les ouvertures sur l'enceinte servent à la convection de l'air. Protégez l'équipement contre la surchauffe. **NE COUVREZ PAS LES OUVERTURES.**
7. Assurez-vous que la tension de la source d'alimentation est correcte avant de connecter l'équipement à l'alimentation.
8. Placez le câble d'alimentation de manière à ce que personne ne puisse marcher dessus. Ne placez rien sur le câble d'alimentation.
9. Toutes les mises en garde et tous les avertissements sur l'équipement doivent être notés.
10. Si l'équipement n'est pas utilisé pendant une longue période, débranchez-le de la source d'alimentation pour éviter tout endommagement dû à une surtension transitoire.
11. Ne jamais verser de liquide dans une ouverture. Cela pourrait provoquer un incendie ou un choc électrique.
12. N'ouvrez jamais l'équipement. Pour des raisons de sécurité, l'équipement doit être ouvert uniquement par du personnel qualifié.
13. Si l'une des situations suivantes se présente, faites vérifier l'équipement par le personnel de service:
 - Un liquide a pénétré dans l'équipement.
 - L'équipement a été exposé à l'humidité.
 - L'équipement ne fonctionne pas bien, ou vous ne pouvez pas le faire fonctionner selon le manuel de l'utilisateur.
 - L'équipement est tombé et endommagé.
 - L'équipement présente des signes évidents de rupture.
14. **NE LAISSEZ PAS CET ÉQUIPEMENT DANS UN ENVIRONNEMENT OU LA TEMPÉRATURE DE STOCKAGE PEUT ÊTRE INFÉRIEURE À 0 ° C (32 ° F) OU BIEN SUPÉRIEURE À 50 ° C (122 ° F). CECI POURRAIT ENDOMMAGER L'ÉQUIPEMENT. L'ÉQUIPEMENT DEVRAIT ÊTRE DANS UN ENVIRONNEMENT CONTRÔLÉ.**
15. **ATTENTION: DANGER D'EXPLOSION SI LA BATTERIE EST INCORRECTEMENT REMPLACÉE. REMPLACER SEULEMENT AVEC LE MÊME TYPE OU ÉQUIVALENT RECOMMANDÉ PAR LE FABRICANT, JETER LES BATTERIES USÉES SELON LES INSTRUCTIONS DU FABRICANT. VEUILLEZ CONTACTER LE FABRICANT, ADVANTECH, POUR LE REMPLACER.**
16. Le personnel concerné doit savoir qu'il ne faut pas heurter la section d'angle de l'appareil afin d'éviter tout risque de blessure.

Remarque! Ce produit est destiné à être alimenté par une alimentation homologuée UL adaptée à une utilisation à T_{ma} 60 degrés C min., fonctionnement en altitude jusqu'à 2000 m, dont la sortie est conforme à PS2 (ou LPS), ES1 (ou SELV) et la sortie est nominale:



24Vdc, 2.5A pour les modèles FPM-715xxxxxxxxxxxxxxxxx,
FPM-717xxxxxxxxxxxxxxxxx, FPM-719xxxxxxxxxxxxxxxxx,
FPM-715Wxxxxxxxxxxxxxxxxx, FPM715xxxxxxxxxxxxxxxxx,
FPM717xxxxxxxxxxxxxxxxx, FPM719xxxxxxxxxxxxxxxxx,
FPM715Wxxxxxxxxxxxxxxxxx,

Si vous avez besoin d'aide supplémentaire, veuillez contacter Avantech pour plus d'informations.

Attention! Si l'utilisateur client utilise exclusivement l'alimentation en courant continu pour ce produit, il peut provoquer des interférences radio, auquel cas, le client doit prendre les mesures appropriées.



Attention! Si le client doit utiliser un adaptateur secteur, veuillez utiliser l'adaptateur secteur figurant sur la fiche technique du produit. Si le client utilise un adaptateur secteur non répertorié dans la fiche technique du produit, il peut provoquer des interférences radio, auquel cas il doit prendre les mesures appropriées.



Attention! Évitez d'exposer le FPM-700 à la lumière directe du soleil pendant de longues périodes. Les rayons directs du soleil sur un écran LCD peuvent devenir très chauds et endommager physiquement l'écran car les composants ne sont pas conçus pour tolérer une chaleur intense, ce qui raccourcit la durée de vie de l'écran.



安全指示

1. 請仔細閱讀此安全操作說明。
2. 請妥善保存此用戶手冊供日後參考。
3. 用濕抹布清洗設備前，請確認拔除電源線。請勿使用液體或去污噴霧劑清洗設備。
4. 對於使用電源線的設備，設備周圍必須有容易接觸到的電源插座。
5. 請勿在潮濕環境中試用設備。
6. 請在安裝前確保設備放置在可靠的平面上，意外摔落可能會導致設備損壞。
7. 設備機殼的開孔適用於空氣對，從而防止設備過熱。**請勿覆蓋開孔。**
8. 當您連接設備到電源插座前，請確認電源插座的電壓符合要求。
9. 請將電源線佈置在人們不易絆倒的位置，請勿在電源線上覆蓋任何雜物。
10. 請注意設備上所有的警告標示。
11. 如果長時間不使用設備，請拔除與電源插座的連結，避免設備被超標的電壓波動損壞。
12. 請勿讓任何液體流入通風口，以免引起火災或短路。
13. 請勿自行打開設備。為了確保您的安全，請透過經認證的工程師來打開設備。
14. 如遇下列情況，請由專業人員維修：
 - 電源線或插頭損壞；
 - 設備內部有液體流入；
 - 設備曾暴露在過度潮濕環境中使用；
 - 設備無法正常工作，或您無法透過用戶手冊來正常工作；
 - 設備摔落或損壞；
 - 設備有明顯外觀損；
15. 請勿將設備放置在超出建議溫度範圍的環境，即不要低於 0 °C (32 °F) 或高於 50 °C (122 °F)，否則可能會造成設備損壞。
16. **注意：**若電池更換不正確，將有爆炸危險。因此，只可以使用製造商推薦的同一種或者同等型號的電池進行替換。請按照製造商的指示處理舊電池。
17. 根據 IEC 704-1:1982 規定，操作員所在位置音量不可高於 70 分貝。
18. **限制區域：**請勿將設備安裝於限制區域使用。
19. **免責聲明：**請安全訓示符合 IEC 704-1 要求。研華公司對其內容之準確性不承擔任何法律責任。

注！ 此項提供其它額外信息。



警告使用者：

1. 使用過度恐傷害視力
2. 使用 30 分鐘請休息 10 分鐘
3. 未滿 2 歲幼兒不看螢幕，2 歲以上每天看螢幕不要超過 1 小時
4. [甲類警語]
警告使用者：為避免電磁干擾，本產品不應安裝或使用於住宅環境。

警告! 如果客戶自行為本產品用戶直流電源可能會造成無線電干擾，在這種情況下，客戶必須採取適當的措施



警告! 如果客戶需要使用電源適配器，請使用產品數據表中列出的電源適配器。如果客戶使用產品數據表中未列出的電源適配器，可能會造成無線電干擾，在這種情況下，客戶必須採取適當的措施



警告! 請避免將 FPM-700 長時間暴露在直射陽光下。直射陽光照射到 LCD 屏幕上會導致 LCD 變得非常熱並對 LCD 造成物理損壞，因為這些組件的設計不能承受高溫，從而縮短了 LCD 的使用壽命



Contents

Chapter 1	General Information	1
1.1	Introduction	2
1.2	Specifications	2
1.2.1	General	2
1.2.2	Touchscreens (Optional).....	2
1.3	LCD Specifications	3
1.4	Connectors.....	3
1.5	Interfaces	4
	Figure 1.1 FPM-715/717/719 - I/O Port Arrangement	4
	Figure 1.2 FPM-715W - I/O Port Arrangement	4
1.6	Dimensions	5
	Figure 1.3 FPM-715/717/719 Dimensions	5
	Figure 1.4 FPM-715W Dimensions.....	5
Chapter 2	Mounting Methods.....	7
2.1	Mounting the Monitor / Monter le Moniteur	8
2.1.1	Panel Mounting / Montage Sur Panneau	8
	Figure 2.1 Panel Mounting.....	8
2.1.2	Wall Mounting / Montage mural	9
	Figure 2.2 Wall Mounting.....	9
2.1.3	Desktop Stand Mounting / Montage du support de bureau	10
	Figure 2.3 Desktop Stand Mounting	10
2.1.4	VESA Mounting / Montage VESA	11
	Figure 2.4 VESA Mounting	11
2.1.5	Power Adapter Bracket Mounting (Optional)	12
	Figure 2.5 Power Adapter Bracket Mounting.....	12
Appendix A	Touchscreen	13
A.1	Introduction	14
A.2	Touchscreen Specifications (15"/17"/19"/15.6").....	14
A.2.1	Optical Features.....	14
A.2.2	Electrical Specifications	14
A.2.3	Environmental Specifications.....	14
A.3	Installing Drivers for Windows OS.....	14
A.4	LED Functions.....	14
	Table A.1: LED Function.....	14
Appendix B	OSD Operation Keypad	15
B.1	OSD Board Overview	16
B.1.1	OSD Button Descriptions	16
	Table B.1: OSD Button Descriptions.....	16
B.2	OSD Key Functions.....	17
B.2.1	Menu Start	17
B.2.2	Picture.....	18
B.2.3	Geometry	18
B.2.4	Color Temperature Menu.....	19
B.2.5	OSD Manager	20
B.2.6	Touch Control	21
	Table B.2: Touch Control.....	22

B.2.7	ERP Control.....	22
B.2.8	All Reset	24
B.2.9	Exit.....	24

Chapter 1

General Information

Sections include:

- Introduction
- Specifications
- LCD Specifications
- Connectors
- Dimensions

1.1 Introduction

The Advantech FPM-700 series comprises 15", 17", 19" and 15.6" industrial-grade monitors with sleek, simple lines and a durable true-flat touchscreen. The FPM-700 series features an IP66-rated front bezel. It supports wide operating temperatures (-20 ~ 60 °C) and diverse mounting options.

1.2 Specifications

1.2.1 General

Specifications	FPM-700 series
Construction	Die-cast aluminum
Front Panel	Die-cast aluminum - IP66
Video Port	HDMI/VGA/DP
Mounting Panel	Stand, Wall, Panel, and VESA arm (75 x 75mm)
FPM-715 Dimensions	(W x H x D) 383.2 x 307.3 x 50 mm
FPM-717 Dimensions	(W x H x D) 410.4 x 343.4 x 51 mm
FPM-719 Dimensions	(W x H x D) 454 x 379.8 x 48.5 mm
FPM-715W Dimensions	(W x H x D) 419.7 x 269 x 52 mm

1.2.2 Touchscreens (Optional)

Specifications	FPM-715/717/719
Type	5-wire analog resistive
Interface	USB/RS-232
Light Transmission	Above 75%
OS Support	Windows XP, Vista, 7, 8, 10, XPe and Linux

Specifications	FPM-715W
Type	Projected capacitive touch
Interface	USB
Light Transmission	Above 75%
OS Support	Windows XP, Vista, 7, 8, 10, XPe and Linux

1.3 LCD Specifications

Specifications	15" LCD (LED Backlight)	17" LCD (LED Backlight)	19" LCD (LED Backlight)	15.6" LCD (LED Backlight)
Display Type	XGA TFT LCD	SXGA TFT LCD	SXGA TFT LCD	Full HD TFT LED LCD
Display Size	15"	17"	19"	15.6"
Max. Colors	16.2M Max	16.7M Max	16.7M Max	16.7M Max
Resolution	1024 x 768	1280 x 1024	1280 x 1024	1920x1080
View Angle (H/V°)	176°(V), 176°(H)	170°(V), 170°(H)	170°(V), 160°(H)	160°(V), 160°(H)
Luminance	300 cd/m ²	350 cd/m ²	350 cd/m ²	450 cd/m ²
Storage Temperature	-30 - 70 °C			
Operating Temperature	-20 - 60 °C			
Contrast Ratio	2000:1	1000:1	1000:1	500:1
Backlight Life	70,000 hr	50,000 hr	70,000 hr	50,000 hr

1.4 Connectors

The following connectors are situated on the bottom side of the FPM-715/717/719/715W:

- **DP or HDMI port**
DP or HDMI port is connected with a standard DP or HDMI connector through the I/O port of this unit, located on the bottom side of the system unit.
- **VGA Port (DB-15)**
DB-15 connector can be connected to the system via the external 15-pin DB-15 connector located on the bottom side of the system unit.
- **Touchscreen Connector (USB)**
This connector will be present only if a touchscreen is installed and it must be connected to the USB port of the PC. The touchscreen cable is included with all orders.
- **DC 24 V Power Input Connector**
This connector must be connected to a DC 24 V power supply.

Warning! Please note before connecting the monitor and PC with HDMI / DP or VGA cable:



1. If the PC has an OS installed, please confirm its portrait frequency is within an acceptable range.

1.5 Interfaces

Figure 1.1 shows the I/O arrangement

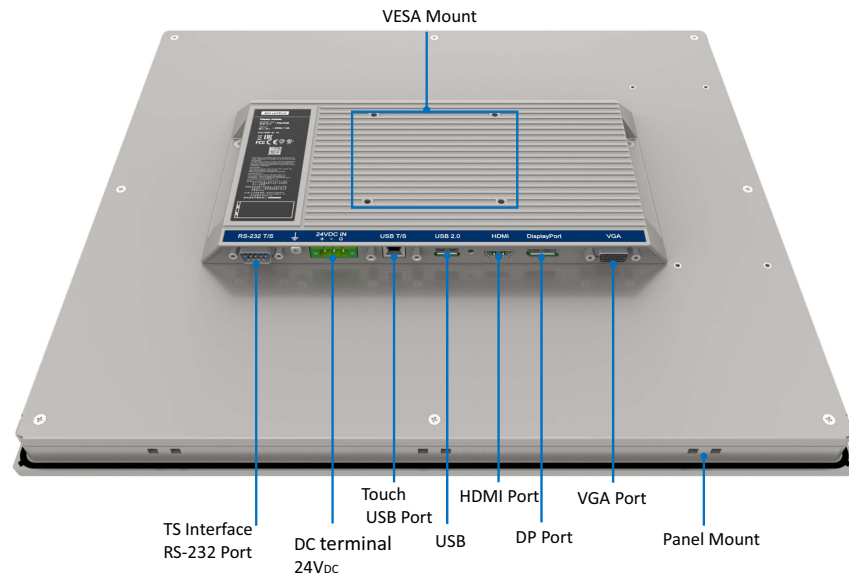

Figure 1.1 FPM-715/717/719 - I/O Port Arrangement

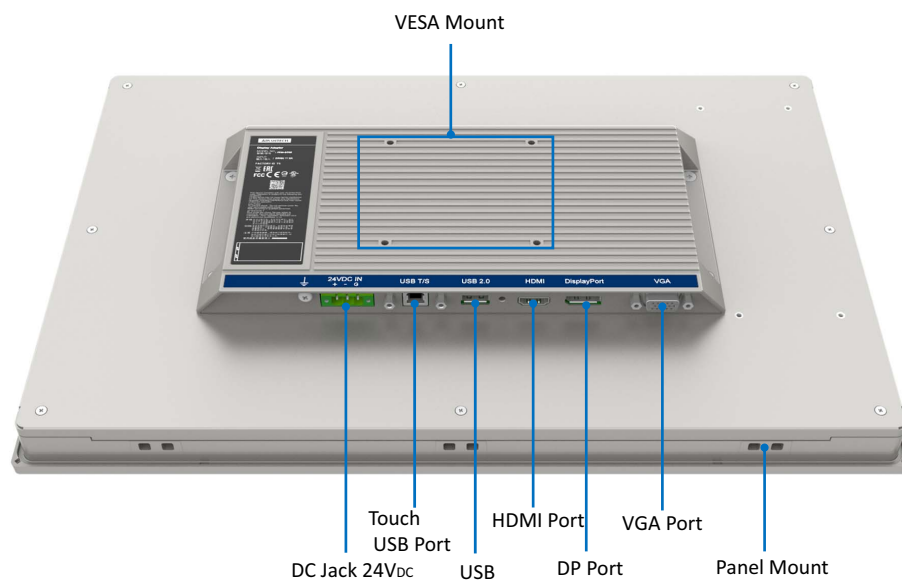

Figure 1.2 FPM-715W - I/O Port Arrangement

1.6 Dimensions

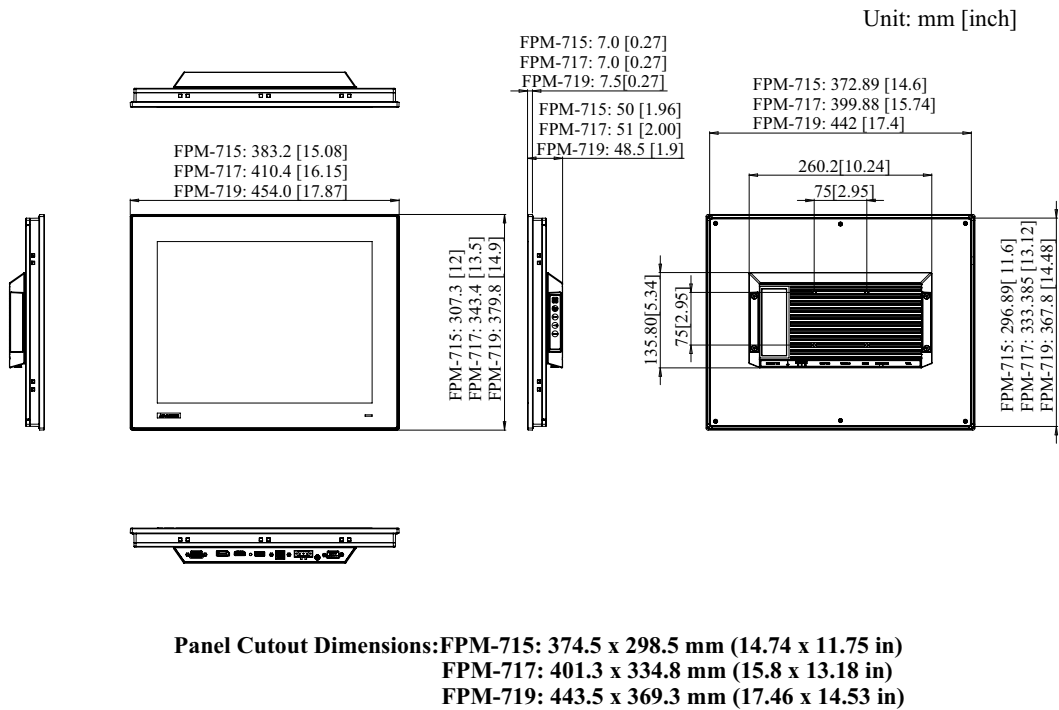

Figure 1.3 FPM-715/717/719 Dimensions

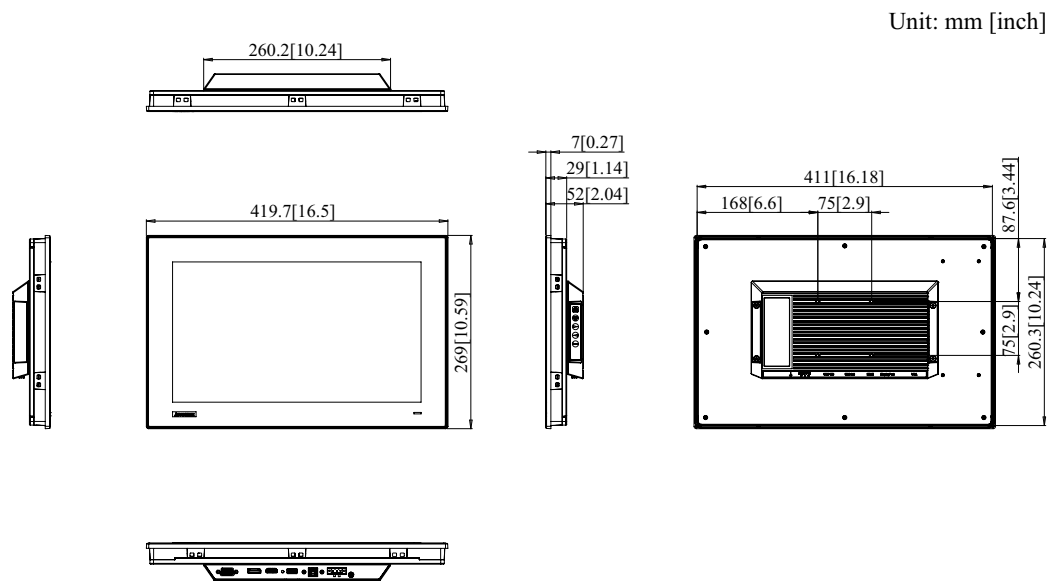

Figure 1.4 FPM-715W Dimensions

Chapter 2

Mounting Methods

Sections include:

- Panel Mounting
- Wall Mounting
- Desktop Stand Mounting
- VESA Mounting
- Power Adapter Bracket Mounting (Optional)

2.1 Mounting the Monitor / Monter le Moniteur

The FPM-700 series can be mounted in many different ways.

La série FPM-700 peut être montée de différentes manières. La polyvalence du FPM-700 lui permet d'être monté sur votre bureau ou ailleurs.

2.1.1 Panel Mounting / Montage Sur Panneau

FPM-700 series can be mounted directly on a panel with additional mounting brackets (provided in the accessory box).

Please refer to Figure 2.1 and follow the following steps:

1. Secure the 10 x panel brackets around the industrial monitor. See the figure below.
2. Secure the panel using the bracket.

La série FPM-700 peut être montée directement sur un panneau avec des supports de montage supplémentaires (fournis dans la boîte d'accessoires).

1. Fixez le support de panneau 10pcs autour du moniteur industriel, reportez-vous à la figure ci-dessous.
2. Fixez dans le panneau en vissant le support.

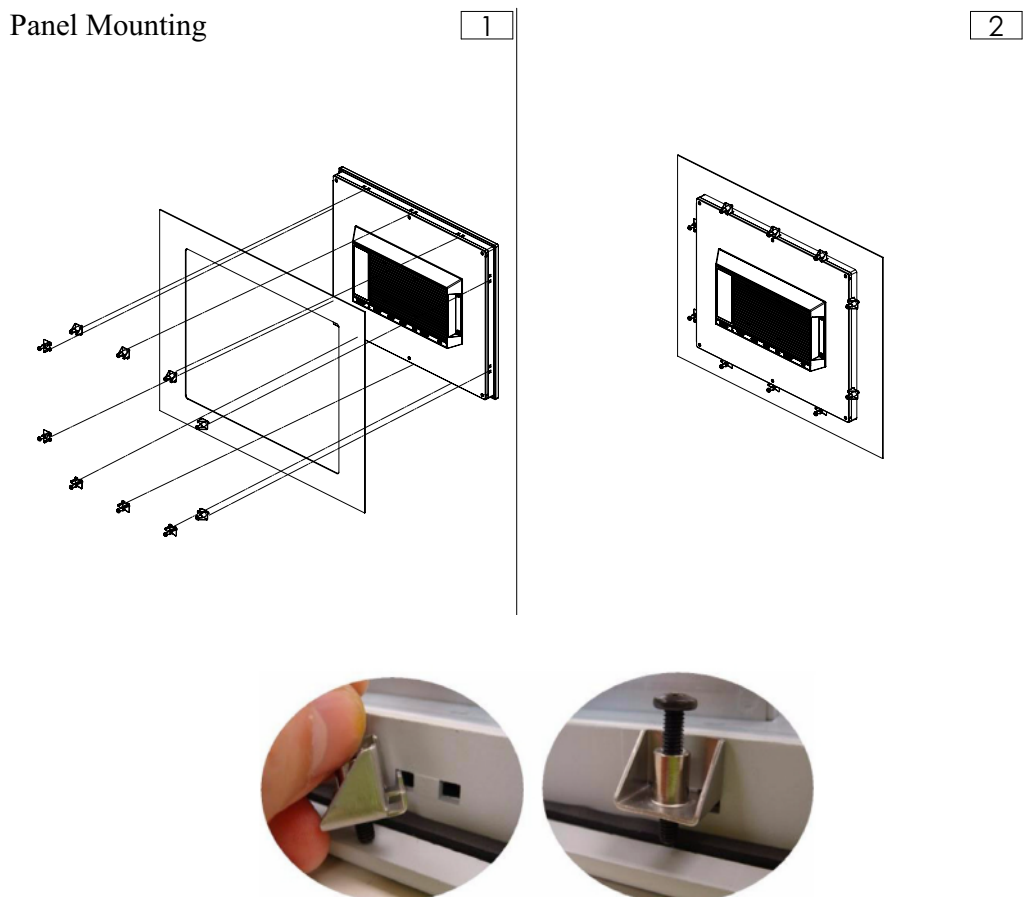

Figure 2.1 Panel Mounting

Panel Mounting

FPM-715/717/715W

10 clampers with M4 * 25mm screws.

FPM-719 12PCS

12 claspers with M4 * 25mm screws.

Diameter of screw = M4 min.

Length of screw = 25.0 min.

Montage sur panneau

10 pinces avec vis M4 * 25 mm.

Diamètre de la vis = M4 min.

Longueur de la vis = 25.0 min.

2.1.2 Wall Mounting / Montage mural

If you need to install the FPM-715/717/719/715W on a wall, you can use FPM-1000T mounting kit. This is offered as an optional accessory for FPM-715/717/719/715W. You need to secure this metal bracket to the wall first then, then fasten the FPM-715/717/719/715W with the included screws. The metal bracket holds the FPM-715/717/719/715W to the wall and completes the wall mounting process.

Please refer to Figure 2.2 and follow the steps shown to mount FPM-715/717/719/715W on a wall:

Si vous devez installer la série FPM-715/717/719/715W dans le mur, vous pouvez utiliser le kit de montage FPM-1000T qui est proposé comme accessoire optionnel pour FPM-715/717/719/715W. Vous devez d'abord fixer ce support métallique au mur, puis fixer le FPM-715/717/719/715W avec les vis incluses. Le support métallique maintient le FPM-715/717/719/715W au mur pour terminer le montage mural.

Veillez vous référer à la figure 2.2 et suivre les étapes suivantes pour monter le FPM-715/717/719/715W sur un mur:

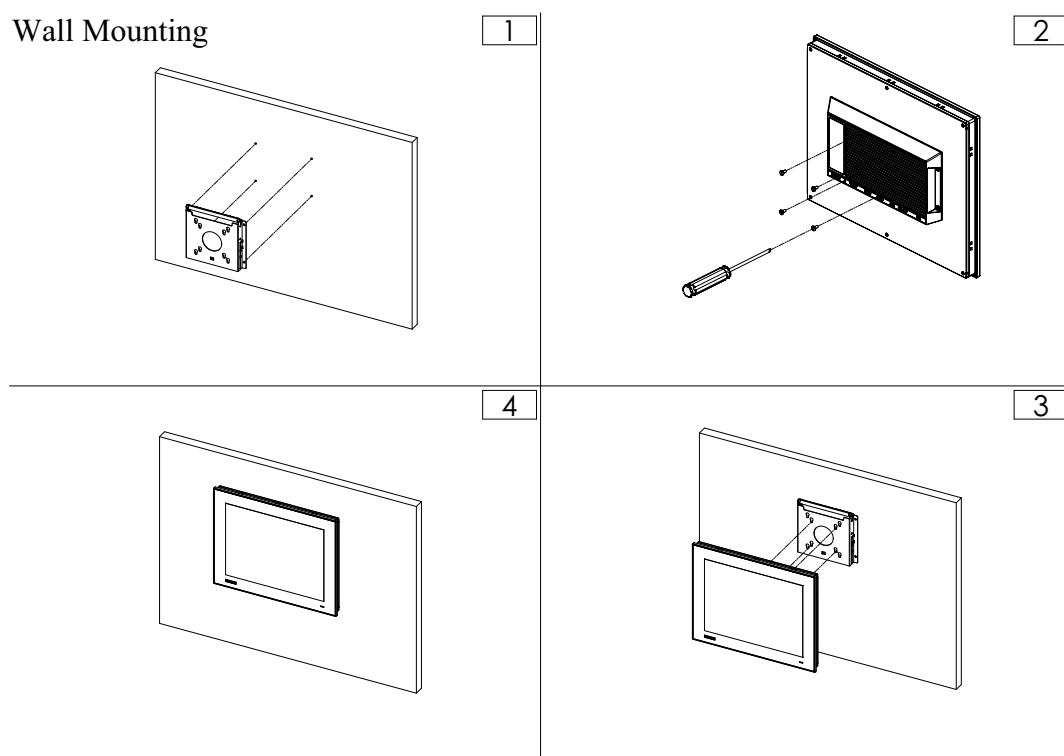

Figure 2.2 Wall Mounting

Wall Mounting

Screw to fix mounting kit

Diameter of screw = M4.

Length of screw = 6-10 mm

Montage mural

Vis pour fixer le kit de montage

Diamètre de vis = M4.

Longueur de vis = 6-10 mm

2.1.3 Desktop Stand Mounting / Montage du support de bureau

If you have to opted for the desk mount stand, you can use the FPM-1000T mounting kit and secure the stand with 2 x M4 screws to the desk for attachment of the FPM-715/717/719/715W mount.

(Note: FPM-1000T Mounting kit are offered as an optional accessory for FPM-715/717/719/715W.)

Si vous devez opter pour le support de montage sur bureau, vous pouvez également utiliser le montage FPM-1000T kit et fixer le support avec 2 vis M4 au bureau pour la fixation du support au FPM-715/717/719/715W.

(Note: Le kit de montage FPM-1000T est proposé comme accessoire optionnel pour le FPM-715/717/719/715W.)

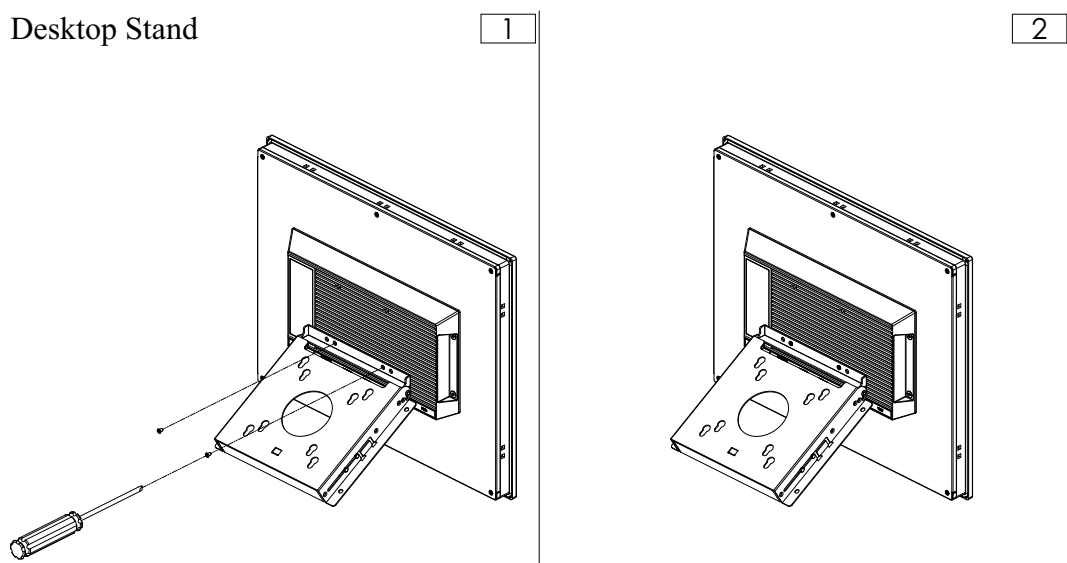

Figure 2.3 Desktop Stand Mounting

Desktop Stand Mounting

Use screws to secure the mounting kit (2 x pcs)

Diameter of screw = M4.

Length of screw = 6-10 mm

Montage du support de bureau

Vis pour fixer le kit de montage (2 pièces)

Diamètre de vis = M4.

Longueur de vis = 6-10 mm

2.1.4 VESA Mounting / Montage VESA

If you use VESA mounting the FPM-715/717/719/715W is a VESA MIS-D, 75, C compliant display equipped with a 75 x 75 mm square-hole pattern. Use M4 screws to attach the mount to the FPM-715/717/719/715W.

Si le montage VESA est préférable, le FPM-715/717/719/715W est un écran conforme à la norme VESA MIS-D, 75, équipé de perforations carrées de 75 x 75 mm. Utilisez des vis M4 pour fixer le support au FPM-715/717/719/715W.

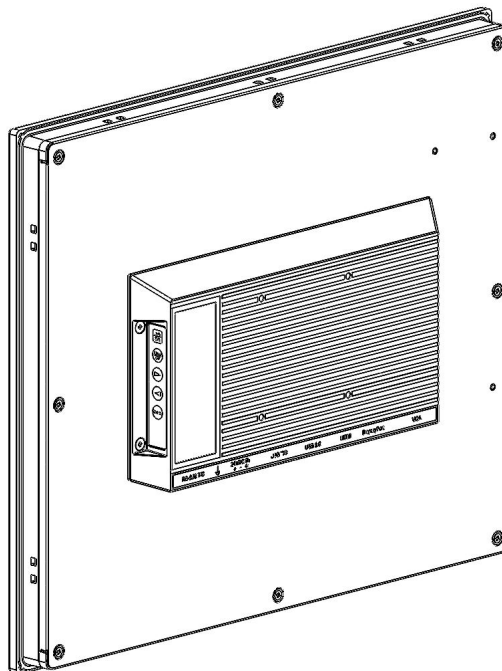

Figure 2.4 VESA Mounting

Warning! Use a suitable mounting apparatus to avoid risk of injury.



Remarque! Utiliser un appareil de montage approprié pour éviter tout risque de blessure.



Warning! VESA screw mounting specifications: M4. Depth of the screw hole: 6 mm(Max.).



Remarque! Spécifications de montage de la vis VESA: M4. Profondeur du trou de vis: 6 mm (max.).



2.1.5 Power Adapter Bracket Mounting (Optional)

A metal bracket is offered as an optional accessory for FPM-717/719/715W.(P/N : FPM-7000G-ADKE). This helps avoid hanging/loose power adapters.

This metal bracket can be mounted on the back of the monitor in 2 x simple steps:

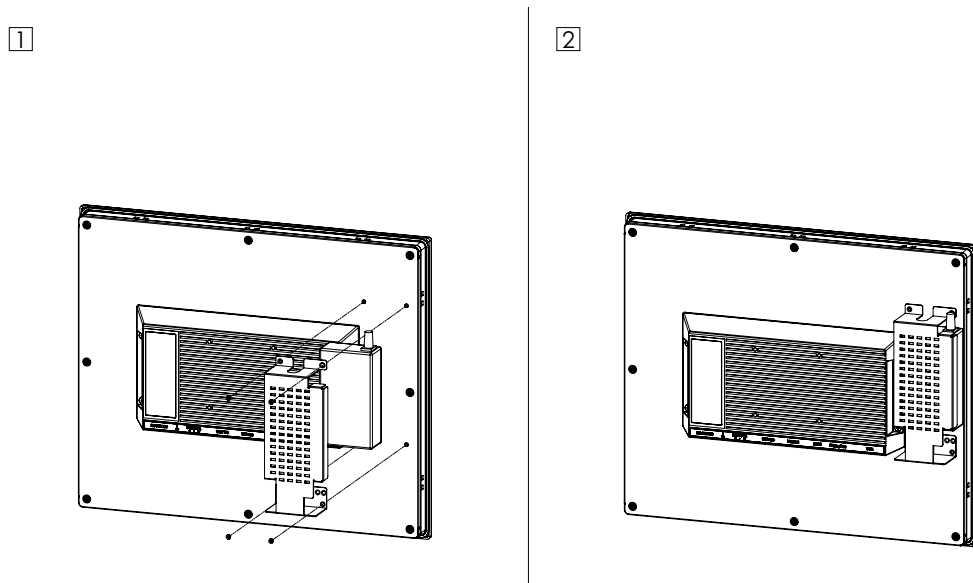

Figure 2.5 Power Adapter Bracket Mounting

1. Place the metal bracket on top of the power adapter and position it against the dedicated holes
2. Secure the metal bracket with the included screws and metal bracket installation is complete

This equipment must be installed and removed by a trained skilled person.

Recommendations for maximum cable distance and wires:

Single copper or multi-core copper wire, at 80 °C.

Wire range 12-24 AWG.

Wire strip length: 4-5 mm.

Screw torque 7.0 lb-inch.

Appendix **A**

Touchscreen

A.1 Introduction

The FPM-715/717/719 touchscreen uses advanced 5-wire resistive technology. The FPM-715W touchscreen uses Projected capacitive (PCAP) touch technology. It provides more accurate sensing capacity than other technologies. The touchscreens are designed for industrial environments and adhere to FCC Class A standards.

A.2 Touchscreen Specifications (15"/17"/19"/15.6")

A.2.1 Optical Features

Specification	15"	17"	19"	15.6"
Light Transmission	Above 75%			
Haze	< 1%			

A.2.2 Electrical Specifications

Specification	15"	17"	19"	15.6"
Operation Voltage	5.5 V or below			
Contact Current	70 mA (Maximum)			

A.2.3 Environmental Specifications

Specification	15"	17"	19"	15.6"
Operating Temperature	-20 -60 °C			
Storage Temperature	-30 -70 -°C			
Humidity	10 - 95%, non-condensing			

A.3 Installing Drivers for Windows OS

The touchscreen has drivers for Windows 7/8/10 and ADV Linux users. The FPM-715/717/719 series need to install Penmount 6000 driver. Please go to below website to download the Penmount 6000 driver then install the driver onto your system.

https://support.advantech.com/support/new_default.aspx

A.4 LED Functions

Table A.1: LED Function

ON	Blue
StandBy	Orange
No Signals	Orange

Appendix **B**

OSD Operation
Keypad

B.1 OSD Board Overview

The OSD keypad, including 6 x keys and a 2 x color indicators, is designed as the OSD operation interface.

Note! *This sheet is only for reference, different models will have different styles, but the functionality is the same.*



B.1.1 OSD Button Descriptions

Table B.1: OSD Button Descriptions

Auto/Exit	Automatically adjust the clock, phase, H-position and V-position. Exit menu.
Up/Right/Increase	Increase the brightness. Move the selector to the next option. Increase the gauge value of the selected option.
Down/Left/Decrease	Decrease the brightness. Move the selector to the previous option. Decrease the gauge value of the selected option.
Menu/Sel	Activate the OSD menu. Enter/confirm the selected option.
Source	Changes Input video source

B.2 OSD Key Functions

Each selected value is stored into LCD memory after SEL signal input or time out. The stored values are not affected if the power is turned off. But the selected value is not available in case a selected mode is changed before time out or power is turned off before time out. TIME OUT -> 5-6 seconds (Can be set in OSD Manager) The default definition of input keys is shown below::

B.2.1 Menu Start





Generate Main Menu

Press MENU Button in OSD function key

- Main Menu -- Displayed On Screen

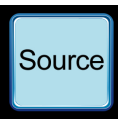

- Available Key Functions

	Select to exit the menu or wait for time-out		·Confirm ·Enter the selected option.
	Move the selector to the up-side Select the sub-menu		Detect video source
	Move the selector to the down-side Select the sub-menu		

B.2.2 Picture

- Generate Main Menu

Select using the up and down button, then press menu button for confirmation.





- Main Menu -- Displayed On Screen

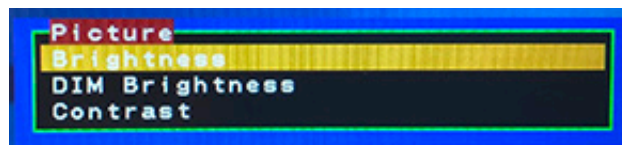

- Sub-Menu – Displayed On Screen



- Available Key Functions

	Select to exit the menu or wait for time-out		·Confirm ·Enter the selected option.
	Move the selector to the up-side Select the sub-menu		N/A
	Move the selector to the down-side Select the sub-menu		

B.2.3 Geometry

- Generate Main Menu

Select using the up and down button, then press menu button for confirmation.





- Main Menu -- Displayed On Screen

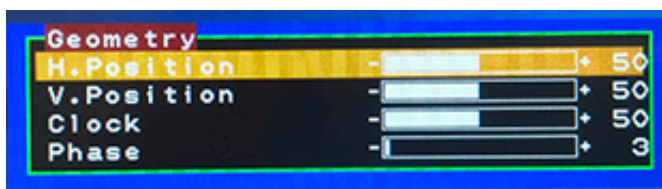

- Sub-Menu – Displayed On Screen

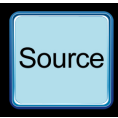

- Available Key Functions

	Return to the previous menu		Select to confirm
	Select to move up		N/A
	Select to move down		

B.2.4 Color Temperature Menu

- Generate Main Menu

Select using the up and down button, then press menu button for confirmation.

- Main Menu -- Displayed On Screen



- Sub-Menu – Displayed On Screen



- Available Key Functions

	Return to the previous menu		Select to confirm
	Select to move up		N/A
	Select to move down		

B.2.5 OSD Manager

- Generate Main Menu
Select using the up and down button, then press menu button for confirmation.
- Main Menu -- Displayed On Screen



- Sub-Menu – Displayed On Screen



- Available Key Functions

	Return to the previous menu		Select to confirm
	Select to move up		N/A
	Select to move down		

B.2.6 Touch Control

- Generate Main Menu

Select using the up and down button, then press menu button for confirmation.

- Main Menu -- Displayed On Screen



- Sub-Menu – Displayed On Screen

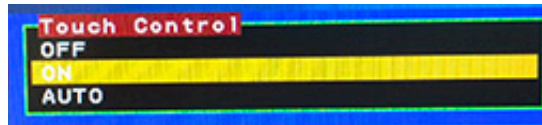

- Available Key Functions





	Return to the previous menu		Select to confirm
	Select to move up		N/A
	Select to move down		

Table B.2: Touch Control

Light Signal	States
Blue/Orange flashing	Off/No Signal
Orange flashing	No Signal
Orange stays on	On/No Signal

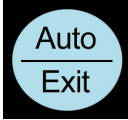
B.2.7 ERP Control

- Generate Main Menu
Select using the up and down button, then press menu button for confirmation.
- Main Menu -- Displayed On Screen





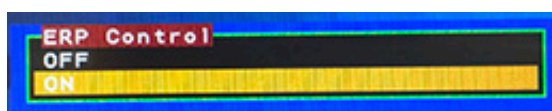

- Sub-Menu – Displayed On Screen

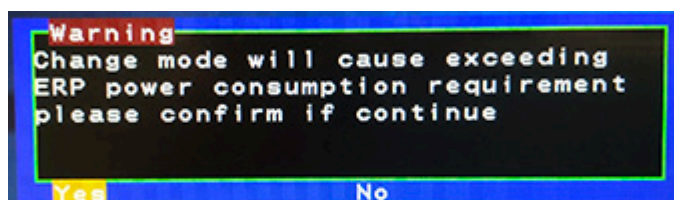

If you select ERP mode off, the system will pop up the following warning which means the system will exceeding ERP power consumption requirement but it still workable.

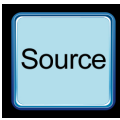

- Available Key Functions

	Return to the previous menu		Select to confirm
	Select to move up		N/A
	Select to move down		

B.2.8 All Reset

- Generate Main Menu

Select using the up and down button, then press menu button for confirmation.

- Main Menu -- Displayed On Screen



- Available Key Functions

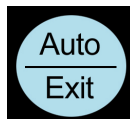

Return to the previous menu



Select to confirm



Select to move up

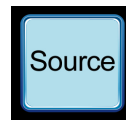

Detect video source



Select to move down

B.2.9 Exit

- Generate Main Menu

Select using the up and down button, then press menu button for confirmation.

- Main Menu -- Displayed On Screen



-www.advantech.com

Please verify specifications before quoting. This guide is intended for reference purposes only.

All product specifications are subject to change without notice.

No part of this publication may be reproduced in any form or by any means, electronic, photocopying, recording or otherwise, without prior written permission from the publisher.

All brand and product names are trademarks or registered trademarks of their respective companies.

© Advantech Co., Ltd. 2023