

# IP AUDIO SYSTEM

## User Manual

SPA-C100B/SPA-C100W  
SPA-C110B/SPA-C110W  
SPA-W100B/SPA-W100W  
SPA-H100B/SPA-H100W  
SPA-P100B/SPA-P100W  
SPA-D1000

# IP Audio System

## User Manual

---

### Copyright

©2023 Hanwha Vision Co., Ltd. All rights reserved.

### Trademark

Each of trademarks herein is registered. The name of this product and other trademarks mentioned in this manual are the registered trademark of their respective company.

### Restriction

Copyright of this document is reserved. Under no circumstances, this document shall be reproduced, distributed or changed, partially or wholly, without formal authorization.

### Disclaimer

Hanwha Vision makes the best to verify the integrity and correctness of the contents in this document, but no formal guarantee shall be provided. Use of this document and the subsequent results shall be entirely on the user's own responsibility. Hanwha Vision reserves the right to change the contents of this document without prior notice.

※ Appearance, specification, etc. of the product is subject to change for performance improvements without prior notice.

The latest update is available on the official Hanwha Vision website. ([www.HanwhaVision.com](http://www.HanwhaVision.com))

※ The ID for the initial login is "admin," and a password should be set.

Please change your password every three months to protect your personal data and prevent identity theft.

Please note that users are responsible for the security and other issues caused by insufficient password management.

## WARNING

TO REDUCE THE RISK OF FIRE OR ELECTRIC SHOCK, DO NOT EXPOSE THIS PRODUCT TO RAIN OR MOISTURE. DO NOT INSERT ANY METALLIC OBJECT THROUGH THE VENTILATION GRILLS OR OTHER OPENINGS ON THE EQUIPMENT.

Apparatus shall not be exposed to dripping or splashing and that no objects filled with liquids, such as vases, shall be placed on the apparatus.

To prevent injury, this apparatus must be securely attached to the Wall/ceiling in accordance with the installation instructions.

## CAUTION

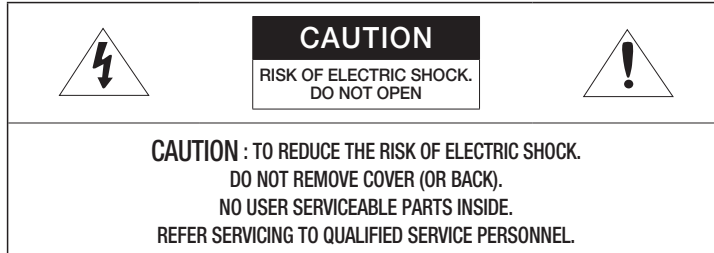

## EXPLANATION OF GRAPHICAL SYMBOLS



The lightning flash with arrowhead symbol, within an equilateral triangle, is intended to alert the user to the presence of “dangerous voltage” within the product’s enclosure that may be of sufficient magnitude to constitute a risk of electric shock to persons.



The exclamation point within an equilateral triangle is intended to alert the user to the presence of important operating and maintenance (servicing) instructions in the literature accompanying the product.

## CAUTION

RISK OF EXPLOSION IF BATTERY IS REPLACED BY AN INCORRECT TYPE. DISPOSE OF USED BATTERIES ACCORDING TO THE INSTRUCTIONS.

## ATTENTION

IL Y A RISQUE D'EXPLOSION SI LA BATTERIE EST REMPLACÉE PAR UNE BATTERIE DE TYPE INCORRECT.

METTRE AU REBUT LES BATTERIES USAGÉES CONFORMÉMENT AUX INSTRUCTIONS.

These servicing instructions are for use by qualified service personnel only.



To reduce the risk of electric shock do not perform any servicing other than that contained in the operating instructions unless you are qualified to do so.

**The ITE is to be connected only to (PoE/PoE+) networks without routing to the outside plant.**

The wired LAN hub providing power over the Ethernet (PoE/PoE+) in accordance with IEEE 802.3af/at shall be a UL Listed device with the output evaluated as a Limited Power Source as defined in UL60950-1 or PS2 as defined in UL62368-1.

Unit is intended for installation in a Network Environment 0 as defined in IEC TR 62102. As such, associated Ethernet wiring shall be limited to inside the building.

## IMPORTANT SAFETY INSTRUCTIONS

1. Read these instructions.
2. Keep these instructions.
3. Heed all warnings.
4. Follow all instructions.
5. Do not use this apparatus near water.
6. Clean the contaminated area on the product surface with a soft, dry cloth or a damp cloth.  
(Do not use a detergent or cosmetic products that contain alcohol, solvents or surfactants or oil constituents as they may deform or cause damage to the product.)
7. Do not block any ventilation openings, Install in accordance with the manufacturer's instructions.
8. Do not install near any heat sources such as radiators, heat registers, stoves, or other apparatus (including amplifiers) that produce heat.
9. Do not defeat the safety purpose of the polarized or grounding-type plug. A polarized plug has two blades with one wider than the other. A grounding type plug has two blades and a third grounding prong. The wide blade or the third prong are provided for your safety. If the provided plug does not fit into your outlet, consult an electrician for replacement of the obsolete outlet.
10. Protect the power cord from being walked on or pinched particularly at plugs, convenience receptacles, and the point where they exit from the apparatus.
11. Only use attachments/ accessories specified by the manufacturer.
12. Use only with the cart, stand, tripod, bracket, or table specified by the manufacturer, or sold with the apparatus. When a cart is used, use caution when moving the cart/ apparatus combination to avoid injury from tip-over.
13. To prevent injury, this apparatus must be securely attached to the Wall/ceiling in accordance with the installation instructions.
14. Unplug this apparatus during lighting storms or when unused for long periods of time.
15. Refer all servicing to qualified service personnel. Servicing is required when the apparatus has been damaged in any way, such as power-supply cord or plug is damaged, liquid has been spilled or objects have fallen into the apparatus, the apparatus has been exposed to rain or moisture, does not operate normally, or has been dropped.
16. This product is intended to be supplied by a Listed Power Supply Unit marked "Class 2" or "LPS" or "PS2" and rated from PoE(802.3af) : 44V-57V , max 300mA / PoE+(802.3at) : 50V-57V , max 510mA.
17. This product is intended to be supplied by isolation power.
18. If you use excessive force when installing the product, the product may be damaged and malfunction.  
If you forcibly install the product using non-compliant tools, the product may be damaged.
19. Do not install the product in a place where chemical substances or oil mist exists or may be generated. As edible oils such as soybean oil may damage or warp the product, do not install the product in the kitchen or near the kitchen table.  
This may cause damage to the product.
20. When installing the product, be careful not to allow the surface of the product to be stained with chemical substance.  
Some chemical solvents such as cleaner or adhesives may cause serious damage to the product's surface.
21. If you install/disassemble the product in a manner that has not been recommended, the production functions/ performance may not be guaranteed.



22. Do not install on a surface where it is exposed to direct sunlight, near heating equipment or heavy cold area.
23. Do not place this apparatus near conductive material.
24. Do not attempt to service this apparatus yourself.
25. Do not place a glass of water on the product.
26. Do not install near any magnetic sources.
27. Do not place heavy items on the product.
28. Please wear protective gloves when installing/removing the product.  
The high temperature of the product surface may cause a burn.
29. This device has been verified using STP cable. The use of appropriate GND grounding and STP cable is recommended to effectively protect your product and property from transient voltage, thunderstroke, communication interruption.
30. In particular installation environments, there might be interference in radio communications.  
When interference of electromagnetic waves occurs between the product and radio communication device, it is recommended to keep a certain distance between the two or change the direction of the receiving antenna.
31. An apparatus with CLASS I construction shall be connected to a MAINS socket outlet with a protective earthing connection.
32. Batteries(battery pack or batteries installed) shall not be exposed to excessive heat such as sunshine, fire or the like. The battery cannot be replaced.
33. Disconnect the main plug from the apparatus, if it's defected. And please call a repair man in your location.
34. Select an installation site that can hold at least 5 times the product's weight.
35. Stuck-in or peeled-off cables can cause damage to the product or a fire.
36. For safety purposes, keep anyone else away from the installation site.  
And put aside personal belongings from the site, just in case.
37. We do not guarantee the quality of third-party products (e.g. accessories) that you separately purchase.
38. When a PoE+ power supply is being used, high volume output may affect the system stability.

## Table of Contents

---

<b>OVERVIEW</b>	3	4	Important Safety Instructions
		6	Names and Functions of the IP Audio Module (SPA-D1000)
		6	Names and functions of the IP speakers (ceiling-mount type) (SPA-C100B/SPA-C100W)
		7	Names and functions of the IP speakers (ceiling-mount type, flame retardant structure / Plenum rate) (SPA-C110B/SPA-C110W)
		8	Names and functions of the IP speakers (wall-mount type) (SPA-W100B/SPA-W100W)
		9	Names and functions of the IP speakers (HORN type) (SPA-H100B/SPA-H100W)
		10	Names and functions of the IP speakers (Pendant type) (SPA-P100B/SPA-P100W)
		11	Broadcast System Configuration Diagram
		12	Connecting To Power And A Network

<b>STARTING</b>	13	13	Connecting to a PC
		13	Access Product
		16	Logging In

<b>ENVIRONMENT SETTINGS</b>	17	17	System Management
		20	Network Settings
		20	Time Settings
		21	snmp Action Settings
		22	Device operation setting

<b>USE IN THE CONTROLLER MODE</b>	23	23	Home Screen Configuration
		23	Operation Mode
		28	Control Mode
		29	System Settings
		39	Maintenance

<b>USING SPEAKER MODE</b>	40	40	Home Screen Configuration
		40	Operation Settings
		50	Maintenance

## NAMES AND FUNCTIONS OF THE IP AUDIO MODULE (SPA-D1000)

Side

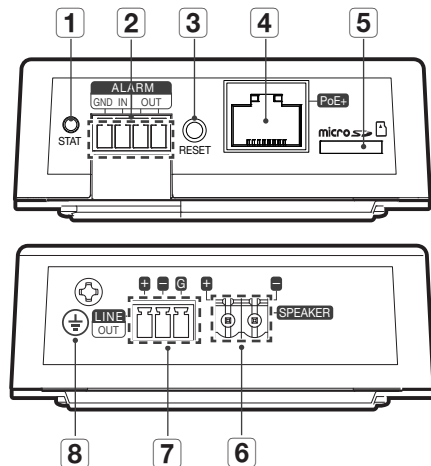

Name	Function Description
<b>1</b> STATUS	When the initialization is in progress, the STATUS lamp blinks fast. When the initialization is completed, it blinks slowly in an interval of 1 second.
<b>2</b> ALARM	ALARM IN: An alarm input terminal. ALARM OUT: An alarm output terminal. GND: It is a ground terminal.
<b>3</b> RESET	A button that returns the product settings to the factory default values. Press the button for approximately 12 seconds, the STATUS lamp blinks at a fast speed, and when the reboot is completed after initialization, it blinks at a slow speed again. <b>!</b> Do not disconnect the power until product resetting is complete. Doing so may cause malfunctions. It will take up to 10 minutes to reboot the product after initializing it.
<b>4</b> Network Terminal	A terminal that connects a switching hub supporting PoE or PoE+ and a network cable for power and network connection.
<b>5</b> micro SD card slot	A slot for a micro SD card.
<b>6</b> SPEAKER	A terminal connected to a speaker.
<b>7</b> LINE OUT	An output terminal for external devices, such as an amplifier.
<b>8</b> Grounding port	Used for earth-grounding. Grounding serves to protect the product from lightning strikes. Before connection, be sure to turn off the power of the device.

## NAMES AND FUNCTIONS OF THE IP SPEAKERS (CEILING-MOUNT TYPE) (SPA-C100B/SPA-C100W)

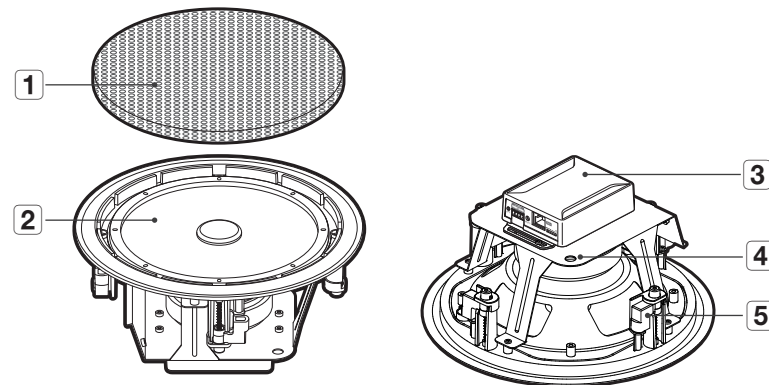

Name	Function Description
<b>1</b> Detachable grille	Prevents dust intrusion.
<b>2</b> Speaker unit	Generates speaker vibration.
<b>3</b> Audio module	Equipped with an audio module.
<b>4</b> Safety cable hook	Secures the speaker during installation to prevent it from falling.
<b>5</b> Bracket	Secures the speaker to the ceiling board.

 The IP audio module can be used as an IP speaker when connected to an analog speaker with a permissible input of 10W or higher and an impedance of 8 ohms.

**NAMES AND FUNCTIONS OF THE IP SPEAKERS (CEILING-MOUNT TYPE, FLAME RETARDANT STRUCTURE / PLENUM RATE) (SPA-C110B/ SPA-C110W)**

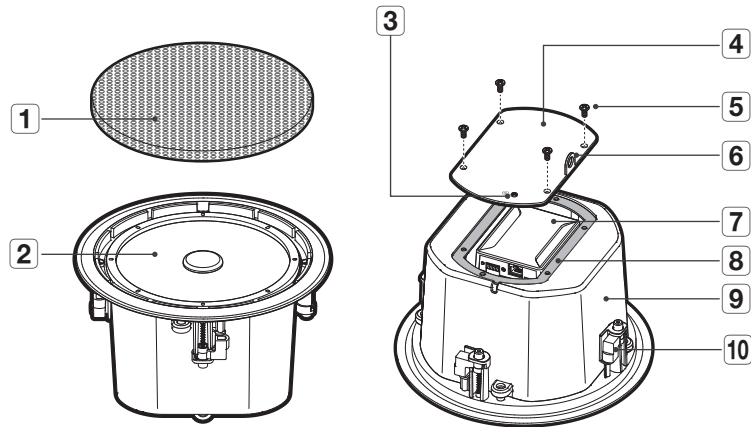

Name	Function Description
<b>1</b> Detachable grille	Prevents dust intrusion.
<b>2</b> Speaker unit	Generates speaker vibration.
<b>3</b> Grounding port	Used for earth-grounding. Grounding serves to protect the product from lightning strikes. Before connection, be sure to turn off the power of the device.
<b>4</b> Speaker terminal cover	Covers the speaker terminal.

Name	Function Description
<b>5</b> Screw	A screw for securing the speaker terminal cover.
<b>6</b> Safety cable hook	Secures the speaker during installation to prevent it from falling.
<b>7</b> Audio module	Equipped with an audio module.
<b>8</b> Gasket	Dustproof/waterproof gasket.
<b>9</b> Speaker housing	Dustproof/waterproof speaker housing.
<b>10</b> Bracket	Secures the speaker to the ceiling board.

## NAMES AND FUNCTIONS OF THE IP SPEAKERS (WALL-MOUNT TYPE) (SPA-W100B/SPA-W100W)

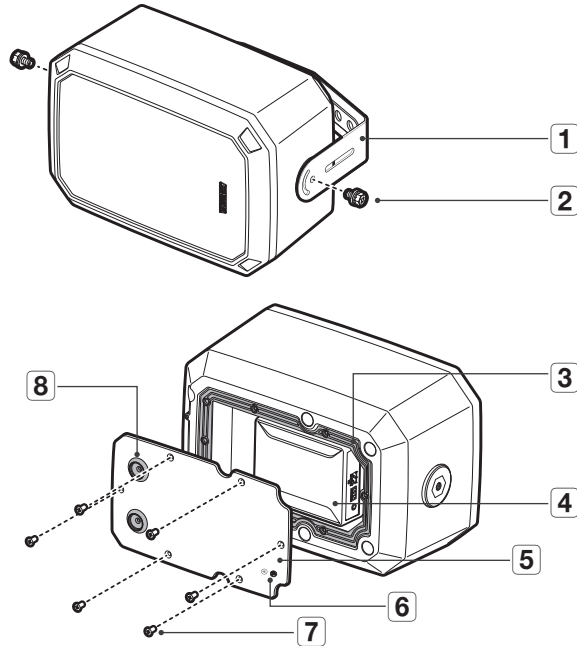

Name	Function Description
<b>4</b> Gasket	Dustproof/waterproof gasket.
<b>5</b> Speaker terminal cover	Covers the speaker terminal.
<b>6</b> Grounding port	Used for earth-grounding. Grounding serves to protect the product from lightning strikes. Before connection, be sure to turn off the power of the device.
<b>7</b> Screw	A screw for securing the speaker terminal cover.
<b>8</b> Cable bushing	Connects network and alarm cables.

Name	Function Description
<b>1</b> Bracket	Mounts the speaker on a wall.
<b>2</b> Bracket fixing screw	Secures the bracket.
<b>3</b> Audio module	Equipped with an audio module.



## NAMES AND FUNCTIONS OF THE IP SPEAKERS (HORN TYPE) (SPA-H100B/SPA-H100W)

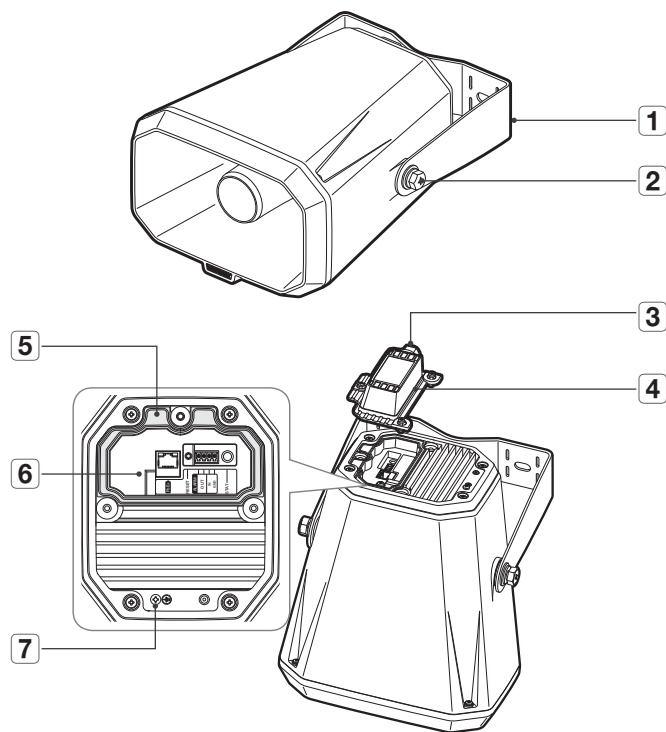

Name	Function Description
<b>5</b> Gasket	Dustproof/waterproof gasket.
<b>6</b> Audio module	Equipped with an audio module.
<b>7</b> Grounding port	Used for earth-grounding. Grounding serves to protect the product from lightning strikes. Before connection, be sure to turn off the power of the device.

-  ■ MicroSD card slot is not available.
- BGM or Chime sound sources can only be uploaded to the internal storage.

Name	Function Description
<b>1</b> Bracket	Mounts the speaker on a wall.
<b>2</b> Bracket fixing screw	Secures the bracket.
<b>3</b> Waterproof plug	Used for waterproofing when connecting the network and alarm cables.
<b>4</b> Speaker terminal cover	Protects the speaker terminals.

## NAMES AND FUNCTIONS OF THE IP SPEAKERS (PENDANT TYPE) (SPA-P100B/SPA-P100W)

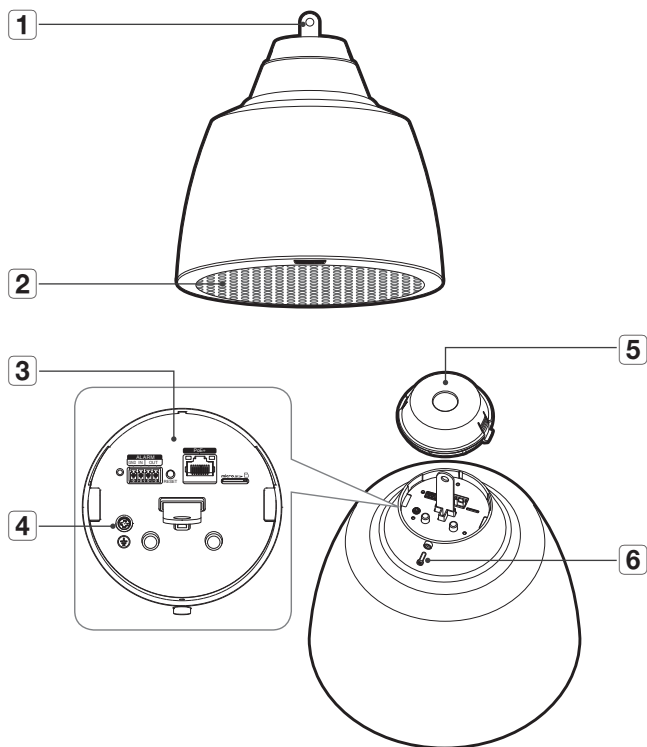

Name	Function Description
<b>4</b> Grounding port	Used for earth-grounding. Grounding serves to protect the product from lightning strikes. Before connection, be sure to turn off the power of the device.
<b>5</b> Speaker terminal cover	Protects the speaker terminals.
<b>6</b> Screw	A screw for securing the speaker terminal cover.

Name	Function Description
<b>1</b> Wire link	Connected to the wire by using the provided carabiner.
<b>2</b> Detachable grille	Prevents dust intrusion.
<b>3</b> Audio module	Equipped with an audio module.

## BROADCAST SYSTEM CONFIGURATION DIAGRAM

### Controller Mode Block Diagram

It is a block diagram for using the IP speakers in a controller mode.

The controller mode speaker provides an operating GUI which is different from a regular speaker, and it can control multiple speakers via the button mode or event & preset menu.

You can configure a broadcast system by connecting the IP microphone (SPA-M1000) to it. Refer to the separate manual for the IP microphone.

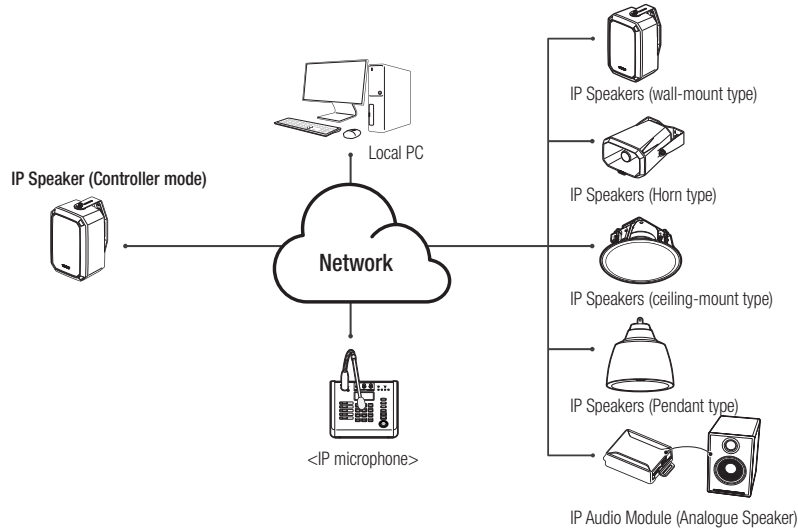

- You can use the IP audio server (SPA-S1000) as a controller.
- The IP audio module can be used as an IP speaker when connected to an analog speaker with a permissible input of 10W or higher and an impedance of 8 ohms.
- There should be only one controller mode product in the broadcast system. If multiple controller mode speakers or servers are registered redundantly, broadcasting cannot be performed properly.

### Speaker Mode Block Diagram

You can run a scheduled broadcasting, BGM, or TTS broadcasting using each speaker by itself.

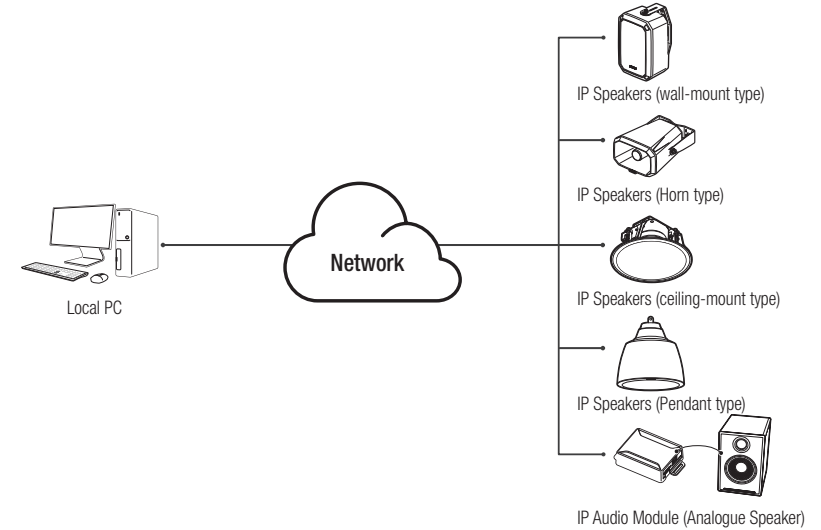

### IP PBX Linkage Block Diagram

You can broadcast voice to each speaker with a VoIP phone which uses the SIP protocol by using the IP PBX server.

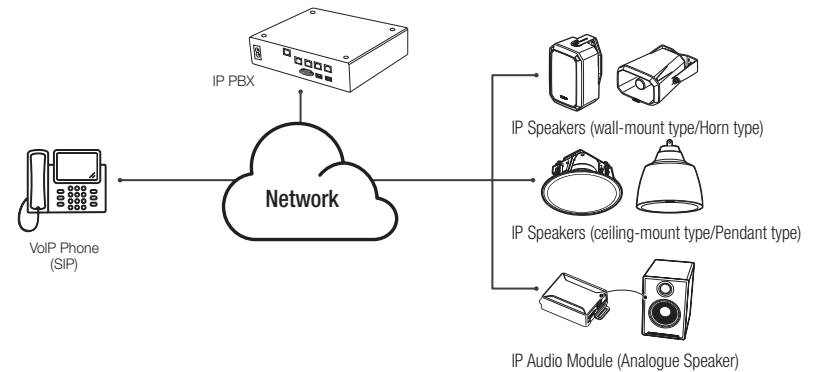

## CONNECTING TO POWER AND A NETWORK

Connect the switching hub that supports PoE or PoE+ to the NETWORK port of the product using a network cable. If you connect the product to a switching hub that supports PoE+ or PoE, you can use it without a separate power source.

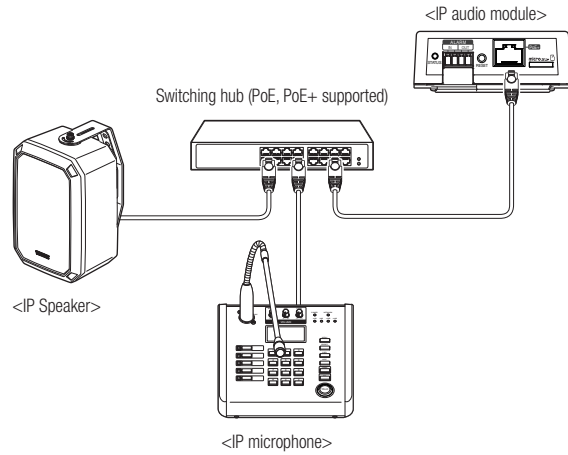

## Network Cable Specification

Item	Contents	Remark
Connector	RJ45 (10/100BASE-T)	
Ethernet	10/100BASE-T	10/100 Mbps
Cable	Category 5e	
Max Distance	100 m	DC Resistance $\leq 0.125 \Omega/\text{m}$
PoE Support	PoE+ / PoE	

- ! ■ Use PoE+ switch hubs that support the IEEE 802.3at standard.
- Use PoE switch hubs that support the IEEE 802.3af standard.

## CONNECTING TO A PC

The PC should be connected to the same network as the product when accessing the product for the first time. Use a network cable to connect the product to the switching hub that is connected with the PC.

-  ■ A speaker or an audio module is powered by PoE/PoE+. Use a switching hub that supports PoE or PoE+.
- The IP microphone can receive power via PoE, or the DC power adapter can be used.

## ACCESS PRODUCT

Various functions, including Operation Mode, System Settings, Maintenance, Environment Setting, and Operation Settings, are available on the product website.

1. Set an IP address to 192.168.1.x, the same band as the product, in the Network Property of the PC.

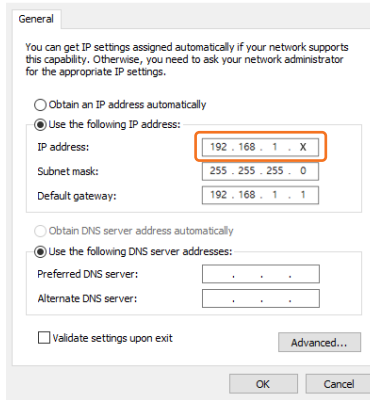

**General**

You can get IP settings assigned automatically if your network supports this capability. Otherwise, you need to ask your network administrator for the appropriate IP settings.

Obtain an IP address automatically

Use the following IP address:

IP address: 192 . 168 . 1 . X

Subnet mask: 255 . 255 . 255 . 0

Default gateway: 192 . 168 . 1 . 1

Obtain DNS server address automatically

Use the following DNS server addresses:

Preferred DNS server: . . .

Alternate DNS server: . . .

Validate settings upon exit

Advanced...

OK Cancel

2. Run a web browser on the PC.

-  ■ An available web browser is Google Chrome (Version 92.0.4515.131 or higher). Google Chrome is available at [www.google.com/chrome](http://www.google.com/chrome).
- It can be used in Chrome as it is a supported web browser. For the computer OS, it can be used in Windows 10 or Mac 11.6 (Big Sur) or 12.2 (Monterey).



3. The initial IP address of all products is 192.168.1.100. Before installing the product, it is recommended to set a static IP address for separate products.

-  ■ If multiple products are connected concurrently to the same switch hub with the initial IP addresses, the web page cannot distinguish the IP addresses, resulting in failing to set passwords. Use Device Manager to set the initial password and IP address to use.

## Registering using Device Manager

If the product is connected to a network which includes a computer where the device manager is installed, you can search products, set up passwords, change IP addresses, upgrade firmware, and access web pages.

Please refer to the manual of the Device Manager Program for more information.

-  ■ The Device Manager Program () is available on the official Hanwha Vision website (<https://www.HanwhaVision.com>) by clicking <Support> - <Online Tool>.

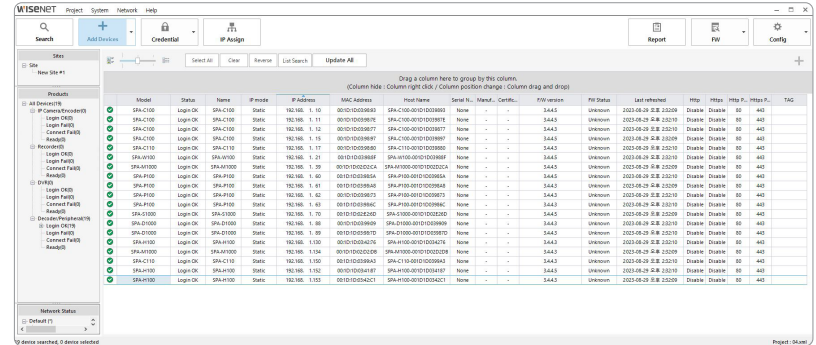

Model	Status	Name	IP Address	MAC Address	Product Name	Serial No.	Menu	Control	Firmware	File Status	Last Refreshed	HTTP	HTTPS	HTTP2	TAG
SFA-C100	Login OK	SFA-C100	192.168.1.10	00:10:00:00:00:00	SFA-C100-0010000001	None	-	-	SA4.0	Unknown	2023-06-26 8:28:20	Disable	Disable	00	443
SFA-C100	Login OK	SFA-C100	192.168.1.11	00:10:00:00:00:00	SFA-C100-0010000002	None	-	-	SA4.0	Unknown	2023-06-26 8:28:20	Disable	Disable	00	443
SFA-C100	Login OK	SFA-C100	192.168.1.12	00:10:00:00:00:00	SFA-C100-0010000003	None	-	-	SA4.0	Unknown	2023-06-26 8:28:20	Disable	Disable	00	443
SFA-C110	Login OK	SFA-C110	192.168.1.13	00:10:00:00:00:00	SFA-C110-0010000001	None	-	-	SA4.0	Unknown	2023-06-26 8:28:20	Disable	Disable	00	443
SFA-A100	Login OK	SFA-A100	192.168.1.21	00:10:00:00:00:00	SFA-A100-0010000001	None	-	-	SA4.0	Unknown	2023-06-26 8:28:20	Disable	Disable	00	443
SFA-A100	Login OK	SFA-A100	192.168.1.29	00:10:00:00:00:00	SFA-A100-0010000004	None	-	-	SA4.0	Unknown	2023-06-26 8:28:20	Disable	Disable	00	443
SFA-F100	Login OK	SFA-F100	192.168.1.40	00:10:00:00:00:00	SFA-F100-0010000001	None	-	-	SA4.0	Unknown	2023-06-26 8:28:20	Disable	Disable	00	443
SFA-F100	Login OK	SFA-F100	192.168.1.81	00:10:00:00:00:00	SFA-F100-0010000008	None	-	-	SA4.0	Unknown	2023-06-26 8:28:20	Disable	Disable	00	443
SFA-F100	Login OK	SFA-F100	192.168.1.82	00:10:00:00:00:00	SFA-F100-0010000003	None	-	-	SA4.0	Unknown	2023-06-26 8:28:20	Disable	Disable	00	443
SFA-F100	Login OK	SFA-F100	192.168.1.83	00:10:00:00:00:00	SFA-F100-0010000004	None	-	-	SA4.0	Unknown	2023-06-26 8:28:20	Disable	Disable	00	443
SFA-S100	Login OK	SFA-S100	192.168.1.79	00:10:00:00:00:00	SFA-S100-0010000000	None	-	-	SA4.0	Unknown	2023-06-26 8:28:20	Disable	Disable	00	443
SFA-S100	Login OK	SFA-S100	192.168.1.80	00:10:00:00:00:00	SFA-S100-0010000001	None	-	-	SA4.0	Unknown	2023-06-26 8:28:20	Disable	Disable	00	443
SFA-D100	Login OK	SFA-D100	192.168.1.89	00:10:00:00:00:00	SFA-D100-0010000000	None	-	-	SA4.0	Unknown	2023-06-26 8:28:20	Disable	Disable	00	443
SFA-H100	Login OK	SFA-H100	192.168.1.100	00:10:00:00:00:00	SFA-H100-0010000001	None	-	-	SA4.0	Unknown	2023-06-26 8:28:20	Disable	Disable	00	443
SFA-A100	Login OK	SFA-A100	192.168.1.104	00:10:00:00:00:00	SFA-A100-0010000008	None	-	-	SA4.0	Unknown	2023-06-26 8:28:20	Disable	Disable	00	443
SFA-C110	Login OK	SFA-C110	192.168.1.100	00:10:00:00:00:00	SFA-C110-0010000003	None	-	-	SA4.0	Unknown	2023-06-26 8:28:20	Disable	Disable	00	443
SFA-A100	Login OK	SFA-A100	192.168.1.102	00:10:00:00:00:00	SFA-A100-0010000001	None	-	-	SA4.0	Unknown	2023-06-26 8:28:20	Disable	Disable	00	443
SFA-A100	Login OK	SFA-A100	192.168.1.103	00:10:00:00:00:00	SFA-A100-0010000001	None	-	-	SA4.0	Unknown	2023-06-26 8:28:20	Disable	Disable	00	443

1. When you connect multiple products to the switch hub, their IP addresses are 192.168.1.100, and their status information are queried as <Need PW>.
  - If they are not queried as <Need PW>, click <New Project> → <Search>, and set the passwords after they are queried as <Need PW>.
  - If you set a password in the [Credential] menu and press [Search] on the list screen, the status information is queried as <Connect Fail>.
  - If you press <New Project> → <Search>, the status information is queried as <Ready>. And if you press <Search> again, it is queried as <Connect Fail>.
2. Select one or multiple products and set a password to use for each product.
  - The <Host Name> and <Serial Number> are queried when you log in using the [Credential] menu after an IP address is assigned to each product.
3. When the password is set, the <MAC Address> of each product is queried.
  - A password should contain 8 or more characters, and if it contains fewer than 9 characters, then a combination of 3 or more English uppercase/lowercase letters, numbers, or special characters must be used. If it includes 10 to 16 characters, a combination of 2 or more types must be used.
  - It is recommended not to use the same character repeatedly or consecutive keyboard inputs as passwords for enhanced security.
  - If the initial password setting in the [Credential] menu fails due to a <Timeout>, set the initial password again after assigning the IP addresses of other products with <Success> in password setting.

4. Select a product to set its IP address, and enter the IP address to use (e.g., Set Static IP).

**When you select products one by one**

- Select **<Assign the following IP address>** from the **[IP Assign]** menu, then set its IP address.
- The DNS server address is automatically set as the product's initial DNS address (DNS1 8.8.8.8, DNS2 8.8.4.4).

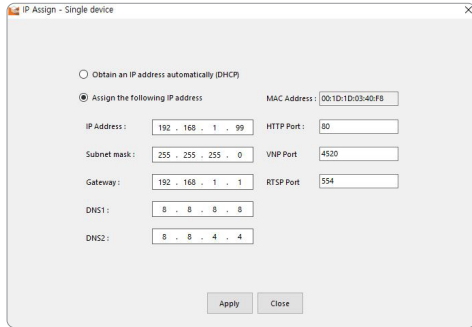

**When you select multiple products**

- Select **<Assign the following IP address>** from the **[IP Assign]** menu. Then apply the starting address in the range of IP addresses to be assigned.

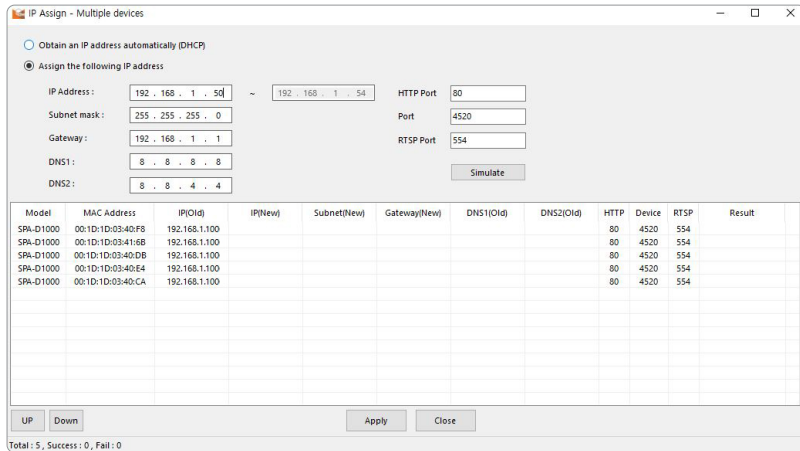

- When you select **<Obtain an IP address automatically (DHCP)>** from the **[IP Assign]** menu, the DHCP IP address is automatically assigned.
- The HTTP port supports only the number 80, and the VNP and RTSP ports are not used in the IP audio product.

5. Products with IP addresses must be logged in from the **[Credential]** menu to be queried as **<Login OK>**.

- When you execute **<New Project>** → **<Search>**, authentication is canceled and the product is queried as **<Login Fail>**.
- If you apply the product password in **<System>** → **<Device Default Credential setting>** in the device manager, it is automatically queried as **<Login OK>** even when you search for it as a new project or re-execute the device manager.

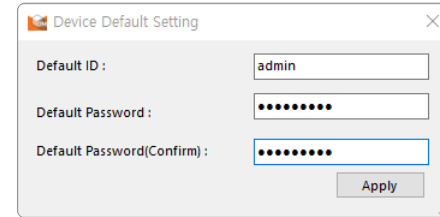

- You can update to the latest firmware for the product using the device manager. Select the searched product in the Device Manager and run **<FW Status Check>** in the **[FW]** menu to get the firmware status (the latest or previous version).
  - Check the firmware distribution information for each product on the Hanwha Vision website (<https://www.HanwhaVision.com>) and download the latest firmware (modelName\_version.imkp) to your PC. You can also download the latest firmware to your PC from Device Manager.
1. When selecting firmware for each product and running **[Upgrade]**, the status will change from **<Login OK>** to **<Progress %>**.

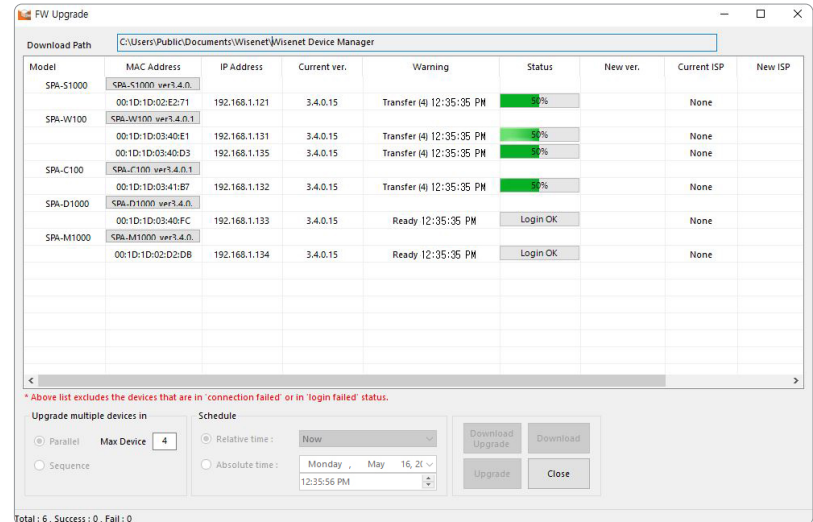

- When the firmware update and reboot are complete, <Progress %> is displayed until 100% and then <Success> is displayed.
- If you update multiple products at the same time, the update will proceed sequentially by four units at a time.

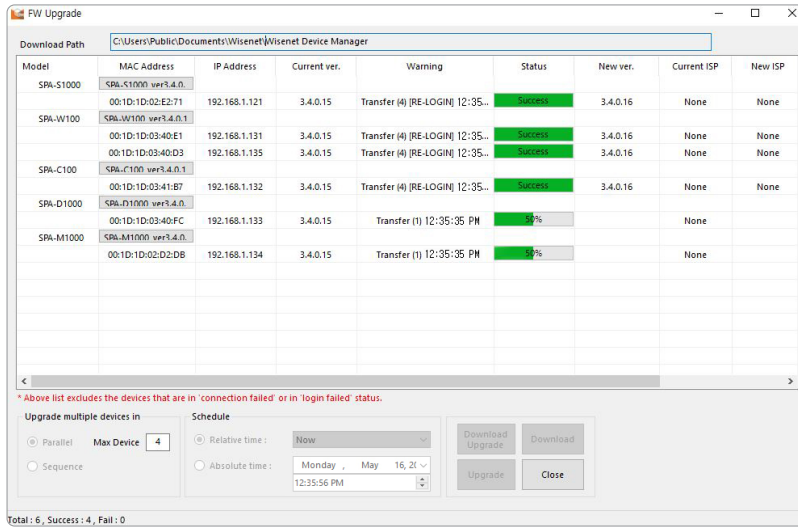

- The speakers share firmware, while the microphones and servers have their own firmware. The update will fail if inappropriate firmware is selected for the product. In such cases, please check whether suitable firmware has been chosen for the product and restart the update.
- The update failure status is indicated as follows:  
Speaker: The status LED on the main body blinks rapidly.  
Microphone: The 'Upgrading Wait' notification is displayed on the screen of the main body.  
Server: The 'Upgrading Error' notification is displayed on the screen of the main body.

## Registering with the product's initial IP address

If you connect only one product to the switch hub, it is possible to set up the password even on the web page.

- Enter the product's initial IP address into the web browser's address bar.



- The admin account password must be registered when accessing the product for the first time. When the <Change Password> window appears, please enter a new password.

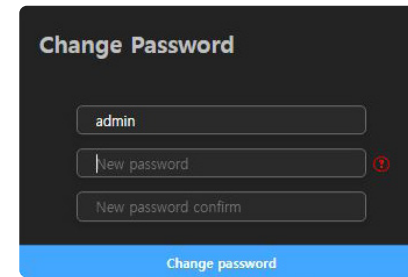

- A password should contain 8 or more characters, and if it contains fewer than 9 characters, then a combination of 3 or more English uppercase/lowercase letters, numbers, or special characters must be used. If it includes 10 to 16 characters, a combination of 2 or more types must be used.
- It is recommended not to use the same character repeatedly or consecutive keyboard inputs as passwords for enhanced security.

- A product login screen appears after successfully setting the password.

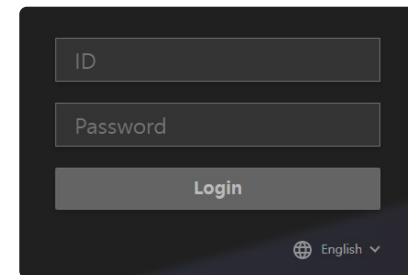

## LOGGING IN

Use the password set for the admin account.

1. Enter "admin" in the <ID> field.
2. Enter a password in the <Password> field.
3. Click the [Login] button to move to the Home screen of the product.  
After 30 minutes of inactivity on the website, you will be automatically logged out.



- If you forget the password, the product has to be initialized by pressing the RESET button for about 12 seconds. Therefore, make sure to write your password down or remember it.  
If you have already logged in, the system can be initialized in the <Environment Setting> → <System Management> menu of the web page.

- Do not disconnect the power until the system initialization is complete after pressing the [RESET] button of the product or during product resetting. It will take up to 10 minutes to reboot the product after initializing it.



- To change the network settings according to the user's network connection configuration, use the <Network Setting> function in <Environment Setting>. (Page 20)

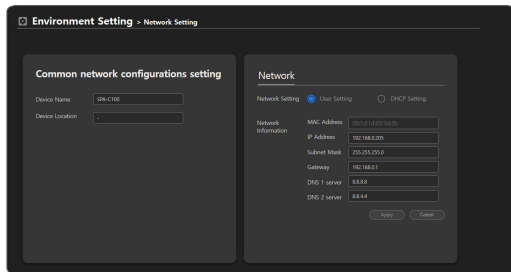

- Available accounts are divided into admin, setup, user, and guest by access authority level. Go to <Environment Setting> → <System Management> → <Change Password> to change the passwords of each account. (Page 17)

- A maximum of five users can log in to the product at the same time. The <Exceed the maximum user> screen will appear if there is an attempt to log in while the maximum number of users are logged in, and it will show the currently connected PC IP addresses.

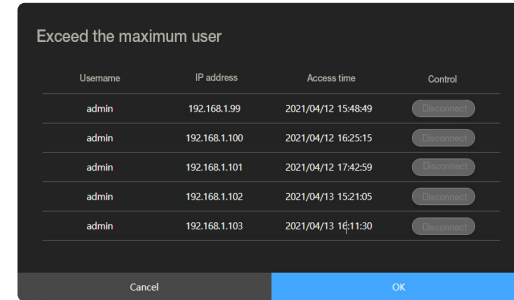



# environment settings

The environment setting menu is a feature which is provided for both the controller-mode speaker and regular speaker.

## SYSTEM MANAGEMENT

Various functions are available, including System Upgrade, Change Password, System Check, Restart, and Reset.

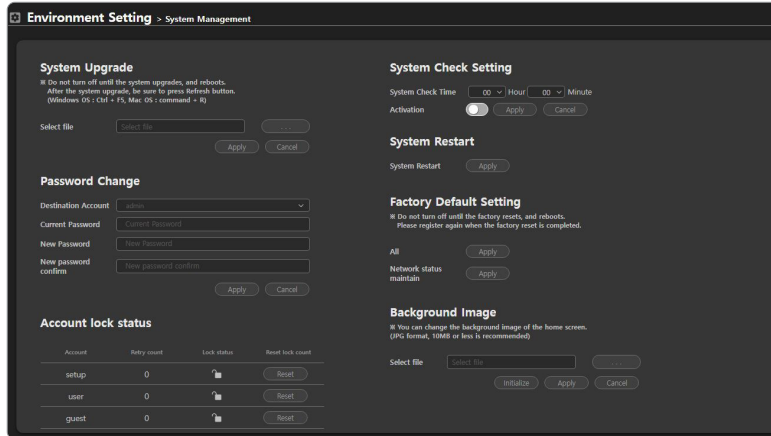

### Upgrading the System

1. Click <Environment Setting> → <System Management> on the Home screen.
2. Click the [  ] button in <System Upgrade>.
3. Select the upgrade file (model name\_version.imkp) that you downloaded from the official Hanwha Vision website (<https://www.HanwhaVision.com>) in advance and click [Open].

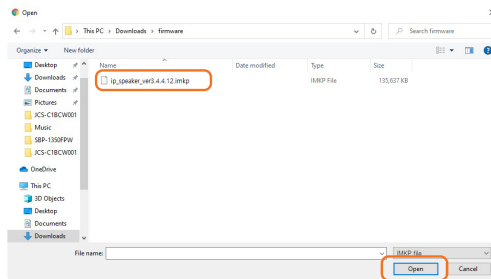

4. Click [Apply] to start System Upgrade. Click <OK> when the "System Restart" window appears after up to five minutes.

- ! If you close the web browser or move to another menu before the "Restart the Program" message pops up, it may not be updated.
- Do not disconnect the power in the middle of a system upgrade. Doing so may cause malfunctions.

5. It will take up to 10 minutes to upgrade the system and reboot the product. The software version information of the product is available in the upper-right corner of the Home screen.

### Changing the Password

You can change the passwords of each account.

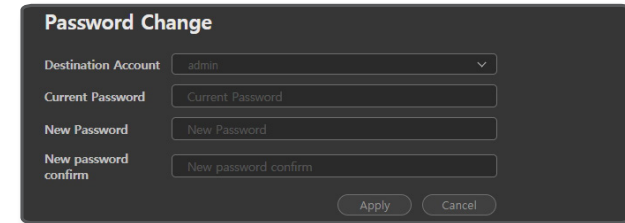

1. On the Home screen, click <Environment Setting> → <System Management>.
2. By clicking <Destination Account> from <Password Change>, select the account you want to change and set the password.
3. Click the [Apply] button after entering a new password in the two input fields.
4. The admin account can be changed if you enter the previous password. If you forgot the previous password, the product has to be initialized, and the passwords for all the accounts will be initialized during the process.
5. The password of the setup, user, and guest accounts can be set, changed, or reset from the admin account if they are forgotten.

### Viewing the supported menu by account

To prevent any confusion due to arbitrary changes to the settings and to continue stable maintenance of the system, access rights are differentiated by account, and all restricted features for each account are disabled on the screen.

[Controller mode]

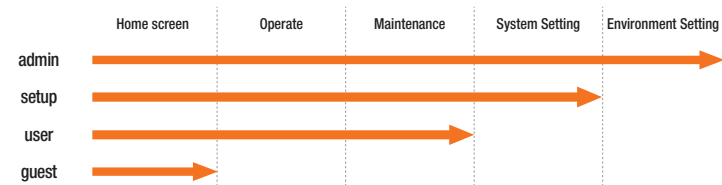

# environment settings

- admin: You can use all the functions of the product.
- setup: You can use all the functions except for environment settings, such as System Upgrade, Change Network, Change Time, etc.
- user: Broadcast ON/OFF operation and product monitoring are available, and log records can be checked.
- guest: You can check the product information on the home screen.

[Speaker Mode]

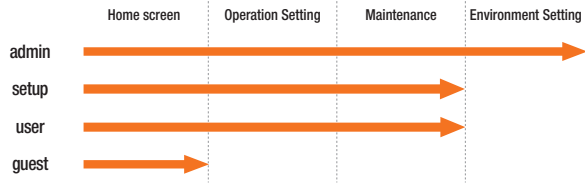

- admin: You can use all the functions of the product.
- setup: You can use all the functions except for environment settings, such as System Upgrade, Change Network, Change Time, etc.
- user: Speaker operation settings are available except DSP Settings, Scheduler, and SIP Settings, and the log history can be checked.
- guest: You can check the product information on the home screen.

## Unlock Account

For all accounts except the admin account, if you enter the wrong password more than 5 times when logging in, the account will be locked for 30 seconds and you will not be able to log in. The admin account can reset the number of retries by checking the number of login retries for each account and whether the account is locked.

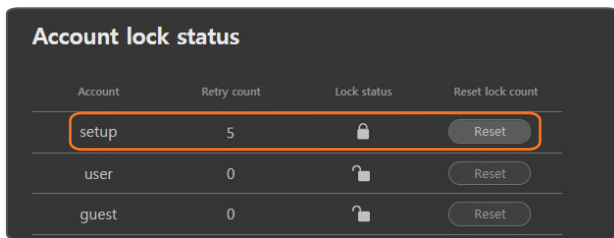

1. On the Home screen, click <Environment Setting> → <System Management>.
2. Click [Reset] after checking the locked account on <Account lock status>. The lock icon is changed to unlocked and the number of retries for the account is reset.

## Setting the System Check Time

Sets the time for the system check. The system reboots automatically at the set time every day.

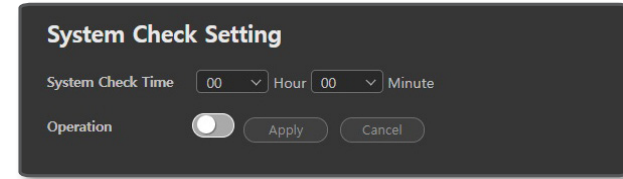

1. On the Home screen, click <Environment Setting> → <System Management>.
2. Set the time to start checking in <System Check Settings>
3. Click [Apply] after clicking the  button of <Operation>.
4. The system will be checked and be rebooted at the set time; it will take approximately 5 minutes.

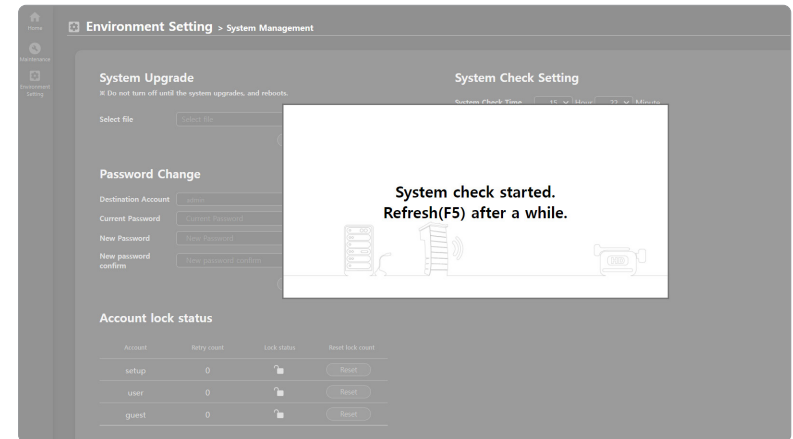

## Restarting System

You can restart the system without disconnecting the power when a system reboot is needed.

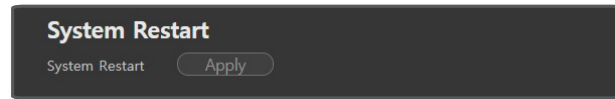

1. On the Home screen, click <Environment Setting> → <System Management>.
2. Click the [Apply] button in <System Restart>.
3. Click <OK> when the system restarting window appears.  
It will take approximately 5 minutes to reboot the system.

## Resetting the System

Initializes every system setting to the factory default values.

An IP address of the product is also initialized to the initial status, which is 192.168.1.100.

Please re-open the web page and access 192.168.1.100.

Even the power mode and operation mode become the PoE, which is the initial state and speaker mode.

1. On the Home screen, click <Environment Setting> → <System Management>.
2. If you click the [Apply] button of the <All> item on <Factory Default Setting>, all set values will be reset, and if you click the [Apply] button of the <Network status maintain> item, all set values except for network information will be reset.

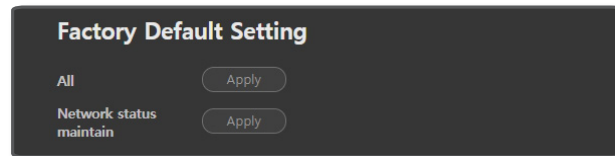

3. Click <OK> when the factory default window appears. Product initialization starts.
4. Click <OK> when the system start window appears on the web browser.

- ! Do not disconnect the power until the factory default settings are restored.  
It will take up to 10 minutes to restart and complete the execution of the internal daemon program after product initialization.

- When the system initialization is completed, previously registered product information should be deleted from the controller mode speaker or audio server (SPA-S1000), and you must register if you wish to use the product.
- As the log information will be deleted when the product's system is initialized, please download it in advance.

## Applying Background Images

1. On the Home screen, click <Environment Setting> → <System Management>.
2. Under <Background Image>, press the [ ] button to select an image file, then click the [Apply] button.
3. Click the [Initialize] button to apply the initial image.

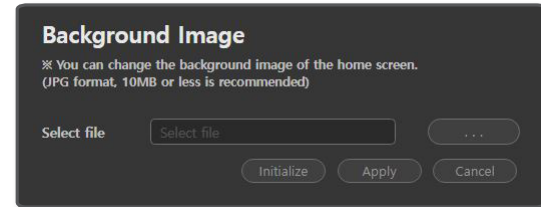

## NETWORK SETTINGS

You can change the network settings according to the user's network connection configuration.

1. On the Home screen, click <Environment Setting> → <Network Setting>.

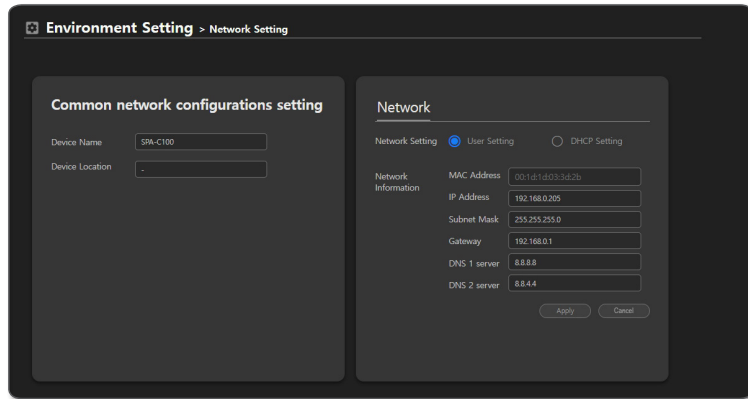

- On the <Common network configurations setting>, the <Device Name> is displayed as <Name> on the device manager's query list.
- You can enter the location of installation in <Device Location> in <Common network configurations setting> (e.g. 6th floor, Main Building)
- You can enter the IP address, subnet mask, gateway, DNS 1 and DNS 2 server addresses for the product by selecting <User Setting> in <Network Setting>.
  - MAC address: The unique physical address of the product. (e.g. Starts with 00:1d:1d.)
  - IP address: Enter the IP address available in your network band.
  - Subnet mask: The subnet mask of the set IP address is indicated.
  - Gateway: The gateway of the set IP address is indicated.
  - DNS 1 server, DNS 2 server: Enter the primary DNS address and secondary DNS address.
- The IP, subnet mask, gateway, DNS 1 and DNS 2 server addresses for the product will be allocated automatically from the DHCP server by selecting <DHCP Setting> in <Network Setting>.
- Click [Apply] to apply the set network information to the product.
- Click [Cancel] to return to the most recent status before changing settings.
  - The system restarts automatically if the network settings are changed.

## TIME SETTINGS

Set the time and date accurately or it may cause problems in operating the broadcast.

1. On the Home screen, click <Environment Setting> → <Time Setting>.

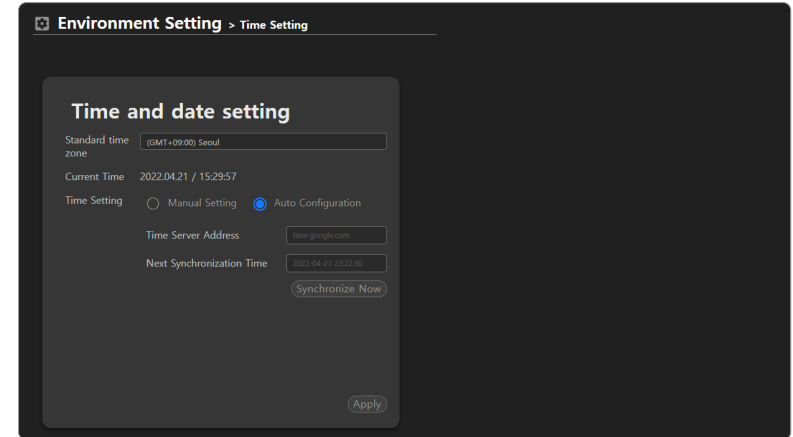

- The current time is set if you select GMT of your location on <Standard Time Zone>
- For the local network which is not connected to the external Internet, select <Manual Setting> in <Time Setting> and enter the time manually to use it.
- If it is connected to the external Internet, select <Auto Configuration> in <Time Setting> to synchronize the time to the standard time of the time server.
- For the domain address in the <Time Server Address> input field, use time.google.com / time.apple.com / pool.ntp.org / north-america.pool.ntp.org / time.bora.net / clock.isc.org.
- Please check if the domain address provides time information which reflects Daylight Saving Time.
- <Next Synchronization Time> automatically changes from the previously synced time every 8 hours.
- Click [Synchronize Now] to synchronize the time to the time server.

2. Click [Apply] to apply the set Time and Date information.

- ❗
  - If the product is used in a local network environment without an external Internet connection, the time information may become incorrect due to the product's accumulated time errors. To accurately schedule the broadcasting time, we recommend installing a separate time server device using GPS signals or enter the audio server IP (SPA-S1000) with high time accuracy into the <Time Server Address> field of other products to synchronize the time information with the audio server.
  - If there is a product connected to an external Internet, enter the IP address of the product in the <Time Server Address> field of other products before using them.
  - IP audio products are not synchronized with the OS time of the PC.
  
- ✍
  - If the product is used in a local network environment without the external Internet connection, Daylight Saving Time is not automatically reflected as it is not synchronized with an external time server.
  - In countries where Daylight Saving Time is applicable, it is recommended for the system administrator to use the product by changing the time manually for the start and end dates of the Daylight Saving Time.

## SNMP ACTION SETTINGS

The SNMP protocol allows system or network administrators to remotely monitor and configure the network devices.

1. On the Home screen, click <Environment Setting> → <snmp action settings>.

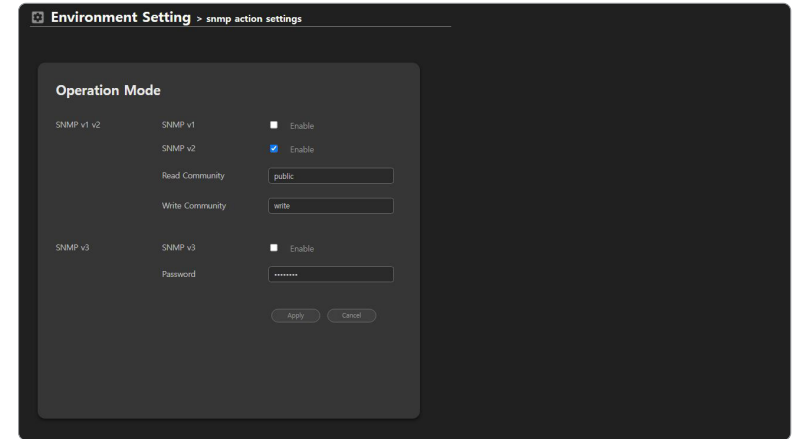

- Use SNMP v1: SNMP v1 is used.
- Use SNMP v2: SNMP v2 is used.
  - Read Community: Enter the name of read-only community to access the SNMP information.
  - Write Community: Enter the name of write-only community to access the SNMP information.
- Use SNMP v3: SNMP v3 is used.
  - Password : Set the initial user password for SNMP v3.  
The initial password is insecure, so we recommend that you change it to a new password.  
The password must be between 8 and 16 characters long, and some special characters (\, |, <, >, ', ", /, ?) are not allowed.

## DEVICE OPERATION SETTING

Select the power and operation mode of the speaker and audio module.

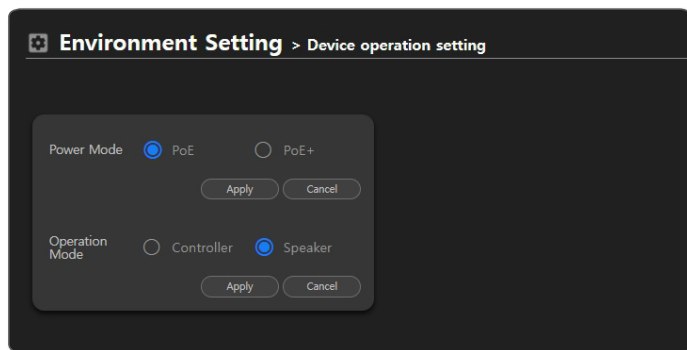

1. On the Home screen, click <Environment Setting> → <Device operation setting>.
2. First, check the PoE, PoE+ power specifications of the switch hub to be used.
3. Select the proper power mode as per the product usage. (Initial power mode: PoE)
  - If the <Power Mode> of the product is set to <PoE+> while the switch hub is specially designed for PoE and it is played loudly, temporary interference (audio playback stops, reboot, etc.) may occur.
- If the switch hub is compatible with both PoE and PoE+, set the <Power Mode> of the product to <PoE> or <PoE+> for each situation. If the product is <PoE+>, check if the channel is set to <PoE+> in the switch hub settings menu.
- As PoE+ (802.3at) can provide about twice more power than PoE (802.3af) through the network cable, its speaker output is louder.

	Standard	PSE supply maximum power	Voltage range (PSE)	Maximum current
PoE	802.3af	15.4W	44~57V	350mA
PoE+	802.3at	30W	50~57V	600mA

- !
  - When the product's power mode is PoE+, a switch hub for both PoE, PoE+ which supports the LLDP (Link Layer Discovery Protocol) function must be used while the LLDP function of the channel, which is connected to the product, is turned on.
  - If you use a switch hub without the LLDP function, the product may not operate properly.

4. For the speaker, you can select one of two operational modes depending on its usage.
  - Controller: You should register only one controller speaker, and the rest should be set up in speaker mode.
  - Speaker: You can use the functions of BGM play, CHIME & TTS setup, or SIP (VoIP phone voice transfer) by themselves. Moreover, you can run the audio broadcasting and control functions operated through a controller by registering it to a device employing controller mode.

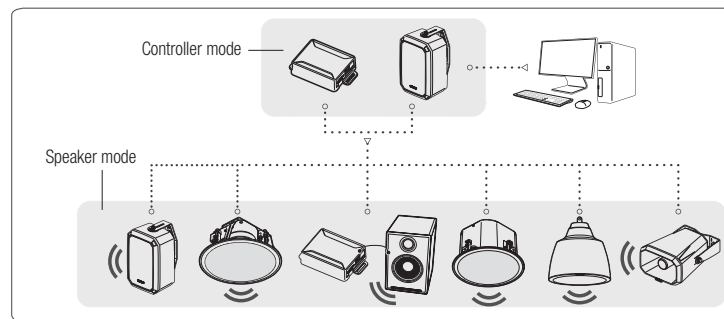

- !
  - If you change into speaker mode while using controller mode, delete other registered products and execute the system initialization on the controller mode status.

# use in the controller mode

If you select <Operation Mode> with the <Controller> in <Device operation setting>, it can be used as a server operating multiple speakers.

An IP audio module (connecting to an analog speaker) or an IP audio server (SPA-S1000) can be used in the Controller mode. To run controller mode, the CP, BGM, CHIME and TTS functions of the other speakers have to be set up in advance.

## HOME SCREEN CONFIGURATION

If you select the <Operation Mode> with a <Controller>, a website will be opened to provide the following function menus.



Name	Function Description
Home	Goes to the Home screen.
Operate	You can turn broadcast operation ON/OFF using the device, Audio Monitoring, Button mode, and control mode.
1 System Setting	Registers the device, source, and zone and sets the Event & Preset and annual schedules.
Maintenance	Checks Failover History Management and Logs of the device.
Environment Setting	The System Management, Network, Time, Device Information, etc. can be set.
2 Product Model Name	Displays the device's model name.
3 Product Information	The IP address, device name, device location, and firmware version are displayed.
4 Connected Account/ Login	Shows a connected account and its login status.
5 Time Information	The connection time to the web page menu, product cumulative operating time, and product time will be displayed.
6 Language	Shows the language options supported on the website. (Korean, English supported)
7 Go to the Official Website	If you click <Hanwha>, the screen will move to the Hanwha Vision Official Website.

■ The optimal monitor resolution is 1920x1080.

## OPERATION MODE

### Device Monitoring

You can monitor the status of the source device and output device connected to the product.

■ To monitor a device, the <Device Registration>, <Source Registration>, <Zone Registration> should be set in <System Setting>.

### Source Device

The speakers registered as the audio <Source> will be displayed in the Source Device list. <Source> means one speaker set as a source device.

- On the Home screen, click <Operate> → <Device Monitoring>.
- Click the <Source Device>.
  - The number of the devices registered as the Source Device will be displayed.

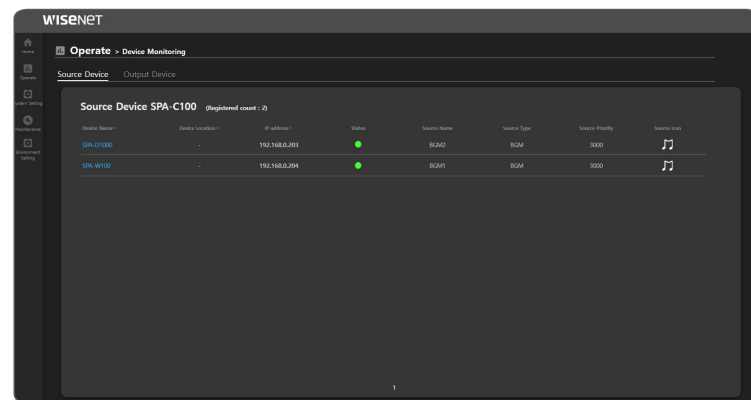

- Device Name: Displays the name of the source.
- Device Location: Displays the location of the source device.
- IP address: Displays an IP address of the source device.  
If you click the IP address, you can go to the website of the device.
- Status: Displays the connection status of the source device.
  - (Green): When the device is connected normally
  - (Orange): When there is interference with device connection
- Source Name: The name of the Source Device will be displayed.
- Source Type: The source type of the Source Device will be displayed.
- Source Priority: The priority of the Source Device will be displayed.
- Source Icon: The setup icon of the Source Device will be displayed.

## Output Device

The speakers registered as the <Zone> of the area for broadcasting will be displayed in the Output Device list. <Zone> refers to one speaker set as an output device.

1. On the Home screen, click <Operate> → <Device Monitoring>.
  2. Click the <Output Device>.
- The number of devices registered as the Output Device will be displayed.

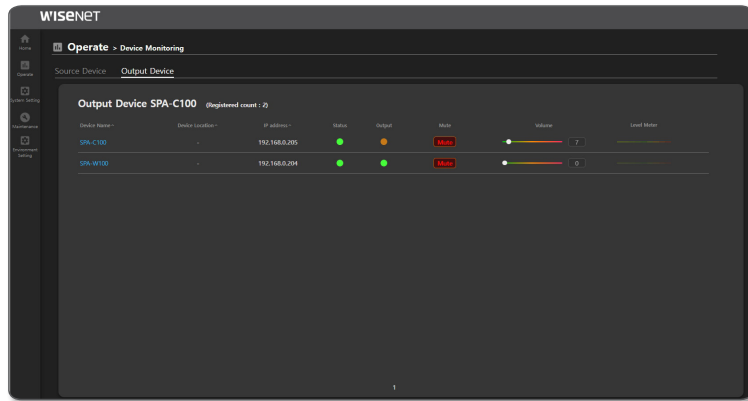

- Device Name: Displays the name of the output device name.
- Device Location: Displays the location of the output device.
- IP address: Displays the IP address of the output device.  
If you click the IP address, you can go to the website of the device.
- Channel : The channel will be displayed.
- Status: Displays the connection status of the output device.
  - ● : When the device is connected normally
  - ● : When there is interference with the device connection
- Output: Displays the play status of the output device.
  - ● : When the device plays audio
  - ● : When the device does not play audio
- Mute: If the [Mute] button is turned on, the audio source will not play in <Operate> → <Button Mode>.
- Volume: Move a control bar to adjust the volume.  
If the volume is adjusted, the speaker volume of the <Button mode> property is reflected on the same level.  
When the volume is adjusted, its output volume will be reflected at the same level in the <Operation Settings> → <DSP Setting> of the Output Device speaker.
- Level Meter: A signal value being played is indicated as a level meter.

## Audio Monitoring

You can monitor the status of the Output Device speakers registered in the <Zone> of the area to broadcast.

1. On the Home screen, click <Operate> → <Audio Monitoring>.

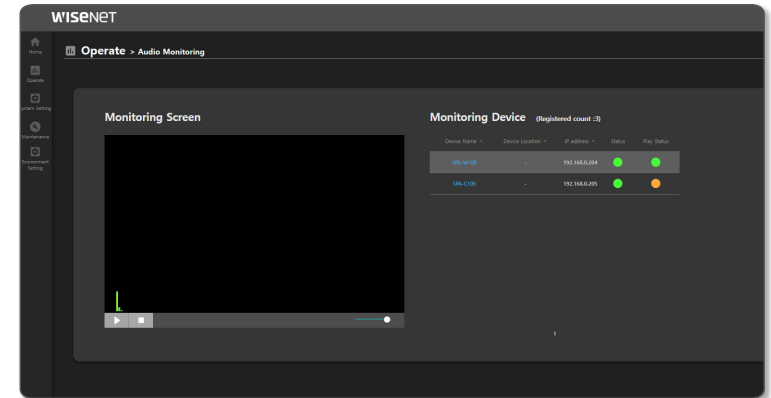

- Device Name: Displays the name of the output device.
  - Device Location: Displays the location of the output device.
  - IP address: Displays the IP address of the output device. If you click the IP address, you can go to the website of the device.
  - Status: Displays the connection status of the output device.
    - ● : When the device is connected normally
    - ● : When there is interference with the device connection
  - Play Status: Displays the amp output status of the speaker.
    - ● : Amp output is On
    - ● : Amp output is Off
  - Monitoring Screen: Select a device to monitor and press the [Play (▶)] button, then the audio signals detected by the device microphone will be visualized.  
You can also listen to sound sources detected by the device's microphone from speakers connected to your PC.
  - Volume Control: The monitoring volume can be adjusted.
- The SPA-D1000 audio module requires an external microphone to be connected to the microphone terminal on the bottom of the product for audio monitoring.



- The output monitoring device can be controlled by clicking [Play] and [Stop].
  - The audio automatically stops 1 minute after it starts playing.
  - Repeatedly clicking the [Play, Stop] buttons within a second may cause abnormal operation.
  - When you click the [Play] button, if there is a pop-up message stating that “The sample rate of the output device is not currently set to 48 kHz. Please change the settings.”, please change the sample speed and the bit level to 16bit, 48000hz in the Audio Device Management Setup Menu of the PC Control Panel.

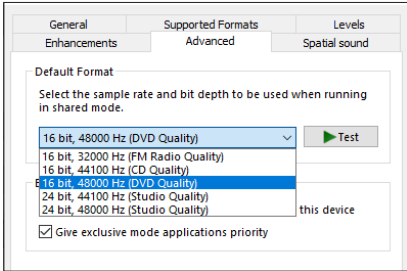

- After seeing the “Please select 'Condenser MIC' as the Input Mode in the Operation Setting > DSP Setting. (Speaker Operation Mode)” pop-up message when you click the [Play] button, connect to the device and run it.

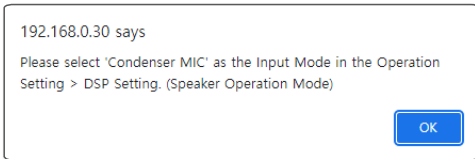

- In Speaker Mode, select **CONDENSER MIC** for **INPUT MODE** in **Operation Setting > DSP Setting**. In **Controller Mode**, switch to **Speaker Mode**, select **CONDENSER MIC** for **INPUT MODE**, and switch back to **Controller Mode**.

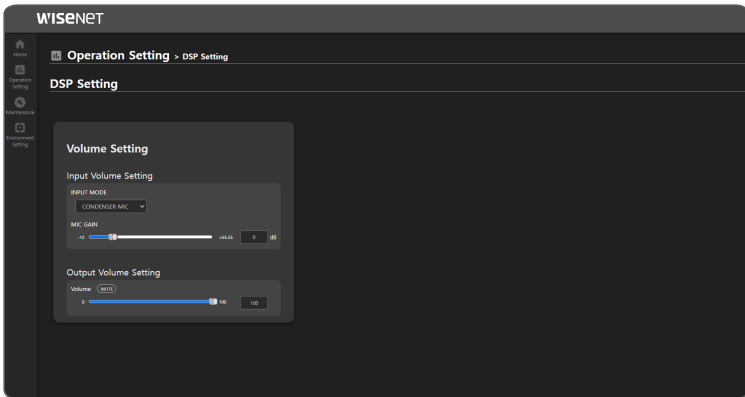

## Button Mode

You can broadcast either by selecting the buttons of the source device and output device connected to the product or by the set Event & Preset and Group formats.

If you set the transmission mode of the source device to Multicast and broadcast the BGM sound source of the source device to the output device, the Multicast IP address and the port information of the source device will be sent to the zone device and appear on **<BGM Streaming>** → **<Broadcast Client>**.

If you want to use a button mode in a controller mode speaker or server, you must not change the transmission method or operation information of the source or zone speaker in **<BGM Streaming>** → **<Broadcast Server>** or **<Broadcast Client>**.

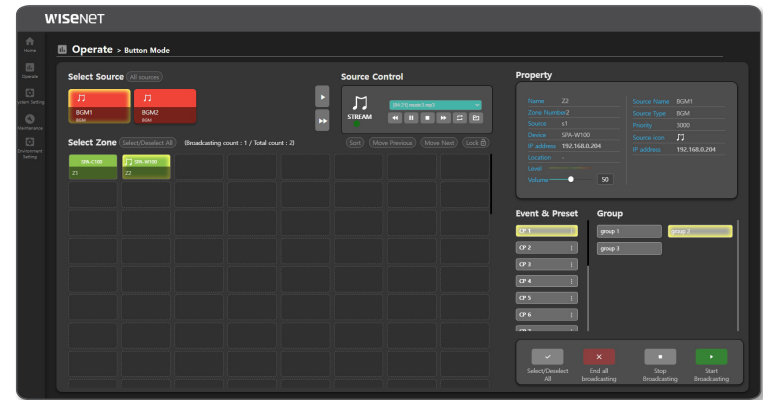

If you press an ID number that is set for a zone or a group on the microphone (SPA-M1000) while broadcasting a sound source in **<Button Mode>**, the output device can transmit the microphone instead of the sound source.

1. Click **<Operate>** → **<Button Mode>** on the Home Screen.



- Select Source: Connected source devices can be selected.
  - The Source Name and Source Type set up in the **<Source Registration>** will be displayed. The selected source device will be displayed as highlighted.
  - If you click the **[All Sources]** button, all connected source devices will be displayed.
  - If you click [▶], the source device will be shown as being moved one by one. If you click [▶▶], it will switch to the last source device.

- Source Control: BGM or TTS lists of the selected source device are displayed. When you select a zone speaker to broadcast and select **<Start Broadcasting>** or **<Stop Broadcasting>**, the broadcast readiness will be displayed in the source control window.



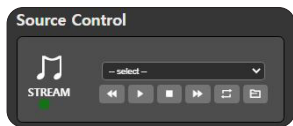



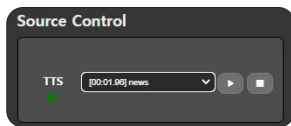

-  : When the **<Start Broadcasting>** button is pressed (Button Mode broadcasting Standby)
-  : Initial status or when the **<Stop Broadcasting>** button is pressed



<BGM Control Window>



<TTS Control Window>

-   : While all the audio sources in the BGM list are played by pressing the  button, if you press either the  button or  button, the previous or next audio will be played.
-  : It will play or temporarily pause the selected audio source.
-  : It will stop playing the audio source.
-  : It will repeat playing the current audio source or all the sound sources.
-  : It will play from the first audio source in the list to the last one.

-  Check the **<CTRL>** box in the **<System Setting>** → **<Source Registration>**, and select the **<Source Type>** and **<CTRL Type>** to display the Source Control Window.
- When you play the sound source in **<BGM Control Window>**, the **<Broadcast Client>** operation of the zone output device is executed, and it is displayed in the level meter. When you stop playing the sound source or pause it, the level meter also stops.

- Select Zone: An output device in the connected zone can be selected. The selected zone will be displayed as highlighted. When you select the Source Device and Output Device and click the **[Start Broadcasting]** button, the BGM or TTS icon will be displayed in the Output Device.
  - If you click the **[Select/Deselect All]** button, all connected zones will be selected or deselected.
  - When you click the **[Sort]** button, they will be sorted in the order of **<System Setting>** → **<Zone ID>** of **<Zone Registration>**. The Zone button can be moved by drag and drop.
  - If you click the **[Move Previous]** and **[Move Next]** buttons, it will switch to the selected devices one by one.
  - If you click the **[Lock]** and **[UnLock]** buttons, the zone selection layout can be locked or unlocked.

- Group : You can select an output group among the set groups, and duplicate selection is also possible. The selected group will be displayed as highlighted. When you select the Source Device and group and click the **[Start Broadcasting]** button, the BGM or TTS icon will be displayed in the Output Device.

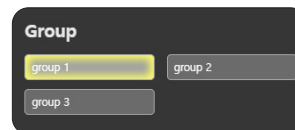

- Property: If you select a source device or zone device, information for each device will be displayed. The output of the audio being played is indicated by a meter, and the volume can be adjusted.

-  When you press each **[Zone]** button, its speaker information value will be displayed on the **<Property>** menu, and you can directly control the **<Volume>**.
- The speaker volume of the **<Property>** menu is linked to the volume of **<Device Monitoring>** → **<Output Device>**.
- The speaker volume of the **<Property>** menu is linked to the volume of **<Output Volume Setting>** of the **<Operation Setting>** → **<DSP Setting>** of the device.
- When you click only the source, its details are displayed in the source portion of the **<Property>**. When you click a zone, details on the zone and broadcasting source will be displayed if it is on air, while only details on the zone will be displayed if it is not on air.

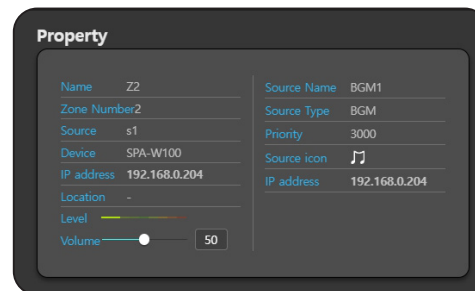

- If you click the **[Select/Deselect All]** button, all connected zones will be selected or deselected.
- If you click the **[End all broadcasting]** button, all the regions' broadcasting which use the source will stop broadcasting. Broadcasting to the region does not stop by pressing the **<Event & Preset>** button. The **[Event & Preset]** button must be clicked and disabled to stop broadcasting.
- If you click the **[Start Broadcasting]** button and play audio on the STREAM or TTS window of the **<Source Control>**, the selected audio of the source device will broadcast through the output device of the selected zone.
- If you click the **[Stop Broadcasting]** button, the selected region's broadcasting will stop.

-  Feedback is caused if you adjust the **<DSP Setting>** → **<Input Volume Setting>** of zone output speakers after TTS audio broadcasting is over or while it is paused. (Only when the same speaker is selected for the source and zone purposes in button mode.) Make sure to adjust the **<DSP Setting>** → **<Input Volume Setting>** of the zone output speakers only when they are in the **[Stop Broadcasting]** status.

- Event & Preset: Select the contact closure (CP) number set in the <Event & Preset> menu to use this menu.
  - When contact closure events (up to 16) are registered in <System Setting> → <All Event & Preset List>, the contact closure number will be displayed.
  - If you click the Contact Closure Number, the event broadcasting configured to the zone will be transmitted without running [Start Broadcasting].
  - If you click the Contact Closure Number, a musical note will be displayed on the zone device button selected in the <Broadcasting Routing> or <Local File Play> of <Event & Preset>.
  - The contact closure output signal can be turned off by turning Off the contact closure number.
  - If you click the [⋮] button on the right of the preset number, you can change the preset name.

- As the zone with the musical note in the zone button box is broadcast even if they are not highlighted, ensure running [End all broadcasting] and reconfigure it. The zone device which can be broadcast is displayed as (Broadcasting count / Total count).



- If the [!] icon is displayed on the registered device, please check the network status of the device.

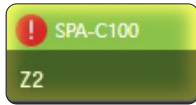

- If you separately control <Broadcast Server> or <Broadcast Client> in the <BGM Streaming> menu on a speaker selected as a source or zone while running all the broadcasts with the <Controller Mode> speaker, an error may occur in the <Button Mode> broadcast, so please be cautious.

- Even if the Controller Mode speaker is turned off during a Button Mode broadcast, the source speaker and zone speaker work normally, so the sound source continues to play. If the Controller Mode speaker (if set as a zone speaker) is subsequently turned on, the sound source is skipped.
  - If the source speaker is turned off during a Button Mode broadcast, all zone speakers stop broadcasting the sound source. If the source speaker is subsequently turned on, the sound source automatically plays again from the beginning.
  - If the zone speaker is turned off during a Button Mode broadcast, only that zone speaker stops broadcasting the sound source. If the corresponding zone speaker is subsequently turned on, the sound source plays in synchronization with the other speaker.
- During a Button Mode broadcast, if the PAUSE button is pressed to pause playback or the STOP button is pressed to stop playback, auto play does not work.

- If you press the number which is set as Zone or Group mode on the microphone device during the broadcast of the sound source in <Button Mode> and run the <Talk> function, the speaker transmits the microphone's audio instead of broadcasting the sound source.
- In order for the microphone to transmit the voice inputs while broadcasting, the microphone's priority must be higher than that of the source speaker running in the <Button Mode>
- The speaker which transmits the microphone's audio displays the microphone's information in the source information of <Property>, and it is converted to the speaker information when <TALK> is stopped in the microphone.

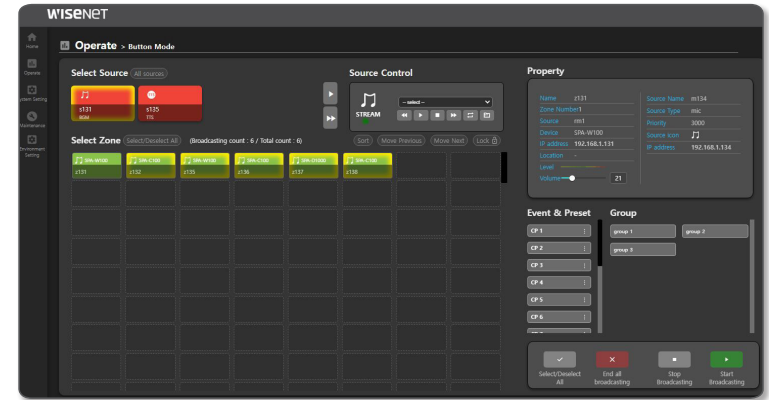
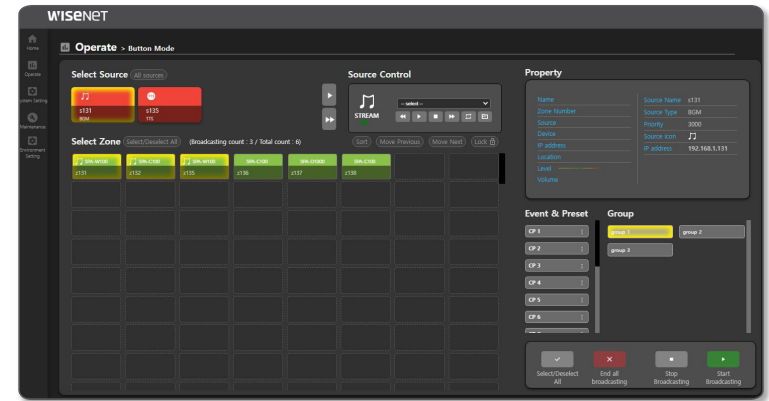

## CONTROL MODE

Functions such as Control Mode (to control zone devices in Button Mode) and Contact Closure Operation Mode (to control event contact closure) are available.

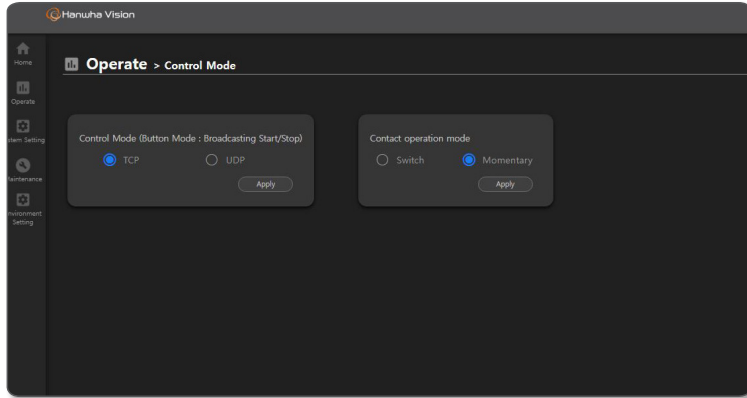

### Setting Control Mode

When you run <Start Broadcasting>, <Stop Broadcasting> from the <Operate> → <Button Mode>, you can control the zone devices with either the TCP or UDP method.

Depending on the UNICAST, MULTICAST setting of <Source Registration> → <Transmission Method>, the number of zone devices which simultaneously broadcast in the <Button Mode> changes.

<Control Mode> is only provided to the admin account.

1. Click <Operate> → <Control Mode> on the Home screen.

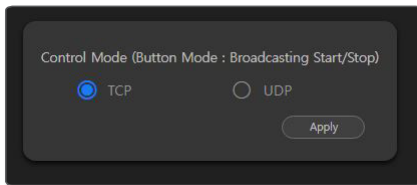

2. Set <Control Mode> as TCP.

- In a UNICAST network, if you set the <Source Registration> → <Transmission Method> to UNICAST on the source device, you can simultaneously broadcast to up to 20 zones (20 output speakers).
- In a MULTICAST network, if you set the <Source Registration> → <Transmission Method> to MULTICAST on the source device, you can simultaneously broadcast to up to 50 zones (50 output speakers).

3. Set <Control Mode> as UDP.

- In a UNICAST network, if you set the <Source Registration> → <Transmission Method> to UNICAST on the source device, you can simultaneously broadcast to up to 20 zones (20 output speakers).
- In a MULTICAST network, if you set the <Source Registration> → <Transmission Method> to MULTICAST on the source device, you can simultaneously broadcast to up to 256 zones (256 output speakers).

4. You have to select <Control Mode> and <Transmission Method> in consideration of the number of zone devices which simultaneously broadcast and the used network environment.
5. Depending on the network environment configuration, the maximum broadcasting count might be limited.

### Setting Contact Operation Mode

When the device receives the event contact closure signal set in <Event & Preset>, the event sound broadcast and contact closure output work in the mode selected in <Contact Closure Operation Mode>.

1. Click <Operate> → <Control Mode> on the Home screen.

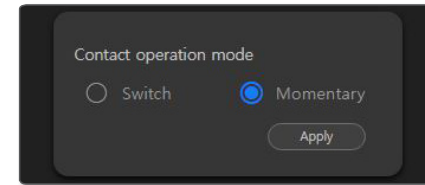

2. Set <Contact Operation Mode> to <Switch>.

- The sound broadcast and contact closure output only work when the event contact closure signal is turned on.
- When the event contact closure signal is turned off, the sound broadcast and contact closure output stop immediately.

3. Set <Contact Operation Mode> to <Momentary>.

- Even if the event contact closure signal is turned on and off, the sound broadcast and contact closure output stop after they reach the end.
- When the event contact closure signal is turned on continuously, the sound broadcast and contact closure output work repeatedly.

## SYSTEM SETTINGS

Registers the device, source, and zone and sets the Event & Preset and annual schedules.

If the system is initialized or the network setting (User, DHCP) is changed after you register the device, you should delete the device before registering it again.

### Register Device

Controllable devices can be searched, and you can register or delete the devices by selecting them.

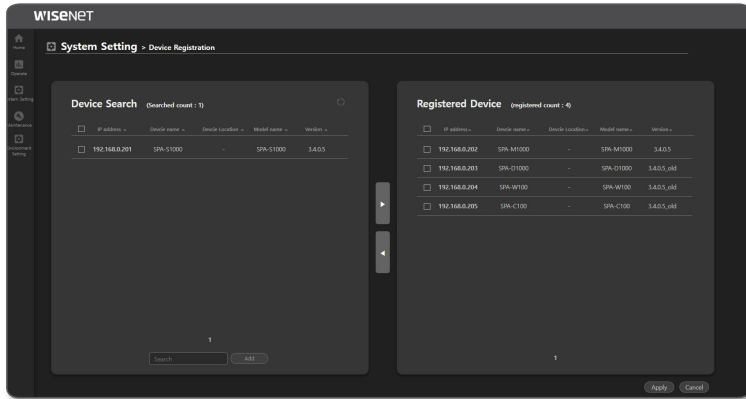

1. On the Home screen, click **<System Setting>** → **<Device Registration>**.
2. Devices connected to the network are listed in **<Device Search>**.  
If you click the [  ] icon, the device list can be updated.
3. If you cannot search for the device, enter its IP address in the search bar and click the **[Add]** button to manually add the device.

4. If you select a device to register from the **<Device Search>** list and click the [  ] button, the device is moved to the **<Registered Devices>** list.

- If you select the moved device and click the [  ] button, it returns to the **<Device Search>** list.
- If you click the **[Cancel]** button, the selected device will be deselected, or devices moved back to the **<Device Search>** list will be recovered.  
The **<Searched count>** and **<Registered count>** will change depending on the device registration status.

5. If you select devices to register and click the **[Apply]** button, devices are registered.

- As only one **<Controller>** mode speaker should exist in the same network, register all the other speakers as **<Speaker>** mode.
  - You can use the **<Controller>** mode speaker as the zone device after performing **<Device Registration>** as with other speakers.
  - You should not use the **<Controller>** mode speaker and audio server (SPA-S1000) simultaneously in the same network. If a speaker and microphone are repeatedly registered, the device may not be controllable.

## Register Source Device

Speakers can be registered as source devices for broadcasts. <Source> means one speaker set as a source device.

1. On the Home screen, click <System Setting> → <Source Registration>.
2. Select <Source Registration> and set the following items:

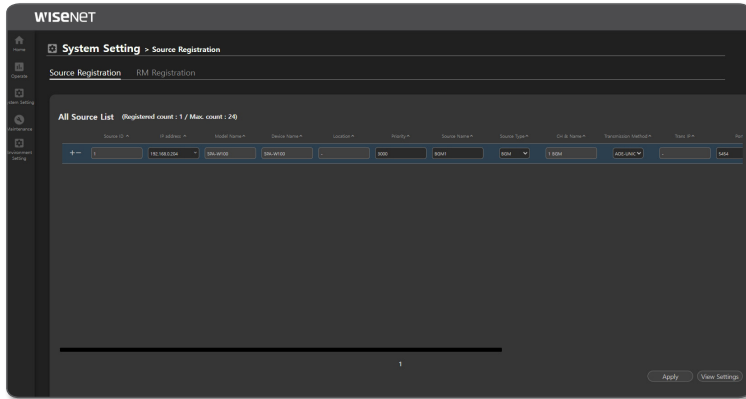

- Source ID: Up to 24 source devices can be registered while the registered count is displayed. Click the **[+]** icon to create a list, and click the **[-]** icon to remove the list. Names such as s1, s2, and s3 are displayed on the website menu.
- IP address: An IP address of speakers to be used as a source. If you select an IP address, Model Name, Device Name, and Device Location will be displayed.
- Priority: The user prioritizes sources. The smaller the number is, the higher its priority is. (Initial value 3000, input value 1000~9999)
- While broadcasting by selecting either source speakers (with 3000 source registration priority) or zone speakers in <Button Mode>, if a schedule time of an event priority is set as "2000" in the <Scheduler> comes up, the <Button Mode> broadcast will stop and the schedule broadcast will start. Conversely, if you select a speaker that a priority of a source speaker is "1000" in <Button Mode> and broadcast, the <Button Mode> broadcast will be kept since the schedule priority in <Scheduler> is higher.
- Source Name: Inputs or changes the name of a source.
- Source Type: Selects BGM or TTS.
- CH & Name: If you select BGM, 1 BGM will be shown. If you select TTS, 2 TTS will be shown.

- Transmission Method: If you select UNICAST, <Trans IP> will be deactivated, and the device's IP address will be used. You can enter the <Port> number in the input window automatically or manually, and it should not overlap with another device. If you select MULTICAST, a MultiCast IP address (e.g., 224.124.0.\* ) and <Port> number are automatically allocated to the <Trans IP>. If you enter the IP address and port directly in the device, be cautious that it does not overlap with automatically assigned information.
  - UNICAST : Up to 20 broadcasts are possible with the UNICAST network.
  - MULTICAST : In a MULTICAST network, you can simultaneously broadcast to up to 256 devices (when the control mode is set to UDP).



- The maximum broadcasting count can change depending on the setup of <Operate> → <Control Mode>.
  - You have to select <Transmission Method> in consideration of the network environment being used.
  - The maximum broadcasting count may be limited depending on the network environment's configuration.
- CTRL: The CTRL box should be checked to activate the <Source Control> window of the source Device in <Operate> → <Button Mode>.
  - To use it as the sound audio device in the <System Setting> → <Scheduler>, the CTRL box should be deactivated.
- CTRL IP : The device List for remote control is provided in the <Button Mode>, so select the same IP as the registered device.
- Device Name: Displays the name of a control device.
- CTRL Type : If you set a source type as <BGM>, select <file\_player>, and if you set a source type as <TTS>, select <tts\_player>.
- I/O CH : If you set a <CTRL Type> as <file\_player>, "1" will be displayed, and if you set as <tts\_player>, "2" will be displayed.
- Icon: Selects an icon (BGM or TTS) and color of a source. If <User Icon> images are directly uploaded on PC, you can select one from the <Icon> list.

3. Once set, click the **[Apply]** button.

4. If you click the **[View Settings]** button, the set value can be saved as a CSV file.

## Registering an RM Microphone

Register a microphone to broadcast via speakers.

1. On the Home screen, click **<System Settings>** → **<Source Registration>**.
2. Select **<RM Registration>** and set the following items:

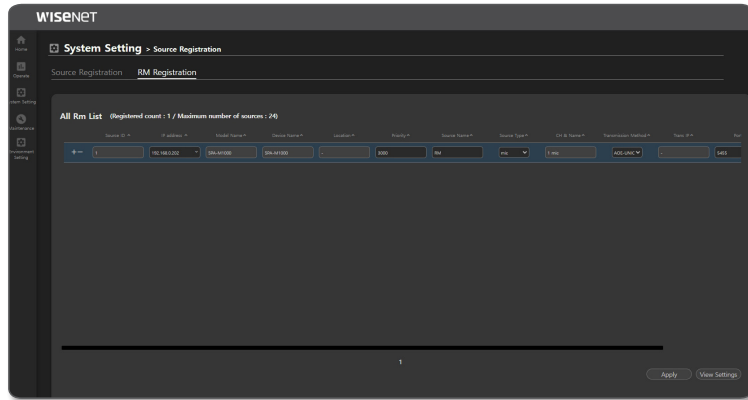

- Source Id: Up to 24 RM microphones can be registered. Click the **[+]** icon to create a list, and click the **[-]** icon to remove the list.
- IP address: An IP address to be used as a microphone. If you select an IP address, Model Name, Device Name, and Device Location will be displayed.
- Priority: The user prioritizes sources. The smaller the number is, the higher its priority is. (Initial value 3000, input value 1000–9999)

- While broadcasting by selecting either the source speakers (with 3000 source registration priority) or zone speakers in **<Button Mode>**, if you select the same zone speakers and talk with a microphone device (with 2000 RM registration priority), audio will be transmitted. Conversely, if you select a speaker that has a source speaker with a priority of "1000" in **<Button Mode>** and broadcast, the **<Button Mode>** broadcast will be kept since the priority of the microphone is higher.

- Source Name: Inputs or changes the name of a source.
- Source Type: Displayed as "mic."
- CH & Name: Displayed as "1 mic."

- Transmission Method: If you select UNICAST, **<Trans IP>** will be deactivated, and the device's IP address will be used. You can enter the **<Port>** number in the input window automatically or manually, and it should not overlap with another device. If you select MULTICAST, a MultiCast IP address (e.g., 224.124.0.\* ) and **<Port>** number are automatically allocated to the **<Trans IP>**. If you enter the IP address and port directly in the device, be cautious that it does not overlap with automatically assigned information.
    - UNICAST : Up to 20 broadcasts are possible with the UNICAST network.
    - MULTICAST : In a MULTICAST network, you can simultaneously broadcast to up to 256 devices (when the control mode is set to UDP).
    - Depending on the network environment configuration, the maximum broadcasting count might be limited.
  - Icon: Selects an icon (mic) and color of a source. If **<User Icon>** images are directly uploaded on PC, you can select one from the **<Icon>** list.
3. Once set, click the **[Apply]** button.
  4. If you click the **[View Settings]** button, the set value can be saved as a CSV file.

## Register Zone

You can register the speaker to the <Zone> of the region for broadcasting. <Zone> refers to one speaker set as an output device.

1. On the Home screen, click <System Setting> → <Zone Registration>.

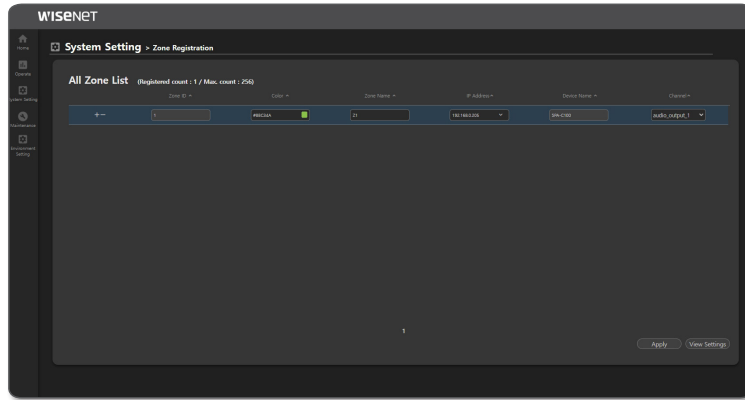

- Zone ID: Up to 256 zones can be registered, and the registered count is displayed. Click the [ + ] icon to create a list, and click the [ - ] icon to remove the list. Names such as z1, z2, and z3 are displayed on the website menu.

- If you click the [Sort] button in the <Select Zone> menu of the <Operate> → <Button Mode>, they will be sorted in the order of z1, z2, z3.

- Color: You can select the color of the zone from the color chapter or create colors you want.
- Zone Name: You can enter the zone name or change it. It is displayed on the <Operate> → <Button Mode> screen of the device.
- IP Address: If you select the Speaker IP address, the <Device Name> is displayed.
- Channel: Displayed as audio\_output\_1.

2. Once set, click the [Apply] button.

3. If you click the [View Settings] button, the set value can be saved as a CSV file.

- As the same speakers can be registered more than once as <Zone>, click <IP address> to sort them in order.

## Group Setting

You can set the <Zone> to be broadcast by grouping it.

1. On the Home screen, click <System Setting> → <Group Setting>.

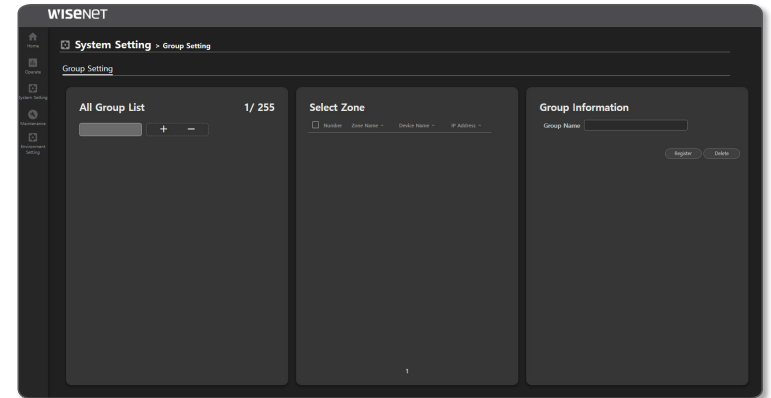

- Group Setting: Up to 255 groups can be set. Click the [ + ] icon to create a group, and click the [ - ] icon to remove the group.

- The set group number is used as the <Group> button in the <Operate> → <Button Mode>.
- For the set group number, after selecting the [Menu] button and switching <Talk Type> → <Talk Protocol> in <IsIs Group>, if you input numbers with the ten key button in the middle of the microphone device, it will be broadcasted with the same group number.

- Zone Select: You can select registered zones (speakers) and set them to the same broadcast group.
- Group Name: You can enter the group name and change it.

2. Once set, click the [Register] button.

- Click the [Delete] button to delete the registered group.



## All Event & Preset List



<Event & Preset Button>

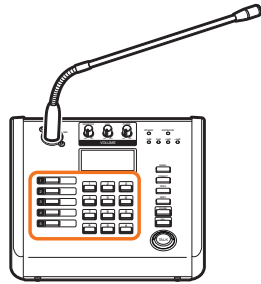

<RM Microphone Button>

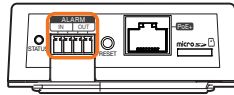

<Audio Module Contact Closure Input>

In the broadcast system, you can broadcast as per the scenario set in the <All Event & Preset List> if an event, such as the Event & Preset of the button mode, RM button of the microphone device, or an external signal (CP) of the audio module, occurs.

There are too many menu properties to fit in a screen, so scroll to set all items.

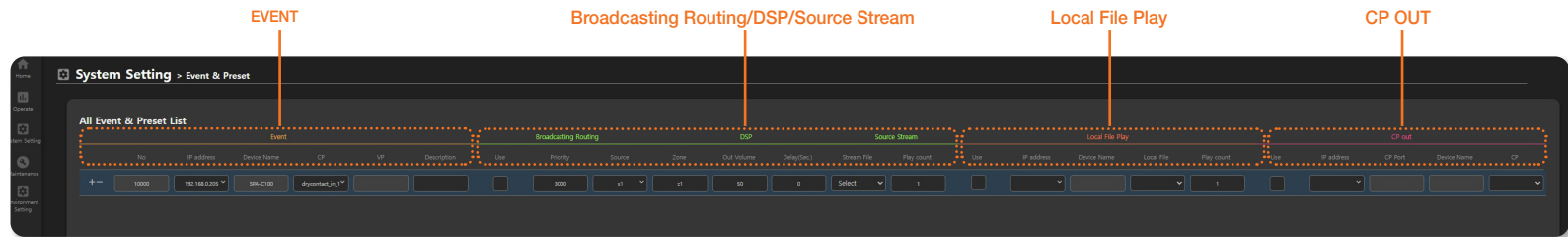

1. On the Home screen, click <System Setting> → <Event & Preset>.
2. Scroll down to set events, such as fire, contact point, external signals, etc. are detected, broadcasting routing, DSP, source stream, local file play, and contact point output (CP Out).
3. The scenario used when an event occurs can be configured as three operations, such as Broadcasting Routing, Local File Play, and Contact Closure Output.

## Event Registration Setting

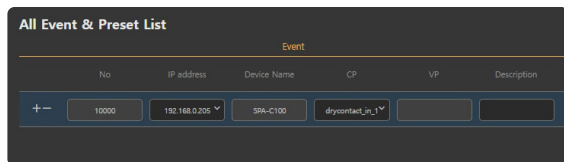

- NO: If you click the [+] icon, a list is created, and if you click the [-] icon, the list is removed.
- IP Address: Select an IP address of the device to register.  
You can register the following three event types.
- If you select [127.0.0.1] for the IP address, the device name will be displayed as <Controller>, and the CP can be selected from CP 1-16.  
If you press the contact Closure Number in the <Event & Preset> of <Operate> → <Button Mode>, an audio source will be broadcast via the speaker set in <Broadcasting Routing> or <Local File Play>.

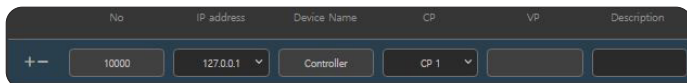

- Clicking a Contact Closure Number will broadcast the sound source as many times as you set in <Broadcasting Routing>, <Local File Play> → <Play count>.
- If the device is registered in the <Contact Closure Output> setting, the Contact Closure Output signal is active until the Contact Closure Number is turned off.
- If the Contact Closure Number is turned off while a sound source is being broadcasted, both the broadcasting and the Contact Closure Output signal will stop.
- If you select the IP address as the speaker, the model name of the <Device Name> will be displayed while the CP is displayed as drycontact\_in\_1.  
If an input signal is generated from the contact Closure device connected to the speaker, the audio source will be broadcast from the speaker set in either <Broadcasting Routing> or <Local File Play>.



- If the Contact Closure INPUT signal is "On", the sound source will be broadcasted as many times as you set in <Play count>.  
If the Contact Closure INPUT signal remains "On" after the sound source has been broadcasted for the number of times you set, the sound source broadcasting will be restarted.
- If the device is registered in the <Contact Closure Output> setting, the Contact Closure Output signal will be active until the Contact Closure INPUT is "Off".
- If Contact Closure INPUT is "Off" while a sound source is being broadcasted, the sound source will be broadcasted for its full length and then stops with the Contact Closure Output signal.

- If you select the IP address as the microphone, the model name of the <Device Name> will be displayed and the CP can be selected from button\_1~5.  
If you press the Contact Closure Number from among the five buttons on the left side of the microphone and press the <TALK> button, the sound source will be broadcasted to the speaker you set in <Broadcasting Routing> or <Local File Play>.  
Microphones can use a VP, and if you enter a VP number, the Contact Closure Number will be disabled.  
Press a VP Number mapped to a combination of 10 buttons (0 - 9) on the middle of the microphone and press the <TALK> button, and the sound source will be broadcasted to the speaker you set in <Broadcasting Routing> or <Local File Play>.

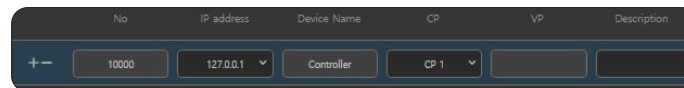

- If the microphone status display shows <Talking...>, the sound source will be broadcast as many times as you set in <Play count>.
- If the device is registered in the <Contact Closure Output> setting, the Contact Closure Output signal will be active until the <TALK> button is turned off.
- If the <TALK> button is turned off while a sound source is being broadcasted, both the broadcasting and the Contact Closure Output signal will stop.

- Device Name: Displays the name of the device automatically upon the selection of an IP address.
- CP: Select a channel and a type of event that can occur to the device.  
As a CP channel and its use are individually designed as per device, the selectable menu of each device will automatically be displayed.
- VP: If you select the IP address as the microphone, you can set either the CP or VP.  
For the VP input value, you can directly enter a number between 1 & 9999.
- Description: The user's description can be input.

## Broadcasting Routing/DSP/Source Stream Settings

When an event occurs, you can broadcast the BGM sound source (mp3, wav) and TTS of the registered source device to the designated zone.



- Use: Choose whether to use a broadcasting routing scenario.  
When you set the broadcasting routing as **<Use>**, you cannot use Local File Play.
- Priority: A lower number has a higher priority. If the priority is "1000", it will be on air prior to any other broadcasts. (The initial value is 3000, the input value is 1000 - 9999)
  - While broadcasting with a source speaker that has a source priority set as "2000" in **<Button Mode>**, if an event that with an event priority set as "1000" in the **<Event & Preset>** occurs, the **<Button Mode>** broadcast will stop and the event setting broadcast will start. Conversely, if the event priority in **<Event & Preset>** is "3000", the **<Button Mode>** broadcast will be continue.
  - During broadcasting, if a schedule that has a schedule priority set as "2000" in the **<Scheduler>** is broadcasting and an event that has an event priority set as "1000" in the **<Event & Preset>** occurs, the **<Scheduler>** broadcast will stop and the event setting broadcast will start. Conversely, if the event priority in **<Event & Preset>** is "3000", the **<Scheduler>** broadcast will continue.
- Source: Select a speaker IP address to use as the source sound (supporting BGM, TTS).  
If the event device is a microphone, you can transmit sound with the microphone by selecting the microphone's IP address.
- Zone: To use it for broadcasting routing, please enter your zone ID set in **<Zone Registration>**.  
(e.g. z1 / z1, z2 / z1-z3 / all)
  - You can select other speakers for **[Source]** and **[Zone]**. If you press a configured **[CP Number]** or an input signal occurs from the connected CP device, the audio source of the speaker which is selected as **[Source]** is played from the speaker selected as **[Zone]**.
  - The speaker IP address in **[Source]** is displayed if you check the **<CTRL>** box in the **<System Settings>** → **<Source Registration>** and set the BGM to file\_player and TTS to tts\_player in the **<Source Type>** and **<CTRL Type>**.
- Out Volume: A speaker's audio output volume can be set. (Initial value 50, input value 0~100)  
The output volume is reflected only to **<Event & Preset>**.
- Delay: Enter the delayed time before starting scenario broadcasting once the event has taken place.  
(Initial value 0, input value 0~300)
- Stream File: Select a file to stream from the audio list of the selected source. Depending on the source registration type (BGM, TTS) of the selected speaker, BGM and TTS sound sources are provided respectively.
- Play count: Input the number of repeats to play the audio file repeatedly. (Initial value 1, input value 1~99)
  - The sources registered as schedulers cannot be used for broadcasting routing.

## Setting Local File Play

When an event occurs, the BGM audio stored in the speaker which is selected as zone will be played. Local file playback does not support TTS sound sources, and is unrelated to the speaker's source registration type.

If you press a set **[CP Number]** or an input signal occurs from the connected CP device, the audio will be played from the speaker.

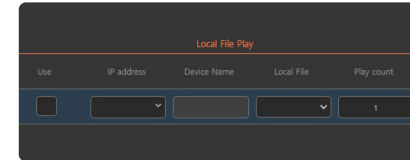

- Use: Choose whether to use a local file play scenario.  
When Local File Play is set as **<Use>**, you cannot use broadcasting routing.
- IP address: Select the IP address of the speaker to play a local file.
- Device Name: Displays the device name of the selected speaker.
- Local File: Select an audio file (that supports BGM) to play from the audio list registered on the speaker.
- Play count: Input the number of repeats to play the audio file repeatedly. (Initial value 1, input value 1~99)

## Setting Contact Point Output (CP Out)

You can set scenario operation for Contact Closure Output.

You can use it as an external device (warning light, power supply) switch through the CP device.

When an event occurs, the Contact Closure Output switch of the configured speaker or audio module will be closed.

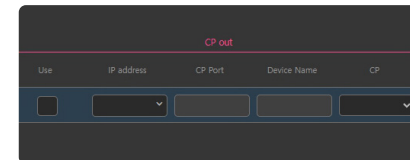

- Use: Choose whether to use a contact point scenario.
- IP address: Select an IP address of the speaker to output the contact point.
- CP Port: Indicated as 20028.
- Device Name: Displays the device name of the selected speaker.
- CP: 1 will be displayed.

4. Once set, click the **[Apply]** button.

5. If you click the **[View Settings]** button, the set value can be saved as a CSV file.

- You can use the CP OUT (Contact Closure Output) portion with the selected broadcasting routing or Local File Play. Or you can also use it alone.

## Scheduler

Broadcast reservations can be set.

With the scheduler, you can perform scheduled broadcasts to as many zones (output speakers) as you want using the audio source of the speaker selected as a source device in the <Source Registration> menu.

The broadcast sound source can be used by directly entering sound source files (mp3, wav) or TTS phrases stored in the source device registered for the Scheduler.

It is possible to create daily, weekly, monthly, and annual loop schedules, and it will not broadcast on days set as holidays.

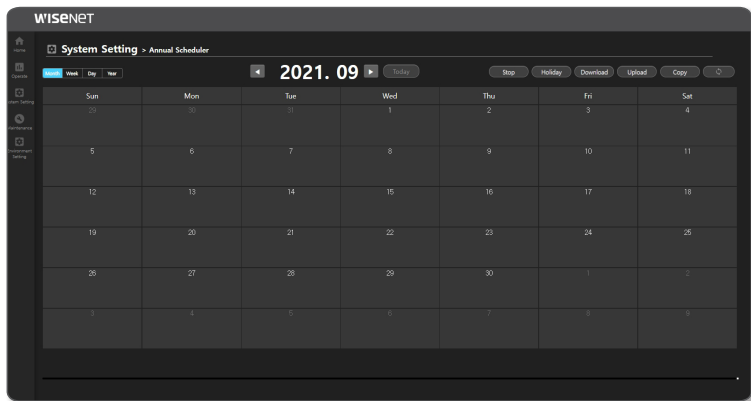

- Click <System Setting> → <Scheduler> on the Home screen.
  - Registered schedules can be viewed by month/week/day/year.
- The scheduler's additional functions can be used.
  - Stop: The currently playing broadcast will stop.
  - Holiday: Holidays can be set.
  - Download: Registered schedules can be downloaded as "xml" files.
  - Upload: A downloaded schedule can be uploaded to other speakers.
    - If there are both weekday and holiday schedules, the holiday schedule will not be reflected even if you upload a downloaded file.
    - For holiday schedules, use the download and upload functions of the <Holiday> menu.
  - Copy: Schedules for each month can be copied.
    - When the Copy Settings window appears, click the [Copy] button.
    - The selected year automatically resets to the fifth year from the pertinent year.
  - : Renews a schedule list.
- Schedules registered on each date are shown, and if you select a date where you want to create a schedule, the schedule setting screen will appear.

If you register 4 or more schedules for one day, it will be indicated as <+2>.

## Schedule Setting Screen

It is a screen where you can set schedules.

If there are duplicate broadcast schedules (BGM, TTS audio source) at the same time, the schedule which is registered later will be run.

If there is a schedule where one time period overlaps with another, the earlier one will stop upon the beginning of the later one while running the later one's broadcast schedule.

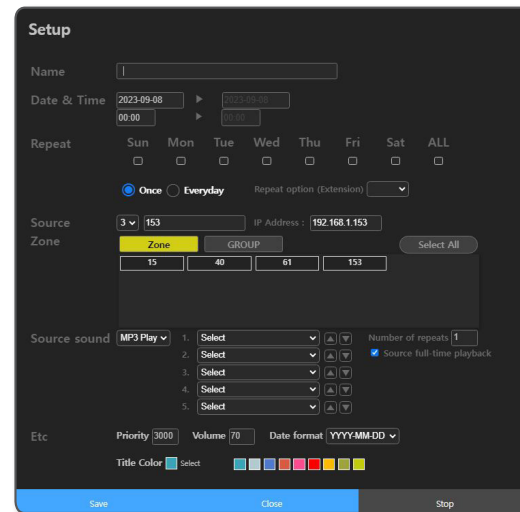

- Name: Input a name for a schedule.
- Date & Time: Select a date when a schedule is to take place.
  - Select or input a time when a schedule is to take place.
  - If you click the [Now+1(min)] button, the start time of the schedule is set to a minute after the current time.

If it is set to Date (2021-01-01 / 2021-01-01), Time (10:00 / 09:00), an input error window (time error) pops up.

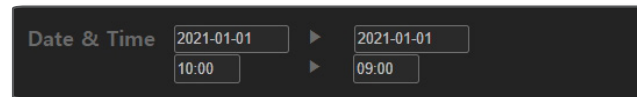

If it is set to Date (2021-01-02 / 2021-01-01), Date (09:00 / 10:00), an input error window (date error) pops up.

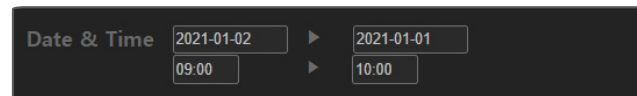

3. Repeat: Select a day, a period, etc. you want to set.

- Select Day: During the set dates, it runs only on selected days of the week. If you select days of the week, <Everyday> and <Once> are deactivated.
- Once: Even during the set period of the dates, it runs only once on the first date.

- ☑ If you set it to the date (2021-01-01 / 2021-01-02), time (09:00 / 09:10), <Once>, the broadcast schedule is set up for 10 minutes from 9:00 to 9:10 on January 1st.

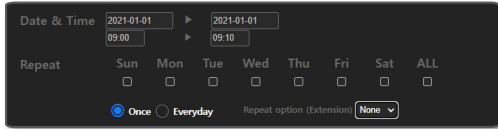

- If you set it to the date (2021-01-01 / 2021-01-02), time (23:00 / 01:00), <Once>, the broadcast schedule is set up continuously from 23:00 on January 1st to 1:00 on January 2nd.

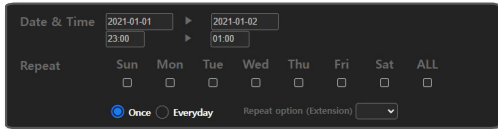

- Everyday: During the set period of dates, it runs repeatedly every day.

- ☑ If you set the date (2021-01-01 / 2021-01-02), time (09:00 / 09:10), <Everyday>, the broadcast schedule is set up for 10 minutes from 9:00 to 9:10 from January 1st until January 2nd.

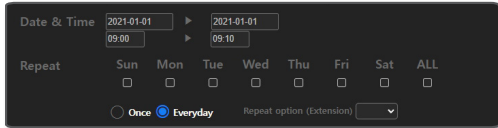

- If you set the date (2021-01-01 / 2021-01-02), time (23:00 / 01:00), <Everyday>, the broadcast schedule is set up twice from 23:00 on January 1st until 1:00 on January 2nd and from 23:00 on January 2nd until 01:00 on January 3rd.

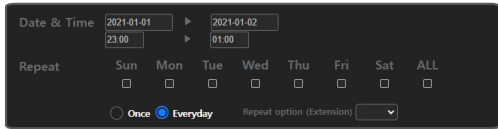

- Repeat Option (Extension): Sets the set schedule to repeat on a weekly, monthly, or yearly basis.

- ☑ If you set up the <Once> or <Everyday> function, check that the set schedule is accurate on the [Weekly Calendar], [Daily Calendar] screen.
- When setting the <Repeat Option (Extension)>, the schedule period should not exceed one week for <Week>, 28 days for <Month>, or 365 days for <Year>.
- For <Week>, a schedule is set every week from the selected day of the week.
- For <Month> and <Year>, if you select a specific day, the schedule is set on the specific date for every month or year.
- If you specify a date range in <Month> or <Year> and select days of the week in [Everyday], the schedule is set only for those days of the week which exist within the date range.
- You can delete a specific day from the schedule date range or delete all recurring events.

4. Source: Indicates registered source ID and IP Address.

- ☑ To be registered as the source of Annual Scheduler, the <CTRL> menu's checkbox of the <Source Registration> should be deactivated.

5. Zone: Indicates a registered <Zone> or <Group>.

- A <Zone> or <Group> can be selected individually, or all zones or groups can be selected and deselected.
- All zone speakers selected in a <Zone> or <Group> are set as the output speakers.

6. Source sound: Select an audio source type to be broadcast from schedules.

- MP3 Play: Displays a list of audio sources registered in BGM Play.  
The length of the selected audio will automatically be reflected to the end time of <Date & Time> and displayed as being deactivated.  
If you input the <Number of Repeats>, an audio source will play repeatedly and automatically displayed at the end time.  
If you uncheck <Source full-time playback>, you can directly enter the end time so that it is broadcast only at the time you want.  
The playing order of the audio can be changed using the [▲▼] button for each file.

- ☑ If the date is 2021-01-01 / 2021-01-01, the time starts at 23:55, and the length of the selected audio source is 10 minutes, the end date and end time will be set to 2021-01-02 and 24:05 automatically.  
If it is set to <Once>, the broadcast schedule is set from 23:55 on January 1st to 0:05 on January 2nd continuously.  
If it is set to <Everyday>, the continuous broadcast schedule is set twice from 23:55 on January 1st to 0:05 on January 2nd and from 23:55 on January 2nd to 0:05 on January 3rd.

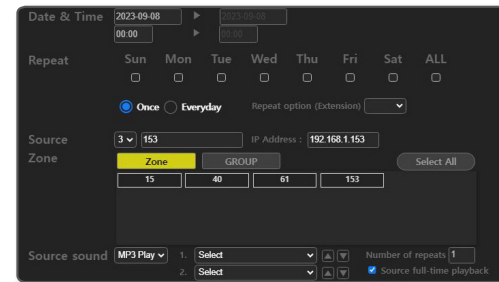

- TTS: Enter sentences with the language to be used in the <Text for TTS> and select the language and gender in Select Speaker.
  - Select language: English (US, GB), German, Spanish, French, and Russian are supported.
  - Select gender: You can select a male or female voice.
  - TTS input language and the language the speaker has chosen should be the same to play TTS-converted audio normally. If they are not the same, there will be a pop-up window that says <A TTS conversion error has occurred. Please check the contents.>
  - When you enter a special character, please refer to the following content.
    - In the TTS input window, you cannot enter & or `.
    - You can enter ^ ( ) \_ ! ' " , but they are not converted to audio.
    - If @ # \$ % = \ / \* are located alone or in the middle of sentence or numbers, they will be converted to audio.
    - Depending on the supported language or sentence structure, a special character may not be converted to audio.

## 7. ETC.: You can set other schedule settings.

- Priority: A lower number has a higher priority. If the priority is "1501", it will be on air prior to any other broadcasts. As the priority of a general audio broadcast is set to 3000 by default, the priority of the Scheduler is recommended to be set at a value lower than 3000. (The initial value is 3000, the input value is 1501 - 9999)



- While broadcasting with a source speaker that has a source priority set as "2000" in <Button Mode>, if the schedule time that a schedule priority is set as "1501" in the <Scheduler> occurs, the <Button Mode> broadcast will stop and the schedule setting broadcast will start. Conversely, if the schedule priority in <Scheduler> is "3000", the <Button Mode> broadcast will continue.
- During broadcasting, an event that has an event priority set as "2000" in the <Event & Preset>, if the schedule time for a schedule that has a priority set as "1501" in the <Scheduler> comes up, the <Event & Preset> broadcast will stop and the schedule setting broadcast will start. Conversely, if the schedule priority in <Scheduler> is "3000", the <Event & Preset> broadcast will be kept.

- Volume: You can set the volume when the schedule is operated. (Initial value 70, input value 0~100) Output volume is reflected only to <Scheduler>.
- Date Format: You can select the date format displayed on the scheduler.
- Title Color: You can select the color displayed on the scheduler.



- If the Controller Mode or source speaker is turned off during the scheduled broadcast and then turned on within the scheduled broadcast time, it automatically plays the first sound source among the selected sources and stops at the scheduled end time.
- If the zone speaker is rebooted during scheduled broadcasting, the sound source is skipped and plays, and then stops when it reaches the scheduled end time.
- If the speaker is turned off and then turned on after the scheduled broadcast time has passed, the scheduled broadcast does not resume.

## Holiday Setup Event

Click the [Holiday] button on the scheduler settings screen and the <Holiday> screen will appear.

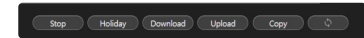

- Add Holiday : You can set holidays in <Add Holiday>.
- Download : You can download the created holiday settings as an XML file.
- Upload: You can upload the downloaded holiday settings files.

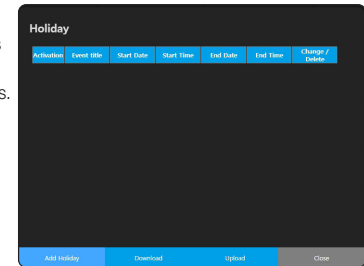

## Add Holiday screen.

1. Click the [Add Holiday] button and the <Add Holiday> screen will appear.
2. Enter the holiday title to be set.
3. Set up the date and time to start and end the broadcast.
4. If you select a month, week, and day under <Specific Holiday>, that day is set as a holiday every year.
5. <Activation> must be checked to operate the holiday settings.
6. Click the [Add Holiday] button when the setting is complete.
7. Set holiday settings are displayed on the scheduler.
8. You can change or delete set holidays.

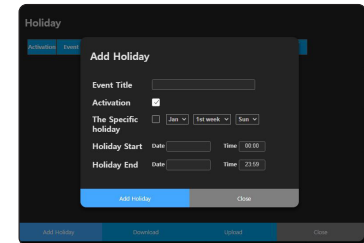

- If you set the date and time to start as 2021-01-01, 08:00 and the date and time to end as 2021-01-02, 23:00, the scheduled broadcast will be suspended from 8:00 on January 1st to 23:00 on January 2nd.

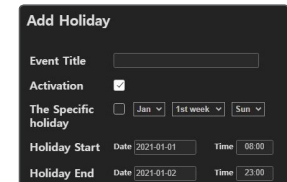

## MAINTENANCE

### Failover History Management

The failure history for the product can be input and managed.

1. On the Home screen, click **<Maintenance>** → **<Failover History Management>**.

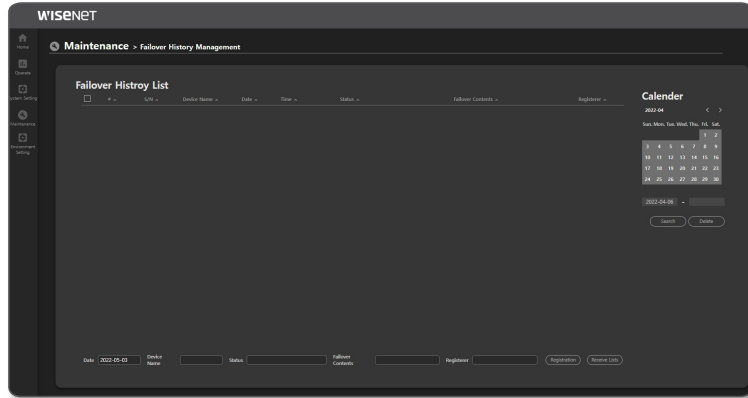

- If you click the **[Search]** button, you can search the results by date.
- Click the **[Delete]** button to delete the selected fault history.
- Lists of Failure History: Shows the entire history of registered failures.
- Register After inputting fixes and status of the failure history, they can be registered.
  - Date: Only the today's date can be entered as an input, and the date cannot be changed.
  - Device Name: Enter the name of the device where a failure occurred. (Max. 20 characters)
  - Status: Enter the failure status. (Max. 20 characters)
  - Failover Contents: Enter the processing details. (Max. 70 characters)
  - Registerer: Enter the name of the user. (Max. 20 characters)
- Receive Lists: The registered history of actions for malfunctions can be downloaded in the "csv" file format.  
As the history of actions for malfunction will be deleted when the product's system is initialized, please download it in advance.

- Every input field must be filled in.
- Special characters (', ') cannot be input in the input field.
- Locate a mouse pointer on a failure history item to see all the registered details.

### View Log

You can check logs generated in the product.

The log items are different for each product, and they are recorded when the log operation occurs.

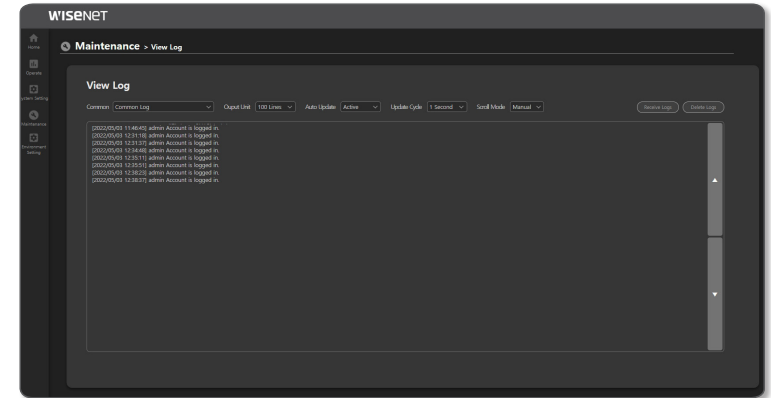

1. On the Home screen, click **<Maintenance>** → **<View Log>**.
2. The action log history for the device is shown by item.  
The Log menu will appear on the View Log when its function is activated.
  - The logs of each menu are queried up to 1000 lines, and if they exceed 1000 lines, the oldest logs are deleted first.
3. If you click the **[Receive Logs]** button, a file can be downloaded in HTML format.  
Check HTML files via Google Chrome.
  - As the log information will be deleted when the product's system is initialized, please download it in advance.
4. If you click the **[Delete Logs]** button, all logs displayed on the screen will be deleted.
5. The Output Unit, Auto Update, Update Period, and Scroll Mode can be set.  
If you activate **<Auto Update>**, logs will be displayed in accordance with the **<Update Cycle>**.
  - If you auto select **<Scroll Mode>**, the screen will be moved downward to show recent logs.
  - Press the **[Top/Bottom]** button to view the upper and lower logs.

# using speaker mode

If you select **<Operation Mode>** to **<Speaker>** in the speaker's **<Device Operation Setting>**, you can perform scheduled broadcasting, BGM and TTS broadcasting using the speaker alone. Also, because it is set up as device register and source (audio input device), zone (audio output device) in the **<Controller>** mode speaker or server (SPA-S1000), it can perform several broadcast operations.

## HOME SCREEN CONFIGURATION

You can move to the website that supports functions below by selecting **<Speaker>** for the **<Operation Mode>** of the Speaker.



Name	Function Description
1 Home	Goes to the Home screen.
2 Operation Setting	Various operations are available, such as Contact, Broadcast, Annual Scheduling, and SIP.
Maintenance	Logs generated in the product can be checked.
Environment Setting	The System Management, Network, Time, Device Information, etc. can be set.
3 Product Model Name	Displays the device's model name.
4 Product Information	The IP address, device name, device location, and firmware version are displayed.
5 Connected Account/Login	Shows a connected account and its login status.
6 Time Information	The connection time to the web page menu, product cumulative operating time, and product time will be displayed.
7 Language	Shows language options supported on the website. (Korean, English supported)
Go to the Official Website	If you click <b>&lt;Hanwha&gt;</b> , the screen will move to the Hanwha Vision Official Website.

The optimal monitor resolution is 1920x1080.

## OPERATION SETTINGS

You can set up the CP function, broadcast audio (BGM, TTS, CHIME), DSP (speaker, built-in microphone volume), scheduled broadcast and SIP (VoIP phone voice transmission).

### Contact Closure Settings

- On the Home screen, click **<Operation Setting>** → **<Contact Closure Setting>**.
- If you select the **<Contact Closure Input>** and **<Contact Closure Output>** tab, the status information will be displayed.
  - : When the input or output device is running,
  - : When the input or output device is not running,
- For Contact Closure Input, a real input signal has to occur to change the status information. Whether the Contact Closure Output is operating or not can be checked manually by clicking its status information on the screen.

#### Contact Closure Input

- By connecting to the Contact Closure Output of an external device, such as an electrical switch, smoke detector, or motion detector, it can be used as the Contact Closure Input of the speaker.
  - You can perform a warning broadcast through the speaker when detecting a motion by connecting the motion detector to the contact closure signal.
- When the contact closure signal is entered, the BGM audio, which is set up in the "Event & Preset" function in advance, will be automatically broadcasted.

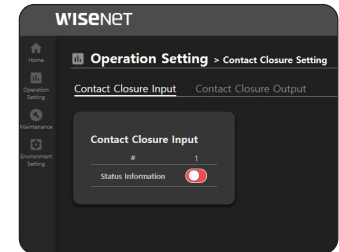

#### Contact Closure Output

- A Contact Closure Output can send signals to the broadcast system or send a warning signal to an external device, such as a lightbar, by connecting to it.
- You can output the command for the contact closure of speakers by simply pressing the CP buttons on **<Button Mode>** → **<Event & Preset>** or the physical CP buttons on the microphone (SPA-M1000).

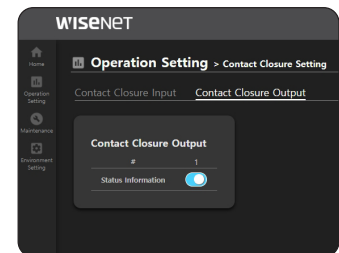

You cannot use contact closure input with a speaker by itself. For the contact closure settings and operation method, refer to **<Event & Preset>** on pages 34 and 35.



## Source File Management

You can register an audio file for broadcasting.

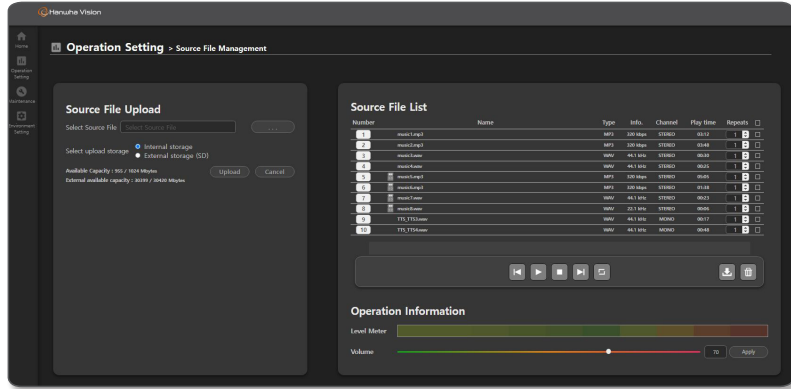

1. On the Home screen, click <Operation Setting> → <Source File Management>.
2. Click the [ ] button to select the PC folder containing the sound source files to be uploaded.

- The internal storage has an available capacity of up to 1GBytes, and there are no restrictions on the size and number of sound files within the capacity.
- Supported source types: WAV (16bit), MP3
- Supported MP3 bit rates: Only MP3 (mono/stereo) in the range of 64kbps to 320kbps
- Supported WAV Sampling Rate: 16Khz, 32Khz, 44.1Khz, 48Khz
- PCM-type WAV files without header information cannot be used.
- If the sound source file name contains special characters, it may not be uploaded. Please change the file name (remove special characters) and upload again.
- Please delete audio files which cannot be played as they will be displayed as "unable to use" on the screen if they are uploaded or played.



3. Click the [Upload] button after selecting source files to upload.
  - You can select External Storage (SD) and upload if the product has a microSD card.
  - The available capacity of the internal and external storage is displayed and an upload unavailable window appears when they are smaller than the source files to be uploaded.
  - Insert or remove the microSD card while the product is turned off.
  - Duplicate sound source file names are not allowed, so a pop-up window will appear saying that it cannot be uploaded.

- Be sure to format the microSD card in FAT32 (file system) before inserting it into the speaker.
- NTFS and exFAT (file systems) are not supported.
- A microSD card capacity of up to 32 GB is supported (SDHC, MLC, Class 10 or higher).
- We recommend Sandisk and Transcend products.
- Compatibility by manufacturer and product type may vary.

4. Uploaded source files are displayed on the right <Source File List>. Various information is provided, and repeated playback of audio (up to 99 times) is also possible.
  - A microSD card icon is displayed with the file name for the files saved to external storage (SD)
  - The TTS file (TTS\_filename.wav) for which the <To BGM> function was used in [TTS File Management] is also displayed in the <Source File List>.
5. You can download the uploaded sound source (except for the To BGM TTS file) or delete it.

- When you try to download two or more audio resources, the pop-up window granting permission will appear. If you have pressed the permission-block button, click the top right button on the web page (shown with the icon) to select <Allow downloading multiple files automatically>.

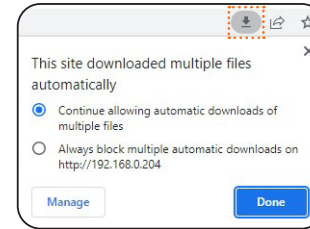

6. Play/pause, stop, previous song/next song (select multiple sound sources), repeat are possible. When audio is played, its title will be shown as it scrolls across the screen.

- If the speaker is turned off and on while a sound source is playing, it automatically plays from the beginning.
- During the sound source play, if the PAUSE button is pressed to pause playback or the STOP button is pressed to stop playback, auto play does not work.

7. The output volume is reflected only to <Source File Management>. If you run mute from the <Device Monitoring> → <Output Device> of the server or controller mode speaker, the mute is also applied to Source File Management.
8. When the file is played, the audio title and level meter can be used to check it.
9. Click the number of the source file list to play through the PC speaker.

## BGM Streaming

- This is a function to directly transmit and play sounds that have been uploaded to Source File Management to speakers registered in <Client Connection List> through the network.
- To connect, you must go to <Broadcast Client Settings> for the speakers and enter the same IP address and port number entered in <Broadcast Server Settings> for Unicast or Multicast.
- You can send audio to another speaker through the <Broadcast Server> setup.
- You can receive audio from another speaker through the <Broadcast Client> setup.
- As it uses audio uploaded to Source File Management, you cannot upload or delete audio on BGM Streaming.
- If the speaker is turned off and on while a sound source is playing, it automatically plays from the beginning.
- During the sound source play, if the PAUSE button is pressed to pause playback or the STOP button is pressed to stop playback, auto play does not work.

1. On the Home screen, click <Operation Setting> → <BGM Streaming>.
2. The <Broadcast Server Settings> and <Broadcast Client Settings> screens are displayed when selecting the initial menu.

## Broadcast Server Settings

- Communication Method: Supports TCP/IP
- Transmission Method: Select between Unicast and Multicast  
You can select both Unicast and Multicast.
  - Unicast can transfer the audio up to 1:20 speakers while Multicast can transfer audio up to 1:256 speakers.
  - You have to select the transmission method in consideration of the network environment being used.
- Operation Information: Sets the port where the server operates  
The basic streaming port is set as 5455.
- Click the [Apply] button to save the settings and move to the Broadcast Server screen.

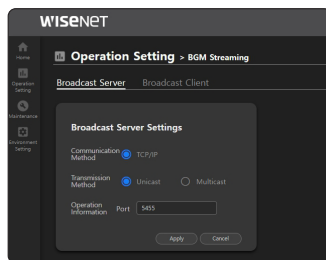

- When operating the broadcasting system with a <Controller Mode> speaker or server (SPA-S1000), you don't need to separately set the transmission method and operation information (IP address, port) of the <Broadcast Server> or <Broadcast Client>.

## Broadcast Server Operation Information

When you click the [Apply] button on <Broadcast Server Settings>, the server begins operation, and you will be moved to the following screen which shows the source file list, playback information & server settings, and the client connection list.

In the <Operate> → <Button Mode> menu or Scheduler menu of the speaker used in <Controller mode>, it can be provided as a selectable audio source.

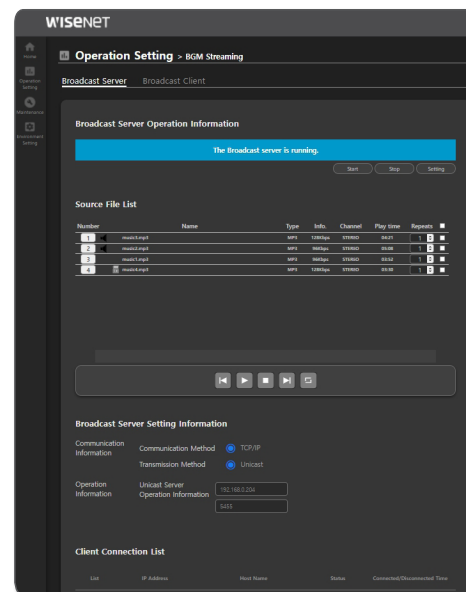

1. Click <BGM Streaming> → <Broadcast Server>.
  - Click the [Start], [Stop] buttons to select whether to operate the broadcast server.
  - Click the [Settings] button to move to the <Broadcast Server Settings> screen.
2. You can check the information of source files on the Source File List.  
Click the number of the source file lists to play through the PC speaker.
3. For audio files that have had their right checkboxes checked on the Source File List, you can play audio files using the [ ] buttons with other speakers in addition to the source speaker.
  - You need to enter the same IP addresses and port numbers that are set as Unicast or Multicast from the <Broadcast Server> in the <Broadcast Client> of the source speakers or other speakers.
4. Communication information and operation information are displayed in <Broadcast Server Settings Information>.

5. <Client Connection List> displays the information of other connected speakers (Activated, Deactivated status) only if the speaker transmission method is set to Unicast.  
If you set the speaker transmission method to Multicast, the information of other connected speakers will not be displayed, but the sound source play function will run.

### Broadcast Client Settings

- Communication Method: Supports TCP/IP
- Transmission Method: Select the same method as the broadcast server to connect between Unicast and Multicast
  - Unicast is a 1:N server-client structure.(Maximum 1:20)
  - Multicast can be broadcast to all clients in the channel via the channel communication method. (Maximum 1:256)
- Set IP Address and Port. Enter the IP address and port of the server to be connected.
- Click the [Apply] button to save the settings and move to the Broadcast Client screen.

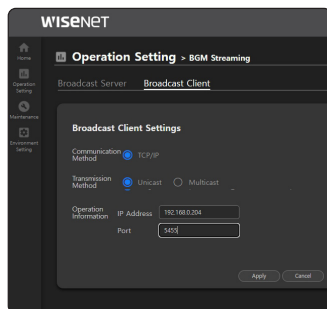

### Broadcast Client Operation Information

When you click the [Apply] button in the <Broadcast Client Settings>, the client operation starts, and you will be moved to the screen below which shows client settings, play, and server and operation information.

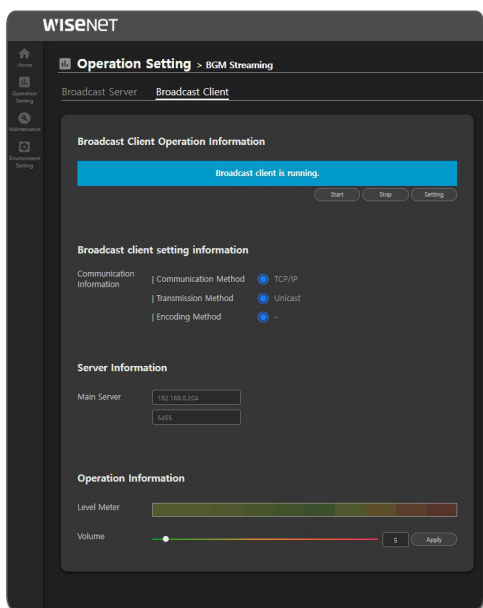

1. Click <BGM Streaming> → <Broadcast Client>.

- Click the [Start], [Stop] buttons to select whether to operate the Broadcast Client.
- Click the [Settings] button to move to the <Broadcast Client Settings> screen.

2. Communication Information and Play Information are displayed on <Broadcast Client Settings Information>. When the source files are played through <Speaker> mode or <Controller> mode, the MP3 Encoding (MP3, WAV) or PCM Encoding (TTS) information value will be displayed on the Play Information.

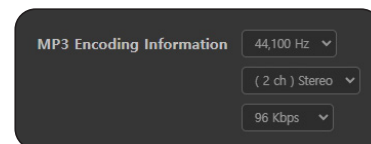

3. Server Information connected to Broadcast Client is displayed on <Server Information>

4. If the source files are played using <Speaker> mode or <Controller> mode, it is displayed on the Level Meter of <Operation Information> and you can control the volume.
5. If you broadcast with the source speaker selected from the <Operation Mode> → <Button Mode> menu of the <Controller Mode> speaker, the source speaker's IP address and port number are automatically reflected in the client's server information.



- If you broadcast with the source speaker selected from the <Scheduler> menu of the <Controller Mode> speaker, the IP address and port number of the source speaker are automatically reflected in the client's server information.

## Chime File Management

If you broadcast TTS audio in the <Operate> → <Button Mode> menu of the speaker used for the <Controller mode>, the chime sound source is provided at the start and end of the broadcast.

If you broadcast TTS audio source entered in the <Scheduler> menu, the chime is not provided.

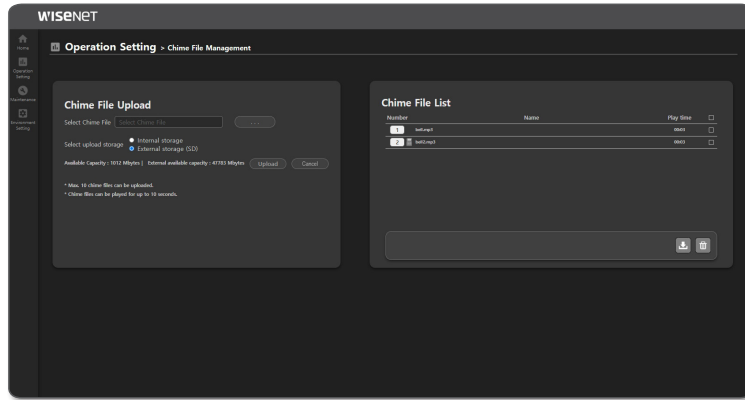

1. On the Home screen, click <Operation Setting> → <Chime File Management>.
2. Click the [ ] button to select the PC folder containing the Chime files to be uploaded.

- Supported source types: WAV (8bit), MP3
- Supported MP3 bit rates: Only MP3 (mono/stereo) in the range of 64kbps to 320kbps
- Supported WAV Sampling Rate: 16Khz, 32Khz, 44.1Khz, 48Khz
- PCM-type WAV files without header information cannot be used.
- If the sound source file name contains special characters, it may not be uploaded. Please change the file name (remove special characters) and upload again.
- Please delete audio files which cannot be played as they will be displayed as "unable to use" on the screen if they are uploaded or played.

3. Click the [Upload] button after selecting source files to upload.
  - Chime files can be uploaded between the internal storage and external storage (SD) and share the Available Capacity with BGM and TTS files.
  - Up to 10 files can be uploaded, and uploaded files up to 10 seconds long can be saved.

4. Uploaded Chime files are displayed on <Chime File List> on the right side. Click the number of the source file to play through the PC speaker.
  - A microSD card icon is displayed with the file name for the files saved to external storage (SD)
5. You can download or delete uploaded Chime files.
6. Chime files can be selected as either a start or stop the chime on the <Chime operation setup> in <Operation Setting> → <TTS File Management>.

## TTS File Management

You can convert the text into a human voice.

If you adjust the intonation, speed, etc., for the input language, a more natural voice output can be generated.

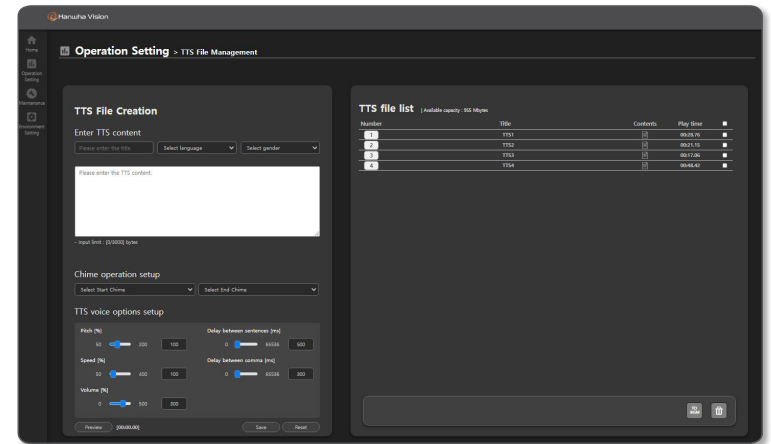

1. On the Home screen, click <Operation Setting> → <TTS File Management>.
2. Enter <TTS content>.
  - The title you enter will be used as the file name.
  - Select language: English (United States, United Kingdom), German, Spanish, French, and Russian are supported.
  - Select gender: You can select a male or female voice.
  - TTS input language and the language the speaker has chosen should be the same to play TTS-converted audio normally. If they are not the same, there will be a pop-up window that says <A TTS conversion error has occurred. Please check the contents.>

- When you enter a special character, please refer to the following content.
    - In the TTS input window, you cannot enter & or `.
    - You can enter ^ ( ) \_ | ' " , but they are not converted to audio.
    - If @ # \$ % = \ / \* are located alone or in the middle of sentence or numbers, they will be converted to audio.
    - Depending on the supported language or sentence structure, a special character may not be converted to audio.
3. Set <Chime operation setup> to be played after the start and end of the TTS broadcast.
    - Select Start Chime: Select the file to be used as a start chime from the list.
    - Select End Chime: Select the file to be used as an end chime from the list.
  4. Select <TTS voice options setup>.
    - Pitch: You can set the pitch of the TTS voice.
    - Speed: You can set the speed of the TTS broadcast.
    - Volume: You can set the default volume of the TTS voice.  
Even when another audio source is broadcasting, it is broadcast with the set TTS volume.
    - Delayed between sentences: You can set the pause time between sentences. The same delayed time is applied to the special characters ? and !.
    - Delayed between comma: You can set the delayed time for the next sentence after the comma.
  5. Click the [Preview] button to play the created TTS files (except for chimes) through the PC speaker.
  6. Click the [Save] button to save the set TTS files.  
If you click the [Reset] button, set values for input information, and options are reset.
    - Only TTS files created directly from the website can be used.
    - TTS files can be uploaded between the internal storage and external storage (SD) and share the Available Capacity with BGM and Chime files.
  7. Click the number of the TTS file to play through the PC speaker.
  8. Delete: Click the [🗑️] icon after selecting TTS files.
  9. To BGM: Select a TTS file and click the <To BGM> button to save it in the <Source File List> of [Source File Management].

## DSP Settings

You can control the speaker's output volume and the microphone's input volume.

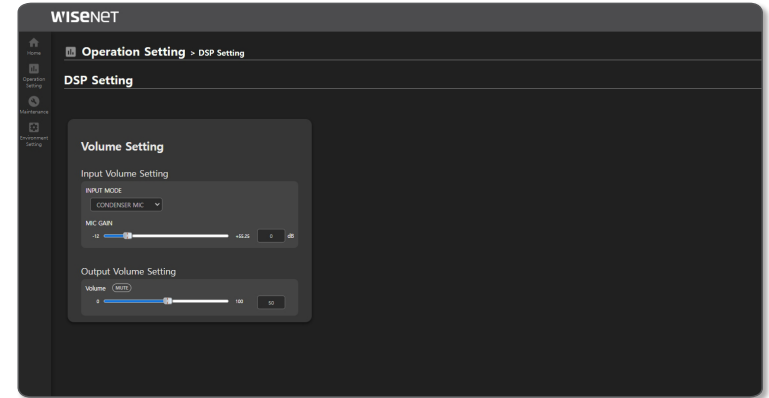

1. On the Home screen, click <Operation Setting> → <DSP Settings>.
2. Set <Input Volume Setting>.
  - DISABLED: The input volume of the internal microphone of the speaker is turned off.
  - CONDENSER MIC: It controls the Gain(Volume) value of the internal microphone of the speaker. <Input Volume Settings> function is available for the audio module after connecting the external microphone.
  - If it is set up as <CONDENSER MIC>, the speaker's audio output status is visualized as audio signals and displayed in <Operate> → <Audio Monitoring> of the <Controller> mode speaker. You cannot hear the actual output audio source.
3. Set <Output Volume Setting>.
  - Volume: Controls the output volume of the speaker. (input value 0~100, increments of 1.0)  
Even if you adjust the speaker's Output volume, it is not reflected to the output device volume in <Operate> → <Device Monitoring> of the controller device.
  - Mute: Mutes the output volume of the speaker.

# using speaker mode

❖ For the IP audio module (SPA-D1000), the Equalizer menu is provided so that its sound can be properly adjusted according to the characteristics of the connected analog speaker. The Equalizer menu is not provided as the DSP optimal value is reflected for each speaker model.

- Parametric Equalizer (PEQ)
  - Flat: Resets the set PEQ value.
  - Type: Provides 8-band peaking type.
  - Gain: Controls the output value for each band. (input value -12~+12, increments of 1.0)
  - FREQ: The frequency band values, which are provided for each BAND, are displayed.
  - PRESET: Saves or loads PEQ set values to apply them.



## Scheduler

A broadcast reservation can be set.

Broadcast sound sources can be broadcast through the speaker alone by directly entering sound files (mp3, wav) registered in Source File Management or TTS phrases.

It is possible to create daily, weekly, monthly, and annual loop schedules, and it will not broadcast on days set as holidays.

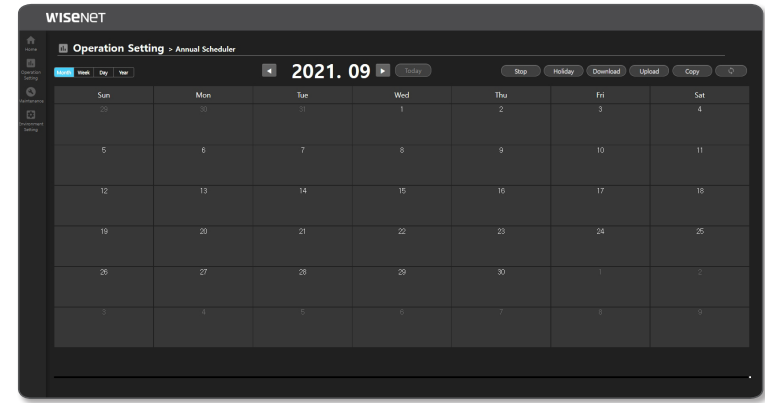

1. On the Home screen, click <Operation Setting> → <Scheduler>.
  - Registered schedules can be viewed by month/week/day/year.
2. The scheduler's additional functions can be used.
  - Stop: The currently playing broadcast will stop.
  - Holiday: Holidays can be set.
  - Download: Registered schedules can be downloaded as "xml" files.
  - Upload: A downloaded schedule can be uploaded to other speakers.
    - If there are both weekday and holiday schedules, the holiday schedule will not be reflected even if you upload a downloaded file.
    - For holiday schedules, use the download and upload functions of the <Holiday> menu.
  - Copy: Schedules for each month can be copied.
    - When the Copy Settings window appears, click the [Copy] button.
    - The selected year automatically resets to the fifth year from the pertinent year.
  - : Renews a schedule list.
3. Schedules registered on each date are shown, and if you select a date where you want to create a schedule, the schedule setting screen will appear.

■ If you register 4 or more schedules for one day, it will be indicated as <+2>.

### Schedule Setting Screen

It is a screen where you can set schedules.

If there are duplicate broadcast schedules (BGM, TTS audio source) at the same time, the schedule which is registered later will be run.

If there is a schedule where one time period overlaps with another, the earlier one will stop upon the beginning of the later one while running the later one's broadcast schedule.

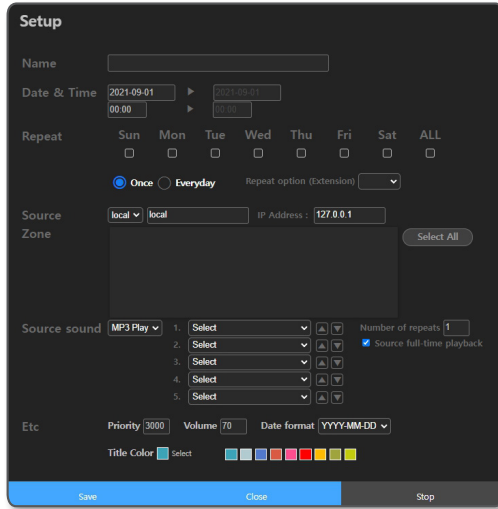

1. Name: Input a name for a schedule.

2. Date & Time: Select a date when a schedule is to be taken place.

Select or input a time when a schedule is set to take place.

If you click the **[Now+1(min)]** button, the start time of the schedule is set to a minute after the current time.

✎ If it is set to Date (2021-01-01 / 2021-01-01), Time (10:00 / 09:00), an input error window (time error) pops up.

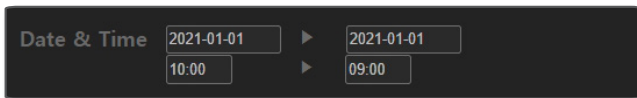

✎ If it is set to Date (2021-01-02 / 2021-01-01), Date (09:00 / 10:00), an input error window (date error) pops up.

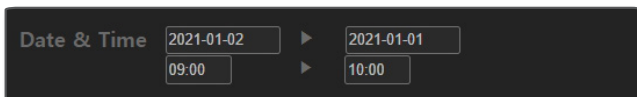

3. Repeat: Select a day, a period, etc. you want to set.

- Select Day: During the set dates, it runs only on selected days of the week. If you select days of the week, <Everyday> and <Once> are deactivated.
- Once: Even during the set period of the dates, it runs only once on the first date.

✎ If you set it to the date (2021-01-01 / 2021-01-02), time (09:00 / 09:10), <Once>, the broadcast schedule is set up for 10 minutes from 9:00 to 9:10 on January 1st.

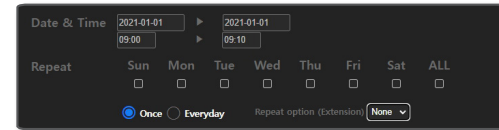

✎ If you set it to the date (2021-01-01 / 2021-01-02), time (23:00 / 01:00), <Once>, the broadcast schedule is set up continuously from 23:00 on January 1st to 1:00 on January 2nd.

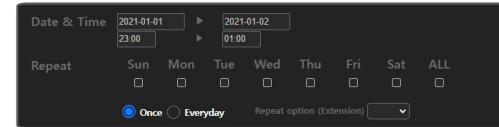

• Everyday: During the set period of dates, it runs repeatedly every day.

✎ If you set the date (2021-01-01 / 2021-01-02), time (09:00 / 09:10), <Everyday>, the broadcast schedule is set up for 10 minutes from 9:00 to 9:10 from January 1st until January 2nd.

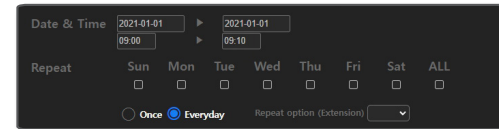

✎ If you set the date (2021-01-01 / 2021-01-02), time (23:00 / 01:00), <Everyday>, the broadcast schedule is set up twice from 23:00 on January 1st until 1:00 on January 2nd and from 23:00 on January 2nd until 01:00 on January 3rd.

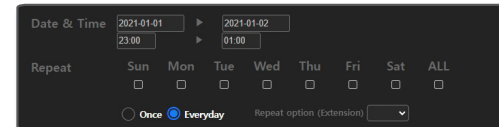

- Repeat Option (Extension): Sets the set schedule to repeat on a weekly, monthly, or yearly basis.

- If you set up the <Once> or <Everyday> function, check that the set schedule is accurate on the [Weekly Calendar], [Daily Calendar] screen.
  - When setting the <Repeat Option (Extension)>, the schedule period should not exceed one week for <Week>, 28 days for <Month>, or 365 days for <Year>.
  - For <Week>, a schedule is set every week from the selected day of the week.
  - For <Month> and <Year>, if you select a specific day, the schedule is set on the specific date for every month or year.
  - If you specify a date range in <Month> or <Year> and select days of the week in [Everyday], the schedule is set only for those days of the week which exist within the date range.
  - You can delete a specific day from the schedule date range or delete all recurring events.

4. Source: The <local>, IP address are displayed as <127.0.0.1>.

5. Zone: Not displayed in <Speaker> mode.

6. Source sound: Select an audio source type to be broadcast from schedules.

- MP3 Play: Displays a list of audio sources registered in BGM Play.
  - The length of the selected audio will automatically be reflected to the end time of <Date & Time> and displayed as being deactivated.
  - If you input the <Number of Repeats>, an audio source will play repeatedly and automatically displayed at the end time.
  - If you uncheck <Source full-time playback>, you can directly enter the end time so that it is broadcast only at the time you want.
  - The playing order of the audio can be changed using the [ ] button for each file.

- If the date is 2021-01-01 / 2021-01-01, the time starts at 23:55, and the length of the selected audio source is 10 minutes, the end date and end time will be set to 2021-01-02 and 24:05 automatically.
  - If it is set to <Once>, the broadcast schedule is set from 23:55 on January 1st to 0:05 on January 2nd continuously.
  - If it is set to <Everyday>, the continuous broadcast schedule is set twice from 23:55 on January 1st to 0:05 on January 2nd and from 23:55 on January 2nd to 0:05 on January 3rd.

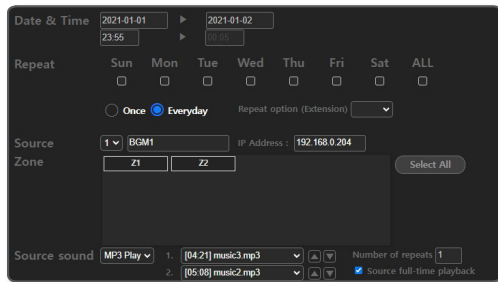

- TTS: Enter sentences with the language to be used in the <Text for TTS> and select the language and gender in Select Speaker.

- Select language: English (United States, United Kingdom), German, Spanish, French, and Russian are supported.
- Select gender: You can select a male or female voice.
- TTS input language and the language the speaker has chosen should be the same to play TTS-converted audio normally. If they are not the same, there will be a pop-up window that says <A TTS conversion error has occurred. Please check the contents.>
- When you enter a special character, please refer to the following content.
  - In the TTS input window, you cannot enter & or `.
  - You can enter ^ ( ) \_ | ' " , but they are not converted to audio.
  - If @ # \$ % = \ / \* are located alone or in the middle of sentence or numbers, they will be converted to audio.
  - Depending on the supported language or sentence structure, a special character may not be converted to audio.

7. ETC.: You can set other settings of the schedule.

- Priority: A lower number has a higher priority. If the priority is "1501", it will be on air prior to any other broadcasts. As the priority of a general audio broadcast is set to 3000 by default, the priority of the Scheduler is recommended to be set at a value lower than 3000. (The initial value is 3000, the input value is 1501 - 9999)
- Volume: You can set the volume when the schedule is operated. (Initial value 70, input value 0-100) Output volume is reflected only to <Scheduler>.
- Date Format: You can select the date format displayed on the scheduler.
- Title Color: You can select the color displayed on the scheduler.

- If the Controller Mode or source speaker is turned off during the scheduled broadcast and then turned on within the scheduled broadcast time, it automatically plays the first sound source among the selected sources and stops at the scheduled end time.
  - If the zone speaker is rebooted during scheduled broadcasting, the sound source is skipped and plays, and then stops when it reaches the scheduled end time.
  - If the speaker is turned off and then turned on after the scheduled broadcast time has passed, the scheduled broadcast does not resume.



## Holiday Setup Event

Click the **[Holiday]** button on the scheduler settings screen and the **<Holiday>** screen will appear.

- Add Holiday : You can set holidays in **<Add Holiday>**.
- Download : You can download the created holiday settings as an XML file.
- Upload: You can upload the downloaded holiday settings files.

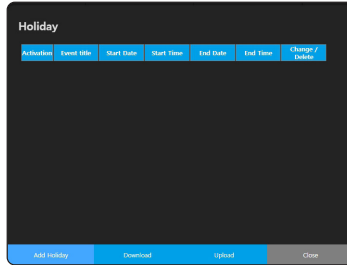
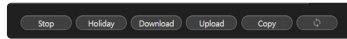

## Add Holiday screen.

1. Click the **[Add Holiday]** button and the **<Add Holiday>** screen will appear.
2. Enter the holiday title to be set.
3. Set up the date and time to start and end the broadcast.
4. **<Activation>** must be checked to operate the holiday settings.
5. If you select a month, week, and day under **<Specific Holiday>**, that day is set as a holiday every year.
6. Click the **[Add Holiday]** button when the setting is complete.
7. Set holiday settings are displayed on the scheduler.
8. You can change or delete set holidays.

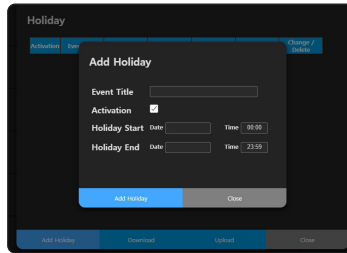

- If you set the date and time to start as 2021-01-01, 08:00 and the date and time to end as 2021-01-02, 23:00, the scheduled broadcast will be suspended from 8:00 on January 1st to 23:00 on January 2nd.

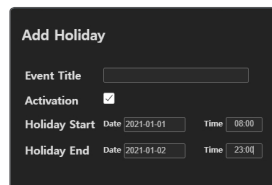

## SIP Management

When it is connected to the VoIP phone which uses the standard SIP protocol and IP PBX server, the voice on the VoIP phone can be played on the speaker.

If you turn on the microphone by setting the **<DSP Setting>** → **<Input Volume Setting>** of the speaker to **<CONDENSER MIC>**, 2-way Talk (Half Duplex) is supported between the VoIP phone and the speaker. The SIP function has been verified in an IP PBX server (Asterisk) and VoIP phone (Grandstream, Yealink, Cisco) environment.

The SIP function has been verified in an IP PBX server (Grandstream) and VoIP phone (Grandstream) environment.

## SIP Account

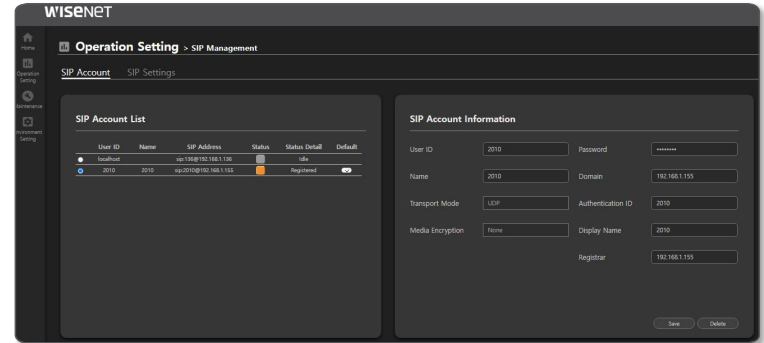

1. Register the account and IP PBX information in **<SIP Account Information>**.

- User ID: ID of SIP users (account in the IP PBX).
- Name: Names that users enter for easy identification.
- Transport Mode: UDP mode is provided using the VoIP packet transmission method.
- Media Encryption: No encryption is used.
- Password: Enter the password provided by IP PBX.
- Domain: Enter the address of IP PBX.
- Authentication ID: Enter the authentication ID provided by IP PBX. (It may not be used depending on the type of the IP PBX.)
- Display name : It is the name which can be displayed on the receiver side. (It may not be used depending on the type of the IP PBX.)
- Registrar: Enter the Registrar Server address. If the account is properly registered with Registrar, authentication is attempted regularly.

2. When you [save] **<SIP Account Information>**, the registered **<User ID>** information is displayed on the **<SIP Account List>**.

On the **<SIP Account list>**, you can select and modify the account.

3. Set whether to use the account as the default account or not.

When you check the account's **[Default]** on the **<SIP Account List>**, it will be sent from/received to that account.

The account's **[Status]** is activated and [detailed information of the status] is also changed from Idle to Registered, and it is displayed as Online Devices in the IP PBX web page's Extensions menu.

When you disable **[Default]**, it is changed to Unregistered, and it is also displayed as Offline Devices in IP PBX.

- If you dial <User ID> on your VoIP phone and speak, it will be received by and played on the speaker. The <Status Detail> of the <User ID> account will display as "Running, Conversation," and if you hang up the phone, it will change to "Disconnected." If you refresh the web screen, the status will be converted to "Registered" and maintained.
- <Local host> is provided as a default, and it can be used in both <speaker mode> and <Controller mode> speakers. For <Local host>, playing audio is possible when the account linked with the IP PBX server is additionally registered or when there is only the VoIP phone without being linked to the IP PBX server. For example, if it is sent from the VoIP phone on the same network to <sip:99@192.168.1.99>, it is connected to the SIP of the local host.

- For the <Speaker mode> speaker, its volume can be controlled in the <Operation Setting> → <DSP Setting > → <Output Volume Setting> menu.
- For the <Control mode> speaker, its volume can be controlled in the <Operate> → <Device Monitoring> → <Output Device> menu.

## SIP Settings

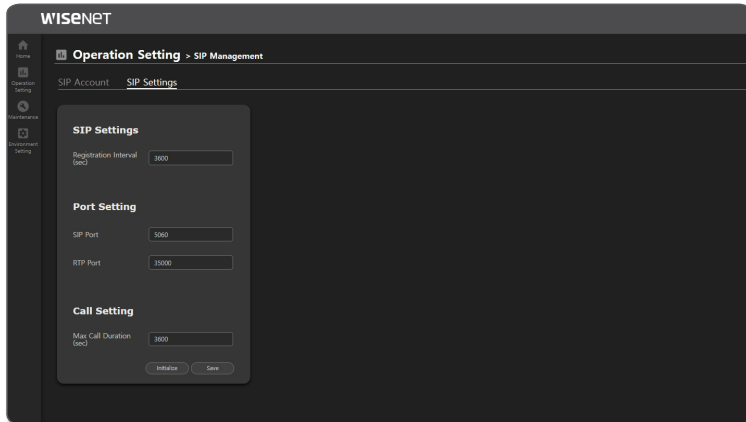

- Enter <SIP Settings> items.
  - Registration Interval: Enter the SIP registration period. (Default: 3600)
- Enter <Port Setting> items.
  - SIP Port: Set up the port to operate SIP communication. (Default: 5060)
  - RTP Port: Set the RTP port. (Default: 35000)
- Enter <Call Setting> items.
  - Max Call Duration: Set the waiting time when a call ends abnormally.
- <SIP Settings> information can be initialized/saved.

## MAINTENANCE

### View Log

You can check logs generated in the product.

The log items are different for each product, and they are recorded when the log operation occurs.

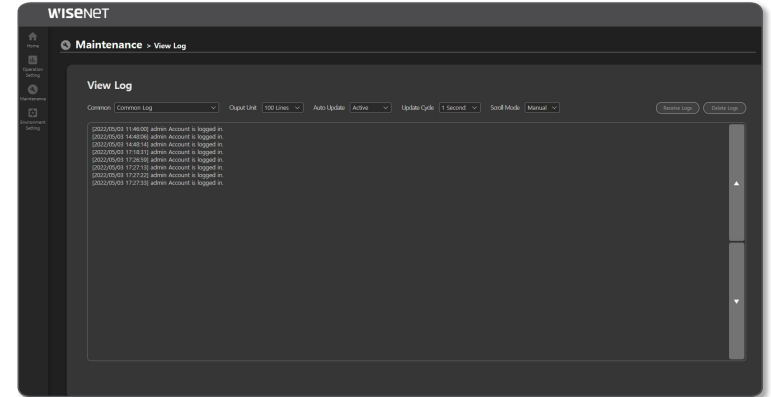

- On the Home screen, click <Maintenance> → <View Log>.
- The action log history for the device is shown by item. Log Menu appears on View Log when its function is activated.
  - The logs of each menu are queried up to 1000 lines, and if they exceed 1000 lines, the oldest logs are deleted first.
- If you click the [Receive Logs] button, a file can be downloaded in HTML format. Check HTML files via Google Chrome.
  - As the log information will be deleted when the product's system is initialized, please download it in advance.
- If you click the [Delete Logs] button, all logs displayed on the screen will be deleted.
- Output Unit, Auto Update, Update Period, and Scroll Mode can be set. If you activate <Auto Update>, logs will be displayed according to the <Update Cycle>.
  - If you auto-select <Scroll Mode>, the screen will be moved downward to show recent logs.
  - Press the [Top/Bottom] button to view the upper and lower logs.



Any changes or modifications in construction of this device which are not expressly approved by the party responsible for compliance could void the user's authority to operate the equipment.

This device complies with part 15 of the FCC Rules. Operation is subject to the following two conditions: (1) This device may not cause harmful interference, and (2) this device must accept any interference received, including interference that may cause undesired operation.

This equipment has been tested and found to comply with the limits for a Class A digital device, pursuant to part 15 of the FCC Rules. These limits are designed to provide reasonable protection against harmful interference when the equipment is operated in a commercial environment. This equipment generates, uses, and can radiate radio frequency energy and, if not installed and used in accordance with the instruction manual, may cause harmful interference to radio communications. Operation of this equipment in a residential area is likely to cause harmful interference in which case the user will be required to correct the interference at his own expense.



Hanwha Vision cares for the environment at all product manufacturing stages, and is taking measures to provide customers with more environmentally friendly products. The Eco mark represents Hanwha Vision's devotion to creating environmentally friendly products, and indicates that the product satisfies the EU RoHS Directive.



#### Correct Disposal of This Product (Waste Electrical & Electronic Equipment)

(Applicable in the European Union and other European countries with separate collection systems)

This marking on the product, accessories or literature indicates that the product and its electronic accessories (e.g. charger, headset, USB cable) should not be disposed of with other household waste at the end of their working life. To prevent possible harm to the environment or human health from uncontrolled waste disposal, please separate these items from other types of waste and recycle them responsibly to promote the sustainable reuse of material resources.

Household users should contact either the retailer where they purchased this product, or their local government office, for details of where and how they can take these items for environmentally safe recycling.

Business users should contact their supplier and check the terms and conditions of the purchase contract. This product and its electronic accessories should not be mixed with other commercial wastes for disposal.



#### Correct disposal of batteries in this product

(Applicable in the European Union and other European countries with separate battery return systems.)

This marking on the battery, manual or packaging indicates that the batteries in this product should not be disposed of with other household waste at the end of their working life. Where marked, the chemical symbols Hg, Cd or Pb indicate that the battery contains mercury, cadmium or lead above the reference levels in EC Directive 2006/66. If batteries are not properly disposed of, these substances can cause harm to human health or the environment.

To protect natural resources and to promote material reuse, please separate batteries from other types of waste and recycle them through your local, free battery return system.

