

SAMSUNG

User Manual

SNOW-1810U
SNOW-JMU

The color and the appearance may differ depending on the product, and the content in the manual is subject to change without prior notice to improve the performance.

© Samsung Electronics

Samsung Electronics owns the copyright for this manual. Use or reproduction of this manual in parts or entirety without the authorization of Samsung Electronics is prohibited. Trademarks other than Samsung Electronics are property of their respective owners.

Table of contents

Before Using the Product

Safety Precautions	6
Safety symbols	6
Electricity and Safety	7
Installation	8
Operation	8
Cleaning	10

Preparations

Checking the Components	11
Parts	12
Front Side	12
Reverse Side	14
Interface Gender Card (I/G Card)	15
Remote Control	16
Prior to Installation	18
Precautions for installation	18
Installing S-Box on Rack Case	18

Connecting and using devices

Before Connecting	19
Pre-connection Checkpoints	19
Connecting to a PC	19
Connection Using an HDMI Cable	19
Connection Using an HDMI-DVI Cable	20
Connection Using an DP Cable	20
Connecting to a Video Device	21
Connection Using an HDMI-DVI Cable	21
Connection Using an HDMI Cable	21
Connecting the MULTI-LINK	22
Connecting the LAN Cable	22
Changing the Input source	23
Source	23
Web Browser	24

Multiple Display Control

Cable Connection	26
RS232C Cable	26
LAN Cable	27
Connection	29
Control Codes	30
Using LED Signage Manager	33
Installing / Uninstalling the software	33

Player feature

Player	34
Viewing content	34
When content is running	35
Available menu	35
File Formats Compatible with Player	36
Schedule	40
Clone Product	41
ID Settings	42
Device ID	42
PC Connection Cable	42
Video Wall	43
Video Wall	43
Horizontal x Vertical	43
Screen Position	44
Format	44
Network Status	45
Picture Mode	46
On/Off Timer	47
On Timer	47
Off Timer	48
Holiday Management	48
Ticker	49
URL Launcher	50
URL Launcher Settings	51

Table of contents

Screen Adjustment

Picture Mode	52
Brightness / Contrast / Sharpness	53
Color Temperature	54
Advanced Settings	55
Picture Enhancer	55
Color	55
Tint (G/R)	55
White Balance	56
Gamma	56
Contrast Enhancer	56
Black Tone	56
Flesh Tone	57
RGB Only Mode	57
Color Space Settings	57
Input Signal Plus	57
LED Picture Size	58
Output Resolution	58
LED Picture Size	58
Resolution	58
Screen Position	59
Fit to screen	59
LED HDR	60
Inverse Tone Mapping	60
Dynamic Peaking	60
Color Mapping	60
Multi-link HDR Settings	61
Picture Options	62

Color Tone	62
Digital Clean View	62
HDMI Black Level	62
Film Mode	62
Auto Motion Plus Settings	63
Apply Picture Settings	64
Reset Picture	64

OnScreen Display

Display Orientation	65
Onscreen Menu Orientation	65
Source Content Orientation	65
Screen Protection	66
Auto Protection Time	66
Message Display	67
Source Info	67
No Signal Message	67
MDC Message	67
Download Status Message	67
Language	68
Menu Size	68
Reset OnScreen Display	69

Network

Network Status	70
Open Network Settings	70
Network Settings (Wired)	71
IPv6	73
IPv6 Status	73
Server Network Settings	73
Connect to Server	73
MagicInfo Mode	73
Server Access	73
FTP Mode	74
Proxy Server	74
IP Remote	74
Device Name	74

Table of contents

System

Accessibility	75
Voice Guide Settings	75
High Contrast	76
Enlarge	76

Start Setup	76
-------------	----

Time	77
Clock Set	77
NTP Settings	77
DST	77
Power On Delay	77

Auto Source Switching	78
Auto Source Switching	78
Primary Source Recovery	78
Primary Source	78
Secondary Source	78
Default Input	78

Power Control	79
Auto Power On	79
Max. Power Saving	79
Standby Control	79
Network Standby	80
Power Button	80

Eco Solution	81
Eco Sensor	81
No Signal Power Off	81
Auto Power Off	81

Fan & Temperature	82
-------------------	----

Fan Control	82
Temperature Control	82

Play via	83
----------	----

Change PIN	83
------------	----

Security	84
Safety Lock On	84
Button Lock	84
USB Auto Play Lock	85
Remote Management	85
Secured Protocol	85
Network Port	85
USB Port	85

General	86
Smart Security	86
Anynet+ (HDMI-CEC)	86
HDMI Hot Plug	88
Custom Logo	88
Empty Storage	89
Audio Delay	89
Digital Output Audio Format	89

Reset System	90
--------------	----

Support

Software Update	91
Update Now	91

Contact Samsung	91
-----------------	----

Terms & Conditions	91
--------------------	----

Reset All	91
-----------	----

Troubleshooting Guide

Requirements Before Contacting Samsung	
Customer Service Center	92
Testing the Product	92
Checking the Resolution and Frequency	92
Check the followings.	93

Table of contents

Specifications

General	97
Preset Timing Modes	98

Appendix

Responsibility for the Pay Service (Cost to Customers)	101
Not a product defect	101
A Product damage caused by customer's fault	101
Others	101
License	102





Chapter 01







Before Using the Product

Safety Precautions

The following safety instructions are to ensure your personal safety and prevent property damage. Please read the following to ensure the proper use of the product.

Safety symbols

Symbol	Name	Meaning
	Warning	A serious or fatal injury may result if instructions are not followed.
	Caution	Personal injury or damage to properties may result if instructions are not followed.
	Prohibition	Do NOT attempt.
	Instruction	Follow directions.

CAUTION			
RISK OF ELECTRIC SHOCK. DO NOT OPEN.			
CAUTION: TO REDUCE THE RISK OF ELECTRIC SHOCK, DO NOT REMOVE COVER (OR BACK). THERE ARE NO USER SERVICEABLE PARTS INSIDE. REFER ALL SERVICING TO QUALIFIED PERSONNEL.			
	This symbol indicates that high voltage is present inside. It is dangerous to make any kind of contact with any internal part of this product.		AC voltage: Rated voltage marked with this symbol is AC voltage.
	This symbol indicates that this product has included important literature concerning operation and maintenance.		DC voltage: Rated voltage marked with this symbol is DC voltage.
	Class II product: This symbol indicates that a safety connection to electrical earth (ground) is not required. If this symbol is not present on a product with a mains lead, the product MUST have a reliable connection to protective earth (ground).		Caution. Consult instructions for use: This symbol instructs the user to consult the user manual for further safety related information.

Electricity and Safety

 The following images are for reference only. Real-life situations may differ from what is shown in the images.

Warning





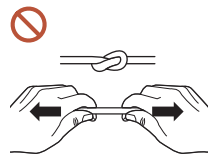

Do not touch the power plug with wet hands. Otherwise, an electric shock may result.

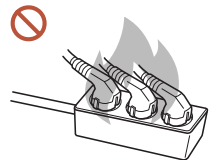

Do not bend or pull the power cable with force. Be careful not to leave the power cable under a heavy object. Product failure, an electric shock or fire may result from a damaged cable.



Do not connect multiple products to a single power socket. Overheated power sockets may cause a fire.

-  Insert the power plug all the way in so it is not loose. An unsecure connection may cause a fire.
-  Clean any dust around the pins of the power plug or the power socket with a dry cloth. A fire may result.
-  Connect the power plug to a grounded power socket. (Except for devices that do not provide grounding) An electric shock or injury may result.
-  Do not use a damaged power plug or a loose power socket. An electric shock or fire may result.

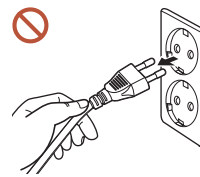

Caution

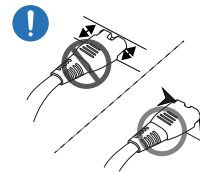

Hold the plug when disconnecting the power cable from the power socket. An electric shock or fire may result.









When connecting the power plug to the port, be sure to connect it completely. If the power plug is not completely connected to the port, the plug may be unexpectedly disconnected, or there is a risk of overheating due to overcurrent, leading to safety accidents.

-  Only use the power cable provided with your product by Samsung. Do not use the power cable with other products. An electric shock or fire may result.
-  Keep the power socket where the power cord is connected unobstructed. When a problem occurs with the product, the power cord must be unplugged to completely cut off power to the product. The power is not completely cut off by using only the Power button on the body of the product.
-  Do not disconnect the power cable while the product is being used. The product may become damaged by an electric shock.









Installation



Warning

-  Before moving the product, turn off the power switch and disconnect the power cable and all other connected cables.
Damage to the cable may cause a fire or electric shock.
-  When installing the product, keep it at a distance from the wall so that it is well ventilated.
An increased internal temperature may cause a fire.
-  If the product is installed in an unusual location, the surrounding environment may cause a serious quality problem. Therefore, be sure to contact Samsung Customer Service Center before installation.
(Places where many fine dusts are generated, places where chemicals are used, places with too high or low temperatures, places with a lot of moisture or water, transportation equipment such as vehicles, airports and stations used continuously for a long time, and more)
-  Do not install the product in a poorly ventilated space such as bookcase or closet.
An increased internal temperature may cause a fire.
-  Keep the plastic packaging out of the reach of children.
Children's misuse of the plastic packaging may cause suffocation.
-  Do not install the power cable (DC power supply) and the product near heat sources.
(Candles, mosquito repellents, cigarettes, sprays, heating devices, places exposed to direct sunlight, and more)



Operation

Warning

-  If the product generates a strange noise, a burning smell, or smoke, unplug the power plug immediately and contact your Samsung Customer Service Center.
An electric shock or fire may result.
-  If a gas leakage is found, do not touch the product or the power plug, and ventilate the room immediately.
Sparks can cause an explosion or fire.
-  Keep the remote control batteries and the small accessories out of the reach of children. Ensure children do not swallow any of them.
If children have had the battery in their mouths, consult your doctor immediately.
-  If the product is dropped or its appearance is damaged, turn off the power switch and disconnect the power cord. Then contact Samsung Customer Service Center.
Continued use can result in an electric shock or a fire.
-  Do not move the product by pulling the power cord or any cable.
Product failure, an electric shock or fire may result from a damaged cable.
-  Ensure the vents are not blocked by tablecloths or curtains.
An increased internal temperature may cause a fire.
-  Do not apply an impact to the product.
 - The screen display may be damaged.
 - An electric shock or fire may result.
-  Do not insert metallic objects (chopsticks, coins, hairpins, etc) or objects that burn easily (paper, matches, etc) into the product (via the vent or input/output ports, etc).
 - If foreign substances enter the product, be sure to power off the product and disconnect the power cord. Then contact Samsung Customer Service Center.
 - Product failure, an electric shock or fire may result.

-
-  Do not place objects containing liquid (vases, pots, bottles, etc) or metallic objects on top of the product.
 - If foreign substances such as water enter the product, be sure to disconnect the power cord. Then contact Samsung Customer Service Center.
 - Product failure, an electric shock or fire may result.
 -  During a lightning or thunderstorm, power off the product and disconnect the power cord.

An electric shock or fire may result.
 -  While the power plug is plugged into a power socket, do not insert a chopstick or other conductor into a remaining power socket. Also, after disconnecting the power plug from the power socket, do not touch the pins of the plug immediately.

Otherwise, an electric shock may result.
 -  There is a high voltage inside the product. Never disassemble, repair or modify the product yourself.
 - Contact Samsung Customer Service Center for repairs.
 - An electric shock or fire may result.
 -  Do not use humidifiers or stoves around the product.

An electric shock or fire may result.





Caution

-  Insert each battery so that its polarity (+, -) is correct.

If the polarity is not correct, the battery may rupture or the internal fluid may leak, causing contamination and damage to the surroundings, fire, or personal injury.
-  When you do not use the product for a long time due to vacation or other reason, disconnect the power cord from the power socket.

Dust accumulation combined with heat can cause a fire, electric shock or electric leakage.
-  The batteries (and rechargeable batteries) are not ordinary refuse and must be returned for recycling purposes. The customer is responsible for returning the used or rechargeable batteries for recycling.

The customer can return used or rechargeable batteries to a nearby public recycling center or to a store selling the same type of the battery or rechargeable battery.
-  Do not use or keep combustible spray or an inflammable substance near the product.

An explosion or fire may result.
-  Do not place heavy objects on the product.

Product failure or personal injury may result.
-  Use only the specified standardized batteries, and do not use a new battery and a used battery at the same time.

Otherwise, the batteries may be damaged or cause fire, personal injury or damage due to a leakage of the internal liquid.
-  Do not lift or move the product when it is in operation.

Cleaning

Warning

-  Do not spray water or cleaner directly on the product.
 - The product's surface may be damaged, or the markings may be erased.
 - An electric shock or fire may result.

Caution

-  When cleaning, be sure to disconnect the power plug and wipe gently with a soft and dry cloth such as superfine fibers or cotton flannels to prevent scratches.

The product's surface may be damaged, or the markings may be erased.
-  Only use a soft cloth (e.g. microfiber, flannel) on the surface of the product to avoid scratches.

The product's surface or the screen display can be easily scratched with foreign substances.
-  Do not apply chemicals containing alcohol, solvent, or surfactant such as wax, benzene, thinner, pesticide, air freshener, lubricant, or cleaner to the product.

The product's exterior may be discolored or cracked, the surface of the panel may be peeled off, or the markings may be erased.

Chapter 02

Preparations

Checking the Components

- Contact the vendor where you purchased the product if any components are missing.
- The appearance of the components may differ from the images shown.
- The RS232C adapter can be used to connect using the D-SUB(9-pin) to Stereo type RS232C cable.

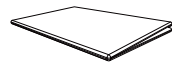

Simple User Guide



Warranty card
(Not available in some locations)



Power cord

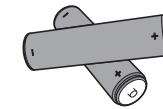

Batteries (AAA x 2)
(Not available in some locations)



Remote Control

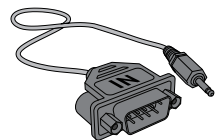

RS232C(IN) adapter



AC/DC adapter

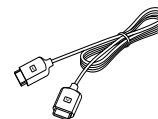

OCM cable

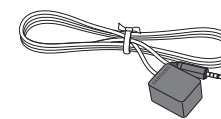

External IR cable

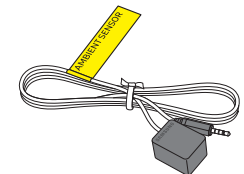

External ambient light sensor

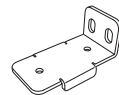

Rack case mounting bracket x 2



Screw (M4 x L8) x 4



Screw (M5 x L12) x 4

Parts



Front Side

 The color and shape of parts may differ from what is shown. Specifications are subject to change without notice to improve quality.

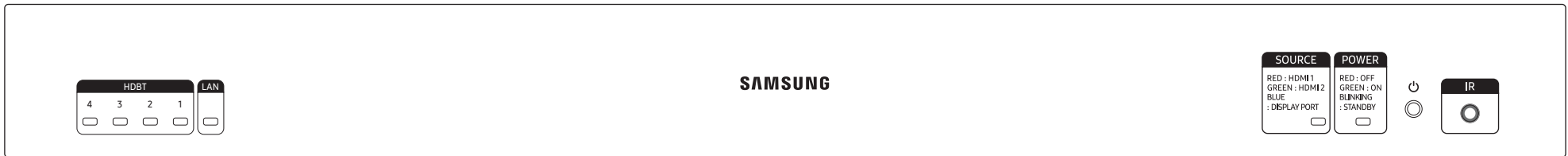
SNOW-1810U



Parts	Description
HDBT 4, HDBT 3, HDBT 2, HDBT 1	View the input HDBT source status. 4 : HDBT 4 / 3 : HDBT 3 / 2 : HDBT 2 / 1 : HDBT 1
LAN	View the input LAN source status.
SOURCE	View the input source status. RED : HDMI 1 / GREEN : HDMI 2 / BLUE : DISPLAY PORT

Parts	Description
POWER	View the power status. RED : OFF / GREEN : ON / BLINKING : STANDBY
	Turn the product on or off.
IR	Connects to an external IR cable that receives signals from the remote control.  Connect the external IR cable while the product is powered off, and then turn on the product.



Front Side

 The color and shape of parts may differ from what is shown. Specifications are subject to change without notice to improve quality.

SNOW-JMU





Parts	Description
HDBT 4, HDBT 3, HDBT 2, HDBT 1	View the input HDBT source status. 4 : HDBT 4 / 3 : HDBT 3 / 2 : HDBT 2 / 1 : HDBT 1
LAN	View the input LAN source status.
MULTI-LINK HDR	Use the multi-link HDR cable (optional purchase) to connect to additional S-Boxes.
SOURCE	View the input source status. RED : HDMI 1 / GREEN : HDMI 2 / BLUE : DISPLAY PORT

Parts	Description
POWER	View the power status. RED : OFF / GREEN : ON / BLINKING : STANDBY
	Turn the product on or off.
IR	Connects to an external IR cable that receives signals from the remote control.  Connect the external IR cable while the product is powered off, and then turn on the product.

Reverse Side

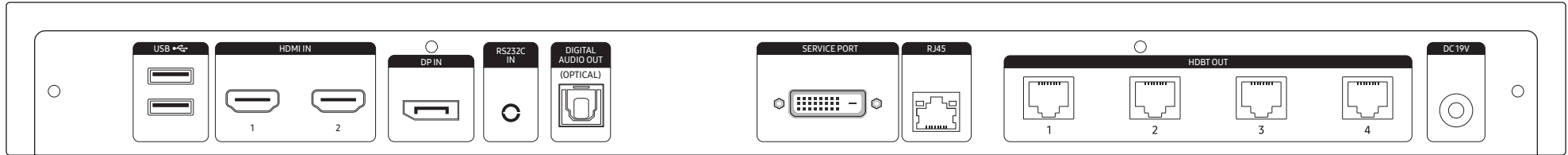
 The color and shape of parts may differ from what is shown. Specifications are subject to change without notice to improve quality.









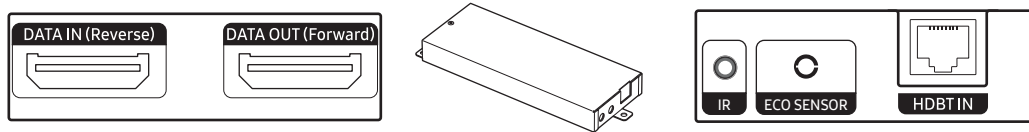

Parts	Description
USB 	Connect to a USB memory device.
HDMI IN 1, HDMI IN 2	Connects to a source device using a HDMI cable or HDMI-DVI cable.
DP IN	Connects to a PC using a DP cable.
RS232C IN	Used for service purposes.
DIGITAL AUDIO OUT(OPTICAL)	Connects to a audio device using the optical(digital) cable.
SERVICE PORT	Dedicated to service technicians.  This port is for servicing only and has no user function. Do not connect a cable to this port.

Parts	Description
RJ45	Connect to a network using the LAN cable. (10/100 Mbps)
HDBT OUT 1, HDBT OUT 2, HDBT OUT 3, HDBT OUT 4	Connect to I/G cards by using LAN cables.  Each HDBT OUT port can send FHD signals. To configure a UHD screen, connect cards to all of the four ports.
DC 19V	Connects to the AC/DC adapter.

Interface Gender Card (I/G Card)

 The color and shape of parts may differ from what is shown. Specifications are subject to change without notice to improve quality.



Parts	Description
DATA IN (Reverse)	Connects to the DATA OUT port on the last cabinet using an OCM cable.
DATA OUT (Forward)	Connects to the DATA IN port on the first cabinet using an OCM cable.
IR	<p>Connects to an external IR cable that receives signals from the remote control.</p> <ul style="list-style-type: none">  Only one external IR cable is supplied.  To connect to an I/G card, select System → Power Control → Network Standby → On.  Connect the external IR cable while the product is powered off, and then turn on the product.
ECO SENSOR	<p>Connects an external ambient light sensor to the ECO SENSOR port.</p> <p>Automatically recognizes the ambient brightness and adjusts the brightness of the cabinet connected to the I/G card.</p> <p>To turn off this function, set Eco Sensor to Off at System → Eco Solution.</p> <ul style="list-style-type: none">  Only one external ambient light sensor is provided. The external ambient light sensor operates with only one of multiple I/G cards. Even if multiple I/G cards are connected, external ambient light sensor operates with only the one I/G card connected at the top.  After connecting to or disconnecting from the ECO SENSOR port on the I/G card, reboot S-Box(SNOW-1810U or SNOW-JMU).  Note that the cabinet may be subject to shadows or light interferences depending on the installation position.  The external ambient light sensor is marked with the label on the sensor cable.
HDBT IN	Connects to the HDBT OUT port on the S-Box by using a LAN cable.

Remote Control

- Using other display devices in the same space as the remote control of this product can cause the other display devices to be inadvertently controlled.
- A button without a description in the image below is not supported on the product.
- The FREEZE function is only available for **Source**.

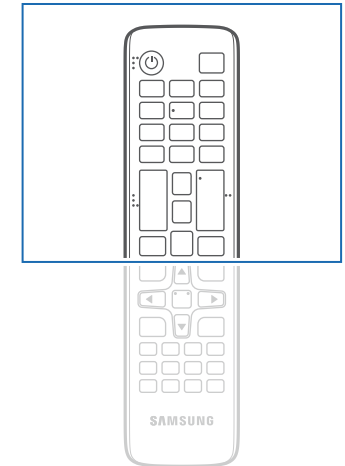
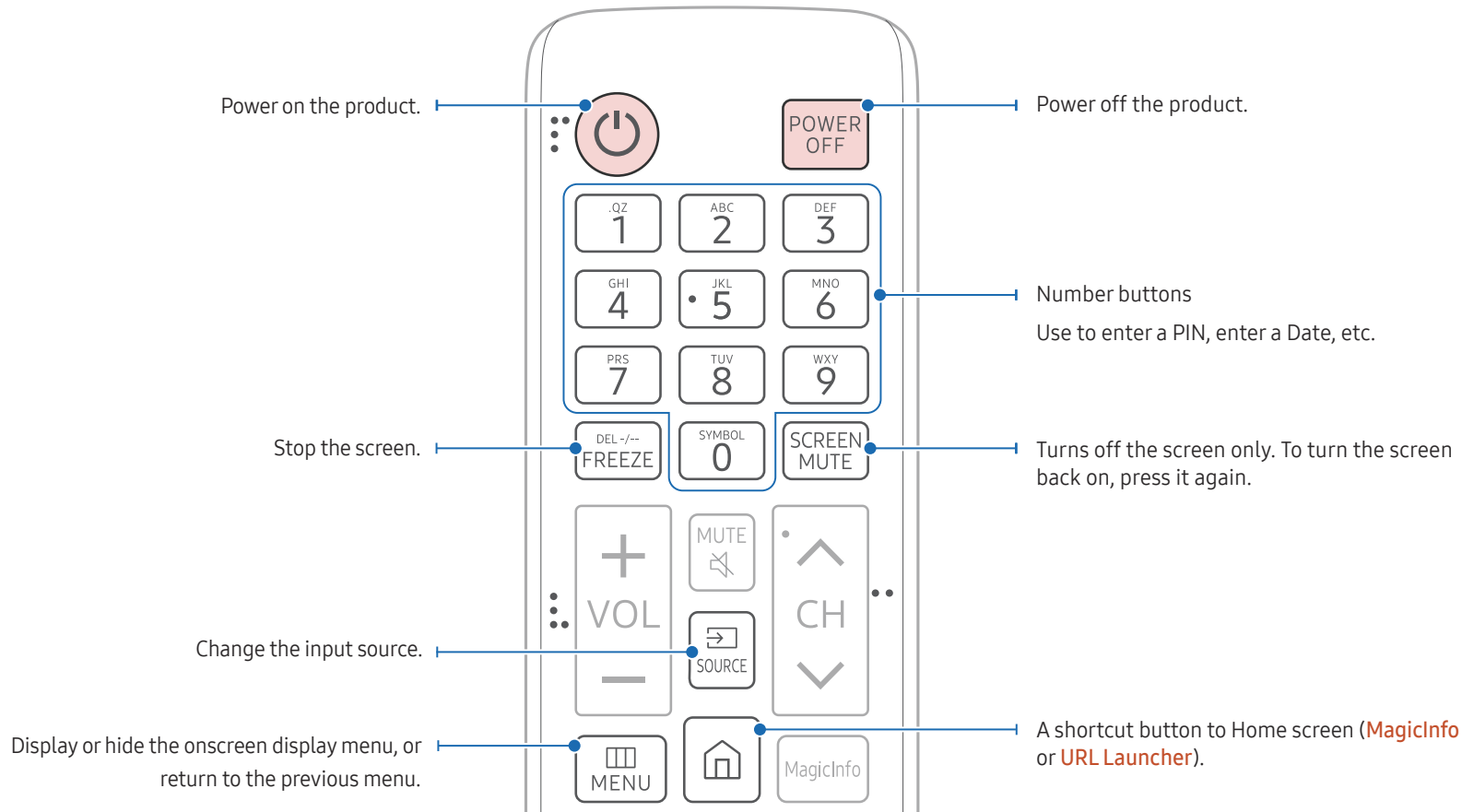

- Remote control button functions may differ for different products.
- Press a button on the remote control pointing at the sensor of the IR cable to perform the corresponding function.
- Use the remote control within 7 m to 10 m from the sensor on the product at an angle of 30° from the left and right.

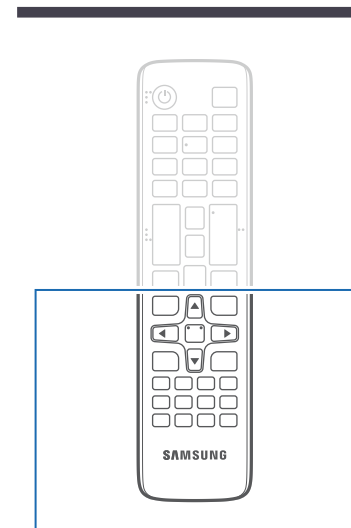
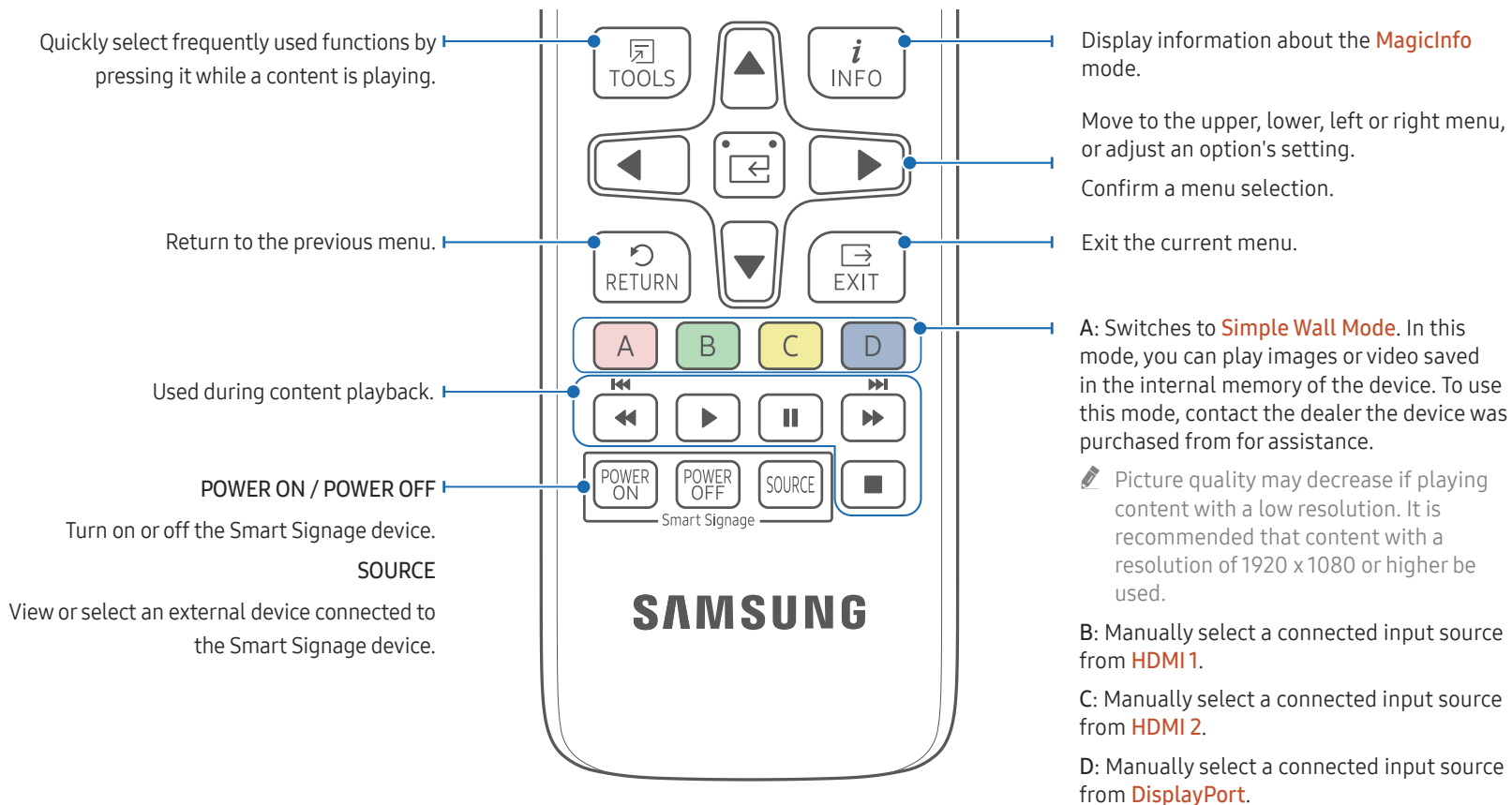

- Remote control button functions may differ for different products.
- Remove batteries when the remote control is not to be used for an extended period of time.

To place batteries in the remote control (AAA x 2)

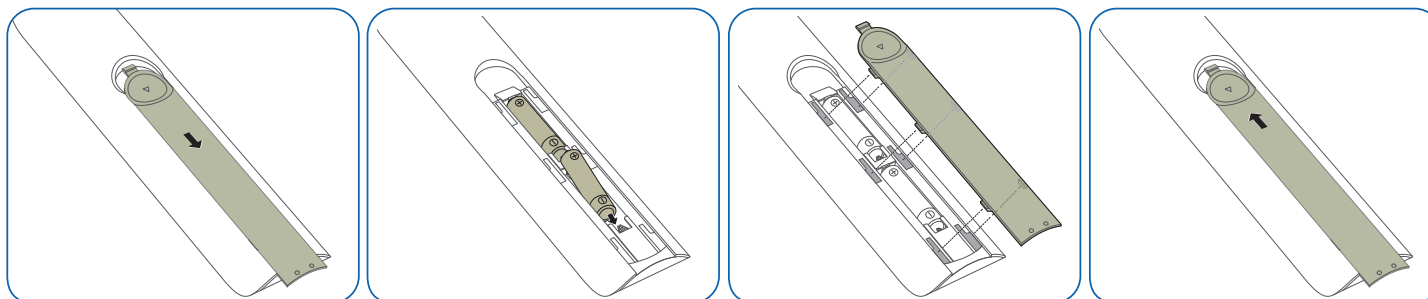

Prior to Installation

Precautions for installation

- It is recommended that this device be installed in a 19-inch rack case, rather than under general consumer environment conditions.
- Make sure that the ambient temperature inside the rack does not exceed 35°C.
- If installing more than one S-Box, ensure that there is a space of at least 1U (approximately 44.45 mm) between the S-Boxes to prevent the vent on top of each S-Box from being blocked.
- Make sure the vent faces upward. Do NOT install the device in portrait orientation or upside down.
- Make sure the vent on top is not blocked to prevent the device from overheating.
- Exercise caution to ensure that no foreign material enters the vent on top of the device.
- If installing the device close to a wall, make sure that there is a space of at least 10 mm between the wall and the four sides of the device to ensure good ventilation.
- Make sure that there is a space of at least 50 mm between the wall and the rear ports of the device to gain access for connection of cables.

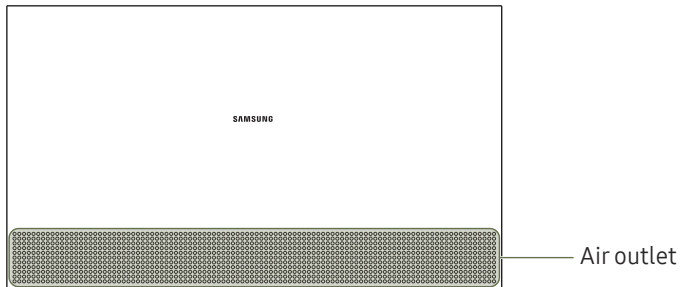

Installing S-Box on Rack Case

 The color and shape of parts may differ from what is shown. Specifications are subject to change without notice to improve quality.

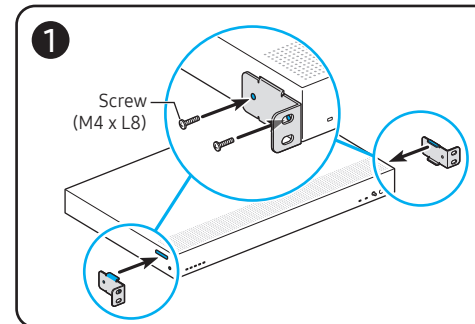
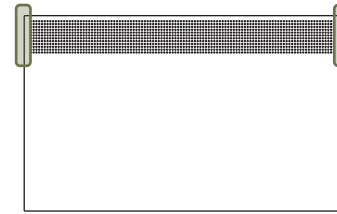

1 Attach the brackets to both sides of the S-Box main unit.

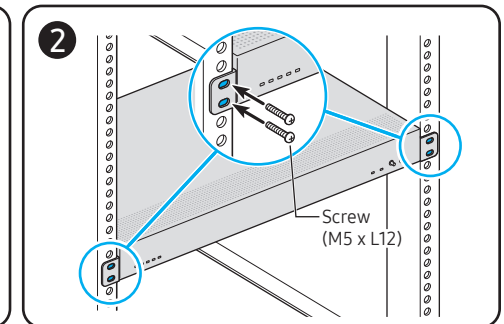

2 Fix the S-Box to the rack case.

 Use appropriate screws that are compatible with the rack case size.

Chapter 03

Connecting and using devices

Before Connecting

Pre-connection Checkpoints

- ✎ Also refer to the user guide for the source device you want to connect with. The number and location of ports available on the source device may vary.
- ✎ Do not connect the power cable until all connections are completed. Connecting the power cable during connection may damage the product.
- ✎ Check the types of ports at the back of the product you want to connect.

Connecting to a PC

- Do not connect the power cable before connecting all other cables. Ensure you connect a source device first before connecting the power cable.
- A PC can be connected to the product in a variety of ways. Select a connection method suitable for your PC.

Connection Using an HDMI Cable

- ✎ Connecting parts may differ in different products.

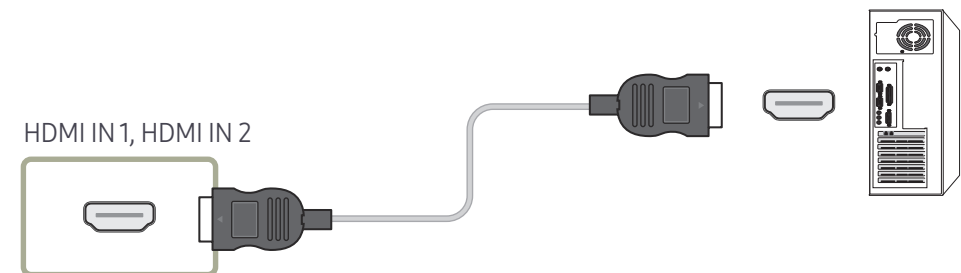

Connection Using an HDMI-DVI Cable

 Connecting parts may differ in different products.

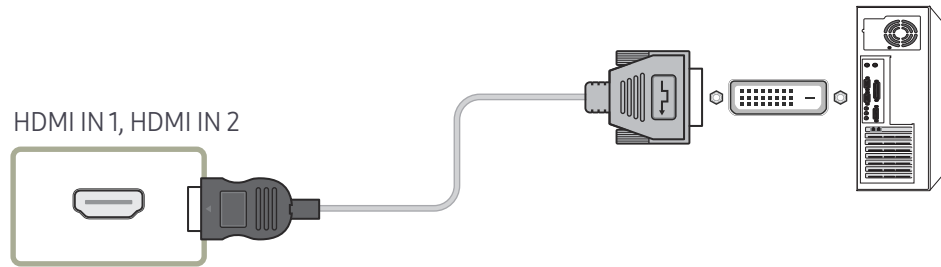

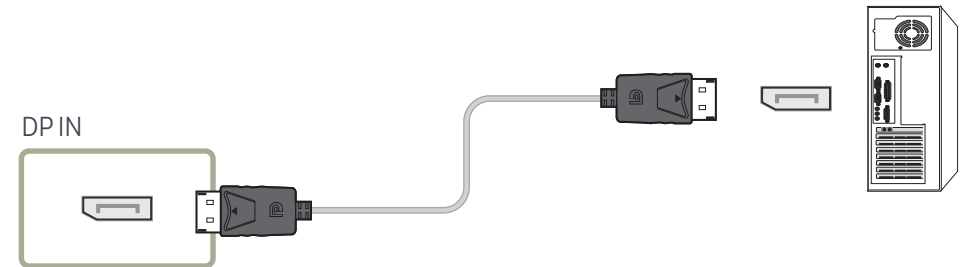

Connection Using an DP Cable

 Connecting parts may differ in different products.



- Precautions for using DP

-  To increase the standby power capacity, the product stops DP communication when it is turned off or in power-saving mode.
If the product in dual monitor mode is turned off or goes into power-saving mode, monitor setting changes may not be updated. As a result, screen output may not be displayed properly.
In the occurrence of this issue, set **Max. Power Saving** to **Off** before using the product.
-  Some graphics cards that are not compliant with the DP standard may prevent the Windows Booting/Bios screen from being displayed when the product is in power-saving mode. If this is the case, make sure to turn on the product first before turning on your PC.
-  Using a DP cable that is not VESA compliant may cause the product to function improperly. Samsung Electronics shall not be held responsible for any issues from using a cable that is not VESA compliant.
Make sure to use a DP cable that is VESA compliant.

Connecting to a Video Device

- Do not connect the power cable before connecting all other cables. Ensure you connect a source device first before connecting the power cable.
- You can connect a video device to the product using a cable.
- ✎ Press the SOURCE button on the remote control to change the source.

Connection Using an HDMI-DVI Cable

✎ Connecting parts may differ in different products.

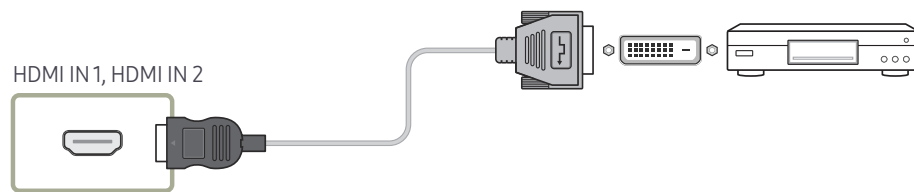

Connection Using an HDMI Cable

✎ Connecting parts may differ in different products.

Using an HDMI Cable or HDMI to DVI Cable

- For better picture and audio quality, connect to a digital device using an HDMI cable.
- If the product is connected to an external device that is compatible with an older HDMI version, the product may not display screen colors properly. It may also display a blank screen. If such a problem occurs, ask the manufacturer of the external device about the HDMI version and, if out of date, request an upgrade.
- Be sure to use an HDMI cable with a thickness of 14 mm or less.
- Be sure to purchase a certified HDMI cable. Otherwise, the picture may not display or a connection error may occur.
- A basic high-speed HDMI cable or one with ethernet is recommended. This product does not support the ethernet function via HDMI.

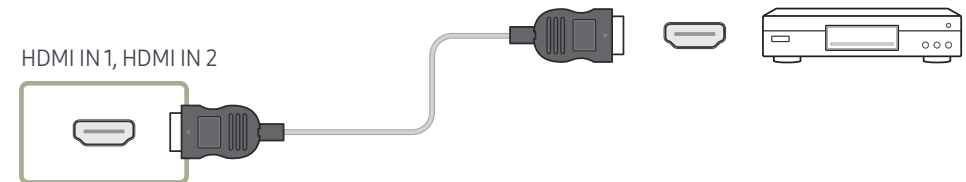

Connecting the MULTI-LINK

 Connecting parts may differ in different products.

 Supported model: SNOW-JMU



Connecting the LAN Cable

 Connecting parts may differ in different products.

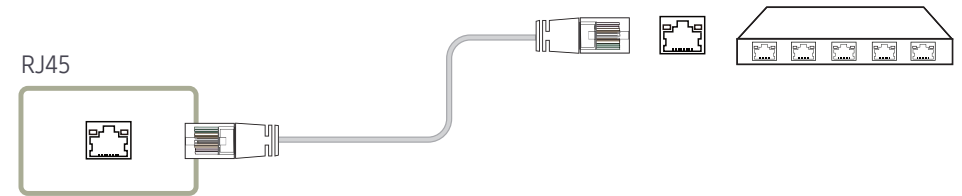

- Use a cable of CAT 6 (*STP type) or higher.
*STP: Shielded Twisted Pair

 Connect to a HUB or router that supports the DHCP function.

Changing the Input source

Source

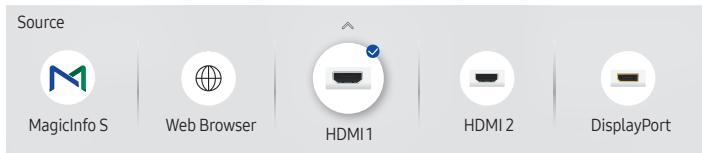

☰ SOURCE → Source



 The displayed image may differ depending on the model.

Source allows you to select a variety of sources and change source device names.

You can display the screen of a source device connected to the product. Select a source from source list to display the screen of the selected source.

-  The input source can also be changed by using the SOURCE button on the remote control.
-  The screen may not display correctly if an incorrect source is selected for the source device you want to convert to.

Edit

☰ SOURCE → ▲ → Edit → ↩

Edit the name and device type of a connected external device.

- The list can include the following source devices. Source devices on the list differ depending on the selected source.
HDMI 1 / HDMI 2 / DisplayPort / Cable Box / Game Console / PC / Blu-ray player
- You cannot edit the following sources.
MagicInfo S / URL Launcher / Web Browser

Web Browser

☰ SOURCE → 🌐 Web Browser → ↗

✎ Connect the network to access the Internet from the product like accessing the Internet from a computer.

Settings

☰ SOURCE → 🌐 Web Browser → ▲ → Settings → ↗

Refresh Interval

Set the time for the web browser to wait before returning to the home page.

- Off / 5 min / 10 min / 15 min / 30 min

Zoom

Set the zoom scale to apply when the web browser is refreshed.

- 50% / 75% / 100% / 125% / 150% / 200% / 300%

Home Page

Set the website to display when the web browser is refreshed.

- Samsung Display / Custom

Custom

Enter the URL to set as the home page.

- Enter URL

✎ Available only when Home Page is set to Custom.

Advanced Settings

General

Hide Tabs and Toolbar automatically	If the browser tabs, menu or toolbar are not used for a while, they will automatically disappear. To make them appear again, move the pointer or focus to the top of the screen. <ul style="list-style-type: none">• Use / Do not use
Hide Cursor in Touch Mode	Hide the cursor to prevent interference with touch operation. <ul style="list-style-type: none">• Use / Do not use
Pop-up Blocker	Make your browsing experience more pleasant by blocking pop-up windows. <ul style="list-style-type: none">• Use / Do not use
Reset Settings	All your customized Web Browser settings will be reset to their default values. Your bookmarks and history won't be affected.

Search Engine

If you enter a keyword in the URL/keyword input field, Web Browser will open the Search Results page. Choose the search engine you want to use.

- Google / Bing

Privacy & Security	
Do Not Track	Ask websites not to track you. <ul style="list-style-type: none"> Use / Do not use
Delete History	Delete your entire browsing history.
JavaScript	Allow all sites to run JavaScript for a better browsing experience. <ul style="list-style-type: none"> Use / Do not use
Delete browsing data	Delete all browsing data such as cookies, cached images and data. Your bookmarks and history won't be affected.
Encoding	
Encoding	Choose an encoding method for web pages. The current setting is Auto. <ul style="list-style-type: none"> Auto / Manual (Current: Unicode)
About	
Display the current version of Web Browser.	

Read Before Using the Web Browser Function

Read this information before using the Web Browser function.

- File download is not supported.
- The **Web Browser** function may not be able to access certain websites, including websites operated by certain companies.
- The product does not support playback of flash videos.
- E-commerce for online purchases is not supported.
- ActiveX is not supported.
- Only a limited number of fonts are supported. Certain symbols and characters may not be displayed properly.
- The response to remote commands and the resulting on-screen display may be delayed while a web page is loading.
- Loading a web page may be delayed or suspended completely depending on the status of the participating systems.
- Copy and paste operations are not supported.
- When composing an email or a simple message, certain functions such as the font size and color selection may not be available.
- There is a limit to the number of bookmarks and the size of the log file that can be saved.
- The number of windows that can be opened concurrently is limited.
- Web browsing speed will differ with the network environment.
- Browsing history is saved from latest to oldest, with the oldest entries being overwritten first.
- Depending on the types of video/audio codecs supported, you may not be able to play certain HTML5 video and audio files.
- Video sources from PC-optimized streaming service providers may not play properly on our proprietary **Web Browser** browser.

Chapter 04

Multiple Display Control

Control multiple display devices connected to a PC simultaneously.

Cable Connection

RS232C Cable

Interface	RS232C (9 pins)
Pin	TxD (No.2), RxD (No.3), GND (No.5)
Bit rate	9600 bps
Data bits	8 bit
Parity	None
Stop bit	1 bit
Flow control	None
Maximum length	15 m (only shielded type)

- Pin assignment

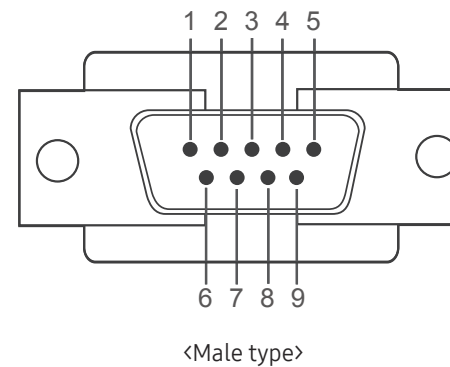

<Male type>

Pin	Signal
1	Detect data carrier
2	Received data
3	Transmitted data
4	Prepare data terminal
5	Signal ground

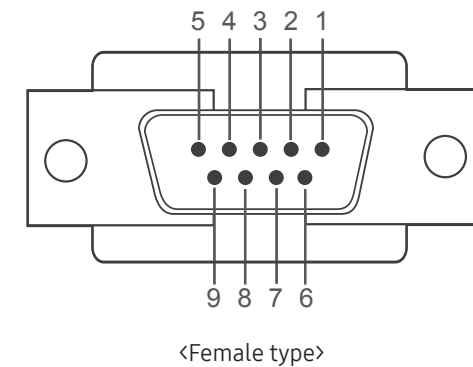

<Female type>

Pin	Signal
6	Prepare data set
7	Send request
8	Clear to send
9	Ring indicator

- RS232C cable
Connector: 9-Pin D-Sub to Stereo Cable

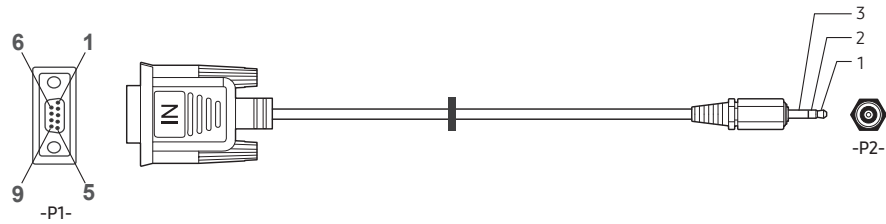

	-P1-			-P2-		
	Rx	3	↔	1	Tx	STEREO
Male type	Tx	2	↔	2	Rx	PLUG
	Gnd	5	↔	3	Gnd	(3.5ø)

LAN Cable

- Pin assignment

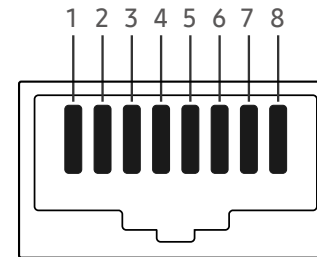

Pin No	Standard Color	Signal
1	White and orange	TX+
2	Orange	TX-
3	White and green	RX+
4	Blue	NC
5	White and blue	NC
6	Green	RX-
7	White and brown	NC
8	Brown	NC

- Connector: RJ45

Direct LAN cable (PC to HUB)

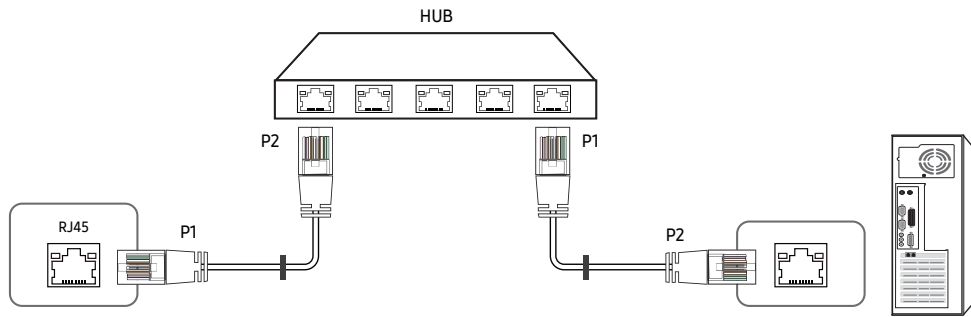

Signal	P1		P2	Signal
TX+	1	↔	1	TX+
TX-	2	↔	2	TX-
RX+	3	↔	3	RX+
RX-	6	↔	6	RX-

Cross LAN cable (PC to PC)

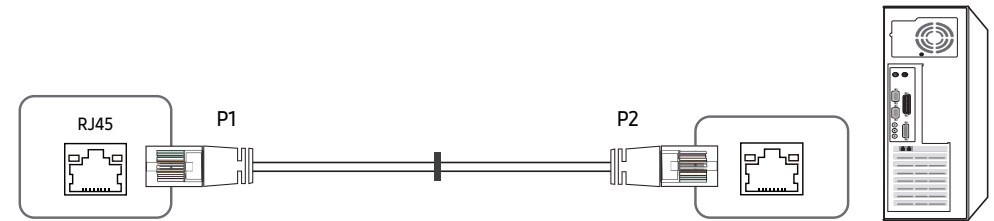

Signal	P1		P2	Signal
TX+	1	↔	3	RX+
TX-	2	↔	6	RX-
RX+	3	↔	1	TX+
RX-	6	↔	2	TX-

Connection

- Connection 1

✎ Ensure that you connect the RS232C(IN) adapter to the RS232C IN port on the product.

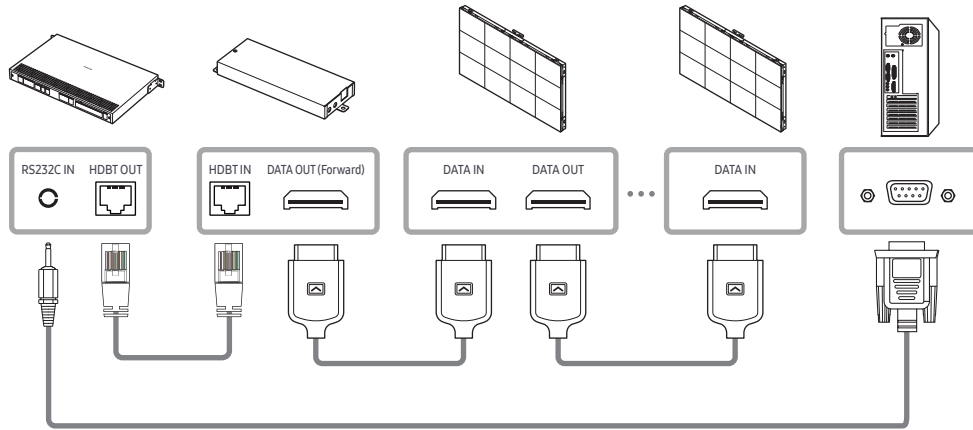

- Connection 2

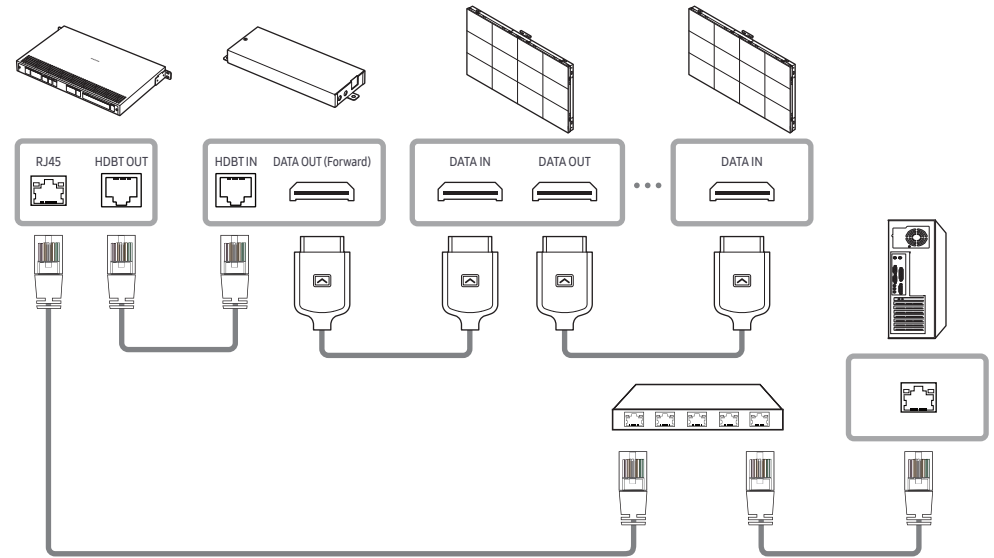

Control Codes

Viewing control state (Get control command)

Header	Command	ID	Data length	Checksum
0xAA	Command type		0	

Controlling (Set control command)

Header	Command	ID	Data length	Data	Checksum
0xAA	Command type		1	Value	

Command

No.	Command type	Command	Value range
1	Power control	0x11	0~1
2	Input source control	0x14	-
3	Screen mode control	0x18	-
4	Safety Lock	0x5D	0~1

- All communications take place in hexadecimals. The checksum is calculated by adding up all values except the header. If a checksum adds up to be more than 2 digits as shown below (11+FF+01+01=112), the first digit is removed.

E.g. Power On & ID=0

Header	Command	ID	Data length	Data 1	Checksum
0xAA	0x11		1	"Power"	

Header	Command	ID	Data length	Data 1	12
0xAA	0x11		1	1	

- To control all devices connected by a serial cable simultaneously irrespective of IDs, set the ID as "0xFE" and transmit commands. Commands will be executed by each device but ACK will not respond.

Power control

- Function
A product can be powered on and off using a PC.
- Viewing power state (Get Power ON / OFF Status)

Header	Command	ID	Data length	Checksum
0xAA	0x11		0	

- Setting power ON/Off (Set Power ON / OFF)

Header	Command	ID	Data length	Data	Checksum
0xAA	0x11		1	"Power"	

"Power": Power code to be set on a product.

1: Power ON

0: Power OFF

- Ack

Header	Command	ID	Data length	Ack/Nak	r-CMD	Val1	Checksum
0xAA	0xFF		3	'A'	0x11	"Power"	

"Power": Power code to be set on a product.

- Nak

Header	Command	ID	Data length	Ack/Nak	r-CMD	Val1	Checksum
0xAA	0xFF		3	'N'	0x11	"ERR"	

"ERR": A code showing what error has occurred.

Input source control

- Function
The input source of a product can be changed using a PC.
- Viewing input source state (Get Input Source Status)

Header	Command	ID	Data length	Checksum
0xAA	0x14		0	

- Setting the input source (Set Input Source)

Header	Command	ID	Data length	Data	Checksum
0xAA	0x14		1	"Input Source"	

"Input Source": An input source code to be set on a product.

0x0C	Input source	At present, supports only reading the input source status.
0x21	HDMI1	
0x23	HDMI2	
0x25	DISPLAY PORT	
0x60	MagicInfo	
0x63	URL Launcher	Operates only with URL Launcher.
0x65	Web Browser	

 This model does not support HDMI1 and HDMI2.

 **MagicInfo** is only available with models that contain the **MagicInfo** function.

- Ack

Header	Command	ID	Data length	Ack/Nak	r-CMD	Val1	Checksum
0xAA	0xFF		3	'A'	0x14	"Input Source"	

"Input Source": An input source code to be set on a product.

- Nak

Header	Command	ID	Data length	Ack/Nak	r-CMD	Val1	Checksum
0xAA	0xFF		3	'N'	0x14	"ERR"	

"ERR": A code showing what error has occurred.

Safety Lock

- Function
PC can be used to turn the **Safety Lock On** function on or off on a product. This control is available regardless of whether or not the power is turned on.
- Viewing the safety lock state (Get Safety Lock Status)

Header	Command	ID	Data length	Checksum
0xAA	0x5D		0	

- Enabling or disabling safety lock (Set Safety Lock Enable / Disable)

Header	Command	ID	Data length	Data	Checksum
0xAA	0x5D		1	"Safety Lock"	

"Safety Lock": Safety lock code to be set on a product

1: ON

0: OFF

- Ack

Header	Command	ID	Data length	Ack/Nak	r-CMD	Val1	Checksum
0xAA	0xFF		3	'A'	0x5D	"Safety Lock"	

"Safety Lock": Safety lock code to be set on a product

- Nak



Header	Command	ID	Data length	Ack/Nak	r-CMD	Val1	Checksum
0xAA	0xFF		3	'N'	0x5D	"ERR"	

"ERR": A code showing what error has occurred

Using LED Signage Manager

The **LED Signage Manager** software allows you to easily control multiple display devices from your computer.

For details on how to use the **LED Signage Manager** software, refer to the Help after installing the software. The **LED Signage Manager** software is available on the website.

-  The installation process for **LED Signage Manager** may be affected by the graphics card, motherboard, and network environment.
-  Make sure that Windows 7 or higher and Microsoft .NET Framework 4.5 are installed on the computer, before installing **LED Signage Manager**.
-  For details on how to connect devices for multiple display control, refer to [page 29](#).

Installing / Uninstalling the software

-  Installing and uninstalling steps can vary depending on the OS.

Installing

- 1 Run the **LED Signage Manager** installation file.
- 2 When the installation window appears, read the instructions and click [Next](#).
- 3 Agree to the license agreement and click [Yes](#).
- 4 Set the installation folder and click [Next](#).
 - If an installation folder is not specified, the software will be installed in the default folder.
- 5 Check that the user information and installation folder have been correctly configured. Click [Next](#).
- 6 After installation is complete, click [Finish](#).
 - To start LSM immediately, select the [Launch LED Signage Manager](#) checkbox.
 - After the software is installed, the shortcut icon is created on the desktop.
 - The shortcut icon may not appear, depending on the computer system and product specifications. If the shortcut icon does not appear, press the F5 key.

Uninstalling

If there is an issue with the software, follow the steps below to uninstall the software.

-  The uninstall process may vary, depending on the computer operating system. This user guide assumes that Windows 7 is used.

- 1 Select **Start** → **Control Panel** → **Programs and Features**.
- 2 From the list, select **LED Signage Manager** and click **Uninstall**.
- 3 When the delete confirmation dialog box appears, click [Yes](#).
- 4 After uninstallation is complete, click [Finish](#).

Chapter 05

Player feature

Accessible using the  button on the remote control.

Player

 → **Player** → 

Play a range of content such as channels with schedules assigned, templates or files.



 The displayed image may differ depending on the model.

 To use the **Player** feature, set **Play via** to **MagicInfo** in **System**.
( MENU → **System** → **Play via** → **MagicInfo**)

 You must set **Clock Set** before you can use this feature.

No.	Description
1	Select between internal or external memory.
2	Play content, templates and schedules configured on the server. <ul style="list-style-type: none"> You can view whether the server is connected (approval) in the Player screen. To view whether the server is connected when a Network Channel is running, press INFO on the remote control. <ol style="list-style-type: none"> Select Network Channel from the Player screen. The No channel. message appears if no channel has been registered in Network Channel. Network Channel will run.
3	Play content stored on the server.
4	Play templates stored in My Templates folder in the Internal Memory.
5	Select a content type as criterion to search for a desired content list.
6	Set different options for Player .

Viewing content

- Select either internal or external memory. The files saved in the selected memory appear.
- Select the desired file. The content appears on the screen. (For more information on compatible file formats, see the "File formats compatible with Player" section.)

When content is running

Control buttons on the remote control

You can play, pause, or skip the content on the playlist by pressing buttons on the remote control.

Button	Function
TOOLS	Brings up the menu bar.
INFO	Displays the information of device and server connection.
▶	Goes to next file or page.
◀	Goes to previous file or page.
◀ / ▶ / ⏸	Plays or pauses slide show or video content.
■	Stops displaying content and goes to the Player screen.
◀◀	Rewinds the video content.
▶▶	Fast forwards the video content.

 If there is only one image file in the Internal Memory or USB, the Slide Show will not play.

 If the name of a folder is too long on the USB, you cannot select the folder.

Available menu

Press the TOOLS button on the remote control during content playback to configure settings.

Menu	Description
Playlist	View a list of content items currently playing.
Channel List	Network Channel / Internal Channel / USB
Repeat All / Repeat One	Set the repeat mode.
Background Music	Set the background music to be played when content is running.
Reset	Reset the background music.
Pause	Pause the background music.
Prev	Play the previous background music on the list.
Next	Play the next background music on the list.

 **Reset, Pause, Prev, Next** only appear when the background music is set.

File Formats Compatible with Player

- Supported file systems include FAT32 and NTFS.
- A file with a vertical and horizontal resolution larger than the maximum resolution cannot be played. Check the vertical and horizontal resolution of the file.
- Check supported video codec types and versions.
- Check the supported file versions.
 - ✎ PowerPoint version up to 97 – 2013 is supported
 - ✎ Audio file is not supported.
 - ✎ For USB-**Internal Memory** file transfer, click **Options** → **Send**.
 - Location of template files
 - **Internal Memory** → USB transfer: USB → under MagicinfoSlide folder
 - USB → **Internal Memory** transfer: **Internal Memory** → under My Templates folder
 - Location of other files (non-template)
 - **Internal Memory** → USB transfer: USB → under MagicinfoSlide folder
 - USB → **Internal Memory** transfer: Under the root folder

Network Schedule Multiframe

Playback restrictions

- 1 to 3 FHD video files can be played simultaneously or only one UHD video file and one FHD video file at a time. In portrait playback mode, 3 FHD video files can be played simultaneously or only one UHD video file at a time.
- For **Office** files (PPT and Word files) and **PDF** files, only one file type is supported at a time.
- LFD(*.LFD) files are not supported.

Template files(*.LFD)

Restrictions

- Check that you have **Contents** and **Schedules** folders published to the USB storage device.
 - ✎ A properly published content appears as Published Content (📁) in the USB device.
 - ✎ When copying a content you published to a USB device (Published Content (📁)) to the **Internal Memory**, the content appears in **Internal Memory** as Published Content (📁) only. **Contents** and **Schedules** folders are not visible under **Internal Memory**.

Playback restrictions

- A maximum of two video (**Video**) files can be played.
- For **Office** files (PPT and Word files) and **PDF** files, only one file type is supported at a time.
- When playing more than one video files simultaneously, make sure that the display areas are not overlapping one another.

Content

File Extension	Container	Video Codec	Resolution	Frame rate (fps)	Bit rate (Mbps)
*.avi	AVI MKV ASF MP4 3GP MOV FLV VRO VOB PS TS SVAF	H.264 BP/MP/HP	4096x2160	4096x2160: 30	60
*.mkv				3840x2160: 60	
*.asf		HEVC (H.265 - Main, Main10)		60	80
*.wmv		Motion JPEG	3840x2160	30	80
*.mp4		MVC	1920x1080	60	20
*.mov		MPEG4 SP/ASP			
*.3gp		Window Media Video v9 (VC1)			
*.vro		MPEG2			
*.mpg		MPEG1			
*.mpeg		Microsoft MPEG-4 v1, v2, v3			
*.ts		Window Media Video v7(WMV1), v8(WMV2)			
*.tp		H 263 Sorenson			
*.trp		VP6			
*.mov					
*.flv					
*.vob					
*.svi					
*.m2ts					
*.mts					
*.webm	WebM	VP8	1920x1080	60	20
		VP9	3840x2160	3840x2160: 60	80
*.rmvb	RMVB	RV8/9/10 (RV30/40)	1920x1080	60	20

Video	Image
<ul style="list-style-type: none"> • 3D video is not supported. • Content with a resolution larger than the resolution specified in the table above is not supported. • Video content with a Bit rate or Frame rate larger than the rate specified in the table above can cause choppy video during playback. • Video content will not play, or not play correctly, if there is an error in the content or the container. • Some USB/digital camera devices may not be compatible with the player. • Supports up to H.264, Level 4.1 • H.264 FMO / ASO / RS, VC1 SP / AP L4 and AVCHD are not supported. • For all Video codecs except MVC, VP8, VP6: <ul style="list-style-type: none"> – Below 1280 x 720: 60 frame max – Above 1280 x 720: 30 frame max • GMC 2 or higher is not supported. • Supports only BD MVC Spec. • When a single video file is playing, Seamless mode is not supported under the following conditions: <ul style="list-style-type: none"> – Incompatible codec (MVC, VP3, MJPEG) ↔ Incompatible codec – Incompatible codec ↔ Compatible codec – The resolution is different from that of the monitor – The frequency is different from that of the monitor 	<ul style="list-style-type: none"> • Compatible image file format: JPEG, PNG, BMP <ul style="list-style-type: none">  32-bit, 24-bit and 8-bit BMP files are supported. • Supported maximum resolution: 4096 x 4096 • Supported maximum file size: 20MB • Supported Slideshow Effect: 9 effects (Fade1, Fade2, Blind, Spiral, Checker, Linear, Stairs, Wipe, Random)

Power Point	PDF	WORD
<ul style="list-style-type: none"> • Compatible document file formats <ul style="list-style-type: none"> – Extension: ppt, pptx – Version: Office 97 ~ Office 2013 • Functions not supported <ul style="list-style-type: none"> – Animation effect – 3D shapes (which will be displayed in 2D) – Header and footer (some subitems are not supported) – Word Art – Align <ul style="list-style-type: none"> A group alignment error may occur – Office 2007 <ul style="list-style-type: none"> SmartArt is not fully supported. 97 out of 115 subitems are supported. – Object insertion – Half-width characters – Letter spacing – Charts – Vertical text <ul style="list-style-type: none"> Some subitems are not supported – Slide notes and handout 	<ul style="list-style-type: none"> • Compatible document file formats <ul style="list-style-type: none"> – Extension: pdf • Functions not supported <ul style="list-style-type: none"> – Content less than 1 pixel not supported because of performance degradation issue. – Masked Image, Tiled Image content not supported. – Content with Rotated Text, not supported. – 3D Shadow Effects not supported. – Some characters not supported (Special characters may be corrupted) 	<ul style="list-style-type: none"> • Compatible document file formats <ul style="list-style-type: none"> – Extension: .doc, .docx – Version: Office 97 ~ Office 2013 • Functions not supported <ul style="list-style-type: none"> – Page background effect – Some paragraph styles – Word Art – Align <ul style="list-style-type: none"> A group alignment error may occur – 3D shapes (which will be displayed in 2D) – Office 2007 <ul style="list-style-type: none"> SmartArt is not fully supported. 97 out of 115 subitems are supported. – Charts – Half-width characters – Letter spacing – Vertical text <ul style="list-style-type: none"> Some subitems are not supported – Slide notes and handout

Schedule

Home → Schedule →

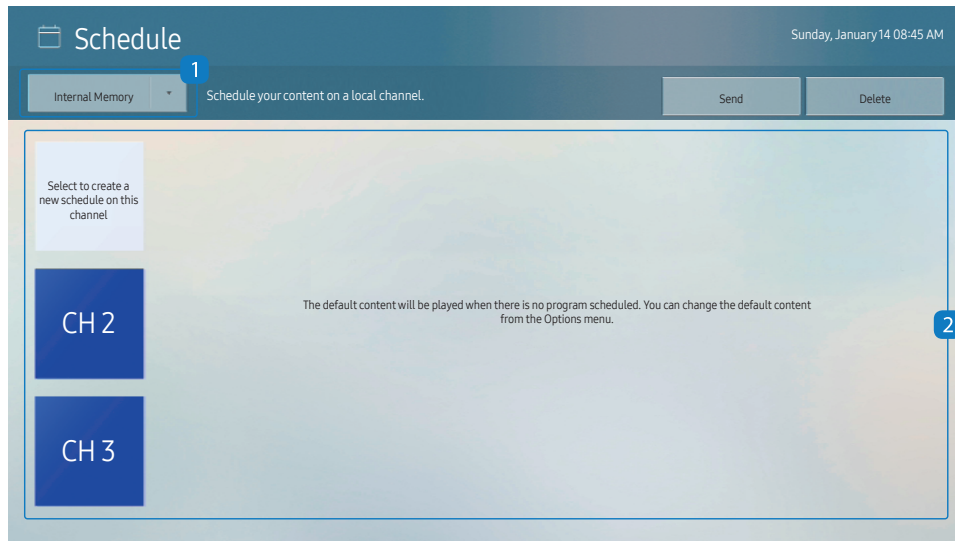

The displayed image may differ depending on the model.

You can check the schedule imported from a selected storage device.

To play the schedule, you must enter the channel that created the schedule.

No.	Description
1	Select the saved location of the schedule.
2	Create/Edit/Delete/View schedule of content playback.

Clone Product

🏠 → Clone Product → 📄

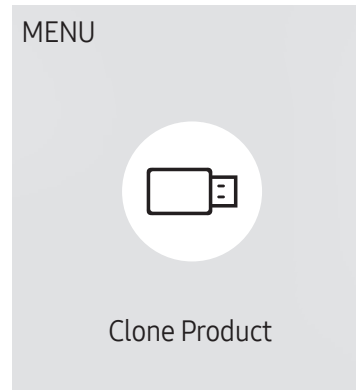

 The displayed image may differ depending on the model.

Export settings on the product to an external storage device. You can also import settings from an external storage device.

This option is useful when assigning the same settings to several products.

When a duplicate file is not found on the external storage device

- 1 Connect the external storage device, then run the **Clone Product** function.
- 2 The **No cloning file found on the external storage device. Export this device's settings to the external storage device?** message appears.
- 3 Select **Export** to export the settings.

When a duplicate file is found on the external storage device

- 1 Connect the external storage device, then run the **Clone Product** function.
 - 2 The **Cloning file found. Please select an option.** message appears.
Run the **Import from External Storage** or **Export to External Storage** function.
 - **Import from External Storage:** Copy settings saved on an external storage device to the product.
 - **Export to External Storage:** Copy settings on the product to an external storage device.
-  After configuration is complete, the product is rebooted automatically.

ID Settings

🏠 → ID Settings → ⏪

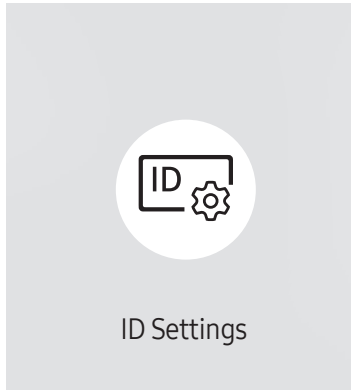

✎ The displayed image may differ depending on the model.

Assign an ID to a set.

Device ID

Set a unique ID number for each product. (Range: 1~225)

✎ Press ▲/▼ to select a number, and press ⏪.

✎ Enter the number you want using the number buttons on the remote control.

PC Connection Cable

Select which type of cable you are using to connect the display to the PC.

- **RS232C cable**
Communicate with MDC via the RS232C cable.
- **RJ-45 (LAN) Cable**
Communicate with MDC via the RJ45 cable.

Video Wall

Home → Video Wall →

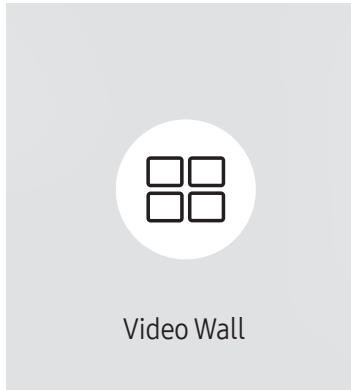

The displayed image may differ depending on the model.

Customize the layout of multiple displays that are connected to form a video wall.

In addition, display part of a whole picture or repeat the same picture on each of the connected multiple displays.

To display multiple images, refer to MDC Help or the MagicInfo user guide. Some models may not support the MagicInfo function.

- To configure a single screen by using multiple S-Boxes, make sure that an input source included in “S-Box Grouping Supported” under [Preset Timing Modes](#) is in use.
- To ensure proper functioning, select **Picture** → **LED Picture Size** and set **Output Resolution** to **UHD**.

Video Wall

You can activate or deactivate **Video Wall**.

To organize a video wall, select **On**.

- Off / On**

Horizontal x Vertical

This feature automatically splits a videowall display based on a videowall matrix configuration.

Enter the videowall matrix.

The videowall display is split based on the configured matrix. The number of vertical or horizontal display devices can be set within the range 1 and 15.

- A videowall display can be split into a maximum of 225 screens.
- The **Horizontal x Vertical** option is only enabled when **Video Wall** is set to **On**.

Screen Position

To rearrange split screens, adjust the number for each product in the matrix using the **Screen Position** feature.

Selecting **Screen Position** will display the videowall matrix with the numbers assigned to the products that form the videowall.

To rearrange products, use the direction buttons on the remote control to move a product to another desired number. Press the  button.

 **Screen Position** allows you to split the screen into a maximum of 225 views (15 x 15).

 The **Screen Position** option is only enabled when **Video Wall** is set to **On**.

 To use the function, make sure **Horizontal x Vertical** is configured.

Format

Select how to display images on the LED display.

- **Full**: Display images in full screen with no margin.
- **Natural**: Display images in the original aspect ratio without enlarging or reducing the size.

 The **Format** option is only enabled when **Video Wall** is set to **On**.

Network Status

Check the current network and Internet connection.

 → [Network Status](#) → 

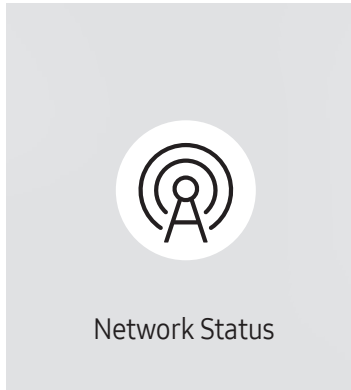

 The displayed image may differ depending on the model.

Picture Mode

🏠 → Picture Mode → 🖼️

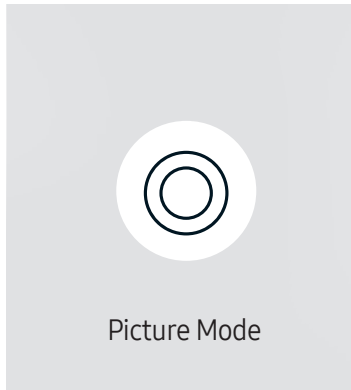

 The displayed image may differ depending on the model.

Select the picture mode that best suits your viewing environment.

- **Dynamic**
- **Natural**
- **Movie**
- **Live**
- **Calibration**

In this mode, the brightness, color, gamma and uniformity settings customized using the color calibration program **Color Expert** are applied.

- To apply the **Calibration** mode properly, make sure you configure the picture quality settings, such as brightness, color, gamma and uniformity, using the color calibration program **Color Expert**.
- To download the **Color Expert** program, visit www.samsung.com/displaysolutions.

On/Off Timer

🏠 → On/Off Timer → 📄

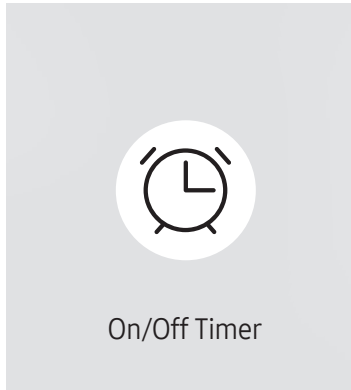

✎ The displayed image may differ depending on the model.

✎ You must set **Clock Set** before you can use this feature.

On Timer

Set **On Timer** so that your product turns on automatically at a time and on a day of your choice.

The product turns on according to the settings of the specified input source.

On Timer: Set the on timer by making a selection from one of the seven options. Ensure you set the current time first.

(**On Timer1 ~ On Timer7**)

✎ While the internal/USB memory option can be used with **On Timer** for **MagicInfo** mode, it is recommended to use an internal memory.

✎ Proper operation of **On Timer** feature cannot be guaranteed if used with a battery powered USB device, which can take longer to be recognized.

- **Setup:** Select **Off**, **Once**, **Everyday**, **Mon~Fri**, **Mon~Sat**, **Sat~Sun** or **Manual**. If you select **Manual**, you can choose the days you want **On Timer** to turn on your product.
 - The check mark indicates days you've selected.
- **Time:** Set the hour and minute. Use the number buttons or the up and down arrow keys to enter numbers. Use the left and right arrow buttons to change entry fields.
- **Source:** Select the input source of your choice.
- **Content** (when the **Source** is set to **Internal/USB** for **MagicInfo** mode): From the USB device or internal memory, select a file (e.g. music, photo, or video) to play just after the product is turned on.

Off Timer

Set the off timer (**Off Timer**) by making a selection from one of the seven options. (**Off Timer1 ~ Off Timer 7**)

- **Setup:** Select **Off, Once, Everyday, Mon~Fri, Mon~Sat, Sat~Sun** or **Manual**. If you select **Manual**, you can choose the days you want **Off Timer** to turn off your product.
 - The check mark indicates days you've selected.
- **Time:** Set the hour and minute. Use the number buttons or the up and down arrow keys to enter numbers. Use the left and right arrow buttons to change entry fields.

Holiday Management

Timer will be disabled during a period specified as a holiday.

- **Add Holiday:** Specify the period you want to add as a holiday.
Select the start and end dates of the holiday you want to add using the ▲/▼ buttons, and click the **Done** button.
The period will be added to the list of holidays.
 - **Start Date:** Set the start date of the holiday.
 - **End Date:** Set the end date of the holiday.
- **Delete:** Delete selected items from the list of holidays.
- **Edit:** Select a holiday item and then change the date.
- **Set Applied Timer:** Set the **On Timer** and **Off Timer** to not activate on public holidays.
 - Press to select the **On Timer** and **Off Timer** settings you do not want to activate.
 - The selected **On Timer** and **Off Timer** will not activate.

Ticker

🏠 → Ticker → 📄

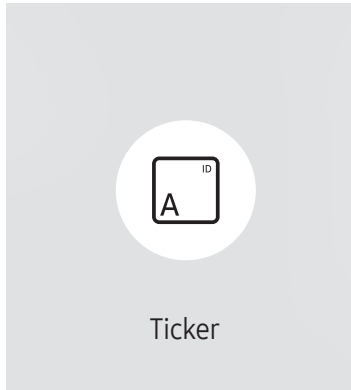

 The displayed image may differ depending on the model.

Input text while a video or image is displayed and display the text on the screen.

- **Off / On:** Set whether or not to use **Ticker**.
- **Message:** Enter a message to display on the screen.
- **Time:** Set the **Start Time** and **End Time** to display a **Message**.
- **Font Options:** Specify the text font and color for the message.
- **Position:** Select a position to display a **Message**.
- **Scroll:** Turn scroll effects of **Ticker** on or not. Specify the scroll **Direction** and **Speed** for the message.
- **Preview:** Preview your **Ticker** settings.

URL Launcher

🏠 → URL Launcher → 📄

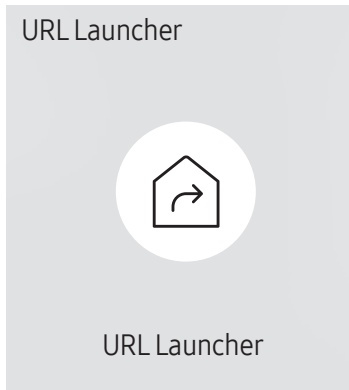

 The displayed image may differ depending on the model.

For details on how to use the **URL Launcher** feature, contact the dealer the product was purchased from.

 To use the **URL Launcher** feature, set **Play via** to **URL Launcher** in **System**.
(☰ MENU → **System** → **Play via** → **URL Launcher**)

URL Launcher Settings

🏠 → URL Launcher Settings → ⏪

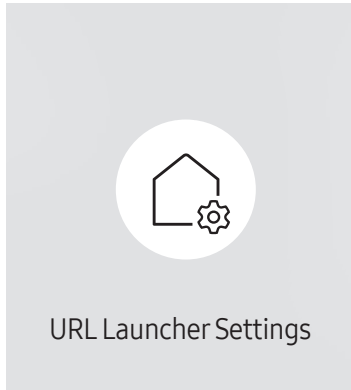

 For details on how to use the **URL Launcher** feature, contact the dealer the product was purchased from.

- **Install Web App:** Enter URL to install the web application.
- **Install from USB Device:** Install the web application from the USB storage device.
- **Uninstall:** Remove the installed web application.
- **Timeout Setting:** Set the timeout period for connecting to the URL.
- **Developer Mode:** Enable developer mode.

 The displayed image may differ depending on the model.

Chapter 06

Screen Adjustment

Configure the **Picture** settings (**Brightness**, **Color Tone**, etc.).

The layout of the **Picture** menu options may vary depending on the product.

Picture Mode

☰ MENU → **Picture** → **Picture Mode** → 

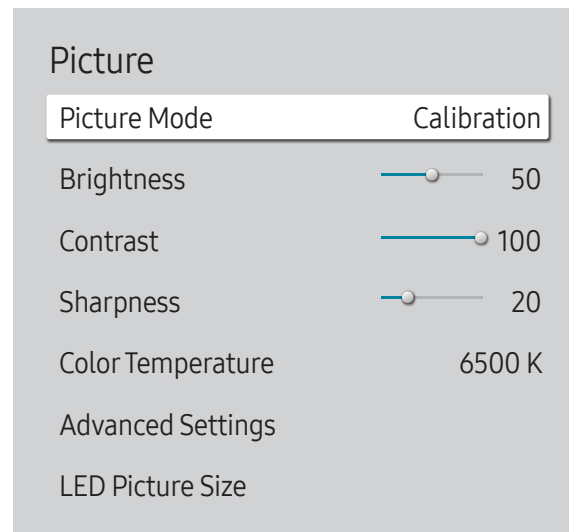

 The displayed image may differ depending on the model.

Select the picture mode that best suits your viewing environment.

- **Dynamic**
- **Natural**
- **Movie**
- **Live**
- **Calibration**

In this mode, the brightness, color, gamma and uniformity settings customized using the color calibration program **Color Expert** are applied.

- To apply the **Calibration** mode properly, make sure you configure the picture quality settings, such as brightness, color, gamma and uniformity, using the color calibration program **Color Expert**.
- To download the **Color Expert** program, visit www.samsung.com/displaysolutions.

Brightness / Contrast / Sharpness

MENU → Picture →

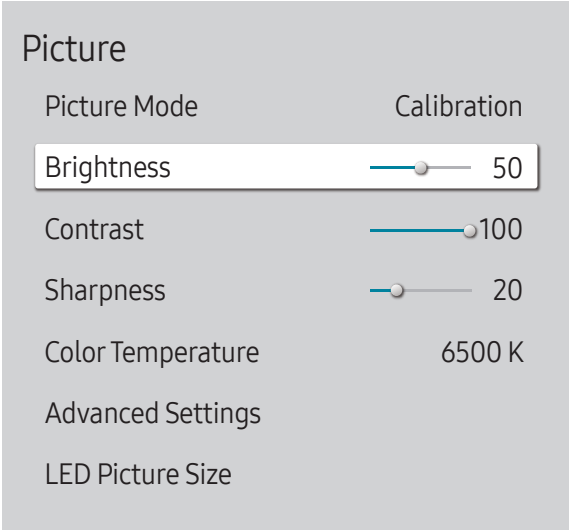

The displayed image may differ depending on the model.

Your product has several options for adjusting picture quality.

- You can adjust and store settings for each external device you have connected to an input on the product.
- Lowering picture brightness reduces power consumption.

Color Temperature

☰ MENU → Picture → Color Temperature → ↻

Picture

Color Temperature 6500 K

It sets color temperature. The value and temperature increase simultaneously, so the ratio of blue color rises. (Range: 2800K–10000K)

 Enabled when **Color Tone** is set to **Off**.

 Available only when **Picture Mode** is set to **Calibration**.

 The displayed image may differ depending on the model.

Advanced Settings

☰ MENU → Picture → Advanced Settings → ⏏

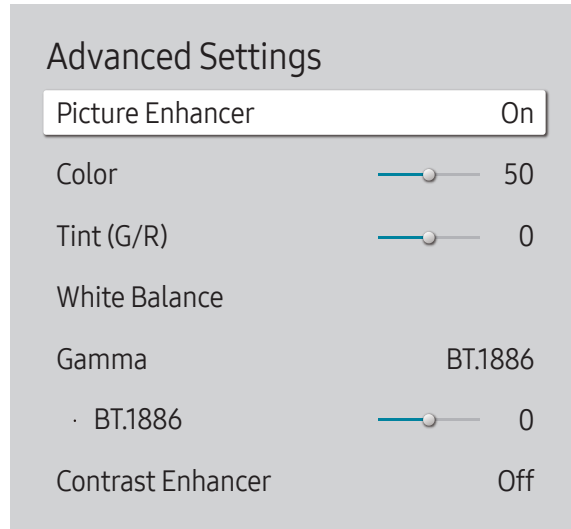

 The displayed image may differ depending on the model.

Configure advanced picture settings to create your preferred picture.

Picture Enhancer

Displays enhanced color and sharpness.

- Off / On

Color

Adjust the color saturation levels. Color saturation intensifies as the value nears 100. (Range: 0~100)

Tint (G/R)

Adjust the ratio of green to red tint levels. Increasing values intensifies the saturation of red and green colors. (Range: 0~50)

White Balance

Adjust the color temperature of the picture so that white objects appear brighter.

2 Point

Adjust red, green, and blue luminosity levels in two sections for precise white balance optimization.

- **R-Offset / G-Offset / B-Offset:** Adjust the proportion of each of red, green and blue colors in dark areas.
- **R-Gain / G-Gain / B-Gain:** Adjust the proportion of each of red, green and blue colors in bright areas.
- **Reset:** Suitable for environments where videowall display are used.

20 Point Settings

Controls the white balance in 20 point interval by adjusting the red, green, and blue brightness.

 Available only when **Picture Mode** is set to **Movie**.

20 Point

Adjust red, green, and blue luminosity levels in twenty sections for precise white balance optimization.

- **Off** (●) / **On** (●)
- **Interval:** Select interval to adjust.
- **Red:** Adjust the red level.
- **Green:** Adjust the green level.
- **Blue:** Adjust the blue level.
- **Reset:** Restore the current level's 20 point White Balance to the default values.

 Some external devices may not support this function.

Gamma

Adjust the primary color intensity.

- **HLG / ST.2084 / BT.1886**

 Available menu items for control may vary, depending on the input source.

HLG / ST.2084 / BT.1886

Adjust the **HLG, ST.2084, BT.1886** levels of the picture.

Contrast Enhancer

Automatically balance the contrast to prevent excessive differences between bright and dark areas.

- **Off / Low / Medium / High**

Black Tone

Select the black level to adjust the screen depth.

- **Off / Dark / Darker / Darkest**

Flesh Tone

Adjust the flesh tone color by increasing or decreasing red levels.

RGB Only Mode

Fine-tune the saturation and tint of the red, green, and blue color channels.

- Off / Red / Green / Blue

 Enabled when **Picture Mode** is set to **Movie**.

Color Space Settings

Configure color space settings to refine the spectrum of colors on your screen.

Color Space

Choose a color space.

- DCI-P3 / Adobe RGB / BT.709 / Custom

 To adjust **Color**, **Red**, **Green**, **Blue** and **Reset**, set **Color Space** to **Custom**.

Input Signal Plus

Expands the input signal range for HDMI connections.

- HDMI1 (Off (●) / On (●))
- HDMI2 (Off (●) / On (●))

 When **Input Signal Plus** is set to **On**, up to the 3840 x 2160 @ 60 Hz resolution is supported.
When **Input Signal Plus** is set to **Off**, up to the 1920 x 1080 @ 60 Hz resolution is supported.

LED Picture Size

MENU → Picture → LED Picture Size →

Advanced Settings	
Output Resolution	UHD
LED Picture Size	Original
Resolution	3840 x 2160
Screen Position	(0, 0)
Fit to screen	Off

The displayed image may differ depending on the model.

Set the details of the picture size.

Output Resolution

Provides optimized pictures according to the LED screen resolution.

- **UHD / FHD**
- ✎ To configure a single screen by using multiple S-Boxes, make sure that an input source included in “S-Box Grouping Supported” under [Preset Timing Modes](#) is in use.
- ✎ To ensure proper functioning, select **Picture** → **LED Picture Size** and set **Output Resolution** to **UHD**.

LED Picture Size

Choose size and aspect ratio picture displayed on screen.

To manually adjust the LED picture size, select **Custom**.

- **Original**: Display images in the original picture quality.
- **Custom**: Changes the resolution to suit the user's preferences.

Resolution

Set the width and height of the LED picture. (Max: **3840 x 2160**)

Output Resolution	Width x Height	
	Max	Min
FHD	1920 x 1080	182 x 182
UHD	3840 x 2160	408 x 408

✎ Available only when **LED Picture Size** is set to **Custom**.

Advanced Settings

Output Resolution	UHD
LED Picture Size	Original
Resolution	3840 x 2160
Screen Position	(0, 0)
Fit to screen	Off

Screen Position

Set the X and Y position to adjust the screen.

Fit to screen

Enlarges pictures to fit the screen.

- Off / On

 Available only when **LED Picture Size** is set to **Custom**.

 The displayed image may differ depending on the model.

LED HDR

☰ MENU → Picture → LED HDR → 

LED HDR	
Inverse Tone Mapping	Off
Dynamic Peaking	On
Eco Image Enhancer	Off
Color Mapping	Off
Multi-link HDR Settings	On

 The displayed image may differ depending on the model.

Set options to provide an optimal HDR effect.

When using multiple S-Boxes, if you set **LED HDR** to **On**, the images qualities of the S-Box outputs may differ. To prevent this, set the sub functions of **LED HDR** to **Off**.

Inverse Tone Mapping

Make the dark elements of the image darker and the bright elements brighter to make the image as realistic as possible.

- **Off / On**

Dynamic Peaking

Enlarge the difference of instantaneous maximum/minimum luminance so that the bright parts can be expressed more clearly.

- **Off / On**

 When connected to an IF Series cabinet, this option is available only if **Picture Mode** is set to **Dynamic** or **Calibration**.

Eco Image Enhancer

Enhance the video quality and reduce power consumption by lowering LED brightness and increasing the gap between the min/max value of instant brightness.

- **Off / Low / Medium / High**

 Available only when **Dynamic Peaking** is set to **On**.

 Enabled only when connect to supported model.

Color Mapping

Map the color of the specific source image to the color of the target image in order to convert it to the desired color.

- **Off / On**

LED HDR

Inverse Tone Mapping	Off
Dynamic Peaking	On
Eco Image Enhancer	Off
Color Mapping	Off
Multi-link HDR Settings	On

 The displayed image may differ depending on the model.

Multi-link HDR Settings

Set the option to apply the HDR effect when the resolution is over 4K.

- Off / On

Multi-link HDR

Turn on to apply the HDR effect to all connected S-Boxes when the resolution is over 4K.

- Off / On

Number of S-Boxes

Select the number of connected S-Boxes.

- 2 / 3 / 4

 When connecting two or more sets for **Multi-link HDR**, install them in the six-sided shield rack.

 For more information about the foregoing rack, please contact Samsung or your system integrator.

S-Box ID

Select the ID of this S-Box.

- 1 / 2 / 3 / 4

 Make sure each connected S-Box has a unique ID.

 **Multi-link HDR** supports the IFH, IFJ and IWJ cabinet models.

 Use this option to apply HDR effect to all connected S-Boxes at resolutions exceeding 3840 x 2160.

 When using **Multi-link HDR**, apply the same image quality settings for all connected S-Boxes.

 Available only when **Picture Mode** is set to **Calibration**.

Picture Options

☰ MENU → Picture → Picture Options → ↗

Picture Options	
Color Tone	Off
Digital Clean View	Off
HDMI Black Level	Auto
Film Mode	Off
Auto Motion Plus Settings	Auto

 The displayed image may differ depending on the model.

Color Tone

Select the color tone that best suits your viewing preferences.

- Off / Cool / Standard / Warm1 / Warm2

 Settings can be adjusted and stored for each external device connected to an input on the product.

Digital Clean View

Reduce picture noise to avoid distractions such as flickering.

- Auto / Off

HDMI Black Level

Adjust the black level to optimize the HDMI picture brightness and contrast.

- Normal / Low / Auto

Film Mode

Make frame transitions from older video sources smoother. This function is only available when the input signal is TV, AV, Component (480i, 576i, 1080i), or HDMI (1080i).

- Off / Auto1 / Auto2

Picture Options

Color Tone	Off
Digital Clean View	Off
HDMI Black Level	Auto
Film Mode	Off
Auto Motion Plus Settings	Auto

Auto Motion Plus Settings

Enhance picture sharpness to optimize for fast-moving images.

Auto Motion Plus

Removes blur and judder from scenes with larger amounts of rapid movement to provide a clearer picture.

The menu names may vary depending on the country.

Off: Switches **Auto Motion Plus** off.

Auto: Sets **Auto Motion Plus** to **Auto** mode.

Custom: Use to reduce the afterimage and judder as much as you want.

- **Judder Reduction:** Smooth out uneven or jumpy visual processing by reducing judder on the screen.
 - This is only supported if the **Auto Motion Plus** is set to **Custom**.

 The displayed image may differ depending on the model.

Apply Picture Settings

☰ MENU → Picture → Apply Picture Settings → ↗

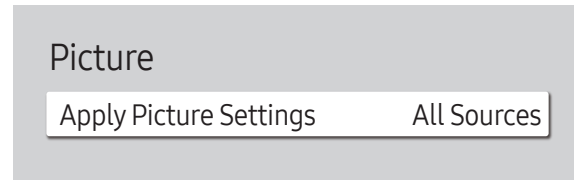

 The displayed image may differ depending on the model.

Apply the picture settings to all external devices connected to the device or to the current source only.

- All Sources / Current Source

Reset Picture

☰ MENU → Picture → Reset Picture → ↗

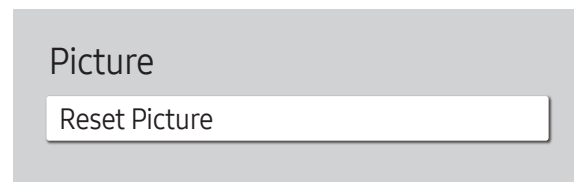

 The displayed image may differ depending on the model.

Restore all picture settings to the factory default.

Chapter 07

OnScreen Display

Display Orientation

☰ MENU → OnScreen Display → Display Orientation → ↩

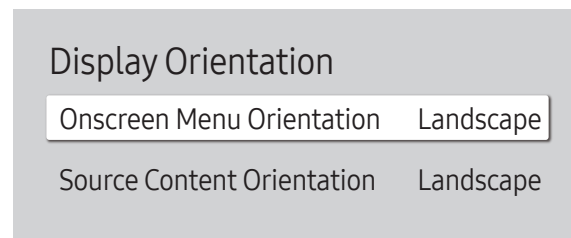

 The displayed image may differ depending on the model.

Onscreen Menu Orientation

Select whether the onscreen menu should be displayed in landscape or portrait orientation.

- **Landscape:** Display the menu in landscape mode.
- **Portrait:** Display the menu in portrait mode on the upper side of the product screen.

Source Content Orientation

Rotate the product screen orientation.

 This feature is not available for input source resolutions higher than 7680 x 4320.

- **Landscape:** Display the screen in landscape mode.
- **Portrait:** Display the screen in portrait mode.

Screen Protection

☰ MENU → OnScreen Display → Screen Protection → ↗

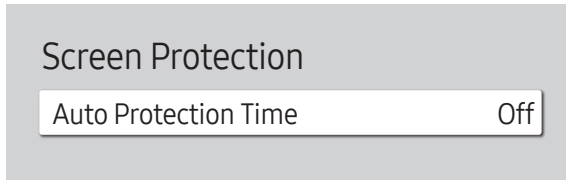

 The displayed image may differ depending on the model.

Auto Protection Time

If the screen displays a still image for a certain period of time you define, the product activates the screen saver to prevent the formation of burnt in ghost images on the screen.

- Off / 2 hours / 4 hours / 6 hours / 8 hours / 10 hours

Message Display

☰ MENU → OnScreen Display → Message Display → 

Message Display	
Source Info	On
No Signal Message	On
MDC Message	On
Download Status Message	Off

 The displayed image may differ depending on the model.

Source Info

Select whether to display the source OSD when the input source changes.

- Off / On

No Signal Message

Select whether to display the no-signal OSD when no signal is detected.

- Off / On

MDC Message

Select whether to display the MDC OSD when the product is controlled by the MDC.

- Off / On

Download Status Message

Select to display the status when downloading content from a server or other device.

- Off / On

Language

☰ MENU → OnScreen Display → Language → ↻

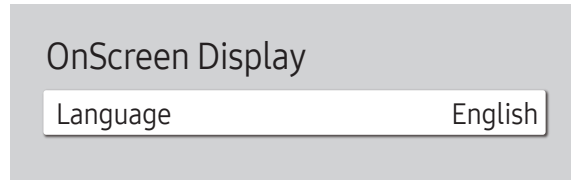

 The displayed image may differ depending on the model.

Set the menu language.

 A change to the language setting will only be applied to the onscreen menu display. It will not be applied to other functions on your PC.

Menu Size

☰ MENU → OnScreen Display → Menu Size → ↻

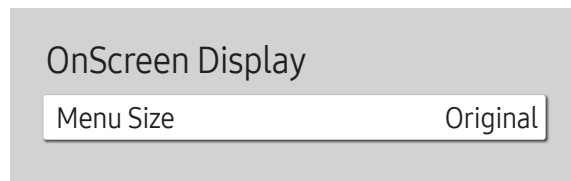

 The displayed image may differ depending on the model.

Set the aspect ratio of the menu to match the screen.

- Original / Medium / Small

Reset OnScreen Display

This option returns the current settings under **OnScreen Display** to the default factory settings.

☰ MENU → **OnScreen Display** → **Reset OnScreen Display** → ↩

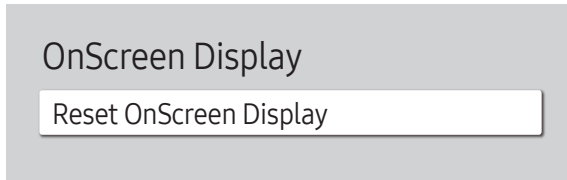

 The displayed image may differ depending on the model.

Chapter 08

Network

Network Status

☰ MENU → Network → Network Status → ↗

You can check the current network and Internet status.

Open Network Settings

☰ MENU → Network → Open Network Settings → ↗

Configure network settings to connect to an available network.

Network Settings (Wired)

Connecting to a Wired Network

There are three ways to attach your product to your LAN using cable.

- You can attach your product to your LAN by connecting the LAN port on the back of your product to an external modem using a LAN cable. See the diagram below.

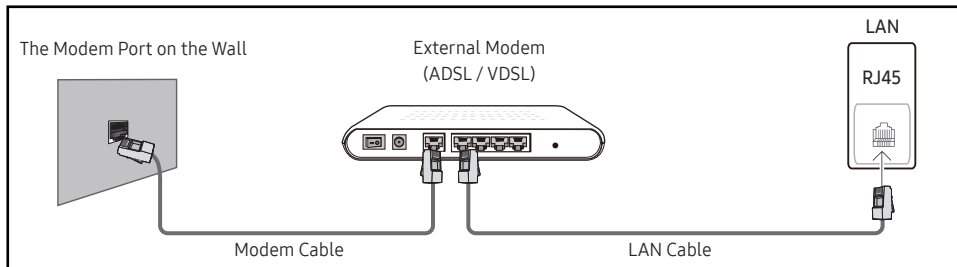

- You can attach your product to your LAN by connecting the LAN port on the back of your product to an IP Sharer which is connected to an external modem. Use LAN cable for the connection. See the diagram below.

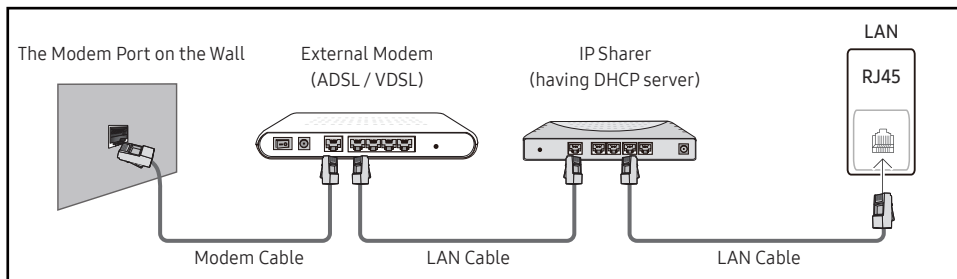

- Depending on how your network is configured, you may be able to attach your product to your LAN by connecting the LAN port on the back of your product directly to a network wall outlet using a LAN cable. See the diagram below. Note that the wall outlet is attached to a modem or router elsewhere in your house.

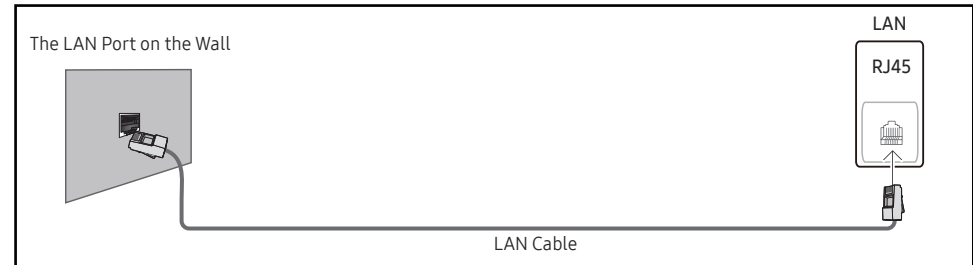

If you have a Dynamic Network, you should use an ADSL modem or router that supports the Dynamic Host Configuration Protocol (DHCP). Modems and routers that support DHCP automatically provide the IP address, subnet mask, gateway, and DNS values your product needs to access the Internet so you do not have to enter them manually. Most home networks are Dynamic Networks.

Some networks require a Static IP address. If your network requires a Static IP address, you must enter the IP address, subnet mask, gateway, and DNS values manually on your product **IP Settings** when you set up the network connection. To get the IP address, subnet mask, gateway, and DNS values, contact your Internet Service Provider (ISP).

If you have a Windows computer, you can also get these values through your computer.

- ✎ You can use ADSL modems that support DHCP if your network requires a Static IP address.
- ✎ ADSL modems that support DHCP also let you use Static IP addresses.

Set the network connection to use Internet services such as perform software upgrades.

Automatic Open Network Settings (Wired)

Connect to the network using a LAN cable.

Make sure a LAN cable is connected first.

How to set up automatically

1 Select **Open Network Settings**. The **Open Network Settings** session starts.

2 The network test screen appears and verifies the network connection.

When the connection has been verified, the “**Success! Your device is connected to the Internet. If you have any problems using online services, please contact your Internet service provider.**” message appears.

 If the connection process fails, check the LAN port connection.

 If the automatic process cannot find the network connection values or if you want to set the connection manually, go to the next section(Manual Open Network Settings (Wired)).

Manual Open Network Settings (Wired)

Offices may use static IP addresses.

If this is the case, ask the network administrator for the IP address, subnet mask, gateway and DNS server address. Enter these values manually.

Getting the Network Connection Values

To view the Network connection values on most Windows computers, follow these steps.

1 Right click the Network icon on the bottom right of the screen.

2 In the pop-up menu that appears, click Status.

3 On the dialog that appears, click the **Support** tab.

4 On the **Support** Tab, click the **Details** button. The Network connection values are displayed.

 The path to the settings depends on the installed OS.

How to set up manually

1 Select **Open Network Settings**. The **Open Network Settings** session starts.

2 The network test screen appears and the verification process starts. Press **Cancel**. The verification process stops.

3 Select **IP Settings** on network connection screen. The **IP Settings** screen appears.

4 Select the field at the top, press , and then set **IP Setting** to **Enter manually**. Repeat the entry process for each field in the **IP Address**.

 Setting **IP Setting** to **Enter manually** automatically changes **DNS Setting** to **Enter manually**.

5 When done, select **OK** at the bottom of the page, and then press . The network test screen appears and the verification process starts.

6 When the connection has been verified, the “**Success! Your device is connected to the Internet. If you have any problems using online services, please contact your Internet service provider.**” message appears.

IPv6

☰ MENU → Network → IPv6 → ↗

Enable or disable IPv6.

- Off (●) / On (●)

IPv6 Status

☰ MENU → Network → IPv6 Status → ↗

Check the status of your IPv6 Internet connection.

Server Network Settings

☰ MENU → Network → Server Network Settings → ↗

Connect to Server

Connect to MagicInfo server.

- **Server Address / TLS / Port**

✎ If you do use the **TLS** option, the server is configured to use https and data transfer is encrypted. (Port number : 7002)

✎ If you don't use the **TLS** option, enter the server IP address and port number. Use 7001 as the port number. (If you are unable to connect to the server using port number 7001, check with your server administrator to find the correct port number and then change the port number.)

✎ Enter the server IP address and port number. Use 7001 as the port number. (If unable to connect to the server using port number 7001, check with your server administrator to find the correct port number and then change the port number.)

✎ For the MagicInfo Server user guide, visit the following website: <http://displaysolutions.samsung.com> → Support → Resources → MagicInfo Web Manual.

MagicInfo Mode

Select the appropriate **MagicInfo Mode** depending on the environment where you are using the product.

- **Lite / Premium**

Server Access

Allow or deny access to MagicInfo server.

- **Allow / Deny**

FTP Mode

Specify the FTP operating mode.

- **Active / Passive**

Proxy Server

Set up your proxy server connection and related functions.

Off / On

- **Address / Port / ID / Password**

 **Address / Port / ID** and **Password** are enabled only when **Proxy Server** is set to **On**.



IP Remote

 MENU → **Network** → **IP Remote** → 

Allow IP control devices to remotely access your LED display and adjust the settings for your viewing environment.

- **Enable / Disable**

Device Name

 MENU → **Network** → **Device Name** → 

Select or enter a device name.

This name can be shown on network device over the network.

- **[LED S/Box]Display1 ~ 6 / User Input**

Chapter 09

System

Accessibility

☰ MENU → System → Accessibility → ↗

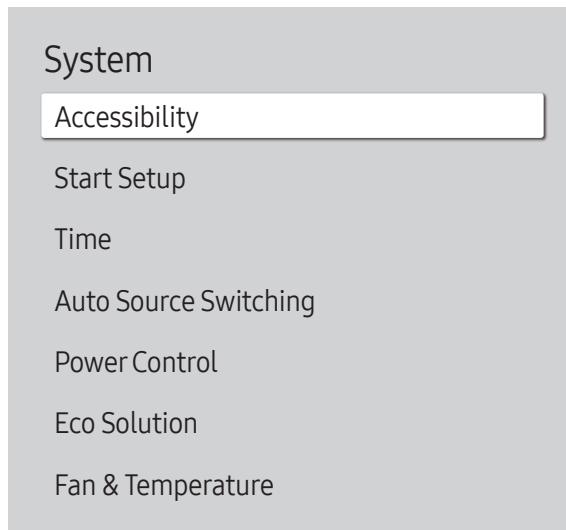

 The displayed image may differ depending on the model.

Voice Guide Settings

Voice Guide

Switch **Voice Guide** on or off. The language used for **Voice Guide** will be the same as the current menu language.

- Off (●) / On (●)
-  **Volume, Speed** and **Pitch** are enabled only when **Voice Guide** is set to **On**.

Volume

Set the volume level for the **Voice Guide**.

- **Loud / Medium / Soft**

Speed

Set the speed of the **Voice Guide**.

- **Very Fast / Fast / Normal / Slow / Very Slow**

Pitch

Tune the pitch of the **Voice Guide**.

- **High / Medium / Low**

Accessibility

Voice Guide Settings Off

High Contrast

Enlarge

 The displayed image may differ depending on the model.

High Contrast

Set the background and font to high-contrast colors in Menu. Menu transparencies become opaque when the option is selected.

- Off / On

Enlarge

Enlarge the size of the Menu area.

- Off / On

Start Setup



 MENU → System → Start Setup → 

System

Start Setup

 The displayed image may differ depending on the model.

Go through the initial setup steps like you did the first time you used this product.

-  Enter your 4 digit PIN number. The default PIN number is "0-0-0-0".
If you want to change the PIN number, use the **Change PIN** function.
-  Change the PIN to keep your device secure.

Time

☰ MENU → System → Time → ↩

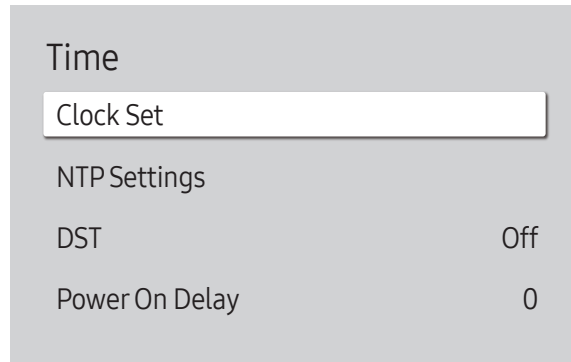

 The displayed image may differ depending on the model.

You can configure **Clock Set** or **DST**. Configure various time-related settings.

Clock Set

Select **Clock Set**. Select **Date** or **Time**, and then press ↩.

Use the number buttons to enter numbers or press the up and down arrow buttons. Use the left and right arrow buttons to move from one entry field to the next. Press ↩ when done.

 You can set the **Date** and **Time** directly by pressing the number buttons on the remote control.

NTP Settings

Set up the server URL and time zone to use the network time.

DST

Switches the DST (Daylight Saving Time) function on or off.

Off / On

- **Start Date**: Set the start date of Daylight Saving Time.
- **End Date**: Set the end date of Daylight Saving Time.
- **Time Offset**: Select the correct time offset for your timezone.

 **Start Date**, **End Date** and **Time Offset** are enabled only when **DST** is set to **On**.

Power On Delay

When connecting multiple products, adjust the power-on time for each product to prevent power overload (within the range 0–50 seconds).

Auto Source Switching

☰ MENU → System → Auto Source Switching → 🖥️

Auto Source Switching	
Auto Source Switching	Off
Primary Source Recovery	Off
Primary Source	All
Secondary Source	DisplayPort
Default Input	Last Input

🖋️ The displayed image may differ depending on the model.

With **Auto Source Switching** feature, the display will automatically search the different video input source when current input source is not active.

Auto Source Switching

When the **Auto Source Switching** is **Preset Input**, the display video source will automatically be searched for active video.

The **Primary Source** selection will be activated, if the current video source is not recognized.

Secondary Source selection will become active, if no primary video source is available.

If both the primary and secondary input sources are not recognized, the display will perform two searches for an active source, each search checking the primary and then secondary source. If both searches fail, the display will return to the first video source and display a message indicating that there is no signal.

Primary Source Recovery

Select whether to restore the selected primary input source when a primary input source is connected.

🖋️ The **Primary Source Recovery** function is enabled only if auto source switching is set to **Preset Input**.

Primary Source

Specify **Primary Source** for the automatic input source.

Secondary Source

Specify **Secondary Source** for the automatic input source.

🖋️ The **Secondary Source** function is disabled if **Primary Source** is set to **All**.

Default Input

Select the default source to switch to when the current input source is disconnected.

🖋️ It is enabled only when **Auto Source Switching** is set to **New Input**.

Power Control

☰ MENU → System → Power Control → ↩

Power Control	
Auto Power On	Off
Max. Power Saving	On
Standby Control	On
Network Standby	Off
Power Button	Power On Only

 The displayed image may differ depending on the model.

Auto Power On

This feature automatically turns on the product as soon as it is plugged in. Pressing the power button is not needed.

- Off / On



Max. Power Saving

Conserve power by turning off PC monitor when PC is not used for certain time.

- Off / On

Standby Control

You can set the screen standby mode to be applied when an input signal is received.

- **Auto**
Power-saving mode will activate if no input signals are detected even though a source device is connected to the display.
The message **No Signal** will appear if no source device is connected.
- **Off**
The message **No Signal** will appear if no input signals are detected.
 -  If the message, "**No Signal**" appears even though a source device is connected, check the cable connection.
 -  If **No Signal Message** is set to **Off**, the **No Signal** message does not appear.
In this case, set **No Signal Message** to **On**.
- **On**
Power-saving mode will activate if no input signals are detected.

Power Control

Auto Power On	Off
Max. Power Saving	On
Standby Control	On
Network Standby	Off
Power Button	Power On Only



Network Standby

This feature keeps the network power on when the product turns off.

- **Off / On**

Power Button

The power button on the remote control  can be set to turn on the power or turn on or off the power.

- **Power On Only:** Set the power button on the remote control  only to turn on the power.
- **Power On/Off:** Set the power button on the remote control  to turn on or off the power.

 The displayed image may differ depending on the model.

Eco Solution

☰ MENU → System → Eco Solution → ↩

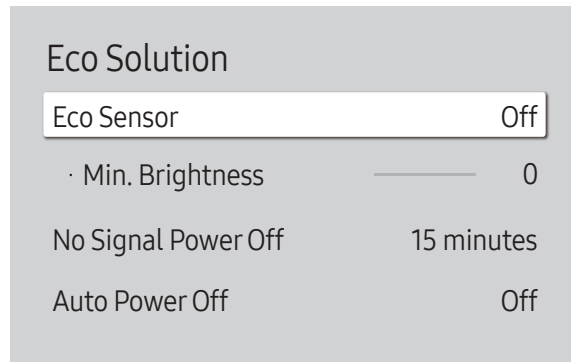

The displayed image may differ depending on the model.

Eco Sensor

Automatically adjust the picture brightness based on the ambient light level.

- Off / On

If the screen contrast is not sufficient, set the **Eco Sensor** to **Off**. If the **Eco Sensor** is **Off**, it may not comply with energy standards.

Min. Brightness

Automatically optimize the screen brightness according to the surroundings.

If **Eco Sensor** is **On**, the display brightness may change (become slightly darker or brighter) depending on the surrounding light intensity.

Available only when **Eco Sensor** is set to **On**.

No Signal Power Off

Save power by turning the product off when no signal is received from any source.

- Off / 15 minutes / 30 minutes / 60 minutes

This function does not operate if the display is in the standby mode.

The product will automatically power off at a specified time. The time can be changed as required.

Auto Power Off

Choose how long the display will wait before turning off after no user interaction is detected.

- Off / 4 hours / 6 hours / 8 hours

Fan & Temperature

☰ MENU → System → Fan & Temperature → ↩

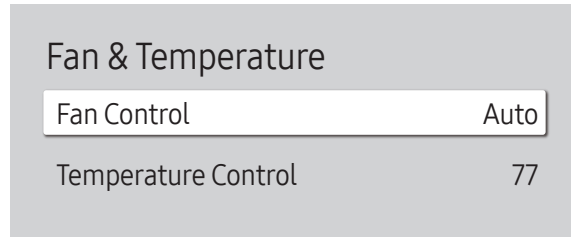

 The displayed image may differ depending on the model.

It sets items related to the speed and temperature of the fan in each set.

Fan Control

Selects auto or manual for the fan speed settings.

- Auto / Manual

Temperature Control

It sets items related to the speed and temperature of the fan in each set.

This function detects the internal temperature of the product. You can specify the temperature range that is acceptable.

The default temperature is set to 77 °C.

The recommended operating temperature for this product is 75 to 80 °C (based on an ambient temperature of 40 °C).

-  The product automatically turns off to prevent overheating if the present temperature exceeds the specified temperature limit and keeps rising.

Play via

☰ MENU → System → Play via → ↻

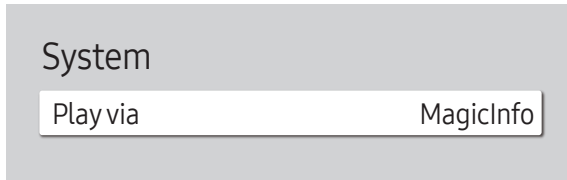

 The displayed image may differ depending on the model.

Select the appropriate **Play via** mode depending on the environment where you are using the product.
The home screen may be different depending on the setting.

- **MagicInfo / URL Launcher**

Change PIN

☰ MENU → System → Change PIN → ↻



 The displayed image may differ depending on the model.

Change your 4-digit Personal Identification Number (PIN).

Choose any 4 digits for your PIN and enter it in **Enter a new PIN..** Reenter the same 4 digits in **Enter the PIN again..**

The product has memorized your new PIN.

 The default PIN number is "0-0-0-0".

 Change the PIN to keep your device secure.



Security

☰ MENU → System → Security → 

Security	
Safety Lock On	
Power On Button	On
Button Lock	Off
USB Auto Play Lock	Off
Remote Management	Allow
Secured Protocol	Off
Network Port	On

 The displayed image may differ depending on the model.

Safety Lock On

-  Enter your 4 digit PIN number. The default PIN number is "0-0-0-0".
If you want to change the PIN number, use the **Change PIN** function.
-  Change the PIN to keep your device secure.

Turn **Safety Lock On** on or off. **Safety Lock On** restricts the actions that can be carried out by the remote control. The correct PIN must be entered to turn **Safety Lock On** off.

Power On Button

Turn on this feature to enable the remote control's Power button to turn on the product while **Safety Lock On** is enabled.

- **Off / On**

Button Lock





This menu can be used to lock the buttons on the product.

Only the remote control can control the product if **Button Lock** is set to **On**.

- **Off / On**

USB Auto Play Lock

Select whether to automatically play **MagicInfo** content saved on a connected USB device.

-  Your content should be a **Published Content**  that is authored by using **MagicInfo Premium application** and published to the USB device you are using. The **MagicInfo Premium application** program is available on the website. (<http://displaysolutions.samsung.com>)
-  When published to a USB device, your **Published Content**  is saved to **Contents** and **Schedules** folders in the root folder of the connected USB device.
- **Off**
Play **MagicInfo** content saved on the USB device automatically.
- **On**
Do not play **MagicInfo** content saved on the USB device automatically.
-  Connecting a USB device containing **MagicInfo** content displays "**USB Auto Play Lock : On**" for five seconds.

Remote Management

You can **Allow** or **Deny** external commands to access your product via a network.

- **Deny / Allow**
-  The changed setting remains even after the product is turned off and on using the Power button or Power switch.

Secured Protocol

Secure the protocol between this device and other devices.

- **Off / On**

Network Port

Block external network access. You can register networks on the server to allow access.

- **Off / On**

USB Port

Block connection to external USB ports.

- **Off / On**

General

MENU → System → General → ↩

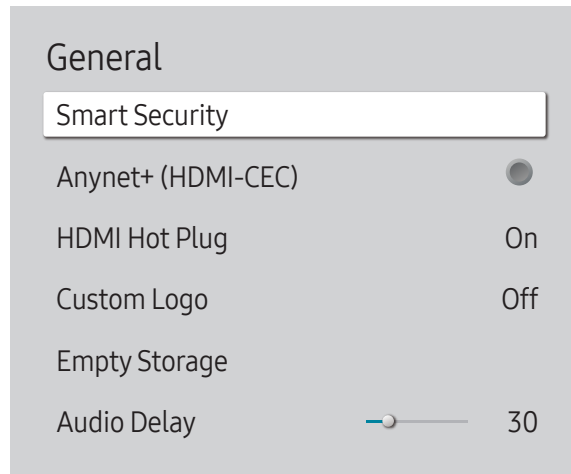

The displayed image may differ depending on the model.

Smart Security

The security provided to protect your display device and connected storage devices against viruses includes.

Scan

Inspect your display device and connected storage devices to check for viruses.

Isolated List

This is the list of items that have been Isolated for containing viruses.

Anynet+ (HDMI-CEC)

Anynet+ is a function that enables you to control all connected Samsung devices that support Anynet+ with your Samsung product remote control. The Anynet+ system can be used only with Samsung devices that have the Anynet+ feature. To be sure your Samsung device has this feature, check if there is an Anynet+ logo on it.

- Off (●) / On (●)

- You can only control **Anynet+** devices using the product remote control, not the buttons on the product.
- The product remote control may not work under certain conditions. If this occurs, reselect the **Anynet+** device.
- Anynet+** works when the AV device supporting **Anynet+** is in the standby or on status.
- Anynet+** supports up to 12 AV devices in total. Note that you can connect up to 3 devices of the same type.

Troubleshooting for Anynet+

Problem	Possible Solution
Anynet+ does not work.	<ul style="list-style-type: none"> • Check if the device is an Anynet+ device. The Anynet+ system supports Anynet+ devices only. • Check if the Anynet+ device power cord is properly connected. • Check the Anynet+ device's Video/HDMI cable connections. • Check whether Anynet+ (HDMI-CEC) is set to On in the System menu. • Check whether the remote control is Anynet+ compatible. • Anynet+ doesn't work in certain situations. (initial setup) • If you have removed and then reconnected the HDMI cable, please make sure to search devices again or turn your product off and on again. • Check if the Anynet+ function of the Anynet device is set on.
I want to start Anynet+.	<ul style="list-style-type: none"> • Check if the Anynet+ device is properly connected to the product and check if the Anynet+ (HDMI-CEC) is set to On in the System menu.
I want to exit Anynet+.	<ul style="list-style-type: none"> • Press the SOURCE button on the product remote control and select a non- Anynet+ device.
The message " Disconnecting Anynet+ device ... " appears on the screen.	<ul style="list-style-type: none"> • You cannot use the remote control when you are configuring Anynet+ or switching to a view mode. • Use the remote control after the product has completed Anynet+ configuration or has finished switching to Anynet+.
The Anynet+ device does not play.	<ul style="list-style-type: none"> • You cannot use the play function when initial setup is in progress.
The connected device is not displayed.	<ul style="list-style-type: none"> • Check whether or not the device supports Anynet+ functions. • Check whether or not the HDMI cable is properly connected. • Check whether Anynet+ (HDMI-CEC) is set to On in the System menu. • Search Anynet+ devices again. • Anynet+ requires an HDMI connection. Make sure the device is connected to your product with an HDMI cable. • Some HDMI cables may not support Anynet+ functions. • If the connection is terminated because there has been a power failure or the HDMI cable has been disconnected, please repeat the device scan.

General

Smart Security

Anynet+ (HDMI-CEC)



HDMI Hot Plug

On

Custom Logo

Off

Empty Storage

Audio Delay



30

HDMI Hot Plug

This feature is used to activate the time delay to turn on a HDMI source device.

- Off / On

Custom Logo

You can download, select, and set the display time of a custom logo that appears when the product turns on.

- **Custom Logo**



You can select a custom logo (image/video) or turn off the custom logo display.



You must download the custom logo from an external USB device to set the custom logo.

- **Logo Display Time**



If the type of custom logo is **Image**, you can set the **Logo Display Time**.

- **Download Logo File**



You can download a custom logo into the product from an external USB device.



The file name of the custom logo you want to download must be saved as "samsung" in all small letters.



When there are multiple numbers of external USB connections, the product will attempt to download the custom logo from the last device that has been connected to the product.

The displayed image may differ depending on the model.

Custom logo file restrictions

- For image type custom logo, only bitmap files (aRGB 32bpp format) are supported.
- The resolution of the image type custom logo must be between a minimum of 128 x 64 and the maximum screen resolution. (Horizontal/Vertical values of the resolution must be multiples of 4.)
- For video type custom logo, only TS Stream types are supported.
- The maximum supported video file is 150 MB. The recommended length of a video file is 20 seconds or less.

General

Empty Storage

Audio Delay 30

Digital Output Audio Format PCM

Empty Storage

Delete files to make space for new content. Recently played files will not be deleted.

Audio Delay

Adjust the delay time between the audio and video tracks. (Range: 0~250)

Digital Output Audio Format

Select the digital audio output format.

- **PCM / Dolby Digital**

 The displayed image may differ depending on the model.

Reset System

Reset all system settings to default.

☰ MENU → System → Reset System → ↩

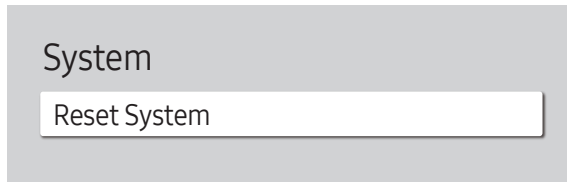

 The displayed image may differ depending on the model.

Chapter 10

Support

Software Update

☰ MENU → Support → Software Update → 

The **Software Update** menu lets you upgrade your product software to the latest version.

 Be careful not to turn off the power until the upgrade is complete. The product will turn off and on automatically after completing the software upgrade.

Update Now

Update the software to the latest version.

 **Current version:** This is the software version already installed in the product.

Contact Samsung

☰ MENU → Support → Contact Samsung → 

You can view the address of the Samsung website, the call center phone number, your product's model number, software version, Open Source Licence and other information.

 Go to **Contact Samsung** and find the product **Model Code** and **Software Version**.

Terms & Conditions

☰ MENU → Support → Terms & Conditions → 

View and set the privacy policy for MagicInfo and other services.

 Make sure that the product is connected to the network.

Reset All

☰ MENU → Support → Reset All → 

This option returns all the current settings for a display to the default factory settings.

Chapter 11

Troubleshooting Guide

 Before calling Samsung Customer Service Center, test your product as follows. If the problem persists, contact Samsung Customer Service Center.

Requirements Before Contacting Samsung Customer Service Center

Testing the Product

Check if your product is operating normally by using the product test function.

If the screen remains blank while the power indicator blinks even when the product is correctly connected to a PC, perform product testing.

- 1 Power off both the PC and product.
- 2 Disconnect all the cables from the product.
- 3 Power on the product.
- 4 If **No Signal** is displayed, the product is operating normally.

If the screen remains blank, check the PC system, video controller and cable.

Checking the Resolution and Frequency

For modes that exceed the supported resolutions, the message "**Not Optimum Mode**" appears briefly.

Set the PC resolution by referring to [Preset Timing Modes](#).

Check the followings.

Installation issue (PC mode)	
The screen keeps switching on and off.	Check that the cable between the product and the PC is connected correctly.
Blank spaces are found on all four sides of the screen when a DP, an HDMI, or an HDMI-DVI cable is connected between the product and PC.	The blank spaces found on the screen have nothing to do with the product.
	Blank spaces on the screen are caused by the PC or graphics card. To resolve the problem, adjust the screen size in the HDMI or DVI settings for the graphics card.
	If the graphics card settings menu does not have an option to adjust the screen size, update the graphics card driver to the latest version. (Please contact the graphics card or computer manufacturer for further details about how to adjust the screen settings.)
Screen issue	
The power indicator is off. The screen will not switch on.	Make sure that the power cord is connected.
No Signal is displayed on the screen.	Check that the product is connected correctly with a cable.
	Check that the source device connected to the product is powered on.
Not Optimum Mode is displayed.	This message is displayed when a signal from the graphics card exceeds the product's maximum resolution and frequency.
	Refer to the Standard Signal Mode Table and set the maximum resolution and frequency according to the product specifications.
The images on the screen look distorted.	Check the cable connection to the product.
The screen is not clear. The screen is blurry.	Set the resolution and frequency to the recommended level.

Screen issue	
The screen appears unstable and shaky.	Check that the resolution and frequency of the PC and graphics card are set within a range compatible with the product. Then, change the screen settings if required by referring to 'Preset Timing Modes'.
There are shadows or ghost images left on the screen.	
The screen is too bright. The screen is too dark.	Go to Picture and adjust the Brightness and Contrast settings.
Screen color is inconsistent.	Go to Picture and adjust the Color Space settings.
White does not really look white.	Go to Picture and adjust the White Balance settings.
There is no image on the screen and the power indicator blinks every 0.5 to 1 second.	The status of product is in power-saving mode.
	Press any key on the keyboard or move the mouse to return to the previous screen.
The product will turn off automatically.	If a PC is connected to the product, check the power status of the PC.
	Make sure the power cable is connected properly to the product and power outlet.
	If the signal from a connected device is not detected, the product automatically turns off after 10 to 15 minutes.
The screen display does not look normal.	Encoded video content may cause the display to appear corrupted in scenes featuring fast moving objects such as in a sports event or action video.
	Low signal level or low picture quality may cause the display to appear corrupted. This does not mean the product is defective.
	A cell phone within a distance of one-meter radius may cause static on analog and digital products.

Screen issue	
The brightness and color do not look normal.	Go to Picture and adjust the screen settings such as Picture Mode, Color, Brightness and Sharpness .
	Reset the screen settings to the default settings. (P.64)
I see red, green, and blue.	Check the cable connections.
	This issue may happen when the panel of the product is defective. Contact a Samsung Service Center to resolve the issue.
The display looks unstable and then freezes.	The screen may freeze when a resolution other than the recommended resolution is used or if the signal is not stable. To resolve the issue, change the PC resolution to the recommended resolution.
The screen cannot be displayed in full screen.	A scaled SD (4:3) content file can cause black bars on both sides of an HD channel screen.
	A video with an aspect ratio different from the product can cause a black bar to appear at the top and bottom of the screen.
	Change the screen size setting to full screen on the product or source device.
The cabinet screen blinks.	Check the LAN cable connected to the device.
	Check that the LAN cable is correctly connected to the device.
	Check that there is no foreign material found in the LAN port on the device.
Remote control issue	
The remote control does not work.	Make sure that the batteries are correctly in place (+/-).
	Check if the batteries are flat.
	Check for power failure.
	Make sure that the power cord is connected.
	Check for any special lighting or neon signs switched on in the vicinity.

Source device issue	
A beeping sound is heard when my PC is booting.	If a beeping sound is heard when your PC is booting, have your PC serviced.
Other issue	
The product smells like plastic.	The plastic smell is normal and disappears over time.
Video playback is choppy.	Check the cable connection and connect it again if required.
	Use a standard cable.
Small particles are found on the edges of the product.	The particles are part of the product design. The product is not defective.
When I try to change the PC resolution, a message "The defined resolution is not currently supported." appears.	The message "The defined resolution is not currently supported." appears if the input source resolution exceeds the maximum resolution of the display. To resolve the issue, change the PC resolution to a resolution supported on the display.
HDMI Black Level is not functioning properly on an external device with HDMI YCbCr output.	This function is available only when a source device with RGB signal, such as a DVD player and STB, is connected to the product to HDMI cable.
The IR sensor is not functioning.	Press a button on the remote control and check that the power indicator blinks.
	<ul style="list-style-type: none"> If the power indicator does not blink, check the connection between the external IR cable and the device, and turn off and then on the power switch of the device. If the power indicator does not blink although the cable is connected correctly and the power switch has been turned off and then on again, contact the nearest service center.
In power-saving mode, when the input source is DisplayPort, PC display settings cannot be saved.	Go to System → Power Control and set Max. Power Saving to Off. Alternatively, configure the PC display output settings again. Ensure the product is turned on.
When booting the PC with the input source set to DisplayPort, the BIOS and booting screens do not appear.	Boot the PC when the product is turned on or when the input source is not DisplayPort.

Chapter 12

Specifications

General

Model Name		SNOW-1810U	SNOW-JMU
Power Supply		AC100-240V~ 50/60Hz Based on the AC voltage of the adapter. For the DC voltage of the product, refer to the product label.	
Environmental considerations	Operating	Temperature: 32 °F - 104 °F (0 °C - 40 °C) Humidity: 10% - 80%, non-condensing	
	Storage	Temperature: -4 °F - 113 °F (-20 °C - 45 °C) Humidity: 5% - 95%, non-condensing * Applicable before the product package is unpacked.	
Supported models		IFH, IFH-D, IFJ, IWJ, IER/IER-F, IFR/IFR-F Series	



Plug-and-Play

This monitor can be installed and used with any Plug-and-Play compatible systems. Two-way data exchange between the monitor and PC system optimizes the monitor settings. Monitor installation takes place automatically. However, you can customize the installation settings if desired.



For detailed device specifications, visit the Samsung Electronics website.



Update to the latest software to ensure support for the IF series cabinets.



Preset Timing Modes

Horizontal Frequency

The time required to scan a single line from the left to the right side of the screen is called a horizontal cycle. The reciprocal number of a horizontal cycle is called horizontal frequency. Horizontal frequency is measured in kHz.

Vertical Frequency

The product displays a single image multiple times per second (like a fluorescent light) to display what the viewer sees. The rate of a single image being displayed repeatedly per second is called vertical frequency or refresh rate. Vertical frequency is measured in Hz.

-  This product can be set to only one resolution for each screen size to obtain the optimum picture quality due to the nature of the panel. Using a resolution other than the specified resolution may degrade the picture quality. To avoid this, it is recommended that you select the optimum resolution specified for your product.
-  When **Input Signal Plus** is set to **On**, up to the 3840 x 2160 @ 60 Hz resolution is supported. When **Input Signal Plus** is set to **Off**, up to the 1920 x 1080 @ 60 Hz resolution is supported.

Model Name		SNOW-1810U / SNOW-JMU
Synchronization	Horizontal Frequency	30 – 135 kHz
	Vertical Frequency	30 – 75 Hz (DP), 24 – 75 Hz (HDMI)
Resolution	Optimum Resolution	1920 x 1080 @ 60 Hz, 3840 x 2160 @ 60 Hz
	Maximum Resolution	1920 x 1080 @ 60 Hz, 3840 x 2160 @ 60 Hz

 About the “S-Box Grouping” function
The S-Box Grouping function is used to control multiple S-Boxes simultaneously or configure a single screen by using multiple S-Boxes.

- To configure a single screen, select **Picture** → **LED Picture Size** and set **Output Resolution** to **UHD**.
- Input sources included in “S-Box Grouping Supported” under [Preset Timing Modes](#) can only be used to configure a single screen.
- If using a single screen configured with multiple devices, the use of some picture quality improvement functions may be restricted. (For details on configuring optimum picture quality settings, contact the dealer you purchased the device from.)

The screen will automatically be adjusted if a signal that belongs to the following standard signal modes is transmitted from your PC. If the signal transmitted from the PC does not belong to the standard signal modes, the screen may be blank with the power indicator on. In such a case, change the settings according to the following table by referring to the graphics card user manual.

Resolution	Horizontal Frequency (kHz)	Vertical Frequency (Hz)	Pixel Clock (MHz)	Sync Polarity (H/V)	S-Box Grouping Supported
IBM/VESA, 640 x 480	31.469	59.940	25.175	N / N	-
Mac, 640 x 480	35.000	66.667	30.240	N / N	-
VESA, 640 x 480	37.861	72.809	31.500	N / N	-
VESA, 640 x 480	37.500	75.000	31.500	N / N	-
IBM, 720 x 400	31.469	70.087	28.322	N / P	-
VESA, 800 x 600	35.156	56.250	36.000	P / P	-
VESA, 800 x 600	37.879	60.317	40.000	P / P	-
VESA, 800 x 600	48.077	72.188	50.000	P / P	-
VESA, 800 x 600	46.875	75.000	49.500	P / P	-
Mac, 832 x 624	49.726	74.551	57.284	N / N	-
VESA, 1024 x 768	48.363	60.004	65.000	N / N	✓
VESA, 1024 x 768	56.476	70.069	75.000	N / N	-
VESA, 1024 x 768	60.023	75.029	78.750	P / P	-
VESA, 1152 x 864	67.500	75.000	108.000	P / P	-
Mac, 1152 x 870	68.681	75.062	100.000	N / N	-
VESA, 1280 x 720	45.000	60.000	74.250	P / P	✓
VESA, 1280 x 800	49.702	59.810	83.500	N / P	-
VESA, 1280 x 1024	63.981	60.020	108.000	P / P	✓
VESA, 1280 x 1024	79.976	75.025	135.000	P / P	-
VESA, 1366 x 768	47.712	59.790	85.500	P / P	-

Resolution	Horizontal Frequency (kHz)	Vertical Frequency (Hz)	Pixel Clock (MHz)	Sync Polarity (H/V)	S-Box Grouping Supported
VESA, 1440 x 900	55.935	59.887	106.500	N / P	-
VESA, 1600 x 900	60.000	60.000	108.000	P / P	✓
VESA, 1680 x 1050	65.290	59.954	146.250	N / P	-
VESA, 1920 x 1080	67.500	60.000	148.500	P / P	✓
VESA CVT, 1920 x 1080	66.587	59.934	138.500	P / N	-
VESA CVT, 2560 x 1440	88.787	59.951	241.500	P / N	-
VESA CVT, 3840 x 2160	133.313	59.997	533.250	P / N	-
CTA-861 VIC 3, 720 x 480	31.469	59.940	27.000	N / N	-
CTA-861 VIC 4, 1280 x 720	45.000	60.000	74.250	P / P	✓
CTA-861 VIC 5, 1920 x 1080i	33.750	60.000	74.250	P / P	-
CTA-861 VIC 16, 1920 x 1080	67.500	60.000	148.500	P / P	✓
CTA-861 VIC 18, 720 x 576	31.250	50.000	27.000	N / N	✓
CTA-861 VIC 19, 1280 x 720	37.500	50.000	74.250	P / P	✓
CTA-861 VIC 20, 1920 x 1080i	28.125	50.000	74.250	P / P	-
CTA-861 VIC 31, 1920 x 1080	56.250	50.000	148.500	P / P	✓
CTA-861 VIC 32, 1920 x 1080	27.000	24.000	74.250	P / P	-
CTA-861 VIC 33, 1920 x 1080	28.125	25.000	74.250	P / P	-
CTA-861 VIC 34, 1920 x 1080	33.750	30.000	74.250	P / P	-
CTA-861 VIC 93, 3840 x 2160	54.000	24.000	297.000	P / P	-
CTA-861 VIC 94, 3840 x 2160	56.250	25.000	297.000	P / P	-
CTA-861 VIC 95, 3840 x 2160	67.500	30.000	297.000	P / P	-
CTA-861 VIC 96, 3840 x 2160	112.500	50.000	594.000	P / P	✓
CTA-861 VIC 97, 3840 x 2160	135.000	60.000	594.000	P / P	✓

Chapter 13

Appendix

Responsibility for the Pay Service (Cost to Customers)

 When the service is requested, in spite of in warranty, we may charge you for a visit from a service technician in the following cases.

Not a product defect

Cleaning of the product, Adjustment, Explanation, Re-installation and etc.

- If a service technician is requested to give instructions on how to use product or simply adjusts options without disassembling product.
- If a defect is caused by external environmental factors (Internet, Antenna, Wired Signal, etc.)
- If a product is reinstalled or devices are connected additionally after installing the purchased product for the first time.
- If a product is reinstalled to move to a different spot or to move to a different house.
- If customer requests instructions on how to use because of another company's product.
- If customer requests instructions on how to use the network or another company's program.
- If customer requests software installation and setup for the product.
- If a service technician removes/cleans dusts or foreign materials inside of the product.
- If customer requests an installation additionally after purchasing a product through home-shopping or online.

A Product damage caused by customer's fault

Product damage caused by customer's mishandling or wrong repair

If a product damage is caused by;

- External impact or drop.
- Use of supplies or separately sold product unspecified by Samsung.
- Repair from a person besides an engineer of outsourcing service company or partner of Samsung Electronics Co., Ltd.
- Remodeling or repairing the product by customer.
- Using it with incorrect voltage or non-authorized electrical connections.
- Not following the "cautions" in User Manual.

Others

- If product fails by natural disaster. (lightning, fire, earthquake, flood damage, etc)
- If consumable components are all used up. (Battery, Toner, Fluorescent lights, Head, Vibrator, Lamp, Filter, Ribbon, etc.)
-  If customer requests a service in case the product has no defect, service fee may be charged. So please read User Manual first.

License



The terms HDMI and HDMI High-Definition Multimedia Interface, and the HDMI Logo are trademarks or registered trademarks of HDMI Licensing Administrator, Inc. in the United States and other countries.

Open Source Licence Notice

In the case of using open source software, Open Source Licences are available on the product menu. Open Source Licence Notice is written only English.

For information on the Open Source Licence Notice, contact the Samsung Customer Center or send email to oss.request@samsung.com.
